

Historic, Archive Document

Do not assume content reflects current scientific knowledge, policies, or practices.



Direct from Grower to Planter-NO AGENTS

627
OUR 1918
CATALOG
of

SEEDS

BULBS
ROSES TREES
BIRDS POULTRY
AND
GARDEN SUPPLIES

OUR MOTTO

"HIGHEST
QUALITY"



SOLDIERS OF THE SOIL

"War Garden Brigade"

Routledge SEED & FLORAL CO

145-147 Second St. PORTLAND, ORE
Between Morrison and Alder St.

READ ALL ON THIS PAGE CAREFULLY

About Prepaying Charges

On CASH ORDERS we prepay charges in the states WEST of the Rocky Mountains only, CANADA AND ALASKA EXCEPTED.

By Parcel Post or Mail Only

On cash orders only, WE WILL, at prices printed in this catalog, SEND BY PREPAID PARCEL POST right to your gate ALL SEEDS by the Packet, Ounce or single Pounds, ALL PLANTS (not potted), BULBS, ROOTS, ROSES (tree roses excepted), FRUIT BUSHES and VINES (fruit trees excepted), SMALL SHRUBS and VINES (Evergreens like Holly, etc., that must be "balled," excepted).

ON ALL OTHER ITEMS, and SEEDS in 5 to 50 Lb. LOTS, YOU MUST SEND POSTAGE EXTRA in addition to price IF WANTED BY PARCEL POST. We give the packed, parcel post weight for this purpose on all miscellaneous merchandise that is mailable. For parcel post rates see top of page 2.

NOTE Plants in pots, large branching shrubs, Evergreens of all kinds, that must be balled in earth, Tree Roses, Fruit and Shade Trees, over one year old and taller than three feet can not be sent by Parcel Post.

By Express or Freight Prepaid

On CASH ORDERS ONLY, we will, at prices printed in this catalog, send by express or freight, charges prepaid, ALL STOCKS designated under prepaid parcel post above and (note this carefully) if your order amounts to \$5.00 OR OVER, WE WILL ALLOW YOU TO INCLUDE Ferns, Palms or Plants in pots, Evergreens and Nursery Stock of all kinds, any size or age.

Note.—We RESERVE THE RIGHT to send part or all of any order, on which we PREPAY CHARGES, by mail, express or freight, i. e., whichever way we find is best and cheapest.

Read This Sure

If your order contains mostly stocks on which we prepay charges, and you wish to include BULK SEEDS, FERTILIZERS, POULTRY SUPPLIES, FOODS or MISCELLANEOUS STOCKS, on which we DO NOT PREPAY, include in your remittance enough extra to cover charges on THOSE ITEMS and we will PREPAY CHARGES ON THE WHOLE SHIPMENT—should you send too much, we will return it.

ACKNOWLEDGEMENT AND NOTICES: We acknowledge all orders the day they are received and notify you by card or letter the day they are shipped so you will know just when to expect them. It generally takes from one to three days to get orders out, depending on the class of stock ordered.

REPORTS—GOOD OR BAD: Will you help us to attain greater success by writing and telling us how our Seeds, Plants and Trees reach you, how they grow and how you like them? We will certainly appreciate it. Your criticisms, if you have any, as well as your praises are desired.

MISTAKES: These will happen occasionally, in spite of all care. Write us at once, with copy of original order, if possible, and mistakes will be promptly rectified.

LARGE ORDERS: Any Gardener, Institution or Individual wishing seeds, plants, trees, or supplies in large quantities, is requested to mail a list of what is wanted, stating grade and size, and we will promptly return it with our very lowest prices. A letter of inquiry may save you dollars if you want to buy in QUANTITY, or some PARTICULAR STOCKS.

NOTE.—We use every precaution in procuring fresh, pure and reliable seeds, etc., but we, in common with other responsible seed houses sell our goods subject to the following disclaimer it being that adopted by the American Seed Trade Association, i. e.: We give no warranty, express or implied, as to description, quality, productiveness or any other matter of any seeds, bulbs, nursery stock, roots or plants sent out and will not be in any way responsible for the crop. If the purchaser does not accept the goods on these terms they are to be returned at once.

ROUTLEDGE SEED & FLORAL CO.

The Four Routledge Brothers

Learn to know them by their given names



RALPH R.
Pres.-Gen'l Mgr.



J. IRA
Sec.-Treas.



C. H.—"DUKE"
Mgr. Salesroom



GEORGE L.
Mgr. Pet Stock Dept.

Portland, Ore., January 5, 1918.

Greeting to Our Customers and Friends:

We are thankful that we are in a position to present to you our 1918 Annual Catalog. War is having its effect upon the Seed Trade and our Supplies, the same as in many other lines of business. In addition to this, the seed crops of many kinds are very short or missing on account of the very unfavorable growing season and harvesting conditions. This in addition to the existing conditions of the seed growing centers abroad is more serious than most buyers realize. All these with the scarcity of labor, higher wages and costs all around, have made it absolutely necessary to make higher prices. We have kept our prices just as low as possible and yet live up to our Motto of supplying "Highest Quality," true, reliable stock.

We believe that before the planting season is over that the supply of many seeds will be entirely exhausted. The demand no doubt will be larger and transportation slower than usual, therefore, we urge you to order early.

By persistence and unusual energy we have secured a good stock of Seed and Supplies in all lines and with added facilities for prompt service, we hope to maintain our high standard of delivery, although the "next call" will probably take one member of our firm and several other young men in our employ.

Those at home must raise more Vegetables, Fruits, Grains, Poultry and Stock to help feed the Nations—"Food for the body" and "flowers for the soul," to gladden the heart and brighten the eye. Even though you have only a small plot of ground, be patriotic and do your "bit." We hope that all near or dear to you who have been "called," will in good time return safely.

With the present high cost of living it will pay everyone, who has the room, to raise all the vegetables, fruit and poultry possible. Aside from the savings, profits and healthful exercise derived, the fact that you know your products are fresh and wholesome will be a great satisfaction.

We thank you sincerely for past orders and hope that we will have the pleasure of serving you again this year.

Yours for a greater development of the Pacific Northwest,

Routledge
Seed & Floral Co.

OUR NEW SEED STORE, 145-147 Second St., Between Morrison and Alder
OUR CITY NURSERY DEPARTMENT, N. W. Corner 4th and Madison Sts.

U. S. Parcel Post

We do not have agents or traveling salesmen, but do a direct mail order business with our customers. This enables us to give you direct and personal attention, quick service and lower prices.

Size and Weight of Parcel Post Packages

Packages cannot be sent that measure over 84 inches in length and girth combined. The weight limit for the local, first and second zones is 50 lbs. The weight limit for the third to eighth zones is 20 lbs., except as follows:

ALASKA, MEXICO, CUBA, HAWAII, PANAMA and the **PHILIPPINES** take the 8th zone rate with a **WEIGHT LIMIT OF 20 LBS.**

CANADA takes the **EIGHTH** zone rate with a **WEIGHT LIMIT OF 4 LBS. 6 OZS.**

Zones

First zone	50 miles, first lb.	5c; each additional lb. or fraction	1c
Second zone	50 to 150 miles, first lb.	5c; each additional lb. or fraction	1c
Third zone	150 to 300 miles, first lb.	6c; each additional lb. or fraction	2c
Fourth zone	300 to 600 miles, first lb.	7c; each additional lb. or fraction	4c
Fifth zone	600 to 1000 miles, first lb.	8c; each additional lb. or fraction	6c
Sixth zone	1000 to 1400 miles, first lb.	9c; each additional lb. or fraction	8c
Seventh zone	1400 to 1800 miles, first lb.	11c; each additional lb. or fraction	10c
Eighth zone	all over 1800 miles, first lb.	12c; each additional lb. or fraction	12c

Postage Rates

War Tax.—Don't forget to add the war tax of 1c extra for each 25c or fraction thereof.

When you order from Portland, look for the zone that corresponds to the number of miles you are away, add up total weight of your order, consult the table above and add postage.

ALL MISCELLANEOUS MERCHANDISE offered in this catalog **THAT CAN BE SENT BY PARCEL POST** is marked **P. P.** and the **PACKED WEIGHT** is given so that extra money for **POSTAGE** can be remitted according to the table above, **OTHERWISE** we will send by freight or express **AT YOUR EXPENSE.**

INDEX TO CONTENTS

Note.—B—Bulbs. P—Plants. R—Roots. F—Flowers.

Page		Page		Page		Page	
A							
Acroclinum	49	Berberis	103	(see Ricinus)...	66	Currants	113
Ageratum	49 P 78	Bellis	F 51, P 79	Catnip	36	Cucumbers	17
Agrostemma	49	Bignonia (see Trum-		Cats	159	Cypress Vine	56
Alfalfa	42	pet Vine)	108	Cat Foods	158	D	
Almond	112	Birds, Seed, Foods		Cauliflower..11, P 36		Dad's Lanterns...131	
Aloysia	49	& Supplies	153-159	Cavies	155	Daffodils	B 97
Alyssum..49, P 78, 79		Blackberries	114	Celosia	54	Dahlias.F 56, B 92-96	
Amaranthus	51	Bleeding Heart (see		Celeriac	13, P 36	Daisies...F 56, P 78	
Amaryllis	B 87	Dicentra)	80	Celery	18, P 36	Daisy (see Bellis)	
Ampelopsis	107	Bone Meal	40	Centaurea	54P 79, F 51	
Anemone	P 79	Bone Mills	150	Cheat Seed	45	Daphne	103
Anise	36	Books	132, 133	Chinese Wool		Dandelion Puller...119	
Antirrhinum	51	Boston Ivy (see		Flower	54	Day Lily (see	
Apples	109	Ampelopsis Veit-		Cherries	110	Hemerocallis)	81
Apricots	110	chii)	107	Chervil	11	Delphinium	
Aquariums	160	Borage	36	Chick Boxes	144F 56, P 80	
Aquilegia..F 51, P 79		Broccoli	10, P 36	Chick Feed	139-141	Deutzia	103
Arabis	F 51, P 79	Brussels Sprouts		Chick Greasers	150	Dewberries	114
Artichoke	5, R 448, P 36		Chickory	11	Dianthus	56
Asparagus	F 51,	Brooders	136 to 139	Chives	36	Dicentra	R 80
S 4 & P 76, R 118		Browallia	52	Chrysanthemum		Digitalis	F 57, P 80
Aspidistra	P 77	Buckwheat	45	..F 55, P 75, 78, 80		Dimorphoteca	56
Asters	50, P 78	Bug Death	127,	Cineraria	55	Dill	36
B		C		Clarkia	55	Dog Foods, etc....158	
Baby Breath (see		Cages, etc.156, 157		Clematis	106-107	Dolichos	57
Gypsophila)		Cabbage	14-15, P 36	Clovers	42	Poronicum	P 81
.....F 58, P 81		Caladium	B 87	Clover Cutter	141	Dracaena	P 77
Baloon Vine	52	Calendula	52	Cobaea Scandens..		Dusty Miller (see	
Balm	36	Calla Lily	B 88F 55, P 78		Centaurea)	54
Balsam	51	Calliopsis	52	Collards	11	Dutchman's Pipe..108	
Bamboo Stakes	119	Caliceolaria	52	Coleus	F 55, P 78	Dutch Bulbs	97
Barley	45	Camelia	103	Columbine (see		E	
Basil	36	Campanula	53, P 80	Aquilegia F51, P 79		Echinocystis	57
Bachelor Button		Canary Birds	153	Conkey's Foods...140		Egg Plant	18
(see Centaurea)		Canary Creeper	52	Conkey's Reme-		Egg Boxes	144-145
.....F 54		Candy Tuft		dies	151	Egg Testers	147
BeansF 53, P 78		Coreopsis	55, P 79	Emmer (Speltz)	48
....4-5-6-7, F 73-78		Canna	F 52, B 85	Coriander	36	Endive	18
Bedding Plants...		Canterbury Bells		Corn Salad	11	Eschscholtzia	57
.....73 to 78	F 52, P 80		Corn (Sweet)	16	Extension Rods	125
Beet	8-9	Caponizing Tools..141		Corn (Field)	46	Evaporator	123
Begonias	P 75, B 88	Carco	127	Corn Planters	121	F	
Belgian Hares, etc.152		Carraway	36	Cosmos	55, P 78	Fennel	36
Bellflower (see		Carrot	12-13	Cow Peas	45	Feeders	142-143-152
Campanula)		Cardinal Creeper.. 53		Cress	11	Ferns, etc.76-77	
.....F 53, P 80		Carnation..54, P 74-78		Crocus	B 97	Fertilizer	37-40
		Castor Oil Bean		Cultivators	120-123	Field Seeds	42-50

INDEX TO CONTENTS—Continued

Note.—B—Bulbs. P—Plants. R—Roots. F—Flowers.

Page	Page	Page	Page
Fish, Fish Food etc.160	Kirk System..... 40	F	Snapdragon (see Antirrhinum) .. 51
Flower Pots, etc....119	Killing Knives....141	Paeony 89	Snowball105
Fountains ...142-143	Kochia 60	Palms, etc..... 77	Sugar Cane..... 48
Forget-Me-Not (see Myosotis) F 62, P 81	Kudzu Vine..... 60	Pampas Grass, P 82; also see Gynerium 58	Summer Savory... 36
Four O'clock (see Marvel of Peru) 61	Kohl Rabi..... 18	Pansy ...64-65, P 73	Spider Lily..... 89
Foxglove (see Digitalis)57, P 80	L	Parsley 26	Spirea105
FuchsiasP 75	Land Plaster.... 40	Parrots, Cages, Foods, etc.155, 156	Spratt's Foods, etc.139-158
G	Labels119	Parsnip 27	Spray Pumps.128, 129
Gaillardia ..57, P 81	Lamps, etc....131 143	Peaches112	Sprays126, 127
Garden Hose, etc.125, 130	Larkspur....60, P 80	Pears111	Speltz 48
Garden Stakes....119	Lavender36, P 81	Peas24-25-26	Speedwell (see Veronica) 83
Garden Tools.119-124	Lathyrus 60	Field 47	Spinach 32
Garlic 18	Lawn Grass..... 41	Peanuts 27	Sprinklers130
GeraniumP 73-78	Lawn Mower, Rollers, etc....124-130	Pentstemon 63	Squash32-33
Gladiola 86	Lawn Sprinklers.130	Pepper27, P 36	Stocks...F 67, P 78
GloxiniaF 58	Leg Bands.....149	Persimmons113	Strawberries .116, 117
Globe Amaranth (see Gomphrena) 58	Lentils 48	Pe-Tsai 15	Sudan Grass..... 43
Godetia 58	Lemon Verbena (see Aloysia)... 49	Petunia63, P 78	SunflowerS 31
Golden Glow (see Rudbeckia)F 66, P 83	Leek 18	Phenomenal Berries114	also HelianthusF 58-59, P 81
Gold Fish, etc....160	Lettuce19-20	Phlox ...66, P 78, 82	Swiss Chard..... 9
Gomphrena 58	Lilac104	Pigeon Nests....141	Sweet Clover..... 40
Gooseberries113	Lilies89-90-91	Pigeon Food.139-141	Sweet Peas...68 to 71
Gopher-Go127	Limestone 40	Pink P 82 (see Dianthus) 56	Sweet Potato Plants 36
Gopher Traps....125	Lime, Puritan....139	Planet Junior....122	Sweet Sultan (see Centaurea) 54
Gourds 58	Lily of the Valley 87	Plant Stakes....119	Sweet William..F 67
Grafting Wax....127	Loganberries114	Plant Boxes..... 78	Swiss Chard (see Beets) 9
Grapes115	LobeliaF 60, P 78	Plums112	T
Grass Seeds.41 to 45	Lupinus61, P 80	Poppy ...F 65, P 81	Thermometers ...147
Guinea Pigs....155	M	Portulaca 66	Thunbergia 72
Gynerium..F 58, P 80	Mahonia104	Potatoes28-29	Thyme 36
Gypsophila.F 58, P 81	Majoram 36	Potato Planters..121	TigridiasB 87
H	Marigold 61	Pots, Pot Labels.119	Tobacco 32
Hanging Baskets.P 78	Marvel of Peru.. 61	Poultry Remedies, Foods, Supplies133 to 152	Tomato32, P 36
Helianthus.58-59, P 81	Maples104	Powder Guns....130	Trap Nests.....141
Heliotrope...59, P 78	Mesembryanthem 61	Privet104	Trowels121
Hemerocallis 81	Mignonette...61, P 78	Primula...F 65, P 82	Trumpet Vine...108
Herb Seed 36	Millet 48	Prunes111	Tritoma ...F 72, P 83
Horehound 36	Mimulus 61	Pumpkin 30	Tube Roses....B 88
Humusul 60	Mole Traps....125	Pyrethrum.F 65, P 82	Tuberous Rooted BegoniasB 88
Hunnemannia 59	Montbretia ...B 89	Q-E	TulipsB 97
Holly103	Moon Flower (see Ipomoea) 59	Quince104-110	Turnip35-36
Hollyhocks...59, P 81	Morning Glory... 62	Rabbits, etc....152	V
Honeysuckle108	Moss119	Radish30-31	Valeriana 72
Hop Roots118	Montbretias 88	Raffia119	Vegetable Plants and Roots.... 36
Hose, etc....125, 130	Mulford's Cultures 37	Rape 48	Verbena ..F 72, P 78
Horseradish ...R 118	Muskmelon 21	Raspberries115	Vetches 48
Hyacinth ..B88-97	Muskplant see Mimulus) 61	Reference Tables.161	Veronica ...P 82
Hyacinth Bean (see Dolichos) 57	Mushroom Spawn. 22	Rhododendrons .105	VincaP 78, 83
Hydrangea103, 104-108	Mustard 22	Rhubarb. S 31, R 118	Virburnum105
Hygrometers147	Myosotis62, P 81	RicinusF 66	Violets...F 72, P 83
HypericumP 81	Myrtle (See Vinca) 83	Rock Cress (see Arabis) P 51, F 79	Virginia Creeper (see Ampelopsis) 107
Hyslop 36	N	Rose Stakes....119	W
I	NarcissusB 97	Roses ...P 98 to 102	Wallflower F 72, P 83
Iberis...P 81, see Candytuft F 53, P 78	Nasturtium 63	Rosemary 36	Walnuts106
Ipomoea 59	Nectarines112	Rubber Plant.... 77	Watermelon 21
IrisB 84	Nemesia 62	Rutabaga 36	Weeders121
Insecticides ..126-127	Nest Eggs147	Rye 48	Weigelia106
Incubator133 to 136, 138	Nests, wire....149	Rudbeckia F 66, P 83	Wheat 48
IvyP 78, R 107	Nitrate of Soda.. 40	S	Wild Cucumber (see Echinocystis 57
J-K	Nicotiana 62	SaxifragasP 83	Wild Flower Garden 72
Japanese Hop (see Humulus) 60	Nigelia 62	Sage 36	Wire Baskets, etc.119
Jasmine108	Nitro-germ 37	Saffron 36	Wistaria108
Kaffir Corn..... 48	Nozzles, etc....130	Salpiglossis ...F 66	Wong Bok..... 15
Kale, Garden 18, P 36	Nox-i-cide139	Salsify 32	Wonder Fertilizer. 38
Kale Stock...45, P 36	O	Salvia ...F 67, P 78	Wormwood 36
Kittens159	Oat Sprouters ...146	Savory 36	Y-Z
	Oats 47	Schizanthus ...F 67	Yucca106
	Ocimum139	Seeders121, 122	ZinniaF 72
	Oregon Grape....104	Shamrock 72	Zephyranthes 89
	Onion Sets..... 22	Shasta Daisy 56, P 83	
	Onion22-23	Shipping Coops..150	
	Okra 22	Smilax 72	
	Oxalis 89		

ARTICHOKE

LARGE GREEN GLOBE.—The well-known French vegetable; the undeveloped flower heads, when properly prepared, make a most delicious dish.

Pkt. 15c; oz. \$1.00

White Jerusalem.—Tubers grown for stock. See page 44.

ASPARAGUS

COLUMBIAN MAMMOTH WHITE.—Gives immense yield of large, clear, white shoots; very tender and of excellent flavor.

Pkt. 5c; oz. 10c; 4-oz. 30c; lb. \$1.00

PALMETTO.—Early, prolific and uniform medium size; dark green. Best commercial variety.

Pkt. 5c; oz. 10c; 4-oz. 30c; lb. \$1.00

CONOVER'S COLOSSAL.—A good, standard large sort of approved quality. Shoots bright green, very tender.

Pkt. 5c; oz. 10c; 4-oz. 30c; lb. \$1.00

ASPARAGUS ROOTS

You can save two years' time by buying Asparagus Roots. For prices, see Vegetable Roots, page 36.



Asparagus Tips

GARDEN BEANS

Dwarf or Bush—Green Podded Kinds

Packet and single pound prices only are prepaid. Add postage to 10 lb. prices if wanted by mail.

Stringless Green-Pod

The most popular and best liked green snap bean.

This famous bean is unequalled as a first-early; also for main crop.

It combines unusual hardiness, extreme earliness, and wonderful productiveness with handsome appearance and finest quality of pods. Extra early plantings may be made to produce the earliest crop, and even with later plantings this bean is the quickest to produce pods.

By repeated plantings pods may be had in constant succession from spring until cut off by heavy frosts in the fall. Combined with the extra hardiness and early maturity, the pods are the finest in quality, of a rich green, very round and almost straight, long, solidly meaty and plump,—deeply saddle-backed, caused by the rounded swell of the fleshy sides. The pods are tender, brittle, and of finest flavor, always entirely stringless even when fully matured.

Large pkt. 15c; lb. 40c; 10 lbs. \$3.25



Stringless Green-Pod.

DWARF HORTICULTURAL.—One of the best dwarf sorts for green shell beans for the home garden and market and can be used early as a garden podded snap bean. The plants are very productive, compact and upright, with large leaves. The mature pods are about five to five and one-half inches in length, broad and thick, curved, with splashes of bright red on a yellowish ground. They become fit for use as green shelled beans early and in this condition the beans are very large, easily shelled and are about equal to the Lima in quality. Seed large, oval, plump, pale buff splashed with deep red.

Large pkt. 15c; lb. 35c; 10 lbs. \$3.00

EXTRA EARLY REFUGEE.—Extremely early, very hardy and productive. Pods round and straight, tender and of excellent quality. In demand as a pickling and canning variety.

Large pkt. 15c; lb. 35c; 10 lbs. \$3.00

Market and Truck Gardeners should write us for special prices and state quality and kinds wanted. We'll save you money and you will get "Highest Quality" Seeds.

INOCULATE THIS SEED WITH MULFORD CULTURE

BEANS—Continued

INOCULATE THIS SEED WITH MULFORD CULTURE

Dwarf or Bush—Yellow Podded

Packet and single pound prices are prepaid. Add postage to 10 lbs. prices if wanted by mail.

Prolific Black Wax

The earliest wax variety. Pods a rich, creamy yellow, round, fleshy, tender, stringless and remain in fit condition for some time. Enormously productive and of fine quality, and one of the most reliable sorts for general use.

Large pkt. 15c; lb. 35c; 10 lbs. \$3.00

Improved Golden Wax

Medium early, heavy cropper, vine vigorous. May be sown early or late with the assurance of a good crop. Pods are golden yellow, fleshy and solid, brittle, waxy texture and have an exceptionally rich buttery flavor. Excellent for home or market garden.

Large pkt. 15c; lb. 40c; 10 lbs. \$3.25



Prolific Black Wax

Medford, Ore., Jan. 18, 1917.

Routledge Seed & Floral Co.,

Dear Sirs: Last year I bought seed from you and the Beans were the nicest I ever tasted. If anybody says "BEANS" to me, I can certainly praise yours.

MRS. WM. FRIDEGER.

Davis Kidney Wax (See Cut)

The most hardy and productive wax bean. The pods are long, white, straight, crisp and tender. The vine is rustless and very vigorous, bearing the pods in clusters. For canning this is unexcelled on account of purity of the pod and bean. It is a remarkably good variety for shipping; seed white, and on this account is desirable for a shelled bean in winter. Large pkt. 15c; lb. 35c; 10 lbs. \$3.00

New Brittle Wax

Extremely early and of such superb quality it might almost be called "Best of All." The plants are of vigorous growth, with large foliage, and appear completely loaded with handsome pods, which are nearly straight and measure 4½ to 6 inches long. They are broad, fleshy, tender, "brittle" and entirely stringless at all stages of growth. The pods are unexcelled as snap-shorts. Seed white, showing only a small dark dot at the eye; any surplus allowed to ripen will be readily salable as winter shell beans. (Seed crop very short.)

Large pkt. 15c; lb. 40c; 10 lbs. \$3.25

Wardwell's Kidney Wax

A popular and well-known variety; pods long, golden-yellow, brittle and stringless; seed white, with dark markings about the eye. Market gardeners find this bean one of the most profitable. (Seed crop very short.) Large pkt. 15c; lb. 35c; 10 lbs. \$3.25

Empire, Ore., Feb. 13, 1917.

Routledge Seed & Floral Co.,

Dear Sirs: I have used your seeds, etc., for several years and have had excellent results from everything purchased from you.

Yours truly,

O. P. BRITT.

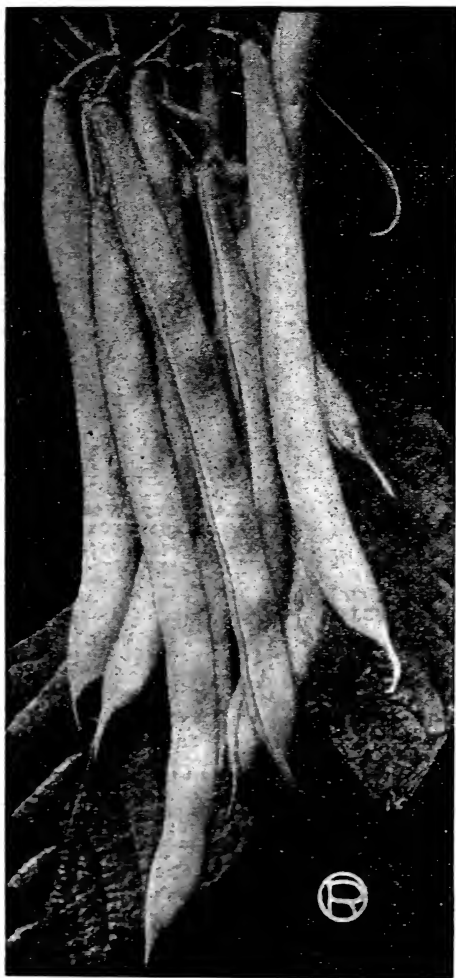

Davis Wax

BEANS—Continued

Packet and Single Pound **ONLY** are postpaid. Add postage if wanted in 10-lb. lots by mail.

Climbing or Pole Beans

Improved Kentucky Wonder (Asparagus)

A very popular variety; often sold as asparagus. By far the best green podded pole variety. Pods green, very long, round and perfectly stringless. **Enormously productive** and early, remaining in "fit" condition a long time. Unsurpassed for the table, being very tender and of delicious flavor.

Large pkt. 15c; lb. 40c; 10 lbs. \$3.25

Kentucky Wonder Wax

This grand new pole bean is a wax podded Kentucky Wonder and many think it is of better flavor. We believe it is a more vigorous grower and will yield fully as heavy as the Kentucky Wonder. The pods are a light yellow, extra large, broad and long and cook very tender. We recommend this bean strongly. Comparatively early.

Large pkt. 15c; lb. 40c; 10 lbs. \$3.25

Worcester Pole

The finest Pole Shell Bean in cultivation and on account of its wonderful productiveness and superior quality takes first rank as a Pole Shell Bean. The strain we offer is an especially fine one. The long, thick pods are brilliantly colored with crimson carmine and are borne in clusters. Unequaled for tenderness and delicious flavor.

Large pkt. 15c; lb. 40c; 10 lbs. \$3.25

Routledge Giant

Although the pods are often a foot long and an inch thick, the flavor and quality when cooked is rich and excellent. It is an enormous yielder, fine for canning. The giant "tender" pods are striped and mottled crimson. (Seed scarce.)

Large pkt. 15c; lb. 40c

DUTCH CASE KNIFE.—A climbing variety with long, flat, fleshy pods, which become creamy white as they mature; seed broad, flat and clear white. Good as a dry bean.

Pkt. 15c; lb. 35c; 10 lbs. \$3.25

LAZY WIFE.—Produces heavy crops of broad, flat, fleshy, tender, stringless green pods. Fine snap beans or shelled for winter use; rich, buttery flavor. Seed crop very short.

Large Pkt. 20c

SCARLET RUNNER.—Grown extensively for ornamental purposes, as flowers are a most brilliant scarlet and borne profusely; beans are broad and flat, and of fine flavor when cooked, same as Lima beans.

Large pkt. 15c; lb. 35c

Pole Lima Beans

Early Leviathan

One of the best pole varieties; pods long and borne in clusters; beans large, fleshy, delicate pale green, and of rich, buttery flavor; very early. A good climber; very prolific.

Large pkt. 15c; lb. 35c; 10 lbs. \$3.00

Oregon Pole Lima

Those who are fond of a good lima or butter bean will find nothing better than this for our Northwest climate. The large, plump, white beans are excellent shelled green or used as dry beans. We recommend this bean, as it is early, hardy and prolific. This bean is fully acclimated.

Large pkt. 15c; lb. 40c; 10 lbs. \$3.50

KING OF THE GARDEN LIMA.—The largest podded variety and very productive vines; very vigorous, often producing pods six to seven inches long. Beans large and of fine flavor.

Large pkt. 15c; lb. 35c; 10 lbs. \$3.00

Dwarf or Bush Lima

HENDERSON'S BUSH LIMA.—Fully two weeks earlier than any other variety. Plant grows about 16 inches high, and very prolific; beans are small; especially recommended where the season is short.

Large pkt. 15c; lb. 30c; 10 lbs. \$2.75

BURPEE'S BUSH LIMA.—The best late dwarf variety; plants grow 18 to 24 inches high; very prolific; pods large, and the beans also large and heavily ribbed; will bear until stopped by frost.

Large pkt. 15c; lb. 40c; 10 lbs. \$3.60

Although pole beans require a little more care and labor, they are, when properly grown, usually of longer bearing period than the dwarf sorts and are much more productive.

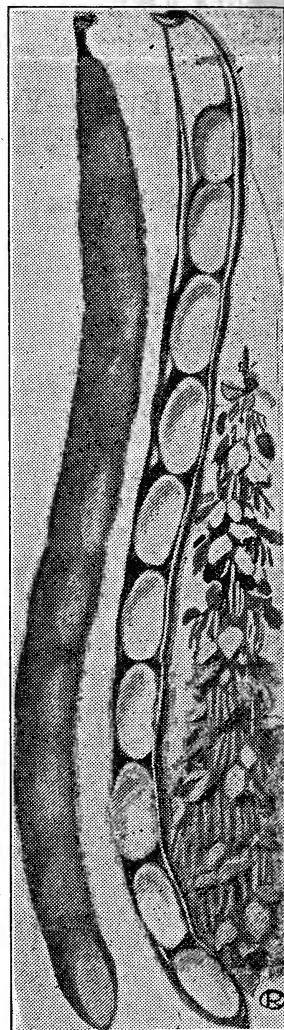

Kentucky Wonder.
Asparagus.

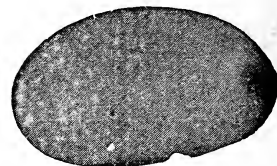

Lima Bean.



See page 37.

Commercial Dry Table Beans

Raise more Beans and help feed the Nations

Beans are a splendid crop to grow in Oregon and the right varieties under proper culture are very profitable. There is no reason why Oregon should not produce enough to supply its own needs as well as a surplus to ship outside.

Beans will grow successfully on most any kind of soil, but they will do better and yield heavier on soil that is mellow, well drained and warm. Land that will produce good corn or wheat will grow good beans. Sandy river bottom is especially good.

PLANT TRUE PURE SEED—It certainly pays to secure a clean, true seed stock. Don't plant any common stock, even though it looks all right. You cannot tell by looking at it whether it is early or late, or acclimated.

The stocks we offer are of known varieties, acclimated and hand-picked and grown especially for seed—by far the safest, best and most profitable in the end, even though it costs a little more at planting time.

Brown or Swedish

This is a medium sized round, oblong, brown bean with a white eye. As a cooking or baking bean the quality is very superior, having a richness and flavor all its own. Our customers who planted it last spring praise it very highly. They say on account of its excellent qualities, they prefer it for their own table use. It is unusually productive, pods long and straight and always well filled. Bush strong, healthy and vigorous. Crop matures early.

Pkt. 15c; lb. 35c; 10 lbs. \$3.00

INOCULATION.— To insure the greatest success always inoculate your seed beans with Mulford's Culture (see page 137).

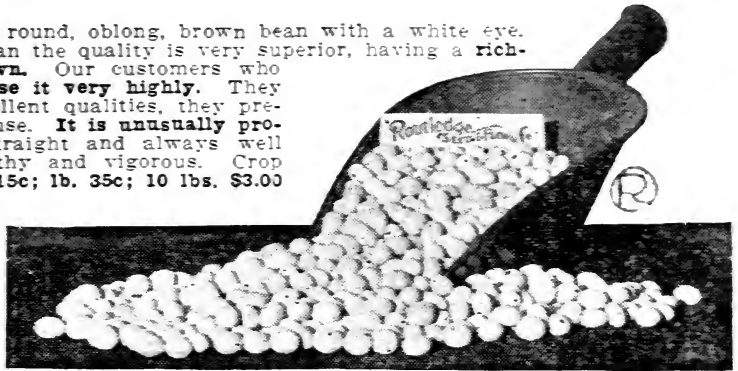

IMPROVED TREE BEAN

Early, Wonderfully Productive

Of all the varieties we have tested we believe this is the best and most profitable white field bean for Oregon from the reports we have had from those who have planted it. On account of its snowy whiteness and uniformly small size, it commands the highest price in all markets. The plants grow upright, have less foliage than most varieties and hold the pods well up from the ground, thus keeping the beans from getting dirty and discolored. The pods are very freely produced, are long and well-filled. The dry bean is small, white, plump and almost round. Cooking and eating qualities are unsurpassed. The whole crop will ripen early and evenly and you can get it safely harvested before the rainy season sets in. This past season, although it was an "off year," it did exceedingly well; in fact, the best of all varieties we inspected. Our stock of this particular strain (our third year with it) is rather limited, so order early.

Note.—Not over 200 lbs. of this variety to a customer this year, as we want to get this strain as widely distributed as possible. We will appreciate reports from all who plant it.

Prices: Large pkt. 10c; lb. 30c; 10 lbs. \$2.50; 25 lbs. \$5.50; 100 lbs. \$20.00.

Lady Washington

A great improvement over the old "Navy," for Western Oregon and Washington growers, as it is much earlier, a trifle larger, and a very heavy yielder, especially adapted to western conditions. The pods all ripen together and early enough to harvest before winter rains. Bean pure white and of excellent quality. Growers report our stock very superior.

Large pkt. 10c; lb. 25c; 10 lbs. \$2.25
Write for quantity prices.

OTHER VARIETIES.—We can secure upon orders Red Kidney, White Kidney, Pink, Navy and Michigan Pea Beans. Write for prices stating quantity wanted.

Improved Tree Beans

Dundee, Ore., January 29, 1917.

Routledge Seed & Floral Co.,

Gentlemen: The Improved Tree Beans I bought of you last season produced the most profitable crop I ever grew. They were certainly true and pure; matured very early and evenly. I had them all inside before my neighbors were able to harvest theirs. I sold them just as they came from the harvester without grading and secured the top price.

Yours truly,

F. M. CULP.

White Wonder

Many of our customers have asked for a green podded white bean that would answer for a "snap bean" as well as a white bean for winter use. White Wonder is the bean to plant for this purpose. The strong points in its favor are its exceptionally fine flavor, remarkable productiveness, extreme hardness and splendid appearance. It is a string bean, but there are few if any beans that cook more tender. Pods large, round and straight. Seed pure white, of medium size and excellent quality, baked or boiled.

Large pkt. 15c; lb. 35c; 10 lbs. \$3.00

Red Mexican

An excellent dry bean for winter use. Used extensively for baking and Spanish dishes. We offer select, hand picked, Oregon grown, acclimated seed.

Large pkt. 10c; lb. 25c; 10 lbs. \$2.25

Broad Windsor

An English variety; large, broad, flat beans of delicious flavor; used as a shell bean. Good for hog pasture; very hardy and very productive.

Large pkt. 15c; lb. 25c; 10 lbs. \$2.00

CASTOR BEAN

Used for medicinal purposes and by some claimed to keep moles away. Ornamental foliage, 4 ft.

Large pkt. 15c; lb. 45c

BRUSSELS SPROUTS

The plants, which are very hardy, grow two or three feet high, and produce, from the sides of the stalks numerous little sprouts, which resemble very small cabbages one or two inches in diameter. The leaves should be broken down in the fall, to give the little heads more room to grow. They should be treated in all respects like winter cabbage or kale.

PERFECTION OR DALKEITH.—Plants are of dwarf growth and stems are thickly set with large, solid sprouts. This variety is very hardy and even during quite severe weather, the plants maintain their sprouts; in fact, the flavor and quality is much improved by frost. **Pkt. 10c; oz. 35c; 4 oz. \$1.00**

CHIVES.—See Vegetable Roots, page 36.

Salem, Ore., Feb. 10, 1917.

Routledge Seed & Floral Co.,

Gentlemen: The garden seed bought from you last year were highly satisfactory.

Wishing you another successful business year, and thanking you for past favors, I am,

Yours very truly,
MRS. CASS. GIBSON.

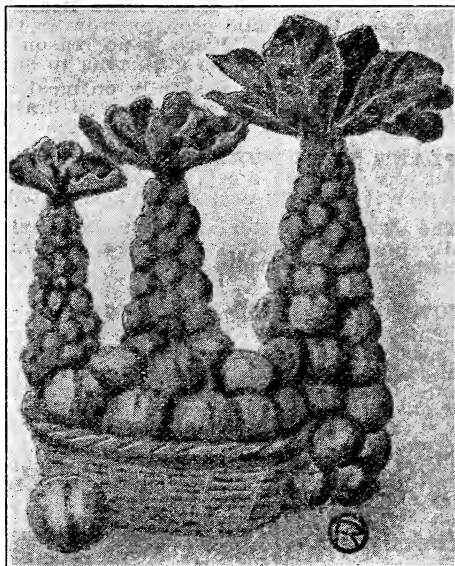

Brussels Sprouts.

TABLE BEETS

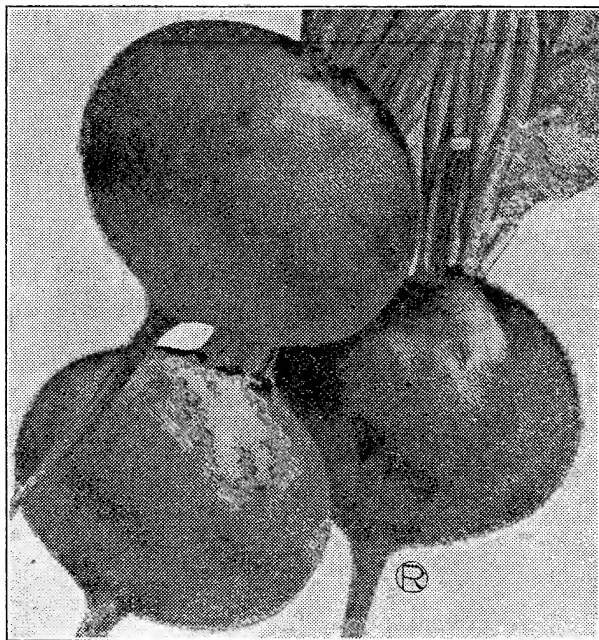

Routledge Favorite.

Routledge Favorite

A select strain, very early. Perfectly globe shaped, with a single tap root, and of the richest color of any of the beets. It is a splendid keeper, is not excelled in yielding qualities by any other sort, is exceedingly tender, fine and sweet and is unequalled for table use. Market gardeners will find our Favorite a very profitable variety to grow, as no other sort approaches it in attractiveness or quality.

Pkt. 10c; oz. 25c; 4 oz. 70c; 1b. \$2.25

Crosby's Egyptian

Very popular early beet, as it reaches the desired size quickly. The beets are of good size, rather flat than round, and flesh dark.

Pkt. 10c; oz. 20c; 4 oz. 60c; 1b. \$2.00

Detroit Dark Red

Excellent variety, nearly globular, dark skin and dark flesh, zoned lighter; maturing early and keeping crisp and tender for a long time.

Pkt. 10c; oz. 20c; 4 oz. 60c; 1b. \$2.00

— OUR MOTTO is —

"Highest Quality"

It's quality **FIRST**, then price as low as possible. The best seeds are the cheapest in the end, even though they cost a little more.

Improved Early Blood Turnip

This is the ideal beet for market gardeners. It is very symmetrical, with small tap root and but few fibrous roots; color outside is deep blood red; fine grained and unsurpassed in quality. It continues to grow until late in the fall, attaining a large size and making a good selling and eating beet for winter.

Pkt. 5c; oz. 20c; 4 oz. 60c; 1b. \$2.00

HALL'S GARDEN CULTIVATORS are priced very low and will save you much work in the garden. See pages 120-123.

TABLE BEETS—Continued

EDMUND'S BLOOD TURNIP.—Unsurpassed for late planting; deep blood-red flesh, very tender and juicy, runs very evenly in size and quite round; grows a small top.

Pkt. 5c; oz. 15c; 4 oz. 50c; lb. \$1.50

HALF LONG BLOOD.—Becoming more and more popular. Excellent in shape and quality; yields well.

Pkt. 5c; oz. 15c; 4 oz. 50c; lb. \$1.50

LONG BLOOD.—The root is smooth and handsome, flesh brilliant in color and excellent quality. Good keeper.

Pkt. 5c; oz. 15c; 4 oz. 50c; lb. \$1.50

Swiss Chard

"Spinach Beet" or Sea Kale.

This does not make edible roots like the regular garden beets, but is grown for the broad white leaf-stalks, which are bunched and cooked in the same manner as asparagus. The young leaves may be gathered also and cooked like spinach. Makes a delicious summer vegetable.

Pkt. 10c; oz. 20c; 4 oz. 65c

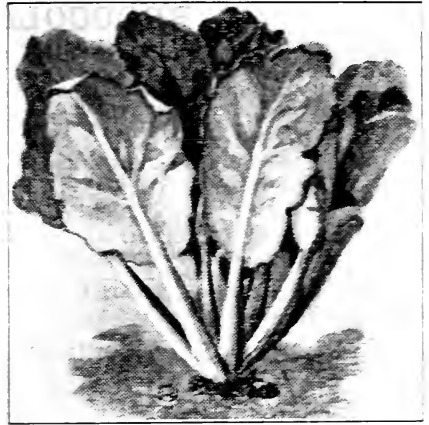

Swiss Chard.

Stock Beets or Mangels

GIANT YELLOW ECKENDORF

A new mangel of great merit. The roots are smooth, long and cylindrical in shape, very heavy, weighing up to 15 and 20 pounds each; grow two-thirds above ground. The flesh is firm, crisp and solid, white in color and of high feeding value. (See cut.)

Pkt. 5c; oz. 20c; 4 oz. 45c; lb. \$1.50

Giant Half Sugar Mangel

Yields as much per acre as the best Mangels, and twice as much per acre (bulk of roots) as the rich sugar beet. Roots grow very large above the ground. Smooth, creamy white in color and very nutritious. Easily pulled. (See illustration No. 1.)

Pkt. 5c; oz. 15c; 4 oz. 35c; lb. \$1.25

MAMMOTH LONG RED

Very popular and much used. A large and heavy cropper. Dark red skin, with whitish flesh; grows one-half or more above the ground; roots quite regular; attain a very large size. (Same shape as No. 2.)

Pkt. 5c; oz. 15c; 4 oz. 35c; lb. \$1.25

DANISH SLUDSTRUP

An improved variety, considered one of the best. Awarded first class certificate. Color, reddish yellow, and of a distinct type. It is very hardy, grows well above ground; is easily pulled and very nutritious. (See cut.)

Pkt. 5c; oz. 20c; 4 oz. 45c; lb. \$1.50

GOLDEN TANKARD

An enormous yielder of weight per acre, and at the same time very nutritious; flesh deep yellow, of fine shape, growing largely above ground, thus being easily harvested. (Same shape as cut No. 3.)

Pkt. 5c; oz. 15c; 4 oz. 35c; lb. \$1.25

Sugar Beets

Pkt. 5c; oz. 20c; 4 oz. 45c; lb. \$1.50

FRENCH WHITE SUGAR.—The sugar beet most generally grown for stock, as it combines, with heavy yield, from 10 to 13 per cent of sugar.

KLEIN WANZLEBEN.—The most popular for table and for sugar production.



(1) Giant Half Sugar.

(2) Danish Sludstrup.

(3) Giant Yellow Eckendorf.

BROCCOLI—Winter Cauliflower

Forms a head like cauliflower, but is much hardier; stands wet and cold better and gives excellent results. For fall use sow from March to May; for winter and spring cutting, May to July. Very extensively planted by our local market gardeners for use in the late fall, winter and spring when cauliflower is out of season.

St. Valentine

Well and favorably known and extensively planted by the large commercial growers. Produces large, solid, white heads. Season March to May. This strain of Oregon grown tested seed has given good satisfaction.

Pkt. 10c; 1/4 oz. 35c; oz. \$1.00; 4 oz. \$3.50; lb. \$12.50.

Routledge H. Q. St. Valentine

In this seed, we are offering our customers a very select, high-grade strain of the well-known St. Valentine. By selecting only the most perfect heads, those showing the most desirable leaf formation for the protection of the developing head and those of large size and perfect compact heads, free from small center head leaflets, we have produced this superb strain. The last two years our **H. Q. St. Valentine** produced larger, later and far better heads than the best imported English seed, and it was so far superior to seed produced from other sources that there was no comparison. For instance—last February our grower reported that **H. Q.** stock was cutting 95 per cent of heads that brought him double the price of other ordinary stock.

Every ounce of our **H. Q. St. Valentine** seed we are offering this year is from just such perfect heads as shown herewith. Our seed of this particular lot is quite limited, so order early.



"H. Q." St. Valentine Broccoli

H. Q.: Pkt. 20c; 1/4 oz. 60c; oz. \$1.50; 4 oz. \$5.00

Sutton's Winter Mammoth

An English variety. Immense white heads, superb in texture and quality, coming into use in mid-winter. Vigorous in habit and self-protecting. (Imported seed.)

Pkt. 10c; 1/4 oz. 40c; oz. \$1.25

Sutton's Late Queen

Quite distinct, dwarf and compact in growth, rarely affected by frost, and when planted late produces splendid heads the following spring in May. Has successfully passed through most severe winters. Heads well protected, large, handsome, excellent quality. (Imported seed.)

Pkt. 15c; 1/4 oz. 50c; oz. \$1.50

White French

A valuable early variety, large white heads of good quality. Hardier and of the same season as summer cauliflower.

Pkt. 10c; oz. 60c; 4 oz. \$2.00



Front leaves broken down to show formation of growth.

NOTE.—We made the above illustration from photographs to show the perfect heading qualities of our reselected strain of "**H. Q.**" **St. Valentine Broccoli**. Note how the large outer leaves form around and the smaller inside leaves completely cover the top of the head. This gives proper protection from frost, rain and sun. The heads will open up perfectly white and the quality and tenderness is unequalled.

FREE BULLETINS AND PAMPHLETS on general gardening and many special crops, also spraying, etc., are issued by the Oregon Agricultural College at Corvallis, Ore. These are sent free on request. We advise our customers to secure them. **THEY ARE OF GREAT VALUE.**

"Highest Quality"

CAULIFLOWER

Plants Page 36



Routledge Snow White.

EXTRA EARLY SNOWBALL (Extra Selected).—This is the choicest selected strain of the popular Erfurt type, and is remarkable for its extreme earliness and reliability in heading. Medium size heads. Plants quite dwarf.

Pkt. 15c; 1 oz. \$1.00; oz. \$3.50

VEITCH'S AUTUMN GIANT.—A large, late variety, very hardy. The heads are well protected by the foliage, enabling it to resist unfavorable climatic conditions.

Pkt. 10c; 1 oz. 60c; oz. \$1.50; 4 oz. \$5.00

ROUTLEDGE'S "SNOW WHITE"

The Finest Cauliflower Grown.

In competition with all other strains, this cauliflower has won the approval of critical gardeners, being early and also the best main crop sort grown. It is suitable not only for early use, but is superior for late planting. The heads are compact, firm and solid, and do not spread as do some of the inferior sorts. No other equals it in purity of color, being clear snow white. It is equally desirable for family use and for the market garden. The heads are large—from 9 to 12 inches in diameter. Very resisting against unfavorable seasons and dry weather, the foliage giving a splendid protection.

Pkt. 25c; ¼-oz. \$1.25; ½-oz. \$2.25; oz. \$4.00

EARLY SNOWBALL

This variety is much in demand by market gardeners. Its earliness, compact habit, large-sized heads and snow-white color recommend it to every grower as a variety of especial merit. We have an extra selected stock of this sort, and recommend it with the greatest confidence.

Pkt. 20c; ¼-oz. \$1.00; ½-oz. \$1.80; oz. \$3.50

NEW CALIFORNIA WONDER.—A late variety, forming good, large, solid heads during the winter. This variety has given great satisfaction in Oregon and California, wherever tried. Pkt. 15c; ¼-oz. 60c; oz. \$1.50; ¼-lb. \$3.00

ALGIERS.—A very strong growing late variety, with large leaves of a bluish cast. In cool locations and rich soil it produces very large, solid, white heads late in the fall.

Pkt. 15c; ¼-oz. 75c; oz. \$2.00

CHICORY

WITLOOF—Called also "French Endive" and "Christmas Salad"

Heretofore large importations have been made, but it is easily grown here. Plant the seed in the spring in drills, 12 inches apart, and thin out to 3 or 4 inches apart in the row. About November pull up the roots, break off the leaves, side shoots if any, and small root end so that the roots are not over 10 inches long. At once, or later as you get time, dig a trench about 18 inches deep and reset these trimmed roots crowns up, placing them about 1½ inches apart. Cover with loose, rich soil; the roots should be set in the trench so that the top will be covered about 8 inches. They will soon make thick shoots or top growth (below the surface) which is the edible part. Dig as wanted, cut just below the crown and serve with French or "mayonnaise" dressing. Witloof is really a delicate and delicious dish.

Pkt. 10c; oz. 50c

LARGE ROOTED OR COFFEE.—Grown quite extensively for the large thick roots, which are sliced, dried, roasted, and ground as a substitute or adulteration for coffee. To secure large smooth roots the soil should be light, rich, and deeply worked, and the plants should be thinned out to stand four to six inches apart. Pkt. 5c; oz. 20c; 4 oz. 75c

BUG DEATH kills all leaf-eating insects; excellent for using on cabbage, cauliflower, etc. Can be used either dry or in water. See description, page 127; also dusters and blowers, page 130.

CHERVIL

CURLED.—An aromatic herb, resembling parsley, and used for flavoring in soups and salads. Fine for garnishing.

Pkt. 5c; oz. 15c; 4 oz. 50c

CRESS

CURLED OR PEPPER GRASS.—Used as a salad and fine for garnishing.

Pkt. 5c; oz. 15c; 4 oz. 50c

TRUE WATER.—This is quite distinct from the former and only thrives when its roots and stems are submerged in water. It is one of the most delicious of small salads.

Pkt. 10c; oz. 40c

COLLARDS

TRUE GEORGIA.—Used as "greens" mainly in the South and West. As the leaves are pulled off, others grow in their places.

Pkt. 5c; oz. 20c; 4 oz. 50c

CORN SALAD

Petticus or Lamb's Lettuce.—This is a hardy winter salad, the small leaves being served like lettuce during the cool fall and early winter months. It does not succeed during warm weather, and the seed should be sown thinly in drills during August, September, and October to supply fresh leaves during the cool fall and winter months. It is quite hardy, and after cold weather sets in can be protected by a thin mulch of soft hay or straw.

Pkt. 5c; oz. 20c; 4 oz. 75c

CARROT

Routledge Model—Coreless

The finest early table variety grown. Handsome, meltingly tender and sweet.

This new carrot is our own strain, grown from the French carrot, Nantes. You will be delighted with the melting tenderness and sweet, mild flavor of Routledge Model.

It is a half-long cylindrical carrot, blunt pointed, with a small tap root and small top. They run very uniform in shape and grow just the right size for table use. The flesh is of fine texture, entirely devoid of stringyness, coarseness and woody heart; color orange scarlet, very attractive when served.

Pkt. 10c; oz. 30c; 4 oz. 85c; lb. \$2.75

Tillamook, Ore.,

Dear Sirs: I was very much pleased with the Seeds received from you last year. Everything came good.

We received first prize at the County Fair on Routledge's Model Carrots. They are certainly a fine variety.

Very truly,

W. L. VEATCH.

EARLY SCARLET HORN

May be planted very early in spring, and is an excellent summer variety. Tops small and roots grow about 3 inches long; reddish-orange and good flavor.

Pkt. 10c; oz. 25c; 4 oz. 75c; lb. \$2.50

Chantenay

The Market Gardener's Favorite.—Tops medium sized, necks small, roots tapering slightly, but uniformly stump-rooted and smooth; color deep orange-red; flesh very crisp and tender; medium early; a heavy cropper.

Pkt. 10c; oz. 25c; 4 oz. 75c; lb. \$2.50

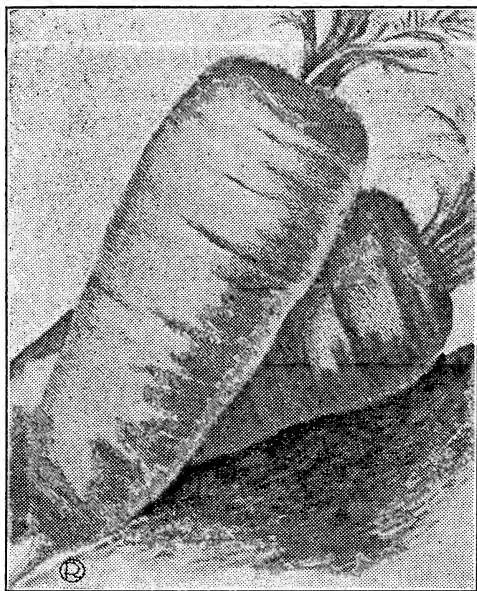

Chantenay.

FRENCH FORCING

Extremely early, sweet and mild, very popular. Roots small, globe-shaped, reddish orange, fine for early table.

Pkt. 10c; oz. 35c

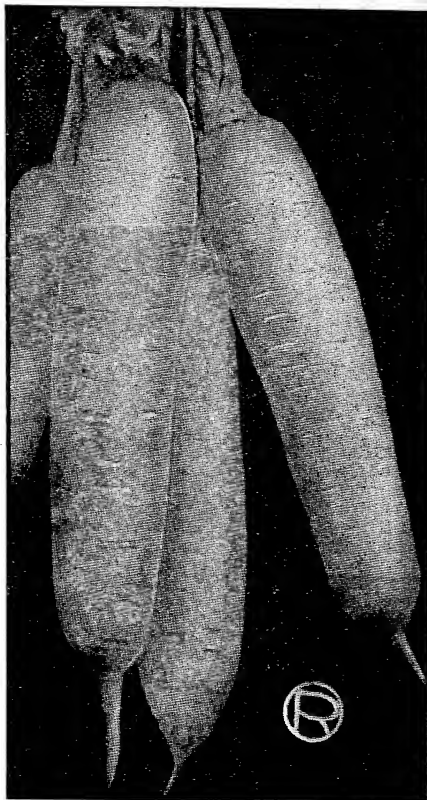

Routledge Model—Coreless.

DANVER'S HALF-LONG

A great favorite; big cropper; the roots are smooth and handsome, medium size, tapering uniformly to a blunt point and of a rich, dark orange; fine for table. On account of its productivity it is a profitable variety to grow for stock feeding.

Pkt. 5c; oz. 25c; 4 oz. 75c; lb. \$2.25

LONG ORANGE IMPROVED

The best of the long carrots, especially for stock; color bright orange, with long, tapering roots, requiring a deep soil.

Pkt. 5c; oz. 20c; 4 oz. 60c; lb. \$2.00

GUERANDE, OR OXHEART.—Bright orange, broad at the top and terminates abruptly in a small tap root. Length about 4 to 5 inches; excellent for shallow soils.

Excellent for shallow soils.

Pkt. 5c; oz. 25c; 4 oz. 75c; lb. \$2.50

LARGE WHITE BELGIAN.—Extensively grown for stock feeding; roots white; green above ground and growing to a large size; flesh rather coarse. A good cropper.

Pkt. 5c; oz. 15c; 4 oz. 45c; lb. \$1.50

Dad's Electric Lantern—A Penetrating, Bright Light

The best and safest light for the farmer. No matches or danger of fire around the barns. See page 131.

CARROTS—Continued

Routledge Mammoth Stock Carrot

The heaviest cropping carrot grown, yielding more tons to the acre than any other sort. The flesh is yellowish-white, crisp and solid, and very sweet in flavor. It is a vast improvement on the Belgian sorts, which have been favorites in the past, as it is not only much more productive, but vastly easier to handle. The roots are short and very heavy at the shoulder, rendering them easily harvested. Too much can scarcely be said of their size and great productiveness. Every farmer should grow a good supply of carrots for winter feed and Routledge Mammoth is the kind to plant. Yields reported from 20 to 50 tons per acre.

Large pkt. 10c; oz. 25c; 4 oz. 75c; lb. \$2.25; 2 lbs., enough for one acre, \$4.00.

Dear Sirs: We have been using your seed for the past three years and find them true to name. Our neighbors come and look at our Mammoth Stock Carrots. They grow to about 30 tons to the acre and we stack them in our root cellar just like cord wood. The people cannot believe it until they come and see them.

Yours,

G. CROMWELL.

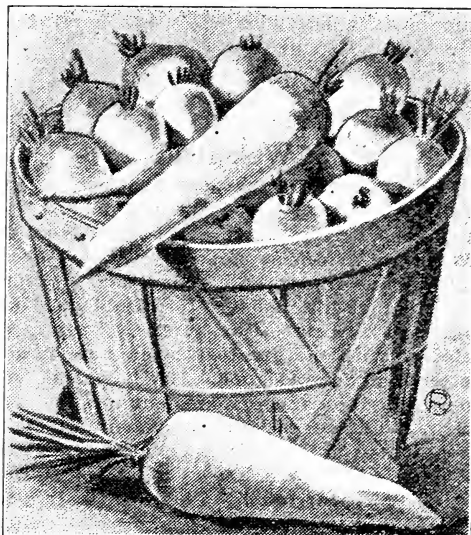

Routledge Mammoth.



Paris Golden Self-Blanching.

GIANT PASCAL

Excellent for fall or winter use, and has increased in popularity every year. A large, tall grower of the finest nut flavor, being free from any bitter taste. Very broad stalks, blanching very quickly with little banking up; an admirable keeper.

Pkt. 10c; oz. 35c; 4 oz. \$1.00

Winter Queen

One of the best winter varieties, and highly recommended. It is tall and forms a large bunch. The leaves are light green.

Pkt. 10c; oz. 35c; 4 oz. \$1.00

Highest
Quality

CELERY

Plants
Page 34

R. R.'S WHITE PLUME

Our Leading Early White Celery.

A handsome, crisp sort, of very easy cultivation. Naturally its stalks and portions of inner leaves and heart are white, so that by closing the stalks, either tying or by simply drawing the soil up against the plant and pressing it together, the work of blanching is completed without the troublesome process of "banking" or "earthing up." It is the earliest celery known, delicious and fine flavored.

Pkt. 10c; oz. 50c; 4 oz. \$1.50

PARIS, GOLDEN SELF-BLANCHING

The finest strain of French grown seed. This splendid variety is without doubt the most popular celery grown. It is a self-blanching sort, for with a little banking or covering, even the outer ribs assume a beautiful golden yellow, while the heart or vine stalks are deliciously tender, brittle and sweet. This variety is being very extensively grown both for market and private use, not only on account of its ease of cultivation, but for its superior quality. It is not quite so early as the White Plume, but is of heavier and more compact growth, the stalks being thick, crisp and brittle.

Select quality: Pkt. 15c; 1 oz. 50c; oz. \$1.50; 4 oz. \$4.50.

GOLDEN YELLOW SELF-BLANCHING.—

Same variety of celery as above, but is American grown. It is equal to most seeds offered, but not as true, dependable or of such high quality as the French grown stock.

Pkt. 10c; oz. 75c; 4 oz. \$2.50

CELERIAC

Turnip Rooted Celery, see pg. 18.

For complete seed and plant tables, amount to plant, etc., see complete reference tables inside back cover. Always refer to "Index," pages 2 and 3, for anything wanted.

"Highest Quality"**CABBAGE****True and Pure**

Our Cabbage Seeds come from the world's best growers—pure, true strains, of highest quality. One ounce will produce over 3000 plants. One-quarter pound of seed will produce plants sufficient for one acre, therefore, don't practice false economy by buying low-priced, low-quality seed.

"Carco," an inexpensive and very valuable insecticide for cabbage growers. Read about it on page 127.

Early Jersey Wakefield

The earliest and hardest heading of first early cabbages. Most gardeners depend upon it for the bulk of their extra early crop. Its exceeding hardiness not only to resist cold but other unfavorable conditions, insures the greatest likelihood of profitable and satisfactory results. **Our stock is grown and selected with the greatest care; there is none better, and few as good.** Head conical, very compact, solid and of excellent quality. The thick, stout leaves and compact habit makes it the best sort for very early setting. **HIGHEST QUALITY SEED.**

Pkt. 10c; oz. 50c; 4 oz. \$1.50; lb. \$5.00

R. S. & F. CO.'S**OREGON WAKEFIELD**

A new, most remarkable and valuable strain of Wakefield. It has the same general characteristics of other Wakefield cabbages, the heads being conical with a rounded or blunt point. It is, however, far superior to other strains, being nearly double the size and of better quality, and at the same time is almost as early. It has few outer leaves, permitting close planting.

Pkt. 10c; oz. 50c; 4 oz. \$1.35; lb. \$5.00

EARLY YORK.—A small, early, conical heading cabbage. Has been very popular. Plant close.

Pkt. 10c; oz. 40c; 4 oz. \$1.25; lb. \$4.25

== "Carco" Your Cabbage ==

This new non-poisonous liquid properly used will insure your cabbage plants against the attack of the cabbage grub or maggot that eats the root. **Don't fail to use it.** See pg. 127.

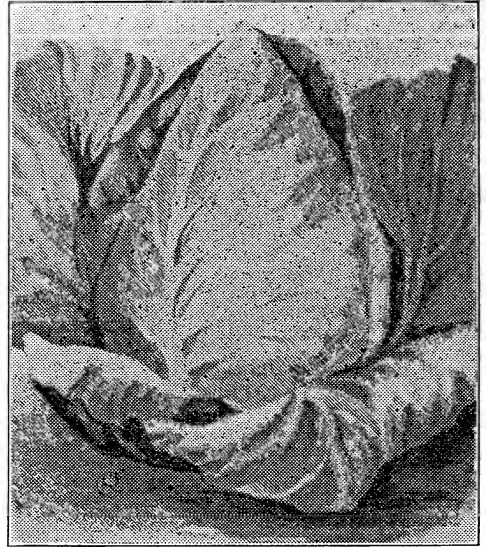

Early Jersey Wakefield,

Saginaw, Ore., Jan. 26, 1917.

Routledge Seed & Floral Co.,

Gentlemen: The reason that I buy all my Garden Seed from Routledge Seed & Floral Co. is because I want the best seed and after tests, that are many at other houses, I have decided to stay with The Routledge Seed & Floral Co.

Respectfully,

J. F. NEAT.

Early Winnigstadt

One of the best for general use, being very hardy, sweet, fine quality, and sure to head. Head regular, conical, very hard and keeps well both summer and winter. It is the hardest, not only as regards frost, but will suffer less from excessive wet, drought, insects or disease than any other second early sort. Pkt. 10c; oz. 50c; 4 oz. \$1.50; lb. \$5.00

Copenhagen Market

The earliest large round-headed cabbage yet introduced. Sure to head and every head perfect. The plant is of vigorous habit but compact, with short stem and few outer leaves which are of rather upright growth. The leaves are medium light green, nearly round, comparatively thick and smooth. The heads are round, very solid and of exceptionally good quality. Its earliness, compact growth, uniformity and size of head, firmness and most excellent quality combine to make Copenhagen Market the most valuable cabbage of recent introduction. We recommend it unreservedly. Worth the additional price.

Pkt. 10c; ½ oz. 35c; oz. 60c; 4 oz. \$2.00; lb. \$6.00.

CABBAGE PLANTS.—During planting season we aim to have on hand large quantities of Cabbage and Vegetable Plants. (See page 36.)

CABBAGE—Continued—Late Varieties**Wong Bok Pe-Tsai****Or Chinese Cabbage**

Chinese or Celery Cabbage has attained great popularity in the last two years.

We offer the true Pe-Tsai or Chinese Cabbage, which has been known and cultivated in China for many years. While practically unknown in many markets, the Chinese gardeners of the Pacific Coast have successfully cultivated it for years.

Pe Tsai produces beautiful, crisp, celery-like heads that blanch easily and that resemble a giant Cos Lettuce. As a salad it rivals the finest lettuce, while cooked like cabbage or spinach it makes a delightful "greens."

Pe-Tsai will not stand heavy frosts, so that heads intended for winter use should be dug and stored in a cool cellar.

Plant seed from June to August thinly in drills or grow like late cabbage and transplant to 1 foot apart in rows. When grown it can be blanched like celery by tying or wrapping up. **Pkt. 10c; oz. 50c**



Wong Bok Pe-Tsai.

Danish Round Head

An earlier short-stemmed strain of the famous Danish Ball Head.

Large and very solid, round head on short stems, having the same keeping quality as the original strain of Danish Ball Head, so widely known. It is 10 days to 2 weeks earlier and produces larger yields. It is especially valuable for high, dry land, producing good sized heads where other strains would be too small. For shipping in the late fall or winter there is no finer cabbage. Our seed of Danish Round Head comes direct from the originator in Denmark and is of the **Highest Quality.**

Pkt. 10c; ½ oz. 35c; oz. 60c; 4 oz. \$1.75; 1b. \$6.00



Danish Ball Head or Hollander.

Premium**Late Flat Dutch**

A low growing variety; heads large, bluish green; round, solid, broad and flat on top; an excellent fall and winter variety, and a good keeper. It is a sure header. Our stock has been grown from carefully selected heads, and we consider it superior to any other strain of Flat Dutch cabbage on the market.

Pkt. 10c; oz. 45c; 4 oz. \$1.40; 1b. \$4.50.

PERFECTION

DRUMHEAD SAVOY.—A variety that is much prized by those who are familiar with it. It is very sweet and crisp, and always tender. Heads medium size and compact, with densely and uniformly crimped or savoy leaves.

Pkt. 10c; oz. 50c; 4 oz. \$1.50; 1b. \$5.00.

MAMMOTH ROCK BED.—Best hard-headed, red variety; large heads, globular, and very deep red on top. Very tender and excellent quality; fine for cold salads on account of its attractive color.

Pkt. 10c; oz. 50c; 4 oz. \$1.50

Danish Ball Head—Genuine Danish Grown Stock

Most remarkable late cabbage yet produced, heads hard and solid—fine grained and tender. Entirely distinct. Exceedingly hardy in resisting cold and wet weather. We offer true, pure seed of the very finest medium short stemmed type. Famous for its hard-heading qualities, which at once recommends it as highly valuable for shipping. The magnificent heads are round in form and keep in excellent condition during winter, coming out in the spring perfectly solid.

Pkt. 10c; ½ oz. 35c; oz. 60c; 4 oz. \$2.00

DO YOU SEND EAST for your Seeds? It's bad policy. Spend your money on this Coast. Here's where you sell your products. Our Seeds are highest quality.

Selected CORN—SWEET OR SUGAR Northern Grown

Packet and single pound prices only prepaid. Add postage to 10 lb. prices if wanted by mail. Write for quantity price.

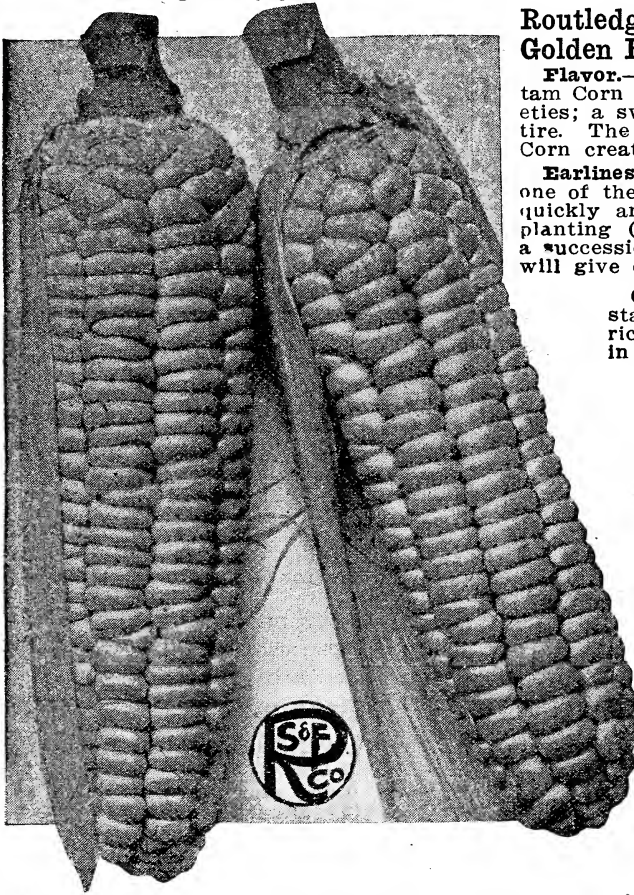

Routledge Selected Golden Bantam.

Routledge Superb

We do not hesitate to recommend this new sweet corn to our customers. Its earliness, hardiness, size and quality make it of real merit to the western planters. It is extremely early, almost two weeks ahead of Golden Bantam and one week ahead of Portland Market. The large ears are always well filled with 12 to 14 rows of large, plump, white, sweet grains, of handsome appearance and excellent quality.

Large pkt. 15c; lb. 45c; 10 lbs. \$4.00

Portland Market

An Oregon introduction, a very early large eared sweet corn and very productive. It's large well-filled ears, together with its plump, sweet grains of purest white, makes it a most profitable home or market variety. Very popular with our market gardeners.

Large pkt. 15c; lb. 40c; 10 lbs. \$3.50

Early Evergreen

This fine variety is 10 to 12 days earlier than Stowell's Evergreen and yields large, handsome, 10 to 12-rowed ears. An excellent variety to follow the first early kinds. Near Portland it will make a late or main crop variety.

Large pkt. 15c; lb. 40c; 10 lbs. \$3.50

Routledge's Selected Golden Bantam

Flavor.—Without exception, Golden Bantam Corn is the richest in flavor of all varieties; a sweet corn of which one will never tire. The first trial of this delicious Sweet Corn creates a taste "like more."

Earliness.—Golden Bantam Sweet Corn is one of the earliest sweet corns. It matures quickly and is suitable not only for early planting (on account of its hardiness), but a succession of sowings may be made which will give continuous supply until fall.

Color.—When picked at the proper stage of its growth the kernels are a rich, creamy yellow and unsurpassed in quality.

Growth.—Being dwarf in its growth, with stalks small in size, it can be planted quite close, and a large crop may be obtained on a small area. The ears are 8 to 10-rowed, and about 6 inches long—just the right size for the table.

Remember our selected strain is northern grown, better flavored and truer than most seed offered.

Price: Large pkt. 15c; lb. 45c; 10 lbs. \$4.00.

Peep o' Day

Extremely early and of excellent flavor and quality. Ears medium sized. Stalks quite dwarf and can be planted quite close, thereby securing a large crop off a small space. An ideal white sweet corn for the home garden.

Large pkt. 15c; lb. 35c; 10 lbs. \$2.75.

Early Minnesota

This old and deservedly popular variety is one of the best early sorts for the market.

Large pkt. 15c; lb. 35c; 10 lbs. \$2.75

Early Mammoth

Medium early. Ears large and well filled, sweet and of good quality. Planted early it will produce a large, profitable crop.

Large pkt. 15c; lb. 40c; 10 lbs. \$3.00

Black Mexican

An extra fine variety, unsurpassed for sweetness. Seed bluish-black when ripe. Highly praised; a great favorite with many.

Large pkt. 15c; lb. 45c; 10 lbs. \$3.85

Stowell's Evergreen

A good main crop or late sort. Remains longer in green state than any other. Very large ears, with deep grains, and remarkably sweet. Locally it must be planted early to mature. Quite extensively planted by dairymen for feeding green on account of its sweetness.

Large pkt. 15c; lb. 40c; 10 lbs. \$3.25

POP CORN

WHITE RICE.—Most popular and profitable kind; short ears, white, pointed kernels.

Large pkt. 15c; lb. 30c; 10 lbs. \$2.75

FIELD CORN—Don't overlook what we have to offer in **OREGON-GROWN FIELD CORN**; "the best ever." See page 46. for **HAND CORN PLANTERS** see page 121.

CUCUMBERS



Routledge Highest Quality Cucumber.

Routledge Highest Quality

A quick grower and always commands "fancy prices" on account of its fine form and superb quality.

It is the earliest white spine cucumber, suitable for table, market or shipping purposes, under all conditions of culture, whether under glass or in the open ground.

Color a very deep green, which it retains during a long period, while in symmetry of form it is so regular, so uniform, as to create comment wherever seen.

Quality is superb, being exceedingly brittle and crisp. The flavor is delicate and entirely devoid of the bitter taste so frequently noticed in other varieties.

Pkt. 10c; oz. 25c; 4 oz. 75c; 1b. \$1.75

Arlington White Spine

One of the best sorts for table use. Vines vigorous, fruiting early and abundantly. Fruit uniformly straight, light, bright green in color, with a few white spines. Flesh crisp, tender and of excellent quality.

Pkt. 5c; oz. 20c; 4 oz. 50c; 1b. \$1.50

Improved Long Green

The leading large variety. Fruit from 10 to 12 inches long, dark green, crisp and tender. A good variety for slicing, and when ripe they are the best for sweet pickles.

Pkt. 5c; oz. 20c; 4 oz. 50c; 1b. \$1.50

Davis' Perfect

As now selected, the long, even fruits are of fine form, with an intensely dark rich green skin. The solid white flesh is of superb quality for slicing. So handsome and regular are the fruits, even when grown outside, that they bring an extra price on the market, often being taken for "hot-house grown."

Pkt. 5c; oz. 20c; 4 oz. 50c; 1b. \$1.50

GHEBKIN FOR PICKLING.—A very small, oval, prickly variety, quite distinct from all others. Pkt. 5c; oz. 20c; 1 lb. 60c

JAPANESE CLIMBING.—A vigorous grower, can be trained on a trellis or the garden fence, thereby saving ground space. Fruit from 12 to 16 inches long, dark green and smooth. Flesh pure white, crisp and tender. Pkt. 5c; oz. 15c; 4 oz. 50c; 1b. \$1.50

Lemon Cucumber

New. Highly recommended by all who have tried it for slicing and salads. Resembles a lemon both in size, form and color. Has a distinctive and delicious flavor superior to and not found in any other cucumber. A variety of real merit—try it.

Pkt. 10c; oz. 25c; 4 oz. 75c

Boston Pickling

A distinct variety, very popular for pickles; color bright green, a great producer and of excellent quality. It is for producing medium-sized pickles that this variety is so highly esteemed. If the fruits are gathered as soon as large enough, the vines will continue bearing through a long season.

Pkt. 5c; oz. 15c; 4 oz. 40c; 1b. \$1.25

EARLY SHORT GREEN.—A very early and productive variety, bright green, rather short, straight and a little smaller at the ends. Crisp and tender. Good for pickling or slicing. Pkt. 5c; oz. 15c; 4 oz. 40c; 1b. \$1.25



Boston Pickling.

USE WONDER.—So many of our customers tell us of the wonderful results, the increased yield and quick growth obtained by using our Odorless "Wonder" Fertilizer, that we again call YOUR attention to it. Remember you can get it by parcel post. See page 39.

DRY FRUIT AND VEGETABLES

By securing one of Oakes' Evaporators you can, with very little trouble, dry your surplus fruit and garden truck for winter use. It will give you more variety and reduce your grocery bill. See Page 123.

CELERICAC

Turnip Rooted Celery.—The roots, which are the edible portion, keep well for winter use and are excellent for soups and stews. They are also cooked and sliced as a salad. Sow seed at the same season and give the same treatment as any root crop.

LARGE ERFURT.—An improved form, producing large, smooth roots, which are nearly round.

Pkt. 10c; oz. 25c; 4 oz. 75c

EGGPLANT

Sliced and fried takes the place of meat. Culture same as for tomatoes.

NEW YORK IMPROVED SPINELESS.—Considered the best variety. Oval shaped, deep purple, large size and fine flavor.

Pkt. 15c; ½ oz. 45c; oz. 75c

ENDIVE

This plant furnishes an attractive and appetizing salad for the fall and winter months or by repeated sowings a supply may be had nearly all the year round. Useful in flavoring soups, stews, etc. Makes delicious greens if cooked like spinach. Cultivation same as for lettuce. The bleaching of Endive is brought about by drawing the leaves together into a head and tying them and this should be done a month before it is wanted for table use.

BROAD LEAVED BATAVIAN.—Leaves are broad, thick, green, more or less twisted and waved with white mid-ribs. It forms large hearts, which when blanched, form one of the best winter salads. Crisp, tender and fine flavor.

Pkt. 5c; oz. 20c; 4 oz. 50c; lb. \$1.50

GREEN CURLED.—The hardest of all, with beautifully curled dark green leaves, tender and crisp.

Pkt. 5c; oz. 20c; 4 oz. 50c; lb. \$1.50

WHITE CURLED.—Very tender and light green, blanches easily, very ornamental.

Pkt. 5c; oz. 20c; 4 oz. 50c; lb. \$1.50

GARLIC

Garlic is a perennial plant with a bulbous root and belongs to the onion family. It has flat leaves and the bulb is composed of several parts or bulbets similar to those of a multiplier onion set. We cannot offer seeds but can supply the bulbs or sets.

Prepare the ground as for onions, separate the sets and plant them in drills eight inches apart and four to six inches apart in the drill, covering two inches deep. Cultivate like onion sets. When the leaves turn yellow, pull up the bulbs and dry in the shade.

Per lb., 35c, postpaid

Write for quantity price. Requires about 250 lbs. sets per acre.

HORSERADISH ROOTS

Will form radishes of large size in one season's growth. For prices, see Vegetable Plants and Roots, page 118.

On Cucumber and Garden Plants use "Bug Death" for Insects (see page 127), and "WONDER FERTILIZER" (see page 39), and you will be more than pleased with results.

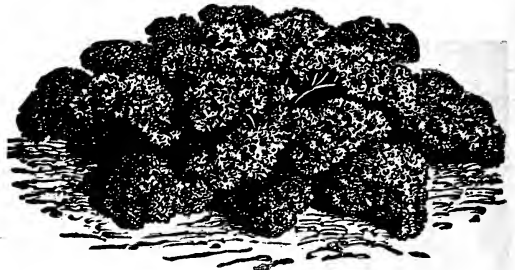

Dwarf Green Curled.

KALE, or BORECOLE

This is a popular boiling-green resembling cabbage in flavor. The plant is entirely hardy in well-drained soil and can be grown easily from seed planted during the summer and fall months. With the tall varieties it is customary to pull off the lower leaves and let the plant grow on to furnish a continuous supply. The sweetness and flavor of these greens are improved by frost or light freeze.

DWARF GREEN CURLED.—Beautifully curled, bright green leaves, tender and of fine flavor.

Pkt. 5c; oz. 25c; 4 oz. 60c; lb. \$1.50

TALL GREEN CURLED.—Grows about 2 feet high; leaves dark green; curled and wrinkled; very hardy.

Pkt. 5c; oz. 25c; 4 oz. 75c; lb. \$2.25

EMERALD ISLE.—A very handsome variety of medium height. Leaves attractive, closely curled and of fine flavor.

Pkt. 10c; oz. 25c; 4 oz. 75c; lb. \$2.25

THOUSAND-HEADED.—For stock feeding. See Field Seeds, page 45.

KOHL-RABI

A delicious vegetable. In growth this is half-way between cabbage and turnip; the edible portion is the large bulb which forms on the stem above the soil. By making successive sowings, tender bulbs may be had throughout summer and fall, and are highly esteemed for their mild, delicate, cabbage-like flavor. Slice and boil, discarding the hard lower part of bulb. Sow in drills or raise and transplant like cabbage 6 to 10 inches apart.

EARLY WHITE VIENNA.—Extremely early, medium size, excellent quality.

Pkt. 5c; oz. 25c; 4 oz. 75c

LEEK

A species of onion which does not form a bulb, but is used for its mild and delicious root, stem or neck. Plant in rows and thin to about four inches. Hardy, and frost improves the flavor. Hill up to whiten.

AMERICAN FLAG.—Mild and sweet; long, large stems; hardy and of the finest quality.

Pkt. 10c; oz. 30c; 4 oz. \$1.00

CARENTAN.—Very broad, thick stems of good flavor. Very large variety.

Pkt. 10c; oz. 30c; 4 oz. \$1.25

LETTUCE

Grand Rapids

Very popular with private gardeners and as a lettuce for greenhouse forcing. It will stand shipping better than most curled sorts. Of quick growth and stands for some days after being fit to cut. The plant is upright, and forms a loose head or cluster of large, bright green leaves, finely crimped and ruffled; rather thin, good flavor, crisp and tender.

Pkt. 5c; oz. 15c; 4 oz. 35c; lb. \$1.25

SIMPSON'S EARLY CURLED.—A very extensively used early loose-leaved, or clustering variety. Leaves light green, slightly frilled, crisp, sweet and tender.

Pkt. 5c; oz. 15c; 4 oz. 35c; lb. \$1.25

EARLY PRIZE HEAD.—A large, clustering, non-heading lettuce, most excellent for the home garden and undoubtedly the most easily grown variety in cultivation. It is too tender, however, to stand shipping or handling on the market. Leaves finely curled and crumpled, bright green tinged with brownish red, very crisp, tender and sweet.

Pkt. 5c; oz. 15c; 4 oz. 35c; lb. \$1.25

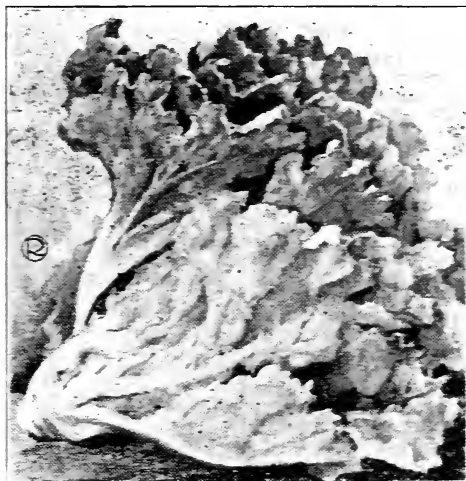

Grand Rapids.

Trianon Cos or Romaine

EARLY WHITE COS—Self Folding.—Distinct in having long, narrow, spoon-shaped leaves, folding into loose, sugar-loaf-shaped heads which blanch better by having the outer leaves drawn about them and tied. Leaves yellowish white, crisp, tender and of a distinct and pleasing flavor.

Pkt. 5c; oz. 15c; 4 oz. 35c; lb. \$1.25

Big Boston—Improved

Plants large, very hardy and vigorous. Leaves broad, comparatively smooth, wavy at edges, thin, very firm and crisp; color bright light green, slightly tinged with reddish brown. Grown extensively in the South for shipment north in the winter. It usually heads up under cold weather conditions better than any other variety.

Pkt. 5c; oz. 15c; 4 oz. 45c; lb. \$1.50

OUR MOTTO:
Quality first,
price as low
as we can
make it.



R. R.'s Wonderful.

HANSON

Improved Hard Heading Stock.—The leading head lettuce. We can recommend this as one of the very best. Heads green outside and white inside; grow to a remarkable size; very solid, and is deliciously sweet, crisp and tender. It withstands the hot sun.

Pkt. 5c; oz. 15c; 4 oz. 45c; lb. \$1.50

Salem, Ore., Dec. 26, 1916.

Routledge Seed & Floral Co.

Dear Sirs: Last spring you sent me a sample package of R. R. Wonderful lettuce seed and it was the best I ever saw. I tried hard to get it to go to seed but it didn't bloom until after the frost, and it was not bad to eat then as it was real tender and sweet yet.

Yours respectfully,

MRS. EDWARD BELLER.

Everett, Wash., April 18, 1917.

Routledge Seed & Floral Co.

Gentlemen: I want to commend your R. R.'s Wonderful Lettuce as the best that I have ever grown, and the two packets that I am now ordering are for a friend.

Yours truly,

E. E. SEARLES.

R. R.'s Wonderful

A reselected, hand-picked strain of the original New York or Wonderful. Our grower has given this stock special attention and it is a wonderful strain. It produces immense heads of closely folding ruffled leaves. The heart blanches beautifully and is crisp, tender and delicious. A robust variety, rooting deeply and thus able to resist hot, dry weather; slow to seed and a sure header. The outer color is of a distinct apple-green. A rapid grower and unsurpassed as a home or market lettuce.

Read reports above.

Pkt. 10c; 1/2 oz. 15c; oz. 25c;
4 oz. 60c; lb. \$2.00.

A NEW STRAWBERRY—Read about the wonderful "Marvel," a new variety of sterling merit, most delicious of all. Get a start—you'll be delighted. See Page 116.

LETTUCE—Continued

R. R.'s Tender Crisp

A distinct and extra choice variety for those who like curly, crisp, tender Lettuce of the finest quality.

Grows to a large size, makes most desirable heads of pleasing appearance, and retains its crispness and mild flavor to a greater degree during the hot summer months than any other crisp-head variety. While especially adapted for midsummer, it is most desirable also for spring and fall. The plants are of quick, strong growth; the leaves are of a soft, bright green, growing closely around the heads, which are tightly folded and blanch to a silvery white, and crisp and brittle as could be desired.

Pkt. 10c; ½ oz. 15c; oz. 20c; 4 oz. 60c; lb. \$2.00.

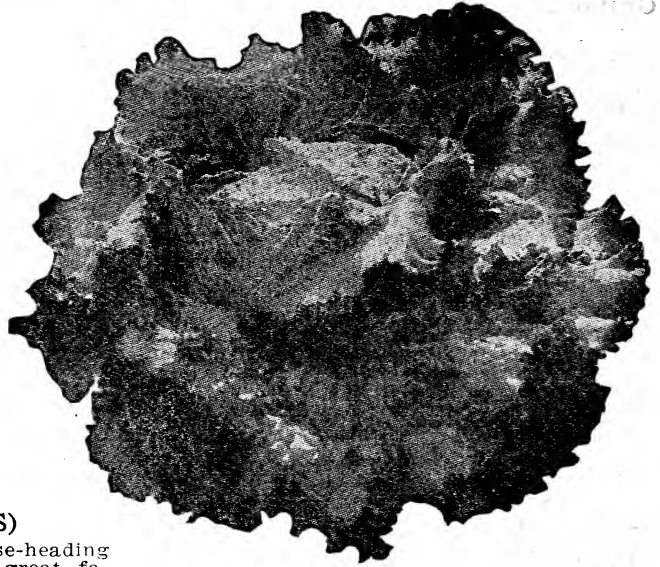

R. R.'s Tender Crisp Lettuce.

NEW YORK (LOS ANGELES)

A large, crisp, curly-leaf, close-heading lettuce of the finest quality. A great favorite in the markets of Los Angeles and San Francisco. Carloads of this variety are shipped by California growers and it brings the highest prices.

Pkt. 10c; oz. 20c; 4 oz. 60c; lb. \$2.00

Early May King

The plants are of quick growth, practically all head and extremely handsome. From early spring plantings in the open ground they grow quickly to a diameter of 6 to 7 inches with the broad, light-green outer leaves folding closely about the round solid head. The inner leaves (practically the entire head) are blanched to a rich golden yellow and have a specially fine, rich, buttery flavor.

Pkt. 5c; oz. 15c; 4 oz. 50c; lb. \$1.50

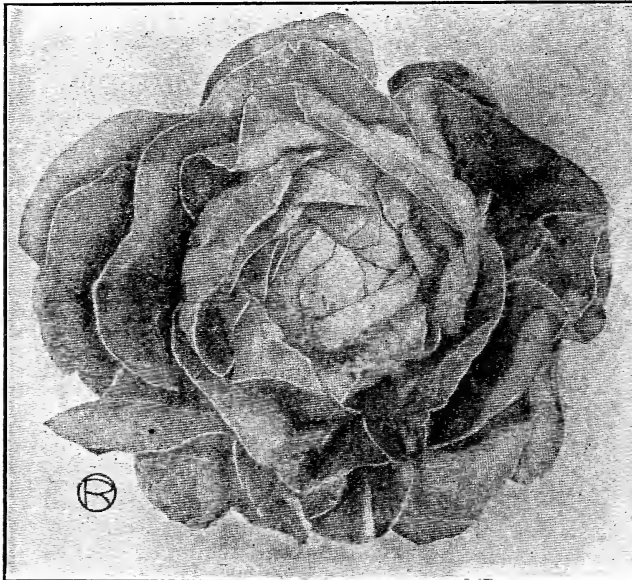

Way-a-head—Extra Early.

CALIFORNIA CREAM BUTTER

A very popular variety for autumn and winter use. Forms a very large head, which is very buttery and of a rich golden yellow inside. The leaves are thick and of bright green, slightly tinged with brown on top of head.

Pkt. 5c; oz. 15c; 4 oz. 45c; lb. \$1.25

IMMENSITY

A very large-heading variety, one of the largest of the cabbage sorts; larger than California Cream Butter, which it resembles in color and shape. It is especially adapted for planting in the fall and winter, and makes a fine, tender, buttery head.

Pkt. 10c; oz. 15c; 4 oz. 40c; lb. \$1.25

Way-a-head Extra Early

A new lettuce showing a remarkable combination of earliness, firm heading character, handsome appearance and fine quality. Both in cold-frames early in the spring and in the open ground—in spring, summer and early fall months—it has proved to be not only the earliest and one of the surest heading of all early lettuce, but also of the very finest quality. It is not only earlier than May King and other fine early varieties, but the tightly folded heads are generally larger in size. The outer leaves are a light green, with the inner head finely blanched to a rich buttery yellow. We urge you to try this new variety (see cut).

Pkt. 10c; ½ oz. 15c; oz. 20c; 4 oz. 60c; lb. \$2.00.

PLANT SMALL FRUITS around your garden. What's nicer than delicious fresh fruit, fresh from your garden? See Fruit Department, pages 109 to 119.

MUSKMELON

NETTED ROCK OR ROCKY FORD

The most popular and best seller among Muskmelons.

The fruit is oval and completely covered with a beautiful lace-like netting. Flesh very thick; green, very sweet, luscious, melting and superb flavor. The fruit is wonderfully uniform in shape and quality. The favorite everywhere.

Pkt. 5c; oz. 15c; 4 oz. 40c; lb. \$1.25.

BURRELL'S GEM — Select Strain.—A new, medium-sized, oval variety, well ribbed and covered with a fine grayish netting and having reddish orange flesh of fine, spicy flavor, sweet and delicious, distinct flavor. There is a growing demand here for the fine-grained, smooth, salmon, red-fleshed Muskmelons.

Pkt. 5c; oz. 15c; 4 oz. 40c; lb. \$1.25.

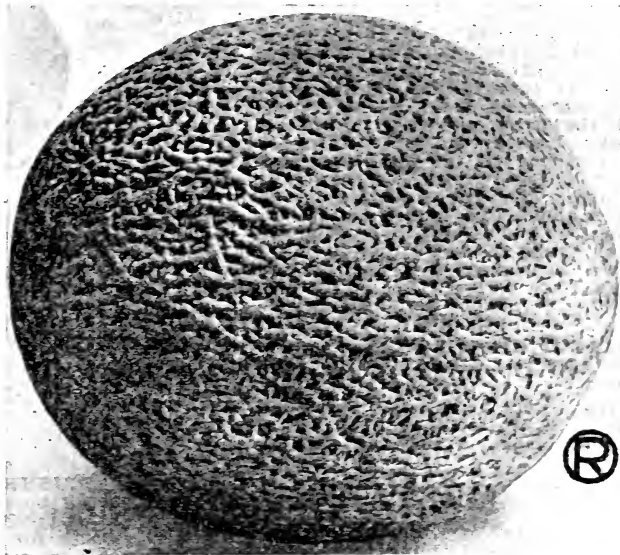

Netted Rock—Rocky Ford

THE HOODOO.—One of the best of recent introductions. It is early and prolific. The fruit is of medium size, the seed cavity very small, the rind very thin, indeed, and the edible fleshy part thick and meaty. It is of orange or salmon color, the type much preferred now; but its great charm is its flavor, which is par excellence. Test it.

Pkt. 10c; oz. 20c; 4 oz. 60c; lb. \$2.00

MONTREAL IMPROVED NUTMEG.—Valued for its size and delicious flavor. Round in shape, with remarkably thick green flesh. One of our handsomest varieties.

Pkt. 5c; oz. 15c; 4 oz. 40c; lb. \$1.25

OSAGE, OR MILLER'S CREAM.—Medium to large, flesh thick, deep salmon, of excellent quality, rich and sweet; skin dark green, slightly netted and ribbed. A favorite variety for the later markets.

Pkt. 5c; oz. 10c; 4 oz. 40c; lb. \$1.25

LARGE YELLOW CANTALOUPE.—A distinct type and very popular with all who have tried it. The fruit is large, oblong, slightly ribbed and coarsely netted. The flesh is light yellowish green, very sweet, crisp and delicious.

Pkt. 5c; oz. 15c; 4 oz. 40c; lb. \$1.25

Golden Beauty Cassaba

Fall and Winter Muskmelons

Skin wrinkled, flesh thick, excellent flavor and fine aroma. When nearly ripe pick and stow away in a cool, dark place until the rind becomes slightly softened and moist. Melons will actually keep until February. Pkt. 10c; oz. 20c; 4 oz. 60c; lb. \$2.00

WATERMELON

ROUTLEDGE'S OREGON PRIZE

We offer this new Melon with the assurance that it is not only remarkably early, but as sweet, delicate and melting in flavor as any variety grown.

The flesh is of a deep scarlet; rind thin, and on this account is not a particularly good shipping sort, but is emphatically the variety for home use and sale. It will ripen in altitudes where it has not been thought possible to mature a good watermelon.

Pkt. 10c; oz. 20c; ¼ lb. 60c; lb. \$2.00

COLE'S EARLY.—One of the best early sorts; medium size, green skin and red flesh. Pkt. 5c; oz. 10c; 4 oz. 35c; lb. \$1.25

KLECKLEY'S SWEET

Unsurpassed for home use or near markets. Vine vigorous and productive; fruit of medium size, oval; color dark green; flesh very bright, rich red and exceedingly sweet.

Pkt. 5c; oz. 15c; 4 oz. 35c; lb. \$1.25

Cuban Queen.—A very vigorous grower; early, very solid and heavy; of most delicious flavor.

Pkt. 5c; oz. 15c; 4 oz. 35c

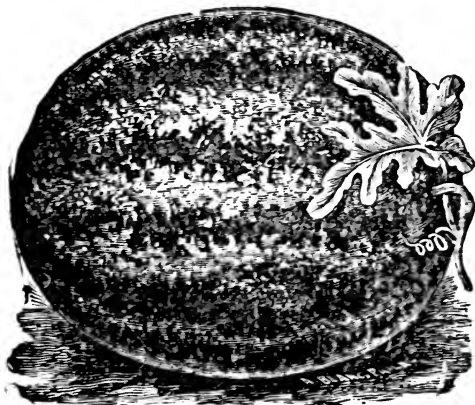

Routledge's Oregon Prize

Citron, Red Seeded.—Flesh white and solid, used exclusively for pickles and preserves.

Pkt. 5c; oz. 15c; 4 oz. 35c

Seed and Reference Tables, Amount to Plant, etc., see complete reference tables inside back cover. Always refer to "Index," pages 2 and 3, for anything wanted.

MUSHROOM SPAWN

LAMBERT'S PURE CULTURE SPAWN.—Mushrooms may be grown in any place where conditions of temperature and moisture are favorable. A shed, cellar or cave may be utilized to advantage for this purpose. It is essential that the temperature be maintained from 53 to 60 degrees F., and that the moisture be properly regulated. Lambert's Pure Culture Spawn is far superior to the old-style varieties, and much better results can be obtained from its use. The bricks should be broken into pieces about two inches square and planted from 10 inches to a foot apart. Bricks weigh from 18 to 20 ounces. A brick will spawn 10 square feet of bed. With Lambert's Pure Culture Spawn it is impossible to raise poisonous mushrooms.

DIRECT SPAWN.—Latest and best. Mammoth White, Cream White or Bohemian Brown.

Price, per brick, not prepaid, 25c; 10 bricks, \$2.35; add postage at rate of 1½ lbs. per brick. Write for quantity price.

MUSTARD

The leaves of mustard make excellent greens of sharp, pungent flavor, and are cooked the same as spinach or beet leaves.

SOUTHERN GIANT CURLED.—Large variety, forming a great mass of beautiful leaves, which are ruffled and finely curled on the edges; hardy, vigorous, highly recommended. Pkt. 5c; oz. 15c; 4 oz. 40c; lb. \$1.25

Ostrich Plume

Leaves dark green, beautifully curled and plume-like. Very vigorous and productive, stands well. Of distinctive flavor; superior to spinach for greens and excellent for salad.

Pkt. 10c; oz. 20c; 4 oz. 60c; lb. \$1.50

White English.—Light green variety; tender leaves; seed light yellow.

Pkt. 5c; oz. 10c; 4 oz. 25c; lb. 65c

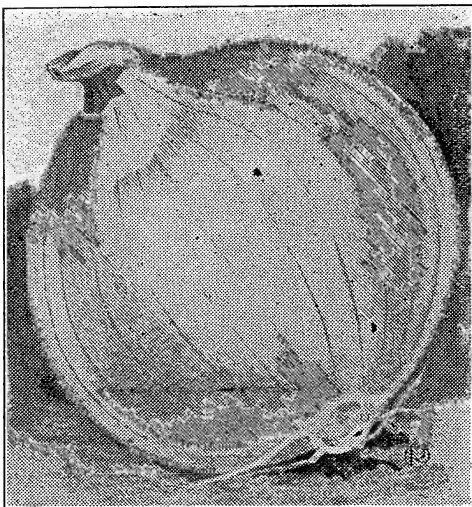

Routledge Prize Taker (see next page).

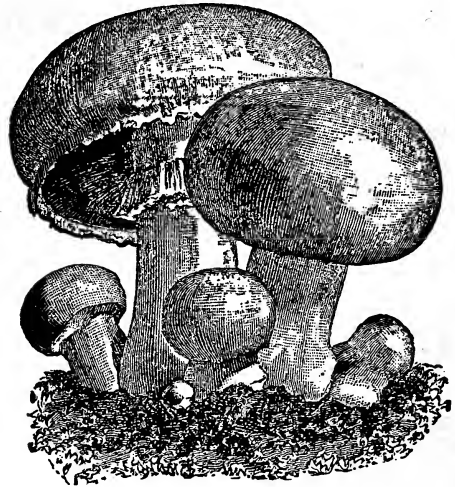

Mushrooms.

MUSHROOM CULTURE.—We have a 32-page booklet on Mushroom Culture, nicely illustrated, for 25c, postpaid. Free with an order for 10 bricks.

VALUABLE BOOKS

We offer many practical and up-to-date books that you will find of interest. Why not gain in a few hours' study what others learned by years of hard work. See page 132.

OKRA

IMPROVED DWARF GREEN.—Very productive; long, slender green pods.

Pkt. 5c; oz. 15c; 4 oz. 30c

ONION SETS

BOTTOM ONION SETS.—These small onions are grown from seed that have been sown too thick to attain a large size. The small onions (about ½-inch in diameter) thus obtained are planted out and are ready in a short time to pull as green onions for the table.

Per lb. 25c; not postpaid 20c or 3 lbs 50c. Write for quantity prices.

TOP SETS.—Lb. 30c; not postpaid 20c.

SHALLOTS.—Valuable for bunching or for an early crop. Each bulb makes from 3 to 5 green onions.

Per lb. 30c; 4 lbs. \$1.00, prepaid

ONION

Highest Quality—True Seed

Extra Early Red Flat

The first Red Onion to ripen. A medium-sized, flat variety; an abundant producer and very uniform in shape and size; fine grained, mild flavored, and comes into use nearly two weeks earlier than the Large Red Wethersfield; very desirable for early market use.

Pkt. 10c; oz. 35c; 4 oz. \$1.25; lb. \$3.50

YELLOW DANVERS.—A popular and well-known variety. Earlier and flatter than Yellow Globe. Excellent for bunching green.

Pkt. 10c; oz. 35c; 4 oz. \$1.25; lb. \$3.50

DON'T Practice false economy by buying low-priced seeds. New-crop seeds are the shortest ever known this year. Low prices means old seed. Be careful.

ONION—Continued

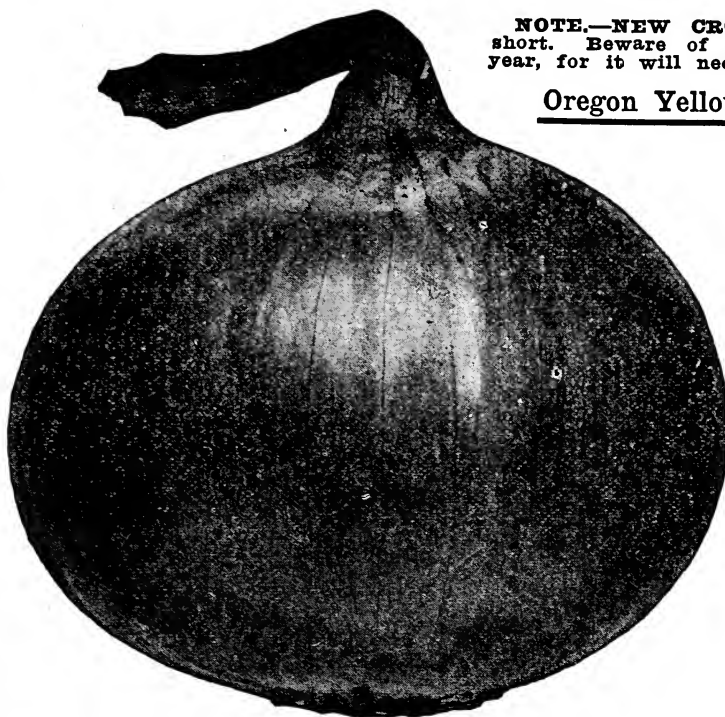

Oregon Yellow Danvers Onion.

NOTE.—NEW CROP ONION SEED is very short. Beware of **LOW PRICED SEED** this year, for it will necessarily mean **OLD SEED**.

Oregon Yellow Danvers

This is the variety planted almost entirely in the Northwest, particularly in Oregon. The largest crops of onions and the best keepers, bringing the highest prices in the Pacific Coast and Middle Western markets, are the Oregon Yellow Danvers. The bulbs are uniformly large, three-quarters globe shape, with small necks. It is the earliest, largest in size, most perfect in shape, the largest cropper and the best keeper, and as a market or table onion cannot be excelled. **Our seed is grown specially for us by the best onion seed growers in Oregon.** No onion grower can afford to plant anything inferior when such seeds can be obtained at the following prices:

Pkt. 10c; oz. 50c; 4 oz. \$1.50; lb. \$5.00.

Salem, Ore., Jan. 26, 1917.

Routledge Seed & Floral Co.,

Gentlemen: I was well pleased with the quality of the vegetables from the seed which you sent me last year, hence this order.

Yours very truly,

C. M. INMAN.

Eugene, Ore., Jan. 23, 1917.

Routledge Seed & Floral Co.,

Gentlemen: I have received your catalog. Your seeds gave perfect satisfaction last year.

Yours very truly,

J. D. MYERS.

Routledge Prize Taker

This onion has become a great favorite on account of its large size and great solidity. It is perfectly globe-shaped, with straw-colored skin; the necks are very small and the onions always ripen up hard. An excellent keeper, exceedingly fine, mild flavor and a very popular variety.

Pkt. 10c; oz. 50c; 4 oz. \$1.50; lb. \$5.00

Yellow Globe Danvers

One of the most extensively used yellow onions. Bulbs of good size, uniformly globe-shaped, with small neck, and ripen very evenly. Flesh white, crisp and of mild and excellent flavor. An enormous yielder and a fine keeper. We offer a select strain, unsurpassed.

Pkt. 10c; oz. 40c; 4 oz. \$1.25; lb. \$4.25

Large Red Wethersfield

The Standard variety of the red onions. Of large size, half globe, a heavy yielder, and one of the best for keeping. Skin a deep purplish red, smooth and glossy; will do better on fair upland soil than most varieties; flesh white, rather strong.

Pkt. 10c; oz. 35c; 4 oz. \$1.25; lb. \$3.75

Crystal White Wax

A large, pure white, flat onion. During the last few years it has become very popular. Extremely early and one of the mildest and sweetest of all. It is very fine for slicing, the color being so clear and pure. We offer the genuine true seed.

Pkt. 15c; oz. 60c; 4 oz. \$1.75

Australian Brown

Its remarkable keeping qualities and handsome appearance makes it very desirable.

Resembles the Yellow Danvers in general appearance, but has a clear, amber-brown skin. It matures early, ripens uniformly and is a good, long keeper.

Pkt. 10c; oz. 35c; 4 oz. \$1.25; lb. \$3.50

Southport White Globe

An enormous yielder and superb keeper; perfect globe-shaped, very large, clear white skin and considered one of the handsomest varieties grown. Planted extensively by market gardeners for green onions.

Pkt. 15c; oz. 60c; 4 oz. \$1.75; lb. \$6.00

WHITE PORTUGAL or Silverskin

The finest flavored of all the white-skinned onions. Quite early, half-globe shaped, a fine cropper; very firm and an excellent keeper. Planted thickly in broad drills makes fine pickling onions.

Pkt. 15c; oz. 50c; 4 oz. \$1.50; lb. \$5.50

WHITE BARLETTA—Queen

An early white variety; prized for home gardens and pickling on account of its small size. White Portugal is a much better keeper. (Very short crop.)

Pkt. 15c; oz. 50c

DO YOU SEND EAST for your Seeds? It's bad policy. Spend your money on this Coast. Here's where you sell your products. Our Seeds are highest quality.

"Highest Quality"**GARDEN PEAS****Hand Picked**

There is a vast difference in "strains" of garden peas. You will find our stock "very superior," healthy, vigorous and true, much better than the average seed sold by wholesale seed dealers and jobbers. Try them if you want "Highest Quality."

Packet and single pound prices only are prepaid. Add postage to 10-lb. prices if wanted by mail. **WRITE FOR QUANTITY PRICES.**

ALASKA.—An extra early, exceedingly hardy pea. Pods of perfect shape, well filled with smooth peas of unrivaled quality. Height 2½ feet. Can be planted much earlier than wrinkled peas.

Large pkt. 15c; lb. 35c; 10 lbs. \$3.00

AMERICAN WONDER.—Well known and very popular; extra early, productive and good flavor; grows 10 inches high.

Pkt. 15c; lb. 35c; 10 lbs. \$2.75

R. R.'s Prosperity

The Earliest Large Podded, Sweet Garden Pea to date.

It is hardy and can be planted fully as early as Alaska.

This grand, large podded, extremely early, prolific variety, is vigorous and robust; height 3½ to 4 feet; only a few days later than the earliest smooth sorts.

The pods are very large, and are invariably well filled with from 8 to 10 sweet, luscious, tender, wrinkled peas of large size and delicious flavor.

The peas remain tender and sweet for some time after they are large enough to use. Its heavy yield and excellent quality makes it a most profitable market variety.

Large pkt. 15c; lb. 40c; 10 lbs. \$3.00; 25 lbs. \$6.25.

Duke's Delight

A very dwarf, extra early delicious pea of great merit.

Our regular customers are now demanding it in preference to American Wonder, Notts and Gem varieties.

Duke's Delight easily outclasses these old popular kinds in **productiveness, size and fullness of pods, color, sweetness and flavor.** The sturdy, stocky, healthy vines grow about 12 to 14 inches high. **Every grower praises it.** Read reports, we receive many like them.

Large pkt. 15c; lb. 40c; 10 lbs. \$3.25; 25 lbs. \$7.25.

GOOD LUCK—Te-a-wha

You will certainly be delighted with this new variety. Sturdy, dark green vines, 2 feet high, covered with large pods containing 9 to 11 superb flavored peas that retain their color and flavor longer than most kinds. Ten days later than Duke's Delight. Excellent for the home or market gardens.

Large pkt. 15c; lb. 35c; 10 lbs. \$2.75

SUTTON'S EXCELSIOR

This handsome wrinkled Pea is so hardy that it may safely be planted as early as Alaska. The plants are dwarf, sturdy, very stout, exceedingly productive and the "quality" is all that could be desired. The pods are large for so dwarf a variety and always well filled. Improvement over Notts Excelsior, Premium and Little Gem.

Large pkt. 15c; lb. 35c; 10 lbs. \$2.75; 25 lbs. \$6.25; 100 lbs. \$22.50.

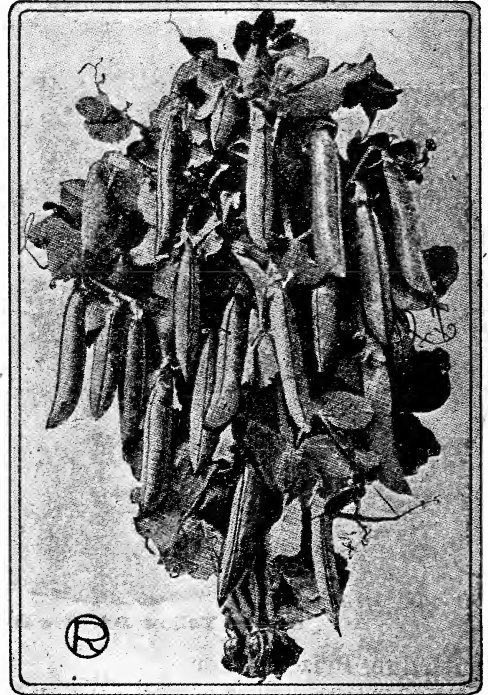

Duke's Delight.

Kootenai, Idaho, July 14, 1917.

Routledge Seed & Floral Co.,

Gentlemen: My "Duke's Delight" Peas are simply delicious, and will surely want more next year! All the other seeds came up good, and our garden is the best looking one for miles around.

Yours very sincerely,
EDW. ANDERSON.

Salem, Ore., June 26, 1917.

Routledge Seed & Floral Co.,

Gentlemen: Enclosed herewith you have money order for which please send me p. d. g. some more of those "Dukes" Delight Peas. We are using them now and they are the best ever. Will have to dig up some other garden truck to make room for them, but they are worth it.

Yours very truly,
C. O. RICE.

Sherwood (King Edward)

A splendid new pea, produces in great profusion the largest pods of any early dwarf variety and the pods are filled with 8 to 10 large deep-colored peas of the most delicious flavor and quality. Very hardy.

Large pkt. 15c; lb. 35c; 10 lbs. \$2.75; 25 lbs. \$6.75; 100 lbs. \$25.00.

Routledge Prize

Largest pods, sweetest peas, most productive main crop variety. **SEE PAGE 26.**

Be sure you read about Mulford's Culture for inoculating pea seed. Increases the yield and improves the soil. (See page 37.) Plant extra early, early and late varieties all at same time for a succession of prime pods.

Highest Quality Garden Peas—Continued

Remember, a little extra cost at planting time will bring "dollars" or greater satisfaction at harvest time. Packet and single pound prices only prepaid. Write for quantity price.

BURPEE'S "BLUE BANTAM"

Unequaled for extreme earliness, superb quality, and unusual productiveness. The dwarf vigorous vines average 15 inches in height and carry really enormous crops of large, deep bluish-green pods. The handsome pointed pods average 4 inches long and are tightly packed with extra large, deep bluish-green peas of most luscious flavor.

Large pkt. 15c; lb. 40c; 10 lbs. \$3.25

LITTLE MARVEL

An extremely valuable variety, especially suited to small home gardens, and early market. It matures very early and produces large crops. Vines 15 to 18 inches high. The pods are dark green, good size, produced in pairs and are closely filled with 6 to 7 peas of extra fine flavor.

Large pkt. 15c; lb. 40c; 10 lbs. \$3.00

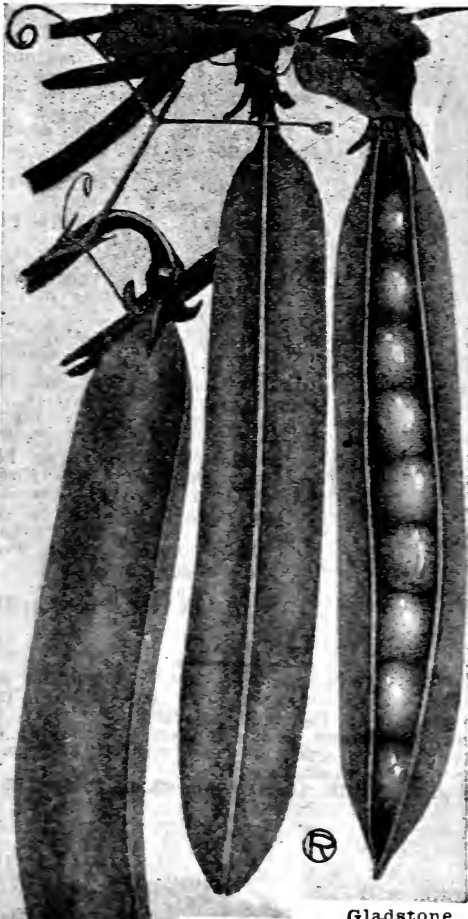

Gladstone.

Richard Seddon

The pods are deep green, crowded with from 7 to 9 large peas of very fine color and flavor. An extremely early type, maturing only a week later than the Alaska, when sown at the same time. A splendid all-around early dwarf variety. On account of its immense productivity, evenness of maturity, compact well filled pods and excellent color and quality, it is especially desirable for canning purposes.

Large pkt. 15c; lb. 30c; 10 lbs. \$2.50; 25 lbs. \$5.75.

DWARF TELEPHONE—Daisy

A splendid mid-season variety, growing only about 18 inches in height; vines very stout and bear a good crop of large, well-filled, bright green pods. The pods average 5 inches in length, containing 7 to 9 large peas which are tender and sweet. A popular sort.

Large Pkt. 15c; lb. 35c; 10 lbs. \$2.50; 25 lbs. \$5.50; 100 lbs. \$20.00.

Gradus

Extra early. This popular large-podded wrinkled pea of finest quality matures pods only two or three days later than the small-podded round-seeded extra earlies. Vines four feet high. It produces uniformly large pods, measuring from four to four and a half inches in length, nearly round, and well filled with very large, handsome peas of the finest flavor.

Large pkt. 15c; lb. 30c; 10 lbs. \$2.50; 25 lbs. \$5.50; 100 lbs. \$20.00.

Gladstone

A grand new second-early; productive of large, luscious, wrinkled peas.

A new English variety of "highest quality." Aside from Routledge Prize it cannot be excelled for a main crop variety. The strong, sturdy vines grow about 3½ feet and are simply covered with extra large, long, pointed and curved pods, that are always full to the end of large, rich, luscious peas, the like of which the average gardener has never tasted. Try it: you will be delighted.

Pkt. 15c; lb. 30c; 10 lbs. \$2.50; 25 lbs. \$5.50

IMPROVED STRATEGEM

A very productive semi-dwarf variety with large leaves and large pods. The peas are dark green, wrinkled, and large. It is planted in large quantities by gardeners for market. In quality it is unsurpassed, the peas when cooked being of the most delicious sweetness.

Large pkt. 15c; lb. 30c; 10 lbs. \$2.50; 25 lbs. \$5.50; 100 lbs. \$20.00.

DWARF SUGAR—EDIBLE PODS

A great favorite with many. In the Edible-Podded or Sugar Peas the pods are gathered, broken and cooked like string-beans when the peas start to develop in the pod or have reached about half their full size. Dwarf Sugar grows about 2 feet in height, producing a heavy crop of small flat pods about 3 inches in length.

Large pkt. 15c; lb. 35c; 10 lbs. \$3.00

Special Pea Offer

To give you a continuous supply of delicious peas at a special price, we offer 1 large packet of **DUKE'S DELIGHT**, **SHERWOOD**, **GOOD LUCK**, **DWARF TELEPHONE** (all dwarf kinds) for only 50c, or 1 lb. each \$1.25 postpaid; or **B. R.'S PROSPERITY**, **GLADSTONE** and **ROUTLEDGE PRIZE** (all tall kinds) for only 35c, or 1 lb. each \$1.00, postpaid.

Market Gardeners who buy Peas in quantity should write us for prices, stating variety and amount wanted. Single pound prices only are prepaid. See notes top of page 24.

Peas—Continued—Large Podded, Late or Main Crop

Packet and single pound prices only postpaid. Special quantity price on request

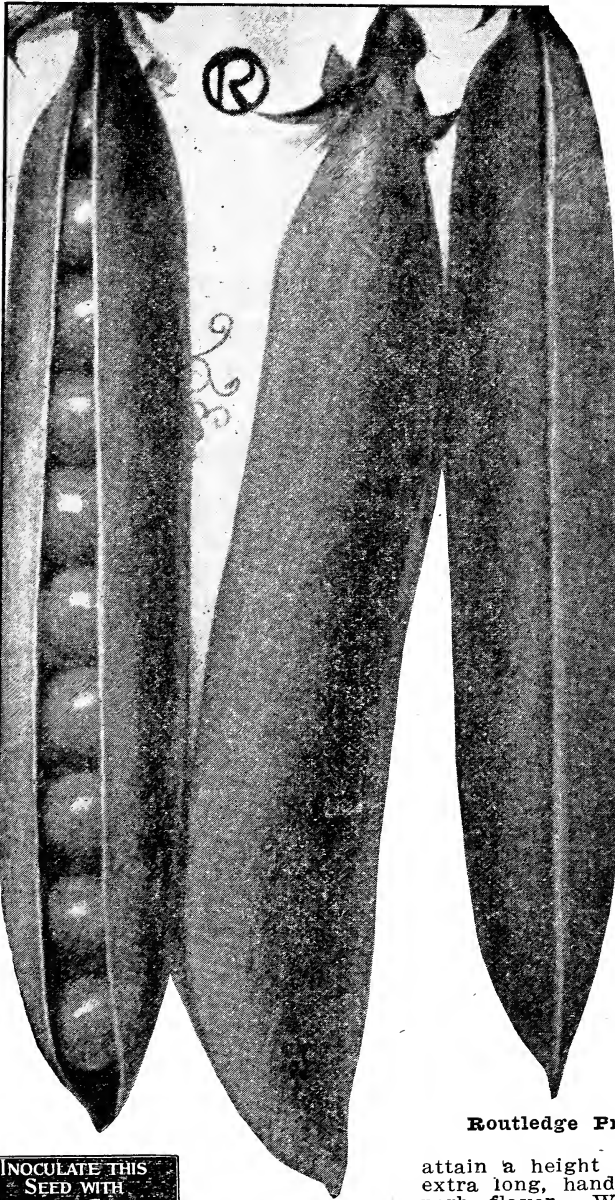

INOCULATE THIS
SEED WITH
MULFORD CULTURE

See Page 37.

Routledge Prize

A new, sweet, wrinkled, mammoth podded Pea of extra value.

This re-selected new strain, grown especially for us in New Zealand, will be found true to name. A sturdy, healthy grower. Vines and pods are a deep, rich green. A bushel of **Routledge Prize** pods will shell out nearly twice as many peas as a bushel of **Telephone**. The vines are enormously productive, being completely covered with immense long pods, well filled with from 8 to 11 large peas of the **richest flavor**. This variety grows about 4 feet high and as an abundant cropper is superior to all other sorts.

Nothing in the line of peas excels the **Routledge Prize** in **richness, sweetness and flavor**. We are sure our customers will agree with us after testing this new pea. Try them and report results if you will.

Large pkt. 15c; lb. 40c; 10 lbs. \$3.25; 25 lbs. \$7.50.

Gaston, Ore., Feb. 8, 1917.
Routledge Seed & Floral Co.,
Dear Sirs: *Routledge's Prize Peas* sure were fine; never saw *Peas* bear so and the pods were full of large, fine-flavored peas. We must have some more of those *Peas*.

Yours truly,
W. W. EARL.

Grangeville, Ida., Feb. 26, 1917.
Routledge Seed & Floral Co.,
Gentlemen: I suppose my report on the *Routledge Prize Peas* is too late for your catalog. They are very good, and fine flavor, but late in bearing, but that makes them desirable as they come after the others are gone. The *Dwarf Sugar, Edible Pods*, are sure a good bearer.

Very truly yours,
JOHANNES BOOGAARD.

Telephone

Routledge Prize. One of the most popular and largest peas we have. Vines attain a height of 4½ feet, bearing profusely the extra long, handsome pods; tender, sweet and superb flavor. We offer a very carefully rogued, select strain of unusual merit.

Large pkt. 15c; lb. 30c; 10 lbs. \$2.50; 25 lbs. \$5.75

PARSLEY

CHAMPION MOSS CURLLED.—An English strain, with beautiful moss-curlled foliage; vigorous grower.

Pkt. 5c; oz. 15c; 4 oz. 40c; lb. \$1.25

ARLINGTON EXTRA CURLLED.—Very choice strain, having the greatest possible curl to the leaves and the darkest green color; a very vigorous grower; will stand heat and drought better than any other.

Pkt. 5c; oz. 15c; 4 oz. 40c; lb. \$1.25

PLAIN LEAF.—Single-leaved variety, very fine and excellent flavor.

Pkt. 5c; oz. 15c; 4 oz. 35c; lb. \$1.00



Parsley Leaf.

TREAT your PEAS, BEANS and SWEET PEAS with Mulford's Nitrogerm Cultures. Makes them healthy and vigorous, insures a full crop. See page 37.



Sweet Marrow Parsnips.

PEPPER

Plant seed early in the spring; culture same as for tomatoes. Plants in season. See **Vegetable Plant List**, page 38.

Royal King

An ideal market variety, bringing the highest prices on account of its shape, color and thick meat, which is as thick again as any other large Bell type. It is perfectly sweet and free from pungency. A heavy cropper and a good shipper. Ruby red when ripe.

Pkt. 15c; oz. 75c; 4-oz. \$2.50

Pimiento—Perfection

This is a sweet Pepper—one which you will enjoy eating in salad, either fresh or canned. Gardeners are planting Pimiento largely. Quite large, top shaped, very thick flesh and wonderful mild flavor.

Pkt. 15c; oz. 75c

Chinese Giant

The largest of all the peppers, very sweet and mild. Brilliant, glossy scarlet when ripe. Excellent for stuffing. **Pkt. 15c; oz. 90c**

RUBY KING.—Plants grow 2 feet high and bear a fine crop of handsome, extra large, scarlet fruits. The flesh is quite thick, sweet, and mild. Especially fine for mangoes. **Pkt. 15c; oz. 75c**

LARGE BELL OR BULL NOSE.—The plants are vigorous, compact and very productive, early and mild, fruit large, bright crimson when ripe. **Pkt. 10c; oz. 65c**

RED CHILI.—A small, pointed, bright red variety. The pods are used in making chili and pepper sauce, and are very pungent and hot; very productive. **Pkt. 10c; oz. 75c**

CAYENNE.—Long, red, pointed pods; very strong and used largely for making pepper sauce; popular variety. **Pkt. 10c; oz. 65c**

CHERRY RED.—Rich, glossy, scarlet fruit at maturity; small, smooth and round; of dwarf habit. **Pkt. 10c; oz. 65c**

PARSNIP

While highly appreciated for the table the great value of the parsnip for stock feeding is but little known. The roots are very rich in saccharine food, adding to the richness of the milk when freshly dug and fed to cows.

Culture.—Sow as early in the spring as the weather will admit in drills 18 inches apart and $\frac{1}{2}$ -inch deep, in a rich, deep soil; thin out 3 to 6 inches apart in the rows. The quality of the roots is improved by leaving them in the ground over winter for spring use.

Sweet Marrow

This fine new parsnip of English origin is offered with full confidence that it will become a prime favorite with all who use it. It is very fine grained and exceedingly sweet, while the peculiar "parsnip" flavor is fully preserved. The roots are unusually smooth and attractive in appearance. The best of all parsnips for the private or market gardens.

Pkt. 10c; oz. 20c; 4 oz. 60c; lb. \$1.75

HOLLOW CROWN.—The most popular variety; medium length roots, very smooth and of the finest quality. Derives its name from a depression at top of crown or root; very fine table sort.

Pkt. 5c; oz. 20c; 4 oz. 50c; lb. \$1.60

PEANUTS

As we have had many calls for peanuts for planting and know that they do fairly well in the Northwest, we offer two good kinds.

Culture.—Remove the shell carefully so as not to break the skin and plant 10 inches apart in rows, cover 2 inches. Warm, sandy, rich loam soil is best. When grown, pull up and dry in the sun.

IVEBSON'S IMPROVED.—Early, large and productive, yielding few imperfect pods and less "pops" than any other sort.

Pkt. 10c; lb. 40c

EARLY SPANISH.—Although small, this variety is especially adapted to the north. Yields heavily, pods solid and unusually well filled. Sweeter and more delicious than the larger varieties. **Pkt. 10c; lb. 40c**

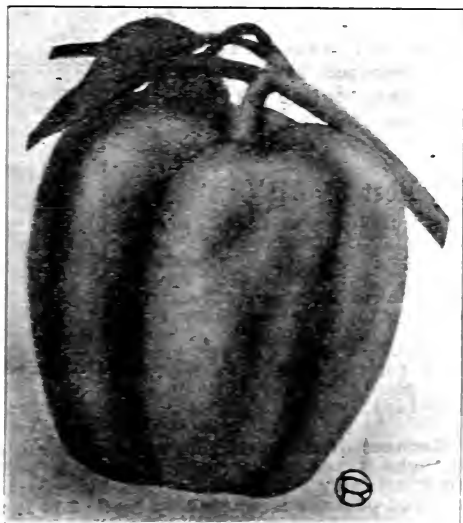

Royal King Pepper.

POSTPAID.—All seeds in packets and single pounds are postpaid. You can't afford to send East. We save you time and money.

Routledge Seed & Floral Co.'s PURE SEED POTATOES

We offer a few varieties of special merit that we recommend to our friends and customers. We think it is folly to plant ordinary or common stock. Many gardeners insist on the **best vegetable seeds**, but plant any old kind of potatoes

Last spring on account of shortage and high prices, most anything that looked like a potato was planted and the results disappointed thousands of planters. Buy our pedigreed select seed potatoes this year and secure a real crop.

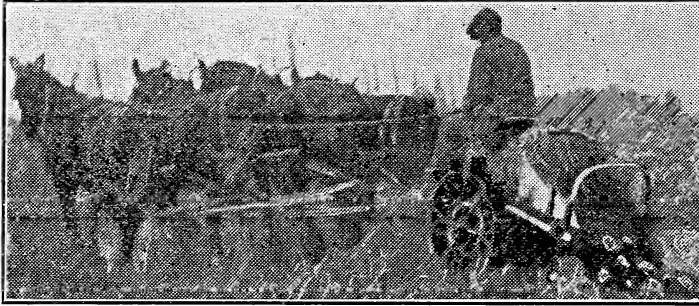

Digging and inspecting a 40-acre field of our "Pride of Multnomah." Illustration from photographs made by the writer. Considering the season, this field certainly produced a phenomenal yield of 95 per cent select, salable potatoes. This proves that hill-selected, disease-free, improved potatoes are the only profitable kind to plant.

ABOUT PRICES.—Prices are subject to important market changes. Ask for quotations on larger lots. Good, true, healthy stock of the best named Seed Potatoes are never plentiful and are always in demand. Order early and get our own contract-inspected stock.

TWO EXTREMELY EARLY POTATOES

Irish Cobbler

One of the first varieties of potatoes to be ready for market, and therefore always commands a good price. The skin is smooth and white, sometimes finely netted, which is an indication of good quality; eyes are strong and well developed. The flesh is white and of fine flavor and quality, even when used very small. Tubers grow to good size very quickly. Excellent keepers. Vines sturdy, stocky and healthy. Always in big demand. Can be planted close.

Price, not prepaid; add postage if wanted by mail: 1 lb. 10c; 5 lbs. 30c; 10 lbs. 50c; 50 lbs. \$2.00; 100 lbs. \$3.50.

"Earliest of All"

Its quick growth and early maturity, combined with its excellent cooking qualities makes it very valuable. Summer drought does not affect it, for its growth is complete before it can be injured. Plant early to obtain large size. Ready for the table nine weeks from planting, and fully matured in 12 weeks.

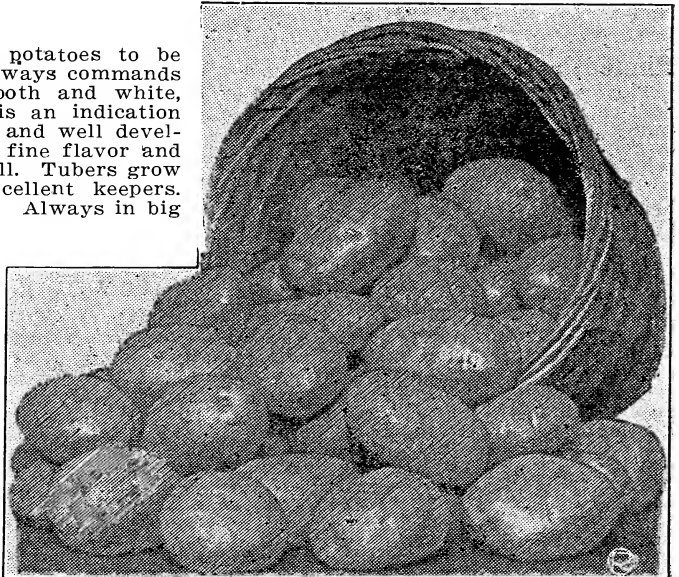

Irish Cobbler, Extra Quality

"Earliest of All" is a healthy, vigorous grower, not subject to blight or disease and does not make a second growth. Keeps as well as any late potato. A handsome, shallow-eyed, round, slightly flattened, white-skinned potato of the finest table quality. **Price, not prepaid, add postage if wanted by mail: 1 lb. 10c; 5 lbs. 30c; 10 lbs. 50c; 50 lbs. \$2.00; 100 lbs. \$3.50**

NOTE—We planted Earliest of All quite late last spring and the tubers are small on account of the dry summer—we have 2 grades: small—1 to 2 ozs., excellent for planting whole, and medium—2-ounce up. If you have a choice state it when ordering.

PRICES.—All potato prices are subject to change without notice. Write for prices, stating quantity wanted, when ready to buy.

Sweet

Potato

Plants

These are ready
in May and June.
See page 36.



We are proud of
our strain of Pride
of Multnomah.

"Pride of Multnomah" raised from our "hill-selected," pedigree stock. Ideal in shape, heavy and solid; free from all disease. The 3 size circle gives comparative size. This stock is worth \$5.00 a sack for seed purposes. Get a start. Order early and be sure.

Early Rose

A great favorite for many years on all markets and many growers still claim that the true stock has never been excelled in quality and productiveness. Potatoes are long in shape, good size, showing trace of pink at the bud end. They cook mealy and are of fine flavor.

Prices, not prepaid, 5 lbs. 25c; 10 lbs. 40c; 50 lbs. \$1.75; 100 lbs. \$3.00; quantity prices on request.

British Queen

A new English variety of real merit. Its great productiveness, large size, excellent quality, health and vigor puts it at "the top" as a fancy table and shipping potato. The past season it made a wonderful showing. Tubers oblong, slightly flattened, with white, smooth skin, shallow eyes. A profitable main crop variety you should try. Stock limited—order early.

Prices, not prepaid, 1b. 10c; 5 lbs. 30c; 10 lbs. 50c; 50 lbs. \$2.00; 100 lbs. \$3.25.

White Rose

A standard market potato. In great demand by California buyers. Tubers flattened, oval, rather elongated, having few eyes and a beautiful, creamy-white skin. As an exhibition variety, White Rose has won many honors at State Fairs. A heavy producer of fine, large potatoes (very few small ones). It makes a vigorous, rapid growth and can be used quite early.

Prices, not prepaid, 1b. 10c; 5 lbs. 30c; 10 lbs. 50c; 50 lbs. \$2.00; 100 lbs. \$3.50.

American Wonder

One of the best all-around white potatoes, very popular for early main crop. A strong grower and a great producer; tubers white, uniform in size, elongated, of excellent quality.

Price, not prepaid: 5 lbs. 25c; 10 lbs. 40c; 50 lbs. \$1.50; 100 lbs. \$2.75; quantity price on request.

TELL US WHAT SIZE.—We have most of our seed potatoes graded into 2 sizes, small to medium and medium to large. If you have a choice, tell us when you order. You must not expect such perfect shape, even, smooth potatoes this year as heretofore as the growing season was "dry" and the one rain we got came just late enough to cause the half-ripe seed to swell and knot or rough the skin, but the true strain is there and your crop will be all right.

We sell **POTATO PLANTERS, FORKS, GARDEN and FARM TOOLS.** Every gardener needs up-to-date tools and supplies. See pages 119 to 124.

Pride of Multnomah

Our leading main crop variety; has no equal as a profitable commercial variety.

This potato, originating in Multnomah County, has made a record for itself, and is in great demand.

It is the heaviest yielding, most even growing main crop variety. The skin is smooth and white, eyes shallow, and cooking qualities unexcelled, being fine grained and of snowy whiteness either boiled or baked. Withstands drought better than most varieties. We offer hand-selected stock from our expert grower. (See illustration.)

The original stock of Multnomah, we thought, had a tendency to grow too long and pointed, and we have hill-selected to get a shorter, thicker, heavier type that ships and handles better, the "Ideal Type" that brings the "fancy prices."

Price, not prepaid, add postage if wanted by parcel post, 5 lbs. 30c; 10 lbs. 50c; 50 lbs. \$1.75; 100 lbs. \$3.00. Do you prefer large or medium seed stock?

Producer

A large, smooth, oval, white potato with shallow eyes, of finest table quality; will not "boil to pieces," and baked has no superior; it is a hardy, vigorous grower that earned its name of "Producer" on account of its enormous and never-failing yield.

"Producer" always gives a big crop even under adverse conditions. "Producer" has been such a success that we consider it a valuable sort—especially for dry or light soil, as it will give a good yield where other varieties would fail.

Price, not prepaid, add postage if wanted by parcel post, 5 lbs. 30c; 10 lbs. 50c; 50 lbs. \$1.75; 100 lbs. \$3.00.

Burbank

A standard commercial variety, but most stock is "run-out." We offer hand selected stock that will yield much heavier than most.

Prices, not prepaid: 5 lbs. 25c; 10 lbs. 40c; 100 lbs. \$2.75; quantity price on request.

PUMPKIN

DOUBLE THE YIELD AND SIZE OF YOUR PUMPKINS by using a handful of "WONDER" Fertilizer to each hill and be sure you mix it well with top soil. (See page 39.)

WINTER LUXURY

An enormously productive variety of medium size and superior keeping qualities. Of rounding shape, about 10 inches in diameter; golden russet color, finely netted, rich deep golden flesh; sweet and tender. **By far the best for pies; try it.**

Pkt. 10c; oz. 20c; 4 oz. 60c; lb. \$1.50

SMALL SUGAR

Fine grained, very sweet and excellent keeper. Skin deep orange yellow.

Pkt. 5c; oz. 15c; 4 oz. 40c; lb. \$1.25

KING OF MAMMOTHS

The largest of all; grow this variety to win the prizes at the fair.

Pkt. 10c; oz. 20c; 4 oz. 60c; lb. \$1.50

CONNECTICUT FIELD

The best for field culture and excellent for stock.

Pkt. 5c; oz. 15c; 4 oz. 30c; lb. 85c

LARGE SWEET CHEESE

A popular variety; fruit flattened; skin mottled light green and yellow; flesh yellow, thick and tender; very nutritious and of excellent quality; a most productive variety.

Pkt. 5c; oz. 15c; 4 oz. 40c; lb. \$1.00

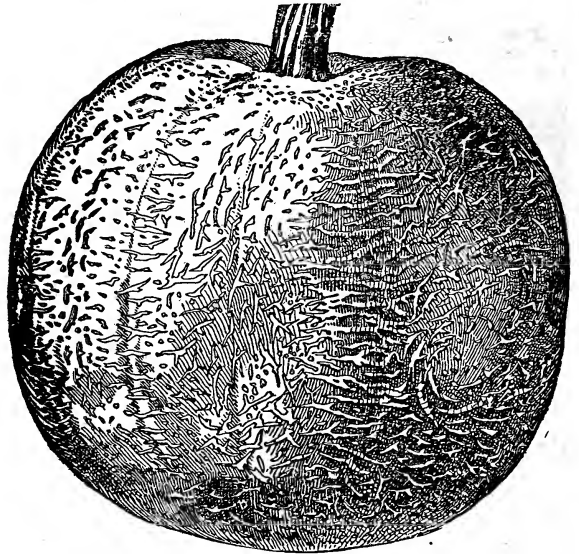

Winter Luxury Pumpkin

"Highest Quality"

RADISH

"Highest Quality"

REMEMBER—For a continuous supply of crisp, tender Radishes, sow seed every week, as they remain in "prime" condition only a few days after attaining full size.

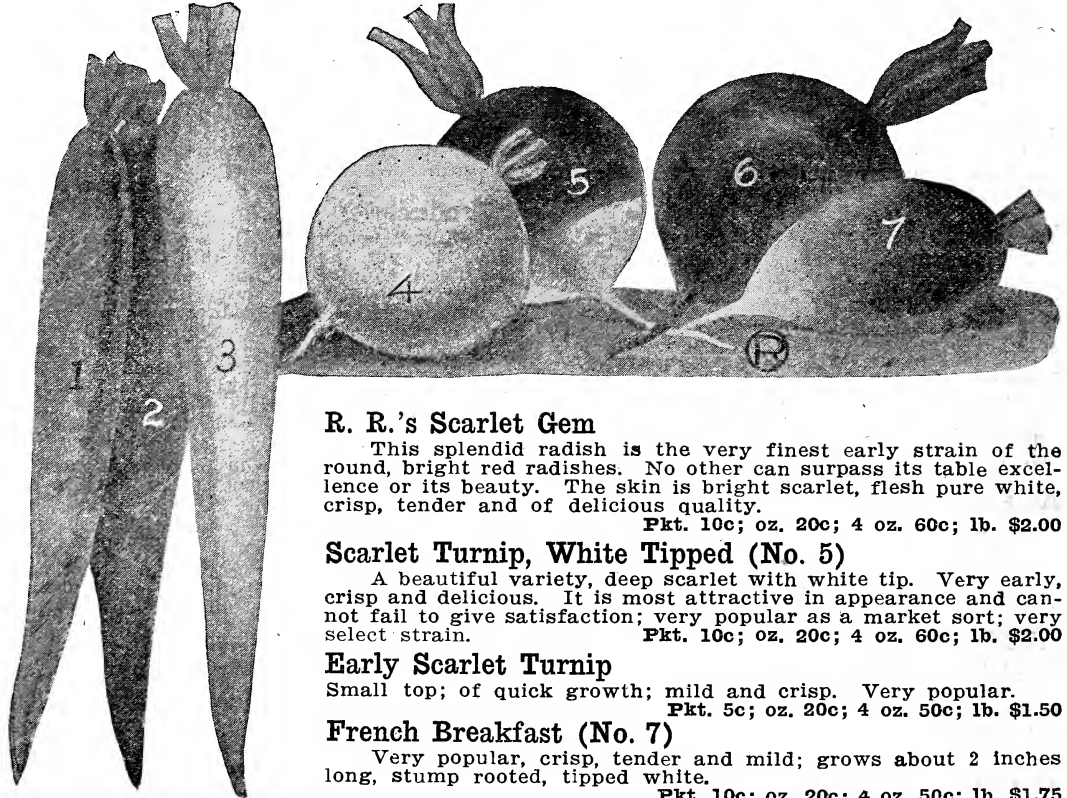

R. R.'s Scarlet Gem

This splendid radish is the very finest early strain of the round, bright red radishes. No other can surpass its table excellence or its beauty. The skin is bright scarlet, flesh pure white, crisp, tender and of delicious quality.

Pkt. 10c; oz. 20c; 4 oz. 60c; lb. \$2.00

Scarlet Turnip, White Tipped (No. 5)

A beautiful variety, deep scarlet with white tip. Very early, crisp and delicious. It is most attractive in appearance and cannot fail to give satisfaction; very popular as a market sort; very select strain.

Pkt. 10c; oz. 20c; 4 oz. 60c; lb. \$2.00

Early Scarlet Turnip

Small top; of quick growth; mild and crisp. Very popular.

Pkt. 5c; oz. 20c; 4 oz. 50c; lb. \$1.50

French Breakfast (No. 7)

Very popular, crisp, tender and mild; grows about 2 inches long, stump rooted, tipped white.

Pkt. 10c; oz. 20c; 4 oz. 50c; lb. \$1.75

DON'T grow WORM-EATEN Radishes. Use "CARCO"—New Discovery; see pg. 127

RADISH—Continued

Make a liberal amount of our kiln-dried pulverized cow manure into your Radish bed if your soil is heavy. See page 38.

Scarlet Giant (No. 6)

"Crimson Giant." The largest early scarlet turnip-shaped radish. The flesh is a sparkling white, solid, crisp, juicy and are of the mildest flavor. The bright, deep crimson color of the skin remains quite constant. **Pkt. 10c; oz. 20c; 4 oz. 60c; lb. \$2.00**

White Icicle (No. 3)

This superb radish is pure white and most attractive. It is not only crisp and tender when young, but retains these qualities until the roots attain large size. It is ready for use almost as quickly as the early turnip-shaped sorts.

Pkt. 10c; oz. 20c; 4 oz. 60c; lb. \$2.00

LONG BRIGHTEST SCARLET, WHITE TIPPED (No. 1).—The brightest and hand-somest long scarlet radish known. Roots mature quickly and continue in good condition until full grown. Of excellent quality.

Pkt. 5c; oz. 15c; 4 oz. 35c; lb. \$1.25

Early Snowball (No. 4)

Model White Box. A grand improvement on the White Box or White Turnip Radish; very early, of a clear white color, solid, juicy, crisp, tender and unsurpassed in flavor. **Pkt. 5c; oz. 15c; 4 oz. 35c; lb. \$1.25**

Long Scarlet (No. 2)

Grows perfectly straight and smooth, 6 to 7 inches in length. Skin scarlet, very thin; the flesh crisp, brittle and of delightful flavor; the finest long red radish.

Pkt. 5c; oz. 15c; 4 oz. 40c; lb. \$1.40

WHITE STRASBURG.—Even when comparatively small this variety is in good condition for use, and continues crisp and tender until matured, when the roots are 4 to 5 inches long and about 2 inches in diameter. This is considered one of the best large summer sorts.

Pkt. 5c; oz. 15c; 4 oz. 35c; lb. \$1.25

Winter Radishes

The merits of Winter Radishes are little appreciated. These grow to large size and keep well for winter and spring use. Sow seed in July and August. Early planting is not advisable.

NERIMA—Japanese Long White

A late fall and winter radish that has recently made its appearance on the Portland market and created much favorable comment. It grows from 12 to 30 inches long and about 2 inches in diameter. Skin white and smooth, flesh firm, crisp, tender and mild. Very popular and in good demand; keeps well all winter.

Pkt. 10c; oz. 20c; 4 oz. 60c; lb. \$2.00

California Mammoth White.—Also called Chinese White Winter or Celestial. A long, thick, stumpy rooted variety. Pure white. The flesh is tender and crisp, keeping well through the winter.

Pkt. 5c; oz. 15c; 4 oz. 40c; lb. \$1.50

SAKURAJIMA.—Japanese variety that grows to an immense size, almost globe shaped. The skin is smooth and white, and the flesh is always mild, crisp and tender.

Pkt. 10c; oz. 20c; 4 oz. 60c; lb. \$2.00

China Rose.—Bright rose color, flesh firm and piquant; largest at the bottom. One of the best. **Pkt. 10c; oz. 20c; 4 oz. 60c; lb. \$2.00**

Long Black Spanish.—Very popular; latest, as well as the hardiest. Roots of medium size, oblong, black.

Pkt. 5c; oz. 15c; 4 oz. 35c; lb. \$1.25

Round Black Spanish.—Three or four inches in diameter; flesh white; good keeper.

Pkt. 5c; oz. 15c; 4 oz. 35c; lb. \$1.25

RHUBARB OR PIE PLANT

BURBANK'S CRIMSON WINTER.—The new variety, which has become very popular and profitable to the grower, has a delicious fruity flavor, is extremely hardy, very prolific and very quick growing. Produces good stems all winter and spring.

Pkt. 10c; oz. 80c; 4 oz. \$2.50

VICTORIA, OR MAMMOTH.—Very large; most popular variety.

Pkt. 5c; oz. 15c; 4 oz. 40c; lb. \$1.25

RHUBARB ROOTS.—From October to June we can always supply one, two, and often larger clumps of Rhubarb Roots. Customers will save much valuable time by ordering roots instead of seed. For prices, etc., see page 118.

SUNFLOWER**Large Russian**

This has very large single heads borne at the top of a single unbranched stalk usually, and with much more and larger seed than the common sorts. It is used extensively for feeding poultry. The plant often grows 10 feet high. Sow seed as soon as ground is fit for planting corn, in rows 3 to 4 feet apart and 10 inches apart in row. Cultivate same as corn. When the seed is ripe and hard, cut off the heads and pile loosely in an airy dry place where they will soon cure so as to be threshed out and cleaned. This variety will yield 1000 pounds or more of seed per acre. Some species are planted largely in the flower garden for ornament. (See Flower Seeds under Helianthus.) **Pkt. 5c; 2 oz. 10c; 4 oz. 20c; lb. 35c, postpaid; for larger quantities inquire for prices.**



Rhubarb.

Remember
"CARCO"
keeps worms
from Radishes.
See Page 37.

EVER USE A LANTERN? If you do, investigate DAD'S ELECTRIC—always ready—no danger from fire; makes "night time a light time." See page 131.

SALSIFY OR VEGETABLE OYSTER

One of the most desirable winter vegetables. The roots when cooked are very palatable and nutritious and are served in a variety of ways. The flavor is similar to oysters. Salsify succeeds best in a light, well enriched soil, which should be stirred to a good depth. Coarse and fresh manure should be avoided, as it will surely cause the roots to grow uneven and ill-shaped. Sow early and quite deep, giving the general culture recommended for parsnip. The roots are perfectly hardy and may remain out all winter. Frost does not injure the roots; may be stored in a pit or in a very cool cellar.

Mammoth Sandwich Island

This variety is large and strong growing with long, smooth, white, tapering roots, and is less liable to branch than the other sorts. It is invaluable for market gardeners' use. Pkt. 10c; oz. 30c; 4 oz. 75c; lb. \$2.50.

SPINACH

Plant in the richest soil you have very early in the spring or not until fall for winter use, as it does not do well in hot weather. Spinach seed very scarce.

IMPROVED THICK-LEAVED.—A variety which grows very rapidly, forming a cluster of large, very thick, slightly wrinkled leaves of fine color and quality when cooked; best for market gardeners.

Pkt. 10c; oz. 25c

LONG STANDING.—An improved variety of excellent quality for general use; slow going to seed. Remains in good condition longer than most. Dark rich green.

Pkt. 10c; oz. 25c

BLOOMSDALE SAVOY LEAVED.—Very early; of upright growth; leaves broad and pointed, dark green, fine quality; grows quickly. Good for all seasons.

Pkt. 10c; oz. 25c; 4 oz. 65c; lb. \$2.25.

PRICKLY WINTER.—Very desirable; very hardy and easily grown; bears large, smooth broad pointed leaves. Color, bright green. A fine winter and spring variety.

Pkt. 10c; oz. 20c; 4 oz. 60c; lb. \$2.00.

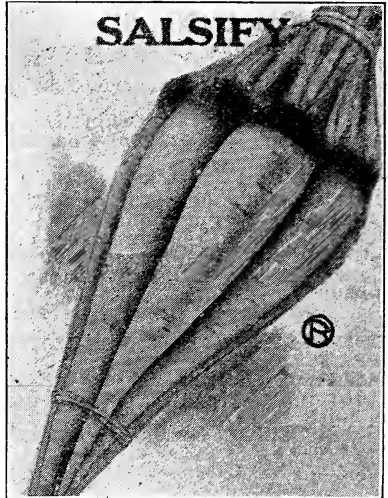

Improved Thick Leaved.

SQUASH

Delicata Squash

A perfect all-season squash. A summer and winter crop on one plant. Produces 15 to 20 fruits to a vine that are as deliciously flavored as the winter kinds.

Delicata grows in vine form. It is ready almost as soon as the early summer sorts, is better flavored than the best of them, and remains in perfect condition as long as any of the keeping varieties.

Its flavor when cooked has been compared to the Sweet Potato, others liken it to roasted chestnuts, but all agree that it is delicious. The fruits are about 9 inches long, and as shown in the cut, slightly ribbed. When ripe, the ground color is deep yellow, irregularly striped and marbled with dark olive-green.

The flesh is thick, of fine texture, and pale-yellow in color. It is unexcelled for baking—the shape and size make it perfect for this purpose. When boiled it turns out dry, mealy and sweet. Excellent for pies.

Pkt. 10c; oz. 25c; 4 oz. 65c; lb. \$2.00

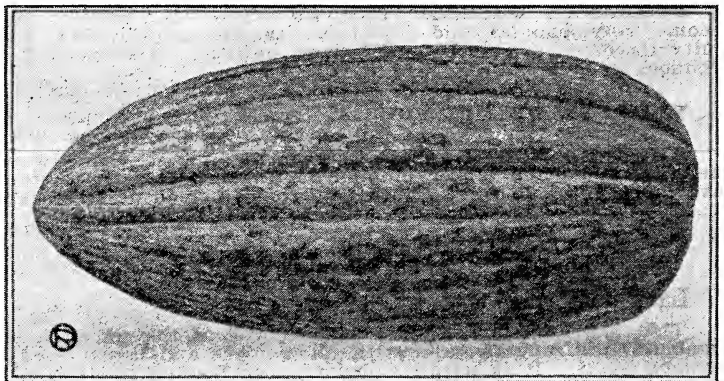

Delicata Squash—Try It.

FERTILIZE—If you want large squash and lots of them. SEE PG. 38-39.

Make liquid manure from "C-M" (pg. 38) and give each hill a quart or two occasionally during hot weather. The results will surely surprise you.

SQUASH—Continued**Mammoth White Bush Scallop**

The fruit is a beautiful, clear, waxy white, superior in size and beauty, and is quite uniformly warted. The handsomest of the scalloped squashes. The stock we offer is exceptionally true to type. **Pkt. 5c; oz. 15c; 4 oz. 35c; lb. \$1.25**

Golden Summer Crookneck

Early and prolific. The fruits are of the true crookneck type, heavily warted and of light golden color. One of the most popular sorts for home and market.

Pkt. 5c; oz. 15c; 4 oz. 40c; lb. \$1.25

VEGETABLE MARROW.—Very early, oblong variety; fruit dark green at first, becoming marbled and striped with yellow and lighter green as they mature. Very fine flavor fried in oil, or stewed; use while small.

Pkt. 5c; oz. 15c; 4 oz. 35c; lb. \$1.25

YELLOW BUSH SCALLOP.—A very early, flat, scallop variety of large size; color yellow; flesh pale yellow and well flavored.

Pkt. 5c; oz. 15c; 4 oz. 35c; lb. \$1.15

Fall and Winter Varieties

BOSTON MARROW.—A popular variety for canning; large oval fruit; skin bright reddish orange, with light cream netting; flesh rich orange, fine grained and of excellent quality.

Pkt. 5c; oz. 15c; 4 oz. 35c; lb. \$1.00



See **DAD'S ELECTRIC LANTERN**, page 121.

Mammoth Chili

The largest of all squashes, growing to an enormous size, often weighing over 200 pounds, while its rich, fine flavored flesh insures its value for all purposes. Its size makes it valuable for stock feeding. **Pkt. 5c; oz. 15c; 4 oz. 45c; lb. \$1.50**

Golden Hubbard

The same in size, shape and quality as the well-known Hubbard Squash, except that it is a bright red or golden color and somewhat earlier. It is also a long keeper; considered by expert judges to be one of the very best fall and winter sorts yet introduced. Matures before the frosts; is vigorous and wonderfully productive. In flavor it has no equal. **Pkt. 10c; oz. 20c; 4 oz. 50c; lb. \$1.75**

Delicious

Finer-grained and more delicious than the well-known Hubbard. The color of skin is green or blue-black. Medium size, weighing from 5 to 10 pounds. The shell is not very thick, but is hard and strong; small

seed cavity; the flesh is very thick, of a bright yellow color, fine-grained and of splendid quality. For table use, either as a fall or winter squash, it cannot be excelled. **Pkt. 10c; oz. 20c; 4 oz. 50c; lb. \$1.75**

True Hubbard

One of the best of the winter squashes. Vines vigorous and very productive. Fruit large, heavy, moderately warted, with very hard shell. Skin uniformly dark bronze green. Flesh bright orange yellow, fine grained, thick, dry and richly flavored. Can be kept in good condition until spring. Our seed is carefully selected and is much superior to most offered.

Pkt. 10c; oz. 20c; 4 oz. 50c; lb. \$1.75

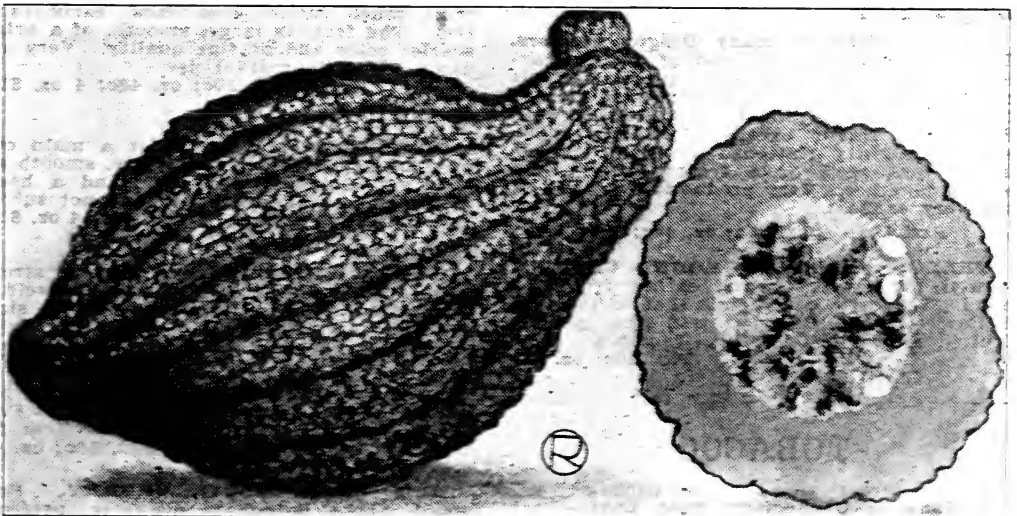

True Hubbard.—Note the thickness of the flesh.

DOUBLE the yield of your squash by using a handful of "WONDER" Fertilizer to each hill. (See page 38.) You know the richer your ground, the larger the yield, and Wonder Fertilizer certainly contains more plant food than any other brand.

TOMATO

Tomato Plants in any quantity. See Vegetable Plant list, page 36.

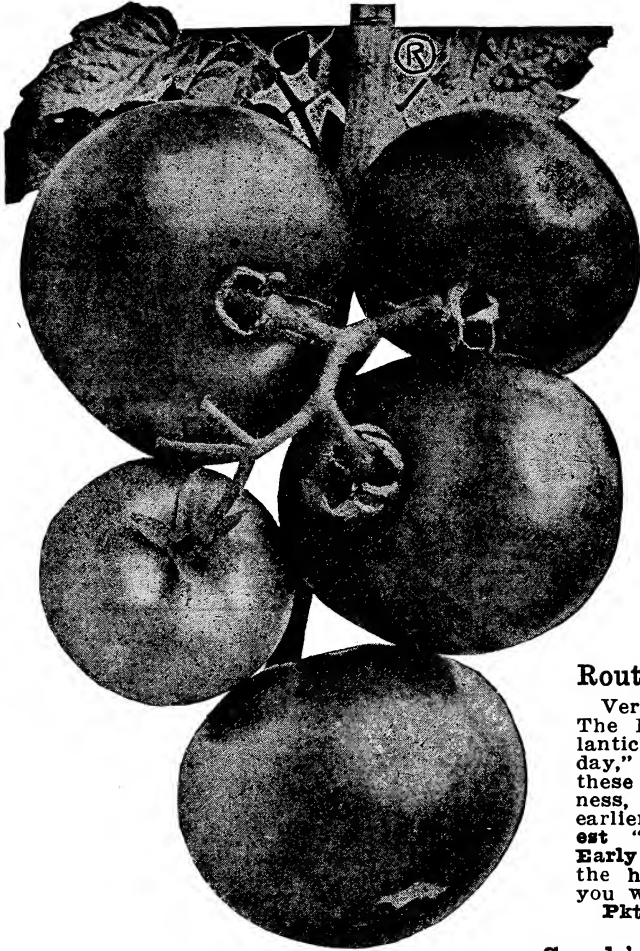

Comet

The Best Tomato for Green-house Forcing.—A recent variety, matchless in form and color. Beautiful, smooth, round fruit in great abundance. Color a rich scarlet red. Sets very freely in bunches. Equally good for outdoor culture as for forcing.

Pkt. 15c; ½ oz. 40c; oz. 75c

Chalk's Early Jewel

The largest, smoothest and finest flavored, extra early bright red tomato, about 10 days later than Spark's Earliana. It is a heavy cropper with tomatoes of larger size, sweeter flavor, produced throughout the season. The plants are of bushy, compact growth, heavily loaded with fruit. The tomatoes are just right for market; very solid and deep through, being almost round; ripening to the stem without cracks or green core. The flesh is thick, solid, of fine flavor, with few seeds.

Pkt. 10c; oz. 40c; 4 oz. \$1.25

Routledge's Early Oregon

Very hardy and succeeds everywhere. The Early Michigan, Fordhook and Atlantic Prize were good sorts "in their day," but the Early Oregon is superior to these in shapeliness, color, size, smoothness, solidity and flavor, as well as being earlier. Those wishing to have the earliest "GOOD" tomato should raise our Early Oregon. Highly recommended for the home or market gardener. Try it; you will not be disappointed.

Pkt. 10c; ½ oz. 25c; oz. 40c; 4 oz. \$1.25

Spark's Earliana

The earliest tall variety, forming ripe fruit much earlier than most early varieties. The fruit is large, smooth, of a bright scarlet color and of fine quality. Very valuable for early market use.

Pkt. 10c; oz. 40c; 4 oz. \$1.25

STONE

Grown very extensively for a main crop by market gardeners; very large, smooth and solid, of a bright red color and a heavy yielder; of excellent quality and not subject to rot.

Pkt. 10c; oz. 40c; 4 oz. \$1.20

DWARF CHAMPION.—Forms a strong, erect, bushy plant 2 feet high; often sold as Tree Tomato. Fruit smooth, medium sized, solid and of good flavor.

Pkt. 10c; oz. 40c; 4 oz. \$1.20

YELLOW OR RED PEAR.—Used for preserves and to make "tomato figs." Fruit distinctly pear shaped and of excellent flavor.

Pkt. 10c; oz. 40c

RED OR YELLOW CHERRY.—Fruit small, about ¾-inch in diameter; perfectly round and smooth; fine for pickles and preserves.

Pkt. 10c; oz. 40c

Bonny Best

Highly prized by many Oregon growers. Tomatoes large, smooth and of a rich scarlet red, the color that sells quickly. Fruit thick with a small core, a profitable tomato for any purpose. Slices exceptionally well. Flesh and flavor excellent. Nearly globe shaped, slightly flattened at stem. Borne in clusters of 5 or 6 fruits all ripening evenly together. Very productive and one of the very earliest.

Pkt. 10c; ½ oz. 25c; oz. 45c; 4 oz. \$1.25

YELLOW HUSK OR GROUND CHERRY.—Used for preserves and eating from the hand. The seed we offer is that of the true Yellow Ground Cherry, not the purple-fruited sort, which is scarcely edible.

Pkt. 10c; oz. 35c

TOBACCO

Culture practically same as cabbage.

Havana or Connecticut Seed Leaf.—Both good, hardy varieties for general planting here.

Pkt. 10c; oz. 50c

Increase the yield and quality of your Tomatoes by using a good plant food. See page 38. **WONDER ODORLESS FERTILIZER** will do it; a spoonful to a plant.

TURNIPS OF "Highest Quality"

For spring use sow very early in rich, loose ground. They must make a quick growth to be tender and sweet. For fall and winter use sow in July, August or early September.

Extra Early WHITE MILAN TURNIP The Very Earliest

An excellent table turnip, and the earliest of all varieties; adapted for very early spring or fall planting. The tops are small; the bulbs of medium size, flattened, and ivory-white in color. The flesh is fine-grained, tender, and of a mild, sweet flavor. It remains in good condition for a long period of time, and does not become pithy or stringy.

Pkt. 10c; oz. 25c; 2 oz. 45c; 4 oz. 75c; lb. \$2.25

Orange Jelly, or Golden Ball

Delicate and sweet, yellow flesh, medium in size, firm, crisp and most excellent flavor; keeps well and is superior as a table variety.

Pkt. 10c; oz. 15c; 2 oz. 25c; 4 oz. 45c; lb. \$1.75

Early White Flat Dutch

A leading white fleshed variety; either for the family, market garden or field crop; it is medium size and produces a large crop; the flesh is firm, but tender and of a superior rich, buttery flavor; a good keeper.

Pkt. 10c; oz. 15c; 2 oz. 25c; 4 oz. 45c; lb. \$1.75

Early Snowball

A superior table variety, meltingly tender, with snow-white flesh. Matures six weeks after sowing; medium size, smooth and perfectly globular.

Pkt. 10c; oz. 20c; 2 oz. 35c; 4 oz. 50c; lb. \$2.25

White Egg

Is perfectly smooth, of a pure clear white; a very choice kind for table use; of excellent flavor, sweet and mild; pulls clean from the ground; thin, snow-white skin. Egg shaped.

Pkt. 10c; oz. 20c; 2 oz. 35c; 4 oz. 50c; lb. \$2.00

EXTRA EARLY PURPLE TOP MILAN.—This variety is ready for the table almost as early as white Milan; flesh white, firm and delicate.

Pkt. 10c; oz. 25c; 2 oz. 40c; 4 oz. 70c; lb. \$2.25

Early Purple Top (Strap Leaved)

One of the best and universally grown; flesh firm, but very tender and sweet; of quick growth; attains large size, profitable for stock, keeps well.

Pkt. 10c; oz. 15c; 2 oz. 25c; 4 oz. 45c; lb. \$1.75

AMBER, OR YELLOW GLOBE.—One of the best yellow-fleshed varieties; skin clear yellow; is of good size and fine flavor.

Pkt. 5c; oz. 15c; 2 oz. 25c; 4 oz. 40c; lb. \$1.50

PURPLE TOP WHITE GLOBE.—A very heavy cropping, globe-shaped variety, with white skin and flesh; excellent flavor and much in favor with the market gardeners.

Pkt. 10c; oz. 20c; 2 oz. 35c; 4 oz. 60c; lb. \$2.25

YELLOW ABERDEEN.—Round, medium size; light yellow; produces a large crop; is hardy and keeps well; flesh very firm, but tender and sweet; a great favorite with the dairymen for feeding cows.

Pkt. 10c; oz. 20c; 2 oz. 35c; 4 oz. 60c; lb. \$2.00

Cowhorn (Long White)

Slightly crooked, pure white, except a little shade of green at the top; grows half out of the ground and is of very rapid growth. Has proved itself one of the best stock turnips ever introduced in Oregon.

Pkt. 10c; oz. 20c; 2 oz. 35c; 4 oz. 60c; lb. \$2.50

NO MORE WORMY TURNIPS

A new and wonderfully successful spray for destroying maggots, grubs and worms which infest Turnips, Radishes, Beets, Rutabagas, Cauliflower, Cabbage, Onions, etc., and also recommended for combatting crown borers in Strawberries.

A marked increase in yield of vegetables follows the use of "Carco" spray. See page 127. Special leaflet on request.

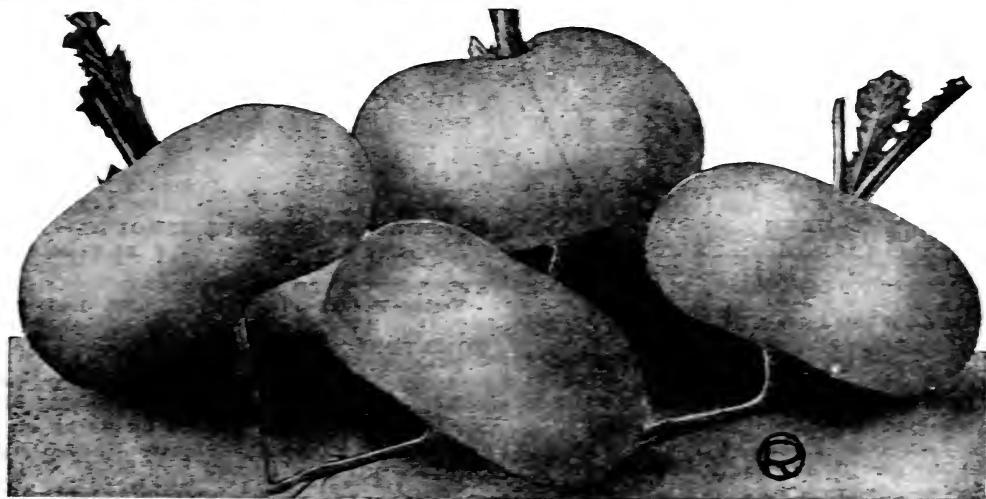

Extra Early White Milan Turnips.

FOR RUTABAGA OR SWEDES, SEE TOP OF NEXT PAGE

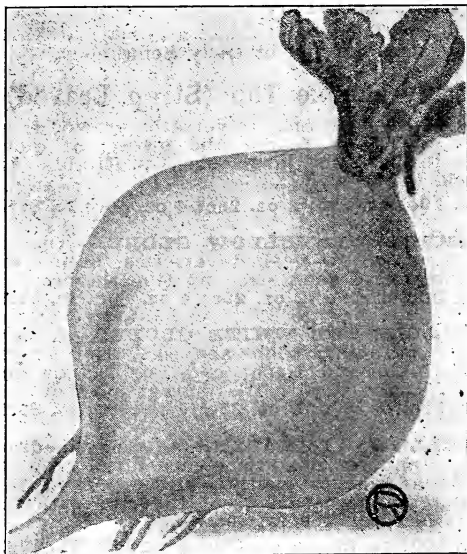

American Purple Top.

RUTABAGA OR SWEDES

For feeding stock in fall and winter there is nothing superior to turnips and rutabagas, as they are much liked by all kinds of stock, and serve to keep them in good condition.

IMPROVED AMERICAN PURPLE TOP.—

The leading and most popular variety, being very distinct in type, attaining a wonderfully large size; immense yielder; the flesh is very firm, cream yellow, fine grained, sweet and tender. Excellent both for table and stock feeding. Keep all winter.

Pkt. 10c; oz. 20c; 2 oz. 35c; 4 oz. 60c; lb. \$2.00

WHITE SWEET GERMAN.—

This variety is most excellent either for table or stock; it grows to a very large size; flesh white, solid, of a firm texture, sweet and rich; an excellent keeper.

Pkt. 10c; oz. 20c; 2 oz. 35c; 4 oz. 60c; lb. \$2.00

HERB SEEDS

Pot, Sweet and Medicinal

Herbs in general delight in rich, mellow soil. Those marked with a (*) are perennial. We offer some of the most useful and popular. They should be cut on a dry day, just before they come into full bloom, and tied in bunches and hung up or spread thinly on a floor where they can dry quickly.

All the Following Herbs 5c per Packet, unless Otherwise Priced

	Oz.		Oz.
Anise.—Seeds aromatic; used medically.	20c	*Horehound.—Bitter; for tonic.	Pkt. 10c 40c
*Balm.—For culinary purposes	35c	*Hysop	35c
Basil.—Sweet; for flavoring soups.	20c	*Lavender.—For fragrance	Pkt. 10c 35c
Borage.—For flavoring; also bee pasture.	25c	*Marjoram.—Sweet; for flavoring	25c
Caraway.—For flavoring	25c	*Rosemary.—Aromatic oil.	Pkt. 10c 75c
*Catnip.—Mild nervine.	Pkt. 10c 85c	Summer Savory.—For flavoring	20c
Coriander.—Used for flavoring	20c	*Sage.—For tea flavoring and dressings.	20c
Dill.—Used medicinally and for pickles.	20c	*Thyme (broad leaf).—For soup.	Pkt. 10c 50c
*Fennel.—Flavor of celery	20c	*Wormwood.—Medicinal use	25c

VEGETABLE PLANTS

We grow large quantities of choice vegetable plants, and can supply all of the varieties listed below, in their proper season, in most any quantity. We can supply all vegetable plants in two grades—plants direct from the seed beds and those that have been transplanted into shallow boxes. Transplanted plants are much stronger and better rooted, and are well worth the price, especially in the early part of the season. We can supply most any of the leading sorts. Tell us your choice of varieties, and we will send it or give good substitute. **NO PLANTS SENT C. O. D.** Write for prices on 5 to 10 thousand lots.

	By Express		By Express	
	Postpaid	Not Prepaid	Postpaid	Not Prepaid
	Dozen	100	1000	1000
CABBAGE AND KALE				
Early kinds, transplanted	\$.20	\$.75	\$ 6.00	
Late, not transplanted	.20	.50	4.00	
Add 15c per 100 for Cabbage Plants by mail.				
CAULIFLOWER AND BROCCOLI				
Early Snowball, transplanted	.25	1.25	8.00	
Early Snowball, not transplanted	.25	1.00	7.00	
Late kinds, transplanted	.25	1.00	7.00	
Late, not transplanted	.25	.75	6.00	
Add 15c per 100 for Cauliflower Plants by mail.				
CELERY AND CELERIAC T. R.				
Leading kinds, transplanted	.25	1.00	7.00	
Not transplanted		.50	5.00	
Add 15c per 100 for Celery Plants by Mail.				
PEPPER AND BRUSSEL SPROUTS				
Transplanted	.25	\$ 1.00	\$ 7.00	
SWEET POTATO PLANTS				
Sweet Potato Plants	.30	1.00	7.50	
TOMATOES				
Leading kinds, transplanted	.30	1.00	7.00	
Not transplanted		.75	6.00	
Add 25c per 100 for above plants by mail.				
Pot Growa Tomato Plants. —These large plants give the most profitable results. Can not be mailed. Prices: 2½-in pots, 10c each, \$1.00 doz.; 3-in. pots, 15c each, \$1.50 doz.; 4 to 5-in. pots, 25c each, \$2.50 doz.; must go by express, charges collect.				
Chives (Schnittlauch) —Per bunch, postpaid 25c				

We Recommend and Sell

Mulford Cultures

FOR LEGUMES

To supply or increase the nitro-gathering bacteria in the soil

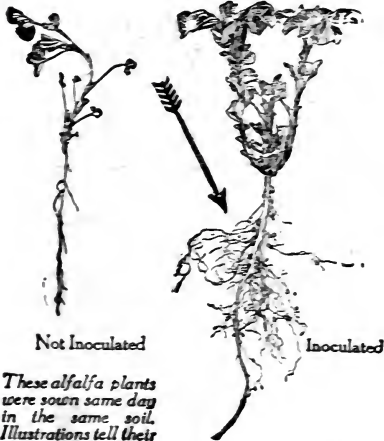

These alfalfa plants were sown same day in the same soil. Illustrations tell their own story.

Mulford's experts claim an "ALL-CROP" culture is not practical.

Without these germs a good crop is impossible. Therefore always inoculate the seeds mentioned at planting time with the MULFORD CULTURES, which contain active nitrogen-fixing bacteria. The bacteria in this product have all been proved by actual test to be active and vigorous. It is easily and quickly used by mixing with water and applying to the seed or soil; the directions which accompany each package are so complete and explicit that anyone can use it.

MULFORD CULTURES are "DIFFERENT" and should not be confused with other brands.

The color is different (they are dark, almost black, due to a special ingredient added to increase the growth and activity of the bacteria).

The count is different (bacterial counts show fully twice as many bacteria as in the old-form cultures).

The bottle is different (being sealed—an important feature which prevents all possibility of contamination from the outside air).

Increase Your Crops—Improve Your Soil

Legumes offer the best-known means of maintaining soil fertility and rejuvenating over-cropped and worn-out fields. They add both humus and nitrogen to your soil and thus increase your yield of non-legume crops.

The U. S. Department of Agriculture and many State Agricultural Experiment Stations recommend inoculation of legumes with nitrogen-fixing bacteria to induce a prompt "catch" and increase your yield.

MULFORD CULTURES are scientifically prepared and tested by experts, in the biological laboratories of H. K. Mulford Co., Philadelphia, with the same degree of care as Mulford Antitoxins, Serums, Vaccines, etc., which are standard all over the world.

CAUTION—Be sure to specify the particular legume on which you desire to use the MULFORD CULTURES otherwise we will not know how to fill your order. We have it for Alfalfa, Red Clover, White Clover, Sweet Clover (Bokhara), Alsike Clover, Field Peas, Vetch, Garden Peas, Garden Beans and Sweet Peas.

The Mulford experts do not believe in an "All-Crop" culture.

PRICES—Quarter acre size, 50c; 1 acre size, \$1.50; 5 acre size, \$5.00, postpaid. **TRIAL**

GARDEN SIZE for Sweet Peas, Garden Peas, Garden Beans only, 25c; postpaid, 30c.

Why buy expensive commercial nitrates when you can grow legume crops and thus increase your yield and at the same time increase the nitrates and enrich and renovate your soil by Nature's own method?

MULFORDS FREE DESCRIPTIVE LITERATURE SENT UPON REQUEST.

WONDER ODERLESS FERTILIZER

The best fertilizer for the city gardener; clean and odorless. Remember, it's **ALL FERTILIZER**; a wonder in action, a giant in strength, and the small amount necessary to use makes it the **CHEAPEST AND MOST EFFICIENT** High Grade Fertilizer on the market, and last, but not least, **IT IS ODORLESS.**

In "**WONDER**" you get the latest scientific discovery in plant food, something which gives results, something that astonishes. This "**WONDER**" fertilizer is the result of years of study and trials by a fertilizer expert. In "**WONDER**" we have a meritorious and **ODORLESS** concentrated fertilizer, put up in small packages, thereby making its distribution a cheap and easy matter. Being a concentrated fertilizer, only a very small amount is required to produce the largest yield. (See general directions below.) There's no use of your paying dray and freight charges on bulky fertilizers containing three-fourths sand, ash or dirt filler. "**WONDER**" is the pure "**DOPE**"—clean and easy to apply. We guarantee it to give results.

The small amount of "**WONDER**" required reduces the expense of fertilizing to about one-half the cost of manure or the average commercial fertilizers on the market. Rich in potash.

The "**WONDER**" Fertilizer is sold only in 25-lb. white, clean canvas bags, 2-lb. odorless cartons and 125-lb. sacks.

Price of "Wonder" Fertilizer

TWO-LB. CANS, Not Postpaid, 35c (P. Post, 2½ lbs). Add postage if wanted by mail. **25-LB. WHITE CANVAS BAG**, f. o. b. cars or boat Portland, or delivered free anywhere in this city or on any rural route within the first or second parcel post zone, \$2.35. By freight or express, 3 sacks, \$6.75; 125-lb. sack, \$9.00.

General Directions for Using Wonder

Remember a 25-lb. bag of "**WONDER**" is equal, in plant food, to 100 lbs. of most any other commercial fertilizer on the market.

For Ferns, Palms and House Plants: One-half teaspoonful to a 6-in. pot, dug into the top soil; 1 teaspoonful, heaping, when repotting, mix well through the soil.

For Vegetables: A teaspoonful to a Cabbage, Tomato, Cucumber, Pumpkin or Melon Vine. Sprinkle lightly, in the row, when planting Radish, Lettuce, Peas, etc., or hoe in the top soil after they are up. **For Flowers outside:** A very little to each plant, or dig into the top soil before or after planting. 1 lb. to 10 foot square.

For the Lawn: One 25-lb. bag of "**WONDER**" will go over a space of your lawn 50x50 or 2500 square feet, and is sufficient for same, applied once yearly. In dry weather **always** water after applying. Double the amount when making new lawns.

For Fruit, Roses, Etc.: A heaping tablespoonful for a small Fruit, Berry, or Rose Bush, a cupful for a 3 or 4 yr. tree; 1 to 3 lbs. to a full-bearing Fruit Tree, large Flowering Shrub or Vine.

CAUTION! Always mix the fertilizer into the top soil as much as possible, and water or sprinkle after applying it, especially on grass or tender foliage or growth.

Ask for "**WONDER**" **20-PAGE BOOKLET** that gives plain facts and full information and directions for all purposes. **FREE.**

NOTE.—Two sacks "C. M." and 1 25 lb. sack "Wonder" (see opposite page) mixed together will make a very rich combination fertilizer, that will prove highly satisfactory for all uses—as it would be very rich in plant food and supply the necessary humus for heavy soils.

ASK FOR
24-Page
"Wonder"
Booklet.
TELLS ALL

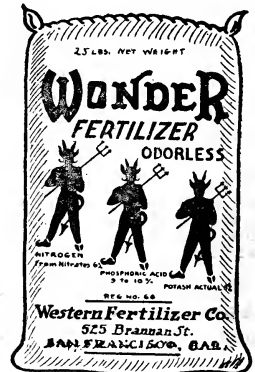

Junction City, Ore., June 12, 1917.
Routledge Seed & Floral Co.,
Gentlemen: I tried your "Wonder" fertilizer last year and find it has the right name. It was wonderful the difference there was between the vegetables where it was and was not used.

Hundreds of our customers say the same

You try it and be convinced. Your report, please

MRS. O. C. IVIE.

Use Fertilizer—Double Your Crops and Help Feed the Nations



Kiln-Dried Pulverized Cow Manure

For Short, We Call It "C. M."

Supplies the "Humus" lacking in chemical Fertilizers and the analysis shows it to be quite rich in nitrogen potash and phosphoric acid. It will not burn or harm the most tender seeds or plants.

This product is made of green cow manure by putting it through a dry-kiln with heat enough to evaporate the water and kill all weed seed without burning the compost or destroying the fertilizing elements. It is then ground finely and sacked.

Gardeners and Florists have discovered its great value, and the demand is rapidly increasing.

EIGHT TO ONE.—You can get a good idea of the value of this concentrated product when we state, that it takes 8 to 10 tons, in the green or natural state, to make 1 ton ready to sack. If you stop and think a minute, you will realize that we are really offering, in a most convenient dry state, a fertilizer and compost that heretofore you

have bought by the wagon load, in a most dirty, foul and disagreeable form.

SUPPLIES THE HUMUS.—This new product supplies all the humus and fertilizing value of the old form, without the disagreeable odor, coarse straw, chaff and weed seeds to get scattered over the garden or lawn. In fact you get everything in an ideal form except the live weed seed and moisture. You do not want the weeds and can easily apply water when needed. There is no use of paying dray, freight or handling charges for dirty, foul, water soaked manure when this product can be had.

CHEAPER AND MORE CONVENIENT.—The old form cow manure costs about \$3.00 a load delivered and about \$3.00 more to get it placed and spaded under. Two sacks of our Dry-Kiln C. M., which is practically odorless and can be spread around by anyone at leisure, will cost less and give better results.

Uses and Directions for "C. M."

FOR FLOWER BOXES OR REPOTTING

This Dry-Kiln Cow Manure will be found very valuable to mix with ordinary garden soil for repotting plants, filling window or porch boxes or the benches in the greenhouse, the top soil of cold frames, hot beds, etc. Use from one-fourth to one-third "C. M." according to the soil.

FOR SEED BEDS

As a top dressing over seed beds, where small flower or vegetable seeds are to be started, nothing else could be better, as it is full of "humus" (like leaf-mold) which keeps the top soil loose and open. Rake "C. M." into the top soil or after seeding, sprinkle "C. M." over the surface.

FOR VEGETABLES AND FLOWERS

Use "C. M." on any soil that needs loosening up and enriching. To raise choice vegetables and large beautiful flowers, the soil must be well worked, rich and loamy.

FOR LAWNS

"C. M." is just what has been wanted for years by amateur and professional lawn-makers. Heretofore on account of heavy soils that would bake and crack, the best cow manure obtainable was used to open up and keep the soil loose. It was not the plant food needed, as that could easily be applied in the form of Chemical Fertilizer, but it was the "humus" in the stable manure that was wanted, but NOW with this Dry-Kiln, weed free, "C. M." the lawn-maker's troubles are greatly reduced.

HOW TO USE.—After the lawn has been graded, raked, seeded and rolled, spread "C. M." broadcast over the seed, covering it well. If it is dry weather, sprinkle, but sprinkle lightly so as not to wash it off until it has settled, after it is once wet it becomes part of the surface soil and will remain.

ANOTHER WAY.—Providing you will use "C. M." in a liberal amount it would be better raked into the surface soil, then seed, rake lightly and roll.

PRICES OF DRY-KILN "C. M."

Large Sks., \$1.75; 3 Sks., \$5.00; 5 Sks., \$8.00; 10 Sks., \$15.00; ton, \$33.00; small lots—2 Lbs., 15c; 5 Lbs., 25c; 10 Lbs., 40c; 35 Lbs., \$1.00.

Up-to-Date Fertilizers of Merit

With our new fertilizer Dry-Kiln "C. M." to supply humus, and "Wonder" the strongest and richest odorless chemical fertilizer and "Ground Lime Rock" the great soil conditioner, we have a combination that will supply every need.

The day of strong smelling, odorous fertilizers is over, we believe, at least for the city and suburban gardener.

For Liquid Manure.—Empty half a sack of "C. M." into a 50 gal. barrel and fill with water. Use this liquid straight or diluted form, for watering. The increased vigor and growth of plants will almost immediately be noticed.

Fertilizers—Continued

NOTICE.—Fertilizer prices subject to market changes. Write for quantity price.

SHEEP GUANO—PULVERIZED

For Lawns and Garden Work.

We can supply this to those who order it, but we like "C-M" better. (See pg. 39.)

Prices: 100-lb. bag, \$2.25; low price per ton.

HIGH-GRADE BONE MEAL.—This is finely ground and of best quality. Used for Lawns, Roses, Shrubs and Trees. Not very quick in action and should be applied in the fall or very early spring. Use 1000 to 2000 lbs. per acre.

Prices: 5 lbs. 30c; 10 lbs. 50c; 50 lbs. \$1.75; 100 lbs. \$3.25. Low ton price.

FERTILIME (Hydrated fertilizer lime).—The best grade, ground very fine; more than worth the higher price. Not sold in less than 100-lb. sacks.

Price, \$1.50; 500 lbs. \$6.00.

GROUND LIMESTONE.—Lime is an indirect soil improver and a very valuable conditioner. Loosens the soil and releases the plant foods. Few people realize its value. Most Western Oregon soils need lime.

Prices: 10 lbs. 50c; 50 lbs. 75c; 100 lbs. 90c; 500 lbs. \$4.00; ton \$12.50.

LAND PLASTER.—Used largely on grass and clover crops. Highest grade.

Prices: 10 lbs. 25c; 50 lbs. 75c; 100 lbs. \$1.00; for ton price, write.

NITRATE OF SODA.—It is very quick in action, and hastens maturity of crops. Being quickly soluble, it should not be applied until the plants are above ground. Be careful or it will burn tender foliage.

Prices: Lb. 10c; 5 lbs. 40c; write for quantity price; market unsettled.

Kirk System of Fertilizing and Spraying

The **KIRKE SYSTEM**, is an Ingenious, Scientific Method of combining in one operation the several others formerly attendant upon fertilizers and insecticides for Lawns, Gardens, Shrubbery and Foliage.

A simple but **clean, odorless**, positively active, easily handled, practicable, **economical**, and efficient method of destroying Insects or Fertilizing requiring no additional labor or experience.

It abolishes the use of unsanitary stable manure, so objectionable, because of its disagreeable odors and the great abundance of weedseeds it contains.

It abolishes the use of cumbersome hand-pumps, hand sprayers, carts and wagons, etc., for distributing Insecticides and Fertilizers.

It is without an experimental feature—it will work as well for you as for the thousands all over the country who already enjoy its benefits.

It brings Maximum Efficiency with a saving to you of **time, labor and money.**

THE KIRKE FEEDER

Consists of a cylindrical nickel-plated metal cartridge holder, which is easily connected to any standard size water faucet or hose nozzle, and in which is placed a **KIRKE Fertilizer, Insecticide or Fungicide cartridge.**

It is a neat device and will last a lifetime. It is simplicity itself, and even a child can handle it. Price \$3.00 prepaid.

KIRKE CARTRIDGES

To be placed in the **Kirke Feeder.** They are composed of the highest grade of concentrated and extremely active chemicals, and **dissolve gradually** with even and positive distribution.



Using Fertilizer Tablet in Sprinking Can.

KIRKE FERTILIZER TABLETS

Sprinking-Can Plant Food

For house plants in pots, porch boxes; flowers or vegetable gardens or grass plots, that are watered by hand.

One tablet is enough for eight gallons of water. Can be dissolved in a stronger solution and then diluted when used.

This fertilizer promotes and sustains vigorous, healthy, luxuriant growth and abundant and richly colored flowers.

Price per box of 12 tablets, 40c postpaid.

PRICE LIST OF KIRK CARTRIDGES.

	Each
Prices subject to market prices of chemicals.	
Fertilizer Cartridges—For garden and lawn.....	.35
Tobacco (Nicotine and soap)—For all sucking insects	.40
Arsenate of Lead—For all leaf-eating insects....	.60
Bordeaux (Fungicide)—For mildew, blight, rust, etc.	.45
Angle Worm Destroyer—For Tennis Courts, Lawns, Golf Links, etc.....	1.25
Sulphur Compound—Insecticide and Fungicide Spray.	.35
Fly-Maggot Compound—Disinfectant and Germicide for stables, kennels, coops, pens, workshops, etc..	.35

NOTE.—Above prices are **NOT POSTPAID.**

Prices subject to changes in Chemical market. Dozen prices on request.

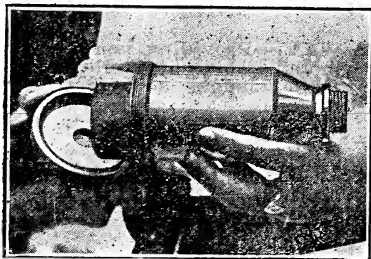

The Kirk Feeder Showing Cap Off and Cartridge Inserted.

"KIRKE SYSTEM" once used always used. "Kirke System" received a special award at both the Philadelphia and New York Flower Shows. **DESCRIPTIVE CATALOG ON REQUEST.**



One of our Portland Bungalows with a beautiful lawn, shrubs and vines

Nothing adds a greater air of refinement to a home than a beautiful, well-kept lawn. The time, labor and money spent is a good investment, to say nothing of the pleasure it gives the owner, as well as those who pass by. The planting of a few Shrubs, Vines and Roses should not be forgotten. The pretty home above is "well done," attractive and inviting, and the owner has just cause to be proud of it.

LAWN GRASS SEED

Though we offer separately, seed of many of the grasses suitable for the lawn, we consider as very erroneous the somewhat prevalent idea that any single variety of grass seed is preferable or equal to a mixture.

R. R.'s Evergreen Lawn Grass

To obtain a good Lawn Grass Mixture, it is necessary that the best possible seed of fine grasses be used in the combination, embracing such varieties as are of neat, close growth, extreme hardiness, and adapted to produce a quick, permanent sod. Judicious selection of seed, knowledge of the habits, vigor, quality and hardiness of varieties used in the mixture can only be gained by thorough and practical tests under different climatic and soil conditions. After many years' experience, we offer our pure, clean Evergreen Lawn Grass Seed Mixture, composed of a thoroughly balanced combination of various native and foreign fine-leaved, deep-rooting grasses of interweaving habit, that will flourish under varied soil and climatic conditions, and which may be depended upon to produce a beautiful, compact evergreen sod that will resist tramping and hard usage, and at the same time present that handsome, velvety appearance so much desired.

PRICE, 45c per lb. postpaid; 10 lbs. or more NOT PREPAID at 40c lb.

Note.—You better spend a few cents or a dollar extra on the seed you buy and have a fine lawn that you'll be proud of. Sow 1 pound seed to 15 feet square for best results.

Seeds for Lawns and Special Mixtures

SEED.—There is as much difference between clean, high grade grass and clover seeds for lawn making and the common or ordinary grass seeds as there is between high grade white flour and bran. You would not think of trying to make light, white bread of bran, neither should you expect to make a fine green, velvety lawn from low grade, light weight, immature and foul grass seeds. **Weight purity and germination** is what sets the price of grass and clover seeds. We buy and use the **highest grade, pure tested seeds** for our Evergreen Lawn Grass Mixture. Of course, they cost more, but we know from experience that they give best results and are the **only kind** of seeds that it pays to use if you want a beautiful lawn. Do not buy low priced Lawn Grass Mixtures and expect good results. **NO ONE** gives you anything better than you pay for.

SPECIAL MIXTURES.—For all round general conditions, our Evergreen Mixture is unexcelled, but we will prepare special mixtures for shady places, low, wet soils, very dry soils and terraces. Just mention it when ordering.

WHITE CLOVER.—Many gardeners like white clover mixed in lawn seeds and it is excellent, especially if your soil is heavy or poor. White clover grows quickly and acts as a nurse crop and protects the fine leaved grasses. Evergreen Lawn Grass with one-fourth white clover is 10c per pound more.

FAIR GREEN LAWN GRASS

For those that are not so particular, or for ordinary purposes, this mixture will give satisfaction. It is not a cheap mixture; far from it. We know it is equal to most fancy or special mixtures being offered.

Per lb. 35c, postage extra; 10 lbs. or more, not prepaid, at 30c lb.

Feed the Lawn

Do not starve the grass if you want it to look green and velvety; use "Wonder" and "C-M," as per directions. See pages 38 and 39.

ALFALFA AND CLOVER SEEDS

Single pound prices on Grass Seed are prepaid. Ten, fifty and one hundred pound prices are NOT prepaid and subject to change. See notes, page 43. For amount of seed to sow per acre see table inside back cover.

White Clover (*Trifolium Repens*)

Used largely in lawns and permanent pasture mixtures. Accommodates itself to a great variety of soils. High grade clean seed is very scarce and high this year; beware of low-priced seed this season.

Choice Seed, 10 lbs. \$6.00. Per lb., postpaid, 65c.

Extra Fancy Seed.—Per lb., postpaid, 75c

For Lawns always buy our Extra Fancy Seed, which is the purest high quality seed obtainable, and the true very dwarf, hardy variety.

It Pays Well to inoculate Alfalfa and Clover Seeds with Mulford's Cultures. See page 37.

Red Clover (*Trifolium Pratense*)

Hardy, and succeeds well on any good soil, 10 lbs. \$2.90; 100 lbs. \$27.00; per lb., postpaid, 35c.

Alsike Clover (*Trifolium Hybridum*)

Valued highly for sowing with other grasses. Excellent for hay and pasture; valuable for bees; resists both drought and excessive moisture.

10 lbs. \$2.90; 100 lbs. \$27.00; per lb., postpaid, 35c.

INOCULATE THIS
SEED WITH
MULFORD CULTURE

The MULFORD CULTURES contain nitrogen-fixing bacteria, which form nodules on the roots of field and garden legumes that act by collecting nitrogen from the air and converting it into nitrates—food for soil and plants. Get wise by reading page 37.



Sweet Clover (*Melilotus*)

Sweet clover has come to stay. There is no doubt about it. Ask any farm paper, any state college, the U. S. Department, or better yet, any man who has grown it.

Sweet clover is used as either a feed crop or as a fertilizer to plow under to improve the soil and increase the crop to follow. It grows fast and is easy to start.

Grows luxuriantly on good soils but it will also grow and thrive on thin, sandy soil, hardpan, gumbo, rocky upland, clay and alkali land.

Sweet clover lives two years. It makes large, rapid growth the first season and can be cut for hay or pastured the last half of the summer, but does not bloom or bear seed. The second year it blooms, bears seeds and dies. Will make two crops of hay or a crop of hay and one of seed the second year. Can be plowed under either the first or second year, but to get the full value in humus the second season is better on account of the large roots that penetrates the lower layers of soil thereby loosening it up and adding much humus and more nitrogen.

Sown very early in the spring. It does well sown either alone or with a nurse crop of small grain. Use 15 to 20 pounds of seed per acre.

Sweet Clover makes excellent pasture for horses, cattle, sheep, hogs or chickens. A very early and continuous cropper.

Price: Per lb. 40c, postpaid; 10 lbs. \$3.25; trial pkg. 10c. Write for quantity price.

Double Your Clover Crop

By treating all clover seeds you plant with Mulford's Culture. BEST BY TEST. See page 37.

Alfalfa, or Lucerne Clover

Reports prove that Alfalfa will grow in all parts of the West, but requires a deep loose soil. Will not thrive on heavy clay or where there is hard pan. As soon as cut it immediately commences to grow. Excellent hay or pasture. Alfalfa, once established, is a crop so profitable that every farmer may well take great care to get a stand. Much has been published about its high feeding, fertilizing and wonderful yield possibilities.

Price: 10 lbs. \$2.25; 100 lbs. \$21.00. Per lb., postpaid, 35c.

Dry Land Alfalfa

For high, dry, hot land, where irrigation is impossible.

Price: 10 lbs. \$2.75; 100 lbs. \$26.00. Per lb., postpaid, 35c.

Crimson Clover (*Trifolium Incarnatum*)

A thrifty annual. It germinates quickly, grows rapidly and stools abundantly.

10 lbs. \$2.75. Per lb., postpaid, 35c

For Best Results Treat All Clover Seeds with Mulford's Cultures (See p. 37)



GRASS AND FIELD SEEDS



ABOUT PRICES

READ THE FOLLOWING

ABOUT PRICES

Only one grade priced, the best, choice, clean seed. Write for prices in quantity. Single pound prices on Grass and Clover Seeds are prepaid. Prices per ten, fifty and one hundred pounds are not prepaid and are subject to market changes. Reference tables inside back cover.

YOU WILL ALWAYS GET YOUR MONEY'S WORTH

Prices on Grass and Field Seeds change occasionally, therefore we cannot print prices good for any length of time. When ready to buy, write us for special prices, stating quantity wanted, or order what you want at catalog prices, and we guarantee that we will give you full value for the money sent, whether the price at the time you order be higher or lower. In other words, we will always ship seed to cover the full amount of money sent to us.

FOR AMOUNT TO SOW PER ACRE, SEE INSIDE BACK COVER

SUDAN GRASS

A New Forage and Hay Crop—A Valuable One-Season Crop

This grass was introduced in the States by the Department of Agriculture and has proved a great success, especially for dry-land conditions, and from many reports and observations and samples of the grass shown it appears to do equally well in all parts of the Willamette Valley.

Sudan Grass is strictly an annual and dies each year like Millet and must be seeded again each spring. This makes it fit admirably into any system of rotation, and while it does not benefit the soil like legumes, it does afford a change in crop and this is a good thing for the soil. Sudan Grass is tall, reaching a height of from seven to nine feet. The plant stools wonderfully and produces under favorable conditions as many as 100 stems from a single root.

It belongs to the sorghum family, but is more slender and grassy in manner of growth, earlier and hardier, and matures in 10 to 12 weeks. Yields a good crop of first-class hay. All stock relish the hay and thrive on it. The quality is said to be equal to timothy. Yields of from two to four tons per acre are common, and under irrigation they run as high as eight to ten tons per acre.

Seeding. Do not plant until the soil has become warm in the spring or any time during the summer as a catch crop, so long as 70 to 80 days intervene before frosts. Sudan Grass can be sown in rows 18 to 42 inches apart, drilled in with a grain drill or sown broadcast. In the semi-arid sections it is much more profitable to seed it in rows and cultivate, and even in the humid regions a small amount of cultivation appears to give added vigor to the plants. Seeded in drills 36 inches apart, 3 pounds per acre; drills, 18 inches apart, 6 pounds; broadcast by hand or grain drill, 16 to 20 pounds per acre.

Harvesting. Sudan Grass is easy to cut with a mower and cures readily. When cut for hay it is best to cut just after full bloom, so that it will have as much time as possible for a second growth. After cutting it renews its growth promptly when moisture conditions are favorable. The grass stools abundantly after first cutting and the second and third cuttings are very fine stemmed.

Every farmer looking for a new forage or hay crop should try at least an acre or two. Beware of cheap, inferior seed.

Prices Select, Tested Seed: 10 lbs. \$2.75; per lb. 35c postpaid. Write for quantity price.

Kentucky Blue (*Poa Pratensis*)

Remarkable for its ability to adapt itself to a great variety of soils, succeeding on an average dry soil as well as on a moist meadow. An abundant yielder and presents a handsome green appearance early in the spring, thus making it of great value for lawn mixtures. Our extra fancy grade for lawns is unequalled.

Fancy, 10 lbs. \$3.00. Per lb., postpaid, 35c.
H. Q. extra fancy, 10 lbs. \$3.50. Per lb., postpaid, 40c.

NOTE.—Our H. Q. (highest quality) Extra Fancy seed is unexcelled for weight and purity. Few dealers handle this high grade recleaned seed on account of its cost. This seed, straight or mixed with Fancy White Clover is excellent for lawns.

English Rye Grass (*Lolium Perenne*)

A strong-growing, hardy perennial grass, noted for its nutritive qualities. It is equally valuable for both grazing and hay. It grows very rapidly and makes a good showing in a few weeks.

For Lawns this is used and recommended by many gardeners. If sown thickly, it makes a good hardy lawn, and for large grounds and parks it is very successful. Often mixed with White Clover.

10 lbs. \$1.75; 100 lbs. \$15.00. Per lb., postpaid, 35c.

Creeping Bent (*Agrostis Stolonifera*)

Perennial. A grass desirable for either lawns or permanent pastures on account of the fine, firm and enduring turf it produces; especially adapted to moist situations.

Per lb., postpaid, 75c

NOTE.—We know you can buy cheaper Grass Seeds from other dealers. We offer only the **BEST RECLEANED HEAVY CLEAN SEEDS**—by far cheapest to buy.

Grass Seeds—Continued

For amounts of seed to sow per acre, see inside back cover

Orchard (*Dactylis Glomerata*)

Of the greatest value in permanent pasture mixtures; thrives best in moist, shady places, but will withstand drought exceedingly well. Valued for hay crop, as it is very nutritious if cut early. Its inclination to grow in tufts necessitates other grasses being sown with it.

10 lbs. \$3.00; 100 lbs. \$28.00. Per lb., postpaid, 40c.

Red Top (*Agrostis Vulgaris*)

Of great value for mixing with hay or permanent pasture grasses; will succeed in nearly any soil, but thrives best in a rich, moist soil; makes a fine bottom growth, rendering it invaluable to be sown with grasses, such as timothy and orchard.

Choice Seed, not hulled, 10 lbs. \$1.40; 100 lbs. \$12.00. Per lb., postpaid, 25c.

Fancy Hulled Seed, 10 lbs. \$2.50; 100 lbs. \$18.00. Per lb., postpaid, 30c.

Mesquite (*Holcus Lanatus*)

It is usually sown on virgin soil, without cultivation, after the ground has been burned over.

Fancy Hulled Seed, 10 lbs. \$2.25; 100 lbs. write. Per lb., postpaid, 30c.

Italian Rye (*Lolium Italicum*)

A quick-growing grass, attaining a height of 2½ to 4 feet; very desirable for meadows or permanent pastures; thrives best on soils that are slightly moist, and will even stand considerable overflow; grows easily and bears an abundance of foliage that makes the best and sweetest hay imaginable.

10 lbs. \$1.85; 100 lbs. \$15.00. Per lb., postpaid, 25c.

Timothy, (*Phleum Pratense*)

As a hay crop, timothy is unsurpassed by any other grass. Thrives on ordinary soil, but succeeds best in a moist loam. Best to cut it when in blossom or soon after flowering. Beneficial to sow timothy with red top and red clover, as they produce more of a bottom growth.

10 lbs. \$1.50; 100 lbs. \$12.00. Per lb., postpaid, 25c.

Bromus Inermis (Brome Grass)

On account of its strong perennial character, and its unusual drought-resisting powers, is the best grass we have for the semi-arid regions of the Northwest. It grows luxuriantly, is freely eaten in either the dry or green state by cattle, and yields enormously, making the best of hay for horses or cattle.

10 lbs. \$2.50. Per lb., postpaid, 35c.

Crested Dog's Tail (*Cynosurus Cristatus*)

A perennial grass, forming a smooth and lasting turf, excellent in mixtures for lawns, putting-greens, and pastures. It thrives best on rich, moist land, but can accommodate itself to almost any soil, and, as the roots penetrate deeply into the ground, it can stand severe drought.

10 lbs. \$4.50. Per lb., postpaid, 50c.

Rhode Island Bent (*Agrostis Canina*)

Forms a very fine turf even on light soils; desirable for lawns, as it forms a very close sward.

Per lb. postpaid, 65c.

FIELD AND FARM SEEDS

Single pound prices are prepaid. Ten, fifty and one hundred pound prices are NOT prepaid and subject to market changes. Seed to cover amount remitted always sent unless otherwise ordered. See notes, page 43. Write for prices on larger quantities when ready to buy.

White Jerusalem Artichokes

Planted and cultivated for the tuber, the same as potatoes. Of great value for feeding stock. They are the best and cheapest hog feed known. They are remarkable for great productiveness, over 25 tons have been raised on 1 acre. Easier to grow than potatoes. They need not be dug. If hogs are turned in on them they can easily root the tubers out. One acre will keep from twenty to thirty hogs in fine condition for several months. Said to be a preventive of cholera and other hog diseases. Excellent for fattening if fed with a grain or mash ration. Plant 400 lbs. per acre early in the spring.

By freight or express, 10 lbs. 40c; 50 lbs. \$1.25; 100 lbs. \$2.00. Per lb., prepaid, 15c; 4 lbs. 50c. Write for quantity price.

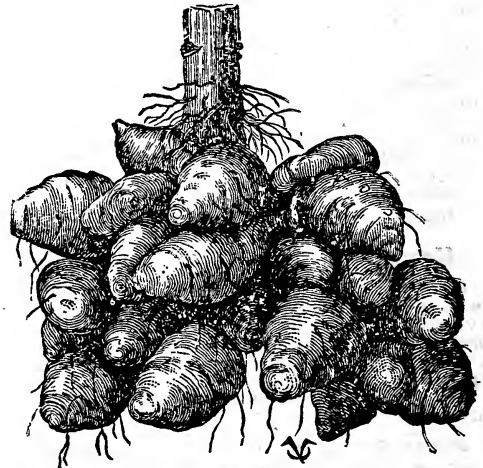

Artichoke Tubers.

VALUABLE BOOKS.—On pages 132 and 133 we offer an up-to-date list of valuable books.

You Need One DAD'S NEW ELECTRIC LIGHT is something that will be of great service to our city, suburban and country customers. It's an all-around light, lantern or flashlight, in fact, it's "THE LIGHT OF ALL LIGHTS"—makes "NIGHT TIME A BRIGHT TIME." It takes the place of ALL open flame, gas or oil explosive lights for ALL PEOPLE and ALL PURPOSES. It is always ready. See page 131.

Barley

BEARDLESS.—The earliest barley known.

The straw is about the height of the common barley, but better, and will stand up on any land; with good season, land has produced 80 bushels per acre. Sow as early as you can; frost does not hurt it. This, as its name implies, is almost entirely beardless, and as easy to grow and handle as oats. It is becoming more popular each season. Per lb., postpaid, 20c. Write for quantity prices.

WHITE HULLESS (Bald Barley).—A grand barley for stock feeding. Grain plump, heavy, and when threshed is hullless like wheat; a heavy cropper. When grown and cut for hay it produces a magnificent crop, which is very rich and almost equal to a grain feed. Much relished by horses and stock of all kinds. An excellent hog feed. Culture same as common barley.

Per lb., postpaid, 25c. Write for quantity prices.

COMMON BARLEY.—We always aim to have a nice, clean stock of good Seed Barley on hand at all times.

Per lb., postpaid, 20c. Write for quantity prices.

Buckwheat

SILVER HULL.—A very good and popular variety; grain is of a light gray color; has a thin husk; matures early, and yields heavily; a good milling variety.

10 lbs. 75c; 100 lbs., write. Per lb., postpaid, 20c.

JAPANESE.—Good yielder, ripens early; excellent for bee to work on as it remains in bloom longer.

10 lbs. 75c; 100 lbs., write. Per lb., postpaid, 20c.

Cheat Seed

Cheat seed yields a good crop of hay, especially on low or moist soil, and will stand considerable overflow without harm. Sow in the fall or early spring, the same as oats and about 100 pounds per acre.

10 lbs. 60c. Per lb., postpaid, 15c. Write for quantity prices.



Cow Peas

Are really small beans of vigorous habit and heavy foliage of great nutritious value, yielding five to nine tons of green feed per acre, or can be cut and cured like clover. They are great nitrogen gatherers and one of the best fertilizers when turned under. Sow two bushels per acre.

WHIP-POO-WILL.—Upright or bush growth, earlier maturing, easily harvested.

CLAY.—Of vigorous growth. Excellent for ensilage; can be planted in hills with corn.

10 lbs. \$1.00; 100 lbs., write. Per lb., postpaid, 20c.

Thousand-Headed Kale

Commonly Called COW KALE

Recommended by agricultural colleges, granges and dairymen as one of the most valuable green forage plants for the Pacific Coast.

It grows rapidly and produces a mass of large, thick, curly green leaves, rich and succulent, which are eagerly eaten by stock and poultry. If planted early will produce valuable green feed during the dry summer months. Makes the most rapid growth if sown in the early spring, but locally it is extensively planted in summer and fall for winter feed. Will stand light freezing. Stalks can be cut off, or the larger lower leaves broken off, leaving the tops to grow. Under good cultivation plants will grow from 5 to 6 feet high. Sow 2 to 3 lbs. per acre, thinly in drills 2 to 4 ft. apart and thin out. For late planting (July and August) it is better to have strong plants from earlier seeding and set out same as cabbage, 2 ft. apart, in rows. Thin out later if plants attain extra large size.

Pkt. 5c; oz. 15c; 4 czs. 30c; lb. 90c. postpaid.



Thousand-Headed Kale.

This cut is from photo, and gives you a good idea of the size and plant when well grown.

ROOTS AND CORN.—Progressive farmers always provide full cellars of Carrots, Sugar Beets, Mangels and Swede Turnips—and we believe it is in the best interest of every farmer to grow plenty of Field Roots in addition to a liberal acreage of Corn for his live stock. These greatly reduce the grain and hay consumed, and keep the stock in excellent health.

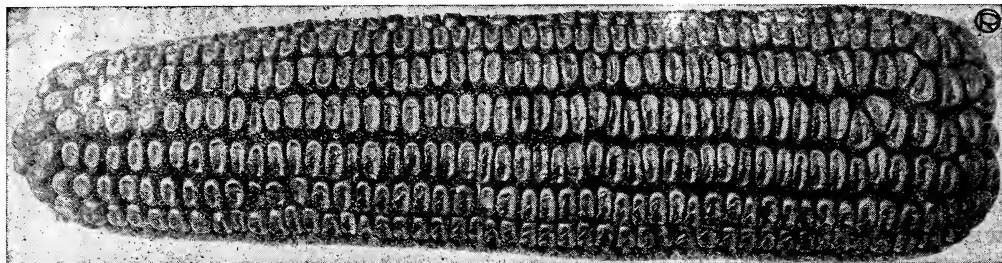

Routledge Pride of the West.

FIELD CORN FOR OREGON

If you want to raise some good Field Corn, plant our Western grown Seed Corn. The strains we are offering you are acclimated and especially adapted to our short, cool summers. Eastern and Southern grown field corn seed is all right for green fodder, but of little value on this Coast, if you want to raise matured, dry ears.

Routledge Pride of the West

(Sample Ears on Display at Our Store.)

Oregon grown; acclimated. A grand success in Oregon. We have been raising this variety for years, and by selecting the earliest ripening and best select ears, now have a strain that is a revelation to many people who have thought Oregon and Washington could not raise profitable field corn.

Routledge Pride of the West Field Corn is an early maturing variety, producing stalks from 6 to 8 and 10 feet high, and large ears, 8 and 9 inches long. Cobs covered with 14 to 16 rows of deep, yellow kernels. It is a heavy yielder. Our strain has been greatly improved in the last 2 years. Plant some of this corn this season; you will be pleased with results, we are sure.

Better Than Ever.—Last season in spite of the late backward spring and unfavorable growing season our grower again harvested over **85 bushels per acre** of large, well-filled, mature ears.

We claim this is the **earliest and heaviest yielding strain** of Yellow Dent corn grown in Oregon. Try it and be convinced.

Large pkt. 10c; lb. 25c, postpaid. Not postpaid, 10 lbs. \$1.60; 100 lbs., write.

Longfellow Extra Early

Unsurpassed for Early Mature Ears and Production.

This valuable corn is a flint variety, Oregon grown and thoroughly acclimated. Has been grown near Portland for the past six years with great success.

We believe this is hardier, earlier, and will grow under more adverse conditions than most any other kind. We recommend Longfellow to all growers who have not had success with the Yellow Dent varieties and for sections with a short season and cool nights.

LONGFELLOW FLINT.—The ears are 8 rowed, from 10 to 15 inches long and $1\frac{1}{2}$ to $1\frac{3}{4}$ inches in diameter. The cob is very small, kernels large, broad, glossy, deep yellow and very rich in food value. Stalks 5 to 7 feet high. Fifty lbs. of corn on the ears will shell 40 lbs. of corn, leaving only 10 lbs. of cob, showing that the grain yield is equal, if not greater than the large eared kinds.

Per large pkt. 10c; lb. 25c, postpaid. Not prepaid, 5 lbs. 85c; 10 lbs. \$1.60; 100 lbs., write.



Longfellow Extra Early Flint

MINNESOTA NO. 13—YELLOW DENT

Well and favorably known in many sections of the West. Produces splendid large ears with deep kernels of bright yellow. A strong and vigorous grower with heavy foliage. A good fodder corn.

Oregon Grown.—Large pkt. 10c; lb. 20c, postpaid. Not prepaid, 10 lbs. \$1.40; 100 lbs., write.

HARTMAN YELLOW DENT

A variety much advertised and claimed to be very early, productive and profitable. Has given excellent results in some sections—true stock.

Large pkt. 10c; lb. 20c, postpaid. Not prepaid, lb. 15c; 10 lbs. \$1.50; 100 lbs., write.

CORN PLANTERS

We offer on page 121 two of the best hand Corn Planters made. They save seed and labor and plant right.

OUR OREGON GROWN ACCLIMATED FIELD CORN WILL PLEASE YOU.

Field Peas

Field Peas are a very profitable crop and are grown here very extensively. They can be grown alone or with oats. When planted with oats and cut green they make a large amount of very rich feed; also very valuable for enriching the soil if plowed under. The dry peas make excellent hog feed and are quite fattening. Sow, if alone, 2 bushels to the acre; if with oats 1½ bushels peas and 2 bushels oats.

WHITE CANADIAN.—The leading and most popular kind; seed creamy white; a heavy cropper. Yields 30 to 50 bushels per acre.

10 lbs. \$1.00; 100 lbs., write. Per lb., postpaid, 20c

BLUE PRUSSIAN.—Valuable variety, seed green. Used extensively as a dry soup pea.

Per lb., postpaid, 25c. Stock scarce, write for price.

INSURE YOUR PEA CROP

Why not be sure of a large heavy crop of peas by inoculating the seed with "Mulford's Cultures?" (See page 37.)

A United States Department of Agriculture Bulletin 524:

"It is worse than useless to attempt to grow any leguminous crop without being certain of the presence of the bacteria, which enable the plants to fix free nitrogen. Certain regions are practically devoid of the right kind of bacteria, and unless some artificial means of inoculating with the germ is resorted to, the crop will be a failure." Use Mulford's Culture, page 37.

SEED OATS

Routledge Prize Oats

This wonderful new Oat, introduced by us in 1908, has proved in growing contests all we claimed for it. **Routledge Prize** certainly is a prize oat, and a real **prize-winner** at the county fairs wherever it has been shown. This grand oat belongs to the tree or branching class, and is a vigorous, healthy grower of strong stooling qualities. This is one of the heaviest yielding oats introduced to date. From several hundred samples we sent out, spring of 1908, the lightest yield reported was over 100 bushels per acre, and from that up to 200 and 300 bushels where it was given special cultivation. Under ordinary conditions and good soil, we know of no variety that will out yield it.

Routledge Prize Oat is a very early, drought-resisting variety. Grain of good size, plump and heavy, and one that matures quickly, making it a very valuable variety where the seasons are short. While this is really a spring oat, it can safely be planted in the fall in the Willamette Valley or any locality where the winters are mild. White seeded variety.

Prices: 1 lb. 20c; 3 lbs. 50c, postpaid. Market unsettled. Write for prices, stating quantity wanted.

Shadeland Challenge

The best white **side oat** we know of. Hardy, vigorous, early maturing, and still maintains its supremacy as the best, heaviest yielding, general purpose Oat in existence.

"**Shadeland Challenge**" is a heavy, plump, thin-hulled oat whose immense heads often measure 18 inches in length, bearing from 250 to 300 kernels. Shadeland Challenge ripens in about 100 days from planting if spring sown, and 100 bushels per acre is not uncommon on ordinary soil. Can be planted in the fall (where the winters are mild) or as early as possible in the spring.

Prices: 1 lb. 20c; 3 lbs. 50c, postpaid. Market unsettled. Write for prices, stating quantity wanted.

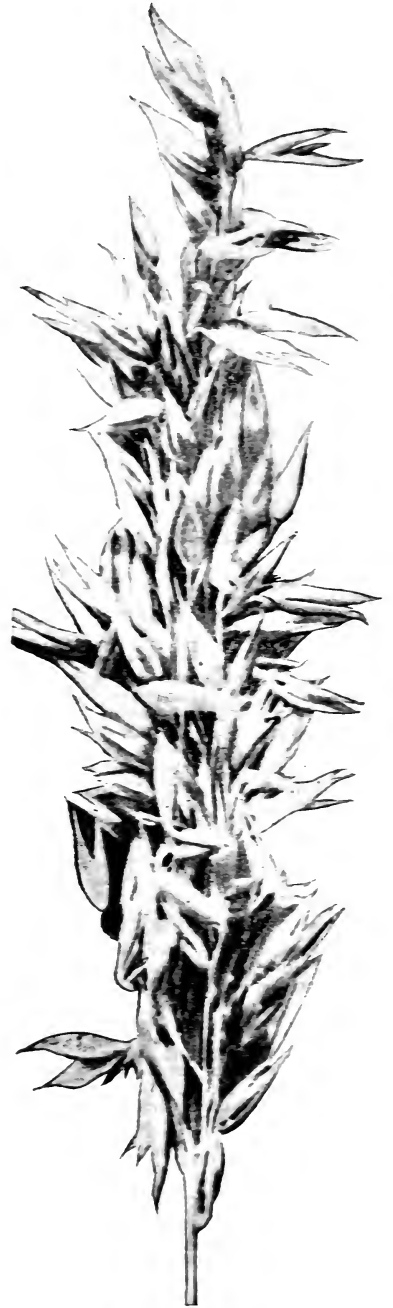

Routledge Prize.

White, Gray or Black Seed Oats

We always aim to have a selected re-cleaned stock of good White, Black or Gray Seed Oats. Can sell them at about market price for No. 1 seed. Market unsettled. Write for prices, stating quantity wanted.

DON'T Practice false economy by buying low-priced grains. It don't pay. Our motto—**Quality First Price as Low as we can make it.**



Millet.

Kaffir Corn

An excellent fodder plant. Seed small and almost round, valuable poultry and pigeon food. It does best sown thinly in drills three feet apart. 10 lbs. \$1.20; per lb., postpaid, 25c

Lentils

Succeed best in dry, sandy soil. A leguminous annual, the seeds of which are valuable for pigeons and are used largely for soups. The leafy stalks make good forage.

Per lb., postpaid, 25c

Millets

Sow in April, May or June, 20 pounds for seed or 35 pounds for hay per acre. Must be sown early to mature in Willamette Valley.

EARLY FORTUNE.—This variety seems to do extra well here; try it. Heads large and loose, and seed is amber red and three times as large as the German. Makes good poultry feed.

10 lbs. \$1.00; 100 lbs., write; per lb., postpaid, 20c

GERMAN.—An improved variety, yielding a larger crop of seed than the common millet. It is also taller than the common, and yields a heavier crop of hay.

10 lbs. \$1.00; 100 lbs., write; per lb., postpaid, 20c

HUNGARIAN.—A dwarf millet; superior for hay.

10 lbs. \$1.00; 100 lbs., write; per lb., postpaid, 20c

Profitable Potatoes for Seed—See Pages 28-29

Rape, Dwarf Essex

We offer you true, pure seed. One of the best forage plants, on account of the large amount of green feed it will produce at a season of the year when everything else is dried up. It has yielded ten tons of green forage per acre, and has twice the feeding value of green clover. Sheep, swine, cattle and poultry eat it readily. Rape will do well on almost any soil. Prepare the ground as for turnips, and sow any time from May till September; or plant it with grain. Sow, per acre three pounds, in drills; or, if broadcast, five pounds.

10 lbs. \$1.60; write for quantity prices; per lb., postpaid, 25c.

Seed Wheat or Rye

When ready to buy any variety of Seed Wheat, write us for quotations on quantity wanted or send in your order and we will give full value at lowest market price.

Speltz—Emmer

Sow in the spring, the same as wheat, at the rate of two bushels per acre. Cut when the grain is past the middle stage of milk, when it will make splendid grain and lots of rich straw hay. Thresh like wheat, only not so closely. Can be fed whole, rolled like barley, or ground.

10 lbs. 75c; 100 lbs. \$4.25; per lb., postpaid, 20c

Sugar Cane or Sorghum

A valuable crop to grow for fodder or ensilage, as it furnishes an immense tonnage to the acre.

10 lbs. \$1.50; 100 lbs., write; per lb., postpaid, 25c

Vetches

OREGON VETCH (Vicia Sativa).—Oregon's greatest forage plant. Often called Fall Vetch. Grown very extensively in the Willamette Valley and on the Oregon coast. It furnishes an abundance of excellent feed, either green or dried. The seed is generally mixed with wheat, oats or rye having a stiff straw to hold it up. Sown alone 85 pounds or 60 pounds with a bushel of grain per acre. Sow in the fall or early spring.

10 lbs. 60c; 100 lbs. \$4.50; per lb., postpaid, 20c

HAIRY SAND OR WINTER (Vicia Villose).—This variety thrives on poor arid, sandy soils. It is sown in the fall or spring, mixed with rye, which serves to support the plants. Sow 20 pounds per acre.

10 lbs., \$2.50; per lb., postpaid, 35c

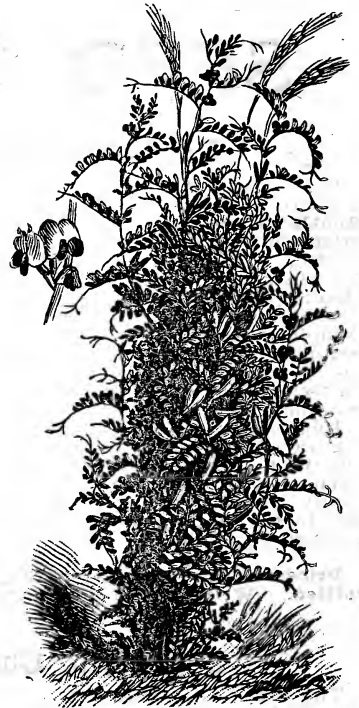

Vetches.

THE WISE ONES

Will use Mulford's Vetch Culture to inoculate their seed before sowing. There is no question about its VALUE. "Evidence," a new booklet, will prove it. (See page 37.)

Single pound prices are prepaid, but ten, fifty and one hundred pound prices are NOT prepaid and subject to market changes. See notes, page 43. For amount of seed to sow per acre see table inside back cover.



Our flower seeds are grown by specialists and are unsurpassed. The following list contains a general assortment of the choicest and most popular and easiest grown flowers for conservatory, greenhouse or garden culture.

How to Raise Flowers Successfully from Seeds

The above is the title of a 2-page leaflet we have issued for our customers. It tells **HOW, WHEN** and **WHERE** to plant. It is free to all. You will find it of great value.

IF YOU WILL MEMORIZE the following definition of the flower classes **THEY WILL HELP YOU WONDERFULLY** in the selection of seeds and your garden work in general.

ANNUALS

These grow from seed, flower, mature their seed, and die in one year, or in other words, the same season.

Half-Hardy Annuals are those which should be started early in the house, conservatory or hotbed, and transplanted to the garden in settled warm weather.

Hardy Annuals are those which can be sown in the open ground in early spring or started inside and transplanted if very early flowers are desired.

BIENNIALS

These grow from seed, sown from June to August, flower, ripen their seed and die the next year, though some varieties bloom the same season if sown early in gentle heat.

Hardy Biennials will winter in the open ground without protection.

Half-Hardy Biennials require the protection of a cold-frame or cool-house during the winter.

PERENNIALS

These grow from seed, and continue flowering annually for many years after the first season. Some varieties flower the first season if started very early. Sow in the fall for flowers next year.

Hardy Perennials can remain in the open ground during winter without protection.

Half-Hardy Perennials require the protection of a cold-frame or cool-housing during winter.

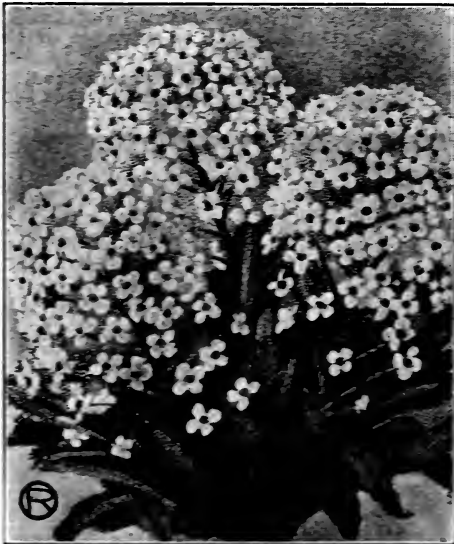

Sweet Alyssum.

Acroclinium

Hardy annual, with everlasting flowers; good for cutting; flowers double and dry nicely if cut in bud; 1 foot; July to October.

Album.—Double white.

Pkt. 5c

Mixed.—All colors.

Pkt. 5c

Ageratum

Half-hardy annuals, especially well adapted to edge large beds of geraniums, salvia coleus or cannas; flower continuous through the summer. 15 inches.

Mexicanum.—Dwarf, blue. **Pkt. 5c; ¼ oz. 25c**

Album.—Pure white, dwarf.

Pkt. 5c; ¼-oz. 25c

Finest Mixed.—All colors.

Pkt. 5c; ¼-oz. 20c

Dwarf Little Blue Star.—New; one of the handsomest blue-flowered dwarf edging plants; grows 5 inches high, and is just covered with small, bright blue flowers.

Pkt. 10c

AGROSTEMMA—Rose of Heaven

Coeli-Rosa.—Superb free-flowering, hardy annual, rose-colored flowers; fine for cutting; height 1½ feet; July to September.

Pkt. 5c; ¼-oz. 20c

ALOYSIA—Lemon Verbena

Citriodora.—A greenhouse shrub, valuable for the fragrance of the foliage; 2 feet.

Pkt. 10c

Alyssum

One of the most popular hardy annuals, used especially for edging and also valuable for cutting on account of the fragrance of flowers.

Sweet.—Pure white; 6 inches; June to November. **Pkt. 5c; oz. 35c**

Little Gem.—The dwarfiest and best for design bedding; plants very compact and bushy, and grow only 3 inches high.

Pkt. 10c; oz. 75c

Lilac Queen.—Dwarf, compact, lilac flowers.

Pkt. 10c

Saxatile Compactum (Gold Dust).—Hardy perennial; yellow flowers; April to June; height 9 inches. **Pkt. 10c; ¼-oz. 20c**

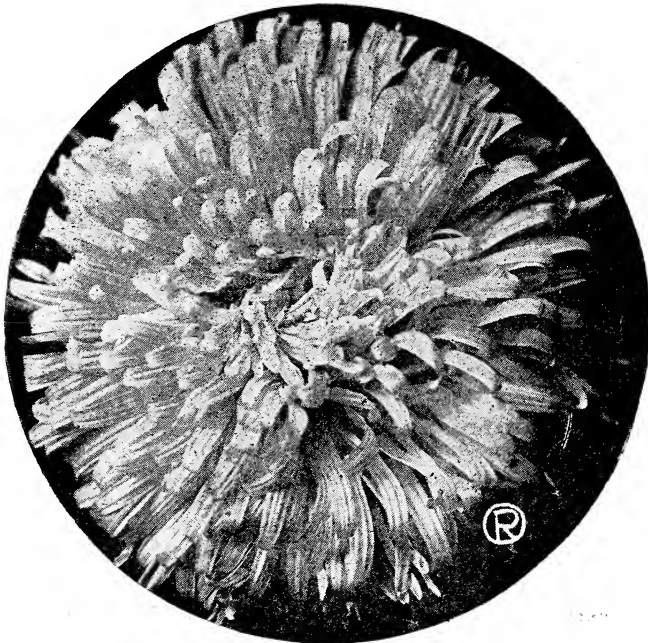

Improved Giant Crego Aster.

White Fleece

One of the largest and most perfect of the early flowering (Comet type), bearing flowers 5 inches and over across, formed into a plummy globe of glistening white; blooms at the same time as Lavender Gem, making a splendid companion.

Pkt. 10c; 1/8-oz. 75c

Mikado

Very similar to the Crego's Giant, but more dwarf in growth and comes into bloom fully two weeks earlier. The plants attain a height of about 18 inches, of branching habit, and the flowers, borne on long, strong stems, are of colossal size. Five and six inches across. We offer two colors, viz.:

Mikado Pink (or Rochester). A charming shade of pink suffused with lavender.

Pkt. 10c; 1/8-oz. 75c

Mikado White. Of purest glistening white; a magnificent and artistic flower.

Pkt. 10c; 1/8-oz. 75c

New Giant Comet

Considered by many to be the most beautiful of all the Asters (see cut). It is an ideal cutting variety, as each plant bears freely exquisitely formed large flowers on long stiff stems.

Pure White, Pink, Crimson, Lavender or Finest Mixed.

Pkt. 15c; 1/8-oz. 75c

Lavender Gem

One of the best; comet type; very early and a charming shade of lavender; excellent in every way.

Pkt. 10c; 1/8-oz. 75c

New Crimson Giant

A late-branching variety of upright growth with extra large, densely double flowers of rich blood-crimson; makes a brilliant bed or border and is splendid for cutting. The form of the flower is nicely shown in plate above.

Pkt. 15c

ASTERS, FINE MIXED.—Many kinds.

Pkt. 5c

Asters

One of the easiest and most satisfactory summer and fall flowers to grow. We take the utmost pains to select seeds from the most perfect flowers only, and wish to assure our patrons that our strains are the superiority of perfection.

Improved Giant Crego

The most beautiful and desirable aster we have ever seen; very hardy, free-flowering and one of the best for general planting; the plant is a strong, healthy grower, and will produce 12 to 15 long-stemmed flowers of the most graceful and pleasing style (see cut). With ordinary care you can grow flowers measuring 5 to 6 inches across. Most of the handsome large aster blooms you see in the Portland flower stores are of this kind.

Pure White, Shell Pink, Rose Pink, Purple, Lavender or Mixed.

Pkt. 10c; 1/8-oz. 75c

SPECIAL.—One packet each of the five colors only 40c.

Terrebonne, Ore., June 20, 1917.

Routledge Seed & Floral Co.,

Dear Sirs: Last year my "Giant Crego" Asters took first prize at Prineville Fair. I raised the plants from seed I bought of you.

Yours respectfully,

MRS. M'CAULEY.

QUEEN OF THE MARKET.—Most valuable for early cutting; the plants branch freely and produce a great many well-formed flowers nearly a month in advance of the later sorts.

White, Pink, Lavender or Finest Mixed.

Pkt. 10c; 1/4-oz. 40c

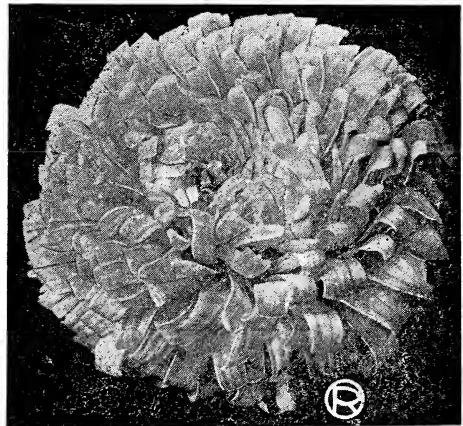

Superb Late Branching.

SUPERB LATE BRANCHING.—The most popular late-flowering aster. Flowers are very full, large in size, 3 to 4 inches across and borne on long stiff stems 2 to 2 1/2 feet high. A very desirable, beautiful and satisfactory variety.

Deep Rose, Dark Blue, Light Blue, Shell Pink, White or Finest Mixed.

Pkt. 10c; 1/4-oz. 60c

AMARANTHUS

Caudatus (Love-Lies-Bleeding).—Hardy annual; ornamental foliage plant; fine for bedding; green foliage with long, drooping crimson racemes; 2 feet. Pkt. 10c

Cruentus (Prince's Feather).—Dark red foliage and feathery flowers; 2 feet. Pkt. 10c

Tricolor (Joseph's Coat).—Ornamental; for foliage only; red, yellow and green. Pkt. 10c

ANTIRRHINUM—Snapdragon.

Half-hardy perennial and annual; blooms in July if sown early in the house; one of our finest cut flowers; 2 to 3 feet.

Queen Victoria.—New, tall; very large; pure white; superb. Pkt. 10c

Daphne.—Soft blush pink. Pkt. 15c

Golden Queen.—Rich, pure yellow. Pkt. 10c

Defiance.—Brilliant scarlet Pkt. 10c

Tall Giant, Finest Mixed.—Our seed of this is exceptionally fine; height, 3 feet. Pkt. 10c; ½-oz. 25c

Semi-Dwarf.—Fine for bedding; 18 inches. Finest Mixed. Pkt. 5c; ½-oz. 25c

AQUILEGIA—Columbine

Hardy perennials; are most elegant plants and invaluable for cutting or as hardy border flowers; beautiful and graceful; June to September. 2 to 3 feet.

Benary's Long Spurred.—Superb mixture of all the most desirable shades. Pkt. 10c; ½-oz. 50c

Single, Finest Mixed. Pkt. 5c; ¼-oz. 20c

Double, Finest Mixed Pkt. 5c; ¼-oz. 20c

ARABIS—Rock Cross

Alpina.—Hardy perennial; pure white flowers in close head; excellent for edging, rockwork or dry situations; 6 inches; April to June. Pkt. 5c; ¼-oz. 25c

FOR PERENNIAL PLANTS SEE PAGES 79 TO 83.



Antirrhinum.

ASPARAGUS

Plumosus Nanus.—A graceful pot plant for either house or conservatory (see illustration under Fern Plants); very finely cut, delicate lace-like foliage. Pkt. 25c; 100 seeds \$1.00

Sprengeri.—Drooping foliage; adapted for hanging baskets or cutting. Pkt. 10c; 100 seeds 50c

BABY BREATH

See Gypsophila, page 58.

BALSAM—Lady Slipper

Hardy annual, succeeding best in sunny situations, rich loam and moisture; very showy and of easy culture; 1½ feet; July to September.

Prize Mixture.—This strain will produce the most perfectly formed double flowers in the greatest variety of colors. Pkt. 10c; ¼-oz. 35c

Improved Camelia-Flowered Finest Mixed.—Large, extra double flowers. Pkt. 5c; ¼-oz. 35c

BELLIS—Double English Daisy

Popular spring and summer flowering perennial; fine for borders; height 4 inches. Easily raised from seed sown from early spring to September; April to September.

Double Mixed. Pkt. 10c

Longfellow.—Double pink flowers. Pkt. 15c

Snowball.—Free flowering; pure white. Pkt. 15c

Giant Red or Giant White.—Mammoth in size; very rare. Give them rich ground. Pkt. 15c

BEAN

Scarlet Runner.—The well-known, rapid-growing annual climber, with bright red flowers, from July to September; height 8 feet. Pkt. 5c; ¼-lb. 15c



Aquilegia (Columbine).

Junction City, Ore., April 21, 1917.

Routledge Seed & Floral Co.,

Gentlemen: The seeds that I got of you last year were just fine and I was very much pleased with them.

Yours respectfully,
MRS. MIDGE HAYS.

USE "WONDER."—The best Fertilizer and plant food known. A teaspoonful to a plant does wonders. See page 38.



Balloon Vine.

BALLOON VINE (Love-in-a-Puff)

A rapidly growing annual climber; succeeds best in light soil and warm situation; flowers white; seed vessels look like miniature balloons and of great interest to children; 8 to 10 feet (see cut).

Pkt. 5c; ½-oz. 15c

BROWALLIA—Amethyst

A very profuse blooming, half-hardy annual bedding plant, bearing during summer and autumn handsome winged flowers of different shades of blue; 1½ feet.

Finest Mixed.

Pkt. 5c; ¼-oz. 25c

CALCEOLARIA

An ornamental plant, and a universal favorite; produces a mass of beautiful puffed, pocket-like flowers of brilliant, self-colors and spotted. Our strains of Calceolaria are very fine.

Hybrida Grandiflora.—Flowers of immense size; seeds saved from finest specimens.

Pkt. 35c

Calendula—Pot Marigold

Hardy annual; one of the most universal garden flowers. The flowers appear in solitary heads on stout stalks; large, with flat, spreading rays; very showy; flowers the entire season; 1 foot.

Double Finest Mixed.

Pkt. 5c; ¼-oz. 15c

Calliopsis

Showy and beautiful free-flowering annuals, of the easiest culture, doing well in any sunny position, blooming all summer and excellent for cutting and massing (see cut). Don't confuse this with the perennial Coreopsis, page 55.

Finest Mixed.—Annual; all shades of yellow, red and brown.

Pkt. 5c; ¼-oz. 20c

Hybrida Superba.—Showy new shades in all of the choicest varieties.

Pkt. 10c; ¼-oz. 35c

A Beautiful Flower Garden

Perhaps you have failed before, but if you will follow our "Cultural Directions" (free on request), we are sure you will be successful.



Calliopsis.

CANNA

A beautiful, large-leaved, showy flowering plant. Seed must be soaked before planting and started in a hot bed under glass. (For Canna Roots, see page 89.)

Crozy's Hybrids Mixed. Pkt. 5c; oz. 35c

CANARY BIRD VINE

A rapid-growing summer-climbing annual, 10 to 15 feet high; it will cover trellis work in the most graceful manner, producing hundreds of pretty winged, bright yellow flowers.

Pkt. 5c; ¼-oz. 20c



Canary Bird Vine.

Perennial Flowers are rapidly gaining in favor. **MORE** should be planted; they are beautiful in borders, beds or among shrubbery, and flower each year. You gain 1 year by buying our field grown plants. See pages 79 to 83.

CANTERBURY BELLS (*Campanula Medium*)

Very ornamental garden plants of easiest culture; excellent for cutting; hardy biennial; 2½ feet high, producing large, bell-shaped flowers of exquisite colors. Hardy biennials. (See plants page 50.)

Single, Finest Mixed, all colors.
Pkt. 5c; ¼-oz. 15c

Single White, Blue or Rose.
Pkt. 10c; ¼-oz. 20c

Double Mixed, all colors. Pkt. 10c; ¼-oz. 25c

B. R.'s PRIZE MIXTURE.—A mixture which contains every color and kind of both single and double biennial and perennials.

Pkt. 10c; ½-oz. 25c

CALYCANTHEMA (Cup and Saucer Canterbury Bells).—This is unquestionably one of the finest types; they have an extra large calyx, which is of the same color as the flower, giving the appearance of a cup and saucer.

Pink, Lilac or White.

Pkt. 15c; 2 for 25c; ¼-oz. 50c

Mixed Colors. Pkt. 10c; ½-oz. 35c

Campanula—Bellflower

Well-known, beautiful, hardy herbaceous perennials, bearing a great profusion of attractive bellflowers; thrives best in light, rich soil; some of the varieties flower the first season if sown early.

PERSICIFOLIA GRANDIFLORA (Peach Bells).—Undoubtedly one of the finest of the hardy Bellflowers; grows 2 to 3 feet high, with large single flowers.

Blue, White or Mixed. Pkt. 10c; ½-oz. 50c

CARPATICA (Carpathian Hare-Bell).—Free-flowering, hardy perennial, continuing in bloom the whole season; color clear blue or white; grows 6 inches high; especially good for edging.

Blue or White. Pkt. 10c; 1-oz. 50c

Candytuft—Iberis

Very popular free flowering annual, fine for beds or cutting; 1 foot. June to frost if sown early and late.

Empress.—A large flowered variety of purest white; grown extensively for cut flowers; very desirable.

Pkt. 5c; ¼-oz. 20c

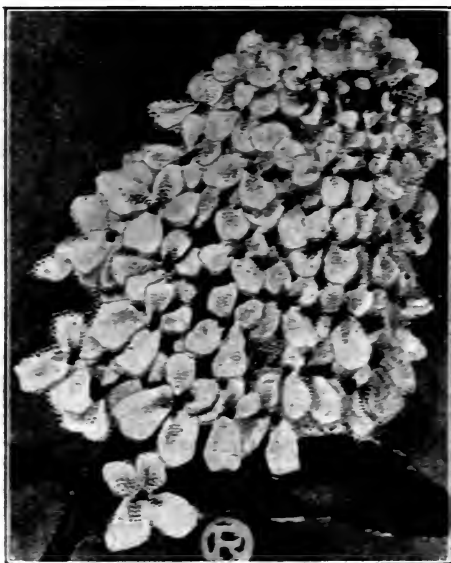

Candy Tuft.

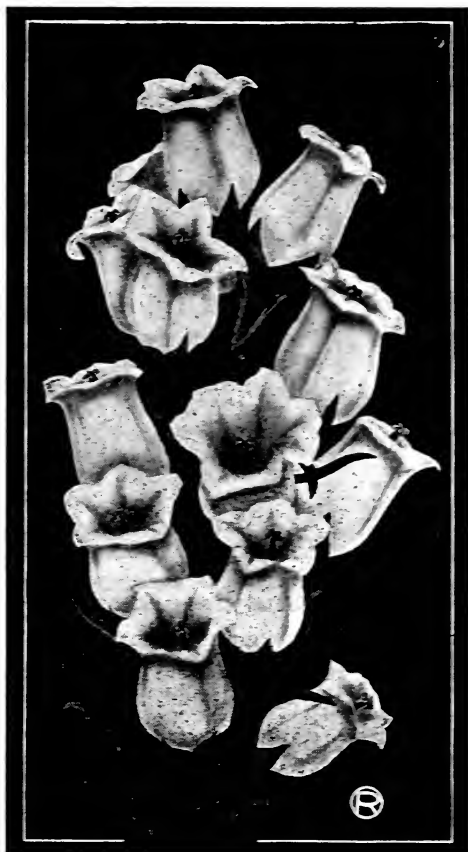

Single Canterbury Bells.

Dwarf White Little Prince.—Grows but six inches high and throws up strong trusses of pure white flowers; excellent for edging or bordering.

Pkt. 10c; ¼-oz. 50c

Pink Beauty (Novelty).—Fine, true pink; an exquisite flower.

Pkt. 10c

Crimson or Lilac.—Very desirable colors, your choice.

Pkt. 10c; ½-oz. 15c

Finest Mixed, all colors. Pkt. 5c; ¼-oz. 20c

Sempervirens.—Perennial; pure white flowers, evergreen foliage; blooms in June; fine for edging, borders and rockeries, 1 foot.

Pkt. 10c; 1-16 oz. 35c

Cardinal Climber

This glorious and absolutely distinct new annual climber is undoubtedly the greatest acquisition to the flower world in years, and the most beautiful and brilliant climber ever grown. It is a strong and rapid grower, attaining a height of twenty-five feet with beautiful fern-like lacinated foliage and literally covered with a blaze of fiery cardinal red flowers from midsummer to frost. The flowers are about 1 inch in diameter and are borne in clusters of five to seven blooms each. Like all "Ipomoeas" it delights in a warm, sunny situation and good, rich soil. The seed should be soaked in water a few hours before sowing and not planted outside until about May first.

Pkt. 15c; 2 pkts. for 25c; ½-oz. 75c

GREAT FOR FLOWER BEDS.—Read page 39, which tells all about our new product—"C-M"—Kiln-dried Pulverized Cow Manure.



Centaurea Cyanus.
Bachelor's Button.

Carnation

Everyone loves Carnations. For started plants of the finest named varieties, see page 75.

MARGARET CARNATIONS.—The earliest to bloom, and producing large, double, sweet-scented flowers; being half-hardy perennials, if they are slightly protected during the winter they will survive and flower profusely the next spring.

Red, White or Yellow.—Large flowers.
Pkt. 10c; 1/8-oz. 50c
Choice Mixed. Pkt. 5c; 1/4-oz. 35c

CASTOR OIL BEAN.—See *Recinus*, page 66.

CELOSIA CRISTATA—Cockscomb

Showy annuals of easy cultivation; 1 foot; producing large, brilliant, comb-like flower heads.

Glasgow Prize.—Showy, dark crimson combs. Pkt. 10c; 1/8-oz. 50c
Finest Mixed.—Rich mixture of finest dwarf kinds. Pkt. 5c; 1/8-oz. 40c

CELOSIA PLUMOSA—Feathered

Cockscomb

The plant grows 2 to 3 feet, is of handsome pyramidal form, and the numerous massive plumes, which resemble an ostrich feather waving gracefully above the foliage, make it one of the most effective; of easy culture.

Thompsoni Magnifica.—The most perfect in constant bloom from July to November; **Finest Mixture.** Pkt. 10c; 1/8-oz. 50c
Golden Plume. Pkt. 10c
Crimson Plume. Pkt. 10c

CENTAUREA—Dusty Miller

These are grown for foliage only; half hardy annuals; leaves are silver-coated.

Candidissima.—Thick, white, upright cut leaves; 1 foot. Pkt. 10c

Gymnocarpa.—Fine, fern-like leaves, very graceful and showy; 1 1/2 foot. Pkt. 10c; 1/8-oz. 25c

Centaurea Cyanus

BACHELOR'S BUTTON, CORNFLOWER.—

Very popular annuals; will grow in the poorest of soil, either on seashore or mountains; seed can be sown either in fall or spring; sandy soil preferable; height, 2 1/2 feet.

Finest Single Mixed. Pkt. 5c; oz. 35c

CENTAUREA CYANUS fl. pl. (Double Bachelor's Button). Beautiful large double flowers.

Double Blue. Pkt. 10c; 1/8-oz. 25c

Double Mixed. Pkt. 10c; 1/4-oz. 25c

Royal Sweet Sultans

CENTAUREA IMPERIALIS (Giant Cornflower).—The flowers are of enormous size, fragrant and of charming colors; in form they resemble the fuzzy part of the thistle bloom. In colors from white to red to purple. Excellent for cutting.

Mixed Colors. Pkt. 10c; 1-oz. 30c

Marguerite.—Flowers 4 inches across; purest white. Pkt. 10c; 1/4-oz. 40c

MOSCHATUS (Sweet Sultan).—Hardy annual, with very fragrant and showy flowers; 1 1/2 feet; June to September.

Finest Mixed. Pkt. 5c; 1/4-oz. 25c

SUABOLENS (Yellow Sweet Sultan).—Very showy. Pkt. 5c; 1/4-oz. 20c



Chinese Wool Flower.

CHINESE WOOLFLOWER

A new annual flower. Very showy, old and novel. The bunches of wool-like glowing crimson flowers are produced in profusion. Flowers come early and do not fade until hit by frost. Height 2 to 3 feet. Start early and transplant after danger of frost is over. A large bed of these plants certainly produce a magnificent display and will be a dazzling blaze of color from early, until frost.

Pkt. 15c; 2 for 25c; 1-16-oz. \$1.00
Plants in Season 10c Each, 75c Doz.

We have Annual Flowering Plants in any quantity during April, May and June. See General Price List, page 73.



Cosmos.

CHRYSANTHEMUM

These are very showy flowers of easiest cultivation, flowering from July to frost; excellent for cutting; height 2 feet. (For plants, see page 68.)

Single Annual, Finest Mixed.

Pkt. 5c; ¼-oz. 25c

Double Annual, Finest Mixed.

Pkt. 5c; ¼-oz. 20c

Japanese Early Flowering (Double Flowering).—These flower in the open ground from August to November; splendid plants for show effect; height 3 feet.

Pkt. 15c

Leucanthemum.—(See Shasta Daisy, under Daisies, page 56.)

CINERARIA

Hybrid Grandiflora.—We pride ourselves in offering the choicest strain of this gorgeous flower; grand, large blooms in umbel spikes are borne way above the foliage; colors and markings are superb; 1½ feet; tender annual for pots. Pkt. 35c

Clarkia

A mighty handsome annual; of easy cultivation; flowers resemble carnations and flower freely; colors, white, crimson, orange shades; 2 feet; July to October.

Elegans.—Double mixed. Pkt. 5c; ¼-oz. 25c

Cobaea Scandens

Our most popular and rapid climbing annual, flowering the first season. Pretty, purple, bell-shaped flowers appear in great profusion during the fall months; foliage very graceful; 20 feet. Start seed under glass. (For plant see page 73.)

Pkt. 10c; ¼ oz. 25c

COLEUS

Splendid bedding plants, with beautifully colored foliage; easily grown from seed if kept in warm temperature; tender perennial that must be started under glass.

Benary's Exhibition.—Superb. Pkt. 25c

HAVE YOU PETS?

Note what we have to offer in Kittens, Puppies, Birds, Etc., see pages 151 to 160.

Cosmos

Beautiful autumn-blooming plants. They produce thousands of beautiful flowers in pure white, pink and crimson shades, furnishing an abundance of cut blooms for autumn decorations when other flowers are scarce. Can be sown in spring in the open ground, when danger of frost is past, or if wanted early the seed should be started under cover and afterwards transplanted. Set plants not less than 18 inches apart. When about a foot high the tops should be pinched out to induce a bushy growth. They do well almost anywhere.

EARLY FLOWERING MAMMOTH.—Claimed to be as large as the Mammoth Perfection and to flower in July and August. If sown early, flowers can be picked in July. Grows 4 feet high; flowers large and beautiful. **Crimson, White, Pink or Mixed.**

Pkt. 10c; 1-oz. 30c

KLONDYKE.—Golden yellow, flowers large and borne on long stems; medium early.

Pkt. 10c

GIANT PERFECTION.—Flowers often 4 inches across; plants 7 feet high; blooms do not appear until October. If topped when half grown plants will bloom earlier. **White, Pink, Red or Mixed.**

Pkt. 10c; 1-oz. 20c

Pink Lady Lenox

Gigantic flowers, with wide, overlapping petals of splendid substance, making a perfectly circular flower which is borne on very long stems, in color a beautiful deep rosy pink.

Pkt. 10c; 1-oz. 25c

Coreopsis

Lanceolata Grandiflora.—Hardy perennial; with large, showy, bright yellow flowers, produced in the greatest abundance from June till frost. As a cut flower they stand near the head among hardy plants, having long stems and lasting in good condition a week or more. Easily grown from seed, flowering the first year, if sown early under glass. Pkt. 10c; ¼-oz. 25c (See illustration and plants, page 80.)



Cobea Scandens.

CULTURAL DIRECTIONS FREE.—Our 2-page leaflet gives full instructions on growing flowers from seed. Free on request. Read it and be successful.

CYPRESS VINE

A fast-growing annual vine, with feathery, dark-green foliage and star-like flowers; July to October; 20 feet. Plant early, in light soil and warm location.

Finest Mixed. Pkt. 5c; ½-oz. 25c

Dahlia

This very popular flower can easily be raised from seed; started inside in March will produce flowers in August.

Cactus Mixed.—Double flowers with pointed petals (see cut). Pkt. 20c

Double, Finest Mixed.—Produce flowers of the "Show" or "Decorative Class." Pkt. 10c

Single Giant Perfection.—Single flowers of great size and beauty. Pkt. 10c

DAHLIA BULBS.—Latest and best. (See pages 92 to 96.)

Daisies—Shasta Daisy

SHASTA.—Very popular and desirable perennial; the large single white flowers are freely produced on long stems. We offer you the best strain in plants or seed. (See cut in Plant Department, page 83.) Pkt. 15c

DOUBLE DAISIES.—(See Bellis, page 51.)

Delphinium—Perennial Larkspur

(See cut, page 80.) Handsome, hardy perennial plants for the herbaceous border and shrubbery, producing a profusion of splendid spikes of flowers throughout the summer. The beautiful, graceful, long stemmed flower spikes make handsome bouquets and last well when cut. If started early will bloom the first season from seed. (For large plants see page 80.)

E. R.'s Prize Mixture—Superb collection of the choicest colors; new, rare and beautiful shades. Makes wonderful cut flower material and should be planted generously. Pkt. 15c; ½-oz. 50c

Chinese Azureum.—Branches very freely and produces its flowers in greatest abundance; clear, deep blue; height 3 feet. Pkt. 10c; ¼-oz. 15c

Belladonna.—Very free and continuous bloomer; delicate and beautiful; clear turquoise blue. Pkt. 25c; 5 pkts. \$1.00

Formosum.—Long-spurred, brilliant blue flowers, with white center; 3 feet; July to October. Pkt. 10c; ¼-oz. 25c

Elatum Hybridum.—Superb collection of finest double blue varieties; 3 to 5 feet. Pkt. 15c; ½-oz. 50c



Dimorphotheca—African Golden Daisy.



Dianthus.

Dianthus—Garden Pink

All the varieties listed below are very desirable, and will flower the first season, even sown out of doors in May; they flower early and continue throughout the entire summer; they are excellent for cutting, and bedding; 1 foot.

CINENSIS fl. pl. (Chinese Pink).—Large, double flowers in unlimited variety of bright colors.

Finest Mixed. Pkt. 10c; ¼-oz. 35c

HEDDEWIGII.—(Japan Pink.) Beautiful rich colors. A very popular variety.

Finest Mixed. Pkt. 5c; ¼-oz. 25c

FIREBALL.—New, extra double, brilliant, dark scarlet; very beautiful.

Pkt. 10c; ¼-oz. 30c

SNOWDRIFT. (Lanceolatus).—Extra large, pure white, double, fringed.

Pkt. 10c; ¼-oz. 35c

BENARY'S PRIZE MIXTURE.—Very rich mixture, all kinds.

Pkt. 5c; ¼-oz. 25c

SEMPEFLORENS (Perennial Hardy Ever-blooming Garden Pinks).—Very beautiful, sweet-scented, double, semi-double and single flowers in great diversity of colors. Pkt. 15c; ½-oz. 35c

DIMORPHOTHECA AURANTIACA (African Golden Daisy.) Hardy annual, a great favorite on account of its handsome golden-orange flowers, which are borne most profusely all summer; 15 inches. Does well in dry situations. (See cut.) Pkt. 10c; ¼-oz. 25c

Vancouver, Wash., Rt. 6, Oct. 19, 1916.
Routledge Seed & Floral Co.,
Gentlemen: Am writing to say that the Hyacinths and Tulips ordered from you were beautiful big bulbs.

Yours respectfully,
MRS. GEO. HILEMAN.

For Lily Bulbs see pages 90 and 91.

A HEDGE of Free Flowering Dahlias is AS BEAUTIFUL and more showy than a hedge of ROSES. They are in full bloom when other flowers ARE SCARCE. See pages 92 to 96.

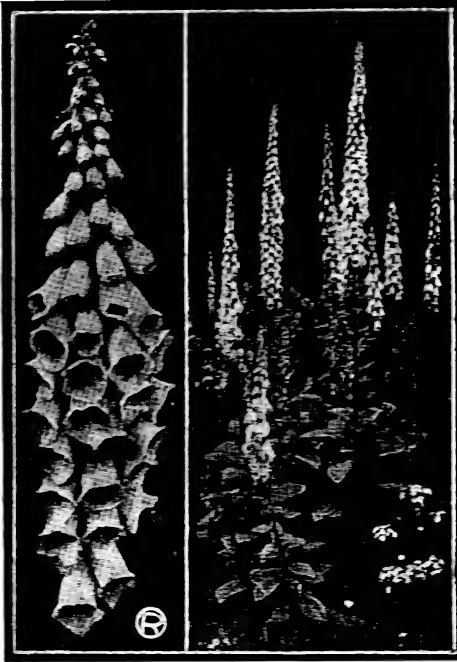

Digitalis—Foxglove Plant and Flower Spike.

Digitalis—Foxglove

Hardy perennials; very desirable for effective massing or grouping; invaluable either in the hardy border, between shrubs or in solid beds; 3 to 5 feet. For strong flowering plants, see page 50.

Beauty Mixture.—Comprising all the choicest colors. Pkt. 5c; ¼-oz. 50c

Gloxinaeflora, Finest Mixed.—Flowers spotted similar to Gloxinias. White, pink and purple flowers. Pkt. 5c; ¼-oz. 25c

Gloxinaeflora Rosea.—Very desirable, flowers rosy pink. Pkt. 10c; ¼-oz. 40c

Montrosa (Mammoth Foxglove).—The tall spikes are surmounted by one monstrous flower; all colors mixed. Pkt. 10c; ¼-oz. 50c

DOLICHOS—Hyacinth Bean

Annual climbers; beautiful foliage and clusters of hyacinth-like purple and white flowers, borne in clusters; 10 feet; July to September.

Daylight.—Snow-white flowers. Pkt. 5c

Mixed.—White and purple. Pkt. 5c; oz. 25c

Eschscholtzia—California Poppy

One of the most popular garden annuals; 1 foot. Sow the seed where plants are to remain in the fall or early spring. It stands considerable cold and blooms early profusely and continuously until July. Later sowings for late flowers. (See cut.)

Finest Mixed.—All shades. Pkt. 5c; oz. 30c

Californica.—Bright yellow. Pkt. 5c; oz. 30c

Alba.—Pure white. Pkt. 5c; oz. 35c

Carmine.—A beautiful rose carmine. Pkt. 10c; oz. 40c

Golden West.—Very large, bright yellow flowers with orange centers. Pkt. 10c; oz. 35c

ECHINOCYSTIS LOBATA

Wild Cucumber.

The fastest-growing annual vine in existence; will grow 20 feet in six weeks; pretty foliage and inconspicuous white flowers; soak seed in water over night before planting in dry weather.

Pkt. 5c; oz. 25c

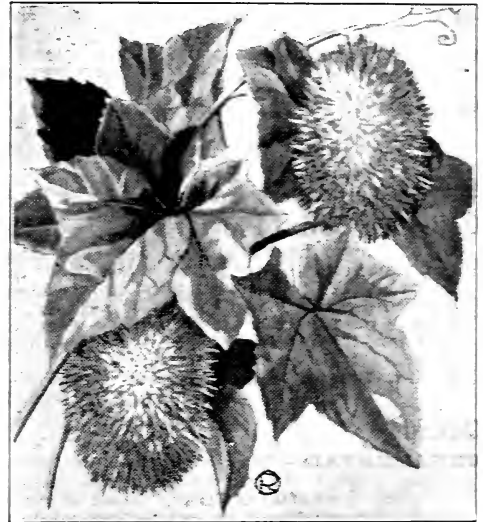

Echinocystis—Wild Cucumber.

Gaillardia—Blanket Flower

Splendid, showy plants for beds or borders; excellent for cutting; the hardy perennial varieties; if sown early will bloom the first season; July to frost; 1½ feet. (Field-grown plants, page 51.)

Grandiflora Superba.—Hardy perennial; splendid mixed varieties; in crimson and gold; 2 feet. Pkt. 10c; ¼-oz. 35c

Lorenziana.—Hardy annual; double mixed colors; 2 feet. Pkt. 5c; ¼-oz. 25c



Eschscholtzia—California Poppy.

FEED YOUR PLANTS. You must supply "food," in other words fertilizer, if you want the best results. Read about "Wonder," and "C. M.", pages 38 and 39; 20-page "Booklet" free.

Wild Flower Gardens

Try a packet of our "wild flower garden," something new and interesting to see most every day. See page 72.

GLOXINIA

Showy free-flowering house plants with rich colored bell-shaped flowers. Tender perennial that need greenhouse culture.

Hybrida Grandiflora.—The best strain in existence, embracing all the choicest self-colored, tigered and spotted flowers.

Pkt. 25c

GOMPHRENA—Globe Amaranth

A dwarf hardy annual, with pretty clover-like beads of purple, white and red flowers; 2 feet; flowers everlasting.

Finest Mixed. Pkt. 5c; ¼-oz. 20c

Godetia—Satin Flower

This showy, hardy annual deserves greater popularity. Attractive flowers of satiny texture, from white to all shades of pink and crimson. They grow rapidly, and flower profusely in poor soil; of easy cultivation. Fine for seashore or mountain resorts; 1 foot; July to October.

White, Bright Red or Finest Mixed.
Pkt. 10c; ¼-oz. 25c

Gourds

ORNAMENTAL.—These are desirable in many places where an immense amount of vine is wanted quickly. Most sorts are good for 20 feet in a season and the blooms of some are quite striking and handsome. With many sorts the fruit is unique and ornamental and often useful. The small fancy gourds are excellent toys for children.

Calabash.—The famous pipe gourd, dipper shaped. Pkt. 10c; oz. 40c

Egg, Orange, Turk's Turban, Pear, Spoon, or Mixed, all kinds. Pkt. 5c; ¼-oz. 10c



Ornamental Gourds.

GYNERIUM—Pampas Grass

Argenteum.—Hardy perennial; the famous pampas grass, with beautiful silvery plumes; 10 feet. (For strong plants, see Pampas, page 82.) Pkt. 10c

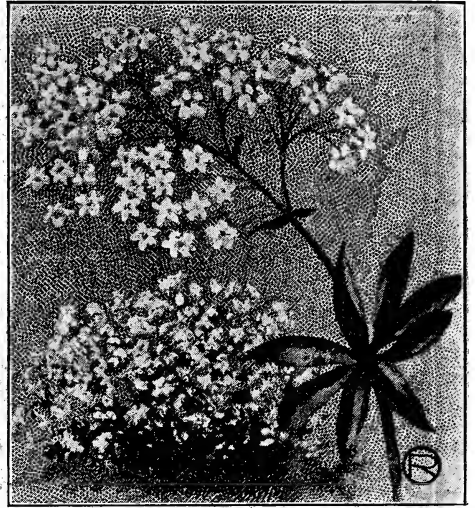

Gypsophila—Baby's Breath.

Gypsophila—Baby's Breath

Pretty free flowering, elegant plants, succeeding in any garden soil. Their misty white panicles of bloom are largely used for mixing with other cut flowers. The annuals should be sown early in the spring and mid-summer for a continuous supply.

Elegans Alba.—Hardy annual, easily grown from seed; flowers pure white; 2 feet; June. Pkt. 5c; ½-oz. 25c

Elegans Rosea.—Hardy annual; flowers bright rose; very dainty; 2 feet. Pkt. 5c; ½-oz. 25c

Muralis.—Hardy annual; plants dwarf, about 6 inches; flowers shell pink; fine for borders or rock work. Pkt. 5c; ⅓-oz. 20c

Paniculata.—Hardy perennial; one of the finest for cutting; pure white flowers, very small, and borne in large, delicate sprays; June to September; 3 feet. Pkt. 10c; ⅓-oz. 25c

(For strong roots of *G. Paniculata* for immediate effect, see page 81.)

Paniculata Fl. Pl.—New perennial; double-flowering; most desirable and valuable; pure white. Pkt. 25c; 2 for 35c

Helianthus—Sunflower

The single annual Sunflowers are indispensable for cutting and a bright display of yellow flowers in the garden, borders or among shrubs. Plant early in a sunny place and they will come into bloom early in the summer and keep up a constant supply of flowers until cut down by severe frosts in the fall. We offer some improved types of special merit.

Globosus Fistulosus (Globe or Dahlia Sunflower). Flowers large, double, very full in the center and of a rich saffron color; 6 feet. Pkt. 5c; ½-oz. 20c

Perennial Mixed.—A choice mixture of the best perennial varieties. Pkt. 10c; ⅓-oz. 50c

Cucumerifolius—Stella (Improved Miniature Sunflower). Grows about 3 feet tall, covered with large single 5 to 6 inch flowers of the purest golden yellow, with black disc. Pkt. 5c; ¼-oz. 25c

MORE HARDY FLOWERING SHRUBS should be planted in the West—they give no trouble, increase in size and grow more beautiful year by year. See pages 103 to 108.



Helianthus—New Miniature.

Orion.—Artistic and effective new variety of "Stella." The petals are twisted like a Cactus Dahlia. **Pkt. 10c**

New Miniature Mixed. A multitude of new varieties have been raised from the popular Miniature Sunflower, which we offer in mixture. They all differ from the parent, most of them being larger, and many with curiously twisted petals. The prevailing colors are pale yellow, golden yellow and creamy white, some with black centers, and all beautiful; for cutting they are indispensable. (See cut.) **Pkt. 10c**

Heliotrope

Delightfully fragrant, tender perennial; popular pot and garden bedding plant; also for cutting. Some of the best plants may be raised from seed very readily; 1½ feet; start inside or under glass.

Finest Mixed. **Pkt. 10c; ½-oz. 35c**

MIDNIGHT.—New; handsome, large flowers, lively shade of purple, variegated with white; foliage beautiful. **Pkt. 15c**



Heliotrope.

Hollyhocks

Very popular perennials. Easily grown.

ALLEGHENY.—Semi-double; mammoth flowers, having the edges of the petals finely fringed and lacinated; will bloom the first year if sown early.

Choicest Mixed Colors. **Pkt. 10c; ¼-oz. 40c**

DOUBLE GERMAN EVER-BLOOMING.—Will bloom the first year from seed, if sown early. **Pkt. 10c; ½-oz. 40c**

NEW ANNUAL EVER-BLOOMING.—This is one of the best introductions of late years. Seeds sown in the house in March will produce flowers in July on plants 4 feet high; the plants do not attain their perfection until their second year, when they grow 7 to 10 feet high, and flower continuously from June till frost.

Single Mixed. **Pkt. 10c; ½-oz. 25c**

Double Mixed. **Pkt. 15c; ½-oz. 50c**

CHATER'S IMPROVED.—Our strain of this is the best that can be produced; seeds saved from the most double flowers.

White, Pink, Crimson, Yellow, Lilac or Mixed. **Pkt. 10c; ¼-oz. 65c**

~~~~~  
**HOLLYHOCK**  
 PLANTS IN  
 ALL COLORS  
 OFFERED ON  
 PAGE 51.  
 ~~~~~



Hollyhock.

HUNNEMANNIA

Fumariaefolia (Giant Yellow Tulip Poppy.)
 —Hardy annual; foliage fern-like; flowers tulip-shaped, golden yellow; very showy; July to frost. **Pkt. 5c; ¼ oz. 25c**

HUMULUS.—See next page.

IPOMOEA—Moonflower

Grandiflora Alba.—Large, heart-shaped leaves, and large, pure white flowers, which open only late in the evening; 10 feet. **Pkt. 15c**

Humulus—Japanese Hop

Hardy annual climber; of rapid growth; attains a height of 12 feet.

Japonica Variegata.—Foliage green and white; very pretty and effective; not affected with insects. Pkt. 10c; ¼-oz. 25c

ENGLISH HOP ROOTS. Each 10c

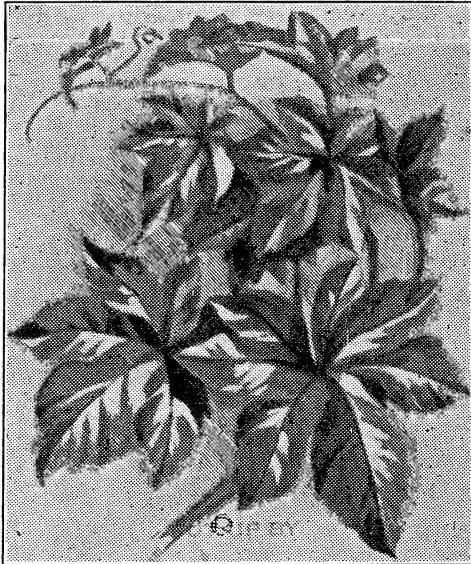

Humulus—Japanese Hop.

KOCHIA—Tricophylla

Summer Cypress or Burning Bush.—Annual; forms dense bushes of upright plumage-like foliage; during the summer they remain light green and in early fall they change to carmine and blood red; 2 feet; makes a dainty and showy hedge or nice single specimens. Pkt. 5c; ¼-oz. 25c

KUDZU VINE—Pueraria Thumbergiana

To this must be awarded first place as the fastest growing hardy climbing plant. It will grow 8 to 10 feet the first year from seed, and after it has become established there seems to be no limit to its growth, 50 feet in a single season being not unusual. Its foliage is large and covers well; it bears small racemes of rosy purple; pea-shaped blossoms towards the close of August. A splendid subject for covering permanently verandas, dead trees, etc. Pkt. 10c; ¼-oz. 25c

Larkspur

These are splendid, hardy annuals, which, when grown in beds or borders, make a pleasing effect, and the slender flower stalks, when cut, are most desirable for vases; July to October.

Double Dwarf Rocket.—1 foot; compact growing bush; splendid spikes of double flowers in all colors. Pkt. 5c; ¼-oz. 20c

Giant Hyacinth Flowered.—3 feet; fine, compact spikes of beautiful flowers. Pkt. 5c; ¼-oz. 20c

Emperor.—Tall, slender spikes of exquisite double flowers in unlimited quantity and of delicate shades; 3 feet. Pkt. 5c; ¼-oz. 20c

PERENNIAL LARKSPUR.—(See Delphinium, page 56.)

LATHYRUS LATIFOLIUS

Perennial Sweet Pea.—Free flowering, hardy perennial climbers, bearing beautiful flowers all season.

White or Pink.
Mixed.

Pkt. 10c; ¼-oz. 25c
Pkt. 10c; oz. 35c

FLOWERING PLANTS.—During the months of April, May and June we have thousands of choice, well-grown plants. See page 78.

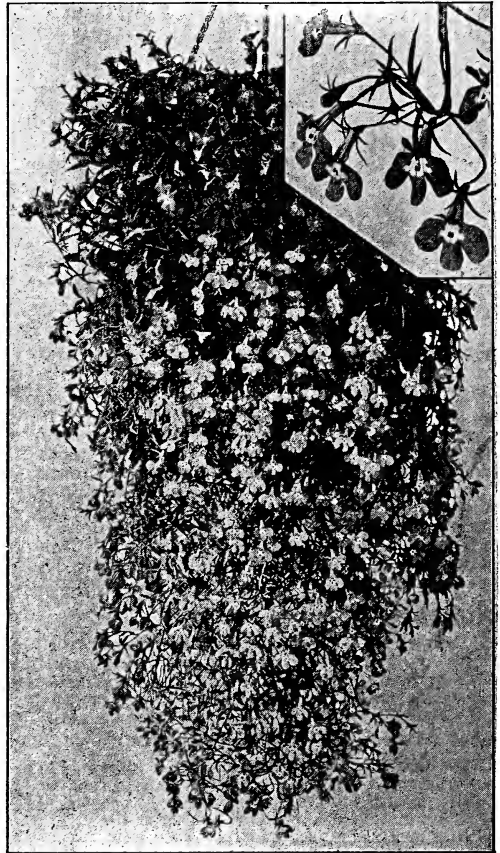

Trailing Lobelia—Sapphire.

Lobelia

Erinus Gracilis.—Trailing bright blue flowers; excellent for vases, hanging baskets and window boxes. Pkt. 10c; ¼-oz. 25c

Hybrida Sapphire (New.)—This is by far the most beautiful trailing Lobelia to date; very large, deep sapphire blue flowers, with a large and clear white eye; very free and early flowering; extra long trailer, for baskets and boxes. Pkt. 15c

Crystal Palace Compacta.—Little dwarf bedding plant; dark blue flowers cover the whole plant during the entire season; very compact and used extensively in carpet bedding or edging; height 4 inches. Pkt. 10c; ¼-oz. 50c

White Gem.—Compact little plants, covered with snow-white flowers. Pkt. 10c

Cardinalis (Cardinal Flower.)—Hardy perennial, with spikes of deep cardinal red flowers; August and September; 3 feet. Pkt. 15c

BUY a package of WONDER ODORLESS FERTILIZER and feed your plants according to directions. YOU WILL BE PLEASED at the results. See page 38.

LUPINUS

Ornamental, free-flowering, easily grown, with long, graceful, upright spikes of rich and variously colored pea-shaped flowers; valuable for mixed borders and beds.

Annual Dwarf Mixed.—Valuable for cutting; 2 feet. Pkt. 5c; ¼-oz. 15c

Polyphyllus Mixed.—Showy perennials, growing stout and erect; good for cutting; flowers in great variety of colors; 3 to 4 feet; May and June. (For plants, see page 81.) Pkt. 5c; ¼-oz. 15c

MARVEL OF PERU—Four o'Clock
Hardy annual, flowering from July to October; brilliant colors; 3 feet.
Finest Mixed. Pkt. 5c; oz. 25c

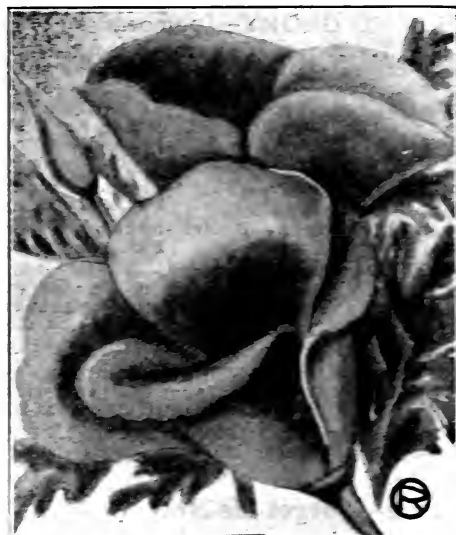

Mignonette—Reseda

A universal favorite; very fragrant; no home garden is complete without Mignonette. It needs a cool soil only moderately rich; grows 6 to 12 inches high and is treated as a half-hardy annual; sown treated as a half-hardy annual. (See out.)

Grandiflora.—Large-flowering, sweet, fragrant, spikes of greenish yellow color. Pkt. 5c; oz. 15c

Defiance.—Giant spikes; flowers abundant and very fragrant. Pkt. 10c; ¼-oz. 15c

Machet Red.—Excellent for pots or garden; highly colored, fragrant flowers. Pkt. 10c; ¼-oz. 25c

White Pearl.—New; the best white flower; very attractive. Pkt. 10c; ¼-oz. 35c



African Marigold.

Marigold—Tagetes

Widely grown, hardy annuals; invaluable for bedding and producing an elegant display of yellow, orange and brown flowers from early summer till frost.

Mammoth African, Finest Mixed.—Very large and double, orange-yellow flowers; 2 to 3 feet. Pkt. 5c; ¼-oz. 25c

Double French.—Flowers double, brown-red and golden-yellow; very rich and pretty. Tall or Dwarf Mixed. Pkt. 5c; ¼ oz. 25c

MESEMBRYANTHEMUM

Dwarf trailing plants of great beauty, blooming the whole summer, thriving best in a dry, loamy or sandy soil; hardy annuals; 12 to 15 inches.

Tri-color.—Very dainty, pointed petaled, salmon-pink flowers. Pkt. 10c

Crystallinum (Ice Plant).—Flowers white; prized for its singular icy foliage. Pkt. 10c

MIMULUS

Moschatus (Muskplant).—A pretty, trailing plant with small yellow flowers, giving forth a musk-like fragrance; fine for hanging baskets, etc. Annual. Pkt. 10c

Our 2-page
Leaflet,
"HOW TO
GROW FLOW-
ERS FROM
SEED."
Free on
Request



Mignonette—Flower Spikes.

GLADOLI BULBS make a beautiful display when in bloom and are of the easiest culture and really not expensive, as they multiply rapidly. See page 86.

MORNING GLORY—Ipomoea

The tall varieties are popular, well known, rapid-growing climbers of the easiest cultivation; very fine for covering arbors, trellises, porches, etc.; give them rich soil and a warm situation. The Minor or dwarf varieties flower very freely and do not require support.

Convolvulus Major.—Tall, choice, single mixed; all colors. Pkt. 5c; oz. 20c

Convolvulus Minor.—Dwarf mixed. Pkt. 5c; oz. 20c

Imperial Japanese Fringed.—These have very large fringed flowers in a great variety of the most exquisite colorings; handsome foliage. Pkt. 5c; oz. 25c

Double Mixed. Pkt. 15c

Choice Prize Mixture.—This is a mixture of both American and Japanese varieties; very choice. Large Pkt. 10c; oz. 20c

(Note.—Soak the Japanese Morning Glory seed in warm water for 24 hours before planting.)

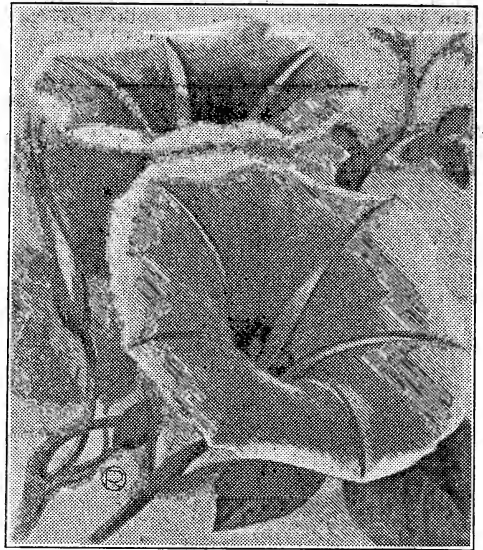

Morning Glory.

Myosotis—Forget-Me-Not

Few spring flowers are more admired than the lovely Forget-Me-Nots, which are especially effective when grown in masses. Perennials and hardy if given slight protection through the winter. Seed may be sown any time from spring till mid-summer. The *Alpestris* and *Dissitiflora* come into bloom in April, and are largely used for bedding or borders in connection with spring-flowering bulbs, Pansies, etc. The *Palustris* sorts do not bloom till May, but continue till fall. Perennial plants, pg. 81.

Dissitiflora.—Rich blue; early flowers in fine sprays; 6 inches. Pkt. 10c; ½ oz. 50c

Alpestris Victoria.—Of bushy habit; bearing large, double, bright blue flowers; yellow eye; very fine; 6 inches. Pkt. 10c; ½-oz. 35c

Alpestris Royal Blue.—Rich indigo blue. 9 inches. Pkt. 10c; ½-oz. 25c

Finest Mixed.—A mixture of blue, rose and white varieties. Pkt. 5c; ½-oz. 20c

Palustris Semperflorens.—Perennial; flowers bright blue; blooms from early spring until autumn. Pkt. 10c; ½ oz. 50c



Myosotis—Forget-Me-Not.

NEMESIA

Grandiflora Compacta Triumph.—A very pretty, half-hardy, free-flowering annual; the plants grow about a foot high and the beautiful, dainty flowers are very varied in color, including rose, yellow, blue, orange, etc. An ideal bedding plant. Seed sown in the autumn makes beautiful pot plants for early spring blooming. Mixed Colors. Pkt. 15c

NICOTIANA

One of the easiest annuals to raise and one of the most effective. The blossoms in shape are not unlike a *Petunia* blossom but with a longer tube. The flowers open toward evening and emit a powerful perfume.

Affinis (Tuberose-flowered Tobacco).—Delightfully sweet-scented, pure white, tubular flowers, blooming continually; annuals; 2 to 3 feet. Pkt. 5c; ¼-oz. 25c

Affinis Hybrida.—Splendid hybrids in blue, red and rose, etc., shades. Pkt. 10c

Sanderae.—A lovely hybrid Tobacco of elegant branching habit, and bearing on light graceful stems great quantities of very beautiful rosy carmine flowers; a valuable border plant, remaining decorative from summer to autumn. Pkt. 10c

NIGELLA—Love in a Mist

Damascena.—A compact, free flowering plant with finely cut foliage, curious looking flowers and seed pods; hardy annuals; blue and white; 1 foot. Mixed colors. Pkt. 5c; ½-oz. 15c

Miss Jekyll.—A lovely variety with cornflower blue blossoms; splendid for cutting. Pkt. 10c; ½-oz. 25c

HOUSE PLANTS

Don't overlook the beautiful Ferns and Palms that we offer on pages 76 and 77. The small sizes go safely by mail and are very pretty.

PERENNIAL FLOWERING PLANTS—By buying our strong field grown plants you save time and get a profusion of flowers the first season. See pages 79-83.

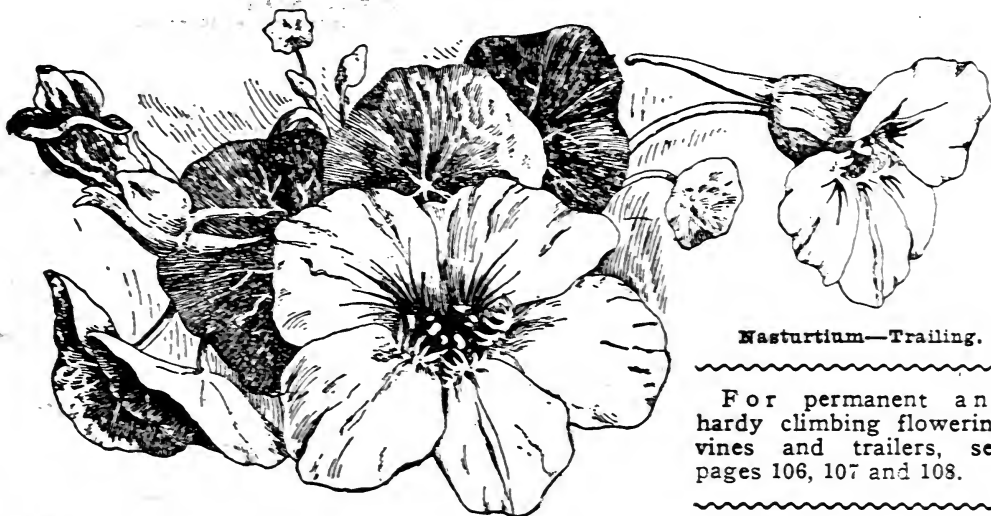

Nasturtium—Trailing.

For permanent and hardy climbing flowering vines and trailers, see pages 106, 107 and 108.

Nasturtium—Tall Climbing

The most popular and most beautiful annual climbing vines. We offer only the finest strains, producing the largest and richest flowers.

- Asa Gray.**—Yellowish white; very fine.
Black Prince.—New; very dark.
Crown Prince.—Rich blood red.
Golden Queen.—Very fine yellow.
Margaret.—Yellow, spotted red and yellow.
Primrose.—Cream, brown spots.
Regina.—New salmon shade.
Spitfire.—Bright fiery scarlet.

Your choice, Pkt. 5c; full collection, 8 kinds, 30c; per oz., any kind 20c.

TALL PRIZE MIXTURE.—This is undoubtedly the finest mixture of tall Nasturtiums offered anywhere; every shade is grown separately and then mixed.

Large Pkt. 10c; oz. 20c; 1-lb. 50c

Tall Choice Mixed.—A very fine selection of beautiful varieties.

Large Pkt. 5c; oz. 15c; 1-lb. 35c

IVY-LEAVED, FINEST MIXED.—The ivy leaves, borne on very slender stems, are of a dark metallic color, which forms a striking contrast to the beautiful flowers; an excellent variety for cases, hanging baskets, etc.

Pkt. 5c; oz. 20c

VARIEGATED QUEENS.—A new strain of tall Nasturtiums having beautifully variegated leaves; green, white and yellow; flowers large and of many bright colors.

Superb Mixed. Pkt. 10c; oz. 20c

Dwarf Nasturtiums

B. B.'s DWARF BEAUTY MIXTURE.—Composed of new and rare sorts; exceedingly brilliant and beautiful.

Large Pkt. 10c; oz. 20c; 1-lb. 50c

Choice Dwarf Mixed.—Not equal to above, but far superior to most mixtures.

Large Pkt. 5c; oz. 15c; 1-lb. 35c

GOLDEN MIDNIGHT (New Dwarf).—A novelty of real merit. From an artistic point of view the contrast between the light foliage and extremely dark flowers is most remarkable. The foliage is light yellow, variegated, while the flowers are deep crimson, almost black; hence the name "Golden Midnight."

Pkt. 10c; oz. 20c

DWARF NASTURTIIUMS

- Aurora.**—Reddish orange, veined carmine.
Beauty.—Yellow and scarlet; very pretty.
Empress.—Deep crimson; extra dark leaved.
Golden King.—A rich golden yellow.
Regellanum.—Deep purplish crimson.
Vesuvius.—New salmon red; very beautiful.
 Price, all above Dwarf varieties, Pkt. 5c; 6 for 25c; per oz. 20c.

PENTSTEMON—Beard Tongue

The handsome, brilliant flowers are borne on long terminal spikes, much resembling Gloxinias. Perennial; will bloom the first season if sown early; 3 feet. All colors from yellow to red and purple. See cut.)

Hybrida Mixed.

Pkt. 10c



Pentstemon.

GROW "PRIZE FLOWERS" by using "WONDER ODORLESS FERTILIZER." But do not use TOO MUCH, it is very RICH. See page 37.

Petunia

One of our easiest cultivated and freest flowering annuals. Will succeed almost anywhere and give a continuity of the most brilliant bloom from June till killed by frost. The strains we offer are the very choicest obtainable.

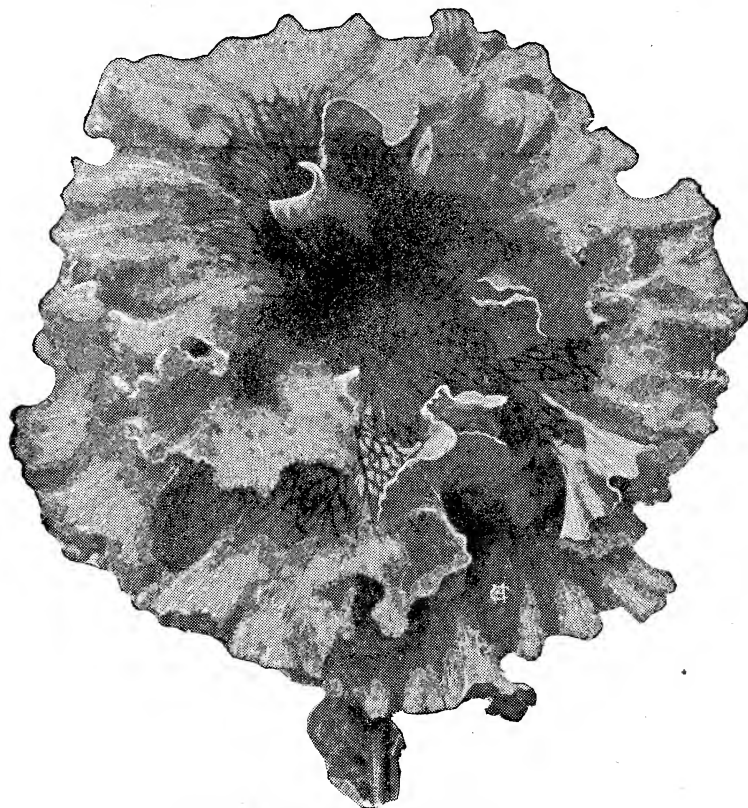

Ruffled Giant Single Petunia.

SINGLE PETUNIAS

Ruffled Giants Prize Mixture.—This strain produces in great profusion enormous flowers, having edges of petals beautifully ruffled and fluted; of great variety of colors, many being beautifully veined; very showy and attractive.

Pkt. 35c; 1,000 seeds \$3.00

Dwarf, Large-Flowering, Fringed.—A new dwarf selection of the most beautiful ruffled and fringed type; compact, free-flowering plants; excellent for bedding or pots.

Pkt. 25c

Large-flowered, Finest Mixed.—Fine, large flowers in superb mixture.

Pkt. 10c

Fine Mixed.—An assortment of medium-sized flowers; fine for bedding. **Pkt. 5c; ¼-oz. 25c**

DOUBLE PETUNIAS

All of our Double Petunias are selected with greatest care, and contain as large a percentage of double flowers as it is possible to obtain.

Giant Double, Finest Mixed Hybrids.—An exceptionally fine strain; remarkable for the large, beautifully colored double flowers.

Pkt. 50c; 500 seeds \$4

Giant Double Mixed.—Fringed, unsurpassed.

Pkt. 35c; 500 seeds \$2.50

Choice Double Mixed.

Pkt. 25c; 500 seeds \$1.50

OUR NEW PRODUCT, "C-M," DRY-KILN PULVERIZED COW MANURE is the ideal covering FOR SEED AND FLOWER BEDS. SEE PAGE 39.

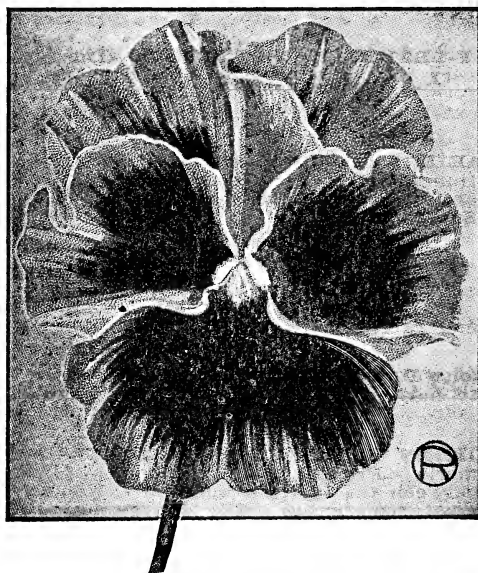

Giant Pansies

This popular flower thrives best on a cool, moist, but well-drained soil enriched with well-rotted barnyard manure or fine ground bone. Seeds sown early will produce fine plants for summer blooming. The florist's method, though, is to sow in July or August and protect the plants during the winter, and they will flower continuously early the following spring and summer.

EXHIBITION PRIZE MIXTURE.—For variety of markings, beauty of form, large size, splendid texture this superb strain cannot be excelled. **Pkt. 20c; ¼-oz. \$1.50**

Steele's Mastodon.—A superb strain. Flowers rare and rich in colors and of giant size; Oregon grown.

Mixed, Pkt. 25c; ⅛-oz. \$1.50

Bugnot's Large Blotched.—A magnificent strain; very large flowers; great diversity of colors. **Pkt. 20c; ⅛-oz. 75c**

Cassier's Giant, Finest Mixed.—Strong-growing strain, producing rich and varied-colored flowers of large size.

Pkt. 15c; ⅛-oz. 75c

English Show Strain.—A splendid strain, valued for the texture and varied markings of the flowers. **Pkt. 10c; ¼-oz. 60c**

Choice Mixed.—A fine bedding strain.

Pkt. 5c; ¼-oz. 50c

PLANTS.—Large flowering, choice pansy plants, ready very early in the spring. Can be safely sent by mail. See page 73.

PANSY—Continued

GIANT TRIMARDEAU.—The most popular strain for this locality, and deservedly so, on account of the strong, sturdy plants and the enormous flowers of the greatest variety of colors.

Finest Mixed. Pkt. 10c; ¼-oz. 60c

Masterpiece.—Elegant ruffled petals; beautiful large flowers, mostly rich dark shades. Pkt. 20c; ½-oz. 75c

GIANT NAMED PANSIES

Full Collection, 9 Kinds 75c

Adonis.—Light blue; beautiful. Pkt. 10c

Golden Queen.—Pure rich yellow. Pkt. 10c

King of Blacks.—Best velvety black. Pkt. 10c

Lord Beaconsfield.—Very beautiful; violet purple, shading to white. Pkt. 10c

Madam Ferret.—Fine wine red shades on white. Pkt. 10c

Snowflake (Candidissima).—Pure white. Pkt. 10c

Sunlight.—New yellow, orchid flowered. Pkt. 15c

Purple-Eyed White.—Very beautiful. Pkt. 10c

Black-Eyed Yellow.—Very fine and effective. Pkt. 10c



Shirley—Poppy.

Poppy—Papaver

Universal favorite of the easiest culture. They produce a wealth of the most beautiful and showy blooms. Both perennial and annual poppies bloom the first year from early-sown seed. Perennial varieties will, but annuals will not transplant safely, therefore sow the annuals where they are to remain and thin out, giving each plant ample room to grow and develop.

King Edward.—New annual of gorgeous coloring; deep scarlet shaded; each petal marked with a big black blotch; yellow antlers; flowers large and freely produced; 2½ feet. Pkt. 5c; ¼-oz. 25c

Admiral (Annual).—A single variety of surpassing beauty; large flowers of glistening white, with a broad band of brilliant scarlet around the top; produce a magnificent effect. Pkt. 5c; ¼-oz. 25c

Miss Sherwood (Annual).—Single, bears large flowers of a satiny white, shaded a silky chamois rose, a combination of rare delicacy. Pkt. 5c; ¼-oz. 25c

Shirley (Annual).—Charming Poppies. Flowers single and semi-double, and range in color from the purest white through the delicate shades of pale pink, rose and carmine to the deepest crimson and blood-red, while many are daintily edged and shaded. The petals are like silk. Free blooming and fine for borders or beds; 1½ to 2 feet. **Mixed.** Pkt. 10c; oz. 40c

Carnation Flowered (Annual).—Splendid double fringed flowers. **Mixed Colors.** Pkt. 5c; oz. 30c

Annual Superb Mixture.—A superior strain, containing the choicest of single and double varieties in all of the brightest colors. Pkt. 5c; oz. 40c

ICELAND, OR NUDICAULE (Perennial).—These are of a very graceful, neat habit, with bright green, fern-like foliage, formed in tufts, from which issue slender stalks, about 12 inches in height, bearing beautiful brilliant single flowers in endless profusion, and most useful for cutting. (For plants, see page 80.)

Yellow, White, Scarlet. Pkt. 10c
Single Mixed. Pkt. 10c; 1-oz. 35c

Double Iceland Mixed.—Very choice. Pkt. 15c; ½-oz. 50c

ORIENTALE BRILLIANT.—This is the most gorgeous perennial Poppy, flowering in June and July, with enormous vivid scarlet blossoms. Pkt. 10c; ¼ oz. 50c

Oriental Princess Victoria Louise.—Salmon pink; very silky and delicate. Pkt. 15c

Oriental Psyche.—Delicate rosy blush. Pkt. 15c

CALIFORNIA POPPY.—(See *Eschscholtzia*, page 57.)

PHLOX.—SEE NEXT PAGE.

PORTULACA.—SEE NEXT PAGE.

Primula—Primrose

The first two varieties named below are hardy, early-blooming, garden plants, and the others beautiful winter-blooming house plants. Their various forms and blending of colors are exceedingly pleasing and effective. They thrive best in a rich, loamy soil.

POLYANTHUS (Veris Mixed).—Early blooming, dwarf growing plants, valuable for outdoor bedding and edging, 8 inches, perennial. (See plants, page 82.) **Mixed.** Pkt. 10c; ½-oz. 35c

VULGARIS (Veris Aurea).—Yellow, common, English Primrose; hardy garden variety; perennial; 8 inches. Pkt. 10c; ½-oz. 35c

Obconica Grandiflora Hybrids.—A lovely, profuse bloomer, bearing beautiful clusters of single flowers; for pots only. Pkt. 15c

Sinensis or Chinese Primrose.—Beautiful, large, fringed flowers; especially fine for winter and spring flowers in the house; free bloomers. Pkt. 25c

Finest Mixed. Pkt. 25c

PYRETHRUM—Golden Feather

Aureum.—Half-hardy perennials, grown as annuals; valuable for edging, as their yellow foliage makes a fine contrast with other bedding plants; 6 inches. Pkt. 5c

THE "KIRK" SYSTEM.—Read about this new way of applying FERTILIZER and SPRAYS WITH THE GARDEN HOSE. See page 40.

Portulaca

Low-growing or creeping tender annual, six to eight inches high, and bearing glossy, cup-shaped blossoms in very brilliant and gorgeous colors. The foliage and stems are thick. The seed germinates slowly and should be started under glass or when the weather is hot. These flowers love the sunshine and do best on rather dry ground; excellent for embankments.

Single, Finest Mixed.
Double, Finest Mixed.

¼-oz. 20c; Pkt. 5c
⅛-oz. 50c; Pkt. 10c



Single Portulaca.

OUR
HIGH
QUALITY
PLANTS
AND SEEDS
PLEASE.



Phlox Drummondii.

PINK.—(See Dianthus, page 56.)

Phlox

Drummondii.—These varieties are the largest flowering of the annual phloxes. They are the very finest strains that can be selected, and should be grown in everyone's garden; 12 to 15 inches.

Alba.—Pure white. Pkt. 10c; ½-oz. 25c

Coccinia.—Bright scarlet. Pkt. 10c; ¼-oz. 25c

Leopoldi.—Rose, white eye. Pkt. 10c; ½-oz. 25c

Grandiflora Mixed.—All colors. Pkt. 10c; 1-oz. 35c

HARDY PERENNIAL PHLOX (Decusata).

—These rank among the finest herbaceous perennials for beds and borders; mixture of the finest colors; 3 feet. (See plants, page 82.) Pkt. 10c; ¼-oz. 25c

Ricinus—Castor Oil Bean

A magnificent and highly ornamental plant, with picturesque foliage and stately growth, combined with brilliant colored fruit of the giant varieties. Grown as single specimens on lawns and on pleasure grounds, they form a striking feature; hardy annuals.

Zanzibarensis, Mixed.—Very ornamental; dark bronzy green and red leaves; 8 to 10 feet high. Pkt. 10c; oz. 35c

Sanguineus Tricolor.—Blood red stems, deep green leaves, with red veins; 6 feet. Pkt. 10c; oz. 35c

Gibsoni.—New dark red foliage; 5 feet. Pkt. 10c; oz. 35c

Finest Mixed.—All kinds. Pkt. 5c; oz. 20c

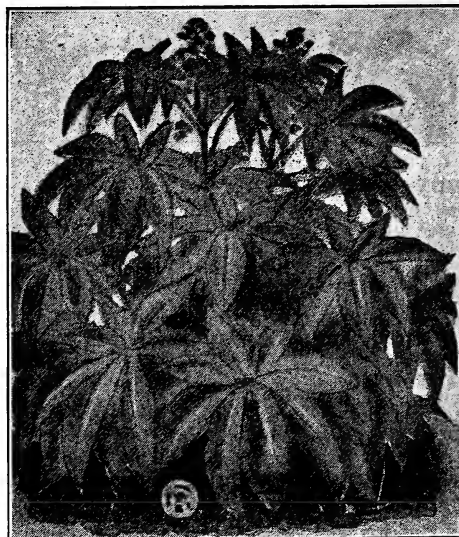

Ricinus (Castor Beans).

Oregon City, Ore., June 5,
Dear Sirs: My small order of Roses and Plants for this spring are all growing and some are in bloom. The Pansies that were planted by your leaflet directions are the finest I or my friends ever saw.

Yours truly,
MRS. FRED HEGDALE.

RUDBECKIA—Cone Flower

Bicolor Superba.—Fine free-flowering annual variety; 2 feet; producing in great abundance on long stems its bright yellow double flowers. Pkt. 10c

Fulgida.—Hardy perennial sort, producing in masses during August and September brilliant orange-yellow flowers; 3 feet. Pkt. 10c

Newman.—Perennial; large, bright orange-yellow flowers. Pkt. 15c

SALPIGLOSSIS

Produces very showy, funnel-shaped flowers of large size; fine for beds; half-hardy annuals.

Grandiflora Mixed.—Large-flowering. Pkt. 10c

HOW TO GROW FLOWERS FROM SEEDS.—Our two-page leaflet gives full information and is free on request.



Salvia.

Salvia—Scarlet Sage

The Scarlet Sage has long been a favorite bedding plant, bearing long spikes of brilliant scarlet flowers in great profusion from July till frost; seed should be sown as early as possible, either indoors or in a hotbed, and the young plants transferred to their flowering quarters when the weather has become settled and warm.

Splendens Compacta.—A splendid showy variety, with large spikes of bright rich scarlet flowers; 3 ft. Pkt. 10c; ¼-oz. 50c

Zurich.—New dwarf, of special merit; very early. Brilliant, free flowering; 15 to 18 inches. Pkt. 15c; ¼-oz. 75c

Bonfire.—Of dense compact growth; useful for bedding or borders. Flowers dark scarlet, on spikes which stand clear of the foliage and attract attention at once; 2 ft. Pkt. 15c; ¼-oz. 65c



Stocks.

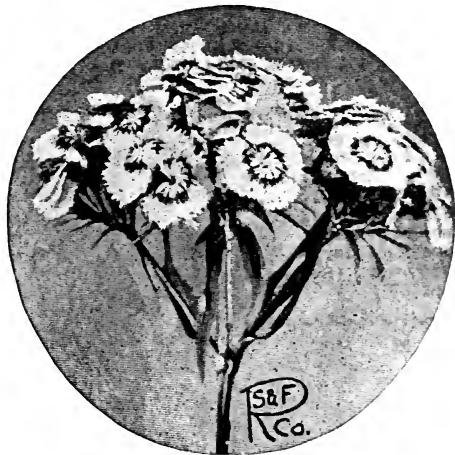

Sweet William

SCHIZANTHUS—Butterfly Flower

Beautiful garden annuals; flowers charmingly fringed and delicately colored; 1 to 2 feet. Blooms quickly from seed.

Grandiflora Mixed.

Pkt. 10c

Stock—Gilliflower

By far one of the most popular annuals for garden or greenhouse culture. They are superb for cutting and are of great value to florists for bouquet work. Flowers are of delicious fragrance, large, mostly double, and borne on handsome spikes. While all will flower the first year, the winter stocks will last for 2 years. They are very hardy and often remain in bloom in the yard all winter in the vicinity of Portland. Sow early and transplant.

LARGE-FLOWERED TEN WEEKS.—A splendid double-flowered strain, especially adapted for bedding and pot culture; pyramidal spikes of brilliantly colored flowers; 1½ feet.

Finest Mixed.

Pkt. 10c; ¼-oz. 50c

GIANT PERFECTION, OR CUT-AND-COME AGAIN.—Grown for us by experts and the greatest possible care is taken in the selection of good seed. Of branching habit, two feet, and 85 to 90 per cent of large, double flowers; fine for cutting.

White, Light Blue, Crimson, Dark Blue, Pink, Yellow, or Finest Mixed.

Pkt. 15c; ½-oz. 60c

BEAUTY OF NICE.—A handsome, new winter and summer stock of quick growth; flowers of large size, double, and freely produced; 2 feet.

Mixed.

Pkt. 15c; ½-oz. 60c

Princess Alice.—Double white. Pkt. 15c

Queen Alexandra.—Soft rosy lilac. Pkt. 15c

Beauty of Nice.—Delicate flesh pink. Pkt. 15c

SUNFLOWER.—(See Helianthus, page 58.)

Sweet William

Hardy biennial, widely grown for the handsome, showy heads of brilliant flowers from June to September; 1½ feet.

Double Finest Mixed.

Pkt. 10c

Mammoth Single Mixed.

Pkt. 5c

PERENNIAL FLOWERS are rapidly gaining in favor. **MORE** should be planted; they are beautiful in borders, beds or among shrubbery, and flower each year. See pgs. 79 to 83.

"Up-to-Date" SWEET PEAS OF "Highest Quality"

This year we have "new novelties" to offer of **special merit**. We have discarded the "Unwin" class and many "Spencers" and Grandiflora types, and we offer you only the **Cream of all Sweet Peas. The Best by Test.**

Treat your Sweet Peas with **MULFORD'S CULTURE**, makes stronger vines, more and larger flowers. (See page 37.)

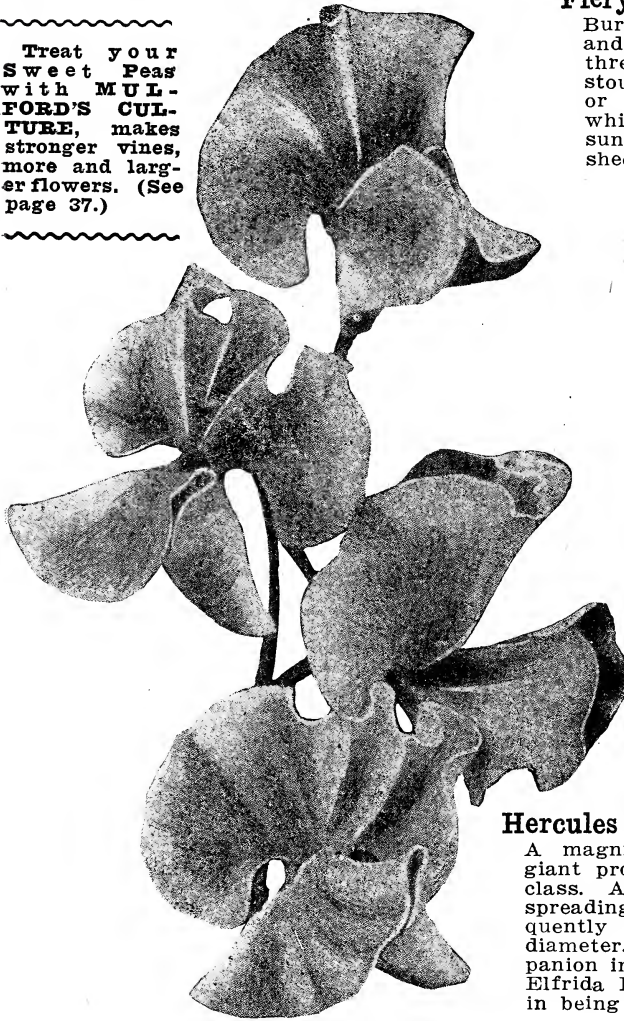

Fiery Cross

Burpee's latest. The beautifully waved and fluted flowers are borne freely in threes and fours, well placed on long stout stems. Color, a scorching fire-red, or scarlet, without any shading and which scintillates and glitters in bright sunlight thus adding a glowing fire-like sheen which radiates over the flower.

Pkt. 25c

1918 Prize Collection

Latest and Best Spencers

Rare, Rich and Wonderful

SPECIAL — Collection price, 10 lovely kinds (value \$1.35), **ONLY \$1.00.**

King White

Well and truly named, it certainly is "the king" of all white sweet peas. In color, size and beauty of flower, length of stem and vigor, King White is unsurpassed.

Pkt. 10c; oz. 35c

Robert Sydenham

This new Sweet Pea is a magnificent glowing, brilliant orange. The large flowers come four on a stem, well placed and beautifully waved. The vines are of vigorous growth, blooming profusely.

Pkt. 15c; oz. 50c

Hercules

A magnificent soft rose-pink self, of truly giant proportions, undoubtedly the best of its class. A flower of great substance; the broad spreading and beautifully waved standard frequently measures two and one-half inches in diameter. This grand variety is a fitting companion in size and form to the superb gigantic Elfrida Pearson, from which it differs chiefly in being of a deeper, warmer shade.

Pkt. 15c; oz. 50c

Constance Hinton

A new, very hardy variety, claimed to be the largest White Spencer to date. The buds are tinted with pink, but as the flower develops the pink fades out, leaving a beautiful large, pure white. Black seed, strong vitality.

Pkt. 15c; oz. 50c

Elfrida Pearson

The flowers are of extra large size, great substance, and lasting quality when cut. They are nicely disposed on extremely long stiff stems invariably borne in fours. The vines bloom in wonderful profusion, and are of such vigorous growth that the flowers frequently come with double standards. The color is a lovely pink throughout, the buds and flowers being tinted with salmon-pink.

Pkt. 10c; oz. 30c

Maud Holmes

An English introduction and superior to others in this color. Elegant form and type and a beautiful crimson scarlet, giant, wavy flowers, four to a stem.

Pkt. 10c; oz. 35c

R. F. Fenton

Undoubtedly the best of the lavender varieties, grand for exhibition and garden decoration; strong grower, gives plenty of fours. The individual flowers are very large and refined; the color is a rich clear lavender.

Pkt. 15c; oz. 50c

Winnifred Deal

A most beautiful variety; pure white with a very distinct picotee-edge of rose-pink. The general effect is light and dainty.

Pkt. 15c; oz. 35c

Edrom Beauty

The bold, majestic flowers are a rich, deep salmon-orange. An excellent grower, producing fours in abundance.

Pkt. 10c; oz. 40c

Royal Purple

A recent novelty of great merit. A true, rich, royal purple that holds its color. Flowers of giant size and elegant form, very beautiful bunched with white.

Pkt. 10c; oz. 35c

The above collection will make a display that you'll be proud of if you follow our cultural directions.

Up-to-Date Spencer Sweet Peas of Real Merit—Continued

No seed house offers a more select list. We classify under colors for your convenience
SPECIAL—Make up your own collections—60c worth for 50c; \$1.25 for \$1.00

WHITE

CONSTANCE HINTON.—See Novelties, page 68.

ETTA DYKE.—One of the largest and most exquisitely formed pure white Spencers. Beautifully waved; color absolutely pure.
Pkt. 10c; oz. 35c

KING WHITE.—See "Novelties," page 68.

WHITE SPENCER.—A pure white, of large size and splendid substance; long, strong stems.
Pkt. 10c; oz. 25c

YELLOW—PRIMROSE

DOBBIE'S CREAM.—We consider this the best deep cream or primrose-colored variety; nicely waved, abundance of four-bloom sprays and most floriferous. Strong and vigorous.
Pkt. 10c; oz. 35c

PRIMROSE SPENCER.—A pronounced primrose or creamy white; excellent flower.
Pkt. 10c; oz. 25c

PINK ON CREAM

ETHEL ROOSEVELT.—A soft, pleasing primrose, overlaid with dainty bright pink; very large and fine.
Pkt. 10c; oz. 35c

MARGARET ATLEE.—This new, charming variety is one of the finest pink yet introduced. The giant flowers are rich, rosy salmon pink on creamy buff, a bright yet delicate pink, immense wavy standards and wings inclined to double.
Pkt. 15c; oz. 50c

NEW MIRIAM BEAVER.—A lovely, soft shell pink and salmon. A beautiful, large, full flower.
Pkt. 15c; oz. 60c

YARBWA.—A new "early flowering Spencer" of value more especially to the commercial florist, for winter forcing. Blooms very early and continuously. Flowers are large, exquisitely waved and almost double; color, bright rosy pink on cream.
Pkt. 15c; oz. \$1.00

MRS. HENRY BELL.—Giant flowers of finest form. A most charming rich pink on cream. Magnificent.
Pkt. 15c; oz. 35c

LIGHT PINK

CONSTANCE OLLIVER.—A refined variety of great beauty and form; rich, rosy delicate salmon pink; charmingly waved and crimped. Large, beautiful flowers on long, strong stems.
Pkt. 10c; oz. 35c

ELFEIDA PEARSON.—See page 68.

MRS. HUGH DICKSON.—One of the best light pink to date. A European variety of sterling merit.
Pkt. 10c; oz. 30c

MRS. BOUTZAHN.—A lovely combination of apricot and pink. Beautiful, large wavy flowers.
Pkt. 10c; oz. 30c

Florence, Ore., Jan. 5, 1917.

Routledge Seed & Floral Co.,

Gentlemen: The Sweet Peas and Alyssum were lovely. The Sweet Peas were nine feet I am sure.

Respectfully yours,

MRS. MAGGIE JENSEN.

Seattle, Wash., March 14, 1917.

Routledge Seed & Floral Co.,

Gentlemen: Sweet Pea seeds received from you last summer were beautiful, tall, long stems, large flowers and perfect.

Yours respectfully,

ALICE B. BENNETT.

Free—Our pamphlet, "How to Grow Prize Sweet Peas"—free with any order if asked for.

PINK

HERCULES.—See "Novelties, page 68.

COUNTESS SPENCER.—Flowers extremely large, beautifully expanded, crumpled and waved. Color soft shell pink, deeper at the outer edges.
Pkt. 10c; oz. 35c

MRS. A. IRELAND.—The form is beautiful; petals waved and crinkled. The extra large long-stemmed flowers are very attractive; the best rosy pink.
Pkt. 10c; oz. 35c

LAVENDER

ASTA OEN SPENCER.—Color a beautiful lavender; flowers large, wavy and generally come four blossoms to the stem. Very popular.
Pkt. 10c; oz. 35c

FLOEA NORTON SPENCER.—A beautiful shade of light blue or lavender; very desirable.
Pkt. 10c; oz. 35c

B. F. FENTON.—See "Novelties," page 68.

ORANGE AND SALMON

NOTE.—To get the most delicate shade in this color, flowers should be lightly shaded.

BARBARA.—Salmon-colored self of large size. It makes a "telling" bunch either for exhibition or table decoration, and is most effective.
Pkt. 15c; oz. 50c

DECORATOR.—The color is old rose with a sheen of terra cotta giving a bright orange effect. The placement and poise of the flower is perfect.
Pkt. 10c; oz. 40c

EDROM BEAUTY.—See "Novelties," page 68.

HELEN LEWIS SPENCER.—A very profuse bloomer. Flowers large, nicely waved and of an intense rich crimson-orange or salmon.
Pkt. 10c; oz. 35c

ILLUMINATOR.—Very distinct and pronounced; rich glowing cerise-salmon, suffused bright orange, rich and glistening. Large, perfect flowers in profusion on long stems.
Pkt. 10c; oz. 40c

ROBERT SYDENHAM.—"Novelty," page 68.

THOMAS STEVENSON.—The flowers, of largest size and finest Spencer type, are of an intense flaming orange throughout. A grand exhibition variety. Unsurpassed in color and beauty.
Pkt. 10c; oz. 50c

QUALITY and TRUENESS is what makes the price in Sweet Peas. Low prices never brought "HIGHEST QUALITY" Seeds. Use Mulford's Culture; see page 37.

Up-to-Date Spencer Sweet Peas of Real Merit—Continued

No seed house offers a more select list. We classify under colors for your convenience
SPECIAL—Make up your own collections—60c worth for 50c; \$1.25 for \$1.00

SCARLET—CRIMSON

FIERY CROSS.—See "Novelties," page 68.

GEORGE STARK.—Giant flowers of perfect form, waved and fluted. Color, bright pure scarlet throughout and absolutely sunproof. **Pkt. 10c; oz. 35c**

KING EDWARD SPENCER.—Of vigorous growth, profuse bloomer, giant flowers; most popular scarlet; long stems. **Pkt. 10c; oz. 35c**

MAUD HOLMES.—See page 68.

THE PRESIDENT—Novelty.—Flowers of beautiful wavy form on long stems, usually carrying four giant blooms of a rich glowing scarlet—claimed to be one of the brightest colors to date and does not burn. **Pkt. (10 Seeds) 15c**

BLUE—PURPLE

CAPTAIN OF THE BLUES, SPENCER.—Clear purple, blue; a bright striking color. **Pkt. 10c; oz. 25c**

NEW MARGARET MADISON.—Flowers clear azure-blue self,—a color that always attracts and is so effective. Awarded Certificate of Merit by the American Sweet Pea Society. **Pkt. 15c; oz. 35c**

ROYAL PURPLE.—See "Novelties," page 68.

DARK RED—CLARET

OTHELLO SPENCER.—Free bloomer, flowers very large and of a rich deep maroon. **Pkt. 10c; oz. 25c**

PICOTEE—BI-COLOR

Shaded and Striped

AMERICA SPENCER.—Bright and attractive; white, striped bright red; very pretty. **Pkt. 10c; oz. 35c**

MARTHA WASHINGTON.—Large, wavy flowers; white, edged carmine rose, very dainty and effective. **Pkt. 10c; oz. 30c**

MRS. TOWNSEND.—The ground color is white, having a beautifully clear wire-like picotee edge of blue around both standard and wings. Large flowers, nicely waved. **Pkt. 10c; oz. 35c**

MRS. CUTHBERTSON.—Flowers of gigantic size; standard, clear rose-pink, wings white. Four on a stem of great length. Vigorous and free flowering. **Pkt. 10c; oz. 40c**

SENATOR SPENCER.—Claret and chocolate stripe, on light ground, large and most distinct, much admired; a profuse bloomer. **Pkt. 10c; oz. 35c**

WINNIFRED DEAL.—"Novelties," page 68.

Popular and Best Grandiflora Sweet Peas

Aside from the preceding varieties these are the "cream" of over 100 named varieties. Your selection, **pkt. 5c; 8 pkts. for 30c; oz. 10c; 8 1-oz. pkts. 60c; ¼-lb. 30c; lb. \$1.00.**

DOROTHY ECKFORD.—A good white of the largest and best grandiflora type.

LOVELY.—Beautiful shades of soft shell pink, changing to very light rose.

KING EDWARD VII.—Large flowers of open form, bright crimson-scarlet.

HENRY ECKFORD.—A bright, soft flaming orange, deepening slightly in the center.

AMERICA.—Heavily striped with bright red on silvery white ground.

LADY GRISEL HAMILTON.—A grand, pale lavender. Planted extensively by florists.

LORD NELSON (Brilliant Blue).—Very large, slightly hooded, the most desirable blue.

Rose City Mixture of Grandiflora

Extraordinary care has been taken in the selection of the varieties and the quantities of each to make up the mixture, and the result is one that cannot fail to excite the admiration of even the most critical. **Large pkt. 5c; oz. 10c; ¼-lb. 25c; lb. 85c**

Winter Flowering (Forcing)

These can be planted outside for early blooms, but are really for florists' use for forcing in greenhouses for winter flowers. **All leading colors in named varieties at 15c oz.; 4 ozs. 50c.**

Cupid Sweet Peas

Compact dwarf plants, not over six or seven inches high. Flowers of good size and substance. For edgings, low beds and pot culture they are unique and pretty. **Mixed, Pkt. 5c; oz. 15c; ¼-lb. 40c; lb. \$1.25**

PRIZE SWEET PEAS—If you want to grow giant flowers on long stems, you must give your sweet peas good soil, plenty of water at the roots in dry weather, some Wonder Fertilizer, and pick the flowers often. Our "leaflet" tells all—free with each order. Use "C. M." in the Sweet Pea trench. See pages 38-39.

Sweet Peas of Highest Quality

Some others may have as good, but none any finer Sweet Pea Seed than we. The new orchid-flowered or **Spencer types are the latest**, and well worth the higher price asked. Those who have tried the true "new Spencers" will never be satisfied again with the old types.



Routledge Special
Our 1918 Collection of
7 Giant Spencers
75c Collection for 50c

We have put up, in one large, beautifully lithographed envelope, seven distinct and new **Giant "Spencers"**; each kind in a separate packet and properly marked. The seed in each packet will plant a row 3 to 4 feet or a total of 20 to 30 feet. With good care and cultivation these will produce **thousands of blooms** which you can pick in separate shades; an ideal way for special effect.

This collection contains our leaflet "**How to Grow Prize Sweet Peas**," and one full-sized packet of the following distinct and popular colors:

- White Spencer**—A large, pure white.
- Primrose Spencer**—Cream or primrose.
- Mrs. Henry Bell**—A rich cream pink.
- Maud Holmes**—Large crimson scarlet.
- Asta Ohn**—A beautiful lavender.
- Mrs. A. Ireland**—Large, wavy, pure pink.
- Helen Lewis**—Orange-rose, free flowering.

Note.—For full description see classification under "Separate Colors," pages 69 and 70.

Add 15c Extra or 65c in all and we will include a 25c packet (1 oz.) of R. R. Superb Spencer Mixture. (Described below.)

Use "**MULFORD'S CULTURE**" for Sweet Peas, 25c and 50c sizes. (See page 37.)

R. R.'s Superb Mixture of Giant Spencer Sweet Peas

This is our own special mixture and is composed only of the best giant orchid-flowering wavy Spencer varieties, also contains some new seedlings of promising merit, that have not as yet been named. For healthy, robust growth, wealth of blooms, size of flowers and exquisite and rare colorings, this mixture is unequalled.

Put up and for sale in sealed packages only, 1/2-oz. pkts., 15c; oz. pkts., 25c each; 3 for 60c; 6 for \$1.00.

SCABIOSA—Morning Bride

Elegant, hardy annual; fine for cutting and bedding; flowers quite large and very showy, blooming freely during summer and autumn; 2 1/2 feet. All colors.

Finest Mixed. Pkt. 5c; 1/4-oz. 25c
White.—Large flowers. Pkt. 5c; 1/4-oz. 25c

SHAMROCK—True Irish

This is the genuine Shamrock, and is gathered by a connoisseur on the native land. Pkt. 25c

SNAPDRAGON.—(See Antirrhinum, pg. 51.)

THUNBERGIA

Extremely pretty yellow flowers with dark eye; rapid-growing annual trailers; used largely for vases, window boxes, etc; will flower all summer till frost; 5 feet.
Finest Mixed. Pkt. 5c; 1/4-oz. 30c

TRITOMA—Red Hot Poker

Striking and exceedingly ornamental autumn flowering plant. Showy flower spikes, shaded red and yellow; 3 feet. (See cut and plants, page 83. Pkt. 10c

VALERIANA—Garden Heliotrope

A fine old-fashioned hardy plant; flowers have a strong heliotrope odor; showy, red or white; fine for bouquets; 2 feet.
Mixed. Pkt. 5c

OUR LEAFLET, "How to Raise Flowers Successfully from Seed," is free and is **OF REAL VALUE.**

Verbena

One of the finest annual bedding plants and also suitable for borders, baskets and window boxes; its heads of brilliant-colored flowers produce one mass of bloom throughout the summer. (See cut.)

NEW GIANT.—The most beautiful and remarkable variety yet introduced.

Hybrida Mixed. Pkt. 20c

MAMMOTH.—A carefully selected and improved strain. The trusses and individual flowers are of the largest size, of brilliant colors; free blooming and of vigorous habit.

Mammoth White, Scarlet, Rose, Purple or Mixed. Pkt. 10c; ¼-oz. 50c

FINE MIXED.—A choice mixture of large flowering sorts. Pkt. 5c; ¼-oz. 25c

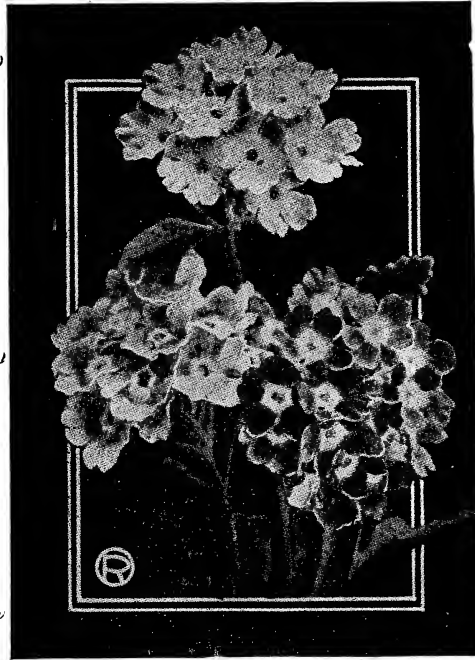

Verbena.

WILD CUCUMBER.—(See Echinocystis, page 57.)

WALLFLOWER

Very highly prized, old-fashioned plants, grown largely for their fragrance; half-hardy perennial varieties; 1½ feet.

Single Finest Mixed. Pkt. 5c

Double Tall Branching, Finest Mixed.—Fragrant; 3 feet. Pkt. 10c

Zinnia—Youth and Old Age

The plants come quickly from seed and make a fine display in a bed or border. Each flower lasts for several weeks, and the plants bloom abundantly until destroyed by frost; 2½ and 3 feet; annual.

MAMMOTH.—White, Golden, Yellow, Scarlet or Flesh; 3 feet. Pkt. 15c; ¼-oz. 50c

ROBUSTA GRANDIFLORA.—A very choice selection of the largest showy varieties. **Double Mixed.** Pkt. 15c; ¼-oz. 40c

Tall Giant, Double Mixed.—Elegant strain, comprising all colors; 3 feet. Pkt. 10c; ¼-oz. 25c

Dwarf Double Mixed. Pkt. 5c; ¼-oz. 25c



Zinnia.

Wild Flower Garden—Mixture

This is a mixture of easy growing, hardy annual and perennial flower seeds, embracing a wide range of different kinds and colors. Very desirable for sowing broadcast along walks, shrubbery, path-ways, roadways or in the garden. With little or no care they will produce a bright effect and furnish an abundance of flowers for cutting. If you wish to get the largest returns plant in a prepared bed and when the plants are a few inches high, transplant here and there or wherever wanted. You will derive a great amount of pleasure from watching the development of the flowers from the unknown plants.

Prices—Well filled Pkts., 10c; oz. 35c.



Can you think of anything nicer than an abundance of flowers for yourself and your friends who have no grounds? See our Special Sweet Pea Collections, pages 68 to 71.

FLOWERING PLANT COLLECTIONS

On this and the two following pages we offer plant collections grown especially for our out-of-town customers. All orders for these plants are sent direct to the greenhouse where they are gathered, packed and wrapped with special care so they will travel in safety by parcel post. Every plant is carefully labeled.

Twelve Grand Single Geraniums

Price 10c each; set of 12 varieties, \$1.00 postpaid.

Albion.—Beautiful free flowering white variety as pure in color as driven snow. Always in bloom.

C. W. Ward.—Rich salmon shaded to orange. Large trusses on strong stalks. Magnificent zoned foliage.



Eugene Sue.—A rare shade of russet orange, the nearest to a yellow geranium.

Jacquerie.—Rich, vivid crimson; immense trusses. Excellent for bedding; blooms freely, stands the sun well.

Mad Chapotan.—Beautiful pink upper petals, marked with white; very pretty.

Madame Mosnay.—Peculiar shade of carmine lake shaded to violet and white.

Maxine Kavolenski.—Odd shade of orange red, very distinctive, splendid bedder, vigorous, handsome, a dependable sort.

Mildred Rival.—Pure rose-pink, with conspicuous white blotch on two upper petals; flower beautifully formed, and the largest of its color.

Mrs. E. G. Hill.—Very large trusses; color, clear salmon, with a white center; one of the finest varieties.

Mrs. A. Blanc.—Silver salmon, shaded peach; glistening texture.

Mme. Cibiel.—Light salmon flesh color bordered orange. Grand trusses of very large florets.

Nuit Poitevine.—Fine, large flowers, lower petals rich violet, bordered with scarlet, upper petals orange scarlet, very distinct.

Twelve Grand Double Geraniums

Price 10c each; set of 12 varieties, \$1.00 postpaid.

Abbie Schaefer.—Beautifully formed flowers of a rich crimson scarlet of velvety texture. A grand sort.

Alphonse Ricard.—Rich velvety scarlet, extra large and brilliant.

Edmond Blanc.—Deep carmine red tinged

Madame Charrotte.—Rosy salmon shaded and reticulated with white; very distinct.

Madame Landry.—Rich bright apricot, shaded with orange, very large trusses. One of the best.

Madame Becamier.—Ivory white flowers in very large trusses. Strong, healthy grower.

Marquis de Castellane.—Rich solferino color. Immense trusses on strong stalks. Robust grower and very free blooming.

Mrs. Gladstone.—Snow-white shaded to flesh pink in center; superb fancy sort.

Mrs. Lawrence.—Lovely satiny pink shaded to white. Its delicate color is delightful. A grand bedding variety.

S. A. Nutt.—The best of the rich, dark crimson varieties; very popular.

Lady Washington Collection English Show Pelargoniums

These are commonly known as Lady Washington Geraniums. Like geraniums they flower during the summer months and are very ornamental either as house or bedding plants. Price, 20c each; set of 6 sorts, \$1.00.

Countess.—Very large flowers of a distinct shade of cerise salmon color; upper petals splashed with maroon.

Crimson King.—Superb dark colored variety. Flowers rich crimson, blotched and feathered maroon. Very free flowering and easy growing.

Easter Greeting.—A new free blooming variety of the greatest merit. Flowers amaranth red with a well outlined maroon blotch on each petal. Blooms very large and in good sized trusses.

Mabel.—Delicate light pink, upper petals feathered and blotched maroon. Elegantly fringed flowers of great substance.

Madam Vibert.—Of very sturdy growth, bushy habit and free blooming. Flowers bright red, blotched black and maroon and edged with light pink and white. One of the most admired.

Fair Maid.—Delicate light pink shaded to white, with maroon blotch and crimson markings on upper petals. One of our finest sorts.

USE "WONDER"—The best Fertilizer and plant food known. A teaspoonful to a plant does wonders. See page 38.

Ever-Blooming Carnations

For beauty, fragrance and abundance of flowers, for its hardiness, easy culture and adaptability to outdoor or indoor cultivation, no plant excels the ever-blooming Carnation, or, as so frequently called, the Pink; rivaling the Rose in beauty of colors and shades, equalling in perfume and even excelling it in profusion of flowers.

Gorgeous Collection Giant Carnations

Price, 20c each; set of 7 sorts, \$1.00 postpaid.

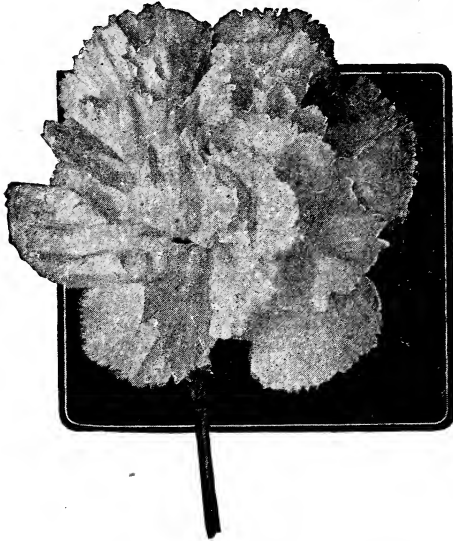

Alice Coombes.—Flowers large, round and full; color a delicate flesh pink, with a very strong clove fragrance; has excellent keeping qualities.

Bella Washburn.—Flowers large, with finely fringed petals. Strong stems holding the flowers erect. Color, rich dazzling scarlet. A true ever-bloomer.

Gorgeous.—A giant among Carnations. Flowers finely fringed, of elegant form with high center. Color, rich ruby-carmine shaded to velvety scarlet.

Matchless.—A wonderful new white. Large massive flowers on strong upright stems. Sweetly perfumed.

Pink Sensation.—Very free flowering. Flowers very large. Color, soft medium rose-pink, of a delicate and pretty shade.

Princess Dagmar.—The largest and best of its color, a bright dazzling crimson. Always in bloom.

Yellowstone.—Vigorous growing, free flowering. Color canary yellow, lightly splashed with pink. A gem among fancy carnations.

Enchantress Collection Everblooming Carnations

Price, 15c each; 12 for \$1.25 postpaid.

Alice.—Delicate flesh pink, very sweet.

Bonora.—White flaked with scarlet.

Beacon.—A brilliant, deep scarlet.

Enchantress.—A superb flesh pink.

Herald.—Large, bright scarlet, fringed.

Lady Bountiful.—Pearly white; fringed.

May Day.—Soft pink with silvery sheen.

Mrs. C. W. Ward.—Bright, glistening pink.

Pocahontas.—Bright, rich crimson.

Philadelphia.—Rose-pink; fragrant.

Victory.—Best intense scarlet.

White Enchantress.—A beautiful white.

Bonanza, Ore.

Nampa, Idaho, Feb. 10, 1917.

Routledge Seed & Floral Co.,

Gentlemen: Received my plants, they are

just fine. Am sending an order for more.

Yours respectfully,

MRS. L. A. CROMWELL.

Routledge Seed & Floral Co.,

Gentlemen: Thanks for such a fine Pelargonium Easter Greeting. Will buy of you always

for you have treated me fine. Will send in a

few days a big order.

MRS. RAY FREUER.

Beautiful Flowering Begonias

10c each, full collection of 6 for 50c postpaid.

Probably the most satisfactory class of plants for house culture obtainable. Of easiest possible culture, their waxy flowers produced in much profusion together with their handsome foliage make them most desirable subjects for the window garden.

Argentea Guttata.—Handsome erect growing sort, with pointed wine-colored leaves with silvery white spots. Pure white flowers.

Bertha Chaterscher.—The freest-flowering Begonia we have; glossy green leaves and bright scarlet flowers.

Gloire de Chatelaine.—Glossy ovate green leaves, covered the year around with beautiful pink flowers, a fine window plant.

Marguerite.—Bronzy green, with purple cast; large trusses of cream and rose-colored flowers.

Marjorie Daw.—A strong growing variety of slender habit with glossy green foliage and producing large racemes of salmon pink flowers, drooping gracefully about the plant.

President Carnot.—Strong growing, large leaved sort, with pendulous clusters of deep pink flowers during a large part of the year.

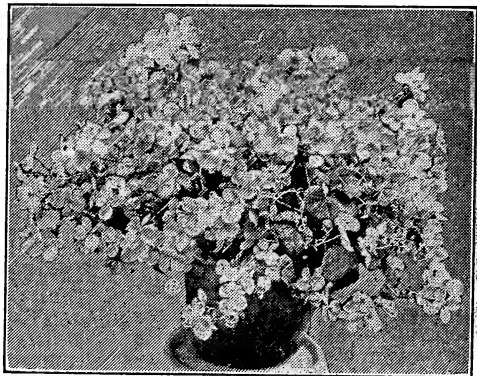

Begonia—Gloire de Chatelaine.

NEW—Chinese Wool Flower, page 54 and Nemesia, page 62. Plants in season, 10c each, 75c Doz., postpaid. THESE ARE NEW AND VERY SHOWY.

Queen Collection Japanese Chrysanthemums

Price, 15c each; sets of 10 sorts, \$1.00 postpaid.

Artistic Queen—Fine exhibition variety. Extra large blooms, loosely incurved, very strong stem. Color, rose-pink, very fresh and beautiful.

George Bruzzard—A beautifully shaped bloom; bronzy red in color with reverse side of petals old gold.

Golden Eagle—Large in size perfect in form and a superb golden yellow in color.

Harvard—Produces a good medium sized bloom of the darkest shade of crimson.

Kitty Lawrence—Lovely shades of cream and fawn. Large, very gracefully formed flowers, with irregular tubular petals of fine substance.

Naomah—Incurved white. Petals broad and incurving. Flowers of excellent substance.

Chieftain—A beautiful broad-petaled, incurving variety, round and ruffled; one of the prettiest forms.

Ramapo—An excellent variety. The heavy golden yellow, richly colored.

Mancato—An enormous exhibition variety with perfectly double flowers. Color, rosy purple.

William Turner—Pure white in color. It is enormous in diameter, deep in build and very perfect in form.



"Incurved" Chrysanthemum

Countess Collection New English Garden Chrysanthemums

To those persons who have planted the late flowering sorts and failed to get them into bloom before frost, these new imported sorts will appeal. All will flower readily in the garden during September and October, and while the flowers will not be as large as the late sorts their freedom of bloom will make up for anything that may be lacking in that respect.

Price, 15c each; full collection of 10 sorts, \$1.25.

Carrie.—Bright golden yellow flowers in great profusion during September. Dwarf habit.

Cranford Pink.—Lovely silvery pink flowers of fine size, nicely incurved and very lasting. Fine for cut flowers.

Countess of Cariel.—A very free flowering sort of dwarf habit. Color, terra cotta and bronze. Rich and handsome.

Glory of Seven Oaks.—Deep golden yellow, very free flowering. Excellent dwarf habit.

Groachers Crimson.—Large handsome flowers of a rich shade of crimson. Blooms very early.

Leslie.—Light canary yellow. Covered with its pretty flowers early in the fall.

Mignon.—Rosy pink, shaded silvery. Strong vigorous grower and very free.

Nina Blick.—Rich golden bronze shaded to yellow. Dwarf spreading habit and free flowering.

Normandie.—Delicate shell pink flowers of wax-like texture. Fine for cut flowers. One of the best of this type.

Queen of Whites.—Snowy white flowers cover the plant early in the fall. A gem in the garden.

Beauty Collection Choice Fuchsias

Beautiful, graceful, free flowering, easily grown, plants for window porch or yard decoration.

Price, 10c each; set of six sorts, 50c.

Annie Earle—Tube and sepals waxy white, corolla single, clear carmine; plant splendid and free blooming.

Dr. Brooks—Rich, dark blue corolla, with crimson sepals. A beautiful single variety, never out of bloom.

General Roberts—Flowers very large, corolla plum color, tube and sepals crimson; one of the finest double varieties.

Little Beauty—A dwarf growing double variety, producing with great freedom small flowers of great beauty. Purple corolla with scarlet sepals. A little gem.

Molesworth—Superb double white variety; tube and sepals bright scarlet; corolla large, double and waxy white.

Sylvia—Calyx scarlet. Corolla giant in size and pure white in color. Beautifully formed single flowers.

Rex Begonias

Grown for the beauty of the foliage. The leaves are large, variegated and margined with a peculiar silver-metallic gloss. The most ornamental of window plants; also useful in vases and baskets.

20c each; 3 sorts for 50c



Fuchsia Plant

NEW CANNAS—You ought to try our new Cannas **FIREFLY** and **CITY OF PORTLAND**. See descriptions, page 85.

BEAUTIFUL FERNS

A home, no matter how lavishly furnished, is not complete without decorative plants and palms.

The bold, majestic palms and delicate, feathery foliage of the ferns lend a grandeur and magnificence that cannot be obtained in any other way.

OSTRICH PLUME (See cut)—The fronds of this popular variety are the most delicate and plume-like. They are beautiful, full and fluffy, well-grown plants; are truly magnificent and last well in the house. Choice plants, 20c to 35c, post paid; specimen plants in pots, \$1.00 to \$2.00; extra large, \$2.50 to \$3.50.

BOSTON FERN—One of the most beautiful and useful of house plants. It is of easy culture, and its sword-like fronds, in large specimens, attain a length of 3 to 4 feet, produced in a bewildering mass, arching, curving and interlacing in every conceivable direction. Choice plants, 20c to 35c, post paid; specimen plants in pots, 75c to \$1.00; \$1.50 and up to \$2.50.

ASPARAGUS SPRENGERI (Emerald Feather) (See cut No. 1)—This is undoubtedly one of the handsomest and most valuable evergreen trailing plants for the house and conservatory ever introduced. It is especially valuable for pots, vases, baskets, etc., covering all with its beautiful sprays of lovely green, feathery foliage; quite hardy and valuable for hanging baskets or porch boxes in summer if given partial shade and plenty of water. Choice plants, 20c to 30c, post paid; specimen plants in pots, 35c to 75c; extra large pots or baskets, \$1.50 to \$2.50.

ASPARAGUS PLUMOSUS (Climbing Lace Fern) (See cut No. 3)—A finer and more delicate plant than the Sprengeri, but hardy and easily grown. Very satisfactory for window and house culture. An extremely graceful window climber, bright green, feathery foliage, as fine as the finest silk or lace. Choice plants, 20c to 30c, post paid; specimen plants in pots, 25c to 75c.

MAIDEN HAIR FERN (*Adiantum Cuneatum*)—A very beautiful and graceful fern. Small plants, 20c, post paid; choice plants in pots, 35c and \$1.00 each.

Filled Fern Dishes

These are pretty, popular, fashionable and very desirable for center pieces for the tea or dinner table or as ornamental plants on the sideboard or center tables.

A choice collection of plants in pretty matt green dishes, \$1.50 to \$2.00. In fancy dishes, \$2.00 to \$3.50. (See cut No. 2.)

NOTE—Must go by express; cannot be mailed.



Fancy Fern Dish Filled

Beautiful Small Ferns

These handsome little ferns are used mostly in filling fern dishes, your choice of the following 20c each; 3 for 50c, post paid.

Aspidium Tsussimense — Without question the most valuable of all ferns yet introduced for fern dishes; of strong but dwarf and graceful habit.

Crytomium Falcatum (The Holly-Leaved Fern.)—One of the most desirable, very hardy and pretty.

Pteris Argyrea (Silver Fern)—A very showy fern, with variegated foliage.

Pteris Wilsoni—A very pretty and useful fern; green leaves with the ends very peculiarly crested; beautiful sort for fern dishes.



No. 1, *Asparagus Sprengeri*. No. 2, Filled Fern Dish. No. 3, *Asparagus Plumosus*.

Specimen Plants—These are large, choice, well-shaped plants, growing in pots, and are very beautiful. They cannot be mailed. We wrap and pack carefully and ship by express. Read what we do about prepaying charges—Inside front cover.

PALMS AND DECORATIVE POT PLANTS

Every one knows how beautiful palms and decorative plants are, and how much they improve the parlor, hall or dining room. We offer here only the best and most desirable kinds of the easiest culture, but we can supply rare tender specimens if wanted.

Note.—Plants in pots cannot be mailed. Read about prepaying, inside front cover.

ARAUCARIA EXCELSIA (Norfolk Island Pine)

This beautiful plant resembles the pine somewhat in appearance, though much finer in texture; it is particularly adapted to parlor table decoration. It is most unique in appearance, the branches being arranged in neat, symmetrical whorls. They do not require much sun, and are hardy and easily cared for. (See cut No. 5.) **Choice plants in pots, 15 to 18 in., \$2.00; 18 to 24 in. and up, \$2.50 to \$4.00.** **Note.**—No smaller sizes this year.



No. 4, Aspidistra. 5, Araucaria Excelsior. 6, Kentia Palm.

KENTIA (See cut No. 6) — A beautiful, graceful, handsome-looking, strong-growing palm, with deep green, crisp foliage; inclined to dwarf and spreading habit. One of the most popular for house culture, as they are very hardy, and stand the dry atmosphere. If we could have but one palm, it would be a Kentia. (See cut.) **Small plants, 12 to 15 in., 75c to \$1.00, postpaid. Choice plants in pots, 18 to 24 in., \$1.50 to \$2.00; specimen plants, \$5.00 to \$25.00.**

ASPIDISTRA (See cut No. 4)—Stately decorative house plant of rapid and hardy growth. The leaves grow quickly from the ground to a height of 18 inches or more. Will stand more gas, dust, cold and heat than any other palm we know of. We have both green and variegated green and white. **Green or Variegated Leaves, fine specimens, in pots, \$1.50 to \$3.00 and up.**

PHOENIX BOEHELENI (See cut No. 7)—A new palm. One of the most graceful and the hardiest. The horticultural world has enthused over this beautiful palm. It has

the grace and lightness of Cocos Weddelliana, but is more robust in growth and has ten-fold the foliage of that fine variety. Foliage from the ground up, gracefully recurved and spreading in habit. It will be most popular for house decoration. **Choice plants in pots, \$1.00 to \$2.00; specimens, \$2.50 to \$4.00.**

RUBBER PLANT (*Picus Elastica*) (See cut No. 8)—This is certainly one of the best plants grown for decorative purposes. It succeeds well with ordinary treatment. Its glossy, thick, dark-green leaves are not affected by dust or gas.

Choice plants in pots, 12 to 18 in., \$1.00; 18 to 24 in., \$2.00 to \$2.50.

DRACAENA INDIVISA (Fountain Plant)—This plant is unsurpassed for hardiness. Leaves graceful, long, narrow and pointed, used extensively for centers in pots, boxes or urns with other plants. Perfectly hardy outside in summer.

Nice plants, 12 to 15 in., 35c to 50c, postpaid; 18 to 24 in., in pots, \$1.00 to \$1.50.



No. 7, Phoenix. 8, Rubber Plant. 9, Cocos Palm.

COCOS WEDDELIANA

(See cut No. 9) — The most elegant and graceful of all the smaller palms. Its slender, erect stem is freely furnished with its graceful arching leaves of rich green color. Small plants are very desirable for centers in fern dishes. **Choice plants, 12 in., 50c to 75c, postpaid.**

Jardinieres, Etc.—We have a full line of standard and new styles **Jardinieres, Pots, Japan Tubs, Etc.**

CANARY BIRDS

Did you ever hear an imported Hartz Mountain Canary Sing? They are the sweetest singers on earth. See page 153.

General Price List of Annual Bedding Plants



During April, May and June we have thousands of flowering and ornamental annual plants. No order too large or too small. Write for 100 prices if interested.

REMEMBER, we are not offering you little seedling plants, pulled from the seed beds. Our plants are strong, healthy, transplanted plants from flats or pots raised from our **HIGHEST QUALITY SEED** or propagating plants of **SUPERIOR MERIT**.

For descriptions see Flower Seed Department of this catalog.

Agerantum —	Each.	Doz.			
Blue, white or mixed, T.....	.05	.50			
Alyssum —					
Sweet, T05	.50			
Aster —					
Giant Crego, white, pink, purple or mixed, T35			
Other varieties, T25			
Candytuft —					
Mixed or white, T05	.50			
Carnation —					
White, pink, red, F or P.....	.10	.75			
Named varieties (see page 74)					
Chrysanthemum —					
White, yellow, pink, F.....	.06	.60			
Named varieties (see page 75)					
Cosmos —					
Red, pink, white or mixed, T...	.05	.50			
Cobea Scandens —					
From 2-inch pots15	1.50			
From 3-inch pots20	2.00			
Coleus —					
Choice colors, 2-inch pots.....	.10	.75			
Choice colors, 3-inch pots.....	.15	1.50			
Daisy —					
Mrs. Saunders, new, 2-inch pots	.15	1.50			
Mrs. Saunders, new, 3-inch pots	.25	2.50			
Dracena Palm (Fountain Plant), (see catalog sizes, page 77). up to \$1.50.)					
Geraniums —					
Single, choice named varieties in red, salmon pink, deep pink, light pink or white.					
Double, choice named varieties, dark red, bright red, salmon pink, double white or ivy leaved trailing, pink or red.					
From 2-inch pots10	1.00			
From 3-inch pots15	1.50			
From 4-inch pots25	2.50			
From 5-inch pots35	3.75			
Pelegonium (Lady Washington)					
From 2-inch pots15	1.50			
From 3-inch pots25	2.50			
From 4 and 5-inch pots, specimens in bloom50	.75			
German Ivy —					
Trailing, 2-inch pots10	1.00			
Trailing, 3-inch pots15	1.50			
Heliotrope —					
Blue, T07	.60			
Blue, 2-inch pots10	1.00			
Blue, 3-inch pots15	1.50			
Blue, 4-inch pots20	2.25			
Lobelia —					
Compacta or Trailing, T (\$3.00 100)05	.40			
2-inch pots, blooming08	.75			
3-inch pots, full bloom.....	.15	1.50			
Mignonette —					
Sweet, T05	.60			
Sweet, 2-inch pots10	1.00			
Myosotis —See page 81.					
Pansy —					
Choice plants not in bloom, postpaid60	
12 in a basket, Steel's Mastodons in full bloom, by express only, charges collect75	to 1.00	
Petunias —					
Irvington Beauty, new pink...	.15	1.50			
Single Ruffled Giants, all colors mixed or choice Double Kinds, all colors, mixed.					
From 2-inch pots10	1.00			
From 3-inch pots20	2.00			
From 4-inch pots25	2.50			
Ordinary Single Mixed, T.....	.08	.60			
Double Mixed, T08	.60			
Phlox —					
Drummond, T05	.60			
Salvia (Scarlet Sage)—					
Splendens, T06	.60			
Zurich, a Fireball, new dwarf, T	.07	.75			
2-inch pots10	1.00			
3-inch pots15	1.50			
4-inch pots25	2.50			
Stocks —					
Fine Mixed Colors, T.....	.05	.60			
Verbena —					
Fine Mixed, T06	.60			
From 2-inch pots10	1.00			
Vinca —					
Variegated, from small pots...	.10	1.00			
Variegated, from large pots...	.20	2.00			
Plant Boxes.					
If you have boxes that are filled with dirt we can furnish Fertilizer and Plants, and plant at 60c to \$1.00 per foot, according to kind and size of plants.					
Japanese Kegs.					
Filled with large flowering plants and vines.					
Size 13-in. \$3.00 to \$5.00 with Dracaena center					
Size 13-in. 2.50 to 3.50 with Daisy center					
Hanging Baskets.					
Filled with large flowering plants and vines.					
Size 10-in. \$2.00 to \$2.25 (Cannot be shipped safely)					
Size 12-in. 2.50 to 3.00					

Note.—“P” stands for plants from pots; “T” transplanted plants from boxes.

NOTE.—If you add 10c per dozen we will prepay charges on above except on plants from pots (3 inches or over), which cannot be mailed safely and must go by express. No plants sent C. O. D. Write for prices on other varieties wanted.

HARDY PERENNIAL FLOWERING PLANTS

No class of plants enjoy greater popularity at the present time than the Hardy Perennials. They have made rapid strides into public favor the past few years, until now they may be considered to have a prominent and a permanent place in our American gardens. Beginning almost before the snow is off the ground, early-flowering varieties open their blossoms, as welcome harbingers of spring. Almost every week until late in the fall some new variety bursts forth into entrancing loveliness, blooming so persistently as to almost defy Jack Frost in his efforts to subdue the floral kingdom. A start may be obtained at so small an expenditure as not to be counted when measured with the satisfaction and pleasure derived from them. Once planted they require very little care, increasing in size of plant and profusion of bloom from year to year. Most varieties can be taken up, divided and reset every third or fourth year.

LARGE STOCKS—LOW PRICES.—We are in a position to supply unlimited quantities at special prices and you will find our plants are strong and well rooted. Limited space will not permit us to list all varieties we can supply. **Ask for any special varieties wanted.**

PRICES—Unless otherwise priced, all varieties 15c each, \$1.50 doz. prepaid. **BY REQUEST** we will send extra large clumps if you will pay express or freight charges.

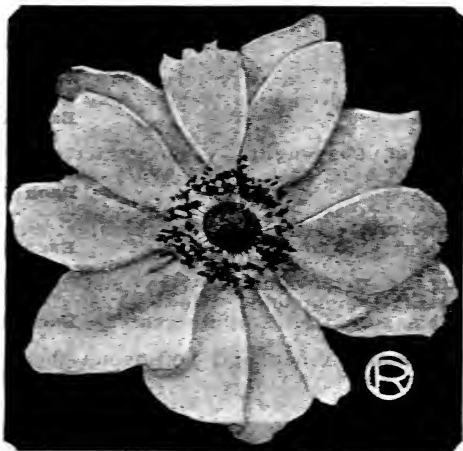

Anemone.

Anemone

JAPANESE.—These beautiful Windflowers are one of the most important hardy plants. They begin blooming early in August and continue in full beauty until cut down by hard frost. Excellent for bouquets, lasting for days when cut. 2½ to 3 feet.

PRICES, YOUR CHOICE, FOLLOWING 3 KINDS, EACH 20c; 3 FOR 50c.

Prince Henry.—Rich pink, semi-double.

Whirlwind.—Pure white, semi-double.

Rubra Superba.—Rosy red.

NEW GIANT FLOWERED VARIETIES.
25c EACH, 4 FOR 85c, DOZ. \$2.25.

Gaente Blance.—Very large, robust, pure white.

Queen Charlotte.—Silvery pink, very large, semi-double; very choice.

Kriemhilde.—Semi-double, 4 inch flowers, petals long, narrow and closely set. Beautiful rose pink.

Alice.—Silvery rose, shaded carmine. Quite full, very beautiful.

Alyssum

Gold Dust (Saxatile Compactum).—Large heads of golden yellow flowers in May and June; silvery foliage; fine for rockeries; 6 inches.

Arabis

ROCK CRESS.—One of the most desirable of the very early spring flowering plants for edging and the rock garden. Forms a dense carpet, completely covered with pure white flowers. 6 inches.
Single, each 15c, doz. \$1.50; Double, each 25c.

Aquilegias

COLUMBINES.—The Columbines are one of the most elegant and beautiful of hardy plants, producing their graceful spurred flowers on stems rising two feet or more above the beautifully divided foliage, and are highly prized for cutting; June to September.

Mixed colors, each 15c, doz. \$1.50
SEPARATE COLORS (about 90 per cent true). Violet Blue, Golden Yellow, White or Rose Pink. Each, 20c; doz. \$2.00

Bellis Perennis

English Daisy.—Popular early flowering plants.

Double Red or White. Each 10c; doz. \$1.00

Giganteum.—Improved, double, large flowering; flowers extra fine; 2 inches across.

Double White or Pink. Each 20c; doz. \$2.00

Coreopsis

LANCEOLATA GRANDIFLORA.—Popular hardy plants. The flowers are a rich golden yellow, of graceful form and invaluable for cutting; the main crop comes during the latter part of June, but it continues in bloom the entire summer and autumn; it succeeds everywhere; 1½ feet. (See cut.)

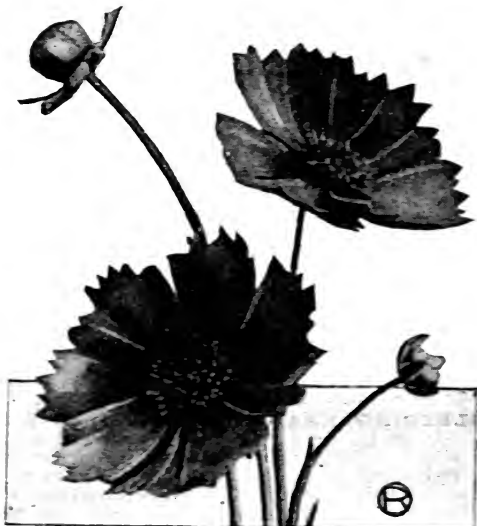

Coreopsis.

NOTE.—15c plants are \$1.50 doz.; 20c, \$2.00 doz.; 25c, \$2.50 doz., etc.

Hardy Perennial Flowering Plants—Continued

PRICES—Unless otherwise priced, all varieties 15c each, \$1.50 doz. prepaid. **BY REQUEST** we will send extra large clumps if you will pay express or freight charges.



Canterbury Bells—Calycanthemum

Canterbury Bells

CAMPANULAS—or Bellflowers.—One of the most popular hardy garden plants on account of the beautiful clusters of long-stemmed, dainty yet large flowers. They are very showy. The "Calycanthemum" are only "biennials."

Persicifolia (Peach Bells).—Large clusters of drooping bell shaped flowers during June and July; 3 feet.

Blue or White. Each 20c

P. Gigantea Moerheimi.—A grand sort with long stems of pure white double camellia-like flowers, 2 to 2½ inches in diameter; in bloom from the middle of May until late in July; 2 to 3 feet.

Each 25c

Calycanthemum (Cup and Saucer Canterbury Bells).—A beautiful form of this favorite flower. (See cut.)

Blue, Rose or White. Each 20c
Mixed, all colors. Each 15c

Chrysanthemums

They produce a lavish profusion of blooms after most flowers are gone; very popular.

Hardy Pompon.—"Button" or small flowers. Yellow, Bronze, Pink or White. Each 15c

Old Fashioned Large Flowered.—Perfectly hardy, same colors as above. Each 15c

DAISY.—See "Bellis," page 79, for English, also page 83 for Shasta Daisy.

Dicentra

BLEEDING HEART.—An old-fashioned favorite; its long racemes of graceful heart-shaped pink flowers are always attractive. Perfectly at home in any part of the hardy border, and especially valuable for planting in the shade. (See cut next page.)

Spectabilis. Each 35c

DAY LILY.—See Hemerocallis.

Delphinium

HARDY LARKSPUR.—These are deservedly one of the most popular subjects in the hardy border, bold, attractive and highly prepossessing plants of easiest culture; perfectly hardy; 3 to 4 feet. Fine for cut flowers, June to October. (See cut.)

Hybrids all shades. Each 15c; doz. \$1.50

CHOICE NAMED VARIETIES

Full Collection the following 6 kinds \$1.25

Belladonna.—A free and continuous bloomer; flowers clear turquoise blue; very beautiful. Each 20c; doz. \$2.00

Carmen.—Flowers very large and semi-double; of a deep blue; center rosy plum. Each 25c

Duke of Connaught.—Very attractive, rich oxford blue, with a bold white eye. Each 25c

Formosum.—Dark blue, white center; an old favorite; 3 to 4 feet high. Each 25c

King of Delphiniums.—New and distinct; giant, semi-double flowers on strong stems; deep blue, white center. Each 25c

Moerheimi.—A new and continuous bloomer; pure white. Each 35c

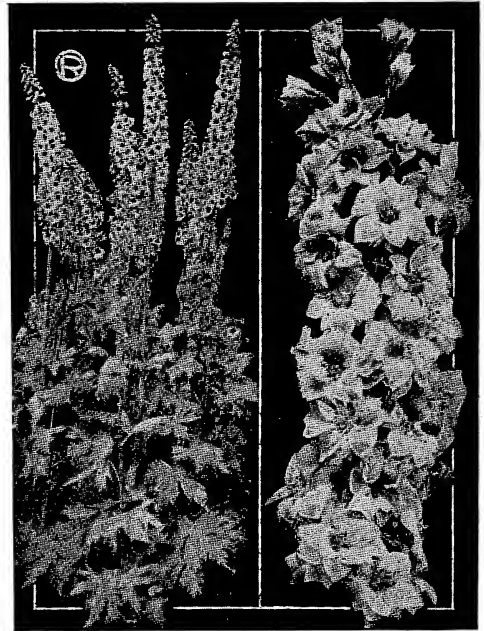

Delphinium (Plant and Flower Spike.)

Digitalis

FOXGLOVE.—Old-fashioned, hardy, desirable plants with broad foliage and showy flowers borne on spikes. June and July; 3 to 4 feet. Mixed colors.

Montrosa (Giant Foxglove).—Handsome, variously colored flowers in spikes surmounted with one large, saucer-shaped terminal flower. Mixed. Each 25c



Dicentra—Bleeding Heart

Doronicum

LEOPARDS BANE.—One of the most effective early flowering perennials. Very large, rich yellow single flowers with long stems during May, June and July; 2 feet. Often called Yellow Marguerite.

Gaillardia

BLANKET FLOWER.—One of the showiest hardy plants, growing about 2 feet high and succeeding in any soil in a sunny position; beginning to flower in June, they continue the entire season. The large flowers are of gorgeous coloring. The center is dark-red brown, while the petals are marked with rings of brilliant crimson, orange and vermilion, and often a combination of all in one flower; excellent for cutting.

Grandiflora. Each 15c; doz. \$1.50

Gypsophila

Baby's Breath.—Fine, delicate foliage. Minute white flowers borne in enormous quantity in open panicles during summer months. Be sure and have a few plants of this for cutting, as it works up beautifully in bouquets of other flowers; 3 to 4 feet. **Paniculata.** Each, small roots, 15c; large, 20c.

Paniculata FL. PL.—New; delicate double white flowers; very pretty. Each 25c

Hollyhocks

Few hardy plants combine as many good qualities as the Hollyhock. For planting in rows or groups on the lawn, or for interspersing among shrubbery they are invaluable. The flowers form perfect rosettes of the most lovely shades of color. We offer strong plants, which will flower this season. **Separate or Mixed colors.**

Hemerocallis

Day Lily.—Popular hardy plants belonging to the Lily family; they succeed anywhere; June and July; 3 feet.

Plava.—Lemon yellow, very fragrant. 15c

Fulva.—Orange or coppery red; showy; 4 feet. Each 20c

Helianthus

Hardy Sunflowers.

Multiflorus FL. PL.—Large, double, golden-yellow flowers in great profusion during July and August; 4 feet.

Sparsifolius.—Gracefully formed single variety, large, deep yellow color, long stems; splendid for cutting; August to September; 6 feet.

Hypericum

St. John's Wort.

Moserianum (Gold Flower).—Of drooping, training nature. Fine for rockeries, etc. Free flowering. Rich golden-yellow; June to frost. Each 15c; large plants 25c

Iberis

Hardy Candytuft.

Most desirable dwarf plants with evergreen foliage, which is completely hidden with dense heads of small flowers early in the spring; 8 to 10 inches.

Sempervirens.—Pure white. Each 15c

Glandulose.—Lavender blue. Each 20c

Lavender

VERA.—The true, sweet, fragrant lavender. Small plants 15c; large plants 25c to 35c each.

Myosotis

Forget-Me-Not.

Palustris.—A variety that is hardly ever out of flower; useful in a shady spot in the border.

Poppy

Nudicaule (Iceland Poppy).—The plant forms tufts of fern-like foliage, from among which the slender flower-stalks rise to about a foot in height and bear fragrant, cup-shaped flowers of white, yellow and orange-scarlet. The profusion of bloom is astonishing. June to October. **Mixed.**

Oriental.—Very large flowers; bright red with a black blotch at the base of each petal. June to July.

Oriental, Salmon Queen.—Beautiful salmon pink. Each 20c; doz. \$2.00



Iceland Poppy.

PRICES—Unless otherwise priced, all varieties 15c each, \$1.50 doz. prepaid. **BY REQUEST** we will send extra large clumps if you will pay express or freight charges.

Hardy Perennial Flowering Plants—Continued

PRICES—Unless otherwise priced, all varieties 15c each, \$1.50 doz. prepaid. **BY REQUEST** we will send extra large clumps if you will pay express or freight charges.

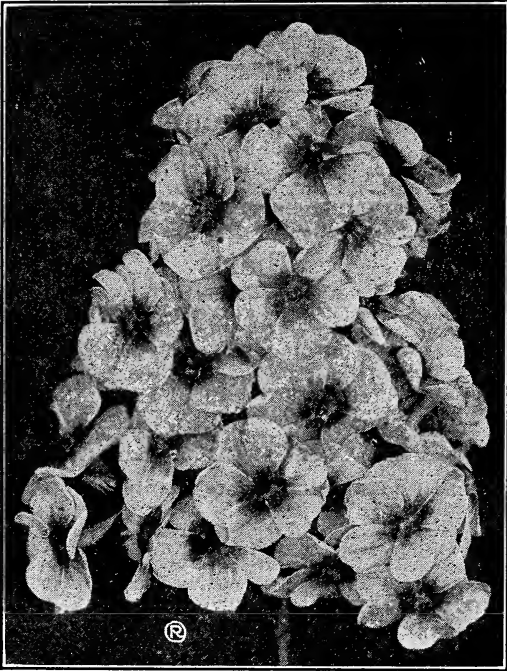

Phlox Decussata.

Pampas Grass

Gynerium Argenteum.—A noble ornamental grass, easily grown, producing long, narrow pointed leaves and majestic, silvery white plumes, which are very valuable for winter decoration. Grows 6 to 8 feet high. Young plants 25c; strong roots 35c to \$1.00; large specimen plants, \$1.50 to \$2.50 up.

Pinks

Dianthus.

Plumaris.—Bearing sweet clove-scented flowers in the greatest profusion during May and June. Indispensable for the hardy border and for cutting; 1 foot. **Finest Mixed or Double White.**

Primullus—Primrose

The hardy primroses are among the most beautiful and interesting of our early spring flowers. (See cut.)

Veris (English Cowslip).—The richest of shades, from pure yellow to the deepest crimson maroon.

Vulgarus.—Canary yellow, very early and fragrant.

Pyrethrum

PERSIAN DAISY

One of the most valuable of our early summer flowers. Charming shades of color, and wonderful lasting properties as a cut flower. They flower in May and June and frequently in August and September the second time; the colors run into almost every shade, which make them foremost of plants in this particular season.

Hybridum.—Mixed colors. **Each 20c**

Uliginosum.—Giant flowers but graceful and refined; color glistening white. August and September. **Each 25c**

Phlox

Among the hardy perennial plants no class is of more importance than the Phloxes, succeeding in almost any soil and position, and flowering through a long season. Excellent for cutting and decorating or for mass effects. Keep well in water.

Decussata Mixed. **Each 15c; doz. \$1.50**

NEW AND EXTRA SELECTED VARIETIES—Rare and rich shades and flowers of largest and best types; very choice. **Prices: Each 20c; doz. \$2.00; one plant of each variety (8), for only \$1.25 postpaid.**

Antonin Mercie.—Large panicals bluish-lilac, white halo.

Bridesmaid.—Pure white, with large pink eye.

Von Lassburg.—Splendid pure white, very large.

Vesuvius.—Pure red, with bright purple eye, a dazzling color.

Goliath.—Bright crimson, handsome, large flowers.

Mrs. Jenkins.—Immense panicals of large, white flowers. Fine for massing.

Harry Pleiderer.—Beautiful salmon pink.

Gen. Von Hentsz.—Brilliant salmon red, white eye, large.

CHOICE NAMED VARIETIES OF REAL MERIT. **Each 15c; doz. \$1.50. Special—One each in this collection of 6 for 70c postpaid.**

Mrs. Lingard.—Pure white, early and continuous bloomer.

Coquelicot.—A fine pure scarlet, crimson eye.

Champs Elysee.—Bright rose, majestic, very effective.

Eugene Danzanvillier.—Lilac shading to white. Free bloomer.

Obergartner Wittig.—Bright magenta, crimson eye, large, fine flower.

R. P. Struthers.—Bright, rosy, carmine.



Primulus.

FEED YOUR PLANTS. You must supply "food," in other words fertilizer, if you want the best results. Read about "Wonder," and C. M., pages 38-39, and ask for 20-page "Booklet."

Rudbeckia

Indispensable plants for the hardy border: grow and thrive anywhere, giving a wealth of bloom, which are well suited for cutting.

Lanceatus (Golden Glow).—Flowers beautiful golden-yellow; very double. Marvelous continuity of bloom from June till late fall; 6 to 8 feet.

Newmani.—Dark orange-yellow flowers, with deep purple cone, borne on stiff, wiry stems 3 feet high; flowers from July to September. **Each 20c**

Saxifragas

Umbrosa (London Pride).—A low-growing, spreading sort, throwing up stems a foot high of pretty pink flowers in dainty clusters. Small, dark evergreen leaves, a fine border plant or for rockeries.

Shasta Daisy

Very large daisy-like flowers, often measuring 4 to 5 inches across, having three or more rows of petals of the purest white. Flowers produced in great profusion on long strong stems. Very popular: 2 to 3 feet. **Each 15c and 20c**

Tritoma

Pfizerii (The Everblooming Flame Flower).— bloom from August to October, with spikes 3 to 4 feet high, and heads of bloom of a rich orange-scarlet, producing a grand effect either planted singly in the border or in masses. (See cut.) **Each 20c**

Veronica

Speedwell

Eupestris.—A fine rock plant, growing 3 or 4 inches high, thickly matted deep green foliage, hidden in spring under a cloud of bright blue flowers. **Each 20c**



Shasta Daisy.

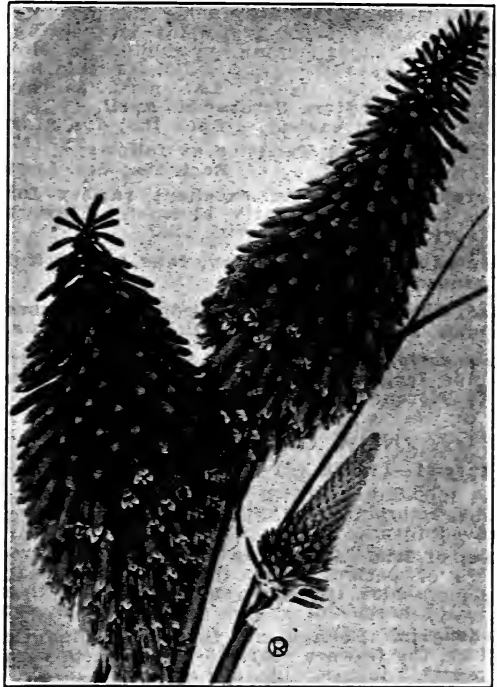

Tritoma.

Vinca

Myrtle

Trailing vine for banks or walls or carpeting the ground. **Green or golden variegated.** **Each 10c to 25c**

Violets

Princess.—Single, deep blue, long stems. Very showy and beautiful.

Each 15c; doz. \$1.50

Double Russian.—Flowers double of gigantic size; color, a very rich shade of blue, and extremely fragrant.

Each 20c; doz. \$2.00

Wallflowers

The old favorite fragrant Wallflower. **Mixed Colors.** **Each 15c; doz. \$1.50**

Canary Bird.—Golden yellow, rich and rare. **Each 20c**

Goliath.—Large free flowering, deep bronze red. **Each 20c**

Yucca

Adam's Needle.—A stately foliage and flowering plant. See illustration and description, page 106.

FEED YOUR PLANTS

If you want to get the best results, large, beautiful flowers, in great profusion, feed the plants. Use our "C-M" and Wonder; far better and cheaper than stable manure. See pages 38-39.

German Iris—Iris Germanica

The German Iris are among the most desirable and easiest grown of our spring-flowering hardy plants, producing in May their showy flowers of exquisite coloring, combining the richest and most delicate tints. **Roots from October to April.**

Mixed, good variety. Each 10c; doz. \$1.00

Choice Named Varieties as follows:

Each 15c; doz. \$1.50

Florentina Alba. An excellent variety for cutting, and an early bloomer. Flowers ivory white, tinged with lilac.

Honorable. Intense yellow, falls a beautiful bronze.

Mad. Chereau. Pure white, edged with azure blue; falls deep white with blue pencilling.

Parisensis. Uprights fine blue, falls deep blue, large and very early, fine companion to Florentina Alba.

NEW GERMAN IRIS.

Special—1 each (6) following kinds \$1.75

A splendid collection of the latest introductions, embracing not only new color, but improved forms.

King of Iris. A striking novelty, with flowers of perfect form, the standards clear lemon-color, falls deep satiny-brown, with a broad border of golden yellow. **Each 40c**

Lohengrin. Foliage and flowers of gigantic size, the flowers nearly 5 inches deep, with petals 2 inches wide, are of a deep mauve-pink. **Each 50c**

Nibelungen. Standards fawn-yellow, falls violet-blue with fawn margin; distinct and pretty. **Each 35c**

Pallida Dalmatica. A queen among flowers, grand and stately. Standards lavender; falls clear, deep lavender. Flowers large and extra fine. **Each 35c**

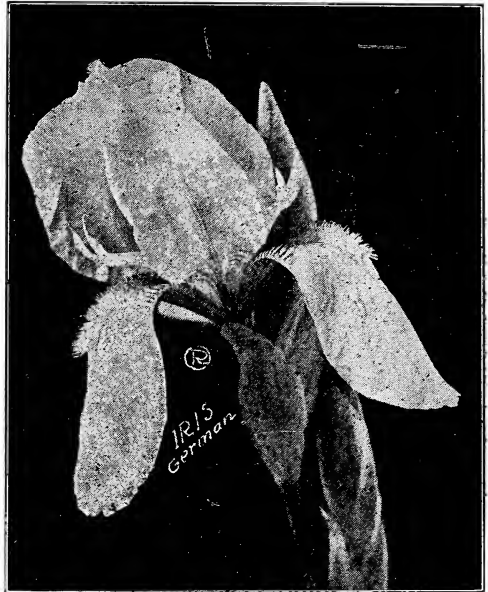

German Iris.

Princess Victoria Louise. Standards pure sulphur yellow; falls rich plum color, with cream-colored edges. A new and distinct combination of colors. **Each 35c**

Rhein Nixe. Standards pure white, falls deep violet-blue, with white margin; will attain a height of 3 feet, with many-branched stems. **Each 35c**

Japan Iris—Kaempferi

Roots from October to June.

The Japanese Iris is quite distinct from all others, and never fails to excite the admiration of all who see it. It is becoming more popular each year. The enormous flowers produced in June and July display a marvelous blending of rich and rare shades. They like a rich soil and plenty of water when in bud and flower. We offer a select collection of named varieties, as well as a very fine mixture.

Mixed, good assortment: Each 15c; doz. \$1.50

SELECT NAMED JAPAN IRIS

YOUR CHOICE, EACH 25c; DOZ. \$2.50

Haker-O-Den.—Beautiful, large, six-petaled white; yellow center.

O-Sho-Kum.—Deep blue, showing darker veins, six petals.

En-U No-Sora.—A charming pink shading to rose, veined violet, six petals.

Momiji-Ga-Take.—Deep crimson, edge of petals and veins lighter, six petals.

Gei-Sho-Ui.—Rich red, beautifully frilled, six petals.

Shi-Chu-Ka.—Creamy white shaded and edged carmine, six petals.

Kumo-Ubi.—Light blue or lavender pencilled yellow to the center.

Ho-So-Kawa.—Rich royal purple, yellow and white markings in the center, six petals.



Japan Iris.

SPANISH IRIS (Bulbs from October to March)

Separate Colors. Doz., 30c; 100, \$2.00
Superfine Mixed. Doz., 25c; 100, \$1.50

ENGLISH IRIS

Separate Colors. Each 6c; Doz. 60c
Superfine Mixed. Each 5c; Doz. 50c

For list and description of Spanish and English Iris, see our Fall Catalog.

CANNA PLANTS



City of Portland

Everyone knows the value and beauty of Cannas for bedding. Their large, massive, tropical looking leaves and magnificent flowers can not be equalled in any other plant, of such easy culture. Plant in May or June, 18 inches apart in the richest bed you can give them (18 plants required for a 7-foot circular bed).

While there are many varieties of Cannas, we offer only 6 kinds, but they can be depended upon to be the most showy and desirable and especially adapted to Western conditions.

PRICES—Plants in season 20c each, \$2.00 per doz. Large plants from 4-inch pots, 25c each, \$2.50 per doz. **Except Firebird.**

CITY OF PORTLAND

The Best Pink Canna to Date.

Named in honor of the City of Portland. This remarkable new canna is a cross between Mrs. Alfred Conard and Venus. The plants are stately, erect and sturdy; attractive green foliage of the best substance. It is an early, profuse bloomer, doing equally well in hot or cool weather. Flowers, a beautiful glowing "testout" pink, showing a little salmon. **Pronounced by experts to be the finest all-round pink to date.** This superb new canna is especially recommended for our cool Oregon climate (3½ to 4 feet). Not as strong a grower as some varieties and can be set 15 inches apart.

FIREBIRD—A gorgeous red flowered green leaved Canna.

This is by all means the very best red-flowered, green-leaved Canna today. The flowers are borne in immense trusses, on strong stalks well above the leaves. They are of splendid form, round and shapely. The petals measure and sometimes exceed 2½ inches across, and the color is a clear glistening scarlet, without any streaks, spots or blotches. (4 feet.)

This new canna was shown at the "Rose Festival Center," 1917, and was admired and praised by every one.

KING HUBBERT—King of the bronze-leaved Cannas; its mammoth flowers are produced in heavy trusses of gigantic size, and are of a brilliant orange scarlet, while the foliage is broad and massive and of a rich, copy bronze; bold, effective (5 feet).

LOUISIANA—Beautiful and showy; green leaves edged bronze, strong and healthy, very fine bloomer. The mammoth flowers are of fine form and a vivid scarlet (4½ feet).

GREEN CHARLOTTE—A very showy and effective variety, foliage green, produces handsome clusters and beautiful scarlet flowers, each petal showing a border of rich yellow (4 feet).

AUSTRIA—One of the best of the giant flowered orchid type. Foliage beautiful green, strong and healthy. Flowers are of a pure golden yellow showing a few red dots on the inside petals (4 feet).

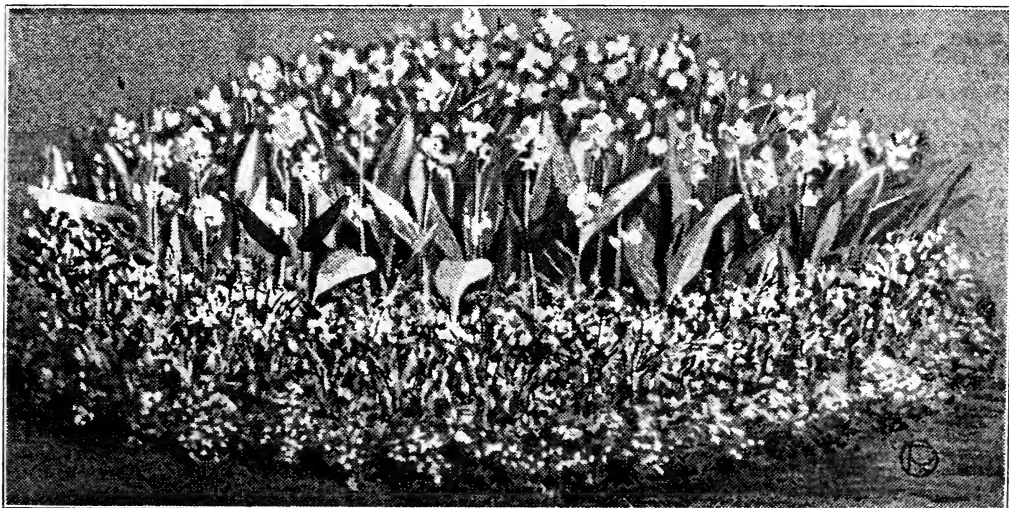

Canna Bed, Edged With Annuals.

Use "C-M" in making the Canna beds. See page 39

Routledge's Superb Gladioli Bulbs

Plant 4 inches deep and as close as 6 inches in beds or borders or among the roses or shrubs. Planted at intervals from very early spring until July 1st, they will give a profusion of flowers until the first frosts.

Choice Mixed Gladioli

Our choice mixture is composed of all large and up-to-date varieties and our customers can depend upon having a large and magnificent variety of colors.

Doz. 60c; 100 \$4.50

Popular Mixture

This mixture will produce a large variety of flowers at a little expense; unequalled for the price.

First size bulbs, Doz. 50c; 100, \$3.50

Second size bulb, but of blooming age, Doz. 35c; 100 \$2.50

AMERICA—Conceded to be one of the finest varieties for cutting or bedding ever sent out; color a beautiful soft flesh-pink.

Each, 5c; Doz., 50c; 100, \$3.25

BENCHLEYENSIS—Vermillion - scarlet; bright and very showy, a great favorite.

Each, 5c; Doz., 50c; 100, \$3.25

BARON HULOT—Rich, royal violet-blue. This, when cut in combination with one of the yellow varieties, is exquisite.

Each 7c; Doz. 75c

FAUST—This grand variety bears immense flowers of an exceedingly rich carmine red. Extra strong spike. Strongly recommended for its rich coloring and size of flowers.

Each 8c; Doz. 85c

FREDERIKA WIGMAN—Magnificent orange red with yellow blotch; very showy.

Each 10c; Doz. \$1.00

GOLDEN WEST—The exact color of a brilliant sunset. A truly wonderful color in Gladiola.

Each 12c; Doz. \$1.00

GLORY OF HOLLAND—Pure white, with slight marking of red in the throat. The best white of moderate price.

Each 8c; Doz. 85c

INDEPENDENCE—Clear salmon pink, exceptionally robust; rather late bloomer.

Each, 10c; Doz., \$1.00

MRS. FRANCIS KING—One of the largest and most showy varieties. Of great merit. Color is a brilliant scarlet, which attracts attention at once.

Each, 5c; Doz. 50c; 100, \$3.25

NIAGARA—A charming American variety, with all the good qualities of America; but of a delicate cream-yellow, lightly marked and splashed with rosy-carmine in the throat; very large, open flowers on tall, straight spikes; beautiful as a cut-flower.

Each 10c; Doz. \$1.00

ORION—Soft salmon pink, with small dark blotch.

Each 6c; Doz. 60c

PRINCEPS—The dazzling scarlet florets are immense in size and beauty. The slight markings of white on the lower petal sets it off to great advantage.

Each 7c; Doz. 75c

PINK BEAUTY—A very valuable variety. A splendid grower and a good forcer. A grand pink with a dark crimson shaded blotch, enhancing its color. The earliest of all the large Gladiolas.

Each 5c; Doz. 50c

FOR TRIAL—Full collection of 17 varieties above, each labeled, for only \$1.25 postpaid. We offer Oregon grown, healthy, vigorous, first size bulbs that will give the best results.

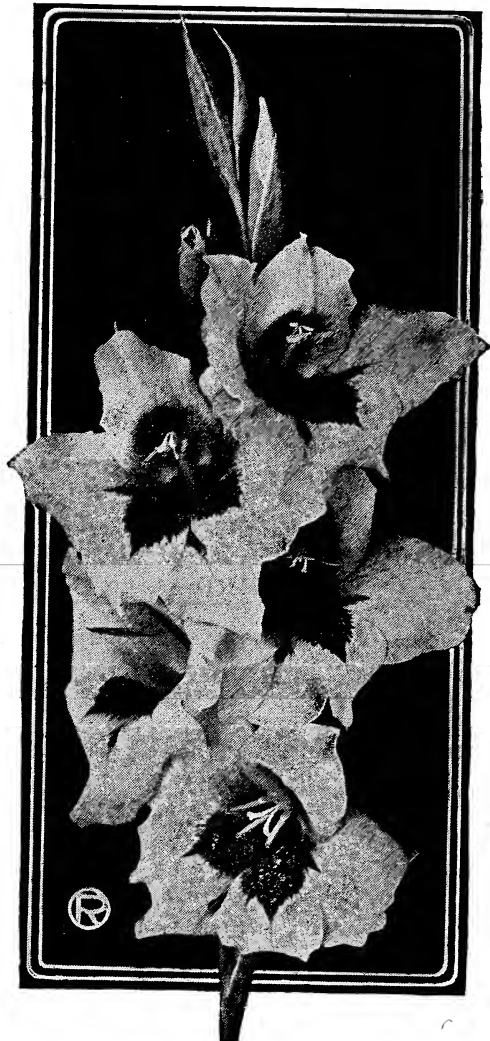

PANAMA—An American introduction of sterling merit; is a favorite wherever high grade varieties are grown. It is similar to and has all the good qualities of America, but in color is a rich rose-pink.

Each 10c; Doz. \$1.00

SALMON QUEEN—A really magnificent salmon colored Gladiolus, good in every way. Perfect spike and very large flower. The best forcer of all the large Gladiolas.

Each 10c; Doz. \$1.00

WILLY WIGMAN—Beautiful soft rose, with dark blood red blotch. A splendid variety, very strongly recommended.

Each 15c; Doz. \$1.50

WHITE GIANTS—White seedlings with enormous flowers and long strong spikes. Many are superior to the late introductions.

Each 10c; Doz. \$1.00

CALADIUM ESCULENTUM.**(Elephant's Ear.)**

One of the most effective plants in cultivation for beds, borders or for planting out upon the lawn. To obtain the best results it should be planted where it will obtain plenty of water and an abundance of rich compost. When full size it stands 6 to 10 feet high, and bears immense light green leaves, 3 to 4 feet long by 2½ feet wide. For best results start early inside and plant out when ground and weather is warm.

Large Bulbs, the only kind it pays to plant, each 25c, mammoth 35c.

TIGRIDIAS.**(Tiger, or Shell Flower.)**

These are gorgeous, rare and unique summer-flowering bulbs. They come in all colors of Yellow, Crimson, White, Rose and Spotted and look well associated with Gladioli, Lilies and kindred stock; grow about 1½ feet high, and flower freely throughout the summer. They require the same treatment as Gladioli, and should be lifted in autumn and dried off in the same way. (See cut.)

Mixed, all colors, 3 for 20c; dozen 60c



Tigridias.

LILY OF THE VALLEY

One of the most charming spring flowering plants, producing in profusion its delicate bell-shaped, delightfully fragrant white flowers. Valleys thrive in any common soil, and will do well in shady situations, where few other plants will succeed. Highly prized for cutting purposes, and exceedingly well adapted for flowering in pots in the winter. Can be forced to bloom in four to six weeks from time of planting. Plant 6 pips to a 6-inch pot.

They are perfectly hardy and most charming planted in beds or borders around the lawn, where they can remain, increase and bloom from year to year. Ready from November to March.

SELECTED PIPS, for forcing indoors or planting outside.

Each, 5c; doz., 50c; 100, \$3.00

NOTE—Higher in price on account of war.



Caladium—Elephant's Ear

AMARYLLIS.

These hardy flowering bulbs are very popular for pot culture and garden. Their giant, lily-like flowers produced on tall stems are exceedingly rich and lasting. For pot culture, 1 bulb to a 6-inch pot. In the garden plant 1 foot apart and cover bulb about 4 inches.

AULICA OR LILY OF THE PALACE.—Summer and autumn bloomer. Broad foliage and large spreading wide open flowers of rich crimson scarlet, lined and pencilled white and maroon. Blooming bulbs.

Large bulbs, each 25c

BELLA DONNA, the **Lovely Pink Bella Donna Lily.**—One of the most satisfactory, bearing on long stems clusters of 8 to 10 superb large beautiful pink, lily-like flowers, with a delightful fragrance. A fine fall bloomer.

Large bulbs, each 20c



Lily of the Valley.

Our Fall Catalog of Dutch Bulbs, such as Hyacinths, Tulips, Narcissus, Crocus, etc., which should be planted from October to February, is issued September first. Free on request.

CALLA LILIES

The Calla is one of the best winter flowering plants for room culture, needing little care beyond abundant water and an occasional washing of the leaves to keep them free from dust. Take a 4 or 5-inch pot, fill it with good, rich loam ($\frac{1}{4}$ leaf mould and $\frac{3}{4}$ good garden soil), then put in bulb, cover it one inch, water well and set away in a dark place for three or four weeks. As soon as it starts growing bring to the light, give abundance of water, light and heat and the result will be most satisfactory. After blooming, set the pots away and let them dry out until the following fall.

WHITE CALLA.—The most extensively grown. Bulbs in season from September to May. Small bulbs, 15c; large, 20c to 25c; extra large, 35c.

YELLOW ELLIOTIANA.—This new Yellow Calla is of marvelous beauty. Flowers are large, rich, dark golden yellow, often 4 to 5 inches across the mouth; leaves are beautifully spotted with white. A most valuable bulb for planting inside. Bulbs in stock from November to June. (See cut.)

Price, each 30c

Dad's Electric Lantern.

Everyone has use for this wonderful new light. Sure, safe and useful in a thousand ways. See page 131.



Yellow Calla Lily.

TUBEROSES

A very desirable and most easily grown summer flowering bulb. Easily recognized by its exquisite fragrance and beautiful spikes of white flowers, which are borne on long stems, making it an admirable cut flower for house decoration. If started in pots and then transplanted to open ground, can be had much earlier. For flowering in the open border, plant in the spring after the ground becomes warm.

Excelsior Dwarf Pearl—select bulbs. Each, 5c; doz., 50c

TUBEROUS ROOTED BEGONIAS

Excellent for pot culture or planting in lawn beds and borders. They should be grown more extensively than they now are, for they require very little attention and are in flower, out side, from early summer until heavy frosts; inside, potted, they are a constant and prolific bloomer. They will thrive either in full sunshine or in shade, but when fully exposed to the sun the beds must be well watered in hot weather.

Culture.

— Before planting, keep the bulbs in a moist, warm place to start them, so that you can tell which is the top. Plant a foot apart in beds or 1 bulb to a 4-inch pot inside, cover about 1 inch.

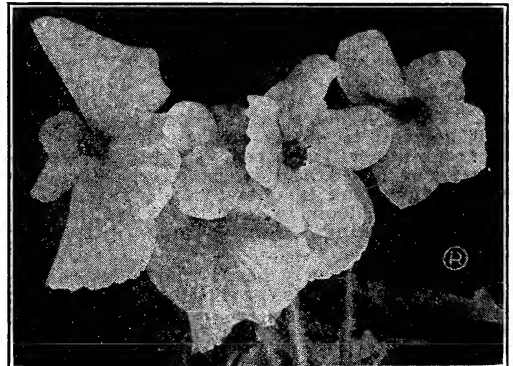

Tuberous Rooted Begonia.

SINGLE FLOWERED.—Separate colors, White, Scarlet, Pink or Yellow. Each, 10c; Doz., \$1.00

DOUBLE FLOWERED.—Separate colors as above. Each, 15c; doz., \$1.50

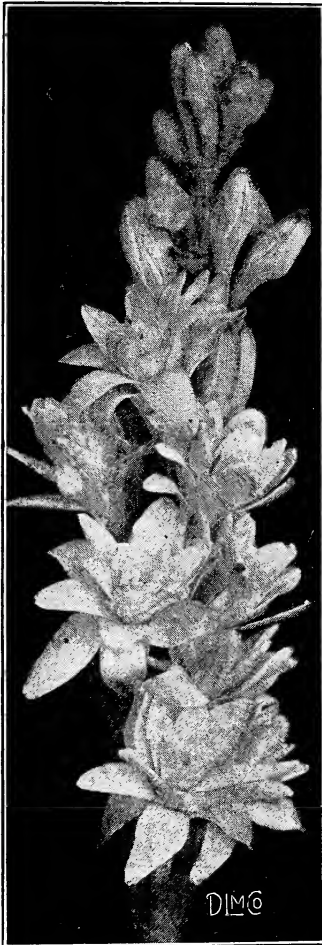

Tube Rose.

POTTING SOIL.—Ordinary garden soil and "C. M." (see page 39) mixed half and half will give excellent results for potting flowering bulbs.

Miscellaneous Summer Flowering Bulbs

MONTBRETIA

One of the brightest and best of summer flowering bulbs. Plant in clumps of six to twelve bulbs in May or June. They greatly resemble the Gladiolus in growth and produce beautiful spikes of star shaped flowers in various shades of orange, yellow and red.

Mixed varieties, 3 for 10c; Doz., 30c

NEW SPIDER LILY

The flowers have a peculiar and striking beauty, which must be seen to be appreciated. The flowers are borne in large clusters, are of waxy-whiteness and unsurpassed fragrance. More beautiful than most of the high priced Lilies. An extra choice garden flower which comes to us strongly recommended. Also a fine pot plant.

Each, 20c; 3 for 50c

SUMMER-FLOWERING OXALIS

Valuable for edging and borders. When planted three inches apart they produce an unbroken row of elegant foliage and pretty flowers; neat and attractive the whole season. They are also splendid when planted in a mass, and make a very showy bed. (1 foot.)

Everblooming—Deep green, clover like foliage. Blossoms bright pink and produced all summer and fall.

Mam. Bulbs, Doz. 25c; 100 \$1.50

CHOICE HERBACEOUS PAEONIES

Special Collection Offer—1 Each (10 kinds), only \$3.25 postpaid.



PEONY (D)—Double Herbaceous.—One of the most beautiful flowering plants, blooming in May and June. The new varieties are simply gorgeous. Once planted they increase in size and profusion of bloom. Most desirable and beautiful for hedges, groups or individual planting. Plant in the fall or early spring.

DELICATISSIMA—Large and showy, a profuse bloomer; very desirable, a beautiful silvery pink; mid-season. **Each 35c**

DUCHESS DE NEMOURS—Sulphur-white, changing to white when in full bloom. A beautiful well-formed flower. **Each 50c**

ZEPHYRANTHES

The Zephyr Flowers or Fairy Lilies, are gems of rare beauty; and when planted either in pots or in the open ground they produce very beautiful Lily-like flowers nearly all summer. For pot culture plant three or four in a 5 or 6-inch pot and they will bloom beautifully. For the garden, plant in spring and lift in the fall, like Gladioli. Those who plant them either in pots or the open ground, will be delighted.

Prices: Each, 10c; 3 for 25c; Doz., 90c

ROSEA—Beautiful clear rose; flowers large and very handsome; blooms all summer. **Each 10c; 3 for 25c; Doz. 90c**

CANDIA—Pure white and the most profuse bloomer of all. **Each 7c; 4 for 25c; Doz. 70c**

HYACINTHUS CANDICANS

Summer Hyacinths

A species of Hyacinth which blossoms during August and September, growing three to four feet high, with spikes of pendulous, bell-shaped, pure white flowers. Perfectly hardy and can remain in the garden. A bed of a dozen or more bulbs produces a grand effect. They thrive in any situation.

Strong Bulbs: Each 5c; 4 for 20c; Doz. 70c

EUGENE VERDIER—Beautiful large flowers, light rose, white center. Tall, erect, free bloomer. Very showy and superb. **Each 60c**

FESTIVA MAXIMA—This truly superb variety, the finest white in cultivation, combines wonderful purity of color, freedom and earliness of flower. Delicate fragrance. **Each 40c**

FELIX CROUSE—Brilliant red, ruby center. Large, handsome, full flowers. An ideal variety. **Each 50c**

GLORIE MUNDI—Pure white with salmon center. A very free flowering variety. Excellent for cutting. **Each 35c**

LOUIS VAN HOUTTE—One of the most conspicuous of the dark-colored varieties. Blooms are freely produced on strong upright stems well above the foliage; color rich dark crimson. Very desirable. **Each 35c**

MADAME DUCEL—A very handsome free-blooming Pink, with silvery reflex. Fragrant and desirable in every way. **Each 35c**

TRIOMPHI DE PARIS—A strong-growing, pure white variety with creamy-white center; good bloomer and habit; mid-season. **Each 35c**

TENUIFOLIA FL. PL. (Fringed or Carrot Leaved)—Distinct; handsome divided foliage; flowers large, very double and of a deep blood-red; a dwarf, compact bloomer. **Each 35c and 50c**

TREE PAEONY

PAEONY MOUTAN—A shrub-like variety growing to a height of 4 to 5 feet. The large beautiful semi-double flowers are borne in profusion after the plant gets well established.

Strong imported roots, postpaid, \$1.00; not postpaid, 75c. Specimen plants \$1.50 to \$2.50, by express, charges collect.

BEAUTIFUL HARDY LILIES

These are the most fragrant, beautiful and stately of all flowers produced from bulbs; they require very little care. Do not disturb them oftener than every three to five years. Plant about six to twelve inches deep, according to size of bulb, and if the ground is not well drained use plenty of sand around the bulb, and lay it on its side. Plant in clusters or groups of six or more for best effect. The Formosa and Longiflorum Lilies force very easily. The Speciosum are, next to the Auratum, the most magnificent species for outdoor culture. They increase in size and beauty each year.

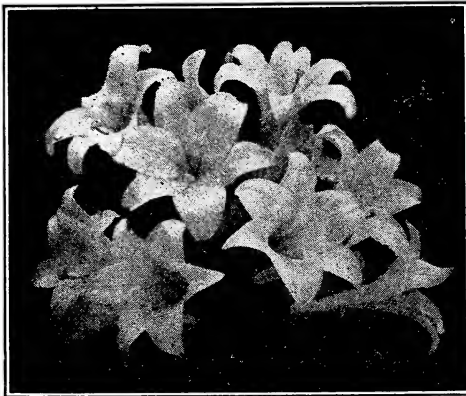

Eastern Lily—Longiflorum.

Lilium Longiflorum

More generally known as the "Easter Lily." Thousands are forced by florists for Easter day. Plant one bulb to a 6-inch pot or planted outside they bloom in June or July.

Each, 15c; doz., \$1.50; mammoth bulbs, each, 20c; doz., \$2.00.

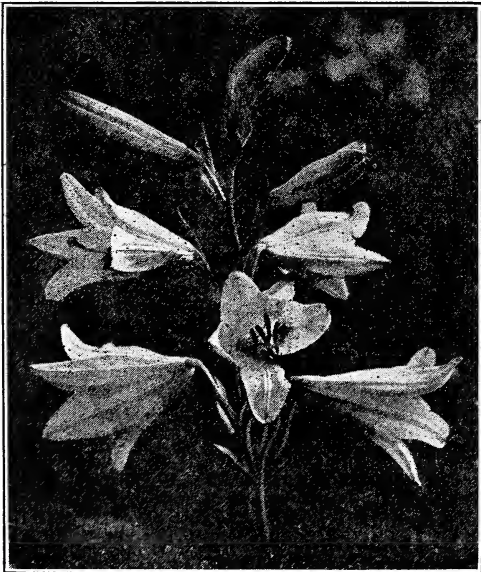

Candidum Lily.

Lilium Candidum

ST. JOSEPH or MADONNA LILY. This is the ever popular, fragrant, snow-white, hardy garden Lily. The flowers are produced in clusters, at the top of 4 to 5-foot stems; blooms in the open ground in June. A very hardy and popular Lily. (See cut.)

Each 15c; Doz. \$1.50; Mammoth Bulbs \$1.20.

SPECIAL.—15c bulbs; \$1.50 doz.; 20c, \$2.00; 25c, \$2.50, etc., ten times the each price and you can select different varieties if you wish.



Auratum Lily.

Lilium Auratum (Gold Banded Lily)

The handsomest and probably the most popular of the Japan Lilies. Its immense ivory-white flowers are thickly studded with yellow and crimson spots, while in the center of each petal is a golden band, shading its edges into white; very fragrant. (See cut.)

Each 20c; 3 for 50c

AURATUM MACRANTHUM. One of the most wonderful Lilies in cultivation. The stems attain a height varying from 7 to 10 feet. The flowers are similar in color to Auratum, heavily spotted, but are much larger, the petals more overlapping, and of greatest substance. Each 25c

AURATUM PICTUM. A most magnificent flower of same shape and color as Auratum above except that one-half of the gold band on each petal is a bright crimson; very rare and showy. Each 30c

AURATUM RUBRUM VITTATUM. Very large flowers, often one foot across, pure ivory-white, with broad crimson stripe through center of each petal. Each 35c

Washingtonianum (Mt. Hood Lily)

MT. HOOD LILY. A beautiful lily, native of Oregon; flower of open form; white, tinted with pink; grows 3 to 5 feet high; very fragrant.

Three sizes, 15c, 20c, 25c each

Elegans Quilp

Beautiful vermilion color with few black spots overspread with bright lustre; petals broad and somewhat rounded; fine form flower much in the way of a tulip.

Each 25c; 3 for 60c

Lilies—Continued

Tenuifolium

The lovely **Coral Lily of Siberia**. A great beauty. The brightest of all lilies. Grows 20 inches high, with finely cut foliage, slender stems and beautifully shaded flowers of a very brilliant coral-red. Blooms very early with 12 to 20 flowers per stem. (See cut.) **Each 15c**

Wallacei

This Lily is very floriferous, each bulb throwing up from 4 to 6 flower stems, each one of which is crowned with 8 to 10 beautiful upright blossoms, of a delicate, bright apricot color. It is very perfect in form and a most delicate sort.

Each 20c**Lilium Speciosum**

No words can over-estimate the brilliant beauty of this charming variety. Its six broad white or pink petals are thickly dotted with rose or carmine spots, and the graceful form, brilliant color, and exquisite fragrance make this one of the most effective and desirable of the Lily family. They are profuse bloomers, and last for many days after being cut and put in water. (See cut.)

SPECIOSUM ALBUM.—Beautiful, recurving flowers of glistening white. **Each 25c**

SPECIOSUM RUBRUM.—Flowers white, with a deep pink band in middle of each petal and numerous crimson spots towards the center. **Each 20c**

Henryi (The Yellow Speciosum)

THE YELLOW SPECIOSUM.—A splendid new rare Lily from China. It is so healthy and sturdy, so hardy and beautiful, so easy to grow, that in time it will be in every garden, as the Tiger Lily is now. It grows, when established, 3 to 5 feet high, each stem producing 5 to 8 large rich apricot yellow flowers, banded with green. (See cut.) **Each 40c**

Elegans Sanguineum

Upright trumpet shaped flowers; very rich dark red with few spots. **Each 20c**

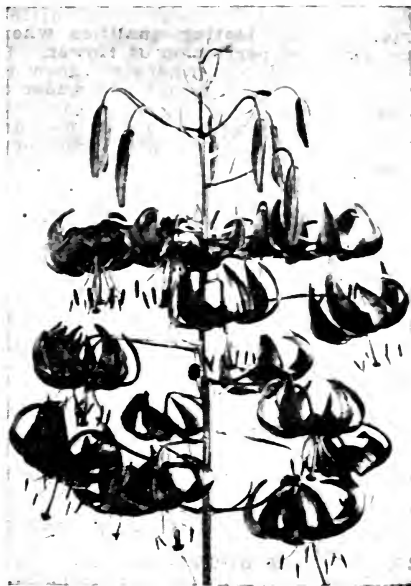

Tenuifolium—Coral Lily.

Superbum

Three to six feet high, flowers from five to forty nodding, brilliant orange red; blooms in July. **Each 20c**

Tiger Lilies

TIGRINUM FLORE PLENO (Double Tiger Lily).—A magnificent Lily of stately habit, bearing immense clusters of large, double flowers; color bright orange, spotted with black. **Each 20c**

TIGRINUM SPLENDENS (Improved Single Tiger Lily).—Large flowers of excellent form; color orange salmon, with dark spots; hardy and free bloomer. **Each 15c**



Speciosum Rubrum.



Lilium Henryi.

LILY COLLECTIONS—Make your own selection of lily bulbs to the value of \$1.20 and remit \$1.00; \$2.40 for \$2.00—20c extra on each dollar dozen prices excepted.

NEW AND POPULAR DAHLIAS

We are large growers of **new and up-to-date** Dahlias, but do not grow seedlings or out-of-date varieties. We believe in keeping in the front ranks with **quality first**. Wonderful advancements have been made in the different classes of Dahlias in the past few years. Most important is the **lasting qualities when cut, length of stems, upright (not drooping) blooms, size and perfection of flower**. These qualifications constitute our **standard of judging** in our field trials, where we grow thousands without irrigation or special cultivation. If they do well and pass our test **under ordinary farm culture**, they can be depended upon to be **prize winners** under special garden culture.

We believe there are far too many varieties of named Dahlias of ordinary merit, many are almost duplicates; we will endeavor to keep our list down to about 100 of the **choicest varieties**.

Choice Paeony Dahlias

Special.—Our full collection of 14 varieties (value \$5.80), only \$4.50.

AMERICA.—New. A glowing old rose, overlaid with a rich shade of old gold; giant flowers with broad, gracefully twisted petals; long, strong stems. **Each 50c**

ATTRACTION.—A grand 1916 Paeony novelty from Holland. The handsome, mammoth flowers are freely produced on long, strong stems, color light rosy pink, with a delicate sheen of lilac. An exhibition flower. **Each \$1.00**

AVALANCHE.—A new variety of real merit. Large, pure white flowers. **Each 60c**

BERTHA VON SUTTNER.—Color beautiful salmon pink, suffused yellow; large full, fluffy flowers, good stems **Each 40c**

DUCHESS OF BRUNSWICK.—Flowers bright apricot red, showing some orange. Prize winner in Holland and London. **Each 60c**

CAESAR.—A large semi-double flat petaled pure yellow flower, produced freely on long stiff stems. **Each 25c**

GREAT BRITAIN.—Magnificent, large, full flowers; graceful; beautiful, clear mauve color. **Each 50c**

GIANT EDELWEISS.—Pure white, petals extra long and pointed. **Each 25c**

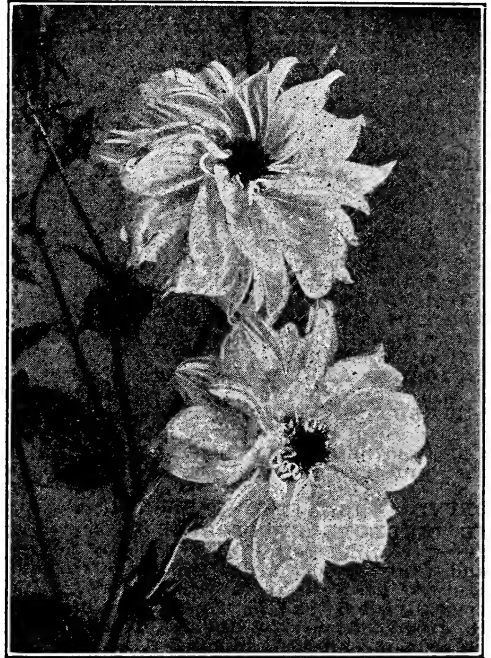

Leo XIII



Attraction.

GEISHA.—No garden is complete without one of these gigantic flowers. Often ten inches across. The center is yellow, beautifully shaded and suffused scarlet and gold. The petals twist and curl, giving it a graceful, fluffy appearance. **Each 50c**

HORTULANUS WITTE.—A giant white of great beauty, the broad, graceful petals are of good substance and of a glistening pearly white; good stems. **Each 35c**

HORTULANUS BUDDE.—Opens a clear, bright crimson, changing to old rose and delicate fawn; broad, velvety petals. A grand, giant flower. **Each 50c**

LEO XIII.—A giant yellow, rich, deep and brilliant. The full massive flowers are of ideal form with petals twisted and incurved, making a graceful fluffy flower well poised on strong stems. **Without question the best yellow of its class to date.** Excellent for cutting. **Each 50c**

P. W. JANSSEN.—Old rose and salmon-bronze, with dash of yellow to the center. Excellent stems and flowers. Free bloomer. **Each 25c**

QUEEN EMMA.—A graceful, flat petaled flower, freely produced on long stiff stems. The best pink in this class. **Each 25c**

ZEPPELIN.—A beautiful, true, new lavender. Large, well-formed, open flowers, gracefully poised on long, strong stems. Excellent for cutting and decorations. **Each 35c**

SPECIAL CASH OFFER.—In collections (of 3 or more bulbs) we will give you \$2.40 worth for \$2.00; \$3.60 for \$3.00, etc. (20c extra on the dollar), collection and dozen prices excepted.

Decorative Dahlias

Many beautiful varieties have been introduced, some with flat petals, others reflexed, incurved or curiously twisted, but nearly all are without formality or stiffness, and practically all of them are leaders as cut flowers, bearing their blooms on long, stiff stems.



Delice

DELICE—A beautiful glowing rose-pink. Perfect shaped flowers on long, stiff stems. Excellent for cutting. (See cut.) **Each 35c**

GALETY—A superb new vivid scarlet, beautifully tipped with pure white. **Ea. 25c**

Vancouver, Wash., March 8, 1917.
Routledge Seed & Floral Co.,
Gentlemen: Your seeds, plants and bulbs
are always first class.

J. A. HAYDEN.

Show Dahlias—Quilled

Very beautiful and desirable. Excellent for cutting. Stand handling and shipping well. In shape they are rather round or ball-shaped, and the petals are generally quilled (see illustration below).

PRICES—Unless otherwise priced, your choice 20c each, 6 varieties \$1.00, postpaid.

BALZAC—Extra large perfect flowers, dark velvety maroon, very rich.

CALEB POWERS—Early, free bloomer. Good size, soft pink, splendid form.

DIADEM—Very large, of fine form on long stems; a beautiful rich crimson.

DREER'S WHITE—A pure glistening white. Free flowering and most valuable for cutting and show.

GRAND DUKE ALEXIS—Very popular and always in demand. Color, ivory white, lightly tinged rosy lavender on edge of petals. **Each 25c**

LE SIAM—A grand flower, same style and shape as the popular W. W. Rawson, but of a rich, silvery rose. Free bloomers and good stems.

LUCY PAWCETT—Sulphur-yellow, flaked crimson. Fine large flowers, very full.

THOMAS PENDRED—Without doubt the finest yellow show Dahlia ever offered.

W. W. RAWSON (See cut.)—Large, perfect but graceful flowers are borne on long, stiff, erect stems. The color is pure white, overlaid with amethyst-blue, producing a beautiful effect. **Each 35c**

HOETULANUS PIET—New. Of mammoth size. A rich and pleasing apricot shading to old gold. Beautiful flowers on good stems. **Each 40c**

LE GRAND MANTO—A most effective fancy variety of splendid shape and very large, shaded, striped and blotched with deep red and violet, some flowers may be solid color. **Each 25c**

MEADOW GOLD—Flowers large and produced in great profusion. Primrose yellow, tinged delicate pink. **Each 25c**

MINNIE BURGLE—The finest cut flower Dahlia yet produced and very popular with florists. The large yet graceful blooms are carried on long, strong, erect stems; color rich glowing crimson. **Each 35c**

MME. JEANNE CHANTRE—Rich pink or bright rose, shading to a creamy white. Grand, showy and pleasing flowers on strong stems. **Each 35c**

PERLE DE LYON—A valuable white decorative Dahlia for cut-flower purposes; of good size and held erect on long, stiff, wiry stems. **Each 25c**

PRINCESS JULIANNE—Award of Merit, Amsterdam, and London. Flower large, full, pure white, perfect shape, stands erect on long stems and lasts for days. **Each 35c**

REISE VON STUTTGART—Sport from Souvenir de Gustave Doazon. A bright blood-red, shading deeper to the center. **Each 25c**

SOUVENIR DE GUSTAVE DOAZON—The immense flowers are borne in profusion; color bright red. **Each 20c**



W. W. Rawson

OTHER VARIETIES?—We are in close touch with all Oregon Dahlia growers and will gladly procure any particular Dahlia you want; send price listed at by others.

New Hybrid Cactus Dahlias

In order to distinguish these giant flowering chrysanthemum shaped Cactus Dahlia from the ordinary cactus type, the National Dahlia Society, at our last Dahlia Show, made a new class to be known as the Hybrid Cactus. This class is often listed as Paeony Dahlias.

These flowers are a cross between the Peony and Cactus type, very large and full and have long, rather broad, curling and full twisted petals in fantastic shapes. **The flowers are more than double the size of most Dahlias and very beautiful.** Produced on strong stiff stems; make beautiful single specimens for small vases or a gorgeous display in large vases or baskets.

With good cultivation, moisture, fertilizer and disbudding flowers of mammoth size can easily be produced.

MRS. WARNAAR—Giant flowers on long stiff stems. Cream white, suffused delicate pink, the back of the long twisting petals shell pink, giving the flower a very pleasing and beautiful appearance. Award of Merit. **Each \$1.00**

YELLOW KING—By far the finest and most beautiful clear primrose yellow to date, mammoth flowers on upright stems; produces in great profusion perfect flowers of elegant shape and style. First class certificate. **Each 75c**

GARRIBALDI—The very large flowers are very full and perfect in form, with long flat petals that curl and twist in most fantastic style. Color bright scarlet, shading deeper to center, back of petals orange scarlet; very free bloomer. Very graceful and distinct. **Each 75c**

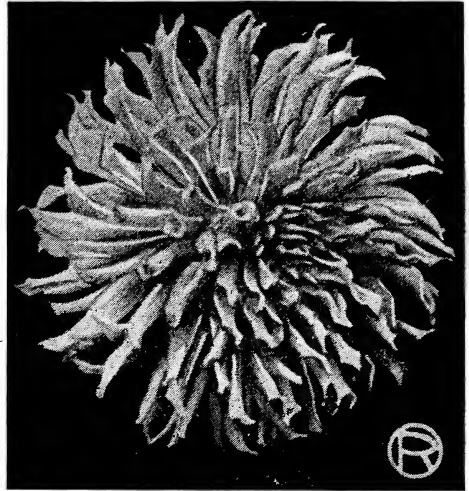

Mrs. Warnaar

KALIF—It is an exceptionally strong grower and the large and beautiful flowers are produced very freely and carried on strong, erect stems. The color is a pure scarlet, very rich and glowing. **Each 75c**

Very Select Cactus Dahlias of Decided Merit

As stated before (see top of page 92), we are offering less varieties of Dahlias in each class. A list of several hundred is only confusing and unnecessary. The **range of colors, perfection and poise of the flowers, size and profusion of bloom** in the following list is unsurpassed. Any one if well grown should be a **prize-winner in any show**. There is not a poor or inferior variety in the whole list, so you can make a selection to suit your fancy with **perfect safety**. The prices are within the reach of all.

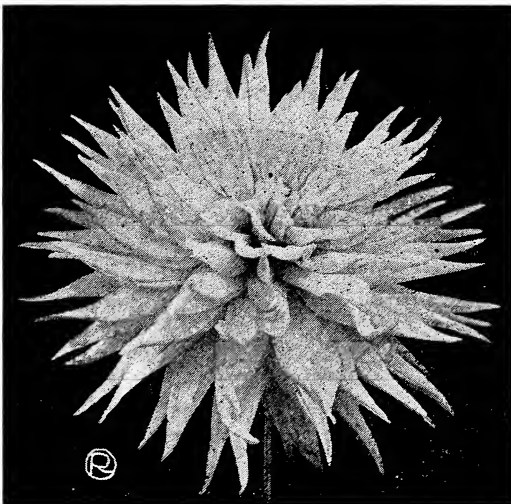

Mademoiselle Cazalis

GWENDOLINE TUCKER—A beautiful shaded silvery pink, large, full flower; petals incurved, carried on long, strong stems. An exhibition variety. **Each 50c**

ALFRED NOMBLOT—Extra large; incurving petals; Geranium red; under side of petals plum, with a golden sheen at base of petals. Very desirable. **Each 35c**

COUNTESS OF LONSDALE—For perfection of bloom, size, stem, abundance of flowers and lasting qualities when cut, this variety has not been excelled. The color is a rich salmon, tinted apricot. **Each 25c**

DUCHESS DE CHANTRES—An incurved long petaled exhibition variety. The color combination of sulphur-yellow and mauve produce a beautiful pink. **Each 50c**

EXTASE—Beautiful rosy pink, lighter to the center. A grand flower in every way and very large. **Each 25c**

FERDINAND CAYEUX—The darkest Dahlia to date, deep velvety maroon, long pointed petals, extra good stems. **Each 35c**

GOLDEN GATE—A new giant golden-yellow. Highly recommended by eastern growers; profuse bloomer. Should be disbudded and pinched back to secure large perfect flowers. **Each 35c**

GOLDREGEN—Pure yellow; large handsome flowers. An ideal yellow. **Each 35c**

GUNTHER—A splendid pure white Dahlia with broad, twisted petals. **Each 25c**

JACQUELINE GUILLOT—A beautiful and attractive flower of good size, long stems; blood red, tipped white. **Each 25c**

JOHN RIDING—Dark rich scarlet; long florets; incurving over the center of the flower; best of its color. **Each 50c**

OTHER VARIETIES?—We are in close touch with all Oregon Dahlia growers and will gladly procure any particular dahlias you want, at prices listed by others.

Very Select Cactus Dahlias—Continued

SPECIAL CASH OFFER.—In collections (of 3 or more bulbs) we will give you \$2.40 worth for \$2.00; \$3.60 for \$3.00, etc., (20c extra on the dollar) collection and dozen prices excepted.

MANON—Extra large flowers, sulphur-yellow shading to primrose at points of petals. A free bloomer. **Each 25c**

MADEMOISELLE CAZALIS—Pure white flower, perfect in form, large, very full; very free bloomer. **Each 35c**

MERCURY—Beautiful large full flowers. Petals fine and pointed, incurving. Coral red, deeper to the center. **Each 35c**

MODELL—Yellow, with a delicate plum blush sheen over tips of petals; a dainty, lovely flower of large size, perfect form; erect on long stems. **Each 35c**

MONSIEUR CAZALIS—White, overlaid with violet rose, producing a lavender shade. Very desirable. **Each 25c**

MONSIEUR BARAT—A large and beautiful flower; color, white, striped and lined purple and violet. **Each 50c**

MRS. DOUG. FLEMING—Without doubt the best white Cactus Dahlia. Petals long and tubular and so numerous as to make massive flowers. Exhibition. **Each 50c**

MAD. HENRYI CAYEAUX—Of premier merit, elegant form. A beautiful, tender rose. Petals long, white tips. **Each 35c**

MRS. HENRY WIRTH—This splendid va-

riety is in full bloom from early until late, full double flowers of intense rich glowing scarlet. **Each 25c**

MRS. FERDINAND JEFFRIES—Long petals curved and twisted; beautiful and full; deep velvety red. **Each 35c**

NEW YORK—Rosy salmon-orange color, with bronzy shadings. One of the largest, held erect on long, strong stems; perfectly free bloomer. **Each 50c**

BENE CAYEUX—An early, continuous and free bloomer. Flowers borne well above the foliage. For a hedge or a mass effect it could not be equaled. A rich, bright red. Bushes rather dwarf. **Each 25c**

SEQUOLA—Deep saffron-yellow, with long tubular petals cleft at the tops. **Each 25c**

UNCLE TOM—Free bloomer; deep crimson, almost black; excellent shape. **Each 25c**

VIOLA—A full well-shaped flower, very rich and desirable. Violet purple. **Each 35c**

WM. MARSHALL—Flowers extra large, fine form, long twisted petals. Color yellow overlaid and shaded orange. **Each 35c**

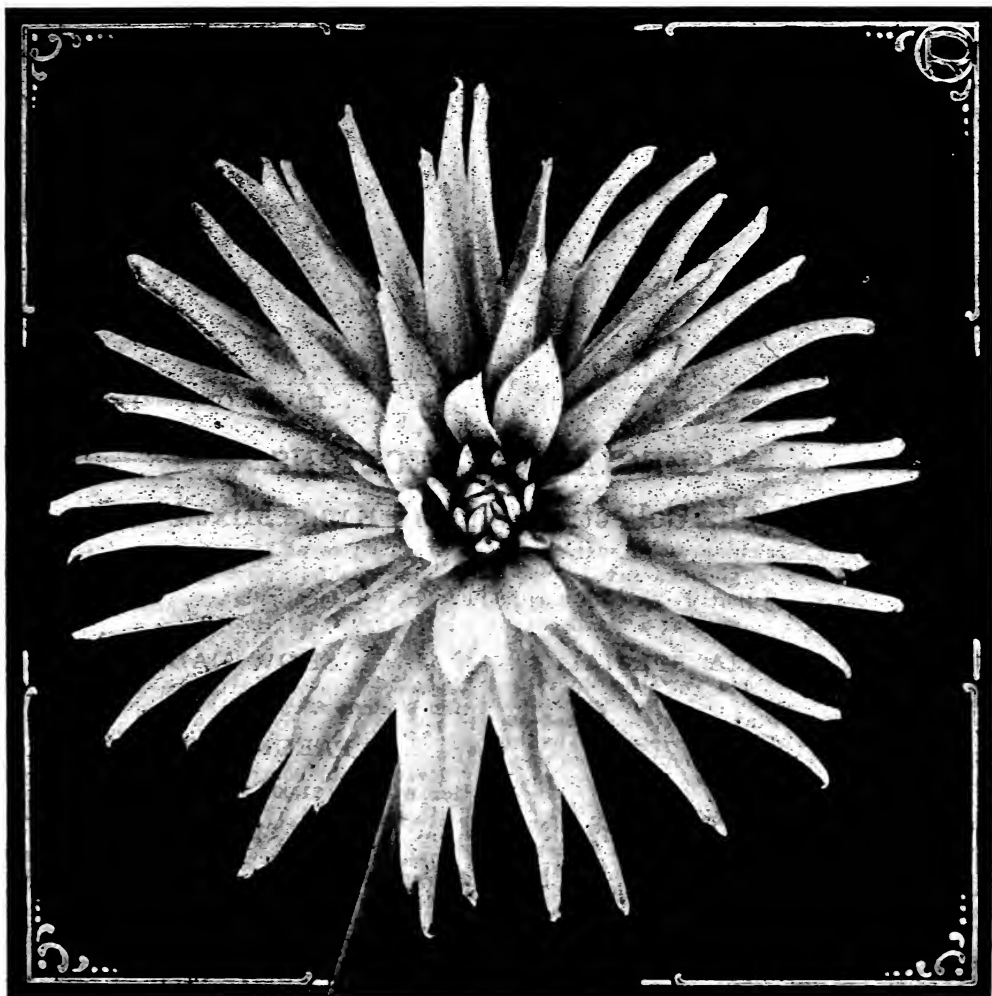

Cosmea Flowered or Star Dahlias

This new type has beautiful, clear cut, medium size single flowers and ideal stems for cutting. They resemble in style of bloom the Mammoth Annual Cosmos. Our original stock came from England.

We are much pleased with this new type. The flowers are freely produced on long, stiff stems, well above the foliage. They are charming in bouquets and last well. **WHITE, YELLOW** and **ROSY PINK**. Each 35c, 3 for \$1.00.

Single Flowered Dahlias of Merit

This class of Dahlias has become quite popular of late; they are showy in the garden, very free flowering and excellent for cutting and general decorating.

PRICES—Your choice, each 25c. Full collection (5 kinds), \$1.00 postpaid.

CARDINAL CENTURY—Very large, bright cardinal red with round petals.

FRAU DE NEBELTHAU—The best pure white, excellent stems, large flower.

MRS. J. C. HANCE—Large, well rounded flowers; white slightly flushed with soft pink.

ROSE PINK CENTURY—Largest and best deep pink with long stiff stems; fine for cutting.

ROTGOLD—Bright red, centered with a broad, yellow zone; very attractive. Giant flowers on long stems. **Each 35c**

French Collerette Dahlias

An entirely distinct type, having a row of artistic petals around the disc, which form a frill or collar and which is of a different color from the rest of the flower. Excellent for cutting, have good stems, last well in water and the fall rains do not discolor them. (See cut.)

PRICE—Your choice 20c each, 6 for \$1.00

EUREKA (Diadem)—Perfect pointed petals of brilliant carmine; collar white. Very pretty. (See cut.)

EXPOSITION DE LYON—Very gay; bright garnet; collarette cream-yellow; very attractive; free bloomer.

IDEAL—Cardinal red, collarette yellow, very attractive.

M. MARTINET—Very large, vermilion shaded yellow; collarette yellow.

PRINCESS LOUISE—Rich glowing, crimson; broad flat petals and white collarette, very distinct.

WINDSOR—Pale chrome yellow, suffused with rosy pink. Straw colored collarette.

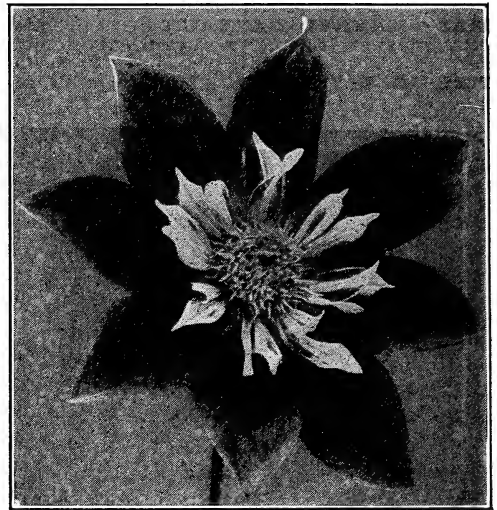

Eureka (Diadem)

SPECIAL COLLECTIONS

Dahlia Collections and All Kinds Mixed

If you are not particular as to just what named varieties of Dahlias you plant, as long as you get good kinds, you can save money by buying the following collections. Naturally these will be varieties that we have in surplus, but all will be popular, well-known varieties, that will give choice flowers at a small cost.

CACTUS DAHLIA SPECIAL

Our selection of named varieties (not labeled), but your selection of colors in shades of **White, Yellow, Pink, Red** or **mixed**—6 for \$1.25, 12 for \$1.75. This enables us to use surplus stocks, even though they may be our high priced varieties.

DECORATIVE DAHLIAS

We will select for you **six choice varieties** all different and correctly labeled for \$1.00. You can name colors preferred and we will comply as near as possible.

SHOW DAHLIAS

Every bulb correctly labeled. **Our selection 6 kinds 85c.**

PAEONY DAHLIAS

Every bulb correctly labeled. **Our selection 6 kinds \$1.00.**

MIXED DAHLIAS

This is a mixture of all classes, **Cactus, Paeony, Show, Decorative, Single and Collar-ette**, a wide range of all colors—(unlabeled). **2 for 25c, 6 for 70c, 12 for \$1.25, postpaid.**

DAHLIA CULTURE—When you get your bulbs, put them in a warm place and keep them moist so as to start an eye or sprout. Some varieties sprout quicker and earlier than others, but do not plant until they start, then you will have no vacant places. When you plant, remove the label and fasten it to a stake beside the bulb. We attach copper-wired wooden labels that will last for a season.

SPRING FLOWERING HOLLAND BULBS

We import in carload lots from the best growers in Holland a complete stock of Dutch Bulbs. These generally arrive here in October and are planted any time from then until early spring, either in pots inside or outdoors in beds. Perfectly hardy; freezing after planting does not injure.

March 10 Latest Date.—Do not order these bulbs later for spring planting, as all remaining stocks are sold or planted by March 15.

Pamphlet "HOW TO GROW BULBS" free.

HYACINTHS

One of the most popular and beautiful spring flowering plants for indoor and outdoor decorations. For pots, porch or window boxes and the open ground, they are unexcelled. Bright, cheerful and fragrant.

Prices Postpaid.

Order mixed or separate colors.	Each	Doz.
Exhibition Size, any color.....	\$0.20	\$2.00
First Size Named, any color.....	.15	1.50
Mixed Bedding, any color.....	.10	.85
French Roman, white only.....	.08	.75

DAFFODILS

The Narcissus affords perhaps more pleasure and satisfaction than any other flowering bulb. They are very beautiful, very hardy, bloom freely, are delicately fragrant, thrive in almost any soil and last for years without resetting. Culture same as Hyacinths.

KINDS & PRICES POSTPAID

SINGLE TRUMPETS.—Pure yellow or cream white with yellow trumpet. Each 6c; Doz. 60c. Choicest Kinds, Each 7c; Doz. 75c.

SINGLE.—With small cup or eye, white or yellow, Each 4c; Doz. 40c.

DOUBLE TRUMPETS.—Von Sion, often called Double Daffodils, Each 5c; Doz. 50c.

DOUBLE.—Full flowers, white—yellow and orange or pure yellow. Each 5c; Doz. 50c

POLYANTHUS.—Single flowers in large clusters, can be grown in water like China Lilies. Pure white—white with yellow cup or yellow with orange cup. Each 7c; Doz. 75c

Hyacinths

NOTICE

Orders received after March 10 will be held and filled in the fall.

TULIPS

No other flower excels the Tulip in beauty of form, brilliancy of color, effective bedding and gorgeous show. They are very desirable for garden beds or borders as well as for window or porch boxes. For pot culture indoors the single early kinds only do well.

Single or Double Named Varieties, White, Pink, Yellow or Scarlet. Doz. 45c; 100 \$2.50

Good Mixture of single or of double varieties. Doz. 30c; 100 \$2.00

Single Late Flowering. Three weeks later; tall stems, large flowers. Doz. 50c; 100 \$3.00

Darwin Tulips. Late, tall stems, giant flowers, rare colors. Doz. 60c; 100 \$4.00

CROCUS

These bright, charming little flowers bloom very early in the spring which makes them most welcome. Very hardy and flower from year to year.

Giant Named, White, Purple, Yellow or Striped. Doz. 25c; 100 \$1.75

Mixed, White, Yellow, Purple or Striped. Doz. 20c; 100 \$1.50

MISCELLANEOUS BULBS

Scillas.—Blue, White, Red..... Each 3c Doz. 25c

Grape Hyacinths.—White or Blue 4c 40c

Anemones.—Mixed colors 5c 50c

Sparaxis.—Very pretty mixed... 3c 30c

SNOW DROPS.—First flowers to bloom in the spring. Single, Doz. 30c; 100 \$1.50.

Double, Doz. 35c; 100 \$2.50.



Tulips

Double Narcissus

Single Narcissus

CHOICE ROSE PLANTS

For Spring and Early Summer Planting
Only and Not for Fall Delivery.

On this page we are offering four choice collections of the finest roses. This is the popular mail order size that we send by mail prepaid. They are grown in 3-inch pots, are strong, healthy and well rooted and from 10 to 12 inches high. They should not be planted outside before severe weather is over in the spring. While this size will not produce so many blooms the first season as our large field-grown plants offered on the following pages you will be surprised at the results you can obtain, and at quite a saving in prices.

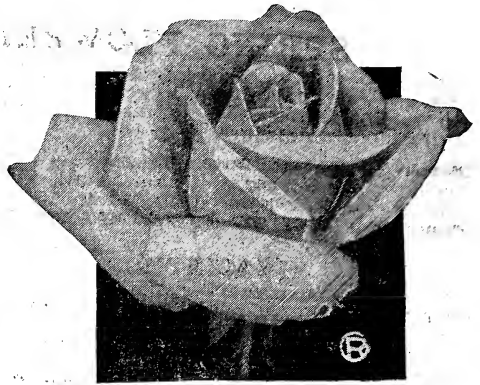

Tipperary

Gorgeous Collection of New Roses

Price 20c each. Set of 6 sorts \$1.00.

CLEVELAND.—Old rose shaded with copper at base of petals. Large flower, handsome foliage.

GORGEOUS.—Orange yellow heavily bordered with reddish copper. Large, finely formed buds and flowers freely produced.

HOOSIER BEAUTY.—Glowing, crimson-scarlet with maroon shadings. Beautiful buds on long stems. Wonderfully free in bloom. A valuable new American rose.

OPHELIA.—Salmon, flesh, shaded rose, base of petals apricot yellow. Fine shaped flowers. Excellent habit.

SUNBURST.—Without doubt the finest yellow rose in existence. Large buds and flowers of an orange-copper color shaded golden yellow. Superb.

TIPPERARY.—Bright lemon yellow; exquisitely shaped buds opening into finely formed flowers. A fine decorative garden rose.

Beauty Collection Choice Roses

Price 15c each. Set of 12 sorts, \$1.25.

American Beauty.—Large rosy crimson flowers; sweet-scented.

Betty.—Coppery pink; long, beautiful buds.

Florence Pemberton.—Large white flushed peach. Strong grower.

General McArthur.—Grand crimson scarlet. One of the finest.

Helene Cambier.—Coppery yellow, beautifully shaped buds.

Mad. Abel Chatenay.—Salmon pink, shaded darker. Always in bloom.

Mad. Caroline Testout.—The famous Portland rose. Large, bold, bright pink flowers.

Maman Cochet.—Beautiful rosy pink. Long pointed buds.

Richmond.—Crimson scarlet buds. A beautiful free flowering variety.

Souv. de P. Notting.—Rich yellow, bordered pink.

Souv. de President Carnot.—Shell pink and fawn.

White Maman Cochet.—Pure white; elegant buds.

Rainbow Collection Everblooming Roses

Price 15c each. Set of 12 sorts, \$1.25.

Dean Hole.—Bright carmine with silvery shadings.

Earl of Warwick.—Salmon pink shaded with vermilion and gold.

Kaiserine Augusta Victoria.—Large pure white; very free and constant.

Lady Ashtown.—Silvery pink shaded yellow. Fine large bloom.

Lady Battersea.—Bright cherry crimson, long pointed buds.

La France.—Silvery pink, large and very sweet-scented.

Marie Van Houtte.—Light yellow, flushed carmine.

Papa Gontier.—Cherry red, shaded yellow. Grand bedder.

Rainbow.—Creamy pink striped and mottled crimson.

Safrano.—Apricot yellow, tinged fawn; beautiful buds.

Virginia E. Coxe (Gruss an Teplitz).—Fiery scarlet.

Viscountess Folkstone.—Delicate flesh pink; full and handsome.

Glorie Collection Hardy Roses

Price 15c each. Set of 12 sorts, \$1.25.

Anna de Diesbach.—Beautiful clear carmine pink.

Baron de Bonstettin.—Dark, rich red; very large.

Clio.—Massive, light pink flowers.

Conrady F. Meyer.—Beautiful silvery pink.

General Jacqueminot.—Bright crimson.

Glorie Lyonnaise.—Chamois yellow; full, sweet, distinct.

Margaret Dickson.—Ivory white, shaded flesh.

Mrs. R. G. J. Crawford.—Silvery pink; fine form.

Mrs. John Laing.—Soft, delicate pink; free flowering.

Paul Neyron.—Large, deep rose; double and handsome.

Prince Camille de Rohan.—The best dark maroon.

Ulrich Brunner.—Rich, glowing crimson; large.

Climbing or Pillar or Rambler Roses

We can supply most of our climbing roses in one-year-old plants at 15c each, 4 for 50c. Make your selection from varieties described on page 102.

REMEMBER.—These pot grown rose plants can be supplied in the spring and early summer months only.

Choice Field Grown Rose Bushes

We make a specialty of Rose Bushes and sell thousands upon thousands. Our bushes are strong, healthy field grown stock, well rooted, and will produce a profusion of bloom the first season, if given good care and cultivation. We enjoy the reputation of supplying the best stock at reasonable prices. The following list is the choicest of American and European introductions.

SHIPPING AND DELIVERY.

We can fill orders for our large two-year-old rose bushes any time from October to May—the best planting time is during favorable weather in November, December, January, February and March. One-year-old from March to July. See special collections, page 98.

WE PRUNE THE TOPS of all bushes sent by mail as they carry better. If all rose bushes when set out were cut back to within 10 or 12 inches of the ground, results would be better than when tops are left on.

Abbreviations

T.—TEA—One of the best classes of Roses and truly ever blooming. They are hardy in this section, although during our coolest weather and in cold sections they should be protected with a covering of fir boughs, straw or burlap.

H. T.—HYBRID TEA—Most of these are as free flowering and as constant bloomers as the teas, and are hardier, stronger growers.

H. P.—HYBRID PERPETUAL—The hardiest of all roses, vigorous in growth, bright blooming.

AMERICAN BEAUTY (H. P.)—Constant bloomer, magnificent buds; large, bold flower; color rich, rosy red.

Each 35c and 50c

AVOCA (H. P.)—Brilliant, velvety-crimson; buds long; flowers large, sweetly perfumed.

Each 35c and 50c

BARONESS BOTHCHILD (H. P.)—Large size, fine globular form; color bright rosy pink.

Each 35c and 50c

BRITISH QUEEN (H. T.)—Pure white, large full flowers of exquisite form.

Each 60c

CHATEAU DE CLOS VOUGEOT (H. T.)—A very rich, fiery scarlet shading to deep velvety crimson. It is delightfully fragrant, a prolific and continuous bloomer.

Each 50c and 60c

CORONATION (H. T.)—Large exhibition rose; delicate flesh pink shaded to shrimp pink.

Each \$1.00

DUCHESS OF WELLINGTON (H. T.)—Intense saffron-yellow, later becomes deep coppery yellow; delightful fragrance.

Each 60c and 75c

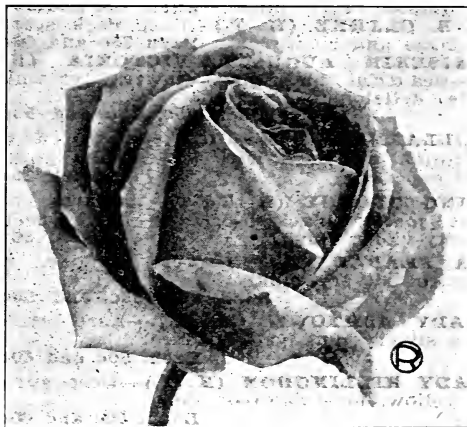

George Dickson

Marietta, Ohio, Sept. 5, 1917.

Routledge Seed & Floral Co.,
Gentlemen: This is my second order for these Roses since March. The first twelve bushes have done wonderful and bloom continuously. With good attention, they have done about as well as those we saw in Portland. They were two-year-old plants and I did not lose a single bush. Hope these will be as good. Please get these to me by the quickest route.

Very Respectfully,

G. HENRY MEISTER.

DOROTHY PAGE ROBERTS (H. T.)—Coppery pink suffused with apricot yellow, very free and profuse bloomer.

Each 50c and 60c

EDWARD MAWLEY (H. T.)—Of grand size and build and a free bloomer. Color intense crimson scarlet and of velvety texture.

Each 50c and 60c

FRAU CARL DRUSCHKI (H. P.)—A large, grand, hardy, pure white; best and most popular.

Each 35c and 50c

FLORENCE PEMBERTON (H. T.)—Creamy white, suffused pink; flowers very large and full.

Each 35c and 50c

GENERAL McARTHUR (H. T.)—Color, brilliant scarlet; beautiful buds and most desirable in every way.

Each 35c and 50c

GENERAL JACQUEMINOT (H. P.)—Bright shining crimson scarlet; very rich and velvety; one of the best.

Each 35c and 40c

GEORGE DICKSON (H. T.)—A velvety blackish crimson with the back of the petals heavily veined with pure crimson maroon. Pronounced by all who have seen it to be unequalled to date.

Each 60c and 75c

HIS MAJESTY (H. P.)—The **Crimson Frau Karl Druschki**. Dark, deep crimson, shaded deep vermilion-crimson towards the edges; of great size.

Each 40c and 50c



Coronation—New.

DOZEN PRICES.—We give you our 35c selected two-year-old bushes at \$3.00 doz.; our 40c and 50c extra selected at \$4.00 doz. We can supply the ordinary grade of 25c bushes at \$2.50 doz. For 1-year pot roses, see page 98.

HUGH DICKSON (H. P.)—Brilliant crimson, shaded scarlet; good size and fine form; finely perfumed.

Each 35c and 50c

IRISH ELEGANCE—Bronze orange in the bud, opening into large single flowers of a lighter shade.

Each, 50c

IRISH FIREFLAME (Dickson & Sons, 1914.)—These buds are wonderfully rich in coloring; opening to a large single flower Old gold, shaded ochre.

Each, 60c

JULIET (H. P.)—Very attractive; inside of petals golden yellow, outside rosy red; large, full, fragrant.

Each, 35c and 50c

JONKEER J. L. MOCK (H. T.)—A magnificent and unique rose. Inside of petals red, outside bright pink.

Each, 40c and 50c

J. B. CLARKE (H. T.)—Deep dark scarlet, large and beautiful.

Each 35c and 50c

KAISERIN AUGUSTA VICTORIA (H. T.)—Beautiful buds and flowers; creamy white; deliciously fragrant.

Each 25c, 35c and 50c

KILLARNEY—A beautiful shade of deep shell-pink lightened with soft cream pink; very popular.

Each 35c

KING GEORGE (H. T.)—A new rose of great merit; blackish-crimson with deep velvety-violet flush.

Each, 60c

LA FRANCE (H. T.)—Very popular. A beautiful silvery pink.

Each 25c, 35c and 50c

LADY ASHTOWN (H. T.)—Rare, rich, large silvery pink yellow-toned.

Each, 50c and 60c

LADY HILLINGDON (H. T.)—Deep apricot yellow, long pointed bud.

Each, 50c and 60c

LADY URSULA (H. T.)—Truly magnificent; a delightful shade of flesh pink.

Each, 40c and 50c

LADY PIBRIE—Deep coppery salmon, shaded to apricot and fawn. Strong erect-growing and free blooming. An ideal variety.

Each 50c and 60c

LYON ROSE (H. T.)—Distinct. Shrimp pink with salmon and chrome yellow shadings, beautiful beyond description.

Each 50c and 60c

MABEL DREW (H. T.)—A magnificent rose, exquisitely shaped; deep cream, passing to intense canary-yellow in the center.

Each, 60c

MADAME CAROLINE TESTOUT (H. T.)—Portland's famous brilliant pink rose.

Each 25c, 35c and 50c

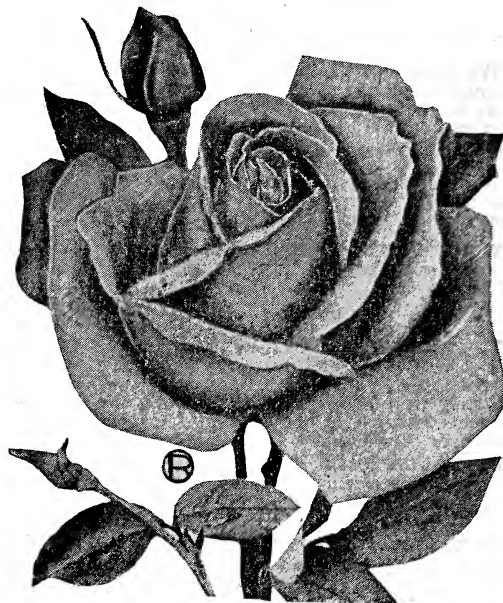

Mad. Eduard Herriot

MADAME EDOUARD HERRIOT—Long pointed buds, a deep coral red color shaded to yellow at the base; flower of a rare shade of rosy scarlet flushed with shrimp and apricot tints. Won the Daily Mail's \$5000 gold cup.

Each 60c and 75c

MAD. MAURICE DE LUZE (H. T.)—Rich, rose pink carmine.

Each 40c and 50c

MAD. MELANIE SOUPERT (H. T.)—Saffron yellow suffused with carmine and pink. A great favorite.

Each 50c and 60c

MADAME LEON PAIN (H. T.)—A beautiful salmon-pink overlaid with silvery-white, center yellow. Similar, but better than Killarney.

Each 35c and 50c

MAD. SEGOND WEBBER (H. T.)—A magnificent light rosy salmon. Buds long and pointed, flowers immense.

Each 40c and 50c

MADMOISELLE CECILE BRUNNER—Dwarf Polythanus. Exquisite little roses, buds dainty, pointed, bright salmon pink, yellow center.

Each 35c and 50c

MAMAN COCHET (T.)—Very popular; a deep, rosy pink, the inner side of petals silvery rose.

Each 35c and 50c

MARIE VAN HOUTTE (T.)—Straw-yellow color; outer petals shaded bright rosy carmine.

Each 35c and 50c

MELODY (H. T.)—Yellow, deepening to apricot in the center; perfect in form, free bloomer.

Each 50c and 60c

MARQUISE DE SINETY (H. T.)—Beautiful golden-yellow shaded rosy-red delightfully fragrant.

Each 60c and 70c

MILDRED GRANT (H. T.)—Large and beautiful, silvery white, shaded peach.

Each 40c and 50c

MRS. AARON WARD (H. T.)—Very distinct. Coppery orange in the bud, shading to gold and pink.

Each 50c and 60c

MRS. A. WADDELL (H. T.)—Color, deep reddish apricot toned with salmon; long pointed buds.

Each 40c and 50c

MRS. FRANK BRAY (H. T.)—A rich deep coppery ecru, developing as the flower opens to a very delicate coppery-fawn with a shading of ivory shell-pink.

Each 50c and 60c

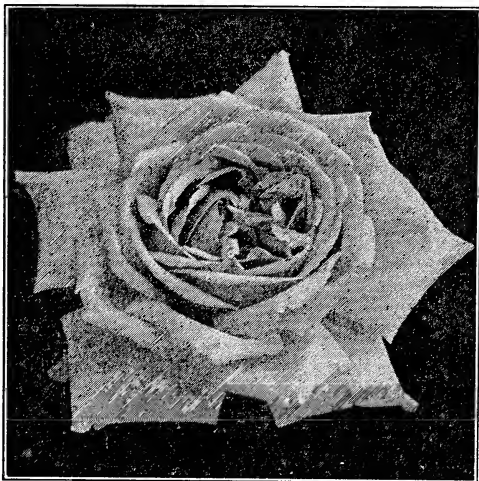

Willomere

DOZEN PRICES.—We give you our 35c select two-year-old bushes at \$3.00 doz.; our 40c and 50c extra select at \$4.00 doz. We can supply the ordinary grade of 25c bushes at \$2.50 per-dozen. One-year-old from March to July. See Special Collections, page 98.

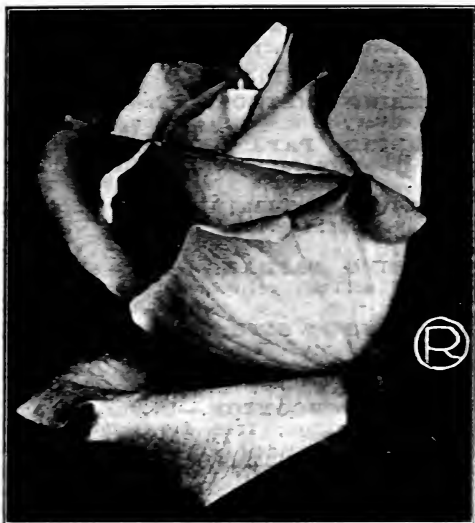

Lady Hillington

Roy, Wash., April 22, 1917.

Routledge Seed & Floral Co.,

Gentlemen: The Roses I got from you are doing fine.

MRS. M. S. TEMPLIN.

MY MARYLAND—This rose is little less than marvelous; a bright glowing pink, each petal being shaded lighter at its base. Each, 35c and 50c

OLD GOLD (New).—A vivid reddish orange with rich coppery red and coppery apricot shadings. Long dainty buds lasting a long time in perfect condition. Each 60c and 75c

OPHELIA (H. T.).—A beautiful new rose of perfect shape. Creamy white shaded peach or apricot. Greatly admired at our late rose shows. Each 50c and 75c

PAPA GONTIER (T.).—Vivid cherry red color, shaded yellow. Prized highly for its beautiful pointed buds. Each 35c and 50c

PAUL NEYRON (H. P.).—Deep, shining rose; a giant in size. Each, 35c

PERLE DES JARDINS (T.).—Beautiful, clear, golden yellow, entirely distinct from any other variety. Each 35c and 50c

PINK DRUSCHKI (H. P.) Heinrich Munch).—Immense globular flower of a beautiful silvery-pink color. On account of its size and color this variety will soon gain the same popularity as the famous white Frau Karl Druschki. Each, 60c and 75c

PRINCE CAMILLE DE ROHAN (H. P.).—Very dark, rich, velvety crimson, passing to intense maroon, shaded black; the best dark variety. Each, 35c and 50c

RAYON D'OR OR GOLDEN RAYS (H. T.).—A gorgeous new golden-yellow rose superb. Each 60c and 70c

RHEA REID (H. T.).—Long buds, large flowers; color, a vivid scarlet. Each 50c and 60c

RICHMOND (H. T.).—A magnificent, rich scarlet-crimson; ever-blooming rose. Each, 25c, 35c and 50c

SAPRANO (T.).—Bright apricot yellow, tinged orange; beautiful buds; delicious tea scented. Each, 35c and 50c

SUNBURST (H. T.).—Rich cadmium yellow, shaded orange. The buds are very long and beautiful form, opening into a gorgeous colored flower. Each 60c and 70c

ULRICH BRUNNER (H. P.).—Glowing crimson, flamed with scarlet; a good grower and free bloomer. Each, 25c, 35c and 50c

WILLOMERE (H. T.).—An improvement upon the famous Lyon Rose, more vigorous, stronger stems. Long, elegant buds, coral red suffused with carmine, opening into a large full flower of a rich shrimp pink, shaded to yellow at the center. Each 75c

WHITE MAMAN COCHET (T.).—White, shaded pink on edges of petals; very beautiful. Each, 35c and 50c

WHITE KILLARNEY.—Beautiful flowers, elegant buds, delicious fragrance. Each, 35c and 50c

WINNIE DAVIS (H. T.).—Rich apricot-pink, shaded to flesh. Beautifully formed buds and flowers. Each, 35c and 50c

Standard or Tree Roses

Tree Roses are budded or grafted on hardy rose stocks, about four feet high. They soon make good-sized heads, forming a small tree, especially desirable for planting as single specimens in back grounds or rows along walks or driveways.

Not all varieties are obtainable, but order any color or variety you wish, and we will send it or give you as good a substitute in same color as possible.

Prices, \$1.00 to \$1.50 each, according to size and shape of head. (Cannot be mailed.)

Moss Roses

Strong vigorous growers, much admired for moss-covered buds; hardy; most varieties bloom but once in a season, but remain for a long time and very handsome.

Price, 35c each

Blanch Moreau.—Best pure white.

Chapeau de Napoleon.—Beautiful pink.

Eugene Verdier.—Best Red Moss.



Pink Druschki

ABOUT PREPAYING.—We will prune the tops and mail any of our rose bushes at catalog prices, but of course we can send larger, heavier bushes by express, CHARGES COLLECT, IF YOU SO ORDER.

Climbing Roses. Hardy, Large Flowering

The lavish profusion of bloom on climbing Roses, literally hundreds of flowers on each plant, their beautiful colors and exquisite fragrance render them unequalled for covering houses, arbors, pergolas, fences and boundary walls.

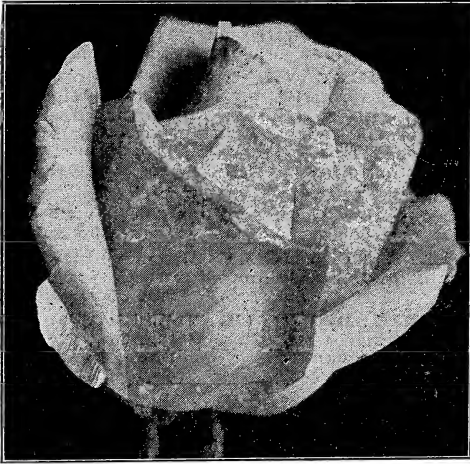

Kaiserine

CLIMBING CECILE BRUNNER (Poly).—A rampant climber. Flowers same as the bush variety. Each 35c and 50c

CLIMBING MADAME CAROLINE TEST-OUT.—Without doubt the finest pink climbing rose to date. Each, 40c and 50c

CLIMBING KAISERIN.—Flowers fine ivory white; a grand addition to our list. Each, 35c and 50c

CLIMBING METEOR.—Free flowering. Rich, velvety crimson. Each, 35c and 50c

CLIMBING PAPA GONTIER.—Splendid cherry-red flowers; strong climbing habit. Each, 50c and 60c

CLIMBING RICHMOND.—Very free and vigorous; bright crimson. Each, 50c and 60c

CLIMBING SAFRANO (Reve d'Or).—A beautiful saffron yellow, very desirable. Each, 35c and 50c

CLIMBING WHITE COCHET.—Flowers white, edged pink, beautiful form and substance. Strong grower, perpetual bloomer. Each, 40c and 50c

CLIMBING WOOTTON.—Bright red, shaded deep crimson; free flowering, strong grower. Each, 35c and 50c

GLOIRE DE DIJON (Cib.).—Large, fragrant yellow flowers shaded amber and carmine; a magnificent climber. Each, 40c and 50c

MADAM ALFRED CARRIERE (Cib.).—Extra large, very double and sweet, profuse bloomer, white, tinged pale yellow. Each, 35c and 50c

MARECHAL NEIL.—The popular fragrant golden yellow climber, but not as hardy as others. Each, 35c, 50c and 75c

REINE MARIE HENRIETTE.—Vigorous; flowers large, full; glowing crimson. Each, 35c and 50c

SILVER MOON.—Large, semi-double blooms of good substance with golden stamens. Foliage bronze green and is immune to mildew. Each, 40c and 50c

SHOWER OF GOLD.—A beautiful new semi-double; golden yellow flowers in masses. Each, 35c and 50c

RAMBLER OR PILLAR ROSES

The following climbing Roses all grow vigorously, and are profuse bloomers and very hardy anywhere. The flowers are borne in large clusters. They all belong to the polyanthus class, or more commonly known as the Ramblers.

AMERICAN PILLAR.—A single-flowering variety of great beauty. Flowers large and a lovely apple blossom pink, white eye and yellow stamens. Each 35c and 40c

CRIMSON RAMBLER.—See Flower of Fair Field.

DOROTHY PERKINS.—(See illustration). Flowers in immense clusters, beautiful shell-pink, very double with petals artistically crinkled. Each 25c, 35c and 40c

FLOWERS OF FAIRFIELD.—A perpetual flowering "Crimson Rambler." The flowers are bright scarlet and produced in great profusion. Each 25c, 35c and 40c

TAUSENDSCHON (Thousand Beauties).—Entirely distinct. The individual flowers are very large, fully 3 inches across, of a most elegant and graceful single. A most delightful shade of soft pink, shaded carmine, and produced in trusses of from 10 to 15 flowers, each truss a veritable bouquet. It is a rampant grower, very healthy with magnificent foliage. Each, 25c, 35c and 50c

WHITE DOROTHY.—As its name indicates, it is a sport from Dorothy Perkins, possessing all the fine qualities of that grand variety, but having pure snow-white flowers. Each 25c, 35c and 40c

YELLOW RAMBLER (Aglaia).—Strong grower, profuse bloomer. Each 25c, 35c and 40c

DOZEN PRICES.—We give you our 35c selected two-year-old Bushes at \$3.00 doz.; our 40c and 50c extra selected at \$4.00 doz.

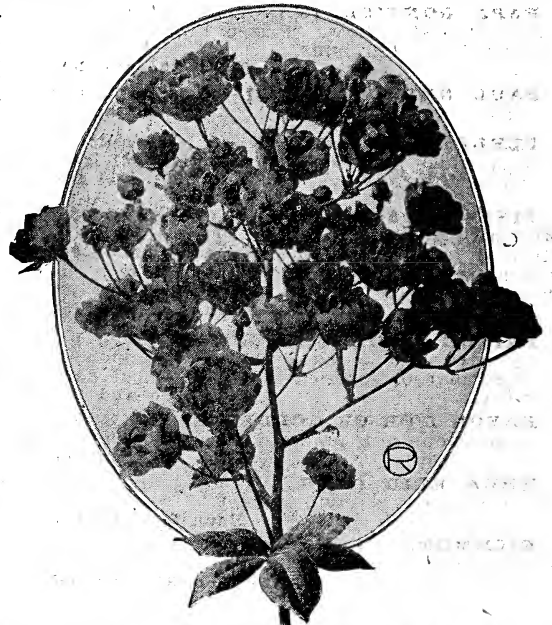

One Flower Spray—Dorothy Perkins

Hardy Flowering Shrubs and Trees

NOTE.—"D" stands for Deciduous plants that drop their leaves in the fall. "E" for Evergreens that are not mailable—see prepay instructions, inside front cover.

BERBERIS (D) (Barberry).—The Barberry is an interesting family of shrubs, varying in size from 3 to 6 feet and having graceful, feathery foliage. Its showy flowers in early summer are succeeded by bright-colored fruit, which is very conspicuous in autumn and early winter.

Thunbergii.—A beautiful Japan variety of dwarf habit. Small foliage, changing to beautiful red in autumn. Very desirable for grouping.

Each 60c to 75c

Vulgaris (Common European).—Yellow flowers in drooping racemes in early summer, followed in autumn by orange-scarlet fruit. Each 50c, 60c and 75c

Vulgaris Purpurea (Purple).—Violet-colored foliage and fruit; rich-looking and very effective when contrasted with plants of lighter foliage.

Each 50c, 60c and 75c

CAMELLIA (E).—Beautiful for the house or garden; evergreen foliage; wax-like flowers which appear about Christmas indoors or early spring outside.

Japonica, Double White, Pink or Red.

Each, 2 feet up, \$1.25 to \$1.50; extra select, \$2.00 to \$3.00.

DEUTZIAS (D).—Their hardihood, fine habit, luxuriant foliage, and profusion of attractive flowers, render them among the most beautiful and deservedly the most popular of flowering shrubs at the present time. The flowers are produced in May and June.

Price, your choice, 60c to 75c and up.

Crenata Fl. Pl.—Grows 4 to 6 feet tall. Flowers very dainty and pretty; white, tinged rose; very double and full.

Gracilis.—Low-growing, compact; covered all over with pure white, bell-shaped flowers.

Lemoinei.—Flowers very large and produced in broad-based, cone-shaped heads of from 20 to 30 flowers each, of purest white.

Pride of Rochester.—Flowers very double and full; pure white, tinged with blush; great profusion.



Flower Spray, Pride of Rochester Deutzia.

DAPHNE (E).—Superb evergreen shrub of compact growth, bearing in early summer many bluish white flowers, highly perfumed, and very lasting. The sweet-scented shrub in existence. Hardy only west of the Cascades. (Not mailable.)

White or Pink. Each \$1.00 to \$1.50

HOLLY (E)—Ilex.—Beautiful small specimen tree for lawn planting. Attractive all the year because of their broad, glossy, prickly leaves, but most beautiful from November to April, when laden with bright scarlet berries.

English (Aquifolia).—Budded stock, guaranteed berry-bearing. Well balled and carefully packed.

Each, 1½ to 2 ft. \$2.00; 2½ to 3 ft. \$2.50 to \$3.00; specimen plants, 4 to 5 ft. \$5.00 to \$7.50. Not mailable—by express or freight charges collect.

HYDRANGEA HORTENSIA (D).—A handsome half-hardy Japanese shrub; most frequently seen in tubs and pots, and does well in somewhat sheltered place. Ornamental foliage and beautiful flowers in large trusses. (See cut.)

Hortensia Blue.—Large flowers; clear blue. Very popular.
75c to \$1.00. Specimens, \$1.50 to \$2.00

Hortensia White.—Pure white; large flower.
75c to \$1.00. Specimens, \$1.50 to \$2.00

Hortensia Pink.—A beautiful new pink from Japan. Large, free flowering.
Each 60c, 75c and \$1.00; extra large \$1.50 to \$2.00.

Schizophragma (Climbing Hydrangea).—
(See Climbers), page 108.



Hydrangea Hortensia

ABOUT PRICES.—The higher prices are for specimen plants, for a large display and immediate effect.

Hardy Flowering Shrubs—Continued



Hydrangea Paniculata Grandiflora.

HYDRANGEA—Cont'd.

Paniculata Grandiflora.—The grandest as well as the most popular of all shrubs, and hundreds of thousands of them are sold every year; excellent for hedges or massing; unsurpassed for the lawn; blooms in July and August, and continues in bloom for two or three months. The flowers are massive, cone-shaped, sometimes 10 inches in length, and changing from the original pure white to pink, and finally to a beautiful rich coppery red.

Each 35c, 50c and 60c

LILACS (D)—*Syringa*.—Everyone loves the lilac and no garden is complete without one or more. The new imported grafted varieties are very beautiful and produce magnificent large flowers.

Common White or Purple.

Each 60c to 75c; large specimens, \$1.00 to \$2.00.

Imported Budded Varieties.—Your selection following named varieties, 3 to 4-year-old select plants, 3 to 4 feet and up, \$1.00 to \$1.25; specimens, 4 to 6 feet, well branched, \$1.50 to \$2.00.

Charles X (Single).—A strong, rapid grower; leaves dark and shining; trusses large and rather loose; color rosy purple.

Marie LeGraye (Single).—Beautiful creamy white flowers of immense size.

Souvenir de Louis Spaeth (Single).—Immense trusses of a deep dark red.

Mme. Lemoine (Double).—Fine double white variety; very fragrant.

Michael Buchner (Double).—The best pale lilac or lavender.

President Grevy (Double).—Long trusses; double; beautiful blue rosy lilac or purple.

MAHONIA AQUILIFOLIA (E)—**Oregon Grape.**—Native of Oregon, and our state flower. Very valuable and desirable on account of its beautiful foliage and clusters of yellow flowers in spring, followed by blue-black berries. Choice plants, nursery grown, Each 50c to 75c; large, \$1.00 to \$1.50.

MAPLE (D)—*Acer Japonica*—**Japanese.**

A beautiful class of low-growing, shrub-like trees, having brilliant colored leaves, which retain their brightness from spring until fall. Nothing finer than these can be had for planting, either in groups or singly on the lawn.

Price: Any of the following varieties of Japanese Maples, choice plants, \$1.25 to \$1.50; specimen plants, \$2.00 to \$3.00.

Atropurpureum.—Deep maroon, palmate leaf.

A. Atropurpureum Variegatum.—Bright crimson, with deep maroon variegation.

A. Atropurpureum, Dissectum.—Deep maroon, richly fringed, thread-like leaflets.

A. Osaka-Zuki.—Light maroon, changing to blood red in fall; palmate leaf.

A. Scolopendrifolium Rubrum.—Dark red fine, ribbon-like leaflets.

PRIVET (Evergreen).—One of the best hedge plants; has small, pointed, evergreen leaves; grows rapidly and compactly; stands severe pruning, and can be kept in fine shape with little care. (See cut.)

1-year-old plants, 12 inches up, per 50, \$2.00; per 100, \$3.50; 2-year-old plants, 24 inches up, per 50 \$4.00; per 100 \$6.00.

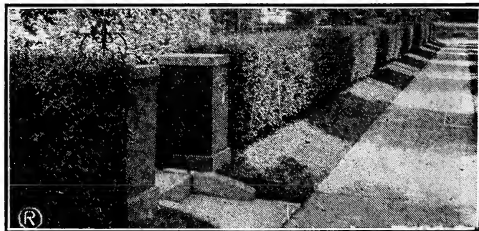

Privet Hedge.

QUINCE (D)—*Cydonia*.

Japonica (Japan Quince).—Popular shrub, which blooms profusely in early spring; flowers dazzling scarlet; makes an excellent hedge. Each 50c, 60c and 75c

SHADE TREES.—We have thousands of all kinds of shade trees for street and park planting. Evergreens, etc., descriptive list on request.

RHODODENDRONS (E).—This, wherever known, is universally acknowledged to be the most showy, magnificent, hardy evergreen shrub that grows. The broad, thick, evergreen foliage with its glossy richness, would alone entitle it to a place foremost in the rank of evergreen shrubs, but when, in May and June, this mass of luxuriant foliage is almost hidden by the magnificent array of beautiful flowers in all colors from white to purple, the effect is simply grand. We import from Holland the choicest and best-named varieties.

Choice Named Varieties.—Strong and bushy, well set with flower buds that will flower nicely the first year; your selection of colors in **White, Pink, Rose,** bright or dark **Red, Lavender, Eosy, Lilac** or **Purple.**

PRICES:—Freight or express only charges collect (not mailable). Two foot plants \$1.50 each; select, \$2.00 each; extra select, \$2.50 each; extra large specimens, \$3.00 to \$5.00 each.

SPIREAS (D).—Graceful shrubs, everyone should plant. They are of the easiest culture, and very desirable in collections. All the Spiraeas bloom with a riotous extravagance which makes them quite striking. Their individual style, color and habits of growth differ so markedly, that a collection of varieties will ensure bloom the entire season.

Anthony Waterer (Bumalda).—Covered nearly the whole growing season with large umbels of deep crimson flowers. Each 75c

Franifolia (Bridal Wreath).—Slender, erect ingrowing variety, bearing very early in the spring, small double white flowers the entire length of its branches; very graceful habit. Each 50c to 75c

Van Houttei.—The grandest of all the Spiraeas. It is a beautiful ornament for the lawn at any season, but when in flower it is a complete fountain of white bloom, the foliage hardly showing; perfectly hardy and an early bloomer. (See cut.) Each 50c to 75c



Spirea Van Houtte.

Thunbergii.—Of graceful habit; the branches are slender and somewhat drooping; foliage in autumn changes to bright red and orange; flowers in feathery masses, white, appearing early.

Each 50c to 60c

SNOWBALL (D)—Virburnum.

Sterilis (Common Snowball).—Blooms in latter part of May. Flowers pure white, large balls. Every one should plant a Snowball.

3 to 4 ft. each 50c to 75c; extra choice plants, \$1.00 to \$1.25.

Plicatum (Japanese Snowball).—One of the most charming hardy flowering shrubs in existence; bears great wreaths and clusters of pure white globular masses of flowers; covered with bloom for weeks in the spring; grows 4 to 6 feet high; entirely hardy.

2 ft., 60c to 75c; 2 to 3 ft., \$1.00 to \$1.25



Viburnum Plicatum—Japanese Snowball.

OTHER NURSERY STOCK.—We have all kinds of Shade and Ornamental Trees and Shrubs, Evergreens, etc. Descriptive list on request.

WEIGELA (D) — (Diervilla).—Beautiful shrubs that bloom in May, June and July. The beautiful trumpet-shaped flowers are produced in so great profusion as to almost entirely hide the foliage. They are very desirable for the border or grouping, and as specimen plants.

Prices: Following kinds, Each 40c to 60c; extra large plants, 75c to \$1.00.

Candida.—Beautiful white flowers; a continuous and profuse bloomer; very hardy.

Rosea.—Lovely large, rose-colored flowers, borne in such profusion that the whole bush appears a mass of rosy bloom.

WALNUTS (D).

English.—Nut-bearing, second-generation stock, not grafted.

Prices: Each 4 to 5 ft. 60c; 6 to 8 ft. 75c to \$1.00; 8 to 9 ft. \$1.25.

Grafted Stock.—This year we are prepared to supply you with **Oregon grown** trees that are extra select and **ESPECIALLY FINE ROOTED**, much superior to the California trees on account of the fine growth of strong fibrous roots. The stock we offer is **Voorman's famous Franquette** grafted on California black walnut roots.

Prices: 4 to 6 ft. \$1.25; 6 to 7 ft. \$1.50; 8 to 9 ft. \$2.00.

YUCCA (E).—Adam's Needle.

A stately foliage and flowering plant equally imposing in solitary or group plantings, always conspicuous. The broad sword-like foliage is evergreen; while midsummer shows great erect branching stems bearing a showy display of pendant, creamy-white bells.

Prices: Small plants, 8 to 10 in., 25c each; 2-year and up 35c to 50c; 18 to 24 in. 75c to \$1.50; specimen plants, \$1.50 to \$2.50.



Yucca Plant, in Bloom.

Beautiful Hardy Climbing Vines

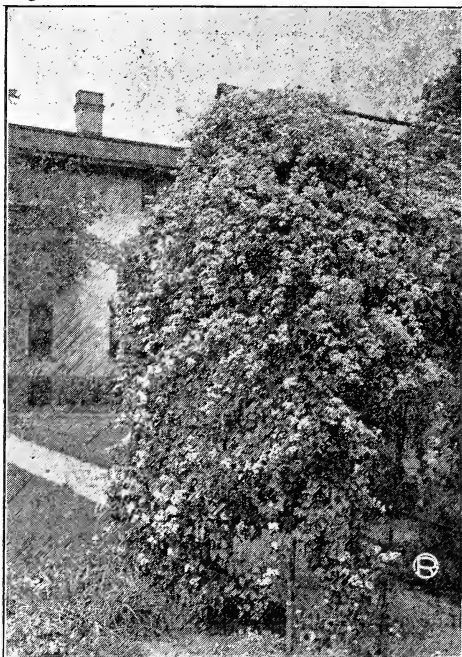

Clematis Paniculata.

CLEMATIS (Virgin's Bower).—No hardy flowering climbing vine excels in beauty and effectiveness the finer sorts of Clematis. As a climber for the veranda, a screen for fences, for pillars along the garden walks, for training on walls or arbors or in masses on rockwork, it has no rival among strong growing blossoming plants. The Clematis should be grown in rich, deep, sandy loam and well mulched with rotten manure in winter. The richest sheets of bloom and largest flowers are obtained where it has partial shade and a liberal supply of water at the roots.

Paniculata (New Sweet-Scented Japan Clematis).—Of very rapid growth quickly covering trellises and arbors with handsome, clean, glossy, green foliage. The flowers are of small size, pure white, borne in profusion in September and October, and of a most delicious and penetrating fragrance. Choice plants 35c; large 2 to 3-year-old plants 50c to 75c each.

C. Montana.—A hardy rapid grower, flowers snow white, fragrant and freely produced in May and June.

Strong plants, 60c to 75c

Montana Rubens.—New, same as above, except in color, which is of a pleasing shade of soft rosy red. Each 75c

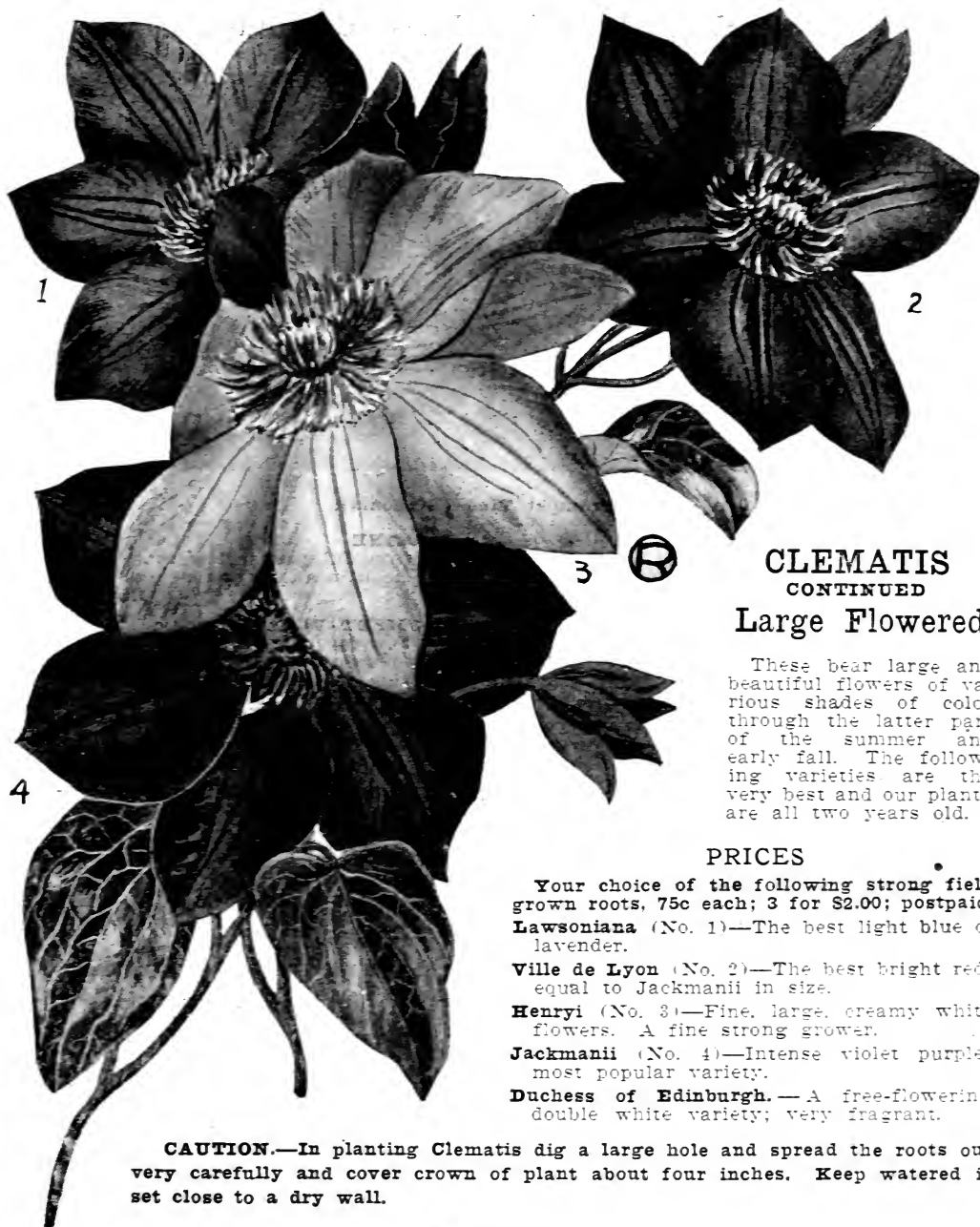

CLEMATIS CONTINUED Large Flowered

These bear large and beautiful flowers of various shades of color through the latter part of the summer and early fall. The following varieties are the very best and our plants are all two years old.

PRICES

Your choice of the following strong field grown roots, 75c each; 3 for \$2.00; postpaid.
Lawsoniana (No. 1)—The best light blue or lavender.

Ville de Lyon (No. 2)—The best bright red; equal to Jackmanii in size.

Henry (No. 3)—Fine, large, creamy white flowers. A fine strong grower.

Jackmanii (No. 4)—Intense violet purple; most popular variety.

Duchess of Edinburgh.—A free-flowering double white variety; very fragrant.

CAUTION.—In planting Clematis dig a large hole and spread the roots out very carefully and cover crown of plant about four inches. Keep watered if set close to a dry wall.

AMPELOPSIS

Veitchi (Boston Ivy, or Japan Ivy).—The most popular and desirable climbing plant for covering brick, stone or cement walls, etc.; when it becomes established at the root it is of very rapid growth and clings to the smoothest surface. The foliage is of a rich olive green during the summer, changing to various shades of bright crimson and scarlet in the fall. In planting cut back to within 6 inches of the ground, so that the new growth may cling to the wall from the bottom up.

Strong plants, 35c; extra strong 50c

Quinquifolia (Virginia Creeper, or American Ivy).—This well-known climber is one of the best and quickest growing varieties for covering trees, trellises, arbors, etc.; its large, deep green foliage assumes brilliant shades of yellow, crimson and scarlet in the fall.

Strong plants 35c; extra strong 50c

Engelmanni.—Very much like the above, but on a rough surface it will cling without support in the same way as the Veitchi.

Strong plants 35c; extra strong 50c

"MAKE 'EM HOP."—If you will mix a cup full of Wonder Fertilizer with 5 lbs. "C-M" and work both thoroughly into the soil around your climbers you will get wonderful growth and lovely flowers. See pages 33-39.

Hardy Climbing Vines—Continued



Trumpet Vine (Bignonia).

CLIMBING HYDRANGEA

Schizophragma.—This bears large panicles or trusses of flowers, which resemble a white Hydrangea. It clings readily to any rough surface or wall, flowering freely during July and August. Large imported plants \$1.00 each; pre-paid \$1.35.

HONEYSUCKLE

A beautiful climber, rapid grower and very desirable; flowers very fragrant, and produced in great profusion. Your choice of the following, 50c each; extra strong 60c to 75c.

Halleana.—Very popular; almost evergreen; profuse bloomer; flowers white, passing to yellow.

Belgica (Monthly Fragrant).—Flowers are large; color red and yellow.

Sempervirens (Scarlet Trumpet Honeysuckle).—Flowers of a bright scarlet.

Flava (Yellow Trumpet).—A choice but scarce species, with bright yellow flowers.

IVY EVERGREEN

Common English.—Thick, leathery, evergreen leaves; strong grower.

Good roots, each 15c to 25c; large 50c

WISTARIA

A rapid, hardy climber that will grow to a height of 50 feet or more. The fine foliage and flowers are produced early in the season and come in magnificent clusters. One of the most desirable and showy climbers we know of.

Multijuga.—This valuable new Wistaria was introduced from Japan and produces magnificent racemes of lovely flowers, often measuring 18 to 24 inches in length.

WHITE OR PURPLE—budded stock from Japan \$1.00 to \$1.50; extra large and strong \$2.00 to \$2.50.

American Grown.—2-year, 75c.

Sinensis.—Lovely panicles of flowers, produced in the most wonderful profusion. **WHITE OR PURPLE**, strong, 2-year vines 75c; extra heavy \$1.00 to \$1.50 each.

Important.—When planting Clematis and other vines be sure you spread out the mat of fine roots so that the soil comes in contact with all of them, otherwise they will dry out and die. Be very careful with Clematis especially. Use "Wonder" and "C-M," pages 38-39.

JASMINE

Graceful, pretty flowers with fine foliage, clean, neat, attractive and hardy.

Each 50c to 60c

TRUMPET VINE—Bignonia

For covering unsightly places trellises, rockwork or wherever a showy-flowering vine is desired, the Bignonias will be found very useful. The flowers are large, attractive and borne profusely when the plants attain a fair size.

Strong plants, each 50c to 75c

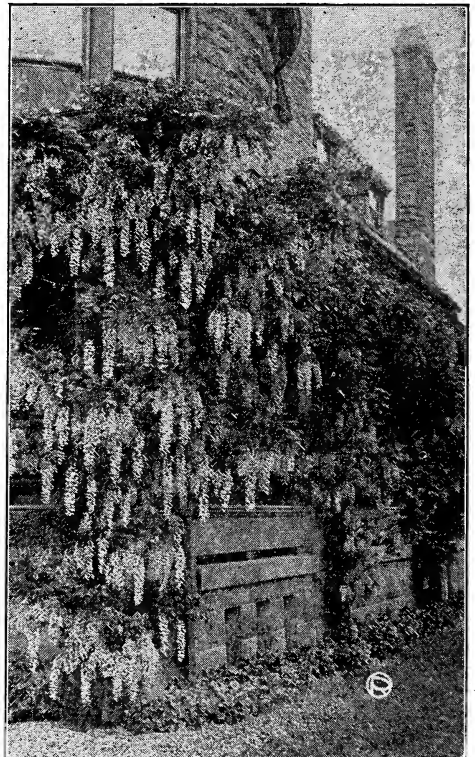

Wistaria Vine in Bloom

FRUIT TREES, BUSHES, VINES AND PLANTS

We are making a specialty of select fruit stock. This branch of our business has made immense growth. Our manager has been in this line of work in Oregon for over 20 years. Aside from large stocks grown for us on contract, we are in close touch with the largest, most reliable and careful growers. We know where the best stock is produced.

We again call your attention to the fact that we are catering to the "Particular Planter," who wants "High Quality," and is willing to pay a price necessary to secure it. Any sensible person knows that "Highest Quality" in stock of any kind is more expensive to produce than common, and therefore is worth more. Our prices are low, quality considered.

SUBSTITUTION If the varieties of the tree ordered cannot be supplied or bought locally, others equally as good and correctly labeled will be substituted, unless otherwise ordered.

Other Varieties.—On this and the following pages you will note that we give full description of only a few varieties under each heading. These, we believe, are the best for general or home planting, and you will not miss it by selecting them. We, however, will try and secure for you any variety grown in the West.

APPLES

Unless otherwise priced	Each	Doz.
One year old, 3 to 4 feet.....	\$.20	\$2.00
One year old, 4 to 6 feet.....	.25	2.50
Two year old, branched.....	.30	3.00
Selected, 2 to 3 year.....	35c to 50c	

Write for our low price by 100 or 1000.

SUMMER VARIETIES.

RED ASTRACHAN. Medium, deep crimson, flesh white, moderately juicy, with an agreeable rich acid flavor; very productive.

YELLOW TRANSPARENT. Medium size, roundish, slightly conical; skin pale yellow, flesh tender, juicy, sub-acid; good.

AUTUMN VARIETIES.

***GRAVENSTEIN.** Large, beautiful yellow, dashed with deep red and orange; tender and crisp, with a highly aromatic flavor; tree very vigorous; very popular sort.

KING OF TOMKINS COUNTY. Very large, globular; yellowish, shaded with red; flesh yellowish, rather coarse, juicy, rich flavor.

WEALTHY. Medium, whitish yellow, shaded with deep red; flesh white, tender and juicy.

WINTER VARIETIES

***BALDWIN.** Large, rounded; deep, bright red; very productive; one of the best and most popular winter apples.

DELICIOUS. A splendid apple; coming into prominence rapidly. Tree vigorous and hardy and the fruit equals the name in every respect. Fine for market and home use; late; keeps till April.

NORTHERN SPY. Large, round, greenish-yellow, stripes of purplish red; flesh white, juicy, brisk sub-acid; valuable for market and cooking.

ORTLEY (White Bellflower). Fruit medium to large, yellow; sometimes with a sunny cheek; flesh white, fine-grained, tender, juicy, sub-acid.



WINTER VARIETIES—Continued.

SPITZENBERG. Large, oblong, yellowish ground with broken stripes of bright red; flesh yellow, juicy with a delicious rich flavor.

WINTER BANANA. Winter; yellow; bluish cheek; sub-acid; medium size; a good keeper; a handsome apple; fine flavor, tender and delicious.

YELLOW NEWTOWN PIPPIN. Large, skin smooth, golden yellow; flesh firm, crisp, juicy; one of the standard varieties.

ARKANSAS BLACK. Dark maroon; long keeper; good.

GRIMES' GOLDEN. Of the highest quality; large, yellow.

JONATHAN. Yellow, covered with red stripes.

RHODE ISLAND GREENING. Greenish yellow; large.

ROME BEAUTY. Large, yellow, shaded bright red.

WINESAP. Yellow ground, streaked with red.

NOTE—1917 STOCK.—On account of the very dry summer most fruit trees and bushes did not make their usual tall growth. However, the "root growth" was good and they "cured up" in excellent condition; but don't expect as large stock as usual.

CRAB APPLES

Prices the same as Apples on page 109.

GIBBS.—Of superior merit. Large size, flattened on both ends. Color, orange; flesh, yellow; juicy and good. Productive annual bearer.

TRANSCENDENT.—Fruit very large, skin yellow, striped with red; the best of its class for cider.

Yellow Siberian.—Fruit small, golden yellow.

FLORENCE.—Size medium, red striped, early bearer; bearing full crop each year; tree immensely productive; juicy and crisp.

Hyslop.—Large, dark crimson; popular.

APRICOTS

Unless otherwise priced	Each	Doz.
1-year-old, 4 to 6 feet.....	.30	3.00
2-year-old	\$0.35	\$3.50
Selected50	

MOORPARK.—Very large, yellowish-green; brownish red on the sunny side; flesh bright orange; fine for canning and drying; freestone.

LEWIS.—One of the largest apricots known; handsome in appearance; flavor excellent. If you have room for only one apricot tree, plant the Lewis.

Price, 1-year 60c; 2-year 75c

Royal.—Above medium size; sweet, rich and juicy.

Tilton.—Large, rich color, high flavor; very productive.

Manning, Ore., Feb. 11, 1917.

Routledge Seed & Floral Co.,

Gentlemen: The "Clark Seedling" Strawberries we got from you last spring look splendid this year.

Yours truly,
WM. L. SCARTH.

Mt. Angel, Ore., Feb. 19, 1917.

Routledge Seed & Floral Co.,

Gentlemen: We received the bundle of trees and are very much pleased with them. They are nice trees.

Yours respectfully,
VOLNA J. WHITE.

CHERRIES

Unless otherwise priced	Each	Doz.
1-year-old, 3 to 4 feet.....	\$0.40	\$4.00
1-year-old, 4 to 6 feet.....	.50	5.00
2-year-old, branched75	7.50
Selected, 2 to 3 year.....	1.00 to 1.25	

Write for our low prices by 100 or 1000.

BING.—Originated in Oregon; fruit large, dark brown or black; very fine; late; a good shipping variety.

KENTISH (Early Richmond).—Light red, juicy; one of the best acid cherries and unsurpassed for cooking purposes; very productive.

LAMBERT.—Fruit of largest size and of fine quality; color deep, rich red; flesh firm and of fine flavor; a fine market variety; ripens two weeks later than Royal Ann.

MAY DUKE.—Large, rich, dark red; flesh tender, juicy, and sub-acid; an excellent variety, and one of the earliest of its class.

MONTMORENCY.—A beautiful, large, red, acid cherry; larger and finer than Early Richmond, and fully ten days later. Being extraordinarily prolific and very hardy, it can be recommended as a variety of great value. Valuable for canning and preserving. A free grower.

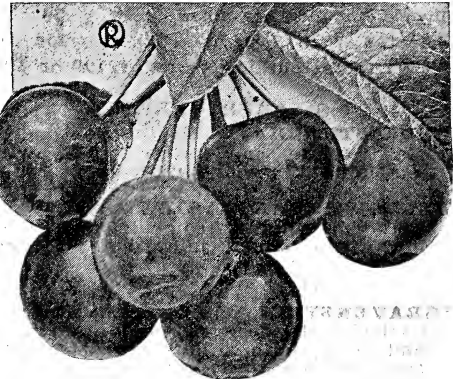

LATE DUKE.—Large, light red; late and excellent; sub-acid.

MILLERS LATE.—This new cherry resembles the Late Duke in color, shape and flavor, but it is a larger and later variety, which makes it very valuable and desirable.

ROYAL ANN (Napoleon Bigarreau).—A magnificent cherry of the largest size; pale yellow, becoming amber in the shade; richly dotted and spotted with deep red, and with a bright red cheek; flesh very firm, juicy and sweet; tree a rapid grower and immense bearer.

QUINCE

1-year-old	Each	35c to 50c
2-year-old, branched		50c to 60c
Extra Select		75c

CHAMPION.—Large, yellow; flesh cooks very tender; flavor is most delicious; more productive than the orange, ripening two weeks later.

PINEAPPLE.—The fruit in form and size resembles the Orange Quince, but is smoother and more globular. Makes a superior jelly. Can be eaten raw, and is said to cook as tender in five minutes as the best cooking apple, possessing a most exquisite and delicious flavor, not equaled by any other quince.

RAISE CLEAN, PERFECT FRUIT BY SPRAYING—Don't let the bugs get started. **SPRAY EARLY.** We offer you a complete line of insecticides and sprayers at low prices, pages 126 to 130.

PEARS

Unless otherwise priced	Each	Doz.
One year old, 3 to 4 feet.....	\$.35	\$3.50
One year old, 4 to 6 feet.....	.40	4.00
Two year, branched50	5.00
Selected two year	50c to 75c	

SUMMER VARIETIES

BARTLETT.—Large, skin thin, clear, lemon yellow, with soft blush on the sunny side; flesh white, buttery, very juicy and highly flavored; the best summer pear in existence.

CLAPP'S FAVORITE.—Fine-grained and melting.

SECKEL.—Rich and highly flavored; its highly concentrated, spicy, honey flavor is unequalled; skin brownish green, russet brown cheek; flesh whitish, buttery and melting.

AUTUMN AND WINTER VARIETIES

FLEMISH BEAUTY.—Large, juicy, rich, very hardy, productive and profitable. September-October.

BEURRE CLAIRGEAU.—Large, yellow, shaded with orange and crimson; covered with russet dots; flesh yellowish, buttery, juicy; October-November.

BEURRE D'ANJOU.—A large, fine pear, buttery and melting, with sprightly, vinous flavor; tree a fine grower and good bearer; one of the very best; October-January.

COMICE.—A splendid commercial variety, being of fine size; good appearance; ships well; October.

FALL BUTTER.—Favorite fall pear; yellow, smooth and juicy; September.



Bartlett.

WINTER BARTLETT.—Originated in Eugene, Oregon. Fruit large, closely resembling the famous Bartlett in shape and appearance, but ripening considerably later; tender, juicy and melting and with a most pleasing flavor.

WINTER NELLIS.—Medium; skin yellowish green, dotted with gray russet; flesh yellowish white; fine grained and abounding with juice of a rich saccharine, aromatic flavor; especially adapted to this valley, producing large crops every year; an excellent shipper and good keeper; November-December.

PRUNES

Unless otherwise priced	Each	Doz.
1 year old, 3 to 4 feet.....	\$.25	\$2.50
1 year old, 4 to 6 feet.....	.30	3.00
2 year old, branched.....	.35	3.50
Selected 2 year old	50c to 60c	

Write for our low prices by 100 or 1000.

GIANT.—New; of immense size, dark crimson on yellow ground; good yielder; flesh firm, rich, sweet, delicious; good shipper.

HUNGARIAN.—Very large, dark red; juicy and sweet.

ITALIAN (Fallenberg).—Medium, oval, tapering at both ends; dark purple; flesh greenish yellow; separates freely from the stone; best for drying.

PETITE (French).—Small size, egg-shaped; violet purple; sweet, rich and sugary; very productive; standard for drying.

SUGAR.—Tree vigorous grower; early bearer; fruit ripens earlier than the French; is four times as large and dries in half the time; flesh tender and rich in sugar; color dark purple; August.

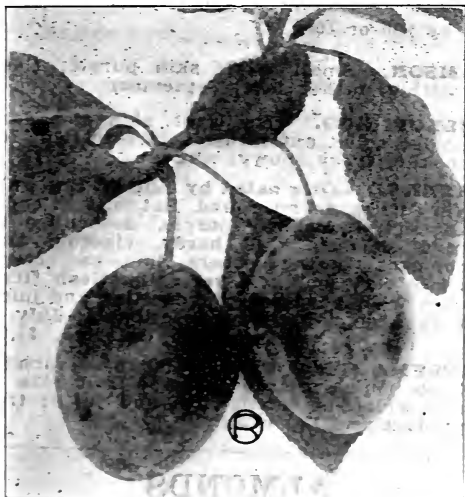

Italian.

Marshfield, Ore., March 12, 1917.
Routledge Seed & Floral Co.,
Gentlemen: Received the order of Fruit and Berry Plants in fine shape. Was very much pleased with them.

MRS. FRANKIE LATTISS.

SPRAY PUMPS—We carry in stock a complete and up-to-date line of hand, bucket and barrel spray pumps—see pages 128 to 129.

PEACHES

Unless otherwise priced	Each	Doz.
1 year old, 3 to 4 feet.....	\$.20	\$2.00
1 year old, 4 to 6 feet.....	.25	2.50
2 year old, branched.....	.35	3.50
Selected 2 year old.....	40c to 50c	

Write for our low prices by 100 or 1000.

EARLY CRAWFORD.—Very large, yellow; with red cheek; flesh sweet and excellent; our most popular peach for table and canning; freestone.

ALBERTA.—Very large, bright yellow, red cheek; flesh yellow, juicy, sweet; regular bearer; fruit very showy and perfect; freestone; early.

EARLY CHARLOTTE.—An improved seedling from Early Crawford, originated at Salem, Ore. This remarkable peach succeeds in Oregon, where many other varieties fail. Flesh yellow, melting and juicy, with a rich and excellent flavor; freestone; ripens ten days after Crawford's Early.

LATE CRAWFORD.—Very large, roundish; yellow, with dark red cheeks; flesh deep yellow, juicy and melting; flavor rich and excellent; very popular; valuable for canning and drying; freestone; September.

GOLDEN CLING.—Good size, round; skin yellow; flesh fine-grained, firm, rich and sugary; clear yellow to the pit, which is very small; clingstone.

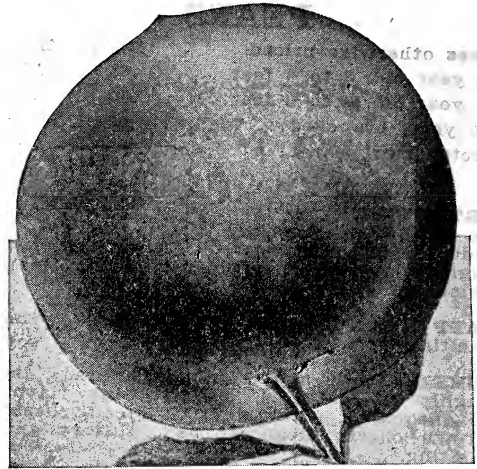

HALE'S EARLY.—Skin greenish white, red cheek, flesh white; juicy and sweet; semi-freestone; very early and good.

MUIR.—Large, pale yellow, very firm and sweet; best for drying; freestone; August.

SALWAY.—Creamy yellow, red cheek; flesh deep yellow, red at the pit; rich and sweet; a standard late peach; freestone.

PLUMS

Unless otherwise priced	Each	Doz.
One year old, 3 to 4 feet.....	\$.25	\$2.50
One year old, 4 to 6 feet.....	.30	3.00
Two year old, branched35	3.50
Selected, 2 to 3 years	50c to 60c	

Write for our low prices by 100 or 1000.

BURBANK.—Largest and handsomest of the new plums; perfectly hardy, free from disease; juicy, tender and sweet; ripens early July; as fine eating as a peach; freestone; should be in every collection.

COE'S GOLDEN DROP.—Large and handsome; light yellow; firm, rich, sweet; one of the best of late plums; last of September.

COLUMBIA (Shippers' Pride).—Largest size, nearly globular; brownish purple; rich, sugary, freestone; August.

GREEN GAGE.—Small, round; flesh pale green, melting and juicy; freestone; August.

PEACH.—Very large; skin brownish-red, slightly coarse-grained, but juicy; freestone; very popular as a home and market variety; August.

DAMSON. Small, oval; skin purple; flesh melting, rather tart; September

YELLOW EGG. Very large, skin of a deep golden color, but rather acid; excellent for cooking; very showy; August.

MAYNARD.—Originated by Luther Burbank. Very large, nearly round, flattened at ends. Of richest crimson-purple, deepening to royal damask. Tree hardy, vigorous and compact grower; bears immense crops while very young; never fails; flesh firm, even when dead ripe, but melting and juicy with a deliciousness indescribable; July. Price 75c; selected, \$1.00

SATSUMA (Blood Plum). Japanese variety. Quite popular, large dark red from skin to pit, which is small, firm and juicy; tree productive. Early July.

NECTARINES

Prices—4 to 6 feet, each 40c; doz., \$4.00.

BOSTON.—Large, deep yellow bright bluish; flesh yellow; very rich and luscious. Best for Oregon; August.

EARLY VIOLET.—Medium; skin pale, shaded violet; flesh white; good; July.

ALMONDS

Almonds can be grown successfully in most sections of Oregon and Washington, and are attracting much attention from commercial orchardists. Select Trees, 4 to 5 feet, each 35c to 50c.

I. X. L. A vigorous grower and sure cropper, producing nuts of large size and handsome appearance; shell thin; most popular.

SAVE SUGAR AND GLASS JARS—Make money by drying your surplus fruit and vegetables in an **OAKES SANITARY EVAPORATOR**. See page 123.



Oregon Champion

GOOSEBERRIES

Unless otherwise priced	Each	12	100
1 year old	\$.15	\$1.00	\$8.50
2 year old	.20	1.50	10.00
Extra Selected	.25	2.50

Write for our low price per 1000.

OREGON CHAMPION.—Berries large, round and pale green; fine for table use and pies; hardy, strong, and a very prolific bearer; most popular and best commercial variety. Low prices by the thousand. Write.

DOWNING.—Large, light green; soft, juicy and good. Vigorous and very productive.

RED JACKET (Josselyn).—Of large size, smooth, prolific and hardy; of best quality; a wonderful cropper, with bright, clean, healthy foliage.

Prices: 1-year each 20c; per doz. \$1.50
2-year each 25c; per doz. \$2.25

INDUSTRY.—English variety; large oval; dark, red, hairy, rich and agreeable; vigorous and productive.

Prices: 1-year each 20c; per doz. \$1.50
2-year each 25c; per doz. \$2.00

CURRENTS

Low prices by the thousand.

Unless otherwise priced	Each	12	100
One year old	\$.15	\$1.25	\$7.50
Two year old	.20	1.75	8.00
Extra large selected bushes	.25	2.50

BLACK NAPLES.—Very large, black; valuable for jams and jellies.

CHERRY.—Large, deep red; rather acid; fine for preserving; valuable market variety.

FAY'S PROLIFIC.—A new Currant, larger than the Cherry; has less acid, and is more prolific.

WHITE GRAPE.—Large, yellowish-white, valuable for the table; the finest of the white sorts.

PERFECTION.—New; a late introduction of great merit. Our grower says: "You cannot say too much about the good qualities of this grand new sort." So, whether you plant ten or a hundred, plant a good proportion of Perfections, which is the largest, most productive, finest-flavored rich, mild, sub-acid; plenty of pulp; few seeds), healthy, bright red currant to date.

1-year, each 20c; per doz. \$1.50; per 100 \$10.00

2-year, each 25c; per doz. \$2.00; per 100 \$15.00

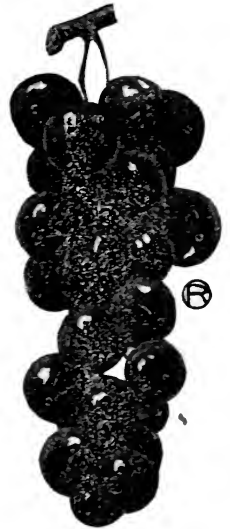

Oak Point, Wash., Feb. 2, 1917.
Routledge Seed & Floral Co.,
Gentlemen: The trees I bought from you a few years ago are doing fine and I am well pleased with them. I would not buy anything from an agent. You do well not to send out any.

Yours very truly,
ARTHUR WHEELER.

PERSIMMONS

These are perfectly hardy and do well here. We can supply the American or larger Japanese varieties. Price, 4 feet, 60c each.

FERTILIZE the ground and SPRAY the fruit if you want a large, profitable, satisfactory crop.

BLACKBERRIES

Unless otherwise priced	Each	Doz.	100
1 year	\$.15	\$1.00	\$6.00
Extra strong20	1.50	8.00

LAWTON. The favorite market variety; large, good quality, uniform, hangs long on vine when ripe, productive and profitable. The most generally planted for commercial markets in the Pacific Northwest. Oregon's most popular kind.

ELDORADO. New. Very vigorous and hardy; yield is enormous; berries large, jet black, borne in large clusters, and ripen well together; sweet, melting and pleasing to the taste; no core, and keep eight or ten days after picking with quality unimpaired. Select, price, 25c each; \$2.00 per doz.; \$10.00 per 100; 1 year, each 20c; per doz. \$1.50; 100 \$8.00.

EVERGREEN. Introduced from Oregon; beautiful lacinated foliage, which it retains all winter; berries long, black, sweet, rich and delicious; ripens from July to November; a fine berry for family use. Select, each, 20c; doz. \$1.60; 100 \$10.00; 1 year, each 15c; doz. \$1.25; 100 \$8.00.

HIMALAYA GIANT. A new grand variety; an exceedingly strong, rampant grower of a trailing nature; a heavy cropper; the berries are large, juicy, coreless, sweet and firm, with a delicious aromatic flavor. Its deep-rooting qualities enable it to produce a large, firm berry even in a very dry season.

Select, price 20c each; \$1.60 per doz.; \$10.00 per 100; 1 year, each 15c; doz. \$1.25; 100 \$8.00.

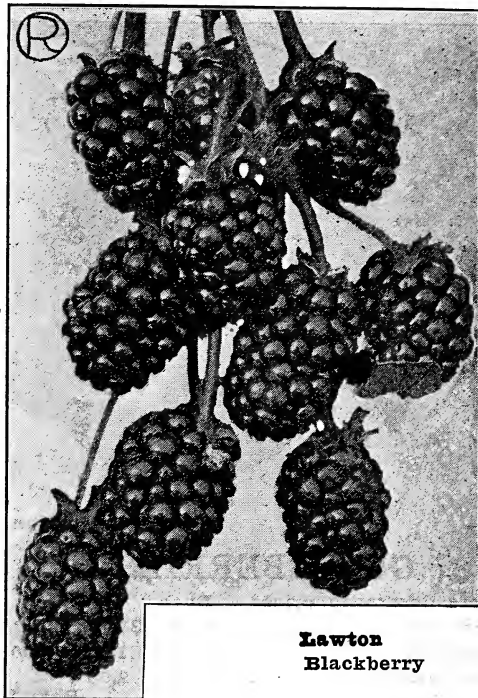

Lawton
Blackberry

Plant a Few of These Delicious Berries

Trail Them On the Garden Fence or Over a Trellis.

PRICES—Your Choice of the following, strong, transplanted 2 year plants 20c each, \$1.65 doz., \$10.00 per 100. Write for special quantity prices. Tips or 1 year roots give poor results—we do not offer them.

Loganberry

In great demand again for canning and drying. An exceedingly strong grower and an enormous bearer. The fruit is larger and longer than the blackberry and produced in immense clusters; color, dark red. Has a pleasant, vinous flavor, delicious and peculiar to this berry alone; fruit ripens early. It is excellent for the table, eaten raw or stewed, and for jelly or jam is without an equal.

Burbank's Phenomenal

A most desirable, refreshing berry for the home garden. Of a bright crimson raspberry color; very productive, and most delicious of all berries for pies, canning, jellies or jams. Sweeter than the Loganberry and fine as a fresh table fruit.

New Mammoth Blackberry

A grand addition to the list of Blackberries. The handsome, large juicy berries are delicious. It is a rampant grower, of trailing habit; enormously productive and early. Fruit is enormous, specimens measuring two and one-half inches long; seeds small, soft and abundant; cores small and soft. In size and flavor it surpasses all other varieties of blackberries. Excellent for home use.

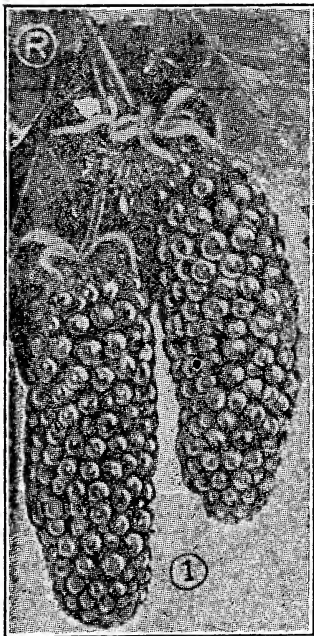

New Mammoth.

DEWBERRY

LUCRETIA.—Fruit ripens between the raspberry and the blackberry. Berries large, handsome, sweet and luscious; trailing vines.

Selected, each 15c; per doz. \$1.50; \$10.00 per 100; 1 year, each 10c; doz. \$1.00; 100 \$8.00.

NOTE.—Our 2-year-old Logan-Phenomenal and Mm. Blackberry plants are transplanted tips grown 1 year in nursery row and all will live.. They are cheaper than "tips" at any price. "Tips" will not ship safely.

RED RASPBERRIES

	Each	12	100
1 year	\$.10	\$1.00	\$7.00
Extra strong15	1.25	8.00

Very low prices per thousand.

CUTHBERT. Berries very large, deep, rich crimson; good for shipping; the most popular of all raspberries; stands the sun and heat well.

MARLBORO. Very large and early; beautiful, bright scarlet; good quality; hardy and productive.

ST. REGIS (New)—The St. Regis everbearing raspberry is the sensation of the day. It is being talked about from the Atlantic to the Pacific. The demand is enormous. It is a very valuable variety. It originated in New Jersey among a colony of Italians who made money by selling the fruit to hotels and restaurants late in the fall after all other kinds of berries were gone. It is a fine berry in every respect, being hardy, very productive, of good color and fine flavor. It does finely in the regular season and you get the fall crop extra. We unhesitatingly recommend this variety. Price, each, 15c; doz. \$1.25; per 100 \$10.00. Select, extra strong, each 20c; doz. \$1.50.

SUPERLATIVE. (New.) The berry is large and firm, with very small, brittle seeds; color, soft crimson. The healthy, vigorous growth, remarkable productiveness, hardness, immense size, handsome, uniform shape and rich, luscious flavor makes the "Superlative" peerless among raspberries and from the shipper's standpoint a most desirable berry; disease resisting, and nearly a week earlier than the Cuthbert. Price, each 15c; doz. \$1.25; 100 \$8.00.

QUALITY—We call your attention to the fact that we are catering to the "Particular Planter," who wants "High Quality," and is willing to pay a price necessary to secure it. Any sensible person knows that "Highest Quality" in stock of any kind is more expensive to produce than common, and therefore is worth more. Our prices are low, quality considered.

GRAPES

Unless otherwise priced	Each	12	100
One year old	\$.15	\$1.50	\$10.00
Two year old20	2.00	12.50
Extra large and strong roots.....	.25c to	.35	

CAMPBELL'S EARLY. Clusters large and handsome; berries large, round, black, with purplish bloom; flesh firm but tender; seeds few; flavor rich, sweet and slightly vinous. A strong and vigorous grower and ripens its fruit early. Berries do not drop from the clusters, and fruit keeps a long time in perfection.

Price: 1 year, 25c each, \$2.50 doz.; 2 years, 35c each, \$3.00 doz.

CONCORD. Large, black grape, bunches compact, berries round, sweet and pleasant; very popular.

DELAWARE. Best of our native grapes; grows freely and is perfectly hardy; ripens early; berries small, light red.

MOORE'S EARLY. Bunch medium; berry large, resembling Concord, but more pulp, and is earlier.

OTHER GRAPES. It would take pages to list all the varieties of grapes grown on this Coast, especially in California. We list the most popular hardy sorts for general use.



BLACK RASPBERRIES

	Each	12	100
1 year	\$.15	\$1.25	\$10.00
Extra strong20	1.50	12.00

GREGG. For many years the leading standard best known market sort. Very productive, large size, firm, meaty berries, covered with heavy bloom.

CUMBERLAND. A healthy, vigorous grower, producing immense crops of magnificent berries. Fruit very large, firm and excellent quality, keeps and ships well. A most profitable market variety; mid-season.

KANSAS. Early blackcap and of superior quality; 10 days earlier than Gregg, coming in with the earliest reds. A most desirable and profitable new sort. Extra strong, each 20c; doz. \$1.50; per 100 \$12.00; 1 year, \$10.00.



NIAGARA. Berry large, pale yellow; flesh tender and sweet productive; one of the best white grapes.

WORDEN. Bunch very large and compact; berry large, black; an improved Concord.

NEW BOOK. Littooy's 48-pg. booklet, *New Raspberry and Blackberry Culture*. Written for Western conditions and endorsed by experts. Worth dollars to you. Only 45c postpaid

**SELECTED
STRAINS**

STRAWBERRY PLANTS

**BETTER
NONE**

Our strawberries are carefully grown trimmed and packed in the best manner to insure their arrival in good, fresh condition. If you want good, strong, healthy, vigorous plants and true to name, send to us. Our prices are right; our plants are O. K.

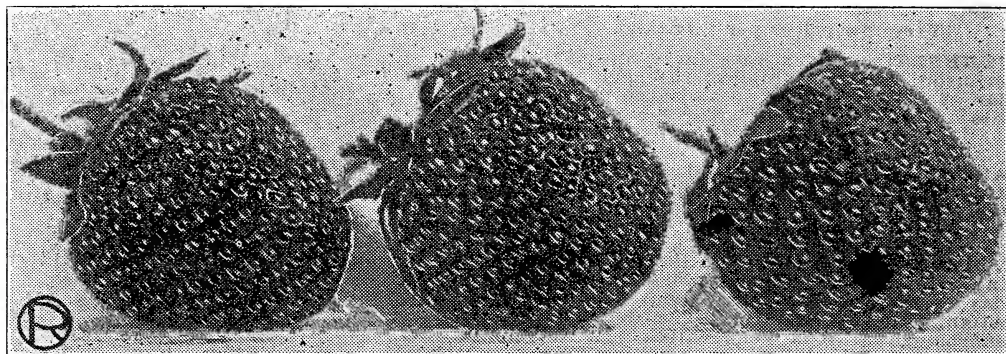

"Wellington Marvel," the Latest Strawberry With a Future.

"Marvel"—A New Strawberry of Great Merit

WELLINGTON'S MARVEL was originated by Wellington S. Butler of Merlin, Ore., a strawberry specialist. We have the exclusive sale of all his plants, and take great pleasure in introducing this really superb and meritorious new variety. In all our experience and observation, we have never seen the equal of the "Marvel" in color, shape, size and quality. The ripe berries command instant attention on account of the bright, fresh, delightful appearance. The commercial grower, who gets a start of this variety and markets the fruit, will reap a rich harvest.

BEST BY TEST. If we were to tell you how far ahead, how superior, the "Marvel" is over Clarks, Magoons, Oregon, Gold Dollar and such varieties, you would scarcely believe it. We claim there is no comparison at all. The "Marvel" is in a class by itself, and head and shoulders above all in Beauty, Flavor, and Production.

Wellington's Marvel is almost frost-proof. The foliage is heavy and spreading, and each fruit-stalk seems to be perfectly covered and protected.

Let us emphasize the word, "fruit-stalks." These can really be called "fruit-stalks" on the "Marvel" plants, for they are strong and sturdy, producing from 12 to 18 berries. Every plant in Mr. Butler's patch produces from 15 to 20 of these fruit-stalks. It is really amazing to gather the center foliage together and behold the enormous productiveness of the "Marvel."

The ruddy glow of the Marvel spreads evenly and leaves no white tips. It is very firm and a peerless shipper; excellent for canning.

A Two-Crop Variety—It ripens a monster crop of very early berries, after which, if the tops are cut off, plants cultivated and, if possible irrigated a few times, they will bloom again in July and produce a second crop, lasting until winter.

====The Right Place at Last====

Umpqua, Ore., Feb. 16, 1917.

Routledge Seed & Floral Co.,

Dear Sirs: Your Strawberry Plants arrived in good order and as you see I want some more. Also am sending an order for seeds. Have found it hard getting seeds true to name and am glad I have at last struck the right place.

Yours respectfully,

MRS. N. E. DURNAM.

Don't use plants from old berry fields. Buy our healthy vigorous, properly grown plants. The most profitable kind.

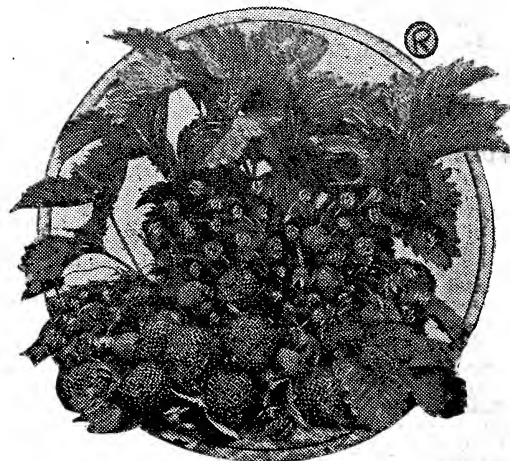

Wellington "Marvel" plant with some leaves removed to show mass of young fruit.

Prices for 1918

Three for 35c, 12 for \$1.00; 100 for \$7.50, prepaid. Order early. Our supply of plants is quite small this year.

BEWARE! To protect our customers, all Wellington Marvel strawberry plants will be marked with a printed wooden label, as follows: **Originator's Stock Wellington Marvel** on one side and our name, **Routledge Seed & Floral Co.**, on the other. Plants not marked thus **ARE NOT OUR TRUE STOCK.**

REPORTS ON THE "MARVEL"

"The most wonderful strawberry I have ever seen."

"I claim to be an expert on strawberries, but the 'Marvel' has never been equalled in perfection, color and quality."

"This certainly is a luscious berry."

"Put me down for 100 plants. The flavor is delicious."

"I will pay Mr. Butler a premium above market price for all the 'Marvel' berries he is growing."

Strawberry Plants—Continued

The New Everbearing Strawberries

This "new class" of strawberries is becoming more popular each year. Their long fruiting season and the grower's ability to secure berries when the market is high is their real value. Left alone they will flower and fruit the whole season, but to secure a **large crop** in the **late fall** keep the blooms off until the last of June.

Your choice, doz. 50c; 25 plants 75c; 50 \$1.25; 100 \$1.75, prepaid \$2.00; 1000, write.

SUPERB-EVERBEARING

This we believe is the **best of the everbearing** kinds. **Superb** is a truly wonderful fall bearing variety. It is doubly valuable as it yields heavily, early as well as late. This new **Superb** is really a true everbearer and gives a good supply of **choice, rich, red berries**, until stopped by heavy frosts in the fall. This everbearing strawberry has real merit and a good flavor and color. Growers who have tested it on this coast are **enthusiastic over it**. A very profitable variety.

PROGRESSIVE EVERBEARING

A leading and popular variety in this class. Berries, rich red in color, firm and of delicious flavor. Good keepers and shippers. You will find this berry in the Portland markets late in the fall when prices are very high.

Pendleton, Ore., Feb. 3, 1917.

Gentlemen: *The Marvel Strawberry I got of you last year, as well as the Superb Everbearing, done excellent. I picked over two quarts of berries though it was very late to plant.*

E. E. GERVAIS.

POPULAR, WELL-KNOWN OREGON-GROWN STRAWBERRIES

PRICE LIST—Your choice following varieties, **PREPAID**, doz. 25c; 25 plants 40c; 100, 50c. **NOT PREPAID**, 25 plants 35c; 100, 75c; 1000, \$5.00; 500 plants all one kind at 1000 rate.

CLARK'S SEEDLING. The berry that has made Hood River famous; excellent shipper; berries large, firm and of delicious flavor; vines bear large crops; is especially adapted to the Pacific Coast.

GOLD DOLLAR. One of the earliest berries on the market. Fruit good, medium size, and attractive; rather tart; fine flavor; foliage, heavy, large and spreading, which protects the blooms from early frosts.

OREGON IMPROVED. One of the finest and most satisfactory strawberries ever introduced. It always looks bright, fresh and attractive. The berry is very large, firm and handsome; rich, dark red, extending to the center. The flavor is rich, sweet and delicious. For table use and canning, it cannot be surpassed. The "Oregon" ripens early and continues in bearing until late in the season.

MAGOON. Berry large, fine and excellent; sub-acid flavor; bears heavily and throughout the season.

MARSHALL. One of our best Western varieties and very popular wherever known. Marshall is one of the blood-red varieties that never fails to attract the eye and to satisfy the taste. It is deliciously sweet, generously prolific, and is in every way an ideal variety for extensive planting or home garden. Excellent for canning, as it holds its color, shape and flavor.

WILSON. A heavy bearer of fine, moderate-sized berries; sharp acid flavor. Many prefer this sort for canning.

Route No. 1, Post Falls, Idaho,

Routledge Seed & Floral Co.

Dear Sirs: *Enclosed find Express Money Order for 1000 Strawberry Plants, which I wish you to send to me at once. I received the other order of Plants O. K. Was well pleased with them, so I want more Plants.*

Yours truly,

C. J. FRITZ.

W. S. Butler Does Not Approve Plan of Setting Plants in Fall. Claims Roots and Tiny Fibers Are Hurt by Removal.

Strawberries, he says, should be set in the spring instead of the fall.

"During the fall and until winter sets in," he says, "numerous hair-like rootlets convey the requisite elements from the soil to the crown of each plant for the formation of fruit buds. Digging plants while this important function is being exercised spells irreparable injury to the fruiting organism.

"Therefore, it is obvious that the breeding or propagating plot, where the plants grew and received the finishing touches of maturity, is their only safe habitat until spring. Fall-set plants, with their broken radicles, having only the cold, wet soil to nurse their wounds all winter, reach spring in a feeble state because of this violation of the laws that govern plant life. Severance of the tiny fibers from the roots in the spring is a benefit; in fact pruning them back about one-fourth to one-third strengthens the plant.

As to the treatment of plants received, Mr. Butler gives some of the following suggestions:

"Immediately on receipt of the plants open the bundles and put side by side in a V-shaped trench and cover all but the crowns with fine dirt. When the ground for setting is ready, dig them out with a fork and cut off with a knife or shears one-third to one-fourth of the roots, according to their size.

Care Insures Big Crop.

The ground for spring setting should be plowed in autumn and well enriched with stable or commercial fertilizer. In the following spring, as early as conditions will permit, work thoroughly and set the plants.

"The first runners should be removed, also all the 'bloom buds,' as fast as they appear during the season. One summer of intensive culture will insure a bumper crop of berries in the following spring."

DON'T be misled by the fine catalogs sent out from the East. Buy Western grown plants and Western varieties, better berries than ever grew in the East. We know it!

Why Not Raise Some Asparagus and Rhubarb

Every garden large or small should have at least a small supply. If you want special information on culture of these roots, we have **ASPARAGUS CULTURE**, by Hexamer, 174 pages, 60c, and **NEW RHUBARB CULTURE**, by Morse and Fiske, 130 pages, 60c.

ASPARAGUS ROOTS

One of the earliest and finest of spring vegetables; very easily grown. A bed once planted is good for years if properly attended to and well manured. Set plants 18 inches apart, in rows 3 feet apart.

ONE YEAR OLD.—Prepaid, dozen 35c; 50c 75c; 100 \$1.25. Not prepaid, dozen 25c; 100 \$1.00; 1000 \$8.00.

TWO YEAR OLD.—Prepaid, dozen 50c; 50 \$1.25; 100 \$2.00. Not prepaid, dozen 40c; 100 \$1.50; 1000 \$10.00.

Buy Roots and Save 2 to 3 Years.

HOP ROOTS

Regular Root Cuttings, price, 5c each; 40c per dozen; \$1.50 per 100. Low prices by the thousand.

Crown Roots give quicker results; each, 10c; dozen, \$1.00.

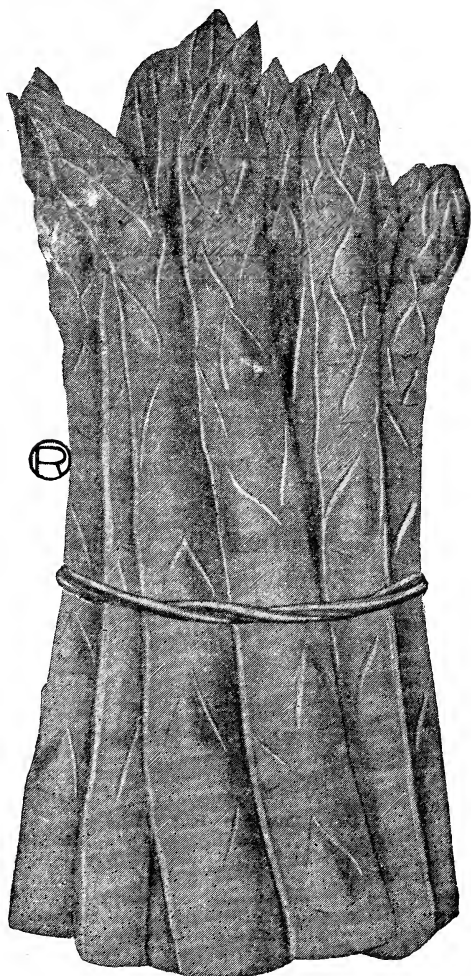

Asparagus Tips.

COW MANURE.—It is troublesome, disagreeable and expensive for the city gardener to get it. We offer "C-M." **THE REAL PRODUCT**, in most convenient form, free from weeds. Read page 39 carefully. **YOU NEED THIS FOR YOUR ASPARAGUS AND RHUBARB.**

HORSE-RADISH ROOTS

Plant in the spring 18 by 24 inches apart. Set the whole root small end down. Prices, 10c each; 50c per doz.; \$1.50 per 100. Low prices by the 1000.

RHUBARB

PIE PLANT—WINE PLANT

Plant in the fall or early spring from 3 to 4 feet apart, in the richest soil you have, or can prepare. New book: "Rhubarb Culture," a complete guide to dark forcing and field culture (well illustrated), 130 pages, 60c.

BANWINE RHUBARB—A Moneymaker

This comparatively new and very profitable rhubarb is claimed by our grower to be superior to all ordinary varieties and unequalled by any known marketable sort. The trueness of the strain is unquestionable, as it is only propagated from root divisions or growing buds from stock, that shows the **superior merits** of the parent stock.

Banwine is a quick, very early grower, producing very freely giant heavy stalks, that are exceedingly tender, brittle and of the finest flavor and color. A "peerless" rhubarb for home gardens or commercial plantings. Send for pamphlet giving testimonial and cultural directions.

PRICES: Divided Roots (Buds or Eyes, as they are often called), 15c each, 6 for 75c, 12 for \$1.25, postpaid; per 100 \$8.50. Large divisions and clumps, each 50c to \$1.50.

BURBANK'S CRIMSON WINTER

Very early medium size, brilliant crimson and of fine quality. Highly esteemed in California. Prices: Small roots, each 15c, doz., \$1.50; large, 20c, \$2.00 doz., postpaid.

WAGNER'S GIANT

Giant Crimson Winter.—Our grower describes this as "about twice the size of Burbank's Giant Winter, and four times the size of Crimson Winter. Average stem is 1½ feet long and weighs ½ lb." This valuable variety has all of the good qualities of Crimson Winter plus large size. A sure money maker.

PRICES.—True stock, root divisions:
1 YEAR 15c each; \$1.25 doz. prepaid. Not prepaid, \$1.00 doz.; \$6.00 per 100.
2 YEAR, 20c each; \$1.75 doz. prepaid. Not prepaid, \$1.25 doz.; \$8.00 per 100.
Special prices in quantities.

VICTORIA MAMMOTH

A popular variety that has been grown for years.

One Year.—Each 12½c; doz. \$1.00 postpaid. Not prepaid, each 10c; doz. 60c; 100 \$4.00.

Two Year.—Each 15c; doz. \$1.50 postpaid. Not prepaid, each 10c; doz. \$1.00; 100 \$6.00.

If wanted in larger quantities, write for special price.

MISCELLANEOUS GARDEN TOOLS AND SUPPLIES

Plant and Rose Stakes

Prices Not Prepaid.

CEDAR.—Round; painted green, white top; last and look well. Per doz., 3 ft. 85c; 3½ ft. \$1.00; 4 ft. \$1.25; 5 ft. \$1.75; 6 ft. \$2.50; 8 ft. \$3.50.

BAMBOO.—Inexpensive and very desirable for pole beans, etc., or flowering plants or shrubs.

NOTE.—State for what purpose you want them, as we have them from pencil thickness (¼-inch) up to ¾-inch.

Price per dozen: 1½ ft. 15c; 2 ft. 20c; 3 ft. 25c; 4 ft. 35c; 5 ft. 50c; 6 ft. 60c. Write for low price by the 100 or 1000.

Wooden Labels

The tree and pot labels we offer below are strictly No. 1 labels, smooth and well made. The painted labels are "really painted," not dipped in oil. Ordinary lead pencil writing on the painted labels is always readable: it don't wash off.

TREE LABELS

P. P.	4 lbs.	25	100	M
Painted, copper wired	..	\$0.15	\$0.35	\$2.00
Unpainted, copper wired	..	.15	.25	1.75
Unpainted, iron wired	..	.10	.25	1.35

POT LABELS

	Wgt. per M.	25	100	M.
Painted, 4-in. (P. P. 3½ lbs.)	..	.10	.25	\$1.35
Painted, 5-in. (P. P. 4½ lbs.)	..	.15	.25	1.55
Painted, 6-in. (P. P. 5 lbs.)	..	.15	.30	2.00

GARDEN LABELS

Same style as above but thicker and wider.

Painted, 8-in. (P. P. 15 lbs.)	..	.20	.60	5.80
Painted, 9-in. (P. P. 17 lbs.)	..	.25	.70	6.25
Painted, 10-in. (P. P. 20 lbs.)	..	.30	.85	7.25

DANDY-LION WEED KILLER

A new, simple, yet practical tool that is **automatic, quick and sure in its work.** Cutting or pulling off the tops of weeds only makes the roots grow more vigorously; digging them out with a knife gives one the backache or lame knees, therefore use the "Dandy-Lion" same as a cane.

You simply fill it with solution (of gasoline, salt or vitriol, directions tell how) put the point on the root crown of the weed press a little, swing the top around in circular movement to open a hole and press down until the cross bar on the point (see cut) releases the fluid. **The solution kills the root and all.**

The amount of solution deposited can be regulated. Spring, valve and base removable. **PRICE, NO. 1, Brass Covered, \$1.75; NO. 2, Solid Brass, \$2.00.** P. P. Weight 3 inches long—see cut). **Price 60c, postpaid 70c**

We give the P. P. (Parcel Post) weight so you can add postage if wanted by mail. Don't forget to send it extra.

Pots and Saucers



No. 1 No. 2 No. 3 No. 4
Fig. 1—Fern Dish Filler; 2—Bulb Pan; 3—Azalia or Fern Pot; 4—Standard Flower Pot. All styles same prices.

Size	Prices		Saucers
	Each.	Doz.	
2-inch\$0.02	\$0.20
3-inch03	.30
4-inch04	.40	\$0.02½
5-inch06	.60	.02½
6-inch10	.90	.06
7-inch12	1.20	.07½
8-inch16	1.75	.10
9-inch25	2.50	.15
10-inch4020
12-inch6035
15-inch 1.5050

Prices by express or freight. Not mailable.

Should you wish a few small sizes by mail, write for prices packed.

JARDINIERES, ETC.

We carry in stock a large and complete assortment of the best styles and latest designs. Limited catalog space will not permit us to illustrate and describe them,

RAFFIA

Natural color, best quality. Per lb. 35c; 5 lbs. 33c lb. Postage extra.

WIRE HANGING BASKETS

Well made of heavy wire and painted green. 6 in. 20c; 8-in. 20c; 10-in. 25c; 12-in. 30c; 14-in. 50c (not mailable).

OREGON MOSS

For florists' and nurserymen's use. Per lb. 5c; 100 lbs. \$3.25.

HALL DANDELION PULLER

Here is a tool that gets the dandelion roots and all, and operator stands up. No wet knees or aching back.

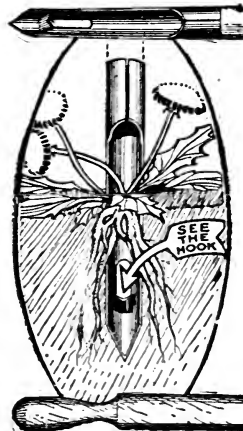

Hall's Dandelion Puller.

Directions. — Just push the blade down in the ground close to the weed, press towards the weed and pull up. A ratent hook near point of blade does the trick.

A slot prevents dirt from clogging the hook. Study the illustration carefully. Is made of polished steel and will last a lifetime. The only successful dandelion weeder to date. Wooden handle 30 inches long, steel part 8 inches.

Price 60c (P. P. 1 lb.)

Miscellaneous Tools That Every Gardener Needs

Note.—We give the P. P. (Parcel Post) weights so you can add postage if wanted by mail. Don't forget to send it extra.

Hall's Garden Tools

HALL'S NO. 1.—This has 5 adjustable steel spring teeth or cultivators. Spread 7 inches; length 6 inches; height 6 inches; 4 foot handle. (P. P. wt. 3½ lbs.) **Price \$1.00.**

HALL'S NO. 2.—Same as above, only 3 prongs. A smaller and lighter tool for small gardens or narrow rows. (P. P. wt. 2 lbs.) **Price 85c.**

HALL'S NO. 4.—A double tool; a square hoe blade 4½ inches wide on 1 side and 2 cultivator teeth on other end. (P. P. wt. 2½ lbs.) **Price 75c.**

HALL'S NO. 5.—A double tool; a square 3-inch hoe tapering to a point on other end. (P. P. wt. 2¼ lbs.) **Price 60c.**

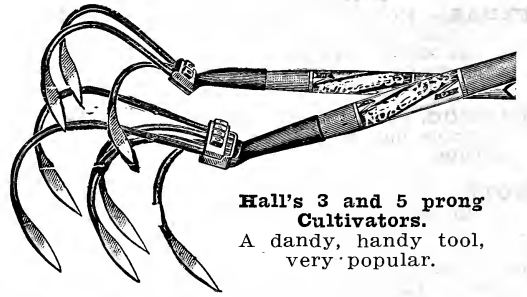

Hall's 3 and 5 prong Cultivators.

A dandy, handy tool, very popular.

HALL'S NO. 6.—A combination tool; a 6-inch hoe blade on one side and a 4-tooth hoe or rake on other end. (P. P. wt. 4 lbs.) **Price 85c.**

Pull Easy Adjustable Garden Cultivators

Everyone who has worked in a garden will see at a glance the advantages of the "PULL-EASY" over any other kind of a garden tool. When the arms are spread out to full width of 18 inches the cultivator is like a rake.

For narrower rows the outer ends of the arms can be closed to any width down to 7 inches.

The width of the cultivator is adjusted by simply loosening the two wing nuts, moving the bars and tightening them again.

The shape of the teeth and the way in which they are attached to the steel side bars makes the cultivator entirely different from any ordinary rake because the teeth penetrate the ground, stir it up and pulverize it thoroughly without the operator being

obliged to exert any downward pressure on the handle.

The middle tooth can be instantly removed permitting narrow rows of small plants to be straddled and cultivated two at a time.

These are high grade, well made tools. Finest quality polished ash handle, malleable iron socket, high carbon steel parts and teeth.

NO. 1 PULL-EASY. Adjustable 7 to 18 inches (P. P. wt. 4 lbs.), **price \$1.75.**

NO. 2 PULL-EASY. Same style as above with 4 teeth and 4 ft. handle. A mighty handy cultivator and being lighter in weight and smaller than No. 1 is a favorite with many and for small gardens. (P. P. wt. 2 lbs.) **Price 85c.**

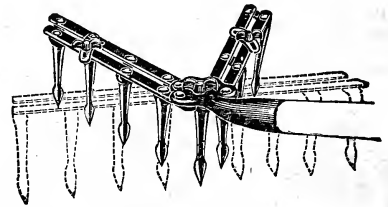
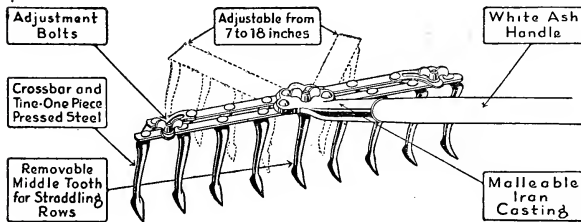

Pull-Easy Rocker Hoe

A new style, practical, labor and time saver.

The two-edged, keen blade of this hoe cuts on both the forward and backward motion. The socket casting has side stops which limit the oscillating movement of the blade keeping it at just the right angle under the surface to cut properly.

The hoe proper is not lifted from under the ground—but tilts forward or backward automatically as you push or pull.

It would not be an exaggeration to say that a gardener using this PULL-EASY Rocker Hoe can do the work of two or three persons relying only on old fashioned hand implements.

The PULL-EASY Rocker Hoe does not waste any effort. It is used about an inch or more below the surface with about the same movement as using a mop. The keen two-edged blade cuts off all weeds below the surface while the four upstanding teeth and

the pivot leg in the same movement, break up the soil and produce the most desirable dust mulch.

The use of this perfectly controlled tool permits very close and careful weeding and cultivation under and around large tender leaved plants such as tobacco and cabbage, easily damaged by the most careful stroke of a common hoe.

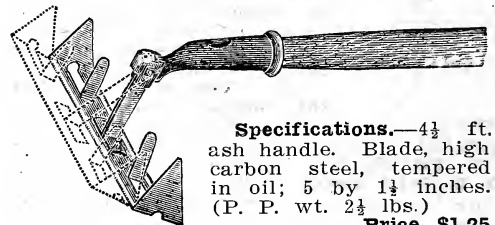

Specifications.—4½ ft. ash handle. Blade, high carbon steel, tempered in oil; 5 by 1½ inches. (P. P. wt. 2½ lbs.)

Price \$1.25

Garden and Farm Tools of Merit

"SPEED UP," SAVE MONEY BY SAVING TIME AND LABOR.



Rittenhouse Broadcast Seeder No. 3

A great favorite with farmers the world over. Works easily, automatic stirrer, anti-clogging, all-steel frame, strong cogs and gear. The lightest yet strongest and best. For seed or fertilizer. Sack holds $\frac{1}{2}$ bushel. Descriptive pamphlet on request. (P. P. wt. 4 lbs. Price \$2.25.

CAHOON BROADCAST SEEDER.—A popular kind. (P. P. wt. 5 lbs.) Price \$4.50.

Corn Planters

ACME NO. 6.—See illustration. Length 38 inches. A popular and successful planter; light, durable, well made and accurate. Operated by bringing together and separating the handles. (P. P. wt. 5 lbs.) Price \$1.25.

SEGMENT AUTOMATIC NO. 5.—See illustration. Length 34 inches. This seems to give the best satisfaction of all the automatic styles—absolutely dependable, accurate and easy working, and hangs right for either hand. It plants just the number of kernels that it is set for and plants them right. For Corn or small Beans. (P. P. wt. 6 lbs. Price \$1.75.

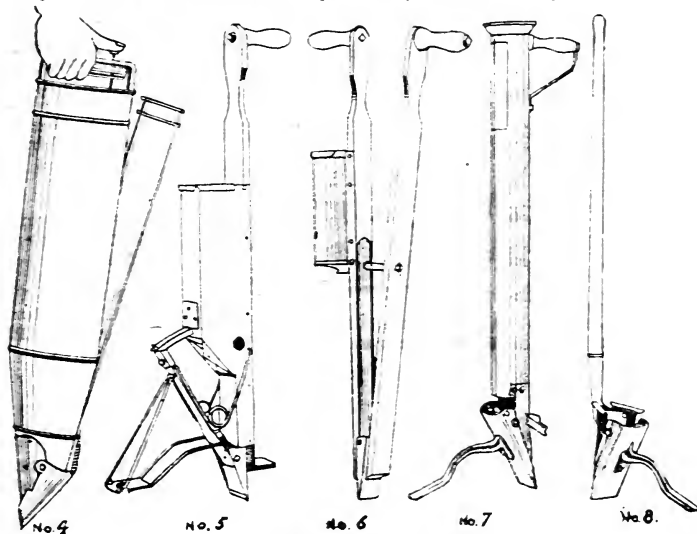

Masters' Plant Setter

See illustration No. 4. Size 30 by 6 $\frac{1}{2}$ inches. Watertight jacket holds enough for 150 plants. Simple, accurate and automatic—drop a plant in the large tube, push the planter into the soil, press the water button. As you step forward the plant is released and you repeat the operation as fast as you walk. No stooping. Hot, dry weather has no terror for plants set by this new method. Descriptive pamphlet on request. (Weight packed 5 lbs.) Price \$5.50.

Hand Potato Planters

TUBULAR NO. 7.—See illustration. Length 36 inches. The best and most popular. Plants any size or any number of pieces and at a uniform depth. Self locking, adjustable and automatic. The planter locks itself as it is lifted out of the ground, so that the next potato can be dropped in at once. (P. P. wt. 5 $\frac{1}{2}$ lbs.) Price \$1.75.

WIRE TUBULAR NO. 7 $\frac{1}{2}$.—Of same construction as the No. 7 excepting that the tube is of heavy galvanized wire mesh, which enables the operator to watch the seed in the tube. (P. P. wt. 5 lbs.) Price \$1.85.

ACME NO. 8.—See illustration. This works on the same principle as No. 7, but has no tube and the planter must be raised and the seed dropped into the hopper. (P. P. wt. 4 lbs.) Price \$1.25.

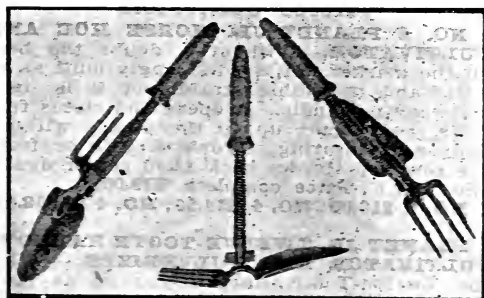

"ALCA" GARDEN TOOL

Best all-around garden tool made. This remarkable combination tool is a trowel, fork, hoe, weeder and dibble—all in one. A spring releases the particular tool you desire. Light but strong and handles nicely. (15 inches long—see cut.) Price 60c, postpaid 70c

NOTE.—On account of war conditions we have not been able to get prices or delivery on our regular line of garden tools such as Weeders, Hoes, Rakes, Forks, Pruning Shears, etc. We expect stock early enough for spring use and will gladly quote prices by letter if you will write and tell us what you want.

A Safe Bright Light

Every farmer has use for DAD'S ELECTRIC LANTERN. It's always ready, wind and storm proof and gives a REAL LIGHT. See page 131.

PLANET JR. GARDEN AND FARM TOOLS

For 40 years Planet Jr. Garden Tools have stood the test of world-wide usage and are recognized in every known country as the highest type of garden implement. In Europe where labor is cheapest Planet Jrs. are in constant use. How, then, can you afford to be without them where labor is both high and scarce?

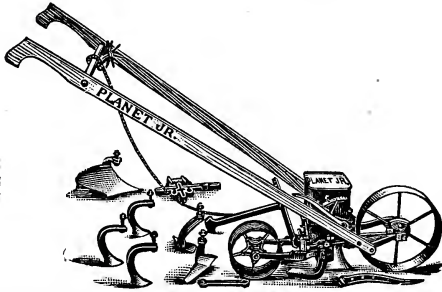

Planet Jr. No. 4 Combined Hill and Drill Seeder, Wheel Hoe Cultivator and Plow.

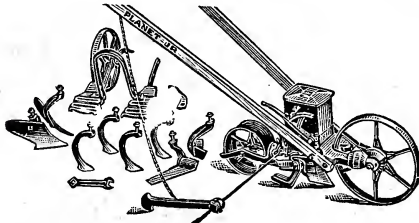

Planet Jr. No. 25 Combined Hill and Drill Seeder and Double Wheel Hoe, Cultivator and Plow.

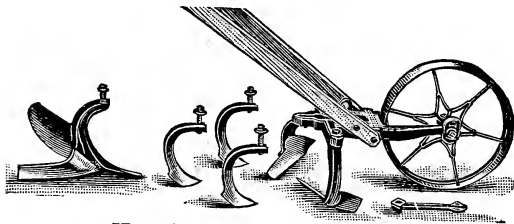

No. 17 Single Wheel Hoe.



Planet Jr. No. 12, Double Wheel Hoe.

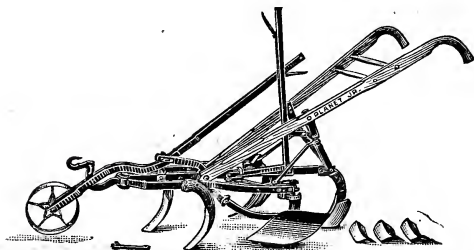

No. 3 Planet Jr. Horse Hoe and Cultivator.

NO. 4 PLANET JR. Combined Hill and Drill Seeder, Single Wheel Hoe, Cultivator and Plow.—This tool combines in a single convenient implement a capital 4, 6, 8, 12 or 24-inch hill-dropping seeder, a continuous row-seeder, an admirable single wheel hoe, an excellent furrower, a capital wheel cultivator and a rapid and efficient wheel garden plow.

Price complete, \$17.75; weight 53 lbs.; No. 4 D, seeder only, \$14.25. Holds 2½ quarts of seed.

NO. 25 PLANET JR. Combined Hill and Drill Seeder and Double Wheel Hoe, Cultivator and Plow.

The change from Drill to Wheel Hoe and back again is quickly made, and the entire combination is one we can heartily recommend and guarantee satisfactory. Plants in hills or drills same as No. 4.

Price, \$20.75; weight packed 59 lbs. Holds 2½ quarts of seed.

NO. 31 PLANET JR. Combined Drill Seeder and Wheel Hoe.—An improved 1918 tool of great value. (Wt. 32 lbs.) Price \$12.50. **NO. 31 D, seeder only, (Wt. 26 lbs.) price \$10.50.**

Planet Jr. Single Wheel Hoes

NO. 17, see cut. Just the tool for the home garden, price \$8.50. **NO. 16**, same outfit with an extra pair of rakes, price \$10.00. **NO. 17½**, same as No. 17 without the plow, price \$7.50. **NO. 18** same as No. 17 but has 1 pair hoes or weeders only, price \$6.50.

Planet Jr. Double Wheel Hoes

NO. 12, see illustration. Very desirable and convenient; works between or a-straddle of the row, price \$11.75. **NO. 13**, without cultivators or plows, price \$8.75.

See Planet Jr. Catalog for full information and new 1918 attachments.

Horse Cultivators

NO. 8 PLANET JR. HORSE HOE AND CULTIVATOR.—Without a doubt the best on the market. It is so strongly built as to withstand incredible strain, yet it is light and easy to handle. It opens and closes furrows, hoes right up to the plants without danger of injuring, throws dirt to or from the row and throws back from center again. (See cut.) Price complete, \$19.00.

NO. 7, \$18.00; NO. 4, \$14.50; NO. 4 D, \$12.50.

PLANET JR. TWELVE-TOOTH HARROW, CULTIVATOR AND PULVERIZER.—With the Twelve-Tooth Harrow you go as deep or shallow as you like, come up close to row without injuring plants, cut out all the weeds, stir the soil and mellow and fine it as with a garden rake. You widen and narrow as you please between 12 and 32 inches.

NO. 90, price complete, \$19.00. **NO. 90 B**, less pulverizer, \$16.00; **NO. 90 D**, less pulverizer and wheel, \$12.50. Planet Jr. Catalog shows other styles as cheap as \$10.25.

REMEMBER Planet Jr. 72-pg. Catalog, illustrated, descriptive and up-to-date, with complete price list, free on request. Prices subject to change.

OAKES SANITARY EVAPORATOR

A Practical Machine for Drying All Kinds of Vegetables and Fruits for Home Use

The National Food Garden Commission says "Drying vegetables and fruits for winter use is one of the vital national needs of wartime. As a national need it becomes a patriotic duty. As a patriotic duty it should be done in every family."

The drying process enables you to preserve perishable food for winter use without fruit jars, cans or sugar. It is the simplest and cheapest method, and in many cases dried vegetables and fruits are superior to canned goods, in both flavor and nutritive properties.

With each machine we furnish a booklet explaining the many uses you will find for the Oakes Sanitary Evaporator, and the directions given by the U. S. Government experts for handling and drying all sorts of vegetables and fruit.

The Oakes Sanitary Evaporator is complete in itself, furnishing its own heat. It consists of a heater and six drying trays about 18 inches in diameter.

The Construction is such that the current of warm air passing through the machine is obliged to spread out through the fruit in each tray, and thus takes up the moisture and carries it away very rapidly, drying any sort of fruit or vegetables in a few hours. The direct draft from the lamp goes through the heater only and does not enter the evaporating trays.

The Trays are made of seamless pans, stamped from bright tin plate. They fit together accurately, and the lid over the top tray thoroughly protects the fruit from dust, flies and all insects.



The Oakes Sanitary Evaporator is so compact in its construction, that it occupies only 18 by 18 inches space; but the six trays have a drying surface of nearly ten square feet, giving a capacity of three to four pecks of apples per day and a proportionate quantity of other fruits or vegetables.

In Results, the Oakes Sanitary Evaporator is equal to machines which sell at \$25 to \$50 and its capacity is much greater than that of any other dryer selling at anything like the same price.

An O. K. Safety Lamp furnishes the heat. This lamp burns ordinary kerosene oil. It is made especially for producing heat, and only a small flame is required.

PRICE COMPLETE, \$10.00 WEIGHT 25 LBS.

HALL'S E-Z GARDEN CULTIVATOR

Just the right size and the right price for the average garden maker. Everyone who makes much garden should have one, as it reduces the labor on-half. Makes gardening a pleasure. Combination tools for all kinds of garden work. Does away with the tiresome hand hoeing, weeding, etc.

NO. 6 HALL.—Double handles quickly adjustable to fit man or child—adjustable draft for light and deep cultivation. Swing Frame gives the plow a hang or balance—making it easiest running plow on market. The double extended curved handles insure steady, even work. Each tool furnished is carefully sharpened, polished, and will scour in any soil.

Tools Furnished.—Plow or mould board for cultivating, hilling, plowing, covering seed. Bake for cultivating, harrowing. Weeder for cutting weeds. Double Diamond Point for marking seed rows, etc.

Strong 24-inch wheel. Weight 24 lbs.

Price complete, only \$6.00

NO. 1 HALL.—This is a favorite with the ladies and children as it is smaller and lighter. It has a "straight to axle" adjustable handle and a 16-inch wheel. Can be taken apart and sent by parcel post. (P. P. wt. 14 lbs. Price complete \$4.50.

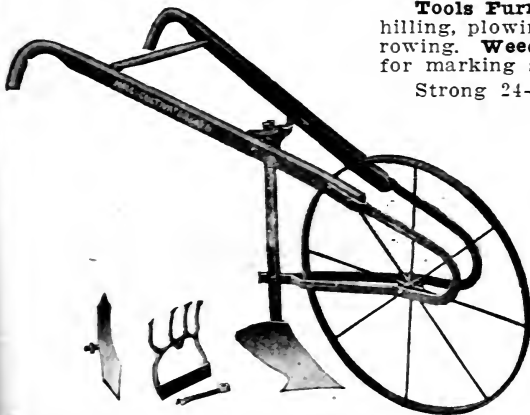

Hall's No. 6 Garden Plow and Cultivator



E-Z Garden Cultivator No. 1 with 5 tools (one reversible)

"SPEED UP"
Equip yourself with garden tools so as to double your output.

Labor is scarce and high. These tools will pay for themselves in a few days' use.

WITH A GARDEN CULTIVATOR YOU CAN CULTIVATE YOUR WHOLE GARDEN IN THE TIME IT WOULD TAKE YOU TO HOE A FEW ROWS.

Lawn Mowers

We do not carry a large variety, but we do offer the makes that run easily, wear well and do satisfactory work. Order early, prices liable to advance.

GREAT AMERICAN BALL-BEARING.—Open cylinder, five blades, 10-inch wheel, solid cast steel butting knives, hardened in oil; steel balls of highest grade, placed in dust-proof steel cup; cuts close; easily adjusted. 15-inch \$15.00; 17-inch \$16.00; 19-inch \$18.00; 21-inch \$19.75.

GREAT AMERICA.—Closed cylinder, three blades, 7-inch wheel; hardened and tempered solid cast steel cutting knives, positively self-sharpening. 12-inch \$10.00; 14-inch \$11.25; 16-inch \$12.00; 18-inch \$14.00.

FAULTLESS.—Best cheap lawn mower for money; has 3 blades tempered tool steel; good adjustment, 14-inch \$4.50; 16-inch \$5.50.

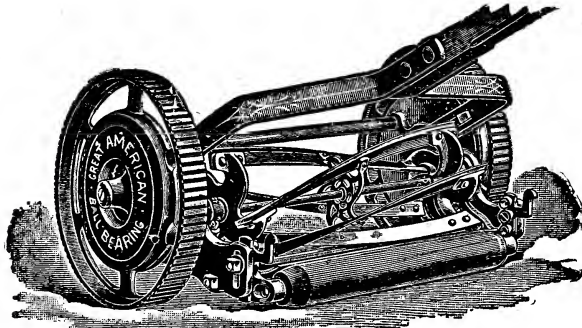

Great American Lawn Mower.

Grass Catchers

SIMPLEX.—Good, cheap grass catcher. Canvas sides, galvanized bottom, wire frame. No. 1 for 14 to 17-inch mower, \$1.75; 18 to 21-inch, \$2.25.

NOTE.—Write for prices on Grass Hooks, Shears, Sickles, etc. We hope to have stock.

Dunham Water-Weight Lawn Rollers

This roller has a water-tight steel drum which can be filled with water to make it heavy, and emptied when storing away.

The roller is fitted with steel roller bearings and is an easy running, long-wearing machine. Ask for booklet—"The Proper Care of Lawns"—free. We carry the following sizes in stock.

Order No.	Drum Sizes	Number Sections	Filled			Portland Prices
			Empty	Water	Sand	
WB3...	14x20 in.	1	65	200	300	\$13.25
WB5...	18x24 in.	1	80	300	500	16.75
WB7...	24x24 in.	1	125	500	800	21.50
WB11...	18x24 in.	2	115	330	500	22.75
WB13...	24x32 in.	2	170	650	1000	30.00
WB15...	24x24 in.	2	145	500	800	26.50

During Winter Months freezing and thawing and heavy rains loosen the soil and heave the turf away from the sub-soil, leaving millions of sensitive "feeder-roots" exposed to the air. In the spring when the grass should start growing these roots soon dry out and die.

In summer, too, sun and wind tend to dry out, bake and crack the surface soil around the roots and this is equally harmful to the lawn. A good roller will compress the soil around the roots, and press the turf back against the moist sub-soil so the roots can absorb the water and plant food.

Rolling occasionally throughout the summer (especially after heavy rains) keeps the surface even and prevents the soil drying out. It discourages the work of worms, ants, moles and gives a smooth, even lawn for the mower to run over.

It is absolutely impossible to keep a lawn, large or small, in perfect condition without rolling, no matter how many other things may be done in taking care of it.

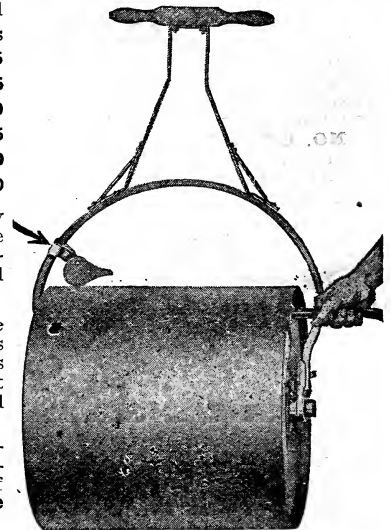

Dunham Lawn Roller

(Showing new "No Tip" handle lock and how to fill.)

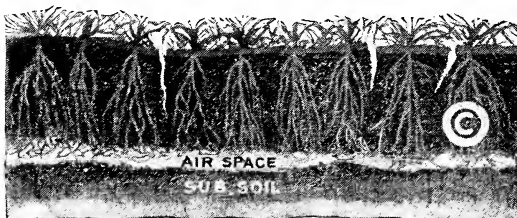

AIR SPACE
SUB SOIL

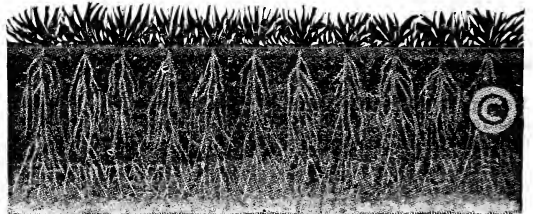

Before rolling—uneven, air spaces, cracks.

After rolling—level and compact.

R. R.'S EVERGREEN LAWN GRASS SEED (page 41) and WONDER ODORLESS FERTILIZER (page 38) makes those beautiful green, velvety lawns so much admired.

SPRAY AND GARDEN HOSE

We offer new stock only of high-grade hose for spray pumps and garden purposes. We advise our customers to buy the best. It is cheapest in the end. Don't buy old stock.

XXX GRADE (Non-Kinkable.—Guaranteed.

This hose gives excellent satisfaction. Good enough for any ordinary spraying outfit, and by far the best hose for florists' or gardeners' use. One customer reports that he used a 50-foot length of this grade for 3 seasons continuously, which proves that it is the cheapest hose to buy. We have this on 500-foot reels, and cut any length wanted.

Price per foot, corrugated $\frac{1}{2}$ inch, 16c; $\frac{3}{4}$ inch 18c; smooth finish, $\frac{1}{2}$ inch 15c; $\frac{3}{4}$ inch 17c.

SPECIAL SPRAY HOSE.—The highest grade extra heavy spray hose made; guaranteed. Price, $\frac{1}{2}$ in. only, 20c ft.

TROUT COTTON HOSE.—Makes an excellent garden hose for those preferring cotton on account of lightness. Made of 4-ply canvas with a good, thick, rubber lining. Price in 50-ft. lengths with couplings, $\frac{1}{2}$ inch \$5.00; $\frac{3}{4}$ inch \$6.00.

BAMBOO EXTENSION RODS



These are necessary for spraying trees. Our stock is made up in the best possible manner. No. 1 bamboo poles lined with either aluminum or steel tubing, screw threaded into brass connections at either end. Stopcock or cutoff necessary to make connections complete.

	6 ft.	8 ft.	10 ft.	12 ft.
ALUMINUM LINED	\$2.40	\$2.70	\$3.00	\$3.30
STEEL LINED	1.50	1.70	1.90	2.10

EXTRAS FOR EXTENSIONS.—Stopcock, each 90c; Angle Cutoff \$1.00; Drip Guard 20c.

Safe, Sure,
Simple

THE IDEAL GOPHER TRAPS

"Quick as
a Wink"

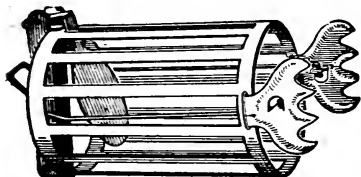

The Ideal Trap.

The only trap guaranteed to catch small or large pocket gophers. Being round, with thin edges, gopher walks into trap before detecting anything in runway. 100 per cent efficient—catches the gopher every time. Far safer and surer than poisons or gas. Hundreds of users have recommended the Ideal. Full instructions with each trap. Pamphlet on request.

Price, 60c postpaid, 2 for \$1.00

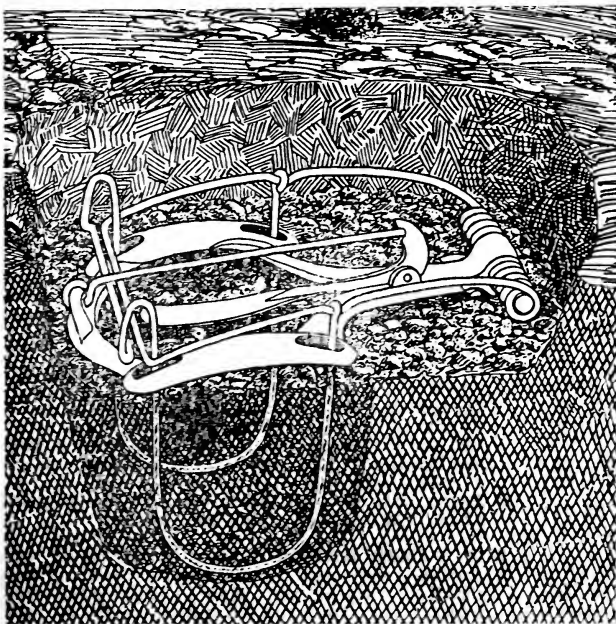

Phantom View of the Nash Trap Set on One of the Deeper Runways.

Nash Mole Trap

The Only Trap that Always Catches the Mole in All Kinds of Ground and When Coming from Either Direction.

After repeated requests from customers who would not take any other we have stocked this trap and have sold many. We have had nothing but praises from the operators. It is very strong and can be set in the deep or shallow runways. If you will find the main runway you can soon catch all the moles, for the "Nash" never misses; "it catches 'em coming or going." Both the choker wires are made of a single piece of metal, bent to the desired form, so that they are held perfectly in place, not depending on numerous joints. The springs which operate the trap are of one piece of best Bessemer spring steel, while the trap as a whole is strong enough so that no clods, stones, sticks or anything of that kind prevents its perfect operation. Full directions with each trap. Price, \$1.20 postpaid.

Get Rid of the Destructive Gophers by Using an Efficient Trap

SPRAYS, INSECTICIDES, ETC.

The best and most economical method of spraying is with a hand or power sprayer.

ARSENATE OF LEAD

For spraying trees and shrubs or plants against the attacks of leaf-biting or leaf-eating insects of all kinds, such as green worms, slugs, etc. Especially valuable for spraying to prevent the codling moth on Apple and Pear, and should be used just before the calyx cups close, for eating insects, whenever they appear. Can be combined with other sprays.

PASTE FORM Arsenate of Lead.—It comes in paste form and is diluted in water at the rate of about 1 ounce to a gallon of water, or 2 to 3 lbs. to 50 gallons of water. (Not mailable.)
Price, 1 lb. jar 40c; 5 lbs. \$1.50. Low quantity price.

DRY POWDERED Arsenate of Lead.—Has many advantages over the paste, easier to mix and requires less, is more efficient on account of its extreme fluffiness and will adhere longer. Does not deteriorate, harden or freeze, consequently can be carried over. Use 1 to 2 lbs. to 50 gallons of water. 1 to 2 tablespoonsful to a gallon. Put up in sift proof cartons with adjustable tops. (Poison not mailable.)
Prices, 1 lb. 60c; 5 lbs. \$2.75. Quantity price on request.

LIME AND SULPHUR SPRAYS

Particularly effective in the control of the following: San Jose Scale, Oyster Shell Bark Louse, Scale Insects, Fungus Diseases such as Peach Leaf Curl, Apple and Pear Canker, Apple Scab, Brown Rot of Peach or Plum, Blister Mite, etc.

LIME AND SULPHUR SOLUTION.—The original and old form liquid spray for San Jose scale. Use 1 part of this liquid to 9 parts of water for dormant spraying. We offer high grade quality. (Not mailable.)
Price, Qt. 25c; gal. 65c; 5 gals. \$2.50; 10 gals. \$4.25. Write for price per barrel.

SHERWIN-WILLIAMS DRY LIME SULFUR.—A true type and not to be confused with substitutes or compounds offered on the market. Overcomes disadvantages of the liquid material such as the possibility of freezing, leaky packages, hauling bulky packages, etc. Has all the insecticidal and fungicidal qualities of the liquid material, and all of its advantages with none of its disadvantages. Is absolutely safe and effective not only as a dormant spray for scale, insects, etc. but also as a summer spray in combination with arsenate of lead. From 10 to 12 lbs. Dry Powdered Lime Sulfur dissolved in 50 gallons of water should be used as a dormant spray; from 2 to 3 lbs. to 50 gallons of water in combination with the usual proportion of arsenate of lead should be used for summer spray on all seed fruits such as apples pears, etc.; from 1 to 1½ lbs. to 50 gallons of water in combination with the usual strength of arsenate of lead for summer spray of peaches, plums, and all stone-fruits. (Small cans mailable.)
Prices, 1 lb. 25c; 5 lbs. \$1.00; 10 lbs. \$2.00; 25 lbs. \$3.75; 100 lbs. \$11.00.

SCALE DESTROYER

"Target Brand."—A soluble oil spray of decided merit for San Jose scale, the most effective for leaf roller, all tree infesting scale and most soft bodied sucking insects.

Has many advantages over Lime and Sulphur Solution. Reads more readily, getting into every little crevice. Will go twice as far. Has no bad odor, does not discolor and much more agreeable to apply as it does not burn the eyes and skin; no clogging of nozzles, mixes easily. Use 1 gallon to 20 of water, after the leaves are off and up to time buds appear. For summer spray use 1 gallon to 100 gallons of water. (Not mailable.)
Price, Pt. 35c; qt. 50c; gal. \$1.50; 5 gals. \$6.00; 10 gals. \$10.50. Write for price per barrel.

BORDEAUX MIXTURE

For Blight, Mildew, Rust and Fungus Diseases. Also prevents and cures Black Rot and Scab, and acts as a deterrent for insects on fruits and vegetables.

BORDEAUX MIXTURE—PASTE.—High grade, easy to use. All ready to mix with water at the rate of 1 pound to 5 gallons of water when the leaves are off; use 1 to 10 for summer when foliage is out.
Prices, 1 lb. can 40c; 5 lb. can \$1.50; 10 lb. can \$2.75 (not mailable).

BORDEAUX MIXTURE—POWDERED.—This is a perfect dry Bordeaux mixture concentrate in a dry powder. It is scientifically founded to insure perfect results, stays in suspension well and adheres to the foliage. It can be used in combination with other insecticide with an extraordinary degree of safety. For general winter use, 8 lbs. to 50 gals. of water; one-half strength for summer (Not mailable.)
Price, 1 lb. 50c; 5 lbs. \$2.35; 10 lbs. \$4.25.

BLACK LEAF "40."—A concentrated solution of nicotine sulphate containing 40 per cent nicotine. Indorsed by the foremost experts of the U. S., for red bug, green and woolly aphids, trips, plant lice, codling moth, pear psylla and all sucking insects. Descriptive pamphlet on request. (Not mailable.)

Price, 1 oz. bottle 25c, makes 5 gals.; ½ lb. can 75c, makes 47 gals. spray; 2 lb. can, \$2.50, makes 240 gals. spray; 10 lb. can, \$10.75, makes 1000 gals. spray.

Note.—Fish oil soap mixed in this solution makes it more effective and is necessary for perfect results. It makes it stick and last longer. Use 4 lbs. to 50 gals. solution. Full and detailed instructions with each can.

WEED KILLER ("Target Brand").—Guaranteed to destroy weeds, grass, poison ivy and all undesirable vegetation. Keeps roadways and paths free from weeds. Cleans tennis courts and ball diamonds. Cleans alleyways and fence corners. An effective combination of high grade chemicals which diluted in water at 1 to 50 destroys the roots as well as the tops of all vegetation. One gallon diluted will cover 100 to 150 square yards; and one or two applications are sufficient for an entire season. (Not mailable.)
Price, Ft. 40c; qt. 60c; gal. \$1.75; 5 gals. \$7.50. Write for price per barrel.

S-W PARIS GREEN.—This is the most effective, safe and economical Green on the market. Kills the insects but does not blight the foliage. Usually four to six ounces to fifty gallons of water will be satisfactory. Price, 1 lb. 60c; 2 lbs. \$1.15.

NOTE.—Prices on Sprays, etc., subject to market changes—some stocks are very scarce and liable to advance.

Sprays and Insecticides—Continued

"CARCO" VEGETABLE SPRAY

For many years the gardeners of the Pacific Coast have suffered from a scourge of root-maggots and worms that has made gardening, if not impossible, much more unprofitable than it should have been. Many remedies have been tried with little success until the "Carco" formula was discovered.

A wonderfully successful spray for destroying root maggots, grubs, etc., that infest Turnips, Radishes, Beets, Rutabagas, Cauliflower, Cabbage, Onions, etc., and also recommended for combatting crown borers in Strawberries.

To get best results, the ground should be sprayed freely before planting, then again as soon as the vegetables come up. Dip cabbage plants in a solution of "Carco" before planting. "Carco" is highly concentrated; use 1 part "Carco" to 100 to 125 parts of water. Descriptive pamphlet and testimonials on request.

Prices, $\frac{1}{2}$ -pint cans prepaid 30c; larger sizes by freight or express only, $\frac{1}{2}$ pints 20c; pints 30c; quarts 50c; $\frac{1}{2}$ -gal. 90c; gal. \$1.75.

BUG DEATH

Non-poisonous.—A most effective powder that kills the squash, cucumber and cabbage bugs, curraut worm and all bugs and worms that eat the leaves of plants and vines. Bug Death is a wonderful protection against insects. Absolutely non-injurious. Contains no arsenic. Kills the bugs, prevents blight, revives and aids the healthy growth of plants and shrubs. Does the work as nothing else will. You can't afford to be without it. Bug Death is generally applied dry, but is very effective mixed with water and sprayed. Use 1 pound to 2 gallons water.

Prices: 1 lb. cans with perforated shaker tops postpaid 30c. By express, 1 lb. 25c; 5 lbs. \$1.00; 10 lbs. \$1.75; 25 lbs. and up 16c lb. Add postage if wanted by mail.

BLUE LABEL SLUG DESTROYER.—This is the first powder of its kind that we ever found to positively kill slugs and keep them away from young plants. Full directions on each package.

Price: Large pkg. 30c (P. P. wt. 2 lbs.)

NICO-FUME

The purest and most highly refined nicotine product offered for spraying, vaporizing and fumigation in Green Houses. Our Florists like NICO-FUME better than other similar preparations such as Nicotidine, To-bak-ine, etc., because it is safe and less expensive. Read descriptive pamphlet and be convinced. Free on request.

Nico-Fume Liquid for spraying or vaporizing: $\frac{1}{2}$ -lb. tin 50c; 1-lb. tin \$1.50; 4-lb. tin \$5.50; 8 lbs. (gal.) \$10.50. (Cannot mail.)

Nico-Fume Fumigating Paper.—Quick, safe and effective for greenhouse work. Price per can of 24 sheets 85c (weight 1 lb.); 144 sheets \$4.00 (weight 4 lbs.). Add postage. 288 sheets direct from factory prepaid for \$7.50, guaranteed fresh.

FUMOTH FUMIGATORS.—For killing moths, millers, mosquitoes, mites and lice in hen house, etc. Vapor does not injure clothing, furniture, etc. Full directions on the can. Price 50c; postpaid, 60c

FREE ADVICE.—If you will write and tell us what insects or plant disease you want to combat we will advise you to the best of our ability.

NIAGARA 3 IN 1—Dusting Mixture

This new preparation is meeting with great success everywhere. It is a combination of Sulphur, Arsenate of Lead and Tobacco dust. It is specially prepared and exceedingly fine, which insures a good even distribution and splendid sticking qualities.

A combined insecticide and fungicide for mildew, green or black lice or any leaf-chewing insects. Apply with a powder gun (see page 130). No muss or slopping liquids to contend with. (Not mailable.) Prices in bulk: 1 lb. 35c; 5-lb. sack \$1.00; 10-lb. sack \$1.50; 25-lb. sack \$3.00; original 100-lb. sacks \$10.50.

SULPHO-TOBACCO SOAP

For spraying or sponging or dipping ferns, palms or potted plants, or spraying roses, shrubs or vines it is invaluable. Kills Aphids, Red Spider, Plant Lice and Sucking Insects. Acts quickly and effectively against these pests. Will not injure the tenderest plant. Two ounces of soap make a gallon of solution. Non-poisonous perfectly safe and yet very efficient.

Prices: Postpaid, 3-oz. bar 15c; 8-oz. bar 25c.

GOPHER-GO

Sure Death to Gophers, Squirrels, Prairie Dogs, Rats and Mice

No more use for traps. Guaranteed to do the work or your money back.

The only prepared poison that will get a gopher. The government advises poisoning as the most effective and best method of exterminating ground pests. Gophergo is a combination that never fails. They are sure to get it, they like it and they eat it. Gophergo has been tested and endorsed by many state experiment stations. If farmers and gardeners would carry a small can of Gophergo when walking around their places and leave a few pellets where "signs" are discovered the pests will soon disappear. Full directions on each can. (Not mailable.) Price, 10 oz. can 35c; $1\frac{1}{2}$ lb. can 60c; 3 $\frac{1}{2}$ lb. can \$1.10. (Cannot mail.)

Read this Report.

Eugene, Ore., June 12, 1917.

Routledge Seed & Floral Co.,

Gentlemen: Enclosed find check for a 10-oz. can of "Gopher-Go." It certainly is fine, and will do all that you claim for it. I make a practice of having a can of it whenever I go into my fields and have not had to go over the ground the second time for the gophers "fall for it,"—pardon the slang,—every time. I open runway and drop a few grains wherever I see they have been at work. I have often found several mice stretched out on the ground next morning.

Very sincerely,

M. C. TILLOTSON.

TOBACCO DUST.—Valuable as an insecticide. Lb. 10c; 10 lbs. 75c

GRAFTING WAX.—We sell Target Brand, a high-grade preparation.

$\frac{1}{2}$ lb. 10c; $\frac{1}{4}$ lb. 25c; lb. 40c; postage extra

FISH OIL SOAP.—For aphids, plant lice, etc. Best grade. Postage extra.

1 lb. 20c; 10 lbs. \$1.50; 100 lbs. market price

SULPHUR POWDER.

Lb. 10c; 100 lbs. market price

SULPHUR CANDLES.

Each 10c, postpaid 15c; 3 for 35c

SPRAY PUMPS AND SPRAYERS

We can supply nearly twenty different styles, from a light hand pump to the large powerful power outfits. Hardie's handsomely illustrated and descriptive catalog on request. **HARDIE PUMPS ARE GUARANTEED TO DO THE WORK CLAIMED OR YOUR MONEY BACK.**

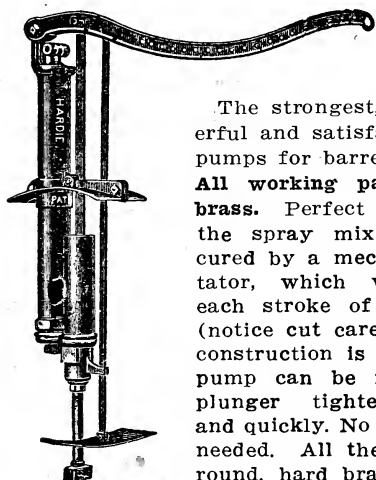

No. 6 Hardie.

The strongest, most powerful and satisfactory spray pumps for barrels or tanks. All working parts are of brass. Perfect agitation of the spray mixture is secured by a mechanical agitator, which works with each stroke of the handle (notice cut carefully). The construction is simple. The pump can be repacked or plunger tightened easily, and quickly. No pipe wrench needed. All the valves are round, hard brass balls.

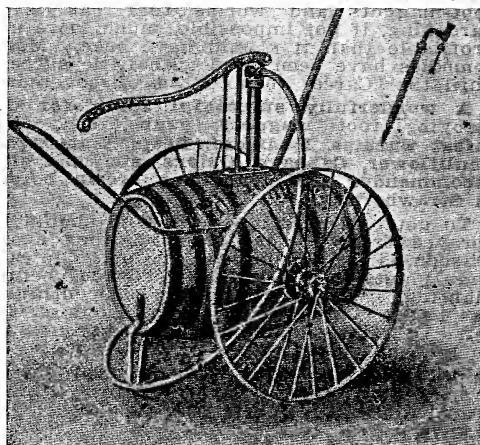

Hardie Wheel Outfit No. 21

Category No.	No. Trees Suitable for	Capacity per Hour	Size of Plunger	Handle Stroke	Price A. B.	Price W. I. C.
NO. 5	25 to 30	50 gal.	1 1/2 inch	4 inch	\$14.00	\$12.50
NO. 6	30 to 75	75 gal.	2 inch	4 1/2 inch	17.00	14.50
NO. 7	100 up	120 gal.	2 1/2 inch	5 inch	20.50	18.00

NOTE.—A. B., all brass—W. I. C., with iron air chamber.

Free instructions for mounting. Barrel "pump plates" or holders for end or side; state which you prefer. For nozzles, hose, extension rod, etc., see following pages. (Extension Rods, page 125.)

OUR SPECIAL OUTFIT NO. 17 1/2.

One No. 6 all-brass pump, mounted on barrel one 15-foot lead best 1/2-inch hose, one 10-foot steel lined bamboo extension rod with stopcock and drip guard, one Vermorel nozzle, all complete and ready for work.

Price \$22.50; mounted on barrel \$26.50; extra lead of hose, extension and nozzle, \$5.25 extra.

OUR SPECIAL OUTFIT NO. 21

This outfit is designed to meet a long-felt want by the small fruitgrower and gardener. The 30-gallon barrel is mounted on strong wrought-iron wheels, 26 inches in diameter, with 1 1/2-inch tires. No. 5 pump, 5 feet best hose and couplings, 8-foot bamboo rod and leakless stopcock, 1 Vermorel nozzle. Price \$26.50

HARDIE BUCKET PUMP.

A high-grade, all-brass bucket pump, especially designed to meet the long-felt want in this line. It is the only bucket pump on the market that has a mechanical agitator and that is so designed as to always stand in position in the center of the bucket. It can readily be detached from the bucket by unscrewing a nut on the spider. This new device for holding the pump firmly in place in the center of the bucket enables the operator to carry the whole outfit with one hand. A practical outfit for light work. This is the only bucket pump in the market that is giving entire satisfaction. Good-sized air chambers enables one to maintain a high pressure and continuous spray.

BUCKET OUTFIT NO. 10

Price, including No. 4 Pump, one 5-gallon heavy wooden bucket, three feet best 1/2-inch hose, one spraying lance 18 inches long, one Vermorel nozzle, price \$9.00.

To reach the tops of tall trees, you should order, extra, an extension rod. For price of extension rods, see page 125.

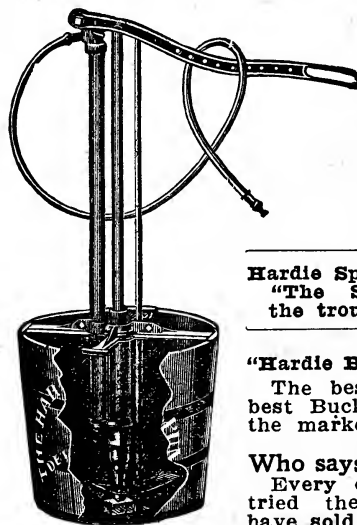

Hardie Spray Pumps—
"The Sprayer with the trouble left out"

"Hardie Bucket Outfit"
The best value and best Bucket Pump on the market.

Who says So?
Every one who has tried them; and we have sold hundreds.

Our experience shows us that if you get a good outfit, one large enough to do your work, you will spray well and as often as necessary; but if you get a cheap outfit or one that is too small, you will become disgusted, throw it aside and let this most important work go undone. Hardie Mfg. Co.'s handsomely illustrated catalog on request.

SPRAY PUMPS—Continued

LOWELL FOUNTAIN SPRAYER

Every city gardener, florist and poultry keeper needs a Lowell Fountain Sprayer; clean and easy to operate; no need to get any spray on your hands or clothes; will last a lifetime with reasonable care. (Try one at our store.)

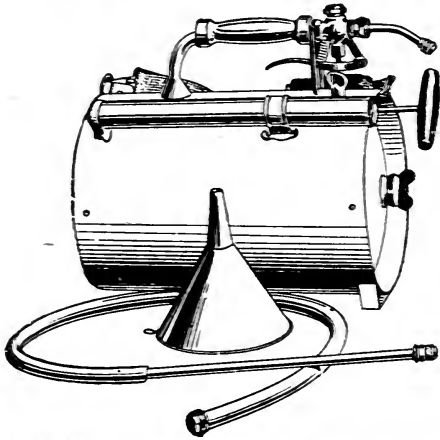

Lowell Fountain Compressed Air Sprayer.

Special Features: Capacity 3 gallons; can be carried by the handle (see cut) or a strap that goes over the shoulder. The automatic controlling valve under the handle is easily operated with one finger. You have perfect control of the spray and don't waste any. The air pressure pump is outside where you can get at it, the filler plug is well made and fits tight. The tank after being seamed and riveted is dipped into molten solder, making it absolutely air-tight and the strongest Air Pressure Sprayer made, standing five times the air pressure necessary to operate.

Hose with 4-inch rod, 2 nozzles and filler funnel, with each outfit. The short crook and nozzle shown in the cut is used without the hose when spraying vegetables. For reaching the under side of leaves of low bushes, attach the hose and use the **vine attachment** extension rod. For high spraying use as many **two-foot extensions** as needed. Descriptive booklet on request.

Prices: No. 111 brass tank \$9.00; No. 110 galvanized tank \$6.50. (P. P. 12 lbs.)

NOTE—Can be sent by parcel post, but express is safer.

Extras—2-foot brass extension rods, each 75c; vine attachment, 2-foot extension with bent neck, each \$1.00. (P. P. 1 lb.)



NO. 3 GLASS TANK

Well constructed, the glass reservoir which is a quart Mason jar, is not affected by any kind of spray. You can have several jars of different sprays (already prepared) and when you wish to change, take out one and put in another. No delay. Extra long air chamber, special plunger and throws a strong, fine spray in any direction. (P. P. 3 lbs.) **Each (not prepaid) \$1.25**

DON'T WAIT until the fungi, such as mildew, rust, black spot, etc., have attacked your roses and trees; the fungicide sprays are merely preventives and should be used in the fall or early in the spring. After the disease has developed, it may be too late to save the plant.

O. K. BRASS BUCKET PUMP

(See cut) — Constructed entirely of brass. It is furnished with three feet of best quality rubber hose, detachable; malleable iron stirrup, three interchangeable brass nozzles which throw a fine mist, coarse spray or a solid stream. Pump is provided with large air chamber, with brass ball valves and valve seats. Throws a continuous spray; neat in appearance as well as durable in construction. Much superior to pumps of this class offered heretofore. Look at illustration carefully. (P. P. 7 lbs.) **Price \$4.75**

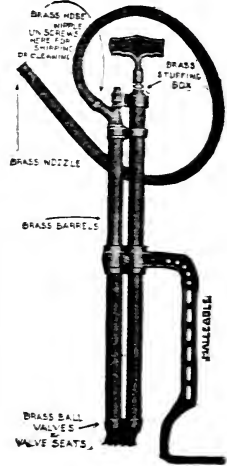

O. K. Bucket Pump

No. 32, 1 barrel, \$5.50; No. 31, double barrel and lever handle \$6.50. Description on request.

HAND SPRAYERS OF "MERIT"

The "Perfect" Sprayers offered below are well and properly constructed of heavy, high grade material. We offer the "Lowell" line, far superior to most makes. Full size, 20 inches long, capacity 1 quart. Adapted for all kinds of general spraying. Your choice of styles.



No. 7 Perfect.

No. 6 or No. 7 (P. P. weight 2 lbs.) your choice, each 65c.



No. 6 Perfect.

NO. 5 CONTINUOUS SPRAYER

Has 2 spray caps for spraying up, down, straight ahead or at any angle and is so constructed that it not only sprays on the downward stroke of plunger, but also when it is drawn back, thus causing a continuous mist-like spray, enabling one to spray three times as fast and with one-third the labor. Length 20 inches. Capacity, one quart. (P. P. weight, 2 lbs.)

Each, **TIN, \$1.00; GALVANIZED, \$1.25; BRASS, \$1.75.**



No. 5 Continuous.

Powder Sprayers, Blowers and Dusters

These are used for applying Sulphur, Bug Death, Dry Bordeaux or insect powder of any kind.

LOWELL POWDER GUN (See cut).—Heavy tin. Finished in aluminum. If the powder is sifted and dry it will not clog; guaranteed. Throws a fine cloud of powder. Capacity 1 quart. (P. P. 2½ lbs.)
Price \$1.00

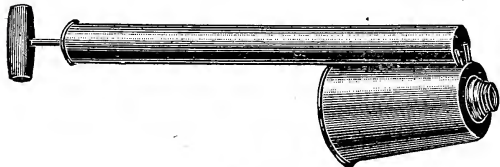

Lowell Powder Gun

NIAGARA DUST GUN.—A new style, light weight, durable and powerful dust gun.
Price \$2.50

DEFENDER.
Holds about 1 oz.
15c; postpaid 20c.



FLORADORA.
Holds about 4 oz.
Larger, Better.
35c; postpaid 40c.

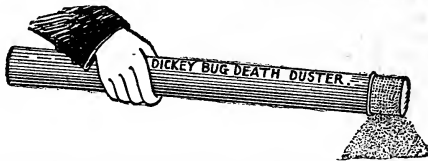

DICKEY BUG DEATH DUSTER.—For using when applying Lime, Dust or Powder of any kind. For use on small gardens this is very handy. Saves powder, puts it on evenly and just where you want it.
(P. P. ¼ lb.) Each 50c

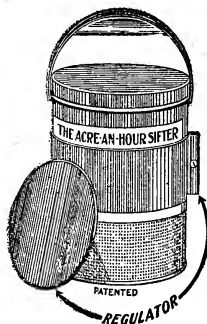

ACRE AN HOUR DUSTER OR SIFTER.—Bucket shaped, straight sides, made of heavy tin, good handle, holds 5 lbs. powder. A simple twist of the wrist does the work. As its name implies, you can cover an acre of plants an hour. (P. P. 2 lbs.) Each \$1.00

NOZZLES, SPRINKLERS, RODS, EXTRAS, ETC.

For Bamboo Extension Rods, etc., see page 125.

GARDEN HOSE, THE "WEAR-EVER" KIND, page 125.

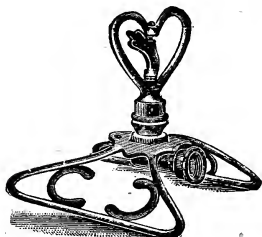

Busy Sprinkler

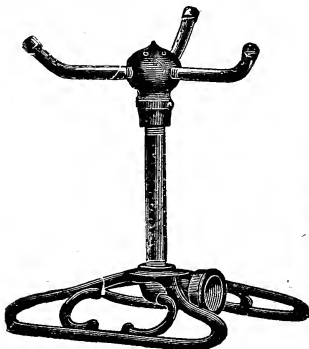

Pluvius Sprinkler

INVESTIGATE THE KIRK SYSTEM of spraying insecticide and fertilizer through the garden hose. See pg. 40.

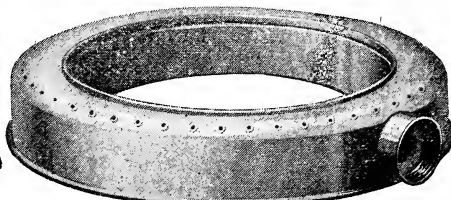

Fountain Sprinkler

LAWN SPRINKLER

Don't waste time holding the hose nozzle—use lawn sprinklers, and change positions as often as necessary.

Pluvius Lawn Sprinkler—Upright standard, 3 brass arms. (P. P. 4 lbs.) Each \$1.75

Monarch or Midget—Same style as above, only lower. (P. P. 2½ lbs.) Each \$1.25

Busy Lawn Sprinkler—Covers 25-foot circle. Very desirable for medium sized yards. (P. P. 3 lbs.) Each \$1.35

Fountain Sprinkler—Circular brass tube. Large \$1.50; small 75c (postage 10c)

Little Wonder—Cheap, but good. Excellent in small yards. Covers 20 feet. (P. P. 1 lb.) Each 50c

No. 31—Diamond Hose Nozzle—Best for sprinkling; adjustable from solid stream to a fine spray. (P. P. ½ lb.) Each 75c

No. 41—Dandy Hose Mender—Best mender made, simple and quick; nothing to catch; sure to hold.

Postpaid, ½ in., 15c; ¾ in., 20c

No. 40—Garden Hose Connections. Both male and female couplings.
½ in. or ¾ in., pair 50c (6 oz.)

Hose Washers. Doz. 10c, postpaid

No. 45—Metal Mender Tubes.
½ in. or ¾ in., each 10c postpaid

No. 42—Hose Clamps, single band.
½ in. or ¾ in., each 10c postpaid

No. 44—Hose Clamps, double band.
½ in. or ¾ in., each 15c postpaid

SPRAY PUMP NOZZLES

Single Bordeaux (Best for Whitewash) \$.90
Single Vermorel (Very Fine Spray) .90

PLANT SMALL FRUITS around your garden. What's nicer than delicious fresh fruit, fresh from your own garden? See Fruit Department, pages 109 to 118.

Books You Should Read

Garden Making.

By L. H. Bailey. In this book the beginner in gardening is shown how easy it is to raise flowers, fruits and vegetables, and to beautify one's home grounds, if one starts right and has a genuine love for plants. Illustrated, 5x7 inches, 417 pages, cloth. New edition, \$1.75 postpaid.

Asparagus.

Its Culture for Home Use and for Market. A practical treatise on the planting, cultivation, harvesting, marketing and preserving of Asparagus, with notes on its history and botany, by F. M. HEXAMER. Handsomely illustrated, 5x7 inches, 174 pages. Cloth, Price, postpaid, 85c

New Rhubarb Culture.

A Complete Guide to Dark Forcing and Field Culture.

Copiously illustrated from photographs and sketches made exclusively for this work. The only complete, practical, scientific and up-to-date manual on this crop. 5x7 inches, 130 pages, cloth. Price, postpaid, 85c.

Onion Raising.

By J. J. H. Gregory. What kinds to raise, and the way to raise them. Paper, 40c postpaid.

Our Farm of Four Acres

Money We Made By It.

This work is written by a woman who describes in its pages her experiences in selecting and managing a small farm; the first difficulties encountered; details of making butter and bread; care of poultry and pigs; gardening, etc. It is a model in style, and while conveying many useful suggestions, portions of it are fully as interesting as a romance. Paper, 50c postpaid.

Miscellaneous Farm and Garden Books—Continued

	Prices Postpaid
Celery Culture. —(Beattie), 150 pages...	\$0.60
Draining for Profit and Health. —152 pages	1.25
Forage Crops, Other than Grasses. —(Shaw)	1.35
Fruit Garden. —(Barry's). 516 pages...	2.00
Greenhouse Construction (Taft). 210 pages	2.00
Greenhouse Management. —(Taft). 382 pages	2.00
Irrigation, Garden, Farm, Orchard. —276 pages	1.10
Keeping One Cow. —136 pages, 5x7.....	1.10
Kitchen Garden. —How and What to Grow, 198 pages30
Landscape Gardening. —(Waugh). 152 pages	1.00

Carrots, Mangold-Wurzels, Etc.

By J. J. H. Gregory. How to raise them, how to keep them, and how to feed them. Paper, 40c postpaid.

Barn Plans and Outbuildings.

New, revised and greatly enlarged edition, modernized and brought up-to-date. Edited by EDWIN C. POWELL.

This book contains a wealth of designs and plans for a very small sum; 375 illustrations, 5x7 inches, 404 pages. Cloth, postpaid, \$1.75.

Beginner's Guide to Fruit Growing.

A simple statement of the elementary practice of propagation, planting, culture, fertilization, pruning, spraying, etc., by F. A. Waugh. Just the right kind of a book at last. Well illustrated, 5x7 inches, 120 pages, price, \$1.00 postpaid.

The Pruning Book.

By L. H. Bailey. This is the first American work exclusively devoted to pruning. Every part of the subject is made so clear and plain that it can be readily understood by even the merest beginner. Illustrated, 5x7 inches, 400 pages, cloth. New edition, \$2.25 postpaid.

Dry Land Farming.

By Thomas Shaw. The dry land farmer will find it a helpful and reliable guide. Illustrated, 5x7 inches, 460 pages, \$2.20 postpaid.

Alfalfa.

By F. D. Coburn. Its growth, uses and feeding value. Much information is given in this volume for every part of America by the highest authority. Illustrated, 5x7 inches, 164 pages, cloth, 85c postpaid.

	Prices Postpaid
Practical Potato Culture. —126 pages...	\$1.00
Money in the Garden. —(P. T. Quinn). 268 pages	1.25
Mushrooms—How to Grow Them. (W. Falconer). 170 pages, 5x7.....	1.25
Mushroom Culture25
New Western Raspberry—Blackberry Culture. —(Littwoy.)40
Practical Fruit Grower. —(Maynard). 128 pages85
Profitable Dairying. —(Peck), 200 pages	1.10
Strawberry Culturist. —(Fuller). 59 pp.	.30
The Rose. —(Ellwanger)	1.35
The American Apple Orchard. —226 pp..	1.25
The Potato. —(Frazer.) 200 pages, 5x7.	.85
Tomato Culture. —Western25

Save time, energy and money by reading these practical and up-to-date books. Did you ever stop to think that a few hours' reading now and then will give you valuable information that it has taken others YEARS OF LABOR AND EXPERIENCE to obtain?

BOOK**"The Call of the Hen"****BOOK****IT WILL CUT DOWN YOUR FEED BILL**

Why feed the hen that never lays or that never lays enough eggs to pay her keep? There is a way to prevent this. Learn which of your hens lay best.

THIS BOOK WILL TEACH YOU HOW

But once in a century is a discovery made which revolutionizes an industry, adding to the sum of human knowledge a "missing link" in the chain of civilization—creating an exact science, where before chaos reigned supreme,—where things went sort of hit and miss fashion. What Edison has done with electricity, what Burbank has accomplished in the field of horticulture, Walter Hogan has done for the poultry industry. So that you can understand and apply to your own poultry work the result of all this, the full details in plain and terse language is given in his new one hundred and fifty page cloth bound book.

Under the touch of his magic hand Nature's secrets stand revealed—secrets, the value of which cannot be estimated in dollars and cents—secrets which have enabled hundreds of thousands of poultrymen to double profits in a single year.

Don't Kill the Layer—Swat the Drone

If you only keep a dozen hens you need this book. It will cut down the feed bill and increase your average egg yield. Don't judge "The Call of the Hen" by other poultry books. It's a cloth bound illustrated description of a new discovery, revolutionary in nature, the result of a lifetime of investigating and experimenting and has been thoroughly tested by hundreds of the most successful poultry plants and pronounced wonderful and sure.

Cull Your Flock Now—Sell the Loafers—Keep the Workers

By the Hogan method you can not only select your good layers, but also good breeders, both male and female; birds that will reproduce their kind and enable you to rapidly increase the average egg production of your flock.

PRICE: \$2.00, postpaid. You take no chance. Examine the book and if not satisfied return it for your money.

CYPHERS COMPANY INCUBATORS

FREE IF INTERESTED—If you want to know more about Cypher's Incubators and Brooders we will gladly mail copy of Cypher's 1917 Catalog free.

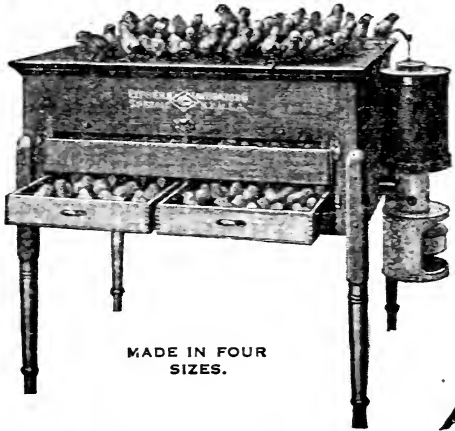

MADE IN FOUR
SIZES.

No. 2 Cypher's 244 Egg Size.

CYPHER'S INCUBATORS are built to hatch and to last. With proper care—the same care you would give a valuable piece of household furniture—a Standard Cyphers will last an ordinary lifetime. Machines sold many years ago are still doing first-class work.

For twenty years Cyphers' Incubators have been recognized as the "standard hatchers of the world." Tens upon tens of thousands of them have been sold and are in successful use in every civilized country on the globe. They are the last word in incubator building, not a penny being spared anywhere in their construction to make sure of their doing sat-

Standard Cypher's Incubators

The CYPHERS' INCUBATOR has been known for years as the "business incubator of the age." It has WON ITS WAY in all parts of the world because it has given the BEST RESULTS. It is used on Government Agricultural Experiment Stations, Large Practical Poultry Plants, Successful Egg Farms, and by thousands of prominent Poultry Fanciers everywhere. It hatches a LARGE PERCENTAGE of the eggs entrusted to it, and produces LARGE, STRONG, HEALTHY and VIGOROUS chicks. It is well known from coast to coast and is probably the "most popular and best known incubator" today.

isfactory work in all climes, under widely different conditions, in the hands of all sorts of people.

NO. 3—390-400 egg capacity—PRICE \$49.00

STILL IN BUSINESS.—It has been told about that the Cyphers Incubator Company is "out of business." The fact is they reorganized and are "still in the ring." The reorganization delayed orders, but we have in stock about 40 No. 3 large size incubators and one No. 1, 144-egg, price \$28.00, for prompt delivery. (Cyphers Electric Machines, page 138.)

OTHER POULTRY AND PET STOCK BOOKS.—Our page of up-to-date poultry, bird and pet stock books was crowded out of this catalog. Ask for descriptive leaflet if interested.

Routledge Seed & Floral Co's

UP TO DATE
"HIGHEST QUALITY"

POULTRY SUPPLIES



We have in stock practically everything needed and used in the profitable rearing and keeping of poultry and offer you what we believe to be the **best line** of Incubators, Brooders, Supplies, Foods and Remedies in the U. S. A.

You will note that we have added the Queen Incubators and Brooder Stoves this season. We are not wedded to any one make or line of supplies, and when we find something of superior merit, we buy it. We are **Western Agents** for the **Queen Incubator Co.** of Lincoln, Neb.

QUEEN HOT WATER INCUBATORS.

It is with great pleasure and satisfaction that we offer to our western buyers the **QUEEN INCUBATORS**. While they have not been extensively advertised in the Pacific Northwest several carloads have been distributed from Oregon, Washington and California points and we find upon investigation that they have given the **BEST OF SATISFACTION** and have many staunch friends. The **QUEEN IS VERY POPULAR AND HIGHLY PRIZED** in all localities where they are known. They have been manufactured for 20 years and **EACH YEAR THE DEMAND IS GREATER**.

THE QUEEN INCUBATOR COMPANY enjoy a large, growing, profitable and satisfactory business, and **THERE'S A REASON**. They are willing to live and let live—they don't crave publicity by lawsuits, damage claims, etc.—they don't want to put all other manufacturers out of business—they don't claim every egg put into a Queen Incubator will hatch—they don't bluff and brag. **BUT THEY DO** build a **PRACTICAL, HONEST, SUCCESSFUL INCUBATOR** and offer it at a reasonable price. The Queen Incubator Company is composed of a **HIGH GRADE CLASS** of **CLEAN CUT, HONEST, ACCOMMODATING GENTLEMEN** willing and anxious to help you succeed in your poultry work. **WE LIKE THEM AND THEIR MACHINES**—they have "**CLASS, DIGNITY and QUALITY**."

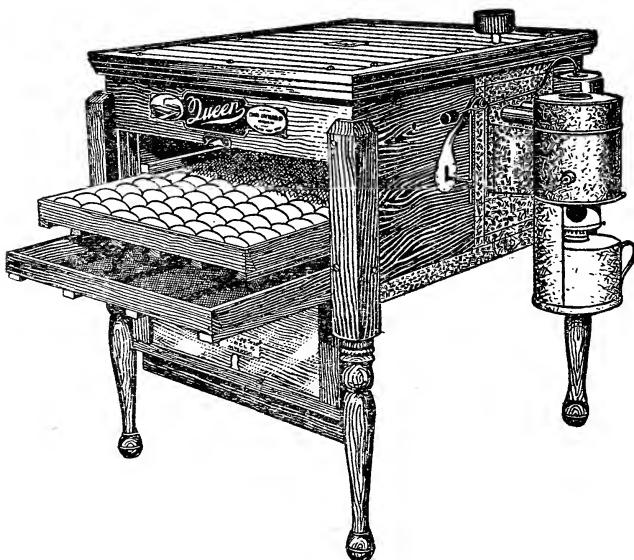

No. 3 Queen, 180 Eggs, a Favorite Size.

WESTERN REPORTS

"I used two **QUEEN** machines last year with good results."

DAVID LINGMAN, Beaverton, Ore.

"I purchased a 130-egg **QUEEN** incubator and have taken off three hatches. First time I got 98 chicks from 103 fertile eggs, second time 78 chicks from 84 fertile eggs, and third time 88 chicks from 90 fertile eggs."

H. J. CORRELL, McMinnville, Ore.

"I have a 180-egg **QUEEN** and ran it twice last season in a tent, with the outside temperature 100 degrees. I got 80 and 85 per cent hatches."

W. H. SEARLE, Medford, Ore.

"I am pleased to report that every fertile egg hatched in my **QUEEN**. I am very well pleased with it."

MRS. F. V. WESTBROOK, Huntley, Wash.

"We have been running four 360-egg **QUEENS** for four seasons, and they have given entire satisfaction in every way. Any time we increase our hatching capacity, it will be with **QUEENS**."

THE GALLOWAYS, Geneva, Wash.

Order Your Incubator Early. Don't Wait and Be Late

QUEEN INCUBATORS



No. 2 Queen, 125 Egg.

QUEEN incubators are famous for big hatches of **strong, healthy chicks** that live and grow. The **QUEEN** is accurately regulated—taking care of a temperature variation of 70 degrees without danger. It is built of genuine California Redwood—very scarce in these days of imitation and cheap substitution. Redwood **DOES NOT ABSORB THE ODOR** from the hatching eggs. Cheaper woods, and pasteboard lining in a great many machines, **RETAIN THE ODORS**, to weaken and kill the hatching chicks.

Remember, it is not how many you **HATCH** that counts, but how many you **RAISE**. Chicks that hatch out **WEAK AND WOBBLY**, live but a few days and mean nothing to you except trouble and loss. They make one sick of the poultry business. Most of the chicks you lose in the first two weeks die because they did not hatch out with enough vitality or strength for a good start.

INSULATION

Many incubators, nowadays, are not well insulated. Proper insulation adds considerable expense to the manufacturing cost, and the manufacturers of cheap machines dispense with it, or use an inferior substitute. However, proper insulation is an absolute requirement of a good incubator.

Good insulation means a proper maintenance of uniform heat throughout the hatching period, less fuel and stronger chicks.

Poor insulation means a fluctuating temperature. The **QUEEN** is doubly insulated. First,

EVERY MANUFACTURER CLAIMS HIS MACHINE IS THE BEST. The most extravagant claims are often made for the cheapest and most flimsy machines. Unfortunately, there is at present no law to protect the public against irresponsible exaggeration, and it is wise for you to make some investigation.

WE WELCOME ANY SUCH INVESTIGATION and comparison, for you will find **MORE GENUINE VALUE IN THE QUEEN**, for the amount of money you pay, than in any other incubator on the market.



No. 25 Queen, 500 Egg (2 doors, 4 trays).

perature, more fuel and weak chicks. we use double walls of California Redwood, forming a dead air space. Second, we use corrugated strawboard between the wooden walls.

HOT WATER HEATING SYSTEM

The **QUEEN** Hot Water system eliminates the injurious drying out tendency found in all hot air incubators and provides a soft, uniform heat over every part of the egg chamber that is most natural for the hatching eggs. This form of heat under ordinary conditions makes unnecessary the application of moisture, because in the **QUEEN** the circulation of water through the radiator neither adds nor takes away the moisture, and air is supplied to the eggs in a natural form as under a mother hen. Hot water is admittedly the best heat for incubators.

SELF-SUPPORTING EGG TRAYS

It is expensive to have a tray of eggs slip out and drop to the floor. This cannot happen with a **QUEEN**. It has self-supporting egg trays.

Start Your Chicks With a Queen Constitution.

Many people write us that they have never known a machine that hatched such **STRONG, HEALTHY CHICKS** as the **QUEEN**. The **QUEEN** is not a cheap incubator, compared with many of the cheaply constructed machines on the market, but it is **CHEAP IN THE LONG RUN**. It will be turning out high percentage hatches years after the cheap machines have been junked.

PORTLAND PRICES ON QUEEN INCUBATORS

We order in carload lots and can make prompt shipments. All machines fully guaranteed.

No. 1— 85 egg capacity	\$ 19.00	No. 25— 550 " "	\$ 76.50
No. 2— 125 " "	26.50	No. 45—1000 " "	155.00
No. 3— 180 " "	32.00	No. 0— 65 " Lincoln	12.00
No. 4— 275 " "	43.00		
No. 5— 400 " "	51.50		
No. 25— 550 egg capacity	\$ 76.50		

NOTE—Prices on request for 1500 and 2000 egg capacity Queens.

WE WILL GLADLY MAIL TO YOU A COPY OF THE QUEEN INCUBATOR CO.'S ILLUSTRATED AND DESCRIPTIVE CATALOG. IT GOES INTO DETAIL AND PLAINLY SHOWS YOU JUST HOW THEY ARE CONSTRUCTED AND WHY THEY ARE SO SUCCESSFUL. WRITE US TODAY; A POSTAL WILL DO.

Queen Colony Brooder

The only Brooder Stove with Automatic Control of Both Check and Draft.

DON'T HATCH CHICKS AND LOSE THEM—USE A "QUEEN."

Without a question the "Best" brooder stove on the market today. Note the improvements—the self-feeding, straight fire bowl, no clogging like in the old barrel-shaped bowls. A full-size rocker grate, a real automatic wafer regulator that really works in connection with a right-principle damper or check valve. A fire-proof, ventilated stove base and a collapsible, four-piece hover (to save freight charges and to save room when not in use).

The QUEEN Colony Brooder is a new and improved design of brooder stove. It is made of highest quality iron castings that will wear and last indefinitely.

There are no drafts on the smoke pipe of the QUEEN. The check rests on top of the stove and opens outward when fire is too warm, thus giving a gentle inflow of air to retard the heat. While the opening of the draft to increase the fire is located on the top of the stove, it opens into the fire at the base through an opening extending down the side to the bottom. This feeds the draft into the fire from underneath with no opening below the hover. As will be seen from the illustration, the check and the draft lids are cast together and operated together. Thus, when the fire is too hot, the wafer automatic regulator expands and closes the draft and opens the check, but if at any time it gets too cool, the wafer contracts and closes the check and opens the draft. This keeps an even heat all the time, both night and day, in cold weather or warm, and does it automatically. You don't have to pay any attention to it whatsoever. Just set the regulator for the proper temperature at the start of the season—it will do the rest.

Next to a good draft through the chimney, the principal secret of a good fire in any stove is a good grate that will free the fire from ashes properly and prevent clinkers. The grate in the Queen stove is the rocker type and strikes the fire at four points. This is far superior to any draw-center or shaker grate, because it cleans the fire thoroughly and by striking at four points will break up and remove all clinkers.

The hover used on Queen stoves is collapsible and made of four pieces of galvanized

iron. This hover comes knocked down, with holes punched and stove bolts attached, ready for putting together. By being collapsible, it enables you to save room when storing and lessens the danger of damage when not in use. Hover has a cast-iron ring on top which sets firmly on top of the stove, and is furnished with a wire hook to which rope and pulleys may be attached. It is not necessary to raise the hover to put in coal.

The Queen stove provides a constant, correct heat, and a constant distribution that makes the chicks develop into STRONG, HEALTHY CHICKS. By brooding with a "Queen," the chicks get plenty of pure, fresh air, plenty of exercise, and there is no POSSIBLE CHANCE OF THEM CROWDING OR SUFFOCATING.

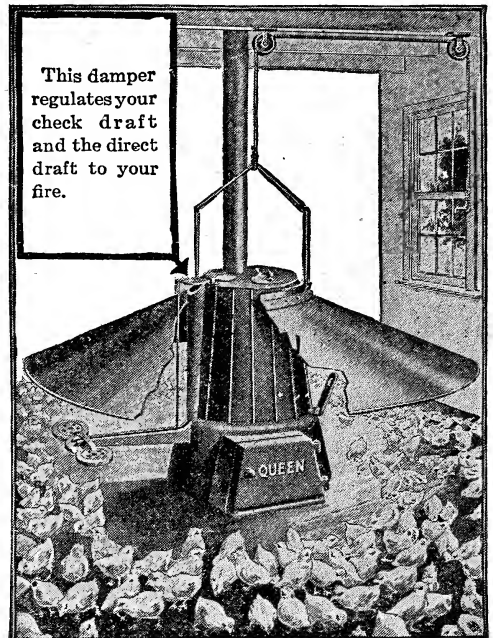

Dimensions

	No. 1-600 Chick Size	No. 2-1200 Chk.
Height to top of stove.....	18 inches	21 inches
Diameter of cylinder top.....	10 "	11 "
Diameter of hover	42 "	52 "
Diameter of grate	9 "	10 ³ / ₄ "
Height of hover from floor.....	8 ¹ / ₂ "	11 "
Price	\$19.50	\$22.50

NOTE—ORDER WHAT 3-INCH STOVEPIPE YOU NEED AT 30c PER 2-FOOT LENGTHS; ELBOWS, 50c.

Every chick hatched represents possible profit. The work laid out before you is to get this chick into a vigorous laying hen, or fit for market in the SHORTEST TIME possible—this is your PATRIOTIC DUTY NOW.

OAKES ECONOMY HOVER

ALL STEEL, LIGHT, STRONG AND DURABLE

It furnishes plenty of heat with a small lamp flame and is **guaranteed to give satisfaction in every respect**. It is complete in itself and can be used anywhere, without any preparation, other than lighting the lamp.

It is made of steel throughout, and all parts are seamed or welded together, strong and durable.

It is compact, light and all in one piece, so that it can be conveniently lifted by the two handles and moved from one place to another without even disturbing the lamp.

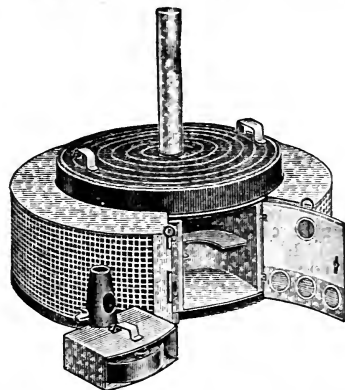

Economy Hover with rat-proof wire cage; showing construction of lamp, lamp box and lamp slide.

SAFE, CONVENIENT AND ECONOMICAL

The lamp, lamp slide and lamp box form a very convenient combination, the lamp has an O. K. **Safety Burner**, and the lamp box is **fireproof**.

The Economy Hover can be used anywhere with perfect safety and **ONLY A VERY SMALL FLAME** is required to keep up the temperature as the lamp is inside, and **no heat is lost**. The lamp is held securely in the lamp slide and the slide is an accurate fit in the lamp box, so that no adjustment of the lamp is necessary, simply push the slide in as far as it will go. The curtain is double, and made of heavy ducking and outing flannel. It is attached to the drum of the hover with eyelets and large hooks.

REPORTS ON ECONOMY HOVERS

Gentlemen: Last spring I purchased one of your new Economy Brooder Hovers and I take pleasure in expressing my full satisfaction in the ability of said Hover to raise every healthy chick entrusted to its care.

Out of three broods (147 chicks) not one was sick or died. We never raised a better lot of pullets.

Yours truly,
ALBERT HAAS.

Gentlemen: I have given your Economy Hover a good trial, and think it is the finest Brooder ever put on the market. I would never again think of raising chicks without the Economy Hover.

I had wonderful success. I raised 95 per cent of my chicks with the Hover. I recommend it to everybody that is interested in raising chicks.

Yours truly,
MRS. GEORGE GERST.

ECONOMY WIRE RAT-PROOF CAGE

Thousands of chicks are killed every year by rats—probably half the failures are due to that cause. The wire cage for the Economy Hover, if closed at night, prevents the possibility of any such losses.

The cage is also a great convenience in preventing the chicks from going too far from the hover during the first two or three days. The two halves of the cage are hinged to the lamp box, and can be opened during the day to allow the chicken to run out and in.

With each cage we furnish an extra panel, which closes the opening between the two halves of the cage and makes quite a little yard that is convenient when you do not wish to let the chicks at large.

PRICE'S ECONOMY HOVERS AND CAGES

- No. 2—100 chick size (22-in. drum)....\$10.00
- No. 1—50 to 60 chicks (18-in. drum)... 7.00
- No. 2—Wire cage, small size..... 2.90
- No. 1—Wire cage, small size..... 2.75

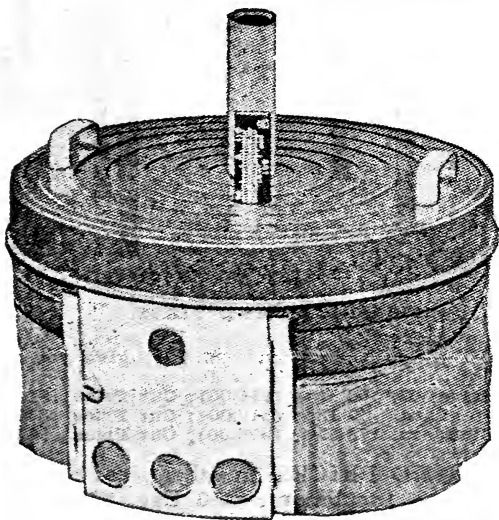

Economy Hover without wire cage.

CYPHER'S ADAPTABLE HOVER

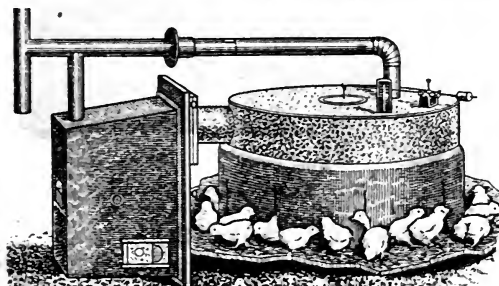

Cypher's Adaptable Hover.

Has all the desirable qualities that one hover can have, and it has successfully stood the most exacting, practical tests that could be made. It will brood chicks anywhere, in cold or warm weather, indoors or out, and can be installed in regular brooder cases, rough store boxes, small colony houses or regular brooder houses.

It is **self-regulating, ventilating and fire-proof**, will never blow out. An economical, convenient and durable 22-inch hover—**capacity 100 chicks.**

Price \$11.50

KRESKY'S "PRIDE OF PETALUMA" OIL-BURNING BROODER STOVE

If you want a perfectly reliable, economical and satisfactory oil-burning colony brooder, buy a Kresky. We sold a great many of these last season and they gave excellent satisfaction. We can refer you to those who are operating them, if you wish.

No. 12—A "Fresh Air Model," 500 to 1500 capacity, \$38.50 prepaid.

NEW LIBERTY BROODER STOVE—We are informed by the manufacturers that this stove for 1918 will be of a new model and wonderfully improved and require less oil. **Price complete, \$42.50.**

If interested, send for descriptive catalog of Kresky's Brooder Stoves. We are sure you will be benefited by Kresky's methods and ideas.

Routledge Seed & Floral Co.

Gentlemen: I am very glad to say that my experience with your "Kresky" room brooder has been very satisfactory. I have used other brooders, but this is the only one which I consider practical.

Yours truly,

J. R. CAPLES.

Note: Mr. Caples raised 1150 chicks at one brooding.



Kresky Oil Burner

Portland, Ore., Nov. 3, 1917.

BUCKEYE HOT WATER INCUBATORS AND BROODERS.

Limited space in this catalog will not permit us to go into detail and tell you "all the good things" about the Buckeye Incubators, but we will gladly mail to you, on request, a fully illustrated and descriptive catalog.

These well-known and much advertised incubators are very successful. They are fully guaranteed, well constructed, nicely finished, self-regulating, require no artificial moisture, need no watching and "will produce strong, healthy, vigorous chicks." We have sold many Buckeyes and they have given satisfaction.

The Buckeye is so simple that a boy or girl can operate it. That's the secret of its wonderful success.

We have a large storage stock to draw from and can ship promptly.

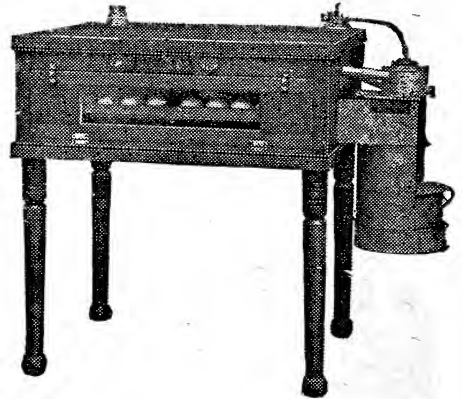

"Standard" Buckeye.

1918 PRICES AND SIZES.

The "cut prices" on some sizes are machines that we bought before the advance, and we give you the benefit of the lower prices as follows:

No. 15 Style "H," 60 Egg (\$16.00); **Cut Price..\$12.00**
No. 60 Standard, 60 Egg (\$19.00); **Cut Price \$15.50**
No. 2 Standard, 175 Egg (\$32.00); **Cut Price..\$27.50**

PORTLAND PRICES on other sizes of Standard Buckeye Incubators: 110 Egg, \$26.50; 175 Egg, \$32.00; 250 Egg, \$43.00; 350 Egg, \$51.50; 600 Egg, \$76.50.

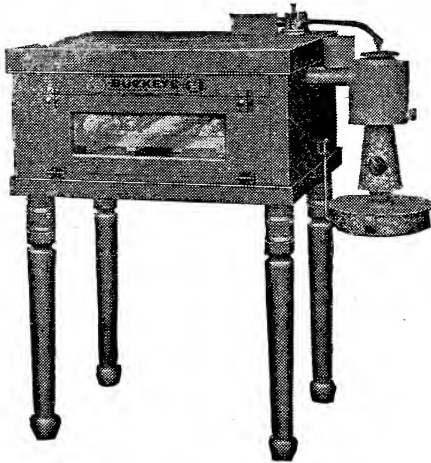

Style "H" 60-Egg Buckeye.

BUCKEYE HOT WATER, SELF-REGULATING BROODERS.—Well made and properly constructed. Equipped with automatic heat regulator and overhead hot-water tank. Very easy to operate. Lift the top off to clean out.

No. 2 Outdoor, size 20x44 in.....\$8.50

Can be used outside in any kind of weather. Rain and wind-proof.

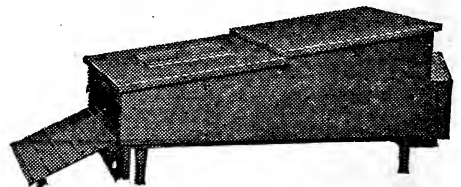

No. 2 Buckeye Brooder.

Cypher's Electric Incubators and Hovers

We have in stock Cypher's **60 Egg (\$21.00)** and **120 Egg (\$27.00) Electrobators** and **100 Chick (\$12.00) Electrohovvers.** These can be attached direct to any electric light socket. Regulation is simple and accurate. No fumes or gases, economical and convenient. Descriptive Catalog on request.

OCULUM, A WONDERFUL SCIENTIFIC GERMICIDE

Ask for Pamphlets giving full information and testimonials

Ocolum Liquid For Poultry

"OCULUM" is not a stimulant but is a SCIENTIFIC GERMICIDE. It destroys disease germs in the bowel and keeps fowls healthy.

DIRECTIONS FOR FEEDING.

Use one drop of "OCULUM" a day to each grown fowl (or 10 drops to each pound of feed). A teaspoon holds 60 drops.

Mix the "OCULUM" with water (just enough to sprinkle) and sprinkle the feed with the mixture, stir it and cover it up and the "OCULUM" will penetrate the feed in thirty minutes. "OCULUM" mixes with feed wet or dry, whole or cracked grain. It mixes best with scratch feeds.

"OCULUM" may be successfully used in water, put 5 drops to the quart of water daily for 30 days as a tonic.

You can feed "OCULUM" treated feed with PERFECT SAFETY to any size fowl from a day old chick up. Use "OCULUM" feed ONLY ONCE A DAY, all the fowls will eat. Feed "OCULUM" DAILY for ONE MONTH and then stop for one month and so on.

PRICES: Trial size, 1 oz. (240 feeds), 15c; 50c bottles, 60c and \$1.00 bottles, \$1.10 postpaid; by Express, Pints, \$2.00; Quarts, \$4.00; Gal., \$10.00.

For Stock and Poultry Insecticides Remedies, Tonics, etc., see Conkey's, page 151.

Ocolum Oil For Stock

STOCKMEN ARE DELIGHTED WITH ITS QUICK AND CERTAIN ACTION AND REASONABLE COST

Sick hogs and sick sheep quickly relieved by its magic power. Sick horses and sick cattle made well again by its use. Feed bills reduced.

"Ocolum Oil" is a scientific germicide for animals. Used in feed, it kills germs and worms in the organs of animals. Makes meat.

DIRECTIONS.

For Health and Extra Flesh: Feed hogs, sheep, goats, and other small animals 3 drops "Ocolum Oil" once a day in the feed to each 100 lbs. live weight; feed horses, cattle and other large animals 5 drops once a day in the feed to each 100 lbs. live weight. Feed it 4 weeks at a time, then rest 4 weeks and so on.

For Sick Animals. Inject "Ocolum Oil" in the anus, and also feed the sick animal "Ocolum Oil" according to directions with each bottle.

We Guarantee Ocolum Oil to Save Feed and Make More and Better Meat or Money Back. Full directions with each order.

PRICES: Trial size, 60c, or Half Pint \$1.15 postpaid; by Express, Pints, \$1.50; Quarts, \$2.50; Gal., \$7.50.

SPECIAL SYRINGE FOR ANIMALS, 25c.

SPRATT'S Patent Limited Cooked FOODS

FOR PHEASANTS, CHICKENS AND TURKEYS

Spratt says: "Our experience of over 50 years in the poultry, game and dog-food business convinces us that a predigested cooked food, the basic ingredients of which is wheat and meat, solves the problem successfully." It promotes health, strength and vigor. This food, after being cooked and baked, is reground into 3 sizes:

NO. 12—Pinhead size for baby chicks.

NO. 5—Rice grain size, chicks over 3 weeks.

NO. 3—Split pea size, adult birds.

In ordering be sure and state size wanted. **PRICES—1 lb., 10c; 5 lbs., 60c; 10 lbs., \$1.10; 50 lbs., \$4.75; 100 lbs., \$9.00.** Postage extra.

SPRATT'S CARDIAC

A tonic powder, for poultry and game. It has been used with the greatest success. Full directions on the package. **PRICE, 1½-lb. carton, 30c (postage extra).**

SPRATT'S CRISSEL

A high grade especially prepared meat food to take the place of "insect life" the birds get in the wild state. **PRICES, 1 lb., 10c; 5 lbs., 45c; 10 lbs., 90c; 25-lb. sacks, \$2.10. (Postage extra.)**

PHEASANT BREEDERS should have a copy of **Spratt's Pheasant Culture** 25c postpaid. Your name will be put on Spratt's mailing list for free booklets and bulletins if you request it.

PIGEON SALT CAT

Aids digestion, invigorates the system and promotes good health. It is put up in brick form, which keeps the birds busy picking at it, and prevents waste. Crumble the salt cat for young birds. **Price, per brick, 25c; doz., \$2.50. Mailing weight 1½ lbs. each.**

PURITAN LINE

A highly refined lime product especially prepared for household and specific uses, such as **Lime Water Egg Preserver, Deodorizer, Fruit and Garden Uses, etc.** Goes twice as far.

FOR WHITEWASH—Take one 5-lb. package Puritan Lime and one pound table salt. Stir both into from 1 to 2 gallons hot water and apply with spray or brush.

PRICE, put up in 5-lb. cartons, 25c. Add postage if wanted by mail.

NOX
+
CID

**Keeps Your Coops
Free from Germs**

Conkey's Nox-I-Cide is absolutely unequalled as a non-poisonous deodorant and germ destroyer. It positively prevents diseases in poultry houses, runs and brooders, dog kennels, stables, or from cesspools, sinks, drains, garbage pails, etc.

**Conkey's Nox-I-Cide
Saves Medicine Money**

Indispensable to poultrymen. Use it for cholera, roup, canker, gapes, chicken pox, pip, etc. A sure louse destroyer. Sold in any quantity. Ask for special book.

For prices, see Conkey's List, page 151.

"UNCLE SAM" has asked that an extra hundred million pounds of poultry be raised in the United States this year. Be patriotic—DO YOUR SHARE.

Routledge's "Highest Quality" Poultry Foods

The planter who buys high grade seed gets better crops. He who fertilizes his soil—manures it well—is amply repaid in the size of his harvest. The poultryman who feeds the "Highest Quality" poultry foods even though it is a little higher in price, makes more profit than he who is content with cheap mixtures or low grade grains because it costs less.

IMPORTANT NOTICE TO POULTRY KEEPER.—We want your trade direct—not the dealer's, therefore give you strictly wholesale prices in 5, 10 and 20-bag lots. Send a list of kind and quantity wanted. **PRICES** on this page subject to important market changes.

POULTRY SHELLS, CRUSHED

These should be within reach of your hens at all times. Not straight Oyster Shells, but a combination of Oyster, Sea and Clam Shells that is rich in lime material for egg shells. Gives good results and is much cheaper. Put in one section of your Sanitary Feeder.

Price, 5 lbs. 10c; 14 lbs. 25c; 100 lbs. \$1.00; 500 lbs. @ 90c.

OYSTER SHELL, CRUSHED

This is pure hard oyster shell crushed and sifted, preferred by some to our Poultry Shell.

Price, 4 lbs. 10c; 12 lbs. 25c; 100 lbs. \$1.35; 500 lbs. @ \$1.25.

GRIT—Best Grade

Every poultry raiser should keep a supply of this grit in each pen. **Baby chicks and ducklings must have it.** Made in three sizes chick, pigeon or broiler and hen size. We always send hen size unless otherwise ordered.

Price, 5 lbs. 10c; 14 lbs. 25c; 100 lbs. \$1.00; 500 lbs. @ 90c.

GRANULATED BONE—"SPECIAL"

We offer only highest quality, white, pure and clean. Rich in phosphates, lime and protein. Should be kept before your chickens at all times. Feed in a Sanitary Shell and Grit Box. (See page 12.)

Price, 5 lbs. 25c; 12 lbs. 50c; 100 lbs. \$3.25; 500 lbs. @ \$3.20.

STANDARD.—Good but not so white. **100 lbs. \$3.00.**

POULTRY PEPPER

A good tonic and invigorator. Ground.

Price, 1 lb. 25c; 5 lbs. \$1.00

POULTRY MUSTARD

Ground fine. **1 lb. 20c; 6 lbs. \$1.00**

FISH MEAL—H. Q.

The grade we sell is the best obtainable, it contains nothing but pure fresh fish properly processed and will not taint the eggs. Fish Meal is rapidly taking the place of Beef Scraps, Beef and Meat Meal, Blood Meal, etc., as it contains more available animal protein.

Prices, 5 lbs. 35c; 10 lbs. 60c; 50 lbs. \$2.35; 100 lbs. \$4.75. Write for quantity prices.

CLOVER OR ALFALFA MEAL

The best substitute for green food for winter feeding; helps keep the egg basket full; mixed with the soft feed is good for large or small chicks; endorsed by leading experts. For cut clover see **Clover Cutter**, page 18.

Price, 1 lb. 10c; 10 lbs. 50c; 100 lbs. \$2.50

CHARCOAL

Our stock is prepared especially for poultry; no dust; a preventive of bowel trouble, sour crop and indigestion; a health preserver. State size wanted. **A** for mash, **B** for chicks, **C** for large chickens or hens. **Price, 1 lb. 10c; 3 lbs. 25c; 10 lbs. 75c; 50 lbs. \$2.00; 100 lbs. \$3.75.**

BEEF SCRAPS

Our "Highest Quality" beef scraps are rich in materials which make bone, muscle and lean meat. They insure health, thrift and vigor, and satisfy the natural craving of the bird's system for flesh-food in some form. Rich in protein. Can be fed dry or with cooked rations. Don't waste any, feed in one section of Sanitary Feeder. See page 12.

Price, 5 lbs. 35c; 10 lbs. 65c; 50 lbs. \$2.85; 100 lbs. \$5.75.



CONKEY'S BUTTERMILK

STARTING FOOD

Buttermilk your baby chicks and make them grow like weeds.

Put vim and vigor into them when they most need it; help them throw off disease and withstand exposure.

Conkey's Buttermilk Starting Food provides buttermilk for the chicks in a dry, sanitary mash form. It makes a regular, uniform supply possible, and in addition to this it contains sweet, pure grains and just enough medication to start the organs working in a normal way. It is a nourishing, stamina-building food that makes the youngsters husky and strong. It should be their very first food. Feed dry. **Prices, 1 lb. 10c; 3 lbs. 25c; 6 lbs. 50c; 14 lbs. \$1.00; 25 lbs. \$1.70; 100 lbs., write.**

Mt. Angel, Ore., January 3, 1918.

Routledge Seed & Floral Co.,

Portland, Oregon.

Gentlemen: In reply to your inquiry as to the merits of Conkey's Buttermilk Mash Starting Food, will say we are more than pleased with the results obtained from its use, and would be very much disappointed if we could not buy it again for the coming season.

We have raised more chicks, healthier chicks and better chicks than ever before by using "Conkey's Buttermilk Mash Starting Food." It has reduced the sickness to a minimum.

We divided one flock of several hundred chicks, giving one lot "Conkey's Buttermilk Mash" and the other lot regular chick feed of other sorts and watched results.

In four weeks' time the ones fed "Conkey's Buttermilk Mash" weighed twice as much as the others and the loss was over 33 per cent less. The pullets from the lot fed "Conkey's Buttermilk Mash" started laying at four and one-half months of age, being the finest developed lot of pullets on our place, which we know is due to proper starting on "Conkey's Buttermilk Mash."

We cannot say too much for this most wonderful starting food for chicks and will want at least one ton of it this coming season from you. Please quote us price and date of delivery at once.

Thanking you for past favors, we remain

Yours truly,

MT. ANGEL COLLEGE POULTRY FARM,

By Father Boniface, Mgr.

Don't invite diseases and loss by using old pans, open dishes or wooden troughs. See page 142.

FISHER'S PURE FOODS FOR POULTRY

READ THIS

A year ago we took up the sale of the Fisher's Flouring Mills Co. line of Poultry Foods, because we decided that the Fisher's Foods were the best that money and experience could produce. Our sales more than trebled and thousands of our customers now agree with us that Fisher's Poultry Foods are unequalled in quality and always the same. Prices change but the formulas never and you can always depend on getting full value. We claim they are the cheapest because the most profitable. We are in a position to quote very low prices and supply promptly in any quantity these pure high grade foods.

A TRIAL WILL CONVINCING YOU OF THEIR SUPERIORITY OVER THE MUCH ADVERTISED "LOCAL BRANDS."

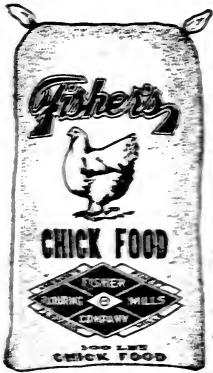

FISHER'S CHICK STARTER

The critical time in the life of a chick is the first few weeks. Until chicks are thirty-six hours old they should be given nothing but water and fine grits. Many play havoc with their broods by feeding them immediately. Avoid this fatal error. Fisher's Chick Starter contains food ingredients necessary to promote quick, rugged growth. You will find it a perfect food for the first four weeks. Make them scratch for it and keep Fisher's "Developing Mash" or Conkey's "Buttermilk Mash." Dry, in a feeder before them at all times.

Prices, 4 lbs. 25c; 10 lbs. 50c; 100 lbs. \$4.75; 50 lbs. @ \$4.65.

FISHER'S CHICK FOOD

This is a preparation of steel cut, pure, wholesome grains, carefully and scientifically combined. A month or two on this diet will bring remarkable results in the rounding out of the body and the development of a superb coat of feathers. Every element that goes into Fisher's Chick Food counts heavily in the building of the fowl. There is no waste.

Prices, 4 lbs. 25c; 10 lbs. 50c; 100 lbs. \$4.75; 500 lbs. @ \$4.65.

FISHER'S DEVELOPING MASH

There is no better known food ration for growing strong, sturdy and active chicks quickly, either for layers or for the show pen. It is a bone, tissue and feather producing ration of known merit. It should be fed after chicks are six or seven days old and kept continually before them until they are fully matured. (Feed it in a dry food hopper.) See pages 12-13.

Prices, 5 lbs. 25c; 10 lbs. 50c; 100 lbs. \$3.80; 500 lbs. @ \$3.70.

FISHER'S GROWING FOOD

This meets the wants of the growing chicks from the time they are six to eight weeks of age until ready for scratch food. It contains the nutritive elements necessary for the rapid building of tissue and if fed Developing Mash will bring about the quickest possible development.

Prices, 4 lbs. 25c; 10 lbs. 50c; 100 lbs. \$4.65; 500 lbs. @ \$4.55.

FISHER'S FATTENING MASH

Prepared expressly to meet the wants of the fancier who lacks weight in his show birds or the grower desiring to quickly fatten and finish young or old stock for the market. It will quickly add weight to a mature or growing fowl.

Prices, 5 lbs., 25c; 10 lbs., 50c; 100 lbs., \$3.50; 500 lbs. @ \$3.40.



FISHER'S SCRATCH FOOD

This is a perfectly balanced ration which, when fed with Fisher's Egg Producer for laying hens or Fisher's Developing Mash for maturing youngsters, contains all the food elements required to obtain the very best results known to scientific poultrymen. In its preparation only the purest and choicest grains are used. Experienced Poultry recognize it as the best scratch food the market supplies.

Prices, 5 lbs. 25c; 10 lbs. 50c; 100 lbs. \$4.25; 500 lbs. @ \$4.10; ton, write.

FISHER'S FOODS PROFITABLE

Milwaukie, Ore., Nov. 1, 1917.

Routledge Seed & Floral Co.

Gentlemen: My contract with you for 3 tons Fisher's Scratch Food and 2 tons Egg Producer is now completed and I must have more. I wish at this time to say THAT I AM MORE THAN PLEASED with the EVEN: HIGH QUALITY OF FISHER'S FOODS. I believe it is by FAR THE BEST and MOST PROFITABLE FOOD on the market. My hens MUST PAY ME A PROFIT and they HAVE DONE IT ON FISHER'S FOODS

Yours for success.

JOHN BOROS.

FISHER'S EGG PRODUCER

A mash mixture containing all the ingredients necessary to the matured laying hen; very rich in protein. It renders unnecessary the feeding of blood meal, beef scraps, etc. The rapidly increasing demand for Fisher's Egg Producer proves its real money making value. Results will prove this the most economical mash on the market.

Price, 5 lbs. 25c; 10 lbs. 50c; 100 lbs. \$3.55; 500 lbs. @ \$3.45.

FISHER'S PIGEON FOOD

In compounding a food for pigeons, the proper selection of various grains is of great importance, especially so during the breeding season and when squabs are to be marketed. The health of the birds and the weight of the squabs are dependent upon correct feeding.

Fisher's Pigeon Food is the most reliable and satisfactory mixture of the best grains obtainable for this purpose. It is practically impossible for any feeder to purchase on the open market materials of this kind and quality and assemble them at a price as low as ours.

Prices, 4 lbs., 25c; 9 lbs., 50c; 50 lbs., \$2.50; 100 lbs., \$4.60. Write for quantity price.

CYPHERS' SALT CAT FOR PIGEONS.
PAGE 139.

We make special prices direct to Poultry Raisers. 5 bags assorted foods at 500-lb. prices. Prices subject TO IMPORTANT MARKET CHANGES. Write for quantity price when ready to buy. WE'LL SAVE YOU MONEY.

Up-to-Date Sanitary Drinking Fountains and Feeders

Increase your profits by saving the chicks. Start now by ordering sanitary economical, up-to-date Fountains and Feeders. Note.—When wanted by parcel post, add postage.

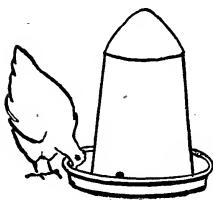

No. 1.

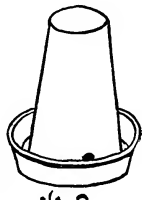

No. 2

NO. 1. CONE TOP FOUNTAINS

Most desirable, new style, pressed, galvanized. On account of "cone shaped top" (see cut) birds cannot roost on them.

Capacity.	P. P. Wt.	Each.	Doz.
1 qt.	1 lb.	35c	\$3.50
2 qt.	1½ lb.	45c	4.50
4 qt.	2 lb.	85c	8.50

NO. 2. CYPHER'S DRINKING FOUNTAINS

Pressed out of heavy galvanized iron; will last for years. Easy to clean inside and out. (See cut.)

Capacity.	P. P. Wt.	Each.	Doz.
1 qt.	1 lb.	35c	\$3.50
2 qt.	1½ lb.	45c	4.50
4 qt.	2 lb.	85c	8.50

NO. 3. SANITARY STONE FOUNTAINS

An old and popular style that keeps the water cool; see cut. (Not mailable.) Price, 1 qt. 30c, 2 qt. 45c, 4 qt. 60c, 8 qt. \$1.00.

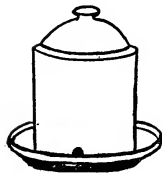

No. 3

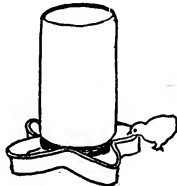

No. 4

NO. 4. STAR JAR FOUNTAIN

Very desirable style—chicks can't get wet. Any Mason jar fits it. Price (without jars), each 25c; doz. \$2.50, prepaid.



No. 5

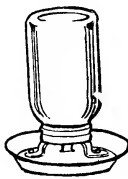

No. 6

NO. 5. PERFECTION FOUNTAIN

This consists of a shallow 6-inch pan and a collar to fit any size Mason jar. You fill the jar, screw on the collar, slip the pan in and turn it over. Simple sanitary and perfect for small chicks. Price (without jar), 25c each, \$2.50 per doz., prepaid.

NO. 6. "O-K" FOUNTAIN OR FEEDER

(See cut.) Any size Mason jar will fit the collar that is riveted to the 6-inch pan. Very desirable for chick feed, grit, small grain or water. Price (without jars), each 20c; doz. \$2.25, prepaid.

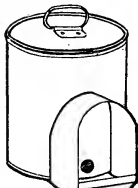

No. 7



No. 8

WALL FOUNTAINS

Very desirable for adult fowls; hang up on the wall out of litter and dirt; made of heavy galvanized iron.

NO. 7. CYPHER'S STYLE. Price, each, ½ gal. (P. P. 2 lbs.) 60c; 1 gal. (P. P. 3 lbs.) 80c; 2 gal. (P. P. 3½ lbs.) \$1.00.

NO. 8. MOES STYLE. Opening pressed in. ½ gal. (P. P. 2 lbs.) 50c each; 1 gal. (P. P. 3 lbs.) 70c; 2 gal. (P. P. 3½ lbs.) 90c.

CHAMPION 2-PIECE TELESCOPE FOUNTS. The top pulls out, easy to clean. ½ gal. 75c; 1 gal. \$1.00; 2 gal. \$1.25. P. P. Wgt. ½ lb. heavier than above styles.

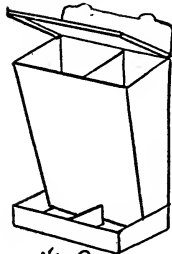

No. 9

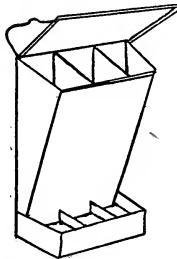

No. 10

GALVANIZED FEEDERS

Made of galvanized iron; soon pay for themselves in preventing waste. Sanitary, closed top self feeders for granulated bone, beef scraps, grit, shells, charcoal, dry mash, etc. If these necessary foods are kept before your fowls they will eat just what their systems require for profitable results; in other words, properly balance their rations. Hang up out of the litter.

NO. 9. Large—two compartments, one 6 qt. and one 3 qt. (P. P. 4 lbs.), each \$1.00. **Small**—two compartments, 2 and 4 qts. (P. P. 3 lbs.) each 60c.

NO. 10. CHAMPION—Three compartments holding 2 qts. each (P. P. 3½ lbs.) Each 85c

NO. 10. NESTO—Same style, little smaller; three compartments, 3 pts. each (P. P. 3 lbs.) Each 60c

NO. 11. MOE'S—Extra strong and well made; the feed trough at bottom is round; 4 section, 2 qts. each (P. P. 5 lbs.) Each \$1.25. 3 section, 2 qts. each (P. P. 4 lbs.) Each \$1.00.

NO. 12. MOE'S CHICK SERVER

Practical and a great saver of feed. Chicks can not get into it. For water or feed. **SMALL** (P. P. weight 2 lbs.) each 25c; **LARGE** (P. P. weight 3 lbs.) each 35c

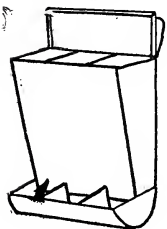

No. 11

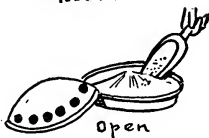

Open



No. 12

NOTE.—Above prices subject to change if metal continues to advance.

Sanitary Food Holders



Sanitary Food Holders.

For Poultry and Ducks of All Ages.—They are especially recommended for use in feeding mashies of any kind; steamed or dry alfalfa or sprouted grain. This protected receptacle saves 15 to 25 per cent in foodstuff. The topguard that keeps the fowls out of the feed is removable from the pan, making them very easy to clean. There is nothing to get out of order. Made of heavy galvanized iron; safe, sanitary, saving and serviceable.

No. 12 Chick,	size 1 x3¼x12 inches	(P. P. Weight 1¼ lbs.);	Price, each.....	\$0.50
No. 15 Small,	size 1¼x4 x15 inches	(P. P. Weight 1½ lbs.);	Price, each.....	.50
No. 18 Medium,	size 1¾x4 x18 inches	(P. P. Weight 2 lbs.);	Price, each.....	.75
No. 24 Large,	size 2¾x5¼x24 inches	(P. P. Weight 3 lbs.);	Price, each.....	1.00
No. 30 Extra Large,	size 3 x6 x30 inches	(P. P. Weight 4 lbs.);	Price, each.....	1.25

Boston Dry Food Hoppers

We believe this Food Hopper to be the best device of the kind on sale for the use of thrifty, up-to-date poultry raisers. With this device fowls cannot waste food, yet food is always accessible and always in sight. It cannot clog, is easily refilled when empty, and easy to clean and keep clean. During the day the front screen is dropped down against the feed, at night lifted up and hooked to keep the rats out. (See cut.) Insures your chickens clean food entirely free from filth of any kind. Every poultryman will appreciate this feeder. Made of heavy galvanized iron; with care will last forever.

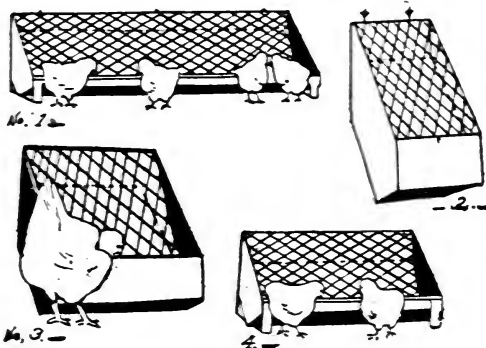

Boston Food Hoppers.

See Cut No.	Capacity	Size	P. P. Wt.	Each
No. 3 Large	½ Bu.	17x8x13	7 lbs.	\$1.25
No. 2 Medium	1 Pk.	17x8x 7	6 lbs.	1.00
No. 4 Short	½ Pk.	15x8x 4½	4 lbs.	1.00
No. 1 Long	1 Pk.	29x8x 4½	5 lbs.	1.50

Food and Water Cups

Made of galvanized iron, strong and durable; wire hangers; hold half pint. For exhibition of shipping coops. (See cut.) Each 20c; doz. \$2.00 (P. P. wgt. doz. 4 lbs.)

"OCULUM"—Great dope—see page 9.



Kant Klog Feeder.

"Kan't Klog" Feeder and Exerciser

One of the best combined feeders and exercisers, cannot clog. No spring to get out of order. Swinging deflector scatters the grain all around, a little at a time, whenever the birds pick at the grain bait cup. Holds enough to be of real service. Can be set to feed little or much. Hang in the scratching pen with straw on the floor.

No. 29 Capacity 10 qts, each.....	\$2.50
No. 31 6 qts., for low houses, each.....	1.75

Oakes Hydro Safety Lamps

Made especially for incubators and brooders. They have a water jacket to keep oil and burner cool and are perfectly safe, economical and satisfactory in every way.

No. 1—7½ in. high; ¾ in. wick (P. P. 1¼ lbs.)	\$1.10
No. 2—8 in. high; 1 in. wick (P. P. 2 lbs.) 1.65	
No. 3—9 in. high; 1¼ in. wick (P. P. 3 lbs.)	1.90

Cypher's Incubator Lamps

Seamless bottom, with burner and wick complete. No. 0, \$1.25; No. 1, \$1.50; No. 2 or 3, \$1.75. BURNERS only No. 0, 65c; No. 1, 75c; No. 2 or 3, 90c. WICKS, 5c each, 6 for 20c; Doz. 35c, postpaid.

Equip your poultry houses and yards with these money-saving, sanitary utensils. Don't invite diseases and loss by using old pans, open dishes or wooden troughs. Add postage.



Coop Cups.



Oake's Safety Lamps.

UP-TO-DATE SHIPPING BOXES FOR HATCHING EGGS

ORDER EARLY SO YOU WILL NOT BE DISAPPOINTED IN YOUR DELIVERY. PRICES BELOW SUBJECT TO CHANGES.

UP-TO-DATE EGG CARRIERS

Do not class these "Up-to-Date" boxes with the cheaply constructed egg boxes that are made along similar lines. These are double strength and cushion frame on all sides. Note the illustrations carefully. Safe and reliable for the mailing or expressing of table or hatching eggs.

Note.—Center box open, to the left "slip on" cover, to the right, box closed, ready to ship.

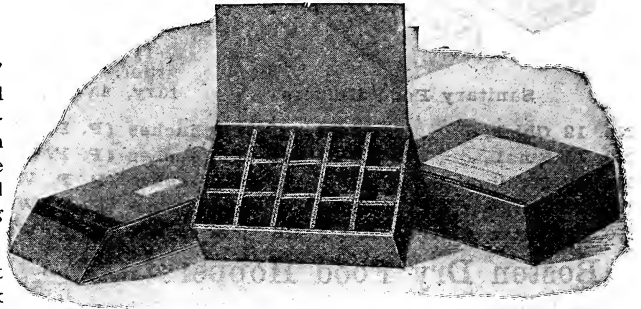

This has been a popular egg box for several years. Note the extra outside "slip-on" cover. A safe box for the expressing of fancy eggs, for hatching. Each egg can be wrapped in paper before dropping into its place.

Size	Weight, Empty	Each	Doz.
15 egg	1 lb. each	20c	\$2.00
30 egg	1½ lbs. each	25c	2.60
50 egg	2¼ lbs. each	35c	3.75
100 egg	5 lbs. each	75c	7.00

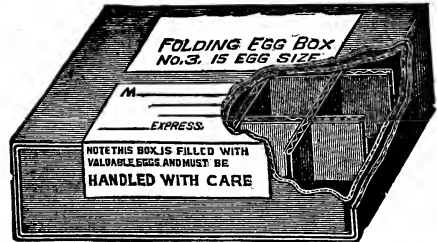

15-egg size. Open corner showing egg cells.

POSTAGE.—In ordering above egg or chick boxes by parcel-post be sure you add extra money for postage. Otherwise we will send by express or freight.

UP-TO-DATE BABY CHICK BOXES

Well made, properly ventilated.

These insure the safe arrival of your chicks.



Made from the best grade of corrugated card board. Shipped in the flat, but quickly set up by anyone. The use of this box has made long distance express shipments of live baby chicks possible and safe.

Size	Weight Empty	Each	Doz.
25 chick	P. P. 1¼ lbs.	20c	\$2.25
50 chick	P. P. 2¼ lbs.	30c	3.00
100 chick	P. P. 3 lbs.	45c	4.50

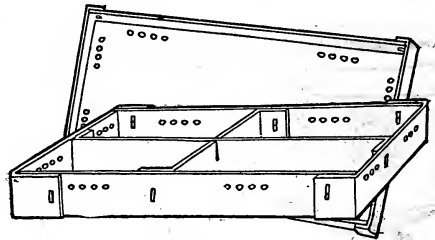

100-chick capacity, showing partitions.

Don't wait until your chicks hatch to order your boxes. Order early and be sure of stock when you want it.

Ideal Egg Box

Hold 12 eggs; very handy and convenient for private trade. Saves eggs and counting.

Price—Per doz. 20c (P. P. 1¼ lbs.); 100 for \$1.25 (P. P. 1½ lbs.); 1000, \$10.00.

Fillers only. 10c doz.; 75c per 100.

Buck Parcel Post Egg Crate

Made of wood, cardboard fillers.

Very light, but strong; metal corners; holds 12 dozen eggs; wire bale wooden handle. (P. P. weight 6 lbs.) Each 75c.

ARE YOU READY? There are no two ways about it; this will be a great year for poultry keepers. The demand for eggs for hatching, day-old chicks, broilers, etc., will be greater than ever before. Are you ready to grasp your opportunity? DON'T FORGET your "UNCLE SAM" has appropriated a big sum to help increase the production of poultry, for he WANTS 100,000,000 POUNDS MORE THIS YEAR.

WALLACE PARCEL POST EGG CARRIERS

POSTAGE.—In ordering above egg boxes by mail or P. P., be sure you add extra money for postage.

The Wallace Egg Carrier was designed to ship eggs by mail or express. It is the result of great study and experiment over a long period, by an experienced marketing man. It has been in practical use for over three years, during which time it has proven to thousands of satisfied users that eggs can be shipped by mail without breakage and in a carrier that is not prohibitive in cost.

Single Egg Containers—Each egg is packed in a small container (see illustration below) and these small containers are packed one, two, three or six dozen in a strong corrugated cardboard carrier. The result is a really practical Parcel Post Egg Carrier at a nominal cost.

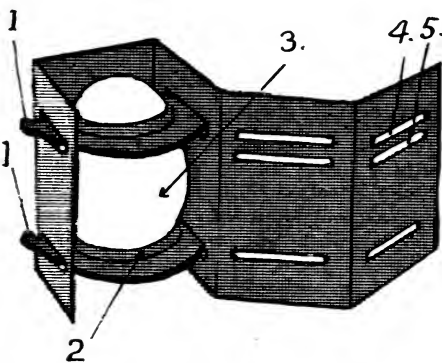

SINGLE EGG CONTAINER

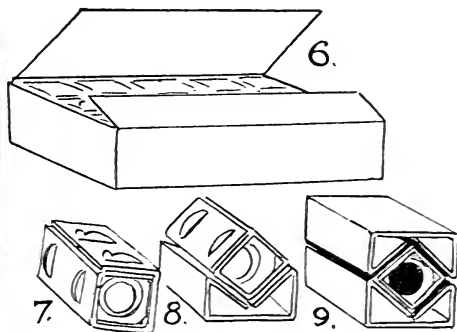

"HATCHING EGG" CARRIER

NO. 1—Lug on discs locks container by slight turn. **NO. 2**—Crimp in discs fits egg snugly all round—by reversing discs a perfect fit for any normal egg, large or small, can be had. **NO. 3**—Showing egg suspended but held firm. **NO. 4**—Disc slot for large eggs. **NO. 5**—Disc slot for small egg.

NO. 6—Wallace 15-Egg Box, which is mechanically perfect and the safest carrier for "Fancy Eggs" for hatching. First the eggs are packed in a single egg container (No. 7), and then laid sideways in the cushion-frame holders (see No. 8-9) that fit snugly into the square partitions of the shipping case.

PRICES AND SPECIFICATIONS, SET UP, READY FOR USE WITH ADDRESS LABELS.

Capacity.	Approximate Weight Empty.	Approximate Weight Filled (2-oz. eggs).	Price Singly.	Price per Doz.
1 doz.	13 oz.	2 lb. 5 oz.	\$0.20	\$ 2.00
2 doz.	1 lb. 7 oz.	4 lb. 7 oz.	.35	3.25
3 doz.	2 lb. 1 oz.	6 lb. 9 oz.	.45	4.50
6 doz.	3 lb. 14 oz.	12 lb. 15 oz.	.75	7.50
15 doz.	7 lb. 14 oz.	30 lb. 10 oz.	1.50	15.00

WALLACE EGG CARRIER FOR HATCHING EGGS
 Price 15-EGG SIZE (P. P. wgt. 2½ lbs.), each 35c; doz. \$3.50.
INDIVIDUAL CONTAINERS
 only—Per 100, 75c; 300, \$1.50.
 (Wgt. per C, 2½ lbs.)

Eggs by Mail and its Advantages

Write to your friends in the city, telling them that you can furnish new-laid eggs 24 hours old, quote prices, explain your method of marketing by mail, and you will meet with the same success that thousands of other up-to-date people are having who are using this method to dispose of their eggs.

The Wallace is the one carrier that will safely deliver the eggs, irrespective of jars, jolts or pressure coming from any angle. When the carrier is packed for shipment you can stand on the top, bottom, ends or sides without its buckling or crushing. An egg packed properly in a single container can be thrown around the house like a ball—and the egg won't break, either.

The poultryman can gather his eggs in the evening, pack them in the containers,

put them in a cool place over night and in the morning hand them over to the rural carrier when he passes. They are delivered to the consumer by the mail carrier in any part of the city, and by return mail, or as soon as the package has been emptied, it can be mailed back to the producer and delivered to him at his door for refilling.

THE FIRST COST THE ONLY COST

At first sight it would appear that the cost of our carriers was commercially prohibitive, but when you consider that they are used over and over again, the cost becomes a small item of expense. The saving in breakage alone will more than pay for them, even with eggs at 30c per dozen. The Carrier cost is about 1 cent per dozen.

CAMPERS, HUNTERS, PACKERS, AUTOISTS SHOULD ALL USE THE WALLACE INDIVIDUAL CONTAINERS EVEN THOUGH THEY DON'T USE THE CARRIERS.

OAT AND GRAIN SPROUTERS

The Perpetual Poultry Silo—grows green feed while you wait—makes two to four bushels of feed from one of grain—runs up the egg yield—cuts down the feed bill—insures the health and vigor of your poultry. Ask any authority or poultry man who has fed Sprouted Oats.

Remember, no other green food has the **WONDERFUL QUICKENING VIRTUE** of young, growing **OAT SPROUTS**.

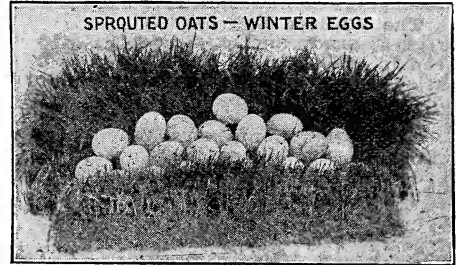

DOUBLE QUICK SPROUTER

HOW THE DOUBLE QUICK IS BUILT.

Outside Cypress Wood Walls insulated with asbestos and resin board for retaining heat. **Inside Metal Grain Chamber** of open hearth galvanized sheet steel that is non-destructive by moisture and minimizes mold troubles. **Lamp Heat and Fumes** pass up between the two walls and escape from openings near top, no fumes entering the grain chamber. **Every Unit of Heat** is thus utilized so that the cost is small. **The V-Shaped Vapor or Water Pan** is just above the lamp, so the first thing the lamp heat strikes is the bottom of this pan, producing the warm vapor that bathes the grain in moisture. **A Drain Tube** leads from the vapor pan down into the lamp box to take care of the surplus water when grain is watered. **Glass Doors** give abundance of light to stimulate growth. **Movable Top** permits water poured over top tray to percolate down through all trays. **A Perfect Ventilation System** produces in every part of the machine a positive movement of air, which means death to mold. **Best of Cypress**, the lumber that never rots, is used. **The Entire Machine** is made throughout of first class material. is finished in **natural wood colors**, and will last many years. **EVERY POULTRY KEEPER SHOULD FEED SPROUTED OATS. WE KNOW IT.**

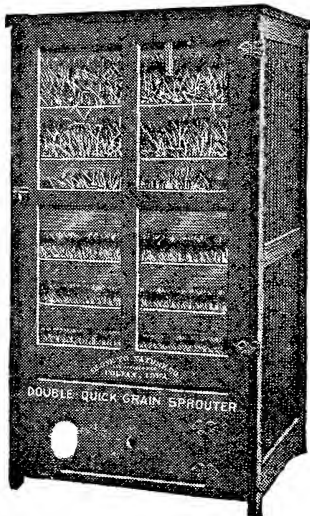

Double Quick

No. 1.	¼ bu.,	2 trays,	25-35	hens,	18x14x23,	35 lbs.	Price.....	\$ 9.75
No. 2.	½ bu.,	4 trays,	50-75	hens,	18x14x30,	45 lbs.	Price.....	12.00
No. 3.	1 bu.,	5 trays,	100-150	hens,	21x17x40,	70 lbs.	Price.....	18.75
No. 4.	2 bu.,	6 trays,	200-300	hens,	25x20x44,	95 lbs.	Price.....	24.75
No. 5.	4 bu.,	12 trays,	400-600	hens,	39x25x45,	150 lbs.	Price.....	37.75
No. 6.	8 bu.,	16 trays,	800-1200	hens,	52x27x60,	250 lbs.	Price.....	57.75

COLFAX METAL SPROUTERS

INVENTED BY THE ORIGINATOR OF THE DOUBLE QUICK.

Built in Sections—buy what you need now and add sections as your flock grows. **Stove Pipe Fit**—Sections fit on bases and each other by the telescope or stove pipe method which prevents leakage of heat outside and smoke into grain chamber at joints, as is the case where sections simply rest on bases or other sections. **Telescope or Stove Pipe Fit** prevents sections being put out of alignment by pulling out or pushing in trays. **This feature is very important. You Can Fasten** sections on permanently, if desired, which makes as solid a sprouter as if made all in one piece.

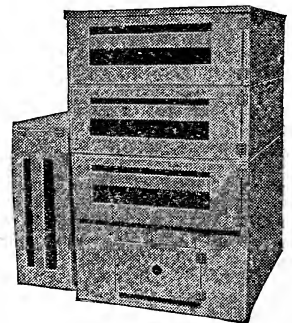

Prices, Size and Capacity Colfax Sectional Metal Sprouter.

Small Base,	13x16x20,	2 trays,	¼ bu.,	25-35	hens,	weight 25 lbs.	Price.....	\$ 9.25
Extra Sections,	13x16x10,	2 trays,	¼ bu.,	25-35	hens,	weight 12 lbs.	Price.....	4.25
Large Base,	26x26x22,	2 trays,	1 bu.,	100-150	hens,	weight 50 lbs.	Price.....	18.50
Extra Sections,	26x26x10,	2 trays,	1 bu.,	100-150	hens,	weight 33 lbs.	Price.....	9.25

Furnished all complete, with lamp, thermometer, full instructions, directions etc.

The capacities are based on dry grain. We rate one bushel (dry grain measure, sprouted 4 days) to every 100 hens for egg production, or 150 hens if fed only what is needed to keep in good health. If allowed to grow six or eight days feed less as more food is produced.



Without a reliable, accurate thermometer an incubator is practically worthless. Hundreds of hatches fail every year because of inferior thermometers and large numbers of brooder chicks are destroyed for the same reason.

We sell the "Tyco's" tested, recognized as the most dependable.

FOR INCUBATORS

NO. 22 "TYCO'S."—Very popular. Generally suspended on string or wire on level with eggs. (Cypher's style.) Postpaid 85c; wire hanger 10c extra.

NO. 22½ MODEL.—Same shape as No. 22 but not of as high grade finish. Postpaid 75c.

NO. 24 PERFECT.—Similar in shape to the No. 22 except that the mercury bulb extends below the metal to allow the bulb to rest on the eggs. High grade. Postpaid 75c.

TYCO'S CERTIFIED.—Same style as No. 22. Scale is etched on glass tube as well as metal back. "Certified correct," worth the price. Postpaid \$1.25.

NO. 20.—Tested, for incubators, used in Queen incubators. Postpaid \$1.00.

NO. 23 TYCO'S.—Similar to No. 20, with folding legs, adjustable; to be set up in egg tray. Postpaid \$1.00; Model, same style, 75c.

FOR BROODERS

NO. 29.—New style and most convenient; temperature readable from above the hover. Used in Economy, Cypher's and Buckeye Brooders. Postpaid, each 75c.

NO. 30.—For Cypher's Hovers. Portable, 85c; Adaptable, 75c.

NO. 31 INTERNATIONAL.—Same style as No. 30. The mercury bulb and glass is well protected. Very desirable for Brooder Stoves and Brooder Rooms. Suspend it from above so as to be on a level with the chicks. Postpaid 65c.

NO. 5120 THERMOMETER.—Excellent for general use or for the brooder house. Red mercury in the tube. Scaled from 10 below zero to 120 above. Metal face, wood back. 8 inches. **Price \$1.50**

Incubator Hygrometers

"Moisture Indicators"

Millions of chicks die in the shell every year, for the want of proper moisture conditions. The importance of a correct percentage of moisture during incubation has made the "Tyco's" Incubator Hygrometer as necessary as the "Tyco's" Incubator Thermometer. Neither takes the place of the other, but together they give the practical poultry raiser all the facts required for successfully regulating the heat and moisture of the incubator. Descriptive pamphlet on request.

Hygrometer, with full instructions, postpaid \$1.50; with Tyco's "Certified" \$1.25 Incubator Thermometer only \$2.50. Extra wicks, 15c each.

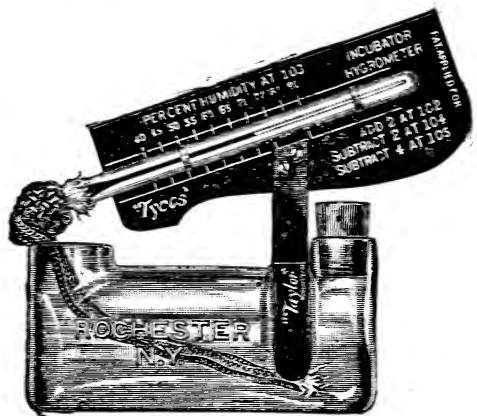

Tyco's Hygrometer.

Nest Eggs



NEW MEDICATED.—Answers as a nest egg, also an insecticide. Keeps lice out of the nests and off the hen. Non-breakable. Each egg wrapped with paper and full instructions.

Each 10c; 3 for 25c; 12 for 85c; (P. P. 2½ lbs. per doz.)

LIME NEST EGG.—Better than China eggs; non-breakable. More natural.

Each 5c; 3 for 10c; 12 for 35c (P. P. 2 lbs.) per doz.)

X-Ray Egg Tester

Used to test fertility of eggs during first week of incubation. Use on an ordinary lamp (No. 2 burner) in a dark room. It will illuminate interior of egg so that you will know if the chick is alive. Also shows size of air-cell.

Price, postpaid, 60c



X-Ray.

NOTE.—WE KEEP IN STOCK MISCELLANEOUS EXTRA PARTS FOR CYPHER'S INCUBATORS AND BROODERS. ASK FOR PRICE OF PARTS WANTED. SEE LAMPS AND BURNERS, page 143.

Sanitary Wooden Pigeon Nests

Made of 10-inch, solid square redwood blocks. Sanitary and prevents chilling of eggs or squabs. Cannot tip over. Large enough for any variety of pigeons.
Price, 20c each; \$2.00 doz. (Parcel Post weight, 20 lbs. per doz.)



For Pigeon Food, page 141.
 Pigeon "Salt Cat," page 139.

The Humane Anti-Hen-Setting Device

(Patented March 13, 1917)

The only device ever invented that will stop a hen setting and cure her of broodiness in twenty-four hours, and do it without the slightest pain or suffering for the hen, and no wasted time or trouble for you.

Clasp on leg and let the hen run free for 24 hours, then remove.

READ WHAT USERS SAY OF IT

"I have investigated and examined your Anti-Setting Device for breaking up setting hens and can see nothing about your method that can be called cruel or that will cause physical pain. I think it the most humane way of treating a setting hen, and you have my consent to use it."—Fred J. Bartles, Humane Agent, Hornell, N. Y.

"I believe it to be the most practical and humane method of preventing hens from setting in use today. It does the trick so quickly and efficiently."

PRICE 10c each; \$1.00 dozen, postpaid

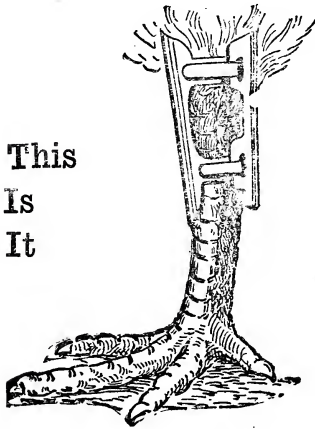

This
 Is
 It

Ross Clover Cutter

The illustration shows our small hand-power chaff cutter. It is no toy, but a practical, easy-running, fast-cutting cutter. It is arranged to cut 1-16 inch lengths and will handle perfectly clover, alfalfa, or, in fact, any kind of hay or straw. It is primarily intended for cutting feed for poultry, but can be used equally well for any other like purpose. The machine is constructed entirely of iron and steel except the wood handle, and weighs as shown about 58 pounds. It is designed to be fitted on a table or workbench. The cutting apparatus consists of four adjustable knives and an adjustable shear plate, making it possible to set knives as close as a pair of scissors. Many of our customers have called for "short-cut" clover, which is not obtainable in this market. This is just the machine that will make it.

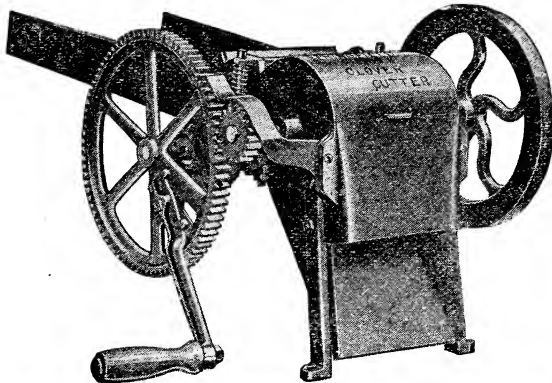

Ross Clover Cutter

Try this: Cut half a bucket of dry clover hay, pour hot water over it, cover and let it steam. This chicken salad will work wonders. **Price, \$10.00;** weight crated, 65 lbs.

Poultry Killing Knives

You open the fowl's mouth and cut the jugular vein. Hang up by the feet, let them bleed, and pick dry while warm.

MOE'S NEVER FAIL TRAP NEST

DELICATE TRIGGER HOLDING TRAP RELEASED BY HENS ENTRANCE FALLING SILENTLY

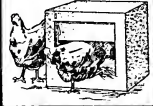

A solution of all trap nest troubles. Lice proof—only 1 bird can enter at a time. Trap door removable for ordinary nest.

TRIGGER LOCKS TRAP AND HENS THEN THERE TO STAY UNTIL RELEASED



Made of galvanized iron, light, durable and as the name implies, it never fails. Every nest set up and ready for use when shipped.
No. 33. 12x12x12 in. (P. P. 6 lbs.).....\$1.40
No. 34. 12x12x14½ in. (P. P. 7 lbs.)..... 1.75

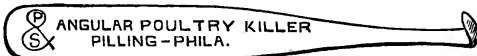

Angular Killing Knife.

Postpaid 65c

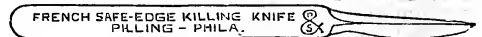

Pilling French Poultry Knife. Postpaid 65c

CAPONIZING TOOLS

Poultrymen can double their profits by caponizing. The operation is very simple; the instructions are so full and explicit that any man, woman or child, after a careful reading, will be able to perform the operation.

Philadelphia Set (see cut).—Complete with instructions. Cardboard box, postpaid, \$3.00; wooden case, velvet lined, \$3.25.



LEG BANDS FOR POULTRY AND PIGEONS

Keep a supply of Leg Bands on hand at all times; this is the only safe way to mark your different birds so you can tell certain stock or strains. Of course every bird must be marked with a band before it can be entered in a show.

WHAT SIZE?—When you order, tell us size or what kind of birds you want them for and whether male or female. **DON'T FORGET.**

NO. 1. LEADER ADJUSTABLE (see cut). —Has neat, compact and smooth fastening, with no catching points, easily attached and is absolutely secure.
Prices, postpaid, any size, 12 for 15c, 25 for 30c, 50 for 50c, 100 for 80c. (State size.)

NO. 2. CHALLENGE ADJUSTABLE. — A new light weight, smooth, adjustable band, having embossed or raised numbers which makes them easier to read. (One size adjustable for any breed.)
Prices same as Leader No. 1

NO. 3. COLORED LEADER. — Adjustable. Latest band. The color is inlaid in metal protecting band. Answers every purpose. Colors, white, pink, red, blue, yellow and green. Nos. 1 to 100.
Prices, 12 for 35c, 25 for 70c, 50 for \$1.10, 100 for \$2.00.

NO. 4. MOE'S SELF LOCKING LEG BAND. —You simply push ends together to lock it and it must be destroyed to remove it. Far superior and much cheaper than the leg bands requiring a sealing tool to seal them. Same price as Double Clinch. (State size.)

NO. 5. DOUBLE CLINCH. — A desirable band, very safe; no exposed corners, ends or loops; has double fasteners (see cut). Also made in Pigeon sizes.
Prices postpaid, any size, 12 for 15c, 25 for 30c, 50 for 50c, 100 for 80c. (State size.)

No. 6--Colored Spirol--Celluloid

Have no ends to fasten together—made on the same principle as a key ring. Once put on they stay till taken off and do not chafe the leg. The ease with which these bands are used will be a revelation to the man who has used other style leg bands. And best of all they can be used again and again, without destroying in the least the utility of the band.

Durable, Practical, Economical. Provide instant identification without handling the birds. You can identify birds as far as you can distinguish colors, which will tell you the yearling hens and which are older, your different matings, and so on. Fine for baby chicks. Made in ten colors: Red, White, Pink, Amber, Light and Dark Blue, Black, Purple, Green and Garnet. Do not fade and weather-proof.

PRICES—(Order by Class or Breed)
Baby Chicks or Pigeons.
15 per doz.; 25 for 25c; 100 for 60c
American or Mediterranean.
20c per doz.; 25 for 30c; 100 for 75c
Asiatic or Turkeys.
20c per doz.; 25 for 35c; 100 for 85c

NO. 7. OPEN PIGEON OR CHICK BANDS.
—Same price as Double Clinch (see cut).

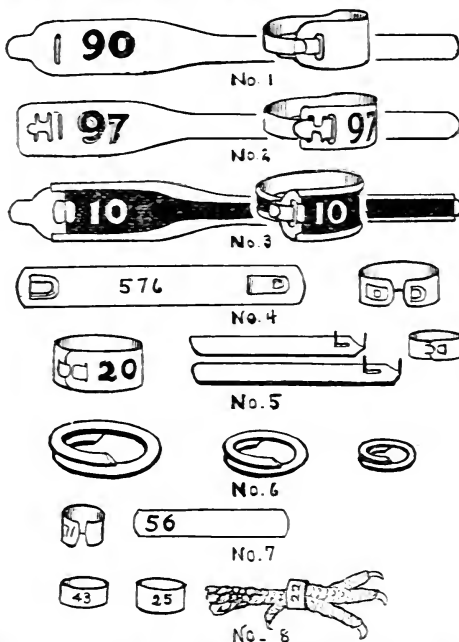

NO. 8. SEAMLESS PIGEON OR BABY CHICK BANDS. Prices postpaid, same as Colored Leader.

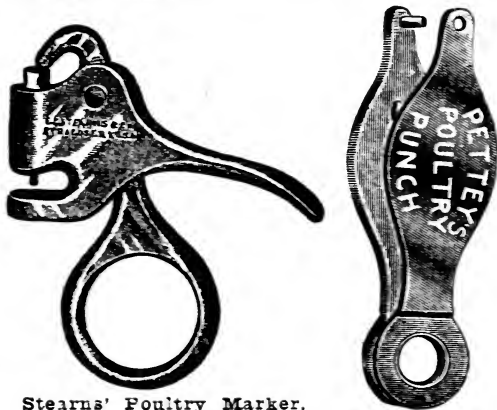

Stearns' Foultry Marker.

Poultry Markers

Used for marking the web between the toes of baby chicks, if you wish to know different strains or stocks. Colored leg bands are now more popular.

OTIS & MOE.—About the same style as Petteys. Price, postpaid, 25c
Pettey's—(See illustration). Postpaid, 25c
Stearns—(See illustration). Postpaid, 35c

Wire Hen Nests

These nests are strongly made from coppered wire with reinforced coppered steel ribs. They fasten to the wall with screws or screw hooks; they are easy to keep clean; are far superior to boxes.

Price: Each, 25c; per doz., \$2.25
Parcel Post Weights: Each, 1 lb.; 1 doz., 8 lbs.

DAD'S ELECTRIC LANTERNS—Every poultry keeper needs one. It's always ready—no danger of fire, makes a REAL LIGHT. See page 131.

Automatic Chick Greaser

(See illustration)—every chick its own doctor. It is the large lice which collect on the heads of young chicks which cause them to droop and die; and formerly the only way was to catch each chick and rub grease on its head; but this slow and tedious process is not necessary since the invention of the Automatic Chick Greaser. The wick around the upper part of the greaser is saturated with Conkey's Head Lice Ointment or with a mixture of two-thirds lard and one-third kerosene (or black oil) and every chick which eats out of the pan will get its head thoroughly greased in a very few minutes. Can be moved from one pen to another.

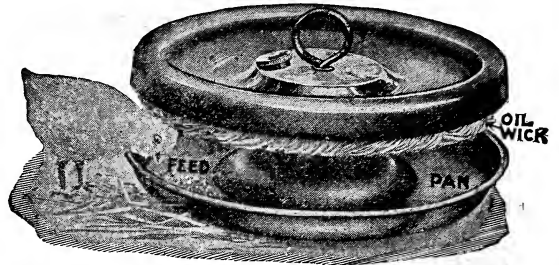

Automatic Chick Greaser.

NEW STYLE.—Mailing wt. 2 lbs., add postage. Price \$1.25

Up-to-Date Shipping Coops

These coops are really "up-to-date" and will give your customers that impression of you if you use them when shipping. Buyers who pay fancy prices for thoroughbred birds like to see them come in a nice coop—not some old cracker box or oil case. These coops are light but strong. The ends have the cleats nailed on. We ship in the flat to save charges, but it's an easy matter to nail them together, for each part is marked.

Number	Width	Length	Height	Each	Doz.
NO. 2	10½ in.	18 in.	24 in.	50c	\$5.00
NO. 4	10½ in.	24 in.	24 in.	60c	6.00
NO. 6	19½ in.	24 in.	24 in.	75c	7.50

For Parcel Post—No. 2 weighs 8 lbs.; No. 4, 9 lbs.; No. 6, 15 lbs.

Capacity.—No. 2 suitable for single birds or pair Mediterranean. No. 4 suitable for Asiatic male, American or Mediterranean pair or small trio. No. 6 for a pen of five birds, any variety.

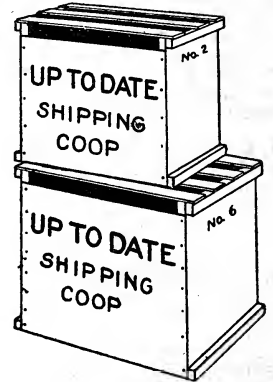

Shipping Coop.

Grinding Mills

NO. 32 POULTRY FEED GRINDING MILL.—In this mill are embodied all the good features of other hand grinding mills to which have been added universal burrs or grinding plates that are quickly adjusted and locked for grinding coarse or fine. This machine will grind any kind of grain or seeds, dry bone, shells, crockery, etc., for poultry feed. Has a 16-inch fly wheel and is light running; the capacity is not equalled by any other of the same size. Weight 40 lbs. Illustrated booklet on request. **Price \$7.00**

Seaside, Ore., Oct. 10, 1917.

Routledge Seed & Floral Co.,

Gentlemen: Regarding the No. 32 Grinding Mill will say that I am well pleased with it and it sure is a dandy.

Yours truly,

A. BUTIKOFER.

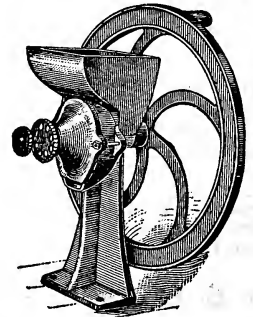

No. 32 Mill—You need one.

Green Bone Cutters

MANN'S GREEN BONE CUTTER.—Without any doubt the best and only successful green bone cutter on the market today. The No. 5-B and No. 7-BM are the two best and most popular sellers.

MANN'S NO. 5-B.—Has a large balance wheel, making it easy to operate. Should be mounted on a bench. Has four knives, large, solid cylinder, and has the latest patent automatic governing spring feed, which makes it one of the best low-priced bone cutters ever offered. **Price \$13.00**

MANN'S NO. 7-BM.—The new No. 7-BM is mounted on a strong iron stand, and has patent automatic governing spring feed. Large open-hinged cylinder, giving instant access to all working parts, has six knives, gear guard, anti-clog device, heavy balance wheel and other improvements. (See cut.) **Price \$18.75**

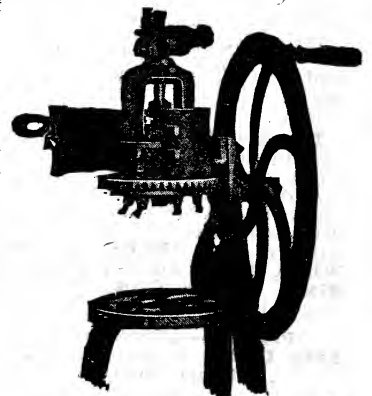

Mann's No. 7 for green bone.

HAVE YOU TRIED "OCULUM" ON YOUR POULTRY?

It surely is a wonderful preparation from what poultrymen say who have used it. Just think of **DOUBLING THE EGG YIELD**, and only 3 to 5 drops, in feed or water, per bird. See page 139. Pamphlet on request.



CONKEY'S GUARANTEED POULTRY REMEDIES

READ THIS.—We handle 2 to 3 carloads a year of these celebrated remedies which have built their reputation upon the scientific basis of one remedy for each disease.

A "Cure All" is not made by the Conkey Company. Each remedy is intended to serve one special purpose and serve it well. These goods are absolutely guaranteed, and we offer them to you on this basis. If they fail to satisfy you in any particular, your money will be refunded to you cheerfully. Conkey's Descriptive Book free on request.



Have a Conkey Corner In Your Poultry House

There is nothing like being ready with a good Remedy when disease develops in your flock,

Conkey's Remedies and Tonics

are good, and if you have them at your elbow you can laugh at disease. We guarantee Conkey Goods to satisfy you or we will refund your money. Ask for Conkey's Poultry Book.

Roup Cure.	30c, 60c and \$1.20	postpaid
Canker Special Remedy.	60c, or 70c	postpaid
Roup Pills. Special.	30c and 60c	postpaid
Bronchitis Remedy.	60c	postpaid
Blackhead Remedy.	60c	postpaid
Cholera Remedy.	30c and 60c	postpaid
Gape Remedy.	30c and 60c	postpaid
Lice Fix.	30c and 60c	postpaid
Limber Neck Remedy.	60c, or 70c	postpaid
Scaly Leg Remedy.	30c, or 35c	postpaid
Rheumatic Remedy.	60c, or 70c	postpaid
Poultry Laxative.	30c, or 35c	postpaid
Poultry Conditioner.	30c, or 40c	postpaid
Poultry Worm Remedy.	50c	postpaid
Poultry Flea Salve.	30c, or 35c	postpaid
Sulphur Candles.	10c, or 15c	postpaid

CONKEY'S WHITE DIARRHOEA REMEDY.

—Save your chicks by putting it in their drinking water. Price 30c and 60c prepaid.

Conkey's Guaranteed Stock Remedies

CONKEY'S 224-PAGE STOCK BOOK FREE.—It's full of the most practical information relative to the raising and keeping of livestock. Housing and feeding problems, diseases—how to recognize them and how to treat them—are all explained. Every dairyman, every stockman, every farmer, should have this book. Get your copy. Free if you call at our store, or send 5c in stamps to cover postage.

Stock Tonic.—For horses, cows, sheep and hogs. Prices (not prepaid): 2 lbs. 30c; 3 lbs. 60c; 7 lbs. \$1.20. Mailing weights given, add postage. 12-lb. pails, \$2.25 and 25-lb. pails \$3.75.

Worm Remedy.—Guaranteed. 60c postpaid.

Colic Remedy.—Just a few drops on the tongue; effective. 60c; postpaid 70c.

Healing Powder.—For gall sores, cuts or wounds; excellent. 30c or 35c postpaid.

Gall Salve. 30c; postage 10c extra.

Pain Lotion.—For swellings, etc. (P. P. 2 lbs.) 60c.

Hoof Remedy.—The very best; to be applied on the hoof. Pint (P. P. 1½ lbs.) 50c; qt. 75c; ½ gal. \$1.25; gal. \$2.00.

CONKEY'S NOXICIDE.—Will keep your coops and your chickens free from germs. Unexcelled for cleansing and purifying poultry houses, runs, brooders, founts and utensils. The poultryman's best friend. Prices (not mailable): Pints 40c; quarts 70c; ½ gal. \$1.00; 1 gal. \$1.75.

CONKEY'S HEAD LICE OINTMENT.—Save your little chicks from the ravages of the deadly head lice. Absolutely harmless to the little chicks. Put up in tubes. Easy to apply. Price 15c and 30c prepaid

CONKEY'S LICE POWDER.—It is positive death to lice, ticks, etc. Equally effective for lice on setting hens and young chicks. Gets them all. Cleans up the coop. Absolutely harmless to even the smallest chick. Easy to apply and does the business or your money back. Get a package today. (Note.—Weights given wrapped for mail, add postage.) Prices (not prepaid): 8-oz. pkg. 15c; 1½ lbs. 30c; 4 lbs. 60c; 8 lbs. \$1.20; 25-lb. pail \$2.50.

CONKEY'S LICE LIQUID.—A powerful liquid that will destroy the thousands of red mites that live in the cracks and crevices of the house and nests in the day and swarm the fowls' bodies at night. You can't reach them with a powder. Paint or spray the roosts, nests and walls. Prices (Not mailable) 1-qt. can 50c; 2 qts. 75c; 1 gal. \$1.25; 5 gals. \$5.50.

CONKEY'S LAYING TONIC (Poultry Tonic).—It insures the maximum egg production both summer and winter. Guaranteed to give results or money back. Prices (not prepaid): 2 lbs. 30c; 4 lbs. 60c; 8 lbs. \$1.20. NOTE.—Add postage if wanted by mail. Weights given are wrapped.

Bag Ointment. 30c and 60c; postage 10c.

Dip.—Best sheep and hog dip made. (Not mailable.) Quart, 70c; ½ gal. \$1.00; gal. \$1.75; 5 gals. \$7.50.

SALT-EM.—Medicated salt, much better than rock salt. Ask for pamphlet. Prices: 100-lb. keg \$6.00; 40-lb. pail \$2.75; 20-lb. pail \$1.50; 10-lb. pail 90c.

FLY KNOCKER.—Best fly spray made; fully guaranteed. (Not mailable.) Qt. 50c; 2 qts. 75c; gal. \$1.25; 5 gals. \$5.50.

COW SPECIAL.—Every dairyman should keep this on hand; fully guaranteed. Prices: 60c can postpaid 70c; \$1.20 can 3 lbs. wrapped; add postage.

BY PARCELS POST.—At last we have an inexpensive way of getting these valuable remedies to our far-away customers. On those NOT MARKED postpaid, take the P. P. (Parcels Post) weight and consult the Zone and Rate Tables, SO YOU CAN ADD PROPER AMOUNT FOR POSTAGE. Liquids in more than pint cans NOT MAILABLE.

RABBITS—BELGIAN HARES

We keep in stock at our store about 20 pens of Rabbits of different breeds and can bring in on short notice most any stock wanted in this line.

Note.—By **Young Stock**, we mean from 2 to 3 months old; **Breeding Stock**, 6 months or over; **Fancy Stock**, high-bred pedigree stock, bred for size, shape and color, for special breeding or show purposes; **Utility Stock**, a pure-bred, good grade of healthy, vigorous stock for meat and general purposes.

NOTE.—In ordering 4 to 6 packages at a time, one-half the amount of postage is enough. Pedigree Stock; weights given full grown.

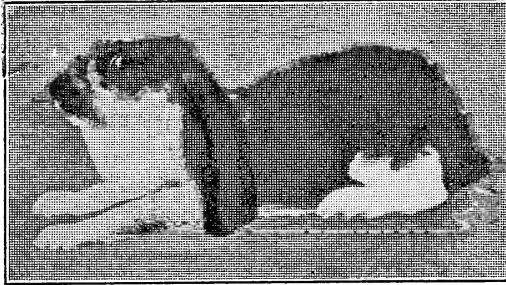

English Lop Ear

WHITE ENGLISH.—Very popular pets with children as their white coats and pink eyes make them so attractive. Always in demand as Easter Rabbits. **Young, 75c to \$1.00; Breeders, \$2.00 to \$3.50.**

RUFUS RED BELGIANS.—Improved strain of the common Belgian Hare. Color, greyish red; coat fine and soft; weight, 8 to 9 lbs. **Young, \$1.00 to \$2.50; Breeders, \$3.00 to \$4.50 and \$5.00 to \$7.50.**

NEW ZEALAND REDS.—A hardy, sturdy strain very popular and much in demand, meat fine in quality and flavor. Color, red. Weight, 8 to 10 lbs. **Prices: Young, \$1.50 to \$2.50; Breeders, \$3.50 to \$5.00 and \$5.00 to \$7.50 and up.**

FLEMISH GIANT—BELGIAN.—Very popular on account of their large size and quick growth, which makes them valuable for market. Color, light squirrel grey to solid black. Weight, 10 to 12½ lbs. **Prices: Young, \$2.50 to \$3.50 each; Breeders, \$5.00 to \$7.50; Pedigreed, \$10.00 and up.**

ENGLISH, LOP EAR.—One of the largest and heaviest varieties. Meat fine and tender. This makes them especially valuable for meat production. Color, varied; weight, 10 to 15 lbs. **Prices: Young, \$2.00 to \$3.00 and \$2.50 to \$5.00; Breeders, \$5.00 to \$7.00 and \$7.50 to \$10.00.**

HIMALAYANS.—Fur bearing. Very attractive; body generally all white, with black nose, ears, feet and tail. The fur is heavy, fine and of recognized value. Weight, 6 to 8 lbs. **Prices: Young, \$2.00 to \$3.00 and \$3.50 to \$5.00; Breeders, \$5.00 to \$7.50 to \$10.00; Bred Does, select, \$12.00.**

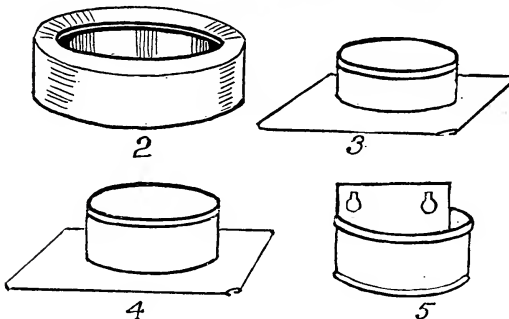

Special Note.—The cheapest and quickest results can be obtained by the beginner by buying one or more **Bred Does** and an extra Buck, not related. **Utility Buck service, 50c; Pedigreed, \$1.00 up.**

RABBITS SOLVE MEAT PROBLEM

With our country at war and our government calling for a greater meat production, coupled with the request to observe at least one "meatless" day a week so as to save more Beef, Pork and Mutton for the Army and the Allies—Bre'r Rabbit should be recognized as King in the field of small meat producers.

Rabbit meat is now a staple and recognized product in the Portland markets and the demand is becoming greater and greater. Rabbit meat is fine grained, tender, easily digested and equal in flavor and quality to chicken. France and Belgium have for years been producing and consuming millions of pounds of rabbit meat.

For cheapness of production, small amount of space, time and care required; the low cost of foods (especially on this coast where greens and root crops are so plentiful), the rabbit industry will surely come into its own. **Start now and make money.**

BOOKS ON RABBITS

The cheap but valuable books we offer on Rabbits will give anyone all the instructions necessary on housing, feeding, breeding and care, to be successful. See page 133.

New Zealand
Belgian Hare.



Ideal Feed and Water Dishes

Made especially for rabbits, cavies and small pets. Cannot tip over, and the saving in feed soon pays for them. See illustration for No.

No. 2.—Earthenware, heavily glazed; the incurving top rim prevents the nosing out of feed. Will not tip over. Not mailable.

Prices: 6-inch, 20c each, \$2.00 doz.; 8-inch, 25c each, doz. \$2.50.

No. 3.—Heavy galvanized tin; 5-inch bowl, 2 inches deep.

Price 30c each, \$3.00 doz. (P. P. wgt. 1¼ lb. each.)

No. 4.—Same as above, 5-inch bowl, 3¼ inches deep.

Price 35c each, \$3.50 doz. (P. P. wgt. 2 lbs. each.)

No. 5.—Heavy galvanized, half bowl shape, to hang on cage door or partition. Cannot drop or be knocked off.

Large, 25c each, \$2.50 doz.; small, 20c each, \$2.00 doz. (P. P. wgt. 1 lb. each.)

SONG AND CAGE BIRDS

We are the largest importers and dealers in Birds and Gold Fish in the Northwest. This department of our business has grown rapidly and we now carry large and complete stocks of cages, supplies and foods and all birds in their season.



We Guarantee Our Singers.

Canary Birds

Note.—Do not compare our prices with the irresponsible bird fakers, who sell for little prices and supply inferior stock and females for males, etc.

AMERICAN BRED CANARIES. Healthy, hardy, well-shaped birds, fine singers: all colors. **MALES, \$3.50 to \$5.00 each. FEMALES, \$1.00;** selected deep yellow, \$2.00.

HARTZ MOUNTAIN ROLLERS. Beautiful, shapely birds. Lovely, free singers, hardy and thrive anywhere. Their cheery song is like sunshine to the soul; their bright plumage, active ways and cheerful dispositions make them the favorites and most popular. **MALES, \$5.00 each; extra selected singers, \$7.50. FEMALES, \$1.00 to \$1.50 each; selected, \$2.00.**

ST. ANDREASBERG. These are world-renowned and the sweetest singers. No imported stock to be had now on account of the war, but we offer home raised birds from imported parents that will please you. **MALES \$7.50 to \$10.00 each. FEMALES, \$2.00 to \$3.00.**

Heppner, Ore., Feb. 24, 1917.

Routledge Seed & Floral Co.,

Last July my beautiful Hartz Mt. Singer I bought of you took a heavy cold and I feared I would lose him; he wheezed and drooped for months and I came to you with my sad story for fear he would die or never regain his grand long voice again. You gave me the Max Geisler's Bird Tonic Treatment "A" to try. I went according to the instructions found in package; first bottle he seemed improved as he did not shed so badly, wheeze or droop, but still he did not sing. I got another bottle of same and used as before, and before the last bottle was half gone he was singing some. I gave him all and now you should see and hear him. His coat is beautiful in color and so smooth and fine and he never sang as he is singing now. People who pass the house stop to listen to him and ask what kind of a bird he is, for they never heard such beautiful singing from a caged bird. I cannot tell you how very grateful I am to you for prescribing for him.

I gave your catalog to my neighbor today as she has a fine home here and wants some Roses, Shrubs and Seeds. I told her she could depend upon what she got from you as being first class and if they failed you would do the square thing by her for I had found you always dependable and that you had that reputation with your home folks.

Trusting and hoping you are having your share of good sunshine there as we are here, I am, as ever, your grateful patron and friend.

MARY DEWEY HAYLOR.

I forgot to say that I use no seed but your H. Q. special bird seed.

YOU ARE ALWAYS WELCOME
With all our birds and pets our store is quite interesting, especially to the children. **YOU ARE ALL WELCOME TO COME AND LOOK AND LISTEN.**

Thane, Alaska, July 12, 1917.

Routledge Seed & Floral Co.,

Gentlemen: I received the bird July 10, in good condition, and I am very much pleased with it. It seems to be doing nicely and is a lively singer.

Yours truly,

MRS. G. W. HASKIN.

Wolf Point, Mont.

Dear Sirs: Canary Bird arrived O. K. and we are very much pleased with the Bird. He is a lovely singer.

Yours truly,

MRS. KNORR.

Fruitland, Idaho.

Dear Sirs: The Canary came through O. K. Thanks for prompt attention.

Yours truly,

MISS ALMA E. CROWTHER.

Other Favorite Cage Birds

We do not always have all of the following birds on hand, but can get them quickly on orders. For further information, write.

	Each	Pair
Japanese Robins	\$5.00	\$8.50
European Gold Finch	4.00	7.50
Chestnut Finch	2.00	3.50
Zebra Finch	4.00	7.50
Bull Finch	5.00	
Society and Strawberry Finch	3.00	5.00

White Java Rice Birds

One of the handsomest of all aviary birds. A little larger in size than the average canary. Color pure white and of such solid, smooth appearance that it looks like a piece of statuary. Beak tinged with dark red toward the base. Attracts more attention in our store than any other bird. **Each, \$5.00; pair, \$8.50.**

FOR BIRD CAGES, SEE PAGE 157.

Paroquets

YELLOW SHELL PAROQUETS. Very rare, plumage a beautiful opal yellow, lovable pets. **Each, \$5.00; pair, \$8.50.**

AUSTRALIAN SHELL PAROQUETS. Often called Lovebirds, look like a miniature parrot, a little larger than a canary, plumage green, very intelligent and beautiful. **Each, \$5.00; pair, \$7.50.**

LIVING PRESENTS—Did you ever stop and consider what a desirable Christmas or birthday present a beautiful CANARY makes? They are so different, interesting and desirable, **SO CHEERFUL AND LOVABLE.**

ROUTLEDGE'S H. Q.—“highest quality”—BIRD SEEDS

We are making a specialty of bird foods and seeds and our rapidly increasing trade shows that the public appreciates the opportunity to get “High Quality” foods and remedies of “Merit” for their pets. NOTE.—Add postage to all prices, not prepaid, if wanted by mail.

ROUTLEDGE SEED & FLORAL CO'S.

H. Q. IMPORTED BIRD SEED.—Our own special mixture for American, Hartz Mountain and St. Andreasberg Canaries; especially prepared for the singers. Contains no hemp, but the correct amounts of “highest quality” re-cleaned Imported Canary Sweet Rape, Millet, Maw, etc.

It is no wonder that thousands of canaries die annually from the effects of common Bird Seeds bought from grocery and drug stores, which is so often old, musty, dirty, inferior seeds incorrectly mixed.

Try a package of our H. Q. and note the difference and also the saving, even though it is 5c higher.

Sold only in sealed 1-lb. cartons (see illustration of our 1-lb. carton). Take no other. Price 20c lb. Add postage if wanted by mail.

- | | |
|--|--------------------|
| Fine Mixed Bird Seed (with hemp). | 15c lb. |
| H. Q. Hemp Seed (feed sparingly). | 10c lb. |
| H. Q. Canary re-cleaned. | 20c lb. |
| H. Q. Millet golden soft shell. | 10c lb. |
| H. Q. Imported Sweet German Rape. | 20c lb. |
| Easily detected by the sweet taste. Beware of wild mustard, kale and turnip seeds sold as bird rape. | |
| Turkish Maw Seed.—Canaries are very fond of it. Should be fed sparingly. | 50c lb. |
| Lettuce Seed, for birds. | 25c lb. |
| Bird Sand, silver washed. 2½-lb. cartons, | 10c |
| Crystal Grit, very fine. | 5c lb., 6 for 25c |
| Cuttle Bone, high grade, large size. Each | 5c; |
| postpaid, 7c; with patent fasteners, 10c | and 15c, postpaid. |



THIS is it—take NO OTHER.



MAX GEISLER'S BIRD FOODS AND TONICS

Highly recommended by all who have used them. Full directions for use with each package. Read Mrs. Haylor's letter on page 23.

M. G. Imported “Roller” Seed for Canaries. Pkg. 20c, postage extra.

M. G. Finch Bird Seed for Finches. Lb. 25c; postage extra.

Treatment A.—(Song Restorer.) For birds which have lost their voices from cold, etc.; 25c; postpaid 30c.

Treatment B.—(Digestive Trouble.) For diarrhoea and bowel disorder; 25c; postpaid 30c.

Treatment C.—(Cold Cure.) For birds which are breathing hard, puffed up or mopeing. 25c; postpaid 30c.

Treatment D.—(General Tonic.) Use once a week in drinking water. 25c; postpaid 30c.

M. G. German Bird Biscuit. For a change in diet. Keeps birds in health and song. Per carton 10c; postpaid 15c.

SAFETY FIRST.—Keep a bottle of Treatment “C” on hand for your “singer” and be safe. He is just as liable to catch cold as you are.

MAX GEISLER'S BIRD FOODS AND TONICS—Continued

- M. G. "Health Food" for Canaries, Redbirds, Mockingbirds and all other seed-eating and soft-billed cage birds.** A "treat" for them. **Per carton 15c; postpaid 20c.**
- M. G. Song and Moulting Food.**—Excellent for birds when shedding feathers and off song. **15c; postpaid 20c.**
- M. G. Prepared Mockingbird Food.** For any soft-billed birds. **Per tin 30c; postpaid 40c.**
- M. G. Medicated Bird Biscuit.**—Food and

- medicine. Excellent for weak and sick birds. **Per carton 20c; postpaid 25c.**
- M. G. Vegetable Extract,** for blood tonic and health producer. **Per vial 25c; postpaid 30c.**
- M. G. Fluid Mite Exterminator.** To be used in the bath. **Per vial 10c; postpaid 15c.**
- M. G. Mite Powder.** For birds that do not bathe. Non-poisonous. **Pkt. 10c; postpaid 15c.**

CANARY BIRD "SPECIALS"

These Four Articles Have Merit, We Sell Gross After Gross

- BIRD MANNA.**—A combination of seeds, herbs and roots that nature intended birds should have. Food and medicine combined. A tonic and conditioner. Comes in round cakes. Fastens on the cage wires. **Per cake, 15c, postpaid 20c; 2 for 35c.**
- BIRD-O-LINE.**—A preparation very similar to "Manna," except that it is granulated and dry and is fed in the seed cups, a little at a time. **Per box, 20c, postpaid.**
- CANARY HIGH BALLS.**—Another article of above merits. Highly praised. Comes in ball form and hangs in the cage. "Mr. Bird" eats it as he needs it. **Each, 15c; 2 for 25c, postpaid.**
- SPRATT'S COD LIVER OIL CAGE BIRD FOOD.**—A food for young birds and birds in the moult. Takes the place of boiled eggs for young birds and brings as good if not better results. **Per pkg. 15c; postpaid, 20c.**



PHILADELPHIA BIRD CO.'S REMEDIES, FOODS, ETC.

Full directions and information with each remedy. Descriptive booklet on request.

- | | | | |
|-----------------------------------|-------------------|--|------------------------|
| Bird Bitters. | 25c; postpaid 30c | Ant Eggs (for soft-billed birds). | 10c; postpaid 15c |
| Bird Orange Color Food. | 25c; postpaid 30c | Nestling Food. | 25c; postpaid 30c |
| German Song Restorer. | 15c; postpaid 20c | Nestling Hair. | Pkg. 5c; postpaid 10c |
| American Salve. | 25c; postpaid 30c | Parrot Plumage Restorer. | 25c; postpaid 35c |
| Moulting Pepper. | 25c; postpaid 30c | Parrot Tablets (for feather pulling). | 25c |
| Mite Exterminator, powder. | 25c; postpaid 30c | Red Bird Gravel. | Pint 10c; postpaid 20c |

Parrot Foods, Tonic, & Etc.

ROUTLEDGE'S

"HIGHEST QUALITY"

- H. Q. Mixed Parrot Seeds.**—This is our own mixture of clean, well cured sunflower, hemp, pumpkin and corn, properly mixed. Your "Polly" will like this. **15c lb.; 2 for 25c; postage extra.**
- H. Q. Sunflower.**—We offer only large, plump, full meated seed properly cured and of the right age for health. Far superior to the average stock sold. **10c lb. straight; postage extra.**
- Parrot Corn.**—Best quality for parrots. **15c lb.; 2 for 25c; postage extra.**
- M. G. Parrot Spray.**—Will cure Parrots of the habit of biting off their feathers. **Per bottle 50c; postpaid 65c.**

MAX GEISLER'S

- M. G. Mixed Parrot Seed.**—Properly mixed for good health and plumage. Full and valuable directions on the care of Parrots on each box. **Per carton 20c; postpaid 25c.**
- M. G. Prepared Corn, for Parrots.**—To be given in addition to the seed. **Per carton 20c; postpaid 25c.**
- M. G. Parrot Biscuit,** for old and young, to keep them in good health and plumage. **Per carton 25c; postpaid 35c.**
- M. G. Parrot Tonic.**—Unexcelled for young Parrots, cures catarrh, etc. **Per bottle 25c; postpaid 35c.**
- M. G. "Health Food" for Parrots,** for health and fine feathers. **Per carton 25c; postpaid 35c.**

Cavies—Guinea Pigs

Bright, active and harmless pets. They are in much demand and money can be made raising them. They come in combination colors of brown, white, yellow, black and tan, generally spotted and prettily marked. Solid colors are not always obtainable and are higher in price.

ENGLISH.—Smooth, short hair; hardy and healthy. **Young, Females \$1.00, Males 50c to 75c; Old, Females \$1.50, Males 50c to \$1.00.** A select breeding pair, \$2.50.

ANGORA.—Long, soft hair; 50c more than above.

ABYSSINIAN.—Quite rare. Hair is peculiarly twisted or turfed into what might be called rosettes. **50c more than English.**

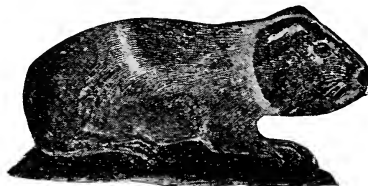

English Cavy (Guinea Pig).

BOOKS
on
Rabbits
Cavies
See page
132.

DON'T OVERLOOK the valuable yet inexpensive books on Birds, Parrots, Dogs, Cats and Poultry, page 133.

PARROTS

We handle more young parrots than all other Northwestern dealers combined. The young parrots arrive during July and August, but we aim to have stock on hand at all times. Price of **trained talkers** on request. We offer hand raised, not the wild, trapped, unmanageable birds.

PANAMA PARROT.—The most popular parrot with our trade. Of quite large size, gentle disposition, easily taught and become great favorites. Deep green plumage. They often show a yellow spot on the back of the head. **Young, each \$15.00 to \$20.00; Trained Talkers, \$25.00 to \$50.00 and up.**

MEXICAN DOUBLE YELLOW-HEADED.—Large size, gentle, learn quickly and make great pets, green plumage, yellow on top and back of head, red-tipped wings and blue feathers in the wing and tail. **Young, each \$15.00 to \$20.00.**

CUBAN PARROT.—Medium size, green plumage, red tips on wings, light face, gentle, fine pets, good talkers. **Each \$7.50.**

MEXICAN RED-HEADED PARROTS.—Medium size, trim and active, make fair talkers, gentle. Green plumage, bright red on head, blue in wing and tail. **Each \$7.50 to \$10.00.**

Palouse, Wash., Sept. 12, 1917.

Routledge Seed & Floral Co.,

Dear Sirs: I want to tell you that my Parrot is just fine, and is learning to talk very fast. I surely am pleased with it.

Thanking you, I remain,

Respectfully yours,

LURA A. BARNES.



Panama Parrot.

Parrot Cages

These are extra strong, large and roomy, well finished and of the latest and best designs of Parrot Cages on the market. **OUR SPECIAL CAGE CATALOG** will show larger cuts of the three styles.

MOULDING BASE SQUARE CAGES

Made of extra heavy tinned wire, new style moulding base, with removable cleaning drawer, and also has wire grating to keep bird from getting down on dirt. Tinned iron, self-locking feed cups.

No.	Size	Height	Price
101	15½x14 in.	27 in.	\$8.00
102	17½x15½ in.	28 in.	9.00
103	21¼x17½ in.	31 in.	11.50

ROUND PARROT CAGES

These are very popular on account of the low prices. Our advice is to get the largest cage you can afford, as it gives "polly" more room for exercise and less danger of spoiling the tail feathers. Heavy tinned wire, strong and well made; zinc bases, self locking feed cups.

No.	Diameter	Height	Price
50	13 in.	19½ in.	\$4.00
55	14 in.	21 in.	4.50
60	15½ in.	23 in.	5.50
65	17½ in.	28 in.	6.50

PARROT STANDS

After your parrot has become tame and well trained, a parrot stand is very desirable. It gives more freedom and the bird greatly enjoys it, and can keep his plumage in much better condition. Keep polly chained when you leave.

No. 1—Finished in black enamel. Complete with feed cups, tray and chain. Good heavy base, so it will not tip over. Tray adjustable to any height. **Price \$3.50.**
Parrott Stand Covers, \$6.50.

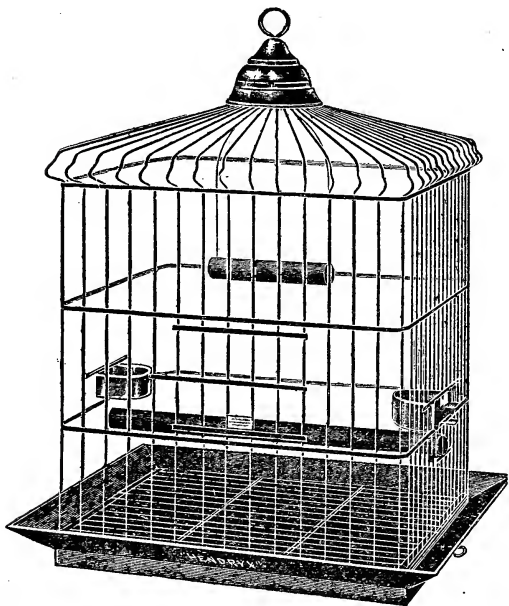

Moulding Base Nos. 101 to 103.

FANCY SQUARE CAGES

Made of extra heavy tinned wire, zinc base, strong self-locking feed cups. They also have a slide cleaning pan on the bottom and wire grating to keep bird from getting down on the dirt.

No.	Size	Height	Price
115	16¾x11½ in.	23 in.	\$6.50
120	17½x14 in.	25 in.	7.50

PARROT FOODS—You must remember that your parrot does not get all the foods nature intended it should have, therefore give "Polly" a treat by feeding our Health Food, Parrot Biscuits, Etc. See page 155.

CANARY BIRD CAGES

We believe we carry the most complete line of plain and fancy cages on this coast. Limited space in this catalog will not permit us to illustrate all, but if further interested send for our SPECIAL CAGE CATALOG. We offer herewith some of our most popular and best sellers.

LA FAVORITE BRASS CAGES

This is one of the new, late models; very popular and one of our best sellers. The full, graceful design at the top adds greatly to its general appearance. Handsome, bright finish, extra well made. (P. P. Wgt. 9 lbs.) See illustration.

No.	Size, Inches	With Guard	Without Guard
7004	9½x6½x12½	\$3.50	\$2.75
7006	10½x7½x13½	4.00	3.00
7008	10½x7½x13½	4.50	3.50
7010	13 x8½x14½	5.00	3.75

IDEAL BRASS CAGES

The best low priced, brass wire, cage on the market; cheap in price only. Made of the best spring brass wire, well fastened, no cheap solder to break. New patent slide catchers that will not pull loose. (P. P. Wgt. 8 lbs.) See illustration.

No.	Size, Inches	With Guard	Without Guard
5004	9½x6½x11½	\$3.25	\$2.50
5006	10½x7½x12½	3.75	2.75
5008	10½x7½x12½	4.25	3.25
5010	13 x8½x14½	4.75	3.50

PURITAN ENAMELED CAGES

Well made and properly finished so that the enamel will not chip off. Color, white with gold trimmings. For a low priced cage, it is impossible to find better value. A person often has use for a second cage for young birds or perhaps an extra one, and these are just the thing. (P. P. Wgt. 8 lbs.) See illustration.

No. 231	Size 9½x6½x15½ in.	Price \$1.65
No. 232	Size 10½x7 x16 in.	Price 1.80
No. 233	Size 11 x7½x16½ in.	Price 2.00
No. 234	Size 12½x8½x17½ in.	Price 2.25
No. 238	Size 13 x8½x18 in.	Price 2.50

CANARY BREEDING CAGES

Enameled, all complete, nests, etc. No. 4 Single, 17x9x13 inches, \$3.50. No. 3 Double, 19x10x14 inches, \$4.00. No. 2 Double, 22x11x16 inches, \$4.75. No. 1 Double, 25x12x16 inches, \$5.50. No. 113 Double, \$6.00.

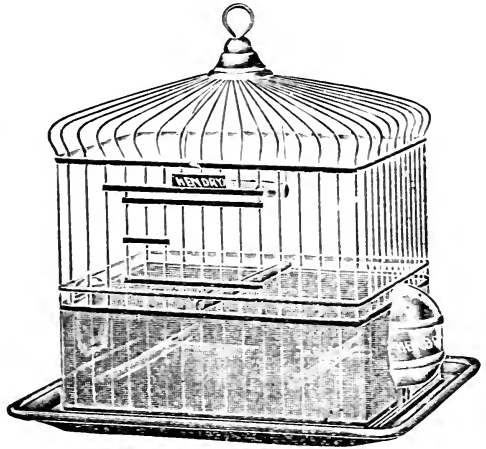

La Favorite, with Seed Guards

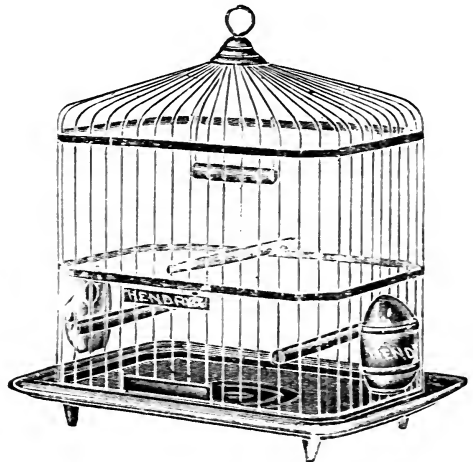

Puritan Enamel, without Guard

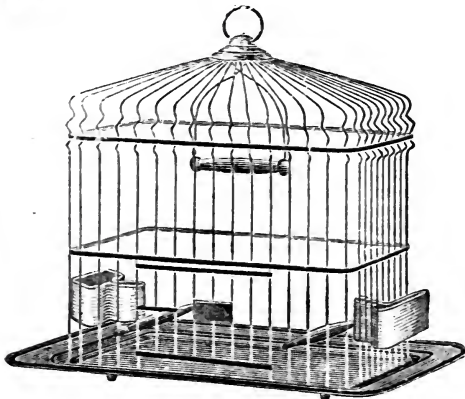

Ideal Brass, without Guard

EXTRAS FOR BIRD CAGES

Food and Water Cups—Opal or clear glass, open or closed top. Tell us what style. 15c each; 20c postpaid.

Brass Suspension Springs—Light, No. 16, 10c; Heavy, No. 14, 20c; Double, No. 19, 25c postpaid.

Wall Brackets or Cage Hooks—Nickel plated. 8 inch, 25c; 10 inch, 30c; 12 inch, 35c; postage 5c extra. Brass plated, 10c higher. Heavy Solid Brass, fancy, swinging, 75c; postpaid 85c.

Cage Swings 10c; postpaid 15c.

Nesting Hair 5c per package; postpaid 10c.

Nests—Wire or willow. 10c postpaid.

BATHING DISHES—Glass 10c; postpaid 15c. Opal Glass 15c; postpaid 20c.

Note.—(P. P. wgt. 8 lbs.) means parcel post weight packed ready to mail, but all cages will be sent by express, which is safest, unless ordered by parcel post and extra money sent for postage in addition to a 25c box charge.

Spratts Dog and Cat Foods and Remedies

Known and used the world over—none better. We have hundreds of customers. Prices subject to changes. Special quantity prices. Descriptive pamphlet on request.



For Cats

Spratt's Cat Food.—A complete food for cats. Used at the leading catteries throughout the world and daily becoming more popular among the fancy. Small pkg. (P. P. 1 lb.), 20c; large pkg., (P. P. 2½ lbs.), price 35c (add postage). The above is also prepared with **Pasteurized Milk**, excellent for kittens and invalid cats, or prepared with **Fish** to be used as a change of diet, especially during the summer months. Prices same as the regular Cat Food above.

Vermifuge Capsules for Cats. Postpaid 50c.

Distemper Tablets for Cats. Postpaid 75c.

Tonic and Condition Tablets for cats. Postpaid 50c.

Malted Kitten Food.—Use tablespoonful to pint of hot water; very valuable and inexpensive. Can, 35c; postpaid, 40c.

CATNIP MICE.—Made of heavy cloth (mouse shape) and filled with catnip. Cats love to play with them. These have taken the place of catnip eggs. Each 15c postpaid

For Dogs and Puppies

SPRATT'S DOG CAKES.—A properly balanced meat, grain meal and vegetable compound that will not spoil with age. Known and recommended the world over as a complete and constant food for dogs. Most owners of dogs rely on scraps from the table as "dog feed." This is all right as far as it goes, but to be on the safe side and for vacation trips, etc., always keep a supply of Dog Cakes on hand. 2½-lb. carton 35c; 5-lb. 65c; 10-lb. sack \$1.20 (add postage); 25-lb. sack \$2.75; 50-lb. sack 5.25; 100-lb. sack, \$10.00.

Cod-Liver Oil Cakes are invaluable for old or delicate dogs or those recovering from sickness. Dogs eat them without coaxing. 2½-lb. carton 35c (postage extra)

Spratt's Puppy Cakes.—A perfect and whole food for puppies of all breeds. Puppies should be started on these biscuits when about one month old and they should be continued until such time as their teeth become sound and strong, usually when they are about six months old.

2½-lb. carton 35c (postage extra)

Plain Puppy Meal.—This meal should be used before, during and after the weaning period to insure large, vigorous and healthy puppies. Also an invaluable food for dogs of any age out of condition. Follow directions on each package.

2½-lb. carton 35c (postage extra)

Bone Meal for Puppies.—Specially prepared in a state to most readily supply the constituents needed to assist in building up a strong frame and preventing rickets, large joints, etc.

3-lb. carton 35c; postage extra

Midget Biscuits.—A small biscuit of superior quality, containing a lesser percentage of meat fibre than the ordinary cake. About 30 to the pound. Excellent for puppies, toy dogs and cats.

2½-lb. carton, 35c; postage extra

"SPRATT'S" "MIDGET" CHARCOAL BISCUITS.—To correct all bowel troubles, weak digestion, fetid breath, etc. All dogs should have at least once a week, and preferably at regular intervals, a meal of these excellent cakes. 2½-lb. carton 35c; postage extra.

"SPRATT'S" MOLLICODDLES (Milk-Wheat-Meat).—For dainty feeders, puppies, for toys. These biscuits satisfy the jaded palate, restore the failing appetite and AT THE SAME TIME provide a sound and wholesome food. 2-lb. carton 35c.

SPRATT'S FIBO—A Granulated Dog Food.—Many dogs will not take to the hard dog biscuits readily, especially where they have been fed on soft foods previously. All dogs will eat Spratt's Fibo with avidity and thrive on it. 3 lbs. 35c; postage extra.

DOG SOAP (White).—Kills lice and fleas, prevents skin diseases and leaves the coat smooth and glossy, contains no tar, nicely perfumed. Per cake 25c; postpaid 30c.

Alternative Cooling Tablets.—For heated blood, etc. Postpaid 50c.

Digestive Tablets.—For severe cases of indigestion. Postpaid 50c.

Diarrhoea Tablets.—To relieve diarrhoea. Postpaid 50c.

Purgative Tablets.—Perfectly safe and effective. Postpaid 50c.

Worm Capsules.—An excellent remedy for Round, Maw and Tape Worms. Postpaid 50c.

Worm Capsules for Puppies.—May be given with perfect safety to puppies from six weeks old to six months. Postpaid 50c.

Tonic and Condition Tablets.—For toy dogs and puppies. Postpaid 50c.

Distemper Tablets.—For toy dogs and puppies. Postpaid 75c.

Vermifuge Capsules.—For toy dogs and puppies. Postpaid 50c.

Dip.—Pints 50c; prepaid 65c.

Mange Remedy.—Pints 50c; prepaid 65c.

SPRATT'S CHICK, PHEASANT AND POULTRY FOODS ON PAGE 139

Puppies and Dogs

Buy your child a puppy and let them grow up together. Aside from the protection and companionship, educational experts advise that all children are better by having pets.



Some of our Farm-raised Scotch Collie Puppies

Most buyers prefer a pup so it can be raised and trained to suit, but occasionally someone wants a full grown dog; we sell both. Our largest demand is for Fox or Irish Terriers, Toy, Boston and English Bulls, Airedales, Spitz, Cocker Spaniels and Scotch Collies, but we can also supply Setters, Pointers and other breeds.

If out-of-town customers will write and tell us what they want—breed, color and sex and what stock, fancy, pedigreed or just good, fairly pure strain, we are sure we can please you and give you extra good value. The prices on the different breeds and stock range from as low as \$5.00 to \$50.00.

Roseburg, Ore., Nov. 14, 1917.

Routledge Seed & Floral Co.,

Gentlemen: The little black Cocker Spaniel arrived O. K. and we are delighted with him. He shows very good training and has exceptionally good sense for a little pup of his age. He is certainly a dear little dog.

Sincerely,

GRACE E. BISHOP.

Persian Angora Cats or Kittens

These long, fluffy, silky-haired pets are great favorites with the ladies, and with their bright intelligence, affectionate dispositions, cleanliness and beautiful appearance it is not to be wondered at. Aside from their value as pets there is good money in breeding and raising them, as they find quick sale. Most of the stock we offer is from pedigreed stock and eligible to registration. The popular colors are Orange, Silvers, Shaded Silvers,—Orange, Brown and Silver Tabbies,—White, Black, Blue and Tortoiseshell.

RANGE OF PRICES.—Young Kittens: Males, \$10 to \$20; Females, \$7.50 to \$15. Old, 6 months or over, prices on request.



DRINKING FOUNTAINS FOR CATS OR DOGS

An ornament to any room. Made of copper, nickel-plated, highly polished, and will not rust. Don't leave your pets without water.

Simply remove the cover and fill from the top, then replace cover and you will have a constant supply of pure water in the drinking pan; will not run over or tip over. Capacity 3 pints. Price \$1.50 each (weight 5 lbs.).

Cat and Dog Pedigree Blanks

We offer breeders, what we believe to be the prettiest and most up-to-date, properly constructed pedigree blanks. These are printed in two colors and beautifully illustrated.

Prices.—For Cats or Dogs, state which, 10c each; 6 for 50c; 12 for 85c.



Silver-shaded Persian Cat.

NOTE—We would be very glad to hear from any reliable breeders of above dogs, when they have stock to sell. Give us full information, BREED, WHAT KIND OF STOCK, AGE, SEX and NET PRICE TO US.

GOLDFISH, GLOBES, FOOD, ETC.

We are the largest retail and wholesale dealers in Fancy Gold Fish in the Northwest, often having a thousand or more on display in our large aquarium at our store.

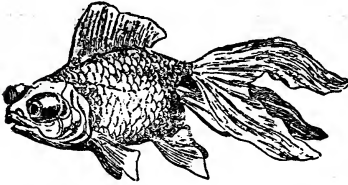

Chinese Telescope

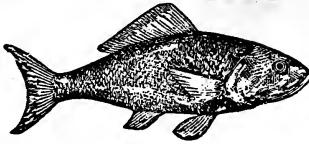

Common Gold Fish



Japanese Fan-tail

An aquarium is a beautiful ornament. It suits everywhere—parlor, library, dining and sitting-room, and may indeed be introduced in apartments of the sick. The bright, active Gold Fish are very interesting, a perpetual source of amusement for both old and young folks. Children are always delighted with them.

CARE OF GOLD FISH.—The care of Gold Fish is very simple and little trouble. The water in the aquaria must be changed from one to six times a week, depending on the size of the globe, the number of fish and the temperature. When the fish come to surface and gasp for air, they should be given fresh water.

FEEDING.—The only safe diet is our prepared Fish-Food, fed daily and only what they will eat up quickly. Bread or cracker crumbs should never be fed. More fish die from over-feeding than from any other cause. **Keep the aquariums out of the direct hot sunlight and in a cool place.**

PRICE LIST OF FISH

COMMON GOLD FISH (see cut).—Very hardy and lively. Each, very small, 15c; small, 25c; medium, 35c; medium large, 50c; large, 3 to 4 inches, 75c; extra large, \$1.00; extra large breeders, \$1.50 to \$2.00; fancy tri-colored, 35c to \$1.00 and up.

COMMON SILVER FISH.—Same as above, except they are silvery white. Each, medium, 25c; large, 50c; large breeders, \$1.00.

JAPANESE FAN-TAIL (see cut).—The most popular fancy fish. The fins and tail are of a delicate lace-like appearance very showy and attractive. Price, golden, small, 25c; medium, 35c; large, 50c to \$1.00; tri-colored, golden-red, pearly-white and black, showing two or all three colors, 50c, 75c and \$1.00 each.



Standard Globe.

COMET.—Very fancy; the most graceful of all. Similar to the Japanese Fan-tail, but the fins and tail are much longer and delicate. The tail is often longer than the fish. Price each, small 25c; medium 50c; large 75c to \$1.00; large fountain size \$2.50.

CHINESE TELESCOPE (see cut).—Curious and attractive on account of the large, elongated eyes, having the appearance of a telescope. Flowing double tails. Very rare. Price each, all gold 50c to 75c; all black 75c to \$1.00; black and gold 75c to \$1.50.

NOTE.—ALL SHIPMENTS (outside of the city) must go by express. A charge of 15c is made to cover cost of Shipping Bucket, holding from two to six fish. Gold Fish can be shipped safely overland hundreds of miles. They cannot be sent by mail.

TADPOLES.—Desirable as scavengers for the aquaria. They consume the decaying matter and help keep the water pure. Price each 15c.

Warren, Ore., Feb. 5, 1917.

Routledge Seed & Floral Co.,

Gentlemen: Received shipment of Gold Fish etc. I am well pleased with them. Many thanks.

Yours very truly,

J. I. WELLBORN.

AQUARIA PLANT OR FISH MOSS

This water plant improves the appearance of the aquaria or globe and helps purify the water, also keeps the water fresh longer. Price per bunch, 25c, postpaid. Cannot supply in July or August.

FISH FOOD

Best rice wafer, large box, enough food for four fish for six months. 25c postpaid. Directions for feeding and care on each box.

FISH GLOBES

Cannot be sent by mail.

Without foot or base, each quart, 50c; ½-gal. 75c; ¾-gal. \$1.00; 1-gal. \$1.25; 1½-gal. \$1.50; 2-gal. \$2.00; 2½-gal. \$2.50; 3-gal. \$3.00. WITH BRASS CHAIN FOR HANGING, 50c extra.

STANDARD GLOBES

Cannot be sent by mail.

Like illustration, each, ½-gal. \$1.25; ¾-gal. \$1.50; 1-gal. \$1.75; 1½-gal. \$2.00; 2-gal. \$2.25; 2½-gal. \$2.75; 3-gal. \$3.25.

AQUARIA CASTLES

As ornaments to set in the globes. Prices, 25c to 50c and up to \$1.00 each. No. 4, 25c; No. 6, 35c; No. 8, 40c; postage 5c extra. See illustrated Bird Catalog.

WHEN? We have the largest supply of Gold Fish on hand during the FALL, WINTER and EARLY SPRING. It is not safe to ship fish during the hot summer months.

REFERENCE TABLES

Quantity of Seeds to produce a given number of plants or to sow an acre
 1918.—We have carefully revised and lowered the following amounts so that you will NOT
 PLANT TOO MUCH and thereby WASTE seed while they are HIGH AND SCARCE.

Vegetable Seeds

	Per Acre		Per Acre
Asparagus—1 oz. to 200 plants....	3 lbs.	Kohl-Rabi—1 oz. to 300 ft. drill....	2 lbs.
Beans, Dwarf—1 lb. to 125 ft. drill.	40 lbs.	Leek—1 oz. to 100 ft. drill.....	3 lbs.
Pole—1 lb. to 150 ft. drill.....	35 lbs.	Lettuce—1 oz. to 200 ft. drill.....	3 lbs.
Pole—1 lb. to 200 hill.....	25 lbs.	Melon, Musk—1 oz. to 50 hills.....	2 lbs.
Field—1 lb. to 200 ft. drill.....	30 lbs.	Water—1 oz. to 35 hills.....	2 lbs.
Lima—1 lb. to 75 hills.....	40 lbs.	Okra—1 oz. to 100 ft. drill.....	5 lbs.
Beet, Table—1 oz. to 60 ft. drill....	6 lbs.	Onion Seed—1 oz. to 200 ft. drill..	3 lbs.
Mangel—1 oz. to 75 ft. drill....	5 lbs.	For Sets	50 lbs.
Broccoli—1 oz. to 3,000 plants.....	3 ozs.	Onion Sets—1 lb. to 35 ft. drill....	200 lbs.
Brussel Sprouts—1 oz. to 3,000 P..	3 ozs.	Parsnips—1 oz. to 300 ft. drill....	3 lbs.
Cabbage—1 oz. to 3,000 plants.....	3 ozs.	Parsley—1 oz. to 350 ft. drill....	2 lbs.
Carrot—1 oz. to 150 ft. drill.....	2 1/2 lbs.	Peas, Dwarf—1 lb. to 125 ft. drill.	80 lbs.
Cauliflower—1 oz. to 4,000 plants..	3 ozs.	Tall—1 lb. to 150 ft. drill.....	60 lbs.
Celery—1 oz. to 5,000 plants.....	3 ozs.	Pepper—1 oz. to 2,000 plants.....	4 ozs.
Chicory—1 oz. to 100 ft. drill.....	4 lbs.	Potatoes	600 to 700
Corn, Sweet—1 lb. to 150 ft. drill..	18 lbs.	Pumpkin—1 oz. to 35 hills.....	3 lbs.
Sweet—1 lb. to 160 hills.....	15 lbs.	Radish—1 oz. to 100 ft. drill.....	10 lbs.
Corn Salad—1 oz. to 50 ft. drill...	5 lbs.	Rutabaga—1 oz. to 250 ft. drill.....	2 lbs.
Cress—1 oz. to 40 ft. drill.....	1 lb.	Salsify—1 oz. to 100 ft. drill.....	8 lbs.
Cucumber—1 oz. to 50 hills.....	2 lbs.	Spinach—1 oz. to 100 ft. drill.....	10 lbs.
Egg Plant—1 oz. to 3,000 plants..	4 ozs.	Squash, Summer—1 oz. to 50 hills..	2 lbs.
Endive—1 oz. to 300 ft. drill.....	4 lbs.	Winter—1 oz. to 35 hills.....	3 lbs.
Horseradish Roots.....	10 to 15 M.	Tomatoes—1 oz. to 3,000 plants....	3 ozs.
Kale, Table—1 oz. to 3,000 plants..	1 lb.	Tobacco—1 oz. to 4,000 plants....	1 lb.
Stock—1 oz. to 300 ft. drill.....	2 lbs.	Turnips—1 oz. to 250 ft. drill.....	2 lbs.

Field, Farm, Grass and Clover Seeds

	Quantity per Acre		Quantity per Acre
Alfalfa	12 to 25 lbs.	Rye Grass—for Pasture.....	30 lbs.
Artichokes	400 to 600 lbs.	Rye Grass—for Lawn.....	100 lbs.
Barley—drills	75 lbs. broadcast 100 lbs.	Sudan—drills	3 to 5 lbs.
Buckwheat—drills	30 lbs. broadcast 50 lbs.	Broadcast	16 to 20 lbs.
Cheat	100 lbs.	Kaffir Corn—drills.....	6 to 10 lbs.
Clover—Alyske and White.....	6 to 10 lbs.	Millet—for Seed	20 lbs.
White for lawn.....	1 lb. to 25 ft. square	For Hay	30 lbs.
Crimson	10 to 15 lbs.	Oats—for Seed	65 to 80 lbs.
Red	8 to 15 lbs.	For Hay	100 lbs.
Sweet	15 to 20 lbs.	Peas, Field—100 lbs. or 80 lbs. with 35 lbs. Oats	5 lbs.
Corn, Field—hills.....	15 lbs.	Rape—drills 3 lbs. broadcast.....	5 lbs.
For Fodder, drills.....	50 lbs.	Rye—for Grain	60 to 80 lbs.
Grass, Kentucky Blue—Pasture.....	20 to 30 lbs.	For Hay	100 to 120 lbs.
Kentucky Blue—for Lawns.....	100 lbs.	Speltz or Emmer.....	80 lbs.
Mixed Lawn	1 lb. to 15 ft. square	Sugar Cane	10 to 12 lbs.
Red Top—Common.....	25 to 30 lbs.	Sunflower	5 to 7 lbs.
Red Top—Hulled, Solid Seed.....	10 to 15 lbs.	Timothy	12 to 15 lbs.
Orchard	25 to 30 lbs.	Vetches—85 lbs. or 60 lbs. with 40 lbs. Grain	30 lbs.
Brome Grass	25 to 30 lbs.	Vetch, Hairy or Sand.....	30 lbs.
		Wheat	80 to 100 lbs.

Suitable Distance for Planting Trees and Plants

<p>Note.—In planting in the home garden for hand cultivation you can set plants or trees closer.</p> <p>Apples, Standard</p>	20 to 30 feet	<p>Currants</p>	4 by 4 feet
Apples, Dwarf	10 to 12 feet	Gooseberries	4 by 4 feet
Pears, Standard	18 to 20 feet	Raspberries	3 by 6 feet
Pears, Dwarf	10 feet	Trailing Berries, Logans, etc..	6 by 8 feet
Peaches and Apricots.....	16 to 18 feet	Other Blackberries	2; by 6 feet
Cherries, Sweet	20 to 25 feet	Strawberries, in Hills.....	1; by 2; feet
Cherries, Sour	16 to 20 feet	Strawberries, Matted Rows..	2; by 4 feet
Plums and Prunes.....	16 to 20 feet	Asparagus, in Beds.....	1 by 1; feet
Quinces	10 to 12 feet	Asparagus, in Field.....	1 by 4 feet
Grapes	5 by 12 feet	Rhubarb	2 by 4 feet

Number of Trees or Plants On An Acre

1 by 2 feet.....	21,784	3 by 5 feet.....	2,904	12 by 12 feet.....	302
1 by 3 feet.....	14,520	3 by 6 feet.....	2,420	15 by 15 feet.....	194
1 by 4 feet.....	10,890	4 by 4 feet.....	2,723	16 by 16 feet.....	170
1 1/2 by 2 feet.....	14,520	4 by 6 feet.....	1,815	18 by 18 feet.....	135
1 1/2 by 3 feet.....	9,682	6 by 8 feet.....	907	20 by 20 feet.....	110
2 by 3 feet.....	7,261	6 by 6 feet.....	1,210	25 by 25 feet.....	70
2 by 4 feet.....	5,446	8 by 8 feet.....	630	30 by 30 feet.....	45
3 by 4 feet.....	3,630	10 by 10 feet.....	430	40 by 40 feet.....	23

RULE.—Multiply the distance in feet between the rows by the distance the plants are apart in the rows, and the product will be the number of square feet, for each plant or hill, which, divided into the number of square feet in an acre (43,569), will give the number of plants to the acre.

CLARKIA

ELEGANS DOUBLE MIXED



PUT UP

Routledge
SEED & FLORAL CO

169-171 2d ST. PORTLAND ORE.

PANSY

PRICE CHOICE MIXED 10 CTS.



Routledge
SEED & FLORAL CO

169-171 2d ST. PORTLAND ORE.

AGERATUM

FINEST MIXED

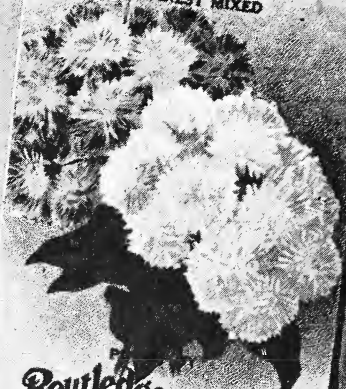

Routledge
SEED & FLORAL CO

169-171 2d ST. PORTLAND ORE.

CARNATION

CHOICE MIXED



Routledge
SEED & FLORAL CO

169-171 2d ST. PORTLAND ORE.



POPPY

CARNATION FLOWERED MIXED



Routledge
SEED & FLORAL CO

169-171 2d ST. PORTLAND ORE.

ASTER

GIANT ORGEO MIXED

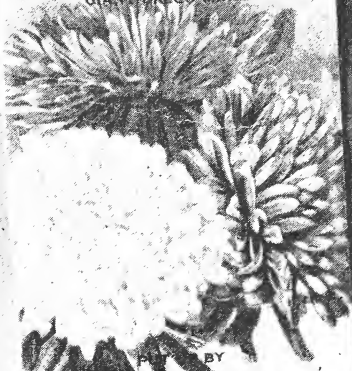

BY

Routledge
SEED & FLORAL CO

169-171 2d ST. PORTLAND ORE.

GOSMOS

MAMMOTH MIXED



PUT UP BY

Routledge
SEED & FLORAL CO

169-171 2d ST. PORTLAND ORE.

MORNING GLORY

CHOICE PRIZE MIXED

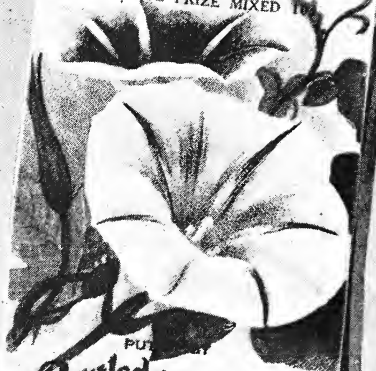

PUT UP BY

Routledge
SEED & FLORAL CO

169-171 2d ST. PORTLAND ORE.