

## **Historic, Archive Document**

Do not assume content reflects current scientific knowledge, policies, or practices.



STERLING QUALITY  
SEEDS 1921



*The Old Parson Gilman Manse, Yarmouth Foreside, Me.  
Original house built in 1771*

ALLEN, STERLING & LOTHROP  
49 EXCHANGE STREET    64 MARKET STREET  
PORTLAND, MAINE

## Information and Suggestions to Customers

*What are "Sterling Quality" Seeds?* "Sterling Quality" Seeds are the very best Seeds that money can buy—"Sterling Quality" Seeds are tested—"Sterling Quality" Seeds are true to name—"Sterling Quality" Seeds are clean and neatly packed. Send us your order early, *now!*

- Caution* "Sterling Quality" Seeds are the highest grade obtainable and intended for the *particular* market gardener, florist and individual. *We do not sell to dealers.* "Sterling Quality" Seeds can be procured only directly from us.
- Free Delivery* We deliver "Sterling Quality" flower and vegetable seeds *free* to any address in the United States when purchased by the *packet, ounce, half pound and pound.*
- Orders* Should be written on our order sheet or on a blank sheet separate from letter, preferably in ink. *Be sure to sign your name and give your address.*
- Remittances* Can be safely sent by Bank Check, Post Office Order, Registered Letter or Express Money Order. Postage Stamp remittances taken in amounts less than \$1.00.
- New Customers* Will kindly remit the amount with their orders, or name business references, as customary before opening new accounts.
- Market Gardeners* *Farmers' Clubs and Institutions* purchasing Seeds in large quantities should write for special prices. Send a list of quantities and varieties required and we will return list promptly with quotations.
- No Charge for Packing* But bags billed at cost. If returned in good condition free of expense, they will be credited at price charged.
- Telephone Orders* Will be given immediate attention. Call Portland 624  
625
- Non-Warranty* There are many contingencies constantly arising to prevent the best seeds from giving satisfaction. We aim to supply only the best quality of seeds and to be as represented; but it is impossible to guarantee seeds under all circumstances. We give no warranty, expressed or implied, as to description, quality or productiveness of any seeds, bulbs or plants, and will not in any way be responsible for the crop. If the purchaser does not accept the goods on these terms, they are at once to be returned.

### ALLEN, STERLING & LOTHROP

PORTLAND, MAINE

For Index of the Contents of this  
Catalogue, see Page 80

For Parcel Post Information  
see Inside Back Cover



Allen, Sterling & Lothrop

49 EXCHANGE STREET

64 MARKET STREET

PORTLAND, MAINE

# ORDER SHEET

"Sterling Quality" Seeds

PLEASE DO NOT WRITE  
IN THIS SPACE

Date \_\_\_\_\_

Gentlemen:—I am enclosing \_\_\_\_\_ for the following seeds to be sent by \_\_\_\_\_

(State here if wanted by Mail, Express or Freight)

Name \_\_\_\_\_

P. O. Address \_\_\_\_\_

St. or R.F.D. \_\_\_\_\_ State \_\_\_\_\_

Express or Freight Station \_\_\_\_\_

[If different from P.O.]

Allen, Sterling & Lothrop give no warranty, expressed or implied, as to description, quality, productiveness, or any other matter of any seeds, bulbs or plants they send out, and will be in no way responsible for the crop. If the purchaser does not accept seeds on these terms, they are at once to be returned.

TEAR OFF THIS ORDER SHEET ALONG THIS LINE  
PLEASE DO NOT WRITE IN THIS SPACE

	Quantity	Names of Seeds or Other Articles Wanted	PRICE	
			Dollars	Cents
			Amount Carried Forward	

Remember—No order too large or too small to send to us!

PLEASE DO NOT WRITE IN THIS SPACE

Quantity	Names of Seeds or Other Articles Wanted	PRICE	
		Dollars	Cents
	Amount Brought Forward		

**Help Us Perfect Our Mailing List**

Is the Address on the envelope inclosing this Catalog correct?

If Duplicate Copies of our Catalog come to your home what name should be stricken from our list?

Kindly give below names of any friends or neighbors whom you think would be interested in receiving our catalog

NAME	POST OFFICE	COUNTY	STATE

# 1921 Catalogue of "Sterling Quality" Seeds

[GARDEN, FIELD AND FLOWER]

Barn Equipment, Separators, Sprayers, Insecticides, Farm and Garden Tools, Poultry and Dairy Supplies, Plants, Bulbs, Fertilizers

## *Will 1921 Be a Prosperous Farm and Garden Year?*

WE say, and say emphatically, that it will be! Farmers and market gardeners had a bitter experience last year; in fact, every business man has been hit hard in the big break from peak prices, but 1920 is a closed book. What of 1921?

First and foremost, farm labor will be more plentiful and will be willing to work for smaller wages as the purchasing value of the dollar increases.

Then again, prices of farm and garden seeds, with the exception of possibly peas, are back to pre-war prices. Fertilizer, however, has shown no reduction, directly attributable to the tremendous increase in freight rates. But will this increase of freight rates work to the ultimate detriment of the New England farmer? We think not, as it will save the New England market for the New England farmer; the South and West being handicapped by the higher freight rates, thus adding to the cost of their products in New England markets.

Once more, it almost seems as if there had been a world-wide over-production, but when one seeks to analyze this problem he will readily see that the contrary is true. As a dam causes a river to back up, so the difference in exchange has dammed the flow of our products to Europe. At the present time, however, not only the government, but large independent trading corporations recently formed in New York, have taken up this matter of breaking the dam and once more opening the markets of the world to American commerce.

You may ask, what has this got to do with me? Just this! The resumption of our trade abroad will immediately have a beneficial effect on every business man in the United States and that surely means the farmer because he is fundamentally the back bone business man of every country. So let's all cheer up and go to work. Surely the worst is behind us. He who lies back and becomes pessimistic will be in no position to share in the prosperity of the future.

## OUR COVER

THE subject of our cover is the old Parson Gilman Manse, one of the truly historical houses in the State of Maine. This house is beautifully situated on the Foreside Road between Portland and Yarmouth, and from its windows and broad piazzas a magnificent panorama of level acres, rolling meadow, marsh, inlet and bay, stretches before the eye.

The original house was built in 1771 by Parson Tristram Gilman, pastor of the First Congregational Church of Yarmouth. Portions of the old house have been rebuilt from time to time, but always with the idea to retain the original atmosphere.

Many of the old furnishings are still in the house, including the desk at which the venerable parson wrote his sermons. The house is now owned by Mr. William N. Taylor, and it is our privilege to assist him, with our seeds and merchandise, in maintaining the splendid flower and vegetable gardens with which the old house is surrounded.



## Allen, Sterling & Lothrop

49 Exchange Street and 64 Market Street

Portland, Maine

## GENERAL LIST OF SELECT VEGETABLE SEEDS

WE PREPAY POSTAGE OR EXPRESS CHARGES ON ALL SEEDS ORDERED BY THE PACKET,  
OUNCE, QUARTER POUND OR POUND.

### ASPARAGUS

Sow the seeds thinly in April or May in rows one foot apart and one inch deep; when the plants are well up, thin to 3 or 4 inches apart in the rows.

The next season plant in rows 3 feet apart and 1 foot in the rows, covering the plants about 6 inches.

The soil should be thoroughly manured and trenched, at least 2 feet.

*One ounce will sow 50 feet of drill.*

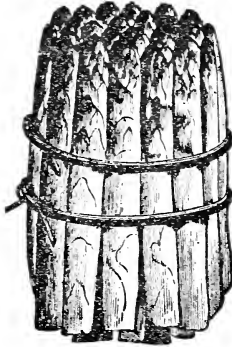

ASPARAGUS

**Columbian Mammoth.** A large white variety of fine flavor. Pkt. 5c., oz. 20c.,  $\frac{1}{4}$  lb. 75c.

**Conover's Colossal.** A standard sort of large size and excellent quality. Pkt. 5c., oz. 20c.,  $\frac{1}{4}$  lb. 75c.

**Early Giant Argenteuil.** An early variety, being ten days earlier than the Palmetto, of larger size and superior flavor. One of the finest sorts in cultivation. Pkt. 5c., oz. 20c.,  $\frac{1}{4}$  lb. 75c.

**Palmetto.** A standard light green variety. Pkt. 5c., oz. 20c.,  $\frac{1}{4}$  lb. 75c.

### BEANS, Dwarf or Bush

Plant in light, warm soil in the spring, when danger from frost is past, in drills from 2 to 3 feet apart, covering about 2 inches deep. Sow every two weeks for a succession. Cultivate frequently until they blossom, but only when dry.

If wanted by Parcel post, add at the rate of 5c. per pt., 10c. per qt.

### BEANS, Green Podded

**Bountiful.** Early and prolific, flat green pods, cook tender. Pkt. 20c., pt. 35c., qt. 65c.,  $\frac{1}{2}$  pk. \$2.50.

**Burpee's Stringless Green Pod.** Combines unusual hardness, extreme earliness and wonderful productiveness. The pods are tender, brittle and of the finest flavor; always entirely stringless. Pkt. 20c., pt. 35c., qt. 65c.,  $\frac{1}{2}$  pk. \$2.50.

**Burpee's Improved Bush Lima.** Compared with Burpee's Bush Lima, both pods and beans are very much larger, while the beans, either green or dry, are nearly twice as thick and ready to market eight to ten days earlier. Pkt. 20c., pt. 35c., qt. 65c.,  $\frac{1}{2}$  pk. \$2.50.

**Low's Champion.** Very early, absolutely stringless, exquisite flavor, very productive. One of the finest snap beans, an excellent shell bean, and is of splendid flavor when cooked dry. Pkt. 20c., pt. 35c., qt. 60c.,  $\frac{1}{2}$  pk. \$2.25.



LOW'S CHAMPION  
BUSH BEAN

**FRENCH'S DWARF HORTICULTURAL.** This is a bean of the Horticultural type. Pods remarkably large, many containing seven beans, beautifully splashed with bright crimson. Never spots or rusts. The vines are vigorous and productive, inclined to send out runners, but do not affect the bean in any way. Very popular with market gardeners. Pkt. 20c., pt. 35c., qt. 65c.,  $\frac{1}{2}$  pk. \$2.25, pk. \$4.00.

**Dwarf Horticultural.** A fine shell bean with long green pods, very productive. Pkt. 25c., pt. 40c., qt. 75c.,  $\frac{1}{2}$  pk. \$2.50.

**Goddard or Boston Favorite** Fine shell bean. Pods and beans similar in color, larger and longer than the Dwarf Horticultural. Very prolific. Pkt. 20c., pt. 35c., qt. 65c.,  $\frac{1}{2}$  pk. \$2.50.

**Long Yellow Six Weeks.** A leading market sort, long green pod. Pkt. 20c., pt. 35c., qt. 65c.,  $\frac{1}{2}$  pk. \$2.50

**Broad Windsor.** (English.) Plant as early in the spring as the ground can be worked, from 2 to 4 inches apart in drills 3 feet apart, cover the seed about 4 inches. Pkt. 20c., pt. 35c., qt. 65c.

**Red Kidney.** Fine for baking and a good shell bean. Pt. 25c., qt. 45c.,  $\frac{1}{2}$  pk. \$1.50.

**Golden California Pea.** The best sort for baking; a very hardy and prolific variety, having the richness and flavor not found in other varieties. Pt. 25c., qt. 40c.

**Snowflake Pea.** The best small white pea bean, early and productive. Pt. 20c., qt. 35c. Price quoted for larger quantity.

**Yellow-Eyed (Old-fashioned).** Very productive. Fine for baking, extensively grown as a dry bean for winter use. Pt. 20c., qt. 35c.,  $\frac{1}{2}$  pk. \$1.25.

**Yellow-Eyed (Improved).** Pt. 20c., qt. 35c.,  $\frac{1}{2}$  pk. \$1.25.



## BEANS, Wax Podded (Dwarf)

**Black Wax, Pencil Pod.** Pods are long, pencil like, tender and brittle. In color they are a rich, dark yellow, hardy and productive. Pkt. 20c., pt. 40c., qt. 70c., ½ pk. \$2.60.

**Burpee's Kidney Wax.** More productive than Wardwell's Kidney Wax; longer pods which are entirely stringless and are much finer quality. Free from blight and rust. Pkt. 20c., pt. 40c., qt. 70c., ½ pk. \$2.60.

**Improved Golden Wax.** An early, hardy variety, flat, golden-yellow pods. Pkt. 20c., pt. 40c., qt. 70c., ½ pk. \$2.60.

**Sure Crop Stringless Wax.** A wax-podded variety of remarkable growth and productiveness. Plants hardy and prolific; pods 7½ inches long and about ½ inch wide, of a rich yellow color, perfectly stringless, excellent for home and market gardens. Pkt. 20c., pt. 40c., qt. 70c., ½ pk. \$2.60.

**Wardwell's Kidney Wax.** A favorite variety bearing long, flat pods of excellent quality. Pkt. 20c., pt. 40c., qt. 70c., ½ pk. \$2.60.



LONDON  
HORTICULTURAL  
POLE BEAN

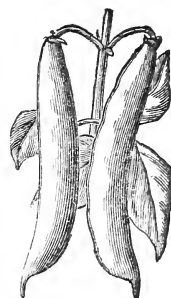

KIDNEY WAX  
BEAN

## BEANS, Pole

Plant in hills 4 feet apart, 4 to 5 beans to a hill. Poles should be firmly set before planting.

If wanted by Parcel Post, add at the rate of 5c. per pt., 10c. per qt.

**Carmine Podded Horticultural.** Pods bright carmine. Both pods and beans are much larger than the London Horticultural. An excellent variety for the market or the home garden. Pkt. 20c., pt. 35c., qt. 65c., ½ pk. \$2.50.

**Horticultural, or Speckled Cranberry.** An old favorite, early and prolific; excellent quality either as a snap or shell bean or for cooking dry. Pkt. 20c., pt. 35c., qt. 65c., ½ pk. \$2.50.

**Kentucky Wonder, or Old Homestead.** A long, green podded variety, very prolific and of fine quality and perfectly stringless. Pkt. 20c., pt. 40c., qt. 75c., ½ pk. \$2.75.

**Kentucky Wonder Wax.** The best pole wax bean; it is similar in habit of growth to "Kentucky Wonder Green Pod." Pkt. 25c., pt. 40c., qt. 70c., ½ pk. \$2.50.

**Large White Lima.** A very popular variety. Beans are large and tender and of excellent flavor. Pkt. 25c., qt. 75c.

**Small White Lima.** Early and hardy. Beans small, good quality. Pkt. 25c., qt. 75c.

**Lazy Wife's.** Beans white; pods green, very thick, meaty, entirely stringless; very productive. Pkt. 20c., pt. 35c., qt. 65c., ½ pk. \$2.50.

**Red Cranberry.** The pods are green, large and tender; one of the best snap beans. Pkt. 20c., pt. 40c., qt. 75c.

**Scarlet Runner.** An ornamental climber with bright scarlet flowers. ½ pt. 25c., pt. 40c., qt. 75c.

**White Runner.** Similar to the Scarlet Runner, flowers being white. ½ pt. 25c., pt. 40c., qt. 75c.

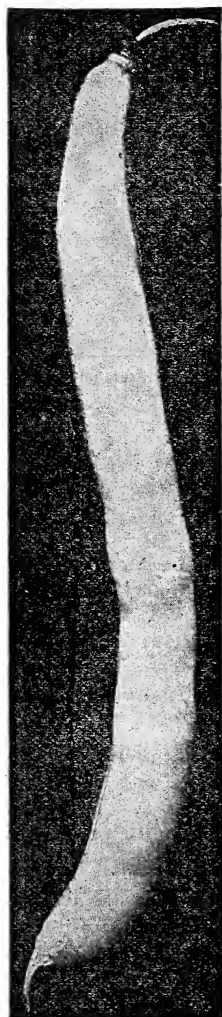

SURE CROP STRINGLESS  
WAX BEAN

"STERLING QUALITY" SEEDS MEAN THE BEST

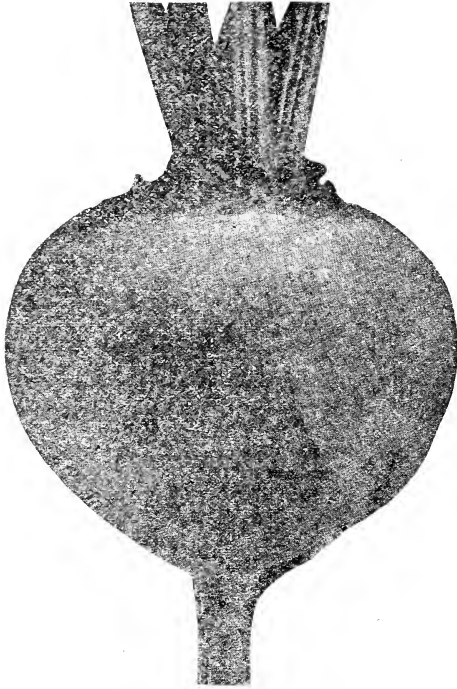

DETROIT DARK RED BEET

## BEET

Sow as early in the spring as the ground can be worked. For succession sow at intervals until the first of July. The soil should be well enriched with stable manure and plowed and harrowed until very fine. Sow in drills 15 inches apart and cover one inch. When well up thin out 4 inches apart in the rows.

*One ounce to fifty feet of drill; six pounds to the acre.*

**EARLY WONDER.** A fine early variety, the market gardener's favorite on account of its symmetrical form, dark color, small top and early maturity. We buy our seed of the originator. Pkt. 10c., oz. 20c., 2 oz. 35c.,  $\frac{1}{4}$  lb. 60c., lb. \$2.00.

**Crosby's Egyptian.** The roots are flattened, globe shaped and very smooth. Exterior color of root bright red. The flesh is bright vermillion red, zoned with a lighter shade, very sweet, tender and of excellent quality. Pkt. 5c., oz. 20c.,  $\frac{1}{4}$  lb. 50c., lb. \$1.50.

**Detroit Dark Red.** The best beet for the market and home garden. Tops small, upright in growth. Root medium-sized, globular or nearly round, very smooth, and of dark blood red color. Very desirable for bunching. Uniform in growth and unsurpassed in quality. Pkt. 5c., oz. 20c., 2 oz. 35c.,  $\frac{1}{4}$  lb. 50c., lb. \$1.50.

**Edmand's Blood Turnip.** A medium early sort, deep red, popular with market gardeners. Our seed is grown from selected roots saved for seed. Pkt. 5c., oz. 20c., 2 oz. 35c.,  $\frac{1}{4}$  lb. 50c., lb. \$1.50.

**Giant Feeding Sugar Beet or Half Sugar Mangel.** A strain of beets very desirable for stock feeding, affording not only a very large crop much easier to harvest than other sorts, but also having a higher nutritive value, being especially rich in sugar. Roots light bronze green above ground, grayish white below with white flesh. On account of growing partly out of the ground, and the long ovoid shape, the crop can be harvested and stored easily and at less expense than any other root crop. Oz. 15c.,  $\frac{1}{4}$  lb. 50c., lb. \$1.50.

GIANT FEEDING SUGAR BEET, OR  
HALF SUGAR MANGEL

## Mangel Wurzel

Sow in drills 2 inches deep, about 2 feet apart; thin out to 10 inches apart. *Six pounds to the acre.*

**Mammoth Long Red.** This variety produces roots of mammoth size and is enormously productive. Yielding from thirty to forty tons per acre on well prepared land. Oz. 10c.,  $\frac{1}{4}$  lb. 30c., lb. \$1.00.

**Golden Tankard.** Recommended for dairymen on account of its milk-producing properties. The flesh is a rich, golden yellow; very productive. Pkt. 5c., oz. 10c.,  $\frac{1}{4}$  lb. 30c., lb. \$1.00.

## Swiss Chard or Spinach Beet

The leaves are used as greens and served like spinach. The mid-ribs may be cooked like asparagus. Cuttings may be used all summer, as it can be cut down to the ground and new shoots will soon spring up and make fast growth.

**Lucullus.** The largest and best. Pkt. 5c., oz. 15c., 2 oz. 30c.,  $\frac{1}{4}$  lb. 45c., lb. \$1.50.

**Early  
Wonder  
Beet**





## **Easy-Blanching Celery**

**Our stock is proven and fancy quality. A first early variety, the stalks are very tender and brittle, and have a rich nutty flavor. Pkt. 10c.,  $\frac{1}{4}$  oz. 30c., oz. \$1.00,  $\frac{1}{4}$  lb. \$3.00.**



DANVERS HALF LONG CARROT

## CARROT

Carrots do best in a good, light and rich soil. Sow in April or May for the early crop, and for the main crop sow in May or June in drills about  $\frac{1}{2}$  inch deep, in rows 14 inches apart, and thin plants to 3 or 4 inches in the rows.

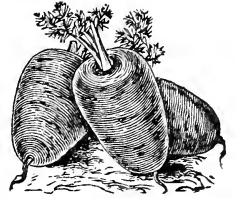

OXHEART CARROT

*One ounce to 100 feet of drill; four pounds to an acre.*

**Early Scarlet Forcing.** The earliest variety for forcing, small round roots and excellent flavor. Pkt. 5c., oz. 20c.,  $\frac{1}{4}$  lb. 60c.

**Early Scarlet Horn.** A favorite early variety, of fine flavor and excellent for the table. Roots grow about three inches long. Pkt. 5c., oz. 20c.,  $\frac{1}{4}$  lb. 60c.

**Danvers' Half-Long.** The best sort for the main crop, dark orange color, growing very smooth, yielding large crops, and is a splendid keeper; roots medium length, tapering uniformly to a blunt point. Pkt. 5c., oz. 20c.,  $\frac{1}{4}$  lb. 60c., lb. \$2.00.

**Danvers' Half-Long.** Special Market Gardeners' Strain. Pkt. 5c., oz. 25c.,  $\frac{1}{4}$  lb. 75c., lb. \$2.50.

**Hutchinson.** A superior strain of seed. Grow to a large size, small tap root and of the finest quality. Small circle of green on top of root. Length, 8 to 10 in. Pkt. 10c., oz. 35c.,  $\frac{1}{4}$  lb. \$1.00, lb. \$3.50.

**Chantenay.** A medium early, half-long variety. The flesh is crisp and tender. Pkt. 5c., oz. 20c.,  $\frac{1}{4}$  lb. 60c., lb. \$1.75.

**Improved Long Orange.** Deep orange color, roots of large size and a good keeper. Pkt. 5c., oz. 15c.,  $\frac{1}{4}$  lb. 50c., lb. \$1.50.

**Guerande or Oxheart.** Medium early roots, short and thick. The flesh is bright orange, fine grained and tender. Pkt. 5c., oz. 20c.,  $\frac{1}{4}$  lb. 60c., lb. \$2.00.

**Large White Belgian.** Very productive and largely used for feeding stock. Pkt. 5c., oz. 15c.,  $\frac{1}{4}$  lb. 50c., lb. \$1.50.

## Cress or Peppergrass

Sow early in the spring on rich soil in drills 10 or 12 inches apart and make frequent sowings every two weeks. Cover seed about  $\frac{1}{4}$  inch.

**Extra Curled.** Fine flavor, may be cut several times. Pkt. 5c., oz. 15c.,  $\frac{1}{4}$  lb. 35c.

**Water Cress.** Sow in the spring near the margin of ponds or running streams. Pkt. 10c., oz. 60c.,  $\frac{1}{4}$  lb. \$2.00.

## DANDELION

One of the earliest and most popular of spring greens. Sow in May in drills 12 inches apart; cover the seed  $\frac{1}{4}$  of an inch deep. The following spring the plants will be ready for cutting.

*One ounce for 200 feet of drill.*

**Improved Thick-Leaved.** A carefully selected strain; popular with market gardeners. Pkt. 10c., oz. 60c.,  $\frac{1}{4}$  lb. \$3.00.

## Brussels Sprouts

Cultivate the same as cabbage. The sprouts resemble miniature cabbage and are very tender.

**Improved Dwarf.** A standard sort. Pkt. 10c., oz. 50c.,  $\frac{1}{4}$  lb. \$1.50.

**Improved Long Island**  
The finest variety very compact sprouts. Pkt. 10c., oz. 50c.,  $\frac{1}{4}$  lb. \$1.50.

## Broccoli

A vegetable much resembling cauliflower.

**White Cape.** The most desirable variety. Pkt. 10c., oz. 60c.

## Chives

Hardy perennial plants grown for their tops, which are used as a salad and for flavoring soups. Seed, per pkt. 10c., oz. 75c. Roots 15c. per bunch, 25c. by mail prepaid.

## Chervil

An aromatic sweet herb used for flavoring and garnishing.

**Curled.** Pkt. 10c., oz. 25c.,  $\frac{1}{4}$  lb. 85c.

ORDER EARLY TO AVOID DISAPPOINTMENT

# CABBAGE

The cabbage is an important crop and should be planted in fresh, rich soil, well manured and deeply dug or plowed. For early use sow in a hotbed in March, transplant to the open ground when danger from frost is past. Plant the early sorts about 18 inches in the rows and the late sorts about 2 feet in the rows and the rows about 3 feet apart. For the late crops sow in the open ground in June. Our cabbage seed is grown from selected stock and is equal to any offered in the market.

*One ounce will produce about 2,000 plants.*

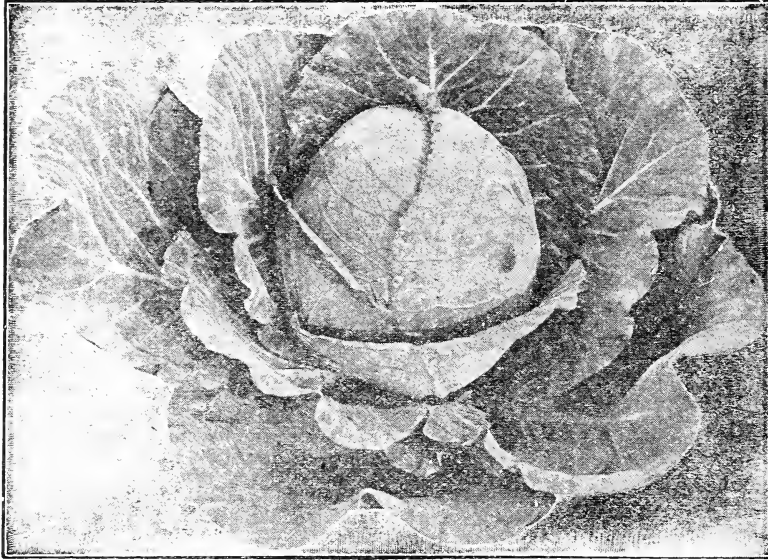

COPENHAGEN MARKET CABBAGE

**All Seasons.** Large heads, round and very solid and sure heading; nearly as early as the Early Summer. Pkt. 10c., oz. 35c.,  $\frac{1}{4}$  lb. \$1.25.

**A. S. & L., CAPE ELIZABETH.**

Heads hard, solid, tender and crisp. It is remarkable for its long-keeping qualities. One of the best shipping varieties. Pkt. 10c., oz. 60c.,  $\frac{1}{4}$  lb. \$2.25.

**Warren's Stone Mason.** An improvement on Stone Mason, round, medium-sized, solid heads, a good keeper. Pkt. 10c., oz. 40c.,  $\frac{1}{4}$  lb. \$1.50.

**DANISH BALL HEAD.**

This variety produces large, round and compact heads. One of the best keepers; plants vigorous and hardy, resisting cold and dry weather. Pkt. 10c., oz. 35c.,  $\frac{1}{4}$  lb. \$1.25.

**Marblehead Mammoth.** The largest variety of Drum-heads. Pkt. 10c., oz. 50c.,  $\frac{1}{4}$  lb. \$1.75.

**Improved American Savoy.** Large, solid round heads, of superior quality, tender and good flavor, the best variety for family use. Pkt. 10c., oz. 40c.,  $\frac{1}{4}$  lb. \$1.50.

**Pe-Tsai, or Chinese Cabbage.** A quick growing plant resembling Cos Lettuce. Pkt. 10c., oz. 40c.,  $\frac{1}{4}$  lb. \$1.50.

**COPENHAGEN MARKET.**

An extra early variety; heads ball-shaped, large and solid, averaging in weight about 10 pounds. It will give perfect satisfaction both as to quality and yield, having few outside leaves. The plants can be set closer than most varieties. The most evenly-maturing and large-heading early cabbage in cultivation. Pkt. 10c., oz. 40c.,  $\frac{1}{4}$  lb. \$1.50.

**Early Jersey Wakefield.** A standard early market variety, conical in shape and good quality; heads uniform and solid. Pkt. 10c., oz. 35c.,  $\frac{1}{4}$  lb. \$1.25.

**Henderson's Early Summer.** A popular second early sort, heads round, medium size very solid and compact. Pkt. 10c., oz. 35c.,  $\frac{1}{4}$  lb. \$1.25.

**Glory of Enkhuizen.** An early, white, solid, variety, medium sized heads. Pkt. 10c., oz. 40c.,  $\frac{1}{4}$  lb. \$1.50.

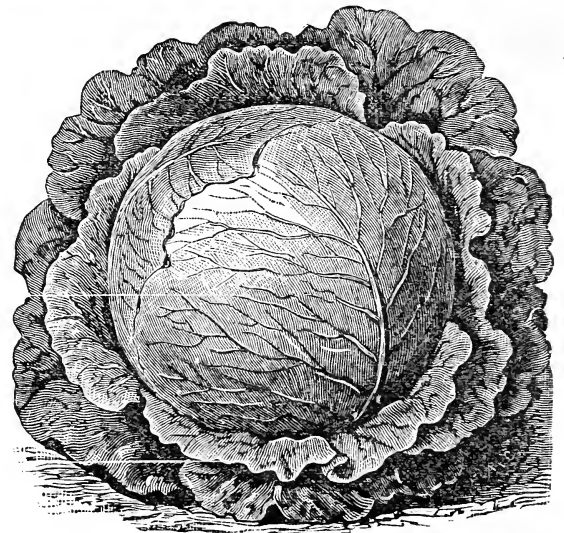

DANISH BALL HEAD CABBAGE

**Red Danish Stone Head.**

One of the largest and most solid and compact of the red varieties, sure heading and tender. Pkt. 10c., oz. 40c.,  $\frac{1}{4}$  lb. \$1.50.

**Mammoth Red Rock.** Heads dark red and solid, fine for pickling. Pkt. 10c., oz. 40c.,  $\frac{1}{4}$  lb. \$1.50.

SEND US YOUR MAIL ORDERS

## CAULIFLOWER

The soil that will grow cabbage will grow cauliflower. It should be made richer and thoroughly worked before planting. For early crop, sow seed in hotbed or in boxes about 6 weeks before time to plant out. Transplant early in spring in rows 3 feet apart and 18 inches in the row. Plants should be cultivated often to be kept growing continuously. For the late cauliflower, plant in the open ground in June and transplant in July.

*One ounce will produce 2,000 plants.*

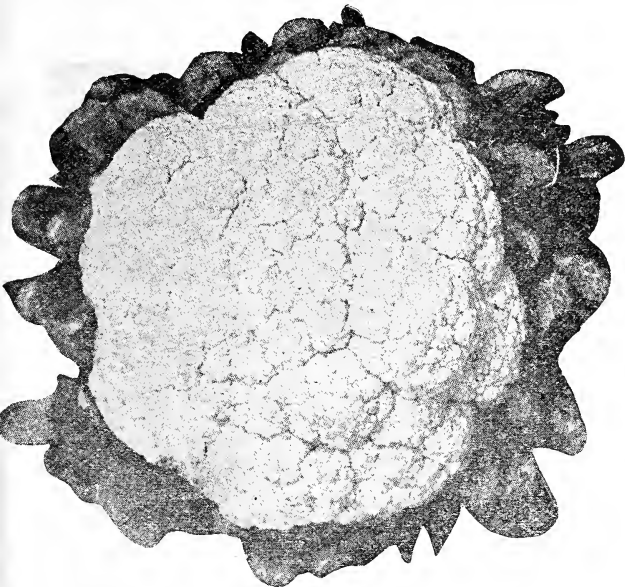

**Earliest Dwarf Snowball.** The earliest cauliflower in cultivation, absolutely sure to head when conditions are ordinarily favorable. Plants are very dwarf and of compact growth, with large firm, snow-white heads. Pkt. 15c.,  $\frac{1}{4}$  oz. 75c., oz. \$2.50.

**Thorburn's Gilt Edge.** Produces large solid, white heads of finest quality. Pkt. 15c.,  $\frac{1}{4}$  oz. 75c., oz. \$2.75.

**Danish Giant or Dry Weather.** This variety is about two weeks later than the snowball. It is of dwarf growth, producing large hard and snow-white heads, fully protected by its foliage. Pkt. 15c.,  $\frac{1}{4}$  oz. 75c., oz. \$2.75.

**Veitch's Autumn Giant.** A large, late sort. Pkt. 10c.,  $\frac{1}{4}$  oz. 30c., oz. \$1.00.

## CELERY

For early celery sow the seed of the self-blanching sorts in a hotbed early in the spring. As soon as the plants are 3 inches high, transplant into frames in well-enriched soil 4 inches apart. Cut them once or twice before setting them out in May or June to make them stocky. When about six inches high transplant into trenches wide enough to hold two rows. The rows should be about 1 foot apart and the plants set about 8 inches apart. For winter celery start the seeds in flats as for early, only a little later. As plants grow they should be earthed up to blanch, taking care not to cover the center of the plant.

*One ounce of seed will produce about 4,000 plants*

### **Easy-Blanching (New)**

A first early variety, the stalks are very tender and brittle, and have a rich nutty flavor. Pkt. 10c.,  $\frac{1}{4}$  oz. 25c., oz. 85c.,  $\frac{1}{4}$  lb. \$3.00

**Paris Golden Self-Blanching.** (French grown, special gardeners' strain). The finest early celery grown, easily blanched and of excellent flavor, solid and crisp. Pkt. 10c.,  $\frac{1}{4}$  oz. 25c., 1 oz. 85c.,  $\frac{1}{4}$  lb. \$3.00.

**Golden Self-Blanching.** Seed grown in California. Pkt. 10c.,  $\frac{1}{2}$  oz. 30c., oz. 50c.,  $\frac{1}{4}$  lb. \$1.50.

**White Plume.** A desirable early variety requiring very little labor in blanching. Pkt. 10c.,  $\frac{1}{2}$  oz. 15c., oz. 25c.,  $\frac{1}{4}$  lb. 60c.

**Boston Market.** White, solid, crisp and tender, the best late variety. Pkt. 10c.,  $\frac{1}{2}$  oz. 30c., oz. 50c.,  $\frac{1}{4}$  lb. \$1.50.

**Giant Pascal.** A tall-growing sort, blanches early and keeps well. Pkt. 10c.,  $\frac{1}{2}$  oz. 25c., oz. 45c.,  $\frac{1}{4}$  lb. \$1.50.

**Soup Celery.** For flavoring. Oz. 10c.,  $\frac{1}{4}$  lb. 20c., lb. 60c.

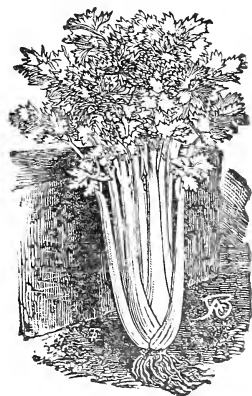

PARIS GOLDEN  
SELF-BLANCHING  
CELERY

A testimonial from one of our many market gardeners:

"Wish to say that your seed for this year has proven very satisfactory in every respect. Every seed came up right and began to grow from the start and has continued to do so."

## CORN, Sweet

Plant in hills 3 to 4 feet apart each way, dropping 6 seeds in each hill, or in drills 3 to 4 feet apart. The seeds should be covered about 2 inches. In this climate Sweet Corn should not be planted before the middle of May.

*One quart will plant 200 hills.*

If wanted by Parcel Post, add at the rate of 5c. per pint and 10c. per quart.

**Early Falmouth (New).** An extra early variety with good sized ears. The stalks are short with little foliage, 4 to 5 feet high; the sweetest and most tender of the early varieties. Gardeners trying for the earliest market should include it in their order. Pkt. 10c., pt. 25c., qt. 50c., ½ pk. \$1.75, pk. \$3.00.

**Early Mayflower.** One of the earliest varieties; white cob and kernels. The ears are larger than White Cory. Pkt. 15c., pt. 25c., qt. 45c., ½ pk. \$1.35, pk. \$2.60.

**Burpee's Golden Bantam.** Early, hardy and of the most delicious flavor; being of a dwarf growth, the stalks can be grown closely together in the row. Pkt. 15c., pt. 25c., qt. 45c., ½ pk. \$1.35, pk. \$2.60.

**Charlevoix.** An intermediate, yellow grained sweet corn of distinctive merit. Ears about seven inches long, usually twelve rowed and when in condition for use are light creamy yellow in color. The grain is rather short, very sweet and tender. An excellent sort both for the home and the market garden. Pkt. 15c., pt. 25c., qt. 45c., ½ pk. \$1.35, pk. \$2.60.

**Morse's Golden Cream.** A cross between Country Gentleman and Golden Bantam. The flavor is rich and delicious, seed yellow. The habit of growth is rather dwarf, and the stalks bear 2 to 4 ears. For a succession plant Golden Bantam, Bantam Evergreen and Golden Cream. Pkt. 15c., pt. 25c., qt. 45c., ½ pk. \$1.35, pk. \$2.60.

**Bantam Evergreen.** A cross between Stowell's Evergreen and Golden Bantam. Kernels are plump and full. The quality is very fine, being exceedingly sweet and tender. Ears 5 to 7 inches long. Pkt. 15c., pt. 25c., qt. 45c., ½ pk. \$1.35, pk. \$2.60.

**Early White Cory.** An early variety, with good-sized ears. Pkt. 15c., pt. 25c., qt. 45c., ½ pk. \$1.35, pk. \$2.60.

**Ellis-Crosby Extra Early.** An extra early and productive variety; ripening nearly as early as the Cory, growing very dwarf with ears set low, averaging from 16 to 20 rows; very sweet and tender. Desirable for both the market and private garden. The seed we offer was especially grown for us in New England for our retail trade. Pkt. 15c., pt. 30c., qt. 50c., ½ pk. \$1.35, pk. \$2.50.

**Early Crosby (Selected).** About ten days later than the Ellis-Crosby; largely used for canning. Pkt. 15c., pt. 25c., qt. 45c., ½ pk. \$1.25, pk. \$2.25.

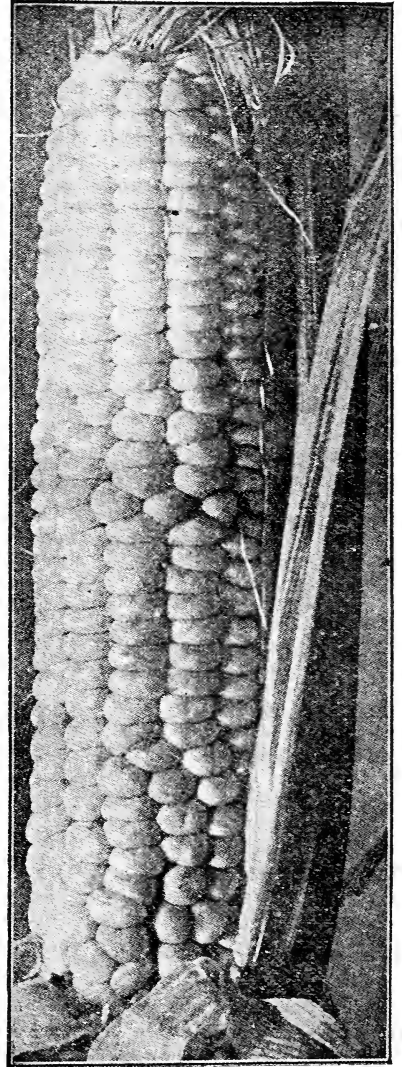

BURPEE'S GOLDEN BANTAM CORN

**Country Gentlemen.** A large, late variety of excellent quality. Pkt. 15c., pt. 25c., qt. 45c., ½ pk. \$1.25, pk. \$2.25.

**Stowell's Evergreen.** A late standard sort of excellent quality. Pkt. 15c., pt. 20c., qt. 35c., ½ pk. \$1.25, pk. \$2.00.

**Black Mexican.** Very sweet and tender, medium early. Pkt. 15c., pt. 25c., qt. 45c., ½ pk. \$1.25, pk. \$2.25.

1921 WILL BE THE BANNER GARDEN YEAR!



# CUCUMBER

For general crop plant when the ground has become warm, in hills 4 feet apart each way. Thin out to 4 plants to each hill after all danger of insects is over. For very early cucumbers sow about April 1st, in a hotbed on a piece of sod, grass side down so that they can be easily transplanted to the open ground when danger of frost is over

*One ounce will plant fifty hills; two pounds will plant an acre.*



WOODS HYBRID CUCUMBER

**WOODS HYBRID.** The best type of slicing cucumber. The color, a rich dark green, is retained a long time after it is picked. The flesh is white, crisp and tender. It is early and prolific, and for home or market, it is far superior to other sorts. Pkt. 10c., oz. 20c.,  $\frac{1}{4}$  lb. 60c., lb. \$2.00.

**Boston Pickling.** This variety is largely planted for pickles. Fruit medium size, smooth, light green and very productive. Pkt. 5c., oz. 15c.,  $\frac{1}{4}$  lb. 50c., lb. \$1.50.

**Cumberland.** Fine variety for pickling or slicing. Vines are of strong growth and prolific and continue in bearing a long time. Pkt. 5c., oz. 20c.,  $\frac{1}{4}$  lb. 50c., lb. \$1.50.

**Davis Perfect.** For forcing or outdoors. The fruit is of fine form, of a rich dark green color, very few seeds, tender, brittle and of fine flavor. Pkt. 10c., oz. 20c.,  $\frac{1}{4}$  lb. 65c., lb. \$2.25.

**Early Cluster.** An early sort growing in clusters. Pkt. 5c., oz. 15c.,  $\frac{1}{4}$  lb. 50c., lb. \$1.50.

**Early Frame or Short Green.** A well-known variety used for slicing and pickling. Pkt. 5c., oz. 15c.,  $\frac{1}{4}$  lb. 50c., lb. \$1.50.

**Kelway's "Freedom."** An extraordinary cropper and of first-rate quality; medium dark skin, 15 to 18 inches long. Per pkt. 25c.

**Improved White Spine.** One of the most popular varieties in cultivation. The fruit is light green with white spines, uniform in size and very productive. Pkt. 5c., oz. 15c.,  $\frac{1}{4}$  lb. 50c., lb. \$1.50.

**Early Russian.** One of the earliest varieties, grows from 3 to 4 inches long. Pkt. 5c., oz. 20c.,  $\frac{1}{4}$  lb. 50c., lb. \$1.50.

**Japanese Climbing.** A quick-growing sort, throwing out tendrils which enable them to climb poles or trellises. Fruit from 12 to 16 inches long. Pkt. 5c., oz. 20c.,  $\frac{1}{4}$  lb. 50c., lb. \$1.50.

**Klondike.** A medium early cucumber of very dark green color and an excellent quality for slicing; vine very hardy and productive. The fruits, when mature, are about 8 inches long. Its uniform size and shape and splendid color make this variety very popular as a shipping sort. Pkt. 5c., oz. 20c.,  $\frac{1}{4}$  lb. 50c., lb. \$1.50.

**Long Green.** An old standard variety. Fruit from 10 to 12 inches long, dark green and crisp. Pkt. 5c., oz. 20c.,  $\frac{1}{4}$  lb. 60c., lb. \$1.50.

**West India Gherkin.** A small prickly variety grown only for pickles. Pkt. 10c., oz. 20c.,  $\frac{1}{4}$  lb. 60c.

## ENGLISH FRAME CUCUMBERS

**Kelway's Extra Selected Telegraph.** A popular variety. Per pkt. 25c.

**TESTED SEED** is the only safe policy for any farmer. Many seeds show a low germination. We are testing all seeds and giving you the benefit of our judgment and experience.

## EGG PLANT

Sow the seeds in hotbeds very early in the spring and transplant when about three inches high into small pots or another hotbed. Do not plant out in the open ground until the weather has become warm and settled.

*One ounce will produce about 1,000 plants.*

**New York Improved Purple.** This variety produces fruit of large size, nearly round, dark purple and excellent quality. Pkt. 10c.,  $\frac{1}{2}$  oz. 35c., oz. 65c.

**Black Beauty.** A valuable early sort, about ten days earlier than the New York Improved; color a rich purplish black. Pkt. 10c.,  $\frac{1}{2}$  oz. 35c., oz. 65c.

## ENDIVE

For early use sow as early in the spring as the ground can be worked in drills 15 inches apart. Transplant to 1 foot each way. When full grown tie the outer leaves at the top to blanch them.

*One ounce will produce 2,000 plants.*

**Green Curled.** A standard sort for fall and winter. Pkt. 5c., oz. 20c.,  $\frac{1}{4}$  lb. 65c.

**White Curled.** A fine, white, curled variety, self-blanching. Pkt. 5c., oz. 20c.,  $\frac{1}{4}$  lb. 65c.

**Broad-Leaved Batavian.** A variety growing very compact, very tender and of fine flavor. Pkt. 5c., oz. 20c.,  $\frac{1}{4}$  lb. 65c.

**French Endive (Witloof Chicory).** Plant the seed in drills 10 inches apart, in deep, rich soil. Thin to six inches apart. One of the finest winter salads grown. Pkt. 10c., oz. 30c.,  $\frac{1}{4}$  lb. \$1.00.

## KALE

Sow from May to June, broadcast or in drills, cover  $\frac{1}{2}$  inch, cultivate the same as cabbage.

*One ounce to 150 feet of drill.*

**Dwarf Green Curled Scotch.** A fine, low-growing variety, the leaves densely crimped and curled; very hardy and productive. Pkt. 5c., oz. 25c.,  $\frac{1}{4}$  lb. 85c.

## KOHL RABI

Seed should be sown in drills as early in the spring as possible. When well established thin to 6 inches apart. The bulb grows entirely out of the ground.

**Early White Vienna.** A very early sort, excellent quality, flesh white and tender. Pkt. 5c.,  $\frac{1}{2}$  oz. 15c., oz. 25c.,  $\frac{1}{4}$  lb. 75c.

**Early Purple Vienna.** Similar to the above except in color. Pkt. 5c., oz. 25c.,  $\frac{1}{4}$  lb. 75c.

## LEEK

Plant in the spring in a light, well-enriched soil in drills 1 foot apart. Cover the seed about 1 inch and thin to 9 inches apart in the drills. Draw earth up to them as they grow.

*One ounce of seed to 150 feet of drill.*

**American Broad Flag.** A strong-growing sort with broad leaves. Pkt. 5c., oz. 30c.,  $\frac{1}{4}$  lb. 85c.

**Musselburgh.** This variety grows to a large size, blanches well and is of superior flavor. Pkt. 5c., oz. 30c.,  $\frac{1}{4}$  lb. 85c.

## MUSK MELON

Melons succeed best in light, sandy rich soil. After all danger of frost is past plant in hills 4 to 6 feet apart each way, six to ten seeds to a hill. When about 3 inches high and all danger from insects is past thin out to 3 or 4 plants to a hill.

*One ounce to 60 hills; two to three pounds to an acre.*

**Burrell's Gem.** Dark salmon flesh, delicious flavor. Pkt. 5c., oz. 15c.,  $\frac{1}{4}$  lb. 40c.

**Emerald Gem.** Fruit of medium size, very early and of fine flavor; flesh deep orange. Pkt. 5c., oz. 15c.,  $\frac{1}{4}$  lb. 40c.

**Long Yellow.** Very large, slightly ribbed and thickly netted; flesh salmon-yellow and sweet. Pkt. 5c., oz. 15c.,  $\frac{1}{4}$  lb. 40c.

**Miller's Cream or Osage.** Most delicious flavor, flesh salmon color, very thick and finely netted. Pkt. 5c., oz. 15c.,  $\frac{1}{4}$  lb. 50c.

**Rocky Ford.** A popular market variety. The fruit is oval, medium size, finely netted; flesh light green and very sweet. Pkt. 5c., oz. 15c.,  $\frac{1}{4}$  lb. 40c.

**Honey Dew.** A medium sized melon 5 to 6 pounds in weight, about 6 inches diameter and slightly oblong. Thick flesh, light emerald green in color. It is fine grained, melting and delicious, and is good clear down to the rind. Pkt. 10c., oz. 20c.,  $\frac{1}{4}$  lb. 75c.

## WATER MELON

Plant in hills about 8 feet apart and cultivate the same as for Musk Melon.

*One ounce for 30 hills; four pounds for one acre.*

**Cole's Early.** One of the best early varieties, medium size, nearly round, flesh dark red and excellent quality. Pkt. 5c., oz. 15c.,  $\frac{1}{4}$  lb. 50c.

**Fordhook Early.** Very early, good size, color medium green, flesh red and of good quality. Pkt. 5c., oz. 10c.,  $\frac{1}{4}$  lb. 30c.

**Mountain Sweet.** An old variety, flesh red. Pkt. 5c., oz. 10c.,  $\frac{1}{4}$  lb. 30c.

**Phinney's Early.** Early and productive, flesh red. Pkt. 5c., oz. 10c.,  $\frac{1}{4}$  lb. 30c.

**Citron.** Used for preserves; white flesh, hardy and productive. Pkt. 5c., oz. 10c.,  $\frac{1}{4}$  lb. 30c.

## MARTYNIA

The seed pods which are produced in great abundance are gathered when young and tender for pickling. Sow in the open ground in May, 3 feet apart each way.

**Proboscidea.** The most productive variety. Pkt. 10c.,  $\frac{1}{2}$  oz. 25c., oz. 40c.

### CAUTION

We do not sell to dealers. "Sterling Quality" Seeds can be procured only directly from us.

## LETTUCE

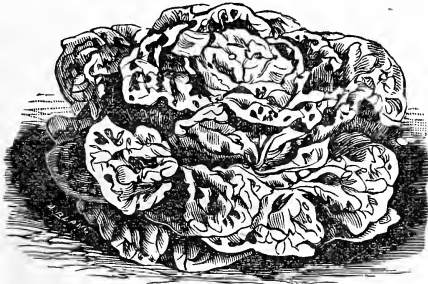

TENNIS BALL LETTUCE

For summer use the seed can be sown in hotbeds in March. Transplant when the weather will permit in rows 12 inches apart and 8 inches apart in the rows. For a succession sow in the open ground every two weeks until fall. Lettuce requires a rich and a rather moist soil. The more rapid the growth, the better the quality.

*One ounce of seed will produce about 3,000 plants.*

**Big Boston.** Fine for forcing or open-ground planting; large, solid heads. Pkt. 5c., oz. 15c.,  $\frac{1}{4}$  lb. 40c.

**Boston Curled.** Leaves beautifully curled, very attractive on table. Pkt. 5c.,  $\frac{1}{2}$  oz. 10c., oz. 15c.,  $\frac{1}{4}$  lb. 40c.

**Crisp as Ice.** Large, solid heads, yellow heart, outside dark green and bronze. Pkt. 5c.,  $\frac{1}{2}$  oz. 10c., oz. 15c.,  $\frac{1}{4}$  lb. 40c.

**Early Curled Simpson.** Very early, forms a close, compact mass of leaves. Pkt. 5c., oz. 15c.,  $\frac{1}{4}$  lb. 40c.

**Grand Rapids.** A very popular variety, leaves crimped, very attractive, matures quickly; the heads are dark green, very crisp and tender. Pkt. 5c.,  $\frac{1}{2}$  oz. 10c., oz. 15c.,  $\frac{1}{4}$  lb. 40c.

## MUSHROOM SPAWN

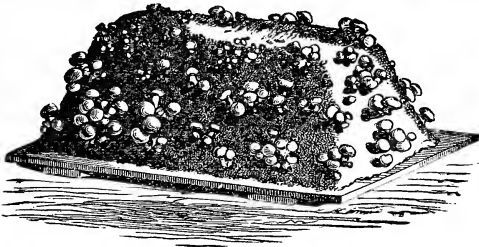

Mushrooms can be grown in cellars, in sheds, or in hotbeds where a temperature of 50 to 70 degrees is easily maintained.

**English Spawn.** In bricks 25c. per lb., 6 lbs. for \$1.25. If wanted by mail, add 10 cents per lb.

**Mushrooms, How to Grow Them.** By Falconer . . . . 1.25

**Mushroom Growing.** By Duggar . . . . . 1.50

**ORDER EARLY TO AVOID DISAPPOINTMENT**

**Hanson.** A large, solid variety. Pkt. 5c., oz. 15c.,  $\frac{1}{4}$  lb. 40c.

**Hittinger's Belmont Forcing.** Heads of larger size than the White-Seeded Tennis Ball, nearly as early and of crisp and tender quality; a superior forcing variety. Pkt. 10c.,  $\frac{1}{2}$  oz. 35c., oz. 60c.,  $\frac{1}{4}$  lb. \$2.00.

**Mammoth Black Seeded Butter.** The largest and best variety for the late crop. Forms a very large head of the finest quality. Pkt. 5c., oz. 20c.,  $\frac{1}{4}$  lb. 75c.

**Market Gardener's Private Stock.** A strain of Black-Seeded Tennis Ball, very desirable for hotbed culture in winter and for withstanding heat in summer. A light green cabbage sort, forming hard heads. Pkt. 5c., oz. 20c.,  $\frac{1}{4}$  lb. 75c.

**May King.** Large, round, solid heads, one of the best varieties for planting in open ground. Pkt. 5c.,  $\frac{1}{2}$  oz. 15c., oz. 20c.,  $\frac{1}{4}$  lb. 75c.

**New York or Wonderful.** The largest head lettuce crisp and tender. Pkt. 5c.,  $\frac{1}{2}$  oz. 10c., oz. 20c.,  $\frac{1}{4}$  lb. 75c.

**Salamander.** Medium size, light green, and forms a hard buttery head of fine quality. Pkt. 5c.,  $\frac{1}{2}$  oz. 10c., oz. 15c.,  $\frac{1}{4}$  lb. 40c.

**Tennis Ball, Black Seeded.** A favorite variety for outdoor crop; forms close, hard heads that are crisp and tender. Pkt. 5c.,  $\frac{1}{2}$  oz. 10c., oz. 15c.,  $\frac{1}{4}$  lb. 40c.

**Tennis Ball, White Seeded.** A well-known forcing variety. Pkt. 5c., oz. 15c.,  $\frac{1}{4}$  lb. 40c.

## Romaine or Cos Varieties

**Paris White Cos.** An early sort with long, narrow leaves. Pkt. 5c.,  $\frac{1}{2}$  oz. 10c., oz. 15c.,  $\frac{1}{4}$  lb. 40c.

**Trianon, Self-Folding Cos.** Requires no tying to blanch, very crisp and tender. Pkt. 5c.,  $\frac{1}{2}$  oz. 15c., oz. 25c.,  $\frac{1}{4}$  lb. 60c.

## MUSTARD

Sow thickly in early spring in shallow drills or in boxes during the winter. Successive sowings may be made every ten days.

*One ounce will sow about 75 feet of drill.*

**Black or Brown.** Pkt. 5c., oz. 15c.,  $\frac{1}{4}$  lb. 40c.

**Chinese.** Leaves twice the size of the ordinary White Mustard, which are curled and eaten boiled like spinach. Pkt. 5c., oz. 10c.,  $\frac{1}{4}$  lb. 25c.

**White London.** The best for salads and flavoring. Pkt. 5c., oz. 15c.,  $\frac{1}{4}$  lb. 40c.

## OKRA

Sow the seeds late in the spring after the ground has become warm in rows about 3 feet apart, 1 inch deep, thinning out to about 9 inches apart in the rows.

**Improved Dwarf Green.** Very productive, long green pods. Pkt. 5c., oz. 10c.,  $\frac{1}{4}$  lb. 30c.

**White Velvet.** Large pods, smooth and free from ridges. Pkt. 5c., oz. 10c.,  $\frac{1}{4}$  lb. 30c.

## ONION

Sow the seeds as early in the spring as the ground can be worked in drills about 1 foot apart and cover about  $\frac{1}{2}$  inch. Thin plants to stand from 2 to 3 inches apart in the drills. The soil should be made very rich and kept free from weeds.

*One ounce to 100 feet of drill; five pounds to the acre.*

**Danvers Yellow Globe.** The most profitable variety to grow, producing bulbs of globular form which ripen early and uniformly, producing large crops. The seed we offer was grown in New England from selected bulbs by a reliable grower of long experience. We cannot recommend this strain of seed too highly, not only on account of its great yield but also of its superior keeping qualities. Pkt. 10c., oz. 30c.,  $\frac{1}{4}$  lb. \$1.00, lb. \$3.50.

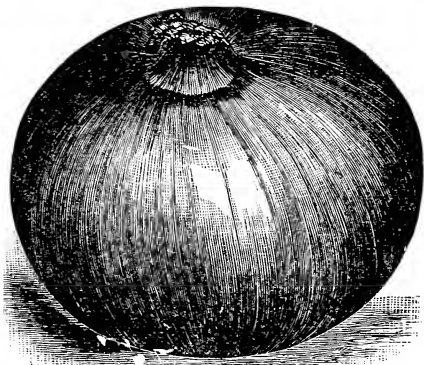

DANVERS' YELLOW GLOBE ONION

**Extra Early Red Flat.** About ten days earlier than the Red Wethersfield, medium size and a good keeper. Pkt. 10c., oz. 35c.,  $\frac{1}{4}$  lb. \$1.00, lb. \$3.50.

**Large Red Wethersfield.** The standard red, flat variety, large size, skin deep purplish red, a good keeper. Pkt. 10c., oz. 35c.,  $\frac{1}{4}$  lb. \$1.00, lb. \$3.50.

**New Queen.** A pure white variety of rapid growth; fine for pickling. Pkt. 10c., oz. 40c.,  $\frac{1}{4}$  lb. \$1.15, lb. \$4.00.

**Prizetaker.** The largest yellow onion, flesh white and of mild flavor. Pkt. 10c., oz. 40c.,  $\frac{1}{4}$  lb. \$1.15, lb. \$4.00.

**White Portugal.** One of the best white sorts; bulbs mature early, very mild flavor, the best to grow for sets. Pkt. 10c., oz. 40c.,  $\frac{1}{4}$  lb. \$1.15, lb. \$4.00.

**Onion Sets (Recleaned).** Onion Sets should be planted as early in the spring as the ground is dry enough to work in rows 12 inches apart and 2 to 4 inches apart in the rows.

Add 5c. per pound if sent by mail.

**White Onion Sets.** Lb. 35c., 8 lbs. \$2.00.

**Yellow Onion Sets.** Lb. 30c., 8 lbs. \$1.75.

**Japanese Sets.** Lb. 35c., 8 lbs. \$2.00.

*For larger quantities prices will be quoted on application.*

## PUMPKIN

Same cultivation as for squash.

*One ounce will plant 20 hills; one pound will plant 250 hills.*



SUGAR PUMPKIN

**Connecticut Field.** Very productive, usually grown in fields with corn for feeding stock. Pkt. 5c., oz. 10c.,  $\frac{1}{4}$  lb. 35c., lb. \$1.00.

**King of the Mammoths.** The best mammoth pumpkin, flesh is a golden-yellow, a splendid keeper and valuable for stock feeding. Pkt. 5c., oz. 15c.,  $\frac{1}{4}$  lb. 45c., lb. \$1.50.

**Mammoth Tours.** Very large size, oblong in shape, largely used for feeding stock. Pkt. 5c., oz. 15c.,  $\frac{1}{4}$  lb. 45c., lb. \$1.50.

**Small Sugar.** Very sweet and fine grained, a good keeper, best sort for family use. Pkt. 5c., oz. 15c.,  $\frac{1}{4}$  lb. 40c., lb. \$1.25.

## PEPPER

Sow the seed in hotbeds early in April. Transplant when 2 or 3 inches high to 3 inches apart. Transplant to the open ground about the first of June, in rows 2 feet apart and 18 inches apart in the rows. The soil should be rich and mellow.

*One ounce will produce about 2,000 plants.*

**Large Bell or Bull Nose.** Large and of mild flavor, largely used for pickling. Pkt. 5c.,  $\frac{1}{2}$  oz. 35c., oz. 60c.

**Long Red Cayenne.** Bright red, long, slender pods, very pungent. Pkt. 10c.,  $\frac{1}{2}$  oz. 40c., oz. 75c.

**Red Cherry Cayenne.** Small round variety, bright scarlet fruit. Pkt. 10c.,  $\frac{1}{2}$  oz. 40c., oz. 75c.

**Red Chili.** Used for seasoning and for making pepper sauce. Pkt. 10c.,  $\frac{1}{2}$  oz. 40c., oz. 75c.

**Squash or Tomato-Shaped.** Fruit medium size, early and productive. Pkt. 10c.,  $\frac{1}{2}$  oz. 45c., oz. 85c.

**Sweet Mountain.** The fruit is very large and smooth, flesh very tender and mild flavored. Pkt. 10c.,  $\frac{1}{2}$  oz. 45c., oz. 85c.

**Sweet Upright.** A large thick variety, flesh thick and tender, and the flavor is mild and sweet. Pkt. 10c.,  $\frac{1}{2}$  oz. 40c., oz. 75c.

## POTATOES

*Eight to ten bushels will plant one acre. One peck will plant 75 hills.*

Potatoes are sent by express or freight, purchaser paying charges.



Early Rose    Irish Cobbler    Delaware    White Albino  
Early White Rose    Green Mountain    Gold Coin

Price on application

## PARSLEY

Soak the seeds a few hours in lukewarm water and sow early in the spring in rich soil in drills one foot apart, thin out the plants to 4 inches apart in the rows.

*One ounce to 150 feet of drill.*

**Double Curled or Covent Garden.** One of the best sorts, handsome bright green color; leaves finely crimped and curly. Pkt. 5c., oz. 15c.,  $\frac{1}{4}$  lb. 45c.

**Fern Leaved.** A fine strain, very dark green. Pkt 5c., oz. 15c.,  $\frac{1}{4}$  lb. 45c.

**Hamburg or Turnip-Rooted.** The roots resemble a small parsnip; used for flavoring soups, etc. Pkt. 5c., oz., 15c.,  $\frac{1}{4}$  lb. 45c.

## PARSNIP

Sow as early in the spring as the weather will permit in deep, rich soil in drills 18 inches apart, covering the seed slightly; thin to 5 or 6 inches apart in the rows.

*One ounce to 100 feet of drill; five pounds to the acre.*

**Abbott's Improved Hollow Crown.** The roots are smooth, large, tender and sugary; a heavy cropper. Pkt. 5c., oz. 15c.,  $\frac{1}{4}$  lb. 50c., lb. \$1.50.

**Arlington Long Smooth.** Roots long and smooth; a good market sort. Pkt. 5c., oz. 10c.,  $\frac{1}{4}$  lb. 50c., lb. \$1.50.

Prices quoted in Catalogue are subject to change without notice

## PEAS

Sow the early, smooth, round sorts as early in the spring as the ground can be worked, in light, dry rich, loamy soil. The wrinkled varieties are more tender and the seed is more liable to rot and should not be planted when the ground is cold and wet. The late varieties do not require as rich soil as the early and dwarf sizes. Sow in rows 3 to 4 feet apart and about 1 inch apart in the rows, 3 to 4 inches deep. Peas grown as a market crop are never staked, but when the taller sorts are grown for private use they are generally sown in double rows, 6 to 8 inches apart, and staked with brush. For best results all garden peas require good, strong, fertile soil.

*One quart will plant about 100 feet of drill; 1½ bushels to the acre.*

Those marked with a (\*) are wrinkled varieties.

If wanted by Parcel Post, add at the rate of 5c. per pt., 10c. per qt.

### Extra Early Varieties

**Alaska.** One of the earliest blue peas, pods dark green, of medium size and uniform in growth; height 2½ feet. Pkt. 15c., pt. 35c., qt. 60c., ½ pk. \$2.50, pk. \$4.75.

**\*Gradus or Prosperity.** The earliest and most popular of the large-podded, wrinkled peas; vines vigorous, bearing large pods from 4 to 4½ inches in length, filled with large peas of the finest quality and delicious flavor; height 3 feet. Pkt. 25c., pt. 45c., qt. 80c., ½ pk. \$2.85.

**\*Laxtonian.** One of the most remarkable varieties yet introduced; very dwarf, growing only 12 to 15 inches high, producing pods in great abundance; nearly as large as the Telephone. The peas are large with a flavor the very sweetest and best. Pkt. 25c., pt. 45c., qt. 80c., ½ pk. \$2.85.

**\*Early Morn.** Of Gradus type, the pods are large and well filled with peas of excellent flavor; height 3 feet. Pkt. 25c., pt. 45c., qt. 80c., ½ pk. \$2.85.

**\*Little Marvel.** A dwarf variety of even growth, about 18 inches in height; pods dark green, medium size, often produced in pairs; as early as Nott's Excelsior, equal in flavor and more prolific. Pkt. 25c., pt. 45c., qt. 80c., pk. \$2.85.

**\*Nott's Excelsior.** A splendid early sort; pods are always well filled with large peas of delicious flavor. The vines are more vigorous than the American Wonder; height 15 inches. Pkt. 25c., pt. 45c., qt. 80c., ½ pk. \$2.85.

**Pedigree.** A quick-growing white, round pea; pods good size well filled, nearly all maturing at one time; height 2½ feet. Pkt. 20c., pt. 40c., qt. 75c., ½ pk. \$2.40.

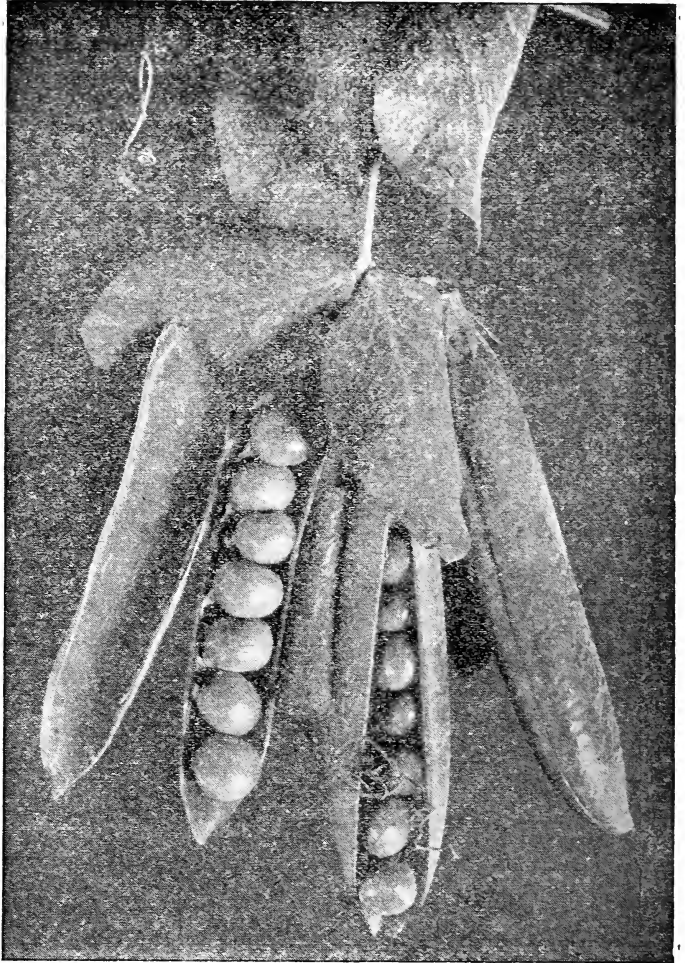

GRADUS PEAS

**\*Sutton's Excelsior.** As early as Nott's Excelsior, with much larger pods, a large cropper and of rich flavor; height 1½ feet. Pkt. 25c., pt. 45c., qt. 80c., pk. \$2.85.

**\*Sutton's World's Record.** Habit very prolific; pods long, dark green, filled with peas of superb flavor; height 3 feet. Pkt. 25c., pt. 45c., qt. 80c., ½ pk. \$2.85.

**\*Thomas Laxton.** Similar to Gradus. The pods are long, straight, with square ends, and contain 7 or 8 peas of the finest flavor; hardy and productive; height 3 feet. Pkt. 25c., pt. 45c., qt. 80c., ½ pk. \$2.85.

**\*Burpee's "Blue Bantam."** An extra early variety of the finest quality. The vines average fifteen inches in height. The pods average nearly as large as the Gradus. Pkt. 25c., pt. 45c., qt. 80c., ½ pk. \$2.85.

"STERLING QUALITY" SEEDS  
MEAN THE BEST

## PEAS—Continued

### Second Early and Medium Varieties

- \***McLean's Advancer.** Fine standard sort, pods medium size; peas tender and of excellent quality; height 2½ feet. Pkt. 20c., pt. 40c., qt. 75c., ½ pk. \$2.75.
- \***Dwarf Telephone (Carter's Daisy).** Similar to the Tall Telephone, bearing heavy pods, about 4½ inches long, height 2 feet. Pkt. 20c., pt. 40c., qt. 75c., ½ pk. \$2.75.
- \***Everbearing.** Very prolific, pods about 3 inches long, peas large and of good quality; height 2½ feet. Pkt. 20c., pt. 40c., qt. 75c., ½ pk. \$2.75.
- \***Yorkshire Hero.** A medium late variety of fine flavor height 2½ feet. Pkt. 20c., pt. 40c., qt. 75c., ½ pk. \$2.75.

### GENERAL CROP

- \***Carter's Quite Content.** The largest-podded variety yet introduced, vines and pods deep green, pods 7 to 7½ inches long, hanging mostly in pairs and contain 9 to 11 large peas of excellent flavor; recommended for the market or private garden; a large cropper; height of 3 to 4 feet. Pkt. 35c., pt. 65c., qt. \$1.20.
- \***Admiral Dewey.** One of the finest and most desirable of the large-podded varieties. The vines are of vigorous growth; the pods are always of good size well filled with peas of the highest quality; specially recommended for the home garden and market growing; height 4 feet. Pkt. 25c., pt. 45c., qt. 80c., ½ pk. \$2.85.
- \***Improved Telephone.** An improvement on Carter's Telephone for purity and uniformity of habits, bearing in great abundance large, dark-green pods containing peas of fine flavor; height 4 feet. Pkt. 25c., pt. 45c., qt. 80c., ½ pk. \$2.85.
- \***Prodigious.** A very superior, wrinkled pea of the style of the Telephone. The pods are dark green, averaging four and one-half to five inches in length; the vines are vigorous and prolific; the peas are of the finest quality; height 5 ft. Pkt. 25c., pt. 45c., qt. 80c., ½ pk. \$2.85.
- \***Champion of England.** A well-known and popular late variety, of excellent flavor and very productive; height 4 to 5 feet. Pkt. 20c., pt. 40c., qt. 75c., ½ pk. \$2.75.
- Black-Eyed Marrowfat.** Largely grown as a field crop; height 4 feet. Qt. 40c., pk. \$2.40.
- White Marrowfat.** Very hardy and prolific; height 4 feet. Qt. 40c., pk. \$2.40.
- White Canada Field.** Valuable for sowing with oats for cattle feeding and for green soiling. Pk. \$1.25.

### Sugar Peas or Edible Pods

- Dwarf Gray Sugar.** Dwarf in habit, with small-sized pods. Pkt. 20c., pt. 40c., qt. 75c.
- Tall Melting Sugar.** Very tender pods, vine 4 feet. Pkt. 20c., pt. 40c., qt. 75c.

## RADISH

The seeds should be sown in light, rich, sandy loam. For an early supply, sow in a hotbed in rows 4 inches apart. Sow in the open ground as soon as the ground can be worked in rows 8 to 12 inches apart ½ inch deep. If the radish makes rapid growth it will be crisp and tender. Sow every week or ten days for succession.

*One ounce for 100 feet of drill.*

**Crimson Giant.** An extra early, turnip-shaped variety, growing very large yet never pithy, always hard and solid; good for forcing and equally as good if grown in the open ground. Pkt. 5c., oz. 15c., ¼ lb. 45c., lb. \$1.50.

**Early Scarlet White-Tipped.** Small, round, red, short tops, crisp and tender. Pkt. 5c., oz. 15c., ¼ lb. 45c., lb. \$1.50.

**Non Plus Ultra.** The earliest forcing variety, round, red maturing in about twenty days. Pkt. 5c., oz. 15c., ¼ lb. 45c., lb. \$1.50.

**Scarlet Globe.** One of the best varieties for forcing or sowing in the open ground; globe shaped, scarlet color, crisp and tender. Pkt. 5c., oz. 15c., ¼ lb. 45c., lb. \$1.50.

**French Breakfast.** Oblong shaped, color scarlet, white-tipped, rapid grower, mild and tender. Pkt. 5c., oz. 15c., ¼ lb. 45c., lb. \$1.50.

**Long Scarlet Short Top.** Long and crisp, for frames or open ground. Pkt. 5c., oz. 15c., ¼ lb. 45c., lb. \$1.50.

**White Vienna.** Finest white radish. It is long, slender, pure white, roots of excellent quality. Fine for forcing. Pkt. 5c., oz. 15c., ¼ lb. 45c., lb. \$1.50.

**White Stuttgart.** A turnip shaped, white radish, growing to large size; fine quality. Pkt. 5c., oz. 15c., ¼ lb. 45c., lb. \$1.50.

**Long Black Spanish.** A good winter variety. Pkt. 5c., oz. 15c., ¼ lb. 45c., lb. \$1.50.

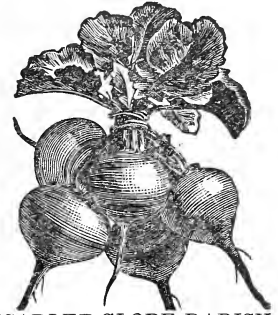

SCARLET GLOBE RADISH

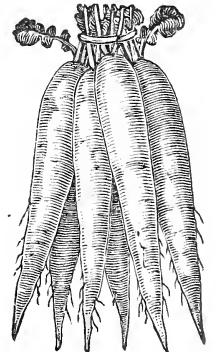

WHITE VIENNA RADISH

### Salsify or Vegetable Oyster

One of the most delicious and nutritious of vegetables.

Sow early in the spring in drills 14 inches apart and 1 inch deep. Cultivate the same as for carrots and parsnips. They can be left in the ground until spring.

*One ounce to 50 feet of drill.*

**Mammoth Sandwich Island.** This variety grows to a large size and is superior in quality to the Long White. Pkt. 10c., oz. 25c., ¼ lb. 85c.

## SQUASH

Squashes are quite tender and should not be planted until the ground has become thoroughly warm and all danger of frost is past. Plant in light, rich soil, well pulverized. Bush varieties should be planted about 4 feet apart and the running varieties about 8 feet.

*Bush varieties, one ounce to 40 hills; running varieties, one ounce to 15 hills, three to four pounds per acre.*

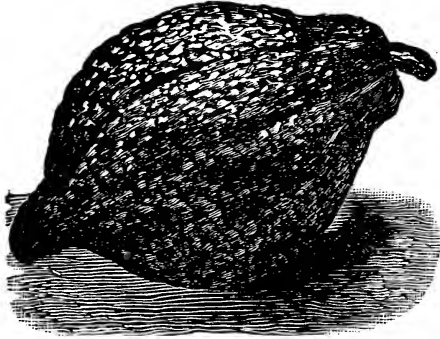

HUBBARD SQUASH

**Early Giant Summer Crookneck.** A desirable table sort, of dwarf, bushy habit, and very productive; the flesh is thick, yellow and of fine quality. One of the best market varieties. Pkt. 5c., oz. 15c.,  $\frac{1}{4}$  lb. 40c., lb. \$1.25.

**Mammoth White Bush Scallop.** Pure white, producing large, thick fruit of fine flavor, early and productive. Pkt. 5c., oz. 15c.,  $\frac{1}{4}$  lb. 40c., lb. \$1.25.

**Delicious.** Fine grained, sweet and dry, no other squash can equal it in sweetness and richness of flavor. In shape and color it is similar to the Hubbard. Weighs from five to ten pounds. Pkt. 5c., oz. 15c.,  $\frac{1}{4}$  lb. 50c., lb. \$1.75.

**Early Prolific Marrow.** The earliest of the running varieties, maturing ten days earlier than the Boston Marrow; color a bright orange red; keeps well. Pkt. 5c., oz. 15c.,  $\frac{1}{4}$  lb. 40c., lb. \$1.50.

**Boston Marrow.** A standard fall variety of a bright yellow color, an excellent sort for pies and largely used by canners. Pkt. 5c., oz. 15c.,  $\frac{1}{4}$  lb. 40c., lb. \$1.25.

**Warren.** Has a shell harder than the Essex Hybrid and the color is of a deeper orange; the quality is superior. Pkt. 5c., oz. 15c.,  $\frac{1}{4}$  lb. 40c., lb. \$1.50.

**Hubbard (Cape Elizabeth grown).** The standard winter squash, more largely grown than any other late variety, dark green skin and rich flesh, an excellent keeper. Pkt. 5c., oz. 15c.,  $\frac{1}{4}$  lb. 50c., lb. \$1.75.

**Golden Hubbard.** Same type as the Green Hubbard but of rich orange red color and earlier to mature. Pkt. 5c., oz. 15c.,  $\frac{1}{4}$  lb. 50c., lb. \$1.75.

**Blue Hubbard.** Flesh fine-grained, dry and of excellent flavor, a good keeper. Pkt. 10c., oz. 30c.,  $\frac{1}{4}$  lb. 90c., lb. \$3.00.

**Mammoth Chili.** Grows to an enormous size; color orange yellow. Pkt. 5c., oz. 15c.,  $\frac{1}{4}$  lb. 40c., lb. \$1.50.

**Vegetable Marrow.** The fruit should be eaten when less than half grown; color creamy white, flesh white. Pkt. 5c., oz. 15c.,  $\frac{1}{4}$  lb. 40c.

## SPINACH

Sow early in the spring in drills one foot apart, covering the seed one inch deep, thinning out as it grows. For a succession sow every two weeks. For winter and early spring use, sow in August; cover with straw on the approach of severe cold weather.

*One ounce to 50 feet of drill; ten to twelve pounds to the acre.*



VICTORIA SPINACH

**Round Thick-Leaved.** A large, dark-green, thick-leaved variety; stands a long time before running to seed. Pkt. 5c., oz. 10c.,  $\frac{1}{4}$  lb. 25c., lb. 75c.

**Victoria.** A variety of dense foliage, leaves thick and of a dark-green color. Pkt. 5c., oz. 10c.,  $\frac{1}{4}$  lb. 25c., lb. 75c.

**Long Season.** A dark-green crumpled variety which withstands the hot weather without shooting to seed for a long time; very desirable for spring planting and of excellent quality. Pkt. 5c., oz. 10c.,  $\frac{1}{4}$  lb. 25c., lb. 75c.

**Bloomsdale.** A very hardy variety; large thick, crumpled leaves, a favorite with Market Gardeners. The best for early spring or fall. Pkt. 5c., oz. 10c.,  $\frac{1}{4}$  lb. 25c., lb. 75c.

**Prickly or Winter.** The hardiest variety for fall planting. Pkt. 5c., oz. 10c.,  $\frac{1}{4}$  lb. 25c., lb. 75c.

**New Zealand.** A plant of branching habits which stands drought. Soak the seeds in warm water before planting. Plants should not be closer than 2 feet apart each way. Pkt. 5c., oz. 15c.,  $\frac{1}{4}$  lb. 50c., lb. \$1.75.

“Sterling Quality” Seeds are the highest grade obtainable and intended for the particular market gardener, florist and individual.

SEND US YOUR MAIL ORDERS



# TOMATO

Sow the seeds about the first week in March in a hotbed, greenhouse or in shallow boxes in a window. When the plants are about three inches high transplant to cold frames, setting the plants about 4 inches apart or in pots singly. Transplant to the open ground when all danger of frost is past. Set in rows 4 feet apart each way, using a shovelful of rotten manure in each hill.

*One ounce will produce about 1,500 plants.*

**Our Tomato Seeds are grown from selected Stocks.**

**“John Baer.”** An extra early variety of superior merit. It produces perfect, solid high crown, beautiful, brilliant red tomatoes, is almost seedless, and has a mild, deliciously sweet flavor. Uniform in size and ripening. An invaluable variety for the market or home garden. Pkt. 5c.,  $\frac{1}{4}$  oz. 20c., oz. 50c.,  $\frac{1}{4}$  lb. \$1.50.

**Earliana.** The best extra early variety. It is the earliest large tomato; color bright red, growing in clusters of medium size, smooth, solid, and of fine flavor; excellent for the market and home garden. Pkt. 5c.,  $\frac{1}{2}$  oz. 20c., oz. 35c.,  $\frac{1}{4}$  lb. \$1.00.

**Chalk’s Jewel.** Color bright red; flesh thick and solid, good quality. Pkt. 5c.,  $\frac{1}{2}$  oz. 20c., oz. 35c.,  $\frac{1}{4}$  lb. \$1.00.

**Bonney Best.** Early and prolific; fruit is smooth, round scarlet, of fine flavor. Pkt. 5c.,  $\frac{1}{2}$  oz. 20c., oz. 35c.,  $\frac{1}{4}$  lb. \$1.00.

**Early Detroit.** Fruit very smooth, uniform in size, nearly globe shaped, firm and of excellent quality; color purplish pink; vine vigorous and productive. Pkt. 5c.,  $\frac{1}{2}$  oz. 20c., oz. 35c.,  $\frac{1}{4}$  lb. \$1.00.

**Stone.** The most reliable of the main crop, very large, bright scarlet, smooth, solid and very productive; is a good shipper. Pkt. 5c.,  $\frac{1}{2}$  oz. 20c., oz. 35c.,  $\frac{1}{4}$  lb. \$1.00.

**Dwarf Champion.** Plant dwarf and compact, medium size, good quality, color purplish pink. Pkt. 5c.,  $\frac{1}{2}$  oz. 20c., oz. 35c.,  $\frac{1}{4}$  lb. \$1.00.

**Dwarf Stone.** Dwarf and compact growing, plant resembling Dwarf Champion but is of a stronger growth, yielding a large crop of very smooth, solid tomatoes of the finest quality, color bright scarlet. Pkt. 5c.,  $\frac{1}{2}$  oz. 20c., oz. 35c.,  $\frac{1}{4}$  lb. \$1.00.

**Beauty (Livingston’s.)** One of the best main crop tomatoes, vine large and vigorous, fruit purplish pink, smooth, large, solid and of excellent flavor. Grows in clusters of 4 to 6 and seldom cracks. Pkt. 5c.,  $\frac{1}{2}$  oz. 20c., oz. 35c.,  $\frac{1}{4}$  lb. \$1.00.

**Ponderosa.** One of the largest varieties, flesh solid and of fine quality. Pkt. 5c.,  $\frac{1}{2}$  oz. 20c., oz. 35c.,  $\frac{1}{4}$  lb. \$1.00.

**Red Cherry.** Scarlet fruit about the size of a cherry, used for pickling. Pkt. 5c.,  $\frac{1}{2}$  oz. 20c., oz. 35c.

**Yellow Cherry.** Bright yellow, best for preserving. Pkt. 5c.,  $\frac{1}{2}$  oz. 20c., oz. 35c.



“JOHN BAER” TOMATO

# TURNIP

Turnips do best in rich, light, sandy soil. For early use, sow in the spring as soon as the ground can be worked in drills 1 foot apart. Cover  $\frac{1}{2}$  inch deep. Thin plants to 6 inches apart. For a succession, sow every two weeks until August. Rutabagas are usually sown broadcast, but larger crops are obtained if the seed is sown in drills 18 inches apart and thinned out to 8 or 10 inches in the rows. Sow from June to the middle of July.

*One ounce will sow 150 feet of drill; one to two pounds to an acre.*

**Early Purple Top Milan.** One of the earliest flat turnips; flesh solid and of good quality. Pkt. 10c., oz. 25c.,  $\frac{1}{4}$  lb. 75c., lb. \$2.50.

**Early White Milan.** Extra early; roots of medium size, pure white, sweet and tender. It is a rapid grower and desirable for early use. Pkt. 10c., oz. 25c.,  $\frac{1}{4}$  lb. 75c., lb. \$2.50.

**Purple Top Strap Leaf.** A well-known and popular variety for the main crop, largely grown for both table and stock. Pkt. 5c., oz. 15c.,  $\frac{1}{4}$  lb. 40c., lb. \$1.25.

**Purple Top White Globe.** An early variety, of superior quality, globe-shaped, white flesh, tender and sweet, one of the best for table use. Pkt. 5c., oz. 15c.,  $\frac{1}{4}$  lb. 40c., lb. \$1.25.

**White Egg.** A pure white, egg-shaped variety of rapid growth; flesh firm, sweet and mild. Pkt. 5c., oz. 15c.,  $\frac{1}{4}$  lb. 40c., lb. \$1.25.

**Golden Stone.** Flesh yellow, firm and fine grained, of fine quality, an excellent keeper. Pkt. 5c., oz. 15c.,  $\frac{1}{4}$  lb. 40c., lb. \$1.25.

**Golden Ball.** Very early, fine quality and of excellent flavor. Pkt. 5c., oz. 15c.,  $\frac{1}{4}$  lb. 50c., lb. \$1.50.

**Cow Horn or Long White.** A very productive, quick-growing turnip, carrot-like in form, growing nearly half out of the ground. Pkt. 5c., oz. 15c.,  $\frac{1}{4}$  lb. 40c., lb. \$1.25.



WHITE MILAN  
TURNIP

# TURNIP—Continued

## Rutabaga or Swede Turnip

### American Purple Top.

Very hardy, productive, and a good keeper; flesh yellow and solid, a fine variety for table use. Pkt. 5c., oz. 15c., ¼ lb. 45c., lb. \$1.50.

### Carter's Imperial

**Purple Top.** Very large and productive; smooth, round heads, yellow flesh, and of good quality. Pkt. 5c., oz. 15c., ¼ lb. 45c., lb. \$1.50.

### Lang's Mammoth.

This variety is an enormous cropper and one of the most hardy, globe-shaped, with short neck, dwarf foliage, and a clean single tap root. Pkt. 5c., oz. 15c., ¼ lb. 50c., lb. \$1.50.

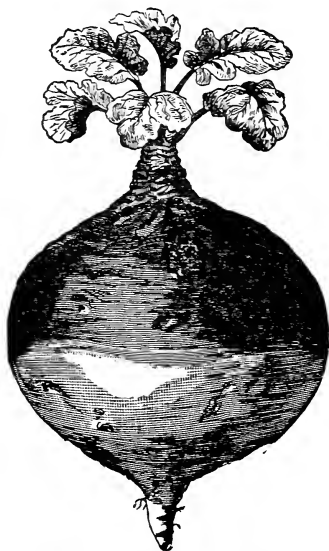

AMERICAN PURPLE TOP  
RUTABAGA

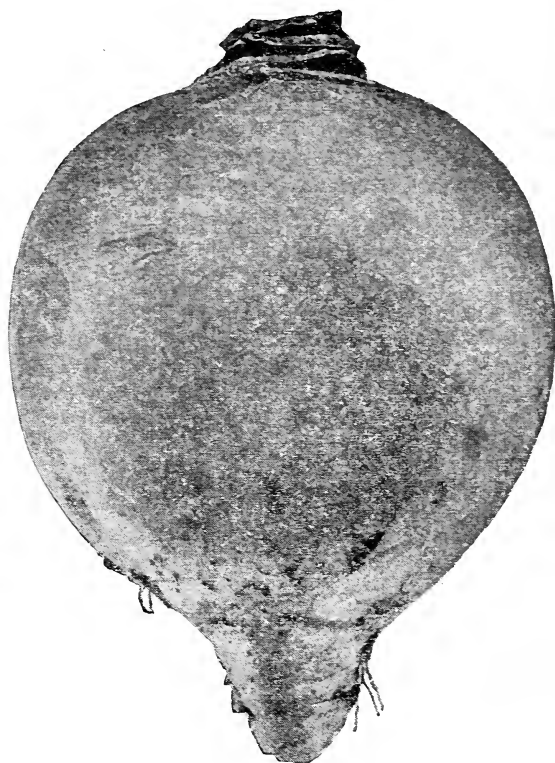

PERFECT MODEL RUTABAGA

**Perfect Model.** An improved strain of the finest yellow-fleshed rutabaga, remarkable for uniform shape and fine quality, very sweet and tender and a good keeper. Pkt. 10c., oz. 20c., ¼ lb. 50c., lb. \$1.50.

**Sweet German.** Flesh white, hard and sweet, keeps well. Pkt. 5c., oz. 15c., ¼ lb. 35c., lb. \$1.25.

## Sweet and Medicinal Herbs

Sow in the spring in shallow drills, 1 foot apart; when up a few inches thin out to proper distances, or transplant; cut the herbs when in flower, tie them up in small bunches and hang in the shade to dry.

Anise <i>Annual</i>	Per oz. 25c., pkt. 10c.	Lavender <i>Perennial</i>	Per oz. 40c., pkt. 10c.
Balm <i>Perennial</i>	Per oz. 30c., pkt. 10c.	Marjoram, Sweet <i>Annual</i>	Per oz. 30c., pkt. 10c.
Basil, Sweet <i>Annual</i>	Per oz. 25c., pkt. 10c.	Mint <i>Perennial</i>	pkt. 25c.
Caraway <i>Biennial</i>	Per oz. 25c., pkt. 10c.	Saffron <i>Annual</i>	Per oz. 20c., pkt. 10c.
Catnip <i>Perennial</i>	Per oz. 60c., pkt. 10c.	Sage <i>Annual</i>	Per oz. 50c., pkt. 10c.
Dill <i>Biennial</i>	Per oz. 20c., pkt. 10c.	Summer Savory <i>Annual</i>	Per oz. 30c., pkt. 10c.
Fennel, Sweet <i>Perennial</i>	Per oz. 20c., pkt. 10c.	Thyme <i>Perennial</i>	Per oz. 50c., pkt. 10c.

We hope our customers will mail orders early this season as it gives us an opportunity to extend to them that little extra attention which means so much to a customer. Why not send the order NOW upon receipt of the catalogue?

# FIELD CORN

## Prices Subject to Market Changes

Prices do not include delivery. Add cost of bags when ordering, as follows:  $\frac{1}{2}$  bush., 10 cents; 2 bush., 60 cents.

If ordered by mail add postage at parcel post rates.

*Corn weight by Parcel Post; Qt. 2 lbs.; 4 Qts. 8 lbs.; Pk. 15 lbs.*

*Plant eight to ten quarts per acre in hills, one to one and one-half bushels broadcast, one bushel in drills.*

**Early Wonder Dent.** A variety of great value. Heretofore, earliness in seed corn has meant that the growth would be small; and a corn that produced heavily usually could not be depended upon to reach maturity in an ordinary season in this section.

All practical and experienced dairymen agree that ensilage containing the largest amount of grain is by far the most valuable for producing a good quality as well as a large quantity of milk, to say nothing of the much lessened amount of grain necessary in the regular ration.

Not only will this corn produce more grain, but also a much larger tonnage to the acre than any known ensilage corn. Another feature is that the foliage starts to grow well down on the stock. Pk. \$1.50, bu. \$5.00.

**Mortgage Lifter.** A heavy yielding, Yellow Dent Corn. Stocks are quite tall and furnish a large amount of fodder which contains a good percentage of grain. The ears are 8 to 10 inches in length, and from 12 to 16 rows. Qt. 25c., pk. \$1.25, bu. \$4.00.

**Genuine Eureka Ensilage.** The corn that grows more ensilage to the acre than any other variety. It grows very tall, attaining a height of 12 to 15 feet and makes a heavy, thick growth of fodder. Try this variety if you want the maximum tonnage. Pk. \$1.25, bu. \$4.00.

**Stickney. (Yellow Flint).** The ears are from 10 to 12 inches long,  $1\frac{1}{2}$  to  $1\frac{3}{4}$  inches in diameter. The cob is small, kernels large and broad. The stalks grow about 9 feet high. Pk. \$1.25, bu. \$4.00.

**Leaming.** Large deep grains, very early; stocks are leafy and makes excellent fodder. Qt. 20c., pk. \$1.25, bu. \$4.00.

**Early Eight-Rowed Yellow Flint.** The earliest yellow variety. Matures in about 90 days. Seed grown in Maine. Qt. 25c.,  $\frac{1}{2}$  pk. 75c., pk. \$1.25, bu. \$3.75.

**Sanford.** An early white flint, eight-rowed variety, largely grown for ensilage. Qt. 20c., pk. \$1.25, bu. \$4.00.

**Sweet Fodder.** For ensilage; and a green summer food for stock. Qt. 20c., pk. \$1.25, bu. \$4.00.

**White Rice Pop Corn.** The most popular for general use.  $\frac{1}{2}$  pt. 15c., pt. 25c., qt. 40c.

### STANLEY'S CROW REPELLENT.

**Saves replanting.** It rids your corn crop of crows and other corn pulling birds and animal pests. Small Can, enough for one bushel, \$1.00.

# GRAINS AND FARM SEEDS

PRICES SUBJECT TO CHANGE WITHOUT NOTICE

Prices do not include delivery. Add cost of bags when ordering, as follows: ½ bush., 10 cents; 2 bush., 60 cents.

**Spring Wheat Marquis (Beardless.)** An early and productive variety. The kernel is flinty, darker red and more plump than Red Fife and matures a week to ten days earlier; weight 64 to 66 lbs. per measured bushel. Write for price.

**Barley, Chevalier.** A two-rowed variety, very hardy and productive. The grain is large and plump. Per bushel \$2.50.

**Barley, Beardless.** Early, hardy and productive. Per bushel \$2.50.

**Hungarian.** A popular annual used for hay and forage, yielding two to three tons per acre. Sow 1 bushel to the acre. Weight 48 pounds per bushel. Write for price.

**Golden Millet.** Grown for hay or green fodder. Sow 1 bushel to the acre. Weight 50 pounds per bushel. Write for price.

**Japanese or Barnyard Millet.** A forage plant of excellent quality, growing 6 to 8 feet in height, and yielding 10 to 15 tons per acre. Sow 20 lbs. per acre broadcast, 15 lbs. in drills 18 inches apart. Write for price.

**Soja Beans.** Valuable as a forage crop or green manure; also as a green fodder and silo plant.

**Early Dwarf Green.** An early maturing variety. Write for price.

**Early Hollybrook.** Makes a large growth of forage. Write for price.

**Southern Cow Peas.** One of the largest yielding forage crops grown.

**Whippoorwill.** An early, upright-growing variety; makes a good growth of vine, which can be easily cut and cured as dry forage. Write for price.

**Spring Vetches or Tares.** Valuable for soiling, also grown with oats for feeding to stock. Lb. 12c., per 100 lbs. \$10.00.

**Winter Vetches or Tares.** Very hardy, recommended for fall sowing with rye. Lb. 22c., per 100 lbs. \$20.00.

**Dwarf Essex Rape.** A forage plant of great value, furnishing rich pasturage for sheep, hogs or cattle within six weeks from the time of sowing. It also makes splendid green feed for poultry. Sow 5 lbs. per acre broadcast, 2 to 3 lbs. per acre in drills. Per lb. 20c., by mail 25c.; per 100 lbs. \$18.00.



A FIELD OF WASHINGTON OATS

**Washington Oats.** A fine, heavy oat, originating in New York. One of the best and most reliable of spring oats. It is an open-headed or tree type of oats, thin hulls making them especially valuable as a feeding oat. They are less liable to rust than most any other sort. Weight, 36 to 40 lbs. measured bushel. By express or freight, at purchaser's expense. Per bush. \$2.25.

**Maine 340 Oats.** This variety makes a strong growth of straw. The heads are large and bushy, yielding large crops of oats of fine quality. Write for Price.

**Spring Rye.** An excellent crop for fodder or grain. Write for price.

**Winter Eye (Rosen.)** Rosen Rye produces a strong vigorous straw and stools to a remarkable degree. The grain is large, plump, heavy and beautiful color. Owing to its vigorous stooling property, less seed is required per acre. Write for price.

**Buckwheat (Japanese.)** The best and most profitable variety. It is earlier and more productive than the Silver Hull. Per bushel \$3.25.

**Buckwheat (Silver Hull.)** A very good variety. Grain is light gray in color. Per bushel \$3.25.

**Canada Field Peas.** A valuable crop for soiling and for cattle feed. Sow 1½ bushels per acre—if sown with oats, use one and one-half bushels each of the oats and peas. Pk. \$1.25, bu. \$4.50.

# GRASS AND CLOVER SEEDS

Prices Subject to Market Changes

SPECIAL QUOTATIONS WITH SAMPLES ON APPLICATION

Prices do not include delivery. Add cost of bags when ordering, as follows:  $\frac{1}{2}$  bush., 10 cents; 2 bush., 60 cents.

**Timothy.** "Sterling Quality." One of the most important of hay grasses, producing a larger crop than any other grass when sown on rich loamy or clayey soils. We sell only the purest and best obtainable.

**Kentucky Blue Grass.** An excellent grass for pastures and lawns.

**Orchard Grass.** Yields large crops of excellent hay, also valuable for pastures, and also succeeds in shady situations better than most other grasses.

**Red Top.** "Sterling Quality." A permanent grass, valuable for hay or pasture.

**Rhode Island Bent Grass.** A valuable perennial for lawns.

**Sweet Vernal (Annual.)** Lasts only one season. Imparts a fragrant odor to grass while being cut.

**Sweet Vernal (Perennial.)** Same as the annual variety, with the exception that it is of a perennial nature.

**Alsike Clover.** "Sterling Quality." A hardy variety and one of the best for sowing with other clovers or grasses. The blossoms are fragrant and are much liked by bees.

**Alfalfa or Lucerne Clover.** Valuable as hay and forage crop.

**Crimson Clover.** An annual variety growing about one foot high.

**Red Clover.** "Sterling Quality." Excellent for pastures and hay. Adds humus to the soil wherever it is sown.

**Sweet Clover, Bokhara (Melilotus Alba.)** Used as a soil-improving crop.

**White Clover.** Largely used in lawn and pasture mixtures.

## LAWN GRASS SEEDS

Lawns made from seed are generally superior to those made by laying turf, and there is a large saving in the expense. The soil should be carefully prepared, made firm and smooth, well drained, and enriched with commercial fertilizer or well-rotted manure.

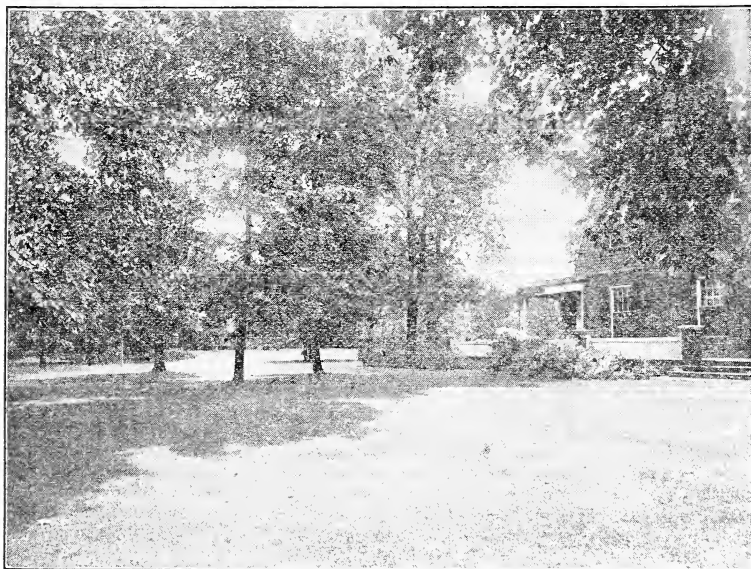

### A., S. & L. EXTRA FINE MIXED.

A combination of the finest and purest grasses best adapted for a permanent lawn. For beautiful, velvety lawns, the "A., S. & L." Lawn Grasses is the best that can be used. We have received many complimentary reports from customers who have used this Lawn Seed. Lb. 35c., by mail 40c.

**Pinetree.** This mixture is composed of grasses adapted to general lawn purposes. Lb. 25c., by mail 30c.

**A., S. & L. Golf Links Mixture.** Made from a formula that will produce a turf which will withstand rough usage. Lb. 45c., by mail 50c.

**A., S. & L. Putting Green Mixture.** The varieties in this mixture are the finest low growing and most hardy kinds. Lb. 45c., by mail 50c.

**SHADY SPOT MIXTURE.** A mixture of fine grasses that will make satisfactory growth under trees and in shady places. Lb. 40c., by mail 45c.

## A., S. & L. PERMANENT PASTURE MIXTURE

This is a mixture composed of the best varieties of the different perennial Grasses and Clover, blended in the right proportions for giving a fine, heavy growth of pasture throughout the seasons and which will last in the ground for many years. Sow at the rate of 35 lbs. to the acre. Per lb. 40c. By mail prepaid 45c. per lb., 10 lbs by Express not prepaid \$3.65.



Uninoculated      ALFALFA      Inoculated

# Mulford Cultures

FOR LEGUMES

Mulford Cultures contain pure, tested strains of active, vigorous nitrogen-fixing bacteria for inoculating seeds of legumes or soil.

The United States Department of Agriculture and many State Agricultural Experiment Stations recommend inoculation of legumes with nitrogen-fixing bacteria to induce a prompt "catch" and increase your yield.

Mulford Cultures are prepared for  
**ALFALFA**                      **ALSIKE CLOVER**      **SWEET PEAS**  
**CRIMSON CLOVER**      **COW PEAS**                      **GARDEN PEAS**  
**SWEET CLOVER**      **SOY BEANS**                      **GARDEN BEANS**  
**RED CLOVER**                      **VETCH**

Be sure to specify the particular legume on which you desire to use the Mulford Cultures. Prices: 5-acre size \$5.00, 1-acre size \$1.50, garden size (1/4 acre) 75c., trial size 35c. Prices include postage.

## PLANTING TABLE

Quantity of Seeds or Number of Plants Required for a Row 100 Feet in Length, with Distance to Plant and Time for Planting

Kind of Vegetable	Seeds or Plants Required for 100 Feet of Row	Distance for Plants to Stand Hand Cultivation		Depth of Planting	Time of Planting in Open Ground	Ready for Use After Planting
		Rows Apart	Plants Apart in Rows			
Asparagus, seed	1 ounce	1 to 2 ft.	3 to 5 in.	1 to 2 in.	Early spring	8 to 4 years
Asparagus, plants	60-80 plants	12 to 24 in.	15 to 20 in.	3 to 5 in.	Early spring	to 3 years
Beans, bush	1 quart	18 to 24 in.	3 to 4 in.	1 to 2 in.	April to July	40 to 65 days
Beans, pole	1 pint	3 to 4 ft.	3 to 4 ft.	1 to 2 in.	May and June	50 to 80 days
Beets	2 ounces	12 to 18 in.	5 or 6 to ft.	1 to 2 in.	April, May and June	90 to 120 days
Cabbage, early	1/2 ounce	24 to 30 in.	12 to 18 in.	1/2 in.	April and May. (Start in hot-bed during March)	90 to 130 days
Cabbage, late	1/2 ounce	24 to 36 in.	16 to 24 in.	1/2 in.	May and June	90 to 130 days
Carrot	1 ounce	18 to 24 in.	6 or 7 to ft.	1/2 in.	April to June	75 to 110 days
Cauliflower	1/2 ounce	24 to 30 in.	14 to 18 in.	1/2 in.	April to June. (Start in hot-bed during March)	100 to 130 days
Celery	1/4 ounce	18 to 36 in.	4 to 8 in.	3/8 in.	May and June. (Start in hot-bed or cold frame during March or April)	120 to 150 days
Corn, sweet	1 pint	30 to 36 in.	30 to 36 in.	1 to 2 in.	May and June	90 to 120 days
Cress	1/2 ounce	12 to 18 in.	4 or 5 to ft.	1/2 to 1 in.	March to May. April to June	80 to 40 days
Cucumber	1/2 ounce	12 to 18 in.	4 to 6 ft.	1 to 2 in.	May to July	80 to 100 days
Endive	1 ounce	18 in.	8 to 12 in.	1/2 in.	May	90 to 110 days
Kohl-rabi	1/2 ounce	18 to 24 in.	4 to 8 in.	1/2 in.	April to June	60 to 90 days
Lettuce	1/2 ounce	12 to 18 in.	4 to 6 in.	1/2 in.	April to August	60 to 90 days
Melon, muskmelon	1 ounce	6 to 8 ft.	Hills 6 ft.	1 to 2 in.	May and June	120 to 150 days
Melon, watermelon	1 ounce	8 to 12 ft.	Hills 10 ft.	1 to 2 in.	May and June	100 to 120 days
Mustard	1/2 ounce	12 to 18 in.	4 or 5 to ft.	1/4 in.	April and May	60 to 90 days
Onion, seed	1 ounce	12 to 18 in.	4 or 5 to ft.	1/2 to 1 in.	April and May	130 to 150 days
Onion, sets	1 quart of sets	12 to 18 in.	4 or 5 to ft.	1 to 2 in.	March to May	90 to 120 days
Parsley	1 ounce	12 to 18 in.	3 to 6 to in.	1/4 in.	Early spring	90 to 120 days
Parsnip	1 ounce	18 to 24 in.	5 or 6 to ft.	1/2 to 1 in.	April and May	125 to 160 days
Peas	1 to 2 pints	30 to 36 in.	15 to ft.	2 to 3 in.	March to July	60 to 90 days
Pepper	1/2 ounce	18 to 24 in.	15 to 18 in.	1 to 2 in.	May and June	100 to 120 days
Potato, Irish	5 lbs. (or 9 bu. per acre)	24 to 36 in.	14 to 18 in.	4 in.	April to June	80 to 140 days
Pumpkin	1 ounce	8 to 12 ft.	Hills 8 to 12 ft	1 to 2 in.	May to July	100 to 140 days
Radish	1 ounce	12 to 18 in.	8 or 12 to ft.	1/2 to 1 in.	March to September	20 to 40 days
Rhubarb, plants	33 plants	3 to 5 ft.	3 ft.	2 to 3 in.	Early spring	1 to 3 years
Rutabaga	1 ounce	18 to 24 in.	6 to 8 in.	1/2 in.	May and June	60 to 80 days
Spinach	2 ounces	12 to 18 in.	7 or 8 to ft.	1 to 2 in.	September or early spring	40 to 60 days
Squash, bush	1 ounce	3 to 4 ft.	Hills 3 to 4 ft.	1 to 2 in.	May and June	70 to 90 days
Squash, late	1 ounce	7 to 10 ft.	Hills 7 to 9 ft.	1 to 2 in.	May and June	120 to 160 days
Tomato	1/4 ounce	3 to 4 ft.	3 to 4 ft.	1/2 in.	May and June. (Start early plants in hotbed during February and March)	100 to 140 days
Turnip	1 ounce	18 to 24 in.	6 or 7 to ft.	1/4 to 1/2 in.	May to July	60 to 80 days

# CHOICE FLOWER SEEDS—Annuals

## General Directions For Cultivation

A rich, sandy loam is the best for most flowering plants. The soil of a good garden should be deep, well pulverized, and if fertilizers are used they should be thoroughly mixed with the soil.

It is best in practically all instances except hardy annuals to start the seed in boxes, preferably a box about 18x24 inches and 4 inches deep, using very sandy soil with leaf-mold that will not bake, and provide for drainage by boring some holes in the bottom of the box. It is best not to put any fertilizer in the seed box, since it is necessary to bring the plants to the third or fourth leaf, when they should be pricked out and reset in another box, in which the soil should be loam mixed with leaf-mold. It is important that the plant be of good size, strong and sturdy, when finally transplanted in the garden.

If the seed be sown directly in the garden, it should be sown in the spring after the soil is well worked and fertilized. When up, the plants must be thinned from two to twelve inches, depending on the variety, otherwise they will be weak and spindling. It is a mistake to leave plants too thick. A common mistake in sowing flower as well as other seeds is covering too deep. As a general rule, cover only to the depth of the thickness of the seeds, or with medium-sized seeds, like Balsams, Zinnias, etc., half an inch or less is the proper depth. Such fine seeds as Portulaca, Nicotiana, etc., need only to be pressed into the soil with a piece of board or palm of the hand. Always press the earth down firmly after sowing all flower seeds, else there is danger of their drying up before the roots can get firm hold of the soil. Seeds of the hardier annuals may be sown where they are to grow; but as a rule, it is preferable to transplant, as the plants are generally stronger and stand the drought better. During very dry weather, and when the seedlings are first set out, they should be watered frequently. Provide some support for all such annuals as require it.

The weeds should be kept down and the ground loosened often, so that the plants will receive the full benefit of the rains and dews, which they will not if the ground is allowed to become hard and baked.

Per Pkt.

**ACROCLINIUM.** A half-hardy annual, bearing white and rose-colored flowers which are used when dried for winter bouquets. 1½ feet. Rose and white, mixed.....\$0.05

**AGERATUM.** A beautiful, hardy annual. The flowers, which are produced in clusters, are very attractive in the garden and are very useful for bouquets.  
**Little Blue Star.** Bright blue flowers, 6 inches ..... .10  
**Blue Perfection.** Dark Blue. 1½ feet..... .10

**ALYSSUM.** A fragrant, hardy annual, bearing spikes of small, white flowers in great profusion throughout the summer and autumn. Useful for borders and for cutting.  
**Sweet Alyssum.** Flowers small and sweet, oz. 35c..... .05  
**Little Dorrit.** Pure white, very dwarf and sweet scented, oz. \$1.00..... .10

**AMARANTHUS.** Hardy annuals, grown especially for their brilliant foliage.  
**Tricolor (Joseph's Coat.)** The plant is 3 feet high, with brilliant leaves in variegated red, yellow, green, etc. .... .05

**AMMOBIUM (Alatum Grandiflorum.)** A hardy annual, with white everlasting flowers; useful as bouquets and as dried flowers..... .05

**ASPARAGUS (Ornamental).**  
**Plumosus Nanus.** An excellent house plant for decorative purposes, on account of its light feathery growth..... .15  
**Sprengeri.** A graceful house plant; valuable for hanging baskets..... .15

**ANTIRRHINIUM (Snapdragon.)** A half-hardy perennial, easily raised from seed. Bloom profusely the first season from midsummer till fall.

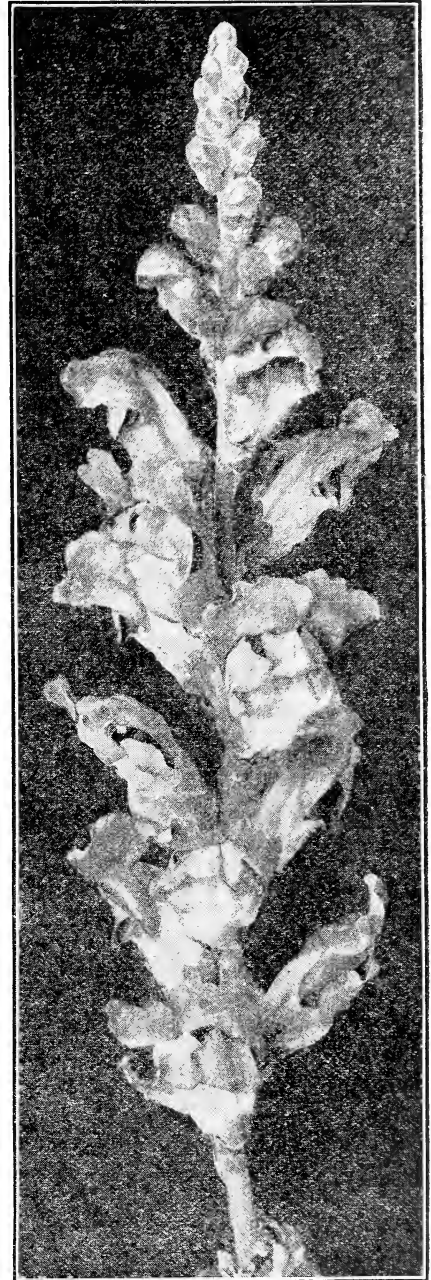

ANTIRRHINIUM OR SNAPDRAGON  
 KATHARINE MORSE

### TALL, LARGE FLOWERING VARIETIES

Per Pkt.

**Carter's Victoria.** White and red..... .10  
**Cottage Maid.** Pink, with white throat..... .10  
**Defiance.** Brilliant scarlet..... .10  
**Delila.** Carmine and yellow, white throat... .10  
**Queen Victoria.** Large pure white..... .10  
**Large Yellow.**..... .10  
**Large Flowering.** Mixed colors... ¼ oz. 35c. .05  
**Katherine Morse.** A new color and form of flower in Antirrhinum. The color is soft tones of old rose and yellow. The tube is soft old rose and face of flower yellow suffused with old rose. The top of the flower is beautifully waved. Plant bears a profusion of large spikes ..... .20

SEND US YOUR MAIL ORDERS

## ASTERS

A popular half-hardy annual produced in a great variety of classes and an almost endless number of colors. The tallest varieties grow about two feet high and some varieties of dwarfs are not six inches high. The best method of culture is to sow the seed in boxes in March or April. Cover the seeds about one-fourth inch deep with rich, light soil, and when the plants have three or four leaves transplant about 15 inches apart each way. The seed can be sown in rows where the plants are to remain, thinning them from six to twelve inches apart, according to variety. One of the best annuals for cut flowers.

### EARLY AND MEDIUM EARLY ASTERS

**Imperial Daybreak.** Flowers very large and double; color a shell pink; height 2½ feet. Per pkt. 10c.

**Imperial Purity.** Similar to Daybreak in form and habit of growth; the blooms are pure white. Per pkt. 10c.

**Imperial Lavender.** The form of the flower and the habit of the plant are identical with Daybreak, but the color is a delicate lavender. Per pkt. 10c.

**Imperial Yellow.** A pale lemon yellow flushed with pink. Per pkt. 10c.

**The Royal.** An early flowering aster; the plants are of branching habit; the flowers are very double and are borne in great profusion on long stems; height 2 feet. White, lavender, shell-pink and mixed colors. Each of the above colors and mixed. Per pkt 10c., ¼ oz. 80c., ½ oz. 45c.

**Queen of the Market.** One of the earliest blooming varieties. The plants are about 1 foot high, bearing from ten to fifteen finely formed flowers on long and graceful stems. White, light pink, lavender and mixed colors. Separate colors, or mixed. Per pkt. 10c., ¼ oz. 60c., ½ oz. 35c.

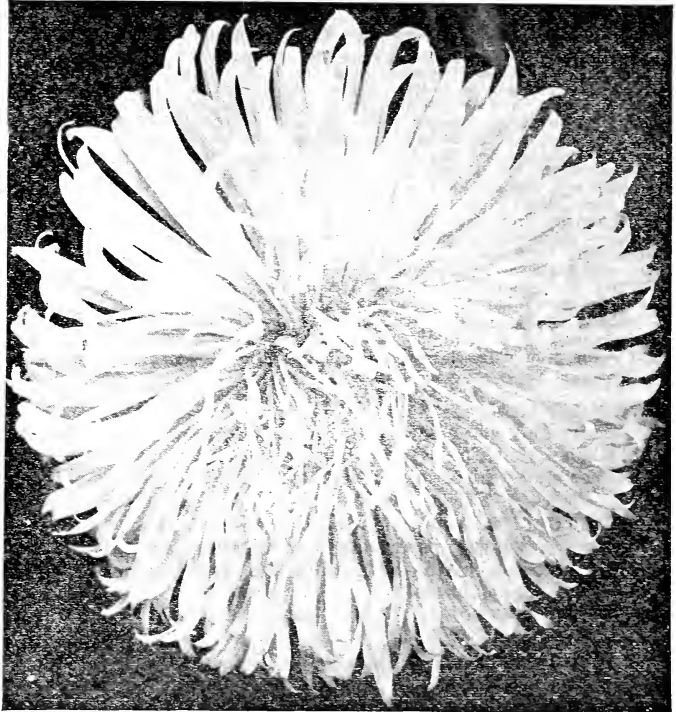

ROCHESTER ASTER

### THE LEADING MID-SEASON ASTERS

**Improved Rochester.** A splendid type of aster. The flowers are of immense size, often 5 inches across, with petals that are very long and narrow, and gracefully recurved. White, lavender-pink, lavender and mixed colors. Pkt. 15c., 2 pkts. 25c., ¼ oz. 75c., ½ oz. 50c.

**Astermum.** A select strain of this new aster. The flowers are of immense size, with curled and twisted petals, closely resembling the blooms of Japanese Chrysanthemums. White, pink, purple and mixed colors. Per pkt. 10c., ¼ oz. 75c., ½ oz. 50c.

**Triumph Comet.** A magnificent new class of mid-season asters with extra long stems and large, full double flowers of the finest type. White and shell-pink. Per pkt. 10., ¼ oz. 75c., ½ oz. 50c.

**Giant Crimson.** The flowers are a rich brilliant crimson; very double. Per pkt. 10c., ¼ oz. 60c., ½ oz. 40c.

**Truffaut's Peony-Flowered Perfection.** This variety has brilliant and showy assortment of colors. Finest mixed. Per pkt. 10c., ½ oz. 50c.

### MID-SEASON TO LATE ASTERS

**Improved Giant Crego.** One of the finest varieties of asters, flowers very large, often five inches across, with long, stout stems. Keep longer in good condition when cut than any other variety. Height 2½ feet. White, shell-pink, rose-pink, lavender, purple and mixed colors. Separate colors, or mixed. Per pkt. 10c., ¼ oz. 85c., ½ oz. 50c.

**Dreer's Superb Late Branching.** The plants form strong, branching bushes 2 to 2½ feet high bearing on long, strong stems flowers which, under ordinary cultivation, average 5 inches across. White, shell-pink, rose pink, lavender and mixed colors. Separate colors, or mixed. Per pkt. 10c., ¼ oz. 60c., ½ oz. 35c.

**Vick's Violet King.** The immense flowers are a rich violet purple. Per pkt. 10c.

**Vick's Cardinal.** This variety is particularly adapted for bedding owing to its free-blooming qualities and brilliant coloring. Per pkt. 10c.

**Quilled German.** A showy class from ½ to 2 feet high, with quilled flowers and branching habit. Mixed colors. Per pkt. 5c., ½ oz. 25c.

**Giant Comet.** A fine variety, with large blossoms. Finest mixed. Per pkt. 10c., ½ oz. 30c.

**China Asters. General Mixture.** A mixture of many sorts and colors blooming from early in the summer to late in the fall. Per pkt. 5c., ½ oz. 20c.





BACHELOR'S BUTTON



BALSAM



CALENDULA

**BACHELOR'S BUTTON.** Hardy annual of easy culture, one of the most attractive of all the old fashioned flowers. Sow the seed where it is to remain and thin to six inches. Per Pkt.

Blue .....	.05
Rose .....	.05
White .....	.05
Mixed Colors.....oz. 30c.	.05
Double Mixed Colors.....oz. 50c.	.10
Double Blue. Fine dark blue..... ¼ oz. 50c.	.10

**BALSAM.** A favorite garden flower producing masses of beautiful, brilliant-colored, double flowers of easy culture; succeeds in a good rich soil; set the plants one foot apart; tender annuals; 2 feet.

Double Camellia-Flowered. Finest mixed .....	.05
Double Rose-Flowered. Finest Mixed .....	.05
..... ¼ oz. 25c.	.05
White Perfection. Double pure white. ....	.10
..... ¼ oz. 50c.	.10

**BARTONIA AUREA.** A free-blooming, showy plant with large, golden-yellow flowers; 18 inches .....

**BEANS, Flowering.** Popular ornamental climbers, 6 to 8 feet.  
 Scarlet Runner..... .10  
 White Runner..... .10

**BEGONIA SEMPERFLORENS.** A variety adapted for house or outdoor culture; easily grown. Seed sown in February or March makes fine plants for bedding out in June. Height 8 to 12 inches.

Choicest Mixed..... .25

**BEGONIA, Tuberos Rooted Varieties.** Very popular and showy plants for summer decoration or window gardening. Sow the seed indoors in February or March.

Single Choice Mixed.....	.15
Double Choice Mixed.....	.25

**BROWALLIA.** Very handsome, free-flowering plants. 1½ feet high.

Elata. Blue .....	.05
Alba. White .....	.05
Mixed .....	.05

**CANARY BIRD VINE.** Half-hardy, climbing annual, bearing an abundance of bright yellow fringed flowers..... ½ oz. 15c. .05

**CALENDULA.** Profuse-blooming dwarf annuals; of easy culture and flowering until frost.  
**Meteor.** Handsome, double and beautifully striped, the petals having a cream center edged with orange-yellow..... .05  
**Orange Giant.** Double; large-flowered; deep orange..... ¼ oz. 15c. .05  
**Mixed Varieties.**..... ½ oz. 10c. .05

**CALLIOPSIS (or Coreopsis.)** A hardy annual growing about 2 feet high, valuable for bright bedding effects or for cutting. Blooms from June until September.

<b>Drummond.</b> Yellow, with maroon center..	.05
<b>Cloth of Gold.</b> Flowers golden yellow.....	.05
<b>Mixed.</b> Fine Varieties..... ¼ oz. 15c.	.05

**CALCEOLARIA.** A tender perennial, used largely in greenhouses and conservatories.

**Carter's Victoria Prize.** Mixed, all colors.. .25

**CANDYTUFT.** A hardy annual of easy culture and valuable for bedding or massing.

<b>Giant Hyacinth Flowered.</b> Very large heads and long spikes of white flowers. 1 foot. ....	.10
..... ¼ oz. 25c.	.10
<b>Empress.</b> Pure white pyramidal; fine for forcing. 1 foot..... ¼ oz. 20c.	.10
<b>Crimson.</b> 1 foot.....	.05
<b>Purple.</b> 1 foot.....	.05
<b>Rose.</b> 1 foot.....	.05
<b>White.</b> 1 foot.....	.05
<b>Finest Mixed.</b> 1 foot. Oz. 30c., ¼ oz. 10c.	.05
<b>Little Prince.</b> Dwarf, white. 6 inches....	.05

**CANNA.** The Canna will bloom from seed the first year if the seed is sown early. Seeds should be soaked for twenty-four hours in warm water before sowing.

**Crozy's Varieties.** Mixed. New large-flowered and free-blooming sorts..... ¼ oz. 20c. .10

**CATCHFLY.** Free-blooming, hardy plants of easiest cultivation, useful for beds and borders. 6 inches.

**Mixed Colors.**..... .05

**CENTAUREA (Dusty Miller.)** Half-hardy perennial, used for borders or edgings.

<b>Candidissima.</b> Silvery white foliage, deeply cut; about 1 foot high.....	.10
<b>Gymnocarpa.</b> Leaves silver gray, with graceful, drooping habit. 1½ feet.....	.10

**CHRYSANTHEMUM (Annual.)** Summer-blooming annuals, growing 12 to 18 inches high. very effective for beds or cut blooms.

<b>Single Mixed.</b> .....	.05
<b>Double Mixed.</b> .....	.05

	Per Pkt.		Per Pkt.
<b>CINERARIA.</b> Magnificent flowering plant for spring decoration for the conservatory or window garden. The flowers measure 2 to 3 inches across; are of white, blue, violet and crimson shades.		<b>DATURA.</b> Large, strong-growing plants with large, trumpet-shaped flowers. 3 feet.	
<b>Carter's Brilliant Prize.</b> Large flowering, choicest mixed.....	\$0.25	<b>Finest Mixed</b> .....	.05
<b>CLARKIA.</b> Beautiful, hardy annuals with rose-colored, white and purple flowers in very brilliant shades. About 1½ to 2 feet high and profuse bloomers.		<b>DIANTHUS or Pinks.</b> Hardy biennials that bloom the first season, remaining green all winter and blooming the next year also if lightly protected. Old plants flower the earliest, but as young ones give the largest, finest flowers, sowings are made every year. Seed can be sown under glass in the spring, or in an open, sheltered bed. The seedlings are easily transplanted. Average height, 1 foot.	
<b>Single Mixed</b> .....½ oz. 15c.	.05	<b>Chinese Double Mixed.</b> A mixture of brilliant coloring and marking.....¼ oz. 15c.	.05
<b>Double Mixed</b> .....½ oz. 15c.	.05	<b>Heddewigi.</b> Very large-flowering, double, choicest mixed, extra fine strain.....	.05
<b>COBAEA.</b> A rapid-growing climber, with handsome foliage and large bell-shaped flowers half-hardy perennial. 20 ft.		<b>Marguerite, Giant Mixed.</b> The flowers are of brilliant colors, ranging through many beautiful shades of red, pink, white, variegated, etc.; they are of perfect form and large size. Those sown in the spring commence flowering in early summer and continue to bloom until checked by frost.....½ oz. 30c.	.10
<b>Scandens.</b> Purple.....¼ oz. 15c.	.10	<b>Marguerite.</b> Dark red.....	.10
<b>COCKSCOMB.</b> Very popular annuals of the easiest culture, producing large, ornamental comb-like heads; useful both for summer bedding and pot plants.		<b>Marguerite.</b> White.....	.10
<b>Glasgow Prize.</b> Brilliant, deep purplish-red combs, dark foliage. Height about 1 foot..	.10	<b>Carter's Choice Double Mixed Carnation.</b> Beautiful variety, producing double flowers of various shades and colors. Seed saved from choicest double flowers.....	.25
<b>Finest Dwarf Mixed.</b>	.10	<b>DAHLIA.</b> A popular late summer and autumn flowering plant. The seed may be planted early in the hotbed and the plants set out in May after all danger of frost is over. By sowing the seed early the plants may be made to bloom the first year.	
<b>COLEUS.</b> A tender perennial, growing about 10 to 18 inches high, and grown for its beautiful, bright-colored, velvety leaves.		<b>Double Mixed</b> .....	.10
<b>Mixed Hybrids.</b> Finest Mixed varieties...	.25	<b>Single Mixed</b> .....	.10
<b>CONVOLVULUS major (Morning Glory.)</b> A handsome, showy climber of easy culture and suitable for covering windows, trellises, etc. The flowers are most brilliant in the morning and run through many shades from white to dark blue, red and striped. Hardy annuals 10 feet high.		<b>DRACAENA.</b> Ornamental plants for vases, baskets and house decorations.	
<b>Finest Mixed</b> .....¼ lb. 30c., 1oz. 15c.	.05	<b>Indivisa.</b> Narrow green leaves.....	.10
<b>Imperial Japanese.</b> Handsome flower of gigantic size and in colors ranging from snow white to carmine, through every shade of blue and purple to nearly black, and striped.		<b>FEVERFEW.</b> Free-flowering annuals for bed, borders and pot culture.	
<b>Oz. 15c., ½ oz. 10c.</b> .....	.05	<b>Double White</b> .....	.10
<b>COSMOS.</b> A very effective flowering plant, quite hardy and rapid growing, forming bush-like plants 4 to 6 feet high and covered with large, single, dahlia-like flowers. Start in March and transplant to open ground about June first.		<b>Golden Feather.</b> Very popular for edgings. 1 foot.....	.10
<b>Early Flowering, Mixed Colors.</b> ¼ oz. 25c.,	.10	<b>FRENCH HONEYSUCKLE (Hedysarum.)</b> Very handsome, free-flowering plants; well adapted for borders or rock-work. Hardy perennial; 4 feet high.	
“ “ <b>White</b> .....¼ oz. 25c.	.10	<b>Scarlet</b> .....	.05
“ “ <b>Pink</b> .....¼ oz. 25c.	.10	<b>Album.</b> White.....	.05
“ “ <b>Crimson</b> .....¼ oz. 25c.	.10	<b>GRASSES (Ornamental.)</b> Ornamental grasses serve the double purpose of rendering the mixed flower bed or border attractive during the summer and for the use of the spikes or panicles in a dried state in winter bouquets.	
<b>Lady Lenox. Late Flowering.</b> Color, shell-pink. Plants strong and vigorous, growing 6 to 7 feet high.....¼ oz. 25c.	.10	<b>Mixed Annual Varieties</b> .....	.10
<b>CYPRESS VINE.</b> A summer, climbing annual with fine, feathery foliage and pretty, star-shaped flowers.			
<b>Scarlet</b> .....	.05		
<b>Mixed</b> .....	.05		
<b>CYCLAMEN.</b> A tender perennial for greenhouses and window gardens. Easily grown from seed. Sow in August or September.			
<b>Persicum Giganteum.</b> Choice mixed.....	.50		



ESCHSCHOLTZIA



HELIOTROPE

	Per Pkt.
<b>ESCHSCHOLTZIA (California Poppy.)</b> The foliage is finely cut and has a bluish tinge, delicate and very attractive. The large, handsome flowers, two inches or more in diameter, are produced in great profusion all summer. Seeds can be sown where the plants are to bloom. Hardy annual; height, 1 foot.	
<b>Californica.</b> Deep yellow, orange center. ....Oz. 20c.	.05
<b>Mandarin.</b> Deep orange.....½ oz. 20c.	.05
<b>Carmine King.</b> Carmine-Rose.....½ oz. 30c	.10
<b>Single Mixed.</b> .....Oz. 20c	.05
<b>Double Mixed.</b> .....¼ oz. 15c.	.10
<b>GAILLARDIA.</b> Very showy plants with brilliant flowers. Hardy annuals, 2 feet high.	
<b>Double Mixed.</b> Annual.....¼ oz. 15c.	.05
<b>GLOBE AMARANTH.</b> Globe-shaped, everlasting flowers. If cut when well matured, will retain their beauty through the winter. Tender annuals; 12 to 18 inches high.	
<b>Fine Mixed.</b> .....	.05
<b>GODETIA.</b> Beautiful garden plants, having large, delicately shaded blossoms. Easily cultivated in garden soil. Hardy annual; about 1 foot high	
<b>Finest Mixed.</b> .....	.05
<b>GOURDS.</b> Ornamental, rapid-growing, trailing annuals, with curiously-shaped, highly-colored fruits. Cultivate the same as melons or squashes; 10 to 20 feet.	
<b>Dipper or Calabash.</b> .....	.05
<b>Hercules' Club.</b> Club-shaped. 4 feet long..	.05
<b>Egg-shaped.</b> Fruit white like an egg.....	.05
<b>Orange-shaped (Mock Orange)</b> .....	.05
<b>Bottle-Shaped</b> .....	.05
<b>Pear-shaped.</b> Striped, very showy.....	.05
<b>Luffa (Dish-cloth or Bonnet Gourd)</b> .....	.05
<b>Mixed Varieties</b> .....	.05
<b>GYPSOPHILIA (Baby's Breath).</b> Free-flowering, elegant plants, succeeding in any garden soil.	
<b>Elegans.</b> A hardy annual, pure white flowers	.05

	Per Pkt.
<b>HELIOTROPE.</b> This class of plants is one of the finest for cutting, as the delicious fragrance of all the varieties is very durable. For the same reason they make excellent house plants. Seed sown early in the spring in the house will make fine plants for summer bedding.	
<b>Queen Marguerite.</b> Bears immense clusters of large deep dark-blue flowers. Very fragrant	.10
<b>Finest Mixed.</b> .....⅓ oz. 35c.	.10
<b>HOLLYHOCK.</b> Hardy annuals, blooming the first season.	
<b>Single Mixed.</b> .....¼ oz. 35c.	.10
<b>Double Mixed.</b> .....¼ oz. 50c.	.10
<b>HELICHRYSUM.</b> The well-known Everlasting Flower. It is everywhere prized for winter decoration. Hardy annual.	
<b>Finest Double Mixed.</b> .....	.05
<b>HUMULUS JAPONICUS (Japanese Hop.)</b> Fast-growing, annual climber. 12 feet..¼ oz. 20c.	.05
<b>HYACINTH BEAN.</b> Tender, climbing annual. Grows rapidly and is valuable for covering a trellis. The shining purple seed pods are very ornamental. Tender annual, growing 6 to 8 feet	
<b>Finest Mixed.</b> .....1 oz. 20c.	.05
<b>KOCHIA TRICOPHYLLA (Summer Cypress.)</b> A splendid ornamental annual plant, forming dense oval bushes 2 to 2½ feet high, of small, feathery, light green foliage. As summer advances, this changes to a carmine hue and finally to a fiery red. A very attractive plant.....¼ oz. 15c.	.05
<b>LARKSPUR. (Delphinium.)</b> Very ornamental plants, producing, in great variety of form and colors, some of the most beautiful flowers in cultivation.	
<b>Double Dwarf Rocket.</b> 1 foot in height	
<b>Mixed colors.</b> .....¼ oz. 15c.	.05
<b>Stock-Flowered.</b> Double, branching; fine for cutting. 2 feet. Mixed colors....¼ oz. 15c.	.05
<b>LAVATERA (Mallow.)</b> Beautiful hardy annuals covered the entire summer with saucer-shaped flowers. The seed may be sown where they are to bloom. Height 2 to 3 feet.	
<b>Pink.</b> .....¼ oz. 15c.	.05
<b>White.</b> .....¼ oz. 15c.	.05
<b>LINUM Grandiflorum Rubrum (Scarlet Flax.)</b> A beautiful and effective plant of slender and delicate growth, having a profusion of bright flowers. Hardy annual; about 1½ feet high	.05



LUPINS



MIGNONETTE

	Per Pkt.		Per Pkt.
<b>LOBELIA.</b> The dwarf varieties are very useful for edging, and the trailing varieties for hanging baskets and window-boxes.		<b>MIGNONETTE (Reseda.)</b> A hardy annual, growing 6 to 12 inches high and bearing pyramidal-shaped flower spikes, which are exceedingly fragrant. Grows easily from boxes or sown out in the garden and thinned to 4 or 6 inches. Valuable for potting, for bedding or for border.	
<b>Erinus gracilis.</b> Blue trailing.... 1/8 oz. 20c.	.10	<b>Large Flowered.</b> Very sweet..... Oz. 20c.	.05
<b>White Gem.</b> Snow-white flowers... 1/8 oz. 20c.	.10	<b>Goliath.</b> A giant, red-flowered variety richly scented..... 1/4 oz. 50c.	.10
<b>Crystal Palace Compacta.</b> 6 inches. Dark blue bedding variety..... 1/8 oz. 40c.	.10	<b>Carter's Perfection.</b> Large spikes, deliciously fragrant..... 1/4 oz. 30c.	.10
<b>LOVE-IN-A-MIST.</b> A hardy annual, 1 foot high, with finely cut foliage. Oddly shaped blossoms in blue and white, and curious seed pods. Of easy culture.		<b>White Pearl.</b> Long spikes of fragrant white flowers. ....	.10
<b>Mixed.</b> Blue and white shades.....	.05	<b>MARVEL OF PERU.</b> The flowers of this old-fashioned favorite open about four o'clock in the afternoon and fade the next morning. 2 feet high, with bright foliage and fragrant flowers of desirable colors. Seed should be planted in the open ground where plants are desired.	
<b>LOVE LIES BLEEDING.</b> Light yellowish green foliage; long, drooping, crimson flower spikes. Plant 3 to 4 feet high. Hardy annual....	.05	<b>Mixed colors.</b> ..... oz. 20c.	.05
<b>LUPINS.</b> Showy plants, with long spikes of various colored pea-shaped flowers; very desirable for mixed borders.		<b>MOONFLOWER.</b> A beautiful vine which grows very rapidly, attaining a height of 50 feet in a season, producing flowers 3 to 4 inches across. Blossoms evenings and cloudy days. Soak the seeds in warm water 24 hours before planting.	
<b>Hartwegii, White.</b> .....	.05	<b>Grandiflora Alba.</b> Large white flowers.	
<b>Hartwegii, Blue.</b> .....	.05	..... 1/2 oz. 20c.	.10
<b>Hartwegii, Rose.</b> .....	.05	<b>Giant Pink.</b> Soft lilac-pink flowers.	
<b>Fine Mixed.</b> ..... 1 oz. 30c.	.05	..... 1/2 oz. 20c.	.10
<b>MALOPE.</b> Free-blooming, hardy annuals suitable for mixed borders and fine for cutting. Height 3 feet.		<b>MOURNING BRIDE (Scabiosa.)</b> A very showy free-flowering plant, producing a great profusion of beautiful and richly-colored double flowers. Beautiful in the garden and excellent for bouquets. 12 to 18 inches high. Annual.	
<b>Grandiflora Mixed.</b> .....	.05	<b>The Fairy.</b> Fine azure-blue.....	.05
<b>MARIGOLD (Tagetes.)</b> A hardy annual plant, in dwarf and tall varieties, growing from 6 inches to 2 feet high. foliage bright green, deeply cut and graceful. The flowers are various shades of yellow and brown. The tall varieties are very valuable for large bedding or background work, and the dwarf varieties for borders. Seeds can be sown in a cold frame and the plants transplanted late in the spring or in the open border.		<b>Snowball.</b> White.....	.05
<b>DOUBLE AFRICAN VARIETIES</b>		<b>Cherry-Red</b> .....	.05
<b>Orange Quilled.</b> A double variety with quilled petals; flowers showy, bloom very early..... 1/4 oz. 15c.	.05	<b>Rose</b> .....	.05
<b>Lemon Queen.</b> Large, lemon-colored flowers.....	.05	<b>Black Prince.</b> .....	.05
<b>Finest Mixed.</b> ..... 1/2 oz. 20c.	.05	<b>Golden Yellow.</b> .....	.05
<b>FRENCH VARIETIES</b>		<b>Mixed Colors.</b> ..... 1/4 oz. 20c.	.05
<b>Tall Double Mixed.</b> ..... 1/2 oz. 20c.	.05	<b>MIMULUS (Monkey Flower.)</b> Handsome flowers of easy cultivation. Perennial in the greenhouse, annual in the open air.	
<b>Dwarf Double Mixed.</b> ..... 1/2 oz. 20c.	.05	<b>Mixed Spotted Varieties.</b> .....	.10
<b>Gold Striped.</b> Double variety, brilliantly marked and striped. 1 ft..... 1/4 oz. 20c.	.05	<b>MUSK PLANT.</b> Fragrant plant, with small yellow blossoms, spotted lightly with brown....	.10
<b>Legion of Honor.</b> A single, dwarf variety, desirable for borders; rich golden-yellow flowers with garnet blotches in center of each petal	.05		



NASTURTIIUM

# NASTURTIIUM

A popular flower which is in constant bloom throughout the season, making a better display than almost any other plant. New colors are being developed, and in our list will be found all the best varieties that have been introduced.

Nasturtiums are of the easiest culture and require very little care after the seed is sown, merely weeding and the seed-balls picked off. If these are permitted to mature the beauty of the plant is soon lost. Plant the seed one inch deep in moderately good soil. The tall sorts are specially adapted for covering unsightly fences or trailing over rocks and rough ground. Hardy annual.

## DWARF VARIETIES

Of dwarf, compact growth; bloom in two months from sowing and most profusely the whole season. Height 1 foot.

	Pkt.	Oz.	¼ lb.
<b>Aurora.</b> Light reddish-orange, veined with carmine.....	.05	.15	.50
<b>Beauty.</b> Scarlet and yellow.....	.05	.15	.50
<b>Chameleon.</b> Mottled crimson, bronze and yellow.....	.05	.15	.50
<b>Crimson</b> .....	.05	.15	.50
<b>Crystal Palace Gem.</b> Sulphur-yellow spotted with carmine.....	.05	.15	.50
<b>Empress of India.</b> A splendid variety, with dark leaves and crimson flowers.....	.05	.15	.50
<b>Golden Cloth.</b> Golden yellow leaves scarlet flowers.....	.05	.15	.50
<b>Golden King.</b> Golden yellow.....	.05	.15	.50
<b>Golden Midnight.</b> The foliage is a light yellowish-green, while the flowers are of such a dark maroon as to seem almost black.....	.10	.20	.60
<b>King of Tom Thumbs.</b> Dark foliage, scarlet flowers.....	.05	.15	.50
<b>King Theodore.</b> Intensely dark crimson or chocolate.....	.05	.15	.50
<b>Lady Bird.</b> Yellow and red spotted.....	.05	.15	.50

	Pkt.	Oz.	¼ lb.
<b>Pearl.</b> Creamy white.....	.05	.15	.50
<b>Prince Henry.</b> Cream, marbled scarlet .....	.05	.15	.50
<b>Queen of Tom Thumbs.</b> Variegated foliage, bright crimson flowers....	.05	.15	.50
<b>Rose.</b> Rose Pink.....	.05	.15	.50
<b>Ruby King.</b> Crimson rose.....	.05	.15	.50
<b>Scarlet.</b> Brilliant scarlet flowers.....	.05	.15	.50
<b>Extra Choice Mixture</b> ..... 1 lb. \$1.60	.05	.15	.50
<b>Fine Mixed</b> ..... 1 lb. \$1.00	.10		.30
<b>Collection of Six Varieties.</b> Our selection			20c.

## TALL OR CLIMBING VARIETIES

Height, 10 to 12 feet.

	Pkt.	Oz.	¼ lb.
<b>Coccineum.</b> Scarlet.....	.05	.15	.50
<b>Dark Crimson</b> .....	.05	.15	.50
<b>Dunnett's Orange.</b> Deep Orange.....	.05	.15	.50
<b>Edward Otto.</b> Brownish lilac.....	.05	.15	.50
<b>Hemisphaericum.</b> Orange-salmon and scarlet .....	.05	.15	.50
<b>King Theodore.</b> Dark red, extra fine..	.05	.15	.50
<b>Pearl.</b> Creamy white.....	.05	.15	.50
<b>Prince Henry.</b> Light yellow, marbled with scarlet.....	.05	.15	.50
<b>Scheuerianum.</b> Straw-color, brown striped .....	.05	.15	.50
<b>Scheuerianum Coccineum.</b> Scarlet striped .....	.05	.15	.50
<b>Schillingi.</b> Bright yellow, blotched with maroon.....	.05	.15	.50
<b>Vesuvius.</b> Brilliant salmon-rose, dark leafed .....	.05	.15	.50
<b>Yellow</b> .....	.05	.15	.50
<b>Extra Choice Mixture</b> ..... 1 lb. \$1.60	.05	.15	.50
<b>Fine Mixed</b> ..... 1 lb. \$1.00	.10		.30
<b>Collection of six varieties,</b> our selection			.20

**NEMOPHILA.** A hardy annual, growing about 6 inches high; has small, cup-shaped blossoms in white and shades of blue Per Pkt. Mixed ..... \$0.05

**NEMESIA STRIMOSA SULTONI.** Free-blooming plants for pot culture and open border. Sow the seed in March under glass or sow out of doors in May. Hardy annual. 1 foot. Blue, lilac, and white flowers..... .10

**NICOTIANA.** Showy plants with slender, tall, flowering stems and fragrant flowers; half-hardy annuals. About 3 feet high. **Affinis.** White and very fragrant..... .05 **Mixed Hybrids.** All colors..... .10

**NIEREMBERGIA GRACILIS.** Tender perennial. Suitable for house culture, or may be treated as a tender annual. Fine for baskets, vases, etc. Light blue, saucer-shaped flowers.... .10

**OXALIS.** Beautiful small plants suitable for the greenhouse, rock work or outdoor culture, flowering the first year; half-hardy perennials; 9 inches. **Pink and Yellow Mixed**..... .10

**PASSION FLOWER (Passiflora.)** A half-hardy perennial climber, bearing attractive blue fringed flowers. Height 10 to 15 feet..... .10

**PRINCE'S FEATHER.** Tall spikes of red flowers 3 feet..... .05



## PANSY

Pansies thrive best in a moist, shady location and in rich, loamy soil. Seed should be sown in the autumn for early spring blossoms. If sown in the spring, get it in as early as possible, so as to secure flowers during the early rains. Seed sown in a cool place in May or June, and well watered until up, will produce fall-flowering plants. To have good flowers, the plants must be vigorous and make a rapid growth; use manure liberally.

Per Pkt.

Rugnot's Superb Blotched. Very large flowers and beautiful colors.....	1/8 oz. \$1.00	.15
Masterpiece. These pansies have a most beautiful combination of rich, velvety coloring and attractive wavy or ruffled petals..	1/8 oz. \$1.00	.15
Black Mastodon. Velvety black.....		.20
Bronze Mastodon.....		.20
Purple Mastodon.....		.20
White Mastodon. Black center.....		.20
Grand Duke Michael. Pure White.....		.20
Madame Perret. Red and wine shades.....		.20
Meteor. Terra cotta.....		.15
Parisian Yellow. Pure yellow.....		.20
Prince Henry. Dark Blue.....		.15
Steele's Adonis.....		.15
Greenhouse Special (New). Mixed, long stems.....	1/8 oz. \$2.00	.25
Allen's Private Stock Mixed.....	1/8 oz. \$1.25	.20
Golden Queen. Pure Yellow.....	1/8 oz. 25c.	.10
King of the Blacks. Velvety black...	1/8 oz. 25c.	.10
Snowflake. Pure white.....	1/8 oz. 35c.	.10
"A., S. & L." Special mixed.....	1/8 oz. 75c.	.10
Fine Mixed.....	1/8 oz. 20c.	.05

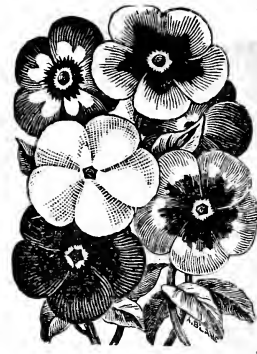

PHLOX DRUMMONDI

Per Pkt.

**PHLOX DRUMMONDI.** A hardy annual, bearing beautiful and brilliantly colored flowers. For brilliant effect and continuous blooming in the flower garden the Phlox cannot be surpassed. Excellent for masses of separate colors or for bouquets. Height 1 foot.

Alba. Pure White.....		.05
Alba Occulata. Dark Purple, white eye....		.05
Brilliant. Bright scarlet.....		.05
Finest Mixed. Best large-flowered varieties.....	1/4 oz. 50c	.05

**POPPY (Papaver.)** The seed should be sown as early in the spring as possible where they are to remain, as they do not stand transplanting. Thin 6 to 10 inches apart. If left thick the plants will be weak and the blossoms inferior. The Shirley is beautiful for cutting.

Admiral. White, with broad, brilliant scarlet band, very effective.....	1/4 oz. 25c.,	.10
Shirley. The most beautiful type of poppies, having soft foliage and an immense variety of single blossoms in white, pink, lavender, purple, shades of red and scarlet; the best and most showy of all single poppies..	1/2 oz. 30c.,	.05
Danebrog. Large flowers of brilliant scarlet, with a silver spot on each of the petals.....	1/4 oz. 20c.,	.05
Tulip. Dazzling scarlet tulip-shaped flowers.....	1/4 oz. 20c.	.05

### DOUBLE ANNUAL POPPIES

Paeony Flowered. Large, showy flowers with broad petals; colors range from white to pink, carmine, scarlet, crimson and maroon.....	1/2 oz. 15c.,	.05
Carnation, Double Mixed. Large, showy, double flowers of various colors..	1/2 oz. 20c.	.05
Carnation, Double. Scarlet.....	1/2 oz. 20c.	.05
Snowdrop. Pure white, fringed..	1/2 oz. 20c.	.05

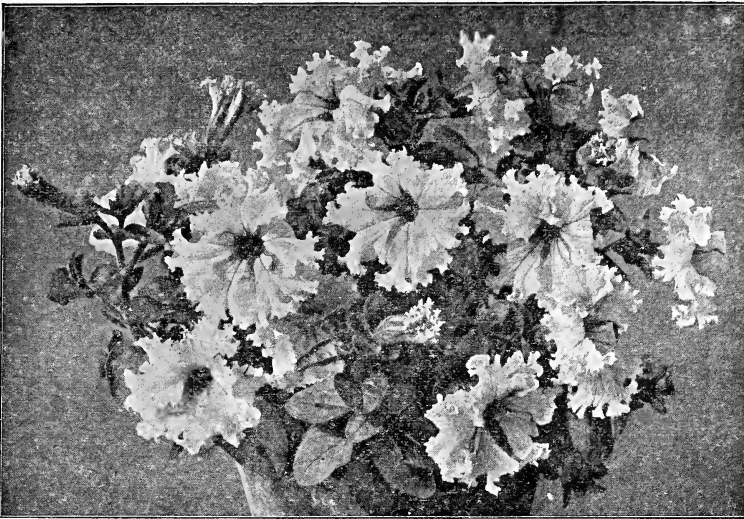

FRINGED PETUNIA

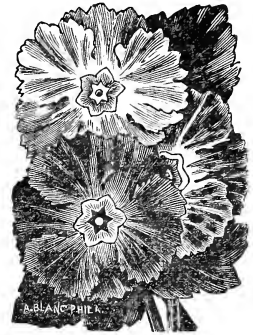

PRIMULA

**PRIMULA (Chinese Primrose.)** A beautiful flowering plant for winter decoration in the home or conservatory.

**PETUNIA.** Free-flowering and easily cultivated; well-known favorites. They thrive in almost any soil and produce a brilliant array of color throughout the season. The seed will germinate with little difficulty if a reasonable amount of care is used in sowing. Be sure that the soil is well pulverized; then sow the seeds on the surface, pressing them into the soil by using a small smooth board, and cover very lightly with fine soil.

	Per Pkt.
<b>Large-Flowered Single, Fringed.</b> Choice mixed .....	\$0.25
<b>Large-Flowered Double, Fringed.</b> Choice mixed .....	.25
<b>Giants of California.</b> Flowers very large, and deeply fringed. A variety of colors.....	.25
<b>Ruffled Giants.</b> Flowers of enormous size, with ruffled edges and brilliant colors.....	.25
<b>Rosy Morn.</b> A bright rosy pink with white throat .....	.10
<b>Howard's Star.</b> A beautiful free-flowering strain, color a rich, dark crimson, with five-pointed white star.....	.10
<b>Pure White</b> .....	¼ oz. 30c., .10
<b>Choice Mixed.</b> Striped and blotched. ....	⅛ oz. 25c., .10
<b>Fine Mixed.</b> All Colors.....	¼ oz. 25c. .05

**PORTULACA.** The plants are of low growth and spreading habit. The flowers of the double varieties are like small roses, and make a particularly brilliant show. Sow seed in the open ground as soon as the weather is warm, or in a hotbed earlier. The plants can be transplanted when in full flower. Annual.

<b>Finest Double Mixed</b> .....	⅛ oz. 50c. .10
<b>Finest Single Mixed</b> .....	¼ oz. 20c., .05
<b>Single Rose</b> .....	.05
<b>Single Scarlet</b> .....	.05
<b>Single White</b> .....	.05
<b>Single Yellow</b> .....	.05

Sow the seed in well-drained shallow pans, from April to the last of July, to insure flowering the following winter. Use finely sifted leaf mold, loam and sand in equal quantities

	Per Pkt.
<b>Sinensis (Alba Magnifica.)</b> Pure white.....	.25
<b>Sinensis (Coccinea.)</b> Bright red.....	.25
<b>Sinensis Double white</b> .....	.50
<b>Sinensis. Double fringed.</b> Choicest mixed....	.50
<b>Sinensis Fimbriata.</b> Fringed varieties. Choice mixed .....	.25
<b>RICINUS (Castor Oil Bean.)</b> A half-hardy annual, growing from 6 to 15 feet high and bearing large, green, deep purple and brown leaves, and bright orange and scarlet flowers. Of the easiest culture. Fine for lawns, massing or center plants for beds.	
<b>Borboniensis.</b> Green foliage; 15 feet..Oz.	20c. .05
<b>Cambodgensis.</b> Dark maroon; stems black; 6 to 8 feet .....	Oz. 20c. .05
<b>Gibsoni.</b> Deep red foliage; 5 feet.....Oz.	20c. .05
<b>Sanguineus.</b> Red stems and seeds; 8 feet. ....	Oz. 20c., .05
<b>Zanzibarensis Mixed.</b> A very large-leaved variety, light and dark green and bronze foliage; 10 to 12 feet.....Oz.	20c. .05
<b>Mixed Varieties</b> .....	Oz. 20c., .05

**RHODANTHE.** Fine for garden. Comes into flower early and continues a long time. One of the best everlasting for bouquets.  
**Fine Single Mixed**..... .05

**SCHIZANTHUS.** Hardy annuals, growing 1½ to 2 feet high, and covered with bright, showy, butterfly-like blossoms. Mixed. Large flowering .....

**SENSITIVE PLANT.** Curious and interesting annuals, with pinkish-white flowers; the leaves close and droop when touched or shaken; 1½ feet..... .05

## SWEET PEAS

The popularity of Sweet Peas is demonstrated by the many and beautiful varieties that are introduced each year. Our list includes all the best up-to-date varieties.

Sow as early as the ground can be prepared in a deep, rich moist soil, in drills 6 inches deep, covering about 2 inches deep. As the vines grow, fill up the trenches with soil and thin out to about 4 or 5 inches apart. A popular plan at the present time is to sow in double rows with a trellis or a row of brush between.

### GIANT SPENCER VARIETIES

The Spencers have very large waved flowers which are produced abundantly on long, strong stems, and are most desirable for cutting.

**AMERICAN SPENCER.** Bright red, striped and flaked on white. Pkt. 10c., oz. 20c.,  $\frac{1}{4}$  lb. 70c.

**Apple Blossom Spencer.** Standard bright rose, wings primrose with a flush of rose. Pkt. 10c., oz. 20c.,  $\frac{1}{4}$  lb. 70c.

**Asta Ohn.** The best lavender, very large and wavy. Pkt. 10c., oz. 25c.,  $\frac{1}{4}$  lb. 80c.

**Aurora Spencer.** White, with stripes and flakes of orange-pink. Pkt. 10c., oz. 20c.,  $\frac{1}{4}$  lb. 65c.

**BARBARA.** Bright salmon orange with dark stems. Pkt. 10c., oz. 25c.,  $\frac{1}{4}$  lb. 80c.

**CAPT. OF THE BLUES SPENCER.** Purplish blue, lighter at edges. Pkt. 5c., oz. 20c.,  $\frac{1}{4}$  lb. 65c.

**Constance Hinton.** The largest white Spencer. Pkt. 10c., oz. 20c.,  $\frac{1}{4}$  lb. 70c.

**Countess Spencer.** The original giant-flowered Spencer, Clear Pink. Pkt. 10c., oz. 20c.,  $\frac{1}{4}$  lb. 70c.

**Dainty Spencer.** White with rose-pink edges. Pkt. 10c., oz. 25c.,  $\frac{1}{4}$  lb. 80c.

**Dobbie's Cream.** The finest primrose-yellow. Pkt. 10c., oz. 25c.,  $\frac{1}{4}$  lb. 90c.

**Florence Nightingale.** Large, pure lavender. Pkt. 10c., oz. 25c.,  $\frac{1}{4}$  lb. 80c.

**Geo. Herbert.** A large Spencer, rose-crimson. Pkt. 10c., oz. 20c.,  $\frac{1}{4}$  lb. 70c.

**Helen Lewis.** Orange-pink with bright orange standard. Pkt. 10c., oz. 20c.,  $\frac{1}{4}$  lb. 70c.

**Henrietta (novelty)** double, flesh pink. Pkt. 10c., oz. 40c.,  $\frac{1}{4}$  lb. \$1.25.

**Illuminator.** Salmon orange overlaid with bright cerise. Pkt. 10c., oz. 35c.,  $\frac{1}{4}$  lb. \$1.25.

**King Edward.** The best pure red Spencer, very large. Pkt. 10c., oz. 20c.,  $\frac{1}{4}$  lb. 70c.

**King White.** The best white. Pkt. 10c., oz. 25c.,  $\frac{1}{4}$  lb. 85c.

**Margaret Atlee.** Best deep cream-pink. Pkt. 10c., oz. 35c.,  $\frac{1}{4}$  lb. \$1.00.

**Margaret Madison.** Best pale lavender. Pkt. 10c., oz. 35c.,  $\frac{1}{4}$  lb. \$1.00.

**Marie Corelli.** Rose-Carmine. Pkt. 5c., oz. 20c.,  $\frac{1}{4}$  lb. 70c.

**Mary Garden.** Bright cream rose-pink; inclined to double. Pkt. 10c., oz. 20c.,  $\frac{1}{4}$  lb. 70c.

**New Miriam Beaver.** Best light cream-pink. Pkt. 10c., oz. 30c.,  $\frac{1}{4}$  lb. \$1.00.

**Othello Spencer.** Deep, rich maroon. Pkt. 5c., oz. 20c.,  $\frac{1}{4}$  lb. 70c.

**Thomas Stevenson.** Bright orange scarlet. Pkt. 10c., oz. 25c.,  $\frac{1}{4}$  lb. 85c.



EARLY NIGHTINGALE

**Early Nightingale.** A new early Spencer. A beautiful mauve lavender when young, but after standing in water a short time the flowers become a beautiful blue lavender. The vines are vigorous and flower profusely, usually four to each stem. Pkt. 25c

**Vermillion Brilliant.** Brilliant scarlet. Pkt. 10c., oz. 35c.,  $\frac{1}{4}$  lb. \$1.00.

**White Spencer.** Pure white. Pkt. 5c., oz. 20c.,  $\frac{1}{4}$  lb. 65c.

**Yarrowa, Early Flowering Spencer.** Color bright rose-pink with lighter base. Pkt. 15c.,  $\frac{1}{4}$  oz. 25c.,  $\frac{1}{2}$  oz. 40c., oz. 75c.

**Superb Spencer Mixed.** A splendid mixture of true Spencer types only. Pkt. 5c., oz. 20c.,  $\frac{1}{4}$  lb. 70c.



# SWEET PEAS — Continued

## Grandiflora— (Large Flowered)

These have large handsome flowers, but the petals are not waved like the Spencer varieties.

Price of any of the following varieties. Pkt. 5c., oz. 10c., ¼ lb. 30c., ½ lb. 55c., lb. \$1.00.

One quarter of a pound of seed will sow fifty feet.

- Black Knight.** Deep maroon.
- Blanche Burpee.** Large pure white.
- Blanche Ferry.** Pink and white.
- Coccinea.** Cherry-red.
- Dainty.** White with pink edge.
- Dorothy Eckford.** Fine pure white, large.
- Duke of Westminster.** Purple, tinted with violet.
- Flora Norton.** Bright blue with tint of purple.
- Hon. Mrs. E. Kenyon.** Primrose-yellow.
- Janet Scott.** Deep bright pink.
- King Edward VII.** Crimson scarlet, very large.
- Lady Grisel Hamilton.** Lavender.
- Lord Nelson.** Deep navy blue.
- Lovely.** Soft shell pink; large flowering.
- Miss Wilmott.** Orange pink; very large flowering.
- Prima Donna.** Soft clear pink.
- Queen Alexandra.** Brilliant scarlet.
- Six 5c. pkts.** Sweet Peas for 20c.; seven 10c. pkts. for 50c. postpaid.

**“A., S. & L.” SPECIAL MIXTURE.** This mixture is made up by ourselves from the best named varieties and cannot fail to give satisfaction. Pkt. 5c., oz. 10c., ¼ lb. 30c., ½ lb. 55c., lb. \$1.00.

### Mixed Sweet Peas In Separate Shades.

- Lavender and Blue Shades.** Pink Shades.
  - Purple and Maroon Shades.** Red Shades.
  - White and Primrose Shades.**
- Each of the above, lb. \$1.00., ¼ lb. 30c., oz. 10c.  
 Collection, one oz., each of the five separate shades, 40c.



SALPIGLOSSIS

**SALPIGLOSSIS.** Very showy bedding or border plants with richly-colored flowers, which are purple, scarlet, crimson, yellow, buff, blue or almost black, beautifully marbled and pencilled. Hardy annual, 2 feet.

- |   |                |
|---|----------------|
|   | Per Pkt.       |
| <b>Grandiflora.</b> Special mixture.....                              | ¼ oz. 50c. .10 |
| <b>Emperor.</b> Finest Mixed. Very large flowers.<br>.....            | ¼ oz. 50c. .10 |
| <b>Smilax.</b> A graceful climber with small, dark green foliage..... | .10            |

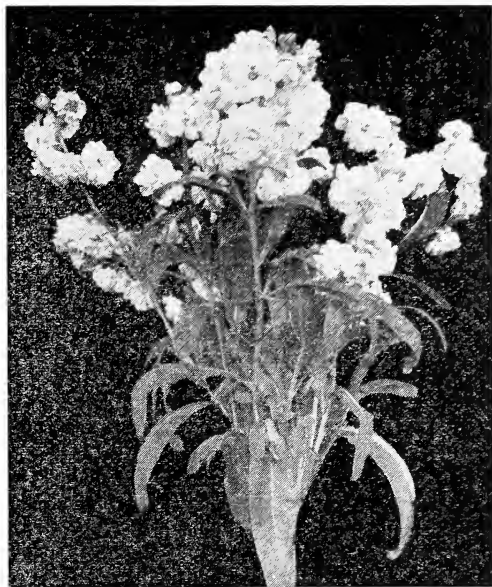

TEN WEEKS STOCKS

**STOCKS (Gilliflower.)** Hardy annuals, 2 feet high, with spikes densely covered with beautiful double flowers of almost every desirable tint. Seeds may be sown in the open ground, hotbed or cold frame, but transplanting should be done when the plants are just out of the seed leaf. Make the soil deep and rich, and set the plants a foot apart.

### LARGE-FLOWERING TEN WEEKS

The best variety for bedding out for summer blooming, producing a large percentage of double flowers.

	Per Pkt.		Per Pkt.
<b>Blood Red.....</b>	\$0.10	<b>Light Blue.....</b>	\$0.10
<b>Canary Yellow..</b>	.10	<b>Rose.....</b>	.10
<b>Flesh Color....</b>	.10	<b>White.....</b>	.10
<b>Mixed Colors.....</b>		<b>½ oz. 60c.,</b>	.10
<b>Dresden Perpetual.</b> (Cut-and-Come-Again or Princess Alice.) Pure white. Plants of robust growth and branching habit. Fine for cutting.....		<b>⅓ oz. 75c.</b>	.10

### EARLY, LARGE-FLOWERING WINTER STOCKS

	Per Pkt.
<b>Beauty of Nice.</b> Strong spikes, with large flowers of a delicate flesh pink.....	\$0.10
<b>Queen Alexandra.</b> Soft rosy lilac, similar to preceding.....	⅓ oz. 75c. .10

**SWEET SULTAN.** Large, sweet-scented flowers on long stems, fine for cutting. 2 feet.

<b>White .....</b>	.05
<b>Dark Blue.....</b>	.05
<b>Light Blue.....</b>	.05
<b>Suaycolens.</b> Large, bright yellow flowers..	.05
<b>Finest Mixed.....</b>	.05

### FREE DELIVERY

To any address in the United States on all Flower Seeds by the packet, ounce, half-pound, and pound.

	Per Pkt.		Per Pkt.
<b>SALVIA.</b> Sow seed early indoors or in a frame in time to get good plants to set out of doors the latter part of May. Bloom from July to frost. Set plants 1 foot apart. Half-hardy annual		<b>VERBENA.</b> A well-known annual for beds, and borders. Seed sown in March will bloom in June and continue until frost. Plants raised from seed are more vigorous and produce more flowers than those grown from cuttings.	
<b>Bonfire.</b> Very compact, with long, erect spikes of brilliant scarlet flowers. The finest Salvia for bedding. 2 feet.....	1/8 oz. 50c. .10	<b>Mammoth White</b> .....	1/8 oz. 25c. .10
<b>Globe of Fire.</b> A new variety. It is the earliest and longest blooming of all. Plants not over 18 inches high and very even growth.	.20	<b>Mammoth Pink</b> .....	1/8 oz. 25c. .10
<b>Splendens.</b> Bright scarlet flower-spikes; 2 1/2 feet .....	1/8 oz. 50c. .10	<b>Mammoth Scarlet</b> .....	1/8 oz. 25c. .10
<b>Zurich.</b> The earliest blooming variety; the plants are dwarf and compact, producing brilliant scarlet flowers. 1 foot.....	1/8 oz. 75c. .15	<b>Mammoth Purple</b> .....	1/8 oz. 25c. .10
<b>Patens.</b> Bright blue, extra large flowers. 1 1/2 to 2 feet.....	.10	<b>'A., S. &amp; L.' Mammoth Mixed</b>	1/4 oz. 50c. .10
<b>SUNFLOWER (Helianthus.)</b> Hardy annuals, growing from 3 to 6 feet high. Of the easiest culture and suitable for a stately row or background. Plant in light or sandy soil.		<b>Fine Mixed</b> .....	1/8 oz. 15c. .05
<b>Californicus fl. pl.</b> Splendid variety, with magnificent heads of double orange flowers. 5 feet.....	Oz. 20c. .05	<b>Lemon Scented.</b> Lemon scented foliage....	.10
<b>Miniature.</b> Small, single rich yellow flowers, with black center. 4 feet.....	Oz. 20c. .05	<b>VIRGINIAN STOCK.</b> Sweet-scented hardy annual Mixed .....	.05
<b>Sutton's Red.</b> Single large red flowers, shading to yellow at tips of petals. 6 ft. Oz. 25c .....	.10	<b>WALLFLOWER.</b> An old favorite garden flower. The large, massive spikes of the Wallflower are very conspicuous in beds and borders and are very useful in making bouquets. Height about 1 1/2 feet.	
<b>Mammoth Russian.</b> Large yellow. Oz. 5c.		<b>Single Mixed</b> .....	.05
<b>TASSEL FLOWER.</b> An annual of easy culture, with tassel-shaped flowers, blooming profusely from July to October. 18 inches. Bright scarlet .....	.05	<b>Double Mixed</b> .....	.10
<b>THUNBERGIA. (Black Eyed Susan.)</b> Beautiful annual trailing plants for hanging basket and vases. Mixed colors. 4 feet. 1/4 oz. 20c....	.05	<b>WILD CUCUMBER (Echinocystis Lobata.)</b> This is a useful climber where a rapid and vigorous growth of vine is desired. The vine is thickly covered with white, fragrant flowers. Hardy annual.....	Oz. 25c., 1/2 oz. 15c. .05
		<b>ZEA JAPONICA (Striped Japanese Maize.)</b> Very ornamental, variegated foliage.....	.05
		<b>ZINNIA.</b> A hardy annual, growing from 1 to 2 feet high. One of the most brilliant and showy plants. They flower early in the summer and keep on blooming until frost. Sow in boxes early and transplant.	
		<b>GIANT FLOWERING DOUBLE</b>	
		<b>Giant Flesh-</b> Per Pkt. <b>Giant Golden-</b> Per Pkt.	
		color.....\$0.10 yellow.....\$0.10	
		<b>Giant Purple</b> .... .10 <b>Giant Scarlet</b> ..... .10	
		<b>Giant Crimson</b> ... .10 <b>Giant White</b> ..... .10	
		<b>Giant Mixed.</b> All colors.....1/4 oz. 40c. .10	
		Collection of 6 varieties. Our collection... .40	
		<b>Double Curled and Crested Mixed.</b> 2 ft. ....	
		.....1/4 oz. 40c. .10	
		<b>Tall, Double Mixed</b> .....	.05

## WILD GARDEN FLOWER SEEDS

A mixture of easily grown varieties of Flower Seeds for Sowing broadcast, require very little care and produce a continual display of bloom throughout the season, and furnish an abundance of flowers for cutting. They are useful for sowing along fences and on unsightly bare spots of ground.

Pkt. 5c., oz. 15c., 1/4 lb. 50c.

Read about these Specialties and Novelties. They have all proven very satisfactory and we can recommend them to our customers.

<b>BEANS</b> —Sure Crop Stringless Wax Kentucky Wonder Wax Burpee's Stringless Green Pod French Horticultural Bush	<b>CUCUMBER</b> —Wood's Hybrid
<b>BEEF</b> —Detroit Dark Red. Early Wonder	<b>ONION</b> —Danvers Yellow Globe (New England grown)
<b>CABBAGE</b> —Copenhagen Market A., S. & L. (Cape Elizabeth)	<b>PEAS</b> —Little Marvel Prodigious Laxtonian Carter's Quite Content Pioneer
<b>CELERY</b> —Easy-Blanching	<b>SQUASH</b> —Hubbard (Cape Elizabeth) Blue Hubbard
<b>CAULIFLOWER</b> —Danish Giant	<b>SWEDE TURNIP</b> —Perfect Model. Lang's Mammoth
<b>CARROT</b> —Hutchinson's Danvers	<b>TOMATO</b> —John Baer
<b>CORN</b> —Morse's Golden Cream (Sweet) Early Falmouth	

# PERENNIAL FLOWER SEEDS

**ABUTILON (Flowering Maple.)** Free-flowering shrubs of strong growth and easy cultivation; drooping, bell-shaped flowers of various colors. \$0.10

**ACONITUM (Monk's Hood.)** Hardy perennial, with helmet-shaped flowers; growing in any good garden soil. Thrives best when planted among shrubbery or in shady situations. 4 feet.  
**Nappellus.** Large blue. . . . . .15  
**Nappellus White.** Large white. . . . . .15

**ALYSSUM.** Saxatile Compactum (Basket of Gold.) Golden yellow flowers. . . . . .10

**AMPELOPSIS VEITCHII (Boston Ivy.)** The best hardy vine for covering brick or stone buildings, etc.; foliage turning to scarlet in the autumn. 1/2 oz. 25c. . . . . .10



BELLIS PERENNIS

**BELLIS PERENNIS (Double Daisy.)** Sow the seed very early. The flowers are abundant in early spring and may be continued later by the use of water. Set about six inches apart in a cool border.

**Longfellow.** Large, rose-colored flowers. 1/8 oz. 50c. pkt. 10c.

**Snowball.** Large, double pure white, 1/8 oz. 50c., pkt. 10c.

**Finest Mixed.** 1/8 oz. 40c., pkt. 10c.

**SHASTA DAISY.** Fine, hardy perennial, producing large flowers which are very desirable for cutting. Height 2 feet.  
**Alaska.** Pure white. . . . . .10



CANTERBURY BELLS

**CANTERBURY BELLS.** Large bell-shaped flowers which are very effective. Succeeds best in light, rich soil. Transplant two feet apart.  
 Height 2 to 4 feet.

**Single Blue,** 1/8 oz. 25c., .10

**Single Rose,** 1/8 oz. 25c., .10

**Single White,** 1/8 oz. 25c., .10

**Single, Fine Mixed.** . . . . . 1/8 oz. 20c., .05

**Double, Fine Mixed.** . . . . . 1/8 oz. 25c., .10

**COLUMBINE. (Aquilegia.)** Well-known hardy perennials, bearing in great profusion, through May and June, exquisite flowers greatly varied in coloring; of easy culture, thriving best in dry soil and growing well in partial shade. 1 to 3 feet.

**Single, Mixed Colors.** . . . . . .10

**Double, Mixed Colors.** . . . . . .10

**DELPHINIUM (Hardy Larkspur.)** **Formosum.** Deep blue, 3 feet. . . . . 1/4 oz. 40c., .10  
**Double Hybrids, Finest Mixed.** 3 feet. . . . . 1/8 oz. 40c. .10

**DIANTHUS (Hardy Garden Pinks.)** **Double Clove.** A hardy perennial pink, very fragrant, choice colors. . . . . 1/8 oz. 30c. .10  
**Plumarius (Grass Pink, or Pheasant-eye Pink.)** A single hardy pink with fringed-edged, fragrant flowers, mixed colors . . . . . 1/8 oz. 30c. .10



FORGET-ME-NOT

**FORGET-ME-NOT. (Myosotis.)** Small star-like flowers borne in clusters. The plant is of easy culture and blooms the first year if seed is sown early. 4 to 9 inches.

**Indigo Blue.** Large, dark blue flowers. . . . . 1/8 oz. 25c. .10

**Victoria.** Large flowers, bright azure blue; dwarf habit; fine for borders. . . . . 1/8 oz. 35c. .10

**Fine Mixed.** . . . . . 1/8 oz. 25c. .10



FOXGLOVE

**FOXGLOVE (Digitalis.)** The Foxgloves are highly ornamental plants. They are fine for the mixed border or planted singly in half-shady places near a walk or drive. The spikes of flowers are often two feet in length, containing scores of the pretty-spotted, thimble-shaped flowers. Perfectly hardy. Sow seed in spring in the garden and transplant as desired.

**Mixed varieties** . . . . . 1/4 oz. 20c. .05

# PERENNIAL FLOWER SEEDS—Continued

	Per Pkt.
<b>FRENCH HONEYSUCKLE</b> ( <i>Hedysarum</i> .) Very handsome, free-flowering plants; well adapted for borders or rock-work. 4 feet.	
Scarlet .....	\$0.05
Albun. White .....	.05
<b>GAILLARDIA</b> . Showy and hardy perennials, Flowering from July to October, 2 ft.	
Grandiflora Copper-red.....	.10
Grandiflora Mixed.....	¼ oz. 30c. .10
<b>GYPSOPHILIA</b> . ( <i>Baby's Breath</i> .) Free-flowering, plants, succeeding in any garden soil. Fine for bouquets.	
Paniculata. White flowers.....	¼ oz. 25c. .10
<b>HELIANTHUS</b> ( <i>Hardy Sunflower</i> .)	
Maximiliana. Golden yellow flowers; continues in bloom until late in Fall. 6 ft.....	.10

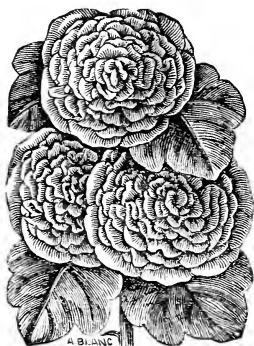

HOLLYHOCK

<b>HOLLYHOCK</b> . Plants of upright, stately growth, 5 to 8 feet high. The double varieties are the most desirable. Very effective when planted in long rows with a background of shrubbery.	
Chater's Double Crimson.....	⅓ oz. 30c. .10
Chater's Double Pink.....	⅓ oz. 30c. .10
Chater's Double Yellow.....	⅓ oz. 30c. .10
Chater's Double White.....	⅓ oz. 30c. .10
Chater's Double Rose.....	⅓ oz. 30c. .10
Chater's Double Scarlet.....	⅓ oz. 30c. .10
Chater's Double Mixed.....	⅓ oz. 30c. .10
Finest Mixed. Single.....	¼ oz. 25c. .10
Allegheny. A semi-double, fringed variety.	
Finest Mixed.....	¼ oz. 25c. .10
<b>HONESTY</b> ( <i>Satin Flower</i> .) The flat, silvery seed pods are used for winter decoration. Very handsome, free-flowering. Hardy biennial. 2 feet .....	.05
<b>IBERIS</b> ( <i>Perennial Candytuft</i> .)	
Gibraltarica Hybrida. White shading to lilac	.10
Sempervirens. Pure white; excellent for cemeteries, rockeries, etc.; 1 foot.....	.15
<b>Kudzu Vine or Jack-and-the-Bean Stalk</b> . A fast growing hardy perennial vine, growing 8 to 10 feet the first year from seed. The foliage is large; it bears clusters of pea-shaped flowers .....	.10

	Per Pkt.
<b>LAVENDER</b> . Chiefly cultivated for the delicious and lasting fragrance of its flowers; succeeds in any common garden soil.....	¼ oz. 10c. .05
<b>LINUM</b> ( <i>Flax</i> )	
Perenne. Bright blue flowers, hardy. 2 ft.	.10
<b>LUPINUS</b> ( <i>Lupin</i> .) Beautiful hardy plants for borders, beds and for cutting, 3 ft.	
Moerheimi. Rose and white.....	.15
Finest Mixed .....	.10
<b>LYCHNIS</b> ( <i>Rose Campion</i> .) Hardy plants of easy culture, bearing clusters of brilliant scarlet flowers. ....	.05
<b>PHLOX</b> ( <i>Decussata</i> .) Hardy plants producing large heads of showy flowers, 3 ft.	
Finest Mixed.....	.10
<b>POPPY</b> ( <i>Papaver</i> .)	
Oriente. One of the most striking and showy of the garden perennials; flowers large brilliant crimson with a black blotch on each petal.....	⅓ oz. 25c. .10
Iceland. Brilliant colors. Blooms first year from seed.....	⅓ oz. 15c. .05
<b>POLYANTHUS</b> ( <i>Primula Elatior</i> .) Early spring free-flowering plants, fine for either pot or outdoor culture; 9 inches.	
Finest Mixed.....	\$0.10
<b>RUDEBECKIA</b> ( <i>Cone-Flower</i> .) Robust-growing plants, very popular for border decoration.	
Newmanii. golden yellow with black center.	.10



SWEET WILLIAM

<b>SWEET WILLIAM</b> . An old-fashioned plant, producing large heads of beautifully colored, sweet-scented flowers. It is hardy and easily grown. 1½ feet.	
Holborn Glory. Large flowers of the most beautiful shades.....	¼ oz. 25c. .10
Auricula-Flowered. Single varieties mixed .....	¼ oz. 25c. .10
Pink Beauty. Rose pink.....	¼ oz. 25c. .10
Double Varieties. Mixed.....	¼ oz. 30c. .10
<b>SWEET ROCKET</b> . Very fragrant, growing freely in ordinary soils, 2 ft.	
Mixed. Purple and white.....	.05
<b>VIOLET</b> , Sweet-scented. Fragrant, spring-blooming plants.	
Single Mixed. Blue and white.....	.10

# SUMMER-FLOWERING BULBS

## GLADIOLUS

Attractive summer-flowering bulbs. They will grow in any good garden soil. Plant 6 inches apart and 4 inches deep.

**America.** The color is a beautiful flesh pink; very large flowers. 6c. each, 50c. per doz. postpaid, by express \$3.00 per 100.

**Baron Hulot.** Rich, deep, indigo blue. 6c. each, 60c. per doz. postpaid, by express \$4.00 per 100.

**Brenchleyensis.** Vermilion-scarlet. 5c. each, 50c. per doz. postpaid, by express \$2.75 per 100.

**Chicago White.** White, lavender marking in throat. 8c. each, 60c. per doz. postpaid, by express \$4.00 per 100.

**Empress of India.** Deep velvety maroon. 10c. each, \$1.00 per doz. postpaid, by express \$6.00 per 100.

**Glory of Holland.** Large pure white with lavender anthers. 10c. each, \$1.00 per doz. postpaid, by express \$6.00 per 100.

**Liebesfeuer.** Brilliant red extra large flower. 20c. each, \$2.00 per doz. postpaid.

**Mrs. Francis King.** Beautiful vermilion scarlet. 6c. each, 60c. per doz. postpaid, by express \$4.00 per 100.

**Mrs. Frank Pendleton, Jr.** Bright salmon-pink, very large flowers. 10c. each, \$1.00 per doz. postpaid, by express \$6.50 per 100.

**Niagara.** Large creamy white flowers, splashed with carmine. 10c. each, \$1.00 per doz. postpaid, by express \$6.00 per 100.

**Panama.** A deeper pink than America, long strong spike with large open flowers. 7c. each, 65c. per doz. postpaid, by express \$4.50 per 100.

**Peace.** Flowers large and of fine form; color, pure white, feathered with pale lilac. 10c. each, \$1.00 per doz. postpaid, by express \$6.00 per 100.

**Princes.** Large flowers of a rich, glowing crimson with white on lower petals. 6c. each, 65c. per doz. postpaid, by express \$4.50 per 100.

**Schwaben.** Clear sulphur-yellow with small brown spot in the throat. 10c. each, \$1.00 per doz. postpaid, by express \$7.00 per 100.

**War.** A magnificent variety of rich ox-blood red; shaded with darkest crimson. 20c. each, \$2.00 per doz. postpaid, by express \$12 per 100.

**Pink Shades.** 4c. each, 35c. per doz. postpaid; by express \$2.50 per 100.

**Scarlet and Crimson Shades.** Mixed. 4c. each, 35c. per doz.; by express \$2.50 per 100.

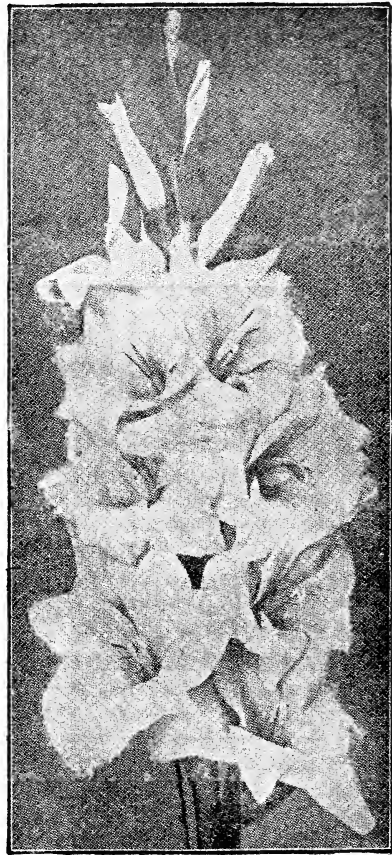

NIAGARA

**BEGONIAS (Tuberous-Rooted).** Unequaled for summer bedding, making a dazzling show throughout the entire season

**Single.** Mixed colors. 25c. each, \$2.50 per doz. Parcel Post prepaid.

**CANNAS.** Fine ornamental plants, blooming from July until frost. Red-flowering, green-foliage Cannas; pink-flowering, orange-flowering, white and cream shades; red gold-edged, yellow shades; bronze-leaved, red-flowering; orchid-flowering. All the above varieties, 15c. each, per doz, \$1.25, by Parcel Post, doz. \$1.50.

**DAHLIAS.** Popular summer and autumn flowering plants. Our bulbs are grown by the Elmwood Dahlia Farm, and are strong grown and healthy. The varieties we offer include the best of the standard kinds as well as late introductions. Bulbs ready for delivery May 20th. 15c. each, \$1.50 per doz.; by Parcel Post, prepaid, \$1.70 per doz.

SEND US YOUR MAIL ORDERS

# PLANT DEPARTMENT

**PLANTS BY EXPRESS.** We use great care in the packing of plants to be sent by express, but cannot be responsible for delays or conditions when received by the purchaser. No plants sent C. O. D. Shipped by express only, except where noted.

## Vegetable Plants

### ASPARAGUS ROOTS

We offer strong two-year old roots of the following varieties—Mammoth White, Palmetto and Conover's Colossal

25 roots, by express, at purchaser's expense..	\$0.35
25 " by mail.....	.40
50 " by express, at purchaser's expense...	.50
50 " by mail.....	.65
100 " by express, at purchaser's expense..	1.25
100 " by mail.....	1.50
1000 " by freight or express, at purchaser's expense .....	9.00

### CABBAGE PLANTS

	April and Doz.	May delivery 100	1000
Early Jersey Wakefield.....	\$0.15	\$1.00	\$8.00
Copenhagen Market.....	.15	1.00	8.00

	June and Doz.	July delivery 100	1000
Stone Mason Drumhead.....	\$0.40	\$3.50	
American Savoy.....	.40	3.50	
Danish Ball Head.....	.40	3.50	

### CAULIFLOWER PLANTS

	May and Doz.	June delivery 100	1000
Snowball.....	\$0.20	\$1.25	
Danish Giant.....	.20	1.25	

### CELERY PLANTS

	100	1000
White Plume .....	\$0.75	\$7.00
Golden Self-Blanching .....	.75	7.00
Boston Market .....	.75	7.00

### LETTUCE

	Doz.	100
Boston Curled .....	\$0.20	\$1.00
Black-seeded Tennisball .....	.20	1.00

### PEPPER

Large Bell .....	\$0.20	\$1.25
Squash .....	.20	1.25

### RHUBARB ROOTS

Each, \$0.15 \$1.50 \$10.00

### TOMATO PLANTS

#### Box Grown.

"John Baer" Earliana, Ponderosa, Early Detroit, Dwarf Champion, Sunrise, Abbott's Model, Dwarf Stone, Bonny Best Yellow Plum.. 50

## Flowering and Foliage Plants for Summer Bedding

### Bedding plants shipped by express only

	Each	Doz.		Each	Doz.
Ageratum. Dwarf, blue.....	\$0.10	\$1.00	Geraniums. Assorted varieties, 3 in. Pots	\$0.20	\$2.00
Alyssum. White .....	.10	1.00	Geraniums. Assorted varieties, 4 in. Pots	.35	3.00
Calendula. Deep yellow .....	.15	1.50	Geraniums. Ivy-leaved sorts, 4 in. Pots..	.35	3.50
Cannas. Dwarf flowering.....	.20	2.00	Geraniums. Rose-scented, 4 in. Pots.....	.35	3.50
Canna robusta. Tall, dark foliage.....	.20	2.00	Heliotrope. Dark and light .....	.15	1.50
Centaurea candidissima.....	.10	1.00	Hollyhock, Double Assorted.....	.25	2.50
Centaurea gymnocarpa.....	.10	1.00	Lantanas. In variety.....	.20	2.00
Cobaea Scandens.....	.15	1.50	Lemon Verbena.....	.20	2.00
Coleus. Fine varieties. Per 100 \$7.00....	.08	.90	Lobelia. Dark blue.....	.20	2.00
Daisy (Bellis Perennis.) In Baskets.....		.50	Marigold. French and African.....	.15	1.50
Dracaena indivisa.....	.75		Petunia, Double. Assorted colors.....	.30	3.00
Forget-me-not. In Baskets.....		.50	Ricinus (Castor-oil Bean).....	.15	1.50
Feverfew. Double white .....	.15	1.50	Salvia Splendens. Best Scarlet.....	.15	1.50
Fuchsias. Various sorts.....	.35	3.50	Vine, or Periwinkle. 5 in. Pots.....	.75	

## DUTCH BULBS FOR FALL PLANTING

Those beautiful early spring flowers you so much admire are the result of only a small amount of labor in the fall.

Our special Bulb Catalogue of Tulips, Hyacinths, Narcissus, Crocus, Lilies, etc., we issue September 1st. This catalogue we gladly mail to those interested. Send full name and address that we may send you a copy.

Special prices quoted on large orders to be packed separately at the grower's and shipped with our general consignment. These orders must be in our hands by July 1st.

**PRICES QUOTED IN CATALOGUE ARE SUBJECT TO CHANGE WITHOUT NOTICE**

# BUCKEYE INCUBATORS

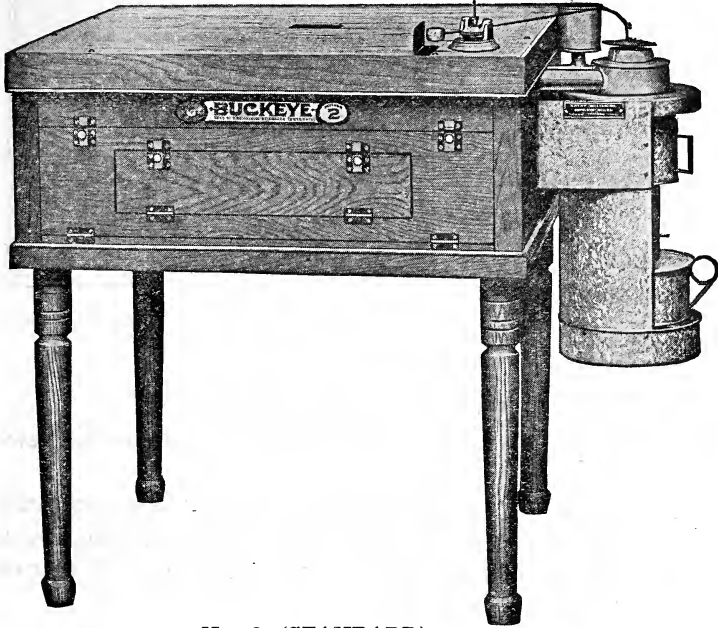

No. 2 (STANDARD)

## The "Standard" Hot Water Hatching Device

Every Buckeye "Standard" Incubator bears the Underwriters' Label of Approval.

During the past 25 years over five hundred thousand Buckeye incubators have been sold.

Buckeye incubators are equipped with every desirable device that can possibly add to incubator efficiency and they are sold with an absolute guarantee to hatch a chick from every hatchable egg.

Buckeye incubators are so simple that the beginner can operate them just as successfully as the experienced poultryman—that's why they are so uniformly satisfactory.

### ... PRICES ...

No. 60, Standard, Capacity 65 Eggs,	\$30.00	No. 3, Standard, Capacity 250 Eggs,	\$65.00
No. 1, Standard, Capacity 120 Eggs,	43.50	No. 4, Standard, Capacity 350 Eggs,	77.50
No. 2, Standard, Capacity 175 Eggs,	51.50	No. 5, Standard, Capacity 600 Eggs,	120.00

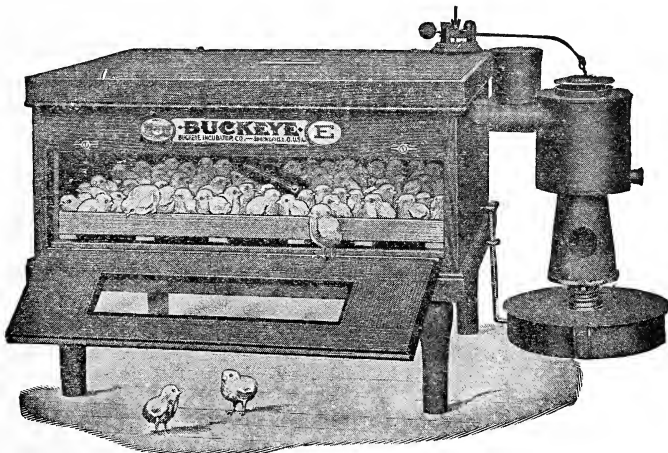

No. 14 (Style E)

## BUCKEYE STYLE E

A Remarkable Incubator  
At a Remarkable Price

With All the Desirable Buckeye Features.

No. 14, Capacity 65 Eggs,	\$18.50
No. 16, Capacity 110 Eggs,	31.00
No. 17, Capacity 200 Eggs,	42.25

Ask For Illustrated Catalogue of Buckeye Incubators.

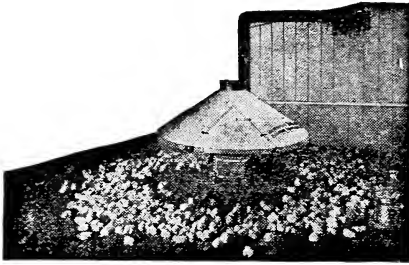

Moving toward or away from the heater, they get the temperature they prefer.

## Newtown Giant Colony Brooder

“BUILT FOR LONG-  
TIME SERVICE”

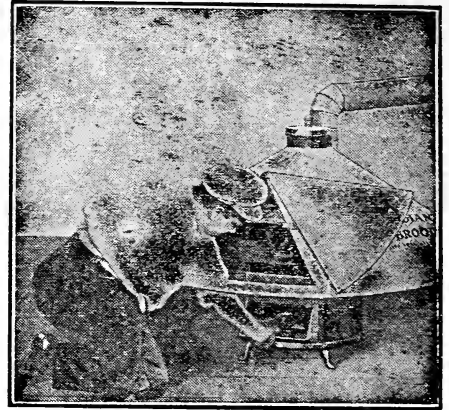

Shaking Grate--Sliding door in Deflector raised

The Great Time, Labor, Fuel and Chick Saver,  
Coal-Burning, Self-Regulating, Simple, Safe and Economical.

Coal is recognized as the safest fuel to use to guard against the burning of property—the Newtown burns coal.

Every part of the Newtown Heater is cast iron with the exception of its heavy sheet metal casing around the fire bowl, which is a *special safety feature*. Air circulates between the heavy sheet metal casing and the hot fire bowl, which prevents over-heating of this part, so that there is no danger of the litter or buildings catching fire. The fire bowl is *not* exposed.

No. 6, For 200 Chicks,	Price \$22.50
No. 7, " 300 "	" 27.50
No. 11, " 500 "	" 35.00
No. 12, " 1200 "	" 42.50

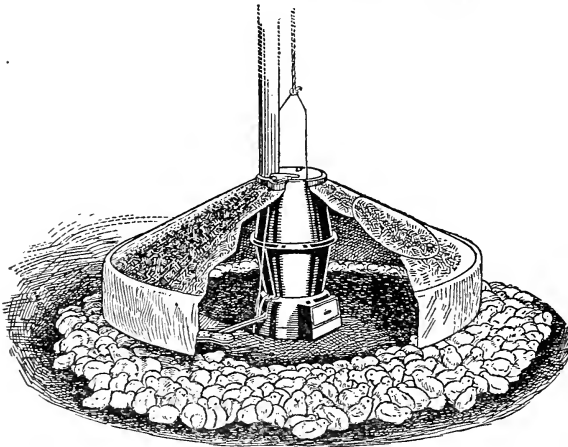

## The Standard Colony Brooder

THE MOST REMARKABLE  
COAL BURNING  
BROODER EVER INVENTED

Makes three chicks grow where one grew before; cuts the cost of equipment to less than half; cuts the cost of operation to less than half; reduces the time and labor to less than a fourth; Guaranteed to raise more chicks and better chicks.

**ABSOLUTE COMFORT FOR THE CHICKS.** It is a well-established fact that every chick is not entirely comfortable in the same temperature—some require a little more heat, while others require less. Under the conditions provided by the Standard Colony Brooder, every chick can seek the precise temperature that suits it best. If it needs plenty of warmth it moves closer to the stove, and if it requires less heat it moves farther away from the stove. They follow the natural inclinations of nature.

**IT IS ECONOMICAL,** as it burns but three to six cents' worth of coal in a day. In ordinary cool weather it cannot burn more than three cents' worth of coal, and with the weather below freezing it cannot burn more than six cents' worth in a day.

Prices: No. 18, 500 Chicks, \$25.50; No. 19, 1000 Chicks, \$31.50

INCUBATORS AND BROODERS TO FILL EVERY NEED



## BUCKEYE PORTABLE BROODERS

The Oil Burning Brooders With all the Desirable Features of the Modern Coal Burner

Guaranteed to be absolutely free from all gases or odors and to provide a circulation of pure, fresh air every minute in the day.

The Outside Shell is made of 28-gauge galvanized steel; the inside shell is 28-gauge black iron, with a one-inch dead air space between.

The Brooder Body is supported by three cast iron legs that are rigidly secured to the sides by a set nut, which makes them easily detachable.



### BUILT IN THREE SIZES

- |                               |               |
|-------------------------------|---------------|
| No. 20, Capacity, 60 Chicks,  | Price \$13.50 |
| No. 21, Capacity, 100 Chicks, | Price 17.00   |
| No. 22, Capacity, 150 Chicks, | Price 21.50   |

Write for Special Catalogue.

## THE LULLABY BROODER

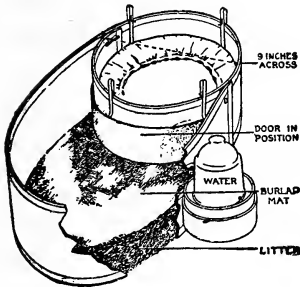

Get away from the old idea that you should keep fifty chickens in a lot. You will make almost, if not quite, as much profit with twenty-five chickens raised in the "Lullaby" way as with fifty raised in the old-fashioned way.

They will make a great deal better use of food consumed, grow larger, hardier, and get to laying earlier, and once you plan your plant properly, you can care for just as many in lots of twenty-five as you did formerly with fifty together.

It is not a question of how many chicks you put together in the spring that tells the profit later. It is "How many did you raise out of every 100 hatched?"

Price, \$2.50; by mail, Postpaid, \$2.60

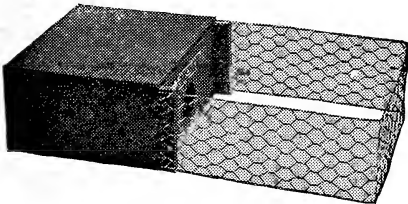

## Buckeye Fireless Brooder

Capacity, 25 Chicks, Price, \$2.00 Parcel Post, \$2.10  
 Size of hover, 12 inches long by 16 inches wide.  
 Size of yard, 16 inches long by 16 inches wide.

## BANNER ROOT CUTTER

No. 7, Exclusively for Poultry

It cuts fast and is easy running. Leaves the feed in fine, brittle, ribbon-like strips that make choking impossible. Fowls large or small can safely eat the feed. The knives are adjustable and made of the very best of steel. An iron gate in bottom of hopper lets dirt and gravel escape before reaching the knives. In this cutter we offer the poultrymen a low-priced, high-grade, nicely finished and mechanically constructed machine. Two to five minutes will cut enough feed for a large flock of fowls. Price \$6.50.



Hatch the chicks! and share in 1921 Poultry profits.



## GRANDIN'S POULTRY FEEDS

Be sure to get the Red Flag Brand of Feeds.

Look for the Red Flag on the Bag, the trade mark of Grandin's Quality Feeds. Best by all tests!

**GRANDIN'S CHICK FEED**—Nothing but the best grains used in this mixture for early and strong growth of the chickens.

**GRANDIN'S GROWING FEED**—Begin to use Grandin's Growing Feed when chicks are two weeks old, and continue till full grown. Keep it before them all the time for best results.

**GRANDIN'S SCRATCH FEED**—Nothing offered the consumer excels Grandin's Scratch Feed. The Best of everything in its mixture is used in the right proportion. Accept no other.

**GRANDIN'S POULTRY MASH WITH BUTTERMILK**—The best Mash made, containing buttermilk, sound grains, fish, meat scraps, etc. For egg production, keep the Mash before the hen all the time.

## SEMI-SOLID BUTTERMILK

for

POULTRY, SWINE AND CALVES

100 Per Cent. Pure Unadulterated Buttermilk, with absolutely nothing added to it, and only the surplus water removed.

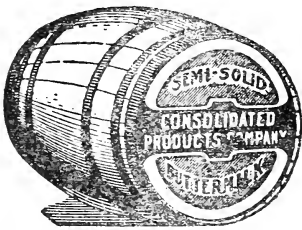

"Nature's own feed"

**BUTTERMILK FOR POULTRY** means healthier and stronger chicks, quicker growth, less mortality, cheaper growth, better pullets, stronger breeding stock, better hatches, more eggs.

**BUTTERMILK FOR SWINE** means better breeding stock, healthier and stronger pigs, cheaper growth, quicker growth, earlier market, more profit.

**BUTTERMILK FOR CALVES** means a saving of whole milk, cheaper growth, healthier calves, consequently better cows.

Special pamphlets and prices on request.

## FRENCH'S POULTRY MUSTARD

Insures healthful and proper conditions at all times. This is not ordinary table mustard, but is prepared for poultry alone. Mix with dry meal, then add water.

Price 1½-lb. pkg. 40c.; 3-lb. pkg. 75c.; 5-lb. pkg. \$1.25; 10-lb. pkg. \$2.40; 25-lb. pail, \$5.50.

PRICES QUOTED IN CATALOGUE ARE SUBJECT TO CHANGE WITHOUT NOTICE



# The Park & Pollard Co LAY OR BUST FEEDS



MANUFACTURED BY  
The Park & Pollard Co 46 Canal St.  
BOSTON, MASS.

**POULTRY FEED SPECIALISTS**



## CONKEY'S BUTTERMILK STARTING FOOD

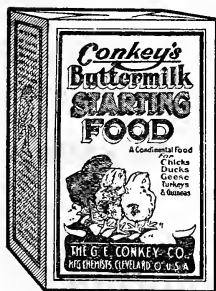

In Conkey's Buttermilk Starting Food you get pure, rich buttermilk in dry powdered form, because Conkey's have found how to remove the great bulk of the water from ordinary buttermilk and still retain the valuable lactic acid with all its digestive and food values. In this dry powdered form, the buttermilk keeps in good condition and is always ready for use whenever a hatch comes off. It is mixed with a combination of clean, wholesome grains that form a balanced ration, just right for little chicks. This makes it a COMPLETE STARTING FOOD for the first three weeks, the most critical period of the chick's life, the time most chicks are lost and the time when egg-producing and other vital organs are forming that mean a profit-making bird or a mere boarder in later life.

The feeding of CONKEY'S BUTTERMILK STARTING FOOD will give you strong, active, vigorous and healthy chicks. One pound will feed twelve chicks for three weeks.

1 lb. pkg. 10c. 100 lbs. \$8.00.

## RAT CORN



**Kill Your Rats, Mice, Gophers and Ground Squirrels**

They simply dry up. Rat Corn is harmless to human beings and live stock.

One pair of rats will produce 900,000,000 rats in five years.

The United States Government states in food alone, rats, mice, gophers, etc., destroy \$200,000,000 every year.

Small Can, 25c. Medium Can, 50c. Large Can, \$1.00.  
Price Includes Postage

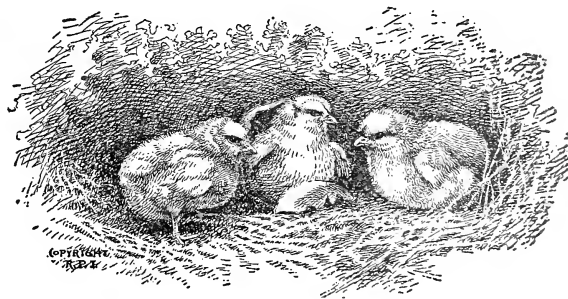

## EGGS FOR HATCHING

At short notice we can furnish Eggs from reliable breeders

ASK FOR QUOTATIONS

### IT PAYS TO HOLD ON!

Poultrymen who had the nerve to hold on through the lean years are now reaping the harvest. With grain prices much lower and eggs sky high, the poultryman who has kept up his flock is now "cashing in." 1921 will be a big poultry year. Will you share in the profits?

## United States Poultry Fence

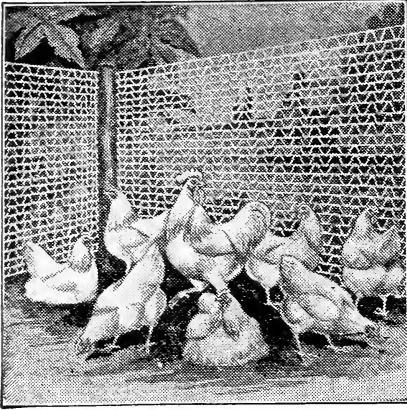

The United States Poultry Fence is galvanized after weaving and will not rust as Fencing galvanized before weaving.

The United States Poultry Fence has proven the best by test. It has long since established its superiority over other makes, and is in a class by itself. It is built to withstand *use and abuse* and is guaranteed to give satisfaction.

The United States Poultry Fence is strictly a "No-Sag" poultry fence, as the combination of line and mesh wires, closely woven, prevents any lengthening or narrowing between posts. In erecting United States Poultry Fence the line wires permit of being stretched to a high tension, which compels the fence to remain rigid and upright. These features place it a long stride beyond the Hex Mesh Netting, which never fails to narrow and lengthen if you attempt to stretch it to a tension required to prevent sagging.

### No. 19. Wire Poultry Fence, 2-inch Mesh

12 in. high, per roll	\$2.48	48 in. high, per roll	\$8.25
24 " " "	4.50	60 " " "	10.30
36 " " "	6.20	72 " " "	12.35

### No. 19. Wire Chicken Fence, 1-inch Mesh

12 in. high, per roll	\$4.95	24 in. high, per roll	\$9.00
18 " " "	7.10	36 " " "	12.35

**SPECIAL AGENTS FOR PORTLAND**

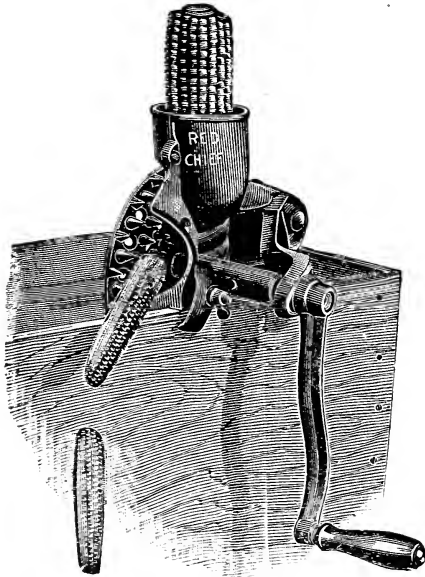

## IMPROVED "RED CHIEF"

### HAND CORN SHELLER

Has patent oval teeth, shelling the corn without cracking the grains. Shells clean, taking off less chaff than any other sheller. Throws the cobs outside every time. Clamps on barrel or tub as well as on box. Price \$3.00.

## Start Oats Sprouting

The feeding of sprouted oats is no longer an experiment. By feeding sprouted oats through the winter, egg production can be kept up to a much larger degree than otherwise.

### Pine Tree Poultry Shipping Crate

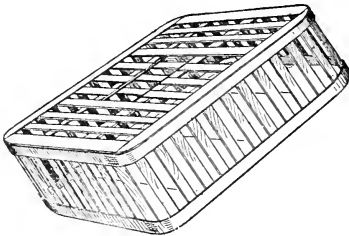

Made of Green Elm, then thoroughly dried. The round corners prevent injury and loss by crowding, so frequent in square cornered crates.

Dimensions 24in. x 36in. x 12in.

Price, \$2.50

### Economy Oat Sprouter

This Sprouter employs the natural process for sprouting. No heat necessary.

The Tray contains five Sprouting Pans and one Drip Pan 16x17 inches.

Made of galvanized iron—will not rust.

Price, \$7.50

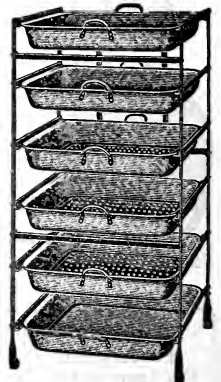

**SEND US YOUR MAIL ORDERS**

### THE ANDERSON EGG BOX

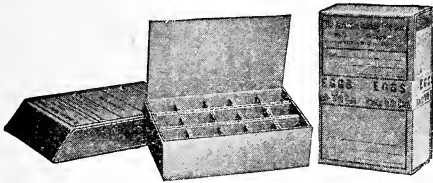

Made of corrugated paper with double faced corrugated paper partitions protecting each individual egg. Folded flat for Shipment.

	Each	Doz.		Each	Doz.
1 Setting	\$0.40	\$4.20	50 Egg Size	\$0.85	\$9.00
2 Settings	.60	5.90	100 Egg Size	1.25	12.50

### PARCEL POST EGG BOXES

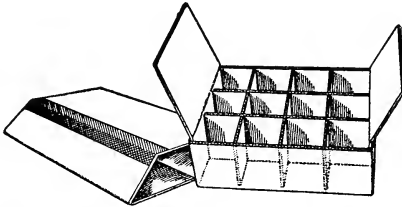

	Each	Per Doz.
1 Doz. Size, 7 $\frac{3}{8}$ x5 $\frac{3}{8}$ x2 $\frac{3}{8}$ inches,	\$0.20	\$2.00
2 Doz. Size. 7 $\frac{3}{8}$ x5 $\frac{3}{8}$ x5 $\frac{1}{4}$ "	.25	2.70
3 Doz. Size. 7 $\frac{3}{8}$ x5 $\frac{3}{8}$ x8 "	.35	3.45
4 Doz. Size. 11 $\frac{1}{2}$ x7 $\frac{3}{8}$ x5 $\frac{1}{4}$ "	.45	4.35
5 Doz. Size. 9 $\frac{1}{2}$ x7 $\frac{3}{8}$ x8 "	.50	5.10

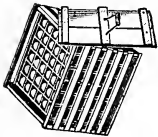

### Humpty Dumpty Folding Egg Crate

A very light, strong and convenient egg crate and carrier.

Size	Each	Per Doz.
3 Doz.	\$0.30	\$3.25
6 Doz.	.35	3.75
9 Doz.	.40	4.25
12 Doz.	.45	4.50

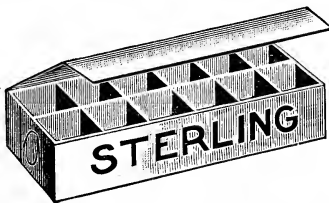

### "STERLING" PAPER EGG BOXES

These boxes are intended for use in delivering eggs to private families. They are of a very convenient size, are shipped knock-down and can be readily set up.

Net price per doz.	
" " " 25	\$0.30
" " " 50	.55
" " " 100	2.00

### SEFTON LIVE CHICK BOX

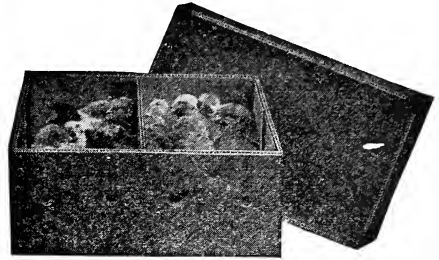

Made from best grade of corrugated paper. For shipment it is folded flat, but can be easily set up and made ready for use.

	Each	Doz.
25 Chicks. Size 13 x 7 x 5	\$0.40	\$3.65
50 Chicks. Size 14 x 13 x 5	.50	4.75
100 Chicks. Size 26 x 14 x 5	.70	7.00

### EYRIE SHIPPING COOP

A Strong, Light Weight Coop for Shipping Fancy Fowls

The body is made from extra heavy Corrugated Fibre Board, protecting the fowls from draughts, heat and cold. The top and bottom are strongly constructed of wood. They are folder flat for shipment greatly reducing freight and express charges.

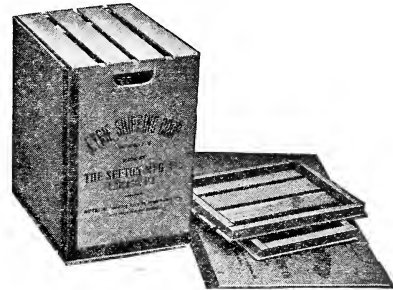

No.	A	Size	Each	Doz.
	A	12x16x18 inches	\$1.15	\$11.50
	B	12x18x22 "	1.35	14.50
	C	12x22x22 "	1.45	16.00
	D	20x22x22 "	1.70	19.00
	E	20x24x22 "	1.80	20.00

### NEST EGGS

Porcelain. Each, 3c., doz. 30c. Lime (medicated), each 4c., doz. 35c. Add 8c. per doz. if wanted sent by mail.

### WATERPROOF SHEETING

Use waterproof sheeting in the windows of your hen house in place of glass. Then there will always be a circulation of pure, dry air and no steam, as caused by glass. You will notice that the Experiment Stations use it. 30c. per yard.

**PRICES DO NOT INCLUDE POSTAGE OR EXPRESS CHARGES**

## Sexton's Dry Feed Hopper

Easy to Fill. No Waste. Rat Proof.  
Dust-Proof

The lower cover is so arranged that it is held up by locking the top cover of Hopper over same, and by raising the top cover the lower cover will fall in place.

This Hopper is arranged to hang on the wall the desired distance from the floor, and never need be removed from the wall to be refilled. It is impossible to waste any feed, as the pan at the bottom takes any feed that may be picked out and the last crumb can be used, therefore saving any waste. The body being covered keeps feed dust-proof and clean, and is always dry.

Body made of galvanized iron and the grating is of round galvanized wire, preventing the Poultry from cutting their bills. Price, \$2.00.

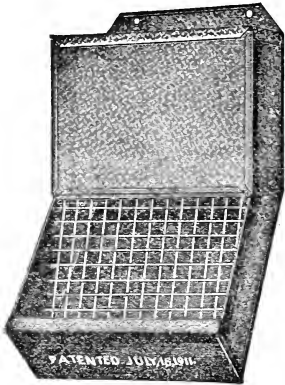

OPEN



CLOSED

### The Apaco Poultry Feeder



This Feeder in general design is built on the same lines as the well-known Norwich Automatic Feeder, but it is a hanging machine rather than arranged with adjustable standard.

The machine is complete with the all-important adjustable valve for regulating the discharge from the hopper, and may be relied upon as a **thoroughly dependable and practicable machine.**

One size only. 12 quarts capacity. Price \$2.00. Parcel Post, weight 5 lbs.

### Junior Chick Feeder

FEEDS DRY MASH  
OR HARD GRAIN

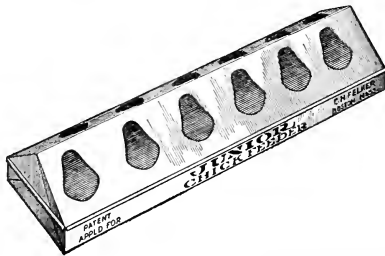

FEEDS SOUR MILK  
OR WATER

Price, 35c. each. By Parcel Post, 40c.

### "Overall" Feeders



These feeders are made of heavy stoneware, are very strong and durable, easily cleaned and never clog, inexpensive, always accessible and at the same time the birds cannot waste the feed.

6 quart size, 95c. each. 8 quarts size, \$1.10 each.

### The Portland Self-Feeding Hopper

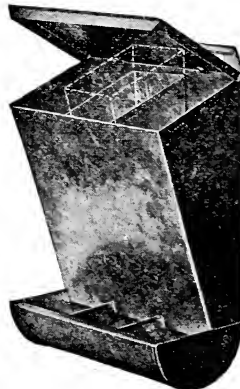

Made of Galvanized Iron, with portable partitions, so that they may be made into one, two, or three compartments as desired. Will not Clog.

No. 1 \$1.10 each  
No. 2 1.25 each

Mailing weights 3 and 4 lbs.

**PRICES DO NOT INCLUDE POSTAGE OR EXPRESS CHARGES**

**THE DUPLEX FOUNTAIN**

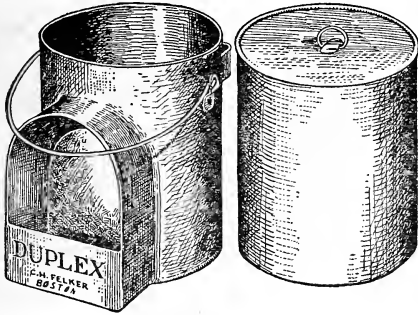

The latest and most practical sanitary fountain on the market. This is a double fount, keeps the water clean and pure. Easy to fill. Easy to care for. 4-qts., \$1.25, Parcel Post, weight 3 lbs.; 8-qts., \$1.50, Parcel Post, weight 4 lbs.

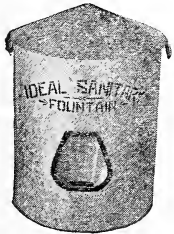

Keeps water cool in Summer and warm in Winter

**Ideal Sanitary Poultry Drinking Fountain**

The simplest, handiest and most practical fountain made. Keeps water the right temperature all the year. Has no lamps to trim and valves to get out of order. Saves time, labor, and worry and costs nothing to run.

The fountain is made of galvanized iron, and is similar in construction to the fireless cooker, being packed with a non-conducting material to retain the temperature of the water.

Size	Extreme height	Diameter	Price
2 gallon	15½ inches	13 inches	\$5.00
5 gallon	17 inches	14 inches	5.50
3 gallon	20 inches	16 inches	6.50

**Norwich Automatic Air-Lock Fountain**

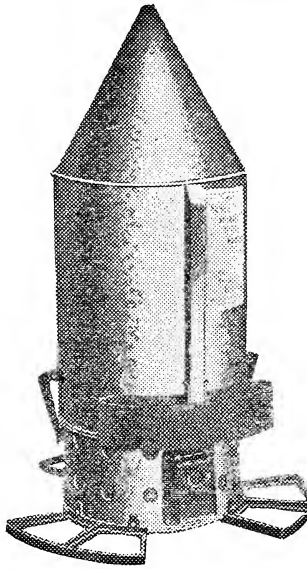

The most perfect device ever placed on the market for automatically supplying pure, fresh water in the poultry house. It is a physical and absolute impossibility to contaminate or pollute the water supply, and requires cleaning about once in three months, only.

Guaranteed frost-proof to ten degrees below zero.

Made in one size only, 5 gallons capacity.

Complete with Burner Base \$7.50.

Without Burner Base, \$3.50.

Mailing weight, 17 lbs.

**The Peerless Brooder Fountain**



It is the ideal fountain for small chickens. Easy to fill and easy to clean.

Price, 40c.

Mailing weight, 2 lbs.



**CUPS FOR POULTRY COOPS**

These cups are made to hang inside of exhibition coops or cages and can be used for birds or small pet animals.

No. 1 holds ½ pint.....\$0.20  
No. 2 holds 1 pint..... .25

**Stoneware Fountains**



They keep the water cool, and it is impossible for chickens to get drowned. 1 qt., 50c; 2 qts., 60c; 4 qts., 75c.

**Carter's Green Food Feeder**

Made of strong, soft twine. Hang in the hen house or yard for poultry feeding. Capacity, one-half bushel of cabbage, beets, clover, etc.

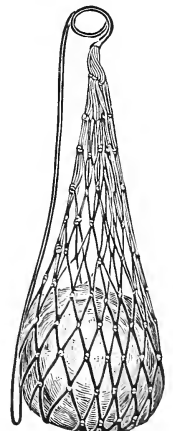

PRICE 35c

By mail, prepaid

PRICES DO NOT INCLUDE POSTAGE OR EXPRESS CHARGES



**Nesco Sanitary Fountain**

Galvanized Pan and Cone-Shaped Top. Easily Cleaned.  
1 qt. 50c.

**The American Feeder and Fountain**

**BEST FOR BABY CHICKS**

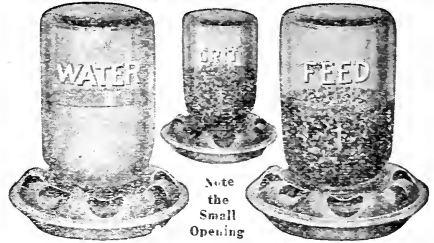

3 Pans 75c POST PAID 4 Pans \$1  
Fit any Mason Jar—Easy to clear

The small openings prevent dirt from getting into the pan—prevent the chicks from getting into the feed or water and prevent them from crowding too close around the feeder.

**SPIR-OL LEG BANDS**



- RED
- WHITE
- BLUE
- GREEN
- BLACK
- PINK
- RUBY
- YELLOW

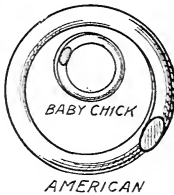
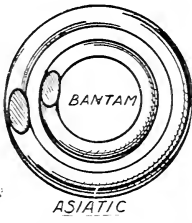

Made of Celluloid

Identify birds as far as you can distinguish colors. Indestructible and can be slipped on and off like a key ring. Sample free. Poultry sizes: 12 for 25c., 25 for 45c., 50 for 85c., 100 for \$1.50, postpaid. Baby Chick Bands: 25 for 25c., 50 for 45c., 100 for 80c., Postpaid.



**FAVORITE LEG BANDS**

(Double Clinch)

This is a popular aluminum leg band with RAISED FIGURES, and can be supplied in consecutive numbers as desired. It is easily attached, and, when in place, cannot be lost off in continuous wear.

Prices: Prepaid by mail, 12 for 25c., 25 for 40c., 50 for 75c., 100 for \$1.25.



**THE VICTOR LEG BANDS**

In Colors with numbers

Made in celluloid and aluminum. Adjustable. Entirely new and different from all others. Large printed numbers, bright and clear colors. Red, blue, yellow and green. Prices: Prepaid by mail: 12 for 50c., 25 for \$1.00, 50 for \$2.00, 100 for \$3.75.



**CAPITAL LEG BANDS**

Made of Aluminum

It is instantly adjustable to the size of the leg. It locks with a double clamp, fits the leg perfectly, and once on, stays on, until you remove it. The Figures are Raised or Embossed and are always clear and distinct. Supplied in consecutive numbers to suit purchaser.

Prices: Prepaid by mail, 12 for 25c., 25 for 40c., 50 for 75c., 100 for \$1.25.



The best small chickmarker, and convenient to carry in the pocket. Postpaid 25c.

**Water Glass**

Put your eggs down in the spring and summer, when they are cheap, and keep them fresh for ten months. One gallon makes sufficient solution for 50 dozen. It has been thoroughly tested. Do not trust eggs to water glass of inferior strength. Water glass must be pure and strong to safely protect eggs.

Prices: 1 pint 25c., 1 quart 40c., gallon \$1.00.





**Sulphur Candles**

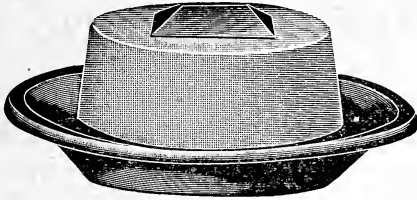

Burns  
Three  
Hours

They are excellent for ridding poultry houses, dog kennels, cellars, outhouses, etc., of most insect pests and disease germs. The vapor from them penetrates crevices which cannot be reached by powders or liquids. Price 15c. each; postpaid, 15c.

**Wire Hen's Nest**

Supported on Walls by hooking over two nails.

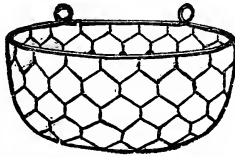

Each, 25c., Per doz. \$2.25

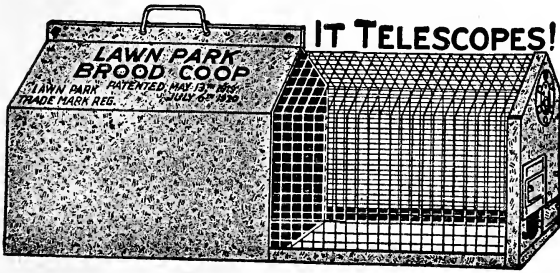

Patented May 13, 1919.



**STERLINGWORTH POULTRY CHARCOAL**

Charcoal aids digestion, promotes health, and is generally corrective of many poultry ills. No poultry raiser can afford to be without it.

- XX (Fine Granulated) for Chicks and Chick Food Mixtures.
- XXX (Medium Granulated) for Half-Grown Fowls, Pigeons, etc.
- XXXX (Coarse Granulated) for Grown Fowls, Geese, Turkeys, etc.

Price: 50-lb. paper lined burlap sacks \$2.50 each.

**MISCELLANEOUS POULTRY SUPPLIES**

Oyster Shells.  
Poultry Grit (Coarse.)  
Chicken Grit (fine.)

Bone Meal.  
Poultry Bone.  
Meat Scraps.

Hemp.  
Millet.  
Sunflower Seed.

Tobacco Dust (in bulk.)  
Powdered Tobacco (in packages.)

WRITE FOR PRICES

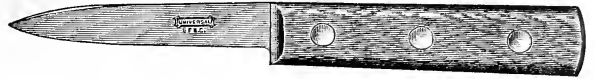

**Universal Poultry Killing Knife**

Every poultry raiser should have one of these Killing Knives. They are made of finely tempered steel.

Price, each, 50 cts. Postpaid.



**The Philadelphia Caponizing Set**

Complete, with instructions.

Price \$3.00, postpaid

**The "LAWN PARK" Brood Coop.**

It is made entirely of galvanized materials, will not rust, and absolutely protects chicks against rats, cats, dogs, hawks, vermin, cold, storms, etc. The metal actually repels lice—that's important. The main part of the coop is made from heavy galvanized steel, while the park is made from strong galvanized wire screen. The "LAWN PARK" is large and roomy, being 18 inches wide, 19½ inches high, and 48 inches long, with park extended. The coop and the park are of equal length. The park permits the chicks to have plenty of sunshine and fresh air and also allows them to range on grass. Can be moved from place to place easily. Coop has removable bottom for quick and easy cleaning. Price, each \$5.00.

# DR. HESS POULTRY AND STOCK PREPARATIONS

Prescriptions by Dr. Hess, M. D., D. V. S.

## Dr. Hess Poultry Pan-a-ce-a



Makes poultry healthy; makes hens lay; not a stimulant, but a tonic that tones up the dormant egg Organs, brings back the scratch and cackle and compels each hen to put her share of eggs in the market basket.

It also contains internal antiseptics that counteract disease; insures a healthy, singing poultry flock. Costs but a trifle—a penny's worth enough for thirty hens per day.

1½ lbs. 30c.; 5 lbs. 75c.; 12 lbs. \$1.50;  
25 lb. pail \$3.00



## Dr. Hess Instant Louse Killer



Kills lice on poultry, horses, cattle; sheep ticks; bugs on cucumber, squash and melon vines; cabbage worm, slugs on rose bushes, etc. Sold in sifting-top cans. Look for the word "Instant" before buying.

PRICE, 1 lb. 30c. 2½ lbs. 60c.

## Dr. Hess Dip and Disinfectant

Non-poisonous and non-irritating, and guaranteed to be absolutely uniform in strength at all times. One gallon of Dip makes from 70 to 100 gallons effective solution. Spray it on roosts. Sprinkle it over the runs and in all cracks and crevices. Spray it on cattle and horses. Makes a splendid dip for hogs and sheep. It's a sure parasite and disease germ destroyer. Purifies stables, troughs, sinks, drains.



Pt. 50c., Qt. 75c., 2 Qts. \$1.25, Gal. \$2.00

## Dr. Hess Stock Tonic

Formula printed on every package

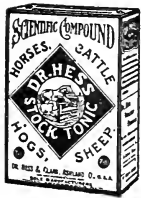

Every ingredient indorsed by the U. S. Dispensary and other high medical authorities. It aids digestion, makes stock healthy, and expels worms. Helps stock convert more ration into milk, flesh, blood and muscle. Every pound backed by the Dr. Hess & Clark unqualified guarantee.

2½ lbs. 30c.; 5 lbs. 60c.; 12 lbs. \$1.25  
25 lb. pail \$2.50; 100 lb. drum \$7.50

## Dr. Hess Worm Powder

For horses, sheep, cattle and hogs. It is highly concentrated and is an effective vermifuge. Dr. Hess' own prescription that proved effective in his practice.

PRICE, 1½ lbs. 50c.



## Dr. Hess Healing Powder

The modern gall cure. Cures galls, cuts, wounds, ulcers, grease heel. Antiseptic and soothing. Heals everything it touches by forming a coating, cleaning and closing up wounds.

Comes in sifting-top cans.

PRICE, 4 oz. 25c.; 10 oz. 50c.



## Dr. Hess Heave Powder

A dependable preparation for relieving horses of heaves, chronic coughs, asthma, bronchitis, etc.; with careful diet, the frequent use of this valuable preparation will afford permanent relief in the majority of cases.

PRICE, 1½ lb. package 50c.



## Dr. Hess Roup Remedy

For the treatment and prevention of Roup, Diphtheria and all catarrhal diseases of fowls.

Price, 25c. and 50c.

YOUR MONEY BACK IF NOT SATISFIED

PRICES DO NOT INCLUDE POSTAGE OR EXPRESS CHARGES

## The "Facile" Improved Babcock Milk Tester

The "FACILE" Hand Tester is very compact, and is the most favored apparatus, in small compass, for testing milk. Price includes a full set of glass ware, comprising test bottles, pipette, acid measure; also bottle brush and bottle of test acid.

2-Bottle Machine	\$7.00	6-Bottle Machine	\$17.00
4-Bottle Machine	8.00	8-Bottle Machine	18.00

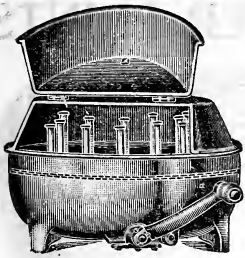

## Champion Milk Cooler and Aerator

Milk cooled as soon as milked makes more and better butter and cheese. Not only cools the milk, but completely aerates it, removing all offensive flavors.



	Capacity of Milk Receiver	Size of Dairy	Takes Care of	Price
No. 2	18 Quarts	10 to 25 Cows	3 Milkers	\$10.50
No. 3	34 Quarts	25 to 50 Cows	5 Milkers	12.50

## Cylinder Churns

No. 1.	3 Gallon Capacity,	\$3.75	No. 3.	7 Gallon Capacity,	\$5.25
No. 2.	4 Gallon Capacity,	4.50	No. 4.	10 Gallon Capacity,	6.00

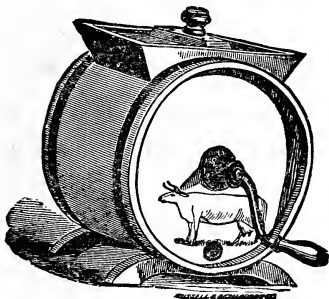

### THE LIGHTNING BUTTER MACHINE

Makes two pounds of milk-charged butter from one pound of butter and a pint of milk.

It is unsurpassed as a general household article for making salad dressing, whipping cream, mixing light batters, and other uses which will become apparent to every housewife.

Made in Four Sizes. Price, each,  
1 qt. \$1.75; 2 qt. \$2.25; 3 qt. \$2.75;  
4 qt. \$3.00.

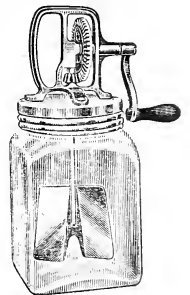

### Folding Paraffined Butter Boxes

1 Pound  
(2 Pieces),  
Price,  
\$1.50 per 100

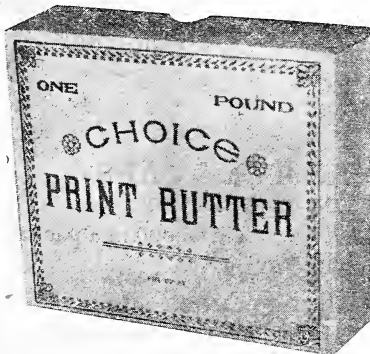

## The Pilling Milk Fever Outfit

For Air Treatment

This treatment recommended by the Bureau of Animal Industry, United States Government, Department of Agriculture.

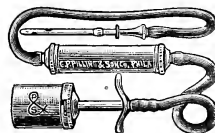

Price \$3.50 postpaid.

SEND US YOUR MAIL ORDERS

PRICES QUOTED IN CATALOGUE ARE SUBJECT TO CHANGE WITHOUT NOTICE

# THE KINERSON COMBINATION BUTTER PRINTS

These Butter Prints are largely used and give perfect satisfaction; practical, simple and durable.

Prints engraved to order with simple design, initial or monogram, without extra charge.

For special design a small advance on the list will be charged.

A paddle and two cutters are furnished with each print.

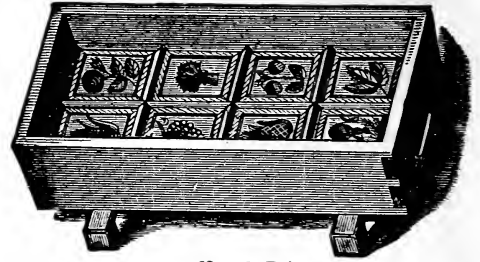

No. 6 Print

No. of Print	No. of Cakes	Capacity of Moulds in lbs.	Capacity of Each Cake in ounces	Dimensions of Moulds in inches	Dimensions of Each Cake	Price
2	4	2	8	11 x 3 $\frac{3}{4}$	3 $\frac{3}{4}$ x2 $\frac{3}{4}$	\$6.50
3	4	2	8	12 x 3	3 x 3	6.50
4	4	1	4	4 $\frac{1}{2}$ x5	2 $\frac{1}{4}$ x2 $\frac{1}{2}$	5.75
5	4	1	4	10 x 2 $\frac{1}{2}$	2 $\frac{1}{2}$ x2 $\frac{1}{2}$	6.50
6	8	2	4	10 x 4 $\frac{1}{2}$	2 $\frac{1}{4}$ x2 $\frac{1}{2}$	7.50
10	24	1 $\frac{1}{2}$	1	10 x 4	1 $\frac{1}{4}$ x1 $\frac{1}{3}$	9.25
12	8	4	8	11 x 5	2 $\frac{3}{4}$ x2 $\frac{1}{2}$	8.80

## BLANCHARD BUTTER MOULDS

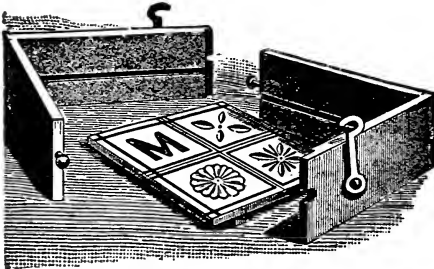

- 1/2 Pound, 2—1/4 lb. Prints, Parcel Post, weight, 1 lb. \$0.75
- 1 Pound, 4—1/4 lb. Prints, Parcel Post, weight, 2 lbs. .85
- 2 Pound, 8—1/4 lb. Prints. Parcel Post, weight, 2 lbs. 1.25

Initial Engraved, 25 cents extra for each cake

## PARCHMENT BUTTER PAPER

For wrapping and covering butter, for layers and caps on top of tubs, jars, tumblers, etc.

Price, 35c. per lb. By parcel post, prepaid, 40c. per lb.



## MILK OR CREAM BOTTLES

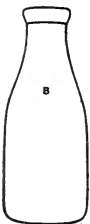

- Half-pint, per dozen
- Pint " "
- Quart " "
- 2 Quart " "

Write for prices

## MILK BOTTLE CAPS

PLAIN OR PRINTED

- 1,000 in a package
- 5,000 in a package

Write for prices.

## Milking Tubes

For Sore and Obstructed Teats and Hard Milking Cows



Price Postpaid, 25c.



**Atlantic  
"SANITARY"  
Dairy Pail**

Soldered Inside and  
Outside

14 Quart, Price, \$2.50

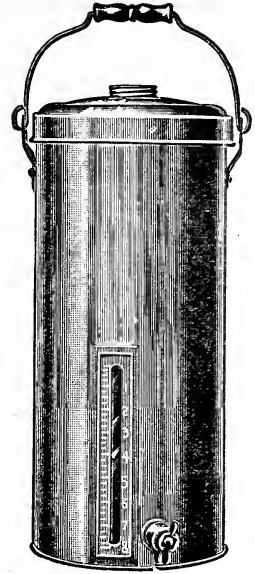

No. 430 Cream Pail  
20 quart, Price, \$3.25



**SMALL'S  
CALF  
FEEDER**

Extra Nipples 40c. each.  
Price, \$4.00

**Dairy and Water Pail**

10 Quart, Price, \$1.15

12 Quart, Price, \$1.25



**Atlantic Strainer Dairy Pail**

12 Quart, Price, \$2.00; 14 Quart, Price, \$2.10



**Cream Pails**

Ventilated Covers, retinned

16-qt., Price, \$2.00; 20-qt., Price, \$2.25;

24-qt., Price, \$2.50

THE NEW  
**SHARPLES**



SUCTION-FEED  
TUBULAR  
CREAM SEPARATOR

The New Sharples Suction-feed Separator saves 50% in cost of operation, in labor of cleaning, in oil and in repairs and *it saves ALL the cream.* The New Sharples requires no speed indicators. It skims clean and produces cream of uniform density at any speed. 28 new features never before used in cream separator construction are represented in the New Sharples Suction-feed Tubular. It is absolutely automatic in its feeding, skimming and separating functions and, even in the hands of a beginner, it cannot lose butter-fat or produce uneven cream.

*Handsome New Catalogue Sent Free On Request*

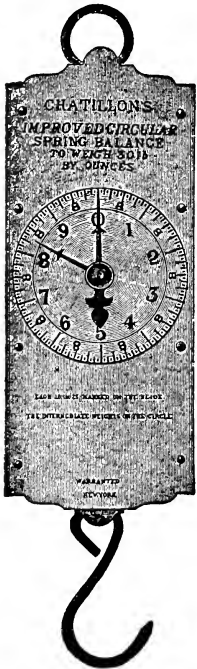

Milk Scale

**Milk and Cream Scale**

The cut represents a special scale designed for weighing milk in the pail, so as to determine the yield of each cow.

30 Pounds Capacity, Price, \$4.00  
60 Pounds Capacity, Price, 4.50

**WE CARRY IN STOCK**

Butter Ladles	Graduating
Butter Spades	Glasses
Milk Pipettes	Test Bottles
Acid Measures	Separator Oil

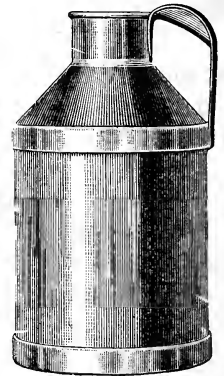

**MILK CANS**

We can furnish any style or size

*Write for quotations*

**WELLS, RICHARDSON & CO.'S BUTTER COLOR**

Purely Vegetable. Always gives satisfaction

Small size, 4 oz., 25c.

Medium size, 10 oz., 50c.

Large size, 24 oz., \$1.00

**SEND US YOUR MAIL ORDERS**

**PRICES QUOTED IN CATALOGUE ARE SUBJECT TO CHANGE WITHOUT NOTICE**

# THE HORNE VERTICAL CAN STRAINER

Made of heavy charcoal tin, all inside joints thoroughly soldered and no angles for accumulation of filth.

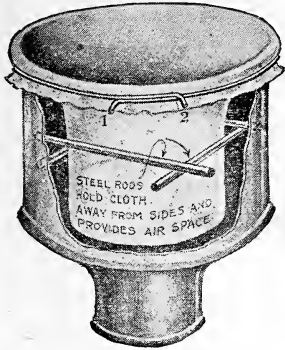

Price of Strainer	\$2.25
Price of filtering flannels 22x22 in. per doz	2.00
Price of filtering flannels each	.20

Write For Descriptive Circular

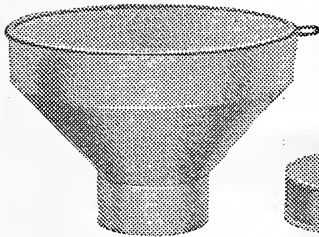

## SANITARY MILK STRAINERS

Extra heavy retinned seamless.

70-Mesh Brass Strainer Cloth.

With extra slip foot for cloth.

3 Quart	...	\$1.00
6 Quart	...	1.25



Booklet, "The Home Cow Doctor," free.

Price 60c. and \$1.20 per can

## Chester Milking Stool

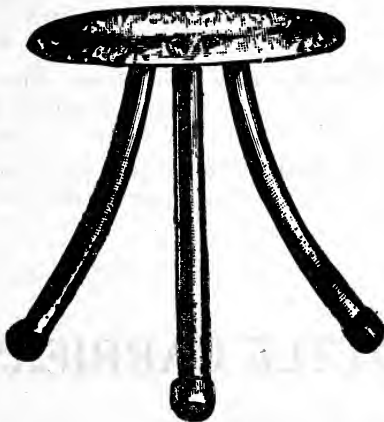

The Chester All Metal Milking Stool is sanitary. The legs and top are steel. The casting that holds the legs is malleable iron, consequently it is practically indestructible. Your stable is incomplete without them.

Price, each .....\$2.00

## Grange Garget Cure

Cures garget without in any way injuring the cow or lessening the flow of milk.

Price 60c. per can

## Worcester Salt

"The Standard of Quality"



# DAIRY BRUSHES



No. 72



No. 67



No. 33



No. 89



No. 47



No. 50



No. 81



No. 6



No. 106



No. 416

No. 72. Hand Bottle Brush. Black China Bristle, brush part  $2\frac{3}{4}$  inches diameter, handle  $\frac{1}{8}$  inch diameter, 9 inches long.....55c. each

No. 67. Hand Bottle Brush. Extra Stiff Grey Hair, brush part 3 inches diameter, handle  $\frac{5}{8}$  inch diameter, 10 inches long.....45c. each.

No. 33. Sharples Bowl Brush. Palmetto Fibre, brush part 2 inches diameter, 3 inches long, length over all 18 inches.....40c. each.

No. 89. Hand Can Brush. Grey Tampico, brush part 5 inches diameter, 5 inches long, length of handle 24 inches, length over all 29 inches....\$1.10 each.

No. 47. Bowl Brush. Black Tampico, brush part  $3\frac{1}{4}$  inches diameter,  $5\frac{1}{2}$  inches long, length over all  $13\frac{5}{8}$  inches.....80c. each.

No. 50. Hand Bottle Brush. Grey Horse Hair Body, Grey Tampico Tufts, brush part  $3\frac{1}{4}$  inches wide,  $2\frac{1}{4}$  inches thick, handle 10 inches long. 40c. each.

No. 81. Machine Bottle Brush. Stiff Grey Hair, brush part 3 inches diameter, handle 5 inches long, tapered to  $\frac{1}{2}$  inch diameter at end....75c. each.

No. 6. Sharples Feed Tube Brush. Grey Russia Bristle, brush part  $\frac{5}{8}$  inch diameter, 2 inches long .....10c. each.

No. 106. Separator Feed Tube Brush. Black China Bristle, brush part  $\frac{1}{4}$  inch diameter, 2 inches long, length over all  $6\frac{1}{4}$  inches.....40c. each.

No. 416. Can Brush. Stiff Palmetto Fibre, brush part 5 inches wide, 4 inches long, length over all 10 inches .....75c. each.

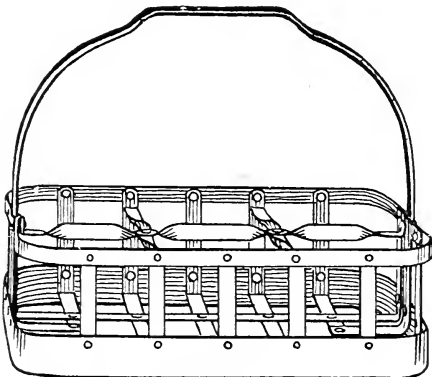

# MILK BOTTLE CARRIERS

4	Bottle (Quarts)	round wire	\$1.00
6	"	" " " "	1.50
8	"	" " " "	1.75
6	"	" flat wire	2.00
8	"	" " " "	2.75



# North Star Wool Fat

(Antiseptic Compound)

This natural skin-fat quickly heals scratched or chapped teats and relieves feverish or caked udders. Dairymen find that cows require less time to milk and "give down" more freely when their udders and teats are kept smooth, healthy and pliable by the frequent application of North Star Wool Fat.

Horse owners can prevent loss of valuable time during the busy season by the judicious use of North Star Wool Fat. It relieves:

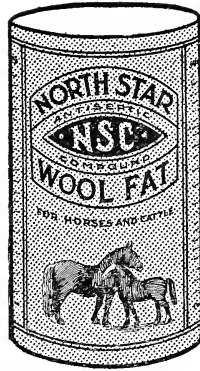

**SORE SHOULDERS**  
**WIRE CUTS**  
**COLLAR GALLS**

**CORNS**  
**HARD AND CONTRACTED FEET**  
**CRACKS**

**SKIN DISEASES**  
**THRUSH**  
**GREASE HEELS**

Applied to calves, pigs and lambs after altering, it protects and heals.

Price: 18 oz. can \$1.00

8 oz. can 50c.

Send for generous sample—FREE



## USE GERM-X IN YOUR DAIRY

Germ-X is a non-poisonous disinfectant. It will sterilize milk cans, bottles, separators, etc. It is more efficient than live steam applied for the same length of time. It loosens slime—saves from one-half to three-fourths the time required for cleaning dairy utensils. Price per gallon, \$2.50. Five gallons, \$10.00.

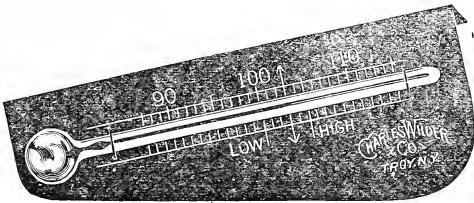

No. 1052

### THERMOMETERS

No. 1052 Incubator, Each	.75
No. 1046 " "	.75
No. 1117 Brooder " "	.75
No. 374 Dairy " "	\$1.00
No. 947 " "	.75

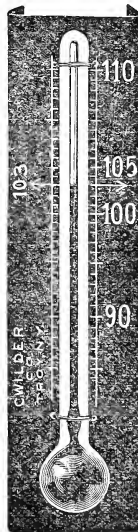

No. 1046



No. 1117



No. 374



No. 947

## For Dairies, Creameries, Etc.



For cleaning vats, pasteurizers, strainers, cans, pipes, separators, and other articles in your plant that have become gummy or tainted with stale odors by the use of soap, soap powder, or some similar washing compound, there is nothing that accomplishes this task so easily, and at such little expense as Wyandotte Dairyman's Cleaner and Cleanser. A daily washing of the dairy or factory equipment will keep everything sweet and clean!

As you may already know, Wyandotte Dairyman's Cleaner and Cleanser is used by four out of every five butter and cheesemakers and by thousands of milk producers. It is the only cleaner recommended by State Dairy College Authorities. We know you will not be without it once you give it a thorough trial, and know what it does, and how little it costs to use.

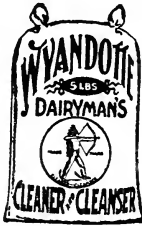

Barrels (bulk) 280 lbs.  
Kegs " 80 "  
Barrels (50-5 lb. sacks)  
5 lb. sack

PRICES ON APPLICATION



## Hotels and Restaurants

Wyandotte Sanitary Cleaner and Cleanser when used for dish washing not only makes the dishes cleaner and brighter than is possible where soap is used, but it also makes the work easier. The same is true in the home.

Drain pipes, sinks, refrigerators, etc., are always kept free and open when Wyandotte Sanitary Cleaner and Cleanser is used.

As a deodorizer and cleaner of everything about the hotel or home it is unsurpassed. We guarantee every claim and you assume no risks or fear of disappointment when you use Wyandotte Sanitary Cleaner and Cleanser.



Barrels (bulk) 280 lbs. }  
Kegs " 80 " } Prices on Application  
5 lb. sacks }

## Wyandotte Detergent

can be used to advantage in cases where a combined abrasive and cleaner are needed

Wyandotte Detergent is quite different in its nature from the "Wyandotte" Dairy or Sanitary Cleaner. It contains a fine, flaky grit which makes it an abrasive and scourer. It also has the freshening and sweetening properties of the other "Wyandotte" products.

For cleaning marble, tile, painted walls, and other similar surfaces, Wyandotte Detergent is unsurpassed. It scours clean, but does not scratch, mar or dull.

Rusty ice cream cans are easily scoured clean with Wyandotte Detergent, and although Wyandotte Detergent is not a metal polisher, for cleaning corroded iron and brass pipes, railings, dirty sinks, urinals, cuspidors and the like it has no equal.



Barrels (bulk) 250 lbs. }  
" (50-5 lb. sacks) } PRICES ON APPLICATION  
Kegs (75 lbs.) }  
5 lb. sacks }

## HOCKING VALLEY CIDER MILLS

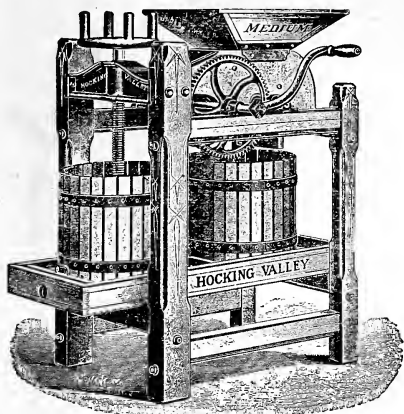

The device for grinding the fruit is the same as is used on the large hydraulic presses, and makes a pomace that yields under the press every particle of juice in the fruit.

An important feature of the mills is the absence of metal of any kind to rust or impair the quality of the cider.

A quart of water will clean it after using.

They are made in the three following sizes:

Senior	Size of Tubs, 13½ in. high, 15½ diam.
Medium	“ “ “ 12 in. high, 12½ diam.
Junior	“ “ “ 10½ in. high, 10 diam.

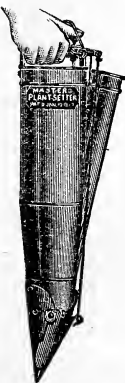

Here is a REAL LABOR SAVER for every Farmer and Gardener

## MASTERS RAPID PLANT SETTER

for transplanting tomatoes, cabbage, strawberries, cauliflower, peppers, asters, and all similar plants.

Each plant is SET, WATERED, and COVERED in one operation. This little machine positively eliminates all of the hard, tedious labor, does perfect work. Is more than three times as fast as hand setting. It is strongly built, and will last for years. Shipping weight 7 lbs., price \$6.75 each.

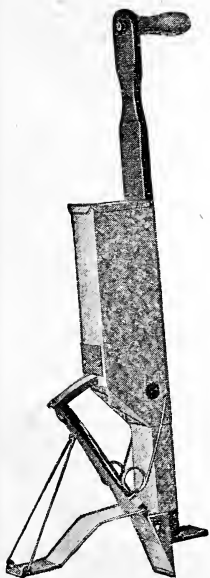

### The Eclipse Rotary Corn Planter

Eclipses all others; has positive feed.

Four changes of discs. Eclipse is the easiest operating planter on the market.

Price, \$2.50

### Cahoon Seed Sower

For Sowing Wheat, Barley, Oats, Buckwheat, Grass Seed, etc.

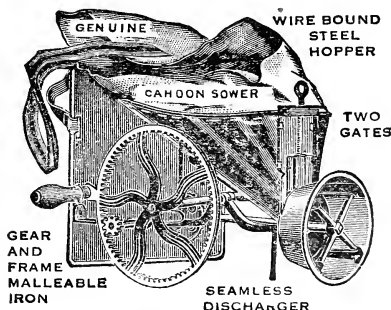

Sows from four to eight acres per hour at a common walking gait, throwing out wheat a distance of 40 feet wide.

Parcel post, weight 9 lbs. Price \$4.50.

# LOUDEN LABOR SAVING BARN EQUIPMENT

BEST FOR THE FARMER—BEST FOR THE HERD

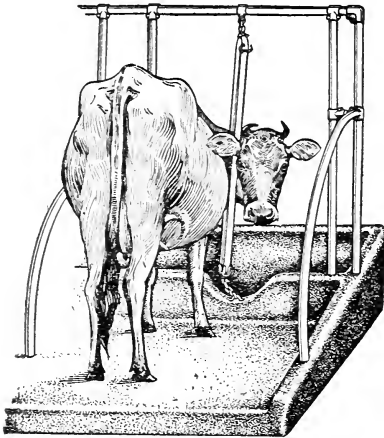

The Louden Steel Stall gives the cow the same comfort and freedom of movement she would have in the field.

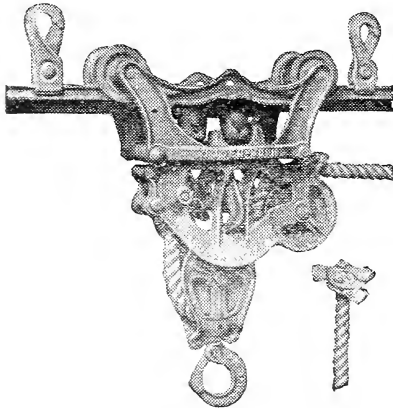

For fifty years Louden Hay Tools have been the world's standard for strength, simplicity and efficiency.

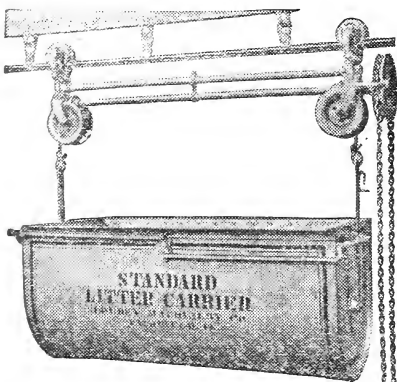

Your time is too valuable to be spent pushing a wheelbarrow. A Louden Overhead Litter Carrier solves the problem.

## We Can Fit Up Your Barn Complete With Louden Modern Sanitary Barn Equipment

Louden equipment makes possible a clean, sanitary barn with a minimum of expense for upkeep.

When cows are transferred from dark insanitary shelters to light, well ventilated, well equipped barns of the Louden type the milk flow invariably increases from 10 to 25 per cent, and the labor of caring for the herd is reduced by one-third or one-half.

The cost of installing Louden equipment is surprisingly small, and it is just as great an economy for the man with half a dozen head of cows as for the man who has to care for hundreds of animals. The percentage of labor saved is the same, and in either case it is 100 per cent profitable.

We are prepared to quote you attractive price on everything for your barn. The items illustrated are only a few products of the largest and most complete line of barn equipment made. Some of these products we carry in stock; others we can secure for you promptly.

### Going to Build or Remodel a Barn?

If so we shall be glad to secure for you, free of cost to yourself, a copy of Louden's \$1.00 book of barn plans. It's the most valuable collection of practical plans and dollar-saving building information ever published. Contains more than 50 plans, with complete description and estimated cost of construction.

It is yours for the asking.

See us or write us in regard to your barn problems. We shall be glad to assist you, and to quote you lowest prices on your complete equipment.

### THE LOUDEN LINE INCLUDES

Everything for the barn.

Hay Tools

Stalls and Stanchions

Steel Pens

Litter Carriers

Feed Carriers

Feed Trucks

Door Hangers

Cupolas and Ventilators

Water Bowls

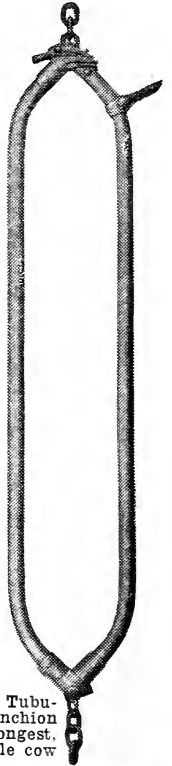

The Louden Tubular Steel Stanchion is the strongest, most comfortable cow tie made.

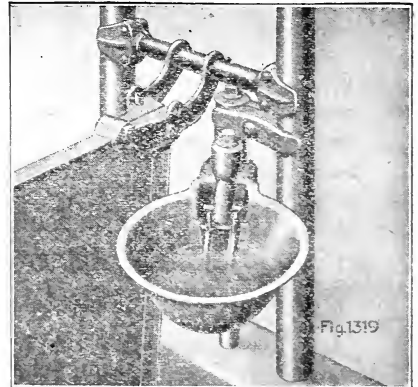

Louden Detachable Water Bowls save time and labor. The cows water themselves.

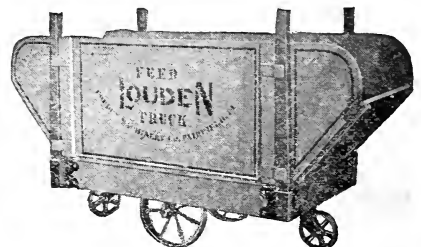

The time and feed you waste in a year would pay for a Louden Feed Truck.

If in doubt let us show you barns we have Loudened.



# Planet Jr. Garden Tools



The "Planet Jr." Catalogue is the best and most instructive book ever issued on a similar subject. Full of little points that bring profit. Full of true and handsome illustrations. We mail it free to any address on application.

## No. 4 Planet Jr. Combined Hill and Drill Seeder, Wheel Hoe, Cultivator and Plow

Price, Complete, \$23.50  
Weight, 50 lbs.  
As a Seeder only, \$18.75  
Holds 2½ Quarts of Seed

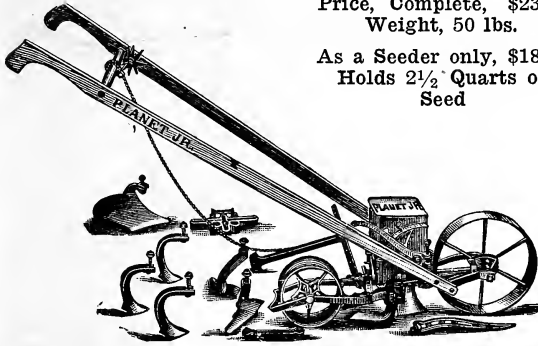

For use as a cultivator, the drill parts are removed and the tool frame substituted by changing but one bolt; it is then a perfect single wheel hoe, with a variety of tools.

## No. 25 Planet Jr. Combined Hill and Drill Seeder, Double Wheel Hoe, Cultivator and Plow

Price, \$26.50

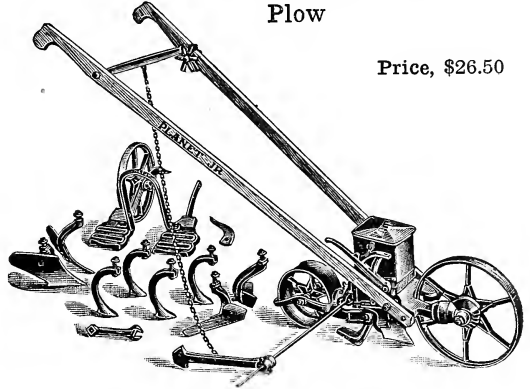

A splendid combination for the family garden, onion grower, or large gardener. It is a perfect seeder, and combined double and single wheel hoe.

## No. 31 Planet Jr. Combined Drill Seeder and Single Wheel Hoe

Price Complete, \$15.50  
No. 31D as a Drill Seeder only \$12.50

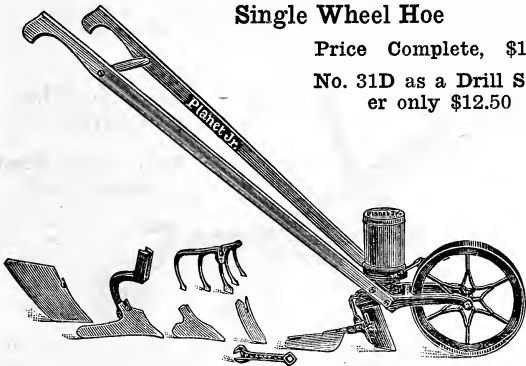

This new tool is of great value to gardeners who have never felt able to own either a seed drill or a wheel hoe. It will sow even a small packet of garden seed with great precision. Quickly changed to a splendid wheel hoe. A special machine for the small gardener.

## No. 12 Planet Jr. Double and Single Wheel Hoe

Price, \$15.50



A single and double wheel hoe in one. Straddles crops till 20 inches high, then works between. Has steel frames and 14-inch steel wheels.

## No. 3 Planet Jr. Hill and Drill Seeder

Price, \$22.00

Holds 3 Quarts of Seed

A favorite among onion growers, market gardeners and seedsmen.

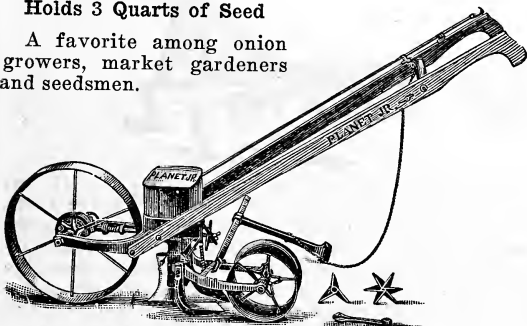

## No. 33 Planet Jr. Single Wheel Hoe

Price, \$8.00

This combination will delight the suburbanite, the growing boy, women, younger or older, who will find it a light running wheel hoe that will save them hard work

and help much to supply the table with fine vegetables.





# Planet Jr. Garden Tools



We offer these Tools as the highest type of their class. They have a great variety of attachments which adapt the implements to a large variety of work, and there is scarcely any garden culture of which they are not capable.

## No. 16 Planet Jr. Single Wheel Hoe, Cultivator, Rake and Plow

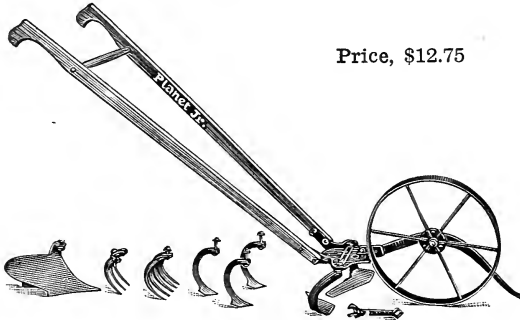

Price, \$12.75

The highest type of Single Wheel Hoe made. Light but strong, and can be used by man, woman or boy. Will do all the cultivation in your garden in the easiest, quickest, and best way.

Nos. 16, 17, and 17½ wheels, frames and handles are alike, but the attachments sold with each vary.

## No. 17 Planet Jr. Single Wheel Hoe

Price, \$10.75

The No. 17 has a pair of 6-inch hoes, a plow and a set of cultivator teeth.

## No. 17½ Planet Jr. Single Wheel Hoe

Price, \$9.15

The pair of 6-inch hoes, three cultivator teeth and leaf lifter which go with it, are all the finest of their kind.



## No. 19 Planet Jr. Single Wheel Hoe, Cultivator and Plow

Price, \$7.50  
15 in. Steel Wheel

This attractive implement is especially designed for the farmer's garden work, though it offers to every one with either field or garden a cheap and effective tool for wheel-hoe operations. The high wheel makes easy pruning.

## No. 8 Planet Jr. Combined Horse Hoe and Cultivator

Price, with Steel Wheel,  
\$25.00

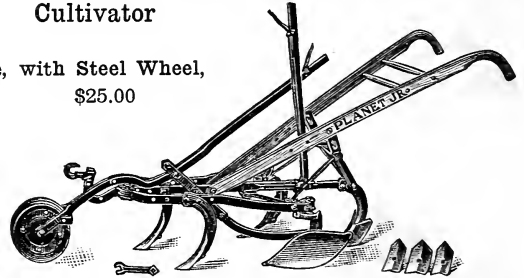

Equipment: Four 3x8-in. plates, one 4x8-in. plate, two 6-in. side hoes, one 7-in. shovel, level wheel, lever expander. Depth regulator.

This is a general favorite, being easily understood and operated. The tool is especially strong, being braced so as to make a stiff, unyielding tool intended for long service.

## No. 9 Planet Jr. Combined Horse Hoe

Price, with Steel Wheel, \$17.25.

This Horse Hoe is identical with No. 8, except that it has no depth regulator and a plain wheel instead of lever wheel.

## No. 9 Planet Jr. Plain Cultivator

Price, with Steel  
Wheel, \$18.75

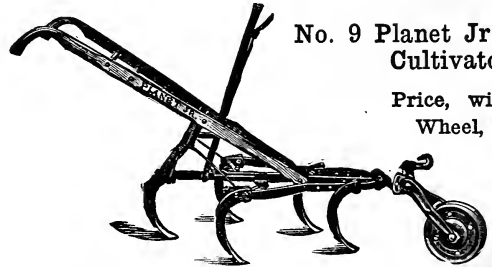

A light and strong tool, having improved patent hollow steel standards, parallel and extra high steel frame, patent lever expanders, handle braces and side adjustments for handles. Used with or without a wheel, the wheel being preferred.

## No. 91 Planet Jr. Twelve-Tooth Harrow

Price with Steel Wheel,  
\$18.75

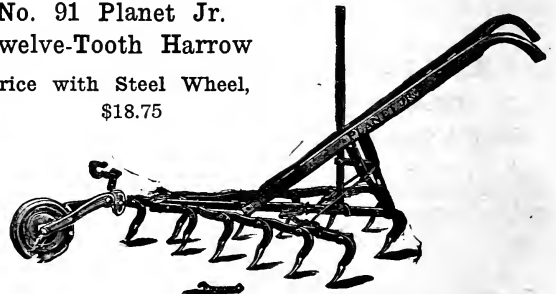

Gardeners cultivate better than formerly. It has been found to pay best. With the Twelve-Tooth Harrow you go as deep or shallow as you like, come up close to row without injuring plants, cut out all the weeds, stir the soil and mellow and fine it as with a garden rake. You widen and narrow as you please between 12 and 32 inches. It's a special favorite with strawberry growers, market gardeners and truckers.

# THE CLIMAX SINGLE WHEEL CULTIVATOR

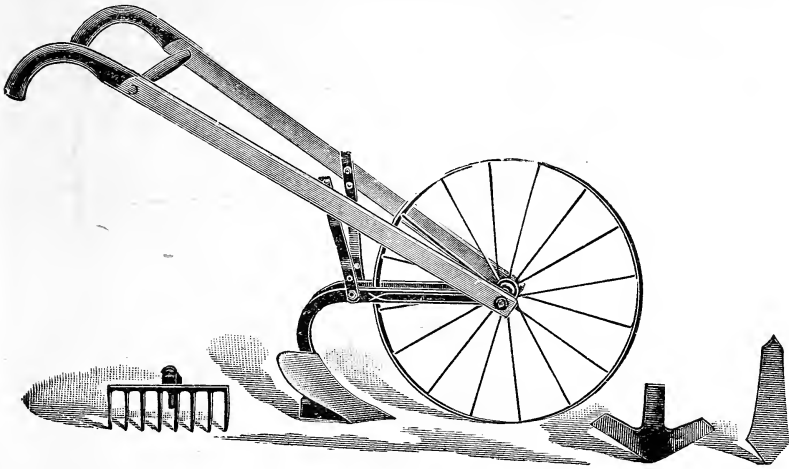

A sturdy high grade, low priced garden cultivator with extra large wire spoke wheel.

Equipment consists of one double end cultivator tooth, one plow, one 11" sweep or coverer and one four-tooth rake.

Price Complete \$5.00

THE PERFECT JAR



## EUREKA FRUIT JARS

Eureka Jars have **straight sides**, as large at the mouth as it is at the bottom, making it easy to fill and easy to empty. No dirt collecting shoulder. **Rubber ring goes on the cover** instead of on the jar, so that housewife has cover all ready to put on the jar when ready to seal.

Whole fruits and vegetables can be easily packed in the Eureka owing to there being no shoulder.

It is more than a fruit jar for it is good for all kinds of canning, whether fruits, vegetables, fish or meats. 1 Pint—1 Quart.



### Fruit Jars "Queen"

1/2 Pint  
1 Quart

1 Pint  
2 Quarts

### GOOD LUCK

*The Original*

### Cold Pack Jar Rubbers

Fit all Popular Jars



### LIBERTY CANNING RACK

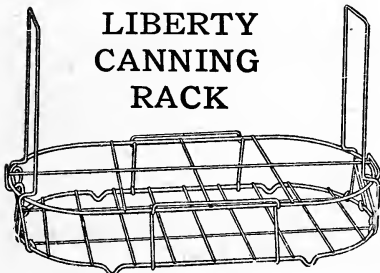

The Liberty Canning Rack fits a No. 8 boiler, which is the smallest boiler ordinarily used, and will be found a great help in putting the jars in and taking them out of the boiler. The partitioned top prevents the jars from striking together, and eliminates the danger of breaking.

Price, 65c.

# SPRAYERS

## The Hudson "Perfection" Sprayer

### HIGH PRESSURE

For potato spraying, whitewashing and general use there is no Sprayer the equal of the Hudson Perfection.

*Pump* has seamless brass tubing, 1 $\frac{3}{4}$ " diameter, 15" long.

*Tank* made boiler fashion, of galvanized steel or brass, 7 $\frac{1}{2}$ x20".

Capacity four gallons.

*Spray Equipment*—Perfection fog nozzle with automatic shutoff, 2 feet of  $\frac{3}{8}$ " spray hose.

The hose is attached to the discharge pipe at the top. This pipe reaches to the bottom of the tank, thus getting all the liquid in the tank.

Galvanized Tank, each \$7.50

Brass Tank, each \$10.50

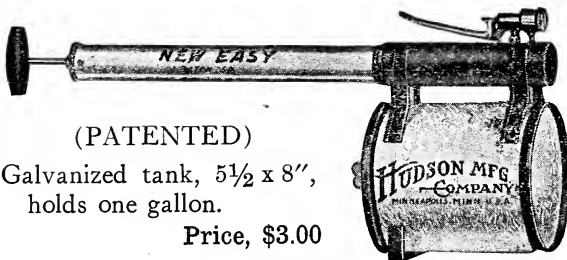
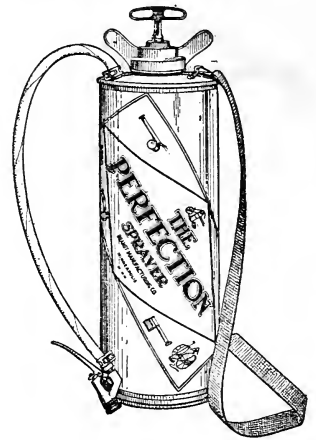

(PATENTED)

Galvanized tank, 5 $\frac{1}{2}$  x 8", holds one gallon.

Price, \$3.00

## Hudson New Easy

### COMPRESSED AIR SPRAYER

The Hudson New Easy is the only hand Sprayer that will throw a fine beaded fog spray. Because of this feature it is peculiarly adapted for use on low lying plants and bushes. It will spray 550 potato hills at one filling.

Pumping is easy because of the short pump. The pump can be detached from the tank.

## Hudson "New Misty"

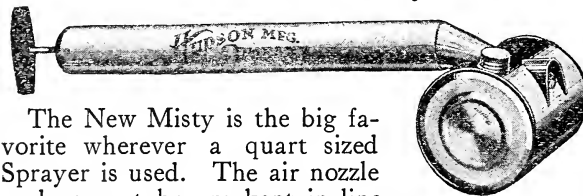

The New Misty is the big favorite wherever a quart sized Sprayer is used. The air nozzle and spray tube are kept in line by the pump passing through the top of the can, which adds greatly to the strength. The entire pump and tank is of high grade tin.

Price, 60c.

## Hudson "Midget" Junior



A small Sprayer for house use. Will handle disinfectants, bug poisons, etc., etc. Made of heavy tin. Holds one pint.

Price, 40c.

## UTILITY TWO WHEEL PORTABLE SPRAYER



No. 85-A.

A very useful and convenient outfit where the nature of the work necessitates the moving about of a large amount of liquid.

It is easily moved about by one hand, which leaves the other free for directing the spray. The steel frame is but 18 inches wide, permitting its use in greenhouses and other places where the passageways are narrow.

The air pressure tank, which is securely mounted on the spider pump casting, is so constructed that a sufficient pressure may be attained and considerable spraying done with one pumping. Tank is supplied with pressure gauge and drain plug.

Tank, 18-gallon capacity, made of heavy galvanized iron, Wheels, 18-inch diameter by 2 $\frac{1}{2}$ -inch face. Equipment, 10 feet of  $\frac{1}{2}$ -inch, 5-ply hose, 4 foot spray rod, and shut-off nozzle. Price, \$46.00.



**Dickey Bug Death Duster**



For use in applying BUG DEATH, DRY to small flower or vegetable gardens. Price, 40c.

**The B. D. Bug Death Sifter**



The B. D. Sifter is the latest hand device for applying BUG DEATH. Easy to operate and gives quick covering to all plants and vines requiring a top application. Price 65c.



**BARRIE'S SOAP SPRAYER**

Made of brass and nickel plated. Soap is placed in the bowl, the sprayer attached to the faucet and the hose to the sprayer. Water entering the bowl agitates the soap, giving a mild insecticide through the hose, while spraying, never injures the plants and is excellent for destroying green fly, etc., in greenhouse and garden. \$6.00 each. Mailing weight 2 pounds.

**Just Slip a Sealed Cartridge in the Gun. THAT'S ALL!**

**IT'S SO QUICK AND EASY**

No Handling--No Mixing  
No Weighing--No Measuring of Chemicals  
And Without the Use of Water.

Key Duster automatically opens Insecticide and Fungicide Cartridges effectively spreading the material just as required.

**Makes Successful Gardening a Pleasure.**

Simply compare the ordinary method of mixing wet sprays or filling loose duster devices with the new patented up-to-date Key Duster simplicity and Cartridge convenience. No longer need you neglect your garden, flowers or fruit because of such troublesome old fashioned practices. You'll enjoy

**More Vegetables--Better Fruit  
Beautiful Flowers or Shrubs**

By using specially prepared Insecticide and Fungicide materials approved by leading Agriculturalists and Agricultural Experimental Stations--all in handy sealed cartridges ready to apply instantly without waste.

Cartridges to Use	Name	Price
For Vegetables and Small Fruit	B. A.	15c each \$1.80 per dozen.
For Flowers and Shrubs	Offoro	15c " 1.80 " "
For Fruit and Vegetables nearly ripe	Hellebore	20c " 2.40 " "
For Aphid and many soft bodied insects	Kaphis	15c " 1.80 " "
For Orchard Fruit	L. A. S.	15c " 1.80 " "

**Handy Sealed Insecticide Cartridges**

KEY BRAND B. A. CARTRIDGE FOR USE IN KEY DUSTER GUN. MANUFACTURED BY INTERSTATE CHEMICAL CO.

KEY DUSTER GUN (length 36 in., Diam 2 3/8 in) 5.00 each

Order your Gun now--You'll enjoy it's ease and it will save --and serve you too--year after year A complete garden spray calendar is supplied with every gun.

**FOR FLOWERS, FRUITS, VEGETABLES AND GARDENS**

**CONTAINS ENOUGH MATERIAL TO DUST ABOUT 100 ORDINARY POTATO PLANTS**

**UTILITY ONE GALLON SPRAYER**

A most convenient size compressed air type sprayer. Especially adapted for sanitary work, disinfecting, etc. Tank, 6 1/4 inches in diameter by 8 1/2 inches high. The discharge is through a 1/8-inch galvanized iron pipe from center of tank when in horizontal position. The nozzle is the self-closing type made of brass, provided with strainer, and is not affected by chemicals.

Price, \$5.50.

**STERLINGWORTH TARRED FELT DISKS**

For protecting cabbage and cauliflower plants when first set out, against the Root Maggot. Place them around the stems of the plants. 50c. per hundred; \$2.50 per thousand.



## INSECTICIDES AND FUNGICIDES



### STERLINGWORTH LIQUID BORDEAUX

A concentrated fungus remedy, used by dissolving in water.

Explicit directions for use on every can.

Prices: 1 qt. can 45c. each, mailing weight 4 lbs.; 1 gal. can \$1.50 each, mailing weight 13 lbs.; 5 gal. kegs \$5.25.

### STERLINGWORTH KEROSENE EMULSION



It kills the green plant louse, scale and most soft bodied and sucking insects. Prices: 1 pt. cans 35c. each, mailing weight 2 lbs.; 1 qt. cans 50c. each, mailing weight 4 lbs.; 1 gallon cans \$1.25 each, mailing weight 11 lbs.



### STERLINGWORTH POWDERED TOBACCO

An effective and cheap remedy for many bugs, worms, lice and spiders on Cabbage, Squashes, Melons, Cucumbers, Potatoes, Plants, etc. It is for use while the vegetation is damp.

Prices: 1 lb. box 20c., mailing weight 2 lbs.; 100 lb. sacks \$7.50 each.

### STERLINGWORTH POWDERED HELLEBORE



For use against rose slugs, currant worms and other leaf-eating insects.

Sterlingworth Hellebore is the fine powdered kind that is ground from pure, fresh, prime root and put up in the round tight sifter-top box.

Prices: 1/4 lb. box 20c., 1/2 lb. box 40c., mailing weight 1 lb.; 1 lb. box 75c., mailing weight 2 lbs.



### STERLINGWORTH WHALE OIL SOAP WITH TOBACCO

Kills most lice and sucking insects on trees, shrubs, plants, vines and rose bushes.

It is a Genuine Whale Oil Soap, made from pure whale oil, the killing values of which are increased by the addition of tobacco and tobacco extractive matter. One pound makes 2 to 5 gallons of spray. Prices: 1 lb. box 30c., mailing weight 2 lbs.; 5 lb. box \$1.25, mailing weight 6 lbs.; 10 lb. box \$2.40, mailing weight 11 lbs.

### STERLINGWORTH AR-BO



A Combined Insect Killer and Fungous Remedy. Does what Bordeaux, Paris Green, Arsenate of Lead will do, all in one application. Sticks like glue. It kills the bugs and prevents blights, rots, rusts, at one job. One pound makes 5 gallons by mixing with water. Prices: 1 lb. 40c., mailing weight 2 lbs.

### STERLINGWORTH ANT-I-CIDE



A powder for use against ants in lawns and gardens.

One pound covers about 200 square feet. Prices: 1 lb. box 30c., parcel post weight 2 lbs.; 5 lb. tin \$1.25, parcel post weight 6 lbs.

### STERLINGWORTH HE-BO

#### A SUBSTITUTE FOR POWDERED HELLEBORE

and will be found satisfactory for use against rose slugs, currant worms, cabbage worms, and many other leaf-eating insects where a milder poison than Paris Green or Arsenate of Lead is desired.

Prices: 1/2 lb. box 25c., mailing weight 1 lb.; 1 lb. box 40c., mailing weight 2 lbs.

### STERLINGWORTH NO-SCAB



Grain Smut prevails wherever oats and other grains are grown. Potato Scab is also more prevalent each year. Never plant potatoes without treating the seed with No-Scab.

For Potato Scab, and to destroy other germs on seed potatoes, soak two hours. 1 pound to 15 gallons of water. Price: 1/2 lb. bottles 75c. each.

# INSECTICIDES AND FUNGICIDES—Continued

## Key-Dry Superfine Powdered Arsenate of Lead.

Better than Paris Green. Does Not Burn Foliage. Can be used for wet spraying and dry dusting. Has all the advantages of Arsenate of Lead Paste, but has double the strength, goes twice as far, and is easier to handle and measure out.

One lb. makes from 15 to 25 gallons of solution, ready to apply. ½-lb. pkg. 30c., 1-lb. pkg. 50c., 5-lb. pkg. \$2.25, 25-lb. drum \$9.50, 50-lb. drum \$18.50, 100-lb. drum \$35.00. Net f. o. b. Portland.



## Key Brand Liquid Lime Sulphur Solution.

For Dormant Spraying of Fruit and Shade Trees. Also for summer spraying of fruits for all forms of Scale insects and for Peach Leaf Curl, Apple Scab, Strawberry and Asparagus Rust. One gallon makes about 9 gallons for a dormant spray and about 40 gallons for summer spraying. Standard 33 degrees Baume test. Write for price.



## Key Brand Dry Lime Sulphur.

For Dormant Spraying of Fruit, or Shade Trees and Bushes against San Jose and Oyster Shell Scale. Also Peach Leaf Curl and Brown Rot of Peaches. Used for same purposes and has all the effectiveness of Liquid Lime Sulphur and is much easier and far more pleasant to handle.

One pound makes 3½ to 5 gallons.  
1 lb. Pkg. 35c.  
5 lb. Pkg. \$1.50



## Key Brand Arsenate of Lead Paste.

For Caterpillars, Codling Moth, Fruit Flies and All Leaf Chewing Insects. Mixes easily in water, stays in suspension well and does not clog nozzle. Sticks like paint, kills quick and will not burn foliage. Five careful tests insures high grade, uniform product. One pound makes about 12 gallons ready to apply.

Prices: 1 lb. 40c., mailing weight 2 lbs.



## Key Brand Bordeaux Mixture Powdered.

For Blight, Mildew, Rust, Etc. It has all the advantages of paste with double the strength. Goes twice as far. Used for dry dusting or wet spraying. Dilute 1 pound to about 8½ gallons of water.

Contains over 12½% Metallic Copper.

Packed in securely lined packages and sift proof boxes.

½ lb. Box, 25c  
1 lb. Box, 40c.  
5 lb. Box, 35c.



## Key Brand Powdered Hellebore.

For the Destruction of Slugs, Worms, Caterpillars, Etc. Less poisonous than Paris Green or Arsenate of Lead and safer to use when fruits and vegetables are nearly ripe. Apply powder just as it comes from package.

Made from white Hellebore Roots. Packed in sift proof boxes.

¼ lb. Pkg. 20c.  
½ lb. Pkg. 40c.  
1 lb. Pkg. 75c.



## Key Brand Cut Worm Killer.

For Use as Poisonous Bait against Cut Worms and Slugs by placing around plants subject to attack. It has an enticing odor that worms prefer to vegetation.

One pound is sufficient for 100 plants in hills or 75 in rows.

Packed in substantial packages and sift proof boxes.

1 qt. Cans, 75c.  
1 Gal. Cans, \$2.50  
5 Gal. Cans, 7.50



## Key Weed Liquid Weed Killer.

Destroys Weeds in Paths, Roads and Gutters. Kills roots as well as tops of all weed and grass growths. Easier and less expensive than hoeing and digging by hand. Very effective in walks and cobbled gutters without injury to roadbed. Does not discolor cement. Usually prevents growth for season.

NOTE: Dilute 1 part Weed Killer to 40 parts of water and apply with sprinkling can or cart.

1 qt. Can, 75c.  
1 Gal. Can, \$2.50  
5 Gal. Can, 7.00



## Hillside Paris Green.

For Use against Potato Bugs, Tobacco Worms, Etc. Strictly pure Paris Green with the maximum amount of combined arsenic and a minimum of soluble or uncombined arsenic. Reliable and effective in killing bugs with a minimum danger of burning foliage.

NOTE: Contains 50% Arsenious Oxide and less than 3½% soluble in water.

¼ lb. Cans, 20c.  
½ lb. Cans, 35c.  
1 lb. Cans, 65c.



## Stanley's Crow Repellent.

Saves replanting, Prevents crows, other birds and animal pests from pulling corn. Protects corn from rot caused by moisture. Makes seed germinate faster. Does not clog planter.

Large can, enough for two bushels of seed corn, \$1.50

Small can, enough for one bushel, \$1.00



# INSECTICIDES AND FUNGICIDES—Continued



## STERLINGWORTH ANTI-CROW CORN OIL

Protects newly planted corn from crows. Mix 1 part Anti Crow Corn Oil with 2 parts hot water. Prices: Pt. 30c., parcel post weight, 3 lbs.; qt. 50c., parcel post weight, 4 lbs.; gal. \$1.50, parcel post weight 13 lbs.



## STERLINGWORTH GYPSY-MOTH CREOSOTE

This is a special creosote preparation for painting the egg clusters of the Gypsy Moth. Do not wait until these egg clusters hatch. Every egg cluster painted before hatching time destroys between two hundred and six hundred eggs.

PRICES: 1 pt. 35c., 1 qt. 60c., 1 gal. \$1.00



Full directions for use on each can. ¼ pt. can 25c., ½ pt. 40c., 1 pt. 65., 1 qt. \$1.00, 1 gallon \$3.00.

## PYROX

kills all leaf-eating insects, like apple worms and potato bugs, also fungus diseases like apple scab and potato blight. Use it on fruits and vegetables, particularly apples, potatoes and tomatoes.

One mixture serves two purposes, saving in cost of application.

All ready to use by adding water.

Sticks to foliage; rains do not wash it off; saving in time, labor and material.

1 lb. 40c., 5 lbs. \$1.75, 10 lbs. \$3.00, 25 lbs. \$6.25, 50 lbs. \$11.00, 100 lbs. \$20.

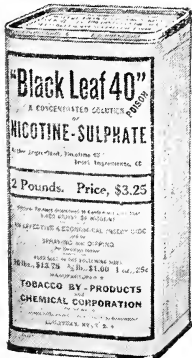

## "BLACK LEAF 40"

A concentrated nicotine solution. Highly recommended by spraying experts for destroying aphids, thrips, etc., without injury to foliage. Soluble in water; no clogging of nozzles.

Spraying directions on each package.

1 oz. bottle 25 cts., ½-lb. can \$1.00, 2-lb. can \$3.25, 10-lb. can \$13.75.

**NICO-FUME (Tobacco Paper)**—For fumigating. Does not injure blooms. In tins, 24 sheets, \$1.25; 144 sheets, \$5.00; 288 sheets, \$9.50.

## "SCALECIDE"

"SCALECIDE" is a mild, smooth, easily applied spray that will not clog your hose nor corrode your machinery. It keeps trees clean and healthy, and effectively takes care of the leaf roller, bud moth, case bearer, San Jose scale, and all kinds of scale. The fungicidal action of "SCALECIDE" will also check such deadly diseases as apple canker and collar rot, and it will also show an invigorating effect on tree growth.

Prices: 1 qt. can 70c.; 1 gallon can \$1.75; 5 gallon can \$7.00. Special prices quoted on application for larger quantities.

## Copper Sulphate.

**For Making Home-Made Bordeaux Mixture for Fungicide Purposes.** It contains over 99% pure copper which gives a strong and fresh mixture when properly made. It is the kind of material that is only safe to use when a dependable home-made product is desired. The extra cost is so slight when compared with the additional satisfaction of knowing crops are protected in the best possible manner that particular users will buy it every time.

Write for price.

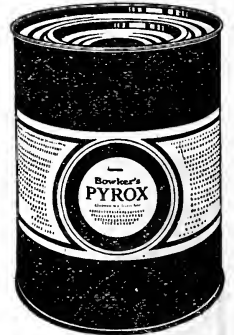

**NICO-FUME (Liquid).** Used as a spray or as a vapor. Does not stain nor injure blooms. ¼ lb. can 65c. 1 lb. can \$2.00, 4 lb. can \$7.50, 8 lb. can \$14.50.

**FUNGINE.** An infallible remedy for mildew and other fungus diseases. ½ pt. 40c., pt. can 65c., qt. can \$1.00, gal. \$3.50.

**VERMINE.** For all soil vermin such as cut, eel, wire and grub worms, slugs, root lice, maggots and ants. One part Vermine to four hundred parts water, thoroughly soaking the ground, does its work effectively without injury to vegetation, and protects your crops and lawns against the ravages under the soil. ¼ pt. 25cts. ½ pt. cans 40 cts., pt. cans 65 cts., qt. cans \$1.00, gal. cans \$3.00

**SULPHUR** For mildew on grape vines and other plant foliage. Lb. 10c., 5 lbs. 40c.

# INSECTICIDES AND FUNGICIDES—Continued



**Bug Death Aphis.** For sucking insects, lice, aphid, flea beetles, and fungus, this preparation is offered. There is no place where it can work injury. Specially recommended for the health of all house plants, as it is absolutely free from all forms of arsenic. 12 oz. pkg. 20c. By mail 25c., 80 lb. drums \$8.50.



Pat. March 16 and Nov. 9, 1897

**Bug Death.** A non-poisonous powder. Destroys potato, squash, and cucumber bugs, currant and tomato worms; safe to handle. Contains no Paris Green or Arsenic. Apply dry or in water. 1-lb. package 20c., 3-lb. package 45c., 5-lb. package 65c., 12½-lb. package \$1.50, 100-lb. keg \$8.50.

## GUARANTEED CATTLE OIL



No long stories or big claims about this Fly Oil. Buy a can. Use half of it. If you are not satisfied bring us the half-empty can and get your money back. Protects all day in ordinary weather. Flies hit by it are killed, others are kept off by the odor. Applied with a brush, or hand sprayer. Prices: 1 qt. can 60c., mailing weight 4 lbs., 1 gal. can \$1.50, mailing weight 11 lbs.

### LA-LO ANIMAL SPRAY

Endorsed by many leading Agricultural Colleges and Dairymen. LA-LO ANIMAL SPRAY IS INVISIBLE, even on white cattle. Has a mild, pleasant odor. Will not gum the hair. Will not irritate or blister. Will not taint milk—even if used freely at milking time. Assists in keeping cows free from flies and mosquitoes in summer and lice in winter. ½ Gal. Cans 80c., 1 Gal. Can \$2.25.

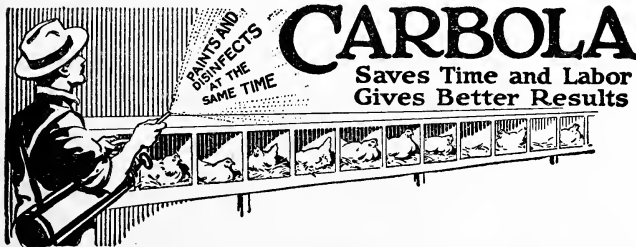

Carbola is a combined disinfectant and paint, or whitewash, that has gained the unqualified endorsement of thousands of poultrymen and farmers.

Carbola comes in powder form packed in convenient sized packages and is ready to use just as soon as it is mixed with cold or hot water.

Trial package (1 lb.) 30c. Delivered by Parcel Post 35c. (Paints and disinfects 250 square feet.) 10 lbs. (10 gals.) \$1.25, 50 lbs. (50 gals.) \$4.00 All F. O. B. Portland.

# CYCLONE SANITARY WIRE FENCING

## Style "F" Fabric

is the most popular and closest mesh sanitary fence. Pickets full weight, full height, full gauge No. 9 heavily galvanized wire spaced  $1\frac{3}{8}$  inches apart at bottom,  $2\frac{7}{8}$  inches at top, making fence absolutely chicken tight.

Best heights are 36, 42, and 48 inches. Other heights from 24 up to 84 inches made to order.

### Style "F" Price per Lineal Foot

36-inch, 20c., 42-inch, 22c., 48-inch, 26c.

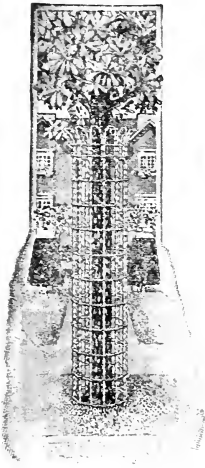
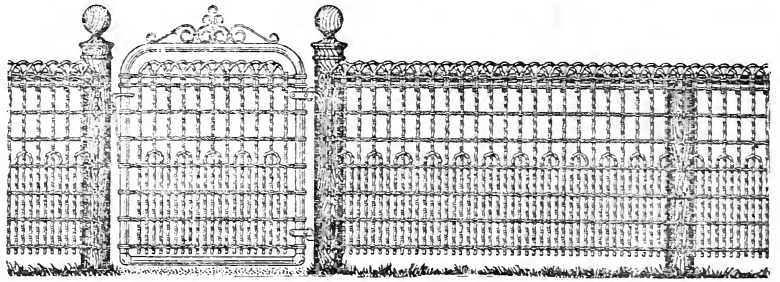

### Cyclone Tree Guards

let in fresh air and sunlight around the trees. Made 6 feet high of heavily galvanized wire in 3 diameters.

Price, each, 9-inch diameter, \$1.25, 12-inch diameter, \$1.45, 15-inch diameter, \$1.75.

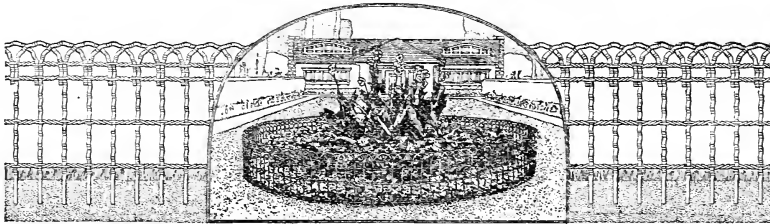

### Cyclone Flower Bed Border

fits any shape or form of flower bed. Ends left straight to be inserted in the ground. No posts necessary. Pickets No. 9, cables No. 13, heavily galvanized wire.

Price per lineal foot, 16-inch height, 11c., 22-inch height, 13c.

### Cyclone Vine Trellis

A perfect vine trainer at a trifling cost. Crimped wires No. 10, cables No. 13 heavily galvanized.

Price per lineal foot, 18-inch width 8c., 24-inch width 10c.

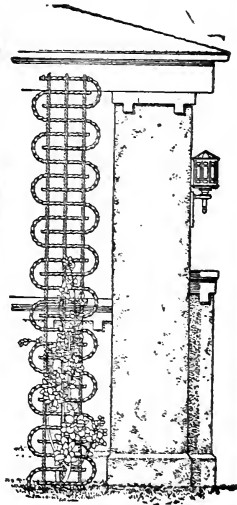

## STANDARD TREE BANDS

(Patent Applied For)

**PROTECTS TREES AND LARGE SHRUBBERY AGAINST ALL CLIMBING WORMS, CATERPILLARS, MOTHS AND INSECTS**

These tree bands are made of very heavy waterproof paper, with a sticky, repellant material under the umbrella-like canopy. This canopy protects the "gum stickum" from the weather, as well as from dirt, dust and falling leaves.

No climbing caterpillar or insect can pass this sticky material. It catches them and holds them if they set foot upon it. In fact, many turn back before they get to it.

Attached to the band, on the inside, is a strip of fluffy felt. This felt fills up the depressions in the bark and prevents passage under the band. No cutting away of bark is necessary. The felt fills it up.

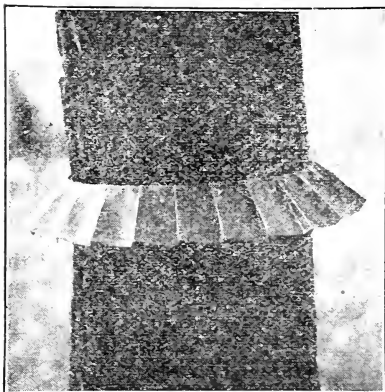

### PRICE:

25 Foot Roll \$1.75 100 Foot Roll 6.75

Postpaid on receipt of price

**PRICES DO NOT INCLUDE POSTAGE OR EXPRESS CHARGES**

# LAWN MOWERS

## TOWNSEND'S FLYER Ball-Bearing

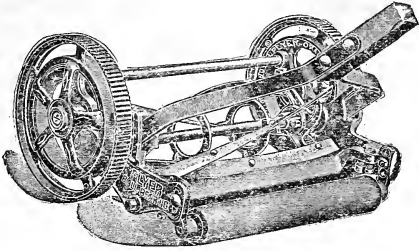

This lawn mower construction is so built to give a ball-bearing mower at a low price. It is the strongest, lightest running mower of its class. Has a 9-in. wheel, 5½-in. reel, 4 blades, crucible steel, oil tempered; lower blade is also crucible steel, oil tempered. Prices, 14-in. \$14.00, 16-in. \$15.00.

## ESSEX Ball-Bearing

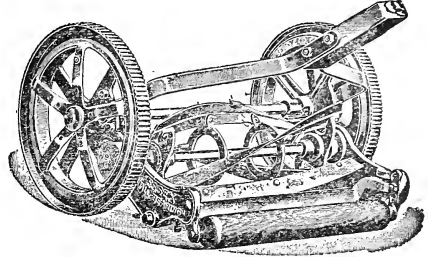

The highest type of a double gear grass cutting machine, 11 inch wheels, 6¼ inch reel, 4 blades (crucible steel, oil tempered.) Its large and strong but light wheels make it roll very easily and steadily.

A great favorite for parks and for long and thick grass. Prices: 16-in., \$23.00; 18-in., \$25.00.

## DEWEY

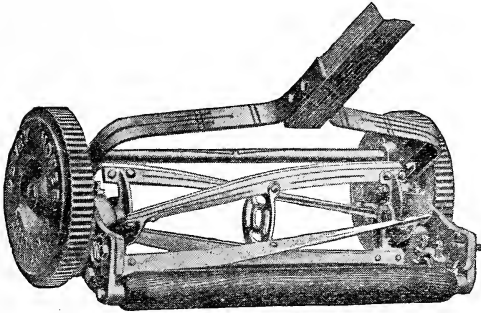

8-inch Wheels, 4 Blades, 5¼-inch Cylinder, Single Pinion, Geared on both sides. Prices: 14-inch, \$10.00, 16-inch, \$10.50, 18-inch, \$11.00.

## Style "K" Genuine "Philadelphia"

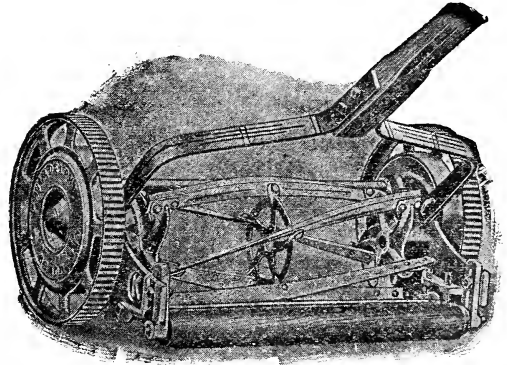

High wheels, it runs light, five knives, it cuts smooth and even. They always give satisfaction. Prices, 16-inch, \$21.00, 18-inch, \$22.00, 20-inch, \$23.00.

## Gleaner Lawn Trimmer

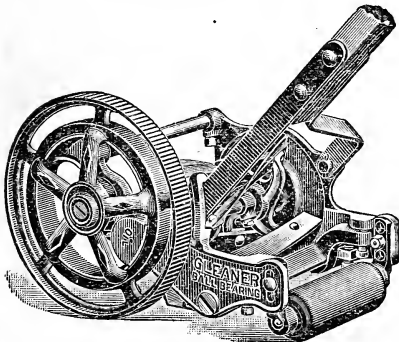

Does what lawn mowers leave undone. Trims and edges the lawn with remarkable speed and perfection. 9-inch wheel ball-bearing; 4 steel blades, 8-inch cut. High grade in every particular

Price, \$10.50

## The "Chicago"

This is one of the best low priced Lawn Mowers on the Market to-day.

Reel, 5¼ inches in diameter, three blades. Wheels, 8 inches in diameter.

Price: 14-inch, \$7.50.

## Distributers for the State of Maine of Ideal Power Lawn Mowers



"DEERING'S OAKS" PARK DEPT., PORTLAND, ME.

### A Few Testimonials NEAR HOME

#### OFFICE EVERGREEN CEMETERY

Allen, Sterling & Lothrop,

Woodfords, Me., Dec. 13, 1920.

Gentlemen:—The Ideal Power Lawn Mower purchased of you last spring has given good satisfaction in every way and been of a special benefit to us in coping with the present labor situation. I feel free to recommend a purchase of a machine of this type to anybody who has a lawn of any size to care for.

Yours very truly, (Signed) Frank M. Floyd, Supt.

#### LIBBY ESTATE

Allen, Sterling & Lothrop,

Scarboro, Maine, Nov. 2, 1920.

Gentlemen:—Three years ago we purchased of you an Ideal Power Lawn Mower for use on our seven acre lawn at Scarboro.

The mower has been absolutely satisfactory, the only repairs we have purchased in the three seasons being a few extra pinions for the cutting reel.

We could not get along now without our Ideal Mower.

Respectfully, (Signed) John C. Woods, Supt.

#### RANDALL & McALLISTER

Portland, Me., December 29, 1920.  
Messrs. Allen Sterling & Lothrop,  
Gentlemen:—

I used your Ideal Power Lawn Mower last summer constantly, and had no trouble whatever with it, and as far as I can see it is perfectly satisfactory.

Yours truly,

(Signed) Oakley C. Curtis.

#### H. M. PAYSON & CO. BANKERS & BROKERS

Portland, Me., Dec. 27, 1920  
Messrs. Allen, Sterling & Lothrop,  
Gentlemen:—

In regard to the Ideal Lawn Mower which I purchased of you last spring. It has proved a most satisfactory investment and ran through the entire season without repairs, although a large part of the time it was operated by my son, who is only thirteen years of age.

Very truly yours,

(Signed) Herbert Payson.

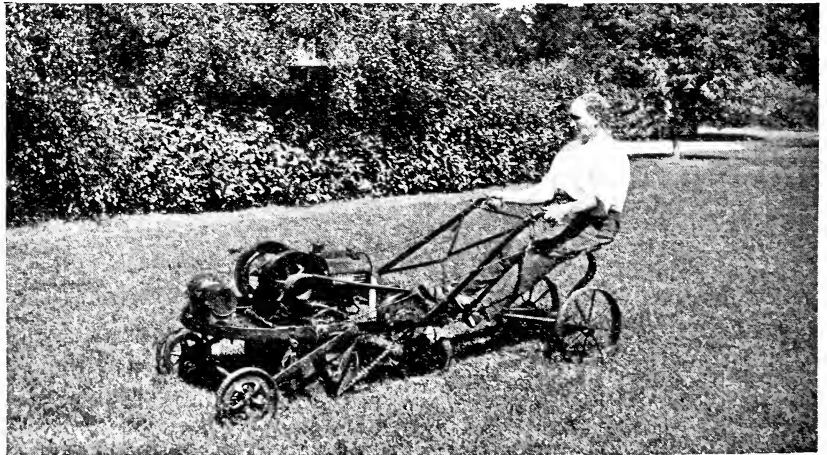

HERBERT J. BROWN ESTATE, FALMOUTH, ME.

### An "Ideal" Model for Every Need!

**IDEAL JUNIOR** for the small and medium sized lawn. Width of cutting unit 22 inches. Speed of machine 3 miles per hour.

**IDEAL THIRTY** for private estates, city parks, cemeteries, etc. Will do the work of five men cutting by hand. Width of cut 30 inches. Will cut  $\frac{3}{4}$  acre per hour.

**IDEAL TRACTOR TRIPLEX** for maintaining golf courses. Width of cut 84 inches. Speed 5 to 7 miles per hour—engine 4 cylinder 15 H. P. This mower literally eats up the Acreage.

WRITE US FOR SPECIAL LITERATURE, DEMONSTRATION, PRICES, ETC.

### How Large Lawns Are Kept in Fine Condition.

Ideal Power Lawn Mowers have simplified the grass cutting problem for thousands of large estates, public parks, colleges, golf clubs, cemeteries, industrial plants, country clubs, etc.

Wherever Ideals are used, labor troubles vanish and smooth, velvety lawns are maintained at a minimum expense.

Actual use on many of the finest, largest and best kept lawns in the country has shown that the Ideal "30" will cut from four to five acres of grass per day; doing the work of five or six hard-working men with hand mowers.

Moreover, Ideals are a power mower and roller in one—the sod is continually kept smooth and firm because it is rolled every time the grass is cut.

The Ideal is of very simple design and sturdy construction. Having no complicated mechanism, it is easy to operate and care for.

Photo above shows the Ideal "30" as a walking power motor,—photo below shows the outfit with our riding trailer, a compact, light weight, and at the same time the most practical riding power mower on the market.

For golf courses or large areas of lawn there is no machine which equals the Ideal Tractor Triplex—it has solved the hardest problem of the country club.



**GALVANIZED STEEL PLANT BOX**

This box has a patented bottom which gives the plants perfect drainage, and at the same time does not leak. The water receptacle runs full length of the box, and gives the roots a plentiful supply of clean water. It is made of strong, galvanized iron, neatly enameled in dark green. Convenient and practical for indoor or outdoor use. No staining of paint or disfiguring in any way.

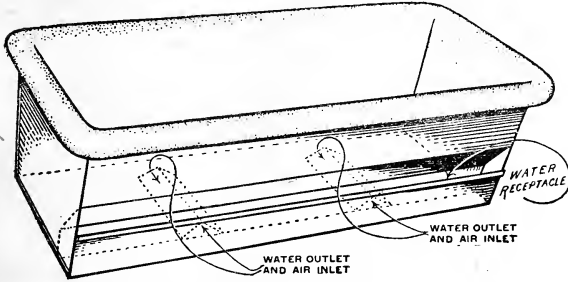

**GALVANIZED STEEL PLANT TUB**

Made on the same principle as the Plant Box

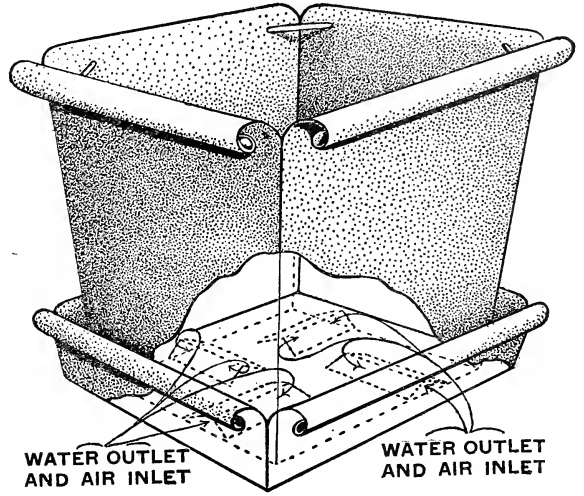

Length	Width	Depth	Each	Length	Width	Depth	Each
24 in.	8½ in.	6¼ in.	\$1.30	36 in.	8½ in.	6¼ in.	\$2.50
30 "	8½ "	6¼ "	1.70	48 "	8½ "	6¼ "	3.50

Length	Width	Depth	Price
12 inches	12 inches	8¼ inches	\$2.00 each
14 "	14 "	10¼ "	2.50 each

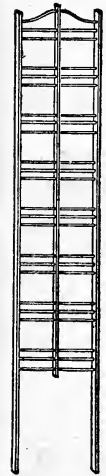

**Veranda Trellises**

Made of Wood and Rattan, painted green

2	3	4	5 x 1½	6 x 1½	7 x 1½	8 x 1½	9 x 1½	10 x 1½	11 x 1½	12 x 1½
feet	feet	feet	feet	feet	feet	feet	feet	feet	feet	feet
\$1.10	1.50	1.85	2.50	3.00	3.50	4.00	4.50	5.00	5.50	6.00
each	"	"	"	"	"	"	"	"	"	"
\$12.00	16.00	20.00	28.00	33.00	37.00	44.00	49.00	55.00	60.00	66.00
per dozen	"	"	"	"	"	"	"	"	"	"

**PLANT STAKES**

For Greenhouse or Garden use. Square. Painted green

	Each	Doz.	100
1½ feet	\$0.03	\$0.30	\$ 2.10
2 "	.04	.50	3.75
2½ "	.05	.75	5.50
3 "	.07	1.00	7.50
3½ "	.08	1.25	9.00
4 "	.09	1.60	12.00
5 "	.12	2.25	18.00
6 "	.15	2.75	20.00



**Jumbo Powder Gun**

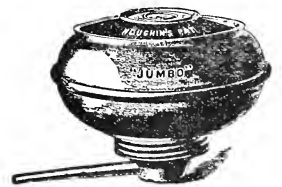

For applying insect powders on plants. Is 4 inches in diameter, holds about 4 oz. Price 35c. each. By parcel post, 40c.

**WOOD LABELS**

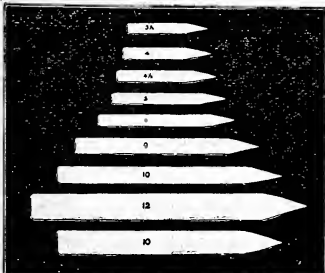

	Plain	Painted
4 inch. Pot labels	100 \$0.20	1000 \$1.10
4½ " " " "	.25	1.35
5 " " " "	.30	1.60
6 " " " "	.35	2.00
10 " " " "	.50	4.85
12 " " " "	.65	5.80
8 " Garden labels	.80	7.40
10 " " " "	1.00	9.60
12 " " " "	1.15	11.40
3½ " Tree labels, copper wired	.25	1.95
		2.45

**RUBBER GARDEN HOSE**

25 and 50 foot length, coupled



**DUNHAM "WATER-WEIGHT" ROLLER**

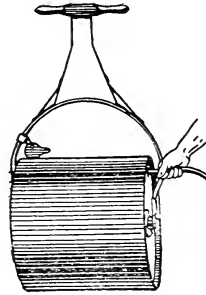

The Dunham "Water-Weight" Roller is electric welded, making the water section one solid drum. No rivets are used. It cannot leak. The rolling surface is perfectly smooth, and cannot cut up the lawn. They are roller bearing and easy to operate. Made in one section, as shown in cut, or with two sections. The handle lock attachment locks the handle to the drum when the roller is not in use, so that the handle remains upright.

*Ask for a free copy of "Proper Care of Lawns."*

Flushing— $\frac{3}{4}$ -inch, 5-ply	15 cents per foot
Flushing— $\frac{1}{2}$ -inch, 5-ply	14 " " "
Tornado— $\frac{3}{4}$ -inch, 5-ply	18 " " "
Tornado— $\frac{1}{2}$ -inch, 5-ply	17 " " "
Princeton Cotton— $\frac{3}{4}$ -inch	17 " " "
Princeton Cotton— $\frac{1}{2}$ -inch	16 " " "

No.	Diam. Inches	Length Inches	Sec. tions	Weight Empty	Filled with Water	Price
WB 5	18	24	1	80 lbs.	310 lbs.	\$17.50
WB 7	24	24	1	115 lbs.	500 lbs.	22.00

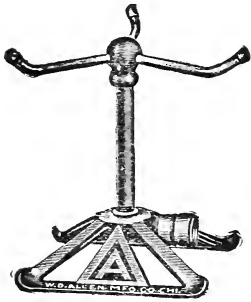

**"Mayflower" Lawn Sprinkler**

On sled base; 3-arm revolving.  
Price, \$1.25.  
By Parcel Post, \$1.40.

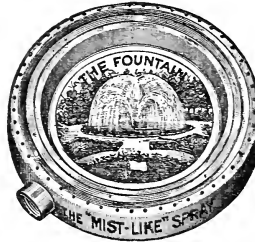

**Fountain Lawn Sprinkler**  
Made of heavy brass.  
Price, 50c., by Parcel Post, 55c.

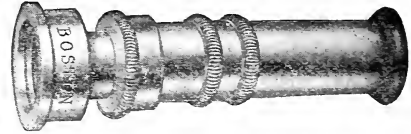

**New Boston Hose Nozzle**

Will throw a coarse or fine spray or a large or small stream as may be desired  
Price, 70c., by Parcel Post, 80c.

**The "Cresent" Lawn Fountain Sprinkler**

It throws all the water to the front and sides.  
Price, 50c., by Parcel Post, pre-paid, 55c.



**"Square Fountain"**

As gentle and even as rain drops. Extra heavy brass. Built to stand the knocks. Price, 35c. By Parcel Post, pre-paid, 40c.

**Perfect Clinging Hose Mender**

It leaves the hose as smooth and strong and tight as a new hose.  
 $\frac{1}{2}$  and  $\frac{3}{4}$ -inch, each 15c. Doz. \$1.50.



**Watering Pots**



4 quart Galvanized Iron	\$ .75 each
6 quart Galvanized Iron	1.25 each
8 quart Galvanized Iron	1.50 each
10 quart Galvanized Iron	1.75 each
12 quart Galvanized Iron	2.00 each
16 quart Galvanized Iron	2.25 each
20 quart Galvanized Iron	2.75 each



**"TYRIAN" Plant Sprinklers**

For sprinkling plants and flowers in house or garden.

4 oz. size, bent neck	50c. each
6 oz. size, bent neck	65c. "
8 oz. size, bent neck	70c. "
10 oz. size, bent neck	80c. "
4 oz. size, straight neck	50c. "
6 oz. size, straight neck	65c. "
8 oz. size, straight neck	70c. "
10 oz. size, straight neck	80c. "

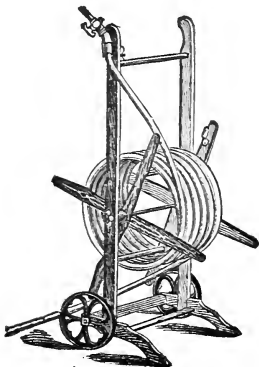

**Hose Reel**

Wood, \$1.00 each  
All iron. \$2.00 and \$2.50

### STANDARD TREE PRUNERS

Waters' Pattern

8 feet long, price each	\$0.85
10 " " " "	.90
12 " " " "	1.00
14 " " " "	1.10
16 " " " "	1.15
Extra Blades	.25

**TELEGRAPH PRUNERS**  
With Socket for Handle  
Each .....\$1.00

### HEDGE SHEARS

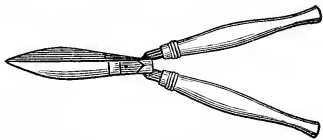

8 in.	\$2.25;
9 in.	\$2.50;
10 in.	\$2.75;
12 in.	\$2.25. With notch, 25c. extra



**BUDDING AND PRUNING KNIVES**  
50c., 75c., \$1.00 each.

### PRUNING SHEARS

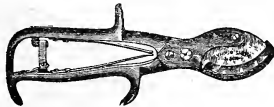

Taylor Pattern, with coil spring, 9 inches	Each \$0.60
California Pattern, with volute spring 9 inches,	" .85
Swiss Pattern, polish, 9 inches	" 1.75
Levin Pattern, 7 inches,	" .50

Sent by parcel post, prepaid.

### ASBESTOS TORCH

It will be found exceedingly effective in destroying nests of caterpillars, so destructive to fruit and shade trees. Attach the torch to the end of a pole of suitable length; saturate with kerosene oil, light and hold under the nests.

Price, 25c.  
By Mail, 35c.



### UNIVERSAL PRUNING SAW

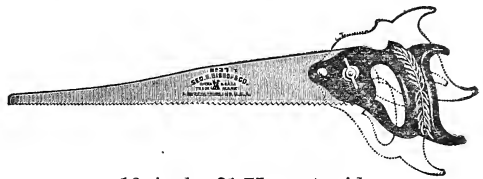

18 inch, \$1.75 postpaid



The best on the market.  
1/4 lb. pkg. 15c.; 1/2 lb. pkg. 25c.; 1 lb. pkg. 40c.

### WIRE FRUIT PICKER GARDEN LINE REEL GRAFTING CHISEL



Each, 65c.



Price, \$1.75



Made from the finest cast steel.  
Price, each 85c.

### STEP LADDERS



Hub,	per foot	75c.
Challenge,	" "	80c.
Imperial,	" "	75c.

### GARDEN LINES



Italian Hemp, 100 feet \$1.25

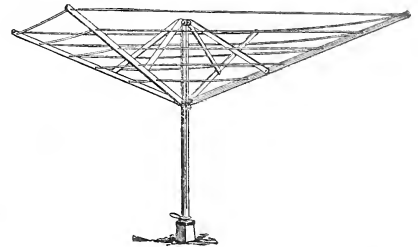

**MAINE OUTDOOR CLOTHES DRYER**  
No. 20. 120 ft. line, Each \$7.50  
No. 25. 160 ft. line, Each 8.00

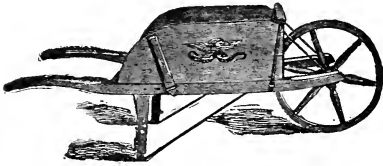

### WHEEL BARROWS

For Farm and Garden Use

A. S. L. Garden. This Barrow is made from the best seasoned timber. The end of the bottom is cut into the back sill, thus preventing the splitting or breaking of the bottom boards. The wheel has a cast iron hub with white oak or ash spokes and rims. The axle is wrought iron, with turned arbors.

Price: No. 4, \$9.00 No. 6, \$11.00

### GARDEN HOES

	Socket, each, \$1.00	Shank, each, .95
	Corn, each, 1.00	Tobacco, each, 1.15
Meadow, each, 1.10	Boys', each, .80	Ladies', each, .75
Warren, each, 1.00		
Onion, each, 1.00		

### SCYTHE SNATHS



No. 50 Regular Seythe, .....	\$1.75
No. 100 Bush .....	2.00

### SCYTHES



Little Giant, Solid Steel .....	\$2.00	Heavy Bush, .....	\$2.00
Conquerer .....	2.00	Bramble, or Light Bush .....	2.00

### SCYTHE RIFLES



Meadow King, 15c. Farmers' Friend, 15c.

### SCYTHE STONES



Crescent, .....	.15
Black Diamond, fine, .....	.20
Carborundum, .....	.30



Wire Vegetable Scoop Price 75c.

### Boothby Toothed Hoe



Price, each, \$1.50

### Arlington Scuffle Hoe



8 in. and 9 in. blades. Each, \$3.50

### Potato Hooks



5 Tine. Each, \$1.25	24 tooth. Each, 40c.
6 Tine. Each, 1.35	36 tooth. Each, 50c.

### Automatic Self-Cleaning Lawn Rake

A backward motion of the operator will clean all the teeth at once, thus avoiding cleaning the teeth with the fingers.

26 teeth, \$1.75  
52 teeth, 2.25

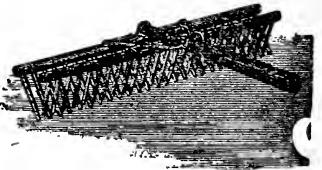

### IRON AND STEEL GARDEN RAKES



14 tooth, Malleable Iron,	\$0.55
12 " Steel	.90
14 " "	1.00
16 " "	1.10
16 " " Gravel	1.20
18 " " "	1.30

### GIBBS' LAWN RAKE

Made of heavy tinned steel wire. These are excellent for lawn or walk work.



Scuffle Hoe  
8 in., \$1.10

### MANURE FORKS



4 Tine D handles,	\$1.65
5 Tine D handles,	1.85
6 Tine D handles,	2.10



Wood Lawn Rakes  
26 teeth.  
Each, 85c.

### HAY FORKS



2 and 3 Tines, \$1.10 to \$1.35

### SPADING FORKS



4 Tine D handles.	Each, \$1.60
4 Tine long handles.	Each, 1.40

### GRASS HOOKS



Meadow King, each, 35c.  
Nolan, each, 85c.

### SHOVELS

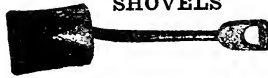

D Handle, Square or Round Point. Long Handle, Square or Round Point.  
Each, \$1.50, \$1.75 and \$2.00

### SPADES

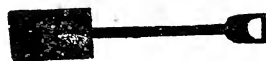

D Handle. Each, \$1.50
Long " " 1.35
Ames' Best " 2.00



Border or Edging Knife	
Long handle. Each, \$1.15	
D handle. Each, 1.30	

**STANDARD FLOWER POTS**



		Earthenware			
	Each	Doz.		Each	
2 inch	\$.02	\$.20	8 inch	\$.30	
2½ "	.03	.25	9 "	\$.45	
3 "	.05	.40	10 "	.60	
3½ "	.06	.45	11 "	.80	
4 "	.07	.50	12 "	1.50	
5 "	.09	.85	14 "	1.75	
6 "	.12	1.20	16 "	4.00	
7 "	.25	2.00	18 "	6.00	
			20 "	7.50	

Inside measurement, width and depth equal

**FLOWER POT SAUCERS**

Size	Each	Doz.
3 inch	\$.03 ea.	\$.30 doz.
3½ "	.04 "	.30 "
4 "	.04 "	.36 "
5 "	.05 "	.50 "
6 "	.07 "	.65 "
7 "	.09 "	.87 "
8 "	.12 "	1.20 "
9 "	.15 "	1.75 "
10 "	.30 "	2.00 "
11 "	.30 "	2.50 "
12 "	.35 "	3.00 "
14 "	.60 "	6.00 "

**BULB PANS**  
Earthenware

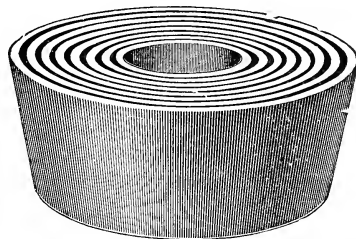
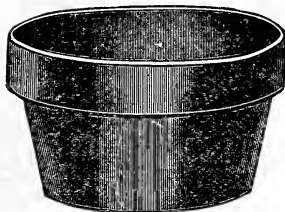

**FERN PANS**  
Earthenware

Size	Each	Doz.
4 x 1½ inches	\$.08	\$.75
4 ¾ x 2 ½ "	.10	.85
5 ½ x 2 ½ "	.12	1.10
6 ¼ x 2 ½ "	.14	1.25
7 x 2 ½ "	.15	1.50
8 x 3 ½ "	.18	2.00

Size	Each	Doz.	Size	Each	Doz.
4 inch	\$.06	\$.50	8 inch	\$.35	\$2.75
5 "	.07	.85	9 "	.50	4.00
6 "	.15	1.20	10 "	.70	5.40
7 "	.25	2.00	12 "	1.50	11.25

**NEPONSET PAPER FLOWER POTS**

The Neponset Paper Flower Pot is a waterproof paper pot made from a tough fibre paper, and is especially adapted to the florist, gardener and nursery trade.



Size	Doz.	100	1000
2¼ inch	\$.10	\$.50	\$ 4.65
2½ "	.12	.55	5.30
3 "	.15	.80	7.00
3½ "	.18	1.00	9.50
4 "	.20	1.20	11.55
5 "	.30	2.00	18.20
6 "	.40	3.00	24.00

**VERBENA BASKETS**

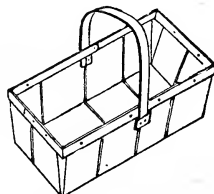

Size—12 inches long, 7 inches wide, 4 inches deep.

Adjustable wooden handles, with tin fastenings on the ends.

Per 100, \$4.25; per 1,000 \$40.00

Size—10 inches long, 5 inches wide, 3 inches deep.

Adjustable wooden handles, with tin fastenings on the ends.

Per 100, \$3.00; per 1,000, \$30.00

Size—10 inches long, 5 inches wide, 3 inches deep  
Wire handle attached.

100, \$3.00; per 1,000, \$30.00

**Bull Dog Paper Clip**

The Florists' Reliable Clip



GRIPS FROM BOTH SIDES

NEVER BECOMES UNFASTENED

Does away with use of twine or pins.

Saves its cost in time and labor many times over.

Packed in Boxes of 1,000—Price \$1.10 per thousand.

**RAFFIA**



For tying plants. Superior to twine for bunching asparagus, celery, etc.

Price per lb., 25c.

**FIBRE FLORISTS' VASES**

For displaying cut flowers

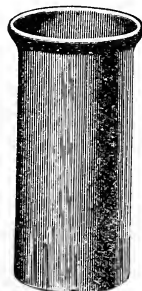

No.	Diam.	Depth	Each	Doz.
0	8 in.	13 in.	\$ 1.75	\$21.60
1	5½ "	10½ "	1.50	17.20
2	4½ "	9 "	1.30	15.00
3	4 "	6½ "	1.10	12.40
4	3 "	5 "	.85	9.60
00	9½ "	21 "	6.25	75.00
11	6 "	18 "	2.00	23.00
22	4½ "	15 "	1.60	18.00
33	4 "	12 "	1.30	15.00
44	3 "	9 "	1.10	12.40

PRICES DO NOT INCLUDE POSTAGE OR EXPRESS CHARGES

**NORCROSS CULTIVATOR HOES**

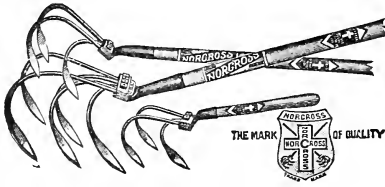

**MIDGET NORCROSS.** Short handle for hand work.  
Price, 40c.

**3-PRONG NORCROSS.** Light and can be used by women and children.  
Price, 85c.

**5-PRONG NORCROSS.** The standard size. A wonderfully useful tool. Every man with a garden should have one.  
Price, \$1.25

**"PEERLESS" GLAZING POINT.**  
(Improved Van Reyper.)

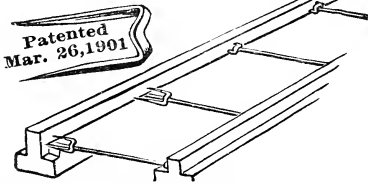

**PEERLESS GLAZING POINTS.** Made of steel wire and galvanized.  
Price, box of 1,000, 75c.; by mail 85c.

**GRASS SHEARS**

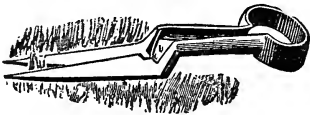

Lightning, 35c.; Sure Clip, 35c. each  
Parcel Post Weight, 1 lb.

**GARDEN TROWELS**



No. 25 Eagle..... 15c.  
No. 30 Socket Pattern..... 30c.  
Keystone 6 inch..... 65c.  
Keystone 7 inch..... 70c.



Steel Transplanting Fork.....45c.  
Iron Transplanting Fork.....15c.



Excelsior Weeder.....15c.

**"Adjusto" Plant Support**

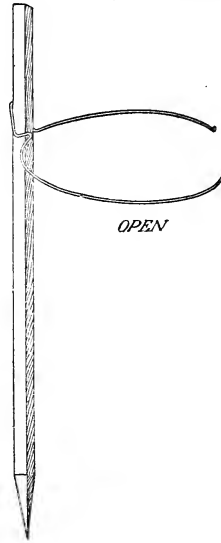

The "Adjusto" is a very simple, unbreakable, practical and cheap support which will last a life time.

It is adjustable in a "jiffy" to any height, to conform to the plant's growth. It is indispensable for Tomatoes, Roses and Dahlias. In fact everything on the lawn or the garden that needs a support.

The stake is made of hard wood having a protecting coat of green paint.

Price, 18c. each; \$1.75 per Doz.

**FOLDING TOMATO SUPPORT**

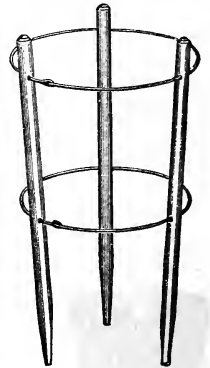

**HOTBED MATS**



**STRAW.** Made by hand of rye straw. Size 6 x 6 ft., each \$3.00; 3 x 6 ft., each \$2.00. Larger quantities, write for prices.

34 inches high. 20 inches in diameter at the top.  
Price—per dozen \$3.50

**ASPARAGUS KNIFE**



Made of Solid Steel  
Goodell Double Point, P. P. Weight 1 lb. Each, 35c.



Lang Weeder 30c. By Mail 35c.



Haseltine Weeder 25c. By Mail 30c.

# AGENTS FOR LISTER'S STANDARD FERTILIZERS

A FERTILIZER FOR EVERY CROP AND DIFFERENT SOIL REQUIREMENTS

BRANDS	GUARANTEED ANALYSIS		
	Ammonia	Ava. P. A.	Potash
Lister's Squirrel Brand Fertilizer .....	1	8	2
Lister's Success Fertilizer .....	2	8	2
Lister's Corn and Potato Fertilizer .....	2	8	3
Lister's Eastern Pride Fertilizer .....	3	8	4
Lister's Standard Pure Super. of Lime .....	3	9	2
Lister's 4-8-4 .....	4	8	4
Lister's 4-8-6 .....	4	8	6

Write for Fertilizer quotations.

## Sheep's Head Brand Pulverized Sheep Manure

We underline **Sheep's Head Brand** because there is a great difference in commercial sheep manures as in commercial fertilizers

Sheep's Head Brand is the best, both by test and reputation, of any brand on the market. It costs more and is worth more. Our trade now insists on the Sheep's Head Brand.

A complete natural fertilizer, supplying all the necessary plant food elements—Nitrogen, Phosphoric Acid and Potash—in combination with organic matter or humus, and it is this natural combination that produces the peculiar action and effect in the soil which can only be had from animal manures. It can be used without fear of weeds and foreign grasses that always follow the application of ordinary stable manures.

For the lawn there is nothing better than sheep manure, and its convenience makes it the logical fertilizer. There is no straw or other refuse in it as is always the case with crude manures. Barnyard manure should never be applied to a lawn, as it usually contains seeds of noxious weeds, which germinate and grow. A few weeks will show surprising results.

Its use on the vegetable garden will double the yield and insure better vegetables, also hurry the growth for earlier table use. Probably the best way to use it is to scatter it broadcast, harrowing or raking it lightly but reserving a little to use in the hills or drills. Then the young plants will have some nourishment close at hand to give them a good start.

Sheep manure is probably more largely used in greenhouse growing of flowers and vegetables for market than any other fertilizer, because it is safe, and can be relied upon for quick, sure results. It is unequalled for either dry or liquid top-dressing, especially for carnations, chrysanthemums, asters, and other hardy floral crops

5 lbs. 35c., 10 lbs. 50c., 50 lbs. \$1.75, 100 lbs. \$3.25.



Write for prices on

**AGRICULTURAL LIME  
ACID PHOSPHATE  
NITRATE OF SODA  
PURE GROUND BONE**

**Send us your mail orders**

### STERLINGWORTH PLANT TABLETS



A concentrated plant invigorator. Makes house plants bloom luxuriantly. Dissolve in water and water soil. No odor. Clean, easily used. Prices: 10c., 25c., and 50c., postpaid.

**Rotted Fibrous Peat.** A fine material for mixing with potting soils for plants. ½ pk. 15c., pk. 30c., bush. \$1.00.

**Potting Soil.** Prepared for pot plants. ½ pk. 15c., pk. 25c., bush. 75c.

**INDEX**

FOR PLANTING TABLE AND SEED TABLE SEE PAGE 22

**VEGETABLE SEEDS.**

	Page
Asparagus	2
Beans	2, 3
Beets	4
Broccoli	5
Brussels Sprouts	5
Cabbage	6
Carrot	5
Cauliflower	7
Celery	7
Chard, Swiss	4
Chervil	5
Chicory	5
Chives	5
Corn, Field	19
Corn, Sweet	8
Cress	5
Cucumber	9
Dandelion	5
Egg Plant	10
Endive	10
Herbs	18
Kale	10
Kohl Rabi	10
Leek	10
Lettuce	11
Martynia	10
Melon, Musk	10
Melon, Water	10
Mushroom Spawn	11
Mustard	11
Okra	11
Onion	12
Onion Sets	12
Parsley	13
Parsnip	13
Peas	14, 15
Pepper	12
Potatoes	13
Pumpkin	12
Radish	15
Salsify	15
Spinach	16
Squash	16
Tomato	17
Turnip	17
Turnip, Rutabaga	18

**FLOWER SEEDS.**

Pages 23-36 inclusive.

**FARM SEEDS AND GRAINS**

Barley	20
Beans, Soja	20
Bent Grass	21
Blue Grass	21
Buckwheat	20
Clovers	21
Corn, Field	19
Golden Millet	20
Hungarian	20
Japanese Millet	20
Oats, Seed	20
Orchard Grass	21
Pasture Mixture	21
Peas, Cow	20
Rape, Dwarf Essex	20
Red Top	21
Rhode Island Bent	21
Rye	20
Spring Wheat	20
Sweet Vernal	21
Timothy	21
Vetches	20

**LAWN GRASS SEEDS.**

A. S. & L. Extra Fine Mixed	21
A. S. & L. Golf Mixture	21
A. S. & L. Putting Green	21
Shady Spot	21

**BULBS, PLANTS, ROOTS AND SEEDLINGS.**

	Page
Bulbs	37
Plants, Flowering	38
Plants, Vegetable	38
Roots	38

**POULTRY SUPPLIES**

Brooders	40, 41
Caponizing Sets	49
Carbola	69
Charcoal	49
Conkey's Starting Food	43
Coops, Brood	49
Coops, Shipping	44
Corn Shellers	44
Dr. Hess' Poultry and Stock Preparations	50
Egg Boxes	45
Eggs for Hatching	43
Feeders	46, 47
Fence, Poultry	44
Fountains	47, 48
Grandin's Poultry Feeds	42
Incubators	39
Killing Knives	49
Leg Bands	48
Live Chick Boxes	45
Mustard, Poultry	42
Nest Eggs	45
Nests	49
Oat Sprouters	44
Park & Pollard's Poultry Feeds	43
Punches, Poultry	48
Root Cutters	41
Rat Corn	43
Semi-Solid Buttermilk	42
Shipping Crates	44
Sulphur Candles	49
Water Glass	48
Waterproof Sheeting	45

**DAIRY SUPPLIES**

Barn Equipment	60
Bottle Caps	52
Bottle Carriers	56
Bottles, Milk	52
Butter Color	54
Butter Moulds	52
Butter Paper	52
Butter Prints	52
Calf Feeders	53
Can Strainers	55
Churns	51
Cream Pails	53
Cream Separators	54
Dairy Brushes	56
Garget Cure	55
Germ-X	57
Kow Kure	55
Milk Cans	54
Milk Coolers	51
Milk Fever Outfit	51
Milk Pails	53
Milk Scales	54
Milk Strainers	55
Milk Testers	51
Milking Stools	55
Milking Tubes	52
Paper Butter Boxes	51
Salt, Worcester	55
Thermometers	57
Wool Fat	57
Wyandotte C & C	58
Wyandotte Detergent	58

**FERTILIZERS.**

Page	79
------	----

**IMPLEMENTS**

Planet Jr. Farm & Garden Tools	61, 62
--------------------------------	--------

**INSECTICIDES AND FUNGICIDES**

	Page
Pages	65, 66, 67, 68, 69

**SPRAYERS**

Pages	64, 65
-------	--------

**FARM AND GARDEN SUPPLIES**

Asbestos Torch	75
Asparagus Knives	78
Baskets, Verbena	77
Cahoon Seeders	59
Canning Rack	63
Cider Mills	59
Clothes Dryers	75
Corn Planter	59
Edging Knives	76
Fence, Cyclone	70
Forks, Hay	76
Forks, Manure	76
Forks, Spading	76
Forks, Transplanting	78
Fruit Jars	63
Fruit Pickers	75
Garden Line	75
Garden Line Reels	75
Glazing Points	78
Grafting Chisels	75
Grafting Wax	75
Grass Hooks	76
Hoes	76
Hoes, Norcross	78
Hose, Rubber	74
Hose Menders	74
Hose Nozzles	74
Hose Reels	74
Hot-bed Mats	78
Labels, Wood	73
Lawn Mowers	71, 72
Lawn Rollers	74
Mulford Cultures	22
Plant Boxes, Steel	73
Plant Setter	59
Plant Sticks	73
Plant Supports	78
Plant Tub	73, 78
Pots, Flower	77
Pots, Paper	77
Powder Guns	65, 73
Pruners	75
Pruning Knives	75
Pruning Saws	75
Pruning Shears	75
Raffia	77
Rakes	76
Rifles	76
Scythe Stones	76
Scythes	76
Shears	78
Shovels	76
Snaths	76
Spades	76
Sprinklers	74
Step Ladders	75
Tomato Supports	78
Tree Bands	70
Trowels	78
Trellises	73
Vases, Florists'	77
Weeders	78
Wheel Barrows	76

**SPECIAL**

**Ideal Power Lawn Mowers, Page 72.**



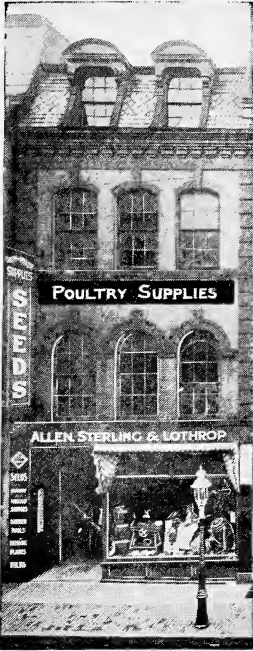

Retail Store and Offices  
49 EXCHANGE STREET

## Our Farm Employment Bureau Gives Free Service

It has been our privilege since we started business to find for a number of our customers very satisfactory farm help. We have also placed a number of farm superintendents, herdsmen, etc. in very satisfactory positions.

As we are constantly receiving employment inquiries from both *farm owners* and *farm workers*, we are now filing these inquiries and this information is at your disposal.

If you are looking for *farm work*—come in and register.

If you are looking for *farm help*—let us know it. The cost of this service is your good will.

ALLEN, STERLING & LOTHROP  
PORTLAND, MAINE

## Notes about Parcel Post

Weight limit 1st, 2nd and 3rd zones, 70 lbs.; in other zones, 50 lbs.

Bulk limit to all zones, 84 inches.

Poisons (Insecticides) cannot be sent by parcel post.

Liquids and goods packed in glass should be sent by express.

### PARCEL POST RATES

		First Pound	Each Additional Pound	Weight Limit
Portland and Rural Delivery	Local	5c.	½c.	70 lbs.
Within 150 miles	Zone 1 and 2	5c.	1c.	70 lbs.
150 to 300 "	" 3	6c.	2c.	70 lbs.
300 to 600 "	" 4	7c.	4c.	50 lbs.
600 to 1,000 "	" 5	8c.	6c.	50 lbs.
1,000 to 1,400 "	" 6	9c.	8c.	50 lbs.
1,400 to 1,800 "	" 7	11c.	10c.	50 lbs.
1,800 miles and over	" 8	12c.	12c.	50 lbs.



TRADE

MARK