

Historic, Archive Document

Do not assume content reflects current scientific knowledge, policies, or practices.

62.61

62.61

✓



LIBRARY
RECEIVED
★ JAN 28 1929 ★
U. S. Department of Agriculture.



Burnett's Seeds

Spring
1929

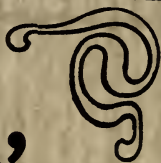
Burnett Bros. Inc.,
92 Chambers St.,
NEW YORK



Burnett Brothers'

RELIABLE

SEEDS·BULBS·PLANTS

Spring
1929

*Our motto: "Reliable Seeds
and Prompt Service"*

IMPORTANT NOTICE

TO THOSE REQUIRING THE SERVICES OF A SUPERINTENDENT, HEAD GARDENER OR ASSISTANT.

We have at all times on our register the names of competent men who are open for such positions, and will be careful to recommend only such as would be most suitable and with first-class references.

TO GARDENERS WISHING POSITIONS

We constantly have calls for first-class gardeners, and to supply such openings we cheerfully ask those who are in want of a position to apply to us, and we will endeavor to find a suitable place for them. We positively make no charge for this service, either to employer or employee.

BURNETT BROS. give no warranty, express or implied, as to description, quality, productiveness, or any other matter of any seeds, bulbs or plants they send out, and they will not be in any way responsible for the crops. If the purchaser does not accept the goods on these terms, they are at once to be returned.

BURNETT BROTHERS, Inc.

Seedsman

92 CHAMBERS STREET

NEW YORK

TELEPHONE, BARCLAY 6138



*Our store at 92 Chambers St.,
a few steps from Broadway and
convenient to all transit lines.*

*"The House famous
for
Lawn Grass Seed"*

The joy of gardening



UCCESS in gardening imparts a mingled feeling of joy and pride to those who put forth untiring efforts to attain it.

But this *success* is dependent upon the *quality* of the Seeds, Bulbs or Plants one purchases, this *quality* again reverting back to the integrity and reputation of the seedsman.

The responsibility of the seedsman is immense. He must earn the confidence of those who buy from him, particularly superintendents and head gardeners of private estates, for they cannot jeopardize their position or reputation as capable men by purchasing stocks from sources of unknown repute. This mutual feeling of confidence between the seedsman and gardener can only be built up through years of faithful service.

For close to a quarter of a century we have provided some of the largest gardens and estates in America with our selected Stocks of Vegetable, Flower and Field Seeds, the products of which have gained Highest Awards in Competitive Horticultural Shows, while our Grass Seeds have earned for us the title of "*The House Famous for Lawn Grass Seed.*"

We are again prepared to make this Gardening year for you a success and joy with our unflinching Standard of Efficiency "Reliable Seeds and Prompt Service."

Burnett Bros. Inc.

Jan. 1, 1929.

Burnett's Lawn Grass Seed Mixtures



Lawn View of Private Estate Sown with Burnett's "Special" Lawn Grass Seed Mixture.

Burnett's "Special" Lawn Grass Mixture

The above mixture is made from our own formula, and composed of grasses specially adapted for the purposes of producing turf which retains its rich green color and velvety appearance throughout the entire Summer and Fall. In making up this high grade mixture we are careful to use only the very finest quality of all the most desirable dwarf evergreen, recleaned grasses, free from chaff and weeds, which thrive well on any soil, thus ensuring a beautiful and permanent lawn. To obtain best results Lawn Grass Seed should be sown as soon as the ground can be prepared in early Spring. It may also be sown in the Fall with good results.

Quantity Seed Required

For making New Lawns, we recommend sowing at the rate of 125 lbs. to the acre (approximately 6 bushels). Where small quantity is required, sow 1 lb. to each 400 square feet (20' x 20'). For renovating old lawns, use half the quantity.

1 lb. 60c., 2½ lbs. \$1.40, 5 lbs. \$2.75, 10 lbs. \$5.25, 20 lbs. \$10.00, 100 lbs. \$50.00

(20 lbs. of Burnett's "Special Mixture" is approximately one bushel.)

Lawn Remarks

A perfect and enduring lawn, one of velvety appearance with closely interwoven, firm, deep and elastic turf, is only created by sowing a composition of the various kinds of grass seeds suited to the conditions and the climate. Several varieties are needed, that the lawn may be evergreen during all seasons and the seeds must be sown liberally (at the rate of from five to six bushels per acre), not only that a lawn may be produced quickly, but because the kinds of grasses suitable for perfect lawns are fine-leaved and should take entire possession of the ground promptly, thus checking the development of weeds, the seeds of which are in all soils. Good, rich deeply worked soil, either of a friable texture or thoroughly drained, is as necessary for the production of a perfect lawn as for garden crops. Early and frequent mowing and rolling, as well as the liberal application of water, which should be applied in the early morning, or late afternoon during dry seasons, is one of the secrets of maintaining beautiful green turf from early Spring to late Fall.

Prevent and Control BROWN PATCH in your lawn. SEMESAN controls this fungous disease. 2 oz. 50c; 8 oz. \$1.60; 1 lb. \$2.75; 5 lbs. \$13.00.

Burnett's Lawn Grass Seed Mixtures



View of Lawn sown with Burnett's Famous "KILLARNEY" Lawn Grass Seed Mixture.

Burnett's "Killarney" Mixture

Burnett's Lawn Grass Seed Mixture "Killarney" is composed of a combination of the very finest European grasses and fescues, the highest grades possible to procure, and specially adapted for this climate. This mixture is composed of all solid, re-cleaned seeds of the highest germination. Therefore, owners of large estates requiring a permanent sod and everlasting lawn should by all means use this high-grade mixture. If the ground is properly prepared, we are certain "Killarney Mixture" will produce a turf of velvet, equal to the most famous Lawns in Europe. Give it a trial. "Sow Killarney and walk on Velvet."

lb. 65c., 2½ lbs. \$1.60, 5 lbs. \$3.00, 12½ lbs. \$7.50, 25 lbs. \$14.00, 100 lbs. \$55.00

(25 lbs. of "Killarney Mixture" is approximately one bushel.)

Burnett's "Central Park" Mixture

This well-known mixture contains a large proportion of permanent grasses that grow quickly, producing a rich, green sward in about four weeks from time of sowing. "Central Park" is very hardy and has always given entire satisfaction in any location wherever sown.

1 lb. 50c., 2½ lbs. \$1.20, 5 lbs. \$2.25, 10 lbs. \$4.25, 20 lbs. \$8.00, 100 lbs. \$40.00

(20 lbs. of "Central Park Mixture" is approximately one bushel.)

Burnett's "Play Ground" Mixture

The above mixture is adapted for a strong, hard-wearing turf of the finest texture, and is composed of some of the hardiest grasses, which will produce a close, thick sod and stand hard usage under all conditions. For Play-Grounds or any place where a strong turf is necessary, this mixture cannot be equaled. We recommend sowing separately some white clover with this mixture.

20 lbs. \$9.00, 100 lbs. \$42.00.

(20 lbs. of "Play Ground Mixture" is approximately one bushel.)

Note: To destroy worms in your lawn, use Richards' Imported Worm Powder. (See Page 5).

Burnett's Lawn Grass Seed Mixtures



View showing Lawn sown with Burnett's "SHADY PLACE" Lawn Grass Seed Mixture.

Burnett's "Shady Place" Mixture

When a lawn is much shaded, either in whole or in part, the shaded portions should be sown with Burnett's "Shady Place" Lawn Grass Seed Mixture, which is a combination of fine, dwarf-growing evergreen varieties, which, in their wild or natural state, are to be found growing in the woods or other sheltered or shady places. Under or in the immediate neighborhood of large trees fertilizers should be applied liberally and frequently, for the trees absorb the fertilizer and impoverish the ground. Ground much shaded is very frequently sour, and if the drainage is defective it is apt to be covered with moss. In such cases an application of lime or wood ashes raked in will sweeten the soil, but the moss should be first removed with a sharp steel-toothed rake.

1 lb. 75c., 2½ lbs. \$1.80, 5 lbs. \$3.50, 10 lbs. \$6.50, 20 lbs. \$12.00, 100 lbs. \$55.00

(20 lbs. of Burnett's "Shady Place Mixture" is approximately one bushel.)

Burnett's "Bank and Terrace" Mixture

On sloping banks it is often necessary to use sod, as heavy rains wash the soil off before the grass seed has time to germinate. It is sometimes even necessary, in sodding very steep banks, to use pins eight or ten inches in length to pin the sods in place, to prevent them from being washed down by excessive rains before the grass roots have had time to fasten in the soil. The Terrace mixture which we offer is composed of deep-rooting grasses which, if once established, will hold the soil and prevent washing, and we advise liberal fertilizer and seeding so that the grasses may be quickly established.

1 lb. 60c., 2½ lbs. \$1.40, 5 lbs. \$2.75, 10 lbs. \$5.25, 20 lbs. \$10.00, 100 lbs. \$50.00

(20 lbs. of Burnett's "Bank and Terrace Mixture" is approximately one bushel.)

Burnett's "Seashore" Mixture

If a few inches of top soil is spread over the surface, and well firmed, an application of Burnett's Special "Seashore" Mixture will produce a good lawn in six or eight weeks. An occasional application of pure Sheep Manure during the spring, summer and fall months will increase the strength and color of the grass. Our formula has been thoroughly tested out in various localities. If the soil is exceptionally poor, and it is not possible to apply a layer of top soil, White Clover will help to make the sod thick, and also protect the grass.

1 lb. 50c., 2½ lbs. \$1.20, 5 lbs. \$2.25, 10 lbs. \$4.25, 20 lbs. \$8.00, 100 lbs. \$40.00

(20 lbs. of Burnett's "Seashore Mixture" is approximately one bushel.)

Burnett's Lawn Grass Seed Mixtures



View of Green sown with Burnett's "Putting Green" Grass Seed Mixture.

Grass Seeds for Golf Courses, Etc.

We have made a specialty of Fine Grass Seed Mixtures for many years, suitable for Putting Greens and Fair Greens, and are direct importers of the various European grasses and handle largely the domestic varieties necessary for the formation of correct formulas to cope successfully with the many different conditions of soil, location and climate.

Many clubs have experimented with their greens until they have been successful in the combination of a mixture that gives perfect satisfaction in their particular location. In such instances, we will be glad to offer the necessary grasses separate or make a mixture to the required formula.

Burnett's "Putting Green" Mixture.....5 lbs., \$4.00 25 lbs., \$18.00 100 lbs., \$65.00

For "Putting Greens" sow 75 to 100 lbs. seed to each green.

Burnett's "Tennis Court" Mixture.....5 lbs., \$3.50 25 lbs., \$16.00 100 lbs., \$60.00

For "Tennis Courts" sow 1 lb. seed to each 100 square feet.

(25 lbs. of the above mixtures is approximately one bushel.)

Burnett's "Fair Green" Mixture.....5 lbs., \$2.50 20 lbs., \$ 9.00 100 lbs., \$40.00

For "Fair Greens" sow 150 to 200 lbs. seed per acre.

Burnett's "Polo Field" Mixture.....5 lbs., \$3.00 20 lbs., \$10.00 100 lbs., \$45.00

For "Polo Fields" sow 150 lbs. seed per acre.

(20 lbs. of the above mixtures is approximately one bushel.)

RICHARDS' WORM POWDER (Imported)

A new and valuable discovery for instantly removing worms from lawns, bowling greens, putting greens, tennis courts and golf links, etc.

Original bags of 112 lbs., each \$12.00

Directions for Use

Use about ½ lb. to the square yard, distributing the powder over the grass as evenly as possible. The next step is to immediately apply the water to wash in the powder.

Non-poisonous to animal and bird life.

Plenty of water should be used, especially during dry weather, as worms are then deeper in the soil.

The use of this worm killer will diminish labor considerably, as far less brushing and rolling will be required to maintain an even, clean surface on the grass.



BURNETT'S GRASSES AND CLOVERS

FOR HAY, MEADOWS AND PERMANENT PASTURES

OUR Permanent Pasture, Hay and Meadow Mixtures are composed of varieties of grasses best adapted for producing an abundant and nutritious food supply for stock. Our formulas are arranged with great care and the mixtures are made to suit the exact location and condition of soil, etc., for which they are needed.

Nothing but the best re-cleaned seeds are used, consequently it does not take so large a quantity per acre as that generally used when poor quality mixtures are sown.

We recommend four bushels to one acre, which may be sown either in the Spring or Fall, with an additional ten pounds of Mixed Clovers sown early in the Spring. When ordering please state whether for high, dry, medium, wet or heavy soil.

Price Bushel 18 lbs. 100 lbs.

Permanent Hay and Pasture Mixture. For high and dry soil...	\$7.50	\$40.00
Permanent Hay and Pasture Mixture. For wet soil.....	7.50	40.00
Permanent Hay and Pasture Mixture. For medium soil.....	7.50	40.00
Meadow Mixture. Made up specially for any soil or location	7.50	40.00
Woodland Pasture Mixture. For rough ground, woodlands...	7.50	40.00

CLOVERS

Our Clover Seeds are all re-cleaned and of the finest samples.

	Weight Bushel	Price Bushel	Price Pound	Price 100 lbs.
Alfalfa or Lucerne (<i>Medicago sativa</i>). (Western grown). A valuable forage plant. Enormous yield; can be cut three or four times a season. Quantity to acre, 15 to 20 lbs.....	60 lbs.	\$30.00	\$0.55	\$45.00
Alfalfa (Grimm) . This Clover has strong spreading roots, well submerged, which prevents it from Winter killing. The seed we offer is Northern grown and very hardy.....	60 lbs.	45.00	.80	70.00
Alsike (<i>Trifolium hybridum</i>). Quantity to acre, 15 lbs.....	60 lbs.	37.50	.65	58.00
Crimson or Scarlet Clover (<i>Trifolium incarnatum</i>). Valuable for green forage. Quantity to acre, 20 lbs.....	60 lbs.	20.00	.40	30.00
Mammoth Red or Pea Vine . Much taller than Medium Red. Good for plowing under. Quantity to acre, 15 lbs.....	60 lbs.	43.00	.75	70.00
Medium Red (<i>Trifolium pratense</i>). Largely grown for general purposes. Quantity to acre, 15 lbs.....	60 lbs.	37.50	.70	65.00
Mixed Clover . Quantity to acre, 15 lbs.....	60 lbs.	37.50	.65	60.00
White Clover (<i>Trifolium repens</i>). The best variety for lawns. Quantity to acre, 10 lbs.....	60 lbs.	45.00	.80	70.00
Sweet Clover, White Blossoms (<i>Melilotus alba</i>). Grown for hay, green forage; valuable for bees.....	60 lbs.	18.50	.35	25.00

STIMUGERM & MULFORD Cultures help Germination of CLOVERS. (See page 110.)



BURNETT'S GENERAL LIST OF RECLEANED GRASSES

All Grasses offered by us are of choicest quality, recleaned new crop seeds of the highest germination and purity.

	Weight Bushel	Price Bushel	Price Pound	Price 100 lbs.
Canada Blue Grass (<i>Poa compressa</i>). For sowing on hard clay and poor soils.....	14 lbs.	\$ 6.00	\$0.50	\$40.00
Chewing's New Zealand Fescue. A splendid Grass of creeping habit, which forms a good sward where no other Grass would succeed. Excellent for lawns and golf links.....	20 lbs.	11.00	.60	50.00
Creeping Bent Grass (<i>Agrostis stolonifera</i>). Excellent for lawns; succeeds well in most situations.....	20 lbs.	26.00	1.35	110.00
Crested Dogstail (<i>Cynosurus cristatus</i>). Excellent for dry soils, pastures and lawns.....	21 lbs.	15.00	.80	65.00
English Rye Grass (<i>Lolium perenne</i>). A very rapid growing variety; valuable for meadows and pastures.....	24 lbs.	7.00	.30	25.00
English Rye (Pacey's). A small-seed variety of the above, suitable for fine mixtures.....	31 lbs.	10.00	.35	30.00
Fine-leaved Sheep's Fescue (<i>Festuca ovina tenuifolia</i>). A fine-bladed Grass, valuable only for lawns.....	14 lbs.	12.00	.90	75.00
Hard Fescue (<i>Festuca duriuscula</i>). Desirable for dry soils.....	14 lbs.	7.00	.55	45.00
Italian Rye Grass (<i>Lolium italicum</i>). Adapted to any soil.....	18 lbs.	5.50	.35	25.00
Kentucky Blue Grass (<i>Poa pratensis</i>). Extensively used for lawns.....	20 lbs.	12.00	.65	55.00
Meadow Fescue (<i>Festuca pratensis</i>). Valuable for pastures.....	20 lbs.	10.00	.55	45.00
Meadow Foxtail (<i>Alopecurus pratensis</i>). Excellent for pasture.....	10 lbs.	8.75	.90	85.00
Orchard Grass (<i>Dactylis glomerata</i>). Valuable for growing in shady, moist places, under trees, etc.....	14 lbs.	6.50	.50	40.00
Red Top "Fancy" (<i>Agrostis vulgaris</i>). Recleaned seed, free from chaff.....	30 lbs.	14.00	.50	40.00
Red Top "Common." Valuable for either pastures or lawns.....	14 lbs.	5.00	.40	30.00
Red, or Creeping Fescue (<i>Festuca rubra</i>). Valuable for lawns.....	14 lbs.	7.50	.60	50.00
Rhode Island Bent (<i>Agrostis canina</i>). Excellent for lawns, etc.....	14 lbs.	Market Price		
Sheep Fescue (<i>Festuca ovina</i>). Excellent for sheep pastures.....	14 lbs.	7.00	.55	45.00
Tall Oat Grass (<i>Avena elatior</i>). Valuable for pastures.....	10 lbs.	4.00	.45	35.00
TIMOTHY or HERD GRASS (<i>Phleum pratensis</i>). Fancy Recleaned. Generally grown for hay. ½ bus. per acre.....	45 lbs.	7.50	.20	14.00
Wood Meadow Grass (<i>Poa nemoralis</i>). Well adapted for growing under trees and in shaded situations.....	14 lbs.	12.00	.90	80.00

(Above prices subject to market changes. Special quotations on large quantities.)

Note. For Farm Seeds—see pages 39 and 40.

Burnett's Novelties and Specialties in Vegetable Seeds



The above illustration shows a magnificent collection of vegetables from Burnett's Seeds.

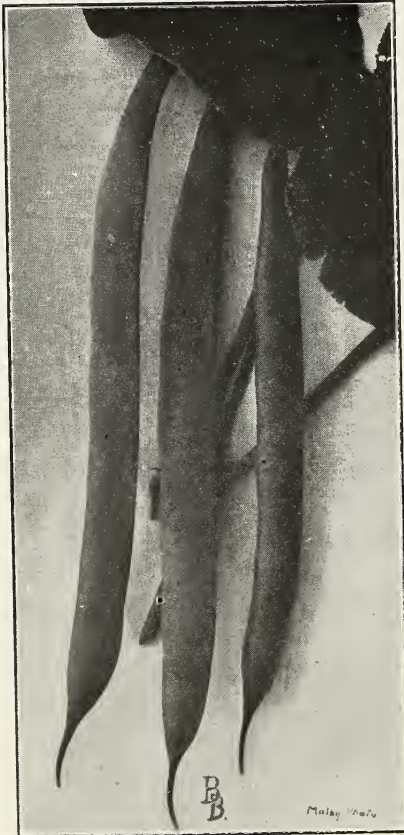

Bean, Masterpiece (Sutton's)

BEAN, Masterpiece (True Stock)

Ever since its introduction, Masterpiece has been very popular. The plant is robust, very prolific, with long, straight, handsome pods. Very tender and perfectly stringless. For Exhibition purposes it is undoubtedly the best variety, whether grown outdoors or under glass. Pt. 85c., Qt. \$1.50, 4 Qts. \$5.00

BROCCOLI

True Italian Sprouting

This vegetable is well known and esteemed highly in Europe and today there is a growing demand for it in this country. It is an entirely distinct sort, producing narrow, tender sprouts, which, when young, can be cooked and served same as asparagus. Flavor delicious. Cultivation is the same as that of cauliflower or cabbage.

True Italian Green Sprouting.

Pkt. 25c., $\frac{1}{4}$ oz. \$1.25, oz. \$4.00

CABBAGE (Savoy)

Burnett's Irish Giant

This new introduction of Irish origin is an improved strain of the old Drumhead Savoy.

It is a large handsome type, leaves heavily curled, heart very solid, of massive proportions and unquestionably one of the finest, long-standing Savoys we have ever seen. Pkt. 25c., $\frac{1}{2}$ oz. \$1.00, oz. \$1.75

CORN

Golden Sunshine

The earliest of the golden yellow type, maturing a week to ten days earlier than Golden Bantam; more dwarf in habit, with ears $6\frac{1}{2}$ in. long, containing 10 to 12 rows of broad yellow delicious sweet grains. Pt. 45c., qt. 85c.

Prevent Ear, Root and Stalk ROTS of Corn. Dust it with SEMESAN JR.
4 oz. (enough for 1 bush.) 60c.

Burnett Bros.' Novelties and Specialties in Vegetable Seeds

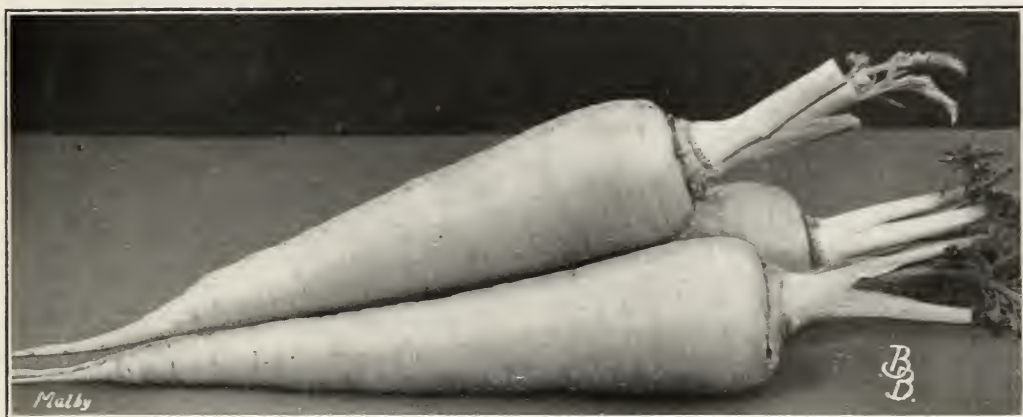

Carrot, Improved Long Red Surrey.

CARROT

Improved Long Red Surrey (Imported)

The longest Carrot offered, especially suited for deep soils. Our stock has been selected with the greatest care, and is above comparison with that frequently offered under the Surrey Carrot. The ideal variety for exhibition purposes. (Imported seed.) Pkt. 15c., oz. 50c., $\frac{1}{4}$ lb. \$1.50.

CARROT

Paris Exhibition Forcing

This Carrot is an improved strain of the French type. The roots are small, globular in shape, fine grained and very delicate. Color bright orange; tops small. For forcing or growing in frames this variety will be found the most desirable. Pkt. 15c., oz. 50c., $\frac{1}{4}$ lb. \$1.50, lb. \$5.00.

CABBAGE

Burnett's Baby-Head

A new Cabbage of merit which forms small, perfectly round heads, of unusual solidity. The outer leaves are very few and small, which enables it to be planted about 8 inches apart, making it a desirable Cabbage for planting in frames and early outdoor cultivation. Baby-Head is an ideal Cabbage where space is limited and the fact that it can be brought to maturity about 6 weeks after planting, makes it a desirable acquisition to the vegetable garden. Pkt. 20c., oz. \$1.00.



Cabbage, Burnett's Baby-Head

CAULIFLOWER

Snowball, "Burnett's Selected Strain"

No other Cauliflower at the present time is so widely known as Snowball, having supplanted all other sorts for early and late planting. For forcing under glass and growing in frames for early use it has proved superior to all. Its dwarf, compact habit and short outer leaves allow it to be planted closer in the same space of ground than other varieties. Heads pure snow white of the finest quality. Our strain of Snowball is specially grown for us in Denmark for our private estate trade and can be recommended with confidence. Pkt. 25c., $\frac{1}{4}$ oz. \$2.00, oz. \$6.00.

CELERY

Burnett's Golden Plume

This is undoubtedly the earliest celery now grown. It is strong, vigorous and immune from blight and rust, blanches easily, is brittle, tender and of finest flavor. The ideal celery for the home garden. Pkt. 25c., $\frac{1}{4}$ oz. \$1.25, oz. \$4.00.



Cauliflower, Burnett's Snowball

SWEET CORN—The Four Leaders

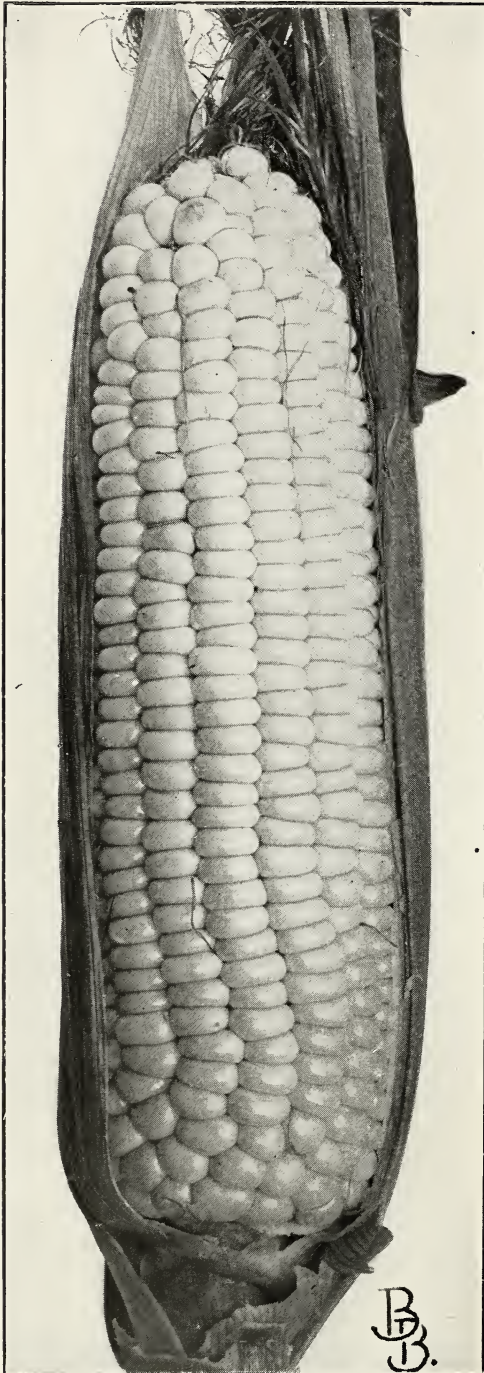

Corn, Burnett's Improved Evergreen

BURNETT'S Improved Evergreen

This new strain of the well-known Stowell's Evergreen Sweet Corn has been derived by crossing Evergreen with an early variety, which produces a longer and narrower kernel with from 18 to 20 rows to the ear. The field from which this stock seed was selected yielded 175 bushels per acre, every stalk producing two or more ears. The high degree of excellence of Burnett's Improved Evergreen was obtained by having our grower carefully select the stock for the past three years, so that we have now a sugar corn that has reached the highest state of perfection. The ears are large, handsome and uniform, therefore all Exhibitors should give it a trial. It is also the best variety for general purposes. Pint 40c., Quart 75c., Peck \$5.00.

Country Gentleman

Burnett's Improved Strain

A distinct variety, with fine deep grains irregularly formed on a long, slender cob. Country gentleman is a general favorite, well known for its yield and unsurpassed sweetness; the strain we offer, has been carefully selected and can be highly recommended. Pint 40c., Quart 70c., Peck \$4.50.

Burnett's Golden Bantam

This Sweet Corn is universally acknowledged to be the earliest, sweetest and most delicious Corn grown. It is of dwarf habit; ears medium, and of a rich golden yellow color. Golden Bantam is an ideal Corn for successive planting. The stock we offer has been selected with the greatest care. Pint 40c., Quart 70c., Peck \$4.50.

Metropolitan Improved

For earliness, productiveness and flavor, Metropolitan is one of the leading Sweet Corns. The ears are large and handsome, measuring from 8 to 10 inches; grains pure white, deep, sweet and tender. Pint 40c., Quart 70c., Peck \$4.50.



Lettuce, Burnett's Balmoral

LETTUCE

Burnett's Balmoral

A grand, early head Lettuce for forcing or outside planting. The heads are of medium size and very solid; outer leaves light green with golden yellow heart. It is crisp, tender, and of perfect quality. Give it a trial and prove its excellence. Pkt. 15c., oz. 50c., $\frac{1}{4}$ lb. \$1.50.

May King

This is a most desirable variety, either for forcing or outdoor planting. It will produce large, solid heads much sooner than any other sort. Heads very attractive, outer leaves yellowish-green, tinged with brown, hearts rich golden yellow. Pkt. 10c., oz. 40c., $\frac{1}{4}$ lb. \$1.25.

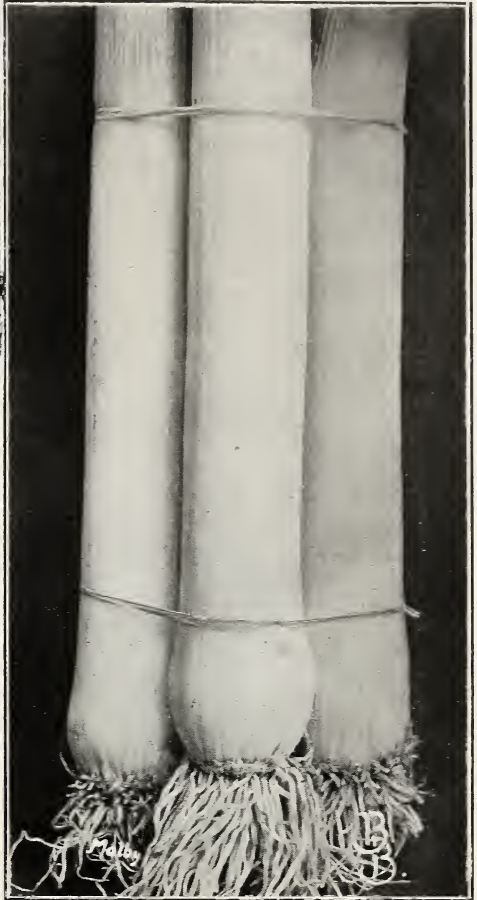

Leek, Waverley Market

LEEK

Waverley Market

A grand exhibition variety with long, thick, snow white stems, Waverley Market grows to an immense size, with dark green leaves, thus differing from all other varieties. It is hardy and productive, a good keeper and of excellent flavor. Waverley Market is superior to any Leek yet offered. Pkt. 20c., oz. 75c., $\frac{1}{4}$ lb. \$2.50.

NEW LETTUCE

(Romaine or Cos.) "Silver King"

This type of Lettuce, which is becoming more popular every year, is well worthy of consideration. The seed we offer is selected with the utmost care by one of the leading houses in Europe, who claims it to be the largest of the Romaine strain. Perfect form, self-folding, very crisp and tender, a solid heart of crystal white. Pkt. 20c., oz. 50c., $\frac{1}{4}$ lb. \$1.50.

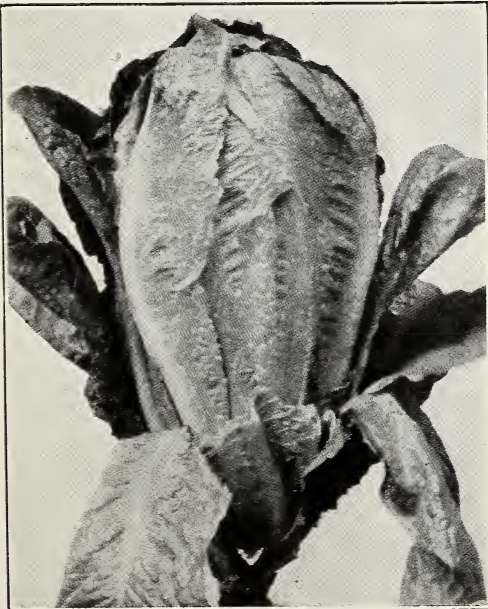

Lettuce, Silver King

Burnett Bros.' Novelties and Specialties in Vegetable Seeds



Muskmelon, Burnett's Discovery

MUSKMELON

"Burnett's Discovery"

For outside culture and forcing under glass "Discovery" has few equals. The fruit is of an emerald-green color, finely netted, flesh very deep, ripening clear to the rind; of a beautiful salmon color, flavor rich and delicious. It is early, prolific and long bearing. An ideal melon for table use. Pkt. 25c., 5 pkts. \$1.00.

MUSKMELON

Emerald Gem—Selected Strain

Emerald Gem has proven to be the most valuable for general use. For outside culture and for forcing under glass it has few equals. The flesh is very deep, ripening clear to the rind, of a beautiful salmon color, rich and delicious. It is very early, prolific and long bearing; fruit small, smooth skin, color deep emerald green, with light stripes. Pkt. 10c., oz. 25c., ¼ lb. 75c.

ONION

Ailsa Craig (Imported)

For exhibition Ailsa Craig is universally recognized as the ideal Onion. The skin is of a pale straw color; flesh white, very mild and quality superb. The bulbs, which are oval-shaped, often attain the phenomenal size of from 3 to 4 lbs., grown exactly under the same conditions necessary to the cultivation of other sorts. Pkt. 25c., oz. \$1.00, ¼ lb. \$3.50.

ONION

Gigantic Gibraltar

The largest Onion yet introduced; while being similar in appearance to Prizetaker, it is much lighter in color and very much larger in size. During recent tests of all Onions, Gigantic Gibraltar was far ahead of any other variety as a weight producer. The flavor is mild and delicious and will, when properly harvested and kept in a dry, airy place, keep until Spring. Pkt. 20c., oz. 75c., ¼ lb. \$2.50.

PARSLEY

Burnett's Emerald Isle

This Parsley is of a beautiful dark green color and more densely curled than the older sorts. The plant is dwarf and very compact, making it most desirable for planting indoors, or for a neat border in the vegetable garden. Pkt. 15c., oz. 50c., ¼ lb. \$1.50.

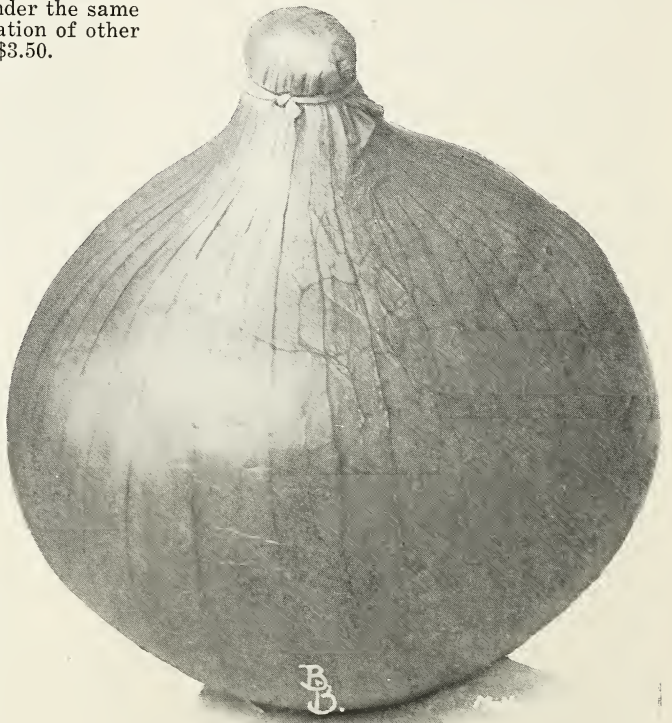

Onion, Ailsa Craig

Burnett Bros.' Novelties and Specialties in Vegetable Seeds

PEAS

The Largest-podded Pea in Cultivation. Sutton's Super-Pea
THE V. C.

The pods of this truly wonderful Pea measure from 8 to 9 inches; filled with ten or more luscious peas of the most delicious flavor. The haulm is very sturdy growing to a height of 5 to 6 ft. Of handsome appearance. This is a second early variety and will prove indispensable for exhibitors. Pint \$1.25, qt. \$2.00.

ADMIRAL BEATTY

This grand new Pea is a medium early variety growing to a height of about 4 ft. It is a remarkable cropper and bears in profusion large pods, each containing 8 to 10 peas of delicious flavor. Pint 85c., qt. \$1.50.

GLADSTONE SELECTED

The strong constitution of this grand variety enables the plant to remain healthy for a long time during drought, and there is no more reliable late Pea. Pods well filled and fit to gather at a period of the year when Peas are specially prized. Enormous cropper. Height 3 to 4 feet. Pint 60c., qt. \$1.00, peck \$7.00.

EARLY BIRD

A grand, early, round smooth-seeded variety, with the flavor of the best wrinkled sorts, which can be planted 10 days earlier than Gradus or Prosperity. It bears a very heavy crop of large pods, well filled with delicious marrow flavored peas. 3 ft. Pint 50c., Qt. \$1.00, peck \$7.00.

NOTE

The above four grand peas are specially grown and imported by us direct from England.

BURNETT BROS.

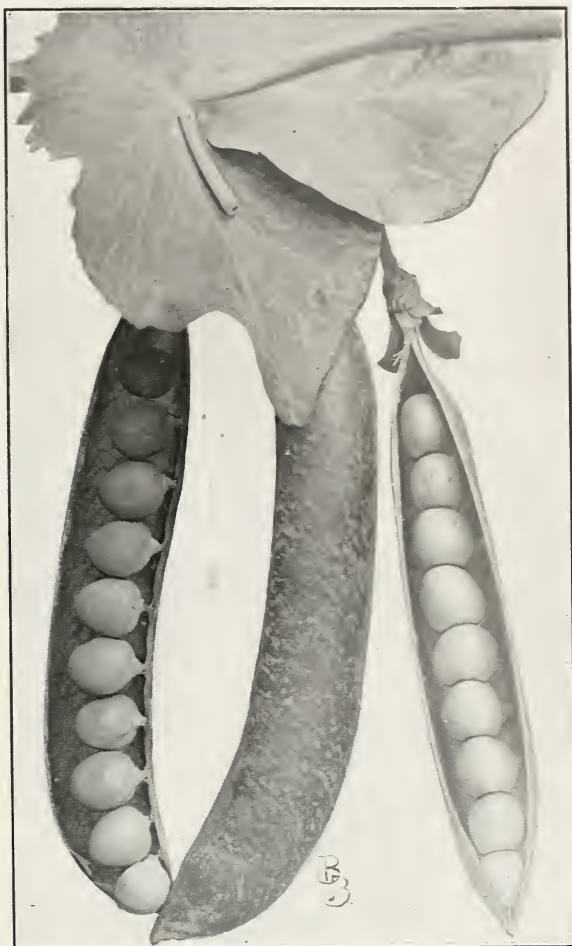

Pea, The V. C.

PARSNIP

Burnett's Winter King

An ideal parsnip for exhibition and table use. The roots are very long, smooth and heavy, of perfect shape, making a beautiful appearance. Quality unsurpassed and flavor delicious. Pkt. 10c., oz. 30c., $\frac{1}{4}$ lb. \$1.00.

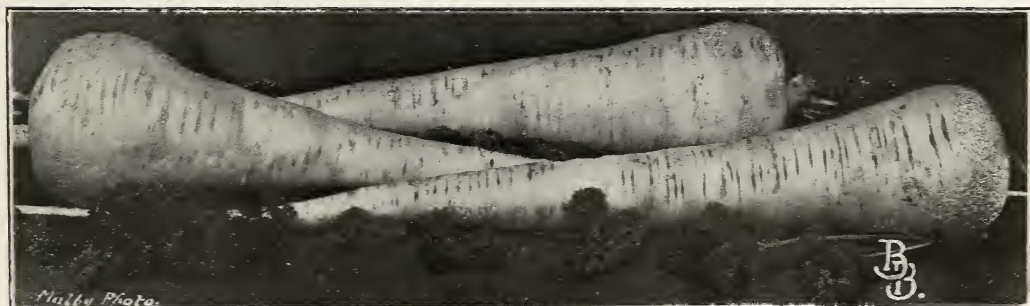

Parsnip, Burnett's Winter King

Burnett Bros.' Novelties and Specialties in Vegetable Seeds

Burnett's Two Famous "Prize Winners"



Tomato, Westchester Pryde

Tomato "Westchester Pryde"

For Forcing or Outdoor Growing

This grand Tomato we can confidently say is one of the finest forcing varieties ever offered. The seed has been saved by the grower from perfect fruit only. Westchester Pryde is a cross between Lister's Prolific and Carter's Sunrise, and is of medium size, fruit uniform and perfect in shape, color beautiful rich red, flavor delicious.

Westchester Pryde, while we claim for it to be a forcing variety, has been grown outside the past season with remarkable success, bearing 40 lbs. of fruit to the plant. Trusses from 12 to 24 to the plant and contain from 15 to 40 fruits to each truss, weighing on an average 4 fruits to a pound. We have had this variety on exhibition in our show window the past season and same was admired by all who saw it. Do not fail to grow Westchester Pryde.

Pkt. 25c., 5 pkts. \$1.00.

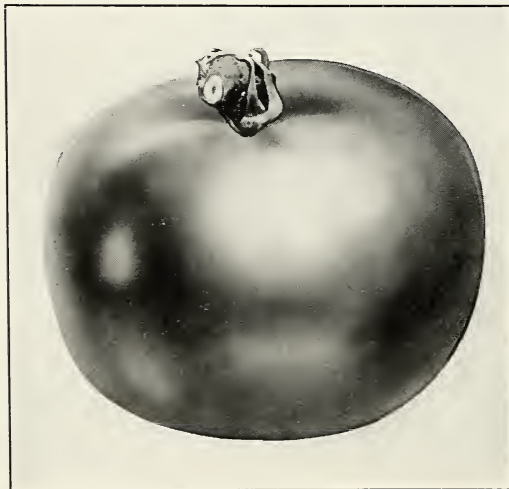

Tomato Burnett's "Liberty"

Tomato Burnett's "Liberty"

For Main Crop and Exhibition
Purposes "Liberty" has No Equal

Liberty Tomato, introduced by us some years ago, still holds undisputed reputation as the best main crop and exhibition variety. We claim for Liberty the distinction of being the finest Tomato on the market today. It is an exceedingly heavy cropper and bears abundantly until very late in the season. The fruit is of a glossy red color, large, perfectly round, uniform in shape, very solid, and meaty, of superb quality with few seeds, and borne in clusters of from ten to twelve perfect fruits. All exhibitors and growers should not fail to give Liberty a trial.

Pkt. 25c., oz. \$1.00.

General List of Reliable VEGETABLE SEEDS

NOTE: We wish to call attention to the fact that we cater to private estates exclusively and handle only the very best stocks obtainable.

BURNETT BROS. INC.

All prices in this catalogue subject to change without notice.



Asparagus. Pedigreed Washington

We draw particular attention to the new "Pedigreed Washington" Asparagus, far in a way ahead of anything before offered. We have it in both seed and roots for those who desire to try it.

ARTICHOKE

One ounce will produce 500 plants.

Sow seeds early in Spring, and when large enough transplant into rows 4 feet apart and 2 feet apart in the rows.

JERUSALEM ARTICHOKE. Roots. Qt. 40c., peck \$2.50.

LARGE FRENCH GLOBE. Seed. Pkt. 25c., oz. \$1.00.

LARGE FRENCH GLOBE PLANTS. Ready after May 1st. Doz. \$3.00, 100 \$20.00.

ASPARAGUS ROOTS

Can be planted either in Spring or Fall.

CULTURE

To make a permanent Asparagus bed, the ground should be trenched deeply and well drained. The trench should be filled up with a rich compost of well rotted manure and loam. Set roots 12 inches apart in the rows, allowing 2 to 3 feet between rows, spreading out and separating the roots carefully so that the crown will be covered with about 6 inches of soil. In November, when the stalks have been cleared away, give the bed a good top-dressing. In early spring a liberal application of agricultural salt will be beneficial.

PEDIGREED WASHINGTON. This new strain was developed by the U. S. Dept. of Agriculture. It is rust-resistant and produces, large, straight, dark green shoots, with tight, firm tips, which do not open until well out of the ground. Extra large selected roots. 100 \$4.50, 1000 \$40.00.

COLUMBIAN MAMMOTH WHITE. Two-year-old roots. 100 \$1.50, 1000 \$12.00. Three-year-old, extra-strong, transplanted roots. 100 \$3.50, 1000 \$30.00.

CONOVER'S COLOSSAL. Two-year-old roots. 100 \$1.50, 1000 \$12.00. Three-year-old, extra-strong, transplanted roots. 100 \$3.50, 1000 \$30.00.

PALMETTO. Two-year-old roots. 100 \$1.50, 1000 \$12.00. Three-year-old, extra strong, transplanted roots. 100 \$3.50, 1000 \$30.00.

We strongly recommend our three-year-old transplanted roots for quickest and best results.

ASPARAGUS SEED

One ounce will sow about 50 feet of drill.

Seed should be sown early in Spring as soon as the soil is in good working condition.

COLUMBIAN MAMMOTH WHITE. Pkt. 10c., oz. 25c., ¼ lb. 50c.

CONOVER'S COLOSSAL. The standard sort. Pkt. 10c., oz. 25c., ¼ lb. 50c.

PALMETTO. Large, bright green. Pkt. 10c., oz. 25c., ¼ lb. 50c.

PEDIGREED WASHINGTON. New, rust-resistant. Pkt. 25c., Oz. 50c., ¼ lb. \$1.50.

BEANS

Plant about the first of May, in a light, rich soil in drills 2 inches deep and 2 feet apart. Hoe well in dry weather to keep down the weeds. For a succession sow every two weeks.

Dwarf Green Podded Varieties

One quart will plant 100 feet of drill.

BLACK VALENTINE. (Black seeded). A good forcer. With long, round solid green pods. Pt. 45c., qt. 85c., peck \$5.75.

BOUNTIFUL. SELECTED. Early and prolific, with long, flat green pods; tender. Entirely stringless. Pt. 55c., qt. \$1.00, peck \$7.00.

DWARF HORTICULTURAL. A grand shell bean, and very productive; pods flat. Pt. 40c., qt. 75c., peck \$5.00.

EARLIEST RED VALENTINE. Pods round, thick, very tender. Pt. 45c., qt. 85c., peck \$5.75.

EXTRA EARLY REFUGEE. Early and prolific. Pt. 45c., qt. 85c., peck \$5.75.

GIANT STRINGLESS GREEN POD. The best long, rounded-podded strain, tender and prolific. Pt. 55c., qt. \$1.00, peck \$7.00.

LONGFELLOW. Long, straight, round, solid green pods. Pt. 50c., qt. 90c., peck \$6.50.

REFUGEE, or 1000-to-1. Largely grown for main crop and pickling. Pt. 50c., qt. 90c., peck \$6.50.

MASTERPIECE. True stock. "Splendid forcer." Pt. 85c., qt. \$1.50, 4 qts. \$5.00. (For description see page 8).

WHITE KIDNEY. Excellent shell or green Bean. Pt. 40c., qt. 75c., peck \$5.00.

WHITE MARROW. Used in a dry state in Winter. Pt. 40c., qt. 75c., peck \$5.00.

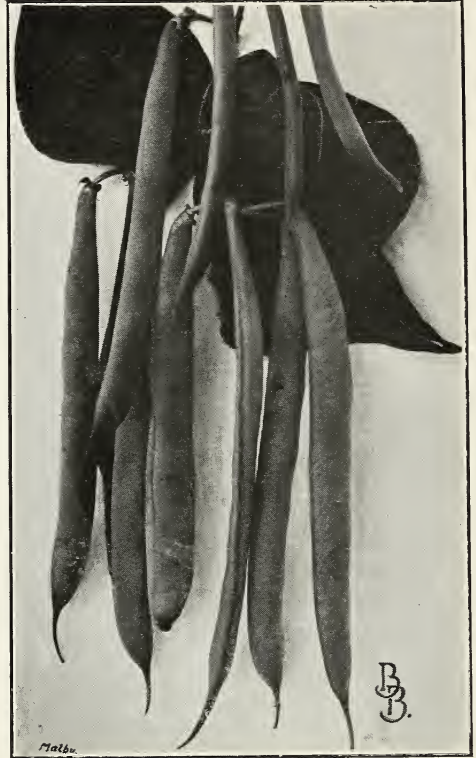

Bean, Bountiful Selected.



Bean, Improved Golden Wax

Dwarf Wax Podded Varieties

DAVIS KIDNEY WAX. Long, handsome waxy white; flat pods. Pt. 50c., qt. 90c., peck \$6.50.

FLAGEOLET WAX. Flat, yellow, stringless pods of great size. Pt. 50c., qt. 90c., peck \$6.50.

IMPROVED GOLDEN WAX. Very early and prolific, with long, flat, yellow pods. Pt. 55c., qt. \$1.00, peck \$7.00.

IMPROVED BLACK WAX. Very early and prolific; round pods, perfectly stringless. Pt. 50c., qt. 90c., peck \$6.50.

REFUGEE WAX. Long, round, waxy pods; very prolific and tender. Pt. 45c., qt. 85c., peck \$5.75.

THE HODSON LONG POD WAX. Very large, tender, flat, waxy pods, absolutely stringless. Pt. 55c., qt. \$1.00, peck \$7.00.

WARDWELL KIDNEY WAX. Early; long, flat, waxy pods. Pt. 50c., qt. 90c., peck \$6.50.

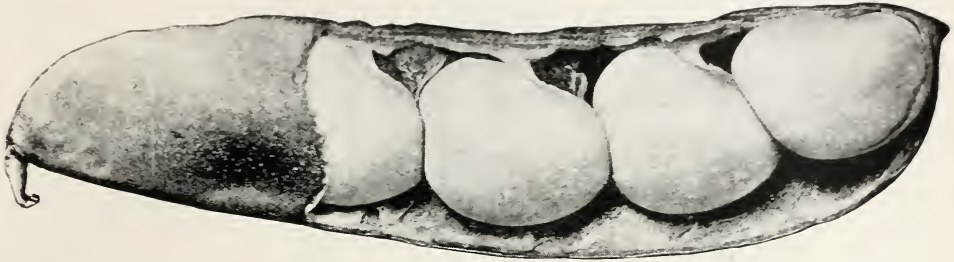

Bean, "New Wonder" Bush Lima

BEANS

Pole Lima

One quart will plant 100 hills.

Limas should not be planted until warm weather sets in. Plant in hills three to four feet apart each way, and two inches deep, allowing six seeds to each hill.

CHALLENGER LIMA. Thick and productive; a fine variety. Pt. 45c., qt. 85c., peck \$5.75.

DREER'S IMPROVED LIMA. (The true Potato Lima.) Thick, and of fine quality. Pt. 45c., qt. 85c., peck \$5.75.

EARLY LEVIATHAN LIMA. The earliest large Pole Lima with long, broad pods, containing 5 to 6 beans of unexcelled quality; very productive. Pt. 50c., qt. 90c., peck \$6.50.

JERSEY EXTRA EARLY LIMA. Ten days earlier than large white. Pt. 45c., qt. 85c., peck \$5.75.

LARGE WHITE LIMA. The most popular of the flat podded sorts. Pt. 45c., qt. 85c., peck \$5.75.

NEW IDEAL LIMA. This variety surpasses anything yet offered in size, productiveness and quality. Pt. 55c., qt. \$1.00, peck \$7.00.

BEANS

Bush Lima

One quart will plant 100 feet of drill.

Plant in light, rich soil, in drills two feet apart, dropping the seeds in rows about three inches apart and cover two inches.

BURPEE'S BUSH LIMA. A bush form of the large white Pole Lima with large flat beans; very productive and of excellent quality. Pt. 50c., qt. 90c., peck \$6.50.

DREER'S BUSH LIMA. Possesses all the good qualities of the Dreer's Improved Pole Lima. Pt. 50c., qt. 90c., peck \$6.50.

FORDHOOK BUSH LIMA. The only stiffly erect bush form of the well-known and popular Potato Lima. "Fordhook" has proved to be the best Bush Lima ever offered. The pods measure from 4 to 5 inches long, 1 to 1½ inches wide and about ¾ of an inch thick, and contain an average of 4 to 5 large beans of excellent quality. Pt. 55c., qt. \$1.00, peck \$7.00.

HENDERSON'S IMPROVED BUSH LIMA. Early and very productive both pods and beans are small. Pt. 50c., qt. 90c., peck \$6.50.

NEW WONDER BUSH LIMA. Beans very large and flat; of fine flavor; an immense yielder. Pt. 50c., qt. 90c., peck \$6.50.

Beans, English or Broad

BROAD WINDSOR. The largest and best variety grown of this type. To obtain best results, plant very early. Pt. 55c., qt. \$1.00.

BEANS

Pole or Running

GOLDEN CLUSTER WAX. Long yellow pods in clusters. Pt. 45c., qt. 85c.

HORTICULTURAL CRANBERRY. Good snap or shell bean. Pt. 45c., qt. 85c.

OLD HOMESTEAD, or KENTUCKY WONDER. Pods green, very long and flat. Pt. 45c., qt. 85c.

SCARLET RUNNER. The popular English Pole Bean; scarlet flowers; useful also for ornamental purposes. Pt. 45c., qt. 85c.

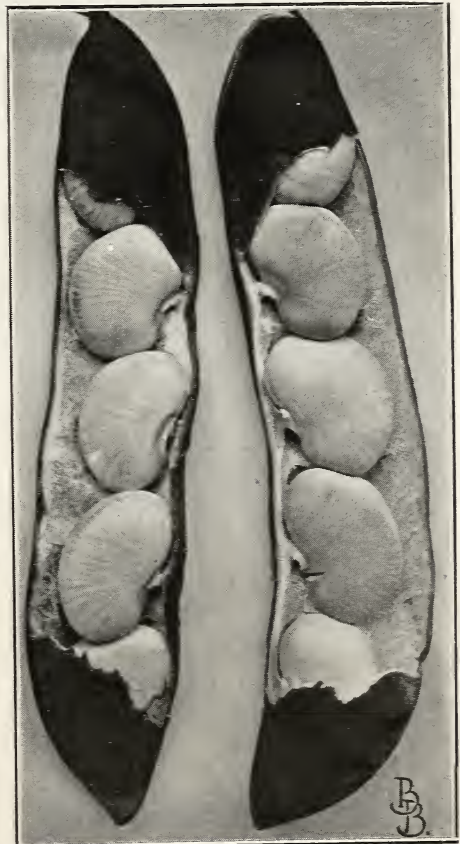

Bean, Large White Pole Lima

BEETS

One ounce will sow 50 feet of drill.

For early use sow as soon as the ground can be worked in a rich, light soil, which has been well manured, in drills one foot apart and two inches deep. For main crops sow in May, and for Winter use, in June. When the plants are well forward, thin out to about six inches.



Beet, Burnett's Early Model

SWISS CHARD or Spinach Beet

This Beet produces leaves only, which are used for greens. Cultivate same as Spinach, sowing the seed early in Spring, in drills 1½ feet apart and 1 inch deep.

GIANT LUCULLUS. This variety is an improvement over the older sort. The leaves are large and crinkled, of a dark green color, pure white ribs which can be used like Asparagus. Pkt. 10c., oz. 25c., ¼ lb. 65c., lb. \$2.00.

SWISS CHARD. (Common Variety.) Pkt. 10c., oz. 20c., ¼ lb. 60c., lb. \$1.50.

BROCCOLI

Cultivate same as Cauliflower or Cabbage.

ITALIAN OR SPROUTING. An entirely distinct sort, producing narrow, tender sprouts, which, when young, can be cooked and served same as asparagus. Flavor delicious. True Italian Green Sprouting. Pkt. 25c., ¼ oz. \$1.25, oz. \$4.00.

EARLY WHITE CAPE. Pkt. 15c., oz. 75c.

BRUSSELS SPROUTS

One ounce will produce 3,000 plants.

Sow in May, same as Cauliflower, and transplant in July, in rows 1½ feet apart. Brussels Sprouts is one of the very best Winter vegetables.

BURNETT'S SUPREME. Seed saved from perfect specimens, producing large, solid sprouts, which are firm and do not burst; the growth is dwarf, robust, compact and hardy. Splendid for exhibition purposes. Pkt. 20c., oz. 75c., ¼ lb. \$2.50.

DALKEITH. Improved dwarf variety with large solid sprouts. Pkt. 10c., oz. 60c., ¼ lb. \$2.00.

LONG ISLAND IMPROVED. Compact heads, very productive. Pkt. 10c., oz. 60c., ¼ lb. \$2.00.

BURNETT'S EARLY MODEL. An exceptionally fine early Beet of medium size, with small tap root, of uniform shape and deep crimson color. Pkt. 10c., oz. 30c., ¼ lb. 75c., lb. \$2.50.

CROSBY'S EGYPTIAN. Extra early, round; dark blood color. Pkt. 10c., oz. 20c., ¼ lb. 60c., lb. \$2.00.

DETROIT DARK RED. Color dark blood-red; medium size; very tender; good for early or late sowing. Pkt. 10c., oz. 25c., ¼ lb. 65c., lb. \$2.00.

EARLY BLOOD TURNIP. Dark red; good for Winter. Pkt. 10c., oz. 20c., ¼ lb. 60c., lb. \$1.75.

EARLY ECLIPSE. Early; round; bright red. Pkt. 10c., oz. 20c., ¼ lb. 60c., lb. \$1.75.

EXTRA EARLY EGYPTIAN. Dark blood color. Pkt. 10c., oz. 20c., ¼ lb. 60c., lb. \$1.75.

IMPROVED CRIMSON GLOBE. Fine globular shape; flesh rich, deep crimson, very tender. Pkt. 10c., oz. 25c., ¼ lb. 65c., lb. \$2.00.

LONG SMOOTH BLOOD. A good late variety for Winter. Pkt. 10c., oz. 20c., ¼ lb. 60c., lb. \$1.75.

SUGAR BEET AND MANGEL WURZEL. (See Farm Seeds, page 40.)



Brussels Sprouts, Burnett's Supreme

CABBAGE

One ounce will produce 2,000 plants.

Cabbage, to be well grown, requires a deep, rich, loamy soil. For early use, sow the seed in hotbeds in February or March. Transplant as soon as the ground can be worked, in rows 2 feet apart, and the plants 18 inches to 2 feet apart, according to variety. For Winter use, the seed should be sown in May, and the plants set out in July.

AUTUMN KING. A fine strain of late Cabbage, producing enormous solid heads of superb quality. Pkt. 10c., oz. 75c., $\frac{1}{4}$ lb. \$2.50.

BURNETT'S BABY-HEAD. A new Cabbage of merit which forms small, perfectly round heads, of unusual solidity. Baby-Head is an ideal Cabbage where space is limited and the fact that it can be brought to maturity about 6 weeks after planting, makes it a desirable acquisition to the vegetable garden. For description see page 9. Pkt. 20c., oz. \$1.00, $\frac{1}{4}$ lb. \$3.50.

BURNETT'S "BASS ROCK."

As a second early variety this Cabbage has no equal. For equality and evenness in size it is, without doubt, the finest of the flat headed type grown either for Summer or Winter use. Pkt. 20c., oz. \$1.00, $\frac{1}{4}$ lb. \$3.50.

CHARLESTON WAKEFIELD. Heads solid; larger than the regular Jersey Wakefield, not so early. Pkt. 10c., oz. 75c., $\frac{1}{4}$ lb. \$2.50.

COPENHAGEN MARKET. The earliest of all ball-shaped Cabbages. The heads are remarkably solid, of fine quality. Average weight about 10 lbs. per head. Pkt. 20c., oz. \$1.00, $\frac{1}{4}$ lb. \$3.50.

DANISH BALL HEAD, or HOLLAND. Very round, solid Winter sort, largely grown. Pkt. 10c., oz. 75c., $\frac{1}{4}$ lb. \$2.50.

IMPROVED EARLY JERSEY WAKEFIELD. The standard early and most popular variety, conical shaped, medium size, fine flavor. Pkt. 10c., oz. 75c., $\frac{1}{4}$ lb. \$2.50.



Malby.

Cabbage, Burnett's Bass Rock

IMPROVED EARLY SUMMER. A good second early, with large, solid, flat heads; tender and sweet. Pkt. 10c., oz. 75c., $\frac{1}{4}$ lb. \$2.50.

LARGE LATE AMERICAN DRUMHEAD. The largest and best keeping sort. Pkt. 10c., oz. 75c., $\frac{1}{4}$ lb. \$2.50.

SELECTED LATE FLAT DUTCH. Heads large and very solid; the best for Winter use. Pkt. 10c., oz. 75c., $\frac{1}{4}$ lb. \$2.50.

SUCCESSION. Very uniform and a sure header. One of the finest midseason Cabbages grown. Pkt. 15c., oz. 55c., $\frac{1}{4}$ lb. \$3.00.

CHINESE, or CELERY CABBAGE. (Pe-Tsai or Cut Cabbage). Becoming very popular. Resembles the Cos Lettuce. The flavor is mild and can be used as a salad or cooked. Pkt. 10c., oz. 60c., $\frac{1}{4}$ lb. \$2.00.

Red Cabbage

MAMMOTH ROCK RED. A large, solid-heading variety of a deep red color; fine for pickling. Pkt. 15c., oz. 55c., $\frac{1}{4}$ lb. \$3.00.

RED DUTCH. A standard variety; heads medium size; a good keeper; used for pickling. Pkt. 10c., oz. 75c., $\frac{1}{4}$ lb. \$2.50.

Savoy Cabbage

BURNETT'S IRISH GIANT. This new introduction of Irish origin is an improved strain of the old Drumhead Savoy. It is a large handsome type, leaves heavily curled, heart very solid, of massive proportions and unquestionably one of the finest, long-standing Savoy's we have ever seen. Pkt. 25c., $\frac{1}{2}$ oz. \$1.00, oz. \$1.75.

PERFECTION DRUMHEAD. A selected strain of American Drumhead, the best for private use. Pkt. 15c., oz. 55c., $\frac{1}{4}$ lb. \$3.00.

CABBAGE PLANTS. (See page 38.)



Cabbage, Improved Early Jersey Wakefield

CARROTS

One ounce will sow 100 feet of drill.

For early crops sow as soon as the ground can be worked, and for later crops from the beginning of May until the latter part of July, in rows 15 inches apart and ½ inch deep. Thin out the young plants to 5 inches, and keep the surface open by frequent use of the hoe.

CHANTENAY HALF-LONG SCARLET STUMP-ROOTED. An old and highly esteemed variety. Pkt. 10c., oz. 20c., ¼ lb. 60c., lb. \$2.00.

EARLY FRENCH FORCING. The earliest variety grown; nearly globular in shape and very tender. Pkt. 10c., oz. 25c., ¼ lb. 85c., lb. \$3.00.

EARLY SCARLET HORN. A well-known standard variety; extensively cultivated for family use. Pkt. 10c., oz. 25c., ¼ lb. 75c., lb. \$2.50.

GUERANDE, or OX-HEART. Very thick and short; of excellent quality. Pkt. 10c., oz. 20c., ¼ lb. 60c., lb. \$2.00.

HALF-LONG SCARLET NANTES, STUMP-ROOTED. An intermediate between Early Horn and Long Orange. Pkt. 10c., oz. 25c., ¼ lb. 75c., lb. \$2.50.

IMPROVED DANVERS. A half-long, stump-rooted variety of a dark orange color. A heavy cropper. Very desirable for table use. Pkt. 10c., oz. 20c., ¼ lb. 60c., lb. \$2.00.

IMPROVED LONG ORANGE. For garden and field crops this is the best and most profitable variety. Pkt. 10c., oz. 20c., ¼ lb. 60c., lb. \$2.00.

IMPROVED LONG RED SURREY. The favorite exhibition variety. (For description see page 9.) Pkt. 15c., oz. 50c., ¼ lb. \$1.50.

NEW INTERMEDIATE, or ST. VALERY. Smooth; handsome; of fine quality, and very productive. Pkt. 10c., oz. 25c., ¼ lb. 75c., lb. \$2.50.

PARIS EXHIBITION. This Carrot is an improved strain of the French type. Color bright orange; tops small. For forcing or growing in frames this variety will be found the most desirable. Pkt. 15c., oz. 50c., ¼ lb. \$1.50, lb. \$5.00.



Carrot, Improved Danvers

CAULIFLOWER

One ounce will produce 3,000 plants.

Sow the seed in a hotbed in January or February. Culture same as for Cabbage. Water freely in dry weather, especially when they begin to head. Cauliflower succeeds best when planted in frames at the close of Winter and brought to maturity before the Summer heat sets in.

EXTRA EARLY DWARF ERFURT "SELECTED STRAIN." Good for forcing purposes; grows very dwarf and compact. Pkt. 25c., oz. \$8.00.

EXTRA EARLY PARIS. An old favorite sort. Pkt. 10c., oz. 75c., ¼ lb. \$2.50.

DRY WEATHER. An excellent variety for dry seasons. Pkt. 25c., oz. \$5.00.

SNOWBALL, BURNETT'S SELECTED STRAIN. Our strain of this popular variety is unequalled. (For description, see page 9.) Pkt. 25c., ¼ oz. \$2.00, oz. \$6.00.

VEITCH'S AUTUMN GIANT. Very large, late variety. Pkt. 15c., oz. \$1.00, ¼ lb. \$3.50.

WALCHEREN. Very hardy late sort. Pkt. 10c., oz. 75c., ¼ lb. \$2.50.

CARDON

LARGE SOLID. Grows about 4 feet high. Pkt. 10c., oz. 50c., ¼ lb. \$1.50.

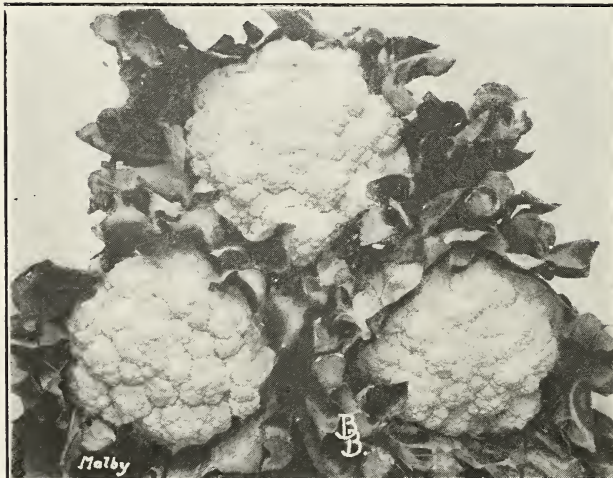

Cauliflower, Extra Early Dwarf Erfurt (Selected)

CELERY

One ounce will produce 3,000 plants.

Sow seed early in April, in an open border, in good rich soil, in drills 8 inches apart. Early in July transplant to trenches 3 feet apart and 6 inches apart in the rows. The beds should be kept well weeded, and an occasional soaking with water in dry weather will do the plants good.

BURNETT'S GOLDEN PLUME. This is undoubtedly the earliest celery now grown. It is strong, vigorous and immune from blight and rust, blanches easily, is brittle, tender and of finest flavor. The ideal celery for the home garden. Pkt. 25c., $\frac{1}{4}$ oz. \$1.25, oz. \$4.00.

BOSTON MARKET. A short white variety; solid and crisp. Pkt. 20c., oz. \$1.00, $\frac{1}{4}$ lb. \$3.50.

DOBBIE'S SELECTED RED. Large, choice strain. Fine for exhibition and general use. Crisp, solid, and of nutty flavor, splendid keeper. Pkt. 20c., oz. \$1.00, $\frac{1}{4}$ lb. \$3.50.

FIN DE SIECLE. Very large, solid and crisp; a good Winter variety. Pkt. 10c., oz. 60c., $\frac{1}{4}$ lb. \$2.00.

GIANT PASCAL. Easily blanched fine-keeping large late sort. Pkt. 10c., oz. 60c., $\frac{1}{4}$ lb. \$2.00.

GOLDEN DWARF. A distinct variety; crisp, solid and tender. Pkt. 10c., oz. 75c., $\frac{1}{4}$ lb. \$2.50.

GOLDEN SELF-BLANCHING, FRENCH-GROWN. A self-blanching variety, of a rich golden yellow color; crisp, tender and of fine flavor. Pkt. 20c., oz. \$1.00, $\frac{1}{4}$ lb. \$3.50.

IMPROVED WHITE PLUME. The standard sort, requires very little labor in blanching; the best for early use. Pkt. 10c., oz. 60c., $\frac{1}{4}$ lb. \$2.00.



Celery, Golden Self-blanching

NEW EASY BLANCHING. The easiest of all Celeries to blanch, crisp and brittle; flavor excellent. Splendid both for early and late use. Pkt. 20c., oz. \$1.00, $\frac{1}{4}$ lb. \$3.50.

PINK PLUME. Same as White Plume, except that stalks are tinged with pink. Pkt. 15c., oz. 75c., $\frac{1}{4}$ lb. \$2.50.

WINTER QUEEN. Very large, solid green Winter sort. Pkt. 10c., oz. 75c., $\frac{1}{4}$ lb. \$2.50.

CELERIAC

Or Turnip Rooted Celery

LARGE ERFURT. For soups and stews. The roots when cooked and sliced, make fine Winter salad. Pkt. 10c., oz. 40c., $\frac{1}{4}$ lb. \$1.25.

LARGE SMOOTH PRAGUE. The finest variety offered. Pkt. 10c., oz. 50c., $\frac{1}{4}$ lb. \$1.50.

CHERVIL

Cultivate like Parsley. Sow at any time in the Spring in shallow drills, 1 foot apart, in well-prepared ground.

CURLED. Leaves used for flavoring soups and stews. Pkt. 10c., oz. 40c., $\frac{1}{4}$ lb. \$1.25.

TUBEROUS-ROOTED. A variety which has edible roots. Pkt. 10c., oz. 50c., $\frac{1}{4}$ lb. \$1.50.

CHICORY

Chicory is cultivated chiefly for its roots. The leaves, when blanched, make an excellent salad.

LARGE-ROOTED. The young leaves are used for salad. Pkt. 10c., oz. 40c., $\frac{1}{4}$ lb. \$1.25.

WITLOOF, or FRENCH ENDIVE. A most desirable Winter salad. Pkt. 10c., oz. 50c., $\frac{1}{4}$ lb. \$1.50.

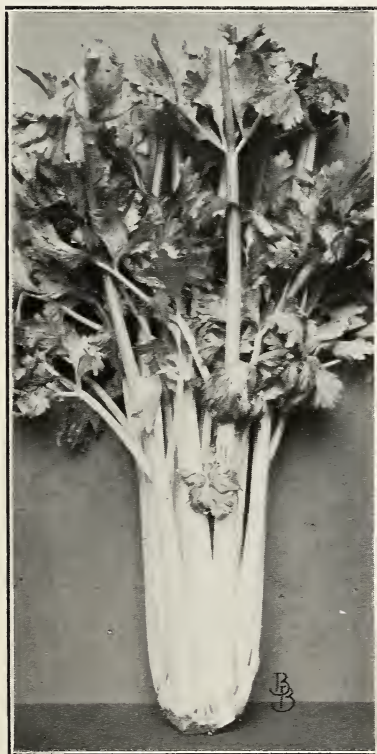

Celery, White Plume

SWEET CORN

One quart will plant 200 hills.

Plant in hills three feet apart each way, dropping five or six kernels in each hill, or in rows three to four feet apart, and the plants thinned out to 12 inches in the row. From May until the middle of July a succession planting can be made every two or three weeks, and by selecting the various varieties a continued supply can be had until frost.

EXTRA EARLY VARIETIES

EARLY MAYFLOWER. A ten-rowed variety, with ears pure white and very sweet. The cob is large and even in shape. Pt. 40c., qt. 75c., peck \$5.00.

EARLY WHITE CORY. Resembles Red Cory, but with white cob. Very early, tender and sweet. Pt. 40c., qt. 70c., peck \$4.50.

GOLDEN BANTAM. Every year Golden Bantam is becoming a greater favorite for the home garden. It is the richest, and sweetest Corn offered; of dwarf habit, ears medium size and of a bright, golden yellow color. Pt. 40c., qt. 70c., peck \$4.50.

GOLDEN SUNSHINE. The earliest of the golden yellow type. For description see page 8. Pt. 45c., qt. 85c.

HOWLING MOB. An early variety, with large ears and white, sweet grains. Howling Mob is without doubt, the best of the large, early sorts. Pt. 40c., qt. 75c., peck \$5.00.

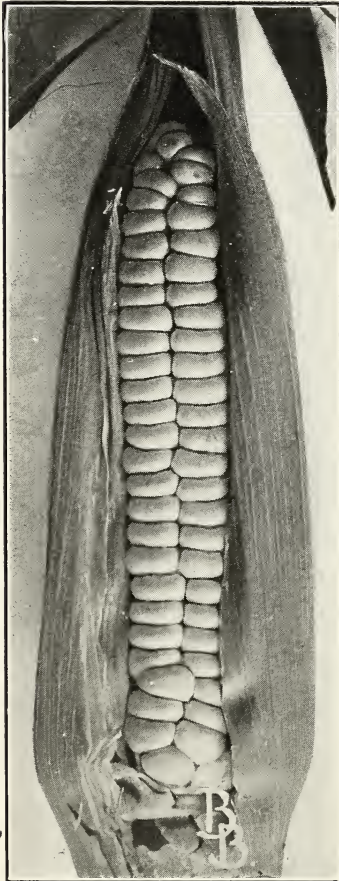

Sweet Corn, Golden Bantam

METROPOLITAN IMPROVED. The ears are large and handsome, measuring from 8 to 10 inches; grains pure white, deep, sweet and tender. Pt. 40c., qt. 70c., peck \$4.50.

SECOND EARLY OR INTERMEDIATE VARIETIES

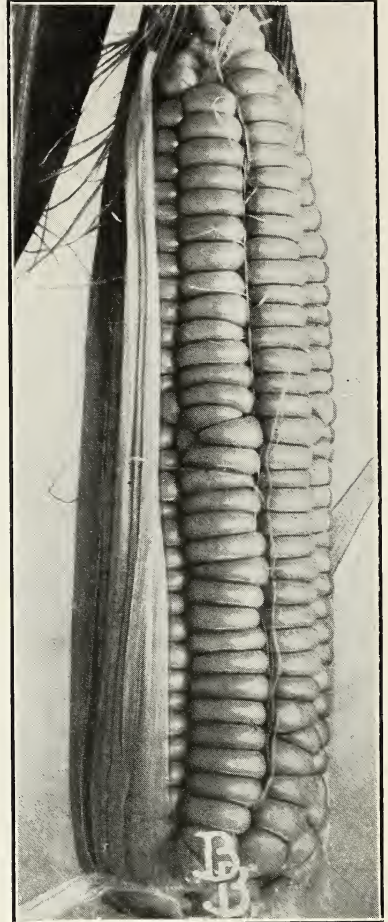

Sweet Corn, Metropolitan Improved

BURNETT'S IMPROVED EVERGREEN. The best Sweet Corn for general purposes ever offered. For description see page 10. Pt. 40c., qt. 75c., peck \$5.00.

GOLDEN ROD. Is a cross between Golden Bantam and Stowell's Evergreen, which makes a complete blending of each sort. Ears medium size, of a beautiful golden color, flavor delicious and appetizing. It is a prolific bearer, yielding two or three ears to the stalk. Pt. 40c., qt. 75c., peck \$5.00.

EARLY CHAMPION. Very large ears; sweet and tender. Pt. 40c., qt. 70c., peck \$4.50.

POTTER'S EXCELSIOR, or SQUANTUM. Ears large and productive. Pt. 40c., qt. 70c., peck \$4.50.

LATE OR MAIN CROP VARIETIES

BLACK MEXICAN. Grains black; a most delicious sweet corn. Pt. 40c., qt. 70c., peck \$4.50.

COUNTRY GENTLEMAN. The sweetest and most tender late corn. Pt. 40c., qt. 70c., peck \$4.50.

LATE MAMMOTH. Ears large, rich and sweet; one of the best. Pt. 40c., qt. 70c., peck \$4.50.

STOWELL'S EVERGREEN. The most popular standard late variety grown; ears large and very sweet. Pt. 40c., qt. 70c., peck \$4.50.

Keep CROWS from PULLING UP your CORN. Coat it with CROWTOX.
Can enough for 1 bus. \$1.00.



Cucumber, Perfection White Spine, Improved

CUCUMBER

One ounce will plant 50 hills.

For early Cucumbers sow seeds in hotbeds upon pieces of sod, or in small pots, so they can be readily transplanted to the open ground. Plant out in rich soil when danger of frost is over. For general crops, sow in the open ground as soon as the weather is settled and warm, and again every two weeks for a succession. For pickles, sow from the middle of June to the first week in July. Plant in hills 4 feet apart, putting a shovelful of well-rotted manure in each hill.

COOL AND CRISP. Early and prolific; long, straight, slender fruit. Pkt. 10c., oz. 25c., $\frac{1}{4}$ lb. 75c.

DAVIS PERFECT. Fine for forcing or for outdoors. The fruit is long and straight, and valuable for slicing. Pkt. 10c., oz. 25c., $\frac{1}{4}$ lb. 75c.

EARLY WHITE SPINE. A favorite variety of medium size; very productive, crisp and tender. Pkt. 10c., oz. 20c., $\frac{1}{4}$ lb. 60c.

EVERBEARING. A valuable variety, producing pickles and Cucumbers until frost kills the vines. Pkt. 10c., oz. 25c., $\frac{1}{4}$ lb. 75c.

EXTRA EARLY GREEN PROLIFIC. Same as Green Prolific, but much earlier. Pkt. 10c., oz. 25c., $\frac{1}{4}$ lb. 75c.

GREEN PROLIFIC PICKLING. The best and most productive variety grown for pickling. Pkt. 10c., oz. 25c., $\frac{1}{4}$ lb. 75c.

IMPROVED LONG GREEN. Fruit long, crisp and tender. Pkt. 10c., oz. 25c., $\frac{1}{4}$ lb. 70c.

JAPANESE CLIMBING. A strong grower; fine for pickling. Pkt. 10c., oz. 25c., $\frac{1}{4}$ lb. 75c.

PERFECTION WHITE SPINE, IMPROVED. A carefully selected strain of White Spine. It is early, prolific and a continuous bearer; fruit uniformly large, of a rich, deep green color; the best for general use. Pkt. 10c., oz. 30c., $\frac{1}{4}$ lb. 85c.

WEST INDIA GHERKIN or, BURR. Used only for pickling. Pkt. 10c., oz. 25c., $\frac{1}{4}$ lb. 75c.

English Cucumbers

Finest for Forcing

	Pkt.
BURNETT'S NORTH POLE	\$0.35
EVERY DAY50
TELEGRAPH IMPROVED35
COVENT GARDEN35
LOCKIES' PERFECTION35

Cress or Peppergrass

One ounce will sow 150 feet of drill.

Sow early in Spring in shallow drills, every two or three weeks for a succession. Water Cress sow in moist situation or by the side of a stream.

EXTRA CURLED, or PEPPER GRASS. The best variety grown for salad and garnishing. Pkt. 10c., oz. 20c., $\frac{1}{4}$ lb. 60c.

WATER CRESS. (True.) Very mild and tender. Pkt. 15c., oz. 75c., $\frac{1}{4}$ lb. \$2.50.

Corn Salad, or Feticus

One ounce will sow 100 feet of drill.

Sow in August or early in September, in drills $\frac{1}{4}$ inch deep and 6 inches apart; hoe well to keep down weeds. In Winter cover thinly with straw or leaves.

LARGE-SEEDED. The most popular variety. Pkt. 10c., oz. 25c., $\frac{1}{4}$ lb. 75c., lb. \$2.00.

Collards

TRUE GEORGIA. Pkt. 10c., oz. 25c., $\frac{1}{4}$ lb. 75c.

Dandelion

One ounce will sow 150 feet of drill.

This is one of the most desirable early Spring salads. Sow in May, in drills of half an inch deep, and 12 inches apart; thin out to six inches.

IMPROVED LARGE-LEAVED. Very productive and of fine flavor. Pkt. 15c., oz. 85c., $\frac{1}{4}$ lb. \$3.00.

Endive

One ounce will sow 100 feet of drill.

For first crop sow about the middle of May, and for succession in June and July.

BROAD-LEAVED BATAVIAN (ESCAROLLE). Fleshy leaves, excellent for Winter salad. Pkt. 10c., oz. 30c., $\frac{1}{4}$ lb. 75c.

GREEN CURLED WINTER. Standard sort for Winter crop. Pkt. 10c., oz. 30c., $\frac{1}{4}$ lb. 75c.

FRENCH MOSS CURLED. Fine for Fall. Pkt. 10c., oz. 30c., $\frac{1}{4}$ lb. 75c.

WHITE CURLED. For early use. Blanches rapidly. Pkt. 10c., oz. 30c., $\frac{1}{4}$ lb. 75c.

EGG PLANT

One ounce will produce 1,000 plants.

Seed should be sown in hotbeds early in Spring and transplanted when 2 inches high into a second bed or small pots. If this is not done, thin to 4 inches apart. Do not plant out until weather is perfectly settled and warm. Cool nights or wet weather will check them. Keep some back in frames for a second planting, in case of weather changing unexpectedly. Set out in rows of 3 feet apart and 2 feet apart in row.

BLACK BEAUTY. An extra early, large variety, almost black in color; very prolific and with few seeds. Fruit large and very uniform. Pkt. 15c., oz. 85c., $\frac{1}{4}$ lb. \$2.50.

EARLY LONG PURPLE. Of distinct shape and very prolific. Pkt. 15c., oz. 75c., $\frac{1}{4}$ lb. \$2.50.

NEW YORK IMPROVED SPINELESS. The standard and best variety grown; fruit large, oval, deep purple; early and productive. Pkt. 15c., oz. 85c., $\frac{1}{4}$ lb. \$2.50.

FINOCCHIO

FLORENCE FENNEL. A delicious vegetable. Highly prized by Italians. The bases of the leaf-stalks are thick and bulb-like, and can be eaten raw like Celery, or boiled. They have a mild, aromatic, sweet flavor. Pkt. 15c., oz. 75c.

KALE or BORECOLE

One ounce will produce 3,000 plants.

Sow and cultivate like cabbage.

DWARF GREEN CURLED SCOTCH. Very dwarf and spreading, with beautifully curled leaves of the richest emerald green. Pkt. 10c., oz. 30c., $\frac{1}{4}$ lb. \$1.00.

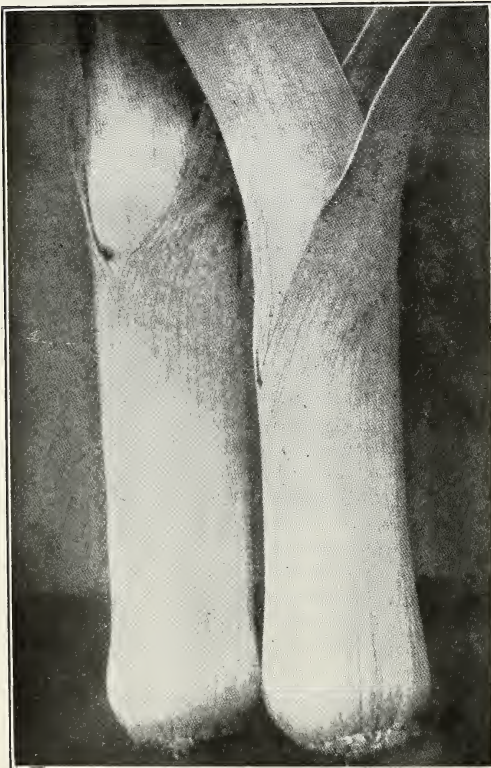

Leek, Large American Flag



Egg-Plant, New York Improved Spineless

SIBERIAN KALE, or SPROUTS. Sow in August and September for early greens. Very hardy; ready for use early in Spring. Pkt. 10c., oz. 30c., $\frac{1}{4}$ lb. 75c.

TALL GREEN SCOTCH. Same as Dwarf Scotch, but taller. Pkt. 10c., oz. 30c., $\frac{1}{4}$ lb. 75c.

KOHLRABI

One ounce will sow 150 feet of drill.

Sow the seed in June, in rows 18 inches apart, and thin out to 8 or 10 inches. Cultivate same as cabbage, but in hoeing be careful not to throw earth into the heart of the plant or the bulb will not mature properly.

EARLY SHORT-LEAVED WHITE VIENNA. The best for family use. Pkt. 10c., oz. 35c., $\frac{1}{4}$ lb. \$1.00.

EARLY PURPLE VIENNA. Forms a fine purple ball. Pkt. 10c., oz. 35c., $\frac{1}{4}$ lb. \$1.00.

LEEK

One ounce will sow 100 feet of drill.

Sow early in Spring in drills 6 inches apart and 1 inch deep. When about 7 inches high transplant them in rows 12 inches apart and as deep as possible, but do not cover the young center leaves. Water thoroughly if dry when planting out.

LARGE AMERICAN FLAG. Hardy and productive. The standard variety. Pkt. 10c., oz. 35c., $\frac{1}{4}$ lb. \$1.00.

MUSSELBURGH. Hardy and a good keeper. Mild flavored. Pkt. 10c., oz. 35c., $\frac{1}{4}$ lb. \$1.00.

WAVERLEY MARKET. A grand exhibition variety with long, thick, snow white stems. Waverley market grows to an immense size, with dark green leaves. It is hardy and productive. Waverley Market is superior to any Leek yet offered. Pkt. 20c., oz. 75c., $\frac{1}{4}$ lb. \$2.50.

LETTUCE

One ounce will sow 100 feet of drill.

Sow the seed in hotbeds in February or March, and transplant out in rows eight inches apart as soon as the ground can be worked. For succession sow in the open ground as early as the weather permits, continuing until July. Always thin out well, or the plants will be strong. When wanted as a cut salad sow the seed thickly in rows or broadcast. Lettuce does best in a sheltered spot with southern exposure.

BIG BOSTON. Color and shape same as Boston Market, but double the size; the best variety for general purposes. Pkt. 10c., oz. 40c., $\frac{1}{4}$ lb. \$1.25.

BLACK-SEEDED SIMPSON. Heads large, light colored. Pkt. 10c., oz. 30c., $\frac{1}{4}$ lb. 75c.

BOSTON MARKET. The standard sort; heads solid, crisp and compact; one of the best for forcing. Pkt. 10c., oz. 30c., $\frac{1}{4}$ lb. \$1.00.

BURNETT'S BALMORAL. A grand, early head Lettuce, for forcing or outside planting. The heads are of medium size and very solid; outer leaves light green with golden yellow heart. It is crisp, tender, and of perfect quality. Give it a trial and prove its excellence. Pkt. 15c., oz. 50c., $\frac{1}{4}$ lb. \$1.50.

DEACON. Heads very large and solid; a splendid Summer variety. Pkt. 10c., oz. 30c., $\frac{1}{4}$ lb. \$1.00.

EARLY CURLED SIMPSON. A standard early variety; very tender. Pkt. 10c., oz. 30c., $\frac{1}{4}$ lb. \$1.00.

GOLDEN QUEEN. A splendid forcing variety of a golden yellow color; heads medium sized, solid, crisp and tender. This is also a good Lettuce for general use. Pkt. 10c., oz. 40c., $\frac{1}{4}$ lb. \$1.25.

GRAND RAPIDS. An excellent forcing variety; heads solid and crisp. Pkt. 10c., oz. 30c., $\frac{1}{4}$ lb. 75c.



Lettuce, May King

ICEBERG. Large, solid, curled heads; yellow heart, crisp and tender. Pkt. 10c., oz. 30c., $\frac{1}{4}$ lb. 75c.

MATCHLESS. This lettuce is a cross between a head variety and a cos or romaine, with numerous leaves which form a long loose head, very tender, sweet and brittle. An excellent Summer variety, also fine for growing in frames. Pkt. 10c., oz. 60c., $\frac{1}{4}$ lb. \$2.00.

MAY KING. Large, round, solid heads, with yellow heart; very tender and a good forcer. Pkt. 10c., oz. 35c., $\frac{1}{4}$ lb. \$1.00.

MIGNONETTE. Distinct russet-colored; solid and compact. Pkt. 10c., oz. 35c., $\frac{1}{4}$ lb. \$1.00.

NEW YORK or WONDERFUL. A large solid-headed variety; crisp, tender and of excellent flavor. Pkt. 10c., oz. 40c., $\frac{1}{4}$ lb. \$1.25.

SALAMANDER IMPROVED. Heads large and compact; resists the Summer drought and heat longer than any other sort. Pkt. 10c., oz. 35c., $\frac{1}{4}$ lb. \$1.00.

WHITE SUMMER CABBAGE. Heads of medium size and very solid; fine Summer variety. Pkt. 10c., oz. 40c., $\frac{1}{4}$ lb. \$1.25.

LETTUCE Cos or Romaine

This type of lettuce is become more popular every year. The leaves are long and upright, forming oval shaped heads, which should be tied loosely at the tops to blanch the inner leaves. Flavor distinct and pleasing, good for Summer planting, as it stands heat well.

PARIS WHITE COS. (Romaine.) The finest for Summer use; the leaves should be tied up to blanch. Pkt. 10c., oz. 35c., $\frac{1}{4}$ lb. \$1.00.

"SILVER KING." (Romaine or Cos.) New Lettuce. For description see page 11. Pkt. 20c., oz. 50c., $\frac{1}{4}$ lb. \$1.50.

TRIANON SELF-CLOSING COS. Leaves long, narrow, forming close upright heads. Pkt. 10c., oz. 35c., $\frac{1}{4}$ lb. \$1.00.

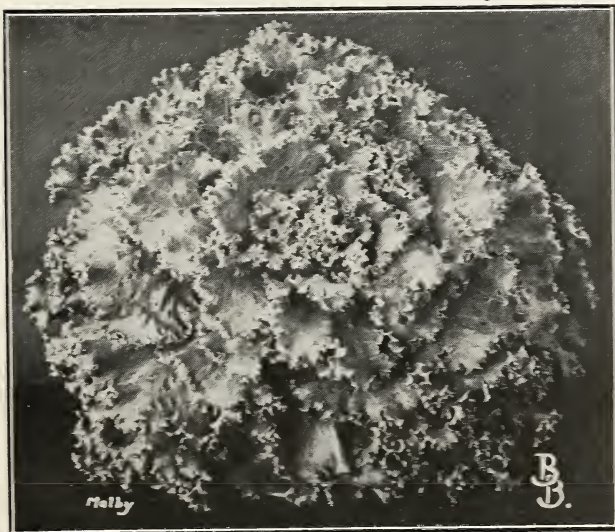

Lettuce, Early Curled Simpson



Muskmelon, Emerald Gem

MUSKMELON

One ounce will plant 50 hills.

Muskmelons thrive best in a light, rich soil. Plant early in May, when the ground has become warm and dry, in hills 6 feet apart each way. The hills should be dug about two feet square, 18 inches deep, and half filled with rotted manure. Sow 6 to 12 seeds to a hill. When up, and all danger of insects has passed, pull out all but 3 plants. Cultivate until the vines cover the ground; pinch the ends of the growing shoots to induce early fruiting. A few hills for early use may be had by sowing the seeds out-of-doors under frames.

Burnett's "Discovery". For description see page 12. Pkt. 25c., 5 pkts. \$1.00.

Burnett's Honey-Drop (Improved). For earliness and flavor this Melon is without a rival. The flesh is very thick, sweet and melting; and of a deep orange color. Pkt. 15c., oz. 60c., ¼ lb. \$2.00.

Emerald Gem. Fruit of medium size; skin smooth; orange flesh, rich and delicious; of a deep green color. Pkt. 10c., oz. 30c., ¼ lb. 85c.

Extra Early Hackensack. Flesh light green. Very large. Pkt. 10c., oz. 25c., ¼ lb. 75c.

Honey Dew. A large, round, light-colored Melon, of delicious flavor, green flesh. Pkt. 10c., oz. 40c., ¼ lb. \$1.25.

Jenny Lind. A small, early green-fleshed sort. Pkt. 10c., oz. 30c., ¼ lb. 75c.

Large Yellow Cantaloupe. Fruit nearly round; flesh yellow. Pkt. 10c., oz. 25c., ¼ lb. 75c.

Miller's Cream, or Osage. Flesh salmon color, very thick; flavor superb. Pkt. 10c., oz. 30c., ¼ lb. 75c.

Montreal Market. Large, round, netted; flesh thick; light green. Pkt. 10c., oz. 30c., ¼ lb. 75c.

Rocky Ford. Fruit oval; flesh thick, green and highly flavored. Pkt. 10c., oz. 30c., ¼ lb. 75c.

MUSKMELONS FOR FORCING

Imported English Varieties

- Blenheim Orange.** Flesh scarlet. Pkt. 50c.
Eminence (Veitch's). White flesh; splendid flavor. Pkt. 75c.
King George. A beautiful Melon. Flesh thick, Scarlet-orange, beautifully netted. Pkt. 50c.
Royal Sovereign. Flesh white, tinged with green. Pkt. 50c.
Sutton's A 1. Flesh scarlet. Pkt. 50c.
Royal Jubilee. Flesh greenish white. Pkt. 50c.

WATERMELON

One ounce will plant 25 hills.

Cultivate same as Muskmelon, except that they should be planted 8 to 10 feet apart, according to variety.

Citron for Preserving. Round and handsome; red seed. Pkt. 10c., oz. 25c., ¼ lb. 65c.

Cole's Early. One of the earliest grown; the flesh is of a beautiful bright red color, crisp and delicious. Pkt. 10c., oz. 25c., ¼ lb. 65c.

Kleckley Sweets. Sweet and fine flavored; dark green skin rind; flesh scarlet, solid and firm. Pkt. 10c., oz. 20c., ¼ lb. 60c.

Mountain Sweet. The old reliable sort; fruit oblong; color dark green; flesh red, sweet and delicious. Pkt. 10c., oz. 20c., ¼ lb. 60c.

Tom Watson. Produces melons 16 to 22 inches long and 8 to 10 inches in diameter. The dark green rind is thin but tough; stands shipping well. Pkt. 10c., oz. 25c., ¼ lb. 65c.

MUSTARD

One ounce will sow 75 feet of drill.

Sow thickly during early Spring in shallow drills, 12 inches apart. For Fall use, sow in September.

White London. Leaves used for salads while young; grows very rapidly. Pkt. 10c., oz. 20c., ¼ lb. 40c., lb. \$1.25.

MUSHROOM SPAWN

One brick will spawn 9 square feet

Mushrooms can be easily grown with a little care and attention under benches in the greenhouse, in a cellar or any dark, dry place where a temperature of from 50 to 60 degrees can be maintained during the Winter months. Pamphlet, How to grow Mushrooms free on request.

American Spore Culture. Per brick 40c., 5 bricks \$1.80, 10 bricks \$3.50, 20 bricks \$6.50, 50 bricks \$16.00.

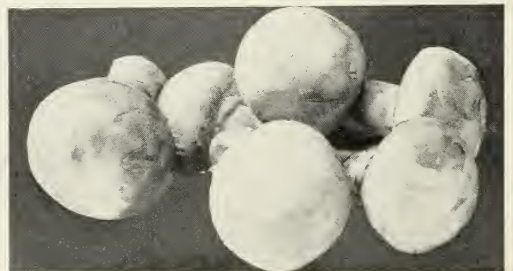



Onion, Southport Yellow Globe

ONION

One ounce will sow 100 feet of drill.

Onions do best in a rich, sandy soil; sow in drills 1 foot apart, as soon as the ground can be worked in Spring. Thin to 3 or 4 inches, using the hoe frequently to keep down weeds. The largest Onions are produced by sowing the seed in a hotbed in February or March and transplanting the seedlings to the open ground. The best results are obtained from ground prepared the previous Fall.

White Varieties

QUEEN. Pure white, small, flat, extra early; fine for pickling. Pkt. 10c., oz. 50c., $\frac{1}{4}$ lb. \$1.50.

SOUTHPORT WHITE GLOBE. Very large, handsome and productive; the best white variety. Pkt. 10c., oz. 60c., $\frac{1}{4}$ lb. \$1.75.

WHITE PORTUGAL or **SILVER SKIN.** A standard sort; mild flavored and a good keeper. Pkt. 10c., oz. 50c., $\frac{1}{4}$ lb. \$1.50.

WHITE BERMUDA. Small, flat; very mild flavored. Pkt. 10c., oz. 50c., $\frac{1}{4}$ lb. \$1.50.

WHITE EXCELSIOR PICKLING. The best white for pickling. Pkt. 10c., oz. 50c., $\frac{1}{4}$ lb. \$1.50.

Yellow Varieties

AILS CRAIG. (Imported.) A very large oval-shaped variety, with pale straw-colored skin; splendid exhibition sort. (For description, see page 12.) Pkt. 25c., oz. \$1.00, $\frac{1}{4}$ lb. \$3.50.

CRANSTON'S EXCELSIOR. (Imported.) The true variety, a fine show Onion, differs in color from Ailsa Craig and rather more oval in shape. Pkt. 25c., oz. \$1.00, $\frac{1}{4}$ lb. \$3.50.

Yellow Varieties—Continued

GIGANTIC GIBALTAR. (For description, see page 12.) Pkt. 25c., oz. 75c., $\frac{1}{4}$ lb. \$2.50.

PRIZETAKER. (Selected Strain.) One of the largest and finest Onions in cultivation. Pkt. 10c., oz. 50c., $\frac{1}{4}$ lb. \$1.75.

SOUTHPORT YELLOW GLOBE. The finest large yellow; very handsome and a good keeper. Pkt. 10c., oz. 50c., $\frac{1}{4}$ lb. \$1.75.

YELLOW GLOBE DANVERS. One of the leading kinds; a good keeper. Pkt. 10c., oz. 50c., $\frac{1}{4}$ lb. \$1.75.

Red Varieties

EXTRA EARLY FLAT. Medium size; deep red and of good flavor. Pkt. 10c., oz. 50c., $\frac{1}{4}$ lb. \$1.75.

LARGE RED WETHERSFIELD. The standard flat red variety; very large, and an excellent keeper. Pkt. 10c., oz. 50c., $\frac{1}{4}$ lb. \$1.75.

SOUTHPORT RED GLOBE. A fine large red sort; good for general purposes. Pkt. 10c., oz. 50c., $\frac{1}{4}$ lb. \$1.75.

For Onion sets see next page.

ONION SETS

One quart will plant 100 feet of row.

Onion sets should be planted early in Spring in rows 12 inches apart and 4 inches apart in the row. Prices subject to change.

	Quart	Peck
WHITE	\$0.50	\$3.00
YELLOW40	2.75
RED40	2.75
WHITE MULTIPLIER50	3.50
POTATO ONIONS40	3.00
SHALLOTS50	3.50
GARLIC SETS. Per lb. 50c.		

OKRA, or GUMBO

One ounce will plant 100 hills.

The pods, when gathered young, are used in soups and stews. Sow middle of May, in drills three feet apart, and thin out to one foot apart in the row.

IMPROVED DWARF GREEN. Very early and prolific. Pkt. 10c., oz. 25c., $\frac{1}{4}$ lb. 60c.

IMPROVED LONG GREEN. Long, smooth, green pods. Pkt. 10c., oz. 25c., $\frac{1}{4}$ lb. 60c.

WHITE VELVET. Long white pods, velvety in appearance. Pkt. 10c., oz. 25c., $\frac{1}{4}$ lb. 75c.

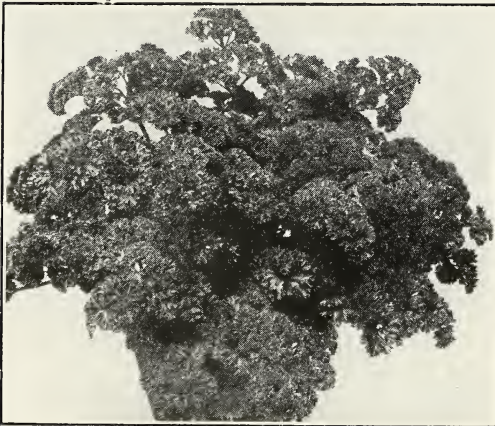

Parsley, Burnett's Emerald Isle

PARSNIP

One ounce will sow 100 feet of drill.

Sow in deep, rich soil, in drills about 18 inches apart as early in the Spring as the ground can be worked. Thin out young plants to 6 inches apart; keep ground open, and free from weeds.

BURNETT'S WINTER KING. A grand exhibition variety (for description see page 13). Pkt. 10c., oz. 30c., $\frac{1}{4}$ lb. \$1.00.

IMPROVED AMERICAN HOLLOW CROWN. Long, smooth, white roots of excellent quality; very tender. Pkt. 10c., oz. 25c., $\frac{1}{4}$ lb. 65c., lb. \$1.75.

EARLY ROUND. A very early variety, with small roots. Pkt. 10c., oz. 25c., $\frac{1}{4}$ lb. 75c.



Onion Sets

PARSLEY

One ounce will sow 150 feet of drill.

Sow the seed early in Spring, in drills one foot apart, and thin out to four inches apart. For solid borders, sow thickly.

BURNETT'S EMERALD ISLE. Very dwarf, emerald green, densely curled; superior to all other varieties. (See description, page 12.) Pkt. 15c., oz. 50c., $\frac{1}{4}$ lb. \$1.50.

EXTRA DOUBLE CURLED. A standard variety; color dark green. Pkt. 10c., oz. 25c., $\frac{1}{4}$ lb. 65c.

CHAMPION MOSS CURLED. A distinct variety; beautifully curled. Pkt. 10c., oz. 25c., $\frac{1}{4}$ lb. 75c.

PLAIN or ITALIAN. Very hardy and of excellent flavor. Pkt. 10c., oz. 25c., $\frac{1}{4}$ lb. 60c.

HAMBURG or ROOTED. Extensively grown for its roots. Pkt. 10c., oz. 25c., $\frac{1}{4}$ lb. 60c.



Parsnip, Improved American Hollow Crown

PEAS

One quart will plant about 100 feet of drill.

Peas do best in a light, rich soil; for private use sow in double rows 6 to 8 inches apart, the rows 2 to 4 feet apart, the tall ones requiring brush. Commence sowing the extra early varieties as soon as the ground can be worked in March; continue for a succession every two weeks until June. A good crop can be secured by sowing the extra early sorts in August for Fall use. The wrinkled varieties are not as hardy as the small round sorts, and if planted early should have a dry soil, or they are liable to rot in the ground; they are, however, the sweetest and best flavored.

Early Varieties

ALASKA. The earliest round blue Pea; very productive. 2½ feet. Pt. 40c., qt. 70c., peck \$5.00.

AMERICAN WONDER. Early and productive. 1 foot. Pt. 40c., qt. 70c., peck \$5.00.

BURNETT'S EXTRA EARLY MARKET. This Pea is unequaled for early use or general planting. Pods are large and well filled with round, smooth peas of a delicious flavor. Height 2½ feet. Pt. 40c., qt. 75c., peck \$5.50.

EARLY BIRD. A grand early variety (for description, see page 13). Pt. 50c., qt. \$1.00, peck \$7.00.

FIRST-OF-ALL. A select strain of extra early; very prolific. 2½ feet. Pt. 40c., qt. 75c., peck \$5.00.



Pea, Burnett's Extra Early Market

Peas, Early Varieties

CONTINUED

GRADUS or PROSPERITY. The most distinct early pea yet introduced. The pods are very large and well filled with large, wrinkled, deep green peas of finest quality. 3 feet. Pt. 45c., qt. 85c., peck \$6.00.

LAXTONIAN. The vines are of vigorous and robust growth, producing in abundance large, dark green pods averaging 4½ inches long, filled with eight to ten very large, wrinkled, deep blue-green peas of very rich flavor. 1½ feet. Pt. 50c., qt. 90c., peck \$6.50.

LITTLE MARVEL. The vines are of dwarf, even growth. The pods average 2½ inches in length, and well filled with 6 to 7 large, deep green Peas of the choicest quality. 1½ feet. Pt. 40c., qt. 75c., peck \$5.00.

MELTING MARROW. Of dwarf habit, delicious flavor, superior to any of the tall, late-growing varieties. Pt. 40c., qt. 75c., peck \$5.00.

NOTT'S EXCELSIOR. Splendid early wrinkled sort; very prolific. 1½ ft. Pt. 40c., qt. 75c., peck \$5.00.

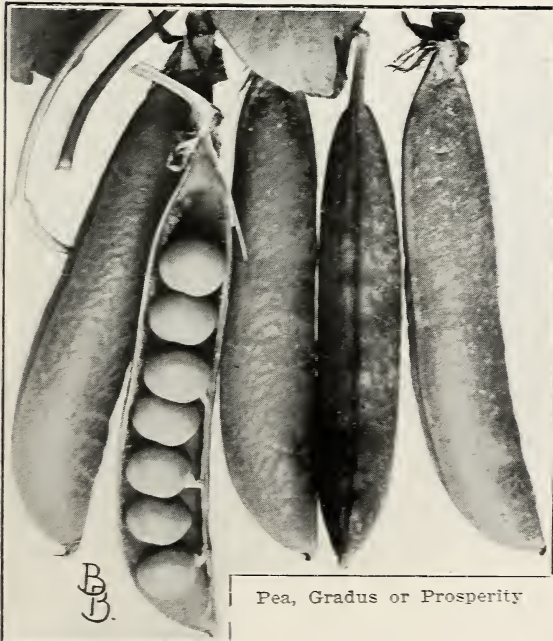

Pea, Gradus or Prosperity

Peas, Early Varieties—Continued

PETIT POIS. This is the small, delicate French Pea so highly prized. It grows well here, producing an abundance of long, slender pods, well filled with extremely small Peas, which should be used when very young. 2½ feet. Pt. 55c., qt. \$1.00, peck \$7.00.

SUTTON'S EXCELSIOR. The finest early, large-podded dwarf wrinkled Pea. 1½ feet. Pt. 45c., qt. 85c., peck \$6.00.

THE PILOT. One of the earliest sorts. The vines are very robust and carry a heavy crop of large pods, well filled with richly flavored Peas. 3 feet. Pt. 45c., qt. 85c., peck \$6.00.

THOMAS LAXTON. A very heavy cropper; the pods are large and contain 7 or 8 large-sized wrinkled Peas of the finest flavor. 3 feet. Pt. 45c., qt. 85c., peck \$6.00.

Peas, Midseason Varieties

ADMIRAL BEATTY. This grand new Pea is a medium early variety growing to a height of about 4 ft. It is a remarkable cropper and bears in profusion large pods, each containing 8 to 10 peas of delicious flavor. Pt. 85c., qt. \$1.50.



Pea, Stratagem



Pea, Sutton's Excelsior

DUKE OF ALBANY. Immense pods filled with large Peas of finest flavor. 4 feet. Pt. 45c., qt. 85c., peck \$6.00.

HEROINE. Large, full pods; enormously productive. 2½ feet. Pt. 45c., qt. 85c., peck \$6.00.

HORSFORD'S MARKET GARDEN. Very prolific and of superior quality. 2½ feet. Pt. 40c., qt. 75c., peck \$5.00.

POTLATCH. A large-podded, wrinkled variety; very productive and of excellent quality. The long pods are rich, dark green, often measuring 6 inches or more, with 9 to 11 enormous Peas of the highest quality. Height, 2 feet. Pt. 45c., qt. 85c., peck \$6.00.

STRATAGEM IMPROVED. A distinct advance on Stratagem. It has a very robust constitution and is suitable for dry soils and situations. The pods and Peas are large and of good flavor. 3 feet. Pt. 45c., qt. 85c., peck \$6.00.

THE V. C. The pods of this truly wonderful Pea measure from 8 to 9 inches; filled with ten or more luscious peas of the most delicious flavor. The haulm is very sturdy growing to a height of 5 to 6 ft. Of handsome appearance. Pt. \$1.25, qt. \$2.00.

Peas, Late, or Main Crop

ALDERMAN. A selected stock of "Telephone" type, with very large deep green pods. 4 feet. Pt. 45c., qt. 85c., peck \$6.00.

CHAMPION OF ENGLAND. The most popular tall growing variety; the pods and Peas are extra large and the flavor unequalled. 5 feet. Pt. 40c., qt. 75c., peck \$5.00.

GLADSTONE. (Selected). English grown; pods exceptionally fine, deep green and recurved. It matures about one or two weeks after Stratagen, and is an enormous cropper. 3 feet. Pt. 60c., qt. \$1.00, peck \$7.00.

JUNO. One of the finest dwarf wrinkled sorts: large, straight pods, often borne in pairs; Peas dark green, sweet and delicious. 1½ feet. Pt. 45c., qt. 85c., peck \$6.00.

QUITE CONTENT. One of the largest podded varieties. The vines are of robust growth and unusually productive. Pods straight and closely filled with extra large Peas of rich flavor. 5 feet. Pt. 50c., qt. 90c., peck \$6.50.

TELEPHONE. The largest podded variety grown: an immense cropper: Peas large and quality unexcelled. 4 feet. Pt. 45c., qt. 85c., peck \$6.00.



Pea, Champion of England

Sugar Peas (Edible Pods)

Sugar Peas have edible pods, which are delicious if cooked when young.

DWARF, GRAY-SEEDED. Very early. 3 feet. Pt. 50c., qt. 90c.

TALL, GRAY-SEEDED. Immense pods. 4 feet. Pt. 45c., qt. 85c.

MELTING SUGAR, WHITE-SEEDED. The best edible-podded sort. 4 feet. Pt. 50c., qt. 90c.

PEPPER

One ounce will produce 2,000 plants.

Sow in a hotbed early in April, or in the open ground, when all danger of frost is past. When the soil has become warm, set in rows 2 feet apart and 18 inches apart in the rows.

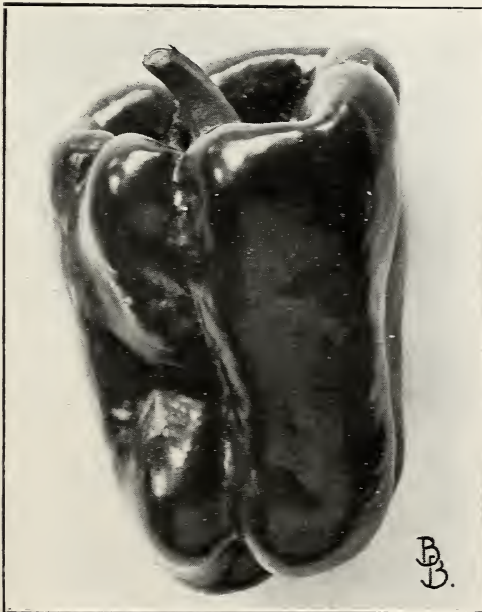

Pepper, Burnett's Monarch

BURNETT'S MONARCH. An extremely large and handsome Pepper, of a bright scarlet color: flesh thick, very mild and remarkably sweet. This Pepper is much larger, more uniform in shape, and superior in quality to any now on the market: an ideal variety for exhibition. Pkt. 25c., oz. \$1.00, ¼ lb. \$3.50.

CAYENNE, LONG RED. The pods are long and slender, of a bright red color: very pungent. Pkt. 15c., oz. 75c., ¼ lb. \$2.50.

CHINESE GIANT. An extremely large and handsome Pepper: color, bright scarlet. Pkt. 15c., oz. 90c., ¼ lb. \$3.00.

LARGE BELL or BULL NOSE. Very large: flesh mild and thick: used for pickling: color bright red. Pkt. 15c., oz. 75c., ¼ lb. \$2.50.

RUBY KING. Fruit bright red, 4 to 6 inches long; of very mild flavor; the best for stuffing. Pkt. 15c., oz. 75c., ¼ lb. \$2.50.

SWEET MOUNTAIN. The largest, sweetest and mildest variety grown. Pkt. 15c., oz. 75c., ¼ lb. \$2.50.

TABASCO. True. Small, long, bright red fruit: very hot: the best for pepper-sauce and pickling. Pkt. 15c., oz. \$1.00.

We also supply the following varieties:

GOLDEN QUEEN, RED CHERRY, RED CHILI, RED CLUSTER. Each, pkt. 15c., oz. 75c., ¼ lb. \$2.50.



Potato, Irish Cobbler

POTATOES

Ten to twelve bushels will plant one acre. Seed Potatoes weigh 165 pounds to the sack, net.

Our seed Potatoes are all Northern grown and free from disease. It is our aim to have true stock. Plant early in Spring, in rows about 3 feet apart, and the sets 1 foot apart in the rows, covering 4 inches deep. To insure a heavy crop, the ground should be deeply dug and well manured before planting. To destroy the Potato Beetle and prevent Blight, spray frequently with Pyrox or Bordo-Lead.

BOVEE. Very early and productive. The tubers grow close together and are very uniform; skin pink, or flesh-color, very smooth, and the quality all that could be desired.

DIBBLE'S RUSSET. A splendid variety of round, uniform shape, russet skin and flesh pure white. Very productive and a good keeper. Excellent for table use.

EARLY ROSE. The standard early sort; very productive and of fine quality.

GOLD COIN. A valuable main crop variety, one of the finest table sorts. Flesh fine grain, pure white; very productive.

PRICES on potatoes cannot be fixed at the time this catalogue goes to press; they will therefore be billed at market prices prevailing at time of shipment. Prices gladly submitted upon request.

IMPROVED GREEN MOUNTAIN. A heavy cropping, medium early variety, of fine quality.

IRISH COBBLER. One of the finest early varieties. The tubers are of good size, flesh pure white, very dry and mealy.

RURAL NEW YORKER No. 2. A valuable late variety of large size; very smooth and a great cropper; quality unexcelled.

SIR WALTER RALEIGH. An enormous producer of very large and handsome tubers; flesh white and mealy.

PUMPKIN

One ounce will plant 50 hills.

Plant in May in the cornfield or in the garden, in hills 8 to 10 feet apart each way, four seeds in a hill. In other respects cultivate in the same manner as melons and cucumbers.

CONNECTICUT FIELD. Grown for feeding stock. Pkt. 10c., oz. 20c., $\frac{1}{4}$ lb. 45c., lb. \$1.25.

EARLY SUGAR. Sweet and prolific; small yellow. Pkt. 10c., oz. 25c., $\frac{1}{4}$ lb. 65c., lb. \$1.75.

LARGE CHEESE. The best variety for family use. Pkt. 10c., oz. 25c., $\frac{1}{4}$ lb. 65c., lb. \$1.75.

LARGE TOURS, or MAMMOTH. Grows very large, often weighing 150 lbs. Pkt. 10c., oz. 25c., $\frac{1}{4}$ lb. 75c., lb. \$2.50.

WINTER LUXURY. The best for pies; color golden russet. Pkt. 10c., oz. 25c., $\frac{1}{4}$ lb. 75c., lb. \$2.50.

Feed your Potatoes with the proper plant food. AGRICO-POTATO Fertilizer has just those chemical elements necessary for large crop yields. 100 pound bag, \$3.50; ton, \$55.00.

RADISH

One ounce will sow about 100 feet of drill.

Radishes thrive best in a light rich, loamy soil, which should be well manured and deeply dug before sowing the seed. For very early use sow during Winter and early Spring in hotbeds, which should be kept well ventilated. In May they can be sown outdoors, in rows 8 to 12 inches apart, every week or ten days for a succession, up to the middle of June. Radishes, to be crisp and tender, should make a rapid growth. Sow late varieties in July and August for Winter use.

Early Forcing Varieties

EARLY SCARLET GLOBE. Of distinct shape; color brilliant scarlet; flesh crisp and white; excellent for forcing. Pkt. 10c., oz. 25c., $\frac{1}{4}$ lb. 65c., lb. \$1.75.

EARLY SCARLET TURNIP, WHITE TIPPED. (Forcing.) A grand forcing variety. Pkt. 10c., oz. 25c., $\frac{1}{4}$ lb. 65c., lb. \$1.75.

EXTRA EARLY DEEP SCARLET TURNIP (Forcing). A small round, deep bright red, with small tops; very mild. Pkt. 10c., oz. 25c., $\frac{1}{4}$ lb. 65c., lb. \$1.75.

GIANT CRIMSON (Forcing). Grows double the size of other forcing varieties without getting pithy or hollow; color deep crimson; flesh pure white. Pkt. 10c., oz. 25c., $\frac{1}{4}$ lb. 65c., lb. \$1.75.



Radish, Extra Early Deep Scarlet Forcing

Olive-Shaped Varieties

FRENCH BREAKFAST. A very rapid growing variety; color scarlet, with white tip. A valuable Summer sort and a good forcer. Pkt. 10c., oz. 20c., $\frac{1}{4}$ lb. 60c., lb. \$1.75.

OLIVE-SHAPED SCARLET. Very tender, crisp and brittle. Pkt. 10c., oz. 25c., $\frac{1}{4}$ lb. 65c., lb. \$1.75.

Turnip-Shaped Varieties

EARLY ROUND DARK RED. Shape same as Scarlet Turnip, but darker in color. Pkt. 10c., oz. 20c., $\frac{1}{4}$ lb. 60c., lb. \$1.75.

EARLY SCARLET TURNIP. A well-known standard variety extensively grown. Pkt. 10c., oz. 20c., $\frac{1}{4}$ lb. 60c., lb. \$1.75.

GIANT WHITE STUTTGART. Large, pure white; very firm, crisp and tender. Pkt. 10c., oz. 20c., $\frac{1}{4}$ lb. 60c., lb. \$1.75.

WHITE SUMMER TURNIP. One of the best for Summer use; does not get pithy or hollow. Pkt. 10c., oz. 20c., $\frac{1}{4}$ lb. 60c., lb. \$1.75.

WHITE TIPPED SCARLET TURNIP. One of the best for general use; crisp and mild. Pkt. 10c., oz. 20c., $\frac{1}{4}$ lb. 60c., lb. \$1.75.

Long Varieties

ICICLE. Pure white, of fine flavor; suitable for forcing. Pkt. 10c., oz. 25c., $\frac{1}{4}$ lb. 65c., lb. \$1.75.

LONG BRIGHTEST SCARLET WHITE TIP. Very handsome and distinct. Pkt. 10c., oz. 20c., $\frac{1}{4}$ lb. 60c., lb. \$1.75.

LONG SCARLET SHORT TOP. Very long and crisp; good for frames. Pkt. 10c., oz. 20c., $\frac{1}{4}$ lb. 60c., lb. \$1.75.

Winter Varieties

CALIFORNIA MAMMOTH. A very large white variety. Pkt. 10c., oz. 25c., $\frac{1}{4}$ lb. 75c., lb. \$2.50.

LONG BLACK SPANISH. The hardiest and best for Winter use. Pkt. 10c., oz. 25c., $\frac{1}{4}$ lb. 65c., lb. \$1.75.

ROUND BLACK SPANISH. Fine for Winter. Pkt. 10c., oz. 25c., $\frac{1}{4}$ lb. 65c., lb. \$1.75.

SCARLET CHINESE. Very handsome and distinct, and keeps well. Pkt. 10c., oz. 25c., $\frac{1}{4}$ lb. 65c., lb. \$1.75.

RHUBARB

One ounce will produce 1000 plants.

Sow early in April in drills 18 inches apart and thin out to six inches. In the Fall or following Spring, transplant the roots into deep, rich soil, three feet apart each way.

LINNAEUS. Early, large, tender and fine flavored. Pkt. 15c., oz. 40c., $\frac{1}{4}$ lb. \$1.25.

VICTORIA. Very large late; the best for cooking. Pkt. 15c., oz. 40c., $\frac{1}{4}$ lb. \$1.25.

RHUBARB ROOTS

EXTRA STRONG CLUMPS. Each 25c., doz. \$2.50.

SELECTED CLUMPS. Each 35c., doz. \$3.50.

*Keep your Potatoes free from SCAB; Treat them with SEMESAN BEL.
1 lb. (enough for 16 bus.) \$1.75.*

SALSIFY, or OYSTER PLANT

One ounce will sow 50 feet of drill

Sow early in Spring, in drills 15 inches apart and one inch deep, thinning out the young plants to six inches. The roots are used same as Carrots. Salsify is very hardy and can be left in the ground until Spring.

MAMMOTH SANDWICH ISLAND. Resembles Parsnip; very mild. Pkt. 10c., oz. 50c., $\frac{1}{4}$ lb. \$1.75.

SCORZONERA (Black Salsify)

Same as above, but roots are black. Pkt. 10c., oz. 50c., $\frac{1}{4}$ lb. \$1.50.

SEA KALE

One ounce will produce 300 plants

Cultivated for its blanched shoots, which are cooked same as Asparagus.

SEA KALE SEED. Pkt. 20c., oz. 75c.

SORREL

One ounce will sow 100 feet of drill

Valuable for its acid properties; mixed with salads. Sow in shallow drills 12 inches apart, and thin out the young plants to six inches.

LARGE-LEAVED FRENCH. The standard sort. Pkt. 10c., oz. 40c., $\frac{1}{4}$ lb. \$1.25.

MAMMOTH LYONS. Extra large improved strain of above. Pkt. 10c., oz. 50c., $\frac{1}{4}$ lb. \$1.50.



Spinach, Large-Leaved Viroflay



Spinach, King of Denmark

SPINACH

One ounce will sow 100 feet of drill

Sow early in Spring, in drills one foot apart and one inch deep every two weeks for a succession. For Fall use sow in August, and for Winter crop in September. Sow New Zealand in hills two feet apart each way, three or four seeds in a hill. Spinach is more productive and of better quality when grown in rich soil.

BLOOMSDALE SAVOY-LEAVED. Curled and wrinkled; very tender and of fine flavor. Pkt. 10c., oz. 15c., $\frac{1}{4}$ lb. 30c., lb. 85c.

KING OF DENMARK. This new, long standing Spinach, forms large, compact tufts, the leaves are slightly crumpled, extra large and broad, and of a glossy, dark green color. Stands hot weather better than any other variety, being very slow to run to seed. Pkt. 10c., oz. 20c., $\frac{1}{4}$ lb. 40c., lb. \$1.00.

LARGE-LEAVED VIROFLAY (Thick-leaved.) Very large, thick, dark green leaves; a splendid sort for Fall or Spring sowing. Pkt. 10c., oz. 15c., $\frac{1}{4}$ lb. 30c., lb. 85c.

LONG-STANDING. Dark green; leaves large and thick; best for Spring growing. Pkt. 10c., oz. 15c., $\frac{1}{4}$ lb. 30c., lb. 80c.

NEW ZEALAND. The best for Summer use; grows 1 $\frac{1}{2}$ feet high and is very prolific; valuable for hot climates. Pkt. 10c., oz. 25c., $\frac{1}{4}$ lb. 65c., lb. \$1.50.

PRICKLY, or WINTER. Very hardy, highly recommended for Fall sowing. Pkt. 10c., oz. 20c., $\frac{1}{4}$ lb. 40c., lb. \$1.00.

VICTORIA. A fine variety for Spring or Fall sowing; leaves very large, and of the deepest dark green color. Pkt. 10c., oz. 20c., $\frac{1}{4}$ lb. 40c., lb. \$1.00.

PERPETUAL SUMMER. A valuable variety, producing large, green leaves in abundance, close to the ground. Immediately one gathering has been made, fresh leaves appear, and a constant supply of spinach is kept up throughout the entire Summer and Fall, longer after ordinary sorts are exhausted. Pkt. 10c., oz. 30c., $\frac{1}{4}$ lb. \$1.00, lb. \$3.00.

SWISS CHARD, or SPINACH BEET

This Beet produces leaves only, in a continuous supply, which are used for greens. Cultivate same as Spinach, sowing the seed early in Spring, in drills 1 $\frac{1}{2}$ feet apart and 1 inch deep.

GIANT LUCULLUS. Pkt. 10c., oz. 25c., $\frac{1}{4}$ lb. 65c., lb. \$2.00.

SWISS CHARD. (Common.) Pkt. 10c., oz. 20c., $\frac{1}{4}$ lb. 60c., lb. \$1.50.

(For full descriptions, see page 18)

SQUASH

One ounce will plant 50 hills.

Sow in hills in the same manner and at the same time as cucumbers and melons, the bush varieties 3 to 4 feet apart, and the running kinds from 6 to 9 feet apart. An occasional feeding with liquid manure will repay in size of fruits.

Running Varieties

- BOSTON MARROW.** Color bright orange; flesh yellow and fine flavored. Pkt. 10c., oz. 30c., $\frac{1}{4}$ lb. 75c.
- DELICATA.** Orange yellow, striped green; very prolific; extra early; a good keeper. Pkt. 10c., oz. 35c., $\frac{1}{4}$ lb. \$1.00.
- FORDHOOK.** One of the best Winter sorts; color bright yellow. Pkt. 10c., oz. 35c., $\frac{1}{4}$ lb. \$1.00.



Squash, Warty Hubbard

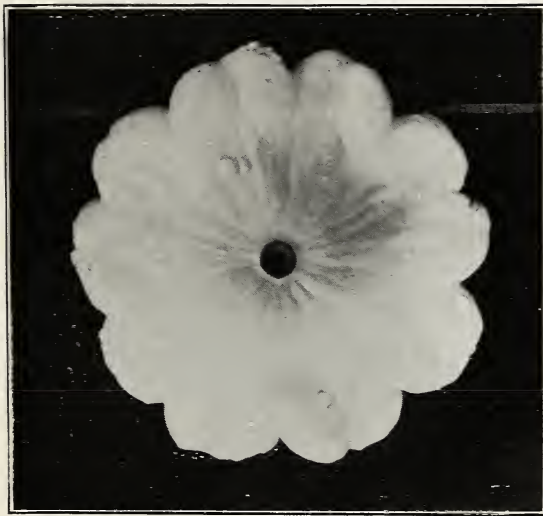

Squash, Long Island Improved White Bush

- GOLDEN HUBBARD.** Similar to the old-fashioned Hubbard in size and form. Skin rich deep orange. Pkt. 10c., oz. 30c., $\frac{1}{4}$ lb. \$1.00.
- HUBBARD.** The best for late use; an excellent sort for pies. Pkt. 10c., oz. 30c., $\frac{1}{4}$ lb. 75c.
- MAMMOTH CHILL.** Rich orange flesh, grows to an enormous size. Pkt. 10c., oz. 30c., $\frac{1}{4}$ lb. \$1.00.
- VEGETABLE MARROW.** The true English strain; color deep yellow; white flesh, about 15 inches long. Pkt. 10c., oz. 30c., $\frac{1}{4}$ lb. \$1.00.
- WARTED HUBBARD.** Of immense size and very productive. Pkt. 10c., oz. 30c., $\frac{1}{4}$ lb. 75c.
- WINTER CROOKNECK.** The best Winter sort. Pkt. 10c., oz. 30c., $\frac{1}{4}$ lb. \$1.00.

TOBACCO SEED

One ounce will produce plants for one acre.

- CONNECTICUT SEED-LEAF.** Pkt. 10c., oz. 30c.
- HAVANA.** Choice imported seed. Pkt. 10c., oz. 50c.

Bush Varieties

- COCOZELLE.** Grows about 20 inches long; the skin is very smooth, of a dark green color; in Italy this variety is eaten when very young. Pkt. 10c., oz. 30c., $\frac{1}{4}$ lb. \$1.00.
- EARLY YELLOW BUSH SCALLOP.** Early, flat, deep orange, with smooth rind. Pkt. 10c., oz. 30c., $\frac{1}{4}$ lb. 75c.
- GIANT SUMMER CROOKNECK.** Double the size of the old discarded Summer Crookneck and equally as early. Pkt. 10c., oz. 30c., $\frac{1}{4}$ lb. 75c.
- GOLDEN CUSTARD.** Exceeds in size any of the scalloped sorts. Pkt. 10c., oz. 30c., $\frac{1}{4}$ lb. 75c.
- IMPROVED EARLY WHITE BUSH SCALLOP.** Extensively grown; flesh tender and delicate. Pkt. 10c., oz. 25c., $\frac{1}{4}$ lb. 75c.
- LONG ISLAND IMPROVED WHITE BUSH.** An improved strain of Early White Bush; very prolific. Pkt. 10c., oz. 30c., $\frac{1}{4}$ lb. 75c.



Squash, Vegetable Marrow

TOMATO

One ounce will produce 1,000 plants.

Sow in a hotbed about the first week in March, in drills five inches apart, and half an inch deep. Transplant to the open ground when all danger of frost is past, setting the plants 3 to 4 feet apart each way. Sufficient plants for a small garden may be started by sowing a few seeds in a shallow box or flower pot, and placing it in a sunny window of the room or kitchen. By training the vines on trellises or tying to stakes the fruit will ripen better and be of finer quality.

BONNY BEST EARLY. This is a very early popular variety. It is a vigorous grower enormously prolific, with splendid foliage and of an intense velvety glowing scarlet color; ripens evenly all over and up to the stem. Pkt. 10c., oz. 50c., $\frac{1}{4}$ lb. \$1.50.

BURNETT'S "LIBERTY." Fruit large, perfectly round and solid; color glossy red (for description see page 14). Pkt. 25c., oz. \$1.00.

CARTER'S SUNRISE. Splendid forcing or outdoor variety; early and prolific; color bright scarlet. Pkt. 25c., $\frac{1}{4}$ oz. \$1.00, oz. \$3.00.

CHALK'S EARLY JEWEL. Very large, solid, bright red; early and prolific. Pkt. 10c., oz. 50c., $\frac{1}{4}$ lb. \$1.50.

CRIMSON CUSHION. Color bright crimson; large, handsome and solid, with few seeds. Pkt. 15c., oz. 75c., $\frac{1}{4}$ lb. \$2.75.

DWARF CHAMPION. Foliage dark green; habit of plant dwarf and upright; fruit smooth, medium in size and of a pinkish purple color. Pkt. 10c., oz. 50c., $\frac{1}{4}$ lb. \$1.50.

DWARF STONE. Resembles Tall Stone in color and size of fruit; has the earliness and compact habit of Dwarf Champion. Pkt. 10c., oz. 65c., $\frac{1}{4}$ lb. \$1.75.

EARLIANA. Extra early; bright red; smooth, solid and meaty. Pkt. 10c., oz. 50c., $\frac{1}{4}$ lb. \$1.50.

GOLDEN PONDEROSA. Largest of the yellow fruiting varieties, similar to Ponderosa except in color of fruit. Pkt. 20c., $\frac{1}{2}$ oz. \$1.00.

GOLDEN QUEEN. Fruit large, solid, golden yellow. Pkt. 10c., oz. 50c., $\frac{1}{4}$ lb. \$1.50.

JOHN BAER. (True.) The earliest and best Tomato. Fruit solid. Color, bright red. Pkt. 15c., oz. 75c., $\frac{1}{4}$ lb. \$2.50.

LIVINGSTON'S GLOBE. Glossy rose color, tinged with purple. Pkt. 10c., oz. 60c., $\frac{1}{4}$ lb. \$1.75.

PONDEROSA. Fruit exceedingly large and solid. Pkt. 10c., oz. 75c., $\frac{1}{4}$ lb. \$2.75.

STIRLING CASTLE (Forcing). The best forcing variety; fruit small, very solid and of excellent quality. Pkt. 25c., $\frac{1}{4}$ oz. \$1.00, oz. \$3.00.

STONE. Flesh firm, solid and of excellent quality; color bright scarlet; the most popular variety grown. Pkt. 10c., oz. 50c., $\frac{1}{4}$ lb. \$1.50.



Tomato, Stirling Castle

SUTTON'S BEST OF ALL (Forcing). Sets freely and an immense cropper; color deep scarlet. Pkt. 25c., $\frac{1}{4}$ oz. \$1.00, oz. \$3.00.

WESTCHESTER PRYDE has proved all we claim for it, both as a forcer and an early outside cropper. For description see page 14. Pkt. 25c., 5 pkts. for \$1.00.

SMALL-FRUITED VARIETIES

We supply the following well-known sorts, generally used for preserves and pickles:

RED CHERRY, RED CURRANT, RED PEACH, RED PEAR, RED PLUM, STRAWBERRY, or WINTER CHERRY, YELLOW CHERRY, YELLOW PEACH, YELLOW PEAR, YELLOW PLUM. Each, Pkt. 10c., oz. 60c.

Collection of 1 Pkt. each of above 10 varieties, 75c.

PLAN-TIE, new tying material. Does not bruise plants; Breaks with the fingers; Resists wind and weather. Supersedes raffia, jute, etc.

Spool, 25c., dozen, \$2.50.

TURNIPS

For early crop sow in Spring, as soon as the ground can be worked, and again in July and August in drills half an inch deep and 18 inches apart; thin out to six inches in the row. Sow Ruta-Baga in June and July in drills two feet apart; thin out to nine inches in the row. Turnips do best in a rich, light soil.

EARLY SNOWBALL. Small; one of the best for table use. Pkt. 10c., oz. 20c., $\frac{1}{4}$ lb. 60c., lb. \$1.50.

EARLY WHITE MILAN. A handsome pure white; flesh very sweet and tender. Pkt. 10c., oz. 25c., $\frac{1}{4}$ lb. 75c., lb. \$2.50.

EARLY WHITE STRAP LEAF. A good early sort; very solid. Pkt. 10c., oz. 20c., $\frac{1}{4}$ lb. 50c., lb. \$1.50.

EXTRA EARLY PURPLE TOP MILAN. White, with purple top; flesh pure white, sweet and crisp; the best early. Pkt. 10c., oz. 25c., $\frac{1}{4}$ lb. 75c., lb. \$2.00.

GOLDEN BALL. Very handsome, bright yellow, of rapid growth. Pkt. 10c., oz. 25c., $\frac{1}{4}$ lb. 65c., lb. \$1.75.



Turnip, Early White Milan

PURPLE TOP WHITE GLOBE. A handsome globe-shaped variety, of superior quality. Pkt. 10c., oz. 20c., $\frac{1}{4}$ lb. 60c., lb. \$1.75.

REP TOP STRAP LEAF. A well-known variety extensively grown for general use. Pkt. 10c., oz. 20c., $\frac{1}{4}$ lb. 50c., lb. \$1.50.

WHITE EGG. Shape nearly oval; flesh pure white, fine grained, mild and sweet. Pkt. 10c., oz. 20c., $\frac{1}{4}$ lb. 50c., lb. \$1.50.

YELLOW ABERDEEN PURPLE TOP. Hardy and productive; good for either table or stock. Pkt. 10c., oz. 20c., $\frac{1}{4}$ lb. 50c., lb. \$1.50.

YELLOW STONE. The best known sort; flesh very firm and solid; excellent for table use. Pkt. 10c., oz. 20c., $\frac{1}{4}$ lb. 60c., lb. \$1.75.

RUTA-BAGA

Russian or Swedish Turnip

IMPROVED AMERICAN PURPLE TOP. The standard variety; very large and uniform; flesh bright yellow and quality unequalled. Pkt. 10c., oz. 20c., $\frac{1}{4}$ lb. 50c., lb. \$1.50.

LONG ISLAND IMPROVED. Of immense size and a good keeper; flesh rich yellow. Pkt. 10c., oz. 20c., $\frac{1}{4}$ lb. 60c., lb. \$1.75.

LONG WHITE FRENCH. An excellent keeper; flesh white and of fine quality. Pkt. 10c., oz. 20c., $\frac{1}{4}$ lb. 50c., lb. \$1.50.



Ruta-Baga, Long Island Improved

We handle a full line of Vegetable Plants, such as Cabbage, Cauliflower, Celery, Egg-Plant, Lettuce, Peppers and Tomatoes in Season. (See page 38.)



Sweet Basil



Sage



Sweet Marjoram



Summer Savory



Thyme

HERBS

SWEET, POT AND MEDICINAL

Sow early in Spring in shallow drills, one foot apart; when up a few inches thin out, or transplant to permanent beds.

- ANISE.** For garnishing. Pkt. 10c., oz. 30c.
BALM. For culinary purposes. Pkt. 15c., oz. 50c.
BASIL, SWEET. For flavoring. Pkt. 10c., oz. 30c.
BENE. Leaves used for dysentery. Pkt. 15c., oz. 50c.
BORAGE. Used in salads. Pkt. 10c., oz. 30c.
BURNET. Useful for salads and soups. Pkt. 10c., oz. 30c.
CARAWAY. Seeds are used in cakes. Pkt. 10c., oz. 25c.
CATNIP. Has medicinal qualities. Pkt. 15c., oz. 75c.
CORIANDER. For garnishing. Pkt. 10c., oz. 25c.
DILL. Used for flavoring. Pkt. 10c., oz. 25c., $\frac{3}{4}$ lb. 75c.
FENNEL, FLORENCE, or NAPLES. Resembles celery. Pkt. 10c., oz. 50c.
FENNEL, SWEET. Seeds aromatic. Pkt. 10c., oz. 30c.
HOREHOUND. Used for its tonic properties. Pkt. 15c., oz. 50c.
HYSSOP. Has medicinal qualities. Pkt. 15c., oz. 50c.
LAVENDER. Used as a perfume. Pkt. 15c., oz. 50c.
MARJORAM, SWEET. Used for seasoning. Pkt. 15c., oz. 50c.
MARJORAM, POT. For seasoning. Pkt. 15c., oz. 50c.
ROSEMARY. Yields aromatic oil. Pkt. 15c., oz. 50c.
RUE. Perennial. Pkt. 15c., oz. 50c.
SAFFRON. Used for dyeing. Pkt. 15c., oz. 50c.
SAGE. Leaves used in dressings. Pkt. 15c., oz. 50c.
SAVORY, SUMMER. Used for flavoring. Pkt. 15c., oz. 50c.
SAVORY, WINTER. For flavoring. Pkt. 15c., oz. 50c.
TANSY. Generally used in bitters. Pkt. 15c., oz. 50c.
THYME, BROAD-LEAVED. Dried leaves are used for seasoning. Pkt. 15c., oz. \$1.00.
WORMWOOD. Has medicinal qualities. Pkt. 15c., oz. 50c.

VEGETABLE PLANTS AND ROOTS

- ASPARAGUS ROOTS.** (See page 15.)
ARTICHOKE PLANTS, LARGE FRENCH GLOBE. Ready after May 1st. Doz. \$3.00.
ARTICHOKE TUBERS, JERUSALEM. Qt. 40c., pk. \$2.50.
CABBAGE PLANTS. Doz. 30c., 100 \$2.00, 1000 \$15.00.
CAULIFLOWER PLANTS, EARLY SNOWBALL. Doz. 60c., 100 \$4.75.
CELERY. Ready in June. 100 \$1.25, 1000 \$10.00.
CHIVES. For flavoring. Per clump 25c., doz. \$2.50.
EGG-PLANTS, POT-GROWN. Ready May 15th. Doz. \$1.00, 100 \$7.50.
HORSE-RADISH ROOTS. MALINER KREN. Doz. 50c., 100 \$3.00.
LETTUCE PLANTS. Doz. 30c., 100 \$2.00.
MINT PLANTS. Each 25c., doz. \$2.50.
PARSLEY PLANTS. Doz. 60c., 100 \$4.50.
PEPPERS, POT-GROWN. Ready May 15th. Doz. 60c., 100 \$4.75.
RHUBARB ROOTS. Large, each 25c., doz. \$2.50. Extra large, each 35c., doz. \$3.50.
SWEET POTATO PLANTS. Ready in June. 100 \$1.00.
TARRAGON ROOTS (Estragon). Extra large, each 50c., doz. \$5.00.
TOMATO PLANTS. Ready May 1st. All varieties. Pot grown. Doz. 60c., 100 \$4.75.
TOMATO PLANTS, BURNETT'S LIBERTY. Doz. 75c., 100 \$5.00.

Strawberry Plants—Write For Descriptive List

BURNETT BROS'. RELIABLE FARM SEEDS



SEED OATS

Sold at standard weight of 32 lbs. to the bushel
Sow three Bushels to the acre

SCOTTISH CHIEF. This is one of the most productive and desirable varieties offered to the farmer. It makes a very strong growth of straw with immense heads well filled with large and heavy white grains. The yield is exceptionally large; 60 to 70 and even 100 bushels per acre have been harvested. Bushel (32 lbs.) \$3.00, 10 bushels or more \$2.75 per bushel.

STORM KING. This is a very early variety and an enormous cropper. It does well on any good farm land and is very profitable. The heads are large and well filled. The straw long, strong and stands well. Bushel (32 lbs.) \$2.50, 10 bushels or more \$2.25 per bushel.

SWEDISH SELECT. A strong grower, with a short plump and heavy grain. Heavy yielder on any soil; a medium early variety. Bushel (32 lbs.) \$2.75, 10 bushels or more \$2.50 per bushel.

BUCKWHEAT

Sow one bushel per acre

JAPANESE. Early and productive. Bushel (48 lbs.) \$3.50.

FIELD PEAS

Sow 1½ bushels per acre

CANADA FIELD. Valuable for ensilage. Bushel (60 lbs.) \$5.50.

COW PEAS. Largely grown for fodder and plowing under.

New Era. Bushel (60 lbs.) \$5.50.

Whippoorwill. Bushel (60 lbs.) \$5.50.

MILLET

One bushel will sow one acre

GERMAN or GOLDEN. Bushel (48 lbs.) \$5.00; lb. 15c; 100 lbs., \$9.00.

HUNGARIAN. Bushel (48 lbs.) \$5.00; lb. 15c; 100 lbs., \$9.00.

JAPANESE. Lb. 20c; 100 lbs., \$10.00.

RYE

Sow 1½ bushels per acre

BURNETT'S GIANT SPRING RYE. A great improvement on the small-grained Spring Rye usually sown. It is a very large yielder with full, plump, heavy grains. Bushel (56 lbs.) \$3.50.

MAMMOTH WINTER. A heavy cropper. Bushel (56 lbs.) \$3.00.

NEW ROSEN. A four-row Winter variety. Bushel (56 lbs.) \$3.50.

WHEAT

Sow 1½ bushels per acre

RED WINTER. (Beardless.) Standard sort. A heavy yielder. Bushel (60 lbs.) \$4.50.

MARQUIS. (Beardless.) Most popular Spring variety, a heavy yielder. Bushel (60 lbs.) \$4.50.

SOJA BEANS

Sow ¾ Bushel per acre

MAMMOTH YELLOW. Valuable for improving the soil. Also good for fodder, either green or dry. Sow in drills 3 feet apart, and cultivate same as Field Corn. Bushel (60 lbs.) \$5.00.

RAPE

Sow 10 to 12 pounds per acre broadcast and 5 to 6 pounds per acre in drills 15 inches apart

DWARF ESSEX. For sheep pasture the Dwarf Essex Rape is invaluable. If sown in May it will be ready for pasturing in July. Lb. 20c., 100 lbs. \$15.00.

VETCHES

Sow 1½ bushels per acre

SPRING (*Vicia sativa*). Valuable for green fodder and soiling. Lb. 15c., Bushel (60 lbs.) \$7.50.

WINTER or HAIRY (*Vicia villosa*). Produces good crops on poor sandy soils. Being perfectly hardy, it may be sown either in the Spring or Fall, mixed with Oats or Rye. Lb. 30c., Bushel (60 lbs.) \$15.00.

Prices on all Farm Seeds subject to change without notice

STIMUGERM & MULFORD Cultures help Germination of Field Peas, Soja Beans and Vetches. (See page 110.)

RELIABLE FARM SEEDS—Continued

MANGEL-WURZEL AND SUGAR BEETS

Six pounds will sow one acre.

- CHAMPION YELLOW GLOBE MANGEL-WURZEL.** Large productive, and a good keeper. $\frac{1}{4}$ lb. 35c., lb. \$1.00.
- GOLDEN TANKARD MANGEL-WURZEL.** Large, bright yellow, very productive. $\frac{1}{4}$ lb. 35c., lb. \$1.00.
- LEVIATHAN LONG RED MANGEL-WURZEL.** A large selected strain; enormously productive. $\frac{1}{4}$ lb. 35c., lb. \$1.00.
- LANE'S IMPERIAL SUGAR BEET.** The best for feeding stock. $\frac{1}{4}$ lb. 40c., lb. \$1.25.
- WHITE SUGAR BEET.** A heavy cropper. $\frac{1}{4}$ lb. 35c., lb. \$1.00.

RUTA-BAGA

Russian or Swede Turnip

Two to three pounds will sow one acre.

- IMPROVED AMERICAN PURPLE TOP.** Yellow flesh; extensively grown for stock. $\frac{1}{4}$ lb. 50c., lb. \$1.50.

LONG ISLAND IMPROVED. A handsome globe-shaped variety. $\frac{1}{4}$ lb. 60c., lb. \$1.75.

LONG WHITE FRENCH. An excellent keeper and fine for stock. $\frac{1}{4}$ lb. 50c., lb. \$1.50.

FIELD CARROT

Three pounds will sow one acre.

IMPROVED DANVERS HALF-LONG. For market and agricultural purposes. $\frac{1}{4}$ lb. 60c., lb. \$2.00.

IMPROVED LONG ORANGE. For field crops this is the best variety grown. $\frac{1}{4}$ lb. 60c., lb. \$2.00.

LARGE WHITE BELGIAN. Extensively grown for feeding. $\frac{1}{4}$ lb. 50c., lb. \$1.50.

Prevent Ear, Root and Stalk ROTS of Corn. Dust it with SEMESAN JR. 4 oz. (enough for 1 bush.) 60c.



Field Carrot
Improved Long Orange



Mangel-Wurzel
Leviathan Long Red.

FIELD CORN

Eight quarts will plant one acre in hills; three bushels will sow one acre broadcast or half that quantity in drills.

DENT VARIETIES

EUREKA YELLOW DENT. Ears beautiful deep yellow, containing from 18 to 22 rows. A very heavy yielder. Bushel \$5.00.

LEAMING IMPROVED. Early and productive; ears very large, with deep golden kernels. Bushel \$5.00.

QUEEN OF THE PRAIRIE. Matures in 90 days. Bushel \$5.00.

FLINT VARIETIES

EARLY YELLOW CANADA. Early. Bushel \$5.00.

LARGE YELLOW FLINT. Bushel \$5.00.

LARGE WHITE FLINT. Bushel \$5.00.

LONGFELLOW. Very long ears. Bushel \$5.00.

ENSILAGE AND FODDER VARIETIES

SOUTHERN HORSETOOTH. Bushel \$4.50.

EVERGREEN SWEET FODDER. Bushel \$5.00.

Prices on all Farm Seeds subject to change without notice.

Feed your Corn with the proper plant food. AGRICO-CORN Fertilizer has just those chemical elements necessary for large crop yields. 100 pound bag, \$3.50; ton, \$55.00.

NOVELTIES AND SPECIALTIES IN FLOWER SEEDS

All gardening enthusiasts are more or less interested in something new in the floral world, and for this reason we keep in touch with all new introductions as they appear from year to year. The few novelties and specialties offered below have been selected by us as having a good claim to merit and are well worthy of a trial.

ADONIS ALEPPICA The Syrian Flos Adonis

The news that it is again possible to obtain seeds of this superb summer plant will be universally welcomed.

The plant is pyramid shaped and grows 16 to 20 inches tall, is strongly ramified and produces numerous round flowers measuring about 3 inches across. The color of the flowers is a shining deep dark blood red of greatest brilliancy. It blooms for two months and when the flowers are cut and placed in water they remain fresh for a long time.

The Syrian Flos Adonis is especially suited for brilliantly colored beds and borders.

The seed can be sown either in the open or in cold frames, preferably in the early spring. Pkt. 50c.

ANCHUSA Annual "Blue Bird"

The perennial Anchusa, the "Dropmore variety," is deservedly popular for its lovely bright blue flowers. This esteem has been shared to some extent by the annual Anchusas. This novelty, which grows about 18 inches high, is of compact habit. Flowers are of a vivid indigo blue and of brilliant effect in any scheme for the decoration of beds and borders. Pkt. 50c.

ANEMONE ST. BRIGID "Creagh Castle Strain"

Anemones, especially the St. Brigid variety, have now attained great popularity and we, therefore, welcome the opportunity of introducing this present strain which has originated in the home of St. Brigid Anemones.

The flowers are extremely large and the range of colors exceptional. Pkt. 75c.

AQUILEGIA VULGARIS COM- PACTA ERECTA "Edelweiss"

One of the earliest spring flowers, this charming Aquilegia variety covers its bushes, 16 to 20 inches high, with large erect snow-white blossoms; the very thing in conjunction with the light green foliage for awaking joy in the garden. Pkt. 50c.

DELPHINIUM Hollyhock Flowered "The Wrexham Strain"

This wonderful new strain of Delphiniums is the finest in existence today and has created a rage, both in Europe and America.

The seed we offer is procured by us direct from one of England's foremost growers of this strain. Pkt. \$2.00; 3 pkts. \$5.00.



Meconopsis Baileyi

DAHLIA Coltness "Improved Hybrids"

The annual Single Dahlias are much prized for their light and graceful decorative flowers. These new hybrids with their pastel shades of delicate pinks, mauves and roses and their richer yellow, scarlets and purples will win many new friends. Plants are of dwarf habit and compact, producing great quantities of flowers. Pkt. 50c.

NEW FORCING CALENDULA Sensation (Campfire)

A distinct new type. It is of vigorous growth, the flowers borne on stout stems needing little disbudding. The blooms are flat, and are undoubtedly larger than those of any type previously introduced. Pkt. 25c.

MECONOPSIS BAILEYII "The Blue Poppy"

A perennial Poppy, discovered in Thibet, throwing up strong leafy stems 3 to 4 feet high, terminating in large four-petalled blossoms of a glorious sky-blue shade, placed around a central zone of golden yellow anthers. A remarkable perennial of rare beauty and one of the most valuable plant discoveries in many years. Pkt. 75c.

NOVELTIES & SPECIALTIES—Cont'd

MIGNONETTE**Golden Goliath**

This was introduced as a Novelty from England last year. The flowers are a deep golden yellow in color with spikes of immense size, surpassing both in color and size any variety that has yet been introduced. Pkt. 50c.

PRIMULA OBCONICA**Gigantea Rose Queen**

The largest and most vigorous Primula Obconica in existence. The immense trusses of flowers are freely borne on long stout stems, and are of great size and substance.

The color is of the purest rose, and a tone that we are convinced will be welcomed. Pkt. 75c.

SCABIOSA CAUCASICA**House's Sensational Strain**

Scabiosa Caucasica is now becoming popular for growing under glass, and we prophesy that this strain of hybrids will greatly increase the popularity of Scabiosa Caucasica when it becomes known. Caucasica Hybrids are a great improvement over the Caucasica, being more vigorous with larger and longer stems and larger and heavier petals, which are ruffled and slightly frilled on the edges. In this hybrid strain you will find colors ranging from white to the darkest blue, but the predominating colors are of delicate lilac and mauve. Pkt. 50c.

INCARVILLEA**Variabilis Hybrids**

A new perennial, which, if planted early in the spring, can be handled as an annual. It is valuable as a border plant and produces a good showing of medium-sized, attractive trumpet-shaped flowers the entire summer. The colors range from yellow and white to deep pink. This mixture of hybrid Incarvillea is a result of several years of painstaking hybridizing and we consider it a valuable addition to the perennial border. Pkt. 50c.

STATICE DUMOSA

This very valuable Sea Lavender is a great improvement upon all popular species; it forms densely packed cushions of pure silvery grey flowers. Their stems are stiff and wiry, the panicles are thickly covered with blossoms. Pkt. 75c.



Texas Blue Bell

TEXAS BLUE BELL
(Eustoma Russellianum)

A fine greenhouse plant, which used to be well known, and is again becoming popular. It has rich deep purple flowers with black centres and yellow stamens. Pkt. 25c.

STOCKS**Early Giant Imperial**

GOLDEN ROSE. A rich light rose enhanced by a pleasing golden effect in the shade of each individual floret. Flowers are large, very double and held on long stems. Pkt. 50c.

ANTIQUE COPPER. Rich Hellebore red, overlaid with copper, the whole giving a very pleasing reddish "antique copper" effect. The strain is very double with individual florets, 2 inches in diameter, on long stems. Pkt. 50c.

ELK'S PRIDE. A new shade of intense royal purple of vigorous growth. very early blooming, flowers large and sweetly scented. Pkt. 50c.

TWO NEW GLADIOLI**Dr. F. E. Bennett**

Peach red, overlaid with flame scarlet, throat speckled ruby and creamy white; very large flowers of great substance, many open at a time on strong stem; sturdy grower. Doz., \$4.00; 100, \$30.00.

Mr. W. H. Phipps

La France pink, overlaid with salmon rose, lighter towards the center, lower petals faintly striped and speckled with ruby; enormous flowers, as many as 20 open at a time and perfectly placed on gigantic stem; a real super glad. Doz., \$4.00; 100, \$30.00.

Burnett's Reliable Flower Seeds



A well planned Old-fashioned Garden

Aid for the Amateur.

One of the most fascinating and economical ways of making a flower garden, is in raising the plants from seed. One sees far too many of those summer gardens of Cannas, Geraniums, Salvias, Coleus, etc., that are more or less characteristic of the order telephoned to the florist round the corner, to "come and fix up the garden": very effective in their way, but their similarity and frequency are monotonous, and what is more, such gardens are expensive. A few packages of well chosen annual seeds costing but a few cents, give far more enjoyment in the raising, and a much more useful and interesting variety of flowers.

Flowers that can be raised from seed are divided into 7 classes, viz:—

- H. A.—Hardy Annuals.** Seeds sown outdoors where they are to bloom; they die after the first year.
- H. H. A.—Half Hardy Annuals.** Those that are sown under glass in the early Spring and transplanted outdoors in April and May.
- H. B.—Hardy Biennials.** Seeds sown outdoors and bloom the next year; some bloom the first year if sown early.
- H. H. B.—Half Hardy Biennials.** Seed sown one year under glass and planted outdoors the following Spring.
- H. P.—Hardy Perennials.** Seeds sown outdoors one year, bloom the next and each succeeding year without protection.
- H. H. P.—Half Hardy Perennials.** These bloom from seed the second year, but need winter protection thereafter.
- G. P.—Greenhouse Plants.** Tender plants for growing under glass.

Our list of Flower Seeds has again been carefully revised and comprises only the choicest and most select types in their respective classes, which we are certain will give satisfaction.

- | | |
|--|--|
| Abnronia. H. H. A. Beautiful trailer. Pkt. | Acanthus mollis. H. P. Stately hardy Pkt. |
| umbellata. Rosy lilac..... ¼ oz. 30c., .10 | plant with large, decorative leaves, flowers white, July and August. 3 ft..... .15 |
| Abutilon. G. P. Extra Choice Mixed25 | |
| Acacia. G. P. Elegant Winter and Spring flowering plants. Finest Mixed ¼ oz. 30c., .10 | Achillea Ptarmica, The Pearl. H. P. Double white flowers; fine for cutting. 2 ft..... ¼ oz. \$1.00, .25 |

	Pkt.
Achimenes. G. P. Easily grown bulbous stove plants which may be given the same treatment as Gloxinias. The flowers are of the richest and most varied colors. Choice Mixed25
Aconitum. (Monk's Hood.) H. P. 4 ft.	
Napellus. Blue and white.....	¼ oz. \$1.00, .15
pyramidatum. Blue.....	¼ oz. \$1.00, .15
Wilsonii. Light blue.....	.25
Acroclinium H. H. A. Everlasting flowers. 1 ft.	
Double. Pure white.....	¾ oz. 35c., .10
Double. Bright rose.....	¾ oz. 35c., .10
Finest Mixed	¾ oz. 25c., .10
Adlumia cirrhosa (Mountain Fringe). H. A. 15 ft. White.....	.15
Adonis æstivalis. H. A. Green foliage, with scarlet flowers. 1 ft.....	.10
Aethionema grandiflorum. H. P. A very elegant plant which succeeds well on the rocky. The clear-colored rosy flowers, produced in long racemes, continue in beauty from May to August. 12 to 18 in.....	.50
Agatheæ celestis (Blue Daisy). H. H. P. Flowers sky-blue with yellow disk.....	.15
Agrostemma coronaria. H. P. (Rose Campion.) Dark blood-red. 2 ft.	
coronaria alba. White.....	¾ oz. 50c., .10
cœli-rosa. H. A. Free flowering with bright rose flowers. 18 in.....	¾ oz. 50c., .10
Agrotum. H. H. A. Blooms throughout out the entire Summer and Fall. 1 ft.	
Dwarf Blue	¾ oz. 50c., .10
Dwarf White	¾ oz. 50c., .10
Swanley Blue	¾ oz. 50c., .10
BLUE PERFECTION. Finest blue bedding variety.....	¾ oz. 50c., .15
Princess Victoria Louise. Light blue with white center.....	¾ oz. 75c., .15
LITTLE BLUE STAR. Compact, very free flowering.....	½ oz. \$1.50, .25
Allwoodii. H. P. This new race of hardy plants belongs to the Dianthus family; exceptionally hardy, commencing to flower in early Spring, and continues through the Summer and Autumn.....	.50
Alpinus. Eminently suitable as rock and alpine plants. Height about 6 inches. Colors, chiefly pink, white and purple shades. Very free flowering.....	.50
Alonsoa warscewiczii compacta. H. H. A. Bright scarlet, fine for pots and for bedding; 12 ins.....	.15
Alstroemeria chilensis. H. P. Extremely attractive in the garden and of great service for cutting. Spotted Lily-like flowers of various shades of pink, rose, red and yellow. Height 2 to 3 feet. Mixed colors50
Alyssum. H. A. A very pretty border plant, valuable for beds, edgings and rock-work. Blooms the entire Summer.	
odoratum (Sweet-Scented). White flowers. ½ ft.....	Oz. 50c., .10
LITTLE GEM. Of dwarf, compact habit 3 to 4 in. high.....	Oz. 75c., .10
CARPET OF SNOW. Pure white, grows only 2 to 3 in. Splendid for carpet bedding.....	Oz. \$1.00, .10
Lilac Queen. Lilac flowers.....	Oz. \$1.00, .10
saxatile compactum. H. P. A pretty yellow-flowered variety. ¾ ft.....	¼ oz. 75c., .15



Alyssum, Carpet of Snow

	Pkt.
Amaranthus. H. H. A. Ornamental foliage plants.	
Burnett's Dazzler. The leaves are deep green and bronze, developing a brilliant head of dazzling carmine scarlet in late Summer and Fall.....	.50
caudatus (Love-Lies-Bleeding) 3 ft.	
¾ oz. 35c., .10	
cruentus (Prince's Feather). Scarlet.	
¾ oz. 35c., .10	
Molten Fire. Fiery crimson.....	¼ oz. \$1.00, .15
salicifolius (Fountain Plant). Leaves marked orange-carmine.....	¼ oz. 50c., .10
tricolor (Joseph's Coat). Leaves scarlet, yellow and green. 2 ft.....	¼ oz. 50c., .10
Ampelopsis veitchii. H. P. (Boston Ivy.) Useful for covering stone buildings, etc.....	.10
Anagallis grandiflora (Pimpernelle). H. A. For rockwork or edging. 6 in. Mixed.....	.10
Anchusa capensis. H. A. Flowers resembling large Forget-Me-Nots.	
¾ oz. 50c., .10	
Blue Bird (Annual). See Novelties.	
italica (Dropmore Variety). H. P. This is a great improvement over existing varieties; rich blue.....	¾ oz. 75c., .25
Anemone. H. P. Beautiful Spring flowers, valuable for cutting.	
coronaria, Single De Caen15
St. Brigid. Poppy flowered.....	.25
japonica alba15
alpina. A lovely species for the rock garden. Flowers white tinted slaty blue. 1 ft.....	.25
pulsatilla (The Pasque Flower). Large purple flowers with yellow anthers, covered with silky hairs on outside. 9 in.....	.25
Creagh castle (see novelties).	
Angelonia grandiflora. A very sweetly scented greenhouse perennial, plants attain a height of 1½ to 2 feet, flowers pale lilac, white spotted.....	.25

PLANT-TIE

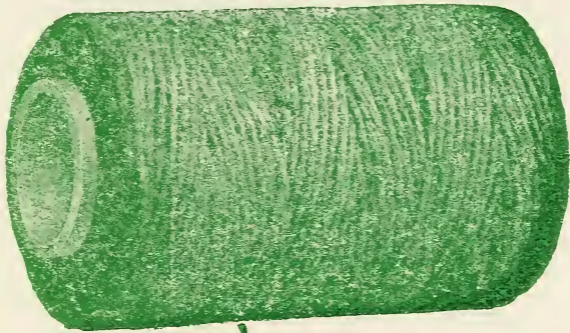

New and Better Tying Material

“ IT ”

Supersedes Raffia, Jute etc.

No scissors or knives necessary

Easily broken with fingers

Defies Winds and Storms

Does not chafe hands or plants

Dyed a pleasing Dark Green

Spool of 300 feet

25 cents each

dozen \$2.50

BURNETT BROS. INC.
SEEDSMEN

92 CHAMBERS STREET
NEW YORK CITY

“The House Famous For Lawn Grass Seed”

THE ORIGINAL

ALUMINIZED

METAL EGG CRATES

MADE BY ELLIS

BUY EGGS DIRECT
FROM THE FARM

STRICTLY FRESH
BY PARCEL POST

SOLD BY

BURNETT BROS., INC.,
92 Chambers St., New York, N. Y.

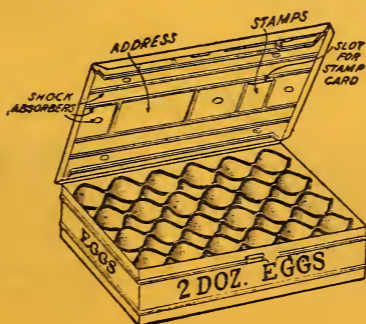

THE ALUMINIZED METAL EGG CRATES

(New Model)

The aluminized metal egg crate has proven itself by its thousands of users to be the only practical way to ship eggs, butter and other farm products by parcel post.

A PROVEN SUCCESS

We have sold over a half million metal crates and our early model crates are still in service after seven years of steady use. That is an endorsement of quality and a sound reason why our metal egg crates and combination crates will pay you.

THOUSANDS OF DEALERS

The best Department Stores, Seed and Poultry Houses and House Furnishing Stores in the United States recognize Metal Egg Crates for Parcel Post as a household necessity of today. Satisfies customers—saves annoyance—cuts down losses—brim full of economy—makes shipments of country products successful and desirable.

PRICES

1½ doz. size—all eggs	\$1.25
2 " " " "	1.50
3 " " " "	1.75
4 " " " "	2.00
6 " " " "	2.50
9 " " " "	3.25
12 " " " "	4.00
15 " " " "	4.75

(Add postage to above prices.)

COMBINATION CRATES

With Metal Containers

No. 1— 2 lbs. and 1 doz. eggs	..	\$1.50
No. 2— 4 " " 2 " "	..	2.00
No. 3— 4 " " 3 " "	..	2.25
No. 4— 6 " (3 2-lb containers)		2.25
No. 5—12 " (3 4 " ")		2.50
No. 6—16 " (2 8 " ")		2.50
No. 7—24 " (2 12 " ")		3.50

(Add postage to above prices.)

Metal Egg Crate Co., Mfrs., Fredericksburg, Va.

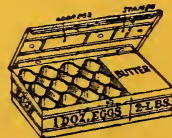

Combination No. 1

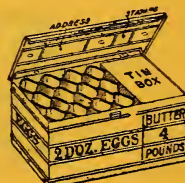
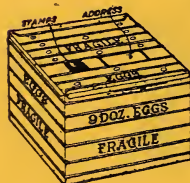
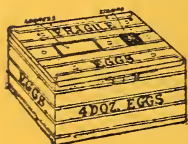

Combination No. 2

MAILING RATES

	WEIGHTS		POSTAGE	
		Empty	Empty	Filled
1½ doz. size...	3 lbs.		7c	9c
2 " "	3 lbs.		7c	10c
3 " "	4 lbs.		8c	12c
4 " "	5 lbs.		9c	15c
6 " "	6 lbs.		10c	19c
9 " "	8 lbs.		12c	26c
12 " "	10 lbs.		14c	32c
15 " "	12 lbs.		16c	38c
Comb. No. 1...	3 lbs.		7c	10c
Comb. No. 2...	4 lbs.		8c	15c
Comb. No. 3...	5 lbs.		9c	18c

The above postage rates apply to the second zone or 150 miles. Add 2c for service charge.

REVERSIBLE ADDRESS CARD

placed under the lid, provides for going and returning addresses, making the Crate intermailable between two parties. This eliminates readdressing for each shipment. Stamp slips are also provided, so that shipper may pay and place postage for the return mailing.

Postage is usually less than for other Egg Carriers.

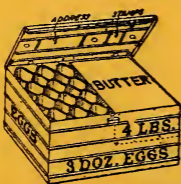

Combination No. 3

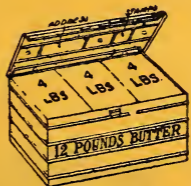

Combination No. 5

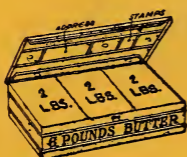

Combination No. 4

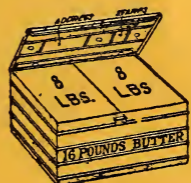

Combination No. 6

LIGHT WEIGHT

Metal egg crates cost no more for postage than other carriers. Made of a light but sturdy aluminized metal, with strength built into every joint, they are nevertheless sufficiently light to carry your products with a minimum of carrying cost. (See table of mailing rates on other side.)

COMBINATION CRATES

Any size Combination Crate desired can be supplied to carry Eggs, with Metal Containers to hold Butter, Lard, Sausage, Honey, Country Sliced Ham, etc. These Combination Crates will be found surprisingly satisfactory. Butter, Lard and other soft products will not melt or run in warmest weather.

Sizes, Prices and Illustrations will be found on other side.

Pat. Nov. 20, '17; March 25, '20

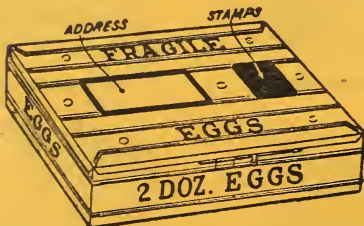

OUR NEW MODEL

Built for enduring service, our new model has many improved features, both inside and out, designed to eliminate waste of fillers, breakage of eggs or deterioration of the carrier.

METAL EDGE FILLER

The new patented Filler made of cardboard, circular in shape (like an egg), and reinforced with Metal Edges to insure strength, yet retain lightness in weight, is a wonder for safety and durability. It is so constructed that shocks from all sides are absorbed without injuring the Eggs. It is practically Egg-break proof, unless the Egg is cracked before shipping. This new Filler is recognized as a permanent fixture and thereby eliminates the necessity of replacement from time to time, making it both a money and time saver.

New Fillers will not fit our old model Crates.

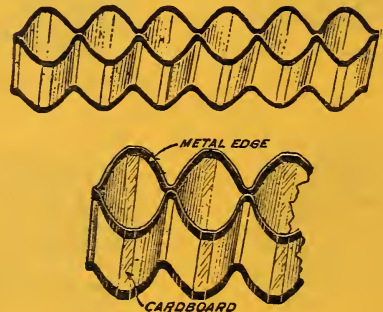

SIMPLEX WEATHERPROOF GARDEN LABELS



The card holder is made of special rust-proof, galvanized iron, electrically welded to an iron stake 24 inches long. The card is white Celluloid with special writing surface, protected by a transparent Mica cover. Beautifully finished in dark green, baked enamel of neutral shade. Designed to harmonize, and not unduly conspicuous.

Sizes	Price Each
No. 10—2 $\frac{3}{4}$ x1 $\frac{1}{2}$ inches.....	25 cents
No. 11—3 x 2 inches.....	30 cents

SIMPLEX CELLULOID POT LABELS



Made of white Celluloid with specially prepared writing surface. For indoor or greenhouse use in seed pans, pots, etc. Excellent for Orchids. These Labels are also marked with ordinary lead pencil. They are practically indestructible and most economical, as the marking may easily be erased and the Labels used over again as often as desired.

Sizes	Per Hundred
No. 20—3x $\frac{1}{2}$ inches	\$1.35
No. 21—4x $\frac{5}{8}$ inches	1.95
No. 22—5x $\frac{3}{4}$ inches	3.00
No. 23—6x1 inches	5.25
No. 24—7x1 $\frac{1}{4}$ inches	7.20
No. 25—8x1 $\frac{1}{2}$ inches	10.20

BURNETT BROTHERS, Inc.

Seedsman

92 CHAMBERS STREET
NEW YORK CITY

SIMPLEX WEATHERPROOF LABELS

Preserve the names of valuable Roses, Dahlias, Gladiolas, Evergreens, and all other plantings you make. Ordinary labels, which come on the plants, roots or bulbs, are soon destroyed by the weather and the names lost, perhaps forever. Simplex Weatherproof Labels are permanent and keep those names for your future enjoyment and that of your friends. The educational value of this for children cannot be over-estimated. Increased knowledge leads to greater interest in the garden. Intimacy with growing things stimulates the love of nature, — one of the finest influences for the young.

SIMPLEX WEATHERPROOF PLANT LABELS WITH COPPER WIRES

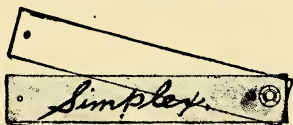

Made of white Celluloid with specially prepared marking surface. The writing, done with ordinary lead pencil, is protected by a transparent cover of Mica, and is not affected by the weather. It will last indefinitely but may be instantly erased whenever desired and the Labels used repeatedly, making them very economical. Mica is used for the protecting cover because it is permanent, and it differs from transparent Celluloid, which does not stand up under constant exposure, but soon deteriorates. The white Celluloid, however, on which the writing is done, is impervious to the elements, and will last indefinitely. Indelible pencil or ink should not be used for marking.

Simplex Weatherproof Labels have been in use for more than 12 years. They are highly esteemed by gardeners everywhere. The pencil marking is very distinct,—black lettering in contrast with white Celluloid.

Prices, Including Copper Wires for Attaching

Sizes	Per Hundred
No. 1— $3 \times \frac{1}{2}$ inches	\$3.00
No. 2— $4 \times \frac{3}{4}$ inches	5.00
No. 3— 5×1 inches	7.00

The No. 1 and No. 2 sizes are packed in boxes of 100. The No. 3 size in boxes of 50.

DUSTERS

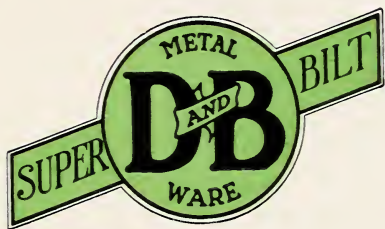

Durable and Dependable



BURNETT BROS. INC.,
Seedsman
92 Chambers Street
New York

No. 100 D&B Superbilt Duster

Simple—Substantial—Effective

EASY TO OPERATE

Without doubt this is the most simple and easy operating Duster of its kind on the market. Light in weight, well balanced and supported over shoulder



The No. 100 D&B Superbilt Duster is best suited for low-growing crops such as Potatoes, Beans, Tomatoes, Cabbage, Berries, Melons, Tobacco, Cotton, etc. It can also be used effectively on shrubs and small trees.

EASY ACCESS TO PARTS

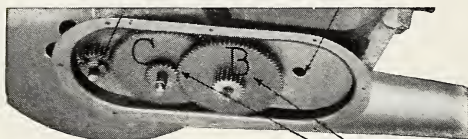

by heavy web strap.

Dial indicator with graduating figures makes possible quick and accurate adjustment for regulating the flow of powder from hopper. It is possible for operator to set the indicator for any definite amount of dust desired.

Distributes the dust uniformly. The powerful air blast produced by the fan breaks up the powder into a fine dust cloud, instantly covering all parts of the plant. The agitator and feeding mechanism are made strong enough to break up all hard lumps of powder without injury to any parts of the Duster.

Comes complete with attachments for dusting one or two rows. Elbows, pipes and wide spreading nozzles can be adjusted to direct dust cloud in many directions.

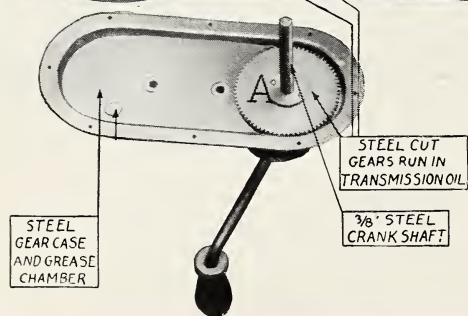

APPROVED BY AGRICULTURAL EXPERIMENT STATIONS.

PENNSYLVANIA UNDERCUT

BALL BEARING TRIMMER

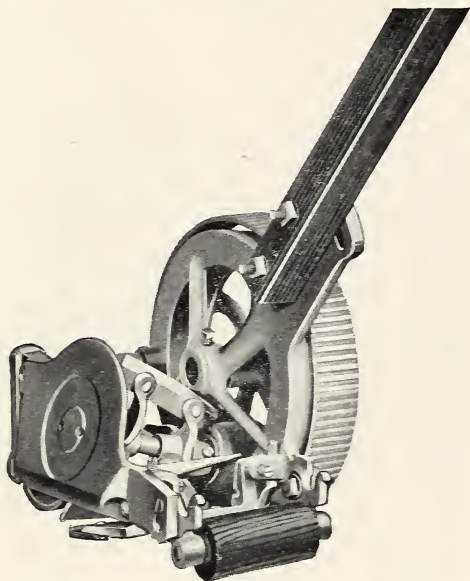



Dusting Potatoes—Two Rows at Once

Construction

Duster is made of heavy sheet steel, lead coated and painted. Gears are of steel, machine cut and enclosed in dust-proof case packed with grease. Bearings are self lubricating and need very little attention. Working parts are well protected but easy to get at.

Description

Capacity 2 to 5 lbs., depending on powder used.

Length without fittings, 20 inches.

Height, 13 inches.

Equipment consists of four 15-inch Pipes, one Branch Connection, two Elbows and two Nozzles.

Packed one in a box.

Net weight with fittings, 8 lbs. Shipping weight, 14½ lbs.

Can be shipped by Freight, Express or Parcel Post.



PENNSYLVANIA UNDERCUT

BB TRIMMER

THE unique construction of the undercut trimmer permits cutting, not only close up to a wall, fence, tree, etc., but it *will get the grass under a fence* or rock-cut base of tombstones, house foundations and other places hitherto out of reach of anything but hand shears. The slanting side plate and conical cylinder make it possible to cut all grass left by the regular style of lawn mower. For cemeteries it has the special advantage of not *marking* or *smudging* the tombstones as the side plate does not come in contact with the stone above the grass line.

It is fitted with the STAYTITE HANDLE, with adjustable steel clamps to take up any possible shrinkage.

9½-inch Drive Wheel. Four-Blade Cylinder.

Width of Cut.....5½ inches
Weight, Boxed, inc. Handle.....35 lbs.
Net Weight.....23½ lbs.

BURNETT BROS., Inc.
92 Chambers St., New York City

	Pkt.
Achimenes. G. P. Easily grown bulbous stove plants which may be given the same treatment as Gloxinias. The flowers are of the richest and most varied colors. Choice Mixed25
Aconitum. (Monk's Hood.) H. P. 4 ft.	
Napellus. Blue and white.....	¼ oz. \$1.00, .15
pyramidatum. Blue.....	¼ oz. \$1.00, .15
Wilsonii. Light blue.....	.25
Acroclinium H. H. A. Everlasting flowers. 1 ft.	
Double. Pure white.....	¼ oz. 35c., .10
Double. Bright rose.....	¼ oz. 35c., .10
Finest Mixed	¼ oz. 25c., .10
Adlumia cirrhosa (Mountain Fringe). H. A. 15 ft. White.....	.15
Adonis æstivalis. H. A. Green foliage, with scarlet flowers. 1 ft.....	.10
Aethionema grandiflorum. H. P. A very elegant plant which succeeds well on the rockery. The clear-colored rosy flowers, produced in long racemes, continue in beauty from May to August. 12 to 18 in.50
Agatheæ cœlestis (Blue Daisy). H. H. P. Flowers sky-blue with yellow disk.....	.15
Agrostemma coronaria. H. P. (Rose Campion.) Dark blood-red. 2 ft.	
coronaria alba. White.....	¼ oz. 50c., .10
cœli-rosa. H. A. Free flowering with bright rose flowers. 18 in.....	¼ oz. 50c., .10
Ageratum. H. H. A. Blooms throughout out the entire Summer and Fall. 1 ft.	
Dwarf Blue	¼ oz. 50c., .10
Dwarf White	¼ oz. 50c., .10
Swanley Blue	¼ oz. 50c., .10
BLUE PERFECTION. Finest blue bedding variety.....	¼ oz. 50c., .15
Princess Victoria Louise. Light blue with white center.....	¼ oz. 75c., .15
LITTLE BLUE STAR. Compact, very free flowering.....	½ oz. \$1.50, .25
Allwoodii. H. P. This new race of hardy plants belongs to the Dianthus family; exceptionally hardy, commencing to flower in early Spring, and continues through the Summer and Autumn.....	.50
Alpinus. Eminently suitable as rock and alpine plants. Height about 6 inches. Colors, chiefly pink, white and purple shades. Very free flowering.....	.50
Alonsoa warscewiczii compacta. H. H. A. Bright scarlet, fine for pots and for bedding; 12 ins.....	.15
Alstroemeria chilensis. H. P. Extremely attractive in the garden and of great service for cutting. Spotted Lily-like flowers of various shades of pink, rose, red and yellow. Height 2 to 3 feet. Mixed colors50
Alyssum. H. A. A very pretty border plant, valuable for beds, edgings and rock-work. Blooms the entire Summer.	
odoratum (Sweet-Scented). White flowers. ½ ft.	Oz. 50c., .10
LITTLE GEM. Of dwarf, compact habit 3 to 4 in. high.....	Oz. 75c., .10
CARPET OF SNOW. Pure white, grows only 2 to 3 in. Splendid for carpet bedding.....	Oz. \$1.00, .10
Lilac Queen. Lilac flowers.....	Oz. \$1.00, .10
saxatile compactum. H. P. A pretty yellow-flowered variety. ¾ ft.....	¼ oz. 75c., .15



Alyssum, Carpet of Snow

	Pkt.
Amaranthus. H. H. A. Ornamental foliage plants.	
Burnett's Dazzler. The leaves are deep green and bronze, developing a brilliant head of dazzling carmine scarlet in late Summer and Fall.....	.50
caudatus (Love-Lies-Bleeding) 3 ft.	¼ oz. 35c., .10
cruentus (Prince's Feather). Scarlet.	¼ oz. 35c., .10
Molten Fire. Fiery crimson.....	¼ oz. \$1.00, .15
salicifolius (Fountain Plant). Leaves marked orange-carmine.....	¼ oz. 50c., .10
tricolor (Joseph's Coat). Leaves scarlet, yellow and green. 2 ft.....	¼ oz. 50c., .10
Ampelopsis veitchii. H. P. (Boston Ivy.) Useful for covering stone buildings, etc.10
Anagallis grandiflora (Pimpernelle). H. A. For rockwork or edging. 6 in. Mixed.....	.10
Anchusa capensis. H. A. Flowers resembling large Forget-Me-Nots.	
Blue Bird (Annual). See Novelties.	
italica (Dropmore Variety). H. P. This is a great improvement over existing varieties; rich blue.....	¾ oz. 75c., .25
Anemone. H. P. Beautiful Spring flowers, valuable for cutting.	
coronaria, Single De Caen15
St. Brigid. Poppy flowered.....	.25
japonica alba15
alpina. A lovely species for the rock garden. Flowers white tinted slaty blue. 1 ft.25
pulsatilla (The Pasque Flower). Large purple flowers with yellow anthers, covered with silky hairs on outside. 9 in.....	.25
Creagh castle (see novelties).	
Angelonia. grandiflora. A very sweetly scented greenhouse perennial, plants attain a height of 1½ to 2 feet, flowers pale lilac, white spotted.....	.25

ANTIRRHINUM (Snapdragon)

Very showy plants for the Summer garden; blooms the whole season. Splendid for beds or borders and one of our choicest cut flowers; extensively forced under glass during the winter.

To have flowers early, sow indoors during February or March, but even if sown outdoors early in May it will bloom in July.

Greenhouse Forcing Varieties

Seeds saved from selected spikes grown under glass.

	Pkt.
GENEVA PINK. Color, a delightful glistening rose-pink, borne in long dense spikes.	\$1.00
GOLDEN DELIGHT. Very fine golden yellow	1.00
JENNIE SCHNEIDER. Beautiful pink Columbia rose color	1.00
KEYSTONE. Fine Forcing Pink	.75
LAURA. (New.) Glossy, deep rose-pink with a snappy twinkle. Medium height, thin, dark foliage, heavy flower head, averaging eleven inches, with large, closely set blooms	2.00
NELROSE. Beautiful coral-pink. A splendid variety for greenhouse growing	.50
ORLANDO. Lovely bronze	1.00
PENN-ORANGE. A vivid orange, decidedly more striking than any other variety in the bronze class. Upright and vigorous growth, excellent keeper	2.00
PHELPS' WHITE. Undoubtedly the best white. Fine for forcing	.75
PHILADELPHIA PINK. Popular pink	1.00
SILVER PINK. A most pleasing color. Soft pink, with silvery sheen	1.00
WHITE ROCK. Extra early pure white	1.00

Maximum Types (New)

This new group of Antirrhinums far surpasses anything yet introduced. In habit they are slightly taller than the Majus varieties.

	Pkt.
CATTLEYA, rosy lilac	.25
COPPER KING, velvety scarlet	.25
DIAMOND, yellow, lilac throat	.25
OLD GOLD, deep golden yellow	.25
PURPLE KING, deep glowing purple	.25
SNOWFLAKE, white, yellow tube	.25
THE ROSE, rose-pink	.25
WALLFLOWER, brownish orange	.25

Collection of above 8 colors \$1.75.

Majus Grandiflorum

Tall, Large Flowering Type

	Pkt.
HARMONY. Color rich terra cotta orange, shaded with rose and merging into golden yellow at the center	.25
CRIMSON KING. Beautiful rich crimson, very large flower	.25
FELTHAM BEAUTY. Deep rose pink, white center, very large flower	.25
TORCHLIGHT. Vivid orange with yellow center, slightly tinted with carmine	.25
SNOW QUEEN. Very large, white	.25
VENUS. A lovely pink shade on white ground, with pure white throat	.25
Collection, 1 Pkt. each, above 6 colors, \$1.25.	
Separate Bedding Colors. White, rose, scarlet, yellow	Each 1/4 oz. 50c.,
Mixed Colors	1/4 oz. 50c., .10



Antirrhinum, Majus Grandiflorum

(Continued on next page)



Aquilegia, Giant Long-Spurred

ANTIRRHINUMS—Continued

Nanum Grandiflorum

Dwarf, Large Flowering Type

MAIZE QUEEN. Beautiful salmon maize, with yellow lips.....	Pkt.	
EMPRESS. Rich, velvety crimson; early blooming25
PRIMA DONNA. Terra cotta, pink and yellow25
PURITY. Pure glistening white.....		.25
WILD ROSE. Fine light pink, white throat25
YELLOW BEAUTY. Fine rich yellow.....		.25
Collection, 1 Pkt. each, above 6 colors, \$1.25.		
Separate Bedding Colors. White, rose, scarlet, yellow..... Each ¼ oz. 75c.,		.15
Mixed Colors	¼ oz. 75c.,	.10

For plants of Greenhouse Forcing varieties, see page 75.

Anthemis montana, pretty small flower, like a White Chrysanthemum. Height, 6 in. Excellent perennial border plant. ¾ oz. 75c.,	.15
Tintoria Kelwayi. Improved strain, with bright yellow, Daisy-like flowers. June to September. 1½ ft. ½ oz. 50c.,	.15

Aquilegia (Columbine). H. P. A most desirable border plant, blooms from May to July. 1½ to 3 ft. Pkt.	
LONG SPURRED BLUE SHADES ¼ oz. \$1.50,	.25
LONG SPURRED PINK SHADES ¼ oz. \$1.50,	.25
LONG SPURRED MIXED ¼ oz. \$1.50,	.25
MRS. SCOTT ELLIOTT'S CELEBRATED STRAIN. A renowned English strain, which enjoys a world's reputation for the greatest array of colors. ¼ oz. \$2.00,	.50
alpina. A charming Alpine species with large and beautiful blue flowers. 1 ft.25
canadensis. Scarlet and yellow, ¼ oz. \$1.50,	.15
chrysantha, Long spurred. Bright yellow, 2 ft. ¼ oz. \$1.50,	.15
cœrulea. Blue. ¼ oz. \$1.50,	.25
cœrulea "Rose Queen" A long-spurred variety. The flowers are light to dark rose with white centers and yellow anthers25
Copper Queen. Copper red with long spurs of a darker hue50
Single Mixed	¼ oz. 75c., .10
Double Mixed	¼ oz. \$1.00, .15
Collection of 6 varieties, 75c.	

Arabis alpina (Rock Cress). White H. P. 6 in. ¼ oz. 50c.,	.15
---	-----

Aralia sieboldii. An elegant greenhouse plant, with broad, glossy, green leaves....	.25
--	-----

Arctotis grandis. White and yellow. Fine for cutting. H. A. 2 ft. ¼ oz. 50c.,	.10
---	-----

Arenaria cœpitosa. H. P. Easily grown dwarf rock plant, bright green foliage, studded with tiny white flowers, from May to July.....	.25
---	-----

grandiflora. H. P. One of the most effective rock plants, of trailing habit, producing large pure white flowers in Spring. 6 in.25
--	-----

montana. H. P. One of the best of rock plants; it forms mounds of foliage which are covered with white flowers. 8 in.25
---	-----

Aristolochia siph (Dutchman's Pipe). A very attractive ornamental climber, flowers resembling the pitcher plant.....	.15
---	-----

Armeria formosa. H. P. (Sea Pink). Lavender Pink10
---	-----

formosa gigantea. Taller than the preceding15
--	-----

Ruby. Forms neat tufts of evergreen foliage, flowers, 2 ft. high, of a brilliant shade of bright rose pink25
---	-----

Artemisia saccorum viridis (Summer Fir). H. A. A light and elegant foliage plant which forms pyramidal bushes from 3 to 5 feet in height of a deep green color25
---	-----

Asclepias curassavica. G. P. Very useful and showy plant for indoor and greenhouse decoration. Flowers reddish orange-scarlet, borne in large clusters25
---	-----

Asparagus plumosus nanus. G. P. This graceful climbing Asparagus has foliage finer than that of the most delicate fern. 100 seeds \$1.00,	.25
--	-----

Sprengeri. A graceful drooping variety, for hanging baskets.....100 seeds 50c.,	.15
--	-----

Asperula odorata (Sweet Woodruff). H. P. Grown for its fragrant leaves; flowers white. 1½ ft.15
---	-----

Azurea setosa. Excellent for cutting; flowers blue. 9 in.10
---	-----

BURNETT'S BEAUTIFUL ASTERS

THE Aster is today the most popular of all Summer and Autumn flowering plants. We take special care to secure the best stocks, true to name and color, without regard to cost. For best results the ground cannot be too richly prepared. Plants from seed sown in the open ground in May will bloom in September and October. For July and August flowers, sow in March or April, in coldframes or hotbeds. We especially recommend the following as being the best for cutting and general garden use.

BURNETT'S GIANT BRANCHING

These are, without doubt, the finest Asters grown for late use. The plants are of vigorous growth and covered with large, long-stemmed flowers, graceful and feathery in effect. 3 feet.

	¼ oz.	Pkt.
Azure Blue. Rich lavender.....	\$0.75	\$0.15
Deep Crimson. Rich and glowing.....	.75	.15
Deep Rose. Distinct and fine.....	.75	.15
Pale Lavender. Exquisite greyish-blue.....	.75	.15
Deep Purple. A rich royal shade.....	.75	.15
Rose Pink. A lovely shade.....	.75	.15
Shell Pink. Soft and dainty.....	.75	.15
Pure White. Perfect in its purity.....	.75	.15
Finest Mixed. All colors.....	.60	.10

Collection: 1 Pkt. each above 8 colors, \$1.00.

AMERICAN BEAUTY ASTERS

This beautiful variety is beyond doubt one of the grandest sorts in cultivation. It is of the Late Branching type, growing from 2 to 2½ feet high. The flowers are large and full with incurved petals.

	¼ oz.	Pkt.
Lavender Beauty. Lavender.....	\$1.00	\$0.25
September Beauty. Flesh pink.....	1.00	.25
Purple Beauty. Violet-purple.....	1.00	.25
Carmine Beauty. Carmine rose.....	1.00	.25
Crimson Beauty. Crimson.....	1.00	.25
White Beauty. Pure White.....	1.00	.25
Finest Mixed.....	.75	.20

Collection, 1 Pkt. each, above 6 colors, \$1.25.

BURNETT'S GIANT CREGO ASTERS

These are the finest Asters for cut flowers, growing 2 feet high, well branched, of sturdy growth.

	¼ oz.	Pkt.
White.....	\$1.00	\$0.15
Rose.....	1.00	.15
Light Pink.....	1.00	.15
Lavender.....	1.00	.15
Crimson.....	1.00	.15
Purple.....	1.00	.15
Finest Mixed.....	.75	.10

Collection 1 Pkt. each above 6 colors, 75c.

THE THREE GEMS

The plants of these three beautiful Asters grow about 2 feet high, are of bushy, branching habit.

	¼ oz.	Pkt.
Purity. Glistening White.....	\$1.00	\$0.25
Daybreak. Seashell pink.....	1.00	.25
Sunset. Delicate light pink, shading to deep, rich pink in center.....	1.00	.25

Collection above 3 colors, 60c.

BURNETT'S CALIFORNIA GIANTS

The flowers are much larger than the Improved Crego, measuring 5 to 6 inches in diameter, and are unsurpassed as cut flowers. Their immense size and beauty, as well as their long and sturdy stems, make them very attractive, and they will deserve their name.

	¼ oz.	Pkt.
Peach Blossom.....	¼ oz. \$1.50,	\$0.25
Light Blue.....	¼ oz. \$1.50,	.25
Deep Rose.....	¼ oz. \$1.50,	.25
Dark Purple.....	¼ oz. \$1.50,	.25
Light Purple.....	¼ oz. \$1.50,	.25
White.....	¼ oz. \$1.50,	.25
Finest Mixed.....	¼ oz. \$1.25,	.20

Collection, 1 pkt. each above 6 colors, \$1.25.

BURNETT'S JAPANESE ASTERS

The finest of all early flowering Asters; the plants grow tall and branching, bearing flowers of immense size on exceedingly heavy, long stems. Flowers measure 6 to 8 inches in diameter, and rival the finest Chrysanthemums. Unequaled for cutting. 2 feet.

	¼ oz.	Pkt.
Pure White, Rose, Dark Blue, Light Blue, Crimson, Scarlet.....	Each ¼ oz. 75c.,	\$0.15
Finest Mixed.....	¼ oz. 60c.,	.10

Collection of 6 separate colors, 75c.



Aster, Burnett's Giant Branching

BURNETT'S BEAUTIFUL ASTERS

ROYAL ASTERS

A very desirable early class developed from the American Branching, but blooming a little later than the Queen of the Market. 2 feet.

	¼ oz.	Pkt.
Lavender	\$0.75	\$0.15
Shell-Pink75	.15
Purple75	.15
Rose75	.15
Deep Rose75	.15
White75	.15
Mixed Colors60	.15

Collection, 1 Pkt. each above 6 colors, 75c.

KING ASTERS

A distinct class of Asters, having long, sturdy stems. The flowers are of great size and beautifully quilled.

	¼ oz.	Pkt.
Lavender King	\$1.00	\$0.15
Pink King	1.00	.15
Violet King	1.00	.15
White King	1.00	.15
Rose King	1.00	.15
Crimson King	1.00	.15
Finest Mixed75	.10

Collection: 1 pkt. each, above 6 colors, 75c.

Heart of France

Plants grow about 24 inches high, nicely branched, bearing in September large, deep ruby-red flowers on long stems.

¼ oz. \$1.25, pkt. 15c.

Queen Of The Market

The earliest flowering Aster, coming into bloom in July. The flowers are of good size and borne on long stems, making them exceedingly valuable for cutting.

Lavender, Crimson, Pink, Purple, White, Rose	Each, ¼ oz.	75c., \$0.15
Mixed Colors	¼ oz.	60c., .10

Collection of 6 colors, 75c.

Early Dawn

This is one of the earliest Asters of the Ostrich Plume type, coming into flower even earlier than Queen of the Market. As a pure white, there is nothing to surpass it for earliness.

¼ oz. \$2.00, pkt. 25c.

Enchantress Pink

A vigorous, upright grower, producing a profusion of extra strong flowering stems, carrying very large, graceful flowers of the branching type, the color being a beautiful delicate shade of pink which does not fade. ¼ oz. \$1.25, pkt. 25c.

White Perfection

The finest mid-season white Aster in cultivation. The flowers are 4 inches in diameter, exquisite in form. The plants are taller growing than the late upright Asters.

¼ oz. \$1.25, pkt. 25c.



Aster, California Giant

Peach Blossom

A large flowering, late-branching variety, very pleasing shade of deep lavender pink. Stems are very strong and hold the flowers erect at all times.

¼ oz. \$1.25, pkt. 25c.

Single Elegance

The plants are strong and vigorous growers, of pyramidal habit, very free blooming, and produce strikingly beautiful single flowers on long, slender stems. Exceedingly beautiful for cutting.

White, Light Blue, Dark Blue, Rose, Pink, Crimson.

Finest Mixed

Each, ¼ oz. 60c., pkt. 15c.

Collection 1 pkt. each above 6 colors, 75c.

Sunshine

A distinct new type of Single Asters, flowers crested with quilled golden-yellow centres. Excellent for decorative purposes.

Pink, lilac, white, flesh, blue, mixed.

Each ¼ oz. \$1.25, pkt. 25c.

Astermums

Lavender. A rich shade of lavender.....	¼ oz.	Pkt.
Pink. Attractive shade of lively rose-pink	\$1.00	\$0.15
White. Purest snow-white	1.00	.15
Finest Mixed	1.00	.15
Finest Mixed75	.10

For Hardy Perennial Asters see next page.

PERENNIAL VARIETIES

- Aster.** H. P. *alpinus Goliath.* A charming little Alpine, 6 inches high, producing in July dainty lilac flowers with golden centres. \$0.25
- alpinus, Nancy Perry.* A very fine variety with lavender-blue ray florets slightly incurved and golden centre, 6 in.25
- subcœruleus.* A Himalayan species of compact habit, bearing deep blue flowers. Easily raised from seed25
- Farreri.** H. P. A lovely soft tone of violet-mauve, greatly enhanced by a large golden-orange disc. Flowers are from 2½ to 3 inches across and each plant carries twenty to thirty on long stiff stems. 2 to 3 ft. May-June35
- Hardy Mixed** (Michaelmas Daisy). Fall-flowering, splendid for cutting. ¼ oz. \$1.0015
- Aubrietia.** H. P. Excellent for rock-work and edging, thrives well in almost any soil, 9 inches.
- graeca.* Purple; trailing25
- hendersoni.* Large rich purple flowers, a very fine variety25
- leichtlini.* A charming variety, with very bright rosy crimson flowers25
- large flowered hybrids.* Exceptionally fine colors25
- purpurea.* Purple25
- violet queen.* Dark violet, large flowers, very distinct variety25
- Auricula (PRIMULA auricula).** H. H. P. A well-known favorite; choice mixed25
- Balloon Vine.** H. H. A. A rapid growing climber, with small, white flowers. Oz. 30c.,10



Begonia, Double-Flowered

- Balsam.** (Lady's Slipper.) H. H. A. Among the finest Summer blooming annuals. They are very showy and easily grown, succeeding best in sunny situations. 1 to 1½ ft. Pkt.
- Double Camellia-Flowered**
- | | |
|-------------------|-----------------|
| Pure White | Lilac |
| Crimson | Primrose |
| Rose | Scarlet |
- All the above ¼ oz. 50c., .15
 Mixed ¼ oz. 50c., .10
Collection 6 varieties, 75c.
- Double Rose-flowered Mixed** ¼ oz. 50c., .10
Collection 6 varieties, 75c.
- Baptisia australis.** H. P. Producing spikes of pea-shaped blue flowers. 2½ ft.10
- Bartonia aurea.** H. A. Flowers large golden yellow. 1½ ft. ¼ oz. 30c., .10
- Begonia.** (Tuberous Rooted.) H. H. P.
- Blackmore and Langdon's Superb Strain.** This superb strain of Double and Single Begonias surpasses all other European introductions.
- Double Mixed**75
Single Mixed50
Single Frilled Mixed50
- Begonia.** (Fibrous-Rooted.) H. H. P.
- Gracilis, Prima Donna.** Carmine rose; brown tinted foliage.25
- Gracilis, Luminosa.** Brilliant, dark scarlet; very effective25
- Semperflorens Salmon Queen.** Brilliant, salmon red; foliage russet crimson25
- Semperflorens "Rosabelle"** (New). This attains a height of 6 inches and perfectly uniform in habit. Color, deep rose pink, large blooms and extremely floriferous50
- Semperflorens Erfordii.** Rosy carmine, green foliage 1/32 oz. \$4.00, .25
- Semperflorens alba.** Pure, glistening white25
- Semperflorens magnifica.** Dark bronze foliage, with bright crimson flowers very striking bedding or pot plant25
- Semperflorens "Vernon."** Red flowers, bronze foliage 1/16 oz. \$2.00, .25
- Begonia Bulbs.** See page 78.
- Bellis.** Double Daisy. H. P. Beautiful Spring flowers, suitable for edging. ½ ft.
- MONSTROSA, Giant White** ¼ oz. \$1.50, .25
MONSTROSA, Giant Rose ¼ oz. \$1.50, .25
MONSTROSA, Giant Mixed ¼ oz. \$1.50, .25
Longfellow, Double Rose ¼ oz. \$1.00, .15
Snowball, Double White ¼ oz. \$1.00, .15
Double Mixed ¼ oz. \$1.00, .15
- Blue Lace Flower.** See Didiscus.
- Bocconia japonica.** H. P. (Plume Poppy.) Flowers, creamy white. 4 ft.15
- Boltonia Asteroides.** H. P. Showy perennials, closely resembling Hardy Asters, flowers pure white. August and September. 6 ft.25
- Latisquama.** Flowers pink, tinged with lavender. August and September. 6 ft. .25
- Brachycome iberidifolia** (Swan River Daisy). H. H. A. For baskets and edging. 8 in.
- Blue, White** Each, ¼ oz. 50c., .15



Calendula, Orange King Improved

- Calendula.** (Pot Marigold). H. A. One of the best free flowering hardy annuals; excellent for beds or mixed borders, continuing in bloom until killed by frost. 1 ft. Pkt.
- "THE BALL."** Bright glowing orange, uniformly double, extra long stems, excellent for forcing..... $\frac{1}{4}$ oz. \$1.00, .25
- MONARCH.** Of great size and intense doubleness. Color purest orange. $\frac{1}{4}$ oz. \$1.00, .25
- Sensation** (Camp Fire). See novelties.
- Lemon Queen.** Lemon-yellow.....Oz. 50c., .15
- ORANGE KING, Improved.** Dark golden orange..... $\frac{1}{4}$ oz. 50c., .15
- Meteor.** Double yellow, striped.....Oz. 50c., .10
- Prince of Orange.** Similar to "Meteor," but much darker.....Oz. 50c., .15
- Calliopsis.** H. A. Charming Summer flowering plants. Sow in the open ground in Spring, giving the plants plenty of room to spread. 1 $\frac{1}{2}$ ft.
- "Evening Star."** Plants are densely covered with large, bright yellow flowers with a zone of deep scarlet..... .25
- Crimson King.** Forms a perfect little bush covered with rich dark crimson flowers, 6 to 7 inches.....Oz. 75c., .15
- atrosanguinea.** Velvety crimson.....Oz. 75c., .10
- tinctoria.** Yellow and brown.....Oz. 75c., .10
- radiata tigrina** (Tiger Star). Rich bronze, striped and mottled yellow.....Oz. 75c., .15
- Drummondii** (Golden Wave). Yellow with maroon center.....Oz. 75c., .10
- Dwarf Mixed**.....Oz. 75c., .10
- Tall, Finest Mixed**.....Oz. 75c., .10
- Callirhoe involucrata** (Poppy Mallow.) H. P. A showy, trailing perennial, bright crimson saucer-shaped flowers..... .15
- Campanula** (Bellflower). H. P. Well known, beautiful, hardy herbaceous plants, bearing large, bell-shaped flowers in great profusion. Fine for borders.
- MEDIA Single.** (Canterbury Bells.)
Blue, White, Rose, Mauve, $\frac{1}{4}$ oz. 50c., .10
 $\frac{1}{4}$ oz. 50c., .10
- Fine Single Mixed**..... $\frac{1}{4}$ oz. 50c., .10
- MEDIA Double.** (Canterbury Bells.)
Blue, White, Rose.....Each, $\frac{1}{4}$ oz. \$1.00, .15
Double Mixed..... $\frac{1}{4}$ oz. 75c., .15
- CALYCANTHEMA** (Cup and Saucer). The flowers are large, of a beautiful shape, resembling a cup and saucer. 2 ft.
- Blue, Rose, White**.....Each, $\frac{1}{4}$ oz. \$1.00, .15
- Mixed.** All colors..... $\frac{1}{4}$ oz. 75c., .15
- Collection of 6 varieties, including Calycanthema, 75c.**
- pyramidalis** (Chimney Bell). Very conspicuous towering spikes.
White and Blue.....Each, $\frac{1}{4}$ oz. 75c., .15
Mixed..... $\frac{1}{4}$ oz. 75c., .10
- persicifolia, Telham Beauty.** Very large flower, china-blue. 2 ft..... .50
- persicifolia grandiflora.** Large flowers.
White and Blue.....Each, $\frac{1}{8}$ oz. \$1.00, .25
Mixed..... $\frac{1}{8}$ oz. \$1.00, .25
- Dwarf Campanulas for Rock Work.**
Extremely interesting subjects for carpeting, edgings and covering rockeries and old walls. The following comprise some of the best for above purposes.
- carpatica.** Blue, showy. 1 ft..... $\frac{1}{4}$ oz. 50c., .10
- carpatica alba.** White. 1 ft..... $\frac{1}{4}$ oz. 50c., .10
- Garganica.** A pretty trailing species, pale blue flowers with white centers, easily grown rock or wall plant. 4 inches..... .25
- Mirabilis.** A most beautiful species from the Caucasus, large pale blue flowers, fine rock garden plant, 3 in..... .25
- Browallia.** H. H. A. Profuse blooming plants, growing freely in any rich soil. 1 $\frac{1}{2}$ ft. Pkt.
- elata grandiflora.** Sky-blue..... $\frac{1}{4}$ oz. 50c., .10
- speciosa major.** Clear blue......25
- Viscosa.** Bright violet blue......25
- Calacia aurea.** H. A. Small tassel-like blooms of golden yellow..... $\frac{1}{4}$ oz. 50c., .10
- coccinea.** Dense heads of scarlet flowers. $\frac{1}{4}$ oz. 50c., .10
- Calandrinia Grandiflora.** H. A. A very attractive hardy annual with fleshy leaves and bright rose colored flowers. 18 in..... .15
- Umbellata.** H. P. Dwarf shrubby trailing habit, flowers bright rosy crimson, useful in the rock garden or border..... .15
- Choice Mixed**......10
- Calceolaria.** G. P. An ornamental plant, with beautiful, pocket-like flowers; universally admired for decorating the greenhouse or conservatory. The strains we offer can be relied upon to produce flowers of the largest size and most brilliant colors.
- BURNETT'S SUPERB STRAIN MIXED**..... 1.00
- Clibrani.** A most beautiful decorative plant for cool greenhouse. It is of shrubby habit, strong and vigorous in growth, produces an abundance of beautiful lemon-yellow flowers..... .50
- rugosa Mixed.** Well-known bedding variety..... .50
- Albert Kent.** Bright golden yellow with maroon blotch. Immense trusses..... .50
- Albert Kent Hybrids.** Many vivid colorings..... .50

DWARF CAMPANULAS—Continued

	Pkt.
Fusilla. A charming dwarf Harebell, forms tufts of foliage, covered with dainty flowers in various shades of blue, 3 in.	.25
RAINERI. Forms creeping masses of dark green foliage, covered with a profusion of saucer-shaped, pale blue flowers. A charming plant for the rock garden. 4 in.	.50
Rotundifolia (Scottish Blue Bell). A graceful plant, with slender, branching stems. Flowers pale blue and bell-shaped	.25
Turbinata. Tufts of neat foliage, and erect, deep blue, cup-shaped flowers. 6 inches.	.25
Special collection, 6 varieties, for Rock Gardens, \$1.50.	

Candytuft. H. A. Is one of the best flowers for edging, bedding or massing, for rockeries and cutting. Sow in April and again in July for Fall flowers. 1 ft.

Crimson	Oz. 75c.,	.10
EMPRESS. Pure white.....	Oz. \$1.00,	.10
GIANT HYACINTH FLOWERED. White.		
	Oz. \$1.50,	.15
Lilac. Compact, dwarf.....	Oz. 75c.,	.10
ROSE CARDINAL. Bright rose.....	Oz. 75c.,	.10
White Rocket. Large white.....	Oz. 50c.,	.10
Finest Mixed	Oz. 50c.,	.10
Perennial Candytufts.		
sempervirens. White.....	1/8 oz. 75c.,	.15
gibraltarica. Blush white.....	1/4 oz. 75c.,	.15

Canna (Indian Shot).

Crozy's Large Flowering. Dwarf mixed.	
	Oz. 75c., .10

Cardinal Climber or **Scarlet Queen**

Cypress Vine. This new hybrid Cypress Vine is one of the most beautiful climbing annuals. Foliage rich, glossy green, brilliant scarlet tubular flowers, 1 to 1 1/2 in. across. It grows about 20 ft. in height..... 1/4 oz. 75c., .15

Catananche caerulea. H. P. Beautiful blue flowers. June to August. 2 ft..... .15

Catchfly (Silene Armeria). A showy, free flowering hardy annual. 1 1/2 ft.10

Carnation. H. H. P. General favorites for their delicious fragrance and richness of colors. They are indispensable both for greenhouse culture in Winter and for the Summer garden. 18 in.

CHABAUD PERPETUAL, Giant Ever-blooming. About two weeks later than Marguerite, producing large, double flowers.

Finest Mixed..... 1/8 oz. 75c., .25
ENGLEMAN'S GOLD MEDAL. Have the perfect formation of the Greenhouse carnations, but slightly smaller and more prolific. Splendid assortment of colors; fine for cutting..... 1.00

Early Dwarf Vienna. Same type as the Grenadin. **Choice Mixed**..... 1/4 oz. \$1.00, .25

Grenadin. Bright scarlet; dwarf. 1/4 oz. \$1.00, .25

Grenadin White. Pure white, dwarf. 1/4 oz. \$1.00, .25

Hardy Border Double Mixed. A good hardy strain for outdoor culture, flowering the second season and producing a mass of flowers in a great variety of colors. 1/4 oz. \$1.00, .15

Giant Marguerite. Perpetual flowering. **Scarlet, White, Pink, Yellow,** Each, 1/8 oz. \$1.00, .15
Giant Mixed..... 1/4 oz. \$2.00, .10

(See also Dianthus and Allwoodii.)



Carnation Engleman's Gold Medal

CELOSIA

CRISTATA (Crested Cockscomb). H. H. A. Highly ornamental plants, producing crested heads of flowers, resembling a cock's comb. 1 ft.

Golden Beauty. Golden yellow.....	1/8 oz. \$1.00,	.15
Empress. Bright crimson.....	1/8 oz. \$1.00,	.15
Glasgow Prize. Crimson.....	1/8 oz. \$1.00,	.15
Queen of Dwarfs. Dark rose-colored		
	1/8 oz. \$1.00,	.15
Fine Dwarf Mixed	1/4 oz. \$1.00,	.10

Collection of 6 varieties 75c.

PLUMOSA (Feathered Cockscomb). H. H. A. Showy plants, producing spikes of beautiful feathery-looking flowers. 3 ft.

Thomsoni magnifica. White, Scarlet, Crimson, Yellow, Purple.....	Each, 1/4 oz. \$1.00,	.15
Finest Mixed	1/4 oz. 75c.,	.10

Collection of 6 varieties 75c.

PRIDE OF CASTLE GOULD. This Austrian Plume Celosia is an entirely distinct type of pyramidalis plumosa and surpasses by far anything yet placed on the market. The colors range from blood red, carmine, golden yellow, salmon, deep scarlet, orange and wine red.

Mixed colors only..... 1/8 oz. \$1.00, .25

spicata. Bright rose, turning to silvery white..... .15

CHILDSII (Chinese Woolflower). This attractive variety grows about 2 ft. high, bearing long brilliant flowers.

Crimson, Pink, Yellow or Mixed Each, 1/4 oz. \$1.00, .15

Celsia arcturus. G. P. Fine spikes of bright yellow flowers..... .25



Centaurea Imperialis (Sweet Sultan)

- Centaurea** (Cornflower). H. A. These old-fashioned flowers represent the best and most beautiful Summer blooming plants.
- | | | |
|---------------------------------|-------------------|-----|
| CYANUS Single Blue | ¼ oz. 30c., | .10 |
| Single Mixed | Oz. 50c., | .10 |
| Double Blue, Rose, White | Each, ¼ oz. 50c., | .15 |
| Double Mixed | Oz. 75c., | .10 |
- IMPERIALIS, Giant Sweet Sultan.** The finest of all Sweet Sultans for cut flower purposes.
- | | | |
|---|-------------------|-----|
| Lilac, White, Pink with White Center, Purple, Rose | Each, ¼ oz. 50c., | .15 |
| Finest Mixed. All colors | ¼ oz. 30c., | .10 |
- suaveolens, Yellow Sweet Sultan.** Fine for cutting..... ¼ oz. 50c., .10
- Margaritæ.** Pure white, 2½ in. across, lacinated and delightfully scented. ¼ oz. 50c., .10
- Americana.** Lilac-purple..... ¼ oz. 60c., .15
- Montana** (Perennial Cornflower). Grows 2 feet high, bearing large, violet-blue flowers from July to September..... .20
- Montana alba.** Large, white form of the above..... .20
- White-Leaved Varieties.**
- | | | |
|---|---------------|-----|
| gymnocarpa. Silver foliage..... | ¼ oz. 50c., | .10 |
| candidissima. Silver white, with deep cut foliage..... | ½ oz. \$1.00, | .15 |
- Cerastium tomentosum.** H. P. (Snow in Summer.) Fine edging plants..... .25
- Chelone Hybrida Torreyi.** H. P. Showy bedding plant, with brilliant scarlet flowers. June to Aug. 2 ft..... ¼ oz. 75c., .15
- Hybrida Mixed.** The colors vary from light pink to deep red and violet, 2 ft. ½ oz. 60c., .15

- Cheiranthus. Allioni** (Siberian Wallflower). H. B. Showy plants with bright orange flowers blooming all Summer. 1 ft. ¼ oz. 75c., .15
- Kewensis—Winter Flowering Wallflower.** The flowers, borne on long, slender stalks, are extremely fragrant. The colors vary from sulphur yellow to brownish violet. 18 in. ¼ oz. \$1.00, .25
- linifolius.** Alpine Wallflower. A charming dwarf alpine, producing freely its pretty mauve, fragrant flowers. May, June. 1 ft.25
- Centranthus macrosiphon.** A very attractive hardy annual producing large heads of bright crimson flowers. 1½ ft. .15
- Chrysanthemums.** H. A. Do not confound these annuals with the Winter flowering sorts. They bloom profusely from early Summer until frost and when grown in large beds or masses their bright colors make a splendid show. 1 to 1½ ft.
- DOUBLE ANNUAL VARIETIES.**
- coronarium.** White, yellow and Mixed. Each, ¼ oz. 25c., .10
- SINGLE ANNUAL VARIETIES.**
- Evening Star.** Golden yellow. ¼ oz. 30c., .15
- Morning Star.** Primrose..... ¼ oz. 30c., .15
- Northern Star.** Pure white..... ¼ oz. 30c., .15
- Single Mixed**..... ¼ oz. 25c., .10
- Collection of 8 varieties, 75c.**
- PERENNIAL VARIETIES.**
- King Edward VII.** Pure white..... .25
- Mrs. C. Lothian Bell.** Pure white..... .25
- Shasta Daisy.** White..... ½ oz. 75c., .25
- Mayfield Giant.** Large, snow white..... .25
- New Early-flowering Single.** Single Chrysanthemums are the craze at the present time, and from a single packet of seed you can get sorts equal to the best named varieties..... .50
- Japanese Mountain.** Sown in early Spring the plants will in the same year, produce a profusion of small graceful flowers with tiny central disk. **Mixed colors**..... .25
- Cimicifuga racemosa.** H. P. Tall, hardy and ornamental; suited for the back of borders or for partially shaded places; white racemes of flowers. 5 to 6 ft. June-July..... .25

CINERARIA

Hybrida Grandiflora. (G. P.)

- BURNETT'S EXHIBITION STRAIN.** Our strain of this highly prized greenhouse plant we can recommend as being superior to any other. The seed is selected with the utmost care by one of the leading growers in Europe, who has made wonderful improvements in Cinerarias within the past few years. **Mixed colors** 1.00
- Hybrida Matador.** Brilliant coppery-scarlet, a striking and novel color, which makes an effective contrast with the other shades..... .50
- Hybrida "Rosamond."** A really good pink cineraria is an unusual and very desirable novelty. "Rosamond" is a true delicate pink with white center..... 1.00
- Hybrida Gigantea.** Giant dark blue..... 1.00
- Hybrida Multiflora Nana.** Producing dwarf plants, with masses of small flowers in compact heads. **Mixed colors**..... .50
- STELLATA.** Star flowered. **Pink, Blue White. Mixed** Each, .50
- Feltham Beauty.** A great improvement on the old stellata class. Beautiful mixture of many colors..... .75
- stellata nana.** Cactus flowered, mixed..... .50
- maritima candidissima.** Pretty, silver-leaved variety, adapted for bedding..... .10

- Pkt.
- Clarkia elegans** fl. pl. H. A. Excellent for bedding and pot culture. 2 ft.
White, Rose, Scarlet, Purple, Salmon, Carmine.....Each, $\frac{1}{4}$ oz. 50c., .15
Finest Mixed. All colors..... $\frac{1}{4}$ oz. 35c., .10
Collection of 6 varieties, 75c.
- Clematis.** H. P. Very rapid growing, free blooming climber, adapted for arbors, fences, etc. 10 ft.
Large flowering Hybrids. Mixed..... .15
- Cleome** (Spider Flower). **Gigantea Rose Queen.** H. A. Rose-colored flowers; the stamens look like spiders' legs, and present a very attractive appearance. Used extensively, planted among shrubbery. Height 3 ft..... $\frac{1}{4}$ oz. 50c., .10
- Clerodendron Fallax.** G. P. Handsome erect-growing greenhouse plants; large spikes of fiery scarlet bloom..... .75
- Clianthus.** G. P. **Dampieri** (Australian Glory Pea). Scarlet and black..... .25
Puniceus (New Zealand Parrot's Bill). Scarlet and white..... .15
- Cockscomb.** See *Celosia*.
- Cobaea.** H. H. P. A half hardy perennial climber, with bell-shaped flowers.
scandens. Blue..... $\frac{1}{4}$ oz. 35c., .15
scandens alba. White..... $\frac{1}{4}$ oz. 50c., .15
- Coleus.** H. H. P. The most popular ornamental bedding foliage plants. 1 ft.
Finest Mixed Hybrids..... .15
Large-Leaved Mixed..... .25
thyrsoides. A very handsome species 2 to 3 feet high, the branches terminating in erect, panicle-like racemes of bright blue flowers. Fine for conservatory..... 1.00
- Collinsia.** H. A. A pretty, free flowering annual. 1 ft.
Verna. White with blue lower lip. Very fine..... .25
Finest Mixed.....Oz. 25c., .10
- Collomia Coccinea.** H. A. A neat and compact plant, producing large heads of bright orange red starry flowers, very distinct and attractive. 9 in..... .25
- Commelina Caelestis.** H. P. A fine border plant, producing an abundance of bright sky-blue flowers. It is tuberous rooted, and should be lifted and stored in Autumn. 1½ feet..... .25
- Convolvulus** (Morning Glory). Beautiful free flowering climbers, with handsome, rich colored flowers, which make a brilliant effect. H. A.
Major Choice Mixed.....Oz. 25c., .10
Imperial Japanese, Choice Mixed.Oz. 50c., .10
- Coreopsis.** H. P. (Perennial Calliopsis).
grandiflora. Golden yellow..... $\frac{1}{4}$ oz. 50c., .15
Auriculata "Superba." An improved form, several tones deeper than the ordinary Grandiflora, with a serrated band of brownish-red encircling the central golden disk. Flowers 3 inches across on long wiry stems..... .35
lanceolata. Bright yellow..... $\frac{1}{4}$ oz. 50c., .15
- Cowslip.** A favorite for the Spring garden. H. P. 1 ft. Finest mixed..... .15



Cosmos, Double Crested

COSMOS

This is one of our most beautiful and useful Autumn-flowering plants. It is most effective when planted in broad masses, or along background borders against evergreens or fences.

- Pkt.
- DWARF EARLY GIANT FLOWERING.**
 If sown in May in the open ground will usually bloom by the second week in July. **Crimson, White, Pink, Mixed**
 Each, $\frac{1}{4}$ oz. 75c., .15
- TALL OR LATE GIANT FLOWERING.**
Pure White, Bright Pink, Crimson
 Each, $\frac{1}{4}$ oz. 35c., .10
Choice Mixed..... $\frac{1}{4}$ oz. 30c., .10
Lady Lenox, Pink. Flowers of enormous size..... $\frac{1}{4}$ oz. 50c., .15
Lady Lenox, White..... $\frac{1}{4}$ oz. 50c., .15
Klondyke. Orange flowered..... $\frac{1}{4}$ oz. 75c., .15
"Fairy Queen." The sturdy bushy plants seldom exceed a height of 2½ feet, are of compact habit, and gay with large flowers of a bright carmine rose..... .25
- DOUBLE CRESTED.** A splendid class producing double flowers, beautifully crested and most striking in appearance.
Crimson King. A beautiful shade.
Pink Beauty. Shell-pink..... $\frac{1}{4}$ oz. \$1.50, .25
White Queen. Pure white..... $\frac{1}{4}$ oz. \$1.50, .25
Mixed..... $\frac{1}{4}$ oz. \$1.25, .20
- Giant "Blush Queen."** A very large-flowered and early variety of quite a new type. The color is a very beautiful blush, flaked with a rosy lilac tint, deepening toward the center..... $\frac{1}{4}$ oz. \$1.00, .25
- New Giant Hybrids.** A new and much improved strain of the early-flowering Cosmos. The colors range from crimson, deep rose, pale rose, blush and white..... $\frac{1}{4}$ oz. \$1.00, .25



Delphinium, Gold Medal Hybrids

- Crucianella. stylosa.** H. P. A plant of trailing habit and rapid growth, producing a profusion of bright rose-colored flowers in summer; very suitable for the rock garden. 6 in. Pkt. .15
- Cucumis** (Ornamental Cucumber). H. A. Remarkable for ornamental and picturesque character of fruit and foliage.
- flexuosus.** 15 ft. Pkt. .15
- Cuphea** (Cigar Plant). Half-hardy perennial, useful for bedding. 1 ft.
- platycentra.** Scarlet and purple Pkt. .25

CYCLAMEN

- persicum giganteum.** These are among the most beautiful Winter and Spring flowering plants for the greenhouse. Not only are the flowers of striking beauty, but the foliage is also highly ornamental. The seed we offer has been saved from prize winning plants by the most eminent Cyclamen specialists in Europe.
- BURNETT'S GIANT STRAIN.** Pure White, Rose, Pink, Salmon, Crimson, Bright Red, White with Claret base.
- Each 100 seeds, \$2.50, .75
- Choice Mixed** 100 seeds, \$1.50, .50
- persicum papilio** (Butterfly). Flowers beautifully fringed. Mixed Pkt. .50

- Cynoglossum Amabile** (Chinese Forget-Me-Not). H. A. A worthy addition to the list of blue flowers, forming strong plants about 18 inches high, producing throughout the summer sprays of blue Forget-me-not like flowers Pkt. .25

- Cyperus alternifolius** (Umbrella Plant). Pkt.
- G. P. An elegant plant for growing in water or damp places. 2 ft.25
- Cypress Vine** (Ipomœa Quamoclit). H.
- A. Beautiful twining annuals, with feathery dark green foliage and star-like flowers. 20 ft.
- Crimson.** Very brilliant ¼ oz. 25c., .15
- White.** Beautiful ¼ oz. 25c., .15
- Finest Mixed** ¼ oz. 25c., .10

- Dahlia.** H. H. P. One of our best Autumn flowering plants; blooms until killed by frost. Can be raised from seed and flowered the same season. 4 to 6 ft.
- Coltness "Improved Hybrids."** These new hybrids of delicate pinks, mauves and roses and their richer yellows, scarlets and purples will win many new friends. 2 ft. Pkt. .50
- Stella.** A striking form of the Single Cactus type. The coloring is extremely varied. Pkt. .25
- Choice Single Mixed** ¼ oz. 50c., .15
- Choice Double Mixed** ¼ oz. 50c., .15
- Choice Cactus Flowered, Mixed** ¼ oz. 75c., .25
- Choice Peony Flowered, Mixed** ¼ oz. 75c., .25
- Choice Collarlette, mixed** ¼ oz. 75c., .25

- Daisy.** (See *Bellis perennis*.)

- Datura** (Trumpet Flower). H. H. A. 3 ft.
- Finest Mixed** ¼ oz. 30c., .10

DELPHINIUM (Larkspur)

These popular, well known hardy perennials produce splendid spikes of flowers throughout the entire Summer and Fall, varying in height from 3 to 6 ft.

- "WREXHAM" STRAIN.** The seed of these beautiful Delphiniums we import direct from a celebrated English grower. Considered the finest type of all. Colors range through the entire range known to delphiniums. 3 Pkts. \$5.00, 2.00 Pkt.
- BURNETT'S GOLD MEDAL HYBRIDS.**
- Choice mixed** ½ oz. \$2.50, 1.00
- belladonna.** Single flowers of a clear turquoise blue ½ oz. \$1.00, .25
- bellamosa.** Deep blue ½ oz. \$1.00, .25
- elatum** (Bee Larkspur). Clear blue. ¼ oz. 50c., .10
- Fanny Stormouth,** light azure blue Pkt. .50
- formosum.** Rich blue, with white center. 3 ft. ¼ oz. \$1.00, .15
- formosum celestinum.** Beautiful azure-blue Pkt. .25
- nudicaule.** Scarlet 1½ ft. Pkt. .25
- Rev. E. Lascelles.** Deep blue Pkt. .50
- Zalil** (Hardy Yellow Larkspur) Pkt. .25
- chinensis. Light Blue, Dark Blue, White and mixed.** Each, ¼ oz. 50c., .10
- Blue Butterfly.** Rich blue, if sown early will bloom in August. ¼ oz. \$1.00, .15
- Dark Blue Hybrids** ½ oz. \$1.00, .25
- Medium Blue Hybrids** ½ oz. \$1.00, .25
- Light Blue Hybrids** ½ oz. \$1.00, .25
- Mixed Hybrids** ¼ oz. \$2.00, .25

- Diascia. Barberæ.** H. H. A. This pretty plant produces rosy-pink flowers throughout the Summer in constant profusion. Makes an excellent bedding plant for dwarf borders. 6 in. Pkt. .25

- Dictamnus Fraxinella** (Gas Plant). Red flowers, fragrant leaves; 2 ft. Pkt. .25
- Alba.** The white variety Pkt. .25

DIANTHUS (or Pinks).

H. A. Better known as Chinese Pinks, are among the most brilliant of our garden flowers, and are excellent for cutting. They bloom profusely until killed by frost. 1½ ft.

SINGLE ANNUAL VARIETIES Pkt.

Chinensis (China or Indian Pinks). Mixed.	
.....	¼ oz. 30c., .10
Heddewigii, Crimson Belle, Dark Red.	
.....	¼ oz. 50c., .10
Eastern Queen. Rose Pink	¼ oz. 50c., .10
Snowflake, Pure White	¼ oz. 50c., .10
The Bride. Fine white, purple center.	
.....	¼ oz. 50c., .10
Mixed	¼ oz. 50c., .10
Laciniatus (Single Fringed Pink). "Salmon Queen" geranium-red	
.....	¼ oz. 50c., .10
Mixed	¼ oz. 50c., .10

DOUBLE ANNUAL VARIETIES

Chinensis (China or Indian Pink). Mixed.	
.....	¼ oz. 50c., .10
Heddewigii, Fireball. Brilliant scarlet.	
.....	¼ oz. 50c., .10
Pink Beauty. Rose pink	¼ oz. 50c., .10
Mixed	¼ oz. 50c., .10
Laciniatus Salmon Queen. Salmon pink.	
.....	¼ oz. 50c., .15
Snowdrift. Pure white	¼ oz. 75c., .15
Imperialis (Imperial Pink) Mixed.	
.....	¼ oz. 50c., .10
Diadematus (Diadem Pink) Mixed.	
.....	¼ oz. 50c., .10

Collection, 6 varieties, including Singles and doubles, separate colors, 50c.

HARDY PERENNIAL VARIETIES

Allwoodii. See Allwoodii.	
Plumarius (Pheasant's Eye).	
Single Mixed	¼ oz. 50c., .15
Double Mixed	¼ oz. 75c., .15
Semperflorens (Perpetual Pinks). Mixed.	
.....	¼ oz. 75c., .15
Scoticus. Double Scotch Pink, Mixed25
DWARF ROCKERY VARIETIES	
Dianthus Alpinus (Alpine Pink). Rosy Pink. A gem for rock gardens. 4 ins.....	.25
Arenarius (Sand Pink). White, fringed. Very free. 4 in.....	.25
Caesius (Cheddar Pink). Bright pink; fine for dry bank, rockeries and old walls. 6 in.....	.25
Deltoides (Maiden Pink). Trailing variety; flowers pink with dark circle. 6 in.....	.25
Deltoides. Alba. White, 8 in.....	.25
Neglectus. Tufts of dark green foliage, brilliant carmine rose flowers. Charming rock plant. 3 in.....	.25
sylvestris. A rock garden gem with large soft pink blossoms. 6 in.....	.25
New Rock Hybrids. A beautiful mixture of colors. Charming plants for rock garden or walls. 6 in.....	.25
Collection, 6 Rock Garden Varieties, \$1.25.	

Digitalis (Foxglove). H. B. Very ornamental hardy perennial plants of stately growth, producing long flower spikes. Specially adapted for shrubberies. 3 to 6 ft.

gloxinioides. Spotted varieties.

Pure White, Rose, Rich Purple	
Each, ¼ oz. 50c.,	.15
Mixed. All colors.....	¼ oz. 35c., .10
Isabellina. A beautiful sulphur-yellow.....	.25
maculata superba. An extra choice strain of beautifully spotted sorts.....	¼ oz. 75c., .15
monstrosa (Mammoth Foxglove). Long spikes, surmounted by one enormous flower; very distinct, mixed ¼ oz. 75c.,	.15
The Shirley. Plants grow from 5 to 6 feet high with enormous spikes of blooms, the colors ranging from white to dark rose, handsomely blotched and spotted.	¼ oz. \$1.00, .25



Dimorphotheca, New Selected Hybrids

Didiscus cœruleus. (The Blue Lace Flower.) An old, almost forgotten favorite. This lovely annual has again become extremely popular, on account of its beautiful lace-like flowers of a delightful lavender-blue..... ¼ oz. \$1.00, .25

Dimorphotheca aurantiaca. H. A. (Golden Marguerite or Star of the Veldt.) Gorgeous orange flowers, produced in great profusion, one of the most brilliant Summer bedding plants. 12 in. ¼ oz. 50c., .15

Eklonis. Not exceeding 12 to 15 inches in height, it forms a strong-growing compact bush with large star-shaped white flowers, and deep blue disk..... .25

New Selected Hybrids. This class produces an almost endless variety of colors from pure white through the many shades of pink, yellow, red, etc..... ¼ oz. 75c., .25

Dodecatheon meadia. (American Cowslip.) H. P. One of the most graceful and interesting plants for sheltered positions in the rock garden; rosy-purple flowers on stems 9 inches high..... .50

Dolichos Lablab (Hyacinth Bean). H. H. A. Very ornamental and rapid growing climber, with dense foliage; purple and white flowers. 10 ft. **Mixed Colors**..... Oz. 50c., .10

Doronicum caucasicum. (Leopard's Bane.) H. P. Clear yellow, daisy-like flowers. The first of the herbaceous perennials to bloom. April-May. 1 ft..... .50

Draacaena Highly ornamental greenhouse plants.
australis. Ornamental leaves..... ¼ oz. 35c., .15
indivisa. Long, slender leaves..... ¼ oz. 35c., .15
Veitchii. Variegated leaves..... .25



Gaillardia, Portola Hybrids

- Echinops Ritro.** (Globe Thistle.) H. P. Pkt.
A hardy perennial with blue, thistle-like flowers; fine for bees. 3 ft. .15
- Echinacea.** See Rubeckia.
- Echinocystis lobata** (Climbing Wild Cucumber). A rapid growing annual climber. 30 ft. .10
- Echium Plantagineum.** H. A. A free growing and continuous bloomer. The flowers open rose and change to purple, making a most attractive and unusual effect. 1½ ft. .15
- Edelweiss** (Leontopodium alpinum). H. P. The interesting white-leaved plant so eagerly sought by tourists in the Swiss Alps. 6 in. .25
- Eremurus. Gold Medal Hybrids.** H. P. Stately plants with long spikes of various colored flowers. 6-8 ft. .50
- Erigeron speciosus.** H. P. Pale mauve flowers, gold centers. 1½ ft. .15
- Erinus Alpinus.** H. P. A charming Spring-flowering plant with pale purple flowers. Valuable for Rock Garden. 2 ins. .50
- Eryngium Amethystinum** (Sea Holly). H. P. Ornamental hardy perennial, blue flowers. 4 ft. .25
- Erysimum.** H. A. Free flowering hardy annuals, the plants resemble Wallflower; fine for cutting.
- Golden Gem.** Golden yellow, like a miniature yellow wallflower, very early. 12 in. .15
- Linifolium.** H. P. (The Mauve Alpine Wallflower.) Produces a profusion of flowers of a bright, clear mauve, resembling Aubrietia Graeca .25
- Rupestre.** H. P. (The Fairy Wallflower.) A lovely Alpine plant producing pale yellow flowers abundantly in early spring. 6 in. .25

- Eschscholtzia** (California Poppy). H. A. Very attractive for beds, edgings, or masses; blooms continually from June till frost. 1 ft.
- Aurantiaca** (True California Poppy). Rich orange .¼ oz. 30c., .10
- alba.** Creamy white .¼ oz. 30c., .10
- Carmine King.** Beautiful carmine-rose on both sides of petals .¼ oz. 50c., .15
- Chrono Queen.** Clear yellow .¼ oz. 50c., .15
- Golden West.** Deep yellow .¼ oz. 30c., .10
- Mandarin.** Inner side of petals rich orange, outer side scarlet .¼ oz. 30c., .10
- Rose Cardinal.** Rose color .¼ oz. 35c., .10
- Finest Mixed** .Oz. 50c., .10

- Bush Eschscholtzia.** See Hunnemannia.
- Eucalyptus. Globulus** (Blue Gum). G. P. Admirable for sub-tropical bedding or greenhouse decoration. .25
- Eupatorium Fraseri.** H. P. A pretty, hardy plant; blooms the first season from seed, producing clusters of white flowers; fine for cutting. 2 ft. .10
- Euphorbia.** H. A. Strong growing annuals, suitable for beds or mixed borders.
- variegata** (Snow on the Mountain). Attractive foliage, veined and margined with white; 2 ft. .¼ oz. 35c., .10
- heterophylla** (Mexican Fire Plant). The plants grow 2 to 3 ft., with smooth, glossy green leaves .¼ oz. 50c., .15
- Exacum affine.** G. P. Beautiful pot plant, producing sweetly scented bright mauve flowers, within six months from sowing. 9 in. .50
- Ferns.** The seed is saved from a large collection of new and interesting varieties.
- Hardy Ferns finest mixed.** Spores of the best hardy varieties .50
- Greenhouse Ferns finest mixed.** Spores of varieties suitable for culture under glass .50
- Feverfew.** See **Matricaria.**
- Four o'Clocks.** See **Marvel of Peru.**
- Francoa Ramosa.** (Bridal Wreath.) H. H. P. Beautiful snow-white flowers, excellent for cutting. 2½ ft. .25
- Fuchsia.** H. H. P. The well-known house plant of easy culture .25
- Gaillardia (Annual Varieties).** Very showy, remarkable for the profusion, size and brilliancy of their flowers.
- Indian Chief.** (New.) Bronzy red. .¼ oz. 50c., .15
- amblyodon.** Single blood-red .¼ oz. 50c., .10
- picta.** Single crimson and orange. .¼ oz. 25c., .10
- picta Lorenziana.** Double flowering mixed. .¼ oz. 35c., .10
- picta, Mixed.** Single sorts .¼ oz. 25c., .10
- Gaillardia (Perennial Varieties).** H. P. Most effective hardy plants, and should find a place in every plant border. Fine for cutting. 2 ft.
- Portola Hybrids.** (New.) Shades of bronzy red, golden tipped; very robust. .¼ oz. \$1.50, .25
- kermesina splendens.** Rich crimson, narrow yellow border .¼ oz. 50c., .15
- grandiflora "Dazzler."** Bright golden-yellow with rich maroon-red center. .¼ oz. 50c., .15
- grandiflora maxima.** Golden yellow. .¼ oz. 35c., .10
- Giant Hybrids, Mixed** .¼ oz. \$1.00, .25
- Collection of 6 varieties, 75c.

Galega. (Goat's Rue.) H. P. Fine hardy border plant, covering itself with spikes of pea-like blossoms. 3 ft.	Pkt.
Hartlandi. White and lilac, variegated foliage	.25
officinalis. Blue	.15
Gaura Lindheimeri. H. A. A graceful plant bearing numerous spikes of rosy white flowers from July until frost. 3 ft.	1/4 oz. 50c., .15
Gazania splendens hybrida mixed. H. H. P. A tender perennial blooming the first season from seed. The flowers vary from light to deep yellow with black centres. 2 ft.	.25
Gentiana acaulis (Blue Gentian.) H. P. Intense blue bell-shaped flowers, suited to moist and shady situations. 6 in.	.15
Geranium. H. H. P. The most popular flowering plant for garden or pot culture.	
Extra Choice. Mixed	.25
Gerbera Jamesoni Hybrida. (Barberton or Transvaal Daisy.) H. H. P. and G. P. A wonderful border plant, and now forced extensively for Winter and Spring flowers under glass. Our new hybrids are of great merit and contain a grand diversity of colors	100 seeds \$1.00, .50
Jamesoni. Orange-scarlet	100 seeds \$1.00, .50
Gesneria Robusta Perfecta Hybrids. This makes a fine pot plant. It belongs to same class as the Gloxinias and needs same culture in greenhouse.	
Mixed Shades	.50
Geum. H. P. Mrs. J. Bradshaw. Handsome variety with large, double, bright scarlet flowers	1/4 oz. 75c., .25
Orange Queen. Large and free-blooming	.35
Lady Stratheden. Rich golden yellow	.50
Coccineum. Single, bright orange scarlet	.15
Gilia coronopifolia. H. H. B. This is a very striking flower, and by no means well-known. They are tubular shaped, and of the most brilliant scarlet-crimson, with which the finely cut foliage is interspersed. 2 1/2-3 ft.	.25
Finest Mixed	Oz. 50c., .10
Globe Amaranth. (Gomphrena.) H. A. Showy annuals, or everlasting flowers, usually preserved for Winter bouquets. 2 ft.	
Orange, Purple, Rose, White and Mixed.	
Each, 1/4 oz. 35c.,	.10
Gloxinia. G. P. This charming greenhouse plant produces beautiful trumpet-shaped flowers of the most exquisite and gorgeous colors. Extensively used for decorating.	
Burnett's Superb Mixed	.50
Gloxinia Bulbs. See page 55.	
Godetia. H. A. An attractive hardy annual. Very showy when grown in beds or masses. 1 ft.	
Crimson Glow. Dazzling crimson.	1/4 oz. 50c., .15
Duchess of Albany. Satiny-white.	1/4 oz. 35c., .10
Lady Satin Rose. Bright carmine.	1/4 oz. 50c., .15
The Bride. White and carmine.	1/4 oz. 35c., .10
Gloriosa. Large, satiny, brilliant, blood-red flowers; richest color of all.	1/4 oz. 50c., .15
Choice Mixed	1/4 oz. 30c., .10



Gerbera Jamesoni

Gourds. (Ornamental Mock Orange.) H. H. A. Of rapid growth, bearing fruit of the most varied forms; very desirable for trellis work. 10 to 20 ft.	Pkt.
Chinese Loofa (Sponge or Dish Rag)	
Nest Egg. White fruit	1/4 oz. 25c., .10
Hercules' Club	1/4 oz. 25c., .10
Dipper Shaped	1/4 oz. 25c., .10
Finest Mixed	Oz. 50c., .10
Collection of 12 varieties,	\$1.00.
Grasses, Ornamental. Many of these Grasses will be found useful in the formation of Winter bouquets, in connection with the Everlastings.	
Agrostis nebulosa. H. A. Graceful and pretty. 1 1/2 ft.	.10
Briza maxima (Quaking Grass). H. A. Very pretty. 1 1/2 ft.	.10
Briza gracilis. H. A. (Small Quaking Grass.) Graceful. 1 ft.	.10
Bromus briziformis. H. A. Fine for Winter bouquets. 1 ft.	.10
Coix lachrymae (Job's Tears). H. A. 1 1/2 ft.	.10
Erianthus Ravennae. H. P. Silvery-White plumes. 3 ft.	.10
Gynerium argenteum (Pampas Grass). H. P. Useful for decoration. 10 ft.	.10
Hordeum jubatum (Squirrel Tail). H. A. For bouquets. 2 ft.	.10
Lagurus ovatus (Hare's Tail). H. A. Small, white plumes. 1 1/2 ft.	.10
Pennisetum longistylum villosum. H. A. Grayish-colored plumes. 1 1/2 ft.	.10
Pennisetum Rupellianum. H. A. Crimson plumes. 1 ft.	.10
Stipa pennata (Feather Grass). H. P. Very pretty. 2 ft.	.10
Collection of 12 varieties,	\$1.00.
Grevillea robusta (Silk Oak). H. H. P. A beautiful decorative plant, with fern-like foliage; excellent for table decoration and Summer bedding. 3 to 5 ft.	
	1/4 oz. 75c., .15



Helichrysum (Straw Flower)

- Gypsophila.** H. A. Pretty, free flowering plants; largely used for mixing with other cut flowers. 2 ft.
- elegans grandiflora alba.** Large, pure white flowers. 18 in. Oz. 60c., .10
- rosea.** Rose flowers. 18 in. Oz. 60c., .10
- muralis.** Dwarf, with rose flowers, suitable for rockwork. 6 in. ¼ oz. 35c., .15
- PERENNIAL VARIETIES**
- paniculata.** H. P. White flowers, fine for bouquets. 2 ft. ¼ oz. 50c., .15
- PANICULATA FL. PL.** H. P. The new double flowering Baby's Breath, and one of the finest hardy plants for cutting. .25
- Repens.** H. P. A pretty dwarf trailing species for the rockery. It has pinkish-white flowers, and is a continuous bloomer. 6 in. ½ oz. \$1.00, .25
- Repens Alba.** H. P. Pure white. 6 in. ½ oz. \$1.00, .25
- Helenium.** H. P. Very fine for cutting.
- Bigelow.** Flowers bright yellow, black centre. .15
- autumnale,** pale yellow. .15
- Elverton Gem,** orange, dark centre. .15
- Helianthemum.** (Rock Rose, Sun Rose.) H. P. Dwarf evergreen plants for rock gardens, walls, or for clothing dry banks. Also useful for edging in the herbaceous border.
- Mutabilis,** Mixed. ¼ oz. 50c., .15
- Helianthus.** (Sunflower). H. A. The following sorts are remarkable for their stately growth, size and brilliancy of flowers, making a splendid effect among shrubbery and for backgrounds.
- cucumerifolius.** Small, single rich yellow flowers. 3 ft. ¼ oz. 30c., .10
- stella.** Single, golden-yellow, black centers, fine for cutting. 4 ft. ¼ oz. 35c., .10
- Russian Mammoth.** Immense flowers. 6 ft. Oz. 15c., .05

HELIANTHUS--Continued

- Red Hybrids.** Dark centered, brilliant flowers banded with bright chestnut-red, merging to yellow at the tips of the petals. 6 ft. ¼ oz. 25c., .15
- Double California.** Large, double yellow flowers. 5 ft. Oz. 50c., .10
- Double Chrysanthemum Flowered.** Golden yellow flowers. 7 ft. Oz. 60c., .10
- Double "Globes of Gold."** Dwarf orange. 4 ft. Oz. 50c., .10
- Perennial Varieties, Mixed** ¼ oz. 75c., .15

Helichrysum monstrosum. H. A. (Improved Double "Strawflowers"). Pretty and effective border plants. The dried flowers are highly prized for Winter bouquets. 2 ft.

- Fireball.** Scarlet. ¼ oz. 50c., .10
- Golden Ball.** Rich yellow. ¼ oz. 50c., .10
- Rose Queen.** Carmine-rose. ¼ oz. 50c., .10
- Salmon Queen.** Pink. ¼ oz. 50c., .10
- Silver Ball.** White. ¼ oz. 50c., .10
- Violet Queen.** Violet. ¼ oz. 50c., .10
- Mixed Colors** ¼ oz. 50c., .10

Collection of above 6 varieties, 50c.

Heliopsis Pitcheriana. H. P. (Orange Sunflower.) Deep golden yellow single flowers. ¼ oz. 50c., .15

Heliotrope. H. H. P. Very fragrant plants. Much admired in the conservatory and flower garden. 1½ ft.

Lemoine's Giant Hybrids, Mixed.

- White Lady.** White, very fine. ¼ oz. \$1.00, .15
- Regale.** Dwarf, compact blue. ¼ oz. \$1.00, .25

Heuchera. H. P. Beautiful graceful sprays held erect over its prostrate foliage; fine for borders or rock garden. 12-18 in.

- brizoides,** distinct new species dwarf habit, pale rose flowers. .25
- gracillima,** fine new form with slender, graceful pink sprays. .25
- Sanguinea splendens.** Bright scarlet-crimson. .25
- Alba.** White. .25
- Hybrida Grandiflora.** Many choice varieties, Mixed. .25

Hibiscus (Marshmallow). H. P. Very ornamental perennial plants, for mixed beds or shrubby borders, having large-sized, beautifully colored flowers; blooms the first year if sown early. 2 to 4 ft.

moscheutos (Swamp Mallow). Flowers like single Hollyhocks but much larger; excellent for moist situations.

Roseus. Pink. ¼ oz. 50c., .20

grandiflorus Rainbow Hybrids. New giant flowering Marshmallows. Very large flowers in various colors. ¼ oz. 60c., .15

Giant Yellow, or Golden Bowl. H. A. Cup-shaped flowers; cream, maroon center. ¼ oz. 50c., .15

africanus. Free-growing hardy annual. Yellow, with maroon center. ¼ oz. 50c., .10

Hieracium aurantiacum. H. P. Little flowers 6 inches high like miniature paint brushes dipped in burnt orange. Spreading but easily controlled where the summers are hot and dry. June-July. .25

Honeysuckle. H. P. (Hedysarum coronarium.)

French. A plant of easy culture. Flowers red and white. 15 ft. .15

Honesty. (Moonwort, Satin Flowers.)

Hardy biennial, admired for its silvery seed pouches. 2 ft. .15

Pkt.

- Hollyhock.** H. P. Very effective in large groups and borders for planting among shrubbery or forming a back-ground for other flowers. 6 ft.
- Double "Imperator" (New).** Strikingly original type, with very large flowers like a crested Begonia. A variety of delicate tints—cerise, salmon, cream reflecting rose, rose red, yellow, etc. .50
- CHATER'S DOUBLE, Pink, Yellow, Blood Red, Crimson, Rose, Maroon, White.**
 Each, $\frac{1}{4}$ oz. \$1.00, .15
 Double Mixed $\frac{1}{4}$ oz. 75c., .10
 Collection 6 colors Chater's Double .75
Double Annual Everblooming Mixed.
 Flowers the first season from seed .25
Single, Red, Pink, Rose, White, Yellow.
 Single Mixed. Choice colors $\frac{1}{4}$ oz. 75c., .15
 $\frac{1}{4}$ oz. 50c., .10
- Humea. Elegans.** G. P. Highly decorative, graceful plant for greenhouse, with fragrant foliage, and long pendulous panicles of purplish-brown flowers .50
- Humulus.** (Japanese Hop). H. A.
japonicus. A very ornamental, rapid growing climber. 15 ft. $\frac{1}{4}$ oz. 25c., .10
variegatus. A variegated variety of the above $\frac{1}{4}$ oz. 35c., .10
- Hunnemannia.** (Bush Eschscholtzia.)
fumarifolia. H. A. The plants grow about 2 ft. high, bearing large, Poppy-like, yellow flowers $\frac{1}{4}$ oz. 50c., .15
- Hyacinth Bean.** See **Dolichos.**
- Iberis.** See **Candytuft.**
- Ice Plant.** (Mesembryanthemum crystallinum.) A little trailing plant of dwarf habit for rockwork or borders. H. A. .10
- Impatiens.** Charming greenhouse plants, producing bright, waxy-looking flowers.
Sultani. Brilliant rosy-scarlet .15
Holstii, New Hybrids. Choice mixed .25
- Incarvillea.** (Hardy Gloxinia.) H. P.
Delavayi. Pink. 2 ft. .25
- Inula Glandulosa grandiflora.** H. P. (Flea Bane.) A very fine hardy border plant, large golden yellow flowers 4 inches across. June to August .25
- Ionopsidium Acaule.** H. A. A lovely miniature hardy annual forming dense tufts of foliage smothered in tiny pale lilac flowers, thrives best in damp situations. 2 in. .15
- Ipomoea.** H. A. Rapid growing Summer climbers. For covering arbors, walls, trellises, etc.
Bona-nox (Evening Glory). Rosy lilac flowers, opening in the evening. 15 ft. Oz. 50c., .10
grandiflora alba (Moonflower). At night and during dull days the plant is covered with large, pure white, fragrant flowers. Oz. \$1.00, .10
rubro cœrulea (Heavenly Blue). Immense flowers of bright sky-blue $\frac{1}{4}$ oz. 35c., .10
setosa (Brazilian Morning Glory). Flowers rose color, borne in large clusters. 15 ft. $\frac{1}{4}$ oz. 35c., .10
Imperial Japanese (Japanese Morning Glory). Mixed Oz. 50c., .10
- Kochia trichophylla.** H. A. (Summer Cypress or Mexican Fire Plant). A rapid growing annual of pyramidal habit with slender green leaves, turning to bright red in the Autumn. 3 ft. $\frac{1}{4}$ oz. 25c., .10
- Lantana.** H. H. P. A splendid bedding plant, also fine for pots. 2 ft.
hybrida, Finest Tall Mixed $\frac{1}{4}$ oz. 50c., .15
hybrida, New Dwarf Mixed $\frac{1}{4}$ oz. 75c., .15



Larkspur, Double Stock Flowered

Pkt.

- Larkspur.** (Annual Delphinium). H. A.
 This is one of the best known garden plants for Summer flowering. 2 ft.
Double Stock Flowered:
Pure White, Sky Blue, Shell-Pink, Bright Rose, Dark Blue, Scarlet, Mixed.
 Each, $\frac{1}{4}$ oz. 50c., .15
Collection of 6 varieties, 75c.
- La France** (New). Huge spikes of beautiful salmon-pink. .25
Newport Pink. Color rosy-scarlet. $\frac{1}{4}$ oz. 50c., .15
Blue Butterfly. Rich blue (see Delphinium).
Exquisite Rose. Beautiful shade of rose-pink .25
Emperor Mixed $\frac{1}{4}$ oz. 50c., .10
Dwarf Rocket, Mixed Oz. 75c., .10
Tall Rocket, Mixed. 2 $\frac{1}{2}$ ft. Oz. 50c., .10
- Larkspur Perennial.** See **Delphinium.**
- Lathyrus latifolius** (Everlasting Pea.)
 H. P. Ornamental climber for trellises, etc. 6 ft.
White Pearl, Pink Beauty Each, $\frac{1}{4}$ oz. 60c., .15
Finest Mixed Oz. \$1.00, .10
- Lavatera.** H. A. (Annual Mallow.) Useful border plant.
splendens alba $\frac{1}{4}$ oz. 30c., .10
rosea, very pretty $\frac{1}{4}$ oz. 30c., .10
Mixed $\frac{1}{4}$ oz. 30c., .10
- Lavender.** (Lavandula). Much prized for the delicious fragrance of its violet flowers. H. P. 2 ft.
Spica. Common broad leaved $\frac{1}{4}$ oz. 25c., .10
Vera. True lavender $\frac{1}{4}$ oz. 35c., .15
- Leptosiphon.** H. A. Beautiful dwarf hardy annuals, particularly suitable for edgings or rockwork.
Anreus. A lovely little plant, covered with small golden yellow flowers .15
Hybridus, Mixed. Bright flowers of various colors. 3 in. .15

	Pkt.	Pkt.
Leptosyne stillmannii. H. A. Bright yellow, free flowering, flowers six weeks after sowing.....	¼ oz. 50c., .15	
maritima, large flowered yellow Marguerite very effective in beds, fine for cutting.....	¼ oz. 50c., .15	
Liatriis spicata (Blazing Star). H. P. Slender spikes densely crowded with rosy purple flowers. A splendid flower for cutting, now very popular in the better New York Florists Shops.....	.25	
Pycnostachya (Kansas Gay Feather). Nothing can be planted that will attract more attention on account of its unusual appearance; but it is beautiful as well as odd. It blooms in midsummer and throws up long, narrow spikes of rich purple flowers, which last a long time on the plant or in water. A peculiarity of this plant is its great attraction for butterflies.....	.25	
Limnanthes. Douglasi Grandiflora. H. A. Yellow flowers adapted for growing in moist ground, delightfully fragrant, valuable for bees. 9 in.....	¼ oz. 25c., .10	
Linaria (Toad Flax). H. A. and H. P. Useful plants with beautiful flower spikes like miniature snapdragons, for borders and beds.		
Maroccana Hybrids. H. A. A most beautiful plant exhibiting many new colors. It can be sown in the open ground or raised in pots.....	¼ oz. 35c., .15	
Alpina. H. P. A brilliant little rock plant, with glaucous grey leaves, flowers violet with orange lip.....	.25	
cymbalaria (Kenilworth Ivy). Trailing perennial with neat foliage and small violet flowers.....	.10	
Linum grandiflorum coccineum. (Scarlet Flax.) H. A. Brilliant scarlet, 12 in.....	¼ oz. 25c., .10	
flavum. H. P. Golden yellow.....	.15	
perenne. H. P. Blue Flax.....	¼ oz. 35c., .15	
alpinum. Dwarf, spreading; lavender blue; fine for Rock gardens.....	.25	
Lisianthus. Russellianus. (Texas Bluebell.) G. P. A fine greenhouse plant, which used to be well known, and is again becoming popular. It has rich deep purple flowers with black centres and yellow stamens.....	.25	
Lobelia. Popular and beautiful flowering plants for pot culture, edgings, hanging baskets, etc., blooming profusely from June to November.		
ANNUAL VARIETIES		
CRYSTAL PALACE COMPACTA. Rich deep blue, dark foliage, the finest dark blue for bedding.....	¾ oz. \$1.00, .20	
Blue Emperor. Very compact variety; sky-blue flowers.....	¾ oz. \$1.00, .15	
White Gem. Forms a perfect ball of snow-white flowers.....	½ oz. 75c., .15	
gracilis. Light blue, trailing.....	.15	
Tenuior. Upright habit, large flowers of rich cobalt blue, white eye.....	.15	
PERENNIAL VARIETIES		
cardinalis (Cardinal Flower). A native variety, with spikes of brilliant scarlet flowers; 3 ft.....	.25	
hybrida. Various shades of scarlet.....	.25	
Queen Victoria, scarlet.....	.25	
Lophospermum scandens. H. A. Annual climber, with rosy-purple Foxglove-like flowers. 8 ft.....	.25	
Love-in-A-Mist. See <i>Nigella</i> .		
Lupinus (Annual Lupine). H. A. Splendid for beds, borders and for cutting. 2 to 3 ft.		
Hartwegii. Sky blue.....	¼ oz. 25c., .10	
Dark blue	¼ oz. 25c., .10	
albus. White.....	¼ oz. 25c., .10	
rosens. Rose.....	¼ oz. 25c., .10	
Mixed	Oz. 50c., .10	
Luteus. Fine yellow Annual Lupine.....	.15	
Lupinus (Perennial Varieties). Hardy and effective Summer flowering plants, producing long spikes of pea-shaped flowers.		
polyphyllus, Blue	¼ oz. 35c., .10	
Rose	¼ oz. 50c., .15	
White	¼ oz. 35c., .10	
Choice Mixed	Oz. 75c., .10	
Lavender Queen. Lavender, tinted rose.....	.25	
Moerheimi. A beautiful variety; long spikes of pink and white flowers.		
New Sweet-Scented Hybrids. A wonderful new strain, among the most beautiful of all hardy flowers. Colors are both rich and delicate in shades of blue, mauve, pink, etc.....	¼ oz. 75c., .25	
Golden Spire. Fine golden yellow.....	.25	
Arboreus (Tree Lupine). Fine hardy shrubby plant, covering itself with its long flower spikes.		
"Snow Queen." Pure white.....	¼ oz. 75c., .25	
Lychnis. (Campion.) H. P. Handsome hardy plants, for massing in beds and borders; blooming the first year. 2 ft.		
Alpina. Dwarf Rose pink. Splendid rock plant.....	.25	
Arkwrightii. Beautiful, new hybrids, many distinct and attractive shades.		
chalcedonica. Scarlet flowers.....	½ oz. 75c., .25	
Haageana hybrida. Mixed.....	½ oz. 50c., .15	
Lythrum roseum superbum. (Loosestrife.) H. P. A remarkable plant with 3 ft. spikes of rosy pink flowers. Excellent for moist localities and bog gardens.....	.25	
Malope. (Mallow.) H. A. Handsome free-blooming annuals, with showy flowers suitable for beds and borders. 3 ft.		
Grandiflora Mixed	¼ oz. 25c., .10	
MARIGOLD		
H. A.		
These are very effective when planted in groups or borders, producing a wealth of color that is simply invaluable. 1½ to 2 ft.		
African Varieties:		
Giant Lemon Queen. Rich, lemon-yellow.....	¼ oz. \$1.00, .15	
Giant Prince of Orange. Beautiful orange color.....	¼ oz. \$1.00, .15	
African. Mixed. 2 ft.....	¼ oz. 50c., .10	
Collection of 6 varieties, 50c.		
French Varieties:		
Gold Striped. Rich maroon, striped yellow.....	¼ oz. 50c., .10	
Legion of Honor. Single, yellow marked velvety crimson.....	¼ oz. 50c., .10	
Dwarf French Mixed	¼ oz. 35c., .10	
Collection of 6 varieties, 50c.		
Marvel of Peru. (Four o'Clocks.) H. A. Handsome plants of compact growth, and splendid bloomers. 1½ ft.		
Finest Mixed	Oz. 50c., .10	
Mathiola bicornis (Night-scented Stock.) H. A. Pink and lilac. 1 ft.....	¼ oz. 35c., .10	
Matricaria (Feverfew.) H. H. P. 1¼ ft.		
Golden Ball. Pure yellow, splendid for cutting.....	¼ oz. 75c., .25	
Silver Ball. Double white.....	.25	
capensis fl. pl. White.....	¼ oz. 50c., .15	

Maurandia. H. H. P. Rapid growing, Pkt. **Finest Mixed** 15
graceful climbing plants. 10 ft.

Meconopsis *Baileyi* (New.) H. P. A perennial Poppy, discovered in Thibet, throwing up strong stems 3 to 4 feet high, terminating in large, four-petalled blossoms of a glorious sky-blue, around a central zone of golden yellow anthers. Of rare beauty and one of the most valuable plant discoveries in many years. 75
Cambrica (The Yellow Welsh Poppy). Showy variety with pale yellow flowers, fine for rock-work 25

Mignonette (Reseda). H. A. A popular fragrant annual, prized as much for forcing in Winter as for the Summer garden.

BURNETT'S CONQUEROR. The finest Mignonette for greenhouse growing. It is very robust in growth and produces magnificent spikes about 12 in. in length. All seed is saved from greenhouse grown plants 1/16 oz. \$1.00, 50

Allen's Defiance. Large compact spikes. 1/4 oz. 50c., 15
Golden Queen. Yellow spikes 1/4 oz. 35c., 10
Goliath. Red, large spikes 1/4 oz. 75c., 15
Machet. Dwarf, very fragrant. 1/4 oz. 50c., 10
odorata grandiflora. Large flowered. Oz. 50c., 10
See Sensitive Plant.

Mimosa Pudica See Sensitive Plant.

Mimulus (Monkey Flower). H. H. P. Profuse blooming plants, with flowers of singular form and brilliant colors. 6 in.
tigrinus. "Queen's Prize", very large flowers with splendid markings, many colors, including deep and pale rose 25
moschatus (Musk Plant). For hanging baskets 15

Mina lobata. H. H. A. A handsome vine of rapid growth; flowers in the buds are orange yellow 25

Momordica. H. H. A. Very curious climbing vines, with ornamental foliage. 10 ft.
balsamina (Balsam Apple). Apple-shaped fruit 1/4 oz. 25c., 10
Charantia (Balsam Pear). Pear-shaped fruit 1/4 oz. 25c., 10

Monarda didyma (Bergamot). H. P. Crimson flowers, fragrant foliage. 50

Moonflowers. See *Ipomea*.

Morning Glory. See *Convolvulus*.

Musa Ensete (Abyssinian Banana). Sub-tropical plant; very effective. 10 ft. 100 seeds, \$2.50, 25

Myosotidium Nobile (The Giant Forget-Me-Not of the Chatham Islands). Bears large heads of beautiful blue flowers, edged white; requires winter protection. Height 1 1/2 ft. 50

Myosotis (Forget-me-not). H. H. P. These beautiful little plants with star-like flowers bloom the first year if sown early. Fine for edgings and borders. Height 6 to 12 in.

BURNETT'S WINTER BLOOMING. Large flower, dark blue, recommended for Winter bloom 1.00
alpestris. Blue 1/4 oz. 75c., 10
ROYAL BLUE. Rich indigo-blue. 1/4 oz. \$1.00, 20

VICTORIA. Azure blue. Fine for pots. 6 in. 1/4 oz. \$1.00, 20

disstiflora. Sky-blue. 3/4 ft. 1/8 oz. \$1.00, 25
palustris. Blue 1/4 ft. 1/4 oz. 75c., 10
palustris semperflorens. Perpetual flowering. Bright blue. 6 in. 1/4 oz. \$1.00, 20

HYBRIDA RUTH FISCHER. Very large, pale blue flowers. 6 in. 50
Choice Mixed 1/4 oz. 50c., 10

Nemesia H. H. A. A splendid annual for Pkt. small beds, with very attractive flowers. The colors include, white, yellow, orange, pink and crimson. 1 ft.

STRUMOSA SUTTONI. **Finest Mixed.** 1/16 oz. \$1.00, 25
compacta, Blue Gem. Beautiful Forget-me-not blue 25
White Gem. Fine white 25
Fire King. Carmine scarlet 25
Orange Prince. Golden yellow 25
Dwarf Compact Hybrids. Compact bushes 9 in. in height, now greatly used for edgings to summer beds; great variety of new and improved colors and very free flowering.
Choice Mixture 1/16 oz. \$1.00, 25

Nemophila. Exceedingly beautiful, dwarf growing plants. H. A. 1/2 ft.
insignis. Clear, bright blue, white center. 1/4 oz. 25c., 10
Fine Mixed. All colors Oz. 50c., 10

NASTURTIUMS

TOM THUMB, OR DWARF

No annual will produce such a lavish profusion of flowers for so long a time with the same small outlay of time and labor. 1 ft. Pkt.

Aurora. Bright chrome-yellow, veined carmine Oz. 25c., 10
Chameleon. Cream white, spotted bright scarlet Oz. 25c., 10
Cloth of Gold. Yellow foliage, scarlet flowers Oz. 25c., 10
Crystal Palace Gem. Sulphur, maroon spots Oz. 25c., 10
Empress of India. Brilliant crimson, with dark tinted foliage Oz. 25c., 10
Golden King. Golden yellow Oz. 25c., 10
King Theodore. Dark green foliage, flowers nearly black Oz. 25c., 10
King of Tom Thumbs. Scarlet Oz. 25c., 10
Pearl. Creamy white Oz. 25c., 10
Dwarf Mixed 1/4 lb. 75c., oz. 25c., 10

Collection of 12 Dwarf varieties, 75c.

TALL OR CLIMBING VARIETIES

Elegant and luxuriant climbers for verandas, trellises etc. May be used to cover unsightly railings and to trail over rough ground with fine effect. 10 ft. Pkt.

Chameleon. Cream-white, spotted bright scarlet Oz. 25c., 10
Crimson. Velvety crimson Oz. 25c., 10
Jupiter. Rich golden yellow Oz. 25c., 10
Moonlight. Immense, creamy white flowers. Oz. 25c., 10
Scarlet. Bright scarlet, dark-leaved. Oz. 25c., 10
Salmon Queen. Salmon-rose Oz. 25c., 10
Yellow, Spotted Crimson Oz. 25c., 10
Tall, Finest Mixed 1/4 lb. 75c., oz. 25c., 10
Collection of 12 Tall varieties, 75c.

Lobb's Nasturtium (*Tropaeolum Lobbianum*). For vases, hanging baskets and rockeries. 8 ft. **Finest Mixed** Oz. 25c., 10

Nepeta Mussini. H. P. An invaluable border or rock plant always in flower. Lavender violet blooms, very freely produced. 1 ft. 25

Nertera (Madder-worts). H. P. **depressa.** Extremely pretty for pots or rockery, dense tufts, thickly studded with tiny scarlet berries, requires slight protection in severe weather, does best in light soil 25

Nicotiana. H. H. A. These plants produce clusters of long, tube-shaped flowers, fragrant toward evening. 3 ft.
affinis. White 1/4 oz. 35c., 10
affinis. Choice hybrids 1/4 oz. 50c., 15
Crimson King. Deep crimson 1/4 oz. \$1.00, 25
Sanderæ, Hybrids mixed 1/4 oz. 50c., 20

	Pkt.	
Nierembergia Gracilis. H. A. 6 in. Flowers white, shading to and veined lavender, an exceedingly graceful plant for hanging baskets, rockwork, etc.....	.15	
Nigella (Love-in-a-Mist). H. A. Beautiful border plants, with prettily cut foliage and curiously formed flowers. 1½ ft.		
MISS JEKYLL. Cornflower blue.		
¼ oz. 35c.,	.10	
MISS JEKYLL. White.....	¼ oz. 35c.,	.10
Finest Mixed	¼ oz. 30c.,	.10
Nycteria Capensis. H. H. A. Charming little plants for pots, edgings and rockwork. White with maroon, delightfully fragrant, flowers opening at night. 9 in.	.25	

Oenothera (Evening Primrose). Charming plants, with large and showy flowers. 2 ft.		
"Afterglow." H. A. Yellow with brilliant red calyx. Very attractive.....	.15	
Fraseri. H. P. Large yellow.....	.15	
"Clutei." H. B. This handsome new Evening Primrose is a native of Arizona. From a large rosette of basic leaves it throws up a stout central stalk 4 feet in height bearing in great profusion large flowers of a soft yellow hue.....	.35	
Oxalis H. H. P. Suitable either for greenhouse decoration, rockwork or rustic baskets out-of-doors. 1½ ft.		
rosea. Delicate rose.....	.25	
tropaeoloides. Deep yellow.....	.25	

BURNETT'S BEAUTIFUL PANSIES

The Pansy is undoubtedly the general favorite of all early Spring flowering plants, and no garden is complete without them. The finest blooms are obtained by sowing the seed in July or August, giving the plants protection during Winter, when they will bloom profusely the following Spring and Summer.

BURNETT'S SCOTTISH CHIEFTAIN

This magnificent monster-flowering strain of Pansies is the most remarkable in existence, not only in size, but in the wonderful variety of rich and brilliant colorings. The flowers are splendidly formed and of a beautiful velvety texture. The selection is the result of many years' devoted attention on behalf of this favorite flower by one of the most famous Scottish growers, and will be found by all who grow it to surpass all other strains in every respect. ¼ oz. \$4.00, ½ oz. \$2.50, Pkt. 75c.



Pansy, Scottish Chieftain

Burnett's Gorgeous. This select strain contains a most beautiful collection of colors and markings not found in any other mixture.....	¼ oz. \$3.00,	.50
Triumph of the Giants. Flowers extremely large, with beautiful markings. Mixed colors.....	¼ oz. \$2.50,	.50
Masterpiece (Frieded Pansy). Petals beautifully waved. Mixed colors.	¼ oz. \$2.00,	.25
Mme. Perret. Profuse bloomer, many fine colors, rich red shades.....	¼ oz. \$2.00,	.25

Orange King. The lower portion of the flower is of a vivid orange color, shading at the center to a lighter tone, a distinct creamy tint is to be seen in the upper petals.....	.25
--	-----

Giant Winter Blooming

These new Pansies are a great introduction, sown at the same time as other Pansies, they begin flowering early in March and continue to bloom right on into Summer. The flowers, in addition to being of giant size, have a pleasant delicate perfume.	¼ oz. Pkt.
Celestial Queen. Sky-blue.....	\$1.50 \$0.25
Ice King. White with dark blotch.....	1.50 .25
March Beauty. Dark velvety purple.....	1.50 .25
Winter Sun. Golden yellow, dark blotch.....	1.50 .25

Burnett's Special Greenhouse Mixture

This comprises all the superb forms and colors in our famous "Scottish Chieftain strain," and all the early flowering qualities for growing under glass.

⅓ oz. \$2.75; 1/16 oz. \$1.50; Pkt. 75c.

Pansies In Separate Colors

Adonis. Light blue.....	¼ oz. Pkt.	\$1.50 \$0.15
Azure Blue. Sky-blue.....	1.50	.15
Bronze Queen. Rich bronze.....	1.50	.15
Emperor. Ultramarine blue.....	1.50	.15
Fire King. Crimson and gold.....	1.50	.15
Giant Snow Queen. Pure white.....	1.50	.15
Giant White. White, purple eye.....	1.50	.15
Golden Queen. Pure yellow.....	1.50	.15
Giant Golden. Yellow, dark eye.....	1.50	.15
Giant, Striped. Mahogany, striped white.....	1.50	.15
King of the Blacks. Glossy black.....	1.50	.15
Lord Beaconsfield. Purple violet.....	1.50	.15
Royal Purple. Rich royal blue.....	1.50	.15
Victoria. Wine-red.....	1.50	.15
Choice Mixture of above colors,	Oz. \$3.00, 1.00	.10
Collection, 6 varieties, 75c., 12 varieties, \$1.25.		

VIOLA, OR TUFTED PANSIES

These Tufted Pansies are now considered indispensable for beds and borders. Seed sown in Spring commence to bloom in June, and continue to do so until frost.

"Blue Gem" (Jersey Gem). Pleasing deep violet blue. Blooms profusely for a very long period and resists drought better than any other viola. Comes about 70 per cent. true from seed.....	¼ oz. Pkt.	.35
Admiration. Dark blue, blotched.....	¼ oz. Pkt.	\$1.50
Lutea. Yellow.....		1.50 .20
Lutea Splendens. Orange.....		1.50 .20
Papilio. Lilac.....		1.50 .20
Perfection. Blue.....		1.50 .20
Purple Queen. Dark blue.....		1.50 .20
White Perfection. White.....		1.50 .20
Finest Mixed.....		1.25 .15
G. Wermig. (New.) Long stems, violet blue flowers.....		.50

PETUNIAS

For outdoor decoration or house culture few plants equal Petunia in effectiveness. They commence flowering early in Summer and continue throughout the whole season until killed by frost. Our strain of both the single and double varieties, which we endeavor to improve each year by careful selection, is the best procurable. H. H. A.

Giant Double Varieties

BURNETT'S DOUBLE FRINGED

Mixed. Flowers large; beautifully fringed, exquisite colors. Pkt. 50c.

Double Fringed White.....	Pkt.	.50
Double Fringed Pink.....		.50
Double Fringed Rose.....		.50
Double Fringed Purple.....		.50
Choice Double Mixed. All large double flowers, many of them fringed.....		.35
Collection, 6 Choice Double Varieties, \$2.50.		

Giant Single Fringed Varieties

Ruffled Giants. Mostly red and dark shades, richly marked and veined.....	Pkt.	.50
Giants of California. Mixture of pink and rose shades, fringed and ruffled, attractive deep throats.....		.50
Coppery Red. Attractive new Shade.....		.50
Pink Triumph. Clear bright pink delicately fringed.....		.50
Romany Lass. Deep crimson, purple throat.....		.50
Scarlet Beauty. Beautiful scarlet.....		.50
White Beauty. Very large, fringed.....		.50
Giant Single Mixed.....	1/16 oz.	\$2.50, .25

Dwarf Bedding Varieties

Carmen Sylva. Violet, white throat.....	Pkt.	
Countess of Ellesmere. Rose, white throat.....	¼ oz.	\$1.00, .25
General Dodds. Velvety blood red.....	¼ oz.	\$1.00, .25
Howard's Star (Improved). Velvety purple, pure white star.....	¼ oz.	\$2.00, .25
Rosy Morn. Pink, white throat.....	¼ oz.	\$2.00, .25
Rose of Heaven. Rose pink.....	¼ oz.	\$2.00, .25
Violet Queen. A magnificent bedding variety; color, rich violet blue.....	½ oz.	\$1.50 .50
Violacea. Deep violet.....	¼ oz.	\$1.50, .25
Snowball. Pure white.....	¼ oz.	\$1.00, .25
Striped and Blotched.....	¼ oz.	\$1.50, .25
Dwarf Bedding Mixed.....	¼ oz.	75c., .15



Petunia, Burnett's Double Fringed

Balcony Varieties

A splendid large and free single-flowering type either for window boxes, vases, hanging baskets, etc. The flowers average 3 inches across and make a very effective display over a long season.

Balcony Blue. Velvety indigo blue.....	¼ oz. Pkt.	\$1.50 \$0.25
Balcony Rose. Brilliant rose-pink; very effective.....	1.50	.25
Balcony White. Pure white.....	1.50	.25
Balcony Crimson. Rich velvety crimson.....	1.50	.25
Balcony Mixed.....	1.00	.15

Papaver. See Poppy.

Passiflora (Passion Flower). H. H. P.

Cœrulea. A useful climbing plant for the greenhouse, with attractive blue flowers... .25

Pentstemon. H. P. Plants highly ornamental, graceful in habit, used for borders. 3 ft.

Gloxinioides. This type flowers first season from seed.....		
Pink Shades. Very fine.....		.25
Sensation. Mixed. Flowers first season from seed.....	¼ oz.	75c., .15
Burnett's Giant Flowered Hybrids Mixed.....	1/16 oz.	\$1.00, .25

Perilla nankinensis. H. A. Foliage dark purple. 2 ft..... ¼ oz. 30c., .10

Perezia multiflora. H. P. Branching umbels of star-shaped flowers, of a clear porcelain blue..... .25

Phacelia campanularia. H. A. Bright blue bell-shaped flowers. One of the earliest annuals to bloom. 9 in..... .15



Poppy, Oriental

PHLOX DRUMMONDII

H. A. A splendid little flower for beds or massing, nothing surpasses these beautiful annuals. They produce immense trusses of large, brilliant flowers of numberless hues throughout the entire Summer and Fall. Our *grandiflora* varieties are noted for extreme richness of colors, brilliant effect and continuous blooming, which cannot be surpassed.

GRANDIFLORA VARIETIES:

- White. Pure white..... $\frac{1}{4}$ oz. \$1.00, .15
- Purple. Purple, white eye..... $\frac{1}{4}$ oz. \$1.00, .15

CHAMOIS-ROSE. Soft shade.

- Isabellina. Yellow..... $\frac{1}{4}$ oz. \$1.00, .15
- Crimson..... $\frac{1}{4}$ oz. \$1.00, .15
- rosea. Rose..... $\frac{1}{4}$ oz. \$1.00, .15
- Mixed.....Oz. \$2.50, $\frac{1}{4}$ oz. 75c., .10

- Star-Eyed (stellatus), Mixed. Large flowers, each having a white star.
 $\frac{1}{4}$ oz. 75c., .10

Collection of 6 varieties, 75c.

DWARF VARIETIES:

- Snowball. Pure white..... $\frac{1}{4}$ oz. \$1.00, .15
- Fireball. Bright red..... $\frac{1}{4}$ oz. \$1.00, .15
- Dwarf Mixed..... $\frac{1}{4}$ oz. 75c., .10

PERENNIAL, or Hardy. These grow about 3 ft. high and bear large heads of finely colored flowers.

- decussata, Mixed..... $\frac{1}{4}$ oz. \$1.00, .15
- Large Flowered Hybrids, Mixed.
 $\frac{1}{4}$ oz. \$1.25, .25

Physostegia virginica. (False Dragon-head.) H. P. The delicate pink flowers are carried on long stems and are much esteemed for cutting..... $\frac{1}{4}$ oz. 75c., .15

Virginia grandiflora alba. Large white flowers..... $\frac{1}{4}$ oz. \$1.00, .15

Physalis Francheti. H. P. (Chinese Lantern Plant). An ornamental plant, producing bright, orange-scarlet, lantern-like fruits. 2 ft. In Fall..... $\frac{1}{8}$ oz. 75c., .15

POPPIES

Of recent year the Poppy has become very popular and it may be safely said that no other flower produces a more brilliant display of color during the blooming period.

SINGLE ANNUAL VARIETIES:

- American Legion. Brilliant orange scarlet.
 $\frac{1}{4}$ oz. 50c., .10
- Flanders Field. The famous Scarlet Field Poppy of Flanders..... $\frac{1}{4}$ oz. 75c., .15
- Miss Sherwood. White, edged rose.
 $\frac{1}{4}$ oz. 35c., .10
- The Bride. Pure white, fringed. Beautiful variety..... $\frac{1}{4}$ oz. 50c., .10
- The Shirley "Wild Rose." Rose pink.
 $\frac{1}{4}$ oz. 35c., .10
- The Shirley "Apricot." Beautiful apricot pink..... $\frac{1}{4}$ oz. 35c., .10
- The Shirley. Mixed. Choice and delicate colors in our re-selected strain.
 $\frac{1}{4}$ oz. 35c., .10

DOUBLE ANNUAL VARIETIES:

- American Flag. Pure white ground, margined dark orange scarlet..... $\frac{1}{4}$ oz. 30c., .10
- Carnation Flowered. Mixed..... $\frac{1}{4}$ oz. 25c., .10
- Double Queen Poppies. A most lovely strain of the Shirley type, but double, of delicate and brilliant colors $\frac{1}{4}$ oz. 50c., .15
- Mikado (Japanese Poppy). White, fringed with rose..... $\frac{1}{4}$ oz. 30c., .10
- Paeony-Flowered Mixed..... $\frac{1}{4}$ oz. 25c., .10
- Ryburgh Hybrids. Bushy habit, carrying long-stemmed flowers in charming shades of flesh, salmon, orange, and various shades of rose and carmine..... $\frac{1}{4}$ oz. 50c., .15

PERENNIAL or HARDY POPPIES.

We are pleased to offer some very choice Oriental Varieties of recent European introduction. Height 2-3 ft.

- ORIENTALE APRICOT QUEEN (New). Beautiful apricot shade..... $\frac{1}{4}$ oz. 50c., .15
- Perry's White (New). White, tinged bluish..... $\frac{1}{4}$ oz. 75c., .15
- Mrs. Perry (New). Brilliant orange scarlet..... $\frac{1}{4}$ oz. 75c., .15
- Salmon Queen (New). Salmon pink..... $\frac{1}{4}$ oz. 75c., .15
- Scarlet. Scarlet, spotted black.
 $\frac{1}{4}$ oz. 50c., .15
- Mixed Hybrids. Very choice..... $\frac{1}{8}$ oz. 75c., .15
- Bracteatum. Brilliant scarlet..... $\frac{1}{8}$ oz. 75c., .10

NUDICAULE or Iceland Poppies.

- White, Scarlet or Yellow. Each $\frac{1}{4}$ oz. 75c., .15
- Mixed..... $\frac{1}{4}$ oz. 50c., .15
- Baker's Sunbeam. An improved and glorified strain; very large flowers..... $\frac{1}{4}$ oz. 75c., .15
- Coonara Pink. A delightful pink variety of recent introduction..... $\frac{1}{4}$ oz. 75c., .15
- Thibet. The flowers are brilliant orange, quite different from anything else that can be found in Nudicaule Poppies..... $\frac{1}{4}$ oz. 75c., .15
- Alpine, Mixed (Papaver Alpinum). H. P. A charming dwarf variety, producing a great profusion of flowers of elegant form, 6 inches, charming for rock work..... $\frac{1}{4}$ oz. 75c., .15
- California Poppy. See Eschscholtzia.

Platycodon wahlenbergia. H. P. (Jap. Bell Flower.) Handsome plants, bearing large, bell-shaped flowers in great profusion. May to October. 2 ft.

- Mariesi. Deep blue..... $\frac{1}{8}$ oz. 75c., .15
- grandiflora. Deep blue..... $\frac{1}{8}$ oz. 50c., .15
- grandiflora alba. Pure white..... $\frac{1}{8}$ oz. 50c., .15

Polemonium Coeruleum grandiflorum.

- H. P. (Jacob's Ladder or Greek Valerian.) Clusters of handsome blue flowers.
 $\frac{1}{4}$ oz. \$1.00, .15
- Grandiflorum album. Pure white.
 $\frac{1}{4}$ oz. \$1.00, .15

Pkt. PRIMULA—Continued

Polyanthus (*Primula elatior*). H. P.
Munstead Strain. A magnificent strain, producing wonderful shades of yellow as well as pure white flowers .50
Gold Laced. Brilliant colored flowers with distinct yellow edges .50
Choice Mixed .20

Portulaca (*Sun Plant*). H. A. This is one of our finest hardy annuals. A favorite for beds, edgings, rockwork, etc. ½ ft.
Single—Crimson, Golden Yellow, Rose, Scarlet, Striped, Primrose and White. Each, ¼ oz. 50c., .10
 ¼ oz. 35c., .10
Single Mixed Colors .10
Collection of 6 single varieties, 50c.
Double Mixed. Flowers perfectly double, including brilliant scarlet, crimson, white, yellow, etc. ¼ oz. \$1.25, .15
Collection of 6 double varieties, \$1.00.

Potentilla. Very fine hardy Perennial blooming from June to August. 1½-2 ft.
Single Mixed .15
Miss Willmott. (New.) Beautiful dwarf pink variety, excellent for rock work .25
Double Mixed .25

Primrose. (*Primula Vulgaris*). H. P.
 Amongst early Spring-flowering plants the hybrid Primroses occupy a prominent place; in style of growth they very much resemble the Common Yellow Primrose, but the flowers present a wonderful variety of charming colors. 6 inches.
Dean's Choice Hybrids, Mixed .50
Hybrid Blue. Shades vary from lavender to deep violet. The flowers are produced abundantly .50
Common Yellow. (*Primula Acaulis*.) Well-known charming single primrose. 6 in. ½ oz. \$1.50, .25

Primula. G. P. These beautiful flowers are indispensable for Winter or Spring decorations in the home or conservatory. They are one of our most important Winter blooming pot plants.
SINENSIS FIMBRIATA (*Chinese Primula*). Single large flowered, fringed.
White, Pink, Crimson, Salmon, Blue.
 Any of the above .1.00
Single Mixed. Choicest colors .75
Double Mixed .75

STELLATA (*Star Primrose*). A distinct and valuable variety for pot culture and table decoration.
Giant White Star .50
Giant Pink Star .50
Giant Blue Star .50
Giant Crimson Star .50
Giant Mixed Star .50

OBCONICA GIGANTEA. This improved strain of *Primula obconica* is vastly superior to the old type, the flowers being nearly twice as large, with many new and exquisite colors. The plants are of compact growth and bloom profusely during the winter months.
Giant White **Giant Crimson**
Giant Lilac **Giant Rose**
Giant Salmon **Mixed.** All colors.
 Any of the above .75

MALACOIDES.
Lilac. Light lilac .75
Rosea. Light rose .75
Superba. Deep rosy pink .75
Fimbriata. Lovely pink, delicately fringed .75
Pink Beauty. Beautiful rosy pink .75
Courtland's Seedling. Clear lilac pink, very brilliant .75

Pkt.

MALACOIDES.
Snow Queen. (New). Extremely floriferous, it is a vast improvement on the *Primula Malacoides Alba* hitherto grown, the flowers being much larger and of the purest white .75
Choice Mixed .50
KEWENSIS. Bright yellow fragrant flowers produced in whorls. Fine for Winter bloom.
FORBESII (*Baby Primrose*.) Small lavender-colored flowers .50

Primulas. Hardy Varieties.

Bullesiana Hybrids. These Hybrids are free flowering perennials, adapted both for out-door and greenhouse culture .50
Cashmiriana. A fine species with large globular heads of deep violet blue flowers; excellent for rockwork. 1 ft. .50
Cortusoides. A distinct Siberian species, with soft, wrinkled, heart-shaped leaves. Flowers deep rose. 10 in. .50
Denticulata Hybrids. Many new shades from white to lilac, rose purple and blue, twice the size of the type. 1 ft. .50
Pulverulenta, Bartley strain. A new strain of hardy *Primula*, embracing all shades of pink, rose, and blush .50
Florindae. This giant primrose stands 3 to 4 feet high with broad leaves, and bearing from June to August 60 to 80 terminal pendant flowers of a bright yellow shade .50
Japonica, Finest Mixed. Large flowers, varying in shade from white to crimson .25

Pueraria Thunbergiana. H. P. (*Kudzu Vine*). Strong, hardy climber. Grown chiefly for its foliage. 40 ft. .10

Pyrethrum (*Persian or Painted Daisy*).
 H. P. Delightful plants with daisy-like blossoms on long graceful stems. Single and double flowers ranging from pure white to light pink and crimson. June. 1-2 ft.
Roseum. Single Mixed Hybrids. ¼ oz. \$1.00, .15
Roseum. Double Mixed Hybrids. ½ oz. \$2.00, .25

Rehmannia angulata. H. P. *Gloxinia*-like flowers of rosy-purple with yellow throat. 3 ft. .25

Rhodanthe. H. H. A. Beautiful everlasting, or straw-flower, used for Winter decoration. 1 ft.
maculata. Pink, with crimson circle .10
maculata alba. Pure white .10
Manglesii. Brilliant rose .15
Finest Mixed .15

Ricinus (*Castor Oil Plant*). H. H. A.
 Highly ornamental plants of stately growth and picturesque foliage, with brilliant-colored fruit, producing a sub-tropical effect.
borboniensis. Dark green foliage. 15 ft. Oz. 40c., .10
Gibsoni. Dwarf branching; deep red foliage. 5 ft. Oz. 40c., .10
cambogensis. Main stem and leaf stalks; shining ebony; leaves richly colored. 5 ft. Oz. 40c., .10
sanguineus. Red foliage. 8 ft. Oz. 40c., .10
zanzibarensis, Mixed Oz. 50c., .10
Finest Mixed. All varieties Oz. 30c., .10

Rocket, sweet (Hesperis). H. P. Excellent for naturalizing among shrubbery. Pkt.

Purple	¼ oz. 35c.,	.10
White	¼ oz. 35c.,	.10
Mixed Colors	¼ oz. 35c.,	.10

Romneya coulteri (California Tree Poppy). H. H. P. Large, single white flowers, centers yellow. 3 ft.25

Rudbeckia (Cone Flower). Very popular border plants.

bicolor superba . H. A. Bright yellow, with purple center. 1½ ft.	¼ oz. 50c.,	.10
hirta . (Black-eyed-Suzan.) Golden yellow. 3 ft.15
Purpurea Grandiflora . (Purple cone flower.) 4 ft.15
Newmanii . H. P. Large, golden yellow, with velvety maroon center. 2 ft.	¼ oz. 50c.,	.10

Saintpaulia ionantha. G. P. A very interesting plant, about 4 inches in height, easily raised from seed. Its deep violet-blue flowers are produced with great freedom throughout the winter.50

SALPIGLOSSIS

Large-Flowering or Emperor (H. H. A).

This is one of our most beautiful and popular annuals, producing a wealth of bloom from early Summer until late Fall. Blossoms of orchid-like appearance, with veins of gold and silver running through the flower. They are highly prized, either as a cut flower or for forming gorgeous beds. Seeds may be started indoors or sown in the open, after all danger from frost is past. 1½ ft.

			Pkt.
Light Blue and Gold	¼ oz. \$1.00,	\$0.15	
Crimson and Gold	¼ oz. \$1.00,	.15	
White and Yellow	¼ oz. \$1.00,	.15	
Dark Red	¼ oz. \$1.00,	.15	
Rose and Gold	¼ oz. \$1.00,	.15	
Yellow	¼ oz. \$1.00,	.15	
Violet and Gold	¼ oz. \$1.00,	.15	
Finest Mixed	¼ oz. 75c.,	.10	
Collection of 6 varieties, 75c.			

SALVIA (Scarlet Sage)

Salvia has long been a favorite bedding plant, bearing long spikes of flowers in great profusion from July till frost; blooming the first year from seed.

			¼ oz. Pkt.
BURNETT'S "FOREST FIRE." For effect Forest Fire is unsurpassed. The plant when in full bloom, is about 3 feet high. The individual spikes, which are of a brilliant scarlet, measuring 6 inches across.	\$2.00	\$0.25	
America or Globe of Fire. Of dwarf, bushy, compact growth, and very uniform in height.	2.00	.25	
Bonfire or Clara Bedman. Of dwarf, compact habit. Erect spikes of brilliant scarlet flowers. 2 ft.	1.50	.15	
Dwarf Fireball. The most compact type. 1½ ft.	1.50	.15	
Harbinger. (New.) Very early; dwarf compact habit with brilliant scarlet flowers. 18 in.25	
Splendens. Beautiful bright scarlet. 3 ft.	1.00	.10	
Zurich is the dwarfiest of the Salvias, never exceeding 18 inches in height. The plants are robust and compact, flowers brightest scarlet.	2.00	.25	



Salpiglossis, Emperor Large Flowering

BLUE SALVIAS

Azurea Grandiflora. H. P. Pretty sky blue flowers in great profusion; 2 to 3 feet	1/8 oz.	Pkt.	\$1.00	\$0.25
Farinacea. H. P. but best grown as an annual; light blue flowers on long spikes. 2 to 3 ft.75	.25
Patens (Blue Sage). H. H. P. A beautiful plant for the border or greenhouse; 2 feet.			1.25	.25
Scleara. An attractive, hardy biennial, with mauve and silvery spikes of flowers, 2 ft.50	.15
Saponaria. vaccaria. H. A. Splendid tall growing variety of branching habit. Light graceful sprays of pale rose flowers in great profusion; 2½ ft.30	.10
Calabrica. H. A. Small starry pink flowers, admirable for bedding or massing. 9 in.35	.10
Ocymoides splendens. H. P. Elegant trailing perennial with pretty rose-colored flowers suitable for rockeries.	¼ oz.	35c		.15
Sanvitalia. Procumbens, Double. H. A. Charming dwarf plant, very suitable for edgings, flowers yellow with dark centre. 4 in.25

SCABIOSA (Sweet Scabious)

One of the handsomest border plants, producing large, double flowers in a great variety of shades and colors. 2½ ft.

LARGE-FLOWERING ANNUAL VARIETIES

Peach Blossom. (New.) A beautiful shade of peach blossom pink. Large size and long stems. An excellent cut flower.....	Pkt.	
Shasta. (New.) A pure white of enormous size. The flowers measuring 3½ in. across, with extremely long stems.....		.25
Azure Fairy. Heavenly blue.....	¼ oz. Pkt.	\$0.50 \$0.15
Flesh Color. Delicate tone of pink.....		.50 .15
King of Blacks. Velvety black purple.....		.50 .15
King of Scarlets. Fiery Scarlet.....		.50 .15
Lilac.50 .15
Rose. Soft rose color.....		.50 .15
Snowball. Pure white.....		.50 .15
Yellow. Sulphur yellow.....		.50 .15
Mixed. All colors.....	Per oz.	1.50 .10
Collection, 6 varieties, 75c.		
Dwarf Double Mixed	Oz.	75c., .10

HARDY PERENNIAL VARIETIES

Handsome border plants flowering the entire season.

Caucasica. House's Sensational Strain. See Novelties.	Pkt.	
"columbaria" (Rosy Mauve.) A charming and unique shade.....		.25
"columbaria" (Delicate Mauve).....		.25
Caucasica. Soft blue; 3 feet.....	¼ oz.	\$1.00, .15
Caucasica Alba. Pure white.....	¼ oz.	\$1.25, .25
Japonica. Lavender blue.....		.25

Schizanthus (Butterfly Flower). G. P.

Elegant, free-flowering Annuals; of easy culture, bearing a profusion of pretty butterfly-like flowers of various colors, resembling some species of orchids. Can also be used for summer bedding.

Wisetonensis "Excelsior." An improved Wisetonensis, with markings and colors of a fancy Pelargonium. The flowers have white, buff or rose ground.	Pkt.	
.....	1/16 oz.	\$1.50, .50
"Pink Pearl." Of elegant pyramidal habit, producing a luxuriant wealth of bloom. In the flowers the glistening white of the corolla is set off by a broad rosy-pink margin.....		.50
"Snowflake." Very compact habit, with a profusion of glistening snowy-white flowers.....		.50
Dr. Badger's Hybrids. An improved strain containing many lovely shades. Flowers of great substance, produced in large quantities for quite a long period.....		.50
Grandiflorus, Garraway's Hybrids. Invaluable for cutting and for conservatory. Beautiful large flowers of fine form and great range of colors.....		.50
Hurst's Monarch Strain. One of the finest strains of large-flowered hybrids in existence, embracing a wide range of colors.....		.50
Rose and Amber Shades. Pink and rose tints, most heavily blotched gold and bronze.....		.50
Grandiflorus Hybrids Mixed	¼ oz.	50c., .10
Sedum acre. H. P. Trailing plant forming a regular green carpet. Flowers bright yellow. 4 in.....		.25
Mixed Varieties. Most useful plants for covering rock or old walls; the flowers are very varied in color. 4 in.....		.25
Sensitive Plant G. P. (Mimosa pudica). Very interesting plants; the leaves, when touched, instantly fold up. 1 foot.....		.15
Sidalcea, New Hybrids. H. P. Great range of color, including shades of rose, pink, red, salmon, lilac and heliotrope. 2 ft.....		.25
Rosy Gem. Beautiful deep rose, free flowering perennial, profuse bloomer.....		.25



Scabiosa, Annual Varieties

Silene (Catchfly). H. A. Free blooming pretty plants.	Pkt.	
armeria. 3 ft. Mixed.....	¼ oz.	25c., .10
pendula. 1 ft. Dwarf rose.....	¼ oz.	25c., .10
alpestris. H. P. Delightful little white rock plant of easy culture.....		.25
Smilax (Myrsiphyllum asparagoides). G. P. One of the most useful climbers, for floral decorations.....	¼ oz.	30c., .10
Solanum capsicastrum. G. P. (Jerusalem Cherry.) Of dwarf, branching habit, bearing bright scarlet, globular berries. Very ornamental. 1 ft.....		.15
Statice (Sea Lavender). H. A. Flowers can be dried and used for Winter bouquets.		
Bonduelli. Golden yellow.....	¼ oz.	40c., .10
suworowii. Beautiful soft rose.....	¼ oz.	75c., .25
sinuata, True Blue. A fine strain with rich, deep blue flowers.....	¼ oz.	50c., .25
sinuata, rosea superba. Fine bright rose.	¼ oz.	50c., .25
Mixed. Containing many sorts.....	¼ oz.	25c., .10
latifolia. H. P. Lavender-blue.....	¼ oz.	50c., .15
Stevia Serrata. G. P. Graceful sprays of white flowers valuable for cutting. 2 ft.		
.....	¼ oz.	75c., .15
Stokesia cyanea (Stoke's Aster.) H. P. Flowers large and handsome. 12 to 18 in.		
Blue.....	¼ oz.	\$1.00, .15
cyanea alba. A pure white form.	¼ oz.	\$1.25, .15
Streptocarpus hybridus. G. P. A new hybrid race of the Cape Primrose, the flowers somewhat resembling those of the Gloxinia, but smaller.		
Choice Mixed50
Sunflower See Helianthus.		

GIANT SPENCER SWEET PEAS

"Burnett's Magnificent Selection"

The list of Sweet Peas offered below includes the finest and most distinct varieties to date, and has been carefully compiled from our records and from notes on all those which gained awards at the leading Horticultural Shows.

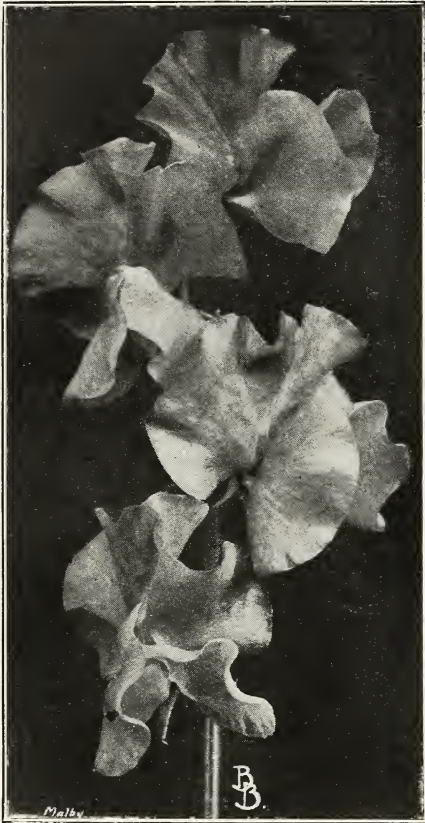

	Oz.	Pkt.
ANGELE. Blue-mauve, suffused pink	.50	\$0.10
ANNIE IRELAND. Color white, with edge of terra-cotta pink	.50	.10
AUSTIN FREDERICK IMPROVED. A beautiful lavender, flowers of great size, carrying four blooms well placed on long stout stems	.50	.10
AVALANCHE. A very fine white with flowers of largest size, great substance and beautifully frilled	.75	.15
BONFIRE. Standards bright cherry-pink, wings cream, lightly veined with pink, abundance of four and five flowered sprays	.60	.15
CHARITY. Color rich brilliant crimson. The standard is large and bold	.50	.10
CHIEFTAIN. In size of flower, length of stem and purity of color, this is a marked advance on other mauve varieties. The plant is most robust in growth and produces very long stems, bearing four to five large perfectly-formed blossoms of a pure satiny mauve	.75	.15
COMMANDER GODSALL. Violet-blue, plant is very vigorous, throwing four and five bloom sprays on long stems.	.50	.10
CONSTANCE HINTON. A very fine black-seeded, white flowered variety of largest size	.50	.10
EDNA MAY IMPROVED. A grand white of great substance and purity, the finest of its color	.60	.15
ELEGANCE. Soft pure silvery-lilac, with pink flush, one of the best	.50	.10
GEORGE SHAWYER. Standard orange-salmon, wings more rosy-tinted. The plant is very robust and produces long strong stems, carrying four, nicely placed, beautifully waved flowers of perfect form	.60	.15
GLORIOSA. The finest and most brilliant Sweet Pea yet obtained. Produces freely, four-flowered sprays of the largest size. The color is fiery orange scarlet, with scarlet sheen	.75	.15
GOLD CREST. Color glowing orange combined with a rich tint of salmon, subtly and perfectly merged into gold. Flowers of largest size and fine substance	.60	.15
HAWLMARK CERISE. Glowing rose cerise on cream ground, beautifully waved	.50	.10
HAWLMARK LAVENDER. A true, clear light lavender with flowers of the largest size	.50	.10
HAWLMARK PINK. Rich bright rose-pink, deeply flushed and shaded salmon, flowers beautifully frilled	.50	.10
HEBE. A large bright pink, with all the vigor of Hercules, but richer in color and broader in the standard	.50	.10
JACK CORNWALL, V. C. The finest navy blue. A very vigorous grower.	.50	.10
JEAN IRELAND, IMPROVED. Creamy buff, standards margined carmine rose	.50	.10
MARGARET ATLEE IMPROVED. A glowing rose-pink on cream ground. Of immense size and exquisite form.	.50	.10
MARY PICKFORD. Color light and dainty cream pink with the faintest suffusion of apricot, a vigorous grower, the flowers perfect in form, beautifully waved and well placed	.75	.15
MATCHLESS. Very fine deep cream, flowers of largest size, fine substance and beautifully frilled, sweetly scented, a very popular variety	.50	.10
MRS. TOM JONES. The best bright blue	.50	.10
PEGGY. Brilliant cerise flushed orange. Flowers of large size, full of substance, and well placed on the stem	.60	.15
PINKIE. A large and lovely deep rose pink, the flowers being free from the blueness of others in this shade, and make a glorious bunch. It is a vigorous grower, giving abundance of bloom	1.00	.25
POWERSCOURT. A very fine lavender. Its characteristics are purity of color, refinement and size of flower, and length of stem. Many growers consider this to be the finest of its color	.50	.10
RENOWN. Carmine rose, beautifully waved, very large in size	.50	.10
R. F. FELTON. Soft, pleasing shade of lavender suffused with rose	.50	.10
ROYAL PURPLE. A beautiful shade of rich, royal purple	.50	.10
ROYAL SCOT. The last word in scarlet. Of a most brilliant hue	.60	.15
SPLENDOUR. Rich red maroon. This variety resembles Warrior in size and vigor, but without a trace of purple	.50	.10
SUNSET. Standard bright rose flushed with glowing cherry red; wings bright rose with cream base	.50	.10

SUPREME. Beautiful clear pink. The flower excels in size, and is of perfect form	Oz. .60	Pkt. .15
TANGERINE IMPROVED. This is the last word in orange-colored Sweet Peas60	.15
VALENTINE. Of vigorous habit with large flowers of a pleasing shade of light pink60	.15
WARRIOR. Rich chocolate-maroon50	.10
YOUTH. Exquisite pink picotee edge on a pure white ground, the delicately tinted white keel also blends beautifully with the whole flower, delightfully perfumed60	.15

**Burnett's Superb Mixture
Giant Spencer Sweet Peas**

This mixture is blended by ourselves from the best of the Spencer varieties and contains every desirable color in Sweet Peas, carefully balanced so as to present a color effect of superb beauty.

Pkt. 10c., oz. 30c., ¼ lb. \$1.00, 1b. \$3.00

**BURNETT'S PRIZE-WINNER
COLLECTION**

1 pkt. each 25 Choice Named Varieties, our selection\$2.50

**BURNETT'S EXHIBITOR'S
COLLECTION**

1 pkt. each 12 Choice Named Varieties, our selection\$1.50
 ¼ oz. each 12 Choice Named Varieties, our selection\$2.50
 ½ oz. each 12 Choice Named Varieties, our selection\$3.75
 1 oz. each 12 Choice Named Varieties, our selection\$7.00



Sweet Pea, Winter Flowering

EARLY GIANT SWEET PEAS

Winter Flowering

A valuable race of early-flowering Sweet Peas, which from an August sowing in pots will give an abundance of bloom under glass from Christmas onwards. On account of their delicious perfume, Sweet Peas are particularly welcome during the dark days of Winter.

	Oz.	Pkt.		Oz.	Pkt.
Early Blue Bird. A charming shade of blue	\$1.00	\$0.25	Lavender King. A rich true deep lavender throughout. The fragrant flowers are of large size and beautifully waved form	1.00	.25
Early King (Improved). A glowing, rich, bright crimson of great size	1.00	.25	Mrs. Kerr. The best Early Flowering salmon Sweet Pea in existence. Large, well waved blooms carried gracefully on long stems	1.50	.25
Early Snowflake. Pure white	1.00	.25	Pink Profusion. A sparkling shade of rich pink which must be seen to be appreciated. The flowers are large, well formed, with both the standard and the wings attractively waved and crinkled	1.50	.25
Burpee's Orange. The most outstanding orange Sweet Pea. It is a clear, pure orange self	1.50	.25	Snowstorm Improved. This is by far the finest of all white Winter-Flowering varieties. The flowers are extra large and of fine form	1.00	.25
Gilda Gray. The standard is a lovely shade of salmon-cerise overlying a bright pink. Blooms freely and continuously, bearing mammoth size blooms on substantial stems	1.50	.25	True Blue. A charming shade of true blue; a color much in demand. Of great size, excellent form, free blooming, long stemmed and of heavy texture	1.00	.25
Glitters. Glitters and scintillates, with a fire-like sheen radiating over the flowers. The standard is a bright fiery orange and the wings are deep orange	1.00	.25	Yarrowa. Color a pleasing shade of bright rose pink with lighter wings	1.00	.25
Imperial Pink (New). A clear pink of enormous size, of vigorous growth, long stems, giving an abundance of bloom over a long period	3.00	.50	Zvolanek's Rose. One of the best in the rose-pink class. The flowers are large and bold	1.00	.25
Jeanne Mamitsch. One of the most notable introductions; flowers large, on long stems; color, a beautiful shade of rose pink	1.50	.25	Mixed75	.15

Any variety not listed will be procured to order at advertised prices.

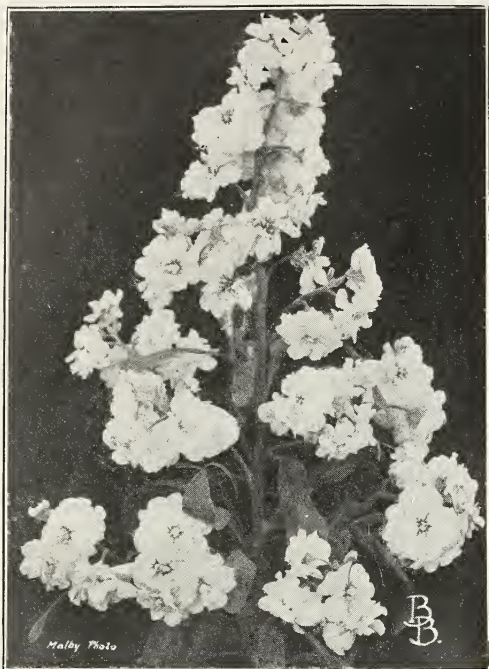

Stock, Burnett's Perpetual White

STOCKS (Gilliflower)

The charming colors, delightful fragrance, and free-blooming character of the stocks have made them favorite plants for both Summer and Winter cultivation.

GIANT PERFECTION, TEN WEEKS

Excellent bedding variety, forming splendid plants of pyramidal growth, and branching habit.

Chamois Rose, Flesh Color, Rose, Crimson, Light Blue, White, Canary Yellow, Dark Blue, Choice Mixed..... Each, $\frac{1}{8}$ oz. \$1.00, \$0.15

Collection of 6 varieties, 75c.

EARLY GIANT IMPERIAL (Improved Bismarck). An especially meritorious class. Growing from twenty-four to thirty inches tall; of branching habit. Very early blooming and producing a high percentage of doubles.

Blood Red, Yellow, Chamois, Dark Blue, Flesh, Lavender, Rose, White, Mixed. Each of the above $\frac{1}{8}$ oz. \$1.50 .25
Collection, six of above colors, \$1.25.

"Golden Rose." (New.) See Novelties.

"Antique Copper." (New.) See Novelties.

DRESDEN PERPETUAL

Useful for outdoor bedding as well as for pots or cut-flowers. They throw out numerous side branches, all bearing very double, fragrant flowers.

	$\frac{1}{8}$ oz.	Pkt.
Brilliant. Blood-red	\$1.50	\$0.20
Creole. Yellow	1.50	.20
Deep Rose. Very fine	1.50	.20
Delicate Flesh. Pink	1.50	.20
La France. White and carmine	1.50	.20
May Queen. Pale blue	1.50	.20
Princess Alice. Pure white	1.50	.20
Rose	1.50	.20
Finest Mixed	1.50	.20
Collection, 6 varieties, \$1.00.		

WINTER FLOWERING or BEAUTY STOCKS

These are extremely handsome and useful pot plants and cut flowers for Winter and Early Spring use.

	$\frac{1}{8}$ oz.	Pkt.
Burnett's Perpetual White. For forcing purposes this Stock is unrivaled.....	\$1.50	\$0.25
Beauty of Nice. Delicate pink.....	1.25	.25
Crimson King. Rich crimson.....	1.25	.25
Empress Augusta Victoria. Rich blue.....	1.25	.25
Empress Elizabeth. Deep rose.....	1.25	.25
Mont Blanc. Purest white.....	1.25	.25
Queen Alexandra. Fine lilac.....	1.25	.25
Salmon King. (New.) Bright salmon rose	1.50	.25
Soleil de Nice. Purest sulphur yellow.....	1.25	.25
Summer Night. Deep blue.....	1.25	.25

SWEET WILLIAM

Dianthus Barbatus. H. P. For richness and variety of color, this old-fashioned flower is unsurpassed; very fragrant.

Burnett's Diadem. Beautiful rich deep crimson with white eye..... $\frac{1}{4}$ oz. 75c., .15

Giant White. Pure white..... $\frac{1}{4}$ oz. 75c., .15

NEWPORT PINK. A distinct color, excellent for bedding and cutting.

$\frac{1}{4}$ oz. \$1.00, .15

Pink Beauty. Fine deep pink..... $\frac{1}{4}$ oz. \$1.00, .15

Scarlet Beauty. Rich scarlet..... $\frac{1}{4}$ oz. \$1.00, .15

Holborn Glory. (Auricula-eyed.) Superb range of colors..... $\frac{1}{4}$ oz. 50c., .10

Single Fine, Mixed..... $\frac{1}{4}$ oz. 30c., .10

Double Fine, Mixed..... $\frac{1}{4}$ oz. 50c., .15

Tagetes. H. A. Fine for edging. 1 ft. *signata pumila.* Yellow striped..... $\frac{1}{4}$ oz. 50c., .10

Tecoma smithii. G. P. Exceedingly beautiful autumn and early winter flowering plant, with large heads of orange-colored tubular-shaped blossoms. 18 inches..... .50

Thalictrum adiantifolium. H. P. A graceful plant with finely cut foliage resembling the Maidenhair fern; extensively used for bouquets..... .15

diptercarpum. Graceful species with pretty rosy-purple flowers..... .25

Thunbergia H. H. A. Rapid-growing climbers used extensively in hanging baskets, vases, etc. 5 ft.

Choice Mixed $\frac{1}{4}$ oz. 35c., .10

Torenia Beautiful plants, used for beds, pots or hanging baskets. H. H. A. 1 ft.

Fournieri Grandiflora. Blue and violet, throat bright yellow..... $\frac{1}{16}$ oz. 75c., .25

Bailioni. Golden yellow, red throat..... .25

Tithonia Speciosa (Mexican Sunflower). H. H. A. Tall-growing plant with rich orange-red flowers of a very telling color. 6 ft..... $\frac{1}{4}$ oz. 75c., .25

Trachelium coeruleum. H. P.; G. P. A free flowering plant producing cloud-like heads of pale mauve flowers resembling the Gypsophila. $\frac{1}{2}$ ft..... .15

Tritoma (Torch Flower, Red Hot Poker). **Stark's Hybrids.** H. P. New perpetual-flowering class which blooms from June to October. The colors embrace yellows and salmons to deep crimson. 2 to 4 ft. .25

Trollius Europæus. (Globe Flower.) H. P. A large-flowered variety of the buttercup with bright yellow globular flowers, 2 ft. $\frac{1}{8}$ oz. 60c., .15

Tropaeolum canariense (Canary Bird Vine). H. H. A. Yellow flowers. 10 ft. $\frac{1}{4}$ oz. 25c., .10

- Valerian** (Garden Heliotrope.) Pkt.
 H. P. Showy, hardy perennials, admirable for wild gardens and rockwork. 2 ft.
Rubra. Bright red flowers in panicles15
White. A white form of the above15

- Verbascum Harkness Hybrids.**
 H. P. Immense spikes, well furnished with large, pure yellow flowers during the whole Summer. 5 ft.25

VERBENA H. H. A.

- Burnett's Mammoth.** A magnificent new strain of Verbenas, of robust compact habit and free blooming. The trusses are immense, the individual florets measuring an inch and over in diameter.
Blue, Pink, Purple, Scarlet, White, Yellow, Mixed.
 Any of the above..... ¼ oz. 75c., .15
 Collection, 6 colors, 75c.
Auricula-eyed. Large flowered Choice Mixed..... ¼ oz. \$1.00, .25
Colossea. Large flowers in huge umbels; rose shades..... .25
Etna. Large trusses of intense Paul Crampell geranium red with a small creamy yellow eye25
Helen Willmott. The color is a delightful salmon pink; robust growth and very free flowering..... ¼ oz. \$1.00, .25
Lucifer. A variety of large size; color deep cardinal scarlet. ¼ oz. 75c., .15



Verbena, Burnett's Mammoth

VARIOUS VERBENAS:

- Erinoides** (Moss Verbena). H. A. Forming elegant little spreading bushes with finely cut foliage and pretty heads of purplish rose ¼ oz. 50c., .15
Venosa (Hardy Garden Verbena). H. P. This variety is largely used for bedding purposes; purple flowers..... ¼ oz. 75c., .15
Lemon Scented (Aloysia Citrodora). G. P. An old favorite plant with delightful lemon-scented foliage15

- Veronica.** H. P. Fine plants of pyramidal habit for late summer and autumn bloom. 1½-2 ft.
longifolia. Long spikes of rich blue flowers ¼ oz. 75c., .15
spicata. Bright blue flowers..... ¼ oz. 75c., .20

- Vinca** (Periwinkle). H. H. P. Ornamental, free flowering plants, excellent for bedding. 1½ ft.
rosea. Rose, very pretty ¼ oz. 60c., .15
rosea alba. White, with pink eye..... ¼ oz. 60c., .15
alba pura. Pure white..... ¼ oz. 60c., .15
delicata. Delicate pink25
Finest Mixed ¼ oz. 60c., .15

Viola. See Pansy.

- Viscaria.** (Rock Lychnis.) H. A. Showy and profuse-blooming, effective in small beds or borders. 1 ft.
Blue Gem. Light ultramarine blue..... .25
Fire King. Beautiful bright Scarlet..... .25
Rosy Gem. Bright Carmine Rose..... .25
Mixed ¼ oz. 25c., .10

- Virginia Stocks** H. A. ½ ft. Fine for borders and rock work. Mixed..... ¼ oz. 25c., .10

- Wallflower.** H. H. B. Well known deliciously fragrant flowers. Pkt.
Single Large Flowering.
Blood-Red, Golden Yellow, Mixed.
 Each, ¼ oz. 50c., .10
Double Large Flowering, Mixed. ¼ oz. \$1.25, .25
Kewensis. See Cheiranthus.
Allioni. See Cheiranthus.
Single Annual. Flowers throughout Summer and Fall, from seed sown in Spring. Finest Mixed ¼ oz. 50c., .15
Double Annual "Early Wonder." Flowers within four to five months after sowing; height 2 to 2½ feet, its long main spike is thickly covered with large double blossoms. **Mixed colors**35

- Xeranthemum** (Everlasting). H. A. This well-known, hardy annual is one of the oldest and prettiest of the Everlasting Flowers for Winter use. Fine for beds and borders. 1½ to 2 ft.
Double Mixed ¼ oz. 50c., .10

- Zea** (Striped Japanese Maize). H. H. A.
 A very graceful and attractive foliage plant. 6 ft.
japonica variegata Oz. 30c., .10

WILD GARDEN FLOWER SEEDS

For beautifying unsightly places or sowing broadcast, nothing approaches this mixture for effect and cheapness. No care is necessary, and a never-ending succession of bloom and fragrance can be obtained throughout the entire summer and Fall. Highly recommended for Bees and for cutting.

Pkt. 10c., oz. 25c., ¼ lb. 75c.

BURNETT'S GIANT ZINNIAS

These magnificent Zinnias have created a sensation for the past few seasons by all who grew them. The flowers are of enormous size, measuring from 4 to 6 inches in diameter. The plants are of strong, luxuriant growth, 2 to 3 feet high. In this grand new type of Zinnias there are a great many shades and colors, some of which are not desirable but our selection offered below embraces the largest, choicest and most pleasing in every respect.

BURNETT'S GIANT

	Oz.	¼ Oz.	Pkt.
GIANT APRICOT-ORANGE	\$2.50	.75	.15
GIANT WHITE	2.50	.75	.15
GIANT CRIMSON	2.50	.75	.15
GIANT PURPLE	2.50	.75	.15
GIANT SALMON-ROSE	2.50	.75	.15
GIANT SCARLET	2.50	.75	.15
GIANT FLESH COLOR	2.50	.75	.15
GIANT YELLOW	2.50	.75	.15
GIANT MIXED	2.00	.60	.10

Collection—Eight distinct colors, \$1.00.

Giant Mammoth Type (New)

The petals of these new Zinnias are decidedly imbricated and from the flower bud to the full bloom, present a very graceful appearance.

	Pkt.
Cerise Queen. Beautiful cerise pink	.25
Lemon Queen. Pale yellow	.25
Orange Queen. Golden yellow	.25
Furty. Pure white	.25
Rose Queen. Striking bright rose	.25
Scarlet Gem. Glowing scarlet	.25

Giant Rose King

Of a beautiful carmine-rose tint. The flowers are of immense size, probably surpassing those of any other Zinnia. ¼ oz. \$1.00, Pkt. 25c.

Giant Picotee

Resembling picotee Carnations. This fine variety has been pronounced the most attractive thing in Zinnias.

All colors mixed. ¼ oz. \$1.00, Pkt. 25c.

Giant Achievement

(Cactus Flowered)

Is distinct from all other Zinnias hitherto raised by the shape of its petals, which are partially tubular at the base and expand in a Cactus-like form toward the tip.

Choice mixed, ¼ oz. \$1.00; Pkt. 25c.

Zinnia, Giant Victory

A very distinct variety with large double quilled flowers, the colors are mostly in russet, orange, old rose and other autumn tints.

Finest Mixed: ¼ oz. \$1.00, pkt. 25c.

Zinnia Elegans.

	Oz.	Pkt.
Dwarf Double Mixed	\$1.00	.10
Tall Double Mixed	\$1.00	.10

Giant Dahlia-Flowered

The flowers of this superb type often measure 4 in. in depth and 6 to 8 in. in diameter. In general appearance, they compare with Show Dahlias.

	¼ oz.	Pkt.
Crimson Monarch. Bright red	\$1.00	\$0.25
Dream. A fine, deep lavender, turning to purple	1.00	.25
Exquisite. Light rose	1.00	.25
Golden State. Rich orange-yellow	1.00	.25
Illumination. Deep rose, self color	1.00	.25
Oriole. Orange and gold, immense size	1.00	.25
Polar Bear. Large, pure white	1.00	.25
Scarlet Flame. A large, beautiful, bright scarlet	1.00	.25
Dahlia Flowered Mixed	.75	.20

Collection, 1 pkt. each of above 8 varieties, \$1.50.



Burnett's Giant Zinnias

DAHLIAS

Recent and Popular Introductions

The following list comprises the most recent novelties of well-known and reliable growers, and the fact that many of them have received awards from the American Dahlia Society, and have been prize winners at leading shows, is ample evidence of points of superiority over existing varieties. We are sure they will give satisfactory results either in the home garden or in competitive exhibition.

ABBREVIATIONS USED: H. C.—Hybrid Cactus; Dec.—Decorative; H. D.—Hybrid Decorative; C—Cactus; H. S.—Hybrid Show; P—Peony-flowered.

NOTE—Varieties marked thus () are offered for the first time, 1929.*

AMBASSADOR (C) Soft yellow buff, shaded salmon pink. Huge flowers on splendid stems.
Tubers only, \$1.00

AMARANTHUS (Dec.) Amaranthus-pink, very large flowers, good stems.
Tubers, \$7.50; Plants, \$1.25

ANDREAS HOFER (H. C.) One of the most beautiful of the new Dahlias. Color is a glowing light pink, with a salmon-rose suffusion. The blooms are held erect on long stiff stems.
Tubers, \$2.50; Plants, \$1.25

BETTY IVINS (Dec.) Color rich salmon, overlaid with an amber glow, showing a rosy pink reverse. Stems stiff and long.
Tubers, \$7.50; Plants, \$3.75

COL. CHARLES A. LINDBERGH (H. C.) A huge flower of a beautiful rose "du Barry" shade, overlaid and suffused with old ivory, shading off to pale gold at center. Reverse of petals light carmine pink. An early and free bloomer.
Tubers, \$7.50; Plants, \$3.75

DERRILL W. HART (Dec.) Capucine yellow, shading to grenadine red; in cool weather almost copper color. The large, well formed flowers of this variety are held erect on fine stems.
Tubers, \$10.00; Plants, \$5.00

EAGLE ROCK BEAUTY (Dec.) Large flower of exquisite form and great substance; color a pleasing blend of pink and cream.
Tubers, \$5.00; Plants, \$2.50

EAGLE ROCK GEM (C) Maize yellow, shaded orient pink. This is certainly the finest shaped, strong stemmed Cactus Dahlia yet produced.
Tubers, \$15.00; Plants, \$7.50

EDNA FERBER (H. C.) A wonderful large flower, with curled and twisted petals, full to the center. Color is a distinct salmon-orange, with old gold center.
Tubers, \$5.00; Plants, \$2.50

ELITE GLORY (Dec.) The giant of great Dahlias. Color is a pure brilliant rich red. A wonderful exhibition bloom.
Tubers, \$3.50; Plants, \$2.00

FORT MONMOUTH (H. C.) One of the giants of the Dahlia world. The color is a rich crimson maroon, with a brightness unusual in the darker tones, and just a faint tinge of bluish violet at tips of petals. Flowers are borne on long stiff stems, high above the foliage.
Tubers, \$10.00; Plants, \$5.00



Decorative
Dahlia "F.T.D."

FRANCIS LOBDELL (H. C.) "Mallow" pink shading to white in center. Large-flowered, free bloomer.
Tubers only, \$1.00

"F.T.D." (Dec.) A sport of Trentonian and manifesting the latter's good habit of growth. Tall and free flowering. Color a rich Tyrian rose. Dark green foliage, long rigid, upright stems.
Tubers, \$4.00; Plants, \$2.00

GALLI CURCI (H. C.) A flower of extreme grace and charm. Bright salmon-orange with a brilliant lustre and golden suffusion.
Tubers, \$10.00; Plants, \$5.00

INSULINDE (Dec.) Colossal flowers of golden orange. Fine for cutting or exhibition.
Tubers only, \$1.00

JEAN HARE (H. C.) In the earlier stages of bloom the color is a beautiful golden yellow; as the flower matures this color is superceded by a gorgeous apricot buff, while the outer row of petals show a golden bronze coloring. This flower attracted an unusual amount of attention at shows this past year.
Tubers, \$7.50; Plants, \$3.75

JERSEY'S BEAUTY (Dec.) The outstanding "Dahlia of Dahlias." Color, clear "erosine" pink. Huge flowers on splendid stems.
Tubers only, \$1.25

DAHLIAS—Continued



New Dahlia "Kathleen Norris"

- JERSEY'S CLIMAX (H. C.)** Large flower of Xanthine orange, with pink reverse. Splendid stem; fine exhibition variety.
Tubers, \$5.00; Plants, \$2.50
- JERSEY'S BEACON (Dec.)** One of the largest and most brilliant of dahlias. Color is dazzling "Chinese" scarlet with paler reverse.
Tubers only, \$1.25
- JERSEY'S DAYBREAK (Dec.)** Hermosa pink with creamy yellow center. Flowers of fine form held on long rigid stems.
Tubers, \$5.00; Plants, \$2.50
- JERSEY'S GLEAM (Dec.)** Large flower with yellow center, petals suffused and tipped with coral pink. Splendid foliage and stem.
Tubers, \$5.00; Plants, \$2.50
- *JERSEY'S GLORY (Dec.)** The flowers are large and of good form, well placed on the stem. The color is best described as a yellow hue of orange. The stems are long and stiff, but sometimes arch gracefully. It is a robust grower and flowers are produced very freely.
Tubers, \$10.00; Plants, \$5.00
- JERSEY'S ELEGANS (Dec.)** "Spinel" pink, with medium large flowers, freely produced on good stems.
Tubers, \$2.50; Plants, \$1.25
- JERSEY'S MASTERPIECE (Dec.)** Strawberry pink and gold. Splendid upright exhibition variety of large size and unique color.
Tubers, \$10.00; Plants, \$5.00
- JERSEY'S WONDER (H. D.)** A vigorous, upright grower with large flowers delicately blended with apricot and "pinard" yellow.
Tubers, \$2.50; Plants, \$1.25
- JUDGE MAREAN (Dec.)** A wonderful and extraordinary blend of salmon pink, red, orange and yellow. One of the most beautiful Dahlias ever created.
Tubers only, \$1.00
- *KATHLEEN NORRIS (Dec.)** A bloom of gigantic proportions. Color a true rose pink, later deepening to mallow pink, but paler in the young central petals.
Plants only, \$7.50
- KEMP'S VIOLET WONDER (Dec.)** The best violet colored Dahlia to date. The predominating color is a rich naphthaline violet, with an underlying tone of royal purple. Reverse is bluish violet. Flowers are as nearly perfect as possible, true decorative and of massive proportions. Blooms upright, above the foliage.
Tubers, \$10.00; Plants, \$5.00
- MARGARET MASSON (Dec.)** A rich silvery rose flower of great depth and giant proportions. Perfect stem and upright growth.
Tubers only, \$1.25
- MRS. I. de VEE WARNER (Dec.)** A wonderful and still very popular dahlia. Soft "orchid" pink.
Tubers only, \$1.00
- ROMAN EAGLE (Dec.)** A real autumn color and a sure winner—a flaming coppery-bronze, on a stiff long stem.
Tubers, \$2.00; Plants, \$1.00
- SANHICAN'S MAGNATE (Dec.)** Another one of the big exhibition varieties. Color delicate amaranth-pink with claret reverse. A remarkable blend.
Tubers, \$2.50; Plants, \$1.25
- SANHICAN'S PEACH (H. C.)** A fluffy hybrid cactus of good size and great charm. In color it is exactly the shade of a ripe California peach with a real "peach-cheek" glow.
Tubers, \$5.00; Plants, \$2.50
- TRENTONIAN (Dec.)** A rich autumn shade of old gold, amber and bronze. Huge flowers of great substance and depth, on a splendid stem.
Tubers only, \$1.00
- WIZARD OF OZ (Dec.)** One of the finest dahlias in existence. Salmon rose, shading to amber.
Tubers only, \$1.00
- *YELLOW BEAUTY (Dec.)** A sensation wherever shown. Splendid habit and style of growth. A seedling of Jersey's Beauty and possesses all the good points of its parent. This is one of the best new cut flower varieties that has been offered in years.
Tubers, \$15.00; Plants, \$7.50

DAHLIAS, MIXED

Unnamed varieties. Extra strong tubers, each 25c., doz. \$2.50.

Note.—Roots and tubers we can supply after April 1st. Plants from May 15th to June 10th.

Other varieties not in the above list we can supply at advertised prices.

For Exhibition Standard DAHLIAS Feed them SPRINGFIELD DAHLIA FOOD.
100 pound bag, \$6.00.

GLADIOLUS

Burnett's Magnificent Selection

This list will be found to contain the choicest and most up-to-date varieties offered, including the best of the standard sorts; also the cream of recent introductions.

Note: All Gladiolus bulbs offered by us are of mammoth size and true to name.

	Doz.	100
ALL. Fine lavender blue inside, slightly darker outside. Strong stem and wide open flowers of good size.....	\$1.50	\$10.00
AMERICA. The flowers are of immense size, of a beautiful soft pink color; indispensable for bedding and cutting.....	.60	4.50
BARON HULOT. Deep indigo blue.....	1.50	10.00
BYRON L. SMITH. Lavender-pink on white ground—equal to that of a very fine Cattleya orchid.....	1.50	10.00
CRIMSON GLOW. Deep, brilliant and crimson, overlaid with darker shades; lower petals blotched with deep velvety crimson. The flowers are immense and plentifully spread on the tall, graceful stem.....	1.50	10.00
EARLY SUNRISE. Reddish salmon with white feathery markings. Very fine.....	1.50	10.00
EMPRESS OF INDIA. Rich, dark brown-red, a rather rare color; splendid for combining with pale varieties.....	1.50	10.00
EVELYN KIRTLAND. Beautiful rosy pink, darker at edges, fading to shell-pink, brilliant scarlet blotches.....	1.25	8.00
FAY LANPHIER. (New.) This magnificent novelty has huge spikes, enormous flowers, delightful coloring (watermelon pink, tinted coral) and graceful habit.....	2.00	12.00
FLORA. A new golden yellow variety; a strong grower with splendid spikes and large flowers.....	1.50	10.00
GOLDEN MEASURE. A deep shade of yellow, heretofore unknown. This is a real gem. Several of these gorgeous flowers in bloom at once on a tall stem give a most magnificent effect.....	2.00	12.00
HALLEY. Large, salmon-pink tinged rose; the lower petals have a cream blotch with a center stripe of bright red.....	.75	5.00
HERADA. The large blooms are pure mauve, glistening and clear, with deeper markings in throat—a very attractive color.....	1.25	8.00
JOERG'S WHITE. The Great 1925 Novelty. Unquestionably the largest-flowered white gladiolus ever introduced. Each 60c.....	6.00



Gladiolus America

	Doz.	100
LE MARECHAL FOCH. Beautiful rose; extra large flowers.....	.80	6.00
LOS ANGELES. Shrimp-pink, with orange-carmine throat; distinct and elegant.....	2.50	15.00
MARY FENNEL. Deep lavender flowers; lower petals penciled with primrose yellow.....	1.50	10.00
MISS HELEN FRANKLIN. Pure White, with pale blue lines on lower petals, very fine.....	1.25	8.00
MRS. DR. NORTON. Creamy white, tipped pink, with pale yellow throat. A very handsome "picotee"-like flower.....	1.25	8.00

GLADIOLUS—Continued

	Doz.	100
MRS. FRANK PENDLETON. Very large and brilliant salmon-pink flushed deeper and marked with glowing blood-red blotches in the throat and on three lower petals.....	.80	6.00
MRS. FRANCIS KING. Color light scarlet, of attractive shade.....	.75	5.00
MRS. LEON DOUGLAS. Begonia rose, enlivened by flame scarlet, lower petals lemon yellow with specks of ruby red. Impressive.....	2.50	15.00
NIAGARA. A delightful cream shade, the two lower petals blending to canary yellow. Throat splashed with carmine, stamens purple and the stigmas carmine.....	1.00	7.00
ORANGE GLORY. Peach red with orange, throat lighter with small carmine blotch, beautifully ruffled..	1.50	10.00
PANAMA. A grand seedling of America which it resembles, but is of deeper pink; flowers very large and spike long.....	.80	6.00
PEACE. Pure white in color, with a pale lilac feathering.....	.80	6.00
PINK WONDER. Pale pink with rose feathering, very large, good for shows or garden effect.....	1.25	8.00
PRINCE OF WALES. An early flowering sort with fine spikes of large flowers of delicate apricot pink suffused salmon.....	1.00	7.00
RED CANNA. Brighter and taller than Mrs. Frances King. A very excellent cut-flower variety.....	1.25	8.00
ROSE ASH. Corinthian red combined with ashes of roses, rather unique large.....	1.50	10.00
SCARLET PRINCEPS. Strong grower, with six or more flowers open at a time; brilliant scarlet, deeper in throat.....	1.50	10.00
SCHWABEN. A robust, dwarf grower; pure canary yellow.....	.80	6.00
WAR. Deep blood red, shaded crimson-black; wide-open flowers.....	1.25	8.00
WHITE CITY. Tall and sturdy. One of the largest pure white varieties grown.....	1.50	10.00
YELLOW HAMMER. One of the finest pure yellow Gladiolus. The growth of stems being extra strong tends to keep the blooms in flower longer than most varieties.....	1.25	8.00



Joerg's White

BURNETT'S SPECIAL MIXTURE

This mixture is our own selection, and blended from the choicest named varieties only, containing a perfect range of color, which for effect cannot be surpassed. Doz. 60c., 100 \$4.50, 1,000 \$40.00.

PRIMULINUS HYBRIDS

These hybrids range in color from pale sulphur yellow to the deepest chrome yellow, orange and pink. From a decorative standpoint they are simply exquisite.

	Doz.	100
ALICE TIPLADY. Deep saffron orange flame.....	\$1.00	\$6.00
DOROTHY WHEELER. Richest rose pink with lighter throat. Very large. Slightly ruffled flower.....	1.25	8.00
JEWELL. Light salmon pink with golden yellow throat. Early flowering, tall variety.....	1.25	8.00
MAIDEN'S BLUSH. Enchantress pink; well-shaped flowers on slim, strong stem; earliest of all.....	1.00	6.00

	Doz.	100
MYRA. Dull salmon-rose lower petals yellow with violet red feather, three to four very large hooded flowers open at once; early forcer, good stem.....	1.25	8.00
ROSE LUISANTE. A much deeper pink than Maiden's Blush, very early, rather tall, well balanced spike.....	1.25	8.00
SALMON BEAUTY. Orange salmon.....	1.25	8.00
SOUVENIR. Pure canary yellow. Exceptionally large and very early..	1.25	8.00
PRIMULINUS HYBRIDS, MIXED. A choice blend of colors from all the leading varieties. 1,000 \$45.00.....	.75	5.00

HARDY LILIES

The demand for "Hardy Lilies" is rapidly increasing. Their stately habit, beauty of form and variety of colors, combined with the various species, make them worthy of a place in every collection. They commence flowering early in Summer and maintain a continuous succession of bloom until Autumn. Excellent for backgrounds and shrubbery borders also suitable for growing in the conservatory.

	Each	Doz.	100
Auratum (The Golden-rayed Lily of Japan). White, spotted with crimson, having a bright yellow band through the center of each petal; very fragrant.			
Extra Size Bulbs , 9 to 11 inches.....	\$0.50	\$5.50	\$40.00
Mammoth Size Bulbs , 11 to 13 inches.....	.75	7.00	50.00
Batemani . A beautiful Japanese variety, with 6 to 8 apricot-colored flowers on a stem; blooms in July and August.....	.40	4.00	30.00
Canadense . (Canadian Bell-flower Lily). Bright yellow flowers with black spots.....	.25	2.50	15.00
Henryi . Tall growing variety, deep orange yellow, lightly spotted.....	.75	8.00	60.00
Speciosum Album . Pure white; fragrant. 9 to 11 inches.....	.65	6.50	50.00
Roseum . White spotted deep red. 9 to 11 in.....	.60	6.00	45.00
Rubrum . Rose, spotted crimson. 9 to 11 inches.....	.60	6.00	45.00
Melpomene . 9 to 11 inches. Rich red, heavily spotted, very fine.....	.65	6.50	50.00



Lilium Regale (Regal Lily)



Lilium Speciosum Album

	Each	Doz.	100
Regale (Myriophyllum). Absolutely hardy and excellent for forcing. The flowers are white, slightly suffused with pink with a beautiful shade of canary yellow.....	1.00	10.00	75.00
Superbum . (Turk's Cap Lily). Deep orange red. Heavily spotted.....	.25	2.50	18.00
Tenuifolium (Coral Lily of Siberia). Brilliant scarlet.....	.40	4.00	30.00
Tigrinum Splendens (Improved Tiger Lily). Rich scarlet, with black spots.....	.25	3.00	20.00
Tigrinum Flore Pleno (Double Tiger Lily).....	.30	3.00	20.00

Cold storage Rubrums, Melpomenes, Giganteums and Magnificums, for forcing, can be supplied throughout the year.

We can also supply many other popular varieties, not listed here, at prevailing market prices.

ROSES (HARDY VARIETIES)

Everblooming, or Hybrid Tea Varieties

This class of Rose is most satisfactory, since they continue to flower throughout the entire season, from early Summer until frost. They are hardy, but it is advisable to give Winter protection. The following list contains the choicest varieties only.

- Betty.** Favorite, Free-Blooming Variety; Coppery Pink Buds, large Reflex Creamy-Pink Flowers.
- Capt. F. Bald.** Brilliant Red; Unusually fine shaped and substance.
- Columbia.** Popular large brilliant pink flowers.
- Duchess of Wellington.** Long Pointed Buds, Orange and Saffron; Flowers, Light Yellow.
- Edel.** Giant double white. Very Beautiful.
- Francis Scott Key.** Double bright red, fragrant.
- Gen. Mac Arthur.** Bright red, free blooming, fragrant.
- Eldorado.** Round, double bright yellow flowers, tinted crimson. Free flowering. **Each \$1.50.**
- Golden Ophelia.** Golden yellow paling to cream-white at the edges.
- Gruss an Teplitz.** A bright, pleasing crimson. Splendid for bedding.
- Henry Ford.** Brilliant yellow flower, tinted red and orange, attractive. **Each \$1.50.**
- H. V. Machin.** Brilliant crimson flowers, large, bold. Stiff bushy plants.
- Jonkheer J. L. Mock.** Enormous double pink.
- Killarney Queen.** Rosy-pink buds and flowers, double.
- Lady Hillingdon.** Pleasing shade of apricot yellow. Very fragrant.
- Los Angeles.** Shining golden pink flowers, beautiful form. Delicious fragrance.
- Matchless.** Large double cerise-pink flowers, fragrant. Sport of Premier. **Each \$1.50.**
- Miss Lolita Armour.** Double creamy coppered globular flowers. Unusual and distinct.
- Mme. Alexandre Dreux.** Small coppery yellow flowers. Sweetly scented. **Each \$1.50.**
- Mme. Butterfly.** Brilliant pink, suffused apricot and gold.
- Mme. Caroline Testout.** Pink and fragrant flowers. Most reliable.
- Mme. Jules Bouche.** Most satisfactory white variety, flush pink center.
- Mrs. Aaron Ward.** Small coppery yellow flowers, opening to pale fawn-white. Popular.
- Mrs. Beckwith.** Soft yellow pointed flowers; bushy plants. **Each \$1.50.**
- Mrs. F. E. Pierson.** Brilliant crimson, fragrant rose. **Each \$1.50.**
- Mrs. Henry Bowles.** Fine perfect shaped vivid pink flowers; vigorous and productive. **Each \$1.50**
- Ophelia.** Salmon flesh, shaded rose, with a chamoise colored center.
- Premier.** Double dark pink fragrant rose.
- Radiance.** Strong growing, free flowering brilliant pink.
- Red Radiance.** Rosy red, habit like Radiance.
- Roselandia.** Rich yellow flower, Ophelia type, vigorous and productive. **Each \$1.50.**
- Souv. de Claudius Pernet.** Pure lemon-yellow; excellent shaped buds.
- Souv. de George Beckwith.** Salmon double cupped flowers, shaded rose and yellow; fragrant. **Each \$1.50.**
- Souv. de Georges Pernet.** Giant golden pink blooms, showy and spectacular. **Each \$1.50.**
- White Killarney.** A pure white sport of the popular Killarney Rose.

Hardy Climbing Roses

Of the many Climbing Roses, we have selected only varieties which are most suitable for all purposes, as for walls, trellises, arches and fences.

Albertine. Large, double flowers of brilliant coppery pink, heavily tinged with yellow.

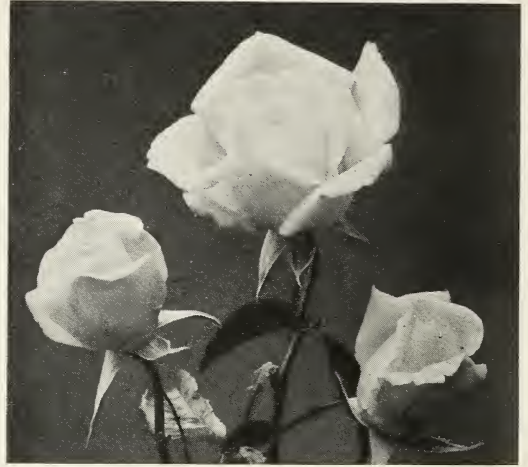

Rose, Mrs. Beckwith

- American Pillar.** Strong grower, lovely foliage, immense trusses of large, single flowers of vivid pink with a shining gold and white eye.
- Aviateur Bleriot.** Clusters of saffron-yellow flowers, with centers of golden yellow. Vigorous and profuse bloomer year after year. **Each \$1.25, doz. \$12.50**
- Climbing American Beauty.** Of the same color and fragrance as the popular variety it is named after. Excellent variety.
- Dorothy Perkins.** The finest for festooning, trailing, or trellis work. Blooms small, brilliant pink.
- Dr. W. Van Fleet.** Long pointed buds of rich flesh-pink.
- Excelsa.** A brilliant counterpart of Dorothy Perkins.
- Emily Gray.** Large soft golden yellow flowers on long stems. Beautiful foliage.
- Hiawatha.** Vigorous, wiry habit. Immense clusters of single bright crimson, Yellow eye.
- Jacotte.** A new type with orange-yellow and salmon flowers. Profuse bloomer.
- Paul's Scarlet Climber.** The reddest of all climbers. Large well shaped flowers.
- Roserie.** Charming cupped flowers of an even shade of deep pink or carmine.
- Silver Moon.** Extremely semi-double flowers, pure white in color.
- Tausendschoen.** Delicate shade of soft pink, changing to carmine on the reverse of petals.

Hybrid Perpetual or June Roses

- Frau Karl Druschki.** The most popular Rose in America. It's pure, snow-white, unshaded blooms are of immense size.
- Gen. Jacqueminot.** Brilliant scarlet-crimson; an old favorite.
- George Arends.** Well shaped, delicate pink buds of pure even color.
- George Dickson.** Velvety black-crimson, reverse veined deep crimson-maroon, with Tea Rose perfume.
- Mrs. John Laing.** Graceful shell-pink flowers, exceedingly fragrant; borne on strong stems. Very popular.
- Magna Charta.** Large flowers of rosy carmine, freely produced.
- Ulrich Brunner.** Large flowers of deep red.
- Price of any of the above Roses (except where specially priced), all extra strong stock, each \$1.00, doz. \$10.50.**

Feed your ROSES the proper plant food. *SPRINGFIELD ROSE FOOD* possesses all these elements. 100 pound bag, \$6.00.

GREENHOUSE AND DECORATIVE PLANTS

FORCING ROSES ALL GRAFTED PLANTS

- Briarcliff.** Sport of Columbia, and has all the growth and characteristics of same. Perfect flowers of bright rose-pink.
Doz. \$9.00; 100 \$70.00
- Columbia.** Old popular variety. Rose-pink.
- Commonwealth.** Deep pink. Like Premier in form.
- Double White Killarney.** Best white rose grown.
- Gold Mine.** Vigorous new variety. Deep rich yellow, with beautiful foliage.
- Matchless.** Deep pink sport of Premier.
Doz. \$9.00; 100 \$70.00
- Mme. Butterfly.** Shell or flesh-pink, shaded yellow at base.
- Mrs. Aaron Ward.** Free flowering, with Indian-yellow buds.
- Mrs. Calvin Coolidge.** New golden yellow.
- Premier.** Rose-pink, free and easy grower.
- Roselandia.** Sport of Golden Ophelia of deep golden orange, tinted apricot at base.
- Souv. de Claudius Fernet.** Most popular yellow greenhouse variety. Doz. \$10.00; 100 \$80.00
- Templar.** Very fragrant, with even shade of red.
- Pot-Grown Plants on any of the above varieties (except where noted) Doz. \$8.00; 100 \$60.00.**

CARNATIONS (Greenhouse Varieties)

	Routed Cuttings	2 1/4 in. Pots	Doz.	100
Benora (Variegated)	15.00	\$3.00	\$20.00	
Betty Lou (Dark Pink)	15.00	3.00	20.00	
Laddie (Rose-Salmon-Pink)	20.00	4.50	30.00	
Maine Sunshine (Yellow)	20.00	4.50	30.00	
Mrs. C. W. Ward (Dark Pink)	15.00	3.00	20.00	
Matchless (White)	15.00	3.00	20.00	
Red Matchless (Red)	15.00	3.00	20.00	
Spectrum (Scarlet)	15.00	3.00	20.00	
White Perfection (White)	15.00	3.00	20.00	

"Varieties not listed can be supplied.
Price on application."

CHRYSANTHEMUMS (Greenhouse Varieties)

STANDARD VARIETIES

- Bronze Turner** (Bronze) Semi-Dwf.
- Calumet**, (Bronze) Tall.
- Elberon**, (Bright Pink) Semi-Dwf.
- Louisa Pockett**, (Pure White) Semi-Dwf.
- Mrs. J. Leslie Davis**, (Pink) Semi-Dwf.
- Mrs. G. G. Mason**, (Blood-Red, Golden Reverse) Semi-Dwf.
- Nagirroc**, (Golden Bronze) Semi-Dwf.
- Nerissa**, (Rosy Mauve) Dwarf.
- Pockett's Crimson**, (Crimson, Gold Tips) Dwf.
- Wm. H. Waite**, (Bright Bronze) Dwarf.
- Wm. Turner**, (Pure White) Semi-Dwf.
- Yellow Pockett**, (Light Yellow) Semi-Dwf.
- Yellow Turner**, (Light Yellow) Semi-Dwf.

MISCELLANEOUS VARIETIES

- Pompon Varieties**, Assorted Colors.
- Single Varieties**, Assorted Colors.
- Feathery, Spidery & Thread-Like Varieties.**
- Anemone Flowered Varieties.**
- Caps and Decorative Varieties**
- Commercial Varieties**, Assorted Colors

Prices on above, in 2 1/4 in. pots,
doz. \$3.00; 100, \$20.00.

ANTIRRHINUM (Snapdragon) (Greenhouse Varieties)

	Doz.	100
Geneva Pink (Rose-Pink)	\$2.00	\$15.00
Jennie Schneider (New Pink)	2.25	17.50
Keystone (Fine Dark Pink)	1.75	12.00
Golden Delight (Yellow)	1.75	12.00
Phelp's White (Best White)	1.75	12.00
Philadelphia Pink (Popular Pink)	1.75	12.00

Above plants supplied in 2 1/4 in. pots

	Doz.	100
ASPAGUS, Plumosus Nanus. 2 1/4 inch pots	\$2.00	\$12.00
Plumosus Nanus. 3 in. pots	3.50	25.00
Sprenger. 2 1/4 in. pots	2.00	12.00
Sprenger. 3 in. pots	3.50	25.00
BEGONIA, Glory of Cincinnati.		
Excellent pink variety, 2 1/4 in.	7.00	50.00
Gustav Knaake. Crimson, 2 1/4 in.	3.00	20.00
Mellior. Vigorous Lorraine type, 2 1/4 in.	7.00	50.00
Mrs. J. A. Peterson. Deep pink flowers, red foliage, 2 1/4 in.	7.00	50.00
BOUGAINVILLEA, Crimson Lake.		
Crimson. 3 in. Each 50c	5.00	—
BUDDLEIA, Asiatica. 3 in.	4.50	—
CALCEOLARIA, Hybrida. 2 1/4 in.	4.00	30.00
Lymanii. Cinnamon red, 2 1/4 in.	12.00	80.00
Medfordii. Velvety maroon, 2 1/4 in.	12.00	80.00
Stewartii. Chrome yellow, 2 1/4 in.	12.00	80.00
CALENDULA, Orange King or Ball's, 2 1/4 in.	—	10.00

CHRYSANTHEMUMS, Hardy (see page 81.)

CINERARIA, Hybrida. 2 1/4 in.	2.50	15.00
Stellata. 2 1/4 in.	2.50	15.00
CYCLAMEN, Giganteum Mixed. 3 in.	6.00	40.00
DRACAENA, Indivisa. Green Foliage.		
Bushy plants, Each \$1.00.		
Massangeana. Green foliage with band of yellow through center, Bushy plants, Each \$1.00.		
Sanderiana. Green foliage with creamy border. Bushy plants, Each \$1.50.		
EUPHOREIA, Jacquiniaeflora. 2 1/4 in.	6.00	30.00
FERNS, Assorted Varieties. 2 1/4 in.	2.50	15.00
GARDENIA, Veitchii. 3 in.	10.00	75.00
MARGUERITES, White. 3 in.	3.50	25.00
Boston Yellow, 3 in.	3.50	25.00
POINSETTIAS, True Oak Leaf Var. 2 1/4 in.	6.00	30.00
PRIMULA, Malacoides. In separate colors. 2 1/4 in.	2.50	15.00
Obconica. In separate colors. 2 1/4 in.	3.00	18.00
ROSES, Hardy (see page 78).		
SMILAX. Greenhouse climber, 2 1/4 in.	2.50	15.00
SOLANUM (Jerusalem Cherry) 2 1/4 in. Red or yellow.	2.50	15.00
STEVIA, Serrata. 2 1/4 in.	2.50	15.00

Any of the above plants can be supplied in larger sizes. Write for prices on requirements.

GERBERA JAMESONII HYBRIDS

"The Transvaal or Barberton Daisy"

This is one of the finest of all winter-flowering plants for forcing; the new colors that are included in these Hybrids vary from delicate flesh pink to rich scarlet, with intermediate shades of cream and orange. Their splendid 2-ft. stems and large brilliant flowers put them in the first rank of winter flowers for cutting.

Strong, 2-year-old clumps, Dozen, \$12.00; 100, \$90.00.

For best results in CARNATION growing, feed them SPRINGFIELD CARNATION FOOD. 100 pound bag, \$6.00.



HARDY PERENNIAL PLANTS

Practically all the following Perennials are offered in field-grown clumps, except in a few instances where pot-grown plants have proved more satisfactory. We feel sure that all will give excellent results.

	Flowering Season	Height	Doz.
ACHILLEA, Millefolium Roseum. Pink Flowers.....	June-Sept.	2 ft.	\$2.50
Ptarmica, Boule de Neige. (Ball of Snow).....	June-Sept.	1½ ft.	2.50
ACONITUM, Fischerii. Dark Blue Flowers.....	Sept.-Oct.	2 ft.	3.00
ALYSSUM, Saxatile. Mass of Yellow Flowers.....	Apr.-May	1 ft.	2.50
AGROSTEMMA, Coronaria. The Mullein Pink.....	June-July	2 ft.	3.00
ANCHUSA, Italica Dropmore. Gentian Blue.....	June-July	4 ft.	2.50
ANEMONE, Japonica Alba. White, Yellow Stamens.....	Sept.-Oct.	2-3 ft.	3.50
Japonica, Queen Charlotte. Pink.....	Sept.-Oct.	2-3 ft.	3.50
ANTHEMIS, Tinctoria Kelwayi. (Golden Marguerite).....	June-Oct.	2 ft.	2.50
AQUILEGIA, Chrysantha. Fragrant Yellow Variety.....	May-June	2-3 ft.	2.50
Coerulea, Blue and White (Rocky Mt. Columbine).....	May-June	2-3 ft.	2.50
Long Spurred Hybrids Mixed	May-June	2-3 ft.	2.50
Mrs. Scott Elliott's Strain	May-June	2-3 ft.	3.00
ARABIS, Alpina (Rock Cross).....	Apr.-May	5 in.	2.50
Alpina, fl. pl.	Apr.-May	5 in.	3.00
ARTEMESIA, Lactiflora. Creamy White, Sweet Scented Border Plant.....	Aug.-Sept.	3-4 ft.	3.00
ASCLEPIAS, Tuberosa. (Butterfly Weed).....	July-Aug.	2 ft.	2.50
ASTERS, Michaelmas Daisies.			
Blue Gem, Semi-Double, Violet-Blue	Aug.-Oct.	4 ft.	3.00
Novae Angliae, (New England Aster) Purple-Violet	Aug.-Oct.	4 ft.	3.00
Novae Angliae, Lil Fardel. Lilac-Pink.....	Aug.-Oct.	4 ft.	3.00
Perry's Blue, Lavender Blue	Aug.-Oct.	2½ ft.	3.00
Perry's Pink, Rosy Pink	Aug.-Oct.	2½ ft.	3.00
Perry's White, White, Shaded Lilac	Aug.-Oct.	4 ft.	3.00
Well's White, Pure White. Large Flower.....	Aug.-Sept.	4 ft.	3.00
ASTILBE (Spirea) Arendsii Hybrids	June-July	2 ft.	6.00
Gloria. Dark Pink, Shaded Lilac (New).....	June-July	2 ft.	7.00
Granat. Crimson (One of the finest).....	June-July	2 ft.	7.00
Rheinland. Crimson, Shaded Salmon.....	June-July	2 ft.	6.00
AUBRETIA, Deltoidea. Violet.....	Apr.-May	6 in.	2.50
BAPTISIA, Australis (False-Indigo) Dark Blue.....	May-July	3-4 ft.	2.50
BELLIS, Perennis (English Daisy) White.....	May-June	5 in.	2.00
Perennis, Pink	May-June	5 in.	2.00

PLAN-TIE, new tying material. Does not bruise plants. Breaks with the fingers but withstands storms. 25c per spool; \$2.50 per dozen.

HARDY PERENNIAL PLANTS—Continued

	Flowering Season	Height	Doz.
BOLTONIA , <i>Asteroides</i> . Pure White	Aug.-Oct.	6 ft.	2.50
<i>Latisquama</i> , Pinkish Lavender	Aug.-Sept.	4-5 ft.	2.50
CALLIRHOE , <i>Involucrata</i> (Poppy Mallow) trailing; Crimson Flower, White Center	June-Sept.	1 ft.	2.50
CAMPANULA , <i>Carpatica</i> . Blue or White (Harebell)	July-Aug.	6 in.	3.00
Medium. (Canterbury Bells) Blue, Rose or White	June	2 ft.	2.50
Medium <i>Calycanthemum</i> . (Cup and Saucer) Blue, Rose or White	June	2 ft.	2.50
<i>Persicifolia</i> , Blue or White (Peach Leaved Bellflower)	June-July	2 ft.	3.00
<i>Pyramidalis</i> , Blue or White (Steeple Bellflower)	Aug.-Sept.	4-5 ft.	3.00
CARYOPTERIS , <i>Incana Mastacanthus</i> (Blue Spirea)	Sept.-Oct.	3-4 ft.	3.50
CENTAUREA , <i>Macrocephalia</i> . Thistle-Like Yellow Flowers	July-Aug.	3 ft.	2.50
Montana (Perennial Cornflower) Blue, White or Rose	June-Sept.	2 ft.	2.50
CEPHALARIA , <i>Alpina</i> . (Roundheads) Primrose-Yellow	June-July	5 ft.	3.00
CERASTIUM , <i>Tomentosum</i> . (Snow in Summer) Rock Plant, Silver Foliage, White Flower	May-June	6 in.	2.50
CHERIANTHUS , <i>Allionii</i> . (Siberian Wallflower) Fragrant Rock Plant, Orange Flower	May-Aug.	1 ft.	2.50
CHELONE , <i>Lyoni</i> . (Shell Flower) Purplish-Red	Aug.-Sept.	2-3 ft.	3.00

CHRYSANTHEMUMS, EARLY HARDY

- Boston, (Clear Bronze)
- Chaldon, (Reddish Crimson with Gold Tips)
- Champaign, (Ruby Red)
- Champ D'Or, (Canary Yellow)
- Cranford Pink, (Light Pink)
- Harvest Home, (Bronzy Yellow)

- Skibo, (Golden Chamois)
- Yellow Normandie, (Bronze Yellow)
- Shasta Daisy (C. Maximum) White flowers.
- Hardy Pompons, Assorted Colors.
- Baby or Button Type, Assorted Colors.
- Price for Strong Plants of all varieties listed above—\$3.00 per dozen, \$20.00 per hundred.

	Flowering Season	Height	Doz.
CIMICIFUGA , <i>Americana</i> . (Bugbane) White Flower	Aug.-Sept.	2-4 ft.	3.50
<i>Racemosa</i> . White Racemes of Ornamental Flowers	June-July	4-5 ft.	3.00
CONVALLARIA , <i>Majalis</i> . (Lily of the Valley). Field Grown Clumps. Large White Bells	May-June	8-10 in.	6.00
COREOPSIS , <i>Lanceolata Grandiflora</i> . Golden Yellow	June-Oct.	2 ft.	2.50
CYRIPEDIUM , <i>Spectabile</i> . (Showy Lady Slipper.) Rose Purple or Nearly White Flowers	June	2 ft.	6.00
DELPHINIUM , <i>Belladonna</i> . Semi-Double Light Blue	June-Oct.	3 ft.	3.00
<i>Chinensis</i> . Gentian Blue	June-Oct.	2 ft.	3.00
<i>Chinensis Alba</i> . Pure White	June-Oct.	2 ft.	3.00
<i>Formosum</i> . Dark Blue with White Center	June-Oct.	3 ft.	3.00
Gold Medal Hybrids. Assorted	June-Oct.	2-3 ft.	11.00
Belladonna Hybrids. Assorted	June-Oct.	2-3 ft.	3.00
<i>Lamartine</i> . Dark Blue, with fine branching habit. Cutting Var.	June-Oct.	4 ft.	5.00
Wrexham Strain (Hollyhock Flowered) Finest Assortment in existence	June-Oct.	3-4 ft.	18.00
DIANTHUS , (Hardy Pinks) <i>Allwoodii</i> . Perpetual Flowering Pinks. Very Fragrant. Assorted	May-Oct.	2 ft.	4.00
Annie Laurie. Orchid Color, with Wine-Red Ring. Sweet Scented	May-Nov.	2 ft.	3.50
<i>Deltoides</i> . (Maiden Pink) Crimson Flower	June-July	6 in.	3.00
<i>Deltoides Alba</i> . White Form of the above	June-July	6 in.	3.00
<i>Sylvestris</i> . (Wood Pink) Bluish Foliage with Salmon-Pink Flower	July-Aug.	1 ft.	4.00
Heddeewigi. (Japanese Pinks) From Pure White to richest crimson. For Bedding	June-Sept.	1½ ft.	3.00
<i>Plumarius</i> . (Clove Pinks) Fringed Flowers	May-June	1 ft.	3.00
<i>Scoticus</i> . (Scotch Pink)	June-Aug.	1 ft.	3.00
<i>Barbatus</i> . (Sweet William) Newport Pink. Salmon Rose Pink	May-June	2 ft.	3.00
Scarlet Beauty. Scarlet	May-June	2 ft.	3.00
<i>Barbatus Double</i> . Assorted Colors	May-June	2 ft.	2.50
DICTAMNUS , <i>Fraxinella</i> . (Gas Plant) Rosy Purple	June-Aug.	3-4 ft.	6.00
DIELYTRA , <i>Formosa</i> . Small Rose Colored Flowers	May-Aug.	1 ft.	3.00
<i>Spectabilis</i> . (Bleeding Heart) Drooping Racemes. Rose-Crimson. Good for Forcing	Apr.-June	2 ft.	10.00
DIGITALIS , <i>Giant Shirley</i> . Flowers from White to Deep Rose Spikes of bloom 4 ft. long. Mixed	June-July	5-6 ft.	2.50
<i>Purpurea Gloxiniaeflora</i> . (Gloxinia-Flowered Fox-Glove) Assorted	June-July	2-3 ft.	3.00
<i>Monstrosa Mixed</i> . Assorted	June-July	2-3 ft.	3.00
DORONICUM , <i>Caucasicum</i> . (Leopard's Bane) Yellow Marguerite-Like Flowers	May-June	2 ft.	4.00
ÉCHINACEA , <i>Purpurea</i> . (Purple Coneflower) Reddish Purple	July-Aug.	3-4 ft.	2.50
ECHINOPS , <i>Ritro</i> . (Globe Thistle) Metallic Blue	July-Sept.	3-4 ft.	3.00
EREMURUS , <i>Himalaicus</i> . Majestic White Flower Spikes. (Per plant \$5.00)	May-June	6-7 ft.	—
ERIGERON , <i>Mesagrande</i> . (Flea-Bane) Dark Lilac Flowers, with Yellow Center	July-Aug.	1½ ft.	2.50

For Exhibition standard CHRYSANTHEMUMS Feed them SMITH'S or THOMSON'S MANURES. (see page 111.)

HARDY PERENNIAL PLANTS—Continued

	Flowering Season	Height	Doz.
ERYNGIUM, Planum. Small Blue Heads on Branching Stems.....	July-Aug.	2 ft.	2.50
EUPATORIUM, Coelestinum. (Mist Flower) Light Blue.....	Aug.-Oct.	2 ft.	2.50
EUPHORBIA, Polychroma. Masses of Chrome Yellow Flowers. Good Rock Plant.....	Apr.-May	2 ft.	2.50
ERICA, (Heath) All Vars.	July-Sept.	6-15 in.	6.00
ERINUS, Alpinus. Rosettes of pretty Foliage. Rosy Purple Rock Plant.....	Apr.-June	6 in.	4.00
FEERNIS, Assorted Vars.		1-3 ft.	3.00
FUNKIA, Undulata Variegata. Leaves Deep Green, Creamy White Center.....	July-Aug.	1-2 ft.	2.50
GAILLARDIA, Grandiflora (Blanket Flower) Orange and Red.....	May-Nov.	1½ ft.	2.50
GALEGA, Officinalis. (Goat's Rue) Rosy Purple.....	July	3-4 ft.	3.00
Officinalis Alba. White Flowers.....	July	3-4 ft.	3.00
GERANIUM, Sanguineum. Blood Red.....	May-Aug.	1-1½ ft.	3.00
GEUM, Atrosanguineum. Dark Crimson.....	May-July	1-2 ft.	3.00
Lady Stratheaden. Double Rich Golden.....	June-Sept.	2 ft.	2.50
Mrs. J. Bradshaw. Double Dark Red.....	June-Sept.	2 ft.	2.50
GRASSES, Ornamental. Assorted.....	Var.	Var.	4.00
GYPHOPHILA, Paniculata. (Baby's Breath) Small Pure White Flowers.....	June-July	2-3 ft.	2.50
Paniculata, Flore-Pleno. Double Flowers of White in great profusion.....	July-Aug.	2-3 ft.	5.00
Enriei. A distinct new early flowering variety of Double Pure White.....	June-Sept.	3 ft.	7.50
HELENIUM, Autumnale. (Sneezeweed) Large Flat Lemon Yel- low Flowers.....	Aug.-Sept.	4-5 ft.	2.50
Hoopesii. Early Flowering Orange Colored.....	May-June	2-3 ft.	2.50
Riverton Gem. Yellow, Changing to Red.....	Aug.-Sept.	5 ft.	2.50
HELIANTHUS, (Hardy Sunflower) Assorted Vars.	Aug.-Oct.	4-10 ft.	3.00
HELIOPSIS, Pitcheniana. Deep Golden Yellow.....	July-Sept.	3-4 ft.	2.50
HEMEROCALLIS, Aurantiaca Major. (Day Lily) Deep Orange, Sweet Scented.....	July-Aug.	3 ft.	3.00
Flava. (Lemon Lily) Lemon Yellow, Sweet Scented.....	May	3 ft.	2.50
Middendorfi. Orange Yellow.....	June-July	2-3 ft.	2.50
Thunbergii. Lemon Yellow, Very Fragrant.....	July-Aug.	3 ft.	2.50
HEPATICA, Triloba. (Liverleaf) Pretty Blue.....	Apr.-May	6 in.	2.50
HEUCHERA, (Coralbells) Sanguinea. Bright Crimson, Free Blooming. Good for Cutting or Rock Garden.....	May-Sept.	1½ ft.	3.00
Hybrids. Assorted.....	May-Sept.	1-2 ft.	3.00
HIBISCUS, (Mallow). Giant Flowering Assorted.....	Aug.-Sept.	5-8 ft.	2.50
HOLLYHOCKS, Chaters Double. White, Yellow, Pink or Rose.....	July-Aug.	5-6 ft.	2.50
HYPERICUM, Moserianum. (Gold Flower) Golden Yellow with Crimson Stamens. Very Snowy.....	June-Sept.	1½ ft.	3.50
IBERIS, Sempervirens Little Gem. (Hardy Candytuft).....	April	6 in.	3.00
INCARVILLEA, Delavayi. Rose Colored, Trumpet Shaped Flowers.....	June	1½ ft.	3.00
IRIS, German Varieties Assorted	May	1-3 ft.	1.50
Japanese Varieties Assorted.	June	1-3 ft.	2.50
Named Varieties. (See page 85.)			
LATHYRUS, Latifolius. (Hardy Sweet Peas) Rose Colored.....	June-Aug.	3 ft.	2.50
Latitonus Albus. White.....	June-Aug.	3 ft.	2.50
LAVANDULA, Vera. (Sweet Lavender) Fragrant.....	July-Sept.	1½ ft.	2.50
LIATRIS, Pycnostachya. Pale Purple.....	July-Aug.	3-4 ft.	2.50
Spicata (Button Snakeroot) Similar to above. Earlier.....	July-Sept.	2-3 ft.	2.50
LILIUM, Named Varieties. (See page 77.)			
LINUM, Perenne (Flax) White or Blue.....	May-Aug.	1½ ft.	2.50
Flavum. Light Yellow.....	June-July	1 ft.	3.00
LOBELIA, Cardinalis. (Cardinal Flower) Scarlet.....	July-Aug.	3 ft.	2.50
LUPINUS, Polyphyllus. Blue or White.....	June-Aug.	4-5 ft.	2.50
Moerheimii. Soft Rose. Flowers 1 ft. long.....	June-July	3 ft.	3.50
LYCHNIS, Chalcedonica. Bright Scarlet.....	June-July	2 ft.	2.50
Haageana. Orange Scarlet.....	May-June	1 ft.	2.50
LYSIMACHIA, Clethroides. (Japanese Loosestrife) White.....	July-Sept.	2 ft.	2.50
LYTHRUM, Roseum Superbum. (Loosestrife) Rose Color.....	July-Sept.	3-4 ft.	2.50
MALVA, Moschata. (Musk Mallow) Rose, Sweet Scented.....	June-Sept.	1-2 ft.	2.50
MERTENSIA, Virginica. (Blue Bells) Blue Funnel-Formed Flowers.....	May-June	1½ ft.	2.50
MONARDA, Didyma. (Bergamot) Crimson-Scarlet.....	July-Aug.	2-3 ft.	2.50
MONTBRETIAS. Mixed Varieties. (Per 100, \$6.00).....	July-Sept.	2-3 ft.	1.00
Named Varieties. (See page 85.)			
MYOSOTIS, (Forget Me Not) Ruth Fischer. Light Blue.....	May-June	8-10 in.	2.50
Palustris Semperflorens. Light Blue.....	May-Oct.	6 in.	2.50
NEPETA, Mussinii. (Ground Ivy) Mauve.....	Apr.-July	8 in.	2.50
OENOTHERA, Fraseri. (Evening Primrose) Pale Yellow.....	June-Oct.	1 ft.	2.50
Missouriensis. Profuse Bloomer, Yellow, Suitable for Rockery.....	June-Aug.	10 in.	2.50
PACHYSANDRA, Terminalis. (Japanese Spurge) Excellent Ground Cover Plant for Shady Places. Green.....	May-June	6-9 in.	2.50
PAPAVER, (Poppy) Nudicaule. (Iceland Poppy) White, Yellow or Orange.....	May-Aug.	1 ft.	2.50
Orientalis. Assorted Colors.....	May-June	2-3 ft.	2.50
PENTSTEMON, Barbatous Torreyi. (Beard Tongue) Scarlet.....	June-Aug.	4 ft.	2.50
PAEONIES, Mixed Varieties	May-June	3-4 ft.	5.00
Named Varieties. (See page 85.)			

PLAN-TIE, new tying material. Does not bruise plants. Breaks with the fingers but withstands storms. 25c per spool; \$2.50 per dozen.

HARDY PERENNIAL PLANTS—Continued

	Flowering Season	Height	Doz.
PHLOX , (<i>Decussata</i>). Baron von Dedem . Large Blood-Red			
Trusses			
Elizabeth Campbell. Large Light Salmon Spikes	June-Oct.	2-3 ft.	3.00
Homeland. Brilliant Dark Orange Red Trusses	June-Oct.	2-3 ft.	6.00
Jules Sandeau. Large Pure Pink Flowers	June-Oct.	2-3 ft.	3.00
Mrs. Ethel Pritchard. Clear Rose-Mauve	June-Oct.	2-3 ft.	4.00
Mrs. Jenkins. Pure White. Very Early	June-Oct.	2-3 ft.	4.00
Mrs. M. Van Hoboken. New Soft Pink	June-Oct.	2-3 ft.	4.00
Thor. Salmon-Pink. Crimson Eye	June-Oct.	2-3 ft.	3.00
Divaricata Laphamii. Lilac Blue. Rockery Plant	May	1 ft.	5.00
Subulata. Alba, Rosea or Lilac	Apr.-May	3-6 in.	3.00
Subulata Vivid. Bright Rose	Apr.-May	3-6 in.	3.50
Suffruticosa, Miss Lingard. Pure White, Pink Eye	Apr.-May	1-3 ft.	3.00
Ovata Carolina. Rosy Red	June-July	1-1½ ft.	3.00
PHYSALIS , <i>Franchetti</i> . (Chinese Lantern Plant) Orange Colored			
Fruit in Fall	Apr.-May	2 ft.	2.50
PHYSOSTEGIA , <i>Virginica</i> . (False Dragonhead) Pink or White	June-July	2-3 ft.	3.50
PLATYCODON , (Balloon Flower) Blue or White	June-July	1-2 ft.	2.50
POLEMONIUM , <i>Humile</i> . (Jacob's Ladder) Blue or White	June-July	1-1½ ft.	3.00
POTENTILLA , <i>Hybrids</i> . (Cinquefoil)	June-July	2 ft.	6.00
PRIMULA , <i>Vulgaris</i> . (English Primrose) Fragrant Lemon Yellow			
Flowers			
Japonica. Purple Crimson	Apr.-May	6-9 in.	3.00
Veris. (Cowslip) Yellow, Red, Bronze and White	June	8 in.	3.00
PYRETHRUM , Single Assorted	Apr.-May	6-9 in.	3.00
<i>Uliginosum</i> . Giant Daisy. White	May-June	2½ ft.	2.50
ROMNEYA , <i>Coulteri</i> . (California Tree) White Transparent	Aug.-Sept.	4-5 ft.	2.50
Flowers			
RUDBECKIA , <i>Laciniata</i> . (Golden Glow) Golden Yellow	June-Aug.	4-5 ft.	12.00
<i>Purpurea</i> . (Purple Coneflower) Purple	Aug.-Sept.	6-8 ft.	2.50
SALVIA , <i>Azorea Grandiflora</i> . Sky-Blue	July-Oct.	3-4 ft.	2.50
<i>Greggii</i> . Masses of Brilliant Carmine Flowers	Aug.-Sept.	3-4 ft.	2.50
SAPONARIA , <i>Ocymoides</i> . (Rock Soapwort) Crimson	July-Aug.	2 ft.	3.50
SAXIFRAGA , <i>Macnabiana</i> . White, spotted Red	May-July	1 ft.	2.50
SCABIOSA , <i>Caucasica</i> . (Pin Cushion Flower) Soft Lilac or White	May-June	1 ft.	6.00
Flowers			
Japonica. Clear Blue	June-Aug.	2-3 ft.	3.00
SEDUM , <i>Acre</i> (Golden Moss, Stonecrop) Yellow	June-Sept.	2-3 ft.	3.50
<i>Sieboldii</i> . Succulent Glaucus Foliage. Pink	May-July	2-3 in.	2.50
<i>Spectabile</i> . (Stonecrop) Rose Colored	Aug.-Sept.	9 in.	2.50
SEMPERVIVUM , (House Leek) <i>Tectorum</i> . Broad Rosettes. Pale Red	Aug.-Sept.	1½ ft.	2.50
Flowers			
SIDALCEA , (Greek Mallow) Rosy Gem. Rose	Sept.-Oct.	1 ft.	2.50
<i>Silene</i> . (Catchfly) <i>Alpestris</i> . White	July	2 ft.	3.00
<i>Schafta</i> . Pink, suitable for Rockeries	May-June	4-6 in.	3.50
SOLIDAGO , <i>Bi-Color</i> (Silver Rod) White	July-Oct.	6 in.	3.00
<i>Canadensis</i> . (Golden Rod) Yellow	July-Sept.	1-3 ft.	2.50
SPIREA . (See <i>Astilbe</i> .)	July-Sept.	4-5 ft.	2.50
STACEYS , <i>Grandiflora Superba</i> . (Woundwort) Mauve			
Flowers	June-July	1 ft.	2.50
STATICE , <i>Latifolia</i> . (Sea Lavender) Blue	Aug.-Sept.	2 ft.	2.50
STOKESIA , <i>Cyanea</i> and <i>Alba</i> . Blue and White	July-Oct.	2 ft.	2.50
SWEET WILLIAM (See <i>Dianthus</i>)			
THALICTRUM , <i>Adiantifolium</i> . Yellow Flowers	June-July	1 ft.	4.00
<i>Dipterocarpum</i> . Rosy Purple, Yellow Anthers	Aug.-Sept.	4 ft.	4.00
THYMUS , <i>Citriodorus</i> . (Creeping Thyme) Lemon Flower.			
Fragrant Foliage	June-July	4 in.	2.50
<i>Serpyllum</i> . (Mother of Thyme) Dense mats of green foliage.			
Dark Red Flowers	June-July	3-4 in.	2.50
TRADESCANTIA , <i>Virginiana</i> . (Spiderwort) Grass-Like Leaves.			
Blue Flowers	May-Aug.	2 ft.	2.50
TRILLIUM , <i>Erectum</i> (Purple Wood Lily)	May	1 ft.	2.50
TRITOMA , <i>Pfitzeri</i> . (Red-Hot Poker Plant) Orange Scarlet	Aug.-Sept.	2-3 ft.	3.00
<i>Rufa</i> . Dainty Yellow	June-Nov.	2½ ft.	4.00
TROLLIUS , <i>Europaens</i> . (European Globe Flower) Lemon colored			
Orange Globe. Large Orange Flowers	May-June	2 ft.	6.00
TUNICA , <i>Saxifraga</i> . Attractive Rock Plant. Pink	May-June	2 ft.	6.00
VALERIANA , <i>Officinalis</i> . (Hardy Garden Heliotrope) Light Pink	July-Sept.	6 in.	3.00
VERBASCUM . Yellow or White. (Mullein)	June-July	3-5 ft.	2.50
VERONICA , <i>Incana</i> . (Speedwell) Silver-Gray Foliage Violet-Blue			
Flowers			
<i>Longifolia</i> . Blue	July-Aug.	1 ft.	2.50
<i>Spicata</i> . Blue	Aug.-Sept.	2 ft.	3.00
VINCA , <i>Minor</i> . (Periwinkle) Evergreen Trailer. Lilac-Blue	June-July	2-2½ ft.	2.50
VIOLA , <i>Cornuta</i> . (Tufted Pansies) Yellow, Mauve, Violet, White and Purple	Apr.-May		3.00
Flowers			
<i>Jersey Gem</i> . Pure Violet. Fragrant	May-Aug.	6 in.	2.50
VIOLETS , <i>Marie Louise</i> . Double Flowers	May-Nov.	6 in.	3.50
Flowers	May-Oct.	8-10 in.	4.00
<i>Mrs. David Lloyd George</i> . Field grown roots	May-Oct.	6 in.	6.00
<i>Princess of Wales</i> . Single Flowers	Apr.-June	3-6 in.	4.00
YUCCA , <i>Filamentosa</i> . (Adam's Needle) Creamy Flowers	June-July	4-6 ft.	6.00

PLAN-TIE, new tying material. Does not bruise plants. Breaks with the fingers but withstands storms. 25c per spool; \$2.50 per dozen.



AQUATICS

DAY BLOOMING TROPICAL WATER LILIES

- Blue Beauty.** Deep blue flowers, with yellow stamens; sepals marked purple. **Each \$3.00**
Gen. Pershing. Finest pink, free bloomer. **Each \$6.00**
Mrs. Ed. Whitaker. Large, frequent bloomer, lavender-blue. **Each \$3.50**
Mrs. Geo. H. Pring. Fragrant, with pointed petals; pure white flowers. **Each \$3.50**
August Koch. Sepals of purplish-lilac and petals pale wistaria-violet. **Each \$3.00**
Mrs. C. W. Ward. Petals rich rose-pink with masses of golden stamens. **Each \$2.50**
Panama-Pacific. Everblooming, predominant reddish color with yellow stamens. **Each \$3.50**

NIGHT BLOOMING TROPICAL WATER LILIES

- Bisset.** Free blooming, beautiful rose-pink. **Each \$2.50**
Frank Trelease. Rich dark crimson with mahogany colored stamens. **Each \$1.75**
Juno. Beautiful white, with saffron yellow stamens. **Each \$3.50**
Omarana. Very pleasing variegated pink flowers. **Each \$1.75**
Rubra Rosea. Rosy-carmine, star shaped. **Each \$1.75**

HARDY WATER LILIES

- Attraction.** Largest size hardy variety. Petals are garnet red, tipped with rose flecked white. Sepals almost white, with faint rose streaks. Turns a beautiful mahogany and yellow hue as it ages. **Each \$3.50**
Chromatella. Best yellow, of a clear rich color. Petals canary yellow, stamens of a deeper hue. A garden favorite. **Each \$2.50**
Comanche. Flowers of a changeable type, opening a rich apricot and then changing to a deep coppery bronze with orange stamens. **Each \$6.00**
Gladstone. King of the white. Strong grower of a brilliant white, with yellow stamens. **Each \$2.00**
Gloriosa. A remarkable variety of red, which thrives under extreme conditions. Fragrant blossoms of bright carmine turning to a cherry red as the season advances. **Each \$6.00**
Morning Glory. Fragrant flowers of a delicate shell pink with a long season of bloom. **Each \$4.00**
Pink Opal. Deep rich pink. A beautiful variety. **Each \$2.50**
Rose Arcy. Deep cerise-pink. A variety of exceptional merit. **Each \$3.50**

BEDDING PLANTS

	Doz.	100		Doz.	100
ANTIRRHINUM, Bedding Varieties	\$1.00	\$ 7.50	LANTANAS, Named Varieties	2.00	15.00
AGERATUM, Blue or White	1.25	9.00	LOBELIAS, Dwarf Blue	1.25	9.00
ASTERS, Assorted Colors75	5.00	MARIGOLDS, Dwarf and Tall75	5.00
BEGONIA, Chatelaine (Red)	2.00	15.00	MYOSOTIS, Blue Varieties	1.00	7.50
BEGONIA, Chatelaine Supreme (Pink)	2.00	15.00	PANSIES, Field Grown Plants		
Gustave Knaake (Crimson)	3.00	20.00	Assorted Varieties.....	5.00	
Luminosa (Red)	2.00	15.00	Giant Flowering Varieties.....	7.50	
BELLIS, English Daisies, Assorted	2.50	20.00	PETUNIA, Standard Single Varieties	1.00	7.50
CALENDULAS, Orange King, Lemon Queen	1.00	7.50	Standard Double Varieties.....	1.50	10.00
The Ball (New Orange)	1.75	12.00	SALVIA, Bonfire	1.00	7.50
CANNAS, Assorted Varieties	1.50	10.00	Splendens.....	1.00	7.50
(See page 85 for Named Varieties)			Zurich (dwarf).....	1.00	7.50
CENTAUREA, Gymnocarpa	1.75	12.00	SWEET WILLIAM, Assorted Colors	2.50	20.00
COLEUS, in variety	1.50	10.00	VERBENA, Lemon, 3 in.	3.50	25.00
FUCHSIAS, in variety	1.50	10.00	Assorted Colors.....	1.25	9.00
GERANIUMS, in 3 1/2 in. pots			VINCA, Rosea, Rosea Alba and Alba Pura	2.50	15.00
Alphonse Ricard (Scarlet).....	4.00	30.00	VIOLA, Jersey Gem	3.50	25.00
Beaute Poitevine (Salmon-Pink).....	4.00	30.00	ZINNIAS, Assorted Varieties75	5.00
S. A. Nutt (Dark Red).....	4.00	30.00			
HELIOTROPE, standard varieties	1.25	9.00			
Standard Varieties, 3 in. pots.....	2.00	15.00			

NOTE—All Bedding Plants supplied in 2 1/4 in. pots, except where noted.

SUMMER FLOWERING BULBS AND ROOTS

	Each	Doz.
AMARYLLIS, Jonnsonii (The Bermuda Spice Lily). Flowers bright red with white stripe.....	\$0.60	\$ 6.00
Vittata Hybrids. A mixture of the finest unnamed seedlings. Extra large, sound bulbs.....	1.00	10.00
BEGONIAS (Tuberous Rooted).		
Single. White, yellow, scarlet, rose.....	.40	4.00
Single. Finest Mixed.....	.35	3.50
Double. White, yellow, scarlet, rose.....	.50	5.00
Double. Finest Mixed.....	.40	4.50
CALADIUM Esculentum (Elephant's Ear). A magnificent sub-tropical plant, producing enormous leaves, often three to four feet in length.		
Extra Large Size Bulbs.....	.50	5.00
First Size Bulbs.....	.40	4.00
Fancy Leaved Varieties. Ideal pot plants for conservatory or bedding.		
Best Named Varieties Mixed.....	.60	6.00
Standard Varieties Mixed.....	.40	4.00
CANNAS.	Doz.	100
American Beauty. 5 ft. Rich carmine.....	\$3.00	\$20.00
City of Portland. 3 ft. Beautiful pink.....	2.00	15.00
Gaiety. 5 ft. Reddish orange mottled.....	2.00	15.00
Hungaria. 3 1/2 ft. Rosy pink.....	2.00	15.00
King Humbert. 4 ft. Orange-scarlet flowers, with bronze foliage.....	2.00	15.00
Panama. 3 ft. Rich orange-red.....	1.50	10.00
The President. 4 ft. Best red.....	1.75	12.00
Yellow King Humbert. 4 ft. Beautiful yellow flowers, with red spots.....	2.00	15.00
Dwarf Mixed Varieties.....	1.50	10.00
Tall Mixed Varieties.....	1.50	10.00
CHRYSANTHEMUMS. (See page 81.)		
DAHLIAS. (See pages 73 and 74.)		
DIELYTRA, Spectabilis (Bleeding Heart). A pretty Spring-blooming hardy plant. Each, 75c.; doz., \$8.00.		
GLADIOLUS. (See pages 75 and 76.)		
GLOXINIAS.		
Gloxinias are the handsomest Summer blooming greenhouse plants. The flowers are gorgeous, and the foliage has a velvety appearance. Choice Mixed Colors. Each, 50c.; doz., \$5.00.		
HYACINTHUS CANDICANS (Summer Hyacinth). A white Summer-flowering Hyacinth, growing 3 to 5 ft. high, gracefully surmounted with many pure white flowers. Each, 15c.; doz., \$1.50.		

IRIS

IRIS, Kaempferi (Japanese Iris). Gorgeous large flowering varieties, with rich variations of color. Flowering during June and July.		
Double White or Gold Bonnd. Double pure white, with deep yellow at base.		
Peacock. Violet-purple, veined with white.		
Pyramid. Indigo-blue, veined with white.		
Stella. Violet, veined white.		
Strong clumps of any above named varieties. Each, 50c.; doz., \$5.00.		
Mixed Varieties.....	doz.	\$2.50
IRIS, Germanica (German Iris or Fleur de Lis). Earlier flowering than Japanese varieties.		
Florentina Alba or Silver Queen. Fragrant variety, flowers porcelain, shading to pure white.		
Isis King. Large brilliant flowers with clear, lemon-yellow stands; falls rich maroon, bordered yellow.		
Pallida Dalmatica. Fragrant, with lavender stands; falls of deeper lavender.		
Purple Queen or Florentine Blue. Rich violet-purple.		
Strong clumps of any above named varieties. Each, 40c.; doz. \$4.00.		
Mixed Varieties.....	doz.	\$1.50
ISMENE (Calathina Grandiflora). One of the best Summer-flowering bulbs. Clusters of large fragrant, pearl white flowers. Resembles Amaryllis. Each, 30c.; doz., \$3.00.		
LILIES, Hardy Varieties. (See page 77.)		
MONTBRETIAS. Hardy Summer flowering bulbs, growing about 24 in. high. Need a covering of leaves to protect them during the Winter.		
	Doz.	100
Croesus. Apricot-yellow.....	\$2.00	\$15.00
Etoile de Fen. Soft red, orange throat.....	1.50	10.00
Fire King. Glowing scarlet.....	1.50	10.00
King Edmund. Orange-yellow.....	1.50	10.00
Macrophylla. Orange, purple inside.....	1.50	10.00
Rheingold. Pure golden yellow.....	2.00	15.00
Speciosa. Orange-red, with yellow throat.....	1.50	10.00
Mixed Varieties.....	1.00	6.00
TRITOMAS. (See page 83.)		
TUBEROSES. Popular sweet scented flowers.		
	Doz.	100
Albino. Single white.....	\$1.25	\$8.00
Dwarf Double. Pearl.....	1.00	7.00

PAEONIES

We advise planting paeonies in the Fall. The following varieties are strong roots, with from 3 to 5 eyes.

	Each	Doz.		Each	Doz.
Albert Crousse. Fragrant late variety. Salmon-pink.....	\$1.50	\$15.00	Mademoiselle Leonie Calot. Mid-season variety. Pale pink, darker in center.....	1.00	10.00
Augustin d'Hour. Fragrant mid-season variety. Dark, solferino red, silvery reflex.....	1.50	15.00	Marguerite Gerard. Late variety, salmon-pink.....	1.00	10.00
Baroness Schroeder. Fragrant late variety. White, shaded flesh.....	2.00	20.00	Mme. Crousse. Mid-season, with pure white flowers, having crimson markings.....	1.50	15.00
Coronne d'Or. Late variety; white with yellow tints.....	1.00	10.00	Mme. Emile Galle. Fragrant late variety. Lilac-pink, milk-white in center.....	1.50	15.00
Duchesse de Nemours. Early variety with pure white flowers, having a sulphur collar.....	1.00	10.00	Mons. Jules Elie. One of the best varieties; pure pink.....	1.50	15.00
Edulis Superba. Early dark pink, very fragrant.....	1.00	10.00	Octavie Demay. Fragrant mid-season variety. Pale hydrangea-pink.....	1.50	15.00
Eugenie Verdier. Fragrant late variety. Hydrangea-pink.....	1.50	15.00	Officinalis Rubra fl. pl. Rich deep crimson. Decoration Day peony.....	1.50	15.00
Felix Crousse. Fragrant mid-season variety. Brilliant red.....	1.50	15.00	Venus. Midseason, with delicate pale pink flowers.....	1.50	15.00
Festiva Maxima. Early paper-white variety, with crimson markings.....	1.00	10.00	MIXED VARIETIES50	5.00

DECIDUOUS FLOWERING SHRUBS

- ALTHEA** (Rose of Sharon). Summer flowering shrub of erect habit.
Double Red, Crimson, Pink, or White.
 1½ to 2 ft. Each 50c; doz. \$5.00
 2 to 3 ft. Each 75c; doz. \$7.50
- AMYGDALUS** (Flowering Almond). Double Pink, or White. 2 to 3 ft. Each \$1.00; doz. \$10.00
- AZALEA, Amoena.** Evergreen shrub with lustrous foliage, with bright rosy-red flowers in June. Bushy plants, 9 to 12 in. Each \$2.50; doz. \$25.00
 Bushy plants, 12 to 15 in. Each \$3.00; doz. \$30.00
- Hinodegiri.** Similar in habit to Amoena, with many fiery-red single flowers. Bushy plants, 9 to 12 in. Each \$3.00; doz. \$30.00
 Bushy plants, 12 to 15 in. Each \$3.50; doz. \$35.00
- Viscosa** (Swamp Honeysuckle). Very hardy with delightfully fragrant white flowers during July and August.
 2 to 3 ft. Each \$3.00; doz. \$30.00
 3 to 4 ft. Each \$4.00; doz. \$40.00
- BUDDLEIA** (Butterfly Bush). Long, graceful, fragrant spikes of flowers of pleasing rich violet-rose, produced in profusion from early June until late August.
Variabilis Magnifica. Large plants. Each 60c; doz. \$6.00
- CYDONIA** (Japanese Flowering Quince). Spiny shrub, with glossy green leaves and large showy scarlet flowers in May-June.
 18 to 24 in. Each \$1.00; doz. \$10.00
- DAPHNE, Cneorum.** (Garland Flower). Prostrate evergreen shrub of spreading habit with small pink, fragrant flowers throughout Summer and Fall.
 Specimen plants Each \$2.00; doz. \$20.00
- DEUTZIA, Crenata, fl. pl.** Double variety, with pink flowers during June.
Crenata Alba, fl. pl. Pure white form of above. Plants of both varieties.
 2 to 3 ft. Each 50c; doz. \$5.00
 3 to 4 ft. Each 75c; doz. \$7.50
- FORSYTHIA** (Golden Bell). Dense masses of bright yellow flowers in April.
Fortunei. Upright grower.
Suspenda. Pendulous growing variety.
Viridissima (Green Barked Forsythia). Plants of above varieties.
 3 to 4 ft. Each \$1.00; doz. \$10.00
- HYDRANGEA, Arborescens Grandiflora** (Snowball Hydrangea). Profusion of snow-white flowers from June to August.
Paniculata Grandiflora. Broad terminal panicles of pure white flowers in August.
Paniculata (Single). Highly recommended in landscape planting. Creamy-white flowers in September.
 Plants of above varieties.
 2 to 3 ft. Each 75c; doz. \$7.50
 3 to 4 ft. Each \$1.00; doz. \$10.00
- JASMINUM, Nudiflorum.** (Winter Jasmine). Golden yellow flowers in early Spring.
 24 to 30 in. Each \$1.50; doz. \$15.00
- KERRIA, Japonica fl. pl.** Summer flowering shrub with slender green branches and pretty serrated leaves. Double orange-yellow flowers in great profusion.
 2 to 3 ft. Each \$1.00; doz. \$10.00
- LONICERA** (Honeysuckle)
Fragrantissima. (Fragrant Bush Honeysuckle.) Creamy pink flowers in May.
Tartarica. (Tartarian Bush Honeysuckle.) Fragrant pink flowers in May, waxy red berries in late Summer.
 3 to 4 ft. Each 75c; doz. \$7.50
- MALUS** (Flowering Crab Apple). Strong growing shrub bearing lovely flowers, followed by attractive fruit.
Atrosanguinea. Bright Pink flowers in May.
Spectabilis. Coral buds, delicate rose flowers.
Furpurea. One of the showiest. Bright red flowers, purple foliage and fruit.
 All varieties.
 3 to 4 ft. Each \$2.50; doz. \$25.00
- PHILADELPHUS, Coronarius** (Mock Orange). Of upright habit, bearing fragrant white flowers in June.
 3 to 4 ft. Each 75c; doz. \$7.50
- PRUNUS, Pissardi** (Purple Leaf Plum). A dwarf growing tree with deep purple foliage throughout Summer and Fall.
 4 to 5 ft. Each \$1.50; doz. \$15.00
- ROSA RUGOSA** (Japanese Rose). Stocky in habit with a wealth of large green leaves, bearing large, single, rose-colored flowers all Summer. 2 to 3 ft. Each 75c; doz. \$7.50
- SALIX, Caprea** (Pussy Willow). Large silvery buds in early Spring.
 3 to 4 ft. Each \$1.00; doz. \$10.00
- SPIRAEA, Anthony Waterer.** Best brilliant purple-crimson variety. 18 to 24 in. Each 75c
Opulifolia Aurea. (Golden Leaved Spiraea.) Yellow leaved form. Each 75c
 3 to 4 ft. Each 75c
- Thunbergii.** Slender, drooping branches, covered with small white flowers in May. Each 75c
 18 to 24 in. Each 75c
- Van Houttei.** (Bridal Wreath). Entirely covered with pure white flowers during May and June. 3 to 4 ft. Each 75c
- SYMPHORICARPUS, Racemosus** (Snowberry). During July and August it has small pink flowers followed by large pure white clusters of berries. 2 to 3 ft. Each 75c
Vulgaris Variegata (Variegated Coral Berry). Low growing, of graceful habit with variegated foliage. Small pink flowers in August and September, followed by dull red berries, which remain all Winter.
 2 to 3 ft. Each \$1.25
- SYRINGA, (Lilac) Villosa.** Japanese Variety. Large panicles; flowers light rosy-purple in bud, creamy-white when open. Very fragrant. Late flowering. 2 to 3 ft. Each \$1.00
Vulgaris (Purple Lilac). Produces many clusters of richly fragrant light purple or true lilac flowers. Early. 2 to 3 ft. Each 75c
Vulgaris Alba (White Lilac). Similar to Vulgaris, having fragrant white flowers.
 2 to 3 ft. Each \$1.00
- Hybrid Varieties.** We can supply elegant assortment of these new marvellous Lilacs, which are far superior to the old sorts.
 2 to 3 ft. Each \$1.50; doz. \$12.00
- TAMARIX, Africana.** Strong, upright, grotesque habit, with airy slender leaves and a profusion of dainty soft pink flowers in May.
 3 to 4 ft. Each \$1.00
- VIBURNUM, Opulus Sterilis** (Common Snowball). It bears large round clusters of pure white flowers in late May and early June. Spreading habit. 2 to 3 ft. Each \$1.00
Plicatum. (Japanese Snowball). Of compact, upright habit with highly ornamental foliage; having dense clusters of pure white flowers in late May and early June.
 2 to 3 ft. Each \$1.50
- WEIGELIA** (Diervilla). Popular shrub, of bold, graceful habit. Flowers trumpet shaped.
Candida. Pure white flowers during late Spring and early Summer. 2 to 3 ft. Each \$1.00
Desboisi. Small, dark crimson flowers.
 3 to 4 ft. Each \$1.00
- Rosea Amabilis.** Great masses of deep pink flowers in June. 3 to 4 ft. Each 75c
Rosea Nana Variegata (Variegated Leaved Weigela). Foliage deeply marked creamy white. Light pink flowers in June.
 2 to 3 ft. Each \$1.00

Ornamental & Flowering
EVERGREENS



Evergreens well chosen and planted.

CLIMBING VINES

- ANDROMEDA** (Lily of the Valley Shrub). Splendid foundation shrub, bearing profusion of delicate white flowers in April. Sturdy stock. 12 to 18 in. **Each \$3.00; doz. \$30.00**
- ARBOR VITAE, Biota Aurea Nana** (Golden Arbor Vitae). Globular shaped with yellow edged foliage. 12 to 15 in. **Each \$2.50**
- Thuja Occidentalis** (American Arbor Vitae). Pyramidal habit, with bright green leaves showing a yellowish hue on underside. 2 to 3 ft. **Each \$2.50**
- Thuja Pyramidalis** (Pyramidal Arbor Vitae). A valuable evergreen of compact upright habit. 18 to 24 in. **Each \$2.00**
- Thuja Occidentalis Compacta**. Dwarf, globular. Excellent hedge plant. 12 to 15 in. **Each \$1.75**
- BUXUS** (Box). See Hedge Plants.
- JUNIPERUS**, (Juniper) **Chinensis Pfitzeriana**. Broad bushy type. 15 to 18 in. spread **Each \$3.00**
- Communis Aurea**. Prostrate growth, bright golden yellow foliage. 12 to 18 in. spread **Each \$2.00**
- Communis Hibernica**, (Irish Juniper). Erect dense conical tree, grayish-green foliage. 18 to 24 in. spread **Each \$2.00**
- Communis Prostrata**. Of dwarf, prostrate habit. 12 to 18 in. spread **Each \$2.00**
- KALMIA, Latifolia** (Mountain Laurel). Finest native hardy evergreen, with dainty rose-pink buds and creamy-white flowers during June. 12 to 18 in. **Each \$1.50; doz. \$15.00**
18 to 24 in. **Each \$2.00; doz. \$20.00**
- PICEA** (Spruce) **Excelsa**. Very hardy and rapid growing. 2 to 3 ft. **Each \$3.00**
- Kosteriana**, (Koster's Blue Spruce). (Can supply excellent stock of these, write for prices, stating sizes required.)
- Orientalis**. Foliage smaller and more dense than other varieties. 2 to 3 ft. **Each \$4.00**
- PINUS** (Pine) **Mughus**. Dwarf, compact, with dark green foliage and formal habit. 12 to 18 in. **Each \$3.50**
- Nigra Austriaca** (Austrian Pine). Massive spreading limbs, long, stiff needles. 2 to 3 ft. **Each \$4.00**
- Resinosa**. Reddish-brown bark, foliage light green. 2 to 3 ft. **Each \$4.00**
- RETINOSPORA** (Cypress) **Filifera**. Valuable for formal work. 2 to 3 ft. **Each \$5.00**
- Filifera Aurea**. Very graceful, golden color throughout the year. 18 to 24 in. **Each \$5.00**
- Picifera**. Tall, pyramidal shape. Deep glossy green foliage. 2 to 3 ft. **Each \$4.00**
- Picifera Aurea**. Golden Picifera variety. 2 to 3 ft. **Each \$4.00**
- Plumosa**. Useful for hedges and formal work. 2 to 3 ft. **Each \$4.00**
- RHODODENDRONS** (Great Laurel) **Maximum**. The hardest variety and a strong grower. Does equally well in sun or shade. Produces light pink flowers in late June and throughout July. 2 to 3 ft. **Each \$2.50; doz. \$25.00**
3 to 4 ft. **Each \$3.50; doz. \$35.00**
- TAXUS** (Yew) **Cuspidata Brevifolia**. Handsome dwarf evergreen, with spreading branches having short dark green needles. 12 to 18 in. **Each \$3.50**
- THUJA**. See Arbor Vitae.
- TSUGA** (Hemlock) **Canadensis**. Excellent as hedge plant or specimen. 2 to 3 ft. **Each \$4.50**
- Sargentii** (Sargent's Weeping Hemlock). A very beautiful variety with pendulous growth. Specimens 18 in. spread **Each \$15.00**
- Note**. Large specimens of above evergreens can be supplied. Write for prices.

- AMPELOPSIS, Veitchi** (Boston Ivy). Rapid growing climber, deep green foliage which changes to crimson and gold in Autumn. Strong. 2 yr. old plants. **Each 50c; doz. \$5.00**
- BIGNONIA, Radicans** (Trumpet Flower). Fern-like foliage and large trumpet-shaped flowers of vivid orange-scarlet. Strong 2 yr. old plants. **Each 50c; doz. \$5.00**
- CLEMATIS, Jackmanii**. Profusion of large rich, velvety purple flowers. **Each \$1.00; doz. \$10.00**
- Paniculata**. Numerous pure white star-like flowers. Quick grower. Strong 2 yr. roots. **Each 75c; doz. \$5.00**
- CINNAMON VINE ROOTS** **Each 25c; doz. \$2.50**
- EUONYMUS**, (Creeping) **Radicans**. Hardy dense growing, dull green leaves with whitish vein. **Each 75c; doz. \$5.00**
- Variegatus**. Same as above, with variegated foliage. **Each 75c; doz. \$5.00**
- HEDERA, Hibernica** (English Ivy). Old favorite vine, useful for covering walls or as ground cover plant. Strong pot grown plants. **Each 50c; doz. \$5.00**
- LONICERA, Halleana** (Hall's Japanese Honey-suckle). Popular vine with abundant, glossy, evergreen foliage. Fragrant flowers. 2 yr. plants. **Each 35c; doz. \$3.50**
- MADEIRA VINE**. Extra large tubers. **Each 20c; doz. \$2.00**
- PUERARIA, Thunbergiana** (Japanese Kudzu Vine). Most rapid growing plant known, its large leaves produce a dense shade. Rose-purple flowers. **Each 50c; doz. \$5.00**
- VINCA, Minor** (Periwinkle). Known as trailing Myrtle. Rapid growing with glossy evergreen leaves. **Each 30c; doz. \$3.00**
- WISTARIA, Sinensis** (Chinese Wistaria). Rapid growing and of great height. Produces in May soft dainty lavender-blue flowers in pendulous racemes. **Each 75c; doz. \$7.50**

HEDGE PLANTS

- BERBERIS** (Barberry). Very popular shrub of dense low growth. Foliage turns to rich colors in Autumn.
- Thunbergii**. 9 to 12 in. **Doz. \$2.50; 100 \$15.00**
12 to 18 in. **Doz. \$3.50; 100 \$27.50**
- Thunbergii Atropurpurea** (Red Leaved Barberry). Strong 1 yr. old stock. **Doz. \$9.00; 100 \$65.00**
- BUXUS** (Boxwood).
- Sempervirens**. The popular variety, frequently grown in globe and pyramidal shape. 12 to 18 in. **Each \$1.50; doz. \$15.00**
18 to 24 in. **Each \$2.75; doz. \$27.50**
- Suffruticosa**. A dwarf, compact variety used for edging. 4 to 6 in. **Each 50c; doz. \$5.00**
6 to 8 in. **Each 75c; doz. \$7.50**
- LIGUSTRUM, Ovalifolium** (California Privet). Popular hedge plant with glossy green leaves. 12 to 18 in. **Doz. 75c; 100 \$5.00**
18 to 24 in. **Doz. \$1.00; 100 \$6.00**
24 to 36 in. **Doz. \$1.50; 100 \$9.00**

FRUIT TREES

APPLES

EARLY VARIETIES.

Red Astrachan. Large deep crimson, flesh white.

Yellow Transparent. Flesh white, juicy and spicy.

AUTUMN VARIETIES.

Fall Pippin. Large, yellow; rich and delicious.

McIntosh. A beautiful apple, deep red in color.

Gravenstein. Large, yellow, nearly covered red.

WINTER VARIETIES.

Baldwin. Dark Red, of good quality.

Delicious. An exceptionally good variety.

Northern Spy. Pale yellow, striped red.

Rhode Island Greening. Yellowish-green, tender.

Stayman's Winesap. Delicious, spicy flavor.

Price on all varieties, Each \$2.00; doz. \$20.00

PEACHES

Belle of Georgia. Mid-season, freestone; white, largely overspread with red. Best white.

Crawford's Early. Large yellow with red cheek; juicy, sweet. Middle of August.

Eiberta. Mid-season. Large fruit; yellow with deep red cheek. Most largely grown.

J. H. Hale. Large, round shape, deep golden yellow skin, overlaid with carmine; flesh golden, of high quality. Mid-September.

Price on all varieties, Each \$1.50; doz. \$15.00

QUINCES

Orange. (Apple). Early yellow fruiting variety. Excellent for preserving.

Each \$2.00; doz. \$20.00

PEARS

Bartlett. Yellow, Summer variety. Most popular sort.

Clapp's Favorite. Early Summer variety. Large, green with red cheek, juicy sort.

Kieffer. Autumn variety. Yellow, with red cheek, being a good winter keeper.

Seckel. Prolific, small variety, of a dull russet hue. Very high quality.

Price on all varieties, Each \$2.00; doz. \$20.00

PLUMS

Abundance (Japanese). Ripens late in August cherry-red; bearing heavy, juicy fruit of high quality.

Bradshaw. Early and very large. Purple with bloom. Good canning variety.

Lombard. Mid-season. Very reliable and prolific variety; violet-red fruit.

Price on all varieties, Each \$1.50; doz. \$15.00

CHERRIES

Black Tartarian (Sweet). Beautiful dark purple; of medium size. Most popular variety. Early.

Early Richmond (Sour). Bright red, very acid, extremely prolific.

Montmorency (Sour). Light red, very acid. Popular for pie making.

Yellow Spanish (Sweet). Pale amber, with red on sunny side; large firm, juicy fruit.

Price on all varieties, Each \$2.00; doz. \$20.00

TRAINED FRUIT TREES

Prices on request.

SMALL FRUITS

BLACKCAPS

Cumberland. Produces the largest berries of any. Midseason.

Strong plants. Doz. \$2.00; 100 \$12.00

BLACKBERRIES

Eldorado. One of the highest in quality; medium size berries, jet black, mild and sweet. Early to mid-season.

Ward. Strong growing variety; a heavy cropper, handsome, first quality berries.

Price on above varieties, Doz. \$2.00; 100 \$12.00

CURRANTS

Pres. Wilder. Produces late in season, large bright red, juicy berries of high quality.

Red Cross. Vigorous grower, heavy cropper. Bears good sized sparkling red berries.

White Grape. Best white sort; translucent and of good mild flavor.

Price, 2 yr. old, Doz. \$5.00

GOOSEBERRIES

Carrie. Heavy cropper, maroon color and of good quality but small fruit.

Downing. Large, pale green berries. Good market variety of fair quality.

Price on above varieties, Doz. \$6.00

Oregon Champion. Distinct from all other sorts. Of slender willowy growth, bearing fruit of pale amber color and of good quality and size. Doz. \$9.00

RASPBERRIES

Cuthbert. Large size, deep crimson berries of high quality.

Strong plants. Doz. \$2.50; 100 \$15.00

Columbian (Cap). Excellent for making jelly or jam, with fruit of purplish-crimson.

Strong plants. Doz. \$2.50; 100 \$15.00

Golden Queen. Best yellow fruited variety.

Strong plants. Doz. \$2.50; 100 \$15.00

La France. Everbearing variety, with fruit of deep pink and of a delicious flavor.

Heavy fruiting plants. Doz. \$5.00; 100 \$35.00

Latham. Undoubtedly the best red raspberry.

Strong plants. Doz. \$5.00; 100 \$20.00

St. Regis. Everbearing variety of excellent quality.

Strong plants. Doz. \$3.00; 100 \$20.00

GRAPES. (Hardy Varieties)

Agawam. Deep red, almost maroon with large, loose bunches of meaty aromatic berries.

Champagne. Amber colored berries of delicious flavor and is highly recommended for wine making.

Catawba. The standard red variety. Vigorous, hardy and productive.

Concord. Most popular variety, has large black fruit of splendid flavor.

Niagara. The most popular white sort.

Strong 2 yr. canes of all varieties, Each 75c; doz. \$7.50



HORTICULTURAL TOOLS and SUNDRIES

DURING our many years in the seed business, we have been called upon from time to time to procure for some of our many customers, certain British-made Horticultural Sundries, to which they had grown accustomed since their apprenticeship.

These many requests have resulted in this array of tools illustrated above.

For the convenience of our patrons, we have standardized these implements and offer them in addition to our regular high grade American made goods, as a feature of Burnett Brothers.



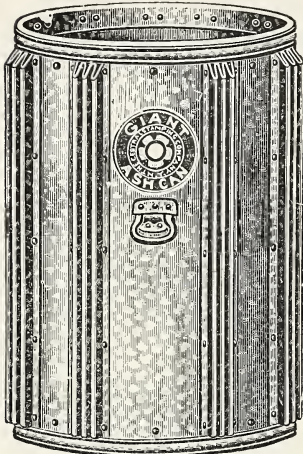

Bill-hook

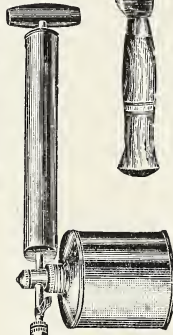

G. V. Sprayer

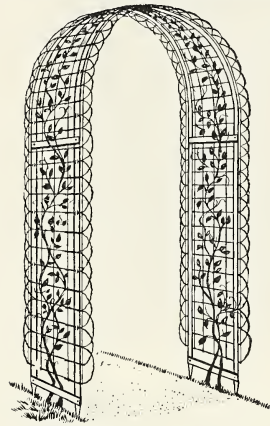

Wire Arch Trellis

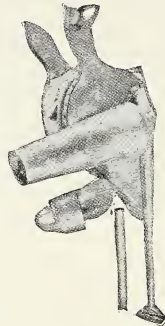

Acme Bellows

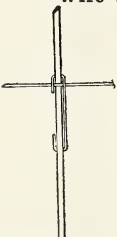

Blake's Lever Clip

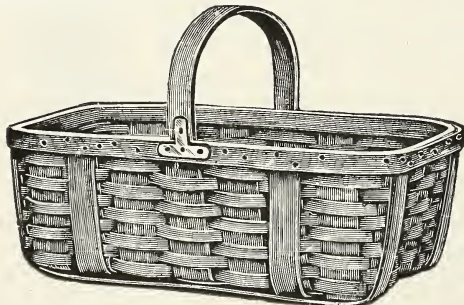
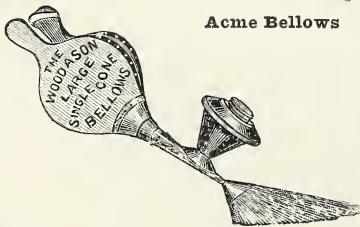

Heavy Oak Market Basket

APRONS, Gardener's Rubber, waterproof.
 each\$3.00
Nancy Lee, rubber; patented waist-clasp
 takes weight off neck; no strings; com-
 fortable.\$4.00
Shalloon or Serge English; imported.....\$5.50

ARCHES, see (Trellises).

ASH CANS, Giant. 17 in. Diam., 26 in. high,
 steel staves make it indestructible. \$5.00
Jumbo, somewhat similar to the Giant,
 each\$3.50
(Covers) for either of above cans.....75c
Capital, 17 in. x 23 in. with cover and drop
 handles, for ashes or storing seeds or feed.
 Each\$3.25

ASPARAGUS BUNCHER\$6.00

ASPARAGUS KNIVES, English; imported,
 each\$3.50
American50c

AXES, Felling, with handles.....\$3.50

BASKETS, Hanging Wire, painted, 10 in. 40c.;
 12 in. 50c.; 15 in. 60c.; 18 in. \$1.00.

Heavy Oak Market Each
 No. 1, 18 x 10 1/2 x 6\$1.50
 No. 2, 21 x 12 x 6 1/21.75
 No. 3, 23 x 13 x 72.00
 No. 4, 24 x 15 x 82.25
 No. 5, 25 x 16 x 8 1/22.50

Bamboo Round
 1/2 Bushel size2.00
 1 Bushel size2.50

Split Oak
 1 Bushel size2.50
 2 Bushel size3.50

Flower & Fruit, a handy shallow basket for
 gathering flowers and fruits. Each
 No. 2, medium size, 20 x 12 x 3 1/2\$1.25
 No. 3, large size, 22 x 14 x 3 1/21.40

Flower Willow, natural willow 17 in. long.
 11 in. wide, 3 1/2 in. deep each \$4.00
Metal, galvanized. 1/2-bus. size, \$1.25; 1-bus.
 size \$1.50.

Strawberry per 100 per 1000
 1 qt. size, square shape\$1.75 \$16.00
 2 qt. size, oblong shape2.75 25.00

BENCHES, "Lite-Wate" Settee. Light, dur-
 able, of channel steel legs and oak slats.
 42 inches long. Each\$4.25

BELLOWS, Powder

Acme, best quality leather; scoop cover;
 non-clogging agitator; extension arm;
 capacity, 16 ounces each \$3.25
Midset No. 7, holds 3 1/4 ounces each 50c.
Small, single cone, Woodason each \$3.00
Large, single cone, Woodason each \$5.00
Double cone, Woodason each \$7.25

BILL HOOKS, English. Imported.

Double edge, short handle each \$3.00
Single edge, long handle each \$6.00

BLAKE'S LEVER CLIPS, for fastening rose
 wire. Per 500, \$1.75; per 1000, \$2.75.

BOOKS for BETTER GARDENS

Around The Year In The Garden, F. F.
 Rockwell gives a program for the whole
 year: 350 pages \$2.50

Book Of Bulbs, F. F. Rockwell describes fall
 and summer flowering bulbs; 264 pages.
 each\$3.00

Dahlias, F. F. Rockwell tells how to grow
 Dahlias of exhibition standard; 80 pages,
 each\$1.00

Evergreens For The Small Place, F. F. Rock-
 well tells of their care, selection and plant-
 ing as suitable for a small place; 84 pages,
 each\$1.00

The Cultivated Evergreens, by Foremost
 Experts, who describe planting, selecting,
 classifying as well as insect controlling of
 evergreens; edited by L. H. Bailey; 434
 pages, each\$3.00

BOOKS—Continued

- Fertilizers**, Voorhees & Haskell tell which fertilizers are best adaptable to lawns, flowers and crops and analyse soil needs; 310 pages.....\$2.50
- Garden Guide**, for the amateur. Foremost experts in every phase of gardening have herein contributed their knowledge. Paper cover, \$1.00; cloth cover, \$1.50.
- The Gardener**, L. H. Bailey treats flowers, vegetables and fruits thoroughly; 260 pages.....\$2.00
- Manual of Gardening**, L. H. Bailey treats drainage, cultivation, fertilization, propagation, planting, pruning and landscaping, 539 pages.....\$3.00
- Gladiolus**, F. F. Rockwell treats them from bulblets to flowers, 79 pages.....\$1.00
- Standard Cyclopaedia Of Horticulture**, edited by L. H. Bailey. This is the one universal and invaluable authority on every horticultural question; 3,637 pages; 3 volumes, fabrikoid binding, 5,000 illustrations, per set.....\$25.00
- Iris**, F. F. Rockwell, 80 pages.....\$1.00
- (Lilies) Garden Cinderellas**, H. M. Fox classifies every Lily in cultivation; tells how to propagate them; 269 pages.....\$5.00
- Pruning Manual**, L. H. Bailey tells when and how to prune properly; 400 pages \$2.50
- Rock Gardens**, F. F. Rockwell shows how to build a rock garden; 86 pages.....\$1.00
- The Rose In America**, J. H. McFarland gives newest information on cultivation, pest control and varieties classified; 233 pages, each.....\$3.00
- Shrubs**, F. F. Rockwell: 76 pages.....\$1.00
- Spraying, Dusting and Fumigating of Plants**, A. F. Mason treats the control of insects intensively; 570 pages.....\$5.00
- The Home Vegetable Garden**, E. M. Freeman, 214 pages.....\$1.75

- BOOTS**, Horse Lawn, made of superior leather, improved double thick riveted soles. In ordering, send outline of hoof. Price per set of four.....\$20.00
- Men's Rubber**, best rubber with leg lining. Short, Storm King or Hip: sizes 6-12, pair.....\$8.00

BOXES, for shipping cut flowers.

Cardboard, Heavy Gray.

No.	Length	Width	Depth	50	100
No. 1	18 in.	5 in.	3 in.	\$3.50	\$ 6.50
No. 2	24 in.	8 in.	5 in.	7.00	13.00
No. 3	28 in.	8 in.	5 in.	8.50	16.00
No. 4	36 in.	8 in.	5 in.	11.00	21.00

Corrugated, Extra strong.

No.	Length	Width	Depth	Doz.	100
No. 1	24 in.	8 in.	6 in.	\$4.00	\$30.00
No. 2	30 in.	12 in.	8 in.	6.00	45.00
No. 3	36 in.	12 in.	8 in.	7.50	55.00
No. 4	48 in.	14 in.	8 in.	9.50	70.00

- BROOMS**, Birch, (Imported) for Lawns, each.....75c
- Corn and Rattan** mixed, for barn, each \$1.75
- Japanese Bamboo**, made of bamboo tips mounted on a bamboo handle. Used on lawns.....each \$1.00
- Stable or Push**, 12 to 16 ins., rattan, each.....\$2.00
- BRUSHES or FLOWER POT SCRUBBERS**
Cone, Bristle with wood handle, imported, each.....\$1.75
- BRUSH HOOKS**, best crucible steel, each \$2.25
- BULE PANS**, see (Flower Pots).
- BULL DOG CLIPS**, for fastening the wrappings on plants; displaces pins; per box of 1000.....\$1.25
- BURLAP**, 36 in. wide, per yard.....25c
60 in. wide, per yard.....35c



Books for better Gardens



Corn Broom



Willow Flower Basket

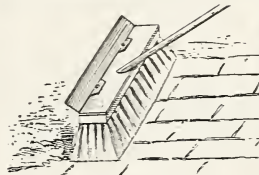

Stable Broom



Norcross Cultivator



Rubber Hip Boots

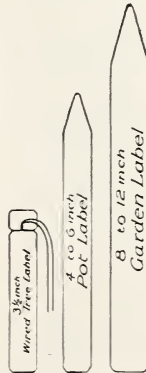

8 to 12 inch Garden Label

3 1/2 inch Wood Free Label

4 to 6 inch Pot Label

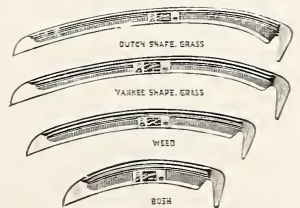

Brush & Scythe Blades

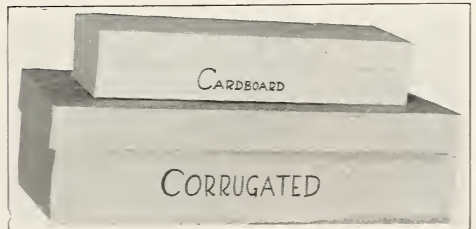

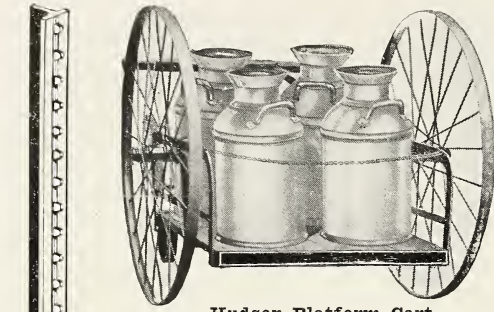

Hudson Platform Cart

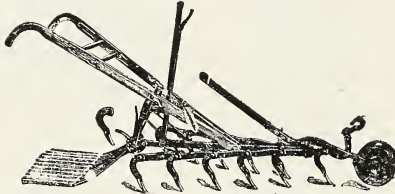

Planet Jr. Harrow & Cultivator

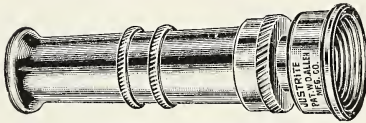

Graduating Hose Nozzle

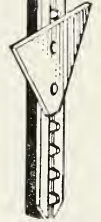

"T" Fence Post



Norcross



Dibble



Caterpillar Torch

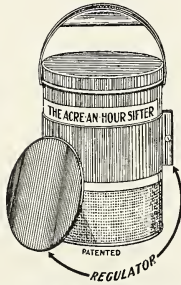

Dandy Duster No. 120

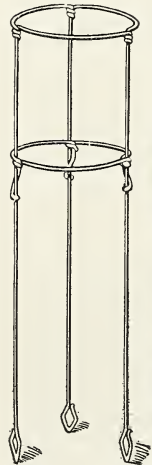

Carnation Support

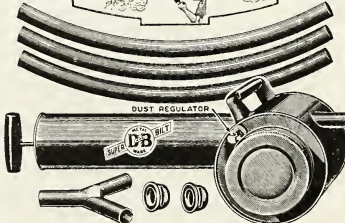
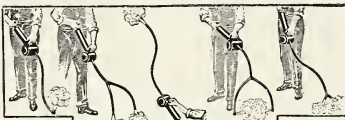

CANE STAKES, BAMBOO

Chinese, natural color.	Doz.	100	1000
Height 4 ft., 1/2 in. diam.		\$0.75	\$5.00 \$45.00
Height 6 ft., 3/4 in. diam.		1.00	7.50 70.00
Height 8 ft., 1 in. diam.		1.25	8.00 75.00

Domestic Tapering for staking 'Mums, Sweet

Peas, etc.	100	1000
6 to 8 ft.	\$3.00	\$27.50
8 to 10 ft.	5.00	40.00

Japanese, stained green. Light and durable.

Height	Doz.	100	1000
1 1/2 ft.		\$0.15	\$0.70 \$ 5.00
2 ft.		.20	1.00 7.00
2 1/2 ft.		.25	1.25 8.00
3 ft.		.30	1.50 10.00
3 1/2 ft.		.35	1.75 12.00
4 ft.		.40	2.25 15.00
5 ft.		.50	2.50 17.50

Other Stakes, see (Plant Stakes).

CANVAS COVERS, for hay stacks or wagon or machine covers. Made to specified sizes in three grades, medium, heavy or extra heavy, absolutely waterproof with brass gommets and ropes on all four hemmed sides, Lock-stitched. Prices and samples of material on request.

CARNATION BANDS, rubber....per ounce 30c.

CARNATION STAPLES, for split carnations per 100050c

CARNATION SUPPORTS, "Model Extension."

Wire, 2-ring	per doz.	\$1.25	per 100, \$7.50
Wire, 3-ring	per doz.	\$1.50	per 100, \$8.50

CARTS, DUMP. Light, durable, one-horse, 5 ft. 10 in. long, 36 1/2 in. wide, 17 in. high, 1700 lbs. capacity, perfectly balanced; each\$85.00

Hudson Platform, wooden platform 27 x 30 in., 36 in. steel wheels for carrying milk cans, farm produce or barrel of water; each\$16.00

Other Carts, see (Sprayer's Accessories).

CATERPILLAR TORCHES, see (Torches).

CELERY BLEACHERS.

Waterproof Paper collars 6 1/2 x 13 in. Per 100, \$4.50.....Per 1000 \$42.00

Areandee R. & D. is a patented flexible, odorless, waterproof material packed in rolls containing 100 feet. Superior to old style bleachers. 100 ft. roll, 12-inch width, including 25 (48-inch) wire supports, \$5.00

CHAMOIS SKINS, large selected 12 x 16 in. Each85c

CORN PLANTER, Segment has steel slide, light, durable and accurate.....each \$2.75

COTTON BATTING, sheets 40 x 40 in., per doz.\$1.00

CULTIVATOR, HAND

Norcross Hand. This cultivator is acknowledged to be the Leader, combining speed, strength, durability and ease in operation. Works between rows, or center shovel can be removed to straddle the row if desired. Price, 5-prong, \$1.40; 3-prong, \$1.00.

CULTIVATORS, Sulky Moline, low wheels, gangs easily worked, even penetration, tongue lever regulates depth of shovels, forged steel, 32-44 in. row adjustments. 8 shovel, spring trip, open sleeve, round shank.....each \$75.00

Other Cultivators, see Planet Jrs.

DIBBLES, Iron point, wood handle....each 85c

DUSTERS, HAND No. 120 Dandy, has fittings for dusting underneath or on top of leaves with one or two nozzles also overhead dusting; has a simple and efficient regulating valveeach \$3.00

Dickey Bug Death, oblong container, 60c.

Acre-An-Hour, 2 qt. can with perforated bottom.....each 75c

DUSTERS, GEARED Little Giant, a light duster for dusting underneath the leaves as well as on top, 3 extension tubes and 5 nozzles..... each \$12.00

Savage, high geared, easy cranking, ball bearing fan shaft, feeds 1 to 20 lbs. per acre, 7 to 10 lbs. container, adjustable nozzle..... each \$20.00

Superbilt No. 200, patented agitators and feeding device and powerful air blast breaks up powder and prevents clogging; 5 to 10 lbs. hopper, easy to operate, comfortable to carry..... each \$15.00

Superbilt No. 100, 3 to 5 lbs. hopper, similar to No. 200. Each..... \$11.25

EDGING KNIVES, see (Knives).

EGG BOXES, Parcel Post.

Corrugated, corrugation throughout prevents breakage and protects eggs against heat and cold.

Capacity	25 boxes	50 boxes	100 boxes
1 doz. size.....	\$3.25	\$6.25	\$12.00
2 doz. size.....	4.25	8.25	16.00

Aluminum, of light metal for continual use, may be reused again and again; patented filler insures 100% safe transportation. Prices each: 1 dozen \$1.00; 1 1/2 dozen \$1.25; 2 dozen \$1.50; 3 dozen \$1.75.

Aluminum Combination Egg and Butter
 No. 1, 2 lbs. butter and 1 doz. eggs.....\$1.50
 No. 2, 4 lbs. butter and 2 doz. eggs.....\$2.00
 No. 3, 4 lbs. butter and 3 doz. eggs.....\$2.25

Plain, not parcel post for delivering eggs.
 3 x 4 stock, 500, \$6.00; 1000, \$10.00.
 2 x 6 stock, 500, \$8.00; 1000, \$15.00.

ENGINES, GAS Cushman from 1 1/2 to 15 horsepower. Prices and illustrated circulars on request.

ENSILAGE CUTTER, Hocking Valley does better work utilizing less power, four sizes, cuts 4 to 15 tons per hour. Prices and illustrated circulars on request.

EXTENSION POLES, 12 ft. (in 4 ft. sections):
 Bamboo, \$1.25; Metal, \$1.00.

FENCES, Wire Flower. Easily pushed into ground without disarranging a single wire; 2 3/4 in. mesh, 22 in. high—per roll of 100 ft.....\$12.50

Wire Lawn, super-zincd No. 9 wire, 2 3/4 x 6 in. mesh; plain or scroll; non-rusting, per 100 ft. rolls: 42 in. \$18.00; 48 in. \$20.00

FENCE POSTS, "T" has steel anchor plate insuring immediate anchorage; posts are notched to hold any type of fencing; 7 wire clamp fasteners furnished with each post; painted grey. Price each: 5 ft. 60c; 6 ft. 70c; 6 1/2 ft. 75c; 7 ft. 80c.

FERTILIZER SPREADER, Thompson's. 200 pounds capacity; 6 ft. swath. For Bone, Sheep Manure, etc.....\$48.00

FLOWER BOXES, see (Boxes).

FLOWER POTS

Standard. Prices subject to change without notice. We take utmost care in packing but are not responsible for breakage in transit. Shipped by Freight only. Packing Extra at cost.

Size	100	1000	Size	100
2 in.....	\$1.50	\$12.50	7 in.....	\$16.50
2 1/2 in.....	2.00	17.00	8 in.....	25.50
3 in.....	2.50	21.50	9 in.....	40.00
4 in.....	4.50	35.00	10 in.....	50.00
5 in.....	7.00	60.00	12 in.....	100.00
6 in.....	11.00	95.00		

Neponset Paper, waterproof.

Size	100	1000	Size	100	1000
2 1/4 in.....	\$0.75	\$ 6.00	4 in.....	\$1.50	\$14.00
3 in.....	1.00	8.00	5 in.....	2.25	20.00
3 1/2 in.....	1.25	10.00	6 in.....	3.00	26.00

Round Bulb Fans

Diam.	Depth	Doz.	Diam.	Depth	Doz.
6 in.....	4 1/2 in.	\$1.50	10 in.....	4 1/2 in.	\$6.50
8 in.....	4 1/4 in.	3.00	12 in.....	4 3/4 in.	13.00
9 in.....	4 3/8 in.	5.00	14 in.....	5 in.	22.00

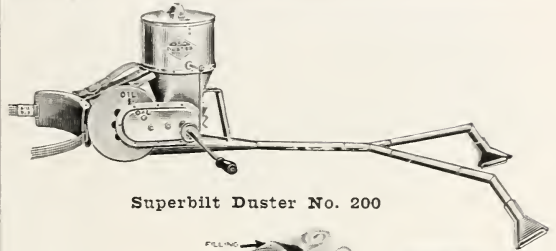

Superbilt Duster No. 200

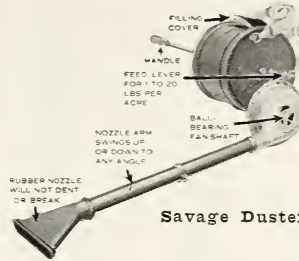

Savage Duster

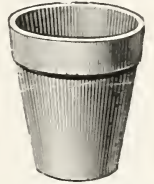

Standard Flower Pot

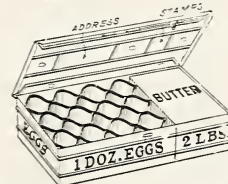

Aluminum Egg Box



Bulb Pan

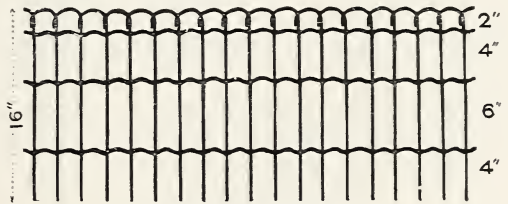

Wire Flower Fence

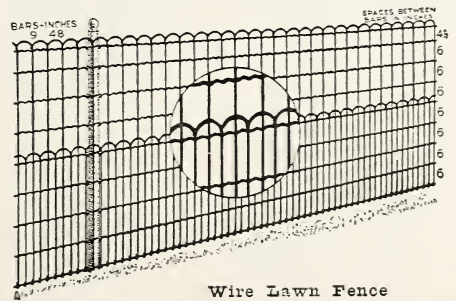

Wire Lawn Fence



Boston Spray Rose



Neponset Flower Pot

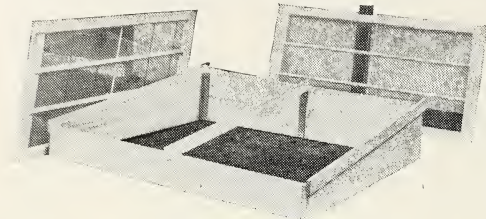

Garden Frames

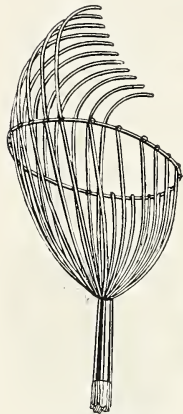

Fruit Picker



Garden Reel



Gem Hand Fork



Marple's



No. 400

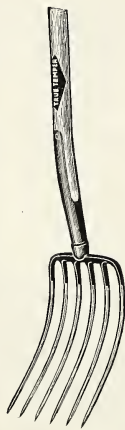

Manure Fork



Glass Cutter



English Grass Hook



Siebert's Glazing Points

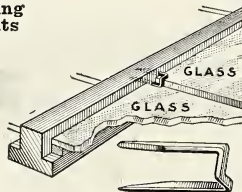

Peerless

FLOWER POT COVERS, waterproof paper, effect similar to Green Crepe paper, decorative.

5 in. \$1.75 for 25; \$6.00 per 100
6 in. \$2.00 for 25; \$7.00 per 100

FLOWER POT SCRUBBERS, see (Brushes)

FORKS

Digging or Spading, Best steel.
4-tine, long or short "D" handle, each \$2.50
5-tine, long or short "D" handle, each \$3.00
Hay, Straight or Bent handles 4 to 5 ft. long.
2-tine, \$1.50 each; 3-tine, \$2.00 each.
Manure, Long or Short "D" handles.
4-tine, \$2.50 5-tine, \$3.00
Transplanting, Hand. "Gem" 3-prong, each 60c
Johnson No. 400, 4-tine each 35c
Marples English, best crucible steel, 4-prongs, varnished oak handle each 75c

FRUIT PICKERS, Wire each 60c
Bamboo Extension Pole, 12 ft. (in 4 ft. feruled sections) to take apart, each \$1.25; Extra 4 ft. sections each 50c

FUMIGATORS, Imported.

X. L. All, Lamp and Stand complete.
Small size \$1.50; Large size \$2.00. Extra glass lamps 50c and 75c. Extra wicks 10c.

GARDEN FRAMES, made of air-dried cypress for regular standard 3 x 6 feet sash; 8 in. front, 16 in. back; 3 x 3 inch rabbited rafters; two coats of paint. Shipped knocked down. Wrought iron angle cleats make them easy to assemble.

Prices:	Grades	Special	Stand-ard
For 2 lights.....	6 x 6 ft.	\$20.00	\$14.00
For 3 lights.....	6 x 9 ft.	26.00	18.00
For 4 lights.....	6 x 12 ft.	30.00	23.00

Larger sizes made to order.

GARDEN FRAME SASH, see (Sash).

GARDEN LINES, Finest braided hemp.
50 ft. \$1.25; 100 ft. \$2.00; 200 ft. \$3.50.

GARDEN REELS, for above, wrought iron, painted. Large \$2.25; Small \$1.40.

GARDEN PENCILS, Indelible black (Imported) each 20c

GARDENER'S GLOVES

English Turnover (Imported) per pr. \$3.25
English Gauntlet (Imported) per pr. \$4.50
Domestic, Gauntlets and Shorts, per pr. \$1.50 and \$2.00

GLASS CUTTERS, 15c, 25c and 50c each.

GLASS FOR GLAZING. Market price.

GLAZING POINTS

Peerless, per box of 1000 80c
Siebert's, Zinc, will not rust. Two sizes, 5/8 and 3/4 in. long per lb. 60c

GRAFTING WAX, for grafting cuts and bruises on trees. Made of best bee's wax, per lb. 60c

GRAFTING CHISEL, forged steel, \$1.75.

GRAIN BINDER, Milwaukee. Light draft, durable, simple construction. 6-ft., weight 1600 lbs., \$230.00 with bundle carrier; transport \$10.75 extra. Illustrated circular on request.

GRAPE BAGS, paper with patented metal clasp. \$1.00 per 100; \$8.50 per 1000.

GRASS CATCHERS, No. 12G; light, made of canvas with galvanized bottom. Fits any mower 16 in. to 22 in. wide. Each \$3.00

GRASS HOOKS or SICKLES

English, riveted back. Medium \$1.00;
Large \$1.25
English, solid back each \$1.00
American, solid back each 75c

GRASS SIGNS, "Keep Off The Lawn" tin, each 25c

GRINDSTONES, Rex Mounted. Very strong and durable. Stones are 19 to 22 inches in diameter, 2 to 2½ inches thick. Weight 85 lbs. each \$12.00

No. 10 Cleveland, 19 in. in diameter, 1¾ in. thick, stone weighs 60 lbs. Mounted on steel frame. each \$13.00

HAMMERS, Garden with claw..... each \$1.50

HANDLES, Axe, Hickory 32 to 36 ins. each 60c

Hoe, 4½ ft. 50c..... 6 ft. 80c

Pick or Mattock, Hickory 36 in. each 75c

HARROWS, Disc, 8, 10, 12 or 14 discs, 16 or 18 in. in diam. \$65.00 to \$85.00 depending on size.

Peg Tooth, 50 to 120 steel square teeth 9½-16 in. long; in either 2, 3 or 4 sections, 191 to 478 lbs.; prices range from \$25.00 to \$55.00 depending on size. Illustrated circular on request.

Scotch Chain, one of the best implements for pulverizing, leveling and smoothing the surface of the soil and covering grass seed after sowing.

One-Horse size, 5 x 6 feet.....\$35.00

Medium Two-Horse size, 6 x 7½ feet.....\$45.00

Full Two-Horse size, 7½ x 7½ feet. \$55.00

Spring Tooth, 8 to 33 oil tempered spring steel teeth, one to four sections, weight 106 to 470 lbs. Prices range from \$17.50 to \$60.00 depending on size. Circulars on request.

Planet Jr. No. 90, see (Planet Jrs.).

HATCHETS, with claw..... each \$2.00

HAY KNIFE, Sickle Edge, weight 60 lbs., each.....\$2.50

HEDGE TRIMMERS

"Little Wonder", Trims every variety of hedge faster than shears. Any one can operate it.

30 in., one-man machine.....\$22.00

40 in., one or two-man machine.....\$25.00

60 in., two-man machine.....\$30.00

Simplicity Hedge Trimmer, for fresh new growth only.....each \$4.00

Simplicity Hedge Pruner & Trimmer for pruning back old growth and trimming new. Makes trimming more accurate, easier and quicker.....each \$6.00

HEDGE SHEARS, see (Shears).

HOES, GARDEN

Draw, with 4 ft. handles, 5 in. 90c; 6 in. \$1.10; 7 in. \$1.20; 8 in. \$1.25 each.

Grub, with pick handle..... each \$1.75

Onion, Short handle 60c; long handle 95c.

Scuffle or Dutch, without handles, imported.

4 in., \$1.00; 5 in., \$1.10; 6 in., \$1.20; 7 in., \$1.30; 8 in., \$1.40; 9 in., \$1.50.

(Handles) extra.....each 50c

Warren, for opening and closing furrows.

7 in., \$1.50..... 8 in., \$1.75

HORSE LAWN BOOTS, see (Boots).

HOSE BANDS, Caldwell. Made of brass wire.

For putting on couplings.....doz. 25c

HOSE PLIERS for the above.....each 50c

HOSE CLAMPS, Bolt pattern, ½ and ¾ in.

Dozen.....60c

HOSE CONNECTION, Siamese for attaching two lengths of hose to one hydrant, solid brass.....each \$1.25

HOSE COUPLINGS, Brass ½ in. and ¾ in.

Set.....25c

Bull Dog Clincher, quickly and easily attached to hose by hammering prongs down.

½, ⅝ and ¾ in.....per set 30c

Rain King, No screwing necessary; snaps on quickly, solid brass..... each 60c

HOSE MENDERS

Each Doz. \$0.15 \$1.25

Cooper, ½, ⅝ or ¾ in......

Perfect Clinching, ½, ⅝ or ¾ in...... .15 1.50



Warren Hoe



Siamese Conn.



Coupling



Mender



Scuffle Hoe

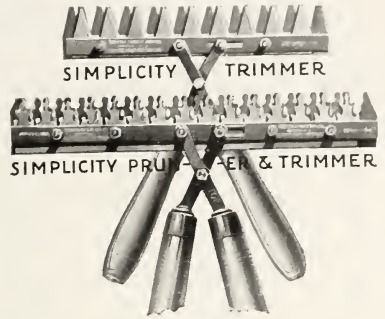

Onion Hoe



Hose Clamp

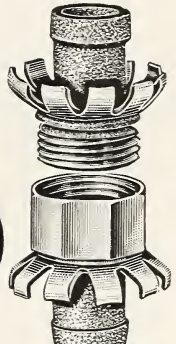

Bull Dog Coupling



Little Wonder Hedge Trimmer

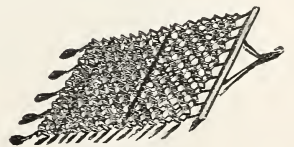

Scotch Chain Harrow



Niagara Sprinkler

KNIVES

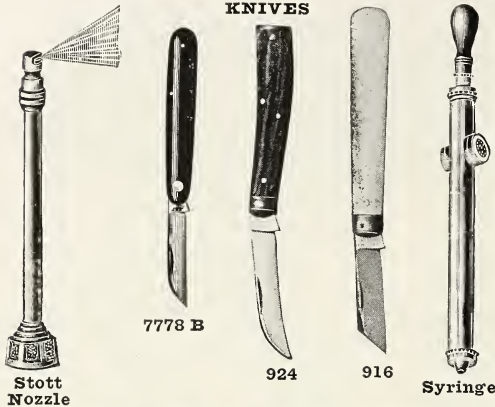

Stott Nozzle

7778 B

924

916

Syringe



727 W



Asparagus Knife



Edging Knife



Rubber Knee Pads

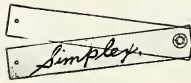

Labels



Non Kinkable Hose



BURNETT BROS.
HUDSON FULTON
NEW YORK



HOSE NOZZLES for Spray Pumps.

- Bordeaux, Adjustable each \$1.25
- Mistry Jr. A fine spray each \$1.25
- Vermorel, fine spray each \$1.25

HOSE NOZZLES for HOSE

- Florist's Spray Rose, 3 in. face \$1.00;
- 4 in. \$1.25
- Graduating, Peerless, 3/4 in. coupling each 75c
- Stott's, Single spray \$1.75 Double \$3.00

HOSE REELS, made of tubular iron; strong.

- No. 10, for 100 ft., 3/4 in. hose.....each \$5.50
- No. 20, for 150 ft., 3/4 in. hose.....each \$6.00
- No. 30, for 500 ft., 3/4 in. hose.....each \$9.50

HOSE, RUBBER. Offered in 25, 50 and 100 ft. lengths with standard couplings.

Electric, is the highest grade ribbed hose manufactured. For strength and flexibility it has no equal.

- Price, 1/2 in., per ft..... 25c
- Price, 3/4 in., per ft..... 26c

Hudson-Fulton, is made of seamless rubber tubing, closely woven light duck, well frictioned throughout.

- Price, 1/2 in., per ft..... 20c
- Price, 3/4 in., per ft..... 22c

Nonkinkable, is made of the very best rubber is very flexible and thoroughly reliable.

- Price, 1/2 in., per ft..... 19c
- Price, 3/4 in., per ft..... 21c

Suburban, a cheaper hose for general use.

- Price, 1/2 in., per ft..... 15c
- Price, 3/4 in., per ft..... 18c

Spray Pump, high pressure hose for use with spray pumps. Made up special, any length with spray fittings.

- Price per foot..... 3/8 in., 35c; 1/2 in. 40c

HOSE WASHERS, 3/4 inch. 10c per doz.;
per 100.....50c

HOTBED SASH, see (Sash).

HYACINTH STAKES, dyed green.

- 12 inches long, per 100, 35c; per 1000, \$3.00
- 18 inches long, per 100, 40c; per 1000, \$3.50

INDELIBLE INK, for zinc labels. (Imported),
per bottle.....35c

KNEE PADS, made of sponge rubber with straps for fastening to knees; always in place; prevents knee soreness when weeding or transplanting.....pr. \$2.25

KINNEY PUMP, for applying liquid manure,
each\$3.00

KNIVES, Asparagus, American.....each 50c
English (Imported).....each \$3.00

- Budding, No. 727W, 2 blades.....each \$2.00
- English, No. 916, one blade.....each \$5.00
- English, 2 blades.....each \$6.00

- Pruning, No. 778B, one blade.....each \$1.75
- English, No. 924.....each \$3.00

- Edging, English. 8 in. \$2.50; 9 in. \$3.00.
- With handle, 50c extra.

- Domestic, with handle.....each \$1.50

Other Edgers, see (Turf Edgers).

LABELS, WOODEN, Pot & Garden. Painted.

Size	100	1000	Size	100	1000
4 in.....	\$0.30	\$2.25	8 in.....	\$1.25	\$ 9.00
5 in.....	.40	2.75	10 in.....	1.40	11.00
6 in.....	.50	3.50	12 in.....	1.60	13.00

Tree, Copper Wired. Painted 3 1/2 inches.
Per 100, 50c Per 1000, \$3.25

Zinc, in various shapes and sizes. 100, \$3.00

Simplex Weather-proof, made of celluloid with transparent mica, has copper wires for attaching. Permanent and clean.

- No. 1, 3 x 1/2 inches per box of 100.....\$3.00
- No. 2, 4 x 3/4 inches per box of 100.....\$5.00
- No. 3, 5 x 1 inches per box of 100.....\$7.00

Simplex Stand, a galvanized iron rustproof card holder welded to a 24-in. iron stake. A celluloid card for marking protected by a transparent mica cover.

- No. 10, 2 3/4 x 1 1/2 in.....each 25c
- No. 11, 3 x 2 in.....each 30c

LADDER, EXTENSION. From 20 to 40 ft. Fitted with rope, two pulleys and special locking device. Price, \$1.00 per foot.

LAMPS, Alcohol for N. L. All fumigators.
Each 50c and 75c

LAWN EDGERS & TRIMMERS

Coldwell, 4 blades, 8 inch cut each \$12.00

Townsend's "The Gleaner" 8 in. cut, each \$11.50.

"The Finisher" 5 in. cut each \$10.00

LAWN MOWER SHARPENER, Logan.

Can be adjusted for any thickness of blade; file has 4 sharpening edges, reversible, each 90c.

LAWN ROLLERS, see (Rollers).

LAWN SPRINKLERS

California, has 4 brass arms attached to a sled base 10 inches square.....each \$2.50

C. B. G., cheap but good. It is built on the principle of the tangential spray. Simple in construction and cannot get out of order. Extensively used on Golf courses, each50c

Cyclone, a three-arm sprinkler identical to the California.....each \$2.25

Eureka, this sprinkler will revolve under extremely low pressure. The head and 3 arms are nickel-plated.....each \$2.50

Mac's Circular Tree, for watering trees thoroughly. Made of 3/4 inch galvanized pipe with 10 special nozzles which throw a stream of water 18 feet from the trunk of the tree. Diameter of Sprinkler 4 feet, each\$25.00

Niagara or Ring, is an ideal sprinkler made of heavy brass. Requires little water pressure.....each 90c

Rain King, Standard.

Best all-purpose adjustable lawn sprinkler. Nozzles are adjustable for stream or spray, stationary or revolving. For use on shrubbery, vegetable gardens and flower beds as well as lawns.....each \$3.50

Rain King, Giant.

Has 4 arms with nozzles adjustable for stream or spray, stationary or revolving. Adjustable also as to height. Covers 50 to 75 feet in diameter.....each \$12.50

The Dayton Rotary & Oscillating.

This sprinkler is adjustable at will from bell-shaped spray or full stream, half or full circle, 15 to 80 feet in diameter. It covers four times the area of any sprinkler its size. Instead of spraying in a continuous circle, it sends the water in one direction and slowly rotates, thus covering every inch of ground evenly. Lawn Type "A".....each \$9.00

The Saucer.

This sprinkler will cover a circle of from 30 to 50 feet, distributing the water evenly and gently. With each sprinkler is a half cap which can be used for a fan-shaped mist. Simply remove the full cap and replace the half cap and it is then changed into a half spray.....each 75c

Universal Lawn Sprinkler & Fountain.

This combination Lawn sprinkler and fountain when in operation on the lawn is very attractive. The nickel-plated arms revolve, distributing the water in rain-like drops over an area of 25 feet or more in diameter according to the water pressure. Each \$3.00

LEAF RACK, J. M., made of extra heavy galvanized mesh wire, bolted to a wooden base, portable, fits any wheelbarrow; capacity, 10 bushels. For carrying leaves, rubbish, etc.....each \$9.00

Wooden, for water barrel cart.....each \$15.00



Eureka



J. M. Leaf Rack

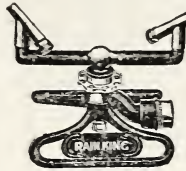

Rain King

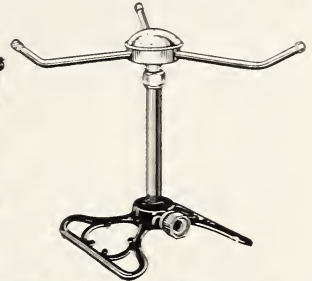

Universal

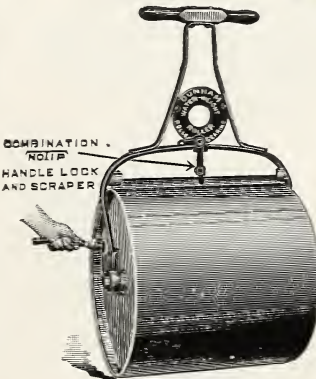

Lawn Roller



Rain King Giant

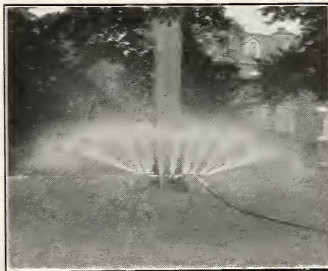

Mac's Circular Tree

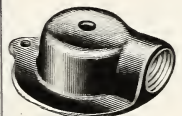

C.B.G.

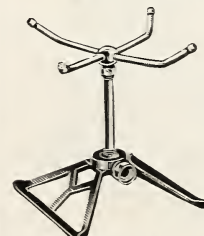

California

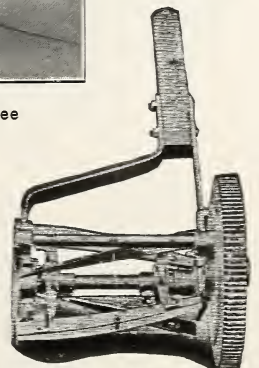

Coldwell Lawn Edger

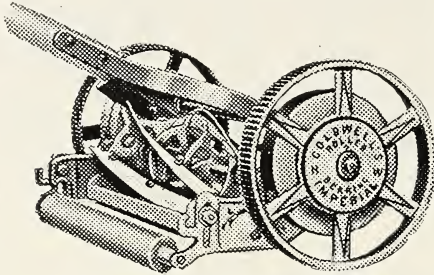

Coldwell's Imperial Roller Bearing

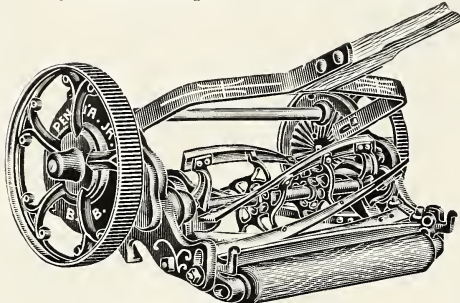

Pennsylvania Junior

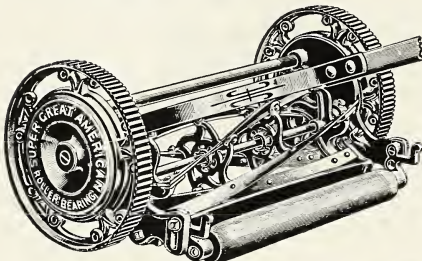

Great American

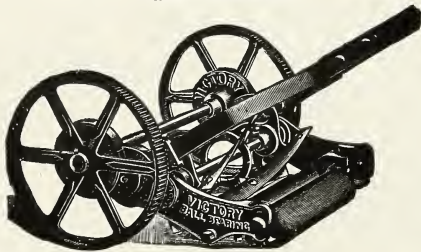

Victory Townsend

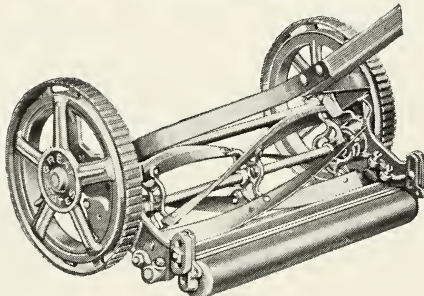

Great States

LAWN MOWERS, HAND

High Wheel Imperial Roller Bearing, Coldwell. Equipped with Standard Hyatt Roller Bearings, which makes it the lightest running machine on the market. 10 1/2 inch wheel; 5 blades.

16 inch.....	\$21.00
18 inch.....	\$22.00
20 inch.....	\$23.00

The Lakewood, Coldwell.

Ball Bearings; 9 inch wheel; 4 blades.

14 inch.....	\$13.00
16 inch.....	\$14.00
18 inch.....	\$15.00

Pennsylvania Junior.

The 5 revolving Blades are driven by a triple set of gears and a 10 inch traction wheel from each side, which makes it capable of cutting grass 6 inches high.

Ball Bearing	Price	Grass Catcher
15 inch.....	\$27.00	\$3.50 Extra
17 inch.....	31.00	3.75 Extra
19 inch.....	34.50	4.00 Extra

Great American, (Pennsylvania)

5-cylinder Blades; Self-sharpening; 10-inch High Wheels; Easy running mower.

Ball Bearing	Price	Grass Catcher
15 inch.....	\$19.50	\$3.50 Extra
17 inch.....	22.50	3.75 Extra
19 inch.....	25.00	4.00 Extra

Townsend's Victory

The most perfectly constructed and easiest running machine made. 10 inch wheels; Triple-Gear; 4 Blades; Ball Bearings.

Size	Price	Size	Price
16 inch.....	\$21.00	20 inch.....	\$25.00
18 inch.....	23.00	22 inch.....	27.00

Townsend's Flyer

Ball Bearing; 9 inch wheel; 4 blades.

Size	Price	Size	Price
14 inch.....	\$14.00	18 inch.....	\$16.00
16 inch.....	15.00	20 inch.....	17.00

Easy Lawn Mower

Self-adjusting Ball Bearings. The only mower made that will cut borders, mounds, terraces, close to walls and fences and all kinds of uneven surfaces with the same ease and efficiency as the smoothest lawn.

Size	Price
12 inch.....	\$23.00
14 inch.....	26.00
16 inch.....	29.00

Great States, has four blades, made of crucible steel, self sharpening with self adjusting ball bearings. Strongly built and have no complicated parts or adjustments.

14 inch.....	\$13.00
16 inch.....	\$14.00
18 inch.....	\$15.00

GRASS CATCHER, No. 12G. Light, made of canvas with galvanized bottom. Fits any mower 16 inches to 22 inches wide, each\$3.00

LAWN MOWERS, HORSE

Coldwell's Improved.

Size	4-Blade	6-Blade
30 inch (complete).....	\$130.00	\$145.00
35 inch (complete).....	153.00	165.00
40 inch (complete).....	175.00	186.00

Townsend's Triplex

Consists of three high-grade lawn mowers mounted in such a way as to allow each mower to adjust itself to the contour of the lawn, thereby cutting an 86-inch swath with extreme evenness.

Price.....	\$385.00	Extra Unit.....	\$110.00
------------	----------	-----------------	----------

LAWN MOWERS, MOTOR

Ideal Power Mower Model 30.

The most widely used model. The heavy traction roller smooths out the lawn as it cuts. Loosely suspended cutting unit tilts to cut over irregular ground, and convenient lever lifts cutting unit entirely off the ground for crossing walks, drives, etc. An all-purpose mower that is simple, easy to operate and cuts close up to trees, shrubbery and flower beds.
Price, 30 inch cut.....\$355.00

Ideal Junior 22

Extremely simple—any man or boy can operate. Especially designed for small and medium sized lawns. Can cut in close quarters, around flower beds, shrubbery, driveways. Cuts 3 to 5 acres a day. Special cutting unit furnished for putting greens. Rolls as it cuts.
Price, 22 inch cut.....\$260.00

Ideal Twenty (Wheel type), for small and medium lawns; negotiates steep grades, speed, 1 to 4 miles per hour; cuts one to three acres per day.
Price.....\$195.00

Ideal Twenty-five (Wheel type).....\$290.00

Coldwell's Cub, a light but strong motor mower. Cuts close to trees; 21 in. cut. Timken roller bearings; automatic lubrication and radiator cooled; cuts 3 to 4 acres per day. 5 crucible steel blades. Height of cut, 3/8 to 2 ins. 1 1/2 h.p.
Price, \$195.00; Grass Box, extra \$10.00.

Coldwell's "L" Junior, 25 in. cut, an exceptionally powerful 1-cylinder water cooled motor, automatic lubrication, self adjusting clutches, Timken roller bearings, 5 crucible steel blades cutting 4 to 6 acres per day; 2.8 horsepower. Can be used for separate rolling on tennis courts, etc.; negotiates grades with ease.
Price, \$255.00; Grass Box, extra \$12.00

Coldwell's "L" Twin 25, same as Junior but more powerful, has two cylinders; gang unit may be attached.
Price, \$335.00; Grass Box, extra \$12.00
With Gang Unit, 60-inch cut.....\$395.00

Coldwell's Twin 30, cuts 6 to 8 acres per day. \$385.00; Grass Box, extra.....\$15.00

PUTTING GREEN or ROLLER

Coldwell's Improved Excelsior.

For putting Greens and Borders. Pioneer of all Roller Mowers. For smooth, close, velvety finish. 6 blades.

Size	Price	Size	Price
12 inch	\$38.00	16 inch	\$42.00
14 inch	40.00	18 inch	44.00

Metal Grass Box, for above, any size, \$6.00

Ideal, a high-grade, close cutting, easy running. For use on modern golf greens where accuracy and close work are prime essentials. 10 inch wheel.
Price, 18 inch cut, 7 blades.....\$46.00
Grass Catcher and Deflector, metal.....\$8.00

Pennsylvania, a close cutting, light running mower for putting greens, tennis courts, etc., Alemite lubrication, roller bearings, seven blades of crucible steel, 18 inch cut.
Price \$50.00; Grass Box, extra.....\$8.00

Townsend's Golf Wonder, Ball Bearing.
For smooth close cuttings on fine lawns and Golf greens. Leaves no marks on the green. The weight of the front part of the machine is carried on a wooden roller. The front wheels may be used or not, as preferred. 6 blades.
Price
16 inch.....\$28.00
18 inch.....30.00
20 inch.....32.00

Grass Catcher, with Elevator and Deflector.
Each.....\$7.00

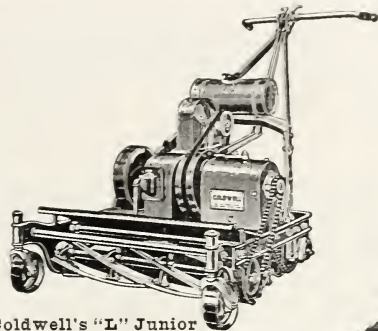

Coldwell's "L" Junior



Ideal 20

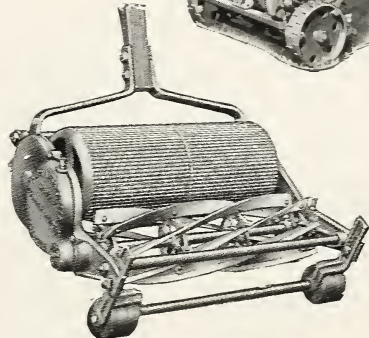

Pennsylvania Putting Green

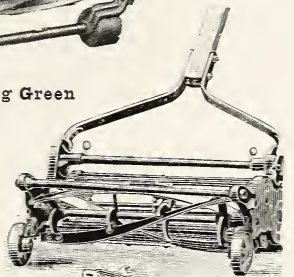

Easy Lawn Mower

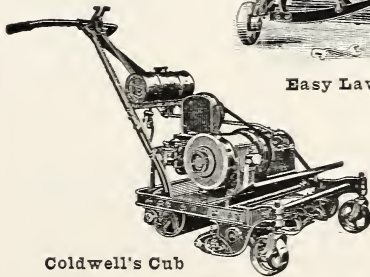

Coldwell's Cub

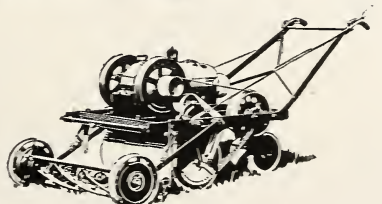

Ideal 30



Smith Tree Pruner



Manure Spreader (Moline)

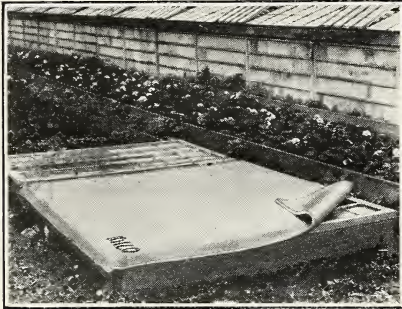

Milo Hot Bed Mat



Bamboo Lawn Rake

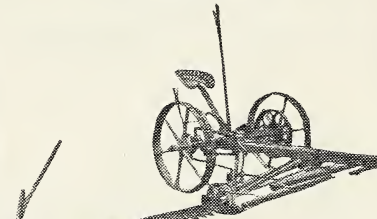

Walter A. Wood Hay Mower

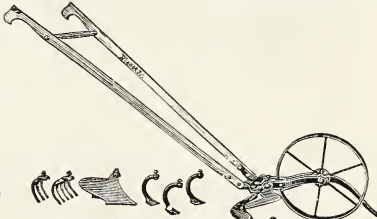

Planet Jr. No. 16



Magic "B" Weeder

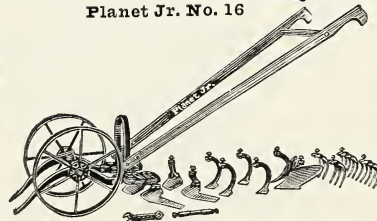

Planet Jr. No. 11

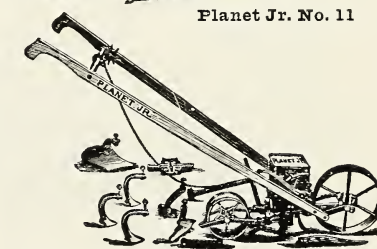

Planet Jr. No. 4

LEVER CLIPS, Rose, 'Mum and Carnation fasteners. Per 500, \$1.75; per 1000, \$2.75
MANURE FORK (see (Forks).

MANURE SPREADER, Moline, light weight, low height allows for easy loading; 50 bushels capacity; Alemite-Zerk lubrication; 2-horse hitch; feeds 6 to 24 loads per acre; cleated tires 4½ in. wide; tears and spreads manure evenly; all-steel frame, with brake.....\$171.00

MASTICA, a putty like substance for re-glazing greenhouses.....gal. \$3.00

MASTICA GLAZING MACHINE, for applying Mastica.....each \$3.50

MATS, HOT BED

Frost Proof Burlap, made of strong burlap cloth, filled with wool waste and burlap. 76 in. x 76 in.....each \$3.75; doz. \$42.00

Waterproof, made of Waterproof duck cotton cloth with wool waste and burlap filling. 76 in. x 76 in.....each \$5.50; doz. \$65.00

Milo, made of a thick layer of felt, treated with a coating of waterproofing. Very light to handle. Impervious to cold, rain or mice.

80 in. x 78 in.....each \$4.50; doz. \$50.00
 Also supplied 78 in. wide in any length up to 50 feet.....per lineal ft. 60c

MATTOCKS, Axe, with handle, \$2.00; without handle.....\$1.50
 Pick, with handle, \$2.00; without \$1.50.

MELON NETS.....per dozen \$4.50

MOLE TRAPS, Schroeter's Imp'd, Self setting device eliminates danger.....each \$2.25 (Cyanogas), also for exterminating moles, see page 108.

MOWERS, HAY, Walter A. Wood No. 2, has vertical lift, one or two horse size. Prices and circulars on request.

NAILS, English Wall, for fastening vines to walls. 100 nails per box; 1 in. and 1¼ in. long.....per lb. \$1.00

NETTING, Strawberry for protecting strawberry beds and cherry trees from birds; 2 in. mesh, 20 or 30 ft. wide; one pound will cover a bed 20 x 10 ft.....per lb. \$3.00

OAT SPROUTER, sectional, galvanized. 11 x 15 in.; 5 pans \$3.00; 8 pans \$4.00.

PAIS, Dairy. Highly finished, 12 qts.....\$2.50
 Water or Stable. Heavy galv., 16 qts.....\$1.50

PAINT, best greenhouse white.....per gallon \$4.00

PAPEE, Crepe Waterproof, Green, blue, pink, scarlet; per roll of 10 ft.....60c

Kraft, Brown Wrapping. 24, 30, 36, & 48 in. rolls; 30 x 40 and 40 x 48 in. sheets. per lb.....14c

Manilla, 24 x 36 in. sheets.....lb. 14c

Wax Tissue, ream of 480 sheets, 24 x 36 in. White, \$4.00 Green, \$6.00

White Tissue, Plain. Ream 24 x 36 in.....\$2.50
 Prices on paper, subject to change without notice.

PAPER STAND CUTTER, price on request.

PICKS, pointed both ends, with handle.....\$2.00

PLANET JR. No. 4, Combined Hill & Drill Seeder, Wheel Hoe, Cultivator and Plow. Price.....\$18.00

No. 4D, as a Seeder Only.....\$14.25

No. 11, Double & Single Wheel Hoe; equipment as illustrated.....\$13.75

No. 12, Double & Single Wheel Hoe; similar to number 11, minus Rakes and 1 pr. Hoes.....\$10.75

No. 16, Single Wheel Hoe, as illustrated. Price.....\$9.00

No. 8, Combined Horse Hoe & Cultivator. Price.....\$16.50

No. 90, Twelve-Tooth Harrow, Cultivator & Pulverizer, complete.....\$17.00

(Catalogue of Planet Jrs. describing them in detail, mailed on request.)

PLANT BED CLOTH, a cheap substitute for glass on hotbeds and coldframes, protecting plants from cold, insects, etc., while permitting proper ventilation.

Light Grade, (tobacco muslin) pieces run about 70 yards.....per yard 20c
Medium Grade (vegetable cloth) pieces run about 60 yards.....per yard 25c
Heavy Grade, pieces run 50 yds. per yd. 30c
Burlap, see (Burlap).

PLANTERS, see (Sowers & Planet Jrs.)

PLANT PROTECTORS, A.B.C. protects transplanted seedlings from sun, cold and frost. 5 x 6 in. 250, \$2.50; 500, \$4.50; 1000, \$8.50

Tar Felt Pads, to protect cabbage and cauliflower plants against Cabbage Maggot; 250, \$1.00 500, \$1.75

Hawkeye Tree, protect trees against Sun-scald, Rabbits, Mice and other Vermin. Made of Water Rock Elm. 10 in. wide and 20 in. high. Per 25, \$1.00; 100, \$3.00; 250, \$7.25.

PLANT SPRINKLERS, see (Scollay Bulb & Watering Can).

PLANT STAKES, see (Stakes & Canes).

PLANT SUPPORTS, Adjusto. Adjustable to any height; for Peonies, Dahlias, Tomatoes, etc., per dozen: 4 ft. stakes \$3.60; 5 ft. \$4.25.

Carnation, see Carnation Supports.

PLAN-TIE, new tying material, see (Twines).

PLANT TIES, Lightning Wire, quickly fastens plant to wire, per box of 1000.....\$2.25

FLOW, South Bend Chilled and Oliver Chilled, (Prices and literature on request).

POST HOLE DIGGER.....each \$2.50

POTATO HOOK, 4-prongs, \$1.50; 5-prongs, \$1.75.

POTS, FLOWER. See (Flower Pots).

POULTRY WIRE NETTING, see (Wire Netting).

POWDER BELLOWS, see Bellows.

POWDER DUSTERS, see Dusters.

PRUNERS, see Tree Pruners, Shears.

PUMPS, Kinney, for applying liquid manure, each\$3.00
 Spray see (Sprayers).

PUTTING HOLE CUTTER.....each \$10.00

PUTTY, Twemlow's Old English.....gallon \$3.50 (see also Mastica.)

PUTTY BULB, Rubber for glazing.....each \$1.50 (see also Mastica Machine.)

RAFFIA, will not bruise plants when tying them. Natural per lb. 45c; Dyed Green per lb. \$1.25. (see also Twines and Plan-tie, a new tying material.)

RAKES, Garden Steel, best steel. 8-teeth, \$1.00; 10-teeth, \$1.10; 12-teeth, \$1.20 14-teeth, \$1.30; 16-teeth, \$1.50.

Hay, Wooden, 12-teeth.....\$1.00

Lawn, Hoover made of flexible steel wire, light, will not tear up grass.....each \$1.00

Japanese, Bamboo. Light, flexible, will not tear up grass. 18 in. \$1.00; 24 in. \$1.50

Reversible Lawn, Galvanized 24-teeth. \$1.00
 Handles extra 50c each.

Self-Cleaning, Wooden has two rake heads interlocked, with a lever for cleansing, each\$2.00

Wooden Lawn, 22-teeth.....\$1.25

Sulky, see (Hay Rake).

RIFLES, EMERY for sharpening scythes. 20c

ROLLERS, LAWN Water Ballast, may be filled with water to any desired weight.

No.	Diam.	L'gth	wt. empty	wt. filled	
10	14 in.	24 in.	60 lbs.	250 lbs.	\$16.00
20	18 in.	24 in.	75 lbs.	330 lbs.	18.00
30	24 in.	24 in.	100 lbs.	440 lbs.	23.00
40	24 in.	32 in.	115 lbs.	590 lbs.	26.00

ROSE WIRE STAKES, see (Stakes).



Adjusto Plant Support

A. B. C. PLANT PROTECTORS

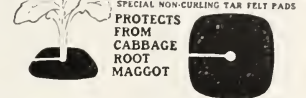

Hawkeye Tree Protector

A. B. C. CUT - WORM



Kinney Pump



Cyanogas Pump



Wire Plant Tie



Scythe Stone

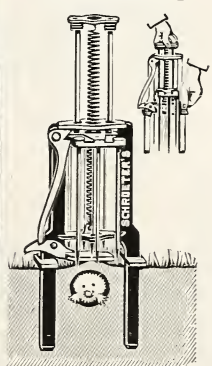

Schroeter's Mole Trap

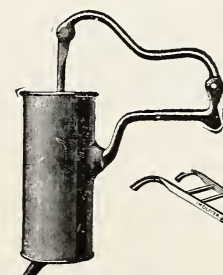

Mastica Machine

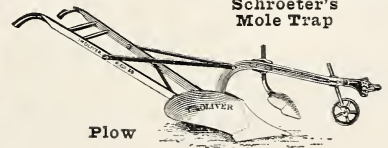

Plow



Hot Bed Sash



Scollay

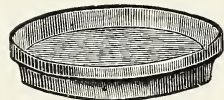

Standard Saucer



English Scythe Blade

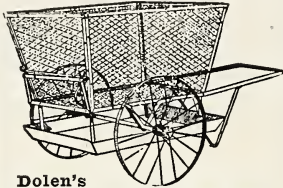

Dolen's Portable Rubbish Burner

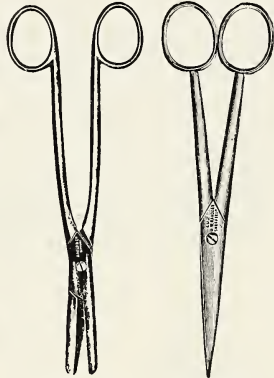

Flower Gatherer

Grape Scissors

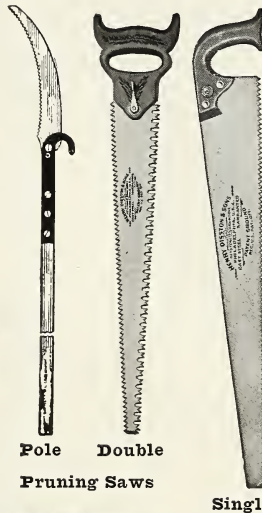

Pole Pruning Saws

Single

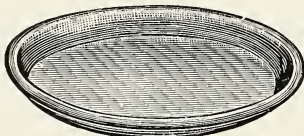

Fibre Saucer

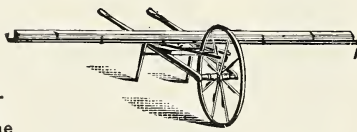

Grass Seeder

RUBBISH BURNERS, I. B., made of expanded metal with heavy handles; 30 in. high; 18 in. top diameter; 15 in. bottom diameter. Sheet steel top and bottom.....each \$4.00
Extra heavy mesh, steel wire top and bottom.....each \$5.00

Just Right, an inexpensive substantial durable and strong burner: 21 in. \$1.75; 28 in. \$2.50.

Portable, Dolen's. An all steel furnace for rapid and convenient destruction of leaves and refuse. Fireproof.

Each
No. 1, capacity, 16 cubic ft.....\$50.00
No. 2, capacity, 11 cubic ft..... 45.00
No. 3, capacity, 5 cubic ft..... 40.00

SAND SCREEN, of wooden frame with 1/2-in. galvanized wire mesh, 3 x 6 ft. each \$16.00

SASH, Hotbed, made from 1-in., gulf Cypress; top and bottom rails 4 in. wide; stiles 2 1/2 in. wide; bars 1 1/4 in., reinforced with an iron cross bar; painted two coats of pure lead and oil; rigidly glazed. 3 ft. x 6 ft. Glazed and painted..... each \$7.50

Hotbed and Cold Frames, see Garden Frames.

SAUCERS, Fibre Flower Pot, of attractive mahogany color, light and absolutely non-porous.

Size	per dozen	Size	per dozen
5 1/2 in.....	\$3.00	12 in.....	\$ 8.50
6 1/4 in.....	3.75	14 in.....	15.00
8 in.....	5.00	16 in.....	17.50
10 in.....	6.50	18 in.....	20.00

Earthenware Flower Pot, Lacquered and waterproof; inexpensive.

Diam.	doz.	per 100	Diam.	doz.	per 100
4 in.	\$1.25	\$ 9.00	7 in.	\$2.75	\$20.00
5 in.	1.75	12.00	8 in.	3.50	25.00
6 in.	2.25	15.00	9 in.	4.50	35.00

(Larger sizes, prices on request.)

Earthenware Flower Pot, Not Lacquered, cheaper but **Not** waterproof; prices on request.

SAW BUCK, plain hardwood..... each \$1.25

SAWS, Pruning—Single Edge; Disston, the best. 16 in. \$1.75; 18 in. \$2.00; 20 in. \$2.25

Double Edge, Disston, the best. 16 in. \$2.00; 18 in. \$2.25; 20 in. \$2.50.

Hook and Saw Combined, "The Orchard" Cuts or saws off branches, best steel. Head only. Disston make.....each \$3.25

Pole Pruning, a 16 in. adjustable saw blade attached to a spruce pole 1 1/4 in. thick; in following lengths: 8 ft. \$4.40; 10 ft. \$4.70; 12 ft. \$5.00; 14 ft. \$5.30; 16 ft. \$5.60 (for other pruning tools, see Shears, Tree Pruners.)

SAW FILES, flat or 3-cornered.....each 25c

SCISSORS, Grape Thinning or Vine. each \$1.50
Flower Gatherers, cuts and holds the flowers. English made: 6 in. \$3.00; 7 in. \$3.50

SCOLLAY BULB, Plant Sprinkler for sprinkling seedlings and house plants.....each \$1.50

SCRAPER, DRAG Michigan, Solid steel for grading, excavating, leveling or filling in, it is indispensable.

No. 1, 33 1/2 x 32 x 11 1/2, capacity 7 cubic ft.....each \$14.00
No. 2, 31 1/2 x 29 x 11 1/2, capacity 5 cubic ft.....each \$12.00

SCREENS, BAMBOO PORCH, with pulleys, 7 ft. drop; Dyed Green: 4 ft. \$4.00; 5 ft. \$5.00; 6 ft. \$6.00; 7 ft. \$7.00; Special sizes made to order.

SCYTHE BLADES, English, riveted back, hammered steel: 32, 34, & 36 in.....each \$3.50

American, made of the best crucible steel, with rib back: 32, 34 & 36 in.....each \$2.50

Brush or Bush, for heavy brush.....each \$2.25 (see also Grass Hook.)

SCYTHE SNATHS (or Handle).....each \$2.25
SCYTHE STONES, English Round.....each 50c
 Domestic, flat.....each 25c

SEED SOWER, Cyclone sows Alfalfa, clover, timothy and other small seeds broadcast by a hand crank which insures even and continuous distribution. The best internationally known hand operated sower; capacity, half bushel.....each \$2.50

Wheelbarrow Grass, most economical; sows evenly a swath 14 feet wide. Light, Double hopper, \$17.00. (See also Planet Jrs.)

SHEARS, Border or Grass Edging.
 English, 8 in. \$5.25; 9 in. \$5.75; 10 in. \$6.25; (with Wheel, 50c extra).

Grass or Sheep, Best English, 6 in. each \$2.50
 Domestic, full polished, 6 in.....each \$1.00

Goodwin, new pattern, saves knuckles; Non-tiring on wrist, ball bearing, each \$2.00.

Wiss' New Pattern, superior to other makes of this pattern because of best cutlery steel, non-rusting, comfortable handles.....each \$1.50

Hedge, English No. 101, notched, best steel; 8 in. \$3.25; 9 in. \$3.50; 10 in. \$4.00.

Maples English, the best steel 8 in. \$3.75; 9 in. \$4.25; 10 in. \$4.50.

Ladies, 5½ in. blade, English, \$2.75; Progress, \$2.00

Wiss' All Steel, Gun metal, Serrated edge prevents slipping; well balanced; tempered steel blades: 8 in. \$3.25; 9 in. \$3.50; 10 in. \$4.00.

Domestic, 9 inch blade.....pr. \$2.50

Lopping, English No. 109, 24 in. riveted handles, best steel: 3 in. cut \$6.00; 3½ in. cut \$6.50; 4 in. cut \$7.50.

American No. 5406, 18 in. handles.....\$2.50

Improved Draw Cut, 24 in. handles, compound lever gives added strength.....\$4.50

McKenney, compound lever, all steel, light, has two cutting blades: No. 1, (1 in. cut), 23 in. handles, \$4.50; No. 2, (1½ in. cut), 30 in. slotted handles give more power, \$6.00.

Rhodes, has two cutting blades, 30 in. \$5.00

Pruning, French watch spring: 7 in. \$2.50; 8 in. \$3.00; 9 in. \$3.50.

Fifteen-Forty, volute spring, 9 in.....\$2.50

Thirty-seven, volute spring, 9 in.....\$1.00

Wiss No. 109, heavy forged steel, 9 in. Pair.....\$3.50

Wiss No. 209, light forged steel, 9 in. \$1.50

Wiss No. 309, medium, unbreakable, 9 in. \$2.50

Ladies Nickel Plated, 6 in. light.....\$1.50

TREE WOUND PAINT, applied to pruned limbs to prevent bleeding or decaying. Qt. \$1.20; gal. \$3.00.

SHOVELS, Ames. Square or Round point. Long or Dee Handle.....each \$2.75

Standard, Square or Round Point. Long or Dee Handle.....each \$1.75

SICKLES, see (Grass Hooks).

SIEVES, ¼, ½, ¾, or 1 inch mesh; 18 inches in diameter; galvanized wire...\$2.00

SILKALINE, Meyer's Green for tying. 2 oz. spools, each 40c; box of 8 spools \$3.00

SMILAX, a green twine for tying. Box of 8 balls, \$1.50.

SOD TAMPER, Iron 8 x 8 in., weight 17 lbs., each \$2.75

SOD PERFORATOR.....each \$4.50

SPADES, Ames best steel, Dee or Long handle.....each \$2.75

Standard, Dee or Long handle.....each \$1.75

STONE BOAT, for clearing fields of stones and for moving a spraying outfit about the orchard.....each \$25.00

SHEARS



English Wiss Wiss English

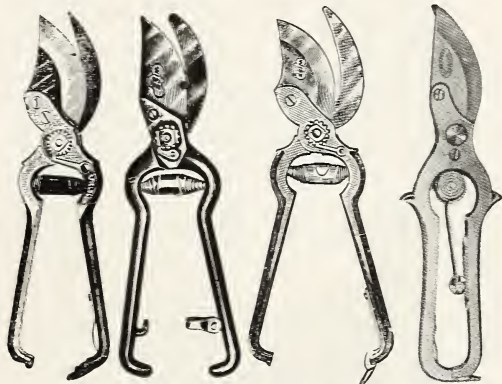

No. 1540 Wiss No. 209 Wiss No. 109 French



LOPPING McKenney



Imp'd Draw Cut

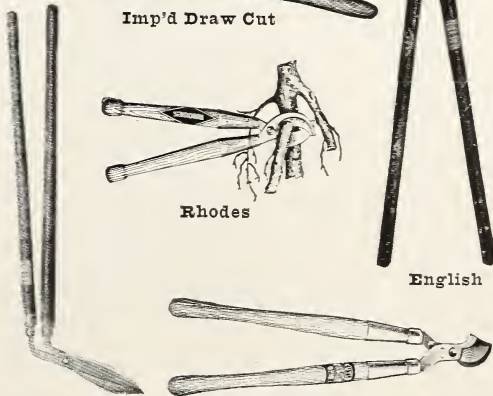

English Border

Rhodes

English

American 5406



Brown No. 9

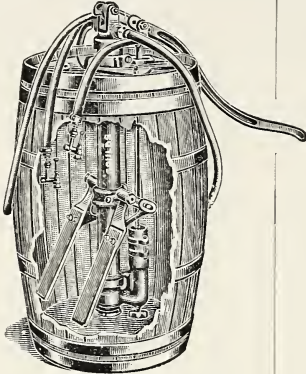

Pomona

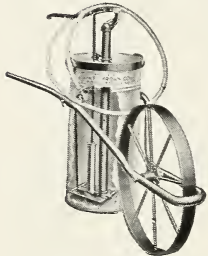

Brown No. 3

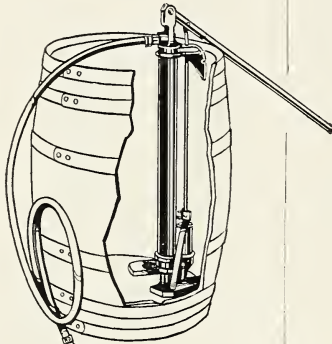

Major

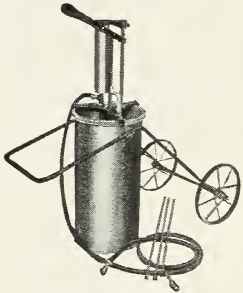

Paragon No. 3

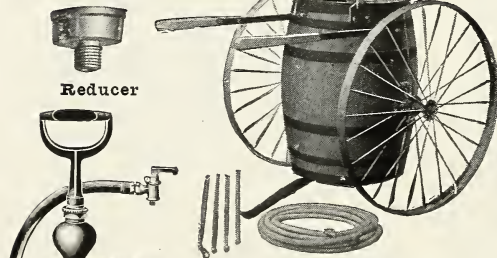

Paragon No. 4

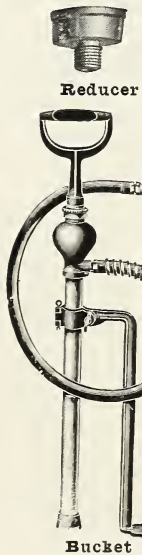

Bucket

SPRAYERS

BARREL, for small garden or large orchard:

Century, for Orchard spraying. Brass internal working parts prevent corrosion; twin paddle agitator, pumps 2 1/2 gallons per minute; brass ball valves and seats; 12 1/2 ft. of 1/2 in. hose, angle nozzle; adjustable on head or side of barrel. Pump and 1 lead of hose.....\$22.00
 Pump, 1 lead of hose and barrel.....\$32.00
 Extra lead of 12 1/2 ft. 1/2 in. hose, with fittings and nozzle.....\$5.75

Major, for orchard spraying, pumps 1 1/2 gallons per minute; attaches to side of barrel; similar construction as the "Century" but permits only one lead of hose. Pump, Nozzle and 12 1/2 ft. 1/2 in. hose, \$18.00; with barrel.....\$30.00

Pomona, most durable orchard sprayer. Bronze internal working parts; pumps 3 gallons per minute; air chamber makes it easy to maintain pressure and even flow; paddle agitator.

Pump, 15 ft. 3/8 in. hose, couplings, and Mistry-Jr. nozzle.....\$28.25
 Pump, 15 ft. 3/8 in. hose, couplings, Mistry-Jr. Nozzle and Barrel.....\$38.25
 Extra Lead of 15 ft. hose & nozzle.....\$6.25

Paragon No. 4, 28 gallon sprayer for greenhouse and tree spraying; 20 ft. spray hose, 10 ft. extension pipe, misty nozzle. Mounted on 30 inch iron wheels. Complete\$39.50

WHEELBARROW SPRAYERS

Paragon No. 3, 12 gallon sprayer mounted on steel truck; 10 ft. spray hose, 7 1/2 ft. extension pipe, nozzle.....complete \$25.00

Brown No. 3C, a 12 gallon brass tank sprayer mounted on a 30 in. wheel; 8 ft. 3/8 in. high pressure hose, 2 ft. 8 in. iron extension pipe, stop cock shut-off and non-clog nozzle.....complete \$22.50

Brown No. 3D, Galvanized.....\$19.50

Farmer's Friend, a Century pump set on a 50 gallon barrel, mounted on a one-horse cart; 12 1/2 ft. 1/2 in. hose.....\$69.00

BUCKET PUMP, an all brass continuous sprayer for greenhouse, garden or chicken house; non-rusting, 3 ft. of 3/8 in. spray hose with bordeaux nozzle. With Air Chamber, \$6.50; without \$5.00.

COMPRESSED AIR SPRAYERS

Brown No. 9B, a 4 gallon corrugated brass tank, with strap for carrying on shoulder, convenient auto-pop automatic shut-off set on 2 ft. hose to which is added a 22 in. brass extension rod with angle nozzle for spraying underneath leaves.....each \$9.75

Brown No. 9D, galvanized tank.....each \$6.75

Banner, a 4 gallon sprayer similar to the Brown for whitewashing and spraying. Brass, \$9.00; Galvanized, \$6.00.

Hudson Jr., a 2 1/2 gallon sprayer of lighter construction but substantial. Brass, \$8.50; Galvanized, \$6.00.

KNAPSACK, French, a 4 gallon kidney-shape brass tank which straps to the back, convenient pump lever, 22 in. brass extension attached to a trigger shut-off and 4 ft. of 3/8 in. hose; brass strainer; bordeaux nozzle; each\$25.00

SPRAYERS, Hand, Compressed Air.

Brown No. 26-AG, a 1 quart continuous sprayer, glass tank, straight and angle nozzle\$1.25

Brown No. 26-C, same as 26-AG, brass.....\$1.50

The G. V., throws a steady stream, heavy spray, mist or vapor mist: 1 quart. Brass. (see Ill. page 90) \$2.25; Tin.....\$1.50

The Robertson, 1 quart misty sprayer. Brass, \$2.25; Galvanized, \$1.50.

SPRAYER ACCESSORIES.

- Bamboo Extension Rod**, brass lined, fitted with brass drip shield, and stop cock: 8 ft. \$4.25; 10 ft. \$5.00; 12 ft. \$7.00.
- Barrel, Water** (50 gallons) with trunnions, each \$8.00
- Hand Cart Box** \$9.00
- Leaf Rack** \$15.00
- Truck** with 3 inch steel tire \$17.50
- Trunnions**, extra per pair \$1.00
- Hose**, high pressure; 3/8 in. 35c; 1/2 in. 40c.
- Hose Nozzles**, (see Hose Nozzles).

SPRAYERS, Dry for powders (see Dusters).

SPRINKLERS, Lawn (see Lawn Sprinklers).
Water, (see Watering Pots & Scollay Bulb).

STAKES, Plant.

- Adjusto Supports**, (see Plant Supports).
- Bamboo Cane**, (see Cane Stakes).
- Dahlia, Heavy Round, Green**. Doz. 100
 - 4 feet \$2.25 \$15.00
 - 5 feet 2.50 18.00
 - 6 feet 2.75 20.00
- Dahlia, Heavy Square, Green**
 - 4 feet \$2.00 \$14.00
 - 5 feet 2.50 18.00
 - 6 feet 2.75 20.00
- Hyacinth**, (see Hyacinth Stakes).
- Light, Round** (tapering) Green.
 - 1 1/2 ft. \$0.50 \$ 3.00
 - 2 ft. .60 4.50
 - 2 1/2 ft. .80 5.50
 - 3 ft. 1.00 7.50
 - 3 1/2 ft. 1.25 9.50
 - 4 ft. 1.50 11.00
 - 5 ft. 2.00 14.00

Light, Square (tapering) Green. Same prices as the Light Round.

Rose Wire, galvanized. Plain or Anchored.
 No. 8 wire.

	per 100		per 100
2 1/2 ft.	\$2.25	4 ft.	\$3.00
3 ft.	2.50	4 1/2 ft.	3.50
3 1/2 ft.	2.75	5 ft.	4.00

SUMMER CLOUD, for shading greenhouses, (Imported) 8 oz. can.....75c

SYRINGES, Brass Garden.

- No. A**, Barrel 12 in. long, 1 1/2 in. diameter with one stream and one spray...each \$3.50
- No. H**, Barrel 16 in. long, 1 1/2 in. diameter with one spray only.....each \$4.00
- No. 10**, Barrel 18 in. long, 1 1/2 in. diameter, with a coarse and a fine spray, one stream, elbow for spraying underneath leaves, patent valves.....\$8.00
- No. 11**, Barrel 18 in. long, 1 1/2 in. diameter with one stream, a fine and a coarse spray.....\$7.00

TENNIS NETS, Single court 27 x 3 ft., Double court 36 x 3 ft., canvas bound. Price on application.

TENNIS MARKER, Dry or Wet. For marking Tennis courts. Prices on application.

THERMOMETERS, Boxwood. 8 in.....\$1.00

- Brooder**, mercury75c
- Copper Case**, plated. Easy reading, 8 in...\$1.00
- Copper Case**, Solid. Heavy, 10 in.....\$2.50
- Incubator**, mercury, with stand.....75c
- Japan Case**, tin. 8 in. 90c; 10 in.....\$1.00
- Mushroom Bed** or Hot Bed, brass tip.....\$3.00
- Self-Registering**, registers the maximum and minimum temperature for any period. Indispensable for Greenhouses. Made of heavy brass, 10 in.....\$7.00

TINFOIL, Plain, lb.....50c
 Violet or Green, lb.....75c

TOOTH PICKS, Wired.....per 1000, 75c

TORCHES, Asbestos for burning caterpillars, each60c

- Collin's Kerosene Lamp**.....\$1.00
- Extension Poles**, 12 ft. (in 4 ft. sections),
Bamboo, \$1.25; **Metal**.....\$1.00

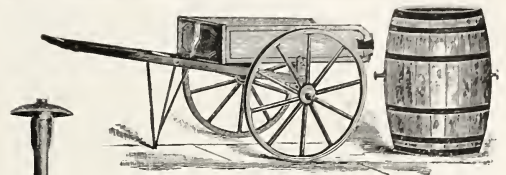

Truck, Box & Barrel



Leaf Rack & Truck

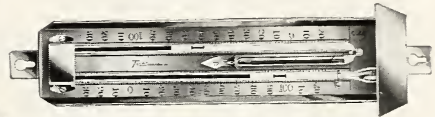

Self-Registering Thermometer

Bamboo Exten. Rod



Mushroom Bed



Copper Case

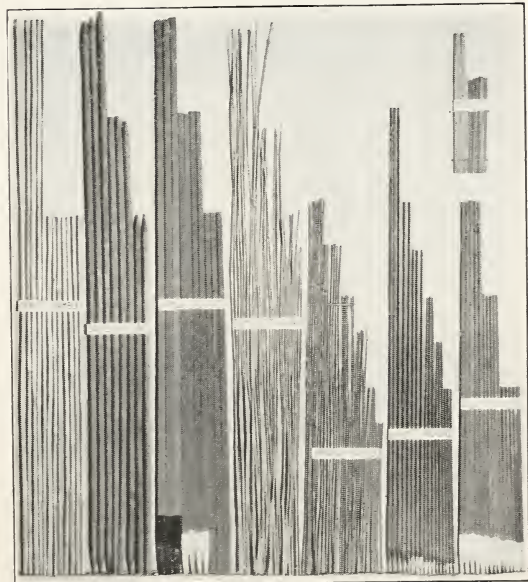

Chinese Bamboo Dahlia Round Dahlia Square Domestic Taper'g Japanese Bamboo Light Round Light Square

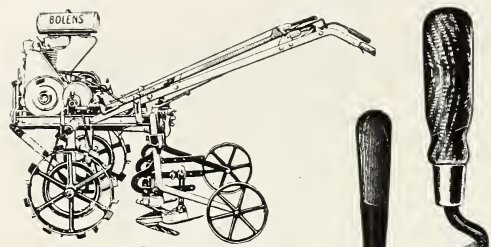

Bolen's Tractor



Edger



Fan Trellis



Maynard No. 211

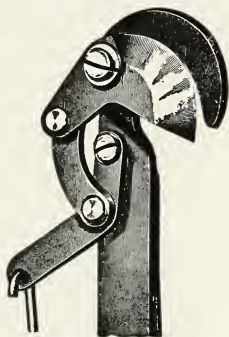

Blair Edger



Marple's

Jointed Pruner

Compound Lever Tree Pruner

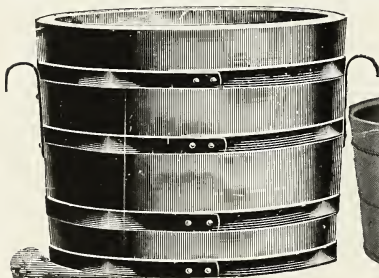
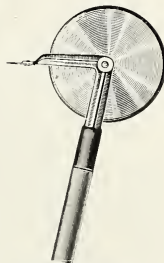

Poughkeepsie Plant Tubs



Universal

TRACTORS, Bolen's & Centaur, prices and illustrated literature on request.

TREE PROTECTOR, Hawkeye. (See Plant Protectors.)

TREE PRUNERS, Compound Lever. More power with less effort; cuts limbs 1 1/4 in. thick with ease. 10 ft. \$5.00; 12 ft. \$5.25; 14 ft. \$5.50; 16 ft. \$5.75.

Jointed-Compound Lever, same knife head as above except the pole is made up in 4 ft. sections, easily joined together for any desired height. 12 ft. \$7.25; 16 ft. \$8.00.

Smith, 6 ft. \$2.00; 8 ft. \$2.25; 10 ft. \$2.50; 12 ft. \$2.75; 14 ft. \$3.00.

Telegraph Pole, head only. May be attached to any length pole.....each \$1.75 (see also Shears, Lopping.)

TREE SCRAPERS, with handle.....\$1.25

TREE PROTECTORS, see (Plant Guards).

TRELLIS, WOODEN Fan. Painted green: 4 ft. \$1.85; 5 ft. \$2.50; 6 ft. \$2.75; 7 ft. \$3.25.

Veranda, 18 in. wide: 6 ft. \$2.75; 7 ft. \$3.00; 8 ft. \$3.50.

Galvanized Iron, painted green, reinforced by cross members; supported on 1 in. channel iron; 4 ft. width.

7 ft. high: 18 in. \$14.00; 24 in. \$15.00; 30 in. \$16.00.

8 ft. high: 18 in. \$15.00; 24 in. \$16.00; 30 in. \$17.00.

TROWELS, Forged Steel No. 211: 6 in. 75c; 7 in. 85c; 8 in. \$1.00.

Marples English. 6 in.....75c

Maynard, solid steel shank, the best.....\$1.00

Transplanting, long and narrow.....each 30c

Transplanting Hoe, 7 in. blade.....each \$1.00

TRUCKS & WAGONS, Light, Medium or Heavy; one or two horses: "Old Hickory" and "Studebaker." Prices and illustrated circulars on request.

TUBS, CEDAR PLANT

Poughkeepsie Style, made of Cedar with extra heavy staves and hoops; painted green; strong and durable; with handles.

No.	Top Diam.	Outside Height	Price Each
00	32 in.	26 in.	\$22.00
0	30 in.	24 in.	18.50
1	28 in.	22 in.	16.00
2	26 in.	20 in.	13.50
3	24 in.	18 1/2 in.	8.50
4	22 in.	17 in.	7.00
5	20 in.	16 in.	6.00
6	18 1/2 in.	15 in.	5.00
7	17 in.	14 in.	4.50
8	16 in.	13 in.	3.75
9	14 in.	12 in.	3.25
10	12 in.	9 1/2 in.	2.75

Universal lighter and cheaper tub. Made of seasoned selected Virginia White Pine, painted green.

No.	Top Diam.	Inside Height	Price
7	12 in.	11 in.	\$1.50
8	13 in.	12 in.	2.00
9	14 in.	13 in.	2.25
10	15 in.	14 in.	2.50
11	16 in.	15 in.	3.00
12	17 in.	16 in.	3.25
13	18 in.	17 in.	4.00
14	19 in.	18 in.	4.25

TURF EDGER, Revolving Wheel, Blair, each \$2.25
Planet Jr......each \$1.80

TURFING IRONS, or Sod Lifter. English \$8.50
 American or Domestic.....\$2.25

TWINES, Binder's, of Java Sisal, 5 lb. balls, each \$2.00

Cotton, White. Light, 6 balls to lb.....lb. \$1.00

Jute, 3 ply. Soft, for tying plants, 1/2 lb. balls.....each 25c

Marline, Tarred. 1 lb. balls, Medium, each 90c; Heavy, each.....75c

TWINES—Continued

Plan-Tie, new and better tying material, 4 plies of soft green cotton yarn; breaks with fingers but resists storms; eliminates knives or scissors, supercedes raffia. 300 ft. per spool, each 25c; per doz.....\$2.50

Parceling Hemp, medium No. 36 and heavy No. 48, ½ lb. balls, each 45c; No. 60 extra heavy, 1 lb. balls, each 80c. Put up in 10 in. reels weighing about 12½ lbs. each.....per lb. 85c

Silkline, 2 oz. spools; each 40c; 8 for \$3.00
Smilax or Sea Island, Green. Box of 8 balls.....\$1.50

VASES, FIBRE for displaying flowers. Waterproof. Each
 No. 44, 9 in. high, 3½ in. diam.....\$1.10
 No. 1, 10 in. high, 6 in. diam.....1.50
 No. 33, 12 in. high, 4¾ in. diam.....1.60

Galvanized Iron, Painted Green, waterproof.
 Height Diameter Each
 12 in.....6½ in.....\$1.25
 12½ in.....9 in.....1.40
 15 in.....7½ in.....1.60
 18 in.....9 in.....1.75

WAGONS, Studebaker & Hickory, prices and illustrated circulars on request.

WATERING POTS, French Pattern. Oval shaped with long spout and brass bow handle, two roses. 6 qts. \$6.25; 8 qts. \$6.50; 10 qts. \$7.00; 12 qts. \$7.50.

Haw's English Pattern, best finished and strongest; patent roses indispensable for watering fine seeds; long spout; painted red. 4 qts. \$7.00; 6 qts. \$8.00; 8 qts. \$8.50; 10 qts. \$9.50.

Philadelphia, Round with long spout and a fine and a coarse rose; 6 qts. \$5.50; 8 qts. \$6.00; 10 qts. \$6.25; 12 qts. \$7.00.

(Roses) extra: fine or coarse.....each 70c

Regular Galvanized, round with extension spouts, 6 qts. \$1.10; 8 qts. \$1.25; 10 qts. \$1.50; 12 qts. \$1.75.

Parlor, painted green, for porch and window boxes, 18 in. spout, 4 qt. \$1.25.

WEEDERS, Eureka 3 steel prongs.....each 65c

Excelsior, 5 claw fingers.....each 25c

Handy, Lawn, the best; powerful small brass jaws extracts weeds without tearing up the lawn, 30 in. handle.....each \$1.50

Hazeltine, or Beet, steel.....each 45c

Magic "B", handiest cheap weeder, 3 prongs, 18 in. handle, 25c; 36 in. handle, 40c.

Magic "F", 4 prongs, 42 in. handle each 85c

Onion, Three-cornered.....each 75c

Out-U-Come, removes Dandelions and Plantains from lawns (Root and all).each 90c

Plantain or Dandelion for lawns.....each 50c

WHEELBARROW, Garden. Very best made, removable sides, well braced, painted green.

No. 4, medium, \$8.50; No. 5, large, \$9.50.

Greenhouse, narrow width of 20 in. overall permits wheeling between benches, each \$11.00.

Golf, steel wheel has a 4 in. crowned face which permits using on lawns each \$12.50

WIRE, Annealed for stemming. 12 or 18 in. strands.

No. 23, very coarse or No. 26, coarse, per lb. 45c.

No. 34, fine hair or No. 35 extra fine, per lb. 75c.

Coils of 12 lbs., Nos. 16, 18, 21, etc., stone \$3.50.

WIRE NETTING, galvanized, in rolls of 150 lineal feet, 1, 1½, or 2 inch mesh; 24, 30, 36, 42, 48, 60 and 72 inches high. Prices on application.

WIRE FENCING see (Fences).

X. L. ALL FUMIGATORS, see (Fumigators).



Twines



Lawn

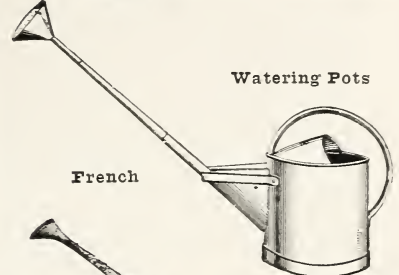

French

Watering Pots

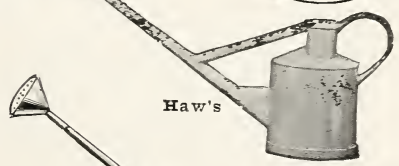

Haw's

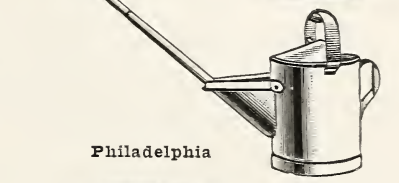

Philadelphia

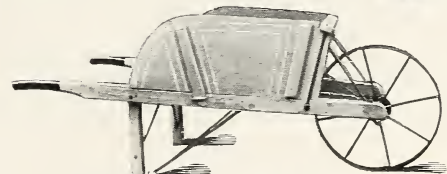

Garden Wheelbarrow



Turfing Iron

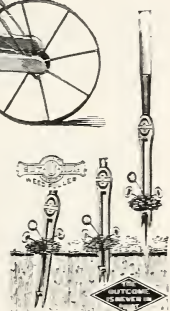

Weeders



Hazeltine



Excelsior



Eureka



Fibre Vase

INSECTICIDES AND FUNGICIDES



ALL AROUND SPRAY, for Chewing Insects (worms, moths, bugs and caterpillars), Sucking Insects (aphis, thrips leafhoppers), Fungus Diseases (mildew, rust and blight); ¼ lb. 45c; 1 lb. 95c. f

ANT EXTERMINATORS, Antrol a poisoned syrup which lures the ants into the jars where they eat the syrup and transmit it to the queen ant thereby exterminating large colonies. For indoors and outdoors. Set of 4 jars and one 4 oz. bottle of syrup.....\$1.00

Cyanogas, "A" grade. For ants, fleas and wasps. Sprinkle in hills and wherever they run. The fumes kill them instantly. 1 lb. can, 75c; 5 lbs., \$3.00.

Key Brand, internal poison; for ants on lawns and golf courses. 4½ ounce sifter can, 50c.

APHINE, for aphids or flies (green, white and black), thrips, white and brown scales. Mealy bug and red spider. Quart, \$1.00; gallon, \$3.00

ARSENATE OF LEAD, Dry. Preferable to paste, has double the strength and easier to handle. For moths, worms, caterpillars, bugs and all leaf chewing insects. ¼ lb. 25c; 1 lb. 50c; 5 lbs. \$2.00; 10 lbs. \$3.50; 25 lbs. \$8.00; 50 lbs. \$15.00.

BLACK LEAF 40, a concentrated solution of nicotine killing aphids (green, white and black), thrips, leafhoppers and all sucking insects by contact and fumes. Also for killing chicken lice in poultry houses. 1 oz. 35c; ½ lb. \$1.25; 2 lbs. \$3.25; 10 lbs. \$11.85.



CUT WORMS

BORDEAUX MIXTURE, Dry.

Preferable to paste, has double the strength and easier to handle. For blight, mildew and rust. Mix 4 pounds to 50 gallons of water. 1 lb. 40c; 4 lbs. \$1.20; 5 lbs. \$1.50; 8 lbs. \$2.20; 10 lbs. \$2.75; 25 lbs. \$5.75.

***BUG DEATH**, a non-arsenical Insecticide and Fungicide for potato bugs, worms and caterpillars. 5 lbs. 90c; 12½ lbs. \$1.75.

BAIT-M, see (Cut Worm Killer).

***CARBOLA**, a disinfectant white paint for poultry houses, barns and stables. Prevents contagious diseases. 5 lbs. 75c; 10 lbs. \$1.25; 50 lbs. \$5.50.

COOPER SOLUTION, for rot (grape, black and brown), mildews, black spot on roses, Carnation rust and blights. Quart \$1.25; gallon \$4.00

***CROW-TOX**, to protect seed corn from crows, pheasants, moles, woodchucks, etc., Small can, enough for 1 bus. corn, \$1.00.

CUT WORM KILLER, Bait-M. A poisonous bait, for use against cut worms and slugs. 1 lb. 40c; 5 lbs. \$1.75.

Key Brand, 1 lb. 50c; 5 lbs. \$2.00; 25 lbs. \$7.50

CYANOGAS, (Calcium Cyanide) "G" grade, a modern fumigant for greenhouses for aphids, thrips, white fly and soft scale; easily applied by scattering on walks of greenhouses. 1 lb. 75c; 5 lbs. \$3.00.

DR. HESS' DIP & DISINFECTANT, for Poultry houses and stables; gallon \$2.75.

DR. HESS' PAN-A-CE-A mixed with food increases egg production of hens. 25 lbs. pail, \$3.00.

ELECTRIC WORM ERADICATOR, for eradicating worms, grubs and other soil vermin from lawns, golf courses and gardens. Harmless to vegetation; mix one

part to 250 parts of water. 1 gallon bottle \$5.00; 5 gallon keg \$18.00; 10 gallon keg \$30.00.



GRASSHOPPERS



Fumigating with Cyanogas "G"

***FISH OIL SOAP**, for destroying many sucking insects and lice. 1 lb. 35c; 5 lbs. \$1.60; 10 lbs. \$3.25; 25 lbs. \$5.50.

FORMALDEHYDE, used as a dip to prevent potato scab and grain smut. Mix 1 pint to 15 gallons of water; 1 to 2 gallons required to treat 1 bushel of seed. Pint, 60c; Quart, \$1.10; Gallon, \$4.00.

FUNGICIDE, ZENKE'S. For black spot and mildew on Roses, rust and other fungi effecting 'Mums and other greenhouse plants. Will not spot foliage. Gallon \$4.00.

FUNGINE, fungicide remedy for certain species of mildew, rust, red spider and brown patch on lawns; also for dipping cuttings. Gal. \$3.50

FUNG-O, WILSON'S. For blight, mildew, rust, black and leaf spots. Gallon \$4.00.

FUNGTOGEN, for rust on Carnations and Snaps, mildew and black spot on Roses and other plants. Pint \$1.25; qt. \$2.00; gal. \$6.00

***GRAPE DUST**, for Powdery Mildew on Grapes, Roses, 'Mums, etc., and preventing blight. 5 lbs. 90c.

***GRAFTING WAX**, for grafting cuts and bruises on trees. ¼ lb. 20c; ½ lb. 30c; 1 lb. 60c.

HELLEBORE, for Currant worms and other chewing insects. 1 lb. 55c; 5 lbs. \$2.50.

HERBICIDE, for destruction of weeds, grasses, etc., on walks, drives and tennis courts. Qt. 70c; gal. \$2.00; 5 gals. \$7.50; 10 gals. \$12.50; 30 gals. \$30.00; 50 gals. \$45.00.

HERBICIDE, NON-POISONOUS same prices as for Herbicide.

IMP. SOAP SPRAY, for rose and mealy bugs, aphids, thrips, red spider, green, white and black flies. Gal. \$3.00; 5 gals. \$12.00; 10 gals. \$22.00.

***KAYSO**, when mixed with spray mixtures, acts as a spreader and adhesive. Should be mixed with every spray solution. ½ lb. 25c; 2 lbs. 75c; 10 lbs. \$3.00.

KEROSENE MISCIBLE OIL, for woolly aphids and other soft bodied insects. Gal. \$1.75; 5 gals. \$7.00.

***KRYSAL GAS**, (Para-Dichloro - Benzine) the best remedy for the Peach Borer. 1 lb. 75c; 5 lbs. \$2.75.

***LEMON OIL**, for scale on palms; mealy bugs, thrips and red spider; pt. 75c; qt. \$1.25; gal. \$3.50.



Leaf Showing Blackspot



Note: Full directions how to use insecticides and fungicides printed on each container.



Fumigating with NICO-FUME Powder

Note: Owing to postal regulations governing poisons, we are prohibited from sending Insecticides by Parcel Post, and consequently must send them by express or freight. Those marked with an asterisk (*) are non-poisonous and therefore available.

LIME SULPHUR, for dormant spraying for **San Jose** and other scales; **brown rot** of peaches; for **summer spraying** for **peach leaf curl**, **Apple scab** and **scales**.

Dry Powder: 1 lb. 40c; 5 lbs. \$1.75; 10 lbs. \$3.00; 25 lbs. \$5.75.

Liquid: Qt. 50c; gal. \$1.25; 5 gals. \$4.50; 25 gals. \$10.50; 50 gals. \$15.00.

MELROSINE, for **Rose bugs**, plant lice and flies, red spider, mealy bug, leaf hopper, Japanese beetle. Pt. \$1.00; qt. \$1.75; ½ gal. \$3.25; gal. \$6.00.

MOLE EXTERMINATOR, Cyanogas "A" grade. 1 lb. 75c; 5 lbs. \$3.00.

NICO-FUME LIQUID, for spraying or vaporizing for **aphis**, **thrips** etc. 1 lb. \$2.00; 4 lbs. \$6.25; 8 lbs. \$11.50.

***NICO-FUME TOBACCO PAPER**, for fumigating **green fly** etc., will not injure the tenderest blooms. 24 sheets \$1.25; 144 sheets \$5.00; 288 sheets \$8.75.

NICO-FUME TOBACCO POWDER, for fumigating greenhouses for **aphis** and **thrips**, etc. It burns evenly and quickly. 1 lb. \$1.00; 5 lbs. \$3.75; 10 lbs. \$6.85.

***PARA-DICHLORO-BENZINE**, see (Krystal Gas)

PARIS GREEN, for **potato beetle** and other chewing insects. 1 lb. 55c; 5 lbs. \$2.50; 14 lbs. \$5.00.

PYROX, for chewing insects and preventing blight and fungous diseases. 1 lb. 50c; 5 lbs. \$1.75; 10 lbs. \$3.50; 25 lbs. \$7.50; 50 lbs. \$11.75; 100 lbs. \$17.50.

SCALECIDE, for **San Jose** and other scales, rust mite, white fly and other sucking insects during the tree's dormant period. Qt. 75c; gal. \$1.75; 5 gals. \$6.25; 10 gals. \$10.60; 30 gals. \$26.00; 50 gals. \$38.00.

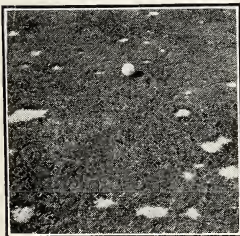

Prevent Brown Patch Use SEMESAN

SCALE-O, for **San Jose** and other scales; a dormant spray. Gal. \$2.00; 5 gals. \$9.00; 10 gals. \$15.00; 30 gals. \$33.00; 50 gals. \$50.00.



Note: Full directions how to use insecticides and fungicides printed on each container.

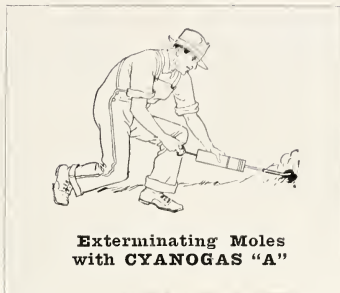

Exterminating Moles with CYANO GAS "A"

SEMESAN, for disinfecting seeds and soils to prevent "**Damping-Off**"; to prevent and control "**Brown Patch**", a grass disease. 2 oz. 50c; 8 oz. \$1.60; 1 lb. \$2.75; 5 lbs. \$13.00; 25 lbs. \$62.50; 50 lbs. \$122.50; 100 lbs. \$240.00.

SEMESAN BEL, a dip treatment for **potatoes** to prevent **scab**, **rhizotonia** and **black leg**. One pound sufficient to treat 16 bus. of potatoes. 1 lb. \$1.75; 5 lbs. \$8.00.

SEMESAN JR., a disinfectant for **corn**, preventing ear, root and stalk **rots**. 4 ounces sufficient to disinfect 2 bus. seed corn. 4 oz. 60c; 1 lb. \$1.75.

***SLUG SHOT**, for potato bugs, cabbage and currant worms; non-poisonous. 1 lb. 20c; 5 lbs. 75c; 10 lbs. \$1.20.

SULPHOCIDE, a summer spray for **Apple scab**, **brown rot of peaches**, **potato** and other blights and **rusts**. Qt. \$1.00; gal. \$2.75; 5 gals. \$8.75; 10 gals. \$15.00; 30 gals. \$39.00; 50 gals. \$60.00.

***SULPHUR**, for preventing mildews on Grapes, Roses, etc. 1 lb. 20c; 5 lbs. 75c; 10 lbs. \$1.25; 25 lbs. \$2.75.

TEROGEN, soil disinfectant and fertilizer; kills larvae and eggs of insects; destroys disease spores of fungi; repels cutworms, moles and field mice; fertilizes the soil. 1 lb. 75c; 5 lbs. \$1.25; 10 lbs. \$2.75; 25 lbs. \$11.00; 50 lbs. \$22.50; 100 lbs. \$40.00.

***THOMPSON'S STYPTIC**, (imported) to prevent **Grape vines** from bleeding. Bottle \$1.50.

***TOBACCO DUST**, fine grade for dusting; for **plant lice** and destroying insects in ground and about plant roots. 1 lb. 15c; 5 lbs. 60c; 10 lbs. \$1.00; 25 lbs. \$1.75; 50 lbs. \$2.75; 100 lbs. \$4.50.



Prevent Corn Rot Use SEMESAN JR.

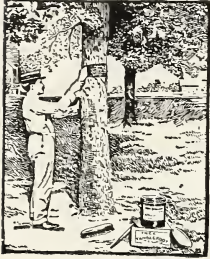

Tanglefoot

INSECTICIDES and FUNGICIDES (Continued)

TOBACCO DUST, for fumigation of green-houses. 25 lbs. \$2.00; 50 lbs. \$3.50; 100 lbs. \$6.00.

TOBACCO STEMS, for fumigating. 100 lbs. bale \$4.00.

***TREE TANGLEFOOT**, protects trees against such crawling insects as ants, canker worms, caterpillars, Tussock, brown tail and Gypsy moths. 1 pound makes about 15 lineal feet of band. 1 lb. 60c; 5 lbs. \$2.75; 10 lbs. \$5.25; 25 lbs. \$11.00.

***TREE WOUND PAINT**, for coating and protecting wounds, cavities and fresh cuts from decay; impervious to rain, cold or heat. Qt. \$1.00; gal. \$3.00; 5 gals. \$12.00.

TWO WAY (Acme), for chewing insects (worms, caterpillars and moths); fungous diseases (blight, mildew and rust); may be used wet or dry; ½ lb. 30c; 1 lb. 50c.

VERMINE, soil sterilizer killing eel worms, cut worms and larvae and eggs of many species of insects infesting soils and roots of trees. Gal. \$3.00; 5 gals. \$13.00.

VOLCK, for red spider, thrips, mildew, mealy bug, leaf roller, scales and rust, on Evergreens, Roses, Mums, Snaps, Carnations and Cyclamen. ½ pt. 50c; pt. 75c; qt. \$1.00; gal. \$3.00; 5 gals. \$12.50.

WHALE OIL SOAP, see (Fish Oil Soap).

X. L. ALL LIQUID, (Imported) an English preparation for destroying mealy bug, scale, thrips, red spider, caterpillars, blight and green or black fly. For syringing or spraying. ½ gal. \$5.00; gal. \$9.00.

X. L. ALL VAPORIZING COMPOUND, best and most effectual greenhouse fumigant for destroying all insect pests injurious to plant life, especially tender plants. Small bottle (sufficient for house containing 10,000 cu. ft.) \$3.00; medium bottle (sufficient for house containing 20,000 cu. ft.) \$6.00.

WEED KILLER, Wilson's. For weeds on tennis courts and driveways. One gallon makes 41, sufficient for covering 800 sq. ft. Gal. \$2.00; 5 gals. \$8.00; 10 gals. \$15.00; 25 gals. \$30.00; 50 gals. \$50.00.

Herbicide, see Herbicide.

"HERBICIDE"

THE WEED EXTERMINATOR



For Paths, Cobble Gutters, Drives, Tennis Courts, etc.

WILSON'S O. K. PLANT SPRAY, for scale, lace fly, spruce gall, red spider, aphid, thrip, etc. ½ pt. 40c; qt. \$1.00; gal. \$3.00; 5 gals. \$12.00; 10 gals. \$20.00; 25 gals. \$50.00; 50 gals. \$90.00.

ZELIO, a poisoned wheat for destroying mice and other rodents. A rodent eating this poison causes him to run for water. 1 oz. can 25c; 1 lb. \$2.00.

SEED INNOCULATORS

MULFORD CULTURES, for inoculating legume seeds or the soils in which they are planted with nitrogen-fixing bacteria. Increases crop yield. For Beans, Peas, Vetches, Soy Beans and all Clovers. When ordering state for which legume the inoculant is wanted.

STIMUGERM CULTURES, formerly sold under the name of Farmogerm. For the same purpose as Mulford culture. Prices for either:

For Small Seeds		For Large Seeds	
½ bus. size.....	\$.60	1 bus. size.....	1.00
1 bus. size.....	1.00	2 bus. size.....	1.00
2½ bus. size.....	2.25	5 bus. size.....	2.25
5 bus. size.....	4.00	10 bus. size.....	4.00

Special Garden size for Garden Peas, Beans and Lima Beans and Sweet Peas, 25c.

POTTING MATERIALS

CHARCOAL. Valuable for mixing with potting soil because of its sweetening characteristics. Fine or Lump: Price of bag (containing about 3 bus.) \$3.00.

LEAF MOLD. For mixing with soil for greenhouse purposes. Bbl., bag, \$3.00.

MOSS, DRY SPHAGNUM. Useful for potting and orchid growing. Bus. bag, \$1.00; bbl. bag, \$2.50; 5 bbl. bale \$6.00.

MOSS, LIVE SPHAGNUM. For growing orchids. Bbl. bag, \$4.00.

MOSS, NATURAL GREEN SHEET. Used for covering soil about plants in tubs, pots and rockeries. Bag \$5.00.

PEAT MOSS, (TORF MULL). For mixing with potting soils, mulching ground to retain moisture and for winter protection, for putting humus in sandy soils, making clayey soils porous. Price per bale (containing 18 to 20 bus.) \$5.00.

PEAT, ORCHID. Finest material for growing Orchids and Ferns. Bbl. bag, \$4.00.

PEAT, ROTTED FIBROUS. Excellent for mixing with potting soils. Bbl. bag, \$3.50.



SEMESAN prevents Damping-Off

HIGH GRADE FERTILIZERS

ACID PHOSPHATE, for supplying phosphorus to soil. Apply at rate of half ton per acre. 100 lbs. \$2.00; 500 lbs. \$7.50; ton \$27.50.

ADCO, for making Artificial Stable Manure. By mixing intermediate layers of non-woody garden refuse and "Adco", a real manure is produced which is equal to the farm yard product in fertilizing power but odorless and free from flies. 25 lb. bag (enough for 12 wheelbarrows of garden waste, making one-half ton of manure) \$2.00; 150 lb. bag (enough for making 3 tons of manure) \$10.50.

ASHES, HARDWOOD. Valuable for potash, destroying insects and controlling diseases. For top dressing lawns; apply at rate of 1 to 2 tons per acre. 100 lbs. \$3.00; ton \$50.00.

BLOOD & BONE (Tankage). Furnishes phosphoric acid. For grape vines, fruit trees, lawns and crops in general. Apply at rate of 1000 lbs. per acre. 100 lbs. \$5.00; ton \$80.00.

BLOOD, DRIED. For supplying nitrogen. Excellent for Carnation, Roses, etc., quick acting. 100 lbs. \$8.00; ton \$140.00.

BON ARBOR. Unsurpassed soluble plant life containing 15% nitrogen, equal to 19% ammonia, 4% each of phosphoric acid and potash. One pound makes 30 gallons of liquid fertilizer. For general use. 10 lbs. \$4.75; 25 lbs. \$10.00; 50 lbs. \$18.00.

BONE MEAL, FINE GROUND. A finely pulverized bone dust, excellent for Roses and valuable for top dressing lawns (1,000 lbs. per acre); also flowers and vegetables. Because of its slow disintegrating qualities, it is more lasting and there is no danger of burning. 5 lbs. 50c; 10 lbs. 90c; 25 lbs. \$1.75; 50 lbs. \$2.75; 100 lbs. \$5.00; ton \$65.00.

BONE, CRUSHED QUARTER INCH. This grade is made from bones crushed to 1/4 inch or more. Excellent for grape vines. 100 lbs. \$7.00.

CARNATION FOOD (Springfield). A commercial fertilizer containing all the foods necessary for the best results in Carnation growing. 100 lb. bag \$6.00.

CATTLE MANURE (SHREDDED). For soil mixing, mulching and liquid manuring. Apply 1 to 3 tons per acre. 100 lb. bag \$4.50; ton \$65.00.

CHRYSANTHEMUM MANURE, Smith's. A perfect food for 'Mums, Sweet Peas and other greenhouse plants. 50 lbs. \$5.50; 100 lbs. \$10.00.

CHRYSANTHEMUM MANURE Thomson's (Top-Dressing). Unlike Thomson's Vine & Plant Manure, it is entirely soluble and therefore very powerful for top-dressing potted Chrysanthemums (1 teaspoonful to each 10 inch pot). The results are amazing. 14 lbs. \$2.50; 28 lbs. \$4.50; 56 lbs. \$8.00; 112 lbs. \$15.00.

CLAY'S CELEBRATED. The best English fertilizer for forcing greenhouse plants. Indispensable for producing plants of exhibition quality. 28 lbs. \$4.50; 56 lbs. \$7.50; 112 lbs. \$13.50.

CORN-AGRICO. A commercial fertilizer specially compounded as to supply the requisite plant foods necessary for large yields of Corn. 100 lbs. \$3.50; ton \$55.00.

DAHLIA (Springfield). A chemically compounded fertilizer containing those elements necessary to producing exhibition Dahlias. 100 lb. bag \$6.00.

FERTILMOSS, an imported fibrous peat. Excellent for producing humus in sandy soils, drainage in clayey soils, mulching ground in summer and winter, for potting plants. 24 qt. bag \$1.50; bale \$4.50.

FLORANID. The most highly concentrated organic nitrogen fertilizer; 46% nitrogen. For general use. Clean and odorless. Used dry or in liquid form. 1 lb. 50c; 5 lbs. \$1.50; 50 lbs. \$9.00.

HUMUS, (HYPER) is organic matter. Makes clayey soils lighter and increases drainage; it binds together sandy soils and helps retain moisture. 100 lbs. \$2.50; ton \$25.00. In car-load lots \$10.00 per ton.

ICHTHEMIC GUANO. High grade imported fertilizer. Splendid for top dressing and using in potting mixtures. 56 lbs. \$9.00; 112 lbs. \$16.00.

LAWN & GARDEN DRESSING (Bowker's). Commercially made to supply those food elements necessary to the proper growths of lawns and flowers. 10 lbs. \$1.25; 100 lbs. \$4.75; ton \$80.00.

LIME, AGRICULTURAL. Used to sweeten sour or acid soils, increases availability of plant food. 10 lbs. 50c; 50 lbs. \$1.50; 100 lbs. \$2.50; ton \$30.00.

MURIATE OF POTASH. Especially beneficial to all root crops because of its high percentage of potash. 100 lbs. \$6.00.

NITRATE OF SODA. An active, quickly soluble, nitrogenous fertilizer stimulating leaf growth. For lawns, leaf vegetables, tomatoes and plants showing tardy growth. 5 lbs. 60c; 10 lbs. \$1.00; 25 lbs. \$2.00; 50 lbs. \$3.50; 100 lbs. \$6.00.

NITROPHOSKA. A highly concentrated complete plant food, 15% each of nitrogen and potash and 30% phosphoric acid. For Roses, Carnations, 'Mums and other plants in the greenhouse and outdoors. 1 lb. 35c; 5 lbs. \$1.25; 10 lbs. \$2.10; 25 lbs. \$4.00; 50 lbs. \$6.00.

POTATO-AGRICO. A commercial fertilizer specially compounded to possess those chemical elements necessary for large yields of potatoes. 100 lbs. \$3.50; ton \$55.00.

POULTRY MANURE, PULVERIZED. A very rich natural fertilizer for use on all crops. 100 lbs. \$4.50; ton \$60.00.

RHODY-LIFE. It is a preparation for making soils acid, a condition which the Rhododendrons, Laurels, Azaleas, Pines, Spruce thrive in. 100 lbs. \$5.00; 1000 lbs. \$45.00.

ROSE FOOD (Springfield), a commercial fertilizer containing those plant foods necessary for the best results in Rose growing. 100 lbs. \$6.00.

SALT, AGRICULTURAL. Used as a top dressing for Asparagus beds. 200 lbs. \$4.00; ton \$30.00.

SALT HAY. A valuable winter covering for Rose beds, perennial borders, etc. Bale, about 200 lb. \$5.00; ton \$45.00.

SCOTCH SOOT (Imported), besides improving the color of foliage and stimulating growth, it is an effective remedy for grubs, slugs and cut worms. 100 lbs. \$7.00.

SHEEP MANURE, High grade, pure. For immediate effect, because its chemical elements are quickly available. For top dressing lawns, mixing with soils, Vegetables, Flowers, etc. Apply at rate of 1 ton per acre. 5 lbs. 50c; 10 lbs. 90c; 25 lbs. \$1.60; 50 lbs. \$2.50; 100 lbs. \$4.00; ton \$65.00.

SULPHATE OF AMMONIA (Arcadian). A specially prepared lawn and garden fertilizer, containing 20% nitrogen. Excellent for keeping down weeds in lawns, by top dressing at rate of 10 pounds per 2,500 sq. ft. 5 lbs. \$1.00; 10 lbs. \$1.85; 25 lbs. \$3.75.

TANKAGE see (Blood and Bone).

THOMSON'S TOP DRESSING, for Chrysanthemums. See (Chrysanth. Manure).

THOMSON'S VINE & PLANT MANURE (Imported). This manure is unrivalled for Vines, Tomatoes, Cucumbers, fruit trees, flowers and vegetables in greenhouse and outdoors; also lawns. So compounded as to combine stimulating with lasting effects. 56 lbs. \$6.00; 112 lbs. \$11.00.

TRUCK-AGRICO. A commercial fertilizer, compounded as to benefit crops in general. 100 lbs. \$3.50; ton \$60.00.

VIGORO, an odorless commercial fertilizer for lawns, flowers, vegetables and trees. 5 lbs. 50c; 25 lbs. \$1.75; 50 lbs. \$3.00; 100 lbs. \$5.00.

TABLE OF CONTENTS

FLOWER SEEDS		Pages
Novelties and Specialties.....		41 to 42
General List (Alphabetically Arranged).....		43 to 72
VEGETABLE SEEDS		
Novelties and Specialties.....		8 to 14
General List (Alphabetically Arranged).....		15 to 37
GRASS SEEDS		
Lawn Grass Mixtures.....		2 to 5
Hay and Pasture Mixtures.....		6
General List.....		7
Clovers.....		6
INSECTICIDES (Alphabetically Arranged).....		108 to 110
FERTILIZERS (Alphabetically Arranged).....		111

<i>Page</i>	<i>Page</i>	<i>Page</i>	<i>Page</i>
Amaryllis.....85	Flower Pot Covers.....94	Mastica.....100	Scythe Blades.....102
Aprons.....90	Fodder Corn.....40	Mats, Hot-Bed.....100	Scythe Snath.....103
Arch Trellises.....106	Forks, Garden.....94	Mattocks.....100	Scythe Stones.....103
Artichoke Roots.....15	Fruit Pickers.....94	Melon Nets.....100	Seeders.....100, 103
Ash Cans.....90	Fruit Trees.....88	Millet.....39	Shears.....103
Asparagus Roots.....15	Fumigators.....94	Mint Plants.....38	Shovels.....103
Asparagus Buncher.....90	Garden Frames.....94	Mole Traps.....100	Shrubs, Flowering.....86
Asparagus Knives.....90	Garden Line.....94	Montbretias.....85	Sickles.....103
Axes.....90	Garden Reels.....94	Moss.....110	Sieves.....103
	Garden Pencils.....94	Mulford Culture.....110	Silkline.....103
	Gladiolus.....42, 75, 76	Mushroom Spawn.....26	Small Fruits.....88
	Glass.....94	Oats.....39	Smilax.....103
	Glazing Materials.....94, 100, 101	Oat Sprouters.....100	Sod Tamper.....103
	Glazing Points.....94	Pails.....100	Sod Perforator.....103
	Gloves, Garden.....94	Paint.....100	Soja Beans.....39
	Gloxinias.....85	Paeonies.....85	Spades.....103
	Grafting Wax.....94	Paper.....100	Sprayers.....104
	Grain Binder.....94	Peat.....110	Sprayer Access.....105
	Grape Bags.....94	Peat Moss.....110	Sprinklers.....97, 105, 107
	Grass Catcher.....94	Perennial Plants.....80-83	Stakes.....96, 105
	Grass Hooks.....94, 102	Picks.....100	Stimugerm.....110
	Grass Signs.....79	Planet Jrs.....100	Stone Boat.....103
	Greenhouse Plants.....79	Plants, Bedding.....84	Strawberry Netting.....100
	Greenhouse Shading.....105	Plants, Greenhouse.....79	Sweet Potato Plants.....38
	Grind Stones.....95	Plants, Mint.....38	Summer Cloud.....105
		Plants, Perennial.....80-83	Syringes.....105
	Hand Cart Box.....105	Plants, Sweet Potato.....38	
	Handles, Wood.....95	Plants, Vegetable.....38	Tarragon Roots.....38
	Harrows.....95	Plant Bed Cloth.....101	Tennis Markers.....105
	Hay Knife.....95	Plant Protectors.....101	Tennis Nets.....105
	Hay Mowers.....100	Plant Sprinkler.....102, 107	Thermometers.....105
	Hedge Plants.....87	Plant Stakes.....105	Tin Foil.....105
	Hedge Trimmers.....95	Plant Supports.....92, 105	Tobacco Seed.....36
	Herbs.....38	Plan-Tie.....107	Tooth Picks.....105
	Hoes, Garden.....95	Plant Ties.....101	Torches.....105
	Horse Radish Roots.....38	Plows.....101	Tractors.....106
	Hose Fittings.....95	Post Hole Digger.....101	Tree Protectors.....101
	Hose Nozzles.....95	Potato Hook.....101	Tree Pruners.....103, 106
	Hose Reels.....96	Pots, Flower.....93	Tree Wound Paint.....103
	Hose, Rubber.....96	Potting Materials.....110	Trellises.....106
	Hot-Bed Sash.....102	Poultry Wire.....107	Tritomas.....83
	Hyacinth Cand.....85	Powder Dusters.....92, 93	Trowels.....106
	Hyacinth Sticks.....96	Pruners.....103, 106	Trucks.....105, 106
	Indelible Ink.....96	Putty.....101	Tuberoses.....85
	Iris.....85	Raffia.....101	Tubs.....106
	Ismene.....85	Rakes.....101	Turf Edgers.....96, 106
		Rape.....39	Turfing Iron.....106
	Kinney Pumps.....96	Rhubarb Roots.....38	Twines.....106, 107
	Knee Pads.....96	Rifles.....101	
	Knives.....96	Rollers, Lawn.....101	Vases.....107
		Roses.....78, 79	Vegetable Plants.....38
	Labels.....96	Rose Wire Stakes.....105	Vetches.....39
	Ladder.....97	Rubbish Burners.....102	Vines, Climbing.....87
	Lamps, Alcohol.....97	Ruta Baga.....40	
	Lawn Edgers.....97	Rye.....39	Wagons.....106
	Lawn Mowers.....97, 98		Wall Nails.....100
	L. M. Sharpeners.....97	Sand Screen.....102	Water Barrel.....105
	Lawn Rollers.....97	Sash, Hot-Bed.....102	Water Lilies.....84
	Lawn Sprinklers.....97	Saucers.....102	Watering Pots.....107
	Leaf Mold.....110	Saw Buck.....102	Weeders.....107
	Leaf Rack.....97, 105	Saws.....102	Weed Killers.....108, 110
	Lever Clips.....100	Scissors.....102	Wheat.....39
	Lilies.....77	Scollay Bulb.....102	Wheelbarrows.....107
		Scraper, Drag.....102	Wire.....107
	Mangel-Wurzel.....40	Screens, Porch.....102	Wire Fences.....93
	Manure Spreader.....100		Wire Netting.....107

OUR AGE-OLD MOTTO

“Reliable Seeds and Prompt Service”

is more than a figure of speech.

*It is a standard of efficiency upon which our
success has been established*



The High Quality of Our

Lawn Grass Mixtures

blended from our own formulae, has earned

for us the reputation of being

“The House Famous for Lawn Grass Seed”



TRADE MARK

The House Famous
for
Lawn Grass Seed

Burnett Bros. Inc.,
92 Chambers St.,
NEW YORK