

Historic, archived document

Do not assume content reflects current scientific knowledge, policies, or practices.

62.13

LIBRARY
RECEIVED
★ MAR 1 1938 ★
U. S. Department of Agriculture.

OLDS & WHIPPLE
INC.
SEEDS AND
FERTILIZERS
HARTFORD, CONN.

1938

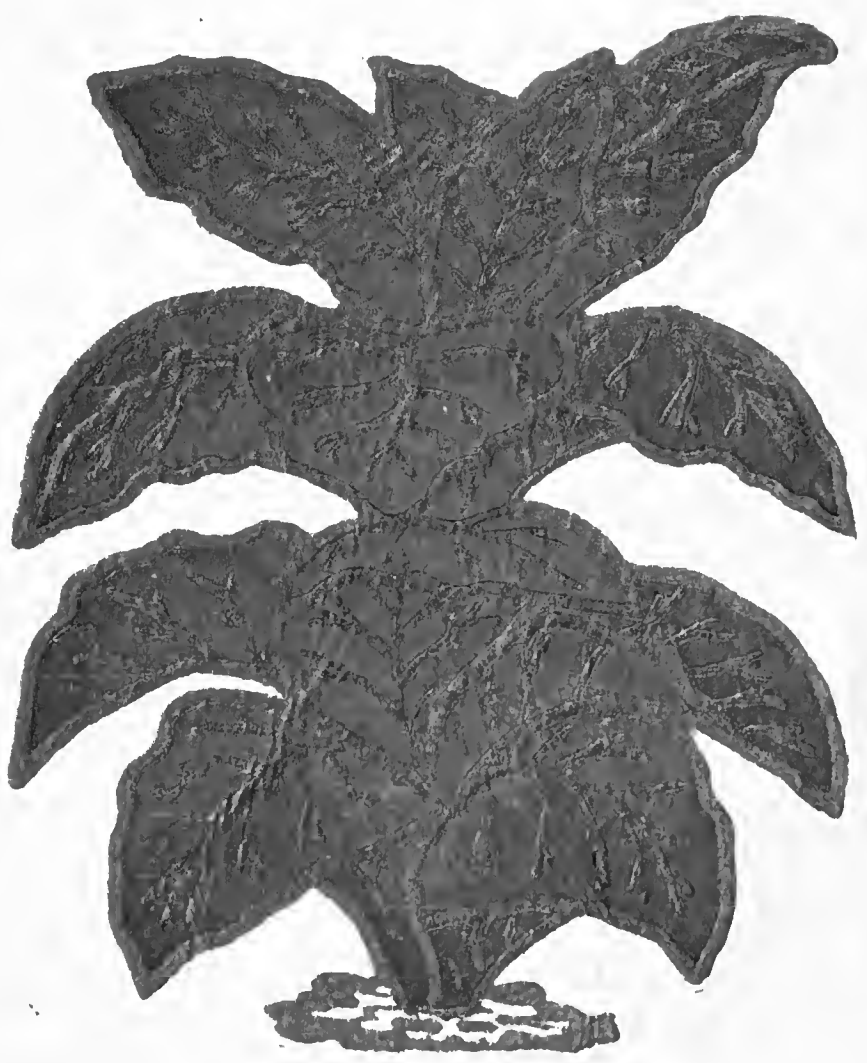



OLDS & WHIPPLE Inc.

168 State Street, Hartford, Conn.

Date 1938 Ship via **Freight** **Express** **Mail**
Check Which

Ship to

Street or R.F.D. County

Post Office State

Express or Freight Office,
if different from P. O.

AMOUNT } Money Order \$..... Stamps \$..... } Check here
ENCLOSED } Check \$..... Cash \$..... } if wanted
shipped C. O. D.

Olds & Whipple, Inc., give no warranty, express, or implied, as to purity, description, quality, productiveness, or any other matter of any Seeds, Bulbs, or Plants they send out, and will not be in any way responsible for the crop. When mentioned, purity and germination tests are for information only and without guarantee.

QUANTITY	NAMES OF ARTICLES WANTED	PRICE	

(Sign order on bottom of next page.) Amount Forward

QUANTITY	NAMES OF ARTICLES WANTED	PRICE	
	Brought Forward		
	Total Enclosed		

Sign here

· SEEDS ·
FERTILIZERS and
AGRICULTURAL IMPLEMENTS

CATALOG FOR 1938



All Prices Subject to Change Without Notice

OLDS & WHIPPLE, Inc.

FERTILIZER FACTORY:
Tolland Street, East Hartford, Conn.

MAIN OFFICE AND IMPLEMENT WAREHOUSE
164-6-8 State Street, Hartford, Conn.

Offices and
Agricultural
Warerooms at
168 State Street,
Hartford, Conn.



Fertilizer Factory located on
Tolland Street,
East Hartford,
Conn.

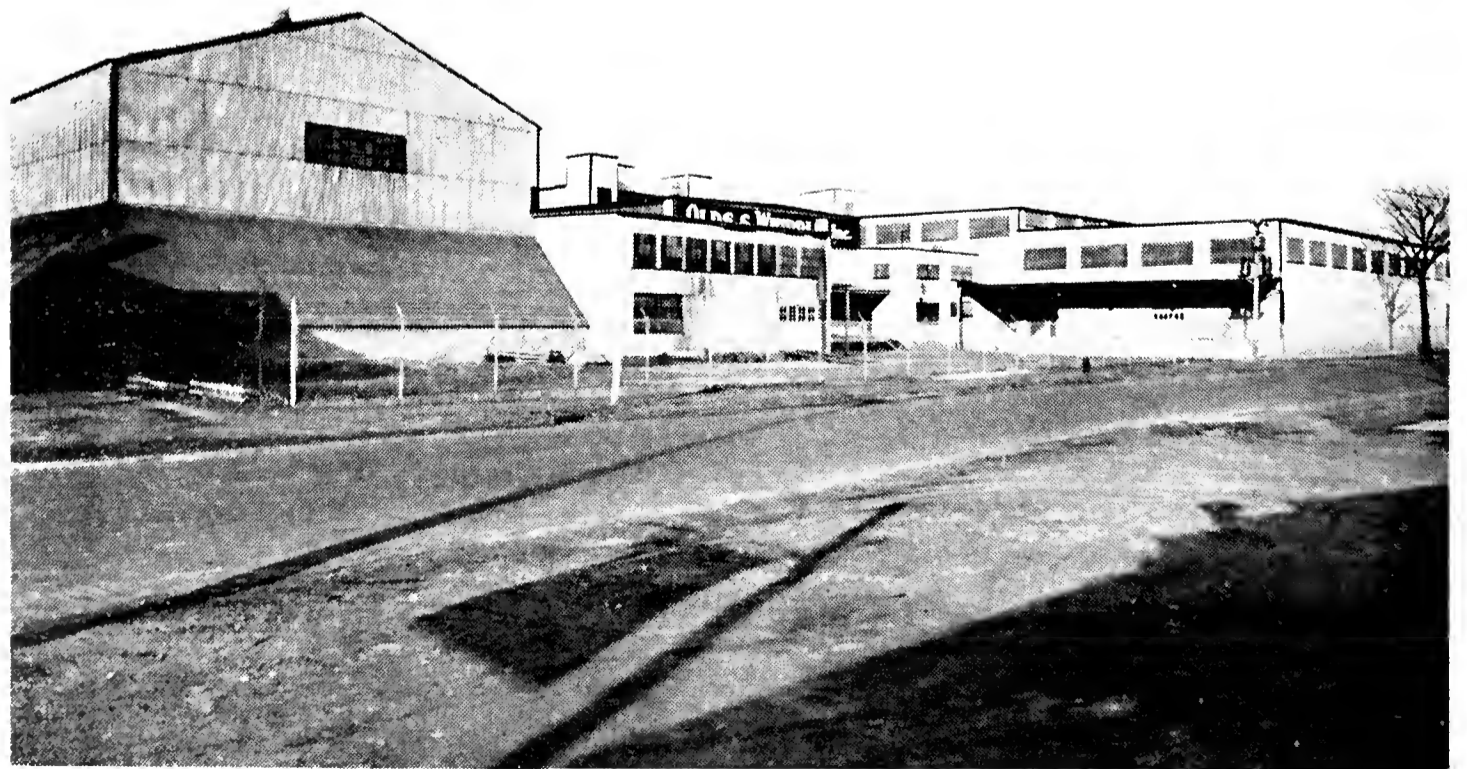

1877

Foreword

1938



Sixty-one years of business under the same management and at the same location is the record of Olds & Whipple, Inc.

The best, the greatest asset of any business organization is the confidence reposed in it by its customers, confidence that the customer will be treated fairly, will receive good value for his dollar and receive every courtesy and consideration should any misunderstandings arise; in other words, application of the golden rule, treat the other fellow as you would wish to be treated. Only in this way can a sound permanent business be built.

And this has been the policy of the founders of the Olds & Whipple, Inc. over a period of sixty-one years and impressed upon every salesman and member of our organization.

That it has borne fruit is evidenced by our constantly growing list of loyal customers who have in such large measure contributed to our success, and to them we wish to express our appreciation and pledge ourselves to so conduct our business in the future to be worthy of their patronage.

OLDS & WHIPPLE, INC.

Olds & Whipple, Inc.

List of Fertilizers and Raw Materials For 1938

O. & W. SPECIAL FERTILIZERS

Complete Tobacco Fertilizer
Blue Label Tobacco Fertilizer
High Grade Tobacco Starter
High Grade Tobacco Starter and
Potash Compound
Top Dressing and Grass Fertilizer
Market Garden Fertilizer

High Grade Potato and Vegetable
Fertilizer
Potato and General Purpose Fertilizer
Double Strength Fertilizer
Corn Special Fertilizer
Corn and Grain Fertilizer
Lawn Fertilizer

WILCOX FORMULA

Corn Special Fertilizer
Potato and General Purpose

Market Garden Fertilizer
Top Dresser

FERTILIZING MATERIALS

Swift Sure Phosphate
Swift Sure Bone Meal
C.S. Meal guaranteed analysis
Cyanamid—Granular
Castor Pomace guaranteed analysis
Sterilized Ground Stems
High Grade Muriate Potash
High Grade Sulphate Potash
Nitrate of Potash
Carbonate of Potash
Urea
Ammo Phos.

Super Phosphate (acid phosphate)
Sulphate of Ammonia
Nitrate of Soda
Sheep Manure
Dry Ground Fish
Tankage
Steamed Bone
Precipitated Bone Phosphate
Lime for Agricultural use
Fine ground Nova Scotia Plaster
Calcium Nitrate
Cotton Boll Ashes

We would call special attention to our market garden and potato fertilizer made with a large part of nitrogen derived from organic sources. A fertilizer made in this way costs more money but we believe the extra cost is justified by increasing yields. The final test of value of a fertilizer is not the price per ton but the crop produced.

We again urge our customers to order their fertilizer at once and allow us to deliver same at an early date and thus avoid the mad scramble that always comes late in the season. There is no good reason for delay.

Our Special Mixtures for All Crops

The following pages give you a list of the special fertilizers which we manufacture at our own factory.

These special mixtures are from tested formulae, proved out by practical growing tests. They are finely ground, and mechanically, in such condition, as to render them readily available to the growing crops.

Their use will repay you. They produce the kind of crops that pay. Used and endorsed by best growers.

Fertilizing Cigar Leaf Tobacco

For Bigger Yields and Better Burning Quality

A good cigar depends upon its burning quality and flavor for its reputation. Leaf tobacco for making a good cigar must be of the best quality, must hold fire well, not burn too fast or too slowly. It must not coal on the cigar and it must leave a clear white or light gray ash, not a muddy ash.

Cigar smokers everywhere are complaining about the quality of the cigar being made today. Manufacturers cannot make good cigars unless they get good tobacco, and that is where the grower comes in.

LEAF WISE

No matter how old a man is, if he is wise, he can still acquire more wisdom. No matter how old a grower is, he can still acquire more wisdom about a tobacco leaf.

The tobacco plant, perhaps more than any other plant, can be and is influenced for better or worse by proper or improper fertilization. In applying fertilizer, the grower must have two essential things in mind: 1, to preserve the productiveness of his soil; and 2, to produce leaf that has the most desirable qualities, namely, BURN — GRAIN — TEXTURE and COLOR. This is a large order, but it can be successfully met by growers carefully studying the right fertilizers to use.

O. & W. Tobacco Fertilizer

To growers who desire a concentrated mixture, we offer this formula made along similar lines as our "Complete" tobacco.

GUARANTEED ANALYSIS

- 7% Nitrogen
- 3% Available Phosphoric Acid
- 7% Actual Potash



Fine crop of Broadleaf tobacco on the farm of William Kiniry, South Windsor, grown on Blue Label tobacco fertilizer. Mr. Kiniry is an outstanding grower and a customer of Olds and Whipple, Inc., for many years.

O. & W. Complete Tobacco Fertilizer

has been a popular favorite with tobacco growers for years. The various sources of plant

food are so blended that the tobacco plant is nourished from transplanting to harvest time.

GUARANTEED ANALYSIS

- 5% Nitrogen
- 3% Available Phosphoric Acid
- 5% Actual Potash

Blue Label Brand Fertilizer

In this brand we use 1000 lbs. of C. S. Meal in each ton. C. S. Meal has long been recognized as a basic ingredient for tobacco fertilizer freeing its plant food as it decomposes in the soil and feeding the plant to maturity. The phosphoric acid and potash are derived from high grade sources and every precaution is taken to keep out all elements that might react unfavorably on finished leaf.

GUARANTEED ANALYSIS

- 6% Nitrogen
- 3% Available Phosphoric Acid
- 6% Actual Potash

O. & W. High Grade Tobacco Starter

This high grade starter has been used with conspicuous success by some of our best growers in the valley. We recommend that it be applied after the first time hoeing. At that critical stage of growth an abundant supply of quickly available nitrogen enables the plant to get a vigorous start, overcome and grow away from any unfavorable condition that may exist.

Experience has taught us that the crop that grows quickly, vigorously and does not stop until it reaches maturity produces the best goods.

GUARANTEED ANALYSIS

- 10% Nitrogen
- 3% Available Phosphoric Acid

O. & W. High Grade Tobacco Starter and Potash Compound

This formula with 5 per cent quickly soluble Nitrogen and 15 per cent actual Potash should be used with C. S. Meal or Castor Pomace in growing the tobacco crop and when so used makes a complete fertilizer. The Nitrogen of C. S. Meal or Pomace is slow acting and on most lands a more quickly soluble form of Nitrogen is needed to start the crop. We recommend using 1000 to 1500 lbs. per acre with a ton of C. S. Meal or Pomace.

GUARANTEED ANALYSIS

- 5% Nitrogen
- 4% Available Phosphoric Acid
- 15% Actual Potash

O. & W. Special Corn Fertilizer

This formula has been tested and tried in the cornfields of Connecticut and Rhode Island and produced excellent crops. It carries a high percentage of available phosphoric acid, necessary to promote hard grain and early maturity. It is also extensively used in market gardening.

GUARANTEED ANALYSIS

- 3% Nitrogen
- 10% Available Phosphoric Acid
- 4% Actual Potash



Field Corn on farm of Anthony Krawski & Sons, Wapping; grown on O&W fertilizer.

O. & W. Corn and Grain Fertilizer

This formula carrying a high percentage of Available Phosphoric Acid is recommended for growing corn and grains and works well with a light coat of stable manure furnishing an abundance of Phosphoric Acid, important to the cereal crop.

GUARANTEED ANALYSIS

- 2% Nitrogen
- 10% Available Phosphoric Acid
- 2% Actual Potash

O. & W. General Purpose Fertilizer

This formula is similar to our complete market garden fertilizer, and is, as its name implies, a general purpose fertilizer.

GUARANTEED ANALYSIS

- 3% Nitrogen
- 8% Available Phosphoric Acid
- 4% Actual Potash

O. & W. Complete Market Garden Fertilizer

This is one of our high grade special mixtures for use on Corn, Potato, Onion Crops, Market Garden and general purpose fertilizer.

The sources of plant food are such as are exceedingly available to the plant and best



Six acres of Cauliflower on farm of Peter Wojtyna, Feeding Hills, Mass. Grown on O&W Vegetable fertilizer.

suited to promoting rapid and vigorous growth. Tested at our own farms we are able to speak authoritatively as to its merits. All growers will be re-paid by using this special mixture on their crop.

Our soils are well adapted to the culture of these crops and to make them profitable as well, is an easy matter if the culture is supplemented and promoted by the use of our special fertilizer.

GUARANTEED ANALYSIS

- 4% Nitrogen
- 8% Available Phosphoric Acid
- 4% Actual Potash

This formula can be furnished with extra organic at a slight advance in price.

O. & W. Potato and General Purpose Fertilizer

This formula should be used in growing potatoes. The 4% Nitrogen content makes it practically the same as our 5-(ammonia) 8-7 of previous years and most agronomists agree that this is a proper balance for the potato crop. This formula is also extensively used in market gardening.

GUARANTEED ANALYSIS

- 4% Nitrogen
- 8% Available Phosphoric Acid
- 7% Actual Potash

This formula can be furnished with extra organic at a slight advance in price.



Green Mountain potatoes on farm of Austin W. Dyckman, Huntington, L. I. Mr. Dyckman used Vermont Certified seed and O&W Extra Organic potato Fertilizer.

O. & W. High Grade Potato and Vegetable Fertilizer

This is a concentrated mixture running high in analysis in every ingredient, and as a formula is extensively used in the potato growing sections of Maine. To produce large crops of potatoes you must feed heavily of Potash. This was thoroughly proven during the war, as even when Potash was extremely high and scarce some of the Maine potato growers paid the price for this ingredient and were well repaid by increased crop.

GUARANTEED ANALYSIS

5% Nitrogen
8% Available Phosphoric Acid
7% Actual Potash

This formula can be furnished with extra organic at a slight advance in price.

O. & W. Double Strength Fertilizer

A highly concentrated formula used principally in growing potatoes. Should be used at the rate of 1000 to 1200 lbs. per acre, being very careful that fertilizer does not come in contact with seed.

GUARANTEED ANALYSIS

8% Nitrogen
16% Available Phosphoric Acid
14% Actual Potash

O. & W. Top Dressing and Grass Fertilizer

A complete fertilizer with all the essential elements for rapid and luxurious growth, carrying both soluble salts and organic material, it is suitable both for top dressing or permanent seeding down mixture.

GUARANTEED ANALYSIS

8% Nitrogen
6% Available Phosphoric Acid
6% Actual Potash

We are now mixing Wilcox formulae, having 6 years ago purchased the mixed fertilizer business of the Wilcox Fertilizer Co. of Mystic, Conn. Wilcox fertilizers have always enjoyed a good reputation. It is our aim to maintain and enhance that reputation, making only such changes as recent scientific research has proved advantageous.

We offer the following Wilcox formulae:

Wilcox Corn Special

This is an old favorite, moderate in price, made of soluble materials, and producing fine crops.

GUARANTEED ANALYSIS

3% Nitrogen
10% Available Phosphoric Acid
4% Actual Potash

Wilcox Market Garden

This formula is deservedly popular in the great garden section of Newport Island, Eastern Connecticut, Massachusetts and surrounding territory. Produces quick luxuriant growth and early maturity of vegetables.

GUARANTEED ANALYSIS

4% Nitrogen
8% Available Phosphoric Acid
4% Actual Potash

This formula can be furnished with extra organic at a slight advance in price.



Melons on Orkil Farms, West Simsbury, Mr. Holcomb Superintendent. Grown on O&W fertilizer.

Wilcox Potato and General Purpose Fertilizer

Used extensively in growing potatoes and market garden truck, carrying a high percentage of potash needed in many crops.

GUARANTEED ANALYSIS

4% Nitrogen
8% Available Phosphoric Acid
7% Actual Potash

This formula can be furnished with extra organic at a slight advance in price.

Wilcox High Grade Potato Fertilizer

This formula carrying a high percentage of Nitrogen is a favorite in certain sections and should be used where a deficiency of vine growth has been noted. Also used successfully by market gardeners.

GUARANTEED ANALYSIS

5% Nitrogen
8% Available Phosphoric Acid
7% Actual Potash

This formula can be furnished with extra organic at a slight advance in price.

Wilcox Top Dresser

A standard mixture made of soluble materials for application to grass lands, used either as top dressing or seeding down.

GUARANTEED ANALYSIS

8% Nitrogen
6% Available Phosphoric Acid
6% Actual Potash

Important Notice . . . Free Delivery of Seeds

We Deliver, Transportation Paid in the 1st and 2nd Postal Zone, Vegetable Seeds by the packet, ounce, quarter-pound, pound.

On larger quantities purchaser pays transportation.

In making this Free Delivery we reserve the right to ship goods either by Parcel Post, Express or Freight.

We reserve the right to advance prices without notice should current conditions require it.

REMITTANCES

May be made by Express Money Order, P. O. Money Order or Check.

NOTE: — If cash or stamps are sent by mail, REGISTER THE LETTER, otherwise it travels at owner's risk.

If goods are wanted C.O.D., 25 per cent of the amount must accompany the order. Charges for returning the money will be collected on delivery.

OLDS & WHIPPLE, INC., give no warranty, express or implied, as to purity, description, quality productiveness or any other matter of any seeds, bulbs or plants they send out, and will not be in any way responsible for the crop. When mentioned, purity and germination tests are for information only and without warranty.

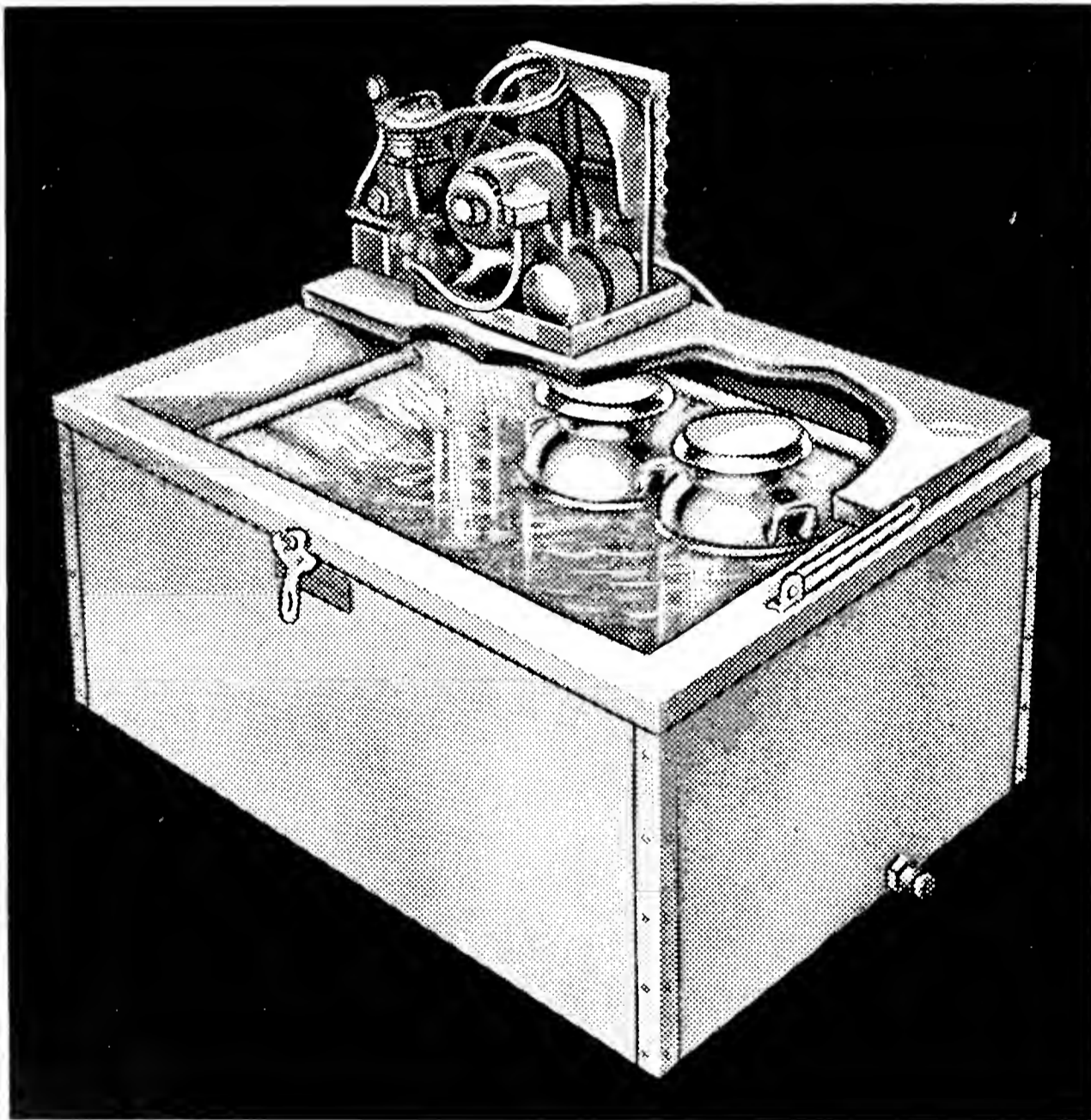

Glenn Refrigerating Equipment. Insures positive, quick and economical cooling.

Prices on application.

1877

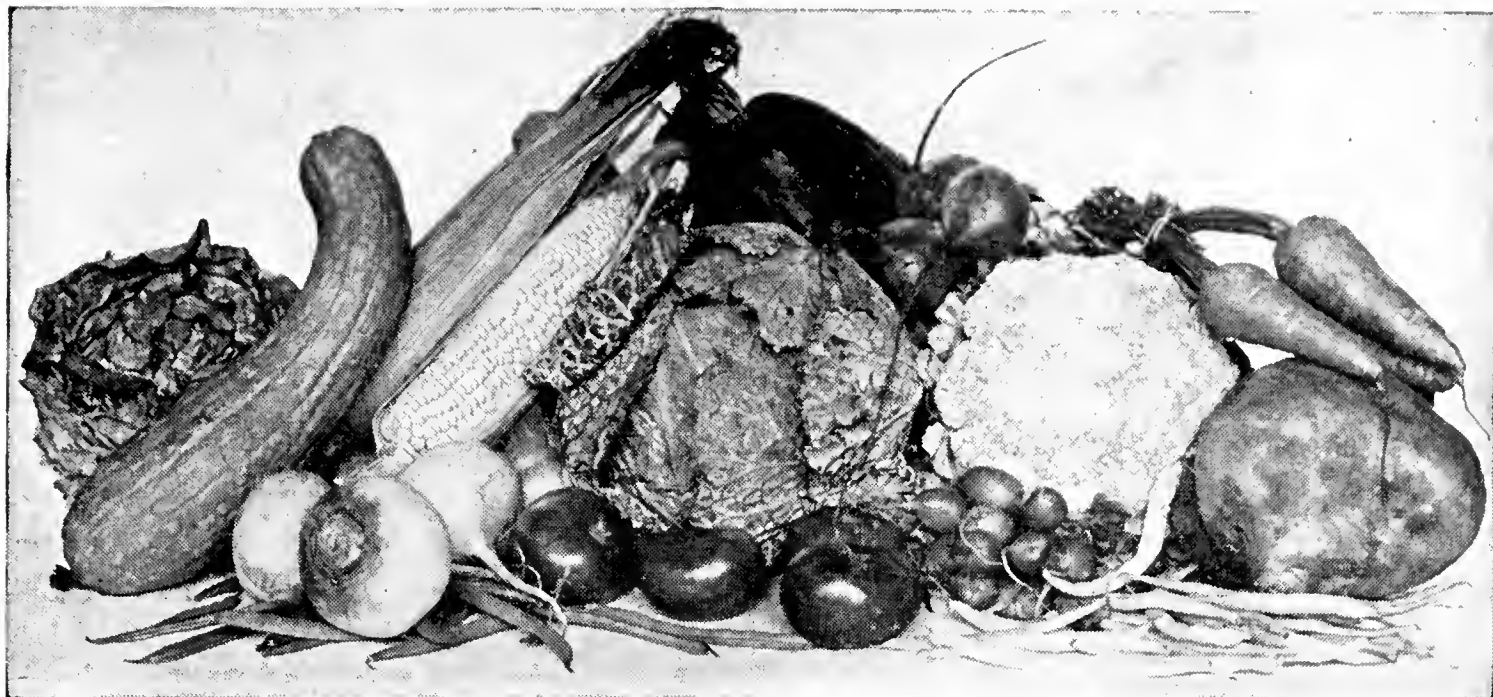

1938

RELIABLE VEGETABLE SEEDS

for Market and Home Gardens



Asparagus

An Asparagus bed may be made from one or two year old roots, planted in fall or spring. Plant the roots in rows four feet apart, leaving about twelve inches between plants in the row. Should be planted in trenches and gradually filled in as plants grow. Seeds may be sown in April in drills one foot apart and one inch deep, and roots transplanted the following year.

Mary Washington—The latest development of rust resistant asparagus; large stalks with very tight tips of fine quality.

Pkt. 10c Oz. 15c ¼ lb. 30c lb. \$1.00

Mary Washington—Strong one year old roots.

80c for 50 \$1.50 per 100

Bush Beans

Can be planted any time from May 1 (or after danger of frost is past) until August. Plant in rows 2½ to 3 ft. apart and 3 to 4 inches apart in the rows. Cover 1½ in. deep. Cultivate after plants are 6 in. high. 2 lbs. will plant 100 ft. row.

DWARF GREEN PODDED VARIETIES

Burpee's Stringless—An early, sturdy, large plant, very productive. Pods round, medium green, very meaty, and of excellent quality.

1 lb. 30c 2 lbs. 50c 5 lbs. \$1.00
10 lbs. \$1.60 15 lbs. or more at 14c per lb.

Black Valentine—Stringless. Plant is large leaved, erect, prolific. Pods are round, dark green, finest quality.

1 lb. 30c 2 lbs. 50c 5 lbs. \$1.00
10 lbs. \$1.60 15 lbs. or more at 14c lb.

Bountiful—An important early variety. Pods flat, light green, stringless and of good quality.

1 lb. 30c 2 lbs. 50c 5 lbs. \$1.00
10 lbs. \$1.70 15 lbs. or more at 15c lb.

Tendergreen—Desirable for home or market garden. Pods round, fleshy, dark green, stringless, fine quality.

1 lb. 30c 2 lbs. 50c 5 lbs. \$1.10
10 lbs. \$1.80 15 lbs. or more at 16c lb.

Low's Champion—Also known as Red Cranberry. Pods deep green, straight, flat, stringless and of good quality.

1 lb. 30c 2 lbs. 50c 5 lbs. \$1.10
10 lbs. \$2.00 15 lbs. or more at 18c lb.

Dwarf Horticultural—Pods green at early stage, changing to greenish yellow, splashed with carmine at maturity; semi-round. Used as a shell bean.

1 lb. 30c 2 lbs. 50c 5 lbs. \$1.00
10 lbs. \$1.70 15 lbs. or more at 15c lb.

Dwarf Green Podded Varieties—Con.

French Dwarf Horticultural—A popular green shell variety. Pods large, exceptionally attractive in appearance. Very good market variety.

1 lb. 35c 2 lbs. 60c 5 lbs. \$1.20
10 lbs. \$2.00 15 lbs. or more at 18c lb.

White Kidney—Excellent quality for dry shell use. Seeds long, white, kidney shaped.

1 lb. 25c 2 lbs. 45c 5 lbs. 90c
10 lbs. \$1.50 15 lbs. or more at 13c lb.

White Marrow—Good quality for dry shell beans, excellent for baking. Seeds rather short oval, white.

1 lb. 25c 2 lbs. 45c 5 lbs. 90c
10 lbs. \$1.50 15 lbs. or more at 13c lb.

Red Kidney—Fine quality for dry bean use. Pods waxy green color, oval flat. Seeds red-dish brown.

1 lb. 25c 2 lbs. 45c 5 lbs. 90c
10 lbs. \$1.40 15 lbs. or more at 12c lb.

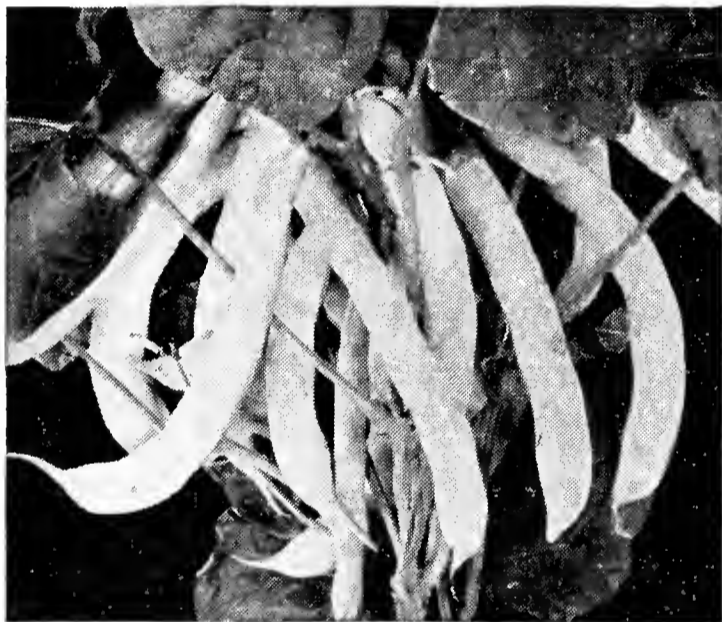
DWARF WAX PODDED VARIETIES

Improved Golden Wax

Improved Golden Wax—Used largely for home garden planting. Pods straight, thick flat, creamy yellow in color; stringless, of good quality. Seeds short, oval, white, with mottling of violet and light yellow around eye and ends.

1 lb. 30c 2 lbs. 50c 5 lbs. \$1.00
10 lbs. \$1.80 15 lbs. or more at 16c lb.

Pencil Pod Black Wax—An exceedingly desirable variety for home and market garden use. Pods round, slightly curved, fleshy, golden yellow, tender, absolutely stringless.

1 lb. 30c 2 lbs. 50c 5 lbs. \$1.10
10 lbs. \$2.00 15 lbs. or more at 18c lb.

Sure Crop Wax—Sometimes called Bountiful Wax. Particularly desirable for market gardeners. Very productive. Pods golden yellow, thick-flat brittle, strictly stringless. Fine texture and quality.

1 lb. 30c 2 lbs. 50c 5 lbs. \$1.00
10 lbs. \$1.80 15 lbs. or more at 16c lb.

Dwarf or Bush Lima

Plant in May after the ground has become warm, in rows 3 ft. apart, with the beans about 12 in. apart in the rows. Cover about 2 in. deep. A second planting may be made in June or early part of July.

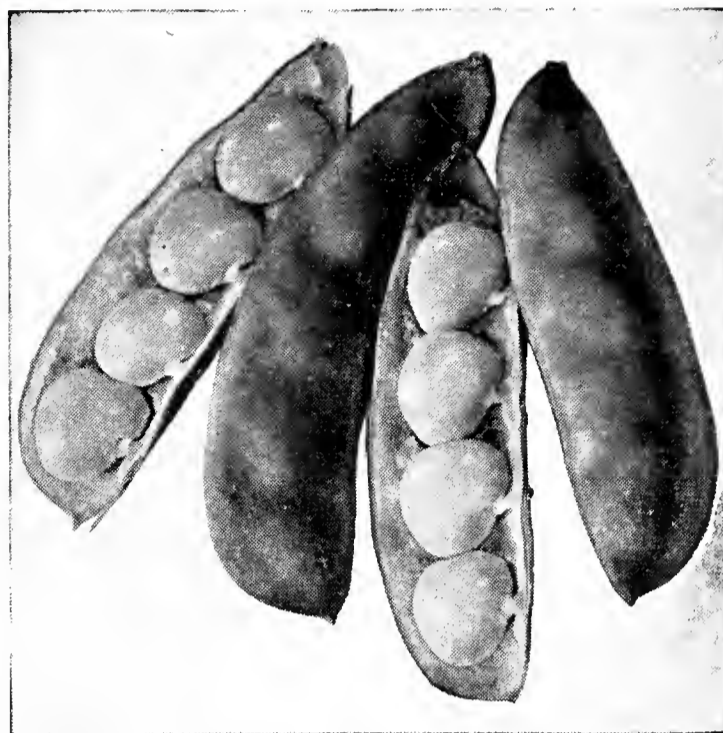

Fordhook Bush Lima

Burpee's Improved—Large plants, erect, vigorous, very productive; pods contain 4 to 5 seeds.

1 lb. 30c 2 lbs. 50c 5 lbs. \$1.10
10 lbs. \$2.00 15 lbs. or more at 19c lb.

Fordhook—A very popular market garden variety. Pods straight, with thick fibrous walls, contains 3 to 4 seeds. Beans large, thick oval of excellent quality.

1 lb. 35c 2 lbs. 60c 5 lbs. \$1.25
10 lbs. \$2.20 15 lbs. or more at 20c lb.



Fine crop of Savoy Cabbage on the Martin McKasty Farms, Huntington, L. I., grown on O&W fertilizer.

Pole or Running Beans

Plant first part of June in hills 3 feet apart in the row and rows 4 ft. apart. Plant 6 or 8 beans in a circle around the hill with eyes of the seed downward and cover with 1½ in. of soil. When 6 in. high thin to 3 or 4 plants to hill. Fix firmly in the center of each hill a

Pole or Running Beans—Con.

pole 5 to 8 ft. high, and when plants show runners help the vines to start by twining them around the pole from right to left.

Early Leviathan Lima—The earliest large-seeded Lima. Pods very straight, containing 5 to 6 beans.

1 lb. 30c 2 lbs. 55c 5 lbs. \$1.25
10 lbs. \$2.20 15 lbs. or more at 20c lb.

King of the Garden Lima—An improved strain of Large White Lima. Grows tall, vigorous, very productive. Pods flat, smooth with 4 or 5 large beans.

1 lb. 30c 2 lbs. 55c 5 lbs. \$1.25
10 lbs. \$2.20 15 lbs. or more at 20c lb.

Mammoth Horticultural King or Worcester—The largest podded and largest seeded of the Horticultural beans. Pods heavily splashed with red.

1 lb. 35c 2 lbs. 65c 5 lbs. \$1.25
10 lbs. \$2.20 15 lbs. or more at 20c lb.

Italian Horticultural—A distinct variety with large, yellow pods heavily splashed with crimson.

1 lb. 30c 2 lbs. 55c 5 lbs. \$1.20
10 lbs. \$2.00 15 lbs. or more at 18c lb.

Kentucky Wonder—The best known and most popular pole bean. Pods are large and practically round, very brittle.

1 lb. 30c 2 lbs. 55c 5 lbs. \$1.20
10 lbs. \$2.00 15 lbs. or more at 18c lb.

Kentucky Wonder Wax—Very popular variety. Good climber, productive. Yellow flat meaty pods, nearly stringless.

1 lb. 30c 2 lbs. 55c 5 lbs. \$1.20
10 lbs. \$2.00 15 lbs. or more at 18c lb.

Beets

For very early crops, sow in hotbeds and transplant as soon as weather permits. For outdoor crops, sow first part of April in drills about 2 ft. apart, covering seed about 1 inch. Thin the young plants when suitable size for greens to four inches apart. One ounce sows 50 ft. of drill.

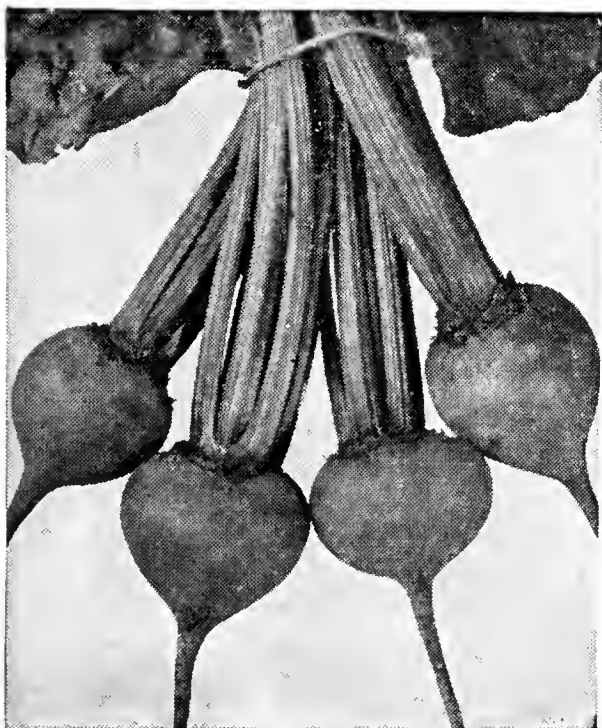

Detroit Dark Red

Quantity Discount, 10 lbs. or more 10c lb.

Crosby's Egyptian—An extra early variety for home and market garden use. Roots a flattened globe shape; skin dark red, flesh a trifle lighter.

Pkt. 10c Oz. 15c ¼ lb. 30c 1 lb. 80c

Early Wonder—Very popular with market gardeners, globular in shape, with small tap root. Flesh is blood red, tender and of good quality.

Pkt. 5c Oz. 15c ¼ lb. 30c 1 lb. 85c

Early Eclipse—Medium sized round, dark red. Interior bright red with whitish zones. Good flavor.

Pkt. 10c Oz. 15c ¼ lb. 25c 1 lb. 80c

Dark Red Egyptian—Very early. Tops small and erect. Roots flattish.

Pkt. 10c Oz. 15c ¼ lb. 30c 1 lb. \$1.00

Detroit Dark Red—One of the very best sorts for home or market garden. Roots smooth, globe shaped of medium size. Tops small, upright, color deep red.

Pkt. 10c Oz. 15c ¼ lb. 30c 1 lb. 85c

Edman's Early Blood Turnip—A medium early variety. Roots top shaped; dark red of good size.

Pkt. 5c Oz. 15c ¼ lb. 25c 1 lb. 80c

Long Smooth Blood—A well known late variety for winter use; tops are large. Roots 10 to 15 inches long.

Pkt. 10c Oz. 15c ¼ lb. 30c 1 lb. 90c

Swiss Chard

Cooked same as spinach and when allowed to grow without cutting has large, flat, wax-like ribs which are cooked and served like asparagus. Sow seed early in spring in drills 18 inches apart.

Giant Lucullus—Desirable for home and market garden use. Leaf color yellowish green, heavily crumpled; stems thick, broad, light green in color.

Pkt. 5c Oz. 15c ¼ lb. 30c 1 lb. 90c

Mangel Wurzel

A Highly Valuable Stock Feed. They are easily grown and are unequalled as a milk producing food for winter feeding. Cultivate same as beets. Six to eight pounds will sow an acre.



Mammoth Long Red

Quantity Discount 5 lbs. or more 10c lb.

Mammoth Long Red—The most popular. Roots extremely large, slightly tapering, grow half above ground. Color light red.

Oz. 10c ¼ lb. 20c 1 lb. 50c

Mangel Wurzel—Con.

Yellow Globe—Large globular formed roots, good for shallow soils.

Oz. 10c ¼ lb. 20c 1 lb. 50c

Giant Half Sugar, Rose—A heavy yielding, valuable variety for feeding. Roots long oval; skin white with rose colored shoulder, flesh white, with good sugar content.

Oz. 10c ¼ lb. 20c 1 lb. 50c

Golden Tankard—A half-long variety of bright yellow color. Very productive.

Oz. 10c ¼ lb. 20c 1 lb. 50c

White Sugar Beet—An attractive heavy yielding variety used largely for stock feeding. Has high sugar content.

Oz. 10c ¼ lb. 20c 1 lb. 50c

Broccoli

A vegetable resembling cauliflower in many respects and requires the same culture, but is much quicker and easier to grow.

Early Green Italian or Calabrese—A leading variety. A tall branching plant forms a central head of bluish green flower buds. After the main head is removed side branches continue to develop throughout the season, and frequently form small heads, which, with the stems, are cut and served the same as Asparagus.

Pkt. 10c Oz. 45c ¼ lb. \$1.35 1 lb. \$4.50

Italian Broccoli Rape or Senaps—Distinct from other Broccolis. The turnip-like leaves are used for greens as well as the small flower heads. Can be sown in autumn for a spring crop.

Pkt. 10c Oz. 20c ¼ lb. 60c 1 lb. \$1.80

**HOTKAPS—An Individual
Hothouse for Every Plant!**

Brussels Sprouts

A member of the cabbage family and cultivated in about the same manner. One ounce of seed will produce about 1000 plants.

Olds & Whipple's Best.

Pkt. 10c Oz. 35c ¼ lb. \$1.00



Fine field of Broccoli on the farm of A. C. Jensen, Market Gardener, Burnham Street, Hartford, grown on O&W fertilizer.

Cabbage

EARLY VARIETIES

For early crop sow in hotbeds in February or March ½ inch deep and prick out plants into cold frames to harden. When danger of frost is over set out plants in the open in rows 2½ feet apart and 2 feet apart in the row.

Golden Acre—An extra early Copenhagen type with small round solid heads. Plants are dwarf with few outer leaves.

Pkt. 10c Oz. 40c ¼ lb. \$1.00 1 lb. \$3.75

Copenhagen Market—Splendid for the early market. Plant small, compact, allowing very close planting; stem short, head uniformly round, proving valuable as early kraut variety.

Pkt. 5c Oz. 30c ¼ lb. 80c 1 lb. \$2.75

Early Jersey Wakefield—An extensively used early variety, with small compact conical heads about 7 inches long. Used largely by market gardeners.

Pkt. 5c Oz. 30c ¼ lb. 80c 1 lb. \$2.80

INTERMEDIATE VARIETIES

All Seasons—Good general purpose cabbage, widely used for kraut, thrifty in hot, dry weather. Large heads.

Pkt. 5c Oz. 30c ¼ lb. 80c 1 lb. \$2.70



Premium Flat Dutch

LATE VARIETIES

O. & W. Premium Flat Dutch—An extra fine selection. Excellent for home or market garden use. Heads extremely large, flat, and solid. A good keeper.

Pkt. 5c Oz. 30c ¼ lb. 80c 1 lb. \$2.75

Surehead—A variety of the late flat Dutch type. Medium long stem, a dependable header. Heads large, hard, round, somewhat flattened.

Pkt. 10c Oz. 30c ¼ lb. 80c 1 lb. \$2.80

Danish Ball Head or Hollander—Most widely used type of late cabbage. Heads deep round, very hard, flavor good, desirable for kraut, keeps perfectly in storage until spring.

Pkt. 10c Oz. 30c ¼ lb. 80c 1 lb. \$2.50

Cabbage—Late Varieties—Con.

Mammoth Red Rock—The largest and best red cabbage. Heads round, to slightly flattened globe shape, very hard, deep purplish red. An excellent keeper.

Pkt. 10c Oz. 30c ¼ lb. 80c 1 lb. \$2.75

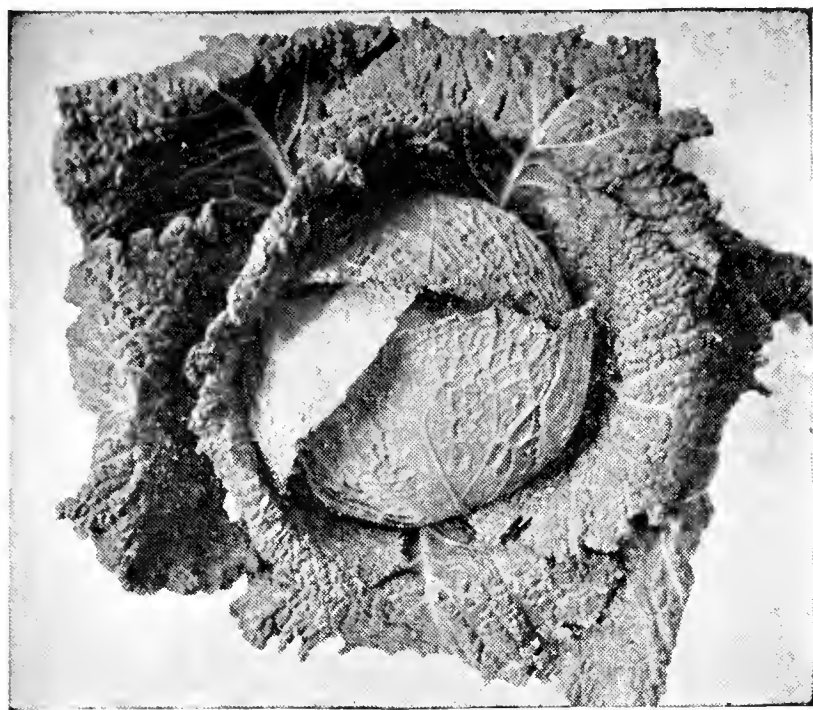

Improved American Savoy

Improved American Savoy—The best of the Savoy group for home use or market. Leaves blistered, stems short. Heads flattened globe shape; large, firm, interior leaves crumpled, attractive light yellow.

Pkt. 10c Oz. 40c ¼ lb. \$1.25 1 lb. \$4.00

Chinese or Celery Cabbage

A species of cabbage from China.

Chihili—Early and dependable in heading. Tall and slender.

Pkt. 10c Oz. 25c ¼ lb. 65c 1 lb. \$2.10

Wong Bok—Select strain. An early dwarf variety with large compact heads.

Pkt. 10c Oz. 25c ¼ lb. 65c 1 lb. \$2.10

Carrots

Thrive best in rather light loam; soil should be well cultivated and fertilized. Plant seed in rows 14 inches apart, and thin plants to 2 or 3 inches in the rows. Plant from the middle of April to the middle of June. One ounce will sow 100 feet of drill, 3 to 4 pounds per acre.

Quantity Discount 5 lbs. or more 10c lb.

Half-Long Nantes—Also known as coreless. Half-long, well shaped and uniform roots, exceptionally fine flavor, fine grained, tender, and practically coreless.

Pkt. 5c Oz. 15c ¼ lb. 50c 1 lb. \$1.50

Imp. Type Chantenay—Early and productive, stump rooted. Rich orange in color, which is well retained when the carrots are cooked. Desirable for home and market garden.

Pkt. 10c Oz. 15c ¼ lb. 35c 1 lb. \$1.00

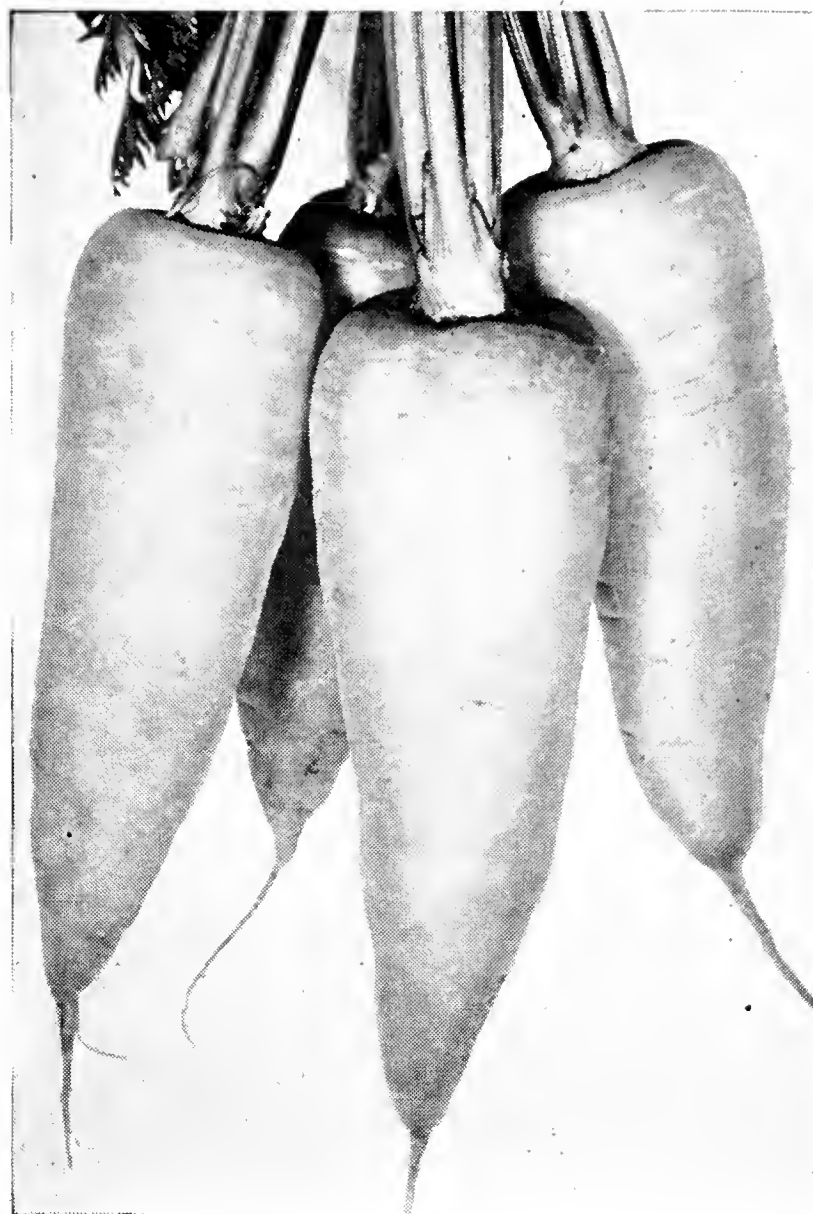

Danvers Half Long

Danvers Half-Long—A favorite late carrot of great uniformity. Fine grained, tender, bright orange flesh, rich in flavor and very sweet.

Pkt. 10c Oz. 15c ¼ lb. 35c 1 lb. 90c

Hutchinson—Very prolific. Roots deep orange with greenish shoulder, nearly cylindrical, ending in abrupt stump end; flesh deep orange. Tender and of good quality.

Pkt. 10c Oz. 20c ¼ lb. 50c 1 lb. \$1.50

Improved Long Orange—A very large, late maturing table carrot which gives a tremendous yield on good deep soil. Roots are long and tapering with smooth skin and deep orange flesh. Valuable for stock feeding.

Pkt. 5c Oz. 15c ¼ lb. 35c 1 lb. \$1.00

Imperator—A new long variety with uniform taper, deep orange skin. Flesh deep orange. A big bright carrot for bunching.

Pkt. 10c Oz. 15c ¼ lb. 40c 1 lb. \$1.10

**FOR BEST RESULTS USE O. & W.
GARDEN FERTILIZER**

Cauliflower

Is one of the most delicious varieties of the Cabbage family. Requires a rich deep soil. For an early crop, start the seed indoors during March and set into the open by the end of April. For a main or fall crop sow the seed during June and plant out the latter part of July. Cultivate thoroughly and frequently. When heads begin to form, bunch the leaves together and tie loosely to protect them from the sun.



Early Snowball—The best and most widely used early variety. Plants dwarf, with short pale green leaves. Heads medium, firm, compact, solid, pure white, and of finest quality.

Pkt. 15c ¼ oz. 60c ½ oz. \$1.00 Oz. \$1.75
¼ lb. \$6.00 1 lb. \$20.00

Erfurt Early Dwarf—Large heads of uniform size, having a closely formed, very smooth, pure white curd of finest flavor.

Pkt. 15c ¼ oz. 50c ½ oz. 85c Oz. \$1.50
¼ lb. \$5.50 1 lb. \$18.00

Danish Giant or Dry Weather—Well adapted to dry weather conditions, later than Early Snowball and of larger growth. Heads creamy white, and of excellent quality.

Pkt. 15c ¼ oz. 60c ½ oz. \$1.10 Oz. \$2.00
¼ lb. \$6.50 1 lb. \$22.00

Celery

Sow seed about the first of April in hot-bed or cold frame. Transplant four inches apart when three inches high in rich soil; water and protect until well rooted, then transplant into rows 3 feet apart either on surface or in trenches about 8 inches deep. Set the plants 4 to 5 inches apart, or for extra large stalks 6 to 8 inches. To blanch draw earth around the plants from time to time, this is continued until only the top leaves remain uncovered.



Boston Market—Excellent fall variety for market garden use. Stalks of medium height form a cluster of heads, tender, crisp, with exceptionally mild flavor; blanches readily to creamy yellow.

Pkt. 10c Oz. 40c ¼ lb. \$1.20 1 lb. \$4.00

White Plume—An extra early attractive variety, leaves bright green tinged with white; stalks medium, easily blanched to pure white; solid, crisp and of good quality.

Pkt. 10c Oz. 40c ¼ lb. \$1.20 1 lb. \$4.00

Golden Plume—Also called Wonderful. Some gardeners consider it the best early variety. Resembles Golden Self Blanching but earlier. Medium height with compact, full heads, blanches readily to golden yellow; excellent quality.

Pkt. 15c Oz. 70c ¼ lb. \$2.50 1 lb. \$8.00

Winter Queen—A medium dwarf winter variety. Stalks light green, broad, solid and crisp; blanches to a creamy white.

Pkt. 10c Oz. 30c ¼ lb. 90c 1 lb. \$3.00

Giant Pascal—A late variety for winter use. Plants large, stocky, with dark green leaves. Stalks long, broad, and solid; blanches to yellow-white of excellent, nutty flavor.

Pkt. 10c Oz. 50c ¼ lb. \$1.50 1 lb. \$5.00

Easy Blanching—A second early variety, excellent for home or market garden. Vigorous and compact in habit of growth, it blanches readily to attractive white, and is a good keeper. Stalks are thick, solid, and of good flavor.

Pkt. 10c Oz. 40c ¼ lb. \$1.20 1 lb. \$4.00

Celeriac

Giant Smooth Prague—Known also as turnip-rooted celery. Plants dark green with hollow stalks. Roots smooth, spherical, 2 to 3 inches in diameter, used for flavoring.

Pkt. 10c Oz. 30c ¼ lb. 90c 1 lb. \$3.00

Corn

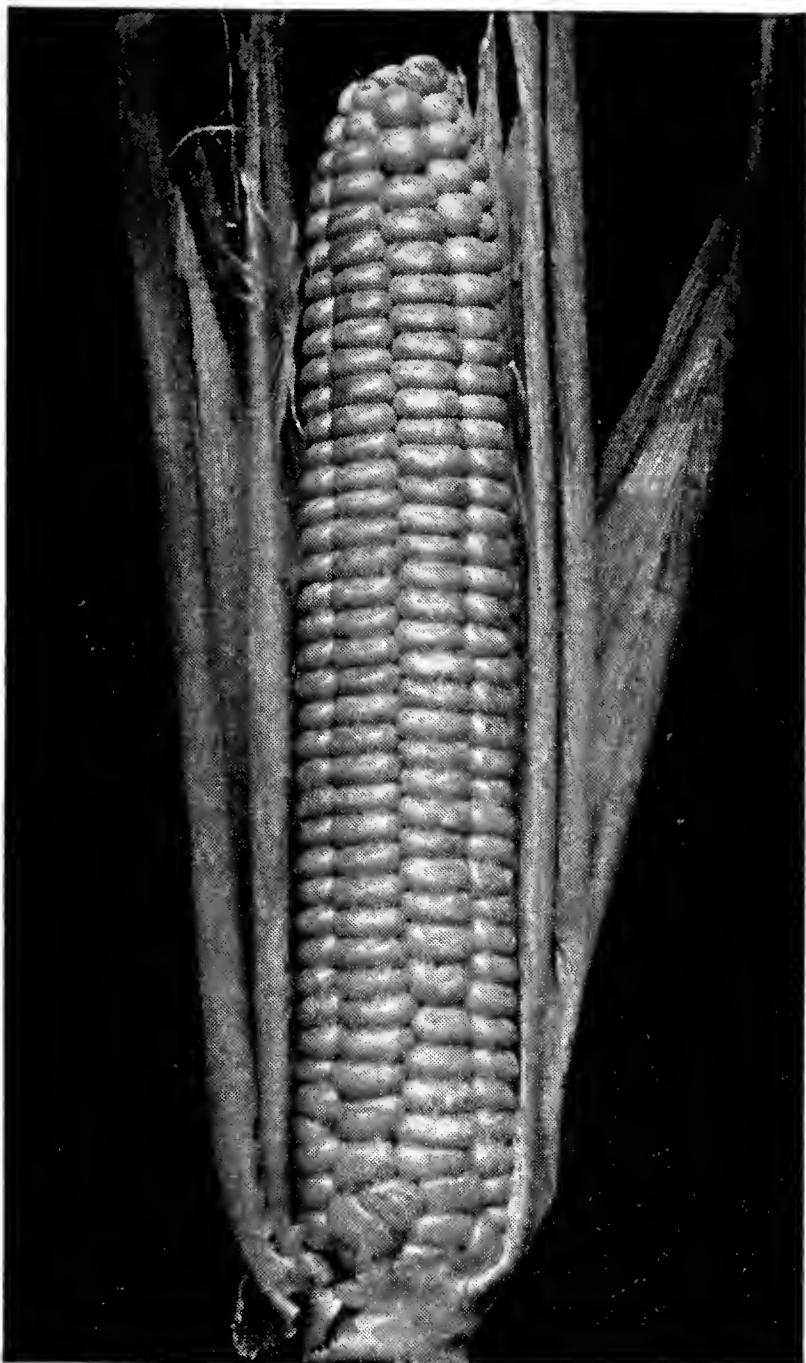

Field Varieties (At Market Prices)

Early Canada Flint—The earliest 8 rowed yellow corn. Medium sized grain, with a small cob.

Early Yellow Dent (Conn. Grown)—Good sized ears and matures in this latitude. Can be used for ensilage. Stalk not as large as most varieties.

Eureka—For ensilage only. Grows a mammoth stalk from 12 to 14 feet high with an abundance of foliage, and we believe will produce more tons of ensilage than any other variety.

Golden Nugget, Early Yellow Flint—Heavy in stalk, foliage and grain. Ears are eight rowed and 10 to 12 inches long.

Improved Leaming—A favorite in the dairying districts and well adapted to the average season. Stalks grow 8 to 12 ft. high with ears 9 to 11 inches long.

Longfellow, Yellow Flint—A well and favorably known variety, large, long ears.

Southern Hybrid Sweepstakes—Yielded 62 bu. of grain per acre, Conn. test, 1934. It made the highest average yield of grain for three yrs. as well as making one of the heaviest average yields of ensilage.

West Branch Sweepstakes—Noted for earliness, productiveness and its adaptation to soil and climate. Stalks grow 10 to 12 ft. high with heavy foliage. Ears are large, averaging 12 in. in length, containing 14 to 20 rows of red, white capped and yellow tinged grains.

SWEET VARIETIES

Requires a rich warm soil. For early varieties plant when ground has become well warmed, successive plantings may be continued until July. Plant in hills about 3 ft. apart. One quart will plant 200 hills.

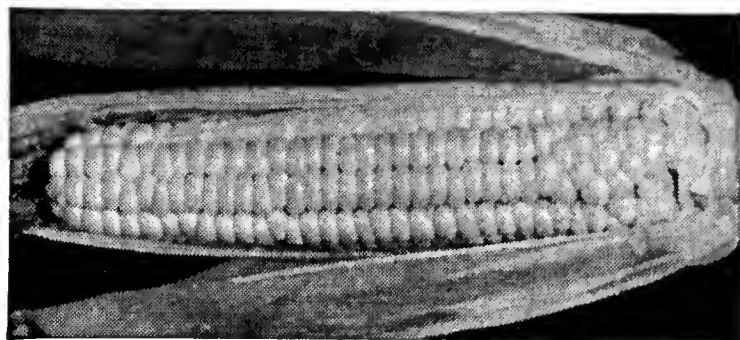

Golden Bantam

EARLY VARIETIES

Golden Cross Bantam—Few days later than Golden Bantam, has 10 to 12 rowed ears, of superior quality. Stalks are stout and leafy and yield more than ordinary varieties. One of the outstanding hybrids from inbred strains for uniformity and resistance to Stewart's disease.

1 lb. 45c 5 lbs. \$1.75 10 lbs. \$3.00
15 lbs. or more at 28c lb.

Marcross—Large Eared—Yellow hybrid variety with 10-14 rowed ears of good quality. Heavy yield for an extra early variety.

1 lb. 45c 5 lbs. \$1.75 10 lbs. \$3.30
15 lbs. or more at 30c lb.

Extra Early Golden—The earliest yellow variety, 10 days earlier than Golden Bantam. Kernels golden yellow, tender, and of good flavor. Very prolific for so early a variety.

1 lb. 30c 5 lbs. \$1.00 10 lbs. \$1.90
15 lbs. or more at 16c lb.

Golden Sunshine—An early yellow variety with good sized ear, desirable for market garden use. Week earlier than Golden Bantam.

1 lb. 30c 5 lbs. \$1.00 10 lbs. \$1.90
15 lbs. or more at 16c lb.

Columbia—Earliest white variety. Very desirable for the early market. Good sized ears.

1 lb. 30c 5 lbs. \$1.00 10 lbs. \$1.90
15 lbs. or more at 16c lb.

Golden Bantam—The best known and most used of all the yellow varieties. Ears 8 rowed, kernels broad, with tender hull, sweet, and of exceptionally fine flavor. Widely used by market and home gardeners.

1 lb. 25c 5 lbs. 95c 10 lbs. \$1.80
15 lbs. or more at 15c lb.

Whipple's Yellow—One of the best early yellow varieties for home and market garden, maturing a few days later than Golden Bantam, with larger ears.

1 lb. 25c 5 lbs. 95c 10 lbs. \$1.80
15 lbs. or more at 15c lb.

INTERMEDIATE VARIETIES

Whipple's White—An excellent mid-season variety with deep kernel. Stalks strong and erect, commonly bearing two ears, very sweet and tender.

1 lb. 30c 5 lbs. \$1.00 10 lbs. \$1.90
15 lbs. or more at 16c lb.

Corn—Intermediate Varieties—Con.

Golden Giant—The result of crossing Golden Bantam and Howling Mob; ears are large, kernels golden yellow, of good quality.

1 lb. 30c 5 lbs. \$1.00 10 lbs. \$1.70
15 lbs. or more at 14c lb.

Black Mexican—Popular for home and market garden use. Ears 8 rowed. Kernels tender, very sweet, white at eating stage, changing to blue-black at maturity.

1 lb. 35c 5 lbs. \$1.25 10 lbs. \$2.30
15 lbs. or more at 20c lb.

LATE VARIETIES

Bantam Evergreen—A cross of Golden Bantam and Evergreen having Evergreen type of ear with 14 to 18 rows. Kernels rich, golden yellow, sweet and of first quality.

1 lb. 30c 5 lbs. \$1.00 10 lbs. \$1.70
15 lbs. or more at 14c lb.

Evergreen—This is the old standard white variety for home and market gardens. Stalks 7 to 8 ft. Ears 8 in. long with 16 or more rows of the finest, large, sweet kernels.

1 lb. 30c 5 lbs. 95c 10 lbs. \$1.70
15 lbs. or more at 14c lb.

Mammoth Sugar—A late, large eared type, popular with market gardeners. Ears 12 to 16 rows. Kernels snowy white and of good flavor.

1 lb. 30c 5 lbs. \$1.00 10 lbs. \$1.90
15 lbs. or more at 16c lb.

FOR BEST RESULTS USE O. & W.
CORN FERTILIZER



**Protect
Your
Seed Corn**

During the period when it is most easily damaged, by ridding your crop of crows and other corn-pulling birds and animals. It saves loss of seed and labor of replanting. It positively will not clog any planter. It is non-poisonous and will not injure the seed or any kind of corn. It is more effective, more convenient to use, and more economical than any other material.

(1 Quart) Enough for 4 bushels seed. **\$1.75**

(1 Pint) Enough for 2 bushels seed. **1.00**

(1/2 Pint) Enough for 1 bushel seed. **.60**



Stanley's CROW REPELLENT

Cress

A desirable salad and garnishing plant. Should be sown thickly in drills, on good rich ground, in early spring.

Curled—A hardy, quick growing annual, having finely curled, deep green foliage, with pleasing pungent flavor; used for garnishing.

Pkt. 10c Oz. 15c 1 lb. 75c

Cucumber



Improved Long Green

To have the earliest cucumbers, start seeds in pots, small paper boxes or berry baskets in a warm place and transplant as soon as weather permits. For general crop plant seeds during May when ground is dry and warm in hills about 4 ft. apart; thin out to three or four plants to the hill when well established. For pickles plant the middle of June.

Early Cluster—A fine pickling variety. Very early, bears clusters of two and three. If kept gathered will continue to bear through a long season.

Pkt. 5c Oz. 15c 1/4 lb. 35c 1 lb. \$1.00

Boston Pickling—Similar to Green Prolific. Excellent pickling variety, medium green, slightly tapered.

Pkt. 5c Oz. 15c 1/4 lb. 30c 1 lb. \$1.00

A & C—Dark green throughout grows about 10 in. long and 2 1/4 in. thick, well rounded at the ends, very desirable for market.

Pkt. 10c Oz. 20c 1/4 lb. 50c 1 lb. \$1.75

Straight Eight—A heavy cropper growing about 8 in. long and 2 in. thick—dark green with no objectionable striping at the tips.

Pkt. 10c Oz. 15c 1/4 lb. 45c 1 lb. \$1.40

Improved Early White Spine—Popular among older early sorts, very good for home garden use. Uniform good size and color.

Pkt. 5c Oz. 15c 1/4 lb. 30c 1 lb. \$1.00

Davis Perfect—A popular slicing variety. Deep dark green with white spines. Solid flesh of excellent quality. Small seed cavity.

Pkt. 10c Oz. 15c 1/4 lb. 40c 1 lb. \$1.25



Fine crop of Pickling Cucumbers on the farms of A. Stockster, Ellington, grown on O&W fertilizer.

Cucumbers—Con.

Longfellow—A variety suited to outdoor or greenhouse culture. Very large and extremely dark green over entire surface and holds its color after pickling. White spined.

Pkt. 10c Oz. 20c ¼ lb. 50c 1 lb. \$1.75

Improved Long Green—Standard late large black spined variety for home garden; excellent for slicing; hardy and prolific, deep green, straight, slightly tapered.

Pkt. 5c Oz. 15c ¼ lb. 40c 1 lb. \$1.25

Dandelion

Sow in drills 12 inches apart, covering seeds about one-half inch deep and thin plants to 4 inches apart in rows. One ounce will plant 100 feet of drill, one pound to the acre.

Improved Thick-Leaved—A highly desirable variety with thick broad leaves. Very productive.

Pkt. 10c Oz. 45c ¼ lb. \$1.40 1 lb. \$4.50

French Garden—Low growing type, early and hardy; closely formed center and fairly large, cut leaves.

Pkt. 10c Oz. 25c ¼ lb. 75c 1 lb. \$2.50

Dill

Used for Flavoring Pickles or as a Condiment

Long Island Mammoth—Grows 2 to 2½ ft. high, with finely cut leaves. Seeds flat and have a strong flavor.

Pkt. 5c Oz. 15c ¼ lb. 25c 1 lb. 75c

Egg Plant

Requires 4 to 6 weeks to produce plants for field setting. Seed should be sown in hotbed during March and when 2 or 3 inches high plants should be transplanted to pots. Set out in open ground during May in rows 3 feet apart, leaving 2 feet between plants.

Early Long Purple—Extremely productive, matures early, very attractive dark purple medium sized fruits.

Pkt. 10c Oz. 40c ¼ lb. \$1.25 1 lb. \$4.00

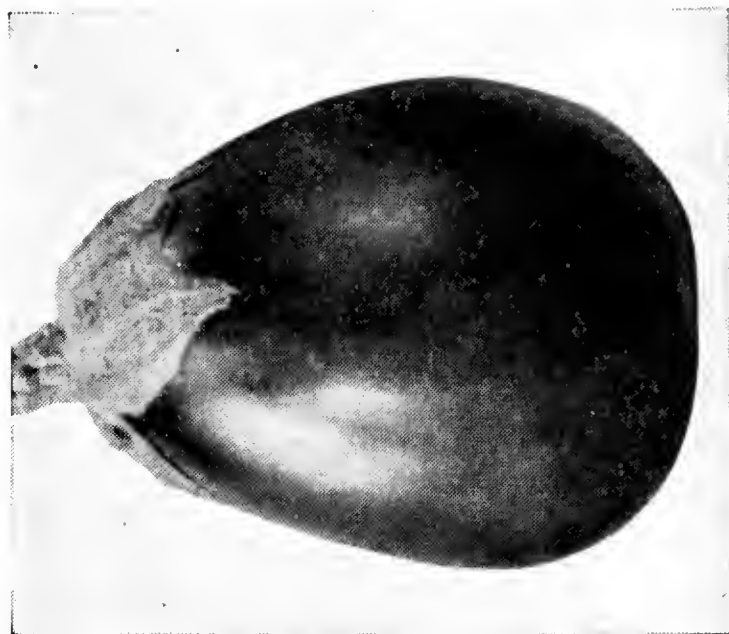

Improved New York Purple—The leading variety for home and market gardeners. Very productive of large smooth, broad oval, black-purple, glossy fruits. Very uniform.

Pkt. 10c Oz. 40c ¼ lb. \$1.25 1 lb. \$4.00

Black Beauty—The earliest of all large fruited Egg Plants. The large egg-shaped purplish black fruits are smooth. And hold well after picking.

Pkt. 10c Oz. 40c ¼ lb. \$1.25 1 lb. \$4.00

Endive

For early use, sow as soon as ground can be worked in spring in drills fifteen inches apart, thin plants to six inches in the row. Any ordinary soil will do, but a moist place is preferred. To blanch the leaves, gather them together when dry and tie with matting or cover with ordinary flower pots inverted. One ounce will produce about 3000 plants.

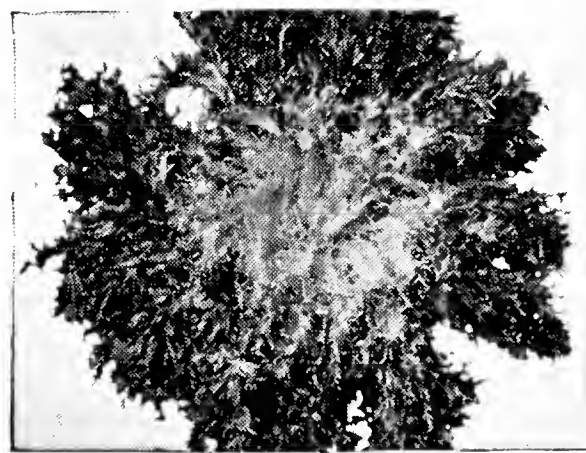

Green Curled

Batavian Full Hearted (Escarolle)—An improved strain of Batavian Broad Leaved, having larger leaf, broader, thicker head and earlier in maturity.

Pkt. 5c Oz. 15c ¼ lb. 40c 1 lb. \$1.25

Green Curled—Leaves are curled giving plants a feathery appearance. Color rich green. Very desirable for salads.

Pkt. 5c Oz. 15c ¼ lb. 40c 1 lb. \$1.25

Moss Curled—Grows more compact than green curled, leaf stems often tinged purple; blanches creamy white.

Pkt. 5c Oz. 15c ¼ lb. 40c 1 lb. \$1.25

Kale

Plant the larger varieties in hills two by three feet apart and thin to one plant to the hill. Requires deep, rich soil. Set out plants in June and treat in same manner as for cabbage. One ounce will produce 2000 plants.

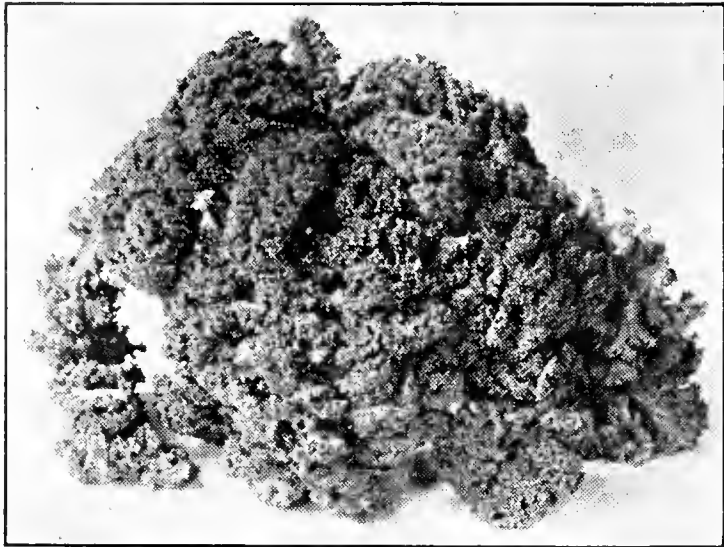

Green Curled Scotch Dwarf—Hardier than cabbage, standing almost zero temperature and is improved by frost. Plants grow about a foot high. Leaves are deep green.

Pkt. 10c Oz. 15c ¼ lb. 30c 1 lb. \$1.00

Green Curled Scotch Tall—Plants of this variety grow to a height of two or three feet. Color, etc., similar to dwarf.

Pkt. 10c Oz. 15c ¼ lb. 30c 1 lb. \$1.00

Siberian (German Greens)—A very vigorous spreading variety; leaves are large, plain in center, cut and frilled at edges; color a bluish green.

Pkt. 10c Oz. 15c ¼ lb. 25c 1 lb. 85c

Kohl Rabi

An intermediate vegetable between the cabbage and turnip. Prepare as for cabbage. Sow in April in rows 18 inches apart and thin out to 8 inches apart in the row. One ounce gives 3000 plants.

White Vienna—An early dwarf variety, suitable for home or market garden. Color light green; flesh clear white.

Pkt. 10c Oz. 20c ¼ lb. 65c 1 lb. \$2.25

Purple Vienna—Similar to White Vienna except in color.

Pkt. 10c Oz. 20c ¼ lb. 65c 1 lb. \$2.25

Leek

Sow in April in drills 1 inch deep and 1 foot apart. When 6 or 8 inches high trim off tops and transplant in rows 10 inches apart each way. Plant as deep as possible. When hoeing, earth up to blanch the necks.



Large American Flag—A very popular early variety, strong growing, stems rather thick, large medium green leaves, the gardener's favorite.

Pkt. 10c Oz. 25c ¼ lb. 75c 1 lb. \$2.25

Lettuce

Lettuce needs a rich and moist soil, should be sown in rows about 12 inches apart and the plants thinned to ten inches apart for the heading varieties. When not grown for head they may be sown broadcast. The more rapid the growth, the better the quality. One ounce for 3000 plants.

HEADING VARIETIES



Big Boston

Big Boston—A very popular variety for cold frame forcing or open culture, medium size compact heads. Leaves are wavy at edges tinged reddish brown.

Pkt. 5c Oz. 15c ¼ lb. 45c 1 lb. \$1.50

Crisp as Ice or Hartford Bronze Head—Very popular home garden variety. Compact medium size heads. Leaves are thick and crumpled; green overlaid with dark brown, slow to start to seed, stands hot weather.

Pkt. 10c Oz. 15c ¼ lb. 45c 1 lb. \$1.50

Lettuce—Heading Varieties—Con.

Hanson—A good summer lettuce. Makes a large, solid, compact crisp head. Leaves are large and very broad, light green color. Very reliable.

Pkt. 5c Oz. 15c ¼ lb. 45c 1 lb. \$1.50

Iceberg—A large, late variety. Heads are compact, with whitish interior, crisp and sweet. Leaves light green with a touch of brown on edges. Different from New York variety which is sometimes called "Iceberg" by growers.

Pkt. 10c Oz. 15c ¼ lb. 45c 1 lb. \$1.50

May King—An early variety for greenhouse forcing or outside planting. Small compact heads, with yellow interior. Leaves yellowish green, tinged with brown at edges. Fine flavor and quality.

Pkt. 10c Oz. 15c ¼ lb. 45c 1 lb. \$1.50

New York No. 12—Commonly sold in our markets as "Iceberg" but is of a different type. A very large, late variety, having a solid head with few outer leaves.

Pkt. 5c Oz. 15c ¼ lb. 45c 1 lb. \$1.50

IMPERIAL 847—New sure heading New York type for warm weather. Dark green, large and hard heading. Best Imperial strain yet produced for eastern climate.

Pkt. 10c Oz. 30c ¼ lb. 90c 1 lb. \$3.00

Tennis Ball (black seeded)—Also called Salamander. Very popular medium early variety. Medium sized round, firm heads of very good quality. Broad medium green crumpled leaves.

Pkt. 5c Oz. 15c ¼ lb. 45c 1 lb. \$1.50

White Boston—Similar to white seeded Big Boston. Leaves are slightly lighter green and have no brown tint. Stands heat very well.

Pkt. 10c Oz. 15c ¼ lb. 45c 1 lb. \$1.50

LOOSE LEAVED VARIETIES

Simpson's Early Curled (also called Early Curled Silesia)—An early, hardy variety with large crumpled, frilled leaves, light green color, very tender. White seed.

Pkt. 5c Oz. 15c ¼ lb. 45c 1 lb. \$1.50

Prize Head—One of the best varieties for broadcast cultivation. Color light brown on a medium green base, leaves crumpled and frilled at edges. White seed.

Pkt. 10c Oz. 15c ¼ lb. 45c 1 lb. \$1.50

Cos or Romaine

Belongs to the lettuce family but leaves are much thicker with a brittle midrib. Sometimes called celery lettuce

Pkt. 10c Oz. 15c ¼ lb. 45c 1 lb. \$1.50

Mustard

Sow from April to June in drills one foot apart and cover seed lightly.

White or English—Used principally for salads. Leaves may be boiled and used as greens.

Pkt. 5c Oz. 10c ¼ lb. 20c 1 lb. 45c

Giant Curled—Very hardy and most popular for greens. Large wide, bright green leaves, curly on edges.

Pkt. 5c Oz. 10c ¼ lb. 25c 1 lb. 75c

Muskmelons

The most suitable soil for melons is rich, warm sandy loam. Plant early in May in hills 4 to 6 feet apart, placing 8 to 10 seeds in each hill. When all danger of insects has passed thin to 4 plants per hill.

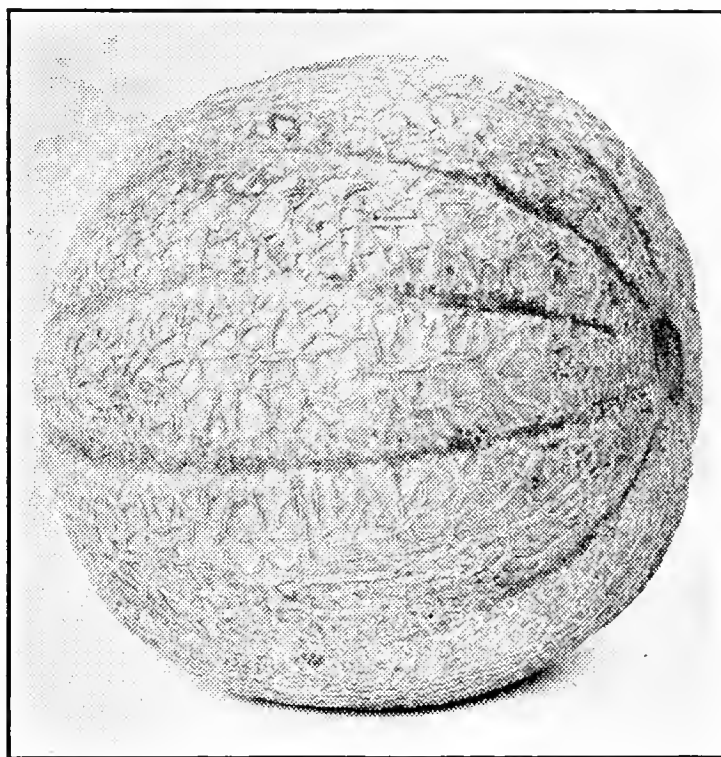

Benders Surprise

Benders Surprise—One of the best. A large delicious, distinctly ribbed, oblong variety with full rounded ends. Bright salmon colored flesh of sweet flavor.

Pkt. 5c Oz. 15c ¼ lb. 45c 1 lb. \$1.50

Delicious—A very desirable early strain of Benders Surprise. Slightly smaller and earlier.

Pkt. 10c Oz. 15c ¼ lb. 45c 1 lb. \$1.50

Emerald Gem—A very popular early home garden variety. Deep emerald green color turning yellowish at maturity, globular, distinctly netted; flesh very thick with small seed cavity.

Pkt. 5c Oz. 15c ¼ lb. 35c 1 lb. \$1.25

Hackensack—A large somewhat flattened prominent ribbed type with little netting. Thick juicy green flesh.

Pkt. 5c Oz. 15c ¼ lb. 35c 1 lb. \$1.25

Hearts of Gold—A medium sized round, heavily netted melon of very good quality with thick orange flesh.

Pkt. 10c Oz. 15c ¼ lb. 35c 1 lb. \$1.25

Muskmelons—Con.

Honey Rock—A very popular new large round, coarse netted melon. Thick orange-salmon flesh. Very sweet and juicy.

Pkt. 10c Oz. 15c ¼ lb. 35c 1 lb. \$1.25

Osage or Miller's Cream—A medium size, home garden variety. Dark green skin sparsely netted and ribbed. Thick fine grained salmon flesh of a very good flavor.

Pkt. 10c Oz. 15c ¼ lb. 35c 1 lb. \$1.25

Lake Champlain—A very early salmon fleshed medium sized melon.

Pkt. 10c Oz. 15c ¼ lb. 35c 1 lb. \$1.25

Rocky Ford or Netted Gem—One of the most widely known of all cantaloupes. A small nearly round, heavily netted variety. Flesh is green with a gold tinge at center. Very thick and of fine flavor.

Pkt. 10c Oz. 15c ¼ lb. 35c 1 lb. \$1.25

Nasturtium

Cultivated for both use and ornament. Young seeds may be used as capers and leaves for salad purposes. The beautiful flowers, blooming freely all summer add a charm to the garden and lawn. Plant in May.

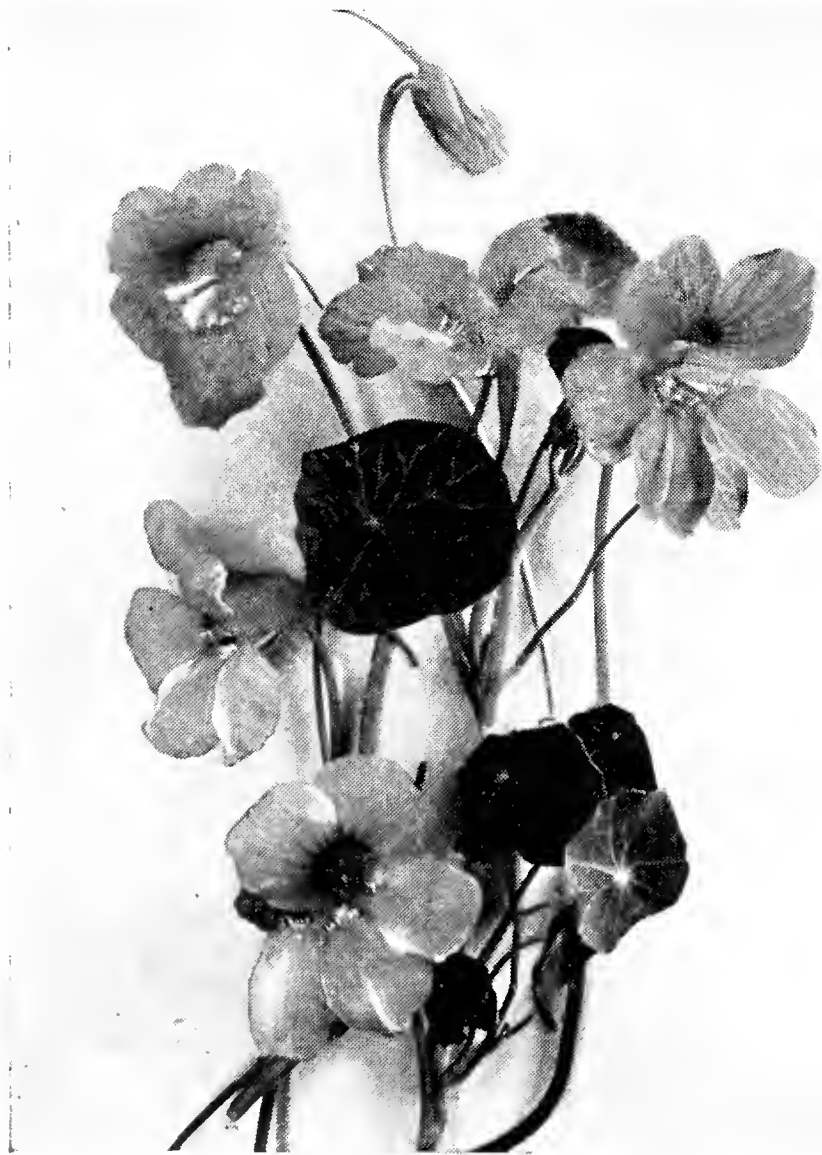

A specially prepared blend of the proper proportions of the various colors to make the most beautiful display.

—Dwarf or Tall Mixed

Pkt. 5c Oz. 10c ¼ lb. 25c

Okra or Gumbo

Sow thickly in drills 2 ft. apart and thin plants to a foot apart in the row. For winter use, when young slice into narrow pieces, string and hang in shade to dry, or may be pickled like cucumbers.

Dwarf Green—Early and productive. Pods are tender and are borne throughout the season.

Pkt. 5c Oz. 10c ¼ lb. 20c 1 lb. 50c

Onion

The onion thrives best in deep, loamy soil, well fertilized. Sow the seeds thinly in drills 1 foot apart. Cover seeds about ¼ inch, roll and tread soil down solidly. When 3 inches high, thin out to 3 inches apart. Cultivate well and keep out weeds. One ounce seed will sow 100 feet of drill. Six pounds to one acre.

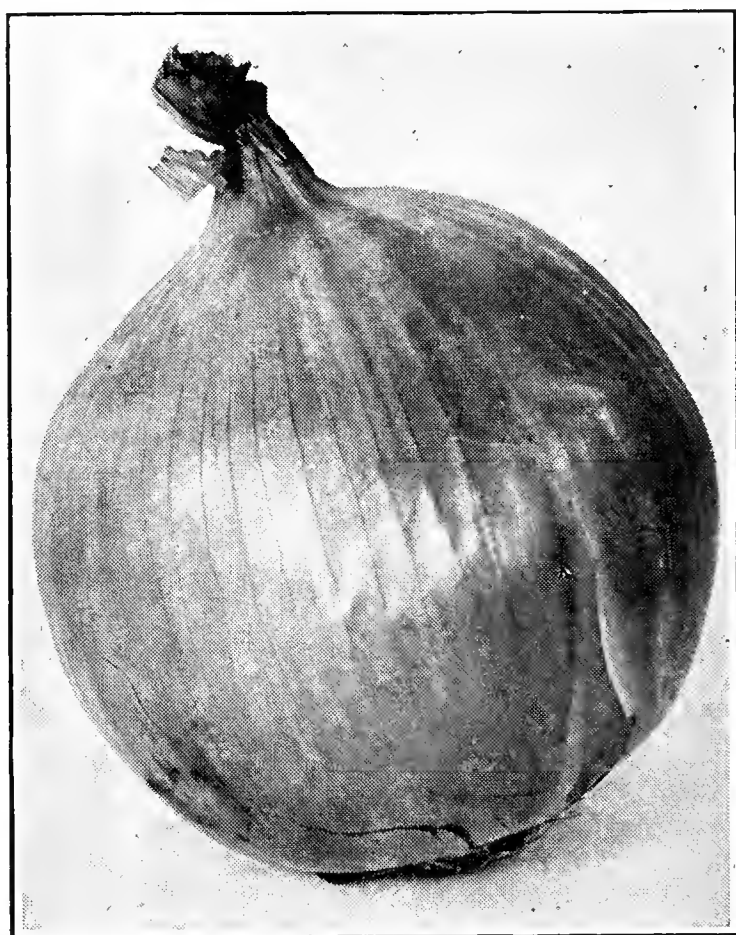

Yellow Globe

Wethersfield Large Red—One of the oldest and best known varieties. A large, flat bottom onion with sloping top. Very attractive in appearance. Smooth red outer skin. Flesh firm, very fine grain tinged with pink, strong flavor. Very productive and a good keeper.

Pkt. 5c Oz. 25c ¼ lb. 65c 1 lb. \$2.00

Southport Red Globe—A very popular variety of good size, perfectly round, with small neck, deep red outer skin. White flesh, pink tinge, good flavor.

Pkt. 10c Oz. 25c ¼ lb. 70c 1 lb. \$2.25

Southport White Globe—The best white variety. Very attractive. Medium size, pure white. Thin delicate skin. Flesh fine grained, crisp, and mild.

Pkt. 10c Oz. 25c ¼ lb. 70c 1 lb. \$2.25

White Portugal or Silverskin—An all purpose variety. Bulbs medium size, hard, thick-flat, clear white, good flavor. Excellent for pickling.

Pkt. 10c Oz. 25c ¼ lb. 70c 1 lb. \$2.25

Onion—Con.

Early Yellow Globe—New early variety maturing from seed as early as the crop from onion sets. Fine shape and three weeks earlier than other globe shaped varieties.

Pkt. 10c Oz. 25c ¼ lb. 75c 1 lb. \$2.50

Southport Yellow Globe—A standard late variety of good keeping quality. Large, solid golden brown, globe shaped bulbs, having a small neck and a heavy thick skin. White, mild, crisp flesh.

Pkt. 10c Oz. 25c ¼ lb. 70c 1 lb. \$2.00

Yellow Globe Danvers—A popular strain of Yellow Globe, earlier than Southport. Bulbs are medium large, skin is light yellow; flesh white with faint tinge of yellow.

Pkt. 5c Oz. 20c ¼ lb. 60c 1 lb. \$1.80

Prize Taker—Very productive. Bulbs large, globular, skin thin, lighter shade of yellow than Southport Yellow Globe; flesh coarse but mild and sweet.

Pkt. 10c Oz. 25c ¼ lb. 70c 1 lb. \$2.25

Japanese or Ebenezer—Medium size, thick skin, firm, dark yellow, deep flat, medium size bulbs. An excellent variety for producing sets, which grow to a large size.

Pkt. 10c Oz. 20c ¼ lb. 60c 1 lb. \$1.75

Onion Sets

Should be planted as early as the ground can be worked in rows 12 inches apart. Set each about 3 inches apart. When onions are grown from sets they can be used in the green state in June, or will ripen by July.



Ebenezer or Japanese—Have light, golden brown skin with pure white flesh.

1 lb. 25c 4 lbs. 75c 8 lbs. \$1.25

Ask for prices on larger quantities

Parsley

Sow early in spring in drills 1 foot apart, covering lightly; thin out the plants to 3 to 4 inches apart; used for flavoring and garnishing. A single row forms a good edging for flower-beds or walks.

Double Curled—An attractive dwarf variety, with finely curled, moss like leaves of bright green color. Excellent for garnishing.

Pkt. 10c Oz. 15c ¼ lb. 30c 1 lb. 90c



Hamburg—(Turnip Rooted.) Edible roots, resemble small parsnips. Extensively used for flavoring soups and stews. Leaves plain, deeply cut.

Pkt. 10c Oz. 15c ¼ lb. 30c 1 lb. 90c

Moss Curled—A vigorous growing, compact, very productive variety. Finely cut, thickly curled, leaves are of a very dark green color, excellent for home and market garden.

Pkt. 5c Oz. 15c ¼ lb. 30c 1 lb. 90c

Plain or Single—Also known as Hardy Italian. Used largely for seasoning, not so attractive for garnishing. Large, plain, dark green, flat, deeply cut leaves.

Pkt. 10c Oz. 15c ¼ lb. 25c 1 lb. 80c

Parsnip

Make the soil very fine and plant the seed very early, in rows eighteen inches apart, thinning plants to three or five inches in the rows, seeds should be covered about one-half inch deep. Parsnips, aside from table use, have great value for stock-feeding purposes. Are improved by allowing to remain in open ground through the winter. One ounce to 150 feet of drill; five pounds for one acre.



Ideal Hollow Crown—Attractive medium-long smooth white roots. Tender and of fine flavor. Very free from side roots.

Pkt. 10c Oz. 15c ¼ lb. 30c 1 lb. 75c

Long Smooth White—A wonderful cropper. Roots 12 to 15 inches long, 2½ to 3 inches thick at shoulder. A hardy variety, grown largely for stock.

Pkt. 5c Oz. 15c ¼ lb. 30c 1 lb. 75c

Peas

The wrinkled varieties, while the sweetest of all peas, are more liable to rot, being tender, and need to be planted thicker and later than the round, hard sorts. Soil needs to be well

fertilized. Have the dwarf varieties in rows two and one-half feet apart; those kinds growing two or three feet high, in rows three feet apart, and the tallest in rows four feet apart. The smooth varieties may be sown as soon as ground can be worked; the wrinkled sorts when soil is well warmed. One quart to 100 feet of drill; one and one-half bushels to an acre.



Suttons Excelsior

SMOOTH ROUND SEEDED VARIETIES

Alaska—A very early variety, slender light green vines from 2 to 2½ feet high. Pods contain 6 to 8 small bluish green peas.

1 lb. 30c 2 lbs. 50c 5 lbs. \$1.00 10 lbs. \$1.70
15 lbs. or more at 15c lb.

East Hartford Extra Early—An extra early variety growing 2½ ft. tall. The vines are very productive, carrying an abundance of well-filled pods containing small luscious peas.

1 lb. 30c 2 lbs. 50c 5 lbs. \$1.00 10 lbs. \$1.70
15 lbs. or more at 15c lb.

WRINKLED SEEDED VARIETIES

Dwarf Alderman—(Improved Dwarf Telephone.) A late larger podded productive sort. Very popular home and market garden variety.

1 lb. 30c 2 lbs. 50c 5 lbs. \$1.10 10 lbs. \$1.90
15 lbs. or more at 17c lb.

Gradus—(Worlds Record Strain.) Popular variety, growing about 2½ ft. tall and bearing an enormous crop of nearly straight pods 3½ to 4 inches in length containing 6 to 8 large peas of a very good flavor, can be planted nearly as early as the smooth varieties.

1 lb. 30c 2 lbs. 50c 5 lbs. \$1.00 10 lbs. \$1.70
15 lbs. or more at 15c lb.

Hundredfold—One of the best known early dwarf large podded sorts. Very prolific and attractive. Popular with home and market gardeners because it bears a heavy crop of excellent quality.

1 lb. 30c 2 lbs. 50c 5 lbs. \$1.10 10 lbs. \$1.80
15 lbs. or more at 16c lb.

Suttons Excelsior—An Improvement of Nott's Excelsior, with large pods and greater productiveness. Height 16 inches.

1 lb. 30c 2 lbs. 50c 5 lbs. \$1.10 10 lbs. \$1.80
15 lbs. or more at 16c lb.

Telephone Tall—A giant podded, mid-season variety. Vines 4½ to 5 ft., color dark green. Immensely productive and of the finest quality.

1 lb. 30c 2 lbs. 50c 5 lbs. \$1.00 10 lbs. \$1.70
15 lbs. or more at 15c lb.

Thomas Laxton—A popular medium early variety. Vines 2½ to 3 feet, medium dark green with dark green pods 3½ in. long containing 7 to 8 large, tender peas of very good quality.

1 lb. 30c 2 lbs. 50c 5 lbs. \$1.10 10 lbs. \$1.80
15 lbs. or more at 16c lb.

Potatoes

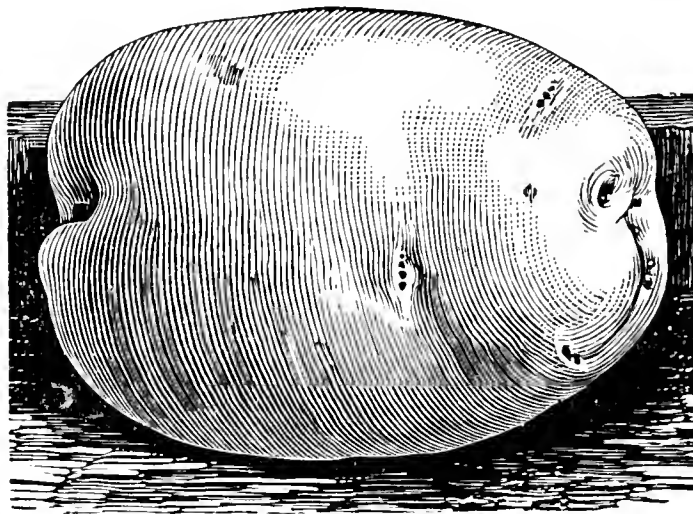

IT PAYS TO PLANT NORTHERN GROWN CERTIFIED SEED POTATOES

Keep your own costs down by raising more bushels per acre, and this can be done by planting Northern Grown Certified Seed.

Seed from the North comes to you with a vigor which your home grown seed does not possess. This fact is recognized by successful potato growers.

We sell certified seed and we select our seed from farms that have produced full crops, that show a low disease count, and finally are stored, handled and shipped by men whose business is seed and have pride in their product.

The low prices at which potatoes are selling at the time our catalogue goes to press may induce some planters to use home grown seed. This we believe would be a mistake. Northern grown certified seed would cost only a few dollars more per acre, and would be justified by increased yield. The more bushels you can grow on an acre reduces your cost per bushel.



Forty acres of Green Mountain potatoes on the farm of Ray Howard, Somers, Conn., grown on O&W fertilizer.

Peppers

Should be started in hotbeds, and transplanted into open ground by end of May; set in rows eighteen inches apart and plants about twelve inches apart in the rows. One ounce of seed will produce about 3000 plants.



Ruby King

Bull Nose or Large Bell—A standard early sweet variety. Plants small and erect. Fruits 3 to 3½ inches long and 3 inches thick. Deep green changing to scarlet red; mild flavor.

Pkt. 10c Oz. 40c ¼ lb. \$1.25 1 lb. \$4.00

Bull Nose Hot—A popular medium sized hot variety.

Pkt. 5c Oz. 40c ¼ lb. \$1.25 1 lb. \$4.00

California Wonder—One of the finest mild flavored early large varieties. Crisp, tender and sweet. Original color dark green, changing to crimson when ripe.

Pkt. 10c Oz. 50c ¼ lb. \$1.50 1 lb. \$5.00

HOTKAPS—An Individual Hothouse for Every Plant!

Harris Early Giant—A large early sweet variety. Plants very productive, bearing 12 to 14 fruits, resembles Bull Nose.

Pkt. 10c Oz. 40c ¼ lb. \$1.30 1 lb. \$4.50

Large Red Cherry—A smooth, round, hot sort. Very productive. Popular for use in pickles.

Pkt. 10c Oz. 50c ¼ lb. \$1.50 1 lb. \$5.00

Large Squash—A thick flesh early hot variety.

Pkt. 10c Oz. 40c ¼ lb. \$1.25 1 lb. \$4.00

Long Red Cayenne—A favorite early hot sort, used principally for canning. Conical shaped 3½ to 4½ inches long, 1 inch through, deep green changing to bright red.

Pkt. 10c Oz. 50c ¼ lb. \$1.50 1 lb. \$5.00

Neapolitan—(Sweet Italian.) A very early, medium large sweet variety. Fruits yellowish green, becoming bright red.

Pkt. 10c Oz. 40c ¼ lb. \$1.25 1 lb. \$4.00

Ruby King—A large, early, sweet favorite for home or market garden. Thick flesh, deep green, becoming red when ripe.

Pkt. 10c Oz. 40c ¼ lb. \$1.25 1 lb. \$4.00

Windsor A—New early thick meated variety very prolific and of good flavor.

Pkt. 10c Oz. 40c ¼ lb. \$1.30 1 lb. \$4.50

World Beater—A cross between Chinese Giant and Ruby King. Very popular with market gardeners. Flesh thick, mild and very sweet.

Pkt. 5c Oz. 40c ¼ lb. \$1.25 1 lb. \$4.00

Pumpkin

Sow in good soil the latter part of May when ground has become warm, in hills 8 ft. apart each way. Cover seed about 1 inch. May be sown in fields with corn by dropping 2 or 3 seeds in every fourth hill.



Small Yellow Sugar—A small round early sort, extensively grown by home and market gardeners. Fruits 8 to 10 inches in diameter, weighing 6 to 8 lbs. Smooth, deep orange skin; flesh yellow orange. Best for pies.

Pkt. 5c Oz. 15c ¼ lb. 30c 1 lb. 80c

Large Cheese—Shaped flat like a cheese box. Grow large, weighing 9 to 10 lbs. Very popular with market gardeners. Flesh yellow, very thick, and of fine quality.

Pkt. 10c Oz. 15c ¼ lb. 30c 1 lb. 85c

Connecticut Yellow Field—A large, smooth, hard surface, slightly oval variety. Used extensively for canning, popular for pies, and excellent for stock feeding.

Pkt. 5c Oz. 15c ¼ lb. 25c 1 lb. 75c

Radish



For early use sow in spring as soon as ground can be worked. Sow in drills six to ten inches apart and thin out to one inch apart in the rows, as the roots are more tender and brittle when grown quickly, a rich light soil is preferred. For a succession sow every two weeks. One ounce will sow 100 feet of drill; eight pounds for an acre.

Quantity discount 5 lbs. or more 10c lb.

Early Deep Scarlet—One of the very earliest round forcing varieties. Bright scarlet skin, white crispy flesh.

Oz. 10c ¼ lb. 25c 1 lb. 75c

Early Scarlet Turnip—A standard early round sort. Red with small white tip. Crisp and mild. Popular for forcing or outdoor culture.

Pkt. 5c Oz. 10c ¼ lb. 25c 1 lb. 75c

Early Scarlet Globe—Equally valuable for outdoor planting or forcing under glass. Globe shaped. Skin bright scarlet. Flesh white, tender and fine quality.

Oz. 10c ¼ lb. 25c 1 lb. 65c

French Breakfast—An early rich scarlet white tipped, oblong variety. Develops best under glass, but does well in outdoor culture.

Oz. 10c ¼ lb. 25c 1 lb. 75c

Giant White Stuttgart—A popular summer and fall variety. Smooth, white top shaped roots 3 to 4 inches in diameter.

Oz. 10c ¼ lb. 25c 1 lb. 85c

Rose China—A popular winter sort. Roots 4 to 5 inches long, 2 inches in diameter at shoulder. Skin is deep rose red color. Flesh white, firm and pungent.

Pkt. 5c Oz. 10c ¼ lb. 30c 1 lb. \$1.00

Round Black Spanish—A round winter variety somewhat top-shaped, 3 to 4 inches in diameter. Skin black, flesh white. An excellent keeper.

Oz. 10c ¼ lb. 30c 1 lb. \$1.00

Long Black Spanish—One of the best keeping winter varieties. Roots 7 to 9 inches long, 2 to 2½ inches in diameter. Skin very dark purple, almost black, somewhat wrinkled. Flesh is white, solid and pungent.

Oz. 10c ¼ lb. 30c 1 lb. \$1.00

Long White Icicle—Pure white roots, 5 to 5½ inches long and 1 inch thick, tapering at the tip. Suitable for forcing or outdoor culture. Mild flavor.

Oz. 10c ¼ lb. 25c 1 lb. 80c

White Turnip—The earliest white variety. Small turnip shaped roots. Clear white throughout. Tender.

Oz. 10c ¼ lb. 25c 1 lb. 75c

Rhubarb

Propagate from roots in richly prepared soil. Plants should be set five feet apart.

Victoria Giant—A very prolific sort with straight stalks of crimson color and delicious flavor. Excellent for pies, preserving, etc.

25c a root.

Special price in large quantities.

Salsify or Vegetable Oyster

Sow early in spring in light rich soil in drills fourteen inches apart and thin out to three inches apart in the row. The roots will be ready for use in October. When cooked the flavor resembles the oyster.

Sandwich Island Mammoth—This variety grows to an unusually large size. Roots 6 to 8 inches long, 1½ inches thick, tapering.

Pkt. 5c Oz. 25c ¼ lb. 65c 1 lb. \$2.00

Spinach

For very early spring use sow in August, for summer use sow in early spring, in drills about ten or twelve inches apart, covering the seed one inch deep. To obtain a succession sow at intervals of two weeks through the season. One ounce to 100 feet of drill, 10 pounds to one acre.

Savoy Leaved Reselected—(Dark Green.) A popular quick growing variety for spring or fall sowing, runs to seed quickly in summer. Extra dark thick leaves, finely curled.

Oz. 10c ¼ lb. 15c ½ lb. 25c 1 lb. 40c

5 lbs. \$1.10 10 lbs. \$2.00

15 lbs. or more at 17c lb.

Savoy Leaved Long Standing—Improved savoy type, best for late spring and summer sowing. Only a few days later than reselected savoy, it stands a week or more longer before going to seed.

Oz. 10c ¼ lb. 15c ½ lb. 25c 1 lb. 40c

5 lbs. \$1.15 10 lbs. \$2.10

15 lbs. or more at 18c lb.

Savoy Leaved Blight Resisting—A very special strain, developed for blight resistance. Vigorous plants and very hardy. Best variety for fall planting and to winter over. Runs to seed quickly if sown at other seasons.

Oz. 10c ¼ lb. 15c ½ lb. 25c 1 lb. 40c

5 lbs. \$1.15 10 lbs. \$2.10

15 lbs. or more at 18c lb.

Summer Savoy—Quick growing long standing dark green savoy type for summer use.

Oz. 10c ¼ lb. 15c ½ lb. 25c 1 lb. 40c

5 lbs. \$1.15 10 lbs. \$2.10

15 lbs. or more at 19c lb.

Old Dominion—A cross between Savoy Leaved Blight Resisting and King of Denmark. New Long Standing variety for summer and fall sowing.

Oz. 10c ¼ lb. 15c ½ lb. 25c 1 lb. 40c

5 lbs. \$1.15 10 lbs. \$2.10

15 lbs. or more at 18c lb.

Spinach—Con.

Nobel Giant—(Giant Thick Leaved.) A popular viroflay type. Plants very vigorous and spreading with large thick, smooth, deep green leaves.

Oz. 10c ¼ lb. 15c ½ lb. 25c 1 lb. 40c
5 lbs. \$1.15 10 lbs. \$2.10
15 lbs. or more at 18c lb.

King of Denmark—Exceptionally long standing variety. Large, slow growing plants with broad, rounded, dark green leaves, somewhat blistered. Excellent for spring planting.

Oz. 10c ¼ lb. 15c ½ lb. 25c 1 lb. 40c
5 lbs. \$1.15 10 lbs. \$2.10
15 lbs. or more at 18c lb.

Princess Juliana—Improved long season summer spinach. Compact plants with large, thick, crumpled, rounded leaves. Fine for home and market gardens.

Oz. 10c ¼ lb. 15c ½ lb. 25c 1 lb. 40c
5 lbs. \$1.15 10 lbs. \$2.10
15 lbs. or more at 18c lb.

New Zealand—A distinct variety, thrives on most any soil in hot, dry weather. Large spreading plants, with small, broad, pointed leaves. The tender leafy shoots may be picked repeatedly throughout the summer.

Oz. 10c ¼ lb. 20c ½ lb. 35c 1 lb. 55c
5 lbs. \$2.50 10 lbs. \$4.50

Squash

Requires rich, warm soil. Plant in hills nine to ten feet apart for running varieties, and five or six feet apart for bush sorts. Leave two or three plants to a hill. Cultivate frequently. One ounce will sow twenty to forty hills; two to four lbs. per acre.

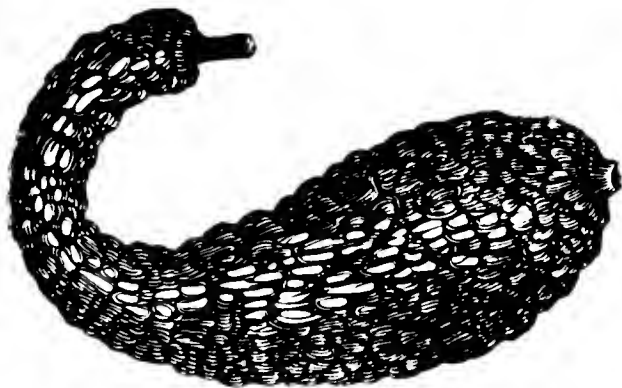

Summer Crookneck

SUMMER VARIETIES

Cocozelle or Italian Vegetable Marrow. (Bush.) Very attractive, dark green marbled with yellow and lighter green stripes. Grows 18 to 20 inches long and 4 inches in diameter if left to mature. Best if picked when 5 or 6 inches in length.

Pkt. 10c Oz. 15c ¼ lb. 45c 1 lb. \$1.30

Early White Bush Scallop—Early creamy white, scallop shaped squash with light green flesh. Vines very prolific, bear continuously.

Pkt. 10c Oz. 15c ¼ lb. 35c 1 lb. \$1.00

Early Summer Crookneck—Very prolific. Extensively used by home and market gardeners. Warty orange yellow skin with thick light yellow flesh.

Pkt. 5c Oz. 15c ¼ lb. 35c 1 lb. \$1.00

Early Summer Straightneck—Conn. strain, medium size. Cream Yellow. Finest quality and popular with housewives as it is easier to prepare than the crookneck.

Pkt. 10c Oz. 15c ¼ lb. 40c 1 lb. \$1.25

Giant Summer Straightneck—A new sort. Selected from Crookneck varieties. Most popular with market gardeners. Its superiority lies in its straightness which permits easy packing.

Pkt. 10c Oz. 15c ¼ lb. 40c 1 lb. \$1.25

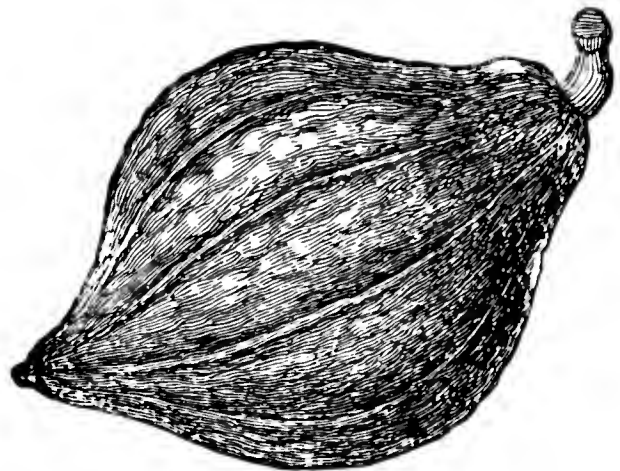

Hubbard

WINTER VARIETIES

Blue Hubbard—Bluish gray skin. Bright yellow, thick, fine grained flesh of good quality. A good keeper.

Pkt. 10c Oz. 15c ¼ lb. 40c 1 lb. \$1.35

Golden Hubbard—Earlier than other Hubbard varieties. Fruits slightly smaller. Skin is a light golden yellow and warty. Flesh deep golden yellow.

Pkt. 10c Oz. 15c ¼ lb. 40c 1 lb. \$1.30

Improved Green Hubbard—The most popular home and market garden sort. Pointed at both ends. Tough, deep, green skin slightly warty. Flesh orange yellow, very thick, fine grained.

Pkt. 5c Oz. 15c ¼ lb. 40c 1 lb. \$1.25

Boston Marrow—A popular, late fall variety. Resembling Hubbard in size and shape. Hard, deep orange skin somewhat rough with thick yellow flesh.

Pkt. 10c Oz. 15c ¼ lb. 35c 1 lb. \$1.00

Golden Delicious—Fruits top-shaped. Color bright orange, with green tip. Flesh, golden orange, sweet and dry.

Pkt. 10c Oz. 15c ¼ lb. 40c 1 lb. \$1.30

Mammoth Chili—Largest of all varieties, growing upwards of 100 lbs. Skin mottled deep orange and yellow. Flesh thick, stringy and coarse. Grown for stock feeding and exhibition purposes.

Pkt. 10c Oz. 15c ¼ lb. 40c 1 lb. \$1.35

Table Queen—An excellent table variety. Small acorn shaped fruits with thin dark green shell and light yellow flesh. Bakes dry and sweet.

Pkt. 10c Oz. 15c ¼ lb. 40c 1 lb. \$1.35

Tomato

Sow the seed in March or April in hot bed. Transplant when plants are five inches high to open ground, after danger from frost has passed. Should be set four feet apart each way, on mounds of earth, to allow foliage to open and sun to reach the fruit.

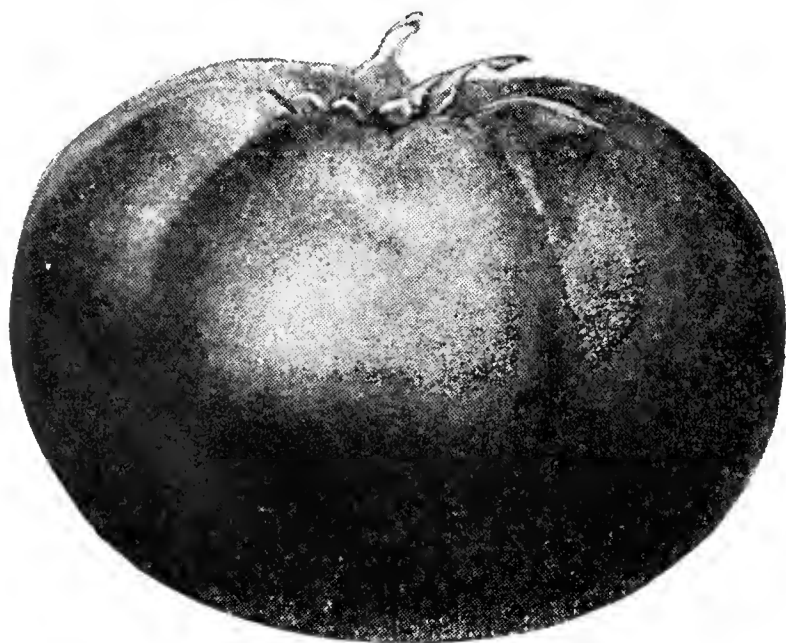

Ponderosa

EARLY VARIETIES

Bonny Best—A general purpose variety, valuable for forcing, bear in clusters. Medium sized, smooth, bright scarlet red, flattened globe-shaped fruits.

Pkt. 5c Oz. 40c ¼ lb. \$1.10 1 lb. \$3.50

Earliana—An extra bright red, medium sized tomato. Nearly round, fleshy and solid. Popular with home and market gardeners.

Pkt. 10c Oz. 40c ¼ lb. \$1.10 1 lb. \$3.50

Pritchard—A scarlet, self-topping disease-resistant variety developed by Dr. F. T. Pritchard of the U. S. Dept. of Agriculture. Fruits are large, smooth, globular shaped, with solid, thick walls. Color a bright scarlet. Valuable for market garden use.

Pkt. 10c Oz. 40c ¼ lb. \$1.25 1 lb. \$4.00

MAIN CROP VARIETIES

Dwarf Champion—Plant of dwarf tree type, with very dark green leaves. Can be planted closer together. Medium size, nearly round, purplish-pink, solid fruits.

Pkt. 10c Oz. 50c ¼ lb. \$1.50 1 lb. \$5.00

Marglobe—A heavy producer of medium sized, smooth, deep globe shaped, bright red fruits. Popular with market gardeners.

Pkt. 10c Oz. 40c ¼ lb. \$1.10 1 lb. \$3.50

Ponderosa—Largest purplish-pink variety grown. Fruits somewhat flat with very thick, solid flesh, and a small seed cavity. Delightful mild flavor.

Pkt. 10c Oz. 50c ¼ lb. \$1.50 1 lb. \$5.00

Rutgers—Globe shaped, scarlet-red color, resembling Marglobe. Has thick outer and inner walls of solid meat with a small seed cavity. An excellent new variety.

Pkt. 10c Oz. 50c ¼ lb. \$1.50 1 lb. \$5.00

Stone—One of the best table varieties. Somewhat flattened, solid, smooth, medium sized fruits. Vines grow large and are very productive.

Pkt. 5c Oz. 40c ¼ lb. \$1.10 1 lb. \$3.50

Yellow Plum—Used for preserves. Small yellow fruits about 2 inches long and 1 inch thick, shaped like a plum.

Pkt. 5c Oz. 50c ¼ lb. \$1.75

For 1 Acre or a Hundred HOTKAPS Pay



HOTKAPS protect growing plants, increase yields, mature crops 2 to 3 weeks earlier, insure premium prices.

Turnip

For early varieties sow as soon as the ground can be worked in spring. For fall and winter use, seed should be sown from the middle of July to middle of August, seed generally sown broadcast, using one pound to the acre.

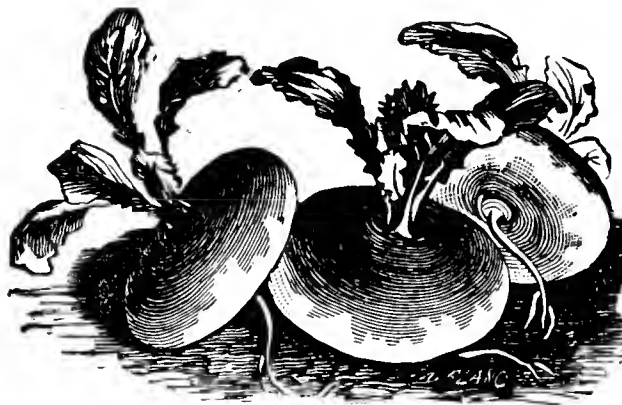

Purple Top Strap Leaf

Quantity discount 5 lbs. or more 10c lb.

WHITE FLESHED VARIETIES

Cow Horn or Long White—Grown largely for stock feeding. Roots 12 to 15 inches long. White with light green top. Flesh tender and flavor mild.

Pkt. 5c Oz. 10c ¼ lb. 20c 1 lb. 65c

Early Purple Top Milan—A very early variety. Good for forcing, as well as garden cultivation. Roots medium size, very flat with small tap root.

Pkt. 5c Oz. 15c ¼ lb. 25c 1 lb. 80c

Early White Flat Dutch—Small erect strap leaved tops. Roots flat, 1½ inches in depth, fine grained, very sweet and tender.

Pkt. 5c Oz. 10c ¼ lb. 20c 1 lb. 65c

Purple Top Strap Leaf—A medium early home and market garden variety. Roots white with purple tops, flat, about 5 inches across.

Pkt. 5c Oz. 10c ¼ lb. 20c 1 lb. 65c

Purple Top White Globe—The most popular white variety for general cultivation. Globe shaped, roots grow 5 to 6 inches in diameter. Best for table use when about 3 inches.

Pkt. 5c Oz. 10c ¼ lb. 20c 1 lb. 65c

Turnip—Con.

White Egg—A quick growing sort. Roots egg-shaped 3 inches long and about 2½ inches thick. Thin skin. Grows nearly half above ground.

Pkt. 5c Oz. 10c ¼ lb. 20c 1 lb. 65c

YELLOW FLESHED VARIETIES

Golden Ball—Recommended for home and market gardens. A good keeper. Round roots about 4 inches in diameter, deep yellow color with light yellow flesh.

Pkt. 5c Oz. 10c ¼ lb. 20c 1 lb. 65c

Large Yellow Globe—A very popular table variety but usually grown for stock. Flesh firm and of good quality. Very tender and sweet if pulled before full grown.

Pkt. 5c Oz. 10c ¼ lb. 20c 1 lb. 65c

Watermelon

A warm light sandy loam preferred. Being tender should not be planted before middle of May. Plant in hills 8 feet apart each way. Cover seeds about one-half inch deep and when well started thin out to 3 plants in a hill. One ounce will plant about 15 hills; 4 pounds to the acre.

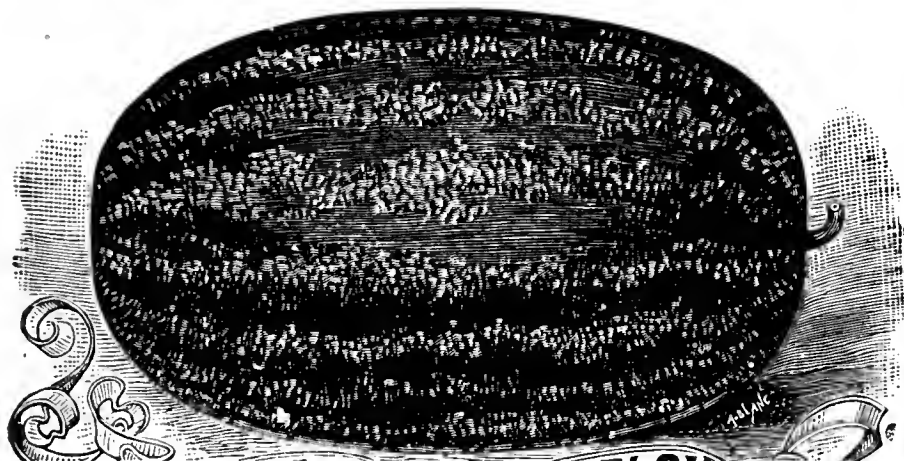

Ice Cream

Cole's Early—A popular extra early variety; fruit 12 inches long and 11 inches in diameter. Very good quality. Thin brittle rind, green striped skin. Bright red flesh with black seeds.

Pkt. 10c Oz. 15c ¼ lb. 30c 1 lb. \$1.00

Ice Cream—One of the most popular early home garden sorts. Thin rind, medium green skin. Flesh rich scarlet, very sweet, seeds white.

Pkt. 5c Oz. 15c ¼ lb. 30c 1 lb. \$1.00

Kleckley's Sweets—A large, medium oblong shaped melon with thin rind. Dark bluish-green skin and delicious sweet, bright scarlet flesh, seeds white.

Pkt. 10c Oz. 15c ¼ lb. 30c 1 lb. \$1.00

Stone Mountain—Large medium early. Oval to round shaped smooth thin skin, light green in color, flesh is deep crimson of very fine flavor.

Pkt. 10c Oz. 15c ¼ lb. 30c 1 lb. \$1.00

Citron—(Red Seeded.) Round melon 8 to 12 inches in diameter. Skin medium green striped with darker green. White flesh, very firm. Used only for preserves.

Pkt. 10c Oz. 15c ¼ lb. 30c 1 lb. \$1.00

Ruta-Baga or Swedish Turnip

Seed should be sown in drills 18 to 24 inches apart and plants thinned out to 6 inches apart in rows.

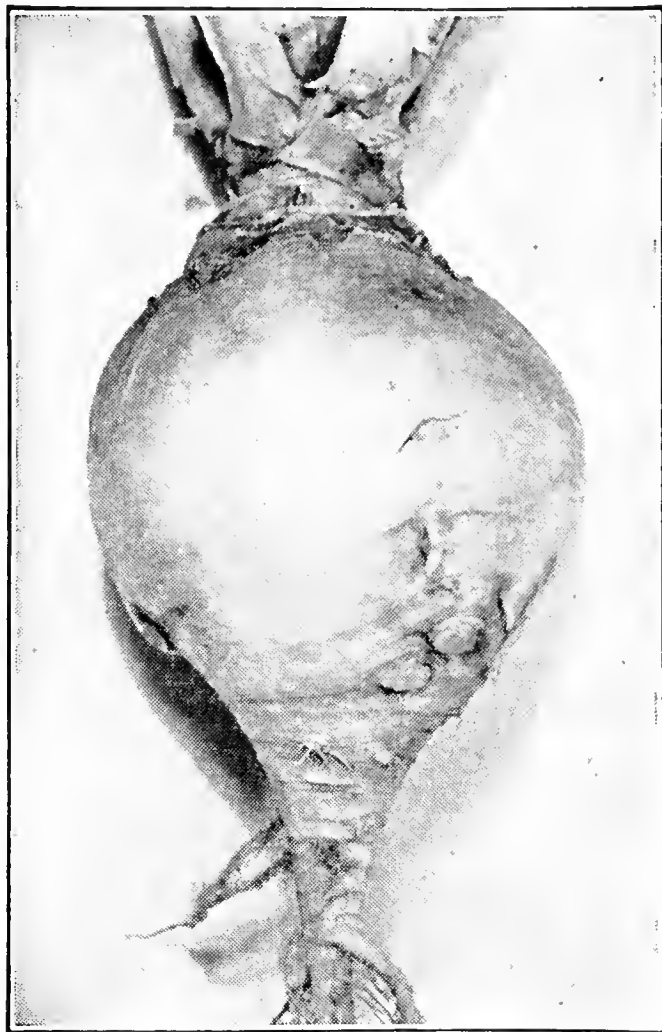

White Rock

Improved Long Island or American Purple Top—A popular home and market garden variety. Large globular roots, purple above ground, yellow below, short neck, a good keeper.

Pkt. 5c Oz. 10c ¼ lb. 25c 1 lb. 75c

White Rock or Sweet German—Very productive. Large white globular roots with bronze green top. Medium neck.

Oz. 10c ¼ lb. 25c 1 lb. 75c

Herbs

Sage—A hardy grey-green perennial, with pleasant aromatic odor. Used for seasoning.

Pkt. 10c ½ Oz. 25c Oz. 40c

Summer Savory—A hardy annual. Used for flavoring.

Pkt. 10c ½ Oz. 25c Oz. 40c

Sweet Basil—An aromatic annual used in seasoning. Has strong sweet flavor.

Pkt. 10c Oz. 30c

Sweet Marjoram—A tender perennial, mostly grown as an annual. Used for flavoring soups, dressings, etc.

Pkt. 10c ½ Oz. 30c Oz. 50c

Thyme, Broad Leafed—A dwarf perennial. Aromatic leaves and shoots used for seasoning and in medicinal preparations.

Pkt. 10c ½ Oz. 30c Oz. 50c



The Value of a Fine Lawn

A fine lawn is a profitable investment. It represents a real addition to the value of your property and unquestionably repays you richly in the enjoyment you derive from its beauty and its actual, though unappraisable, financial worth.

Choice of Seed

Avoid cheap lawn mixtures as they are apt to contain noxious weeds, hulls, chaff and excessive inert matter.

A good lawn grass mixture should be composed of nothing but true turf grasses in the right proportions, carefully re-cleaned. The cost of the seed is the smallest item in the making of a good lawn; it pays to plant good seed.

Our lawn mixtures are all composed of heavy, re-cleaned, high germination seeds, can be furnished with or without White Clover and weigh about 35 lbs. to the bushel.

O. & W. Superfine Lawn Grass Mixture—All that the name implies—composed entirely of the fine, slow growing grasses which produce a soft, velvety, permanent lawn, firm turf and desirable color.

1-lb. pkg. 40c 5-lb. bag \$1.75 10-lb. bag \$3.30
25-lb. bag \$8.00

O. & W. Special Lawn Grass Mixture—A superior mixture of the best and cleanest grades of seed. The varieties which it contains are best adapted to general lawn purposes.

1-lb. pkg. 35c 5-lb. bag \$1.45 10-lb. bag \$2.70
25-lb. bag \$6.50

O. & W. Quicklawn Grass Mixture—A quick growing mixture containing some grasses which produce immediate growth forming a nurse crop for the finer grasses which are slower growing.

1-lb. cellophane package 30c
2-lb. cellophane package 55c
5-lb. bag \$1.20 10-lb. bag \$2.30
25-lb. bag \$5.50

In spots shaded by trees or buildings, give special attention to fertilizing and watering. Sow a special shady place grass mixture. Remember that trees draw heavily on the food and water in the soil, so extra quantities of both must be provided to keep the grass supplied.

O. & W. Shady Dell Lawn Grass Mixture—The best selection of fine grasses which thrive under shade of trees or between buildings where there is little sun.

1-lb. pkg. 45c 5-lb. bag \$1.90 10-lb. bag \$3.70
25-lb. bag \$9.00

**O. & W. HIGH GRADE FERTILIZERS AND FERTILIZING MATERIALS
FOR LAWNS, GARDENS, FLOWERS, SHRUBBERY, ETC.**

Notice: Prices are subject to market changes



Is a scientific blending of plant foods necessary to promote luxuriant growth of lawns, flowers, shrubs, vegetables, fruit and shade trees. LUXURA carries, in the right proportions, and from proper sources, Nitrogen, Phosphoric Acid and Potash, derived from both organic and inorganic materials, which promote a vigorous root system, sturdy stalk, abundant foliage and flowers. One application lasts all season.

100-lb. bag \$5.50

Special price on larger quantities.



The Luxura Hand Plant Food Distributor—For gardeners, florists, nurserymen, truckers, farmers, etc. It is a new, inexpensive time and labor saving device, also convenient for sowing lawn seed on small areas.

Price \$1.00

O. & W. Garden Fertilizer 4-8-4—Very popular with home and market gardeners.

100-lb. bag \$2.50

Special price on larger quantities.

O. & W. Lawn Fertilizer 4-8-4—A complete mixture for old and new lawns.

100-lb. bag \$3.00

Special price on larger quantities.



Sheep Manure—Sheep's Head Brand. Used for lawns and gardens. Does not analyze as high in plant food as our special mixtures.

100-lb. bag \$3.00

Special price on larger quantities.

Steamed Bone Meal—Made from pure animal bone thoroughly steamed and pulverized. Finest quality.

100-lb. bag \$2.85

Special price on larger quantities.

Raw Bone Meal—Finely ground, valuable for lawns, shrubs and trees.

100-lb. bag \$3.25

(Special price on larger quantities.)

Superphosphate—Guaranteed 16% available phosphoric acid. Recommended for land that is deficient in phosphoric acid.

100-lb. bag \$1.50

Special price on larger quantities.

Hydrated Lime—Used for sweetening the soil. Very beneficial to all clovers.

100-lb. bag \$1.00

Special price on larger quantities.

Hyper-Humus—Is in no way intended to act as a chemical fertilizer. It is a soil-builder. It is not sold as a plant stimulant, but is a first aid in the use of fertilizers. Works very well in seed beds.

100-lb. bag \$1.50

Special price on larger quantities.

Nitrate of Soda—Guaranteed 16% Nitrogen. Used as a stimulant for all plants. Must be used with great care.

100-lb. bag \$3.00

Special price on larger quantities.

Sterilized Ground Tobacco Stems—Very beneficial for lawns.

100-lb. bag \$2.50

Special price on larger quantities.

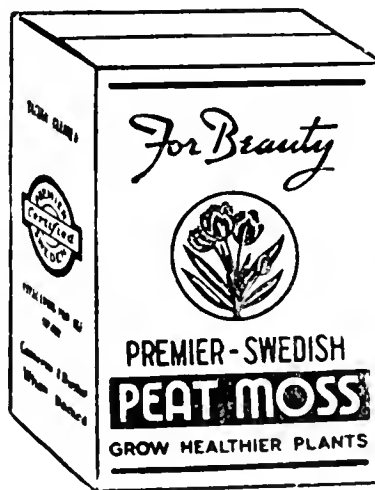

Premier Peat Moss is vacuum cleaned. It keeps soil friable, allows plants to breathe, stores plant food, absorbs and holds moisture.

1 bu. carton 60c

2 bu. bag \$1.00

Large bale (about 20 bu.) \$3.35

Special price for larger quantities.

Salt—(Agricultural.) Used for asparagus beds, walks and driveways to kill weeds.

100-lb. bag \$1.25

Special price on larger quantities.

SEE FRONT PAGES FOR COMPLETE LIST OF FERTILIZERS AND RAW MATERIALS.

PENNSYLVANIA QUALITY LAWN MOWERS

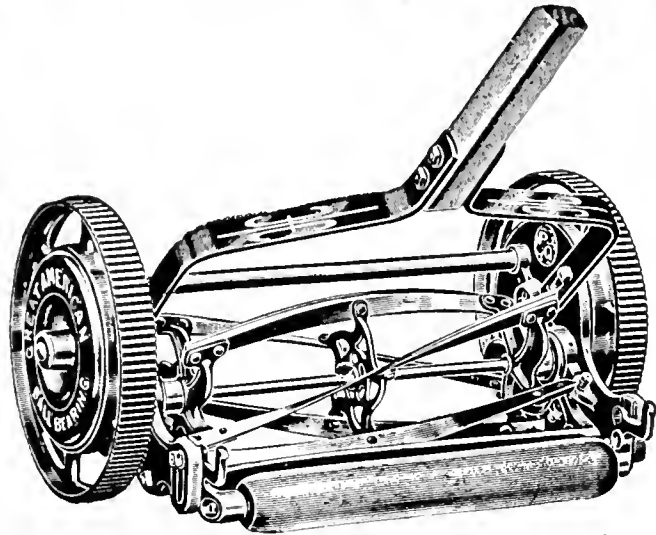

Pennsylvania Junior Ball Bearing is everywhere recognized as the leading mower of the industry. It will cut cleanly all varieties of grasses.

Prices: 15-inch—\$21.95 17-inch—\$23.95
19-inch—\$26.85 21-inch—\$29.85

Pennsylvania DeLuxe Ball Bearing has 10-inch wheels, 6-inch cylinder with 5 crucible steel blades. Automatic spring adjustment on cylinder cones to take up wear. Raised edge lower blade. Is equipped with tough but resilient rubber tires which make for quiet operation.

Price: 16-inch—\$12.00

Olds & Whipple Special—A popular household mower at a fair price, which will give service and satisfaction.

Price: 14-inch—\$7.00

Great American Ball Bearing—This is the best all around mower of its type made. One of the greatest sellers of all time.

Prices: 15-inch—\$16.45 17-inch—\$18.75
19-inch—\$20.95 21-inch—\$22.95

Great American Aluminum with rubber tires. Price: 19-inch—\$23.35

Pennsylvania Lawn Trimmer and Edger—With this combination machine, equipped with a steel disc and a small plow, you can trim the overhanging grass along the edges of paths and flower beds.

Price: \$9.65

The "Easy-Emptying" Grass Catcher

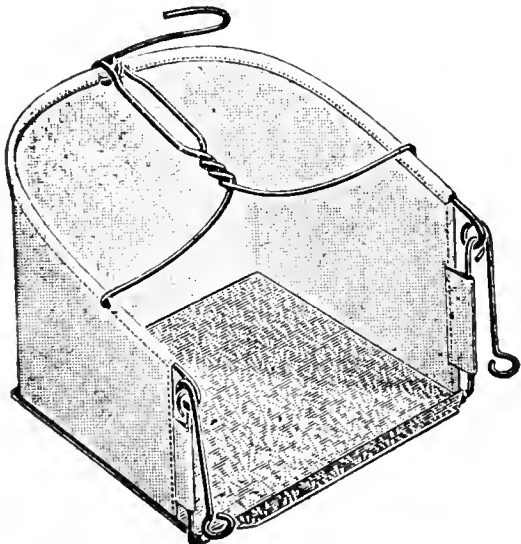

Lift It Off To Empty

Fits Any Lawn Mower Perfectly

Galvanized Steel bottoms, heavy Duck sides. Has New Improved Handle, Front Flange, Eye Bracket and Hook. Hook is permanently attached to catcher and hooks over handle of mower. Catcher is attached and detached instantly with one hand. Hook drops down parallel with handle. Guaranteed to give satisfaction.

Price: 90c each

Water Weight Lawn Rollers

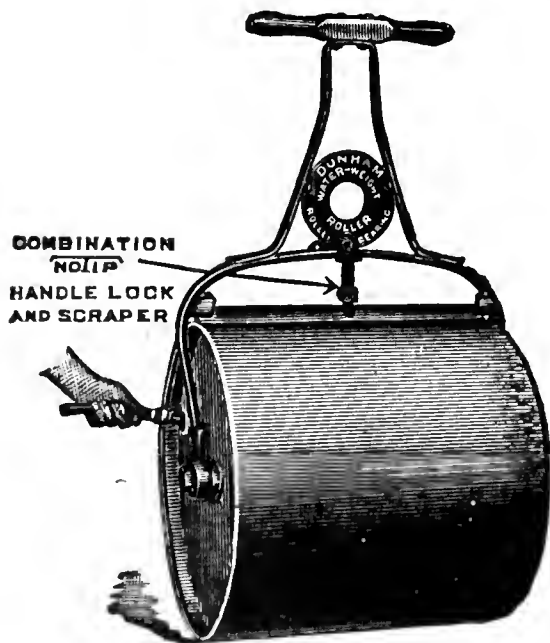

At least one rolling a year is necessary to preserve a healthy turf. This should be done early in the spring, as soon as the ground is dry, to re-firm the soil about the roots after it has been loosened and heaved up by the freezing and thawing of winter. The roller should weigh 150 to 300 pounds, depending upon the texture of the soil.

The water weight lawn roller has almost entirely superseded the old-fashioned cast iron roller. By regulating the amount of water, it can be made to weigh as desired.

Diameter	Width	Weight Empty	Weight Full	Roller Bearing	Plain Bearing
14 in.	24 in.	68 lbs.	175 lbs.	\$12.00	\$10.00
18 in.	24 in.	82 lbs.	265 lbs.	13.50	12.00
24 in.	24 in.	110 lbs.	420 lbs.	16.50	15.00
24 in.	32 in.	130 lbs.	565 lbs.	19.00	

**It's a Pleasure to Keep
Your Lawn Trim With
VILLAGE BLACKSMITH
Handy Tools**



Every item in the VILLAGE BLACKSMITH line is fashioned for the job. They are made up to a standard, not down to a price. However, prices are reasonable—in fact, cheap when value is considered.

“Dollar” Lawn Sprinkler

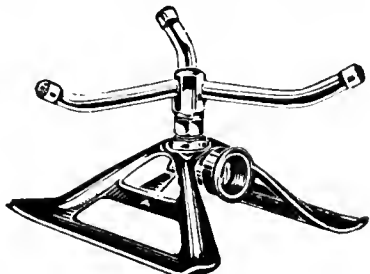

Stands 4 $\frac{3}{8}$ in. high. Base 6 $\frac{1}{2}$ in. by 7 $\frac{5}{8}$ in. Arms are 4 $\frac{1}{2}$ in. long. In operation it gives a widely distributed uniform spray.
Price \$1.00

RAIN KING SPRINKLERS—Ideal for Golf Greens, parks, cemeteries and lawns. Model J with 75-lb. pressure covers a circle of 140 ft. across. \$6.95.

Model G \$3.50 Model D \$2.25
Many other makes from 50c up.

Bamboo Lawn Rakes

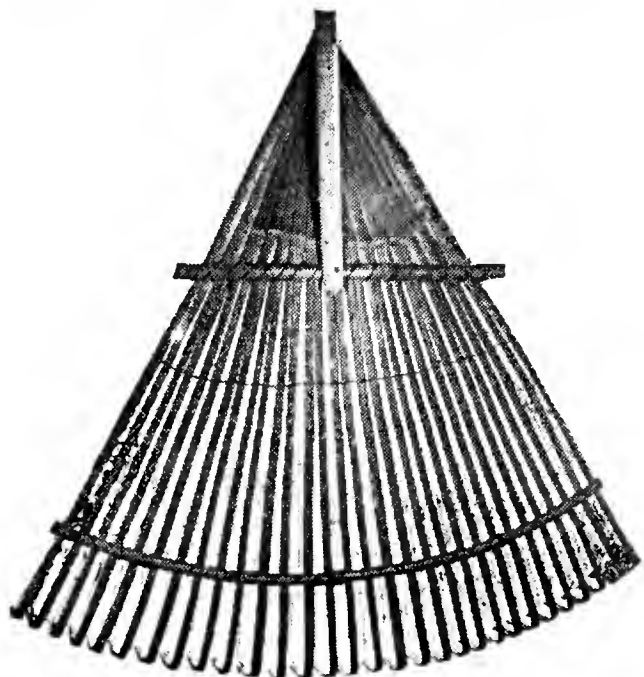

Made of carefully selected bamboo, with heavy, uniform teeth, copper wired top and bottom, also reinforced bamboo cross piece. They have brass clamps and bolts and polished hard wood handles. Our bamboo lawn rakes are by far the best on the market and are vastly superior to the cheaper bamboo handle rakes.

24 in. spread	39 teeth	Price \$.75
30 “ “	34 “	“ .90

Bailie Spring Rake

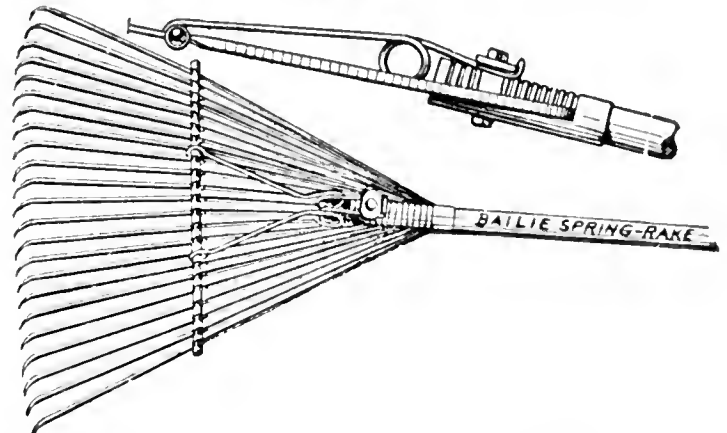

Designed to meet the demand for a rake that has both strength and flexibility. The teeth are NOT in holes but keyed in slotted tubes (known as ferrule and spacer) which prevents cutting and gives them complete freedom. Owing to its NONRIGID construction more ground can be cleaned in less time and with greater ease—NOTE SPRING on back, this exclusive feature takes the strain and NOT THE TEETH.

Ideal for Lawns, Driveways, Cemeteries, Golf Courses and Parks.

Price: \$1.75

Misc. Lawn Rakes

18-inch Lawn Comb (steel)	1.20
24-inch Lawn Comb (steel)	1.50
Stedman's improved (wood)	.95
Stedman's 2 bow (green tip)	.85
Stedman's 3 bow	.90

Galvanized Water Sprinklers



Made of sheet steel and galvanized after being made. Will not leak or rust, furnished with removable zinc rose.

4 qt. 70c	6 qt. 75c	8 qt. 85c
10 qt. 95c	12 qt. \$1.10	16 qt. \$1.35



All leather washable gloves for men and women. Very soft and pliable. 75c pr.

Wood Frame Steel Tray General Purpose Barrow

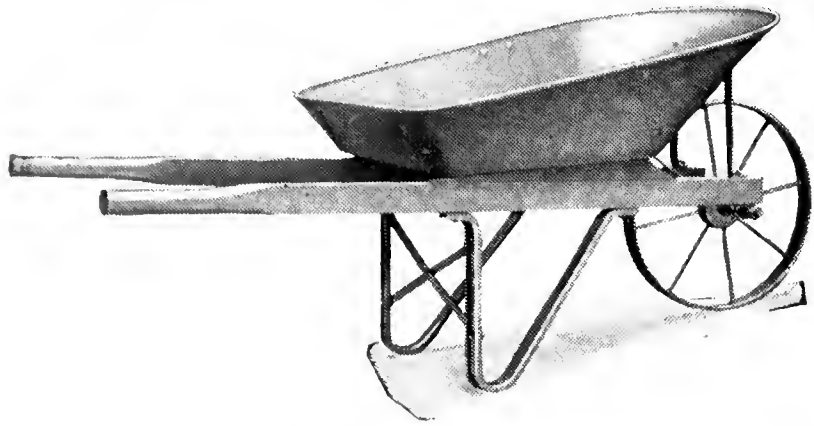

For the contractor, farm, garden and home use. A well constructed barrow.
Price \$4.75

Buch's Garden Barrows

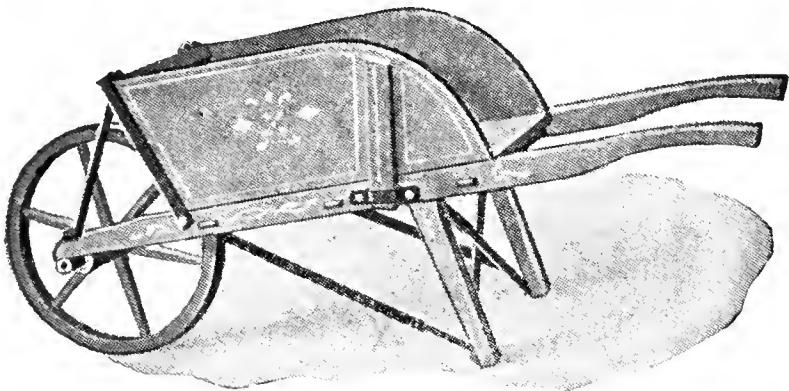

No. 1 is a strong, roomy wheelbarrow for farmer's use. Size of body, 30 inches long, 24 inches wide in front, 25 inches in back. Sideboards, 12 inches high.
Price \$8.50

No. 2. A durable, neat, medium-sized garden barrow. Size of body, 28 inches long, 20 inches wide in front, 24 inches wide at back. Sideboards, 12 inches high.
Price \$7.50

No. 3. Standard size garden barrow. Size of body, 26 inches long, 19 inches wide in front, 22 inches wide in back. Sideboards, 12 inches high.
Price \$7.00

All barrows are furnished with 1 3/4 in. tread wheel. For 3-in. tread wheel add 50c. Above barrows can be furnished with rubber tires.

Buch's Mortar Barrows

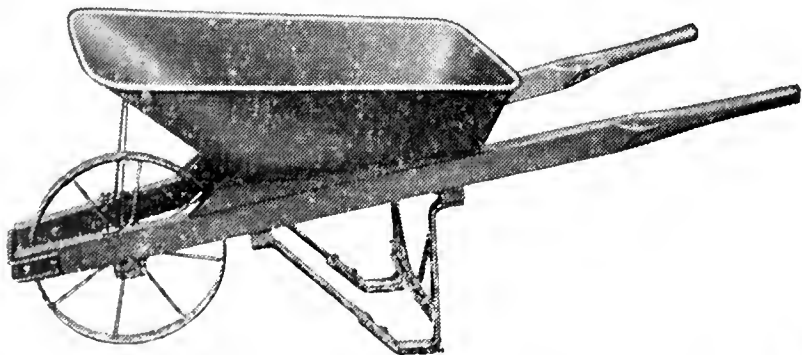

Trays—One piece solid pressed steel #16 guage, with edge turned over 1/4-inch round iron.

- No. B27 Capacity 3 1/2 cu. ft. \$8.00
- No. BR2 Capacity 4 cu. ft. 8.50
- No. 176 Capacity 6 cu. ft. 9.50

Above barrows can be furnished with rubber tires.

Electric Hedge Trimmer



Every man with a hedge to cut will bless this amazing new electric tool. Just try it once and you'll never willingly use a hand shear again. Let us show you how it works.
Price \$29.50



Germaco

Hotkaps



Mature Your Crops EARLIER for Better Profits

These Plant Protectors Mean Larger, Earlier, Premium Crops

HOTKAPS ARE INEXPENSIVE

Germaco HOTKAPS come in rolls of 1,000 each, and in smaller special trial or garden packages. For field use, use the steel HOTKAP setter.

- Prices on Germaco HOTKAPS:
- 1,000 or more \$10.25 per M
 - 5,000 or more 10.15 per M
 - 10,000 or more 10.05 per M
 - 25,000 or more 9.95 per M

- Steel HOTKAPS setter and tamper \$1.50
- Garden setter (light metal) each 50c
- Steel Tamper, each 25c

- Special 100 package (contains 100 HOTKAPS, garden setter and tamper) \$2.65
- Special 250 package (contains 250 HOTKAPS, garden setter and tamper) \$3.85

Bird's IMPROVED NEPONSET Flower Pots

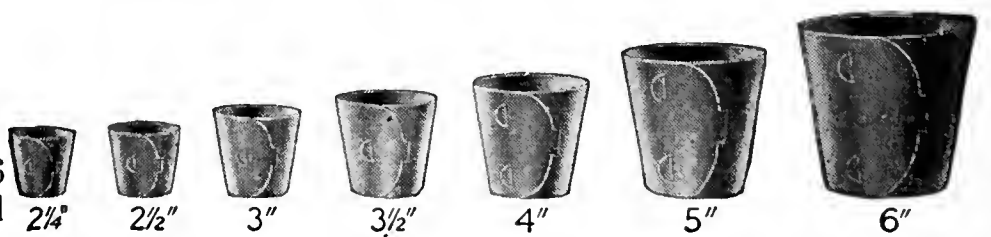

Every grower of plants, large or small, commercial or domestic, can cut his growing costs by using Bird Neponset Flower Pots.

Sizes from 2 1/4-in. to 6-in. inclusive.
Prices on application.

List of Grass, Clover and Millet Seed

Market fluctuations prohibit publishing prices.

Ask for Quotations

LEGUME CROPS

Alfalfa-Grimm (Idaho Blue Tag) State Certified. The highest grade of the hardiest strains. Alfalfa requires well limed soil and good drainage. It furnishes more green forage, more pasture and more dry hay per acre than any other known variety of hay or grass. Sow 20 lbs. per acre. For best results, inoculate every seeding. Weight 60 lbs. per bushel.

Clover-Alsike. Is somewhat smaller in growth than red clover and the blossoms are pinkish white instead of red. Will thrive on poorer soil. Does not require lime and will produce well in damp spots. Sow 8 lbs. per acre. For best results, inoculate every seeding. Weight 60 lbs. per bushel.

Clover—Mammoth Red. This is a distinct type, similar to Medium Red in seed and blossom, but making a larger, coarser growth and a more extensive root system. It matures a little later and is at the best stage for cutting at the same time as Timothy. Sow 10 lbs. per acre. For best results inoculate every seeding. Weight 60 lbs. per bushel.

Clover—Medium Red. Is the most largely grown and most generally useful legume crop in America. In feeding value, the hay ranks next to Alfalfa. As a soil builder, it is the equal of any and superior to most. If sown with Timothy, the Clover usually predominates the first season and the Timothy the second season. After the second season the Clover largely disappears. Sow 10 lbs. per acre. For best results inoculate every seeding. Weight 60 lbs. per bushel.

Clover—Sweet White Blossom. It will grow in almost any climate and on almost any type of soil, thriving on land too poor for Alfalfa or Red Clover. It is a biennial. As hay or green forage, it ranks with Alfalfa in feeding value. Weight 60 lbs. per bushel. Sow 20 lbs. per acre.

Clover—White Dutch. Since it is low growing, it is not adapted for hay. It is used chiefly for pastures and lawns. Although perfectly hardy and not especially sensitive to conditions of soil moisture and drainage, White Clover must have lime. Weight 60 lbs. per bushel.

Cow Peas. They are coarse, bushy and spreading in growth. Since they require a long growing season and considerable warmth, they are not adapted for growing in this climate. Weight 60 lbs. per bushel. Sow in drills, 1 bu. per acre.

Field Peas—Canada. Unlike Cow Peas, they do not need a long growing season but thrive best in a cool, moist climate. They are grown for hay, green forage and soil improvement, usually being seeded with Oats. Weight 60 lbs. per bushel. Sow 2 bu. per acre.

GRASS SEEDS

Timothy. Has been for years the standard and most widely grown hay grass. Is a short-lived perennial; a stand does not last more than four or five years, yielding its best crop the year after it is sown. Weight 45 lbs. per bushel. Sow 12 lbs. per acre.

Kentucky Blue Grass. Requires two or three years to become well set. Once established it is checked by, but lives through, considerable drought. It is the most nutritious of American pasture grasses. Also largely used for lawns. Weight 14 lbs. per bushel. Sow 1½ to 2 bu. per acre.

Canada Blue Grass. Is less productive and slightly less palatable than Kentucky Blue Grass. On the other hand, it is hardier and will grow on poorer soil. Weight 14 lbs. per bushel. Sow 1 to 1½ bu. per acre.

Red Top. No other grass will grow under as great a variety of conditions as Red Top. It will thrive on almost every type of soil except sand. It grows rapidly and vigorously, forming a compact sod that persists under heavy grazing. It is also used for lawns. Weight (re-cleaned) 35 lbs. per bushel. Sow 15 lbs. per acre.

Orchard Grass. Is a long-lived perennial. It gets its name from its ability to grow in the partial shade of orchards and open wood lots. As a consequence, its principal use is for pasture and hay under shady conditions. Weight 14 lbs. to bushel. Sow 1½ to 2 bu. per acre.

Rye Grass—Domestic. (Perennial). Noted for its rapid growth. Is not especially productive but serves a very useful purpose in permanent mixtures because it sprouts and grows quickly, forming a cover while the slower growing grasses are getting established. Weight 24 lbs. to bushel. Sow 1 to 1½ bu. per acre.

Rye Grass—Italian. Slightly coarser than Domestic, annual variety, little used in the North.

Chewings Fescue. Of all the finer grasses, none will stand more hard wear and trampling. It grows on poor, dry, sandy soil; resists drought and does well in shaded places. Particularly fine for lawns. Sow 30 lbs. per acre.

Poa Trivialis. (Rough Stalked Meadow Grass). A fibrous rooted perennial, noted for its productiveness and quick growth, doing best on rich, moist soils and in shaded places.

Sudan Grass. A quick-growing annual summer hay grass. It should largely supplant millet, which yields only a single cutting, whereas Sudan grass will give at least two.

Grass Seeds—Con.

Astoria Bent. A comparatively new and distinct kind of grass; seldom produces stolons but spreads from underground root stalks; produces splendid turf. Excellent for lawns and golf greens.

Seaside Bent. A stoloniferous grass. Used principally for golf purposes. Very good color. A most popular strain of Bent.

MILLETS

These are quick-growing annual grasses, adapted to a wide range of soils and climates, but requiring a good supply of moisture at the start and warm weather throughout their short growing seasons.

German Millet. Also called Golden Millet. Stems heavier, leaves broader and coarser than common Millet. Requires a slightly longer and warmer growing season and a mellow soil. Ready to cut in about 65 days. Weight 48 lbs. per bushel. Sow 25 to 40 lbs. per acre.

Hungarian Millet. Sometimes incorrectly called "Hungarian Grass." An early variety. The hay is of excellent quality and the yield, under good conditions, averages 2 to 2½ tons per acre, ranking second in this respect to German Millet. Weight 48 lbs. per bushel. Sow 25 to 40 lbs. per acre.

Japanese Millet. It is rather coarse and succulent, which makes it difficult to cure for hay and it is not recommended for that purpose. It makes the best silage and green forage of any of the Millets. For green feed, cut just before the heads appear. For ensilage, cut in late bloom or when the seed is beginning to form. Weight 32 lbs. to bushel. Sow 15 to 20 lbs. per acre.

GRAINS

Barley. Oderbrucker. Six-rowed, heavy yielding, used mostly for cover crop. Weight 48 lbs. to bu. Sow 2 bu. to acre.

Buckwheat—Japanese. Yields heaviest on fertile well-drained, sandy loam, but will give fair results on soils too poor for most other crops, matures in about 70 days, ripens best in early Fall. Weight 48 lbs. per bu. Sow one bu. per acre.

Oats—Swedish Select. Large, plump, white kernels, with thin hulls, grows well on light soils and stands considerable drought, earliest of the heavy yielding sorts. Weight 32 lbs. per bu. Sow 2 bu. per acre.

Rye—Rosen Winter. Produces a strong, vigorous straw. The grain is large and heavy and commands a premium over common rye, but the excess yield will more than pay the extra cost. Weight 56 lbs. per bu. Sow 2 bu. per acre.

NOD-O-GEN

A PURE
CULTURE OF NODULE BACTERIA

Make sure of nitrogen gathering nodules for your legume crops by inoculating with NOD-O-GEN. Assures heavy early growth. Better plant growth above and below ground. Higher protein content of crops. NOD-O-GEN improves quality, quantity and yield. Use NOD-O-GEN.

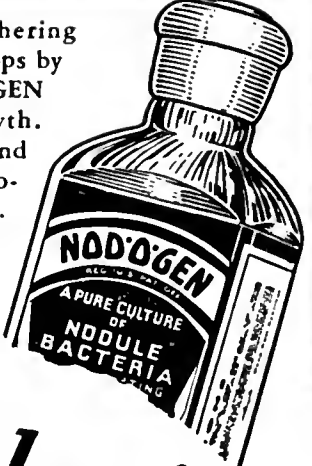

for Seed Inoculation

NOD-O-GEN is available for inoculation of all legumes divided into many separate groups. Write us what legumes you are planning to grow. Full information FREE

FOR ALL LEGUME CROPS

For small seeds, such as Alfalfa, Sweet Clover, Red Clover, Mammoth Clover, Alsike, etc.

PRICES

½ bu. size 35c 1 bu. size 60c ¾ bu. size \$1.00

For large seeds, such as Soybeans, Cowpeas, Vetch, Field Peas, Field Beans, etc.

PRICES

1 bu. size 35c 2 bu. size 60c 5 bu. size \$1.00



At Last! an Ideal Food for Dogs. Purina Dog Chow belongs to the Checkerboard family of quality feeds. That is your guarantee of dependability. When you feed Purina Dog Chow you start in at a point it has taken Purina over thirty years to reach. All of their experience, all of

their science, all of their skill is behind every little cube of Dog Chow. Prices on application.

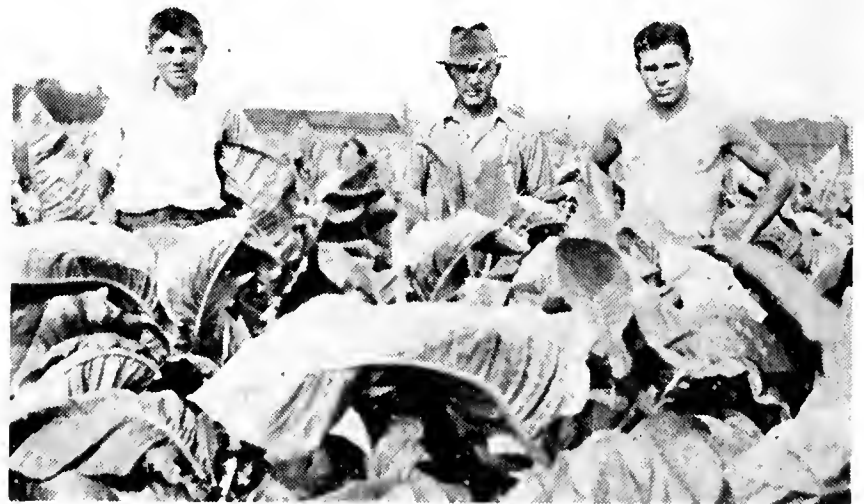

Broadleaf tobacco on the farm of Fred Leone, Silver Lane, East Hartford. Mr. Leone has used O&W fertilizers for many years.

INSECTICIDES FUNGICIDES



ACME ALL AROUND SPRAY. Combines Bordeaux Mixture, the best known remedy for blight and fungus diseases, with arsenate of lead to control chewing insects and Black Leaf "40" to kill sucking insects.

Prices: ¼ lb. 35c. 1 lb. 75c.



ACME ANT-KILL. Kills ants in the nest. Cottage set contains five service cups, five nails and a bottle of syrup.

Price 60c.

Ant Cups—A bottle cap filled with insecticide for killing ants and roaches. 6 in a package. 25c package.



TAT ANT TRAPS. The bait is contained within a metal air-sealed trap.

Price 25c each, 5 for \$1.00.



APHIS SPRAY. An improved nicotine spray for the control of aphis, thrip, leaf-hopper, and many more hardy insects infecting rose bushes, flowers, vegetables, etc. It is a combination of one-third Black Leaf "40" and two-thirds soft fish oil soap.

Price: 3 oz. tube 35c.

ARSENATE OF LEAD (Powder). For spraying trees, shrubs and non-edible parts of vegetables against attack of leaf-eating insects.

Price: 1 lb. 25c.

Prices on larger quantities on application.

ARSENATE MAGNESIUM. Used for the control of the Mexican bean beetle.

Two-pound package makes 100 gallons of spray.

Price: 65c. each.

ATLACIDE (Calcium Chlorate). A non-poisonous weed killer. Can be dissolved in water and applied as a spray or can be dusted on the weed from the sifter can.

5-lb. can \$1.50

15 lb. drum \$3.50 50-lb. drum \$7.00

100 lb. Drum \$13.50

BLACK LEAF "40"—Nicotine Sulphate. This insecticide is highly recommended by experimental stations as a spray for all soft bodied sucking insects and does not injure the foliage. It may be combined with other sprays.

1 oz. bottle 35c 1 lb. \$2.25 2 lb. \$3.25

5 oz. bottle \$1.00 5 lb. \$5.85 10 lb. \$10.60

Prices on larger quantities on application.

BORDEAUX MIXTURE (Powder). For the control of Potato Blight, Celery Blight, Strawberry Leaf Spot, and Black Rot on Grapes.

1 lb. 25c. 4 lb. bag 65c

BREWER'S SNOW FLUFF SPRAY AND DUSTING LIME. Often too little care is shown in the selection of the Lime used in the Sprayer, so that clogged nozzles and uneven spraying has resulted with a consequent loss in crop production and labor. Snow Fluff is free from impurities, extremely light and fluffy, has adhesive properties and increases crop production, costs less because it saves you money.

10-lb. bag 25c 50-lb. bag 65c 100-lb. bag \$1.10

Prices on larger quantities on application.

BUG DEATH. A non-poisonous powder used as a dust. Kills potato, squash and cucumber bugs, also currant and tomato worms.

1 lb. 20c. 3 lbs. 40c. 5 lbs. 60c. 12½ lb. \$1.40
100 lbs. \$8.00

CALCIUM ARSENATE. Used to control potato bugs, tomato and cabbage worms—also many other chewing insects.

1 lb. 20c.

Prices on larger quantities on application.



Spraying potatoes on the farm of Roderick King, South Windsor. Seed, Fertilizer and Insecticides furnished by Olds & Whipple, Inc.

Insecticides and Fungicides—Con.

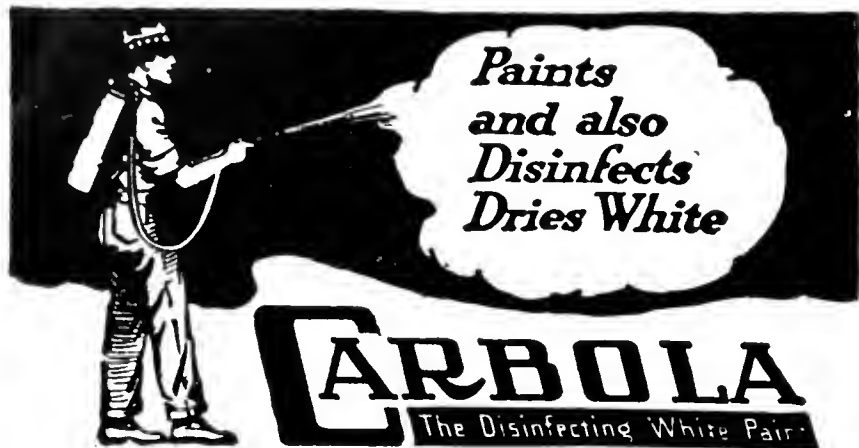

CARBOLA. The modern disinfecting white paint. For poultry houses, stock barns, cellars, etc.

5 lb. package makes 2½ gallons—60c.
10 lbs. 98c 25 lbs. \$1.90 50 lbs. \$3.50

COPPER SULPHATE (Crystals). Used as a spray for rots, molds, mildews and all fungus diseases—principally on potatoes.

Prices on application.

COPPER SULPHATE MONOHYDRATED. Mixed with lime, it is used as a dust for blight control, mostly on potatoes.

Prices on application.



CROW REPELLENT — Insures seed corn against attack by crows, pheasants, blackbirds and other corn annoying birds.

½ pt. can 60c, enough for one bushel of corn
1 pint \$1.00 1 quart \$1.75

CROW-FEZ. Bird and rodent expeller.
½ pt. can 35c 1 pt. can 50c 1 qt. can 85c



CYANOGLAS "A" DUST is a powder which, when exposed to air, gives off a poisonous gas which is the killing agent. For ants, rats, moles, woodchucks and other burrowing rodents.

½ lb. can 45c. 1 lb. can 75c. 5 lb. can \$3.00

CYANOGLAS "G" FUMIGANT. Standard greenhouse fumigant.

5 lb. can \$3.00

DUTOX. Used principally for the control of the tobacco flea beetle and striped cucumber beetle.

1 lb. can 35c 6 lb. bag \$1.25



DAWG-GONE is a combination of rare chemicals releasing an odor very distasteful to dogs. Just hang tube on lower branch of tree at point of approach. Tubes at corners will protect clump of several trees.

Price: 25c ea. 5 for \$1.00

FISH OIL SOAP is recommended as a tree and plant wash to keep them bright, clean, and free from many insects and lice.

1 lb can 30c.



GARDEN GUARD. A good garden dust—perfectly harmless to humans, birds and pets, yet highly effective against insects, both sucking and chewing types. Rotenone, the active ingredient, is highly advocated by certain officials at Washington.

1 lb. can 35c. 4 lb. bag 75c.
25 lbs. \$4.25

KAYSO. The casein spreader that is effective in any mixture, wet or dry, under any conditions. Lime sulphur, bordeaux, lead arsenate, nicotine and whitewash, all cover better and stay longer when mixed with KAYSO. Use one pound to 100 gallons dilute spray.

1 lb. package 30c 2 lbs. 50c 10 lbs. \$1.90
50 lbs. \$8.50 100 lbs. \$16.00

LIME AND SULPHUR SOLUTION is the fungicide most commonly recommended for apple and many other fruit diseases. For early spring spraying use. One gallon to forty gallons of water. For summer spraying, use one gallon to fifty or sixty gallons of water.

1 qt. can 35c. ½ gal. can 50c. 1 gal. can 75c.
5 gal. can \$2.50

Ask for prices on larger quantities.

LIME AND SULPHUR DRY. This fungicide contains the same ingredients as the liquid lime sulphur, but is more convenient to handle. Use 3 to 3½ pounds to fifty gallons of water.

1 lb. can 30c 5 lb. can \$1.35
12½ lb. bag \$1.75 25 lbs. \$3.25
50 lbs. \$6.00 100 lbs. \$10.00

NIAGARA FLOWER GARDEN DUST OR SPRAY is processed to kill the chewing (leaf and foliage eating) insects and prevent diseases in the flower garden; Black Spot and Canker of Roses; Mildews of many flowers and shrubs; Rusts; Leaf Beetles; Caterpillars; Leaf Roller and many other pests.

1 lb. can 35c

Insecticides and Fungicides—Con.

NIAGARA ROTENONE DUST OR SPRAY. Kills Thrips on gladiolus and other plants, many forms of Aphis and other sucking insects. It may also be used to kill leaf and foliage eating insects on plants when the use of an arsenical poison is objectionable.

1 lb. can 50c

NIAGARA VEGETABLE GARDEN DUST OR SPRAY is easy to handle—either dust it on the plants just as it comes from the package or mix it with water and spray.

Don't trust to luck—kill the bugs, prevent the diseases and give your garden a chance.

1 lb. can 45c

NICOTINE DUST. P. A. Nicotine dust contains 4% actual nicotine. The most effective remedy for aphis and all sucking insects on potatoes, peas and other plants.

10 lb. can \$2.50 25 lb. drum \$5.00
50 lb. drum \$9.00 100 lb. drum \$15.00



POMO GREEN. Leaf green sulphur dust for the control of black spot, and chewing insects on plants. Fine for roses. Can be used as a dust or spray.

1 lb. can 50c 5 lb. package \$1.75
25 lb. pkg. \$8.00 100 lb. drum \$20.00

POMO GREEN WITH NICOTINE. Use where aphis are present.

1 lb. can 75c. 5 lb. package \$3.00



Is intended to control external chewing insects and many plant diseases for which Bordeaux mixture is applicable.

May be used on potatoes, tomatoes, cucumbers, cantalopes, squashes and most vegetables, grapes, strawberries, currants and many other fruits

5 lb. can \$1.50 10 lb. can \$2.50 25 lb. can \$5.65
50 lb. drum \$7.25 100 lb. drum \$12.50

PYROX WITH NICOTINE—A complete spray for the control of plant lice, along with leaf-eating insects, and blight.

10 oz. jar 39c 17.6 oz. jar 49c 40 oz. can \$1.00
5 lb. can \$1.75 10 lb. can \$3.00 25 lb. can \$5.65
50 lb. drum \$9.25 100 lb. drum \$17.50



Spray your garden with Red Arrow and you destroy both chewing and sucking insects at the same

time. Absolutely non-poisonous to human beings, domestic pets and birds, but deadly to insects. One ounce makes four to eight gallons of spray.

Price: 1 oz. bottle 35c. ¼ pt. can \$1.00
½ pt. can \$1.50 Pint can \$2.70

ROTECIDE. A Standard Rotenone Spray harmless to the most delicate plants, flowers and foliage.

1 oz. bottle 25c 8 oz. bottle 85c

SANOSEED. Instantaneous potato dip. For the control of Blackleg, Rhizoctonia, Scab and certain other seed-borne potato diseases.

¼ lb. can 50c; enough for 7½ gallons of water. 1 lb. can \$1.75 5 lb. can \$8.00

SCALECIDE—the quality miscible oil. Oldest and best known dormant or delayed dormant spray for fruit trees and ornamentals. Makes them more beautiful, healthful and fruitful. Use 1 to 15 for all deciduous trees, 1 to 20 for evergreens. Kills scale, aphis, red mite and other insect eggs and larvae wintering on trees and ornamentals.

Prices: 1 qt. 65c 1 gal. \$1.50 5 gal. \$5.50
10 gal. \$9.50 15 gal. \$13.25 30 gal. \$21.00

SEMESAN. General disinfectant for vegetable and flower seeds or bulbs and certain plant diseases.

2 oz. can 35c 1 lb. \$2.25 5 lb. \$9.90

SEMESAN BEL. Dip disinfectant for seed potatoes. It is valuable for combatting such surface-borne diseases of white seed potatoes as Rhizoctonia and scab, and for protecting the seed against certain soil-borne organisms that cause premature decay of the seed pieces.

4 oz. 45c 1 lb. can \$1.50 5 lb. can \$6.75

SEMESAN, JR. Dust disinfectant for seed corn, generally preserves the seed against rotting in cold, wet weather and checks certain forms of seedling blight, root and stalk rots. It also increases germination.

4 oz. can 35c 1 lb. can \$1.00 5 lbs. \$4.75



SULPHUR DUST is a preventative rather than a cure for Black Spot on roses, mildew on roses, chrysanthemums, Phlox, Delphiniums, Sweet Peas and Lilacs. Leaf spot on roses, phlox, hollyhocks and peonies.

3 lb. sifter top can, 45c

Ask for prices on larger quantities.

SULPHUR - COMMERCIAL - POWDERED.

Used principally for checking mildew and various blights.

1 lb. 15c 5 lbs. 50c 10 lbs. 80c
25 lbs. \$1.25 50 lbs. \$2.00

TOBACCO DUST. Powdered for dusting flowers, shrubs, melons, squash, cucumbers, etc.

1 lb. 10c 5 lbs. 30c 10 lbs. 50c
25 lbs. \$1.00 50 lbs. \$1.75
100 lbs. \$2.75

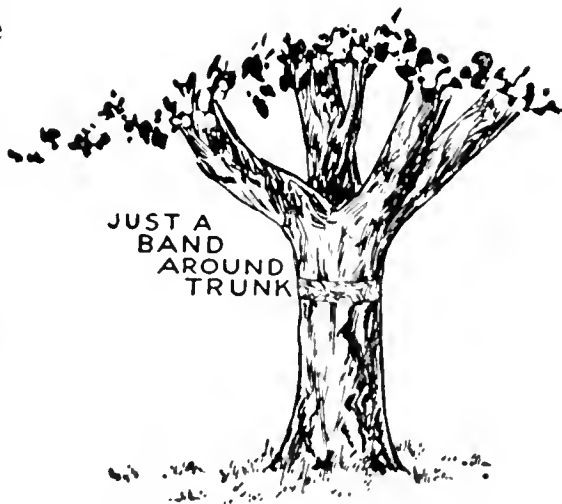

TREE TANGLEFOOT is a sticky material for applying in bands around the trunks of trees and vines to combat the climbing and creeping type of destructive insect pests. It remains effective three to four months, outlasting ten to twenty times any other material.

6 oz. can 35c 1 lb. can 65c 5 lb. can \$3.00

LOWELL GUARD DUSTER

Is most frequently used in and about the home, in destroying roaches, ants, flies, etc. Made of heavy tin. Finished in green lacquer. Powder compartment 1½ in. dia., 3¼ in. long. Pump 1½ in. dia., 7 in. stroke. Price 30c.

LOWELL GENERAL DUSTER

Medium size, powder compartment 3 in. dia., 4 in. long. Valve prevents powder from getting into pump cylinder. Pump 1½ in. dia., 8½ in. stroke. Price 55c.

LOWELL WARRIOR DUSTER

Is designed for use in the garden. Equipment: Two 12 in. extensions, two angle nozzles, one narrow and one wide faced to permit covering large area. Powder compartment 4 in. dia., 4½ in. long, filler cap 2¾ in. dia., pump 1¾ in. dia., 13 in. long. Price 90c.

LOWELL GLADIATOR DUSTER

Is principally adapted for field crops such as beans, potatoes, etc., has the capacity to do a large amount of work. Made of tin coated sheet metal. Finished in green lacquer. Powder compartment: 5½ in. dia., 6¾ in. long. Forced air draft agitates powder continually during operation. Pump: 2¾ in. dia., 12 in. stroke. Equipment: Two 12 in. extensions, one straight nozzle and one wide faced nozzle. Price \$1.15.

LOWELL WHIRL DUSTER

A handy powder blower with 16 oz. heavy glass container, powder always visible to operator. It throws a heavy fog of dust with every stroke of the plunger. Furnished with two 12 in. extensions. Price \$1.00.

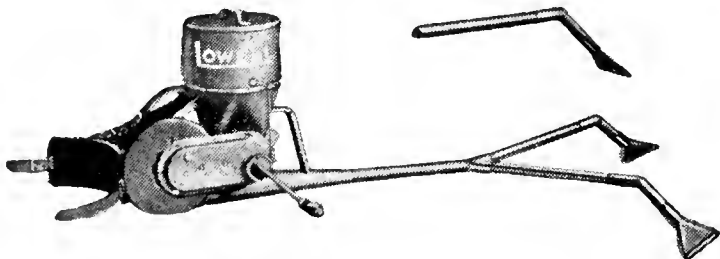
LOWELL CRANK DUSTER

A strong, well made duster which develops a powerful air blast and has ample capacity for two rows of field crops. Equipment: consists of two nozzles, two elbows, a wye connection and four 15 in. tubes, permitting the use of the machine as a single or double row duster. Price \$12.00. Net Cash Price \$11.40.

NIAGARA HAND DUSTERS**Crank Type, Continuous Brush Feed**

No. 42 (as shown). Is well made and of good substantial materials and will operate for a long time if given reasonable care. All moving parts run in ball bearings. Price \$15.00. Net Cash Price \$14.25. Extra for two row attachment, \$1.50.

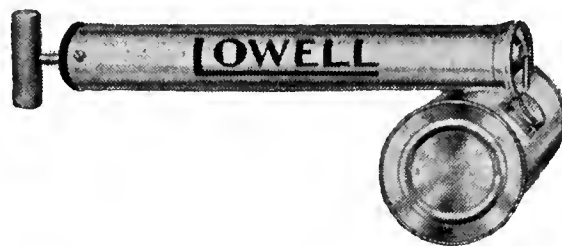
LOWELL MIDGET SPRAYER

Meets the demand for a low priced sprayer for household purposes. Tank: 3 in. dia., 3 in. long, ¾ in. can screw for filling. Capacity ¾ pt. Pump: 1¼ in. dia., 10 in. long. Price 20c.

LOWELL HANDY GARDEN SPRAYER

Is a convenient pattern to use in the back yard garden, around shrubbery or in the poultry house. Made of heavy tin. Tank: 4 in. dia., 4 in. long, capacity 1 qt. Pump: 1½ in. dia., 13 in. long. Plunger fitted with a special leather. Price 30c.

LOWELL MASTER CONTINUOUS SPRAYER

Provides a large volume spray with ease of operation. Nozzle and all working parts are of brass. Tank: 4 in. dia., 4 in. long. Pump: heavy tin, 1½ in. dia., 14 in. long, with brass ball valve.

Price with tin tank .75
Price with brass tank \$1.00

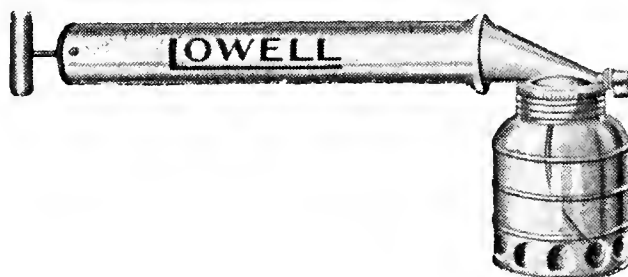
LOWELL AMBASSADOR SPRAYER

Meets the demand for a continuous sprayer with detachable container. Tank: 24 oz. heavy glass jar. Pump: Heavy tin, 1½ in. dia., 13 in. long. Price \$1.20.

LOWELL JUMBO CONTINUOUS

Handles oil solutions very well and will function perfectly with all insecticides. Galvanized tank: 5½ in. dia., 6¾ in. long, 1¾ in. can screw for ease in filling and cleaning. Capacity 3 qts. Pump: 1½ in. dia., 15 in. long. Price \$1.35.

LOWELL BEACON SPRAYER

Is designed to give the consumer the best possible compressed air sprayer at a very attractive price. It will handle all solutions and may be used in the dairy, fields, orchards and for whitewashing, disinfecting and exterminating. Capacity about 3¾ gallons. Galvanized Tank, Price \$5.00. Copper Tank, Price \$8.00.

LOWELL CONTENDER SPRAYER

A favorably priced high pressure sprayer. Capacity about 3½ gallons. Galvanized Tank, Price \$3.00.

Myers Cog Gear Spray Pump (Double Acting)

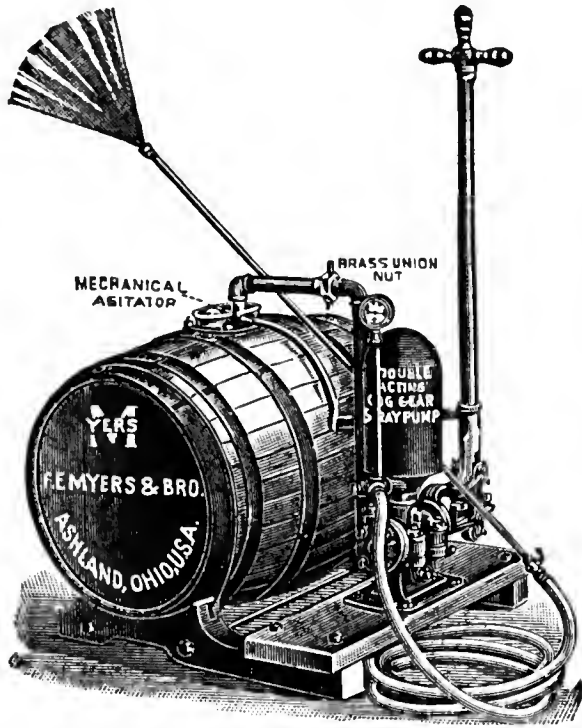

With brass valves and ground bevel brass seats, 2-in. seamless brass removable cylinder, hemp packed plunger and double lever shut-off discharge. **SPECIAL FEATURES:** Cog Gear Movement increases the leverage, adapting it for spraying under heavy pressure. Mounted complete. Occupies smallest possible space. Capacity sufficient for 8 nozzles. An ideal outfit for spraying potatoes. Will set in an ordinary farm wagon box.

No. R316B Pump complete, 50 gallon barrel mounted as shown, with pressure gauge, one 15 ft. lead of $\frac{3}{8}$ -in. 7-ply discharge hose, one Fembro nozzle, one 8-ft. pipe extension with lever shut-off and mechanical agitator.

Price \$60.00 Net Cash Price \$57.00

Myers Portable Sprayer

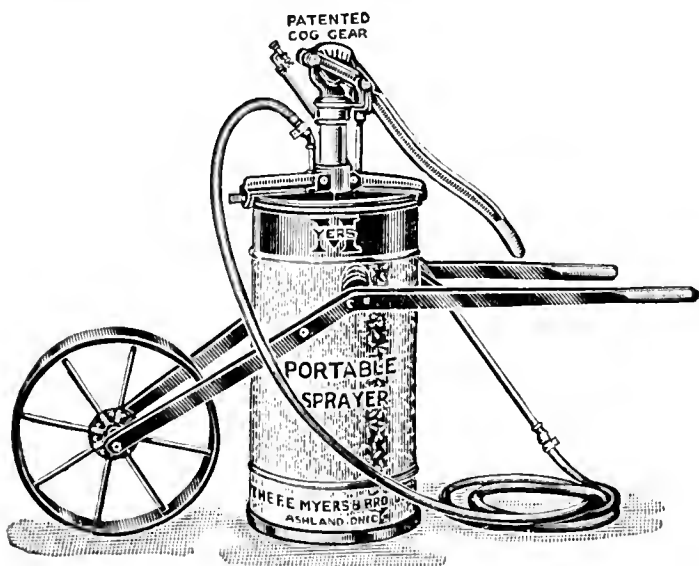

A handy outfit about the home, greenhouse or orchard. The tank is made of heavy galvanized iron thoroughly reinforced at top and bottom by steel bands. Hung in the frame on trunions. 12½ gallon capacity.

R336½ B. Complete as shown, with dasher agitator, 15 ft. ½ in. 5-ply discharge hose, 8-ft extension and Vermorel nozzle.

Price \$26.50 Net Cash Price \$25.18

Myers Cog Gear Barrel Spray Pump

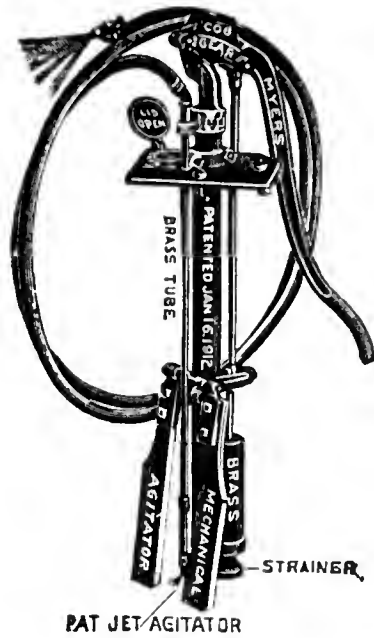

Complete with one lead of 15 feet ½-inch 5-ply discharge hose, graduating Vermorel nozzle, and mechanical agitator for closed head barrel.

No. R318B Price \$17.00
Net Cash Price \$16.15

Myers Cog Gear Lever Bucket Spray Pump

With agitator, complete with detachable hose and graduating Vermorel fine sprinkling and solid stream nozzle.

No. R324 Price \$6.50
Net Cash Price \$6.18

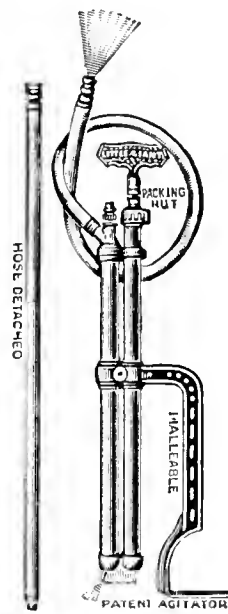

Myers Little Giant Bucket Spray Pump

With agitator, complete with hose and imperial combination fine, coarse spray and solid stream nozzle, with malleable foot rest.

No. 327½ Price \$4.50
Net Cash Price \$4.28

Myers Kwikfill Compressed Air Sprayer

Finished in French Gray Enamel. Complete with 18-in. Brass Extension Rod.

No. 2240 2½ Gallon Galv. Tank \$5.25
No. 2240B 2½ Gal. Brass Tank \$9.50
No. 2242 4 Gallon Galv. Tank \$6.00
No. 2242B 4 Gallon Brass Tank \$10.50

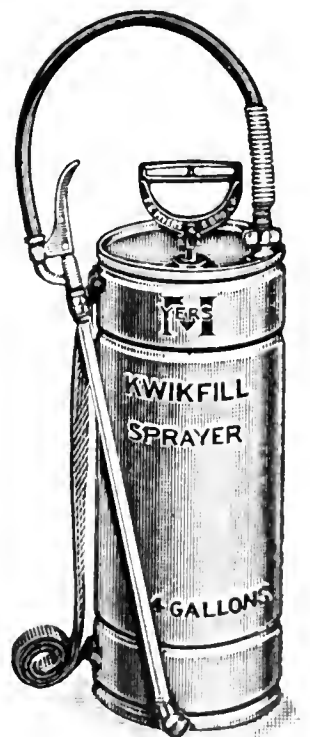

Myers Row Crop Sprayers

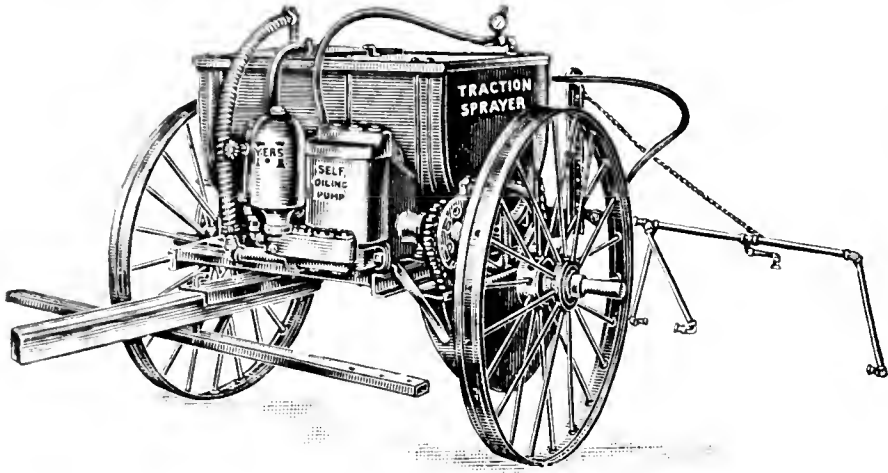

Myers Traction Sprayer No. 1077 as shown with 100-gallon tank, lever cut-off, sediment chamber, long double-tree and neckyoke, 4-row boom.

Myers Traction Sprayer No. 1076 with 50-gallon tank, pressure guage, lever cut-off, long double-tree and neckyoke, 4-row boom.

Prices on application.

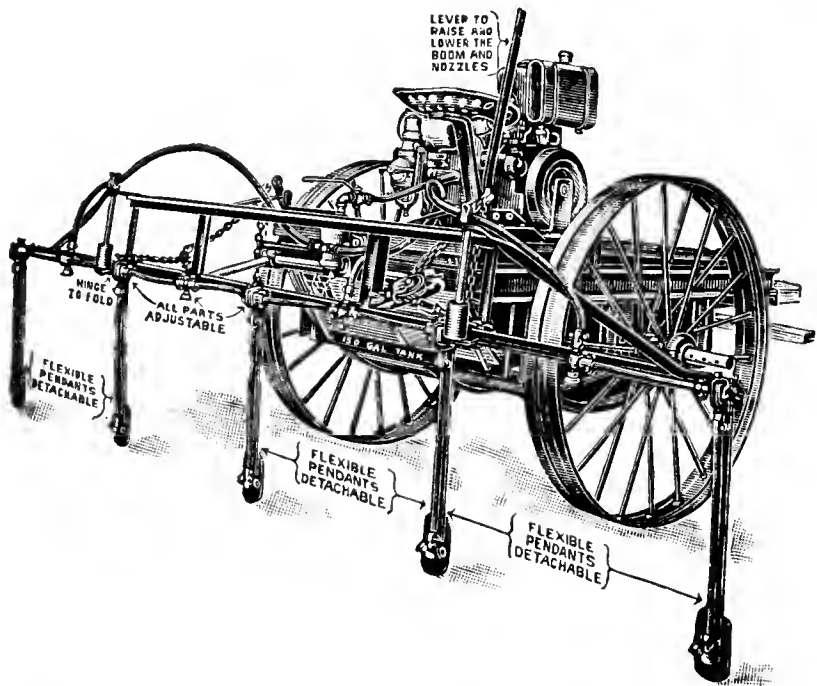

Myers Senior Power Sprayer No. 1070X as shown with 150-gallon tank, duplex self-oiling pump, 4-H. P. engine, 4-row boom.

Myers Junior Sprayer No. 1079 with 100-gallon tank, self-oiling bulldozer pump, 2-H. P. engine and 4-row boom.

Prices on application.

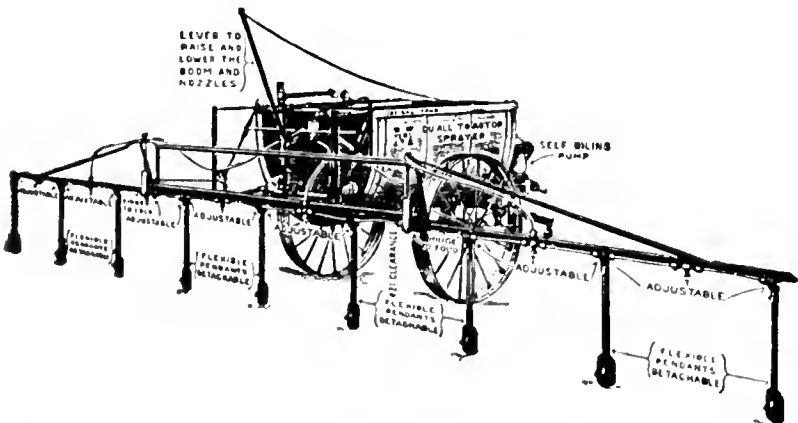

Myers Du-All Tractor Driven Power Sprayer with 300-gallon tank, triplex self-oiling pump and 6-row boom.

Myers Du-All Tractor Driven Power Sprayer No. 1099X with 300-gallon tank, quadruplex self-oiling pump and 8-row boom.

Prices on application.

Myers Orchard Sprayers

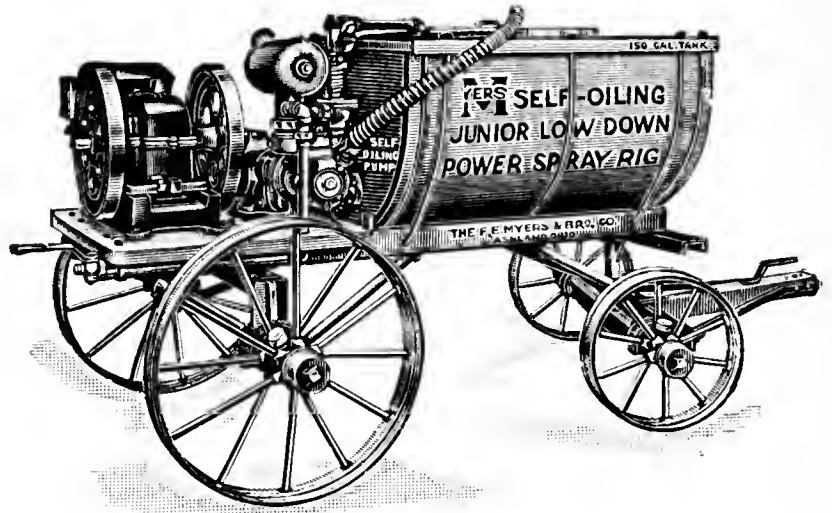

Myers Self-Oiling Junior Low Down Power Spray Rig No. 754 with 100-gallon tank, engine and double acting pump. 250 to 300 lbs. pressure. Designed for the farmer with a small orchard. Prices on application.

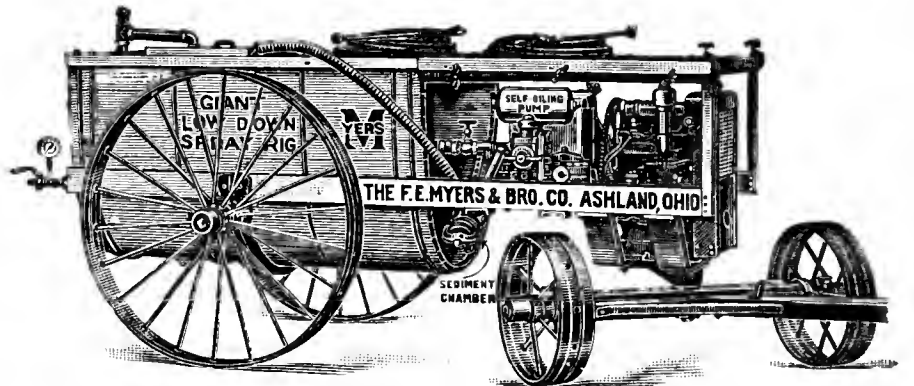

Myers Giant Power Spray Rig No. 724X as shown with 200-gallon tank, Triplex pump and 6-H. P. engine, delivers 10 to 16 gallons per minute, 350 to 500 lbs. pressure.

Myers Giant Power Spray Rig No. 731X with 300-gallon tank, Quadruplex pump and 8-H. P. engine delivers 12 to 20 gallons per minute, 350 to 500 lbs. pressure.

Prices on application.

Myers Silver Cloud Power Spray Rig

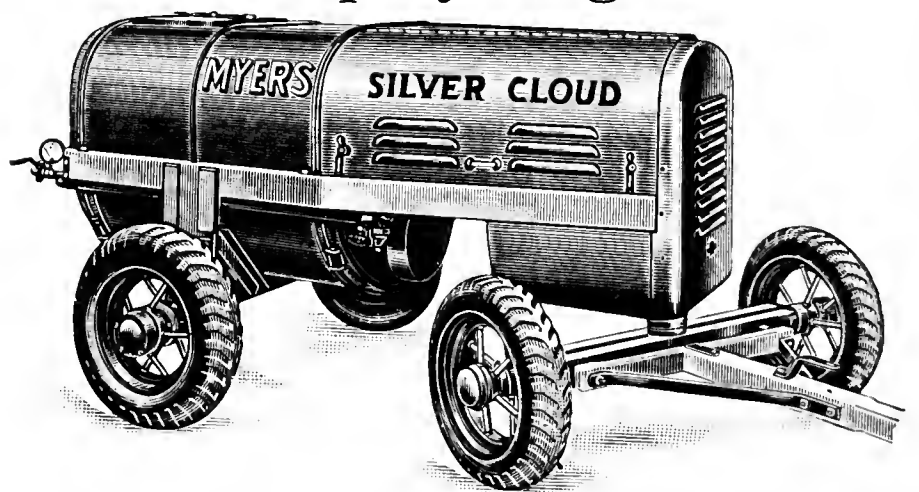

Myers Silver Cloud Power Spray Rig with complete enclosure of all operating parts is designed to meet the requirements of the large commercial orchard. Its sturdiness of construction and low center of gravity will withstand the most severe service.

The Self-Oiling Quadruplex Pump has proven itself over a long number of years as to actual service rendered. In fact, is regarded by all users as the best spray pump on the market. Capacity 16 to 20 gallons per minute. 400 to 500 lbs. pressure.

Prices on application.

Dusting

The Modern Method of Crop Protection.

The rapid strides which the dusting method of crop pest control has made in the past five years is directly traceable to the efforts of the Niagara Sprayer Company. Its success, however, has come because it has done those things which were claimed for it, and brought results by the most direct route.

Dusts of infinite fineness have been perfected, containing those properties necessary to kill insect pests and prevent diseases. Not only do the Dusts do the work done by liquid sprays, but their development has opened new fields of Crop Pest Control.

Niagara Dusts are now being made that stick "through Wind and Rain", and exhibit toxic properties to many fungi and insects heretofore unequalled by either wet or dry materials.

Niagara Dusting Material

Dormant Dust. Delayed dormant dusting for San Jose scale, red mite and aphids on apples, pears and shade trees.

\$10.25 per 100 lbs.

Kolodust. A new dust developed by the Niagara Sprayer Co. It is sulphur fused with bentonite at high temperature and the product is koloized (a colloidal form). This produces a dust of infinite fineness much finer than 300 mesh, which experiment stations have proven more toxic to fungous diseases than any sulphur yet produced.

\$5.35 per 100 lb. bag.

Kolotex. A Sulphur Poison dust that will stick. The New Exclusive Niagara Sulphur Fungicide with Lead Arsenate.

\$7.00 per 100 lb. bag.

Kolokil. A Sulphur Heavy Poison Dust.

\$7.50 per 100 lb. bag.

Kolopeach. A Sulphur Small Poison content Dust suitable for dusting peaches and other stone fruits.

\$6.35 per 100 lb. bag.

Kolopeach Special. Carries a higher lead content. For use in orchards where peaches and apples are interplanted.

\$6.95 per 100 lb. bag.

Super-Sulfodust. A 300 mesh dusting Sulphur.

\$4.50 per 100 lb. bag.

A-1 Mixture. A Contact Poison Dust. High percentage of quickly volatile nicotine fumes. 3% actual 100% nicotine. For aphids, red bugs, pear psylla, etc. The best contact dust for sucking insects, both out doors and greenhouses.

\$11.50 per 100 lb. drum.

P. A. Dust. Used same as A-1, contains 4% actual 100% nicotine.

\$15.00 per 100 lb. drum.

M21. A 50-50 dust for cabbage and cauliflower.

\$7.00 per 100 lb. drum.

Rotenone Dusts. Non-poisonous. Are the latest development in materials for use in the control of chewing insects. They have the additional quality of leaving no objectionable residue at harvest time. The present restrictions in our arsenical residue tolerance have made an increasing demand for materials which kill chewing insects and yet may be used with safety. Price on application.

Vitidust. Copper, Lime, Lead Arsenate. Mixture for grapes.

\$7.00 per 100 lb. drum.

Copodust. A Copper-Lime Dust. The New Exclusive Niagara Copper Lime Fungicide for blights of potatoes and other field crops.

\$4.75 per 75 lb. bag.

Copotex. A Copper Lime Dust, with Poison added for potato bugs, etc.

\$6.50 per 75 lb. bag.

Wildfire Dust. A Copper Lime Dust for tobacco.

\$4.75 per 75 lb. bag.

Above Prices Subject to 5% Discount For Cash.

Niagara Spray Material

Kolofog. A colloidal sulphur, for Summer application on apples and peaches. More toxic than any other non-caustic sulphur spray material. Use 6 lbs. to 100 gallons of water.

48 lb. carton \$4.75

Pre-Harvest Kolofog. A substitute for Kolofog and lime on late applications.

48 lb. carton \$4.75

Kolofog Wettex—Apple. Kolofog with the proper amount of lead. Use 9 lbs. to 100 gallons of water.

45 lb. carton \$4.85

Kolofog Wettex Peach. Use 8 lbs. to 100 gallons of water.

48 lb. carton \$5.00

Emulso. Emulsified Oil for control of red mite, scale and aphids. Price on application.

Peninsular Oil Emulsion. (Used same as above.) Price on application.

The "Dri-Fog" Crop Duster

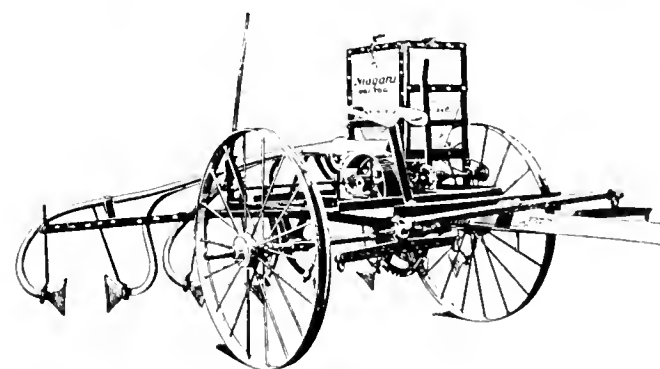

(4-row,
8-nozzle or
6-row,
12-nozzle)

Prices on
application.

Is the most recent addition to Niagara's complete line of Dusts and Dusters. This great crop duster is a new machine in every respect—in design, construction and performance.

Cyclone Fruit Duster, Complete

With self-starter, generator, pneumatic tires and bag racks, powered by a 4 cylinder 8-14 H.P. engine, driving direct on the fan gears, or can be furnished to attach direct to tractor with power take-off.

John Deere--Syracuse No. 821 Series Truss Steel-Beam Hillside Plows

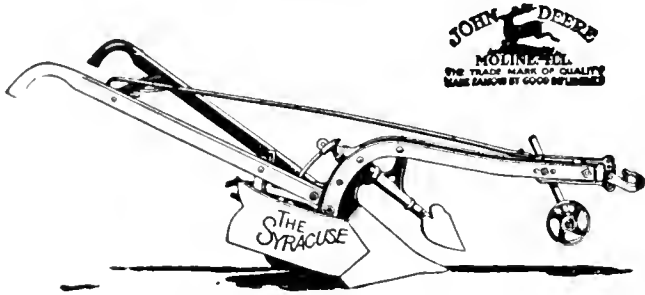

Ample throat room and close-fitting joints prevent clogging. Choice of white iron or tempered steel mouldboard adapts them to a variety of soils. Steel and malleable iron give maximum strength and unusual light weight. Two-piece truss-style beam is extra sturdy. Renewable shoe protects standard and serves as landside.

825 Small, one horse 824 Medium, one horse
823 Large, one horse 822 Medium, two horse
821 Large, two horse Prices on Application.

John Deere--Syracuse No. 31- 32 Series Walking Plows

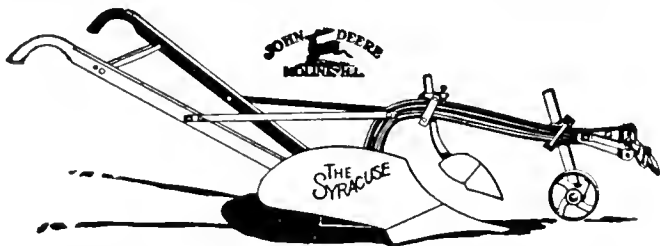

The mouldboard of hardened soft-center steel is formed so that a furrow may be turned smoothly up or down on sloping land. This feature makes Syracuse plows of this series popular in sections where the land is somewhat rolling. Steel landside of extra height, furnished with a cast shoe which can be renewed at slight expense.

32 Medium, two horse 31 Large, two horse
Prices on Application.

John Deere No. 4 Tractor Plow

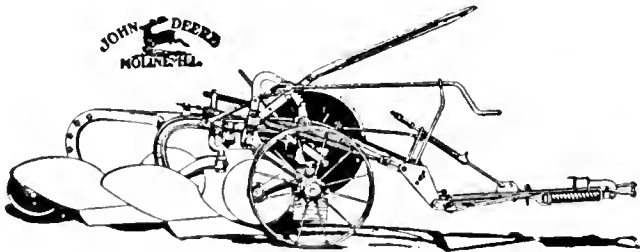

The strongest two-bottom tractor plow ever built. Beams, beam-bracing and other important parts are of the same great strength as similar parts built into larger John Deere tractor plows. Heavy-duty, constant power lift raises bottom to a constant height regardless of depth of plowing. 23-inch clearance from beams to share-points insures freedom from clogging. Rolling landside carries rear weight on greased bearing—no dragging landside friction. Furnished with 12, 14, or 16-inch bottoms. For any farmer operating a "two-plow" tractor, the No. 4 is a mighty satisfactory plow.

24" Cut (1442S Bottoms)
28" Cut (1441S Bottoms)
Prices on Application.

John Deere Universal Steel Lever Harrow

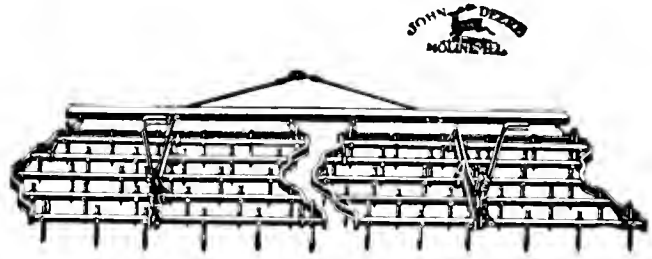

The Universal is the ideal spike-tooth harrow for orchard or vineyard work because the end rails prevent the tooth bars from catching on trees or vines. A spring relief on each lever permits the harrow teeth to pass over roots, stones, or other obstructions without being damaged. We can furnish the Universal in one, two, three, and four sections, with either 25 or 30 teeth to the section.

Price on Application.

Syracuse Spring Tooth Harrow

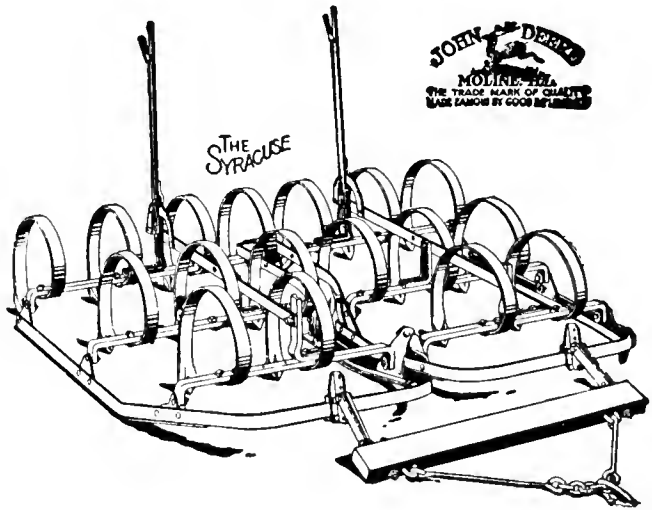

Its special-process, heat-treated spring steel teeth penetrate to a greater depth than any other type of harrow teeth. They tear out the weeds and leave the field smooth. The teeth are securely clipped to the tooth bars—no bolt holes to weaken them. We can furnish any number of sections you desire; also tractor hitch if you want it.

Price on Application.

The Hi-Bar Weed Hog

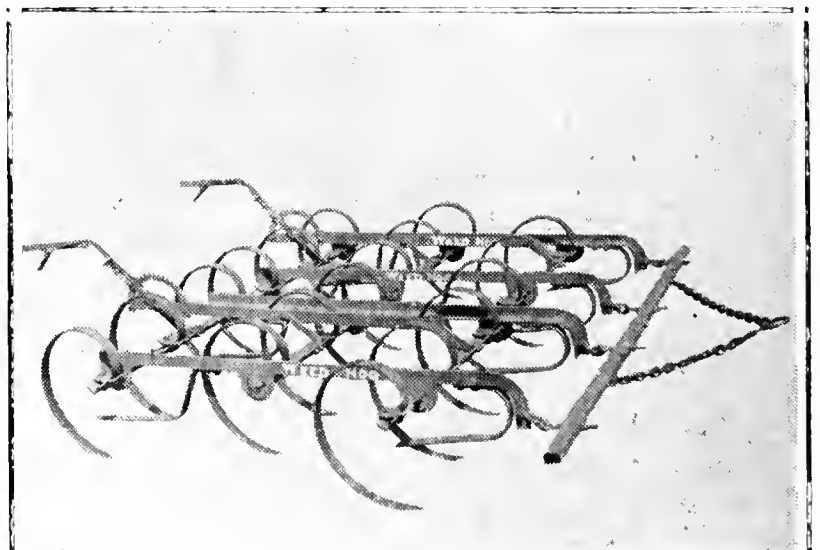

18 Tooth Weed Hog with chain hitch for tractor or horses. Width 7 ft. 6 in. Weight 355 lbs. Price on application.

Acme Pulverizing Harrows



Acme Pulverizing Harrows are constructed entirely of steel and iron. They are practically unbreakable and have nothing to wear out but the coulters, and they are interchangeable.

No. 8—4 ft., 4 in., cut for one horse.

No. 12—6 ft., 6 in., cut for two horses.

Prices on Application.

Clark Cutaway—SINGLE ACTION

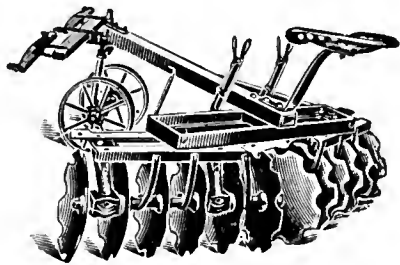

The Clark "Cutaway" single action harrow is reversible, that is, the gangs can be swung end for end, so that the soil may be thrown either out or in. A-4 1-horse, 8-16 inch discs. A-6 2-horse, 12-16 in. discs, with pole or fore-truck. Prices on Application.

John Deere Model B

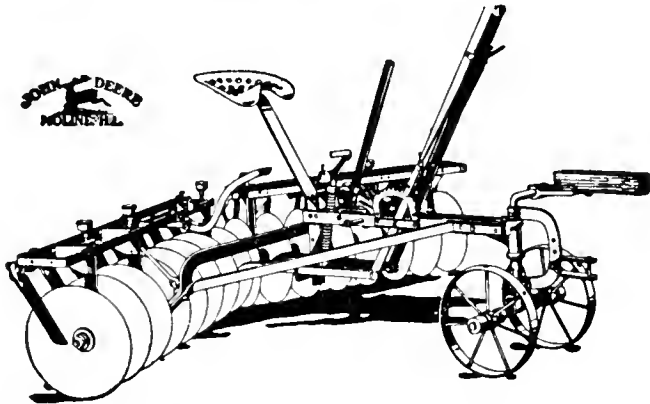

Extremely flexible, penetrates, pulverizes and packs the soil its entire width. Each gang works independently—one gang can pass over obstructions without lifting the other from its work. 12-16 inch discs with pole or foretruck.

Prices on Application.

John Deere Model D.A.

Tractor-Controlled

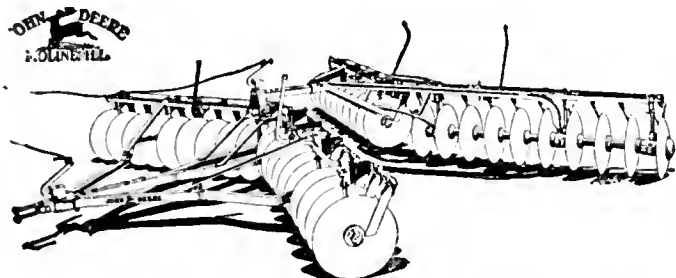

Made in 5-6-7-8-9 and 10 ft. sizes. A pull on the trip rope enables the tractor operator to change the angle of either section instantly to just the proper degree for best disking results.

Prices on Application.

John Deere Model "LC" for Tractor

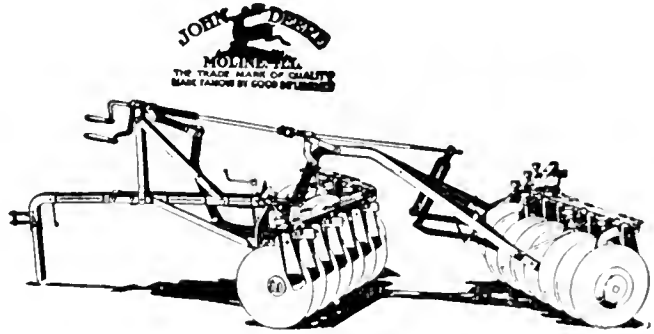

Front and rear sections are angled by independent cranks convenient to tractor operator, without backing or stopping harrow. Automatic yielding lock coupling, an exclusive feature, compels rear discs to cut ridges left by front gangs.

24-16 in. discs, 6 ft. cut

28-16 in. discs, 7 ft. cut

32-16 in. discs, 8 ft. cut

Prices on Application.

"Clark Cutaway" Tractor Wonder Disker

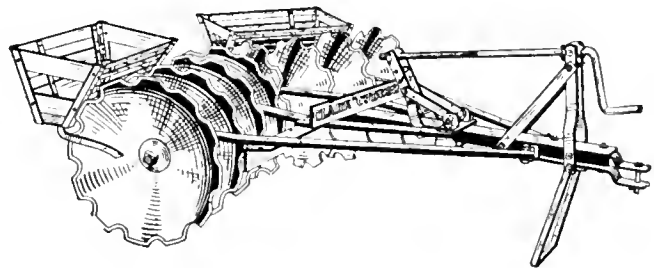

The Wonder Disker is a great improvement over the bush and bog plow and harrow which was popular for many years. It is a large, heavy, powerful implement, built for the unusual job where ordinary plows and harrows either cannot be used at all, or where they make the job too laborious and costly. For orchard work the reversing feature is vital.

Price on Application.

The Fowler Cultivator

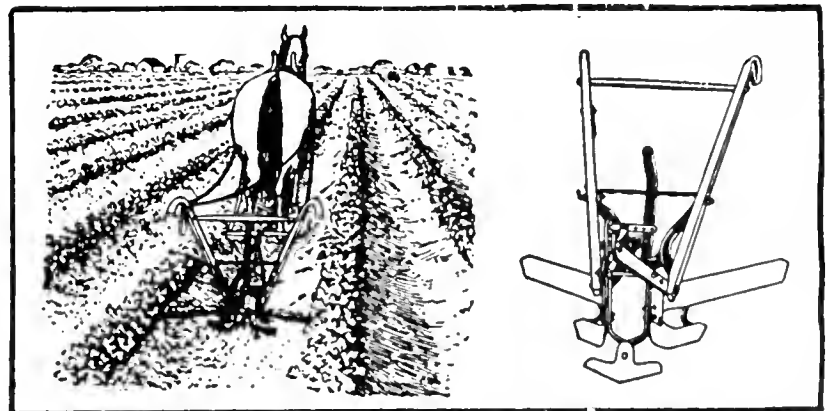

This cultivator has been widely used in all sections for many years. It is a general purpose, one horse cultivator adapted to a wide range of work. Practically all steel, very strong and durable.

Price \$15.00 Net Cash Price \$14.25

Planet Jr. Seeders

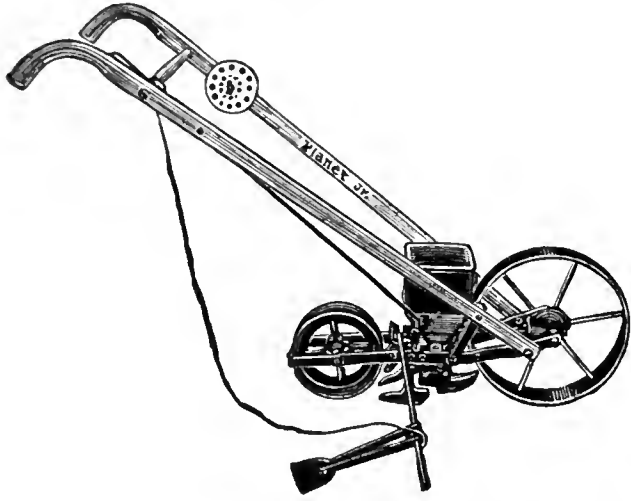

The No. 300A is rapidly becoming the most popular seeder for market gardeners. It is a plate seeder having three seeding plates each with 13 holes giving ample adjustments for any size seed. Adjustments quickly and easily made. Hopper removable. Many exclusive features combine to make the No. 300A easy running, dependable and accurate. For use on ordinary soil.

Price \$21.00 Net Cash Price \$19.95

No. 320 Fertilizer Attachment—Will fit either No. 300 or No. 300A Seeder, applying fertilizer in bands on either side of the row while the seed is being planted. Or can be used for putting formaldehyde dust directly on the seed. Can be used thru the growing season for side-dressing crops, putting the fertilizer in a narrow furrow next to the plants.

Price \$15.00 Net Cash Price \$14.25

No. 3 Hill and Drill Seeder—For many years the No. 3 has been a popular seeder all over the world. There are a number of reasons for this preference on the part of professional growers.

Price \$19.00 Net Cash Price \$18.05

No. 4. Combined Hill and Drill Seeder, single wheel hoe, cultivator and plow.

Price \$19.50 Net Cash Price \$18.53

No. 4-D. Seeder only.

Price \$15.50 Net Cash Price \$14.73

No. 25. Combined Hill and Drill Seeder. Double or single wheel hoe. Cultivator and plow.

Price \$23.50 Net Cash Price \$22.33

Planet Junior Fertilizer Distributor

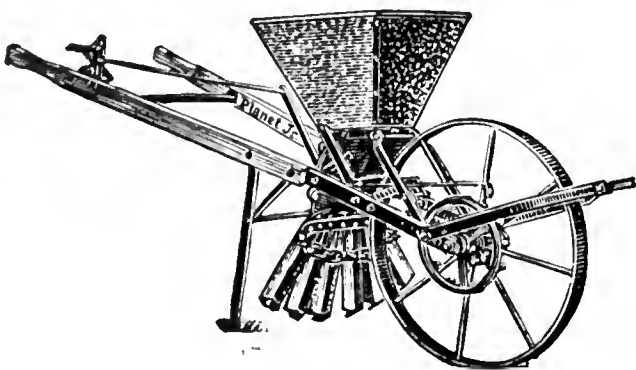

No. 220 will handle any commercial fertilizer and will distribute it evenly in any desired quantities.

Price \$29.50 Net Cash Price \$28.03

Planet Jr. Double Wheel Hoes



No. 11 Equipment (as shown): One pair six inch hoes, one pair 4½" hoes, four steel cultivator teeth, one pair plows, two three-tooth rakes, two five-tooth rakes, two leaf lifters.

Price \$14.50 Net Cash Price \$13.78

No. 12 Equipment—one pair six inch hoes, four cultivator teeth, one pair plows.

Price \$11.50 Net Cash Price \$10.93

No. 13 Equipment—one pair six inch hoes.

Price \$8.75 Net Cash Price \$8.32

Planet Junior Single Wheel Hoes

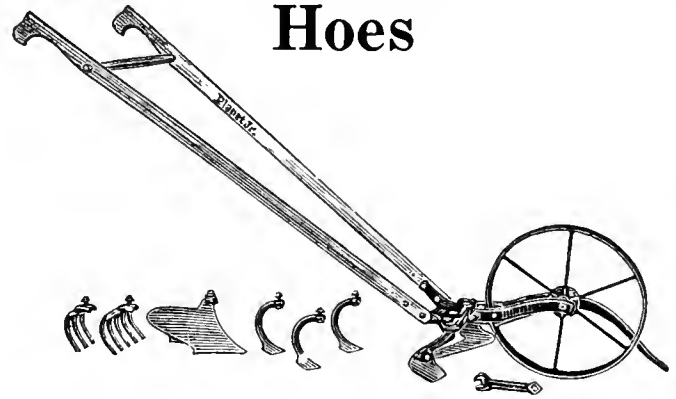

No. 16 Equipment (as shown) one pair of six inch hoes, three cultivator teeth, one garden plow, one seven inch rake, one four inch rake, one leaf guard.

Price \$9.00 Net Cash Price \$8.55

No. 17 Equipment—one pair six inch hoes, three cultivator teeth, one plow.

Price \$8.00 Net Cash Price \$7.60

No. 18 Equipment—one pair six inch hoes.

Price \$6.00 Net Cash Price \$5.70

No. 119 Planet Junior Garden Plow



A complete low priced all around Garden Plow. 24-inch steel wheel 1¼ inch rim. Light, easy running and does fine work. Can be used for weeding, cultivating, furrowing, hilling, etc. Price \$4.00. Net Cash Price \$3.80.

Planet Junior Horse Hoes and Cultivators

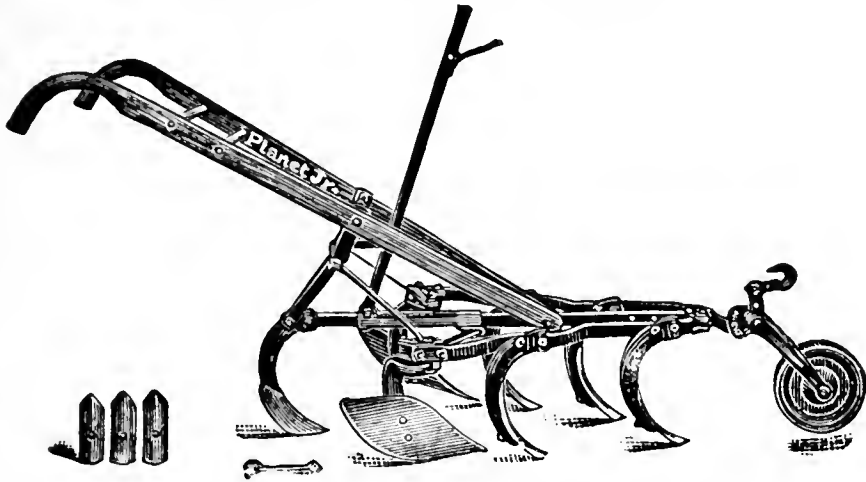

A very popular machine because of the large amount and great variety of work that can be done with it. Finishes rows up to 42 inches apart and works the middle complete at one passage. Zig-zag frame is particularly strong and the seven teeth insure fine and thorough cultivation. In addition to regular equipment other width of cultivator teeth, sweeps, furrowers and turning shovels can be added.

Price (as shown) \$16.00 Net Cash Price \$15.20

—No. 82 with lever wheel.

Price \$17.00 Net Cash Price \$16.15

—No. 83 Planet Jr.—

Equipment. Seven 2¼ x 8 in. cultivator steels, lever expander.

Price \$14.00 Net Cash Price \$13.30

—No. 83 with lever wheel.

Price \$15.00 Net Cash Price \$14.25

—No. 7 Planet Jr.—

Equipment. Four 3 x 8 in. cultivator steels, one 4 x 8 cultivator steel, two six-inch hillers, one seven-inch shovel, lever wheel, lever expander.

Price \$15.75 Net Cash Price \$14.97

—No. 8—Planet Jr.—

Same as No. 7, but has a depth regulator.

Price \$16.75 Net Cash Price \$15.92

—No. 9—Planet Jr.—

Same as No. 7, but has plain wheel instead of lever wheel.

Price \$14.50 Net Cash Price \$13.78

No. 90 Planet Jr.

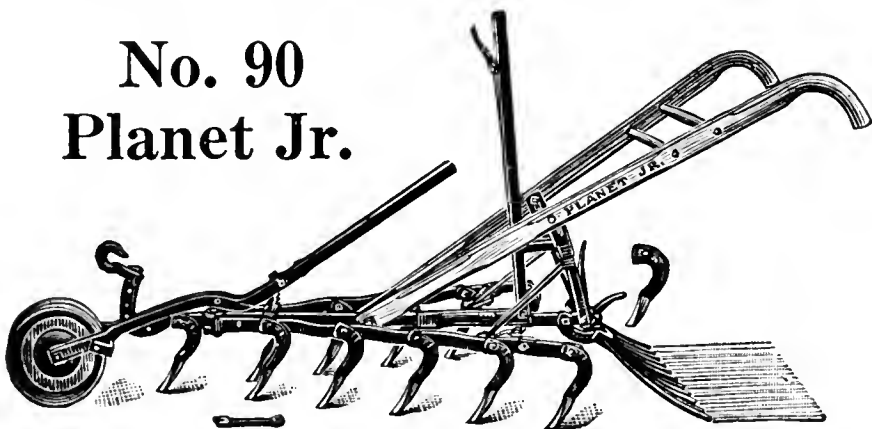

Twelve-tooth harrow (as shown). Price \$17.00 Net Cash Price \$16.15

—No. 90B Harrow (less pulverizer).

This tool has become a special favorite with strawberry, tobacco and sugar beet growers, market gardeners, truckers and farmers, because of the fine work of the chisel-shaped teeth. Cultivates any width from 12 to 32 inches. Handles adjust up, down and sidewise—a great advantage in blackberries, raspberries, etc.

Price \$14.00 Net Cash Price \$13.30

John Deere No. 999 Corn Planter

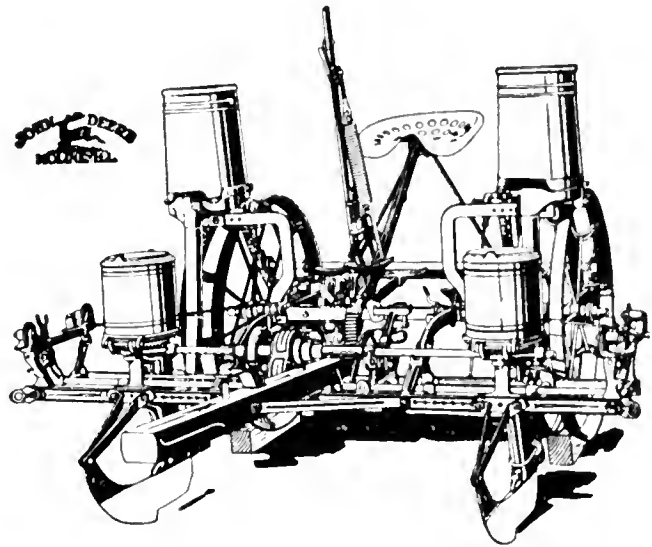

Widely recognized as the most accurate planter on the market. The John Deere Natural Cell-Fill, Edge-delivery seed plates, sloping hopper bottom, improved metal cut-off and knocker insure positive feed and unfailing accuracy. Plants accurately whether the hopper is full or nearly empty. Seed plates for handling every kind of corn; also beans, and many other seeds. Variable drop plants two, three or four kernels in each hill as desired. The number of kernels per hill can be varied merely by shifting foot lever, without stopping the machine. Also varies the distance in drilling. Easy to change from hilling to drilling. Underhung reel; a touch of the toe releases check wire, fertilizer can be checked with each hill, or drilled along a row.

Price on Application.

Clark "Cutaway" Corn Planter

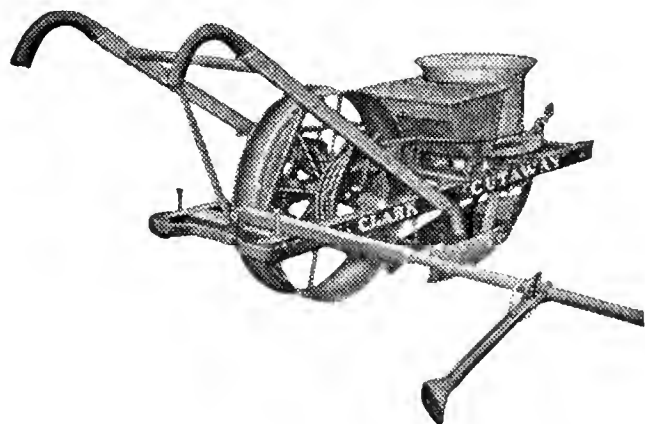

—CLARK "CUTAWAY" CORN PLANTER— is adapted for hilly and rocky land, as well as for easy working conditions. It can be easily pulled by one horse and seven to ten acres can be planted in a day. The seed hopper has two compartments, so two kinds of seed may be planted at the same time, such as corn and beans, or other seeds. Every planter is equipped for planting in hills 4½, 9, 12, 18, 24, 36 and 72 inches apart. It also plants in drills.

Price on Application.

Farquhar Walking Weeder

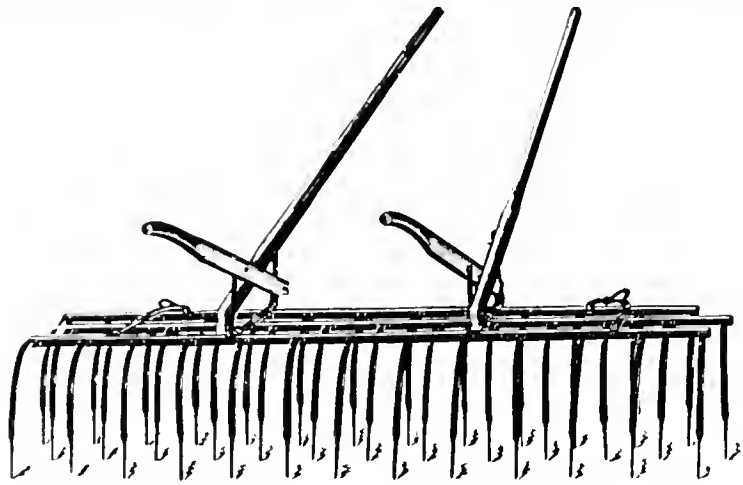

A standard weeder having curved teeth. Built in two sizes 7½ ft.—39 teeth—11 ft.—57 teeth. Prices on Application.

Farquhar Riding Weeder—12 ft.—63 teeth.

Grass seed attachment for above sows in front of the teeth and is driven by sprocket from ground wheel. Quantity ranges from four to twenty quarts per acre.

Prices on Application.

John Deere KL Cultivator

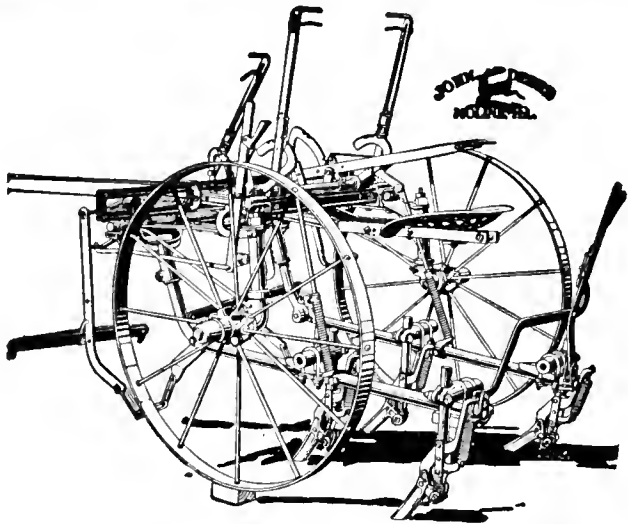

Especially designed for use in narrow or wide rows—the ideal cultivator for diversified farming. Wheel track quickly adjustable to cultivate rows from 28 to 48 inches wide. Easy control to meet all field conditions by means of master lever, independent depth levers, tilting lever and spacing lever. Quick dodge—pedal guide pivots wheels and shifts rigs. Open framework through center gives good view of work ahead of shovels. Strongly built.

Price on Application.

John Deere Tractor Cultivators

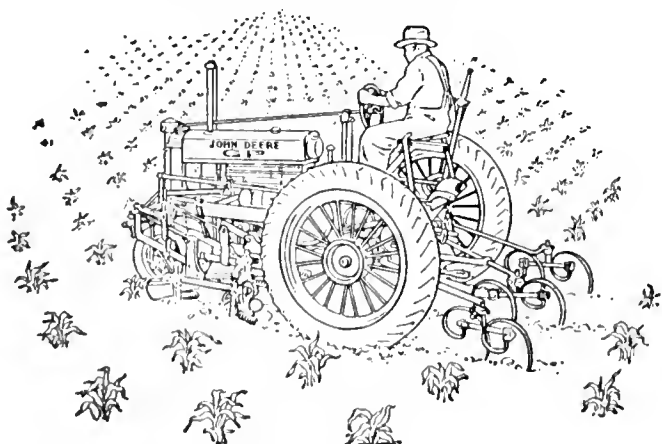

Cultivating is the biggest job on the farm. The two-row shown above covers 2 to 4 acres an hour. Furnished with a choice of hand or power lift. Price on application.

New John Deere Potato Planter

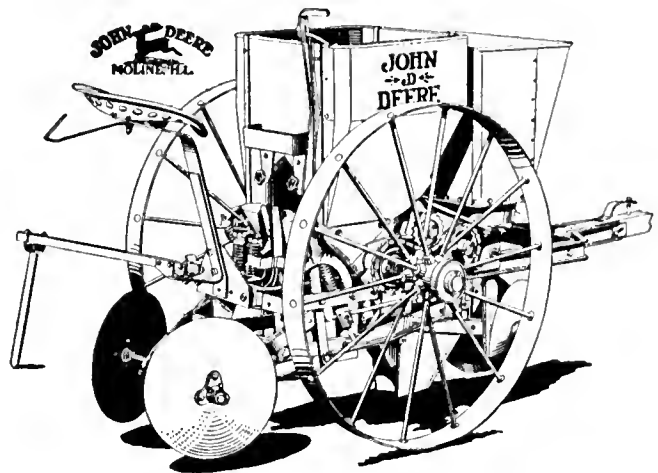

The simple gravity feed insures just the right amount of seed in the bowl for efficient planting. You can plant whole or cut, treated or untreated seed with surprising accuracy. Highly efficient fertilizer equipment, with leak proof hopper bottoms. Handles fertilizer in practically any quantity desired, in just the way you want it handled, and at the desired depth.

Price on Application.

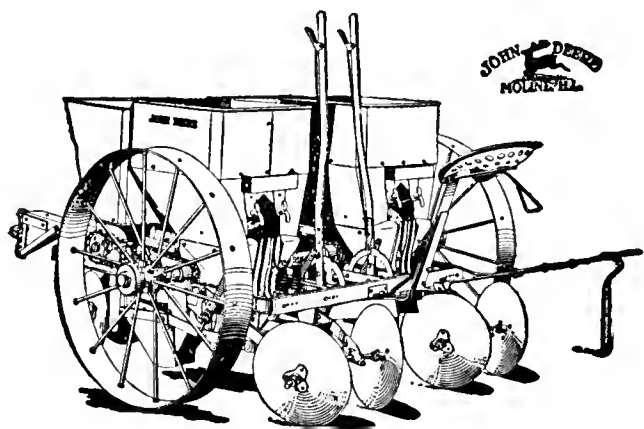

Two row planters are furnished in two sizes, adjustable for rows 30, 32, 34 and 36 inches wide, and for rows 36, 38, 40, and 42 inches wide.

Price on Application.

Iron Age Potato Planters-- One Row

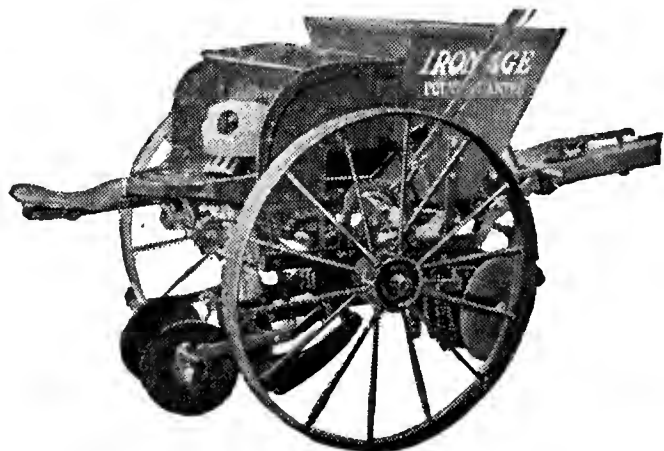

ASSISTED-FEED PLANTER

For many years it has been conceded that in its ground performance, the Iron Age Planter exhibits the highest degree of perfection ever attained. By Iron Age ground performance is meant the opening of furrow, distributing of fertilizer, and finally ideal covering and ridging. Equipped for large seed.

Price on Application.

Iron Age Potato Planters Two-Row

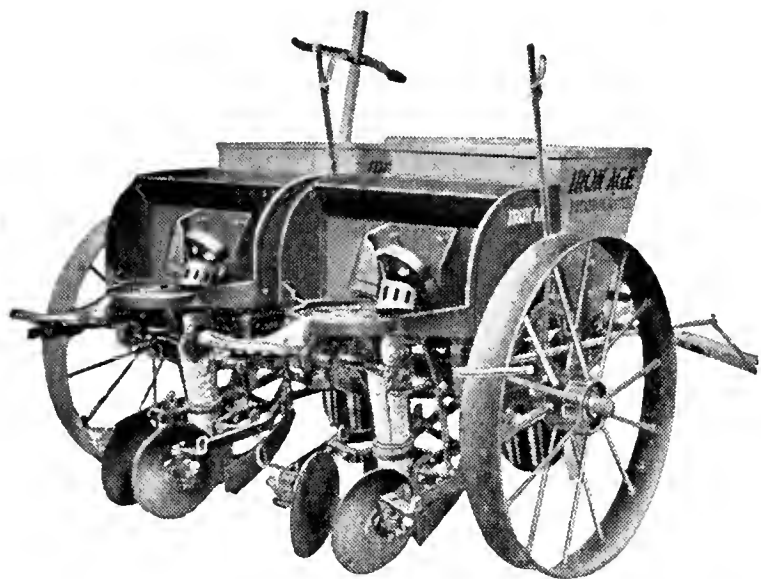

THE TWO-ROW Assisted-Feed Planter—has become very popular with the larger grower—not only because of the increased speed of planting, but because it eliminates the use of one man (another driver), as only one driver is required. It is strongly constructed and braced with heavy angle irons, firmly bolted together, which carry all the center weight without placing strain on the axles. It is supplied in two ranges of four width adjustments. For rows 30, 32, 34 and 36 inches, or 36, 38, 40 and 42 inches. Size wanted must be specified when ordering.

Price on Application.

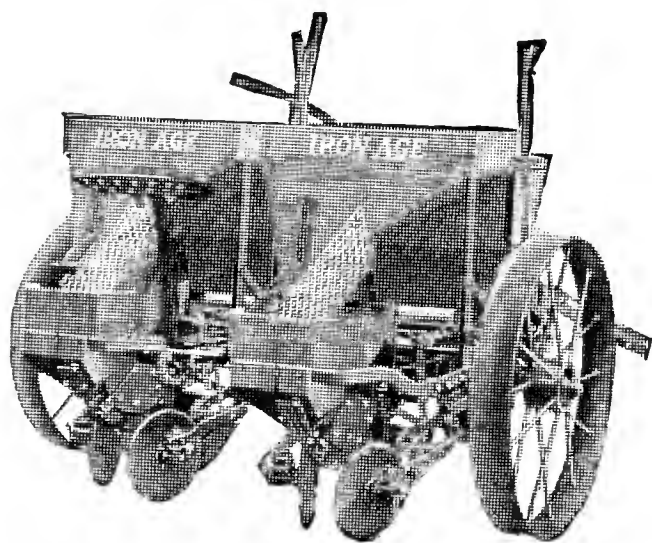

IRON AGE AUTOMATIC PLANTERS differ from the Assisted-Feed Planters only in their mechanical handling of the seed. The picking of the seed and the planting mechanism are always in plain view of the operator.

One and Two Row.
Prices on Application.



**IT PAYS TO USE
O. & W. POTATO FERTILIZERS**

John Deere--Hoover Potato Diggers

These famous mechanical diggers dig the potatoes with a minimum of mechanical injury. Shovel of crucible plow-steel, scours and works in varied conditions without bending or breaking.

Main sides are built up of two steel angles riveted together—much stronger than single-angle construction.

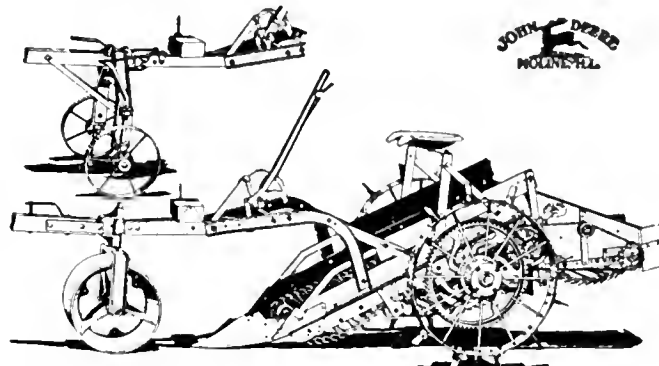

Furnished in one-row size with ground or engine drive, and one-and two-row tractor drive, with equipment to meet your requirements.

Prices on Application.

Farquhar Success Jr. Potato Digger



The most popular plow-type digger on the market. Just the digger for the small grower—in fact no farmer can afford to be without this digger, even if he raises only sufficient potatoes for his own consumption. In time and labor saving it pays for itself the first season.

Price on Application.



Fine field of Chippewa potatoes grown by Higley and Higgins, East Hartford.

Myers Hay Unloader Outfit

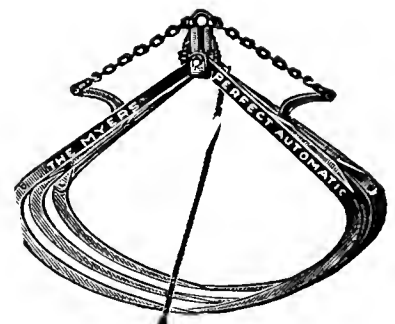
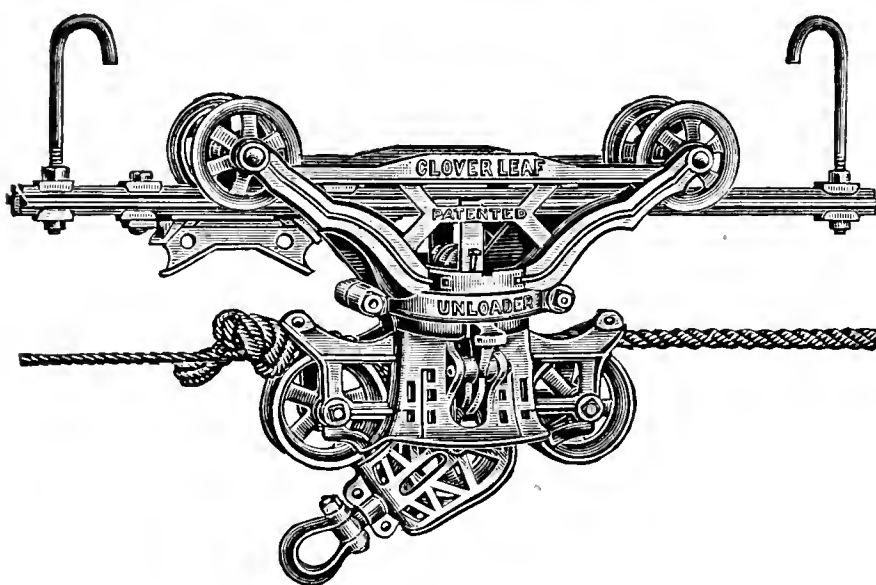
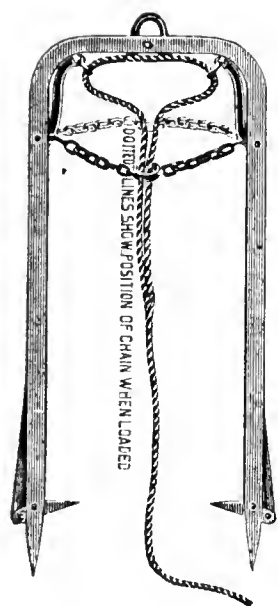
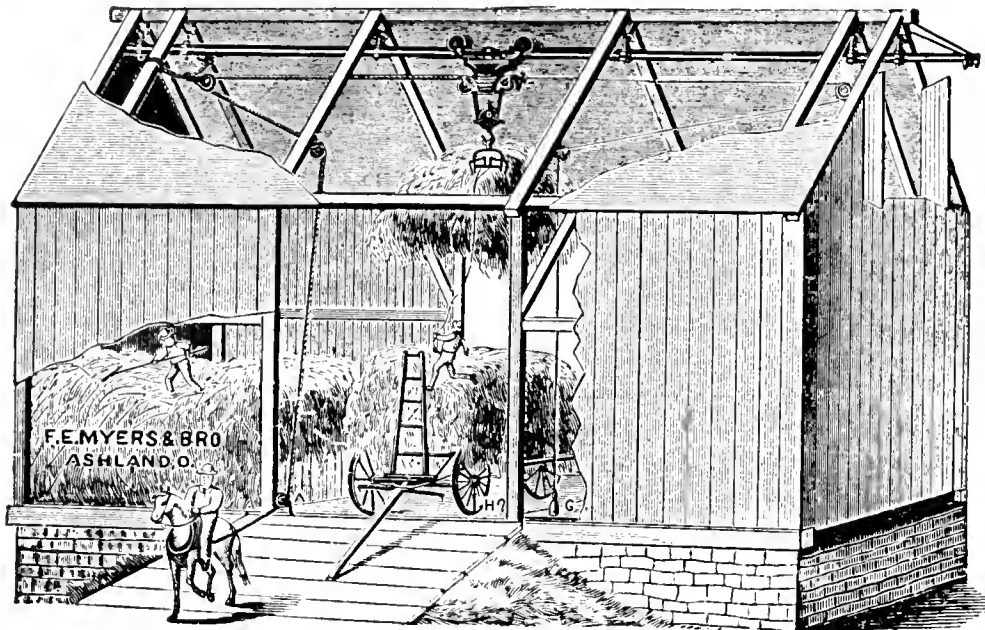

The advantages of a hay carrier as a means of storing away hay or grain are so well known that it is not necessary to go into detail.

Material required for a 40 foot barn: One

Unloader, 36 ft. Steel Track, 19 hanging hooks, 19 rafter brackets, 5 knot passing pulleys, 1 fork, 6 floor hooks, 110 feet $\frac{3}{4}$ " Manila rope, 50 ft. $\frac{5}{8}$ " check rope, 40 ft. $\frac{3}{8}$ " reverse rope.

Prices on Application.

Planting and Picking Bags

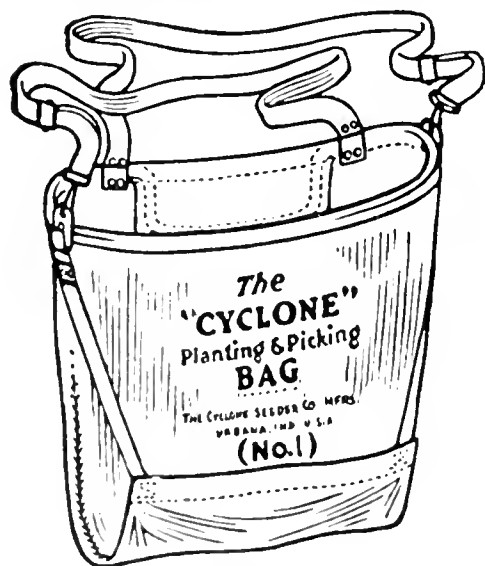

No. 1

The bottom of bag No. 1, left open, is folded back and held secure by rope and hook. To empty, the rope is released which allows contents to flow gently into crate or barrel.

Price \$1.75 each

Price of Bag No. 2 \$1.00 each



No. 2

Cyclone Seed Sower



Its well known Double Feed: insures a uniform flow of Seed. Slope Feed Board: keeps hopper properly filled. Feed Adjustment: is automatic and starts or stops flow of seed instantly. Triple Gears: are adjustable to take up possible wear. Distributing Wheel: is made of metal. Has an interlock hub. Scatters seed evenly—throws equal amounts to equal distance on each side of operator.

Price \$2.75 Net

Thompson Wheelbarrow Seed Sower

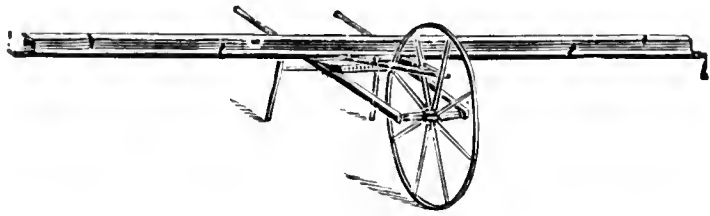

Sows timothy, clover, alsike, alfalfa, millet, turnip and various other seeds.

Price 14 ft. \$15.80 Net Cash Price \$15.00

Grain box for above \$9.50 Net

Boggs Standard Potato Grader

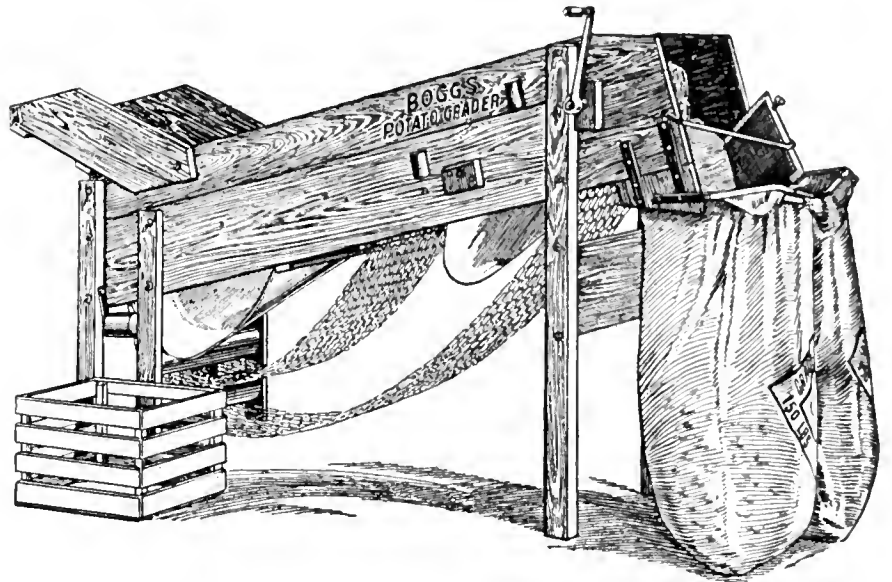

Boggs No. 3 machine permits long or round potatoes to be sorted and graded into No. 1 and No. 2 sizes with less than 3% variation in size from government grades, and cleans them of all dirt, trash and culls in one operation. No. 3 hand grader as illustrated has a capacity of 150 bushels per hour.

When large quantities of potatoes are to be graded, the power equipments will be found most advantageous. They not only have much greater capacity than the hand machine but effect a big labor saving.

Prices on Application.

Cahoon Broadcast Seed Sower

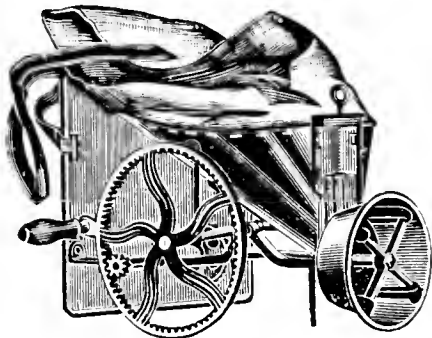

Price \$5.00 Net Cash Price \$4.75

The "New-Way" Twin Engine

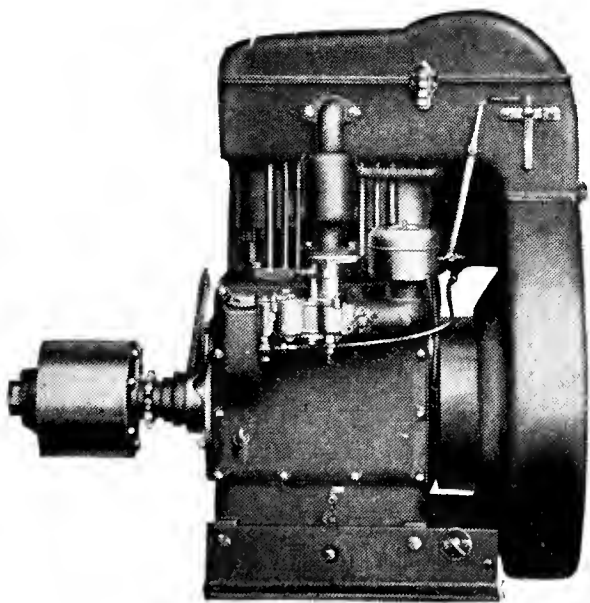

Is adaptable to any method of drive and is easily mounted on any machine at low mounting cost. Combinations are offered that permit of chain, gear or belt drive, or the engine can be direct connected to the driven machine either from the engine crank shaft or from a secondary power take-off shaft. Engines can be furnished with a power take-off using a 2 to 1 chain speed reduction or a 2 to 1 gear reduction. Also a 1 to 2 speed increase power take-off can be furnished. Both the engine crank-shaft and the power take-off shaft can be equipped with plain belt pulley, with "New-Way" friction clutch pulley or with Twin Disc Clutch. All clutches can be furnished with sprockets for chain drives.

Prices on Application.

John Deere Type E Farm Engine

Contains the greatest improvements in engine building made in years. All important

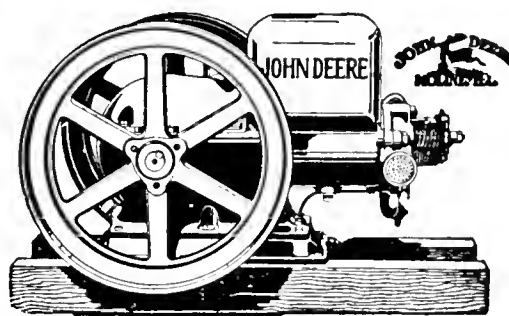

working parts fully enclosed in dust proof case are oiled automatically. Magneto equipped 1½, 3 and 6 Horse Power.

Price on Application.

Columbia Tape Marked Pure Manilla Rope



Guaranteed for high quality, strength, durability and service and in proof of its genuineness, branded with a red, white and blue tape marker.

We carry in stock sizes from ¾" to 1".

Price on Application.

Ohio Disc Harrows

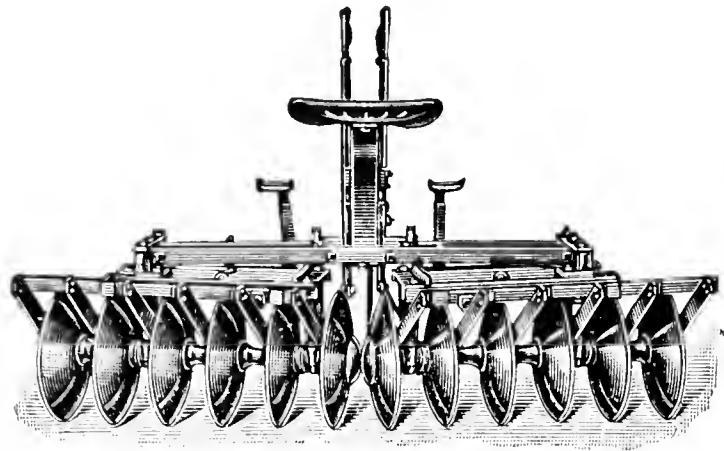

The construction of this harrow is of the very best. It is all steel even to the stub pole. There is a main or top frame to which the two sub-frames are attached by flexible connection which makes the harrow cover every inch of ground.

Prices on Application.

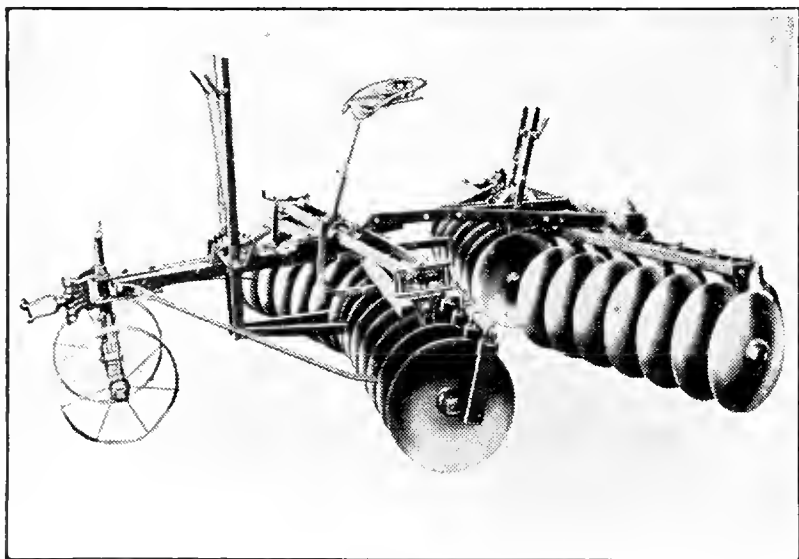

This harrow is substantially built, has sufficient weight and is so designed as to easily reach those clods just below the surface.

Prices on Application.

McWhorter Fertilizer Distributor

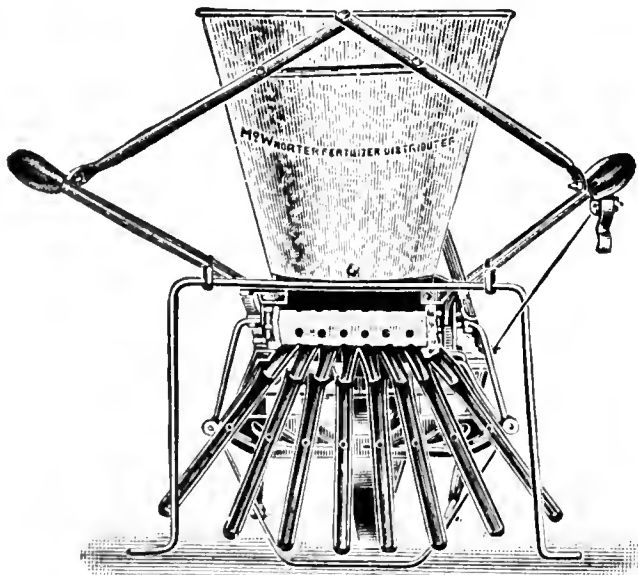

Positive belt feed. Sows 200 lbs. to a ton per acre.

Price \$21.00 Net Cash Price \$19.95

Nonpareil Broadcast Lime and Fertilizer Sowers

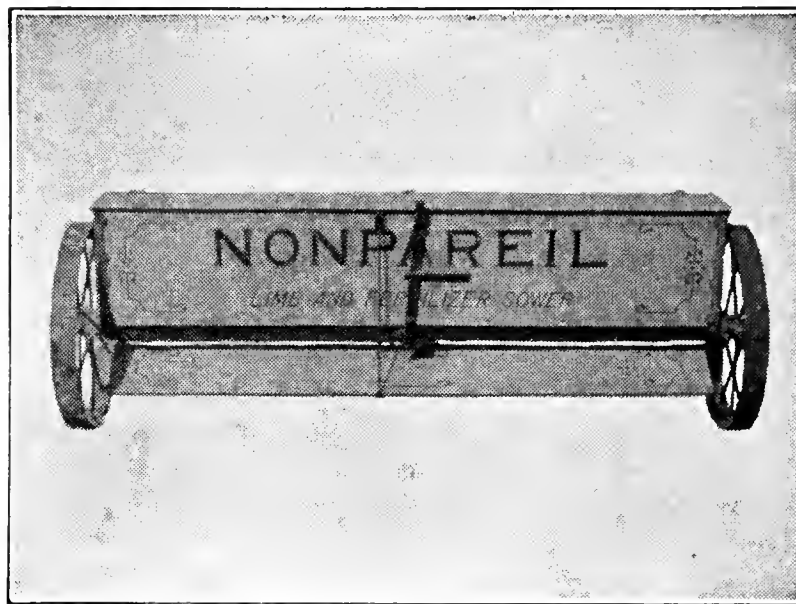

Are designed to handle all the different kinds of agricultural lime and commercial fertilizers in quantities ranging from 100 to 5000 lbs. per acre.

5 ft. size for 1 horse. 8 ft. size for 2 horses.

Prices on Application.

John Deere--Van Brunt Lime and Fertilizer Sower

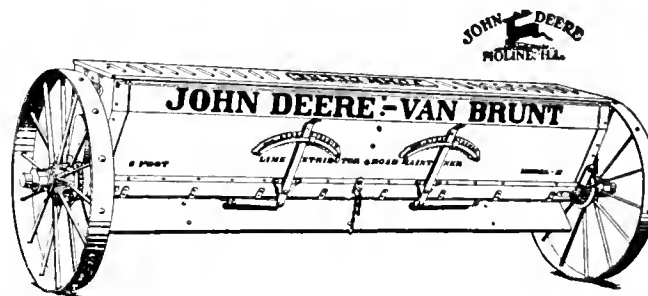

Covers 8 feet of ground; carrying capacity 10 bu. Direct wheel drive—each wheel drives half the machine.

One of the best features of this sower is the simple feed control which enables you to distribute crushed lime rock, commercial fertilizers and other materials in quantities from 150 to 8000 pounds per acre. Half of the mechanism can be disengaged for sowing narrow strips.

Price on Application



Fine field of Havana tobacco on the farm of Frank Kane, Simsbury, grown on O&W Blue Label Tobacco fertilizer.

JOHN DEERE TRACTORS

Model A—General Purpose adjustable tread tractor for row crop work. Handles the load ordinarily pulled by 6 horses. Model B—Is approximately two-thirds the size of the Model A. Handles the load ordinarily pulled by 4 horses. Ask for a demonstration. Prices on application.

John Deere tractors are the only tractors that have been designed to burn low-cost fuels. Not only are these fuels much cheaper per gallon than gasoline or kerosene, but they contain more heat units per gallon and where used in the type of tractor motor that will burn them properly, more power is developed, which means a great saving in operating costs.

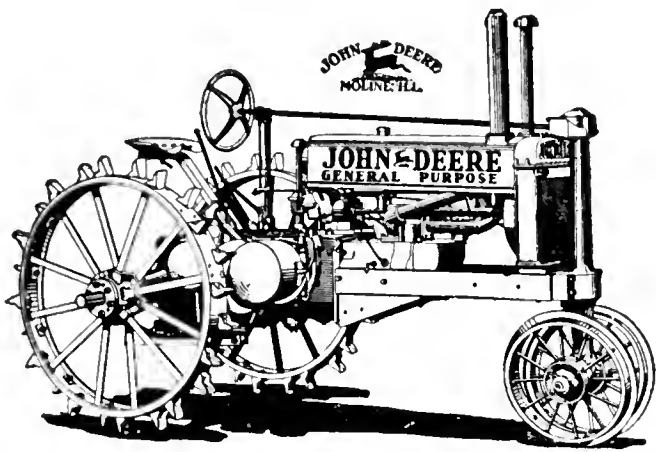

Model A or B on steel wheels. The tread is adjustable on the rear axles from 56 to 84 inches with any desired setting in between.

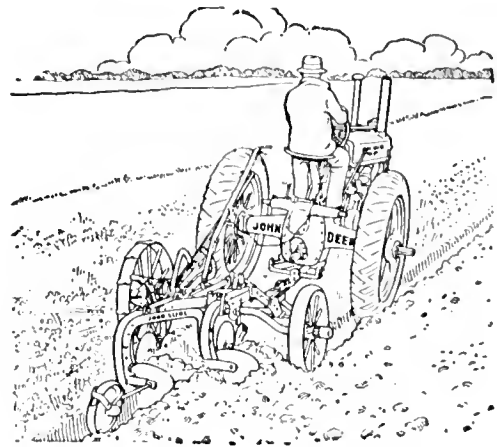

By setting the wheels in on the axles to 56-inch tread, the owner of a Model A or Model B Tractor gets practically a centered hitch on both plow and tractor, which overcomes side draft.

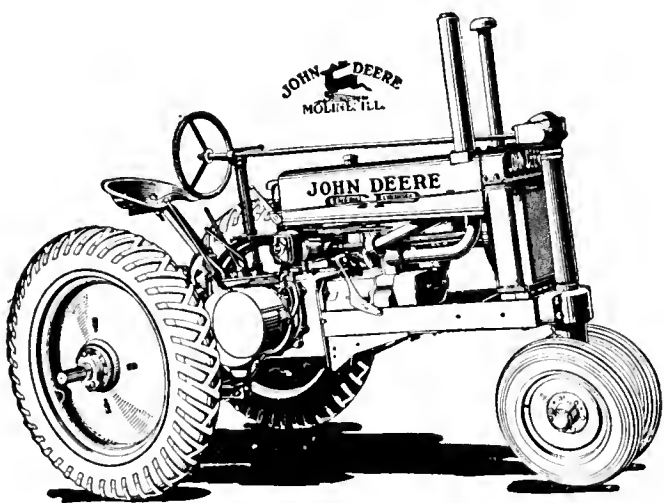

Model A or B on rubber tires and heavy cast rear wheels.

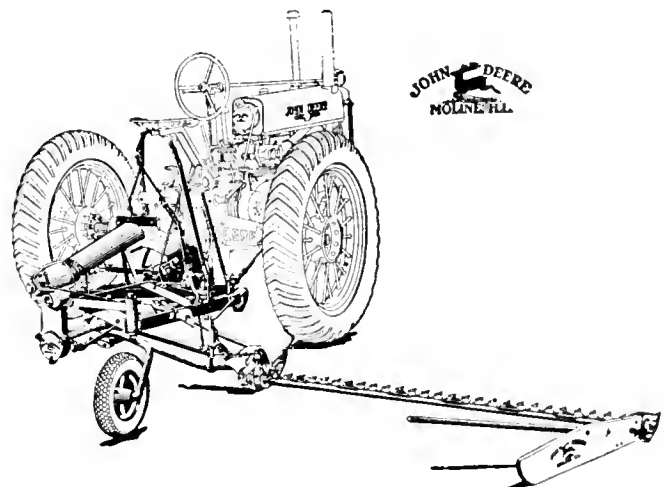

It's easy to do an excellent job of mowing with the John Deere Power Mower. The operator can turn corners quickly and easily. All control levers are convenient and easy to operate. Its simplicity makes it easy to adjust.

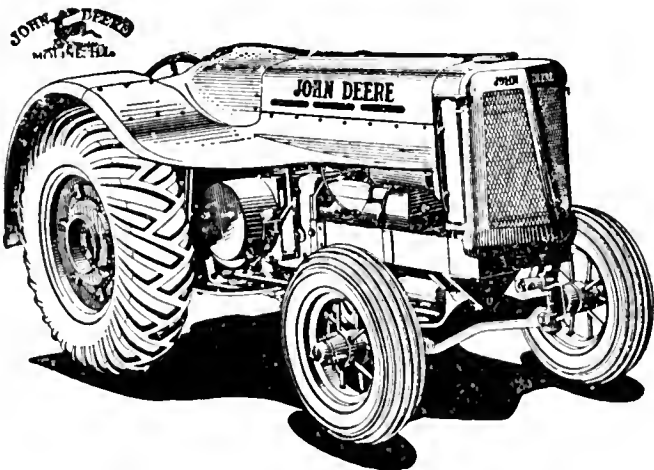

Model AO or BO. For the fruit grower, built low with streamlined hood to get close to trees.

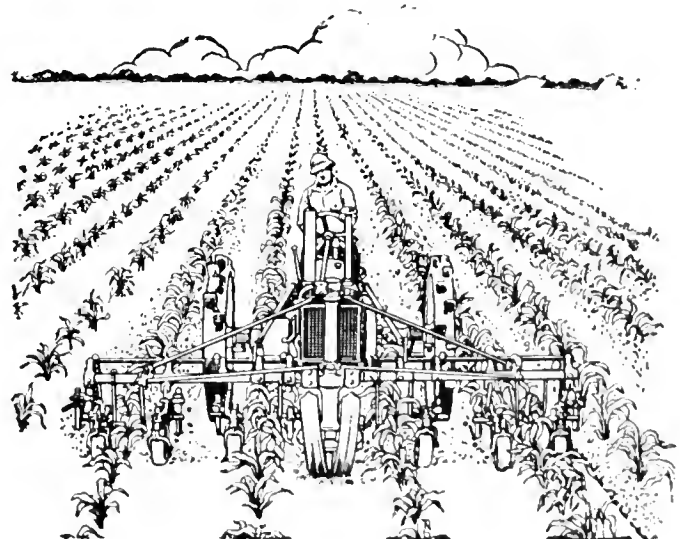

Hydraulic Power lift is available for Model A and B. tractors. It is controlled by a conveniently placed trip operated by either foot. It is quick and positive on the lift and provides a cushioned drop. Used on both 2 or 4-row cultivators.

New John Deere Enclosed Gear Mower

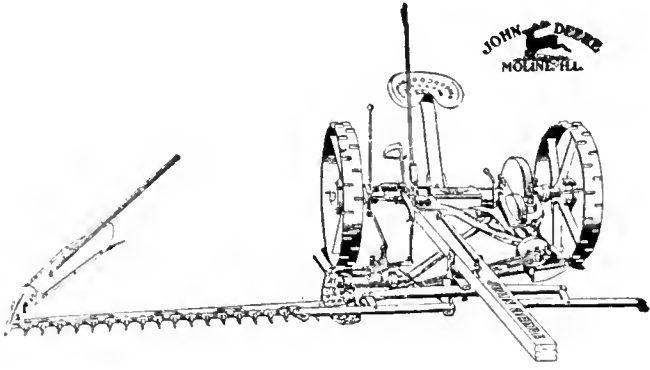

The high lift mower that oils itself. Six quarts of oil in the gear case and one pint of oil in each wheel-hub chamber provide ample lubrication for the average season's cutting.

Made in 4½, 5 6, and 7 foot sizes.

Prices on Application.

New John Deere Side-Delivery Rake

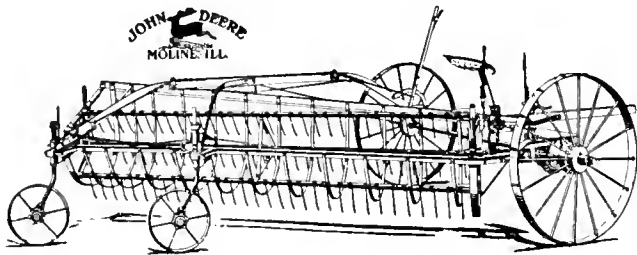

This is the latest development in side-delivery rake construction. Its floating cylinder and universal joint drive cause the hay to be "floated" gently into loose, fluffy windrows, leaves inside, stems out. It makes the John Deere Way of Making Hay of even greater value to the hay grower which means a better quality of hay and bigger profits.

Price on Application



Fine crop of Havana tobacco grown on farm of Frank Wojtkielewicz, South Deerfield, Mass., grown on O&W Blue Label tobacco fertilizer.

"Eddy Yankee" Horserake

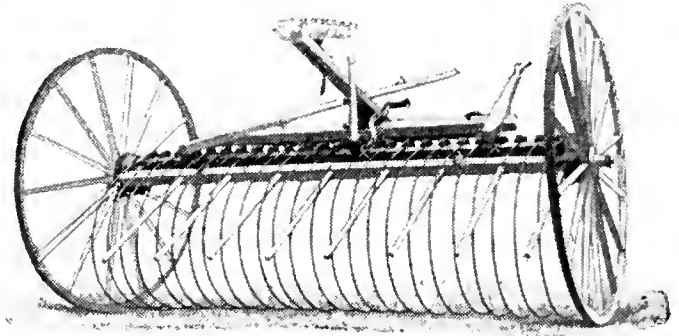

Strength, durability, ease of operation, and clean raking qualities are some of the features that have made this type rake the favorite in the New England States.

8 ft. with 25 teeth; 10 ft. with 31 teeth

Prices on Application.

New John Deere--Steel Sulky Rake

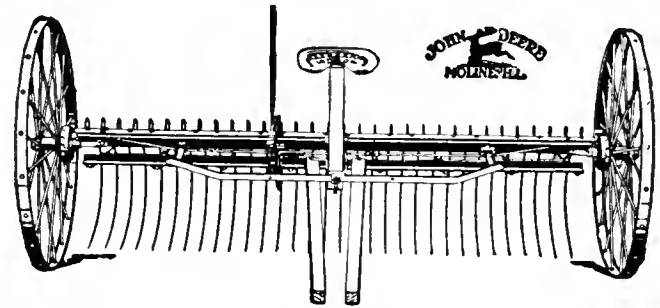

The rake that gives years of service. Wheels interchangeable, and dump rods reversible, giving extra wear without repair expense. There is no hay too heavy or too light for the John Deere Sulky Rake. It will do the kind of work desired under all conditions.

8 ft. with 24 teeth; 9 ft. with 28 teeth; 10 ft. with 32 teeth. Prices on Application

John Deere Single-Cylinder Windrow Hay Loader

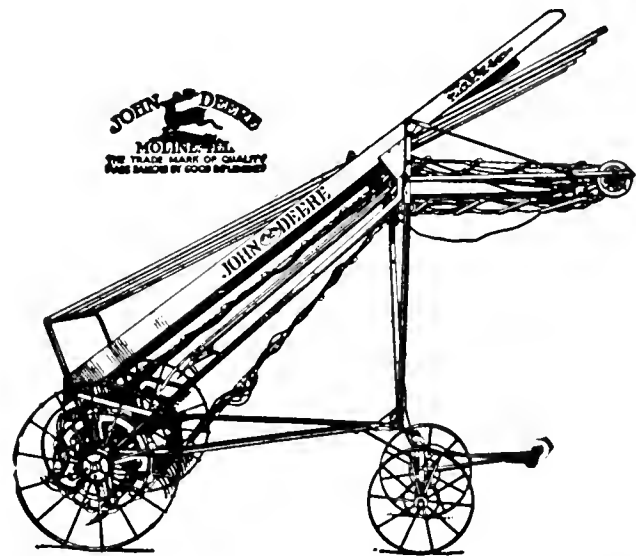

Very light draft and minimum number of working parts. Single drum mounted directly on the axle. Hinged carrier makes loading easy in windy weather. Furnished regularly with fore-carriage—no lifting is necessary when coupling to wagon. Extra strong, well braced frame with hot-riveted corner plates. Gets all the hay when properly raked into windrows. Handles alfalfa and clover without knocking off valuable foliage parts. Capacity ample for all side-rake windrows. Made in six foot width with fore-carriage.

Price on Application

New Improved Tiger Transplanter

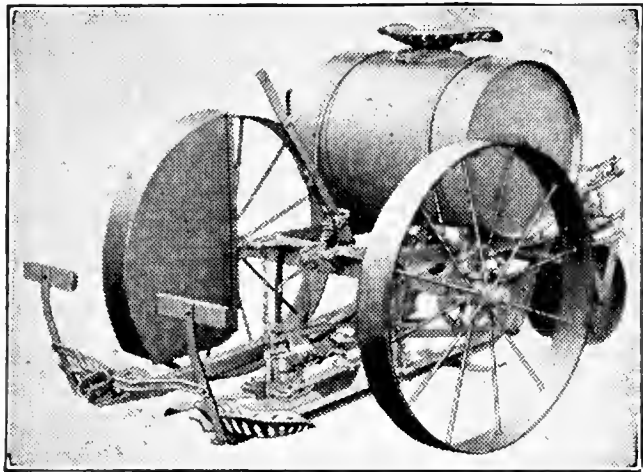

The lifting lever works on an eccentric. A child can lift the weight of two men and when the lever is operated it automatically throws machine out of gear. Simply and strongly made with these new improvements this machine is rapidly coming into favor with discriminating buyers. This machine has 1 1/4 inch water connections. The flow of water is under perfect control and can be regulated to deposit as small a quantity as desired, or to discharge one pint to each plant.

Price on Application

Bemis Transplanter

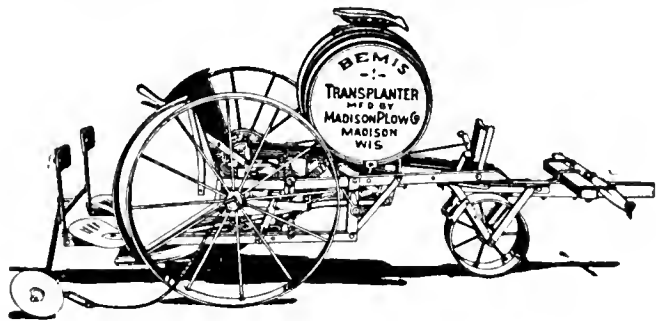

Thirty-five years of practical experience is embodied in the Bemis. Nearly every tobacco farm in the Connecticut Valley is equipped with one or more of these implements.

Price on Application

New Improved John Deere Spreader

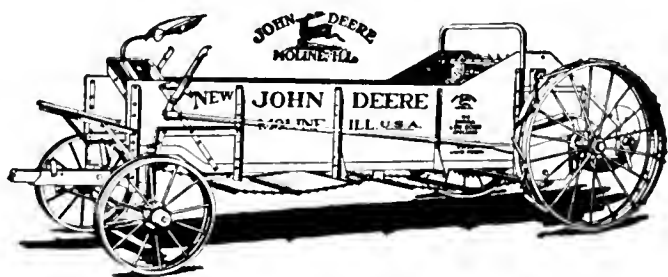

Has a tight bottom, with the beater on the axle and cushion-spring front bolster construction. Low, easy, loading box, is only hip high. High drive wheels, roller bearings on all three beaters, new type non-wrapping spiral beater, non-wrapping four-bar upper beater, and fewer moving parts assure light draft.

Price on Application

CATERPILLAR

REG. U. S. PAT. OFF.

Twenty-Two Tractor

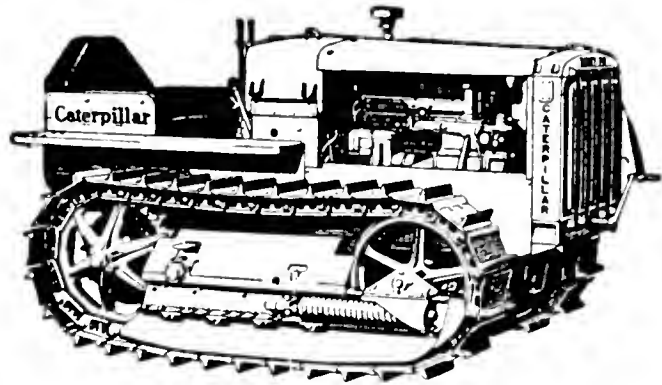

New in performance, New in economy. Backed by unequalled experience. Proved for service. Ask for a demonstration.

Prices on Application.

John Deere Tractor Plows

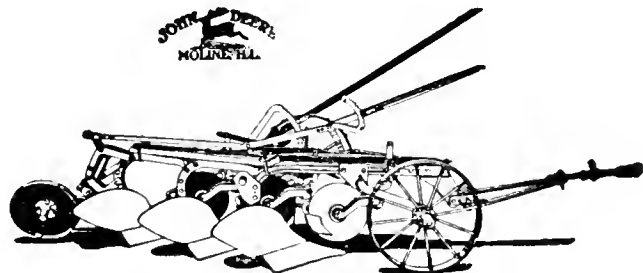

For use with Caterpillar tractors No. 5 and 6 plows are leaders. Sizes 3, 4 and 5 bottom with 12-14 or 16-inch bottoms.

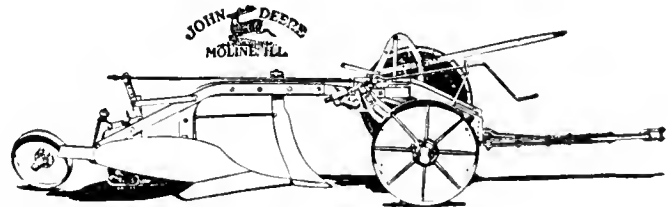

No. 11 Grub Breaker. Will reduce the cost of converting waste brush, bog, and swamp land into crop producing, profit-making farm acreage.



Caterpillar "22" pulling No. 5 Plow with 3-16" bottoms.

Steel Land Roller

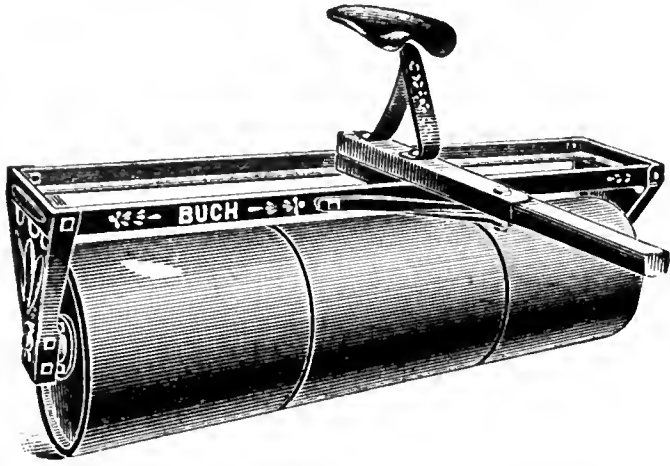

Drums of No. 12 gauge High Carbon Steel with Closed Pressed Steel Heads. Angle Frame—High Carbon Steel—3 x 3 x $\frac{5}{8}$ inches.

Axles—1 $\frac{5}{8}$ inch round.

Hangers—Heavy Wrought Steel with Hardwood boxings.

Built in two or three sections. Tractor hitch furnished if desired. Length 8 feet. Diameter of drum 24 inches. Weight 535 lbs.

Price on Application

Goslee Imp. Field Marker

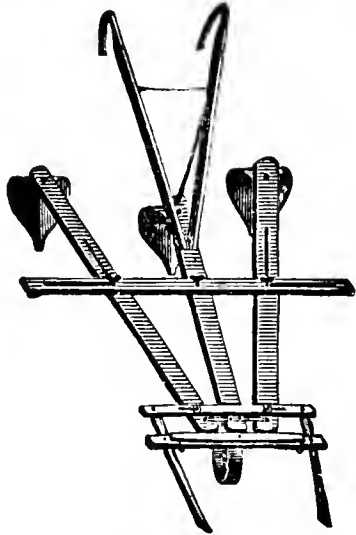

Is designed to mark out rows any width for any crops grown in rows. Teeth are adjustable to any size and depth drill.

Price on Application

Red Chief Corn Sheller

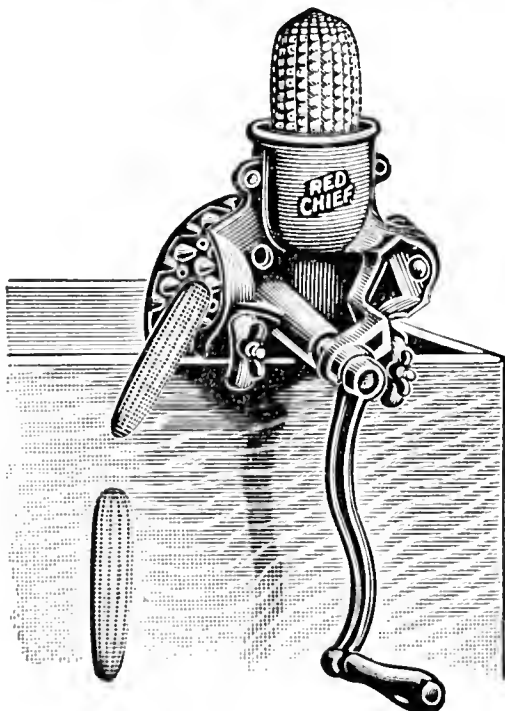

Substantial but low priced, made of iron, painted red. Can be attached to a barrel or box adjustable for large or small ears.

Price \$2.25 Net

Disc Hiller

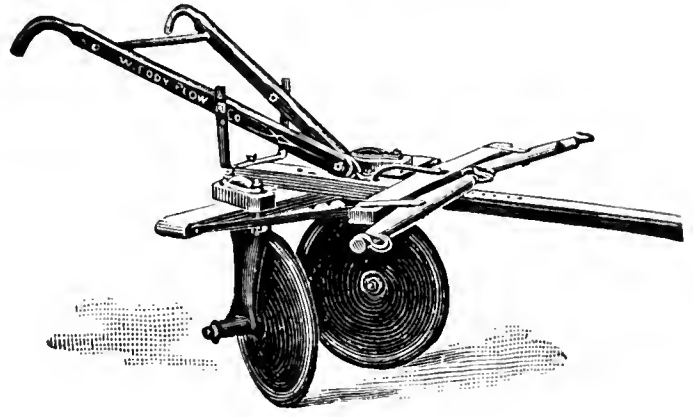

Is not restricted to the use of hilling and covering potatoes only, but can be used for many other crops, such as asparagus, celery, corn, beans, berries, grapes, etc. Has 20" discs made of best harrow steel properly tempered. Can also be furnished with blades in place of disks.

Prices on Application

Jumbo Feed Mill

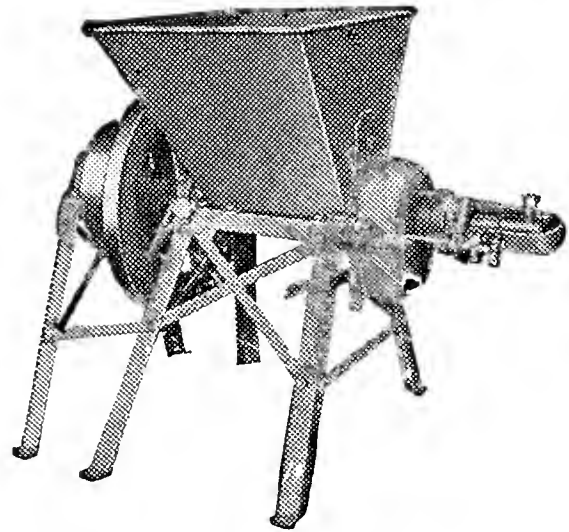

Is designed to work with tractor and engines from eight horse-power to thirty horse-power. You may operate it at 1500 revolutions per minute, and it will give good, dependable service, grinding 110 bushels of cob meal an hour.

The seven ball end thrust bearing easily absorbs the entire end thrust of the mill when running at this speed.

The two spout bagging elevator will attach easily and quickly. Feed is automatically diverted to other spout when one bag and spout are filled.

Prices on Application

New John Deere Hammer Mill

Now, you can get an inexpensive and economical John Deere Hammer Mill that will enable you to prepare your own feeds in the rations desired from the crops raised on your farm. The work of this new 10-inch mill ranges from the finest grinding for chick or pig mash, to the cracking of corn and the coarser grinding for other classes of livestock. It does an excellent job of preparing feed at remarkably low cost, and its big capacity with a minimum of power is a surprise to every farmer who has seen it in operation.

Prices on Application.

Jumbo Saw Frames

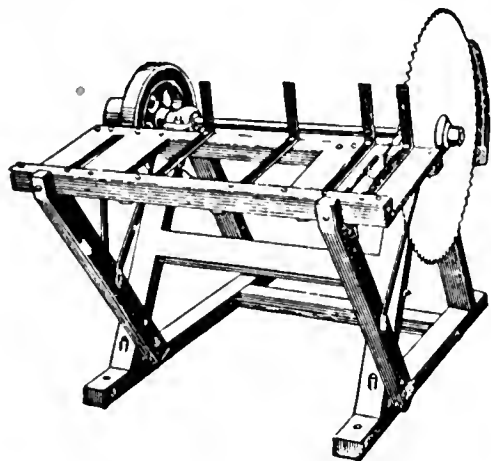

No. 700. With Tilting Table. Built especially for sawing cord wood. Mandrel of finest cold rolled steel $1\frac{7}{8}$ " dia., 49" long—fitted for saw with $1\frac{3}{8}$ " hole. Flywheel is accurately machined and carefully balanced, $15\frac{1}{2}$ " dia.; weight 65 lbs. Standard pulley size 6 x 6".

Prices on Application.

Guaranteed Cord-Wood Saws

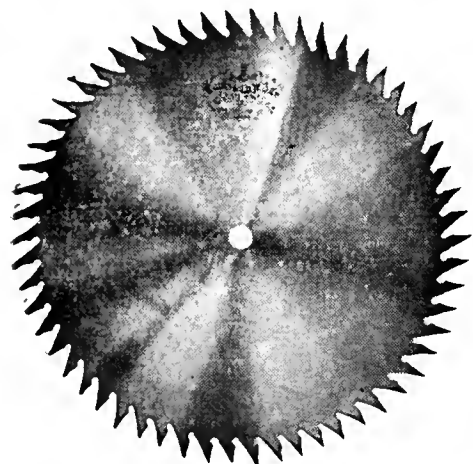

Always run the saw at proper speed, too high or too low is equally bad.

Dia.	No. teeth	Speed	Price
20"	52	1800	\$3.50
22"	56	1636	4.00
24"	60	1500	4.50
26"	64	1384	5.00
28"	70	1285	5.75
30"	76	1200	6.50

Mountville Red Rubber Belting

For Industrial and Agricultural Machinery

Good belting plays an important part in the successful operation of any kind of power machinery. Mountville Red Rubber Belting is made of 32 ounce duck and a high grade rubber compound which prevents its being affected by moisture. Stretching and shrinking are reduced to a minimum, and it remains flexible winter and summer. No breaking-in is necessary and its modern friction surface construction enables it to pull a full load without excessive tension.



Prices on Application.

The Louden Litter Carrier

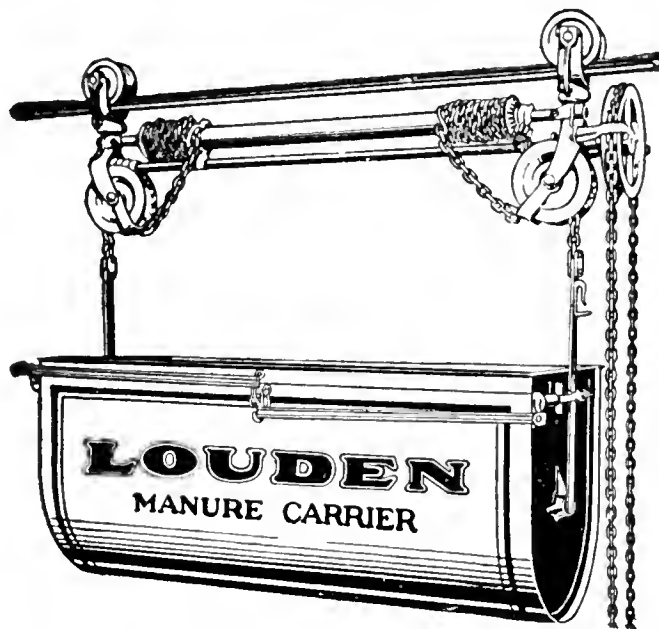

We believe this to be by far the greatest litter carrier ever built. Made to handle heavy loads of wet manure easily, safely and for many years.

Tub is water tight, full 12-bushel capacity. The worm gear hoist on this Louden Carrier is built on the same principle as the highest industrial hoists. It is far superior to the dangerous, troublesome brake and ratchet type.

Load hangs squarely under the track with minimum wear on trolleys. Roller bearing wheels. Sturdy steel track, good for a lifetime. Tub trips from either end. In every respect a quality carrier.

Price on Application.

Louden Double Post Stall

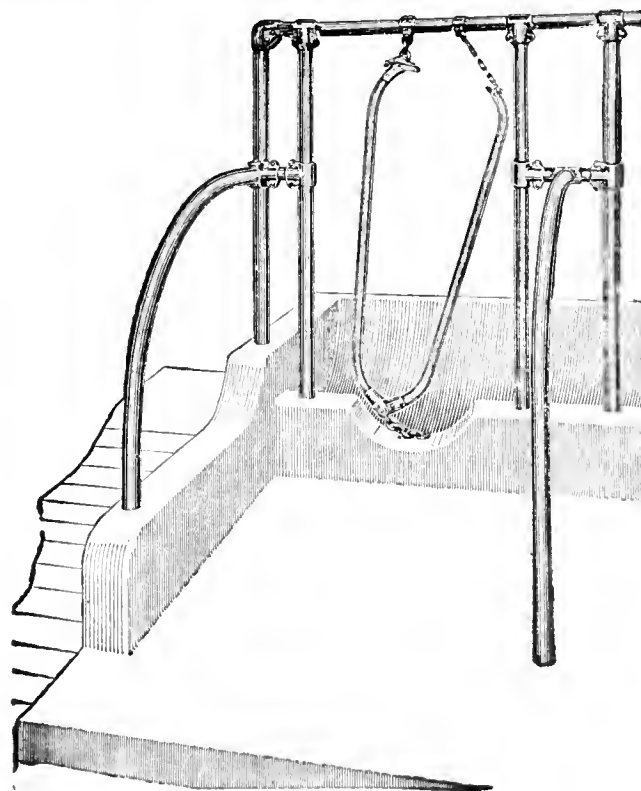

The Louden Cross Braced Double Post Stall is the most popular cow stall ever manufactured. The stall posts are so spaced that with the Louden flexibly hung stanchion there is ample room at either side for the comfort of the cow. The posts are set the proper distance apart to let the stanchion open wide enough to receive the cow's head, and yet not so wide that the cow can walk right through it. Prices on application.

Rex Grindstones

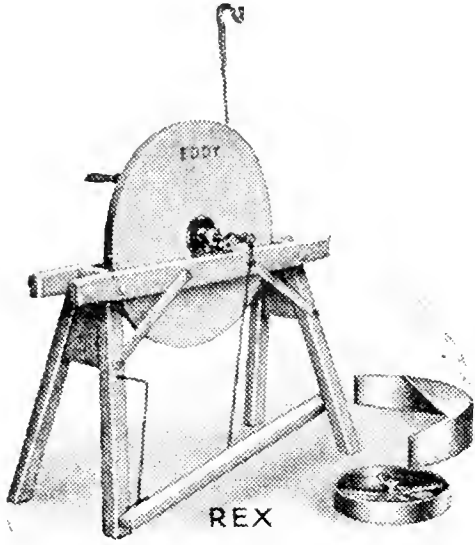

The journals are of the improved hardened steel ball and race type of specially treated steel. Frame which is securely braced and bolted is made of well-seasoned hardwood.

No. 20 size 20" dia. by 2" to 2 1/4" face
Net Price \$10.00

No. 24 size 24" dia. by 2 1/4" to 2 1/2" face
Net Price \$12.00

No. 28 size 28" dia. by 2 1/2" face
Net Price \$15.00

Power pulley 10" dia. 2 1/2" face
Net Price \$2.00

Jewel Grindstones

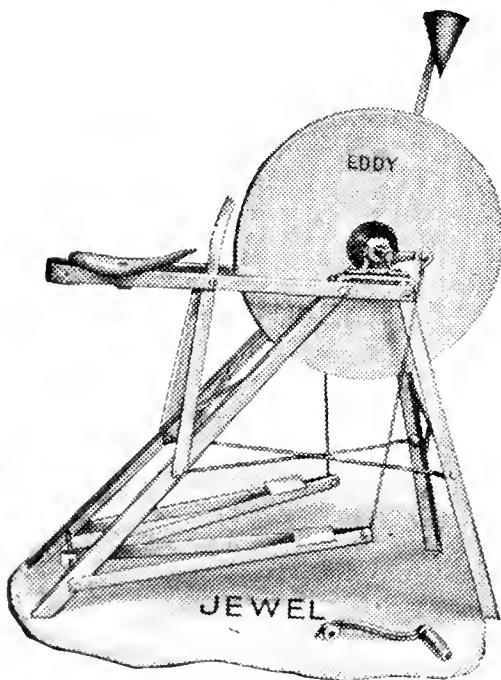

This stone comes equipped with two pedals, adjustable seat, crank and drip cup.

No. 22 size 22" dia. by 2" to 2 1/4" face
Net Price \$12.50

No. 24 size 24" dia. by 2 1/4" to 2 1/2" face
Net Price \$14.00

Carborundum File



Carborundum File 14 in. long. Price \$1.00.
Mighty handy for the farmer or gardener.

Modern Grinders

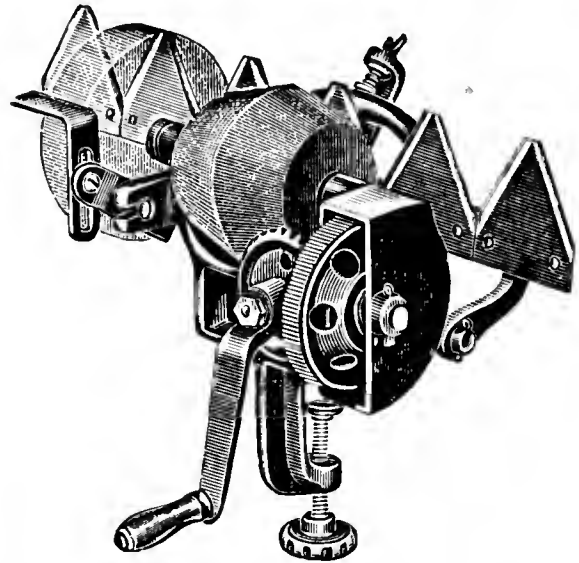

Model G. Machine cut drive gears enclosed. Can be clamped to mower wheel.
Net Price \$9.50

Model MX No. 3. A high grade, low priced sickle grinder.
Net Price \$5.90

Norton Pike Scythestones

Famous old brands which have given service to generations of users.

Granger No. T54—10"x1 1/4"x 3/4" 10c
Green Mountain No. TN10—10"x1 1/4"x 1/2" 15c
Western Red End No. TN13—10"x1 1/4"x 3/4" 15c

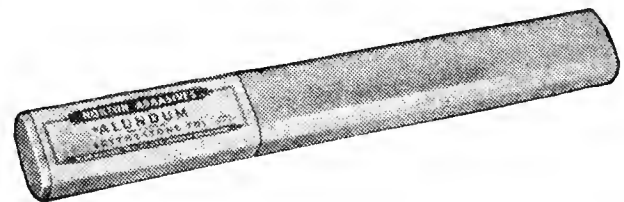

Alundum No. TD2—10"x1 5/6"x 1/2" 20c
Alundum No. TD1—10"x1 1/4"x 3/4" 25c
Black Diamond No. TN304—10"x1 1/4"x 1/2" 25c
Scythe Rifle No. TS3—12 3/4"x1 1/4"x 5/8" 25c



Crystolon No. TJ2—10"x1"x 5/8" 30c
Crystolon No. TJ3—10"x1 1/4"x 3/4" 30c
Sir Pike No. TN15—9 1/2"x1 5/8" 30c
Sir Pike No. N14—12"x1 5/8" 35c
Crystolon Utility File No. JD2 \$1.00

Complete Stone Boat



Handiest implement on the farm. The front is of high grade carbon steel 34 in. wide, firmly bolted and braced to the raves and bottom boards, which are hardwood.

Price \$15.80 Net Cash Price \$15.00

Stone Boat Heads

Cast Iron 32 in. with bolts. Price \$6.00
Steel 34 in. with bolts. Price \$5.00

Steel Drag Scrapers

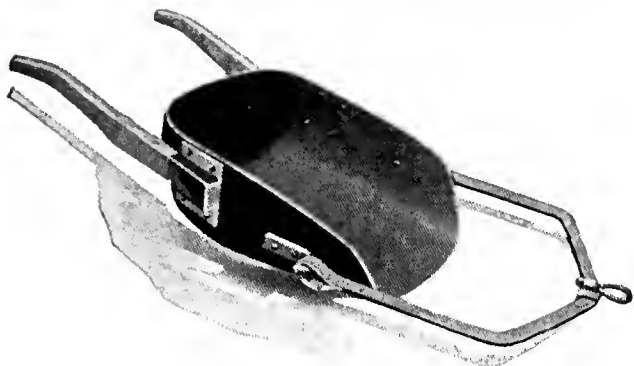

No. 3	3 Cubic Ft.	\$10.00 Net
No. 2	5 " "	10.50 Net
No. 1	7 " "	11.00 Net

Automatic Self-Adjusting Step Ladder

Will not fall if either leg or ladder slips or sinks several inches into the ground. Saves time, labor and trouble. It is insurance against accidents and injuries.

6 ft. \$3.90 8 ft. \$5.20 10 ft. \$6.50



Myers Cog Gear Submerged Cylinder Double Acting Force Pump



For use in drilled or open wells up to 150 feet in depth. Anti-freezing. No. R72 as shown, with brass lined lower cylinder. Price \$20.75.

Net Cash Price \$19.72

Myers Cog Gear Lift Pump

Anti-freezing, with brass lined cylinder. Can be used on deep wells.

No. R1052. Price \$13.00
Net Cash Price \$12.35

No. R1058 same as above except has polished iron cylinder. Price \$10.00.

Net Cash Price \$9.50

Myers Cog Gear House Force Pump

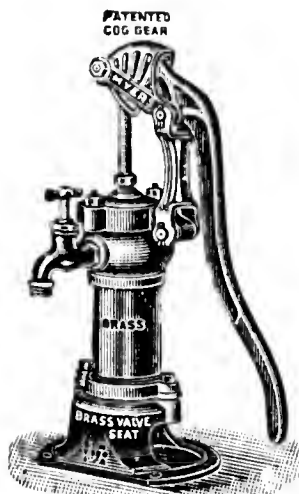

With three-inch seamless drawn brass cylinder, plain brass valve seat and hinged check valve.

No. R414. Price \$8.00

Net Cash Price \$7.60

Myers Cog Gear Pitcher Pump

Fitted with brass valve seat. Long stroke. Large capacity. More water with 33 1/3 % less power required to operate.

No. R416. Price \$4.75

Net Cash Price \$4.52

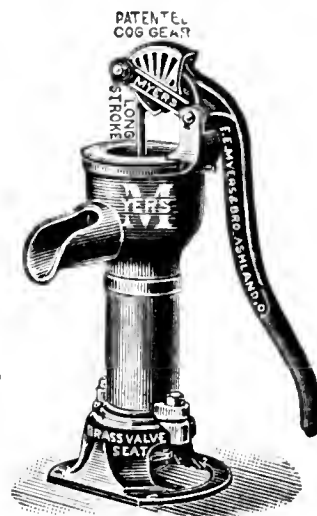

Myers Self-Oiling Home Water System

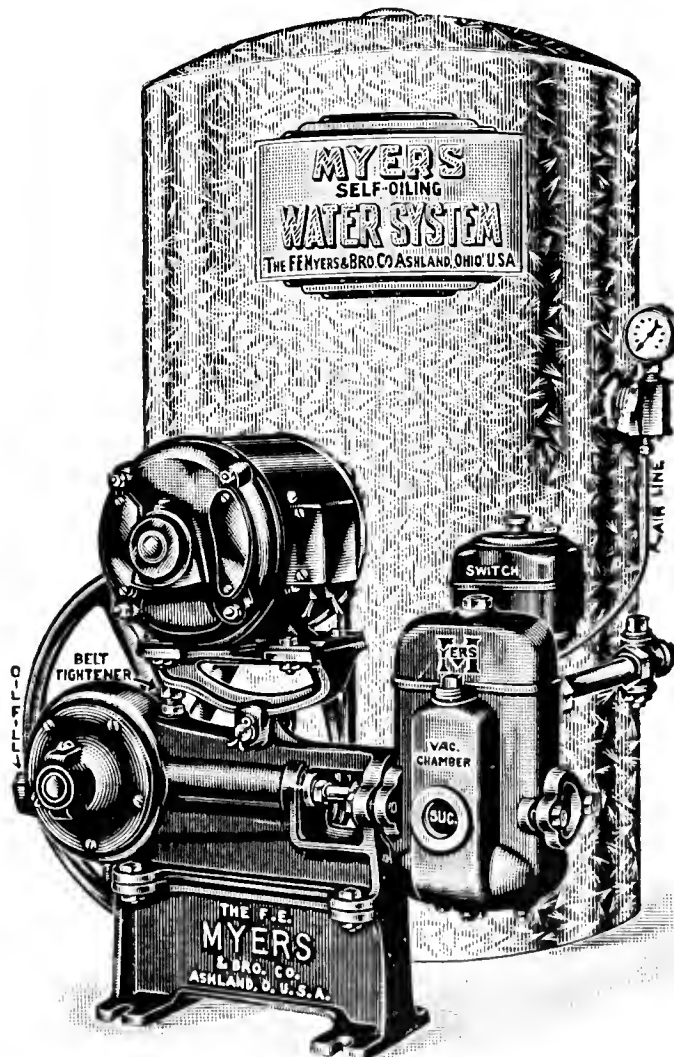

Complete automatic control. No personal attention necessary. Designed for operation from any kind of city current or from farm lighting and power systems. For use in cisterns or shallow wells up to 22 feet to low water level. Capacity 250 gallons per hour. No. 1906AT. Price \$75.00.

Net Cash Price \$71.25

SEND FOR OUR COMPLETE CATALOG OF PUMPS AND WATER SYSTEMS.



"LOOK INTO IT"
TRADE MARK REGISTERED

You must paint—how often you must do it depends upon the paint you use. For long wear and all around satisfaction, we recommend

B. P. S. Paint.

We know that it is ground fine and works so easily under the brush that you can paint with two to three gallons less than with a cheap per-gallon paint. With B. P. S. Paint you will

Use Less to Do More...

The labor usually costs three times as much as the paint, so be sure to employ a good painter. Good judgment in applying is as necessary as good paint.

We carry a full line of B. P. S. Finishes and will be glad to furnish color cards and estimates.



2½ lb. pkg.	.25
5 lb. pkg.	.40
8 lb. pkg.	.60
15 lb. pkg.	.75

Rutland Asphalt Paint

The finest and most durable asphalt known. Dries quickly leaving a hard, glossy, black finish.

1 gal. can. \$1.25

Rutland Roof Cement

No. 4 BLACK	
1 lb. can	\$.20
5 lb. can	.65
10 lb. pail	1.10
25 lb. pail	2.25
50 lb. pail	4.00
100 lb. drum	7.00



Protect your Property - Re-Roof Now!

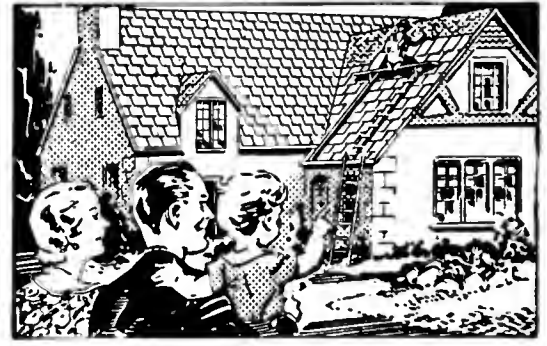

AND when you re-roof, be sure that you buy the material which will insure the best appearance and longest wear. You can do so by choosing Carey Shingles or Roll Roofings, for these high quality products are the result of 60 years of experience.

We'll save you money on exactly the right roof for your needs—let's talk it over.



Rutland Black Roof Paint

Is a fibreless asphalt paint. It does not contain coal tar.

1 gal. can	\$.75
5 gal. can	3.00
25 gal. can	13.50
50 gal. bbl.	22.00

Rutland Asphalt and Asbestos Roof Coating

Is for repairing and renewing old roofs. Will work equally well on metal, paper, or composition roofs.

It also is used for waterproofing the outside of foundation walls.

1 gal. can	\$.75	5 gal. can	\$3.00
25 gal. can	13.50	50 gal. bbl.	22.00



Long Three-Tine Hay Forks

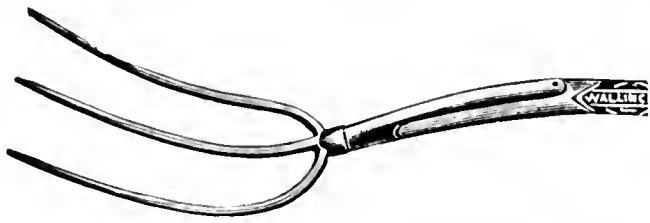

Wallingford Brand First Quality
Plain Ferrule

4 ft. handle	13 in. tine	\$1.45
4½ ft. handle	13 in. tine	1.50
5 ft. handle	14 in. tine	1.60

Wallingford Brand First Quality
Strap Ferrule

4 ft. handle	14 in. tine	\$1.55
4½ ft. handle	14 in. tine	1.65
5 ft. handle	14 in. tine	1.75
5½ ft. handle	14 in. tine	1.85
6 ft. handle	14 in. tine	2.00

10% Discount in Dozen Lots.

Manure Forks

Wallingford Brand First Quality

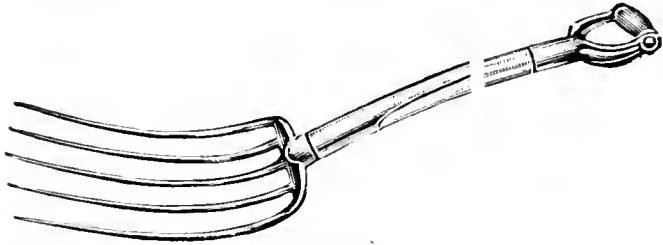

4 Tine	5 Tine	6 Tine
Long Handle Common Ferrule		
\$1.55	\$1.75	\$1.90
Long Handle Strap Ferrule		
\$1.65	\$1.85	\$2.00
Mal. D. Handle Common Ferrule		
\$1.55	\$1.75	\$1.90
Mal. D. Handle Strap Ferrule		
\$1.65	\$1.85	\$2.00
Wood D. Handle Common Ferrule		
\$1.65	\$1.85	\$2.00
Wood D. Handle Strap Ferrule		
\$1.75	\$1.95	\$2.15

Steel Manure Hooks

Wallingford Brand First Quality

Bent Head—Oval Tines

4 tine	5 ft. handle	\$1.40
5 tine	5 ft. handle	1.55

Standard Wedges

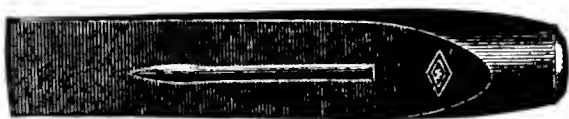

4 lbs. 45c 5 lbs. 55c 6 lbs. 65c

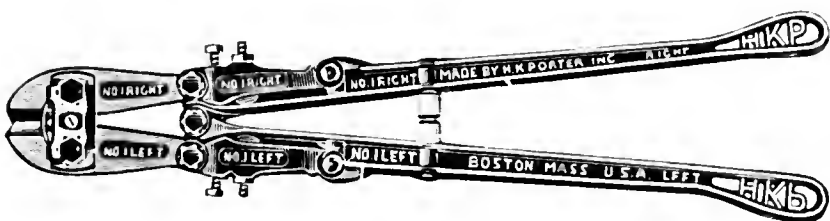

Porter Boat Clippers. Have for more than half a century been the standard.
Prices on Application.

Cutter Mattocks



5 lb. 80c

6 lb. 85c

Pick Mattocks



5 lb. 85c

6 lb. 90c

Railroad Picks



6 lb. 75c

7 lb. 80c

8 lb. 90c



Grub Hoes

4 in. wide 85c



Axes

\$1.00
\$1.75
\$2.00
\$2.50



Axe Handles 25c, 35c, 50c, 60c
Mattock and Pick Handles, 30c, 40c, 50c

Three Power Forester



No. 1—20" long. Capacity 1⅜ in. Especially designed for the fruit grower.
Price \$5.00

No. 2—27" long. Capacity 1½ in. Suitable for forest priming, brush and shrub cutting.
Price \$6.00

No. 3—34" long. Capacity 2 in. An amazingly powerful tool.
Price \$7.00

Wallingford Brand Grade A Tobacco Hoes

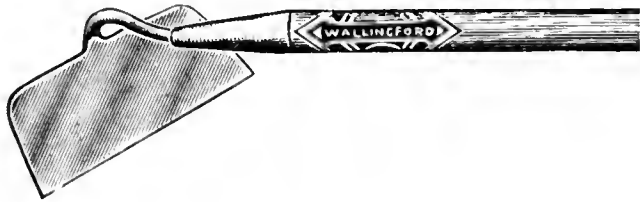

8" x2 ⁵ / ₈ "	\$1.35	9 ¹ / ₂ " x2 ¹ / ₂ "	\$1.45
8 ¹ / ₂ " x2 ³ / ₄ "	1.40	10" x2 ¹ / ₂ "	1.50
9" x2 ³ / ₄ "	1.40	11" x2 ¹ / ₂ "	1.75

10% discount in dozen lots.

Wallingford Brand Field or Garden Hoes

8" x3 ³ / ₄ "	\$1.35	9" x3 ³ / ₄ "	\$1.40
-------------------------------------	--------	-------------------------------------	--------

Steel Garden Rakes

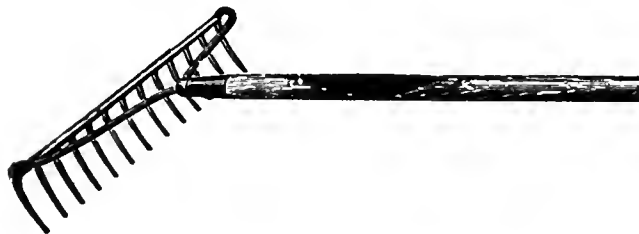

14 teeth 60c to \$1.15 16 teeth 70c to \$1.25

Wallingford Brand Spading Forks

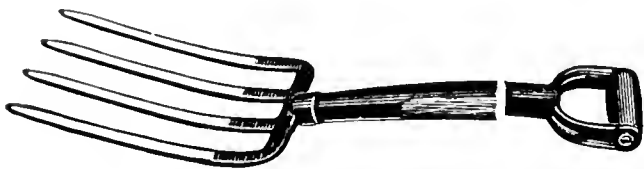

Strap Ferrule

4 tine	Long Handle	\$1.75
4 tine	Mal. D Handle	1.75
5 tine	Long Handle	2.40
5 tine	Mal. D Handle	2.40

Coal Scoops

No. 3 Hollow Back Split D Handle	\$1.45
No. 4 Hollow Back Split D Handle	1.50
No. 5 Hollow Back Split D Handle	1.55
No. 6 Hollow Back Split D Handle	1.60

Full Polish Round Point Shovels



Fox Brand Plain Back No. 2	\$1.85 each
Fox Brand Plain Back No. 3	1.90 each

Square point—same price

Black Round Point Shovels

Fox Brand No. 2	\$1.60
Fox Brand No. 3	1.75
McCarr Brand No. 2	1.25
McCarr Brand No. 3	1.30

Full Polish No. 2 Garden Spade, \$1.85

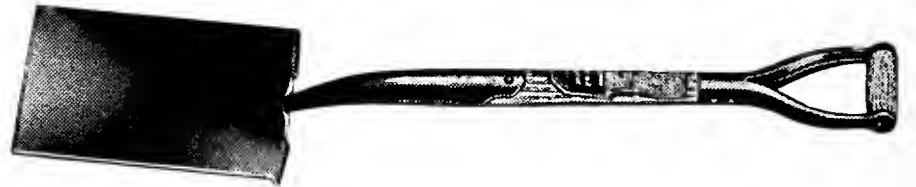

Black No. 2 Garden Spade \$1.10

Snow or Barn Shovels



No. 2	Long Handle	65c
No. 2	Steel D Handle	75c
No. 2	Split D Handle	75c

Flat Top Turf Edger

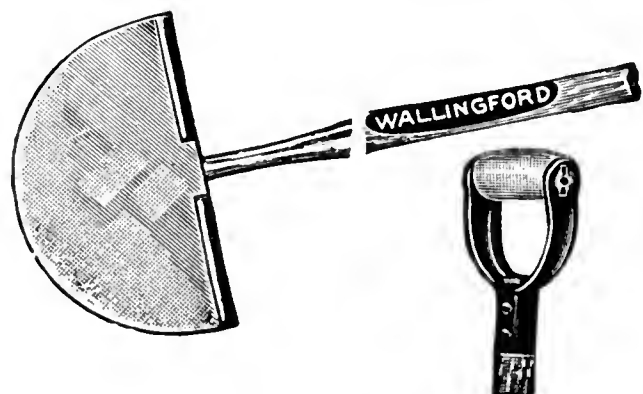

Steel "D" or long Handle \$1.00

Hudson Coal Brooders

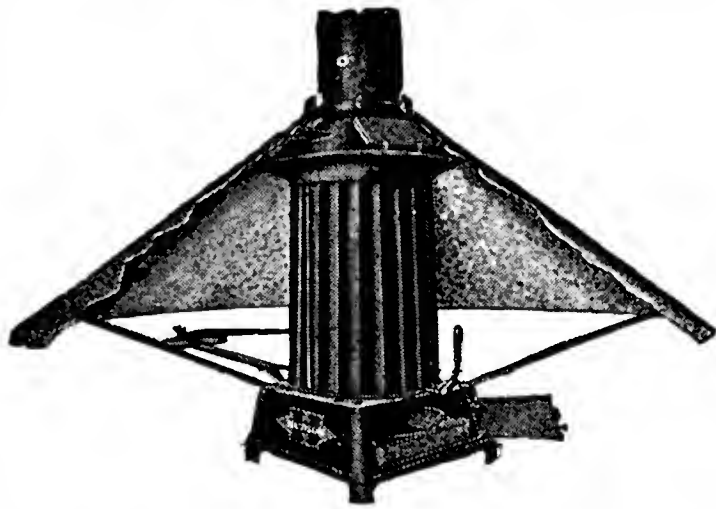

Square base and ashpit of greater capacity. New type coal door hinge, eliminating binding or poor fit.

Prices on Application.

Range Feeder with Grill Type Guard

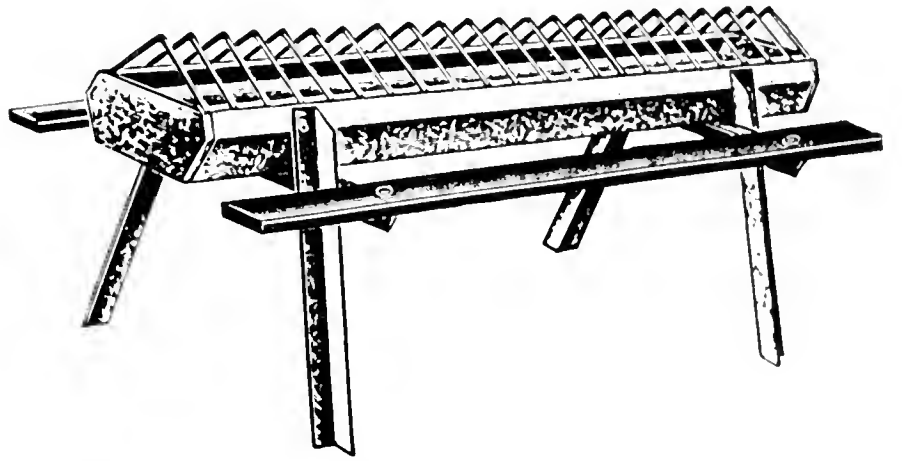

Hinged to permit easy cleaning and filling. 4 ft. Feeder (with perch and legs). Price \$2.50
5 ft. Feeder (with perch and legs). Price 3.00

Chick and Broiler Feeder

Hudson Oil Burning Brooders

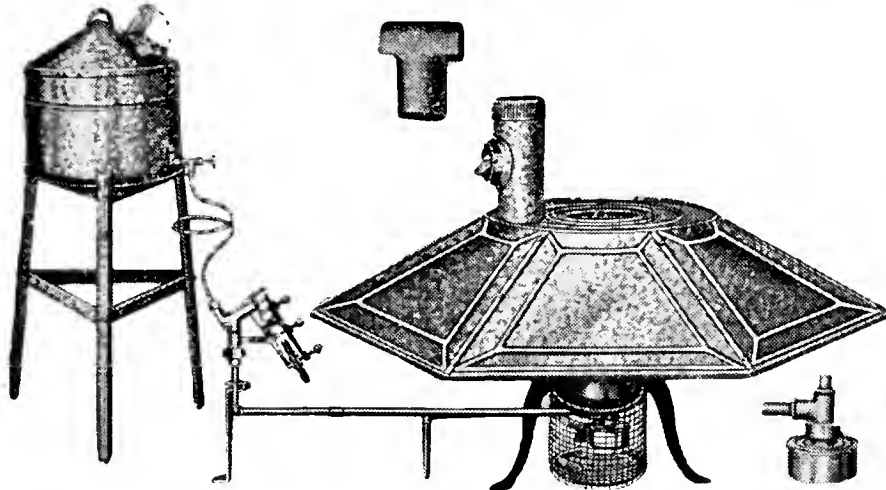

The secret of the success of the Hudson Stove rests in the perfectly functioning valve and powerful specially designed burner which is so efficient that it will burn equally well kerosene or cheap fuel oil (distillate).

Sizes from 200 to 1500 day old chicks.

Prices on Application.

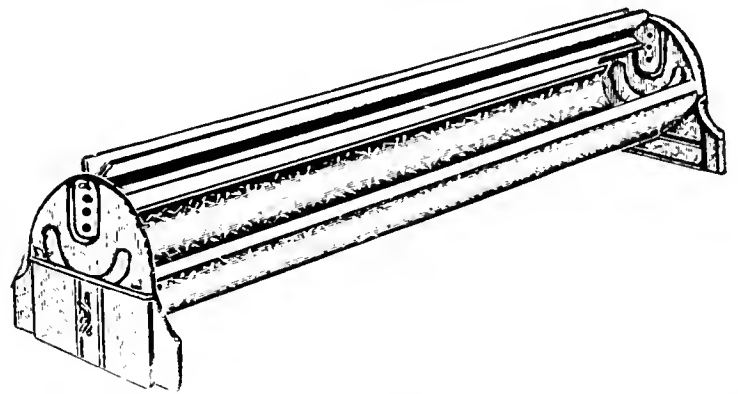

Reel is designed to take care of chicks from one day old to well past the broiler state. For small chicks, feeder stands are adjusted so that feeder bottom is near the ground and reel is in low position. Feeder may be raised by stand adjustment from week to week, as chicks grow, until its maximum height of 2 3/4 inches has been reached. With the feeder and the reel at top position this is an ideal feeder for broilers. Feeder trough 2 1/4 in. deep, 4 in. wide at bottom, 4 3/4 in wide at top with 3/4 in. feed-saving lip.

No. 536 FEEDER Length 36 in. 75c
No. 548 FEEDER Length 48 in. 95c

Slide Top Chick Feeders

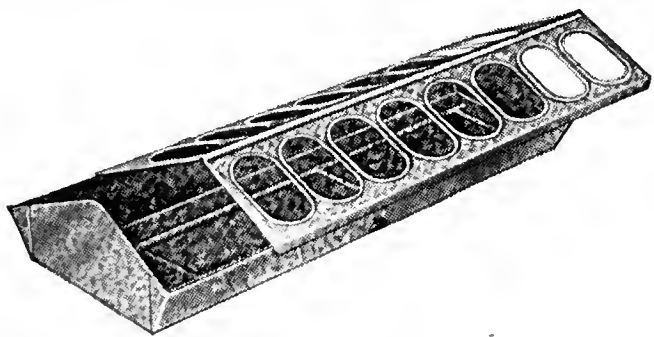

These popular priced feeders are made of galvanized steel. Die stamped.

10" size, 16 holes Price 12 1/2c

Leads-All Chick Feeders

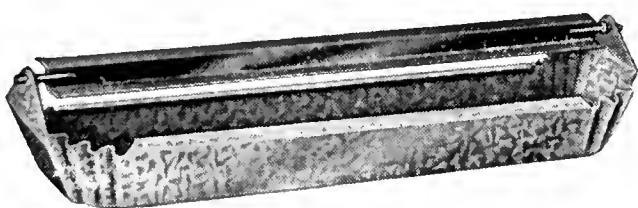

Is not the conventional type of small, low-priced feeder. Die-formed from heavy galvanized steel, with feed-saving lip curved for chick safety and feed economy. Prices, 12 in. 15c; 18 in. 20c; 24 in. 25c.

CHICK FOUNTAINS

Mason Jar Types. Glass as shown 15c. Heavy enameled material 2 for 15c.

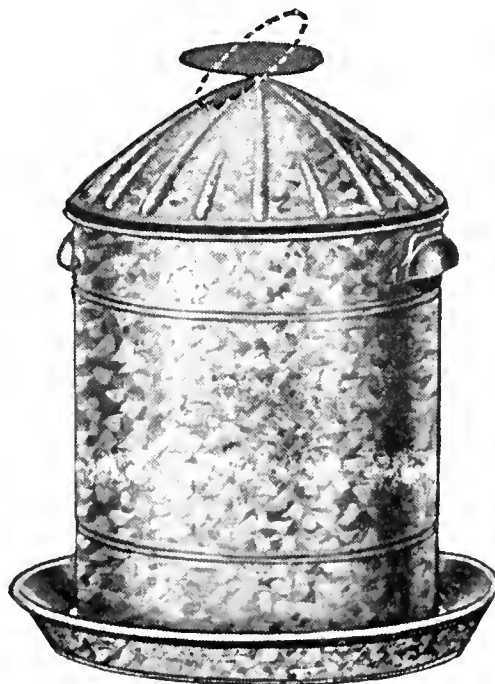

Double Wall Fountains

Top filled. Feeds automatically.

Sizes 5 and 8 gallons.

Prices on application.

Corn Shellers

Chicopee—One Hole—hand (as shown).
Price \$10.00 Net Cash Price \$9.50
Chicopee—Two hole—power.
Price \$22.50 Net Cash Price \$21.37
Lion—One hole—hand.
Price \$11.00 Net Cash Price \$10.45

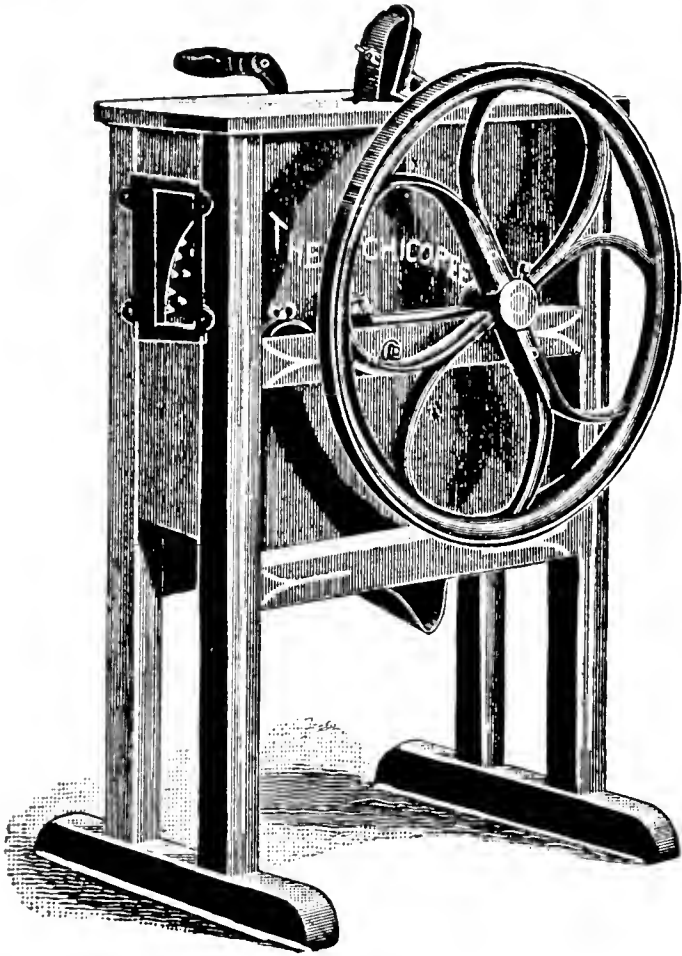

Champion Vegetable Cutters

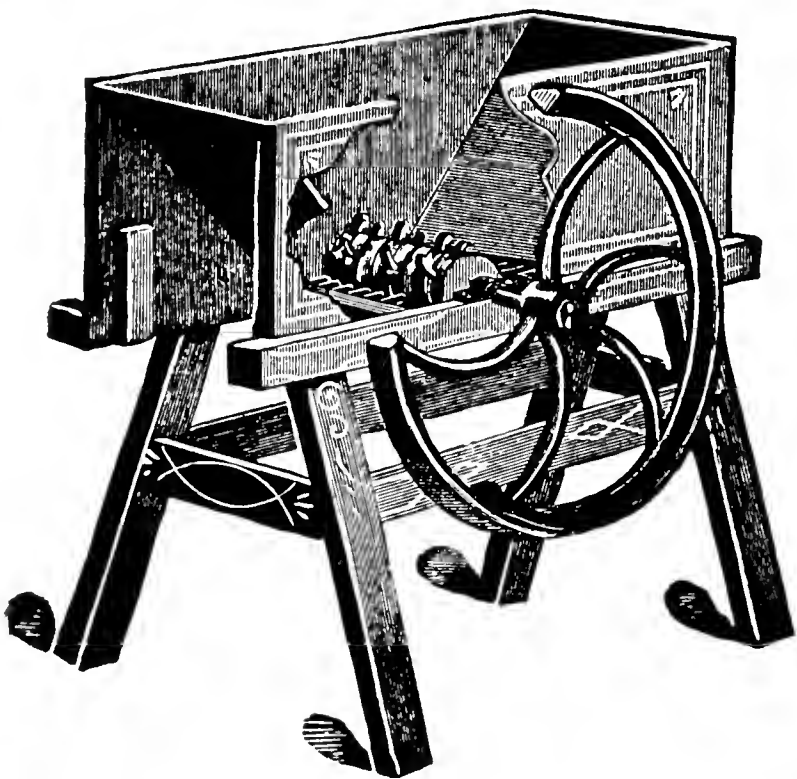

This is one of the best machines on the market for cutting all kinds of vegetables. It is made with a wrought shaft with sections of knives fastened to it, and arranged so that a rotation of knives is continually passing a bed knife with cross knives passing between the sections of knives; cutting always near the center shaft, making it cut easy and fine enough for cattle or sheep; also making a very regular cut.

This machine will cut sixty bushels an hour.
Price \$12.00 Net Cash Price \$11.40

Atlantic Motor Oils

You've heard of the new exclusive process developed by the Atlantic Refining Company. In giving its Motor Oil this amazing High Film Strength (greater even than pure castor oil) Atlantic has made the greatest improvement since the invention of the automobile. High Film Strength (only Atlantic Motor Oils have it) keeps your motor young; the strong film of Atlantic Oil keeps engine surfaces apart and prevents the costly metal to metal contact that leads only to one sad end—new piston rings or other expensive repairs. In preventing what was up to now normal wear Atlantic High Film Strength Motor Oils not only help you save money on repair bills but will retain new car performance.

Give it a real trial. We know the correct grade for your automobile, tractor or farming equipment.

Atlantic High Film Strength Motor Oils cost no more than out-of-date motor oils.

KEEP UPKEEP DOWN

1 gallon and 5 gallon cans

30 gallon and 50 gallon drums.

Prices on Application.

Clipmaster

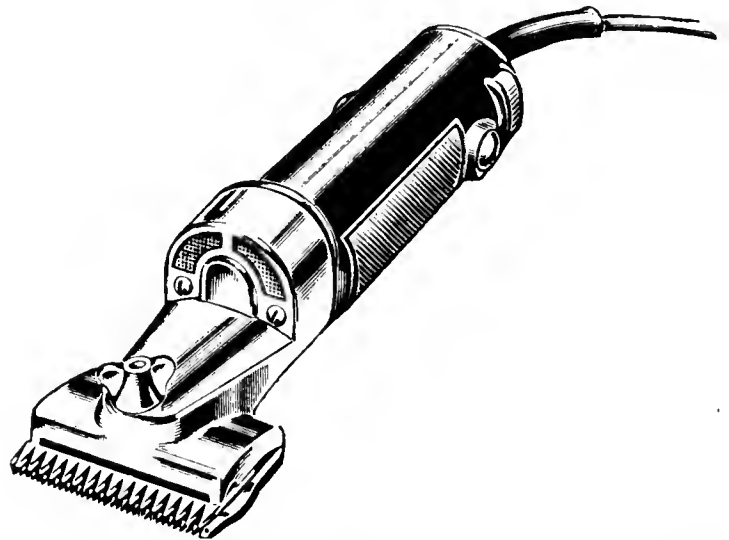

FOR COWS, HORSES, MULES, DOGS

New STEWART Clipmaster with ball-bearing, air-cooled motor inside composition handle. Fully insulated—no ground wire to bother with. 78% more power makes this new Clipmaster by far the finest, fastest, and easiest clipping machine ever built.

Price \$17.95



Harvesting a fine crop of Havana tobacco on the farm of James Wilson, Poquonock, Conn., grown on O&W fertilizer.

ATKINS SILVER STEEL PRUNING SAWS

No. 13 Curved Pruner

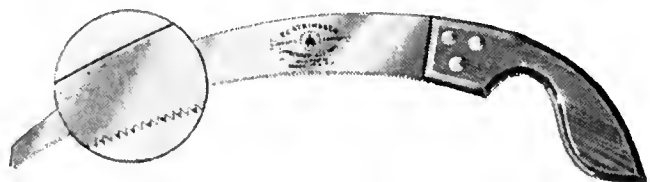

The blade is peg tooth of uniform temper, noted for its edge holding qualities.
Length 14" Price \$1.65

Utility Speed Pruner No. 14

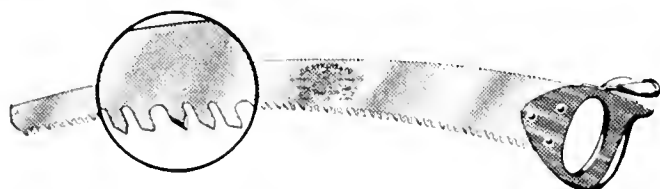

The curve in this pruner gives correct stroke for an easy full cut. Diamond point teeth and raker quickly cleans the cut.
Length 26" Price \$3.50

No. 16 "AAA" Pole Tree Pruner



Fitted with peg teeth and fastened to casting with bolt and wing nuts. The blade is adjustable to cut at any angle.
Length 16" Price \$2.50

No. 3 Duplex Pruner



One edge for extra heavy coarse work. Fine teeth on opposite edge for finer cutting. The handle is of well seasoned apple wood.
Length 18" \$1.75 20" \$1.85

No. 11 Tapered Pruner



Frame is made of high grade crucible steel $\frac{3}{4}$ " wide. Blade can be adjusted to any angle.
Length 18" Price \$2.50

No. 40 Tuttle Tooth Pruner

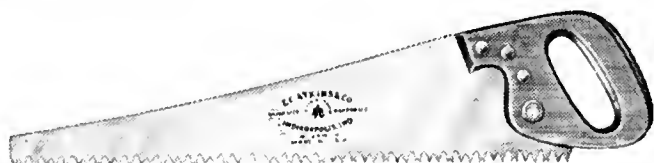

Made of high grade special steel. Teeth hold their edge longer due to extra fine temper. Large and roomy grip reinforced with dowel pin making it rigid.
Length 20" \$2.85 24" \$3.35

No. 41—A six point hand saw tooth with wide set, bevel filed.
Length 26" Price \$4.00

Atkins Silver Steel segment ground cross-cut saws are manufactured with utmost care to insure quality of material and workmanship. Each saw is thoroughly inspected before shipment.

Economy One Man Cross Cut Saw No. 090



Tuttle Tooth. Hardwood handle, easy grip.
Length—feet 3 3½ 4
Price \$2.50 \$3.00 \$3.40

One man Lance Tooth Cross Cut Saw No. 761. Is a very popular pattern with four long lance teeth and one raker to each section. Taper ground, does not bind. Filed and set ready for use.

Price 3 ft. \$4.50 3½ ft. \$5.00

Two-Man Cross Cut Saws

Economy No. 079. Suitable for cutting either soft or hard wood.

Price 5 ft. \$2.25 5½ ft. \$2.50

Hollow Back Forester No. 388 is made of special steel and ground thin back for easy clearance.

Price 5 ft. \$4.65 5½ ft. \$5.25

TUTTLE TOOTH NO. 331

The most popular medium priced two-man cross cut saw on the market. Made of high grade special steel.

Price 5 ft. \$5.25 5½ ft. \$5.75

Segment Ground Cross Cut Saw. No. 9 Forester with the **Blue Ends**, superfine in every way. Hand-smithed blades; perfect temper; expert workmanship. The fastest and smoothest cutting saw ever made and needs very little filing.

Price 5 ft. \$7.95 5½ ft. \$8.95

"Last Word" Hand Saw No. 58

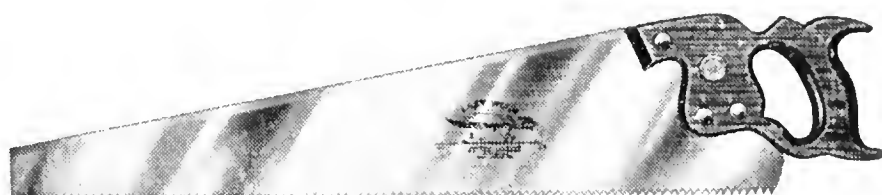

A guaranteed moderately priced straight back saw for general use. New style easy grip handle.

Length 26" 7 or 8 point Price \$2.00



Fine crop of Havana tobacco on the farm of Joseph Falkowski, West Suffield, grown on O&W Complete tobacco fertilizer.



Fine crop of Broadleaf tobacco on the farm of Peter Modzelesky, East Street, Suffield, grown on O&W Blue Label tobacco fertilizer.

Firestone GROUND GRIP TIRES

... FOR YOUR TRACTOR AND ALL FARM IMPLEMENTS ...

PRICES ON APPLICATION



GUARANTEE

This heavy traction tread guaranteed not to loosen from the tire body under any condition, and all other parts of the tire are fully guaranteed to give satisfaction in every respect.



Mrs. Mary Mulcahy's driver with Model B John Deere Tractor, pulling a No. 52 John Deere Tractor plow won 2d prize at the plowing demonstration.



E. J. Bantles Model B John Deere Tractor on Firestone Ground Grip Tires pulling a No. 52 John Deere Tractor Plow at the Plowing Demonstration held last fall on the farm of Dan Andrews, South Glastonbury, Conn.

INDEX

	Page		Page		Page
Alfalfa	33	Handles:		Poa Trivialis	33
Asparagus	9	Axe	59	Potatoes	22
Axes	59	Mattock	59	Potato Diggers	47
Barley	34	Pick	59	Potato Graders	49
Beans, Bush	9-10	Harrow:		Potato Planters	46-47
Beans, Pole	10-11	Acme (Pulverizing)	43	Poultry Supplies	61
Beets	11	Disc	43-50	Pruners, Hand	31-59-63
Belting (Rubber)	55	Spike Tooth	42	Pumps:	
Bent Grass	34	Spring Tooth	42	Myers Hand	57
Blue Grass	33	Tractor	43-50	Myers Water System	57
Bolt Cutters	59	Planet, Jr., 12 Tooth	45	Pumpkin	23
Broccoli	12	Hay Forks	59	Radish	24
Brooders	61	Hay Loader	52	Rakes (Garden)	60
Brussels Sprouts	12	Hay Rakes	52	Rakes (Lawn)	31
Buckwheat	34	Hay Unloaders	48	Rakes (Hay)	52
Cabbage	12-13	Hedge Trimmer	32	Red Top (Recleaned)	33
Carbola	36	Herbs	27	Rhubarb	24
Carrot	13	Hilliers	54	Rollers:	
Cauliflower	13	Hoes	60	Land	54
Celeriac	14	Hooks (Manure)	59	Lawn	30
Celery	14	Hotkaps	32	Romaine	19
Clipmaster	62	Insecticides	35-36-37-41	Roof Cement	58
Clovers:		Kale	18	Roof Coating	58
Medium Red	33	Kentucky Blue Grass	33	Roofing	58
Mammoth or Large Red	33	Kohl Rabi	18	Rope	49
White Dutch	33	Ladders	57	Ruta Baga	27
White Sweet Blossom	33	Land Roller	54	Rye (Rosen)	34
Alsike	33	Lawn Edgers	30-60	Rye Grass	33
Alfalfa	33	Lawn Grass Seed	28	Salsify	24
Coal Scoops	60	Lawn Mowers	30	Salt, Agricultural	29
Corn, Field	15	Lawn Sprinklers	31	Saws	55-63
Corn Planters	45	Lawn Rakes	31-60	Saw Frames	55
Corn Shellers	54-62	Lawn Rollers	30	Scrapers (Ox Shovels)	57
Corn, Sweet	15-16	Leek	18	Scythe Stones	56
Cow Peas	33	Lettuce	18-19	Seeders:	
Cress	16	Litter Carrier	55	Garden	44
Crow Repellant	16	Luxura	29	Grass	48-49
Cucumber	16-17	Mangel Wurzel	11-12	Shears:	
Cultivators:		Manure Forks	59	Grass	31
Deere Riding	46	Manure Spreaders	53	Hedge	31-32
Garden (See Planet, Jr. Imp.)	48	Markers (Field)	54	Pruning	31
Horse (Fowler)	43	Mattock	59	Shovels	60
Tractor	46-51	Meadow Grass	38	Spades	60
Dandelion	17	Milk Coolers	8	Spading Forks	60
Dill	17	Millets	34	Spinach	24-25
Dog Chow	34	Mowing Machines	52	Sprayers:	
Dusters	38-41	Muskmelons	19-20	Lowell (Hand)	38
Edgers (Turf)	30-60	Mustard	19	Lowell (Pressure Can)	38
Egg Plant	17	Nasturtium	20	Myers (Pressure Can)	39
Endive	17	Nod-O-Gen	34	Myers (Barrel Outfits)	39
Engines	49	Oats	34	Myers (Barrel Pumps)	39
Feed Mill	54	Oils (Automobile and Tractor)	62	Myers (Bucket Pumps)	39
Feeders (Chick)	61	Okra	20	Myers (Orchard)	40
Fertilizers	4-5-6-7-29	Onion Seed	20-21	Myers (Portable)	39
Fertilizer Sowers:		Onion Sets	21	Myers (Row Crop)	40
McWhorter, Between the Row	50	Orchard Grass	33	Sprinklers (Lawn)	31
Nonpareil, Broadcast	50	Paints	58	Squash	25
Planet, Jr., Hand	44	Parsley	21	Stalls (Cow)	55
Van Brunt, Broadcast	50	Parasip	21	Stone Boats	56
Fesque Chewings	33	Patching Plaster	58	Stone Boat Heads	56
Field Marker (Goslee)	54	Peas (Cow)	33	Sudan Grass	33
Flower Pots	32	Peas (Field)	33	Swiss Chard	11
Forks:		Peas (Garden)	21-22	Timothy	33
Hay	59	Peat Moss	29	Tobacco Transplanters	53
Manure	59	Pepper	23	Tomato	26
Spading	60	Picks	59	Tractors (Farm)	51-53
Fountains (Chick)	61	Planet, Junior Implements:		Tractor Tires (Rubber)	64
Fungicides	35-36-37	Cultivators, Hand	44	Turf Edgers	60
Furnace Scoops	60	Cultivators, Horse	45	Turnip	26-27
Gloves (Garden)	31	Fertilizer Distributors	44	Vegetable Cutters	62
Grains	34	Harrow, 12 Tooth	45	Water Fountains (Chick)	61
Grass Catchers	30	Seeders	44	Watering Cans	31
Grass Edgers	30-60	Planting and Picking Bags	48	Watermelon	27
Grass Seeds	28-33-34	Plows:		Water Systems (Myers)	57
Grass Seeders	48-49	Deere Tractor	42-53	Wedges	59
Grinders	56	Syracuse Walking	42	Weeder (Dandelion)	31
Grindstones	56			Weeders (Hallock)	46
Grub Hoes	59			Wheelbarrows	32

Seed and Plant Tables

Quantity of Seeds Required to Plant One Acre

Asparagus—1 oz. for 500 plants	1	lb.
Barley	2	bu.
Beans, Dwarf, 1 qt. for 100 ft. of drill	1-1½	bu.
Beans, Pole, 1 qt. for 200 hills	½ to ¾	bu.
Beet, Garden, 1 oz. for 75 ft. of drill	6	lbs.
Beet Mangel, 1 oz. for 75 ft. of drill	5	lbs.
Buckwheat	1	bu.
Cabbage, 1 oz. for 3,000 plants	½	lb.
Carrot, 1 oz. for 150 ft. of drill	2½-3	lbs.
Cauliflower, 1 oz. for 3,000 plants	5	oz.
Celery, 1 oz. for 4,000 plants	4-8	oz.
Clover, Alsike or White Dutch	8-10	lbs.
Clover, Medium Red	10-15	lbs.
Corn, Field (Hills)	¼ to ½	bu.
Corn, Field (Drills)	1-1½	bu.
Corn, Sweet, 1 qt. for 200 hills	8	qts.
Cucumber, 1 oz. for 50 hills	2-3	lbs.
Fesque Chewings	30	lbs.
Grass, Kentucky Blue	1½-2	bu.
Grass, Rye	1-1½	bu.
Grass, Mixed Lawn	3-4	bu.
Grass, Orchard	1½-2	bu.
Lettuce, 1 oz. for 150 ft. of drill	3	lbs.
Melon, Musk, 1 oz. for 80 hills	3	lbs.
Melon, Water, 1 oz. for 50 hills	4	lbs.
Millet, Golden	¾-1	bu.
Millet, Hungarian	¾-1	bu.
Millet, Japanese	½ to ¾	bu.
Oats	2-2½	bu.
Onion Seed, 1 oz. for 200 ft. of drill	5	lbs.
Onion Seed for Sets	30-50	lbs.
Onion Sets—1 qt. for 20 ft. of drill	8	bu.
Parasnip, 1 oz. for 100 ft. of drill	4	lbs.
Parsley, 1 oz. for 200 ft. of drill	3	lbs.
Peas, Garden, 1 qt. for 60 ft. of drill	3	bu.
Peas, Field	2½	bu.
Potatoes	12	bu.
Pumpkin, 1 qt. for 200 hills	5	lbs.
Radish, 1 oz. for 100 ft. of drill	10	lbs.
Red Top, Unhulled	2-3	bu.
Red Top, Recleaned	15	lbs.
Rye	2	bu.
Salsify, 1 oz. for 100 ft. of drill	8	lbs.
Squash, Summer, 1 oz. for 80 hills	2	lbs.
Squash, Winter, 1 oz. for 10 hills	2	lbs.
Timothy	¼ to ½	bu.
Tomato, 1 oz. for 3,000 plants	3	oz.
Tobacco, 1 oz. for 5,000 plants	2	oz.
Turnip, 1 oz. for 200 ft. of drill	1-3	lbs.

Weights of Seeds

	Lbs. per Bu.
Alfalfa	60
Barley	48
Blue Grass	14
Buckwheat	48
Clover, Alsike, Crimson, Red, White	60
Corn, Field	56
Fesque Chewings	24
Millet, Common	48
Millet, Hungarian	48
Millet, Japanese	32
Oats	32
Orchard Grass	14
Peas, Canada Field	60
Rape	60
Red Top, Unhulled	14
Red Top, Recleaned	35
Rye	56
Soy Beans	60
Sudan Grass	50
Timothy	45
Vetch	60
Wheat	60

AVERAGE TIME REQUIRED FOR GARDEN SEEDS TO GERMINATE

	Days		Days
Beans	7-10	Lettuce	6-8
Beets	7-10	Onion	7-10
Cabbage	4-8	Parsley	15-21
Carrot	12-18	Peas	6-10
Cauliflower	4-8	Parasnip	10-20
Celery	10-20	Pepper	9-14
Corn	5-8	Radish	4-6
Cucumber	6-10	Salsify	7-12
Endive	5-10	Tomato	10-14
Kale	5-7	Turnip	4-8

MATURITY TABLE

Beans, table use	50 to 65 days
Beets, table use	60 to 70 days
Cabbages, early for cutting	90 to 100 days
Cabbages, late for cutting	100 to 120 days
Carrots, table use	60 to 70 days
Celery, table use	120 to 140 days
Sweet Corn, table use	85 to 100 days
Cucumbers, table use	65 to 70 days
Lettuce, table use	40 to 50 days
Melons, table use	85 to 100 days
Onions for Storage	90 to 120 days
Peas, table use	50 to 70 days
Radishes, table use	20 to 45 days
Tomatoes, table use	90 to 100 days
Turnips for Storage	65 to 90 days

NUMBER OF PLANTS REQUIRED TO PLANT AN ACRE AT GIVEN DISTANCES

Dist. apart	No. Plants	Dist. apart	No. Plants
12 x 1 in.	522,720	36 x 36 in.	4,840
12 x 3 in.	174,240	42 x 12 in.	12,446
12 x 12 in.	43,560	42 x 24 in.	6,223
16 x 1 in.	392,040	42 x 36 in.	4,143
18 x 1 in.	348,480	48 x 12 in.	10,890
18 x 3 in.	116,160	48 x 19 in.	7,790
18 x 12 in.	29,040	48 x 24 in.	5,445
18 x 18 in.	19,360	48 x 30 in.	4,856
20 x 1 in.	313,685	48 x 36 in.	3,630
20 x 20 in.	15,681	48 x 48 in.	2,723
24 x 1 in.	261,360	60 x 36 in.	2,901
24 x 18 in.	15,520	60 x 48 in.	2,178
24 x 24 in.	10,890	60 x 60 in.	1,743
30 x 1 in.	209,088	8 x 1 ft.	5,445
30 x 6 in.	84,848	8 x 3 ft.	1,815
30 x 12 in.	17,424	8 x 8 ft.	680
30 x 16 in.	13,068	10 x 1 ft.	4,856
30 x 20 in.	10,454	10 x 6 ft.	726
30 x 24 in.	8,712	10 x 10 ft.	435
30 x 30 in.	6,970	12 x 1 ft.	3,630
36 x 3 in.	58,080	12 x 5 ft.	733
36 x 12 in.	14,520	12 x 12 ft.	302
36 x 18 in.	9,680	16 x 1 ft.	2,722
36 x 24 in.	7,260	16 x 16 ft.	170

TABLE TO ASSIST FARMERS AND GARDENERS IN MAKING ACCURATE ESTIMATE OF THE AMOUNT OF LAND IN DIFFERENT FIELDS UNDER CULTIVATION

10 rods x 16 rods equal	1 acre
8 rods x 20 rods equal	1 acre
5 rods x 32 rods equal	1 acre
4 rods x 40 rods equal	1 acre
5 yards x 968 yard equal	1 acre
10 yards x 484 yards equal	1 acre
40 yards x 121 yards equal	1 acre
209 feet x 209 feet equal	1 acre
200 feet x 108.9 feet equal	½ acre
100 feet x 145.2 feet equal	1/3 acre
100 feet x 108.9 feet equal	¼ acre

