

Historic, archived document

Do not assume content reflects current scientific knowledge, policies, or practices.

1938



ROSS SEEDS Farm Machinery • Poultry Supplies
 Insecticides • Fertilizers and Tools
ROSS BROS. CO.
 WORCESTER, MASS.



See Back Cover Page



ROSS'

Lawn Seed Bank and Terrace Mixtures

Use **QUALITY** Lawn Seed

There are only a very few kinds of grasses suitable for lawns. Seeds of these fine kinds are much more expensive than the seeds of other less desirable grasses, most of which make good hay, but do not make good lawns. The cheap seeds will often grow and cover the ground with green, but eventually the lawn will deteriorate and have to be re-made, which is a very expensive and troublesome thing to do.

The Best Results are obtained by sowing the seed quite thickly, one pound or quart to 200 or 300 square feet, but sowing one pound on 400 to 500 square feet will make an excellent lawn although not quite as quickly.

To Renew Old Lawns. Rake thoroughly, stirring the ground as much as possible without killing the grass. All moss and weeds should be removed as far as possible. Sow half as much grass seed as recommended for seeding a new lawn. After seeding, the lawn should be rolled.

PERFECT Lawns Within Reach of All. All of Ross' Celebrated Lawn Grass Seeds are particularly suited to the New England conditions. When properly used, they produce thick velvety lawns of the finest type in a few weeks.

The making of a lawn is not a matter of chance. Good seed, proper fertilizer, the right soil condition—all are vital factors.

If you are contemplating making a new lawn, or restoring an old one, let us help you with your problem.

WORCESTER LAWN SEED

The Worcester Lawn Seed is our own mixture made from a formula which has been given a great deal of careful study and we are positive that no better general purpose lawn seed can be made. If this is used the lawn will be ready for the first cutting in about five weeks and with reasonable care an excellent lawn can be maintained for years. We advise using 140 to 160 pounds per acre. **Price, lb., 45c; 2 lbs., 90c; 5 lbs., \$2.00; 10 lbs., \$3.75; 100 lbs., \$35.00.**

CEMETERY MIXTURE

The locations of many of the cemeteries with which we are familiar, have been selected due particularly to the fact that the soil is well drained and quite often we find a sand or gravel top soil. This mixture is intended for such places, as we have selected the varieties of grasses which are best adapted to such soils. **Price, lb., 40c; 5 lbs., \$1.75; 10 lbs., \$3.25; 100 lbs., \$30.00.**

BANK and TERRACE MIXTURE

We have had so many calls for a mixture of grass seed to be used on a bank or terrace, that last year, for the first time, we offered a mixture for this purpose. It is mixed from grasses which naturally grow a strong, creeping root and are very valuable in holding the soil in place, preventing serious washouts during heavy rains. The seed starts quickly. **Price, lb., 60c; 2 lbs., \$1.20; 5 lbs., \$2.75; 10 lbs., \$5.25; 100 lbs., \$45.00.**

ROSS BROS. COMPANY

179-181 Commercial Street

Worcester, Mass.

January 1938

1843

95TH YEAR OF

1938

ROSS' SEEDS

Everybody Knows Ross' Seed Grows



We greet you again with best wishes for a happy and prosperous new year 1938.

Now in the 95th year of continuous service as merchants supplying seed and agricultural equipment to the farms throughout the country, we extend our heartiest thanks for the loyal support by thousands of our customers.

We have endeavoured to make our 1938 catalogue interesting and attractive and we offer here the best of quality, both in seeds and other merchandise, which we sell. There has been a liberal harvest of seeds and, except for a few of the agricultural grasses, which are lower in price, there is very little change in seed prices.

It is with a great deal of confidence that we anticipate the continuance of your loyal support through the seasons of 1938.

ROSS BROS. CO.

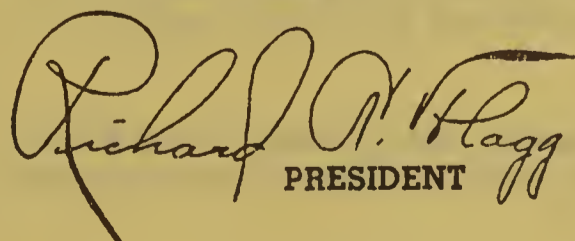
PRESIDENT

DIRECTIONS FOR ORDERING

PLEASE USE OUR ORDER SHEET. It will be a help to us in filling your order correctly. If you desire to write us, use a separate sheet of paper. Be sure to give your full name and address on all orders and letters.

KEEP A COPY OF YOUR ORDER. Sometimes customers complain of not receiving goods which were not ordered. If goods ordered do not reach you in a reasonable time, advise us and send us a copy of your order.

HOW TO SEND MONEY. Remittances can be sent safely by Post Office Money Order, Bank Draft, Express Money Order, Check or by Registered Letter. We do accept stamps for small amounts.

Do not send coins loose in an envelope as they may break through. If bills are sent, your letter should be registered.

ORDER EARLY—We endeavor to fill all orders as soon as received, but during the rush season of April and May, delays are sometimes unavoidable. This, however, can be partly overcome if our patrons will send us their orders early.

FREE DELIVERY—All Vegetable Seeds, Flower Seeds and Bulbs offered in this catalogue will be delivered **transportation paid** in the United States at prices listed. In making this Free Delivery offer we reserve the right to ship goods by Parcel Post, Express or Freight. Other items of seeds and other merchandise will be sent transportation collect unless otherwise noted in this catalogue.

GRASS AND FIELD SEEDS—All Grass and Field Seeds, Onion Sets and Potatoes are shipped only at purchaser's expense by express or freight, as ordered. Prices quoted in this catalogue are F.O.B. Worcester. Small quantities of Grass or Field Seeds sent by Parcel Post if postage is added at parcel post rates.

NOTICE—While it is not our custom to substitute, we feel that in the event of our being sold out of any variety it would be to the advantage of our patrons to allow us this privilege, for, if on receipt of any substitute it is not perfectly satisfactory, the same may be returned and money paid will be refunded.

Telegraph your order with Western Union Money Transfer and goods will be shipped same day order is received.

Add Postage to your order as indicated below— if required.

See Free Delivery on this page.

Weight Lbs.	ZONES							
	Local	1st-2d	3d	4th	5th	6th	7th	8th
1....	\$0.07	\$0.08	\$0.09	\$0.10	\$0.11	\$0.12	\$0.14	\$0.15
2....	.08	.10	.11	.14	.17	.19	.23	.26
3....	.08	.11	.13	.17	.22	.26	.32	.37
4....	.09	.12	.15	.21	.27	.33	.41	.48
5....	.09	.13	.17	.24	.33	.40	.50	.59
6....	.10	.14	.19	.28	.38	.47	.59	.70
7....	.10	.15	.21	.31	.43	.54	.68	.81
8....	.11	.16	.23	.35	.49	.61	.77	.92
9....	.11	.17	.25	.38	.54	.68	.86	1.03
10....	.12	.18	.27	.42	.59	.75	.95	1.14
11....	.12	.19	.29	.45	.64	.82	1.04	1.25
12....	.13	.21	.31	.49	.70	.89	1.13	1.36
13....	.13	.22	.33	.52	.75	.96	1.22	1.47
14....	.14	.23	.35	.56	.80	1.03	1.31	1.58
15....	.14	.24	.37	.59	.86	1.10	1.40	1.69
16....	.15	.25	.39	.63	.91	1.17	1.49	1.80
17....	.15	.26	.41	.66	.96	1.24	1.58	1.91
18....	.16	.27	.43	.70	1.02	1.31	1.67	2.02
19....	.16	.28	.45	.73	1.07	1.38	1.76	2.13
20....	.17	.29	.47	.77	1.12	1.45	1.85	2.24
21....	.17	.30	.49	.80	1.17	1.52	1.94	2.35
22....	.18	.32	.51	.84	1.23	1.59	2.03	2.46
23....	.18	.33	.53	.87	1.28	1.66	2.12	2.57
24....	.19	.34	.55	.91	1.33	1.73	2.21	2.68
25....	.19	.35	.57	.94	1.39	1.80	2.30	2.79
26....	.20	.36	.59	.98	1.44	1.87	2.39	2.90
27....	.20	.37	.61	1.01	1.49	1.94	2.48	3.01
28....	.21	.38	.63	1.05	1.55	2.01	2.57	3.12
29....	.21	.39	.65	1.08	1.60	2.08	2.66	3.23
30....	.22	.40	.67	1.12	1.65	2.15	2.75	3.34
31....	.22	.41	.69	1.15	1.70	2.22	2.84	3.45
32....	.23	.43	.71	1.19	1.76	2.29	2.93	3.56
33....	.23	.44	.73	1.22	1.81	2.36	3.02	3.67
34....	.24	.45	.75	1.26	1.86	2.43	3.11	3.78
35....	.24	.46	.77	1.29	1.92	2.50	3.20	3.89
36....	.25	.47	.79	1.33	1.97	2.57	3.29	4.00
37....	.25	.48	.81	1.36	2.02	2.64	3.38	4.11
38....	.26	.49	.83	1.40	2.08	2.71	3.47	4.22
39....	.26	.50	.85	1.43	2.13	2.78	3.56	4.33
40....	.27	.51	.87	1.47	2.18	2.85	3.65	4.44

ERRORS—We use the utmost care in filling orders, yet in the press of business, errors sometimes occur in which event we wish to be promptly notified of the fact and will make such corrections as will be satisfactory.

Most of the failures with seeds, plants and bulbs are due to causes entirely beyond our control such as unfavorable weather or soil conditions, too deep or too shallow planting, which renders it impossible for us to guarantee success, and although we take all possible care to supply only such goods as will under proper condition, produce satisfactory results,—The Ross Bros. Company gives no warranty, express or implied, as to description, quality, productiveness or any other matter of any seeds, bulbs or plants it sells and will not be responsible for the crop.

People Admire Rich Green Lawns

Ross' Carefully Prepared Grass Mixtures are Your Assurance of a Real Velvety Lawn

Truegreen Lawn Mixture

This is a mixture of three of the best so-called lawn grasses and is adapted to almost any ordinary situation. It is our own mixture of heavy seed and we recommend it to any who do not wish to pay higher prices. This seed will produce lawn ready to cut in about five weeks. **Price: Lb., 35c; 5 lbs., \$1.60; 10 lbs., \$3.00; 100 lbs., \$28.00.**

Shady Spot Lawn Grass Seed

It is possible to produce a lawn under almost any condition but to do this in a situation where shade predominates the greater part of the time is very difficult. A shady location requires special treatment of the soil and in almost every shady spot lime must be added, but most important is the selection of the seed. There are varieties of grass seed which thrive in shade to a much greater degree than others and it is with our knowledge of this that we supply our own Shady Spot Lawn Seed. **Price: Lb., 60c; 5 lbs., \$2.75; 10 lbs., \$5.25; 100 lbs., \$50.00.**

Special Mixtures of Grass Seed

In addition to the several mixtures of grass seeds which we list in this catalog, we can supply grass seed in mixtures suitable for almost any purpose or location.

We will also be pleased to name prices on any special formula on request.

Green Hill Lawn Mixture

We have decided to offer the Green Hill Lawn Mixture after repeated trials as we have found this to be one of the best of the solid seed mixtures. This is composed of only four varieties of grasses as follows: Creeping Bent, Rye Grass, Kentucky Blue and Red Top. These are four of the best lawn grasses known and as we use only the heaviest, cleanest seed possible to obtain, germination is assured nearly 100 per cent. From this mixture you can obtain an exceptionally quick sod and a lawn that can be maintained with very little care. **Price: Lb., 55c; 5 lbs., \$2.50; 10 lbs., \$4.75; 100 lbs., \$45.00.**

Golf Course Mixtures

For Putting Greens and Fair Greens

The turf on all golf courses must be given very careful attention and there are only a few varieties of grass which will withstand the constant trampling of the putting green. Both the fairways and greens require a mixture of seed which will bear very close cutting and which will produce a turf of a strong, persistent nature. Both European and American grasses are used for these purposes and we offer mixtures which are of the highest purity and germination.

Mixture for Putting Greens. Lb., 70c; 5 lbs., \$3.25; 10 lbs., \$6.25; 100 lbs., \$60.00.

Mixture for Fairways. Lb., 50c; 5 lbs., \$2.25; 10 lbs., \$4.25; 100 lbs., \$40.00.

Preparation of Soil

Before seeding, the soil should be thoroughly spaded up, and if it is not a good, rich, garden loam, well-rotted manure should be added and spaded into the ground before the final raking. If the soil is of clay texture, mix equal parts of coarse sand with the manure before spading it in. Rake carefully, removing all stones and rubbish, and breaking up the earth finely. Roll, and rake lightly so the seed may be sown in loose earth.

GERMINATION ON ANY SEED SENT ON REQUEST; ALSO PURITY ON GRASS SEEDS, CLOVERS, AND ALL FIELD SEEDS.



Worcester, Mass., is noted all over the country for its fine lawns. We point with pride to the fact that our grass seeds have played an important part in making these splendid grass-plots.



A well-established pasture is a source of consistent profits

Ross' Unequaled Superfine Grass Seeds

Prices of all Grass Seeds subject to market changes. Prices include bags or sacks unless otherwise noted, 25 lbs. at 100-lb. price.

BENT GRASS, SOUTH GERMAN MIXED. Sometimes referred to as Creeping Bent. Admirably adapted for lawns, also putting greens, tennis courts, etc. Lb., \$2.00; 5 lbs., \$8.75.

ASTORIA BENT. (Botanically the same as Rhode Island or Colonial Bent). Of fine growth, forming a close and permanent sod. One of the best lawn grasses and very desirable for golf courses and polo grounds. Lb., \$1.25; 5 lbs., \$5.50.

ENGLISH OR PERENNIAL RYE GRASS (*Lolium perenne*). Of rapid growth and productive; produces a strong growth in 4 to 5 weeks. Lb., 25c; 10 lbs., \$2.25.

ITALIAN RYE GRASS (*Lolium italicum*). Thrives on a variety of soils, producing early and large crops. Lb., 25c; 10 lbs., \$2.25.

KENTUCKY BLUE GRASS (*Poa pratensis*). One of the most valuable grasses for pasture and lawn, requires some time to become established, but lasts indefinitely on congenial soils. Sown with White Clover it forms a splendid lawn. Lb., 25c; 10 lbs., \$2.00; 100 lbs., \$17.50.

MEADOW FESCUE (*Festuca pratensis*). Largely used for permanent mowing mixtures. Lb., 25c; 10 lbs., \$2.00.

REED CANARY GRASS. A tall growing water grass, thriving in brooks, ditches, ponds and marshy tracts of land. It is of good nutritive value. Lb., 60c; 10 lbs. or over 55c per lb.

RED, OR CHEWINGS' FESCUE (*Festuca rubra*). Its leaves are bright green and the plant does not grow in tufts but creeps by underground stems, so that one plant may eventually cover a circle 2 to 4 feet in diameter. It is used mainly as a lawn plant. On sandy or gravelly soil it makes exquisite lawns. Lb., 60c; 10 lbs., \$5.50.

ROUGH STALKED MEADOW (*Poa trivialis*). Ideal for shade. It is a perennial and grows in soil that is moist and cool. Lb., 55c; 10 lbs., \$5.00.

CANADIAN BLUE GRASS (*Poa compressa*). A hardy perennial with creeping root-stalks which form a strong turf. Lb., 35c; 10 lbs., \$3.00.

DOMESTIC RYE GRASS. Used extensively in lawn mixtures. Lb., 20c; 10 lbs., \$1.75.

WORCESTER RED TOP, FANCY RECLEANED. This is one of the best grasses for sowing for immediate effect. Lb., 25c; 10 lbs., \$1.60; 100 lbs., \$14.00.

ORCHARD GRASS (*Dactylis glomerata*). For early pasturing this is very desirable; also fine for sowing in shaded places. Lb., 30c; 10 lbs., \$2.50.

TIMOTHY (*Phleum pratense*). Timothy is the standard hay of commerce.

WORCESTER GRADE. Our Worcester Grade is a seed which is of the highest quality at the start. Taken from the best fields of full ripe seed, we can assure you, that after going through the cleaning process we can guarantee a purity of 99.50 per cent. In the Worcester brand we are offering the best seed it is possible to obtain. Lb., 10c; 10 lbs., 65c; 100 lbs., \$5.60.

WACHUSETT GRADE. This grade is of fine quality, better than most seed offered as prime. We guarantee this 97.50 per cent pure. Lb., 10c; 10 lbs., 60c; 100 lbs., \$5.50.

The Worcester Mixtures of Grass Seed

For Meadows and Pastures

PERMANENT PASTURE MIXTURE FOR MEDIUM SOIL. Aside from permanency, an important requisite is that of continual growth from early spring until fall, and as many varieties as possible should be used which bear constant tramping and continued close grazing. This mixture is prepared with these ends in view. 40 to 50 pounds to the acre. Lb., 25c; 10 lbs., \$2.25; 100 lbs., \$20.00.

PERMANENT MOWING MIXTURE FOR MEDIUM SOIL. This mixture will produce at first cutting a larger crop and a much heavier aftermath of hay, which, though not like timothy, salable in cities for feeding horses, is, nevertheless, superior for feeding to both cattle and horses. Lb., 25c; 10 lbs., \$2.25; 100 lbs., \$20.00.

No. 1 GRASS SEED MIXTURE. For seeding down use 25 lbs. to the acre. Contains Timothy, Red Top, Medium Red Clover, and Alsike Clover. All domestic seed. Lb., 20c; 10 lbs., \$1.80; 100 lbs., \$16.00.

Clovers -- The Best Grades

BUILD YOUR LAND WITH CLOVERS. In the rotation of crops, clovers are most valuable, and in all sections except possibly the extreme South are indispensable.

ALSIKE OR SWEDISH CLOVER (*Trifolium hybridum*). One of the best for mixing with timothy; it is perfectly hardy in every climate or soil condition and seldom has to be reseeded. **Lb., 50c; 10 lbs., \$4.20; 100 lbs., \$40.00.**

CRIMSON CLOVER (*Trifolium incarnatum*). This is used principally for soiling or green manuring, for which purposes it is highly valuable. If desired for feed, cut it just before it flowers. **Lb., 20c; 10 lbs., \$1.85; 100 lbs., \$16.50.**

LADINO CLOVER FOR LOW WET SOILS. It is an ideal pasture plant for cattle, sheep, hogs, etc. Should be sown in early spring or September, using Oats, Timothy or Rye Grass, as a nurse crop. We recommend about 4 lbs. of Ladino clover per acre. **Price, \$1.00 per lb.**

MAMMOTH RED CLOVER (*Trifolium pratense perenne*). Sometimes called Sapling or Pea Vine Clover and English Cow Grass. This differs from the "Medium," being of a ranker growth and yielding more fodder per acre. **Lb., 55c; 10 lbs., \$5.10; 100 lbs., \$47.50.**

MEDIUM RED CLOVER, AMERICAN GROWN (*Trifolium pratense*). More widely known and used than any other; used principally for hay purposes. Height from 18 inches to 2½ feet. Sow early in the spring or in the late summer. **Lb., 55c; 10 lbs., \$5.00; 100 lbs., \$46.50.**

WHITE DUTCH OR LAWN CLOVER (*Trifolium repens*). This is valuable for pasturage as well as for lawns; it succeeds where other clovers and grasses fail, and it seldom dies out. It can be sown at all seasons, although early spring is best. **¼ lb., 20c; ½ lb., 30c; lb., 50c; 10 lbs. or over, 45c per lb.**

Sweet Clover

The Greatest Soil Renovator, Hay and Pasture Crop
BOKHARA OR SWEET CLOVER (*Melilotus alba*). A native of all parts of the United States and Canada. It is an erect branching biennial plant with woody stems growing the first season 2 to 3 feet high and developing a large root. The second year's growth usually reaches a height of 4 to 7 feet. **Lb., 25c; 10 lbs., \$1.80; 100 lbs., \$17.00.**



Alsike Clover is perfectly hardy

Inoculation for Clovers

See page 6.

Ross' Selected Seed Grain, Peas, Etc.

When sowing Field Seeds, only the best obtainable should be used. The use of inferior seed is not only uneconomical but is decidedly dangerous. Seed that has not been carefully cleaned and graded by experts, and tested in germination laboratories is apt to contain noxious germination, and other weeds.

No farmer would plant weeds knowingly. Make sure you are planting good pure seeds, by buying direct. Ross' Selected Quality Seeds.—It is your assurance of bumper crops.

Barley

WHITE HULLESS. About two weeks earlier than the common type. Closely resembles wheat, is about as heavy and is said to be nearly equal to it in feeding value. It has neither hulls nor beards. **Price, pk., 85c; bu., \$3.00.**

CHEVALIER. A two-rowed variety. Head is a little longer than the six-rowed varieties and the grain is larger, plump, extra heavy and in favorable seasons nearly white. **Price, pk., 60c; bu., \$2.05.**

MANSURY. In our section this six-rowed variety is largely grown for forage. It yields abundantly. It is early and very vigorous in growth. The straw is strong and stiff and seldom lodges. **Price, pk., 60c; bu., \$2.05.**

VELVET. Velvet Barley is a spring, bearded variety; the beards are smooth and no barbs. The yield is not quite so large as the Common Bearded Spring Barley, but the advantage of Velvet Barley offsets that. It is reported to us that the Velvet Barley straw is suitable for feed and the crop handles as nicely as oats. Sow two bushels to the acre. **Price, pk., 65c; bu., \$2.15.**

Dwarf Essex Rape

Culture. Rape is best adapted to moist, rich soil in which there is plenty of humus. Slough lands are especially good. It grows best in cool, moist weather and the time for sowing depends upon when the crop is to be used. When wanted for pasture, allow 8 to 10 weeks for it to attain maximum growth. **Price, lb., 20c; 10 lbs., \$1.40; 100 lbs., \$12.00.**

Mammoth Russian Sunflower FOR THE SILO

We believe every farmer, stockman and dairyman who must grow feed crops should plant a small area with Sunflower. Start now to become familiar with this crop, which is destined to be a prominent feed in economical stock feeding. **Price, lb., 15c; 100 lbs., \$10.00.**

Sudan Grass

Sudan Grass is strictly an annual and dies each year like millet. From seven to nine feet high, with very small stems. Stock prefer it. Sow 10 to 15 lbs. per acre. **Price, lb., 15c; 10 lbs., 85c; 100 lbs., \$7.50.**



Klondike Winter Wheat survives New England winters

**PRICES
SUBJECT TO
MARKET
CHANGES**

**WRITE
FOR
LATEST
PRICES**

Alfalfa - Dependable Varieties

The Farmer's Hay Insurance
Sow 15 to 25 lbs. per acre.

As a soil builder the Experiment Stations tell us that it adds twice as much nitrogen to the soil as the average acre of Red Clover.

COMMON. Requires well-drained land and an abundant application of lime previous to sowing. August is the best time to sow. **Price, lb., 50c; 25 lbs. or more, 42c per lb.**

GRIMM. Only a few strains of Alfalfa equal, and none excel true Grimm Alfalfa in hardiness. It is the safest type to sow wherever there is trouble from winter-killing. **Price, lb., 55c; 25 lbs. or more, 46½c per lb.**

Use Inoculation for Alfalfa.

Buckwheat

JAPANESE. Entirely distinct from all other varieties. It has the advantage of remaining some time in bloom and produces seed earlier. It resists drought and blight better than most varieties. **Price, pk., 60c; bu., \$2.00.**

Cow Peas

NEW ERA. An old stand-by which makes splendid hay. Matures in 60 to 75 days and does splendidly as far north as Minnesota. Vines are smaller than other varieties and are more easily cured. **Pk., 95c; bu., \$3.50.**

WHIP-POOR-WILL. A medium-early variety, very desirable for a forage crop and for rebuilding wornout land. A very prolific yielder and the most commonly used variety for planting broadcast. **Pk., 95c; bu., \$3.50.**

Canada Field Peas

CANADA PEAS may also be sown with other grains as well as with oats, and are sometimes sown in August with Barley. They are also sometimes sown alone. Choice stock for seed. **Lb., 10c; 10 lbs., 80c; 100 lbs., \$7.00.**

Selected Seed Oats

ROSS "SWEDISH SELECT." Extra re-cleaned seed. Briefly described, the Oat is pure white in color; the hull is thin and the kernel large and plump; straw is stiff and strong enough not to lodge. A remarkable root development makes the Swedish Oat a good drought resister—a special feature on light soils. Season medium early and the earliest of the heavy yielding sorts. Especially suited to high land. Seed weighs 40 lbs. per measured bushel. **Price, pk., 30c; bu. (32 lbs.), \$1.00; 3 bus. (full bag and over), 90c per bu.**

LONG'S WHITE TARTAR. The Ideal Side Oat for American Farmers. The earliest, heaviest and most prolific domestic grown Side Oat in cultivation. It is suitable for all soils; of robust and vigorous constitution, is remarkably early and an immense cropper; the straw is

long and stout, stands up well and does not readily lodge or twist. The heads measure from 8 to 10½ inches, and the kernels are of immense size, thick, plump and heavy; it is undoubtedly the heaviest cropping domestic white Oat ever offered. **Crop failed.**

Rye

SPRING RYE. True stock Spring Rye makes an excellent crop where winter grain has been killed out, or for sowing where a fall crop has not been planted. If desired it can be turned under and made to answer a good purpose in adding to the fertility of the soil. Sow seed same time as other spring grain. **Price, pk., 75c; bu., \$2.50.**

ROSEN WINTER RYE. Rosen Rye produces a strong vigorous straw and stools to a remarkable degree. The grain is large, plump, heavy and of beautiful color, commanding a premium on the market over other grains. Owing to its vigorous stooling property less seed is required, the practice being about one and one-half bushels per acre. We believe that Rosen Rye is cheaper to sow even at double the price of common Rye, for the excess yield will more than pay for the seed, not to mention the better quality and high price to be obtained for the crop. **Price, pk., 60c; bu., \$2.10, 10 bus. or over, \$2.05 per bu.**

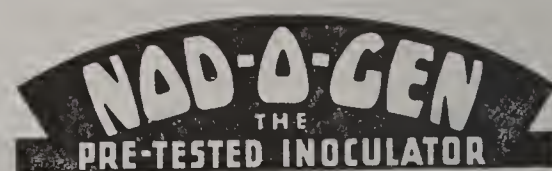
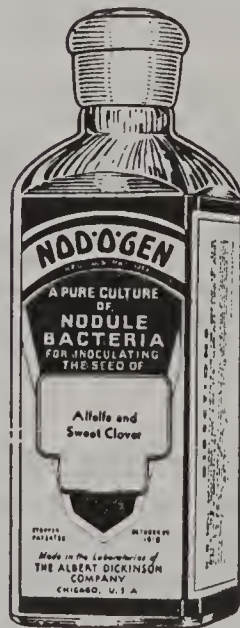

Nod-O-Gen is a high quality jelly culture of nitrogen—gathering bacteria containing all the essentials for healthy bacterial growth. Nod-O-Gen causes nodules to develop on the roots of legume crops. These nodules gather nitrogen from the air and convert it into plant food saving plant food in the soil. Full directions accompany each package. When ordering be sure to state what seed you wish to inoculate.

Group 1 Alfalfa and Sweet Clover.

- | | | |
|---------|--|-----|
| Group 2 | Red, Mammoth, White, Alsike and Crimson Clovers. | |
| | ½ bu. size | 30c |
| | 1 bu. size | 45c |
| | 2½ bu. size | 75c |
| Group 3 | Soy Beans. | |
| Group 4 | Cow Peas. | |
| Group 5 | Field and Garden Beans. | |
| Group 6 | All Vetches, Field and Garden Peas. | |
| | 1 bu. size | 30c |
| | 2 bu. size | 45c |
| | 5 bu. size | 75c |
| | Garden combination for Peas, Sweet Peas, Garden, String and Lima Beans, 25c. | |
| | Add for Postage: 5c for garden and ½ bu. sizes; larger sizes 10c. | |

Millets

Millets are adapted to regions of light rainfall and hot weather. Used principally for forage and valuable where Timothy is an uncertain crop. The hay is fed to dairy cows and sheep, and ranks well above Timothy.

HUNGARIAN (Hungarian Grass). An excellent food for horses when cured. Each root sends up several slender stems which often branch. The leaves grow upright, rather narrow. Heads are borne erect or nearly so, about four inches long, dark purple in color. **Price, lb., 10c; 10 lbs., 75c; 100 lbs., \$6.50.**

GOLDEN. This variety is extensively used throughout the United States. It is sown at the same time and at the same rate per acre as the common Millet. Grows more vigorous, gives a much larger yield of hay than common Millet. **Price, lb., 10c; 10 lbs., 75c; 100 lbs., \$6.50.**

JAPANESE (*Panicum frumentacea*). It is entirely distinct from all other Millets. Grows from 6 to 9 feet high, stands up well and yields enormous crops. When cured it makes good hay and in quality is superior to corn fodder. Relished by all kinds of stock and is rich in milk-producing qualities. **Price, lb., 10c; 10 lbs., 60c; 100 lbs., \$5.25.**

Soy or Soja Beans

BLACK WILSON. Medium size, black seed. Considered the best all-around variety for the North. Of rather upright growth, with a good amount of foliage and a slight tendency to vine on fertile soil. Matures seeds in 125 days and is ready for cutting in 110 days. A heavy seed producer. **Pk., 85c; bu., \$3.00.**

MANCHU. Matures in about 110 days and is the most

popular early variety. Plants erect and bushy, producing large crops of dry forage and seed. Seed light yellow with a black scar. **Pk., 85c; bu., \$3.00.**

Vetch

SPRING VETCH OR SPRING TARE. Grown for soiling, or sown with oats for feeding green. Sow, if alone, 100 pounds to the acre. **Price, lb., 15c; 10 lbs., or over, 9c per lb.**

WINTER, SAND OR HAIRY VETCH (*Vicia villosa*). The branches are from 3 to 6 feet long, covered with fine hairs. It is extremely hardy. Sowings may be made from August 15th to October 1st, or in the spring from April 15th to May 15th. For fall sowings we advise mixing with Mammoth Red Clover or Rye, these giving a support for the vines. Sow, if alone, 60 pounds to the acre, or with Rye, 45 pounds of Vetch and 30 pounds of Rye to the acre. **Price, lb., 20c; 10 lbs., \$1.50; 100 lbs., \$14.00.**

Wheat

MARQUIS (Spring Wheat). It has outyielded all other spring Wheats grown under the same conditions of soil and climate, the increased yield being up to 10 bushels per acre; is flinty and dark in color, being almost dark red. It is a beardless variety, having a smooth, yellow chaff. **Price, pk., 90c; bu., \$3.40.**

KLONDYKE (Winter Wheat). Sow early in the fall for a good firm root to survive our New England winters. Winter Wheat makes an excellent green feed, coming very early in the spring and staying in condition for feed much longer than spring or winter rye. A productive, bald, white variety, large and plump. **Price, pk., 70c; bu. (60 lbs.), \$2.50.**

Ross' Genuine Eureka Ensilage Corn

Outstanding as the Heaviest Producer of Silage Material—It Pays to Plant the Best.

Yield and quality are the most important things to consider when selecting corn for silage. This wonderful product has been the farmer's friend for forty-eight years.

Here is a variety of silage corn that surpasses all others. Forty-eight years of undisputed leadership. Genuine Eureka Corn has always given a maximum yield to the farmer—whether soils are light or heavy, the deep-rooted nature is a characteristic of Eureka Corn that responds quickly to all conditions.

Fourteen to nineteen feet Ross Eureka Ensilage Corn is your assurance.

The astonishing yield of seventy tons and eight hundred pounds of silage fodder per acre in Michigan in 1911 still has not been beaten.

Ross Bros. Co.,
181 Commercial St.,
Worcester, Mass.

Portland, Oregon, Nov. 10, 1936.

Gentlemen:

We were glad to have your letter in regard to the Eureka Ensilage Corn, but California has nothing on us. It grows from eighteen to twenty feet on the average in a fifteen acre field. It has grown twenty-four feet tall and hasn't stopped growing yet. Can you beat this record in Massachusetts?

We will send you an order for Eureka later.

Yours very truly,

Hardy and rugged characteristics; Eureka Corn germinates surprisingly well in cold, wet springs, and today farmers everywhere heartily approve planting the Ross Genuine variety of Eureka Corn.

The Eureka is our own introduction, being first placed on the market by us forty-eight years ago and we still offer the genuine Eureka, which is far superior to many varieties which are sold under this same name. For the protection of the planter, the Eureka comes put up in trade marked bags and our suggestion is that you accept your Eureka Seed Corn in no other package.

The trade mark, "Eureka Corn," is printed on every bag for your protection. Don't take chances on an inferior product. There is nothing just as good, and you take no chances of losing as many dollars as you save cents.

PRICE OF EUREKA CORN FOR 1938:

Bags included

1/2 pk., 45c; pk., 85c; 1/2 bu., \$1.60; bu., (56 lbs.), \$3.00, 10 bus. or over \$2.90 per bu. in our trade-marked bags.



Don't buy a bushel of Eureka Corn unless it has our trade mark printed on the bag.

Ross' Selected Seed Corn

Pure Strains that are true to type, thoroughly re-cleaned
and of highest germination

Improved Leaming

The True Improved Leaming which we offer is a pure, fixed, and distinct variety, having been bred for earliness of maturity, size, shape and color, also for the amount of grain that each ear will produce. It ranks as one of the early dent corns, has a very heavy stalk, growing 12 to 13 feet high and very leafy. The ears are 8 to 10 inches long, filled with medium sized but deep kernels. **Pk., 75c; bu., \$2.90; 10 bus. or over, \$2.85 per bu.**

Early Smoky Dent

A Dent Corn That Can be Grown in This Latitude for Grain

It is a very hardy grower and prolific yielder for so early a corn. This corn has nice leafy stalks, averaging 8 feet in height, which very often yield 2 nice ears, measuring 8 to 10 inches in length, well filled with a good sound kernel of a dark red shade, tipped with pure white, making it a very handsome corn in appearance. **½ pk., 45c; pk., 75c; bu., \$3.00.**

Sweet Fodder

Unexcelled for cutting green and feeding to stock. It should be included in all soiling schedules. **10 lbs., \$1.00; 100 lbs., \$8.00.**



Worcester County Sweepstakes

Worcester County Sweepstakes

It is a big yellow Dent Corn, stalks very large, 1 ½ to 2 inches in diameter, growing 12 to 15 feet high, foliage is long, broad and heavy, starting well down to the ground with an abundance of leaves and produces 15 to 25 tons per acre. It will mature in from 75 to 100 days in this latitude when ready for the silo, carries an exceptionally heavy crop of ears in the milk stage, making the variety ideal for this purpose. **½ pk., 45c; pk., 85c; bu., \$3.00; 10 bus. or over, \$2.90 per bu.**

Westbranch Sweepstakes

One of the finest for silage, the stalks grow 10 to 12 feet high and are completely covered with leaves. The ears are 12 to 15 inches long and 14 to 18 rows. The color is yellow shaded with red. Mature in 100 days. **½ pk., 45c; pk., 85c; bu., \$3.00; 10 bus. or over, \$2.90 per bu.**

Early Canada Flint

Improved strain. This strain is in most respects identical with the original, but the ears are longer and stalks are of slightly larger growth. Ears of the original are about 6 inches in length while of this strain they are 2 inches longer, and of similar or nearly identical strains known as Early Greenfield, Deerfield and Connecticut Valley, ears are often 9 inches or longer. **½ pk., 50c; pk., 90c; bu., \$3.25.**

Sheffield World's Prize Flint

The ear of this corn has a very compact form, usually well capped at the tip, similar to the Improved Canada. The average length of the ear is 8 to 8 ½ inches, the kernels are very broad, and of dark color. This corn exceeds in proportion of corn to cob any other variety. Matures early and makes excellent silage in short season. Crop failed.

Longfellow Flint

This, for a long time, has been very popular in southern New England. Ears are 8-rowed and of remarkable length—12 to 14 inches, with occasionally one 15 inches. Stalks are considerably taller than the Improved Canada, but not so large but that they make excellent and easily handled dry stover. **½ pk., 50c; pk., 90c; bu., \$3.25.**

Sweet or Sugar Corn

1 lb. will plant about 200 hills, 10 to 12 lbs. to the acre.

We deliver free in the United States, all Bulbs, Vegetable and Flower Seeds, at prices listed in this catalog. See inside front cover.

Warm weather, rich soil and moderate moisture are the best for Corn but a satisfactory crop can be grown in any garden if the soil is deeply and thoroughly worked before planting. Sweet Corn seed is disposed to rot if planted in cold weather, so planting should be governed with this in mind. Seeds may be planted in either rows or hills. If planted in rows they should be spaced from 2 ½ to 4 feet apart, depending on the height of the variety. Seeds should be dropped at the rate of five or six to the foot, and covered about 2 inches deep. If planting in hills, drop 5 or 6 seeds per hill and space the hills 3 feet apart each way. When plants are 4 or 5 inches tall, thin to 8 to 12 inches apart and keep well hoed until the ears are set.

To have the finest Sweet Corn it must be picked in just the right condition, that is, when the skin of the grain breaks at the slightest puncture. It will be of inferior quality if it is either a few days too old or too young.

Yellow Varieties

GOLDEN BANTAM. A favorite with all who have grown it. The most famous Sweet Corn in the world today. It is the richest and sweetest of all varieties of Sweet Corn. Golden Bantam is dwarf, the stalks are usually 5 to 6 feet high, and the foliage is short, allowing it to stand closer together in the small garden and thus produce a large crop on a small area. We recommend planting Golden Bantam every ten days during the planting season and you will be assured of a contin-

uous supply of the best Sweet Corn. **Pkt., 15c; lb., 25c; 2 lbs. 45c; 10 lbs., or over, 20c per lb.**

GOLDEN SUNSHINE. The earliest of the Golden Bantam type, maturing a week or ten days earlier than that variety; more dwarf in habit than Bantam, with ears 6 ½ inches long, containing 12 rows of broad, yellow, sweet grain; especially desirable for its extreme earliness. **Pkt., 15c; lb., 25c; 2 lbs., 45c; 10 lbs. or over 20c per lb.**

SWEET CORN—Continued

GOLDEN EARLY MARKET. One of the best extra early yellow varieties for home and market garden. Ears have strong husks; 8 to 12 rowed. Kernels golden yellow, medium, tender, sweet, and of good flavor. Very prolific for so early a variety. Days from planting to eating stage, 75. Ear 6 to 7 inches. **Pkt., 15c; lb., 25c; 2 lbs., 45c; 10 lbs., or over, 20c per lb.**

GOLDEN CROSS BANTAM. Introduced jointly by the U. S. Dept. of Agriculture and Purdue University Agricultural Experiment Station. Excellent for market gardeners. Highly resistant to Stewart's disease and very prolific. Stalks sturdy, with exceptionally broad, dark green leaves. Ears 10 to 14 rowed, slightly lighter yellow than Golden Bantam. **Pkt., 15c; lb., 30c; 2 lbs., 55c; 10 lbs. or over, 22c per lb.**

IMPROVED BANCROSS P39. Outstanding new variety, very heavy producer, large eared and about five days earlier than Golden Cross Bantam, having all of the qualities of the Bantam and in addition, earliness and larger size. We are inclined to think that this variety will soon be a rival of Golden Cross Bantam. **Pkt., 15c; lb., 30c; 2 lbs., 55c; 10 lbs. or over, 22c per lb.**

MARCROSS P39. We consider the earliest large-eared hybrid. This variety has proven very prolific, very vigorous in growth and for such an early variety produces quite large ears. **Pkt., 15c; lb., 30c; 2 lbs., 55c; 10 lbs. or over, 22c per lb.**

GOLDEN GIANT. Awarded the Silver Medal for novelty and excellence at Mass. Horticultural show. Ears twice the size of Bantam and being 14- to 16-rowed gives nearly four times the yield per acre; richer in color, more delicious, equally early. The husks are striped with red and very heavy. Golden Giant can be highly recommended to the market gardener because of the large ears and good shipping qualities of the Corn. Golden Giant is the result of eleven years' selection by Dr. F. S. De Lue of Boston, Mass., from a product of "Howling Mob crossed with Golden Bantam." **Pkt., 15c; lb., 30c; 2 lbs., 55c; 10 lbs. or over, 22c per lb.**

WHIPPLE'S EARLY YELLOW. Twice the size of Golden Bantam and matures about the same time, grows ears 7 to 8 inches long and 12- to 16-rowed, with often two ears to one stalk. Quality is unequalled. **Pkt., 15c; lb., 30c; 2 lbs., 55c; 10 lbs. or over, 22c per lb.**

BANTAM EVERGREEN (Yellow). A yellow variety maturing about 10 days after the Golden Bantam and a week earlier than the Stowell's Evergreen white. It has an ear three times the size of Golden Bantam and runs 12, 14 and 16 rows to the ear. The stalk is about 6 feet tall and is perhaps 1 foot shorter than Stowell's Evergreen and 2 feet taller than Golden Bantam. The Bantam Evergreen has the tender and sweet qualities of the Golden Bantam and combines the quality of the Golden Bantam with the productiveness of Stowell's Evergreen. As a table variety it is unexcelled. **Pkt., 15c; lb., 30c; 2 lbs., 55c; 10 lbs. or over, 22c per lb.**

White Varieties

COUNTRY GENTLEMAN. Medium size, with irregular rows of very deep and slender kernels and small cob. Sweet and tender, not surpassed in quality by any other variety with white kernels. Plant very productive, often yielding three and sometimes four good ears. Plant liberally, as the kernels being much shriveled, seldom germinate so well as those of the regular type. Ready for use a little before the Stowell's Evergreen. **Pkt., 15c; lb., 30c; 2 lbs., 55c; 10 lbs. or over, 22c per lb.**

EARLY CROSBY (New England Strain). The most popular second early strain in New England, largely grown elsewhere. Ears are intermediate in size between those of the first early sorts and the Kendel's Early Giant,

especially attractive and distinct, having rather small, almost square kernels packed so closely on the cob that there is no space between the rows, as with other varieties; has always twelve or more rows and tip is completely covered. **Pkt., 15c; lb., 30c; 2 lbs., 55c; 10 lbs. or over, 22c per lb.**

STOWELL'S EVERGREEN. The best known and most largely planted of all varieties. The Stowell's Evergreen is hard to beat and for a long time to come many will have it in preference to any other sort. Yields large ears and long, deep kernels, with rich sugary flavor and long keeping qualities. It is the standard late sort. **Pkt., 15c; lb., 25c; 2 lbs., 45c; 10 lbs. or over, 20c per lb.**

Black Mexican

A popular variety; until the introduction of the Golden Bantam, the sweetest of all. Ears of medium size; kernels large, when ripe bluish black, but at proper stage for cooking, the color shows but little if at all. **Pkt., 15c; lb., 25c; 2 lbs., 45c; 10 lbs. or over, 18c per lb.**

Delicious Pop Corn for Planting

WHITE RICE. This productive rather late kind supplies delicious popped corn. The plant is vigorous and grows 24-rowed ears, 5½ inches long. **Pkt., 15c; lb., 25c; 10 lbs. or over, 20c per lb.**

DWARF WHITE HULLESS. Dwarf variety used extensively by Popcorn venders. Kernels similar in color and shape to the older types of White Rice. Dwarf growing habit. Ear about 2 to 3 inches long. Matures in about 65 days. **Pkt., 15c; lb., 30c; 10 lbs. or over, 25c per lb.**

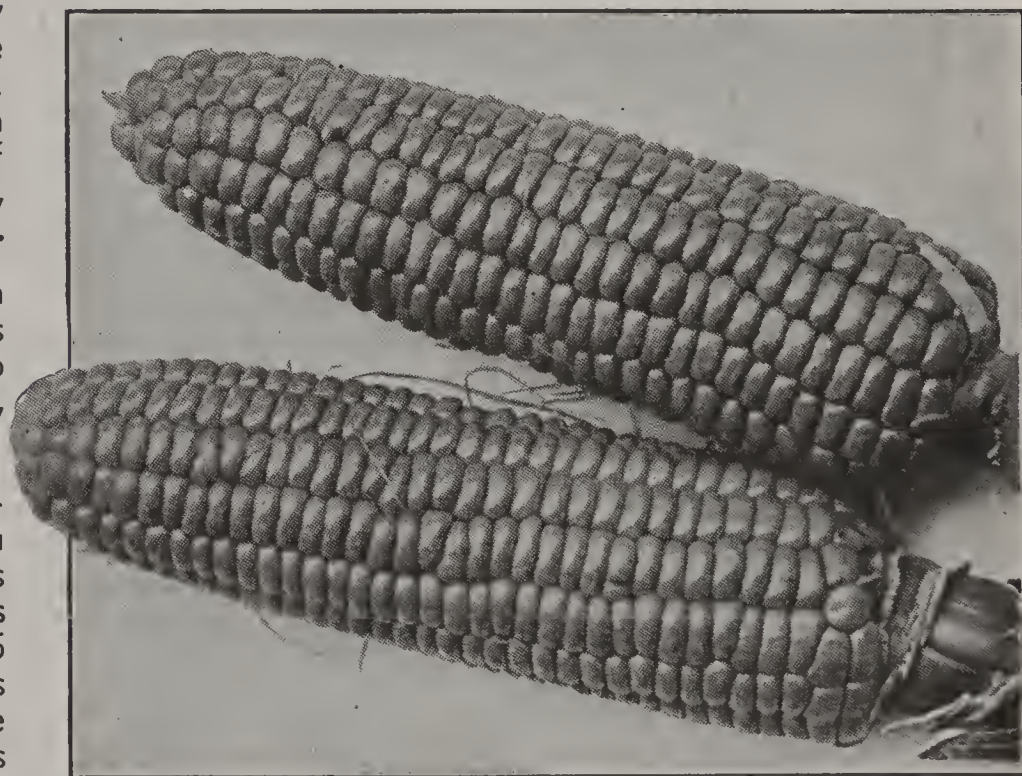

Golden Sunshine Sweet Corn



Golden Cross Bantam Sweet Corn

GOLDEN CROSS BANTAM CORN—TRY IT THIS YEAR

Worcester, Mass.

Ross' Vegetable Seeds



Vegetable strains bearing the Ross name are acknowledged by home and market gardeners to be the best.

Quality is so noticeably better, yields are greater, and yet, the initial price is low.

Plant them this year and see for yourself the finest in New England.

Asparagus

An ounce will sow about 60 feet of drill, and produce 200 or more plants.

MARY WASHINGTON. This is a selection from the Washington showing a marked improvement in every respect. It is much larger than the ordinary strain and is some earlier. Tips very compact and a rich purplish green. The whole stalk from base to tip is remarkably tender. **Pkt., 10c; oz., 25c; ¼ lb., 60c.**

Asparagus Roots

The easiest way to obtain an Asparagus bed is to set out the roots. It takes 3 years to establish one from seed, but with our large, 2-year roots a bearing bed may be had in 2 years. We can furnish strong, selected roots of the variety listed, 50 in a bunch, at the following prices:

MARY WASHINGTON. Doz., 35c; 50 for \$1.25; 100 for \$2.25; postpaid. By express, 100 for \$2.00; 1000 for \$15.00.

Artichoke

GREEN GLOBE. Perennial, large-flowering heads, cooked like asparagus. Matures second year; not hardy in the North. **Pkt., 10c; ½ oz., 35c; oz., 60c.**

Brussels Sprouts

1 oz. will produce 3000 plants

LONG ISLAND IMPROVED. A very hardy plant of the cabbage family, in this section may be left in the ground up to December. The plants of the Long Island strain do not grow up very tall but are covered from the ground up with large solid sprouts. **Pkt., 10c; oz., 40c; ¼ lb., \$1.25.**

Broccoli

ITALIAN GREEN SPROUTING. (Close Heading). Planted and used the same as Cauliflower, bluish green color, largely used by market gardeners. The plants require plenty of water. Seed started in June will make heads which will be in good condition all winter. Seed started earlier will bring heads in for summer. Broccoli takes longer to mature than cauliflower, allow 2 or 3 weeks more. **Pkt., 10c; ½ oz., 25c; oz., 40c.**

WHITE CAPE. Very white, sure to head. Resembles a coarse cauliflower, but withstands greater extremes of temperature. **Pkt, 10c; ½ oz, 15c; oz., 25c.**



Bountiful Beans

Beans for the Home Garden

1 lb. will plant 100 feet of drill; 60 to 90 lbs. will plant an acre.

Beans succeed best in warm, light soil of at least average fertility. In this latitude it is not usually safe to plant much earlier than the middle of May. If planting is made earlier and is followed by especially wet or cold weather, the planter should not blame the seedsman if Beans fail to germinate. Plant the dwarf varieties in drills 2 to 3 feet apart, about 2 inches deep, and thin plants 4 to 6 inches apart. Give frequent, shallow cultivation until time of blossoming.

Dwarf Wax or Butter Beans

BLACK WAX, PROLIFIC. One of the best for a home garden, perfectly stringless and of excellent flavor. Pods are medium size, round and of a clear waxy white color. Pkt., 15c; lb., 25c; 2 lbs., 45c; 10 lbs. or over, 20c per lb.

BRITTLE WAX. One of the best early varieties. The pods are round and long, often six inches in length, and a rich golden yellow; stringless and tender. When ripe, makes good shell beans. Pkt., 15c; lb., 30c; 2 lbs., 55c; 10 lbs. or over, 24c per lb.

IMPROVED GOLDEN WAX. An old, well known and popular variety of excellent quality. Pods flat, long, golden yellow. One of the earliest and best dwarf wax varieties for the private garden. Pkt., 15c; lb., 25c; 2 lbs., 45c; 10 lbs. or over, 20c per lb.

PENCIL POD WAX. Handsome black wax sort, medium early, fairly hardy and productive. The pods are long, 5½ to 6 inches, straight, round, fleshy and of a bright yellow color. Tender, absolutely stringless and are produced through a long season. Seed long, round, medium sized, solid black. Pkt., 15c; lb., 25c; 2 lbs., 45c; 10 lbs. or over, 20c per lb.

ROUND POD KIDNEY WAX. Of unsurpassed quality. One of the best for the home garden and very desirable for market, where round-podded varieties are popular. Pods are long, very white and waxlike; uniformly perfect in shape and vine is very productive. Pkt., 15c; lb., 30c; 2 lbs., 55c; 10 lbs. or over, 24c per lb.

SURE CROP STRINGLESS WAX. An absolutely stringless, rust-proof wax-pod, bush bean. Pods 7 to 7½ inches long, about half an inch in diameter, and a beautiful rich yellow color. Pkt., 15c; lb., 25c; 2 lbs., 45c; 10 lbs. or over, 20c per lb.

We deliver free in the United States all Bulbs, Vegetable and Flower seeds at prices listed in this catalog. See inside front cover.

Dwarf or Bush Green Podded Sorts

BOUNTIFUL. Vine unusually thrifty, rarely affected by blight, bears early, profusely and for a long time. Pods large, flat but thick and meaty, stringless and tender. Pkt., 15c; lb., 25c; 2 lbs., 45c; 10 lbs. or over, 20c per lb.

BOSTON SMALL PEA. More largely used than any other variety for baking. Choice select. Pkt., 15c; lb., 25c; 2 lbs., 45c; 10 lbs. or over, 18c per lb.

BURPEE'S GREEN POD STRINGLESS. A very desirable dwarf podded snap sort for the home garden and largely grown for the market. Pods medium green, 5 to 6 inches long. Seed of medium size and length, yellowish brown. Pkt., 15c; lb., 25c; 2 lbs., 45c; 10 lbs. or over, 20c per lb.

DWARF HORTICULTURAL. Pods thick, broad, of medium length, yellowish green splashed with red when at the stage of fitness for green shell beans and are then very attractive. Pkt., 15c; lb., 25c; 2 lbs., 45c; 10 lbs. or over, 20c per lb.

FRENCH'S HORTICULTURAL. This is a Bean of the Horticultural type which has been grown quite extensively in some localities by the market gardeners for a number of years. The vines are compact and of upright growth; almost always sending out runners to a height of 1½ to 2 feet, but do not climb a pole and are not of sufficient length to affect the Bean in any way. The pods when ready to use are a yellowish green splashed with a bright crimson. Very prolific. Pkt., 15c; lb., 30c; 2 lbs., 55c; 10 lbs. or over, 24c per lb.

EARLY LONG YELLOW SIX WEEKS. The vines of this variety are large, vigorous, erect and very productive. The leaves are large. The pods are long, about 6 inches, straight, flat, handsome, rather light green and when young are of good quality for snaps. Pkt., 15c; lb., 25c; 2 lbs., 45c; 10 lbs. or over, 20c per lb.

GIANT STRINGLESS GREEN POD. Makes an excellent succession to Burpee's Stringless Green Pod when planted at the same time. The plants are of strong growth; pods slightly curved, quite meaty, being broadly rounded and saddle backed; brittle and stringless at all stages. Pkt., 15c; lb., 25c; 2 lbs., 45c; 10 lbs. or over, 20c per lb.

TENDERGREEN. A green podded bean of unusual merit. The pods are long, light green in color, round and absolutely stringless. It yields a heavy crop of early beans. Early, prolific, stringless. Pkt., 15c; lb., 25c; 2 lbs., 45c; 10 lbs. or over, 20c per lb.

IMPROVED YELLOW EYE. One of the best sorts for baking; extremely productive and of superior quality. Pkt., 15c; lb., 25c; 2 lbs., 45c; 10 lbs. or over, 20c per lb.

RED KIDNEY. Large red kidney-shaped Beans of excellent quality. The old-fashioned baking Bean. Pkt., 15c; lb., 25c; 2 lbs., 45c; 10 lbs. or over, 20c per lb.



• Giant Stringless Green Pod

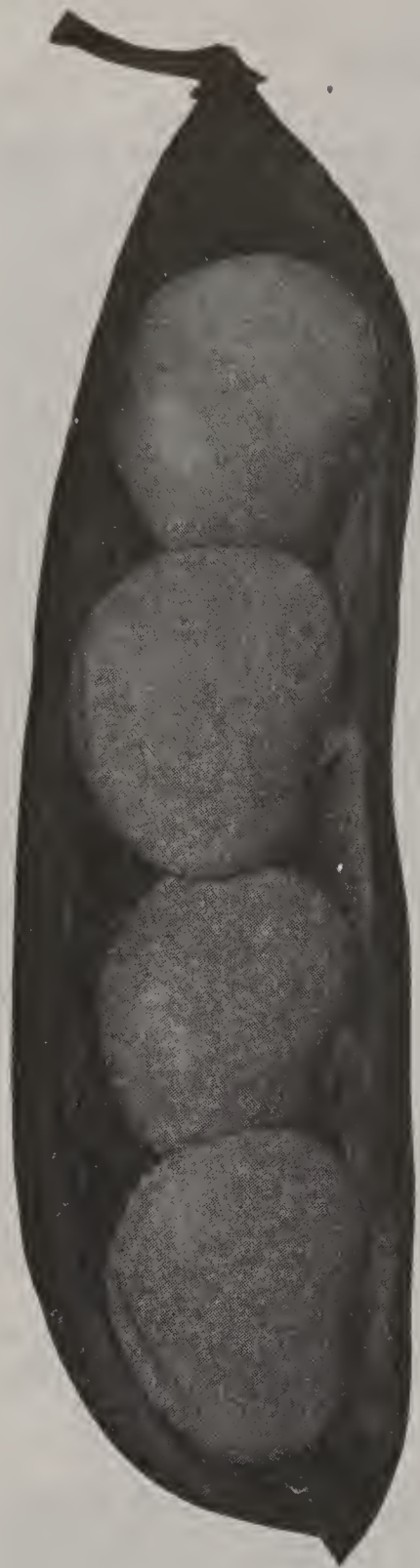

Burpee's Improved Bush Lima Bean

English Broad Bean

BROAD WINDSOR. An old-fashioned English shell Bean. This Bean is very hardy; it should be planted as early as the ground will permit, 3 or 4 inches deep in rows 3 feet apart, and plants 1½ feet apart in row. Dry beans very large and yellowish green. **Pkt., 15c; lb., 35c; 2 lbs., 65c.**

Dwarf Lima Beans

1 lb. will plant about 50 hills

More hardy than the pole varieties and therefore may be planted earlier. Make rows 2 feet apart and plant the Beans, eyes down, every 2 inches. Cover about 2 inches deep. Thin to 6 inches. Note: In very wet weather Bush Lima Beans will sometimes send out runners about 2 feet long.

HENDERSON'S BUSH LIMA. A bush Bean of the Sieva Lima type. Beans small but vine is productive and bears early. **Pkt., 15c; lb., 35c; 2 lbs., 55c; 10 lbs. or over, 24c per lb.**

BURPEE'S IMPROVED BUSH LIMA. A distinct strain. The earliest, largest, and the best of all large Limas. This new strain differs from the popular Burpee's Bush Lima in bearing uniformly much larger pods, producing more Beans, while both pods and beans are much larger and thicker. While the Beans are as large as those of the large Lima, the crop of the Improved is ready for gathering from 8 to 10 days earlier. In quality the Beans are equal to any, being thin-skinned, juicy and of fine flavor. **Pkt., 15c; lb., 25c; 2 lbs., 45c; 10 lbs. or over, 20c per lb.**

FORDHOOK BUSH LIMA. One of the leading varieties of Bush Lima Beans. The plant is of stiffly erect habit, the Beans are much larger and of superior quality and even when full size are juicy and of fine flavor. **Pkt., 15c; lb., 30c; 2 lbs., 55c.**

Pole or Running Lima Beans

1 lb. will plant 100 hills.

SEIBERT'S EARLY LIMA. The earliest variety; the pods are short and rarely contain more than 4 Beans, the total yield compares very favorably with other varieties. Pods are opened easily, owing to the fact that they are very thin. **Pkt., 15c; lb., 30c; 2 lbs., 55c; 10 lbs. or over, 24c per lb.**

KING OF THE GARDEN LIMA. Earlier than the Large Lima, and pods are longer and often contain 5 Beans of the largest size. The vine is large and of remarkably vigorous growth and will produce larger pods and bear earlier if only two are allowed to grow to the pole. **Pkt., 15c; lb., 30c; 2 lbs., 55c; 10 lbs. or over, 24c per lb.**

Beans, Pole or Running, Wax Podded Sorts

1 lb. will plant about 100 hills

Pole Beans require considerable care. They are, when properly grown, of long bearing period, more sensitive to wet and extremes of temperature than the dwarf varieties and should not be planted as early. Set in rows about 4 feet apart, preferably running north and south, allowing about 3 feet between the poles in the row. Plant 6 to 8 inches around each pole and thin to 3 or 4 plants.

GOLDEN CLUSTER WAX. Pods long, broad, thick and fleshy; borne in clusters, creamy white in golden yellow; of best quality. **Pkt., 15c; lb., 30c; 2 lbs., 55c; 10 lbs. or over, 24c per lb.**

"KENTUCKY WONDER WAX." This Pole Bean is quite similar to the very popular green-podded Kentucky Wonder, except that the very long pods are a little broader, and of a waxy golden yellow. These are very attractive, fleshy, stringless and not surpassed in quality. **Pkt., 15c; lb., 30c; 2 lbs., 55c; 10 lbs. or over, 24c per lb.**

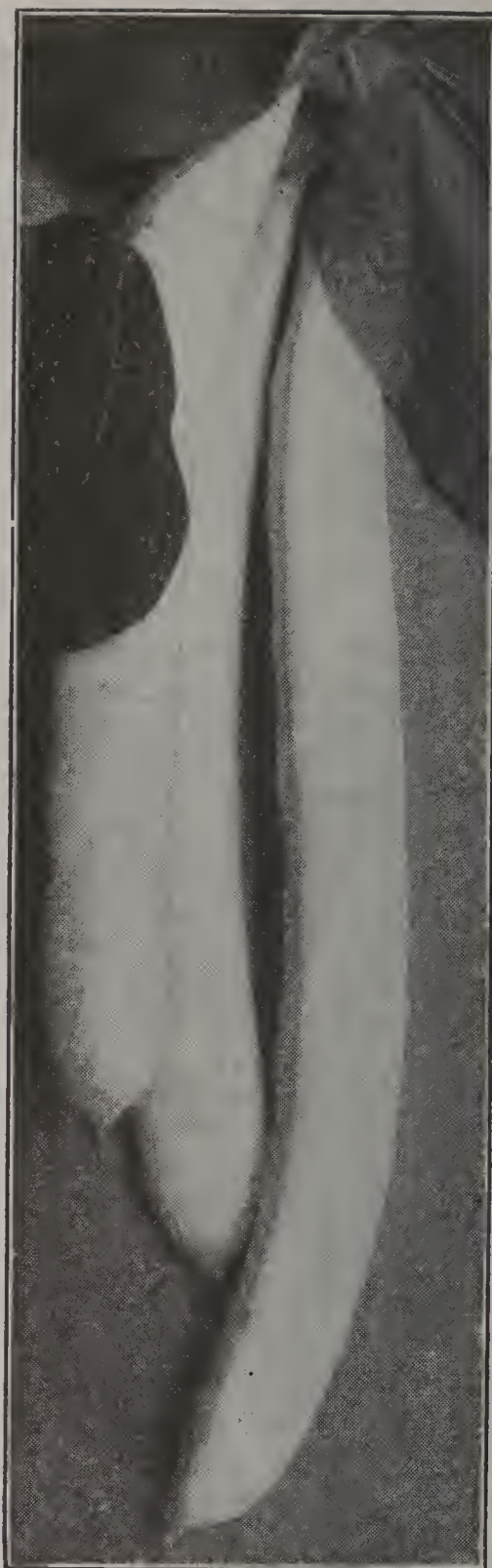

Kentucky Wonder Wax Beans

Beans, Pole or Running, Green Podded Sorts

Don't Forget—Nod-o-gen for Beans

KENTUCKY WONDER OR OLD HOMESTEAD. Pods are borne in large clusters, are of unusual length, nearly round, silvery green; when young, crisp, entirely stringless, of fine texture and flavor. Vine bears early and is very productive. Used only as a string Bean. **Pkt., 15c; lb., 25c; 2 lbs., 45c; 10 lbs. or over, 20c per lb.**

SCARLET RUNNER. Largely grown as an ornamental climber; its rapid growth and early production of dazzling flowers make it a favorite for covering screens, walls, etc. It is also of excellent edible qualities, but rarely grown for that purpose. **Pkt., 15c; lb., 35c; 2 lbs., 65c; 10 lbs. or over, 27c per lb.**

WORCESTER MAMMOTH HORTICULTURAL. This variety, while similar in general character to the Horticultural Pole, is much superior in several ways. The Beans, though closely resembling those of the common strain, are much larger. Its strikingly handsome pod combined with its great size are both features of excellence which recommend it. Added to these excellent qualities are those of thrifty, vigorous growth of vine and great productiveness, all making it a variety especially desirable to the market garden. It easily brings a higher price in the market than any other, and is not excelled by any other sort for the home garden. **Pkt., 15c; lb., 25c; 2 lbs., 45c; 10 lbs. or over, 20c per lb.**

Ross' Garden Beets

FOR TABLE, PICKLING, AND CANNING

An ounce will sow about 100 feet of drill. 5 to 6 pounds required for an acre.

The Beet thrives best in deep, rich, but rather light soil. Sow in drills about 15 inches apart and one inch deep. Make the soil firm over the seed. For early use, sow as soon as the ground can be worked; for fall use, in May; for winter from the 20th of June to the middle of July, according to the variety. Thin plants to 4 or 5 inches apart. Give frequent shallow cultivation.

CROSBY'S EARLY EGYPTIAN EXTRA SELECTED STRAIN. For several years we have given this especial attention and have succeeded in eliminating the light-colored, coarse fleshed specimens peculiar to the Egyptian. Roots are more uniform in shape and tops are more even in growth, a little smaller. We confidently recommend it to market gardeners as an unsurpassed strain. **Pkt., 10c; oz., 15c; 1/4 lb., 40c; lb., \$1.25.**

EARLY WONDER. One of the earliest and most perfectly shaped Beets. Its beautiful, deep blood-red color, globular-shaped roots, make it valuable for the home garden. The attractive appearance, uniform size, shape and color have created a very heavy demand for this variety. It is grown very extensively for late sowing. **Pkt., 10c; oz., 15c; 1/4 lb., 40c; lb., \$1.25.**

ROSS' PERFECTION. Selected by us as the best early Beet for the market gardener. Nearly as early as the Early Egyptian, but the roots are much thicker and more regular in shape. By careful selection the coarse-fleshed and light-colored specimens have been practically eliminated. **Pkt., 10c; oz., 15c; 1/4 lb., 40c; lb., \$1.25.**

EARLY EGYPTIAN. The earliest variety; roots flat; deep crimson; top small. **Pkt., 10c; oz., 15c; 1/4 lb., 35c; lb., \$1.00.**

EDMAND'S BLOOD TURNIP. A standard variety used for both second-early and main crop. Of good quality and keeps well. **Pkt., 10c; oz., 15c; 1/4 lb., 35c; lb., \$1.00.**

DEWING'S BLOOD TURNIP. One of the leading main crop varieties. **Pkt., 10c; oz., 15c; 1/4 lb., 35c; lb., \$1.00.**



Crosby's Early Egyptian Beet

DETROIT DARK RED. A superior second-early and main-crop variety rapidly growing in favor for late planting. Tops uniformly small and grow upright so that the rows may be close together. **Pkt., 10c; oz., 15c; 1/4 lb., 40c; lb., \$1.25.**

Note: For Chard, see page 16.

Sugar Beets and Mangel-Wurzels For Stock Feeding

1 oz. to 100 feet of drill; 5 lbs., per acre.

Culture. Both Mangels and Sugar Beets require deep, well enriched soil. Sow in May or June in rows 18 inches to 2 feet apart and 6 to 8 inches in the row. Young plants may be transplanted to fill up vacancies. As soon as frost occurs, dig the crop. For Winter store in cellar or in pits. Sow 5 to 6 pounds per acre.

The value of Sugar Beets and Mangels for stock feeding is clearly seen in the improved health and condition of the animals. They yield enormously and can be grown at trifling cost.

Mangels make excellent and rich as well as cheap Winter feed for poultry.

GOLDEN TANKARD. It is one of the best stock Beets grown. It has yellow flesh, a very distinct variety, be-

Golden Tankard
Mangel-
Wurzel

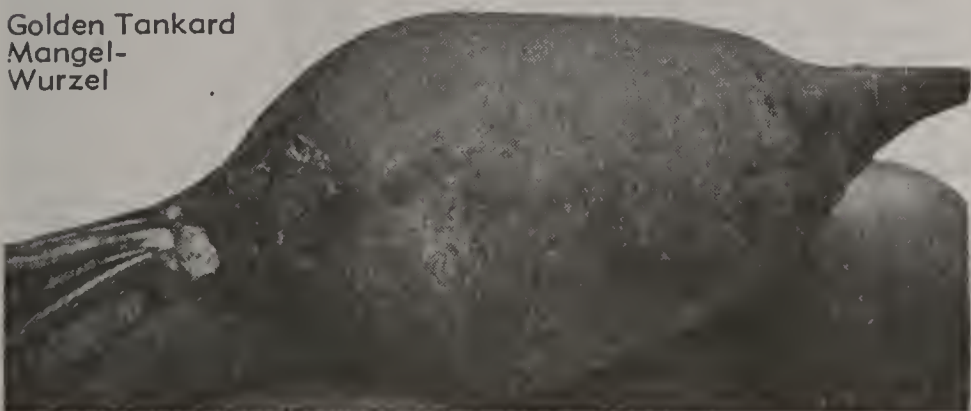

ing short with very little tap root and very easy to harvest. Top and neck very small; root ovoid, flesh yellow, zoned with white; an excellent sort. **Price, oz. pkt., 10c; 1/4 lb., 25c; lb., 75c.**

MAMMOTH LONG RED. This is truly a mammoth, a single root often weighing twenty to thirty pounds. The extra large, long roots are blood-red in color and very nutritious. Enormously productive, yielding, under favorable conditions, thirty to forty tons of roots per acre. **Price, oz. pkt., 10c; 1/4 lb., 25c; lb., 75c.**

NORBITON GIANT LONG RED. Similar to the Mammoth Long Red; has smaller top and neck; flesh scarlet. **Price, oz. pkt., 10c; 1/4 lb., 25c; lb., 75c.**

RIVENHALL GIANT. One of the finest types of yellow globe Mangel in cultivation. Roots are immense size and even in shape. Skin orange-yellow with reddish yellow base. The flesh is white, being firm and fine grain, which renders it an excellent keeping variety. It grows fully three-fourths above ground with a very small tap root which makes it well adapted to light soil. **Price, oz. pkt., 10c; 1/4 lb., 25c; lb., 75c.**

Sugar Beets

KLEIN WANZLEBEN. Root is conical, straight and even, large at top and tapering. Contains the largest percentage of saccharine matter. **Price, pkt., 10c; oz., 15c; 1/4 lb., 30c; lb., \$1.00.**

Ross' Better Cabbage

An ounce will produce about 3000 plants.

Cabbage will thrive on any good garden soil but is more successfully grown on deep, strong loam, and new soil is much preferable, as on old land the roots are more liable to be affected by the disease called club-root. Especially should land be avoided upon which, within two years, cabbage, cauliflower, turnips or radishes have been grown.

For the earliest crop, seed is usually sown in February or March in hotbeds with only moderate bottom heat, and the plants hardened by gradually exposing them to the night air and transplanted as early as the ground is in suitable condition.

Yellows-Resistant Cabbage

The term, "Yellows-Resistant" Cabbage seed, does not necessarily imply that this seed is to be planted only in soil infested with the Yellows or Wilt. Our Resistant seed has a very high germination test, and produces a hardier plant, a surer producer and yields greater tonnage than ordinary commercial strains.

DANISH BALLHEAD "YELLOW-RESISTANT." Pkt., 10c; 1/2 oz., 25c; oz., 40c; 1/4 lb., \$1.25.

Copenhagen Market

The best early Cabbage.

The earliest large, round-headed Cabbage yet introduced. Matures 68 days after transplanting. It is a very sure heading and uniform variety of hardy and compact growth. The heads are 7 or 8 inches in diameter and weigh 3 or 4 pounds. The variety is solid, sweet, crisp and tender. A most excellent sort for the home garden. Pkt., 10c; 1/2 oz., 20c; oz., 35c; 1/4 lb., \$1.00.

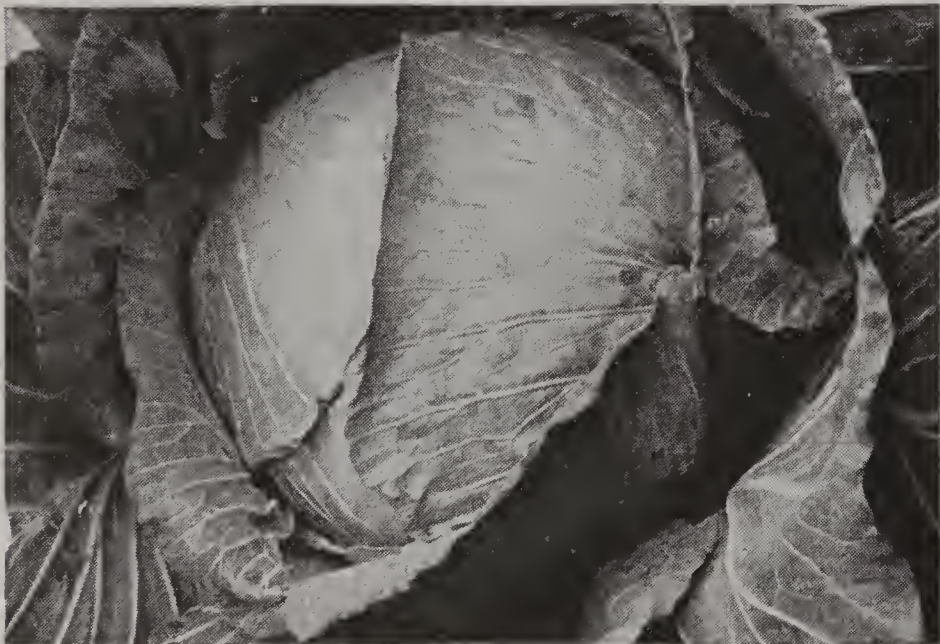

Copenhagen Market

ALL SEASONS. This Cabbage is remarkable for its ability to stand hot sun and dry weather and remain a very long while in condition for use. Intermediate in season, requiring 89 days to mature. The plant grows vigorously and in somewhat spreading form. The head is large, firm and solid, very white and has a small heart. It is broad-oval in shape, 8 inches deep, 10 to 11 inches wide and 9 or 10 pounds in weight. It is crisp, sweet and tender. Pkt., 10c; 1/2 oz., 15c; oz., 25c; 1/4 lb., 75c.

EARLY JERSEY WAKEFIELD. Although this variety is not as early as the preceding one, it will be found the very best conical heading sort to come in immediately after. It is very compact, medium size, conical and a sure header. Pkt., 10c; 1/2 oz., 15c; oz., 25c; 1/4 lb., 75c.

AMERICAN IMPROVED SAVOY. The best of the Savoy type, which should be more largely grown. Pkt., 10c; 1/2 oz., 15c; oz., 25c; 1/4 lb., 75c.

RED CABBAGE FOR PICKLING



Danish Ballhead

DANISH BALLHEAD. This is now the most popular main crop variety for market, due to its remarkable solidity, weight, uniformity in size, fine keeping qualities and attractive round head. It is especially valuable for shipping to distant markets and for late spring use. Though the heads are but of medium size, owing to their great weight the product of an acre exceeds in weight that of any other variety. We offer a strain of seed which has been proved by repeated trials to be unsurpassed. Pkt., 10c; 1/2 oz., 20c; oz., 35c; 1/4 lb., \$1.00.

DANISH ROUNDHEAD. Makes a little earlier than the Danish Ballhead. The heads are nearly round and have a short stalk, and are very hard. Pkt., 10c; 1/2 oz., 20c; oz., 35c; 1/4 lb., \$1.00.

GOLDEN ACRE (Danish Grown). An extra early selection of the Copenhagen type, and the earliest of the round-headed Cabbages, maturing with Jersey Wakefield. Plant small, dwarf and compact, with few outer leaves; heads of medium size, round as a ball, hard, solid and very uniform. We believe it to be the earliest Cabbage in existence. Pkt., 10c; 1/2 oz., 25c; oz., 40c; 1/4 lb., \$1.25.

PENN STATE BALLHEAD. Originated by Dr. Meyers of the Pennsylvania State College. It is a short stem variety, medium size heads, very hard and the color a bright green. Pkt., 10c; 1/2 oz., 25c; oz., 40c; 1/4 lb., \$1.25.

PREMIUM FLAT DUTCH. An old standard late variety. Head large, flat and solid. Pkt., 10c; 1/2 oz., 15c; oz., 25c; 1/4 lb., 75c.

MAMMOTH ROCK RED. Head larger and more solid than Red Drumhead; reliable in heading. Pkt., 10c; 1/2 oz., 15c; oz., 25c; 1/4 lb., 75c.

WARREN STONE MASON. An improved strain of the old Stone Mason. Previous to the introduction of the Danish Ballhead, the most popular variety in New England for main crop. Earlier and more nearly round than the old strain, of medium size, hard, solid and of excellent quality. Reliable and keeps well. Pkt., 10c; 1/2 oz., 15c; oz., 25c; 1/4 lb., 75c.

Chinese Cabbage

PE-TSAI. Distinct from the Cabbage of commerce, somewhat resembling Cos Lettuce; in fact, sometimes called Celery Lettuce. It can be eaten either as a salad or cooked like ordinary Cabbage. Culture same as late Cabbage. Sow early in July. Pkt., 10c; 1/2 oz., 15c; oz., 25c; 1/4 lb., 75c.



Chinese Cabbage, Pe-Tsai

ROSS BROS. CO.

Ross' Carrots for Farm and Garden

For several generations the Carrot has been one of the common garden vegetables, but only in recent years has it come to be recognized as one of our most nutritious and wholesome foods. Health authorities assert that Carrots contain in high degree those elements which constitute a nourishing article of diet. The plant has no serious insect enemies and is rarely subject to disease. The culture of Carrots is easy, being practically the same as that of beets. When practicable it is best to plant them in soil that has been richly fertilized the previous season. Freshly manured soil will often produce divided roots. Plant the seed one-half inch deep in loose, well-prepared soil, making rows 16 to 24 inches apart. Cultivate as soon as the plants are well established and thin to 2 to 4 inches in the row, according to the size of the variety. Plantings may be made from early spring until mid-June. For winter storage the later date is advisable.



Chantenay Carrots

CHANTENAY. A half-long variety most extensively used for the home garden. It is medium early, maturing in about 60 days. This sort is very productive and easy to harvest. The root is smooth, deep orange-red, uniformly stumped but slightly tapered, and about 5½ inches long. The crisp, tender and finely flavored quality makes it most suitable for table use in early maturity. **Pkt., 10c; oz., 15c; ¼ lb., 40c; lb., \$1.25.**

DANVERS HALF LONG. A well known rich orange-red variety, very smooth and handsome, producing extra heavy crops. An excellent market variety; crisp, sweet and tender. Although the roots are short, they produce as large a bulk as the longer field sorts and are more easily harvested. This variety has yielded 25 tons per acre. We have given this our special attention and offer at this time as good strain of seed as is possible to obtain. **Pkt., 10c; oz., 15c; ¼ lb., 40c; lb., \$1.25.**

HUTCHINSON. A very large, nearly cylindrical, stump-rooted Carrot, 10 to 12 inches in length; good color

and immensely productive. **Pkt., 10c; oz., 20c; ¼ lb., 60c; lb., \$2.00.**

IMPERATOR. For market and house garden use. Tops medium, but strong enough for good bunching. Flesh rich orange color, extending to center of root, with indistinct core. **Pkt., 10c; oz., 15c; ¼ lb., 40c; lb., \$1.25.**

LONG ORANGE IMPROVED. Large size, tapering to a point, of deep orange color, and adapted to garden or field culture. A valuable food for stock. **Pkt., 10c; oz., 15c; ¼ lb., 35c; lb., \$1.15.**

LARGE WHITE BELGIAN. Grows one-third out of ground. The portion above ground is green, that below white, large and rather coarse. Used only for stock. **Pkt., 10c; oz., 15c; ¼ lb., 35c; lb., \$1.00.**

PRIDE OF DENMARK. A Carrot of great promise. It is a cross between the Nantes and Chantenay and resembles the Hutchinson in shape and is of equally good quality. **Pkt., 10c; oz., 20c; ¼ lb., 60c; lb., \$2.00.**

Celery -- Ross' Home and Commercial Strains

An ounce will produce about 10,000 plants.

Celery is generally grown as a second crop, following early cabbage, onions, peas, etc. Sow early in April, transplanting about the first of June. Set in rows about three feet apart.

EASY BLANCHING. The plant is of medium height, of great vigor, having thick rather than broad stalks, with shallow ribs. The stalks are very brittle and the flavor extremely spicy. **Pkt., 10c; ½ oz., 20c; oz., 30c; ¼ lb., 85c.**



Golden Self-Blanching Celery

GIANT PASCAL. One of the best for winter use; leaves upright, short and dark green. **Pkt., 10c; ½ oz., 20c; oz., 35c; ¼ lb., \$1.00.**

GOLDEN SELF-BLANCHING. The most popular variety for market, easily blanched, very attractive, of good quality though not equal to some of the green Celeries. **Pkt., 10c; ½ oz., 20c; oz., 35c; ¼ lb., \$1.00.**

WHITE PLUME. The earliest and most easily blanched of all varieties, very showy, of good quality. **Pkt., 10c; ½ oz., 20c; oz., 30c; ¼ lb., 85c.**

WINTER QUEEN. Of medium height, but stout, thick and heavy, with a larger amount of heart than most other sorts. Of fine quality, more easily handled than the Giant Pascal, and an excellent keeper. One of the best for late winter use. **Pkt., 10c; ½ oz., 20c; oz., 30c; ¼ lb., 85c.**

Celeriac—Turnip Rooted Celery

Sow seed and treat in first stage of growth as directed for celery. Set in rows 2 feet apart and 6 inches apart in the row. When roots have reached a size of 2 inches in diameter they are ready for use. These are boiled, sliced and eaten with vinegar. To keep through winter, roots should be packed in moist sand or earth.

LARGE SMOOTH PRAGUE. An improved sort with nearly round roots which have but few side roots. **Pkt., 10c; oz., 25c; 2 ozs., 45c; ¼ lb., 80c.**



Early Snowball Cauliflower

Cauliflower

An ounce will produce 3000 plants.

Sow the first week in May, transplant in July. For wintering under glass, sow second and last week in September, transplant into cold frame, give plenty air in mild weather and cover up in severe. Again, sow in February in a hotbed and transplant in April. Use plenty of rotten manure. Select new ground, as Cauliflower rarely succeeds on ground which has been cropped year after year. Plant in rows 20 inches apart and 2 feet between rows.

EARLY SNOWBALL. The earliest and surest to head. We offer an unsurpassed strain from one of the leading growers in Denmark. Pkt., 15c; ¼ oz., 70c; ½ oz., \$1.25; oz., \$2.00.

EARLIEST DWARF ERFURT. One of the earliest varieties; very dwarf. Excellent for forcing. Pkt., 20c; ¼ oz., \$1.00; ½ oz., \$1.85; oz., \$3.50.

EARLY LONDON. A well known variety, maturing its head soon after the early sorts. Pkt., 10c; ½ oz., 45c; oz., 75c; ¼ lb., \$2.50.

Swiss Chard

SWISS CHARD OR SILVER SEA KALE BEET. Used for greens only. Much superior to other Beets for greens. Plants should be thinned to about one foot apart. When the plants have attained full size, the stems

and mid-ribs are sometimes cooked and served like asparagus. Pkt., 10c; oz., 15c; ¼ lb., 35c; lb., \$1.00.

GIANT LUCULLUS. This Swiss Chard or Spinach Beet is prepared for the table in the same manner as Spinach; sometimes, however, the mid-rib is prepared like asparagus. Seed planted early in the spring will quickly produce plants from which cuttings may be made all summer, as you can cut right down to the ground and new shoots will soon spring up and make a fast growth, while those plants which are allowed to grow on without any cutting will make large, curly leaves, with thick, light colored mid-ribs which are delicious when cooked and served like asparagus. Pkt., 10c; oz., 15c; ¼ lb., 35c; lb., \$1.00.



Swiss Chard, Giant Lucullus

Chervil, Curled

A hardy annual, used for flavoring and garnishing. It is thought by some to exceed even parsley in beauty. Seed should be sown early in the spring and when plants are well rooted, transplant to one foot apart. The leaves will be ready for use in seven to ten weeks from planting. Pkt., 10c; oz., 25c; ¼ lb., 80c.

Corn Salad, Fetticus, or Lamb's Lettuce

A hardy, rapid-growing plant, often used in winter as a substitute for lettuce and is sometimes cooked and used like spinach. Pkt., 10c; oz., 30c; 2 ozs., 55c; ¼ lb., \$1.00.

Chicory

WITLOOF OR FRENCH ENDIVE. Esteemed as a salad plant. Spring-sown seeds produce parsnip-like roots by November. Cut the leaves off 1 ½ inches from the neck, trench 1 ½ inches apart, cover with soil 8 inches over crown; then place a 2 or 3 foot layer of fresh manure which induces new growth of blanched leaves folded like Cos Lettuce, which are eaten raw as salad. Pkt., 10c; oz., 30c; ¼ lb., 85c.

Chives

Are a small, hardy perennial plant resembling onion in appearance and growing in clusters. They are grown for the leaves, which are produced freely from early spring and give a mild onion flavor to sausages, salads and soups. They can be easily grown in pots at a sunny window during the winter. Pkt., 15c; ½ oz., 40c; oz., 75c.

Collards

One ounce for about 5,000 plants.

Collards are very largely used as "greens" in some parts of the country, especially in the South. They are a form of loose-headed cabbage.

GEORGIA. The most satisfactory variety for general use. Pkt., 10c; oz., 25c.

Dandelion

An ounce will sow 200 feet of drill.
Two pounds to the acre.

Sow early in the spring in rich soil in drills 15 to 18 inches apart, cover lightly but make the earth firm.

IMPROVED THICK-LEAVED, or CABBAGING. A distinct variety unsurpassed in thickness of leaf and deep green color. It grows compactly, forming a regular tuft. Pkt., 10c; ½ oz., 35c; oz., 55c; ¼ lb., \$1.75.

CULTIVATED, or FRENCH COMMON. A greatly improved strain of the common Dandelion. Pkt., 10c; ½ oz., 20c; oz., 30c; ¼ lb., 85c.

CICCORIA CATALOGNA, or ITALIAN DANDELION. Pkt., 10c; ½ oz., 15c; oz., 25c.

We deliver free in the United States all Bulbs, Vegetable and Flower Seeds, at prices listed in this catalog. See inside front cover.

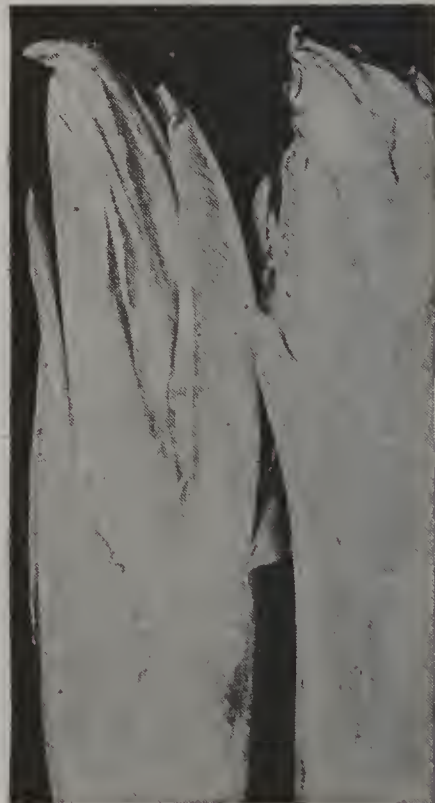

Chicory, Witloof

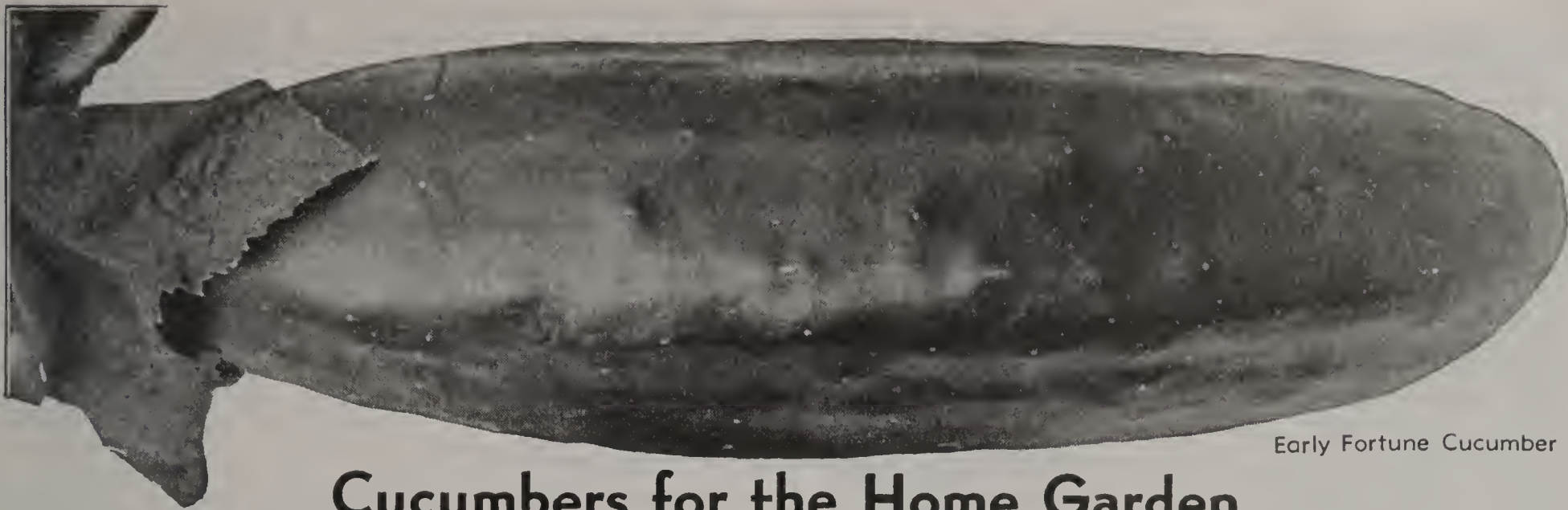

Early Fortune Cucumber

Cucumbers for the Home Garden

One Packet of Seed will sow 15 hills, 1 ounce 50 hills.

The Cucumber requires well enriched soil, and should not be planted until settled warm weather, in this latitude, seldom before the middle of May. Plant the early, small kinds in hills $3\frac{1}{2}$ to 4 feet apart, the larger varieties 5 to 6 feet. Make the hills broad, use 15 to 20 seeds to the hill, dropping them well apart. Cover with not over an inch of earth, and firm this well with the hoe. If the young plants are attacked by the striped bugs or other insects, dust frequently with air-slacked lime, soot or ashes mixed with road dust, taking care that too much is not used at a time. When all danger from bugs is past, thin to three plants to the hill. Give frequent shallow cultivation as long as vines will permit.

COLORADO. This cucumber grows about 12 inches long and about 3 inches in diameter. The color is dark green. It is just a little shorter than Longfellow and far more prolific. We think it will be one of the leading varieties from now on. Pkt., 10c; oz., 20c; $\frac{1}{4}$ lb., 60c; lb., \$2.00.

DAVIS PERFECT. Fine length, slimness, beautiful dark green color, transparent-like flesh with deliciously cool, refreshing flavor, and enjoyable crispness, are distinguishing features and qualities of this, the most popular of the extra long, white spine Cucumbers. Pkt., 10c; oz., 15c; $\frac{1}{4}$ lb., 40c; lb., \$1.50.

BOSTON PICKLING. For pickling. Its fruit is short, pointed at each end, productive and of superior quality. Pkt., 10c; oz., 15c; $\frac{1}{4}$ lb., 40c; lb., \$1.50.

EARLY FORTUNE. The plant is early, very vigorous, with an exceptionally heavy, thick foliage and is almost disease-resistant and very productive. Fruits are uniformly nine inches long, slightly tapering toward each end, perfectly round and of a very dark green color which does not fade in shipping; flesh very thick, firm and crisp, and exceedingly small seed cavity. Pkt., 10c; oz., 15c; $\frac{1}{4}$ lb., 40c; lb., \$1.50.

EXTRA LONG OR EVERGREEN WHITE SPINE. Vine productive and comes into bearing soon after the Early White Spine. Popular with market gardeners. Pkt., 10c; oz., 15c; $\frac{1}{4}$ lb., 40c; lb., \$1.50.

IMPERATOR, W. S. An outstanding variety for shipping, and for market gardeners. Holds its color and firmness when handled long distances. Fruits weigh $2\frac{1}{4}$ pounds; handsome, very dark green color; slightly tapered at both ends; flesh crisp and firm; remains edible for long time; very few seeds. Pkt., 10c; oz., 15c; $\frac{1}{4}$ lb., 40c; lb., \$1.50.

IMPROVED WHITE SPINE. Perfection has been attained in this improvement in the White Spine family. It is early, prolific and produces a continuous crop of uniformly large and symmetrical fruits, faintly marked with light yellowish shading toward the tip. Pkt., 10c; oz., 15c; $\frac{1}{4}$ lb., 40c; lb., \$1.50.

JAPANESE CLIMBING (Black Spine). Vine very vigorous, with especially strong grasping tendrils. Pkt., 10c; oz., 15c; $\frac{1}{4}$ lb., 40c; lb., \$1.50.

LONG GREEN. An old standard variety, very popular for home gardens but little used for market. Fruit very long, slender, very firm and crisp, uniformly dark green; makes fine pickles and is the best of all when ripe for making sweet pickles. Pkt., 10c; oz., 15c; $\frac{1}{4}$ lb., 40c; lb., \$1.50.

English Frame Variety

For forcing in hotbeds and greenhouses

TELEGRAPH. The most valuable variety of this class, superior for market. Pkt., 50c.

Endive

An ounce will sow 300 feet of drill, producing from 2,000 to 2,500 plants.

Endive, like lettuce, may be grown at any season, but is more generally used in the fall. For early use, sow in April, for later, until July, in drills 18 inches apart, or in beds for transplanting, plants should stand 10 to 12 inches apart in the row. When nearly full grown tie outer leaves over center to blanch the heart, or blanch with boards as with celery.

MOSS CURLLED. Of dense growth and finely curled. Pkt., 10c; oz., 20c; $\frac{1}{4}$ lb., 50c; lb., \$1.50.

LARGE GREEN CURLLED. Of larger growth, not so much curled as preceding. Pkt., 10c; oz., 20c; $\frac{1}{4}$ lb., 50c; lb., \$1.50.

BATAVIAN BROAD LEAVED (Escarolle). A variety having broad, more or less twisted and waved bright green leaves with thick, nearly white midribs. The inner leaves form a fairly solid, clustering head which blanches a beautiful deep creamy white and is crisp, tender, and of fine flavor. Unsurpassed for salads. Pkt., 10c; oz., 20c; $\frac{1}{4}$ lb., 50c; lb., \$1.50.

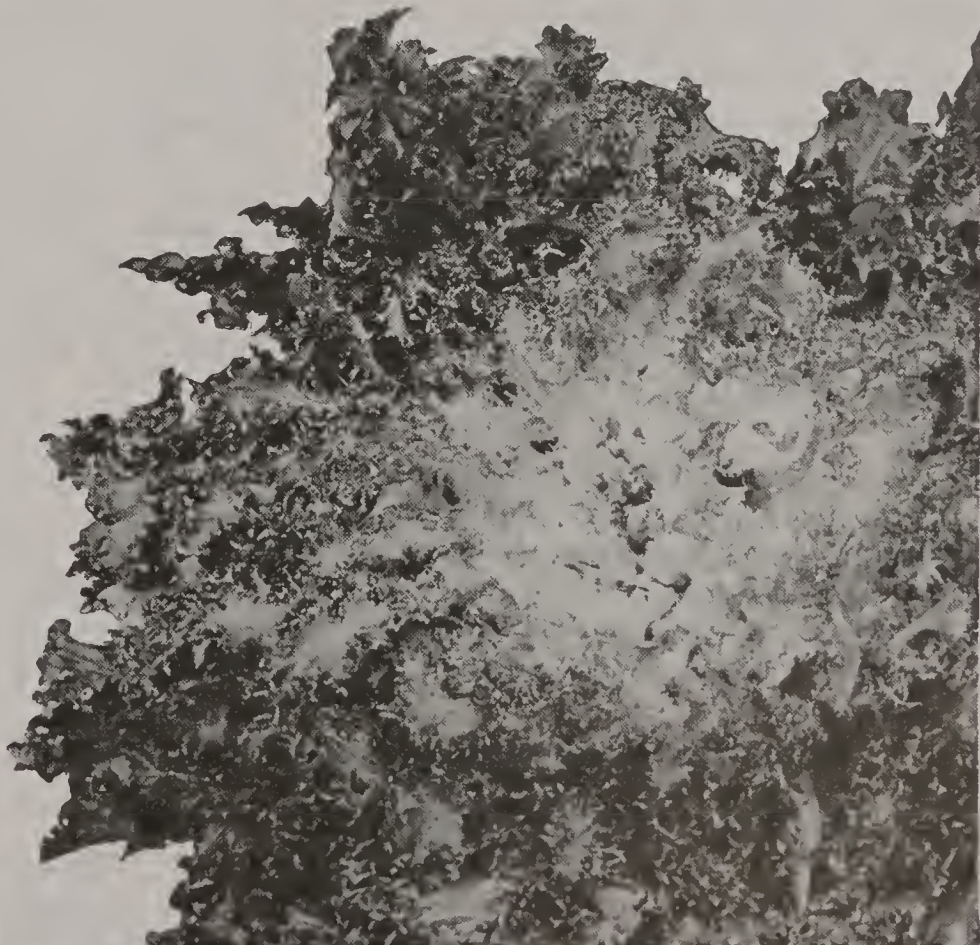

Large Green Curled Endive



Black Beauty Eggplant



American Broad Flag Leek

HOME GARDEN COLLECTION

	Pkt.
Beet, Crosby's Early	10c
Carrot, Imperator	10c
Sweet Corn, Golden Bantam	15c
Cucumber, Imperator	10c
Lettuce, New York Iceberg	10c
Radish, Scarlet Globe	10c

Value65c
 One packet each of the above as listed, six varieties, postpaid to any address in the United States, cash with the order 40c.



Early White Vienna Kohlrabi

Dill

An annual of aromatic odor and warm pungent taste. Its seeds are used for seasoning. It possesses medicinal properties but its largest use is for making Dill pickles. Plant branching, two to three feet high; leaves very much cut into thread-like segments. Pkt., 10c; oz., 20c; 1/4 lb., 50c.

Fennel (Finocchio)

FLORENCE OR NAPLES. Resembles Celery in flavor but has a sweet taste and delicate odor. Should be sown in spring in drills 18 inches apart and the plants thinned to 5 or 6 inches apart. Pkt., 10c; oz., 50c; 1/4 lb., \$1.50.

Cress, Curled or Pepper Grass

A small pungent salad plant, much liked by some with lettuce. Like all salad plants, it should be grown on rich ground. Seed may be sown early in the spring, but if desired through the summer, repeated sowings will be necessary. Pkt., 10c; oz., 20c; 2 ozs., 35c; 1/4 lb., 60c.

Water Cress

Hardy plant which can be grown in a pond or along the banks of a running stream. Largely used as a garnish during the winter and early spring months. Pkt., 10c; 1/2 oz., 35c; oz., 60c; 1/4 lb., \$2.00.

Eggplant

An ounce will produce about 2000 plants.

CULTURE. Plant the seed in March in hotbed, or, for family use, in flower pots in a warm window. Transplant in open ground after weather has become warm and settled, in rows 2 feet apart each way. Require rich soil.

LONG PURPLE. An extra early sort, fruits 7 to 8 inches long, 2 1/2 to 3 inches thick; dark purple, smooth and attractive. Pkt., 10c; 1/2 oz., 30c; oz., 50c.

NEW YORK IMPROVED (Spineless). The favorite variety. Fruit of largest size, rich purple and finest quality. Plant large, spreading and very productive; foliage light green. Pkt., 10c; 1/2 oz., 30c; oz., 50c.

BLACK BEAUTY. A valuable variety, ready for use two weeks earlier than any other sort. The fruit is thick and of a rich purplish black color. Pkt., 10c; 1/2 oz., 30c; oz., 50c.

Kale or Borecole

An ounce will produce 2000 plants.

DWARF CURLED SCOTCH. Sow in May and transplant in June, and treat generally as for cabbage. Curled, low-growing variety; the leaves, when properly cooked make very palatable greens. Pkt., 10c; oz., 15c; 1/4 lb., 40c.

Kohlrabi

An ounce will sow about 200 feet of drill.

The edible part is the turnip-shaped bulb formed above ground. Combines somewhat the flavors of cabbage and turnip. Sow in light, rich soil early in spring in rows 1 1/2 feet apart, thin to 6 inches apart in the

row. Plantings at intervals of ten days will give a succession until hot weather; when they fail to grow well. Plant the latter part of July for fall use.

EARLY WHITE VIENNA. (Extra for forcing). Extremely early with small tops. Bulbs medium size, very light green or nearly white. Pkt., 10c; 1/2 oz., 20c; oz., 30c; 1/4 lb., 85c.

EARLY PURPLE VIENNA. Early with small top, the leaf stems being tinged with purple. Pkt., 10c; 1/2 oz., 20c; oz., 30c; 1/4 lb., 85c.

Leek

Leeks require rich soil. Sow early in spring in deep drills, 18 inches apart, cover with 1/2 inch of soil, thin plants to about 8 inches apart. Draw the earth around them as with celery.

AMERICAN BROAD FLAG. A desirable strong growing, broad-leaved Leek, hardy and productive. Favorite with market gardeners and used for the home garden. Pkt., 10c; 1/2 oz., 20c; oz., 30c; 1/4 lb., 85c.

GIANT MUSSELBURGH. A hardy variety of extra large size; leaves fan-shaped, dark green color. Pkt., 10c; 1/2 oz., 20c; oz., 30c; 1/4 lb., 85c.

Mustard

Used mainly for salads and greens. Sow as early as ground can be worked in drills 18 inches apart and 1/2 inch deep. Successive sowings every 3 weeks.

WHITE OR YELLOW. The common variety used to flavor pickles. Pkt., 10c; oz., 20c; 1/4 lb., 50c.

SOUTHERN GIANT CURLED. Large, light green leaves. The best for salads. Pkt., 10c; oz., 20c; 1/4 lb., 50c.

Mushrooms

BROWN BOTTLE SPAWN. One quart bottle will seed an area of 35 to 40 square feet, depending on the size of the piece planted. Bottle Spawn is now shipped, removed from the glass container. Mushroom culture sent with every spawn. Each, 65c; postpaid, 75c; 3 for \$2.00.

Okra or Gumbo

The young seed pods are used in soups or stewed and served like asparagus. Best results would be obtained by sowing seed in the hotbed. Set plants in rows 2 feet or more apart and about a foot apart in the row.

DWARF GREEN. Early and productive; best for northern cultivation. Pkt., 10c; oz., 20c; 1/4 lb., 50c.

PERKINS' MAMMOTH LONG POD. A dwarf but enormously productive variety. Pods long, slender, deep green and remain tender much longer than most sorts. Pkt., 10c; oz., 20c; 1/4 lb., 50c.



Dwarf Green Okra

Ross' Crisp, Delicious Lettuce

An ounce will produce from 3000 to 4000 plants.

Lettuce thrives on nearly all soils, but because the growth should at all times be rapid to insure crispness and best flavor, the soil should be heavily enriched and well worked before planting. Lettuce being quite hardy, seed may generally be sown as soon as ground can be fitted, as while prolonged or continued freezing will kill the plants, they are but little injured by an ordinary frost. Seed may also be sown in hotbed in gentle heat, and the plants, if well hardened by having been often exposed to the air, may usually be set in the open ground very soon after the time suggested for sowing outdoors.

BLACK-SEEDED TENNISBALL. More extensively grown in New England than any other variety, both for first outdoor crop and for main crop, the medium sized heads being the size most liked by gardeners, while its compact form allows it to be grown more closely together than others. Pkt., 10c; ½ oz., 20c; oz., 30c; ¼ lb., 75c.

GREEN-LEAVED BIG BOSTON. A cabbage butter head; medium size; medium green. Is practically the same as Big Boston with no tint of brown and the head is of a whitish green. Pkt., 10c; ½ oz., 20c; oz., 30c; ¼ lb., 75c.

BLACK-SEEDED SIMPSON. Much larger than the preceding, but not so much curled. Forms a large, loose cluster of leaves rather than a head; leaves light yellowish green. Pkt., 10c; ½ oz., 20c; oz., 30c; ¼ lb., 75c.

CRISP AS ICE. A midsummer variety, surpassing all of this class in crispness, tenderness and fine flavor. Pkt., 10c; ½ oz., 20c; oz., 30c; ¼ lb., 75c.

BIG BOSTON WHITE SEEDED. Probably the most generally used in cultivation. It is a cabbage-head, butter type, medium large, finely shaped, globular, medium light green with slight tinge of brown on margins of outer leaves. It is early and hardy and stands shipping well. The head itself is brittle, buttery and the interior quite a golden yellow. Pkt., 10c; ½ oz., 20c; oz., 30c; ¼ lb., 75c.

EARLY CURLED SIMPSON. (White-seeded). An old variety, with broad, often frilled, very curly, light green leaves; sweet, tender, of fine flavor. Pkt., 10c; ½ oz., 20c; oz., 30c; ¼ lb., 75c.



Black-Seeded Tennisball Lettuce



New York or Wonderful Lettuce

GRAND RAPIDS. One of the easiest varieties of Lettuce to grow. It forms no head but produces an abundant crop of pale green leaves, slightly but closely crumpled which have an excellent flavor. Pkt., 10c; ½ oz., 20c; oz., 30c; ¼ lb., 75c.

HANSON. An old variety of great merit. Large, flat, cabbage-like head, very slow to run to seed. The outer leaves are bright green, with veins of lighter shade, inner leaves white, usually curved and twisted at the base. Grown for home use. Pkt., 10c; ½ oz., 20c; oz., 30c; ¼ lb., 75c.

ICEBERG. The unusual solidity of the heads is insured by the large white main ribs of the leaves, each of which curving strongly into the center, acts like a truss, making it impossible for the leaves to open outward and expose the center, which is consequently thoroughly blanched. The leaves are always crisp and tender. Pkt., 10c; ½ oz., 20c; oz., 30c; ¼ lb., 75c.

MAY KING. A new, very hardy variety of foreign origin, which owing to its hardiness, earliness and large size for a variety of this class, is coming rapidly into favor here, both for outdoor planting and for forcing. Forms compact heads, nearly, if not quite, as early as White-Seeded Tennisball. Pkt., 10c; ½ oz., 20c; oz., 30c; ¼ lb., 75c.

NEW YORK OR WONDERFUL (Dark Iceberg). One of the largest varieties in cultivation. The heads are very solid with but little tendency to run to seed. It blanches itself naturally, is crisp, tender, and of excellent flavor, and always free from bitterness. Pkt., 10c; ½ oz., 20c; oz., 30c; ¼ lb., 75c.

PRIZE HEAD. A large, loose-leaved variety, which has been very popular for home use. Leaves very thin, crimped, bright green tinged with brownish red; sweet, tender and of good flavor, but not equal to Crisp as Ice. Pkt., 10c; ½ oz., 20c; oz., 30c; ¼ lb., 75c.

Romaine or Cos Varieties

Distinct from the ordinary Lettuce on account of their tender, crisp leaves and delicious flavor.

PARIS WHITE COS. One of the finest varieties for summer use. Pkt., 10c; ½ oz., 15c; oz., 25c; ¼ lb., 65c.

Delicious, Sweet Melons, Thick-Meated



Bender's Surprise Muskmelon

An ounce will plant about 50 hills. 1 1/2 to 2 pounds are required for an acre.

The Muskmelon succeeds best in warm, rich soil. Plant when all danger of frost is past, in broad hills 4 to 5 feet apart, 10 or more seeds to each hill. Cover with one inch of soil and firm well with the hoe.

BENDER'S SURPRISE (The Bender Melon). A very popular variety in the East, particularly around Albany, N. Y. A selection from Surprise and a close kin to Irondequoit, differing from that variety in being more oblong, more full and rounded at the ends, not quite as well netted or as early; skin light greenish yellow when ripe. A very delicious, large salmon-fleshed Melon with superior shipping and keeping qualities. Pkt., 10c; oz., 15c; 1/4 lb., 40c.

DELICIOUS. Best described as an early strain of the Bender Melon, a trifle smaller in size. Light green, finely netted, oval fruits. Firm, tender flesh of a beautiful deep orange-yellow color. Pkt., 10c; oz., 15c; 1/4 lb., 40c.

EMERALD GEM. Small to medium size; skin deep green, generally smooth; flesh thick, rich salmon, not surpassed in richness and flavor. But few varieties are so nearly certain to produce uniformly good Melons. Pkt., 10c; oz., 15c; 1/4 lb., 40c.

EXTRA EARLY HACKENSACK. Above medium size, nearly round; flesh green, a little coarse but juicy, sweet and of good flavor. Pkt., 10c; oz., 15c; 1/4 lb., 40c.

HALE'S BEST. New early variety of fine flavor. The rich salmon flesh is very thick, leaving only a very small seed cavity. Fruits are oval-shaped with a heavy netting. Pkt., 10c; oz., 15c; 1/4 lb., 40c.

HONEY DEW. The average size of the Melon is six inches in diameter and seven to eight inches in length. The flesh is an emerald-green, very thick, melting, and fine grained; can be eaten to the extreme rind. The seed cavity is very small, the rind impervious to water. The Melon does not shrink (in weight, is not easily bruised, and is a splendid shipper. It is later than Rocky Ford strains and is very prolific. Pkt., 10c; oz., 15c; 1/4 lb., 40c.

HONEY ROCK. Very prolific and early, almost round, 5 inches across, of medium size, rich salmon flesh of fine quality and ripens uniformly. Sweeter than Rocky Ford but without the sweetness of Honey Dew, fine for home use and market. Pkt., 10c; oz., 20c; 1/4 lb., 50c.

MONTREAL NUTMEG. The fruits are of the largest size, often attaining a weight of 15 pounds. Shape nearly round, flattened at the ends. The flesh is about two inches thick, light green, and of a delicious flavor. Pkt., 10c; oz., 15c; 1/4 lb., 40c.

OSAGE OR IMPROVED MILLER'S CREAM. Of medium size, oval, dark green, shallow netting; flesh deep salmon, thick, very firm, sweet and of rich flavor. Pkt., 10c; oz., 15c; 1/4 lb., 40c.

ROCKY FORD. More largely grown than any other of the small or basket Melons. Oval, slightly ribbed, densely covered with fine netting; flesh green, thick and of rich flavor. Pkt., 10c; oz., 15c; 1/4 lb., 40c.

Watermelons

ANYONE WHO HAS LIGHT, SANDY SOIL CAN RAISE GOOD WATERMELONS

1 oz. will plant about 25 hills; 4 lbs. to the acre.

The culture of the Watermelon is mainly the same as recommended for the Muskmelon; hills should, however, be about 10 feet apart.

HARRIS' EARLIEST. A new extra-early variety, large and of exceptionally fine quality. Slightly oval, mottled in stripes of light and dark green. Flesh bright red. One of the most desirable for planting in the North. Pkt., 10c; oz., 15c; 1/4 lb., 40c.

MOUNTAIN SWEET. An old favorite, early, productive and of good quality. Fruit long, dark green; flesh scarlet. Pkt., 10c; oz., 15c; 1/4 lb., 40c.

PEERLESS OR ICE CREAM. Of medium size, oval, dark green; flesh scarlet, very sweet. Pkt., 10c; oz., 15c; 1/4 lb., 40c.

PHINNEY'S EARLY. A standard early variety of medium size, oval, marbled light and dark green; flesh pink, sweet and crisp. Pkt., 10c; oz., 15c; 1/4 lb., 40c.

SWEETHEART. Large, oval, very heavy; rind thin but firm, mottled light and very light green; flesh bright red, tender, melting and sweet. Retains its good qualities for a long time after ripening. Pkt., 10c; oz., 15c; 1/4 lb., 40c.

CITRON. For preserving only. Pkt., 10c; oz., 15c; 1/4 lb., 40c.



Cole's Early Watermelon

COLE'S EARLY. Small but very early; of fine quality and sure to mature in any latitude where Melons can be grown. Pkt., 10c; oz., 15c; 1/4 lb., 40c.

MUSKMELONS ARE A SURE-FIRE MONEY CROP

ROSS BROS. CO.

Onions for SOUPS, SALADS SEASONING, PICKLING

1 pkt. will sow 50 ft. of drill; 1 oz. about 200 ft.; 4 to 5 lbs. per acre.

Onions are very healthful and wholesome, probably used more often in the kitchen than any other vegetable, either in connection with other foods for seasoning or in many of the delicious ways to prepare them for their own tempting goodness. Highly prized for their tonic qualities, and doctors everywhere recommend the use of Onions in the diet because they are wholesome and nutritious.

Onions are not hard to grow. They like a clean, rich soil. Sow as early as possible in drills 1 foot apart.

AILS CRAIG. Of mammoth size, larger than the Prize-taker, oval-shaped, pale straw colored skin; of very mild flavor. Extra large Onions can, however, be obtained by sowing seed early in the spring in the hot-bed and transplanting to the open ground. Pkt., 10c; ½ oz., 20c; oz., 30c; ¼ lb., 75c.

EARLY YELLOW GLOBE. This is a yellow, globe-shaped Onion with a fine yellow color, a good winter keeper, as its skin is very thick. It will mature three weeks earlier than Danvers and yields very heavily. Pkt., 10c; ½ oz., 20c; oz., 30c; ¼ lb., 75c.

SOUTHPORT RED GLOBE. Identical in form with the preceding; rich, deep red, above medium size; excellent keeper and one of the most attractive of all. Pkt., 10c; ½ oz., 20c; oz., 30c; ¼ lb., 75c.

SOUTHPORT WHITE GLOBE. Of true globe shape. Later than White Portugal; keeps better and, like all globular varieties, a greater weight can be obtained on the same area. Pkt., 10c; ½ oz., 20c; oz., 30c; ¼ lb., 75c.

YELLOW GLOBE DANVERS. The standard variety for winter use in the eastern markets. Produces well ripened bulbs, averaging two inches in diameter. Skin light golden brown or pale yellow, flesh pure white, crisp, and mild in flavor. The plants have very slender necks, and consequently the bulbs keep well over

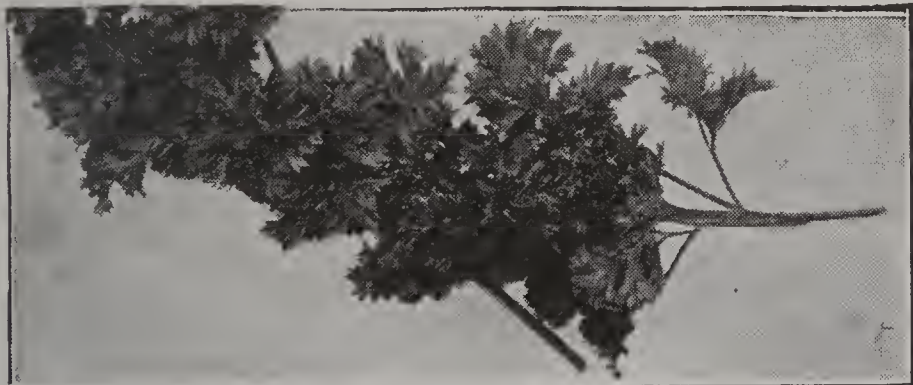

Champion Moss Curled Parsley

Parsley For Seasoning, Garnishing

One ounce will sow 200 feet of drill.

Always required for garnishing, also used for flavoring soups and stews and in salads.

Culture. Sow early, seed is slow to germinate; early radishes can be sown in same row and will be used before Parsley is up. A rich soil is best, but Parsley will thrive in any soil.

CHAMPION MOSS CURLLED. This is a prize winning English variety. Handsome, compact plants. Leaves have the appearance of finely curled moss. Hardy and slow to run to seed. Pkt., 10c; oz., 20c; ¼ lb., 50c.

DOUBLE CURLLED. Plants compact, very curly and finely cut, bright green color. Pkt., 10c; oz., 20c; ¼ lb., 50c.

PLAIN LEAF. The leaves of this variety are flat, deeply cut but not curled. Desirable for flavoring soups and stews, and for drying. The curled sorts are more extensively used for garnishing. Pkt., 10c; oz., 20c; ¼ lb., 50c.

Yellow Globe Danvers Onion



winter. On account of their attractive shape and color and their excellent keeping qualities, they always bring a good price in the markets. Selected strain. Pkt., 10c; ½ oz., 20c; oz., 30c; ¼ lb., 75c.

WHITE PORTUGAL OR SILVERSKIN. An early white, flat variety, of medium size and mild flavor. Pkt., 10c; ½ oz., 20c; oz., 30c; ¼ lb., 75c.

LARGE RED WETHERSFIELD. The standard red variety, Bulb large, flattened but thick; skin deep purplish red. The best of all for light soils. Pkt., 10c; ½ oz., 20c; oz., 30c; ¼ lb., 75c.

PRIZETAKER. Grows to an immense size and for fall marketing is unexcelled. Although of such great size, it is very hardy and a fair winter keeper, as it ripens up hard and firm. Very fine grained and of mild, delicate flavor. The outside skin is rich yellow while the flesh is white. Pkt., 10c; ½ oz., 20c; oz., 30c; ¼ lb., 75c.

Onion Sets

1 lb. will plant 100 feet of row; 250 to 335 lbs. per acre.

We do not deliver Onion Sets free, purchaser pays transportation. Onion Sets weigh 1 pound per quart. For parcel post zone rates see back of order blank.

These sets will provide small green Onions in 2 to 3 weeks after planting seeds, and are an important crop to precede the seed-sown varieties. They mature large Onions much earlier than can be grown from seed. May be planted in early spring as soon as danger of freezing is past.

WHITE GLOBE. Lb., 30c; 4 lbs., \$1.00; 8 lbs., \$1.60.

YELLOW GLOBE. Lb. 30c; 4 lbs., \$1.00; 8 lbs., \$1.60.

EGYPTIAN OR PERENNIAL. (For delivery in September). Lb, 25c; 4 lbs., 80c; 8 lbs., \$1.40.

Special Prices on Bushel Lots.

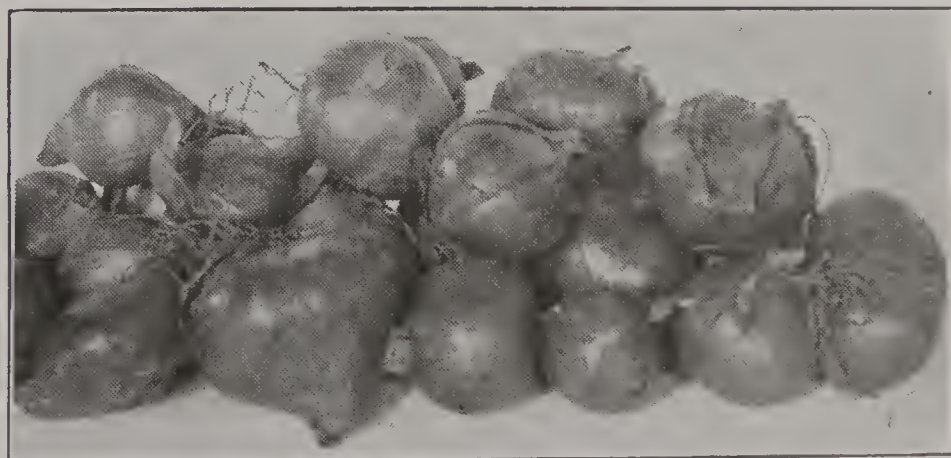

Yellow Globe Onion Sets

Garden Peas SWEET AND TENDER

Inoculate This Seed With NOD-O-GEN.

One lb. will plant about 100 ft.; 70 to 85 lbs. an acre.

Peas of the extra early, smooth class are first to be planted in the spring. The wrinkled sorts follow later, as they are not quite so hardy. The tall, late varieties need brush, wire or some other support. Though light, warm soil is desirable for the extra early varieties, Peas generally produce a much larger crop on soil which is moderately heavy.

Plant the early and dwarf varieties in drills $2\frac{1}{2}$ feet apart and 3 or 4 inches deep, cover with only one inch of soil and fill the trench gradually as plants grow. Plant the taller and later varieties in rows 3 to 4 feet apart and 5 to 6 inches deep, covering as already suggested. The tall, late varieties, plant in double rows.

We deliver free in the United States all Bulbs, Vegetable and Flower Seeds at prices listed in this catalog. See inside front cover.

Extra Early Dwarf Varieties

DWARF TELEPHONE OR DAISY. Pods large; Peas wrinkled, sweet and tender, a heavy bearer. Height, 18 inches. Pkt., 15c; lb., 30c; 2 lbs., 55c; 10 lbs., or over 24c per lb.

SUTTON'S EXCELSIOR. The best of the dwarf varieties. The vine is of more vigorous growth than the Nott's Excelsior, a little taller, fully as productive and matures its crop nearly as early, while both pods and Peas are decidedly larger. In quality, equal to any of the dwarf varieties, all of which compare favorably with the larger and later sorts. Pkt., 15c; lb., 30c; 2 lbs., 55c; 10 lbs., or over, 24c per lb.



Improved Telephone Peas

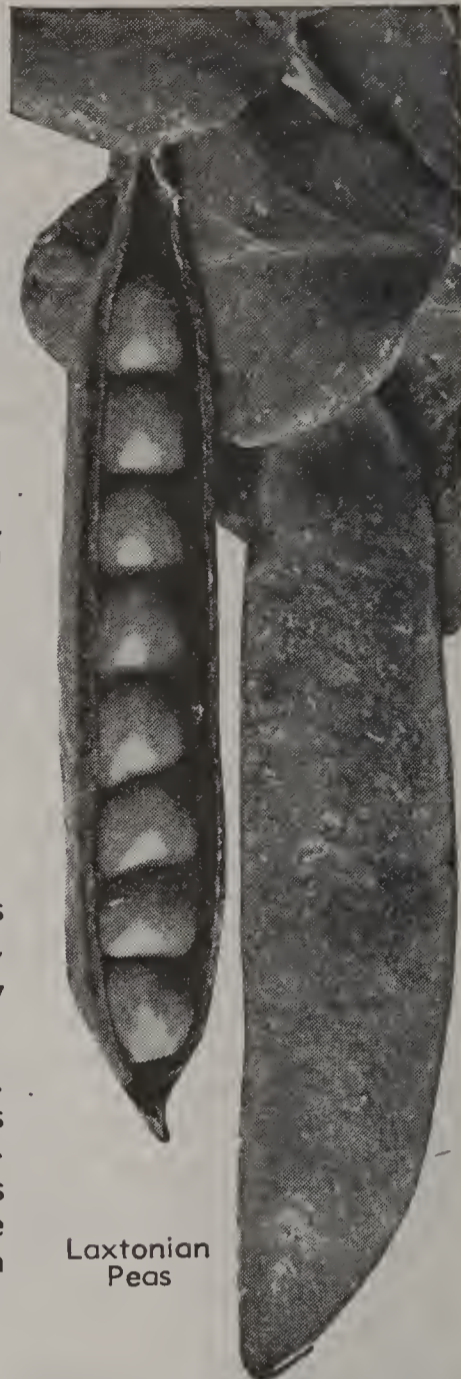

Laxtonian Peas

EXTRA EARLY BLUE BANTAM. The best first early dwarf wrinkled Pea. It is unequalled for combination of extreme earliness, superb quality and unusual productiveness. The dwarf, vigorous vines average 15 inches in height and carry really enormous crops of large, deep bluish green pods. The pods measure 4 to $4\frac{1}{2}$ inches long and are tightly packed with 8 to 10 large, deep bluish green Peas. These Peas are not only large in size but of most luscious flavor. Pkt., 15c; lb., 30c; 2 lbs., 55c; 10 lbs. or over, 24c per lb.

LAXTONIAN. A new dwarf Pea of the same high quality as Thomas Laxton and Gradus. The vines are about 18 inches high, vigorous and when in bearing are loaded with immense dark green pods containing 8 or 9 large, luscious Peas. Productive, and of such good quality it is deserving of a place in every home garden. Largest pod of all the early dwarf varieties, and earlier than Gradus. Pkt., 15c; lb., 30c; 2 lbs., 55c; 10 lbs. or over, 24c per lb.

NOTT'S EXCELSIOR. Extra early dwarf growth. Excellent for home garden; hardy and vigorous, and will mature in 60 days. The pods are filled with 7 to 9 large Peas, superior in sweetness and quality. Large and vigorous vines bearing an enormous yield. Pkt., 15c; lb., 30c; 2 lbs., 55c; 10 lbs., or over, 24c per lb.

LAXTON'S PROGRESS. A delicious new Pea, about 18 inches tall. Ready a few days earlier than Laxtonian. Pods are 4 inches long and tightly packed with 8 to 10 large, sweet, green Peas. The dwarf, vigorous vines average 18 inches in height and carry an enormous crop, bearing in 53 days. Pkt., 15c; lb., 30c; 2 lbs., 55c; 10 lbs. or over, 24c per lb.

LITTLE MARVEL. The Little Marvel Pea in size and shape all podded is very similar to the Nott's Excelsior but far more prolific. It is of exceptionally fine quality and enormously productive. The pods of this Pea are about 3 to 4 inches long. It should be planted in every garden. Pkt., 15c; lb., 30c; 2 lbs., 55c; 10 lbs. or over, 24c per lb.

Extra Early Varieties of Taller Growth

ALASKA. Very early, smooth, blue Pea. Popular with canners and market gardeners for a first early sort. Height $2\frac{1}{2}$ feet. Foliage and pods light green; pods $2\frac{1}{2}$ inches long, round, straight and square ended, containing 6 light green Peas. Very uniform in maturity. Pkt., 15c; lb., 30c; 2 lbs., 55c; 10 lbs. or over, 24c per lb.

GRADUS. A remarkable variety, combining earliness and Peas of largest size and best quality. Mature soon after Nott's Excelsior. Vine resembles the Telephone but is only 3 to $3\frac{1}{2}$ feet high on rich land; productive. Pods 4 inches long, straight, slightly curved at end, light green, well filled. Pkt., 15c; lb., 30c; 2 lbs., 55c; 10 lbs. or over, 24c per lb.

MARKET SURPRISE. This is a smooth seeded sort, and, like all of the class, may be planted very early. It is the earliest maturing variety to date, vines growing to a height of about 30 inches, bearing abundantly pods 3 to $3\frac{1}{4}$ inches long, well filled with Peas of the finest quality. Every garden, large or small, should give this new sort a trial. Pkt., 15c; lb., 30c; 2 lbs., 55c; 10 lbs. or over, 24c per lb.

THOMAS LAXTON. Vine of about the same height as the Gradus, of similar habits but much darker, hardier and more productive. More attractive and better filled with Peas as large and equal in quality. Pkt., 15c; lb., 30c; 2 lbs., 55c; 10 lbs. or over, 24c per lb.

ROSS' WORLD'S RECORD. A large, early wrinkled Pea with pods $3\frac{1}{2}$ to 4 inches long. The pods are well filled with peas of excellent quality. The vines are vigorous, growing about 36 to 40 inches high. Peas are ready to pick 4 to 5 days before Gradus. A variety which should be in every garden. Pkt., 15c; lb., 30c; 2 lbs., 55c; 10 lbs. or over, 24c per lb.

Second-Early, Medium and Late Varieties

ALDERMAN. This midseason Pea, tall growing, is of English origin, and a few days later than the "Improved Telephone." Pkt., 15c; lb., 30c; 2 lbs., 55c; 10 lbs. or over, 24c per lb.

CHAMPION OF ENGLAND. Vine 4½ to 5 ft. high; productive. Pods 2¾ to 3 inches long, broad, well filled. Peas of medium size. Pkt., 15c; lb., 30c; 2 lbs., 55c; 10 lbs. or over, 24c per lb.

IMPROVED TELEPHONE. Extensively grown. Vine 3¼ to 4 feet. Productive on good soil. Pods large. Peas above medium size, of best quality. Pkt., 15c; lb., 25c; 2 lbs., 45c; 10 lbs. or over, 20c per lb.

Tasty Parsnips

A DELICIOUS WINTER VEGETABLE

One ounce will sow 200 feet of drill; 6 lbs. are required for an acre.

A vegetable for all winter use, with a rich, sweet flavor that most people like. Easily and cheaply grown.

Culture. Sow early in the spring, seed is slow to germinate. Sow one-half inch deep in rows 2 feet apart. Thin to 5 inches in rows. Frost sweetens them; can be left in the ground all winter.

ARLINGTON LONG SMOOTH. Roots very long and smooth, with full crown, desirable for deep soil and, owing to the full crown, is less liable to rot if left in the ground through the winter than the Hollow Crown.

HOLLOW CROWN. (110 days). A good cropper, roots 15 inches long, 3 inches in diameter at the top. An old standard variety.

PRICES:

Of each variety we offer a choice selected strain. Each, pkt., 10c; oz., 20c; ¼ lb., 50c.



Hollow Crown Sugar Parsnips

Peanuts

SPANISH. The best variety. An early, heavy bearer; bushes growing close, so very easily cultivated. Best re-cleaned seed stock. Pkt., 10c; lb., 40c, postpaid.

By express, 10 lbs. or more, 35c per lb.

Ross' Giant Peppers



Ruby Giant Pepper

An ounce will produce from 1500 to 2000 plants.

Sow in hotbed in March or April; transplant in open ground when all danger of frost is over, in rows 3 feet apart and 2 feet apart in the row. Seed can be sown outside late in May. Cover seed one-half inch and thin as above.

BELL OR BULL NOSE. Large, bell-shaped, thick-fleshed and less pungent than some other sorts. Good for filling. Pkt., 10c; ½ oz., 25c; oz., 40c; ¼ lb., \$1.25.

CHINESE GIANT. Mammoth fruits measuring 12 to 15 inches in circumference, also early and prolific. The flesh is thick, tender, mild and sweet. Unexcelled for use as salads. Pkt., 10c; ½ oz., 35c; oz., 60c.

HARRIS' EARLY GIANT. The earliest known Pepper and for the far North the most desirable. Plant very dwarf and compact in growth and extremely productive. Fruit 3-lobed, 3½ inches in length by 2½ inches in diameter, very mild and sweet. Pkt., 10c; ½ oz., 25c; oz., 40c; ¼ lb., \$1.25.

CALIFORNIA WONDER. A midseason variety, mild and sweet, about 4½ inches long by 4 inches in diameter. Heavy walls, bright green changing to brilliant crimson. Pkt., 10c; ½ oz., 25c; oz., 40c.

LONG RED CAYENNE. Fruit very slim, pointed, about 4 inches long, and when ripe, bright red. Extremely pungent. Pkt., 10c; ½ oz., 25c; oz., 40c.

NEAPOLITAN. A great market variety on account of its earliness and productiveness. Grows about 3½ inches long and is remarkably sweet. Pkt., 10c; ½ oz., 25c; oz., 40c.

RED CHERRY. Pkt., 10c; ½ oz., 25c; oz., 40c.

RED CHILI. Pkt., 10c; ½ oz., 25c; oz., 40c.

RUBY GIANT. A hybrid of Ruby King and Chinese Giant. It combines the large size of Chinese Giant and the productiveness, shape and color of the Ruby King. The flesh is thick, mild and sweet. Often 5 inches long. Pkt., 10c; ½ oz., 25c; oz., 40c; ¼ lb., \$1.25.

RUBY KING. Pkt., 10c; ½ oz., 25c; oz., 40c.

SQUASH OR TOMATO SHAPED. Fruit flat or tomato-shaped and somewhat ribbed; flesh thick and slightly more pungent than other large sorts, early and sure to mature. Pkt., 10c; ½ oz., 25c; oz., 40c.

SWEET MOUNTAIN. Fruit very large, often 8 inches long by 2 inches in diameter. Flesh thick, sweet and mild. Pkt., 10c; ½ oz., 25c; oz., 40c.

WINDSOR A. It is a thick-walled type, very desirable for home or garden use. The plant is of medium height and very prolific. The fruits are sweet, smooth, thick meated and very little wrinkled or furrowed, mostly three-lobed, occasionally, however, blunt-pointed without lobes. This Pepper has the advantage of being extremely early and having a very heavy first set of fruit. Pkt., 10c; ½ oz., 25c; oz., 40c.

Maine-Grown Certified Seed Potatoes

"Potatoes"

Were introduced into New England by some immigrants from the North of Ireland in 1718 and were first raised in the garden of Nathaniel Walker of Andover, Mass.



Green Mountain

Our potatoes are produced in Northern Maine, and Certified Seed carries the blue certification tag of that State.

Culture: Cut the seed into pieces, having 2 or 3 eyes. Plant in furrows 3 feet apart and 12 to 15 inches apart in the row. One peck of potatoes should be sufficient to plant 75 to 100 hills; 10 to 14 bushels are required to plant an acre. Potatoes do best on new soil and will respond generously to fertilizer applications. Cultivate by bringing the soil well up around the plant. Spray or dust the plants for insects and blight.

POTATO PRICES

Our potato prices are based on the market value at the time our catalog goes to press, and are subject to change without notice. This applies to both advance and decline.

Green Mountain

The Most Popular Potato in the World—Ideal for Main Crop—An Excellent Baking Variety—A Dependable Winter Keeper

A reliable medium late variety that is so popular in some sections that it has superseded all other main crop varieties. It seems to thrive in nearly all sorts of soils and in all locations, making heavy, healthy vines and yielding large crops of smooth, white-skinned tubers of flattish oval form. It cooks white, dry and mealy, and well. It keeps well and is less liable to scab and rot than most other varieties. **Maine Certified Seed, 100 lbs., \$2.15; 60 lbs., \$1.45; 30 lbs., 80c; 15 lbs., 50c.**

Green Mountain Potatoes CERTIFIED CANADIAN GROWN

Because of the persistent inquiry for Canadian grown potatoes for seed, we are offering for the first time, Green Mountain seed potatoes from Prince Edward Island, Canada. We believe that this seed is the best seed that money can buy. They are certified by the Canadian Government, exceptionally well graded and put up in 100-lb. sacks. Shipment during April. **Per 100-lb. sack, \$3.00.**

Katahdin

The Long Keeping Potato

Originated by the U. S. Department of Agriculture and promising to become the outstanding late potato for market or storage. It was originated in Maine, by double crossing unnamed seedlings of Rural New Yorker No. 2 and Aroostook Wonder parentage. It was bred for disease resistance, quality and yield. During the eight years it was under observation, it has been entirely free from mild Mosaic. In yields it has constantly surpassed Rural New Yorker or Green Mountain. The tubers are smooth, short, elliptical to roundish, and have few, very small eyes. The crisp white flesh has a distinct desirable cooking quality which appeals to the housewife. **Maine Certified Seed, 100 lbs., \$2.60; 60 lbs., \$1.75; 30 lbs., 95c; 15 lbs., 60c.**

Early Rose

This is one of the oldest standard varieties of potatoes. It is early, the tubers are oblong and a little flat in shape with a flesh-colored or light pink skin. It is ready a few days later than the Irish Cobbler and the quality is excellent. Selected stock only. **100 lbs., \$2.60; 60 lbs., \$1.75; 30 lbs., 95c; 15 lbs., 60c.**

Irish Cobblers

An early, white-skinned variety, very short, thick, inclining to round. This is yearly increasing in popularity for the early market. Ready for market about ten days earlier than the Early Rose; tubers are uniformly larger and in average production of large crops it is not equaled by any of the extra early varieties, nor greatly surpassed in yield by any of the main crop varieties. The vine is very stocky and vigorous, not as liable to be affected with blight or to suffer by drought as most others. A dependable early variety. **Maine Certified Seed, 100 lbs., \$2.15; 60 lbs., \$1.45; 30 lbs., 80c; 15 lbs., 50c.**



Irish Cobbler

Raffia for Tying

Raffia is the straw-colored inner skin of a palm found in Madagascar. It is very strong and tough but soft and flexible, which makes it the very best material for tying vegetables, plants, vines, etc. It is better than twine, as it does not cut the plants and is much stronger. It is also used for making baskets. Raffia comes in hanks of from 1 to 5 pounds. We offer the best grade. **Price per pound, 30c, not postpaid.**

FORMALDEHYDE. Prevents potato diseases and insures a clean healthy crop.

Directions for treatment of potatoes for common scab, black scurf or rhizoctonia and black leg, cold method:

Soak the uncut tubers 1½ hours in solution of one pound formaldehyde in 30 gallons of water. If tubers are first dipped in or sprinkled with water, then covered with burlap sacks to keep them moist for a day or two before treatment, soaking period may be decreased to one-half hour and the effectiveness increased. See page 77.

Pumpkin - for Pies - for Stock

An ounce will plant 50 hills.

SMALL SUGAR. The popular variety in New England for pies; fine-grained and sweet. Pkt., 10c; oz., 15c; ¼ lb., 35c; lb., \$1.00.

LARGE CHEESE OR KENTUCKY FIELD. Shape flat, skin of rich cream color when ripe, flesh tender and of fine quality. Pkt., 10c; oz., 15c; ¼ lb., 40c; lb., \$1.25.

MAMMOTH TOURS. One of the largest in cultivation, good for feeding stock. Pkt., 10c; oz., 15c; ¼ lb., 40c; lb., \$1.25.

CONNECTICUT FIELD. The standard variety for feeding stock. Pkt., 10c; oz., 15c; ¼ lb., 35c; lb., \$1.00.

JUMBO OR KING OF THE MAMMOTHS. The largest of all Pumpkins. Skin, orange-salmon; flesh, bright yellow, very thick, fine grained and of excellent quality for pies. Pkt., 10c; oz., 15c; ¼ lb., 40c; lb., \$1.25.

QUAKER PIE. Fruits broad, pear-shaped to slightly oval; skin rich cream-buff; flesh fine grained and rich flavor. Pkt., 10c; oz., 15c; ¼ lb., 35c; lb., \$1.00.



Connecticut Field Pumpkin

Crisp, Tender Radishes

An ounce will sow 150 feet of drill.

The secret in growing good Radishes consists chiefly in the observance on the part of the grower of three points. First, they should be grown on light quick soil. Second, they should be given plenty of water, and last, but by no means least, the right kind of seed should be sown. For the first crop sow as early in spring as ground can be worked, and every two weeks throughout the season for succession.

A warm, sandy loam, made rich and light by strong manure, is best. Sow in drills 10 to 12 inches apart. The winter varieties should be sown in July and August. One ounce will sow 100 feet of drill, 8 to 10 pounds per acre.

EARLY SCARLET GLOBE. A very early globe-shaped Radish suitable for forcing or open ground. The Radishes are of handsome shape, attractive bright red, and are crisp, solid and of the finest quality. They grow so rapidly that under favorable circumstances they may be pulled 20 days from sowing the seed. This is the most popular variety for forcing. Our seed is of the very finest strain grown from transplanted roots and will be found unsurpassed. Pkt., 10c; oz., 15c; ¼ lb., 35c; lb., \$1.00.

CRIMSON GIANT. An early but large, round or slightly globular Radish adapted for either forcing or outdoor cultivation. While it grows much larger than other forcing varieties, it does not become pithy under glass, nor outdoors, even when it is twice as large and older. Beautiful crimson-carmine, attractive and of fine quality. Pkt., 10c; oz., 15c; ¼ lb., 40c; lb., \$1.25.

EARLY SCARLET TURNIP. A small, round variety, with small tops; quick grower. Popular for forcing and outdoors. Deep scarlet. Pkt., 10c; oz., 15c; ¼ lb., 35c; lb., \$1.00.

EARLY SCARLET TURNIP, White Tipped. Root nearly round, slightly flattened at bottom, bright scarlet with tip of clear white, early and attractive; suitable for forcing and outside planting. Pkt., 10c; oz., 15c; ¼ lb., 35c; lb., \$1.00.

EARLY LONG SCARLET, Short-Top. Once the most popular Radish but has been largely displaced by the round varieties; 6 to 8 inches long, matures in 25 to 30 days. Pkt., 10c; oz., 15c; ¼ lb., 40c; lb., \$1.25.

You can grow them anywhere. Small in size, rather decorative, a row of Radishes in the flower garden is practical and "different".

EARLY WHITE GIANT STUTTGART. Root large, clear white, often 4 inches in diameter. Can be stored for winter use. Pkt., 10c; oz., 20c; ¼ lb., 40c; lb., \$1.25.

FRENCH BREAKFAST. Stump-rooted; about 3 in. long. Bright scarlet, tipped white. An old favorite. Pkt., 10c; oz., 15c; ¼ lb., 35c; lb., \$1.00.

LONG BLACK SPANISH WINTER. One of the hardiest and best for winter use. Pkt., 10c; oz., 15c; ¼ lb., 40c; lb., \$1.25.

ROUND BLACK SPANISH. White flesh with black skin. Pkt., 10c; oz., 15c; ¼ lb., 40c; lb., \$1.25.

WHITE ICICLE. The earliest pure white, long, summer Radish of most excellent quality. Roots when matured are 5 to 6 inches long by about ½ inch in diameter. One of the best outdoor summer Radishes. Pkt., 10c; oz., 15c; ¼ lb., 35c; lb., \$1.00.

WHITE STRASSBURG. A fine summer variety, growing about 4 inches long and 2 inches thick. Pure white. Pkt., 10c; oz., 15c; ¼ lb., 40c; lb., \$1.25.

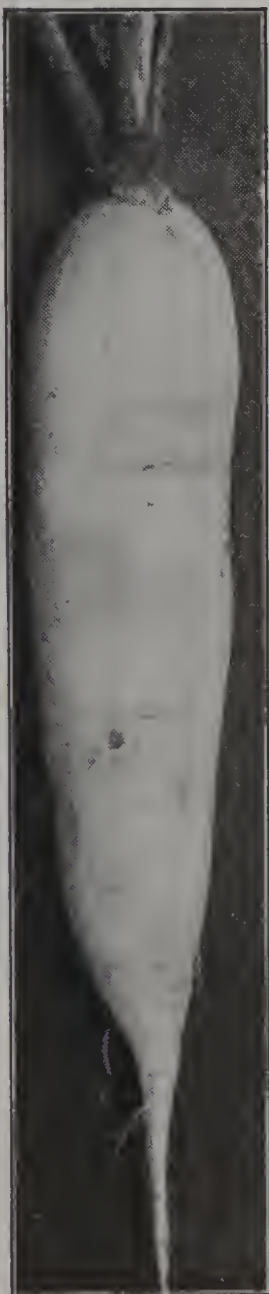

White Strassburg



Early Scarlet Globe Radishes

Spinach is Good for You

BUT FRESH SPINACH FROM YOUR OWN GARDEN TASTES BETTER

An ounce will sow 100 feet of drill, 14 to 16 pounds to the acre.

Culture. For spring and summer use, sow in drills 1 foot apart and 1 inch deep, as early as the ground can be worked, and every two weeks for a succession. For winter and early spring use, sow in September in well-manured ground; cover with straw on the approach of severe cold weather. The ground cannot be too rich.

BLOOMSDALE LONG STANDING. In appearance quite similar to the Bloomsdale strain, the leaves being more intensely green. On account of the low percent of male plants, it stands heat remarkably well. After other kinds have gone to seed this will stand for a long time. **Pkt., 10c; oz., 15c; 1/4 lb., 25c; lb., 75c.**

EARLY GIANT THICK-LEAVED. Leaves very large and thick, deep green, attaining a size suitable for use early and plant grows to a large size before running to seed. **Pkt., 10c; oz., 15c; 1/4 lb., 25c; lb., 75c.**

KING OF DENMARK. **Pkt., 10c; oz., 15c; 1/4 lb., 25c; lb., 75c.**

OLD DOMINION. Blight resistant. Crossed between Virginia Savoy and King of Denmark, used for fall seeding. **Pkt., 10c; oz., 15c; 1/4 lb., 25c; lb., 75c.**

PRINCESS JULIANA. (New). The best second-early variety. Plants grow close to the ground and have dark green, crumpled leaves which retain their crispness for a long time after being cut. **Pkt., 10c; oz., 15c; 1/4 lb., 25c; lb., 75c.**

SUMMER SAVOY. This strain of Long Standing Bloomsdale is fine for a summer crop as it will stand hot weather well. It is a little darker than Bloomsdale Long Standing. **Pkt., 10c; oz., 15c; 1/4 lb., 25c; lb., 75c.**



Bloomsdale Long Standing Spinach

SAVOY-LEAVED, or BLOOMSDALE. The earliest variety and used almost entirely for fall sowing, as it runs quickly to seed in warm weather. Leaves of medium size, dark green, pointed and crimped. **Pkt., 10c; oz., 15c; 1/4 lb., 25c; lb., 75c.**

SAVOY, VIRGINIA YELLOWS-RESISTANT. It will grow on disease infested soil and produce a crop where others fail. **Pkt., 10c; oz., 15c; 1/4 lb., 30c.**

NEW ZEALAND. The hot weather Spinach. Leaves and stems are succulent and tender. May be picked frequently during the summer. **Pkt., 10c; oz., 15c; 1/4 lb., 35c; lb., \$1.25.**

Rhubarb - A Real Spring Tonic

FRESH AND DELICIOUS

The roots can be raised from seed sown in spring, and are ready to transplant to the permanent bed the next spring. The seed must be sown in fine, rich soil, and the seedlings must have good care.

VICTORIA. The most popular variety, fine for family use and market. Comes quite true from seed. **Pkt., 10c; oz., 25c; 1/4 lb., 90c.**

RHUBARB ROOTS. Sent by express or parcel post at buyer's expense. **2 for 25c.**

Salsify or Vegetable Oyster

An ounce will sow 50 feet of drill.

Sow early and deeper than parsnip, otherwise culture is the same and, like parsnips, roots, if desired, may be left in the ground through the winter, but should be dug very early in the spring, as they deteriorate after growth commences.

MAMMOTH SANDWICH ISLAND. Larger, of strong growth, and less liable to grow spongy than the old Long White. **Pkt., 10c; oz., 25c; 1/4 lb., 90c.**

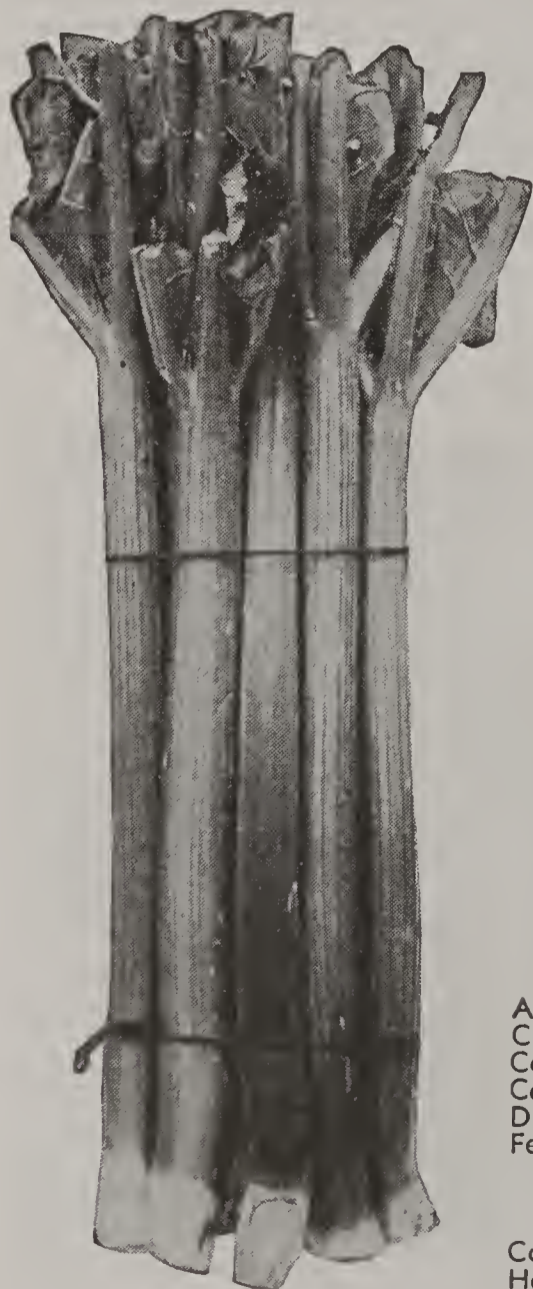

Victoria Rhubarb



Salsify

Herbs

	Oz.	Pkt.		Oz.	Pkt.
Anise		\$0.10	Lavender	\$0.50	\$0.10
Caraway	\$0.30	.10	Marjoram, Sweet	.35	.10
Catnip		.10	Sage	.40	.10
Coriander		.10	Savory, Summer	.35	.10
Dill	.15	.10	Sweet Basil	.30	.10
Fennel	.50	.10	Thyme	.35	.10

Bird Seeds Best Recleaned; For Feeding Only

	Lb.	100 lbs.		Lb.	100 lbs.
Canary	\$0.15	\$10.00	Rape	\$0.12	\$11.00
Hemp	.12	8.00	Sunflower, striped	.12	10.00
Lettuce	.30	28.00	Flax	.16	11.00

Seeds Used for Flavoring and Pickling

	Oz.
Caraway	\$0.20
Celery	.10
Coriander	.20
Dill	.10
Fennel	.20
Mustard	.10

SPRING COMES WITH THE FIRST FRESH RHUBARB

ROSS BROS. CO.

Ross' Squash - for Winter and Summer Use

An ounce will plant from 10 to 25 hills.

Squash seed should be planted at about the same time and in the same manner as cucumbers and melons. The hills should be 9 feet apart each way, slightly elevated and highly manured. Bush varieties may be planted closer together. Use plenty of seed, as the bugs will destroy some plants.

BLUE HUBBARD. Special Market Gardener's strain. The Symmes Blue Hubbard is an entirely distinct variety resembling the Warted Hubbard in shape. It is a pale light blue color, very thick meated, dry and very sweet; its eating qualities cannot be surpassed. The Blue Hubbard is an exceptionally heavy cropper, producing an extraordinary number of Squashes, which, though not of the largest, are of even size, thus making it very easy to handle and market. It has excellent qualities, keeping, with proper storage, much longer than the Delicious. Pkt., 10c; oz., 20c; ¼ lb., 50c; lb., \$1.75.

CHICAGO OR WARTED HUBBARD. W. A selection of the Hubbard, with thickly warted shell. Equal in quality to that and generally considered to be of more attractive appearance. Of this also we offer a carefully selected strain unsurpassed by any we have ever seen. Pkt., 10c; oz., 20c; ¼ lb., 45c; lb., \$1.50.

GOLDEN HUBBARD. A rich orange-red instead of the dark olive-green of the old Hubbard, the flesh is thick and a little deeper colored. Good quality, fine grained and dry. Pkt., 10c; oz., 15c; ¼ lb., 40c; lb., \$1.40.

GREEN HUBBARD. W. A well-known and favorite winter variety, more largely grown than any other. We offer a choice strain, considered by some of our customers to be superior to the popular Chicago Hubbard. Pkt., 10c; oz., 15c; ¼ lb., 45c; lb., \$1.50.

DELICIOUS. A fall and winter variety. Color, usually dark green. Shell moderately hard but very thin; flesh thick, very fine grained, sweet and of finest flavor. Pkt., 10c; oz., 15c; ¼ lb., 40c; lb., \$1.40.

GOLDEN DELICIOUS. A fine home garden variety. Medium size, with deep orange shell and thick orange flesh. A good keeper. Pkt., 10c; oz., 15c; lb., \$1.40.

ESSEX HYBRID. An old, well-known orange turban sort. Flesh is dry, sweet and thick, bright orange color. Pkt., 10c; oz., 15c; ¼ lb., 40c; lb., \$1.40.

EARLY SUMMER CROOKNECK. For early planting the Crookneck type is used in New England to almost the exclusion of any other. This, while much smaller than the Mammoth Crookneck, is yet largely grown, many considering it of better flavor. Pkt., 10c; oz., 15c; ¼ lb., 40c; lb., \$1.40.

MAMMOTH SUMMER CROOKNECK. Vine larger and of more vigorous growth than the Summer Crookneck and fruit is twice as large and deeper colored. Popular with market gardeners. Pkt., 10c; oz., 15c; ¼ lb., 40c; lb., \$1.40.

EARLY GIANT SUMMER. Early, mostly straight necked and much larger than the Summer Crookneck. A fine quality growing from 14 to 16 inches long. Extensively used by market gardeners and exceptionally good for home gardeners. Pkt., 10c; oz., 20c; ¼ lb., 60c; lb., \$2.00.

ITALIAN VEGETABLE MARROW. Dark green at first, becoming marbled with yellow as they mature. The young fruits when fried in oil, constitute a vegetable delicacy very popular. Pkt., 10c; oz., 15c; ¼ lb., 40c; lb., \$1.40.

BOSTON MARROW. Grows larger than either the Prolific or Orange Marrow, but not so deep color. Skin thin, yellow, with pinkish tint. Desirable for pies. Not so dry as the Hubbard. Pkt., 10c; oz., 15c; ¼ lb., 40c; lb., \$1.40.

ORANGE MARROW. An early variety, like the Prolific Marrow in color and pitting, but is more nearly round, later, much thicker meated and of better quality. Pkt., 10c; oz., 15c; ¼ lb., 40c; lb., \$1.40.

TABLE QUEEN or DES MOINES. Desirable for home and market garden use. Acorn-shaped fruit, ribbed, smooth, thin shelled, dark green, flesh light yellow, bakes well, with sweet inviting flavor. Pkt., 10c; oz., 15c; ¼ lb., 40c; lb., \$1.40.

WARREN TURBAN. Has a shell generally harder and thicker than the Essex Hybrid. The color is a deeper and richer orange, while the quality is decidedly better. Grown very extensively by market gardeners. Pkt., 10c; oz., 20c; ¼ lb., 60c; lb., \$2.00.



Blue Hubbard

Table Queen

Early Giant Summer Straightneck

Plenty of Luscious Tomatoes

MAY BE GROWN ON A SMALL GARDEN PLOT

Tomatoes are ideal for a home garden crop, and yield heavily in small spaces.

An ounce will produce about 2,000 plants.

Tomatoes do best on light, warm, not over-rich soil. Sow in hotbed or window-box (where 60 degrees Fahr. is the minimum night temperature) in March, in rows 3 inches apart and 1/2 inch deep. Cover firmly. Later sowings may be made to the end of April. When seedlings are 3 inches high, transplant 4 inches apart each way in hotbeds, cold frames, or singly in 3-inch pots. Harden plants by exposing to the air occasionally. After warm weather is settled, set out plants 3 to 4 feet apart each way in hills, into each of which fertilizer has been previously mixed. Water freely at time of transplanting and shelter from sun until plants are well established.

New Early Worcester Tomato

Early dark solid fruit. A very heavy yielding variety. Our supply is limited. **Pkt., 25c; 1/4 oz., 70c; 1/2 oz., \$1.00.**

ACME. Vine hardy and productive. Fruit in clusters of four to five, round, smooth and of good size; flesh solid and of excellent flavor. **Pkt., 10c; 1/2 oz., 25c; oz., 40c; 1/4 lb., \$1.25.**

BEAUTY. Vines large, vigorous and heavy bearers; fruit large, uniform in size, very smooth, and excellent flavor; color, purplish pink. The best purple sort. **Pkt., 10c; 1/2 oz., 25c; oz., 40c; 1/4 lb., \$1.25.**

BONNY BEST. This Tomato has been tested and found eight to ten days earlier than the Chalk's Early Jewel and ripens about with the Earliana. Very strong grower and the fruit is uniform and smooth; ripens evenly all over; excellent shipper. **Pkt., 10c; 1/2 oz., 25c; oz., 40c; 1/4 lb., \$1.25.**

COMET. Fruit medium size, scarlet. The heaviest yielder of the greenhouse sorts. **Pkt., 10c; 1/2 oz., 35c; oz., 60c; 1/4 lb., \$2.00.**

DWARF CHAMPION. Sometimes sold as the "Tree Tomato." A second early, purplish pink variety, especially desirable where garden space is limited. Vine about two feet high, vigorous, upright and compact. Fruits, medium sized, exceptionally smooth and of very good quality. Our stock is a very superior strain with more even, smoother fruit than the original. **Pkt., 10c; 1/2 oz., 25c; oz., 40c; 1/4 lb., \$1.25.**

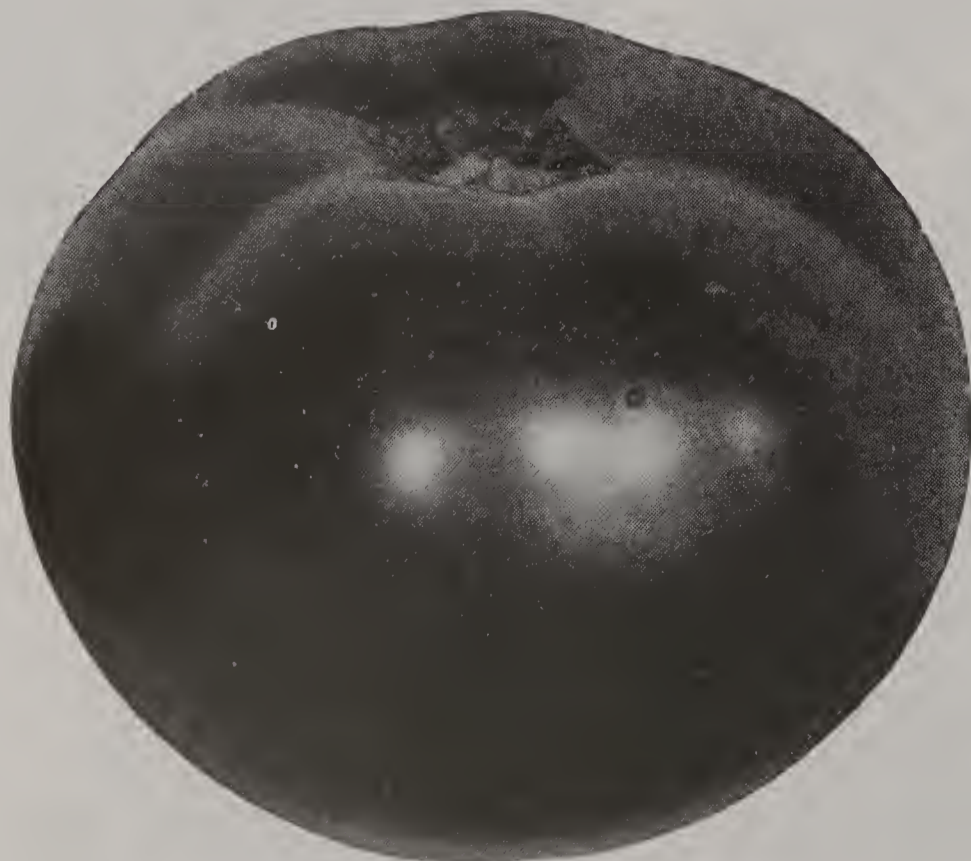

Bonny Best, a fine, extra-early variety

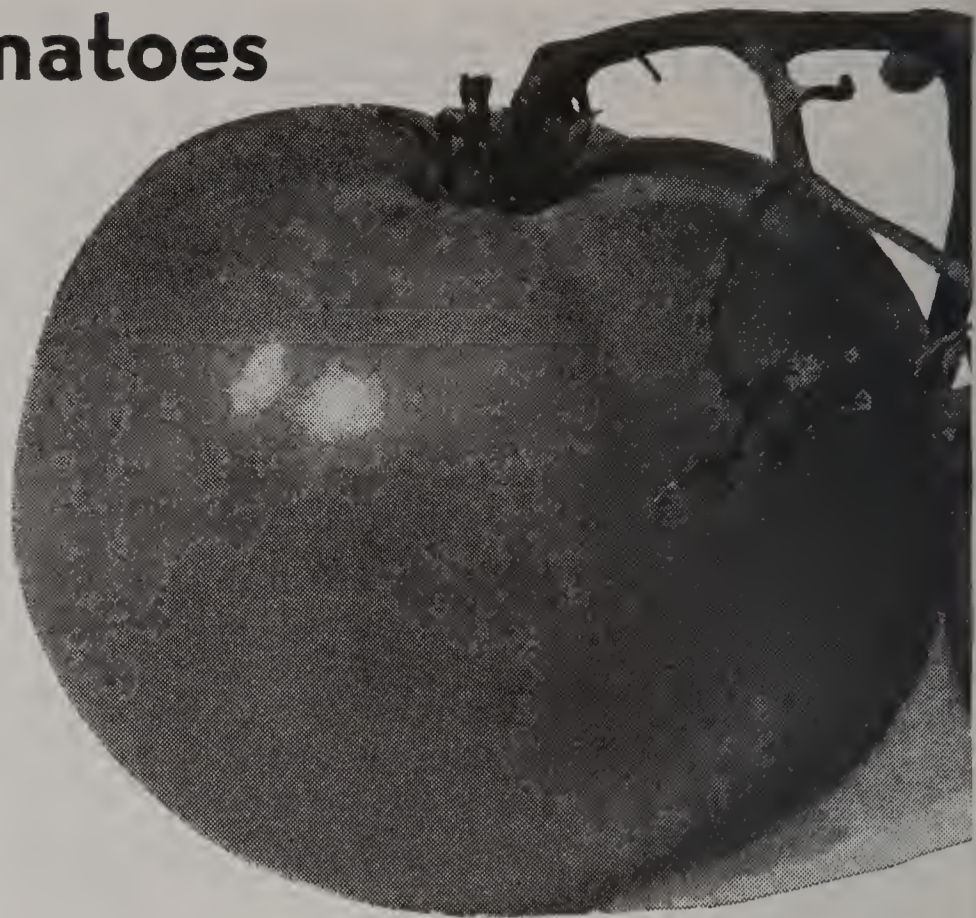

Marglobe is Wilt-Resistant

DWARF STONE. Vine dwarf but vigorous and productive. While maturing with the later sorts, the bright red fruits are of good color, exceedingly smooth and very solid. We consider this the best of the large fruited, dwarf tomatoes. **Pkt., 10c; 1/2 oz., 25c; oz., 40c; 1/4 lb., \$1.25.**

GOLDEN QUEEN. **Pkt., 10c; 1/2 oz., 25c; oz., 40c; 1/4 lb., \$1.25.**

JUNE PINK. An extra early, purplish pink Tomato similar to the popular scarlet fruited Earliana in growth of vine, shape and size of fruits and time of maturing. **Pkt., 10c; 1/2 oz., 25c; oz., 40c; 1/4 lb., \$1.25.**

JOHN BAER. An extra early scarlet fruited variety of superior merit. The vines are very hardy and exceptionally productive. The fruits are the largest of the extra early and are most attractive in color. They are nearly round, smooth, firm and of excellent quality. It is one of the earliest to ripen and it continues to furnish marketable fruits much longer than the other very early varieties. A valuable sort for market gardeners. **Pkt., 10c; 1/2 oz., 25c; oz., 40c; 1/4 lb., \$1.25.**

MARGLOBE. This is a wilt-resistant variety. The plant is vigorous and the fruit is quite large. This is a globe shape Tomato, the color being a handsome deep red. **Pkt., 10c; 1/2 oz., 25c; oz., 40c; 1/4 lb., \$1.25.**

PONDEROSA. A large smooth Tomato. Color, deep purple. The fruit is exceptionally solid, with few seeds and is quite free from acid. Ideal for shipping. **Pkt., 10c; 1/2 oz., 30c; oz., 50c; 1/4 lb., \$1.50.**

PRITCHARD. A great advance in the early class. Ripens with Earliana and ahead of Bonny Best. A cross between Marglobe and Cooper's Special. Good size, intense scarlet, solid, almost no core, small seed pockets; valuable for both market and home garden. **Pkt., 10c; 1/2 oz., 25c; oz., 40c; 1/4 lb., \$1.25.**

SPARKS' EARLIANA. A deep red Tomato. The vines are compact in growth, with short, close-jointed branches. Extra early and the best so far produced. Very productive. Fruit fair size and firm. Ripens 108 days from date of sowing seed. **Pkt., 10c; 1/2 oz., 25c; oz., 40c; 1/4 lb., \$1.25.**

STONE. Vines vigorous and productive; fruit large, smooth, deep red in color, and heavy. The best all around variety where earliness is not important. **Pkt., 10c; 1/2 oz., 25c; oz., 40c; 1/4 lb., \$1.25.**

RED PLUM (Italian). **Pkt., 10c.**

YELLOW PLUM. **Pkt., 10c.**

YELLOW HUSK OR STRAWBERRY. **Pkt., 10c.**

The Best Turnips to Grow



Early Purple-Top
White Globe
Turnip

An ounce will sow 200 feet of drill. If sown in drills, one pound is required for an acre; if sown broadcast, less seed is sufficient if sown evenly.

Culture. For early, sow seed of flat varieties in open ground in spring in drills one foot or more apart, using seed sparingly. Thin to 3 or 4 inches apart. For succession, sow every two weeks until June. For fall and winter, sow in July and August. A good crop may often be grown by scattering seed thinly in the cornfield at last cultivation. For Rutabagas, sow seed in seed-bed in spring and transplant to good warm soil in rows at least 2 feet apart and 8 to 10 inches apart in the rows, or sow in open ground during June and early July. Take up roots just before winter, top and store in cool cellar, or pit outdoors.

EARLY WHITE MILAN. Roots flat, smooth and symmetrical, pure white. Top very small, upright, and compact, permitting close planting. The earliest and much the best of any extra early white variety. Pkt., 10c; oz., 20c; ¼ lb., 50c.

EARLY PURPLE MILAN. Differs from the preceding in that the roots are not quite so thick and are purple on top. Pkt., 10c; oz., 20c; ¼ lb., 50c.

EARLY PURPLE-TOP FLAT. A well-known variety and very extensively grown. Roots smooth, white, with the upper portion purplish red. Pkt., 10c; oz., 15c; ¼ lb., 25c; lb., 75c.

EARLY PURPLE-TOP WHITE GLOBE. One of the handsomest varieties, the upper portions of the root being a purplish red, the lower pure white. A rapid grower, attaining a marketable size sooner than other large globular varieties. Of the best quality and an excellent keeper. Pkt., 10c; oz., 15c; ¼ lb., 25c; lb., 75c.

WHITE EGG. More extensively grown than any other variety. White, egg-shaped, smooth and symmetrical, of medium size; flesh firm, sweet and mild. Pkt., 10c; oz., 15c; ¼ lb., 25c; lb., 75c.

GOLDEN BALL or ORANGE JELLY. Of globular form, medium size, skin rich orange; flesh, pale amber, very fine-grained, mild and sweet. One of the most attractive, of the best quality and keeps well. Pkt., 10c; oz., 15c; ¼ lb., 25c; lb., 75c.

YELLOW GLOBE. The standard yellow variety. The form is round, slightly flattened. Largely grown for stock, and to some extent for market. An excellent keeper. Pkt., 10c; oz., 15c; ¼ lb., 25c; lb., 75c.

COW HORN, or LONG WHITE. Root long, slightly crooked and grows nearly half above ground. Clear white, except a little green at top. Though more largely used for feeding stock, it is a fine table variety, being tender and of mild flavor. Of very rapid growth. Pkt., 10c; oz., 15c; ¼ lb., 25c; lb., 75c.

Swedish, Russian or Rutabaga

SWEET RUSSIAN. An old variety, yet largely grown, mainly for table use. Sweet and mild. Pkt., 10c; oz., 15c; ¼ lb., 35c; lb., 90c.

WHITE FRENCH, or ROCK. Also an old and popular sort. Roots a little longer than Sweet Russian, but does not otherwise differ. Valuable for table or feeding. Pkt., 10c; oz., 15c; ¼ lb., 35c; lb., 90c.

BREADSTONE. An early variety, white, faintly colored at top; medium size, tender, mild and sweet. Pkt., 10c; oz., 15c; ¼ lb., 35c; lb., 90c.

SHAMROCK. A popular English Yellow Swede. A decided favorite with our local trade. Has short neck, shape oblong. Pkt., 10c; oz., 15c; ¼ lb., 35c; lb., 90c.

LONG ISLAND IMPROVED. This is undoubtedly the finest variety of Purple-Top Rutabaga. It grows much larger than other American varieties, is, therefore, desirable for stock, but equally desirable for the table and market, as it is tender and sweet and of very attractive appearance. Pkt., 10c; oz., 15c; ¼ lb., 35c; lb., 90c.

Tobacco

CONNECTICUT SEED LEAF. A hardy cigar variety, well adapted to growing in the Middle and Northern States. Pkt., 10c; oz., 40c.

HAVANA. Leaf very thin, fine texture. Much used for cigar wrappers. Pkt., 10c; oz., 40c.



Long
Island
Improved
Rutabaga

NOD-O-GEN THE PRE-TESTED INOCULATOR

When ordering be sure to state what seed you wish to inoculate.

Group 1	Alfalfa and Sweet Clover.	
Group 2	Red, Mammoth, White, Alsike and Crimson Clovers.	
	½ bu. size.....	\$0.30
	1 bu. size.....	.45
	2½ bu. size.....	.75
Group 3	Soy Beans.	
Group 4	Cow Peas.	
Group 5	Field and Garden Beans.	
Group 6	All Vetches, Field and Garden Peas.	
	1 bu. size.....	\$0.30
	2 bu. size.....	.45
	5 bu. size.....	.75
Garden combination for Peas, Sweet Peas, Garden, String and Lima Beans		25c
Add for Postage: 5c for Garden and ½ bu. sizes; larger sizes, 10c.		

Worcester, Mass.

USE SEEDS WITH HIGH GERMINATION—IT PAYS

Reference Table

GARDEN SEEDS

	Per Acre		Per Acre
Artichoke, 1 oz. to 500 plants	1/2 pound	Kohl-Rabi, 1 oz. to 200 feet of drill	1 1/2 pounds
Asparagus Seed, 1 oz. to 800 plants	4 pounds	Leek, 1 oz. to 200 feet of drill	4 "
Asparagus Roots	2500 to 7000	Lettuce, 1 oz. to 200 feet of drill	3 "
Beans, Dwarf, 1 pound to 100 ft. of drill	60 pounds	Melon, Musk, 1 oz. to 100 hills	2 1/2 "
Beans, Pole, 1 pound to 100 hills	30 "	Melon, Water, 1 oz. to 25 hills	4 "
Beet, Garden, 1 oz. to 100 ft. of drill	6 to 8 "	Mustard, 1 oz. to 50 feet of drill	8 "
Beet, Sugar and Mangel, 1 oz. to 100 ft. of drill	5 "	Okra, 1 oz. to 50 feet of drill	4 to 5 "
Broccoli, 1 oz. to 3000 plants	4 ounces	Onion Seed, 1 oz. to 200 feet of drill	30 to 50 "
Brussels Sprouts, 1 oz. to 3000 plants	4 "	Onion Seed for sets	250 "
Cabbage, 1 oz. to 3000 plants	4 "	Onion Sets, 2 pounds to 50 feet of drill	4 "
Carrot, 1 oz. to 150 feet of drill	2 1/2 pounds	Parsnips, 1 oz. to 200 feet of drill	4 "
Cauliflower, 1 oz. to 3000 plants	5 ounces	Parsley, 1 oz. to 200 feet of drill	4 "
Celery, 1 oz. to 10,000 plants	4 "	Peas, Garden, 1 pound to 100 feet of drill	100 "
Celeriac, 1 oz. to 10,000 plants	4 "	Pepper, 1 oz. to 1500 plants	4 ounces
Chervil, 1 oz. to 8000 plants	4 pounds	Potatoes	600 to 700 pounds
Chicory	4 pounds	Pumpkin, 1 oz. to 50 hills	3 "
Collards, 1 oz. to 5000 plants	12 "	Radish, 1 oz. to 150 feet of drill	8 to 10 "
Corn, Sweet, 1/4 pound to 100 hills	12 "	Sage, 1 oz. to 100 feet of drill	5 "
Cress, 1 oz. to 150 feet of drill	12 "	Salsify, 1 oz. to 60-foot row	8 "
Cucumber, 1 oz. to 50 hills	2 1/2 "	Spinach, 1 oz. to 100 feet of drill	12 "
Dandelion, 1 oz. to 200 feet of drill	2 "	Squash, Summer, 1 oz. to 25 hills	4 "
Dill, 1 oz. to 200 feet of drill	5 "	Squash, Winter, 1 oz. to 10 hills	2 "
Eggplant, 1 oz. to 2000 plants	4 ounces	Tomato, 1 oz. to 2500 plants	3 ounces
Endive, 1 oz. to 300 feet of drill	4 1/2 pounds	Tobacco, 1 oz. to 5000 plants	1 1/2 pounds
Kale, 1 oz. to 300 plants	4 ounces	Turnip, 1 oz. to 200 feet of drill	1 "
		Turnip, Rutabaga, 1 oz. to 150 feet of drill	1 "

GRAIN AND FORAGE CROPS

	Pounds per acre	Weight per bu.		Pounds per acre	Weight per bu.
Alfalfa	15-25	60	Oats, for grain	50-60	32
Barley, for grain	100	48	Oats, for forage	100	32
Barley, for forage	140	48	Peas, Field, Broadcast	150-160	60
Beans, Soy or Soja	60-75	60	Peas, with Oats	90-100	60
Buckwheat	50-75	48	Rye, for grain	60-75	56
Clover, Alsike	6-8	60	Rye, for forage	80-100	56
Clover, Crimson	18-20	60	Rape, Dwarf Essex, in drills	4-6	50
Clover, Mammoth Red	10-12	60	Rape, Dwarf Essex, broadcast	8-10	50
Clover, Medium Red	10-12	60	Sudan Grass, in drills	4-6	40
Clover, White Sweet	20	60	Sudan Grass, broadcast	18-20	40
Corn, Flint for grain	15	56	Vetch, Spring, with one bushel small grain	40-60	60
Corn, Dent for silage	20-30	56	Vetch, Winter or Hairy, with one bushel small grain	40-60	60
Millet, Golden	50	50	Wheat	90-120	60
Millet, Hungarian	50	48			
Millet, Japanese	15-25	35			

GRASS SEEDS

	Pounds per acre	Weight per bu.		Pounds per acre	Weight per bu.
Awnless Brome	18-25	14	Rye Grass, Italian	60	22
Blue Grass, Canada	30-35	14	Rye Grass, Pacey's	50	28
Blue Grass, Kentucky	20-25	14	Red Top, Recleaned Seed, Worcester Brand	40-50	36
Creeping Bent	50	14	Red Top, Unhulled Seed	70	14
Crested Dogstail	30	28	Rhode Island Bent	20-40	14
Fescue, Hard	30	16	Rough Stalk Meadow	30-35	26
Fescue, Meadow	24	16	Sweet Vernal, use only in mixture		
Fescue, Red or Creeping	30	16	Tall Meadow Oat	45	12
Fescue, Sheep's	40	16	Timothy	12-25	45
Fescue, Various Leaved	20-25	15	Lawn Seed Mixture, Shady Spot	100-125	20
Meadow Foxtail	30	8	Lawn Seed Mixture, Worcester Brand	100-125	25
Orchard Grass	20-25	14	Wood Meadow	25-30	19
Rye Grass, English	50	28			

NUMBER OF PLANTS, TREES, ETC., REQUIRED TO SET AN ACRE

Distance	Number	Distance	Number
1 ft. by 1 ft.	43,560	6 ft. by 6 ft.	1,210
1 1/2 ft. by 1 1/2 ft.	19,360	8 ft. by 8 ft.	680
2 ft. by 1 ft.	21,780	10 ft. by 10 ft.	434
2 ft. by 2 ft.	10,890	12 ft. by 18 ft.	302
2 1/2 ft. by 2 1/2 ft.	6,970	15 ft. by 15 ft.	194
3 ft. by 1 ft.	14,520	18 ft. by 18 ft.	134
3 ft. by 2 ft.	7,260	20 ft. by 20 ft.	103
3 ft. by 3 ft.	4,840	25 ft. by 25 ft.	70
4 ft. by 4 ft.	2,722	30 ft. by 30 ft.	40
5 ft. by 5 ft.	1,742	40 ft. by 40 ft.	27

LET US RECOMMEND VARIETIES FOR YOUR SOIL

ROSS BROS. CO.

ROSS' CHOICE ANNUALS

Gardens That are Well Planned Will have Flowers in Abundance This Year

Annuals are flowers that sprout from seed, all of which die within the limits of the garden year. Being inexpensive, they appeal to both the home owner and renter. It is possible to enjoy at a low cost all of Nature's beauty in color and fragrance. The many varieties we offer in this book are carefully selected to supply the utmost in flower beauty and satisfaction.

Ageratum (Floss Flower)

Hardy Annual

A plant of the greatest beauty and value for garden or window, unexcelled for border, rock garden or bedding. Early and constant bloomer.

148 MEXICANUM. Blue. 1½ feet. Pkt., 10c; ¼ oz., 30c; oz., 80c.

149 MEXICANUM ALBUM. White, 1½ feet. Pkt., 10c; ¼ oz., 30c; oz., 80c.

151 LITTLE DORRIT. Azure-blue. 8 inches. Pkt., 10c; ¼ oz., 30c; oz., 80c.

153 LITTLE BLUE STAR. A miniature variety with beautiful mauve flowers. 5 inches. Pkt., 10c; ⅛ oz., 60c; ¼ oz., \$1.00.

154 BLUE PERFECTION. Large heads of amethyst-blue flowers; plant of very even growth, about 8 inches high. Pkt., 10c; ¼ oz., 30c; oz., 80c.

155 DWARF BLUE CAP. This is by far the best all around dwarf Ageratum yet produced. Pkt., 10c; ⅛ oz., 30c; ¼ oz., 50c.

156 PURPLE PERFECTION. Deepest blue. Pkt., 10c; ⅛ oz., 25c.

158 MIXED COLORS. All varieties mixed. Pkt., 10c; ½ oz., 30c; oz., 55c.

Acroclinium (Everlasting Flower)

One of the so-called everlasting flowers, which, when cut and dried, is very valuable for winter bouquets. A graceful plant, growing about 15 inches high and bearing lovely rose and white flowers, which are very effective in beds or borders during the summer, but it is for their use in a dried state during the winter that they are extensively grown.

139 Light Rose and Pure White. Mixed. Pkt., 10c; ¼ oz., 20c.

Agrostemma

Pretty, free-blooming plants of easy culture, especially desirable for dry situations. Excellent for cutting.

160 COELI-ROSA (Rose of Heaven). Rose, white center. Hardy annual. 1½ feet. Pkt., 10c; ⅛ oz., 30c.

Amaranthus

Brilliantly colored foliage, and bearing peculiarly formed flowers. While in rich soil the plants and leaves are much larger, the colors are seldom as brilliant as when grown on rather poor soil. Of easiest culture. Give plenty of room to develop.

175 CAUDATUS (Love-Lies-Bleeding). Long, drooping flower, blood red. Half-hardy annual. 3 feet. Pkt., 10c; ⅛ oz., 25c.

178 TRICOLOR SPLENDENS (Joseph's Coat). Red, yellow, and green foliage. One of the most beautiful of ornamental-leaved Amaranthus. Pkt., 10c; ¼ oz., 30c.

Alyssum

A well-known favorite, hardy annual, blooming profusely the entire season. Excellent for edging. No other white flower is so well adapted for a dense, low carpet, or as borders and ribbons in garden work. Extremely fragrant and frequently used for bouquets. Sow seed early in April.

166 SWEET ALYSSUM. Fragrant, white. 1 foot. Pkt., 10c; ¼ oz., 20c; ½ oz., 35c; oz., 60c.

167 LITTLE GEM. Of spreading habit, forming compact masses of bloom often a foot or more in diameter. White, fragrant. 6 inches. Pkt., 10c; ¼ oz., 25c; oz., 75c.

168 CARPET OF SNOW. Of very dwarf habit; white, fragrant. 4 inches. Pkt., 10c; ¼ oz., 30c; ½ oz., 50c.

169 LILAC QUEEN. Beautiful soft lilac flowers changing to white as they age. Pkt., 10c; ⅛ oz., 20c; ¼ oz., 35c.

171 LITTLE DORRIT. Little bushes fairly smothered with miniature white flowers. A gem for edging and beds. 4 inches high. Pkt., 10c; ¼ oz., 25c; oz., 75c.

Anchusa

184 BLUE BIRD. Compact plants, 20 to 24 inches high with clusters of vivid indigo-blue flowers. Excellent for cutting. Pkt., 10c; ⅛ oz., 25c.

185 CAPENSIS (Cape Forget-me-not). Attractive annual with azure-blue flowers. 1½ feet. Pkt., 10c; ⅛ oz., 25c.



Ageratum, Blue Perfection



Amaranthus
(Love-Lies-Bleeding)



Alyssum, Little Gem

AGERATUM IS EXCELLENT FOR BORDERS

THE ASTER, Queen

In recent years we have paid particular attention to American grown Asters, for they have greatly increased the popularity of this flower. We know of no other flower so easily raised from seed, which combines so much beauty with grace and usefulness and is more satisfactory than Asters. They make a brilliant effect when grown in masses and furnish a constant supply of cut flowers. Every garden, large or small, should contain Asters.

California Giant Double

We take pleasure in recommending this type as the best Aster on the market today. Characterized by the well known Crego or Ostrich Feather type of flower, combined with the Beauty Asters' long, non-lateral branching stems and sturdy habit of growth, the California Giant Double type of Aster stands at the head of the list, not only for florists' use but also for private gardens where quality is appreciated.

- | | |
|---------------------|------------------|
| 8 White. New; fine. | 11 Light Purple. |
| 9 Peach Blossom. | 12 Deep Rose. |
| 10 Light Blue. | 13 Dark Purple. |

Pkt., 10c; 1/16 oz., 30c; 1/8 oz., 50c; 1/4 oz., 90c.

14 MIXTURE OF ABOVE: Pkt., 10c; 1/8 oz., 40c; 1/4 oz., 75c; 1/2 oz., \$1.40.

32 Heart of France (Wilt Resistant)

The best pure-red Aster ever introduced. All others have somber shades of blue or too much yellow in the color pigments. Heart of France opens red as the purest ruby, deepens with age and retains its remarkable beauty to the very end. The petals appear strikingly changeable, showing now a glow and sheen quite unique, now a soft, warm, velvety texture. Pkt., 10c; 1/8 oz., 40c; 1/4 oz., 75c.

32A Lilliput-Flowered

Comparing in size with the Lilliput Zinnias, these baby flowered asters fill a very definite place in the border or cut-flower garden. The flowers are tiny and buttonlike in form, coming in profuse clusters on medium length stems. Mixed. Pkt., 10c; 1/8 oz., 40c; 1/4 oz., 75c.

American Beauty (Wilt Resistant)

Plants 2 1/2 to 3 ft. with long, heavy stems, bearing large, compact flowers. They bloom from late August until frost.

- | | |
|--------------------------------|---------------------|
| 43 Azure Fairy—
Azure-blue. | 44 Purple. |
| 43A Crimson. | 44A September Pink. |
| | 45 White. |
| | 45A Finest Mixed |

Pkt., 10c; 1/8 oz., 40c.

Queen of the Market (Wilt Resistant)

A very early blooming strain, which, though plant is only 1 1/4 feet high, bears from ten to fifteen well-formed, medium-sized flowers on long stems. Much used by florists.

- | | |
|-------------------|------------------|
| 37 White. | 40 Pink. |
| 38 Peach Blossom. | 41 Crimson. |
| 39 Light Blue. | 42 Mixed Colors. |

Each pkt., 10c; 1/8 oz., 40c; 1/4 oz., 75c.

Improved Crego (Wilt Resistant)

Plants robust, branching, about 2 1/2 ft. Flowers large, double and well formed; one of the finest varieties for all purposes.

35A Finest Mixed.
Pkt., 10c; 1/8 oz., 40c; 1/4 oz., 75c.



Aster, Improved Crego



Aster, California Giant Single

California Giant Single

This Aster was developed out of the California Giant Double type. The flowers are large, measuring three to four inches across, with stems 18 to 24 inches in length. The petal has a slight twist, which adds a piquant touch to its beauty. The white blossoms resemble Shasta Daisies in appearance, but their greater length of stem makes them more graceful and better adapted to florists' use.

15 Finest Mixed. Pkt., 10c; 1/8 oz., 35c; 1/4 oz., 60c; 1/2 oz., \$1.00.

16 GOLDEN SHEAF. Wilt Resistant. The flowers are fully double, with a crest-like yellow center; the outside petals being white. Similar to the Aurora type of Aster. The flowers last well when cut. Pkt., 10c; 1/8 oz., 40c.

California Sunshine

An attractive anemone-flowered variety particularly fine for cutting.

24 Mixed Colors. Pkt., 10c; 1/8 oz., 40c; 1/4 oz., 75c.

WILT-RESISTANT ASTERS ARE A BOON TO GARDENERS

ROSS BROS. CO.

of the Annual Garden

Royal (Wilt Resistant)

This is considered by many to be the very best general purpose Aster ever introduced. It is very much like our American Branching variety, having all its good qualities, but coming into bloom in July or early August and lasting in perfect condition for a long time. The habit of the plants and their free flowering make them very desirable for beds or borders, and the long stemmed flowers are ideal for cutting.

- | | |
|--------------------------|------------------|
| 46 Lavender-pink. | 48 Lavender. |
| 47 White. | 49 Mixed Colors. |
| Pkt., 10c; 1/8 oz., 50c. | |

Super Giant

This is the largest and most fully double Aster known in this class. The flowers are from 6 to 8 inches across; full, graceful, interlacing petals. Plants are about 2 1/2 feet tall, with six to eight long non-lateral stems per plant.

- 50 Los Angeles. Shell-pink. Pkt., 10c; 1/8 oz., 40c.
51 El Monte. Crimson. Pkt., 10c; 1/8 oz., 40c.

Victoria

Considered for a long time one of the finest types and improved in recent years. The flowers are large, double, imbricated, having petals which curve outward like those of the Show Dahlias. Bears freely, beautiful long-stemmed flowers.

- 62 MIXED COLORS. A superb mixture. Pkt., 10c; 1/8 oz., 40c.

NOTE: Please order by number as well as name.

Giant Branching Comet - Wilt Resistant

Distinct and valuable; flowers resemble the Japanese Chrysanthemum. Not only larger, but petals are longer and somewhat broader than the old Comet section. The plant is of vigorous, luxuriant growth and produces freely its long-stemmed graceful flowers. 1 1/2 to 2 feet.

- | | |
|---------------|----------------|
| 70 White. | 74 Lavender. |
| 71 Dark Blue. | 75 Crimson. |
| 73 Deep Rose. | 76 Shell-pink. |

Each, pkt., 10c; 1/8 oz., 40c.

- 80 MIXED COLORS. Many colors and shades. Pkt., 10c; 1/8 oz., 40c.

American Branching - Wilt Resistant

A superior late-blooming strain of American origin. The flowers are of the largest size, borne on long, graceful stems often 15 or more inches in length, are exceedingly beautiful and unsurpassed for cutting. The plants are of extra large and strong growth, and bloom profusely. 2 1/2 feet.

- | | |
|---------------|-------------------|
| 108 White. | 111 Crimson. |
| 109 Pink. | 112 Purple. |
| 110 Lavender. | 116 Mixed Colors. |

Each, pkt., 10c; 1/8 oz., 40c; 1/4 oz., 75c.

Semple's Branching - Wilt Resistant

The plants of this Early Branching Aster attain the size and vigor of the famous American Branching, but bloom from 10 days to two weeks earlier. Extra large, perfectly formed flowers on long, stiff stems make them especially desirable for cutting, for exhibitions or for sale.

- | | |
|------------------|--------------|
| 118 Lavender. | 121 Crimson. |
| 119 White. | 122 Mixed. |
| 120. Shell-pink. | |

Each, pkt., 10c; 1/8 oz., 40c; 1/4 oz., 75c.



Aster, American Beauty

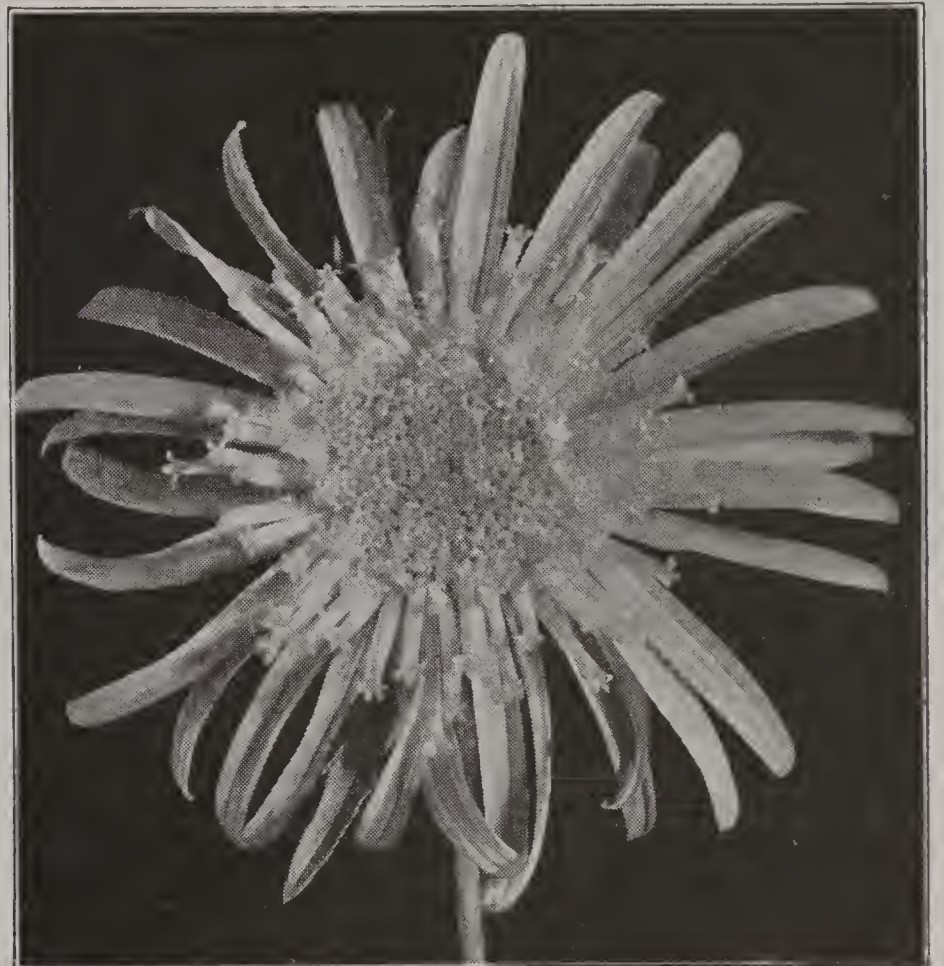

Aster, California Sunshine

124 Worcester Mixture

Our own mixture of the leading choice varieties includes every color and shade known among Asters, and will afford, especially if purchased in bulk, the greatest discovery of both colors and types. Purchaser of a single packet may be certain of securing a choice collection of desirable varieties. Pkt., 10c; 1/8 oz., 40c; 1/4 oz., 60c; oz., \$2.00.

125 Good Mixed

Our own mixture of many varieties; a wide range of colors. Pkt., 10c; 1/8 oz., 30c; 1/4 oz., 50c; oz., \$1.75.

Astermum - Wilt Resistant

A strain of Giant Comet Asters which, on account of their immense size and Chrysanthemum-like appearance, have appropriately been named Astermums. The plants grow about 2 feet high with long, strong stems and should come into bloom about the middle of August.

- 126 White. 127 Pink. 128 Lavender. Pkt., 10c; 1/8 oz., 35c.



Rust-Proof Antirrhinum

Antirrhinum (Snapdragon)

Rust-proof
75% or better Rust-proof

One of the most beautiful and useful bedding plants, blooming profusely throughout the summer. Fine for cutting.

- 190A **AUTUMN SHADES.** Super majestic, old rose suffused amber, golden lip. Pkt., 15c.
 190B **FLORIST PEARL.** Glistening white. Maximum type. Pkt., 10c; 1/8 oz., 35c.
 190C **RED SHADES.** Super majestic. Pkt., 15c.
 191 **SILVER PINK.** Super majestic, deep pink with white lip. Pkt., 15c.
 190D **UNIVERSITY OF CALIFORNIA DE LUXE MIXTURE.** Pkt., 10c; 1/8 oz., 30c.

Snaps for Greenhouse Forcing

- 192 **AFTERGLOW.** Golden bronze. Pkt., 25c.
 193 **CEYLON COURT.** Yellow. Pkt., 25c.
 194 **CHEVIOT MAID.** Bright pink. Pkt., 25c.
 195 **ROSE QUEEN.** Dark pink. Pkt., 25c.
 196 **WHITE ROCK.** Pure white. Pkt., 25c.
 196A **JENNIE SCHNEIDER.** True pink. Pkt., 25c.

Snapdragons, Large Flowered Type

- 197 **TALL MIXED.** Pkt., 10c; 1/8 oz., 20c; oz., \$1.00.
 198 **GRANDIFLORA.** Giant varieties. Mixed, pkt., 10c; 1/4 oz., 35c.
 199 **DWARF VARIETIES.** Mixed colors. Pkt., 10c; 1/4 oz., 35c.

Arctotis

- 210 **GRANDIS** (Blue-eyed African Daisy). 3 ft. It forms bushes bearing 2-inch daisy flowers of pearly white with a gold band surrounding a delicate mauve center. It closes at evening and displays its lilac tinted under sides. Foliage gray-green. Especially good cut flower. Pkt., 10c; 1/4 oz., 35c; 1/2 oz., 60c.
 211 **HYBRIDS.** Showy daisy-like flowers, red and orange shades. Pkt., 10c; 1/8 oz., 40c; 1/4 oz., 75c.

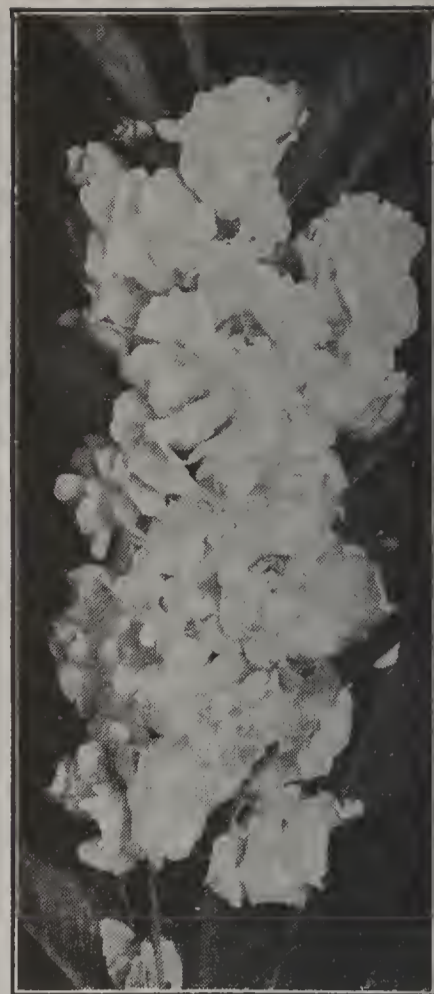

Balsam, Camellia-Flowered



Brachycome

Asparagus

- 216 **PLUMOSUS NANUS.** Beautiful house plants. The feathery foliage is unrivaled for cutting. Pkt., 15c.
 217 **SPRENGERI.** Excellent plants for table decorations. Pkt., 15c.

Balsam

They are among the showiest and most popular of our summer garden annuals, forming bushy plants, covered with double flowers of brilliant colors.

- 225 **IMPROVED CAMELLIA-FLOWERED.** Mixed colors. Double flowers of the finest type and a wide range of beautiful colors. Pkt., 10c; 1/4 oz., 40c.
 226 **DOUBLE CAMELLIA-FLOWERED.** White. Pkt., 10c; 1/4 oz., 35c.
 227 **DOUBLE CAMELLIA-FLOWERED.** Crimson. Pkt., 10c; 1/4 oz., 35c.
 228 **DOUBLE CAMELLIA-FLOWERED.** Salmon-rose. Pkt., 10c; 1/4 oz., 35c.
 230 **CHOICE MIXED.** Double flowers of many colors. Pkt., 10c; 1/4 oz., 20c; oz., 75c.

Balloon Vine

- 235 A tender annual climber of rapid growth, bearing small white flowers, followed by curious inflated seed-vessels, somewhat resembling a balloon. 10 to 15 feet. Pkt., 10c; 1/2 oz., 25c.

Bartonia Aurea

- 236 Showy, hardy annual of distinct character, its golden yellow flowers being freely produced. It grows well in partial shade, but should not be crowded. Pkt., 10c; 1/8 oz., 20c.

Beans, Ornamental Varieties

The Scarlet and White Runner Beans are popular as ornamental climbers. The former is largely grown alone for ornamental effects.

- 240 **SCARLET RUNNER.** Pkt., 10c.
 241 **WHITE RUNNER.** Pkt., 10c.

BLUE LACE FLOWER. See Didiscus.

Brachycome (Swan River Daisy)

A free-flowering plant of dwarf, compact growth, bearing in great profusion beautiful single blue or white flowers. Effective as edgings or in beds, and suitable for rustic baskets or pot culture. Half-hardy annual. 1 foot.

- 250 **Mixed Colors.** Pkt., 10c.

Browallia

A beautiful, free-blooming half-hardy annual. Seed may be sown in the open ground when warm, but preferably should be sown in the house or hotbed and, if possible, repotted once or twice. For beds, borders or pots, few equal it. 1 1/2 feet.

- 251 **Blue and White Mixed.** Pkt., 10c.

Calendula (Pot Marigold)

A very free-blooming hardy annual of easy culture. Grows well in nearly all soils. Flowers double, borne on stiff stems, and are cut to some extent, but the plant is more desirable for bedding. 1 to 1½ feet.

252 CAMPFIRE OR SENSATION. Improved strain. This is much taller growing and the flowers are much larger than Campfire or Sensation sent out in previous seasons. We consider this variety the very best forcing orange Calendula on the market. Pkt., 10c; ¼ oz., 30c; oz., \$1.00.

253 CHRYSANTHA OR SUNSHINE. Chrysantha is a new Calendula which is outstanding among all varieties known up to the present time. The large flowers are an exquisite shade of clear buttercup-yellow, with long loosely arranged petals, which droop to give the rounded appearance found in our favorite Chrysanthemums. Pkt., 10c; ¼ oz., 30c; ½ oz., 50c.

254 RADIO. Improved strain. A special selection of large flowering, well-formed Radio type flowers, borne on long, stout stems—a strain which is more suitable for forcing than the original Radio. Pkt., 10c; ¼ oz., 30c; ½ oz., 50c.

255 THE BALL. A large ball-shaped double flower. Color, bright orange, much used by florists. Pkt., 10c; ⅛ oz., 20c; ¼ oz., 35c; ½ oz., 60c; oz., \$1.10.

256 ORANGE SHAGGY. Deep orange shading, lighter at the center. The plants are free flowering, bearing long stems which make the fringed petaled flowers equally useful in the garden or for cutting. Pkt., 10c; ⅛ oz., 25c.

257 ORANGE KING. Large, dark orange. Pkt., 10c; ½ oz., 30c; oz., 50c.

258 LEMON QUEEN. Clear lemon-yellow. Pkt., 10c; ¼ oz., 20c; ½ oz., 35c.

259 MIXED VARIETIES. Pkt., 10c; ½ oz., 15c; oz., 25c.

Calliopsis

Well-known, profuse flowering hardy annuals of the easiest culture. Numbers 260 to 263 represent the type more commonly known. Numbers 261 and 262 resemble in habit, foliage and flower the perennial type; generally known as Coreopsis.

260 MIXED COLORS. 1½ to 2 feet. Pkt., 10c; ½ oz., 30c; oz., 50c.

261 CORONATA MAXIMA. Yellow; extra large. 1½ feet. Pkt., 10c; ¼ oz., 20c.

262 GOLDEN WAVE (Drummondii). Golden yellow with small dark center, 1½ feet. Pkt., 10c; ¼ oz., 20c.

263 RAY OF GOLD. Yellow, with purplish brown center. 6 to 8 inches. Pkt., 10c; ¼ oz., 20c.

Canary Creeper

(*Tropaeolum Canariense*)

275 A rapid-growing, half-hardy annual climber, bearing curiously formed yellow flowers. Blooms until frost. Fine for shady places. 10 to 15 feet. Pkt., 10c; ¼ oz., 20c.

Candytuft

Popular hardy annual, growing in any soil, requiring but little care, and by repeated sowings may be had in bloom all summer. 6 inches to 1 foot.

276 ROSE CARMINE. Pkt., 10c; ¼ oz., 20c; ½ oz., 35c.

277 DARK CRIMSON (Dunnett's). Pkt., 10c; ¼ oz., 20c; ½ oz., 35c.

278 EMPRESS. Large trusses; pure white. Pkt., 10c; ⅛ oz., 20c; ¼ oz., 35c.

279 GIANT HYACINTH-FLOWERED. Heads of immense size, resembling the Hyacinth. White. Generally considered superior to Empress. Pkt., 10c; ⅛ oz., 20c; ¼ oz., 35c; oz., \$1.00.

280 MIXED COLORS. Pkt., 10c; ¼ oz., 20c; oz., 50c

282 DWARF HYBRIDS. Mixed colors. Of dwarf habit but flowers are large. Pkt., 10c; ¼ oz., 20c; ½ oz., 35c.

283 WHITE FRAGRANT. Pkt., 10c; ¼ oz., 20c; oz., 60c.

Canna

The Crozy Cannas are well known for their dwarf growth and luxuriant foliage. The flowers are large and of most brilliant colors. Soak the seeds in warm water until they show signs of swelling, then sow in sandy loam and place in hotbed.

284 CROZY'S DWARF. Dark, large flowering varieties. Mixed. 3 to 4 feet. Pkt., 10c; ¼ oz., 20c.

285 GIANT FLOWERED NEW HYBRIDS. Mixed. Pkt., 10c; ¼ oz., 20c.

CARDINAL CLIMBER. See Ipomoea, number 549.

CARDINAL FLOWER. See Lobelia, number 588, page 63.

Canterbury Bells

274A FINEST MIXED. A new annual Canterbury Bell which blooms from seed in less than six months. Plants 2-2½ ft. Pkt., 10c.

Cobaea Scandens or Cathedral Bells

345 Elegant, rapid growing climbers, attaining a height of 20 to 30 feet. Particularly desirable for covering arbors, walls, etc. Can be grown in the conservatory in winter. Flowers large and bell-shaped. 20 to 30 feet. Pkt., 10c; ¼ oz., 30c.



Candytuft, Giant Hyacinth-Flowered



Canterbury Bells



Calendula,
Orange
Shaggy

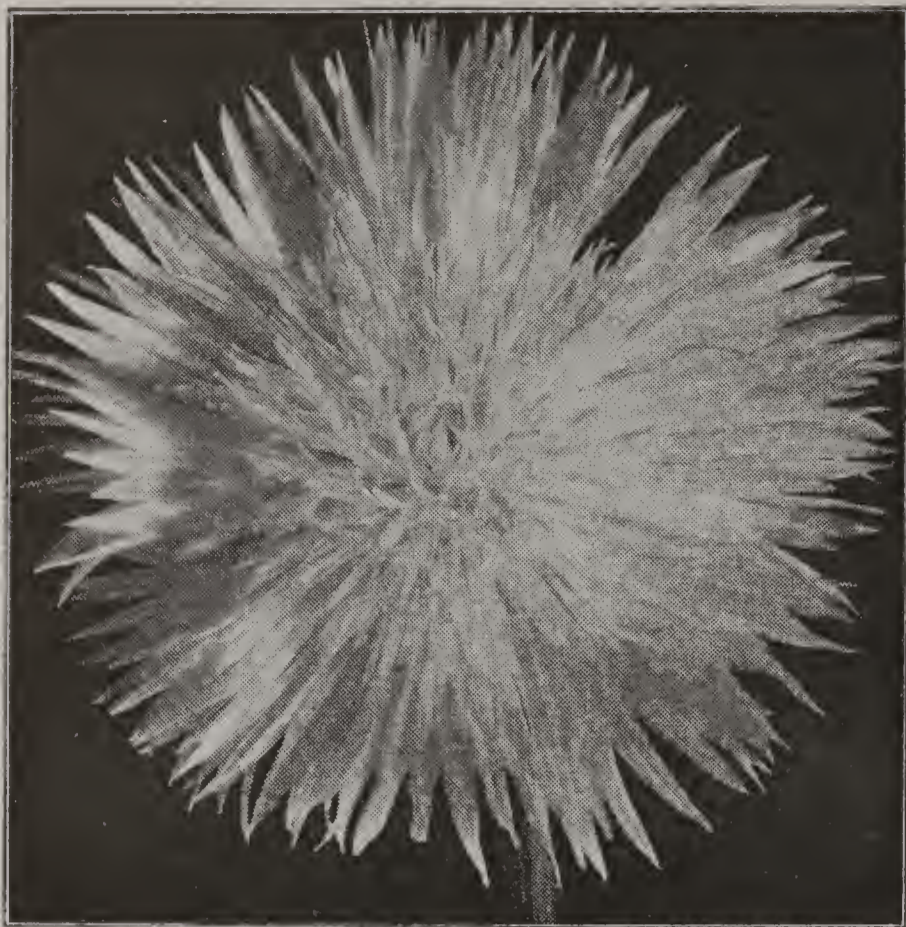

Royal Sweet Sultan

Carnation (*Dianthus Caryophyllus*)

- 287 MARGUERITE GIANTS.** Double special mixture. Flower approaches in form, size, fragrance and beauty those grown by the florist. Pkt., 10c; 1/8 oz., 30c.

Centaurea

To this family belong the well known annuals, Bachelor's Button and Sweet Sultan, and also the plants known as Dusty Millers.

- 316A JUBILEE GEM.** A dwarf variety of Bachelor Button which makes a compact plant literally covered with flowers. The foliage is quite distinct from that of the ordinary variety, being of a bright green, and contrasts well with the dark but very vivid flowers. Plants grow to a height of about 12 inches which makes it adaptable for use as an edging or border plant as well as making a splendid cut flower. This hardy annual does well in any garden soil and produces a profusion of flowers from early summer until late Autumn. Pkt., 15c; 1/8 oz., 50c.

CYANUS (Bachelor's Button or Cornflower)

- 317 DOUBLE BLUE.** A selection of the old-fashioned Bachelor Button, producing a large percentage of beautiful double blue flowers. 2 ft. Pkt., 10c; 1/4 oz., 25c; 1/2 oz., 40c.

- 318 DOUBLE LAVENDER. 318A DOUBLE ROSE.**

- 319 DOUBLE WHITE.**

Each, pkt., 10c; 1/4 oz., 25c.

- 320 SINGLE AND DOUBLE MIXED.** Pkt., 10c; 1/2 oz., 25c; oz., 50c.

CENTAUREA (Sweet Sultan)

- 321 MOSCHATA (Common Sweet Sultan).** Mixed colors. Pkt., 10c; 1/8 oz., 25c; 1/4 oz., 40c.

- 322 SUAVEOLENS (Yellow Sweet Sultan).** Pkt., 10c; 1/8 oz., 25c; 1/4 oz., 40c.

IMPERIALIS (Royal Sweet Sultan)

Improved type of Sweet Sultan. Both plants and flowers are larger than the common. Very fragrant and colors delicate and beautiful.

- 323 DEEP LAVENDER.** Pkt., 10c; 1/8 oz., 30c.

- 324 WHITE.** Pkt., 10c; 1/8 oz., 30c.

- 325 MIXED COLORS.** Pkt., 10c; 1/8 oz., 25c.

WHITE-LEAVED CENTAUREAS (Dusty Miller)

Half-hardy perennials which are grown annually from their seed for their foliage only. Used with other foliage and flowering bedding plants.

- 326 CANDIDISSIMA.** Yellow, silvery foliage. 1 foot. Pkt., 10c; 1/8 oz., 40c.

- 327 GYMNOCARPA.** Lavender, silvery white foliage; of graceful drooping habit. 1 1/2 feet. Pkt., 10c; 1/4 oz., 30c.

Castor Bean (*Ricinus*)

Well-known tender annual, stately, majestic plants of very rapid growth, with palm-like leaves of glossy green, brown or bronze hue; very effective for lawns, planted singly or in groups. 6 to 15 feet.

- 295 BORBONIENSIS.** Large, showy foliage of purplish hue. 15 feet. Pkt., 10c; 1/2 oz., 20c; oz., 35c; 1/4 lb, \$1.00.

- 296 CAMBODGENSIS.** Stalks and stems nearly black; leaves large, of a deep bronze-maroon. 6 feet. Pkt., 10c; 1/2 oz., 20c; oz., 35c.

- 297 SANGUINEUS (Tricolor).** Stalks blood-red, foliage reddish bronze, with scarlet seedpods. 6 feet. Pkt., 10c; 1/2 oz., 20c; oz., 35c.

- 298 ZANZIBARENSIS.** A comparatively new class, with gigantic leaves, ranging in color from light green to deep bronze. 10 to 15 feet. Mixed varieties. Pkt., 10c; 1/2 oz., 20c; oz., 35c.

- 299 GIBSONI.** Large dark-red leaves. 5 feet. Pkt., 10c; 1/2 oz., 20c; oz., 35c.

- 300 ALL VARIETIES MIXED.** Pkt., 10c; 1/2 oz., 15c; oz., 25c.

Chinese Woolflower

(*Celosia Childsi*)

This unique type of *Celosia plumosa* forms, instead of pyramidal panicles of bloom, large globular heads like balls of wool chenille, and of rich bright red color. The plants, 2 to 3 feet in height, branch freely, each branch terminating with a flower-head. It continues in flower from early summer until frost and is very effective for gardens, either massed or grown as individuals.

- 329C MIXED COLORS.** Each, pkt., 10c; 1/8 oz., 35c.

Chrysanthemum

Free-flowering plants of branching habit, grow freely from seed, and are of easy culture, very desirable for cutting. They should be given plenty of room—from 2 to 2 1/2 feet. Hardy annual. 1 to 1 1/2 feet.

- 330 SINGLE (Painted Daisies).** Mixed colors. Pkt., 10c; 1/4 oz., 20c; oz., 60c.

- 331 EVENING STAR.** Covered with bright golden yellow single flowers. Pkt., 10c; 1/8 oz., 20c.

- 333 DOUBLE WHITE.** Pkt., 10c; 1/8 oz., 20c.



Centaurea Cyanus (Bachelor Buttons)

Giant Flowering Cosmos

That Excel in Beauty

Cosmos are among the finest annuals for table decoration, reminding one of a small Japanese Peony of rare grace and beauty. They are invaluable in the mixed border and for their long period of flowering.

359 KLONDYKE, ORANGE FLARE. This is a strain which is in full bloom less than five months from sowing. Pkt., 10c; 1/8 oz., 35c.

360 MAMMOTH PERFECTION. Mixed colors. Of mammoth size, rather late in flowering. Pkt., 10c; 1/4 oz., 30c.

362 LARGE EARLY FLOWERING. The flowers are fully twice as large as the Early Flowering, while the plant blooms as early. Crimson, Rose and White Mixed. Pkt., 10c; 1/4 oz., 30c; 1/2 oz., 55c; oz., \$1.00.

362A Crimson. 362B Pink. 362C White.

Each, pkt., 10c.

The Sensation type of Cosmos grows 4 to 5 inches in diameter, with broad fluted petals which slightly overlap, giving a very full single flower. Plants reach a height of 3 to 4 feet and have a fairly heavy growth of foliage. The flowers are produced within 8 to 10 weeks from the time seed is sown.

364 SENSATION PINKIE. Clear rose-pink. Pkt., 10c; 1/8 oz., 35c.

364A SENSATION PURITY. Pure white. Pkt., 10c; 1/8 oz., 35c.

364B SENSATION FINEST MIXED. Pkt., 10c; 1/8 oz., 25c.

COSMOS, Miniature Yellow. See *Bidens Humilis*, page 60.

Extra Early Double Crested Cosmos

The new annual crested type Cosmos is a distinct type, having double center, with a row of guard petals around the base.

365 Crimson King. Dark crimson.

365A Pink Beauty. Soft pink.

365B White Queen. Pure white.

365C White, Pink and Crimson Mixed.

Pkt., 10c; 1/8 oz., 40c; 1/4 oz., 75c; 1/2 oz., \$1.40; oz., \$2.50.

Coix Lachryma (Job's Tears)

347 An ornamental grass growing from 7 to 9 feet high. Large, broad leaves bearing large shiny seed. Pkt., 10c; 1/2 oz., 25c; oz., 35c.

Coleus

Plants with richly colored foliage of maroon, green, crimson, yellow, etc. For groups on lawns and ribboning, they are indispensable, and also valuable for pot culture. Although tender perennials, they attain perfection from seed the first season. 1 to 3 ft.

350 CHOICE HYBRIDS MIXED. From a large collection; of greatly diverse shades and markings. Pkt., 10c; 1/8 oz., 75c.

351 NEW LARGE-LEAVED VARIETIES MIXED. Saved from new varieties with very large and richly variegated foliage. Pkt., 10c; 1/8 oz., 75c.

Collinsia

A free-flowering hardy annual from California. Seed preferably should be sown in the fall, as the plants will bloom much earlier than from seed sown in the spring. It may, however, be sown in the spring, if desired. 1 foot.

353 MIXED COLORS. Pkt., 10c; 1/4 oz., 20c.

Convolvulus Minor

(Dwarf Morning Glory)

Half-hardy annual of trailing habit, growing about 1 foot high and covering a space of 2 feet, and bearing abundantly bell-shaped flowers.

356 MIXED COLORS. Pkt., 10c; 1/2 oz., 20c; oz., 35c.

Burbank's Rainbow Corn

357 A highly decorative type of Corn. It is an annual, grows about 5 feet high and suckers out, forming good sized clumps. The foliage is striped with rose, purple, green and cream color, exceedingly effective in the mixed flower border. Pkt., 10c; 1/2 oz., 30c.



Double Crested Early Flowering Cosmos

Cockscomb (*Celosia cristata*)

Popular free-blooming, half-hardy annual. While seeds may be, and more generally are, sown in the open ground, for best results it should be sown early in the house and the young plants transplanted into small pots, in which they should remain until they show signs of blooming, when they should be shifted to a permanent location. The Cockscomb requires good, rich soil, ample room and plenty of moisture to fully develop its flowers.

305 GLASGOW PRIZE. Crimson; dark foliage. 9 inches. Pkt., 10c; 1/8 oz., 30c.

307 MIXED. Pkt., 10c; 1/8 oz., 20c.

310 DWARF, EXTRA-CHOICE MIXED. Includes all the latest introductions and colors of the Cockscomb. Pkt. 10c; 1/8 oz., 30c.

Feathered Celosia (*Celosia plumosa*)

Often used for winter bouquets, and for this purpose should be cut before fully ripe and dried in the house.

311 THOMPSON SUPERB. Graceful, feathery plumes of rich crimson. Pkt., 10c; 1/8 oz., 20c; 1/4 oz., 35c.

312 GOLDEN PLUME. Golden yellow. Pkt., 10c; 1/8 oz., 20c; 1/4 oz., 35c.

313 THOMPSONI MAGNIFICA. A splendid strain, large plumes, ranging from clear yellow to darkest red. Pkt., 10c; 1/8 oz., 30c.

316 CHOICE MIXED. Pkt., 10c; 1/4 oz., 20c; oz., 50c.



Delphinium, Tall Double Stock-Flowered

Ross' Giant Cyclamen

Charming house plants, with beautiful foliage and rich colored fragrant flowers. Universal favorites for winter and spring blooming. May be successfully raised from seed with a little care and patience.

369 **GIANT MIXED.** Pkt., 50c.

Cineraria Hybrida Grandiflora

294 **ROSS' PRIZE MIXTURE.** The plants are of compact growth, carrying extra large flower heads with flowerets of unusual size and substance. This strain includes the brightest and richest self color as well as a good mixture of all colors. Pkt., 25c.

Clarkia

A pretty, hardy annual from California. Blooms profusely. Colors: Rose, salmon-pink, purple and white, in mixture. 1 foot.

338 **SINGLE AND DOUBLE MIXED.** Pkt., 10c; 1/4 oz., 30c.

Cleome "Giant Spider Plant"

343 **ROSE QUEEN.** A showy garden annual producing curious heads of flowers of bright rose color with long antenna-like stamens; of easy cultivation, blooming early until late. 4 to 5 feet. Pkt., 10c; 1/4 oz., 30c.

Cynoglossum

(Chinese Forget-Me-Not)

369A **AMABILE.** An easily grown, early flowering annual producing large sprays of rich blue, Forget-me-not-like flowers; excellent for cutting. 18 inches. Pkt., 10c; 1/8 oz., 25c.

Cypress Vine

A popular climbing vine, with delicate fernlike foliage, bearing in abundance small, star-shaped, rose, scarlet, or white flowers. Of easy culture. Half-hardy annual. 10 to 12 feet.

370 **MIXED COLORS.** Pkt, 10c; 1/4 oz., 20c; oz., 60c.

Delphinium (Larkspur)

Showy, hardy annuals thriving in nearly all soils if well enriched and open to the sun. Seed of the annual sorts, though more generally sown in the spring, should preferably be sown in autumn, as plants commence blooming much earlier.

385 **DOUBLE DWARF ROCKET.** 1 foot. Mixed colors. Pkt, 10c; 1/2 oz., 40c; oz., 70c.

TALL DOUBLE STOCK FLOWERED:

387 **Carmine.** 388 **Dark Blue.** 389 **Light Blue.** 390 **White.** Pkt., 10c; 1/8 oz., 20c; 1/4 oz., 35c; 1/2 oz., 60c.

391 **TALL DOUBLE STOCK FLOWERED.** Mixed colors. A superior strain. 2 feet. Pkt., 10c; 1/4 oz., 25c; 1/2 oz., 40c.

392 **GIANT IMPERIAL CARMINE KING.** (New). Deep carmine-rose. Pkt., 10c; 1/8 oz., 25c; 1/4 oz., 40c; 1/2 oz., 70c.

392A **GIANT IMPERIAL MISS CALIFORNIA.** Rich, deep pink on salmon ground. Pkt., 10c; 1/8 oz., 25c; 1/4 oz., 40c; 1/2 oz., 70c.

392B **GIANT IMPERIAL BLUE BELL.** Pkt., 10c; 1/8 oz., 25c; 1/4 oz., 40c.

392C **GIANT IMPERIAL BLUE SPIRE.** Very deep violet-blue. Pkt., 10c; 1/8 oz., 25c.

392D **GIANT IMPERIAL FINEST MIXED.** Pkt., 10c; 1/8 oz., 20c; 1/4 oz., 35c.

Annual African Daisy

376 **AFRICAN GOLDEN** (*Dimorphotheca aurantiaca*). This very showy annual plant is a valuable addition to the list of hardy annuals. When first exhibited, it gained an Award of Merit at the great Temple Show, London, has been very favorably mentioned in the leading horticultural papers of this country and Europe, and all who have seen the plant in bloom praise it. A bed of these plants is remarkably effective, and the flowers are excellent for cutting, while the plant is easily grown from seed sown in the open ground. Pkt., 10c; 1/16 oz., 25c.

379 **SELECTED HYBRIDS MIXED.** Pkt., 10c; 1/8 oz., 35c.

Datura (Trumpet Flower)

Strong growing, ornamental annual shrubs. Flowers trumpet-shaped, large and fragrant.

383 **FINEST MIXED.** Pkt., 10c; 1/4 oz., 20c.



Rock Garden Perennials

Half the charm of a Rock Garden lies in the number of different plants it contains, so we have selected fourteen different hardy perennials that are adapted for this purpose. The fourteen varieties listed give a wide range of color, a long blooming season, and all will grow satisfactorily in this district. Complete descriptions will be found in the general list of Perennials, pages 59 to 66.

	Pkt.
140 ADLUMIA cirrhosa. Flesh-pink	\$0.10
145 ADONIS vernalis. Yellow10
170 ALYSSUM saxatile compactum. Yellow10
189 ANEMONE cor. St. Brigid. Mixed colors10
200 AQUILEGIA. Mixed colors10
209 ARABIS alpina. White10
248 BELLIS monstrosa. Mixed colors10
487 GEUM, Mrs. Bradshaw. Orange10
461 MYOSOTIS, Victoria. Blue10
890 POPPY, Iceland. Mixed colors10
904 PRIMROSE, Hardy Vulgaris. Yellow10
949A SEDUM acre. Yellow20
1340 WALLFLOWER, Single. Mixed colors10
1335 VIOLA cornuta. Mixed colors10

Didiscus

420 COERULEUS (Blue Lace Flower). An attractive annual, blooming from July until frost. The flowers are pale lavender and are valuable for cutting. Pkt., 10c; 1/8 oz., 25c.

Dolichos (Hyacinth Bean)

A rapid growing hardy annual climber, bearing all summer, clusters of white or purplish blue flowers, followed by ornamental seed pods. Sow in May where plants are to remain. 10 feet.

433 MIXED COLORS. White and purple. Pkt., 10c; 1/4 oz., 20c.

Dianthus, Pinks

Hardy biennials, blooming the first year from seed. So easily grown from seed as to be rarely treated as biennials. Seed may be sown in the open ground any time in May. Plant 6 inches apart. Height 1 foot.

398 DOUBLE CHINA (D. chinensis fl. pl.). Small, double flowers, borne in large clusters of many colors, mostly with white edge. Pkt., 10c; 1/4 oz., 25c.

399 HEDDEWIGI DOUBLE (D. Heddewigi fl. pl.). Japan Pinks. Very large, double flowers of a wide range of color, running from white and light pink through shades of red to rich, velvety crimson and deep maroon, almost black. Pkt., 10c; 1/4 oz., 25c.

400 SINGLE MIXED. Large single flowers, varied colorings. Pkt., 10c; 1/4 oz., 20c.

406 LACINIATUS SPLENDENS. The flowers are very large, over two inches across, in a brilliant shade of crimson, with a large boldly contrasting glistening white eye. Pkt., 10c; 1/8 oz., 40c.

408 SNOWBALL. Very double, pure white. Excellent. Pkt., 10c; 1/8 oz., 30c.

415 WORCESTER MIXED. All the above and other choice strains. Unsurpassed. Pkt., 10c; 1/4 oz., 30c; oz., \$1.00.

419 SWEET WIVELSFIELD. A new race of hardy annuals. The growth is like Sweet William but the flowers are large and have a much wider range of colors. Pkt., 10c; 1/8 oz., 40c.

Dracaena (Dragon Plant)

434 INDIVISA. Beautiful ornamental leaved plants; long, narrow, green foliage; indispensable for vases and house decoration. Pkt., 10c; 1/8 oz., 25c.



Eschscholtzia

Eschscholtzia (California Poppy)

A very showy hardy annual, with beautiful, finely cut, glaucous foliage, bearing poppy-like flowers of bright colors. Of easy culture. Sow as early as soil can be worked, where plants are to remain, as they do not bear transplanting well. 1 foot.

439 CALIFORNICA. Yellow. Pkt., 10c; 1/2 oz., 30c; oz., 50c.

442 MIXED COLORS. Pkt., 10c; 1/2 oz., 20c; oz., 35c.

443 ERECTA COMPACTA, ROSE QUEEN. Rose-carmine Pkt., 10c; 1/4 oz., 30c.

Euphorbia

Ornamental foliage plant; easily grown from seed. Striking and effective appearance. Hardy annual.

452 VARIEGATA (Snow-on-the-Mountain). Foliage veined and margined with white. 2 feet. Pkt., 10c; 1/4 oz., 25c.

453 HETEROPHYLLA (Fire-on-the-Mountain). A variety of Poinsettia which grows to a height of 2 1/2 to 3 feet. About the middle of summer the top central leaves turn rich orange-scarlet. Pkt., 10c; 1/4 oz., 25c.

Four O'Clock (Marvel of Peru)

A well known favorite plant, bearing freely white, red and striped flowers, which open about four o'clock in the afternoon. Will grow anywhere. Should be given plenty of room, about 2 feet apart. 2 feet.

465 MIXED COLORS. Pkt., 10c; oz., 25c.

FOXGLOVE. See Digitalis, page 61.

Gaillardia (Blanket Flower)

ANNUAL VARIETIES

Very showy, free-blooming, hardy plants of easy culture. Seed germinate very slowly and should be sown in the house in March. The flowers are very brilliant, borne on long stems. Fine for cutting. 2 feet.

470 PICTA. Single; mixed colors. Pkt., 10c; 1/4 oz., 20c.

471 PICTA. Double; mixed colors. Pkt., 10c; 1/4 oz., 20c.

Geranium

Well known, half-hardy, greenhouse perennials, easily raised from seeds. When sown in the fall or early winter will produce flowers in June, while sown in March, plants will not bloom until September, and sown in the open ground in May or June, plants will bloom in mid-winter.

485 ZONALE (Fish or Horseshoe Geranium). Saved from largest and finest varieties. Pkt., 10c; 1/8 oz., 40c.



Dianthus Heddewigi

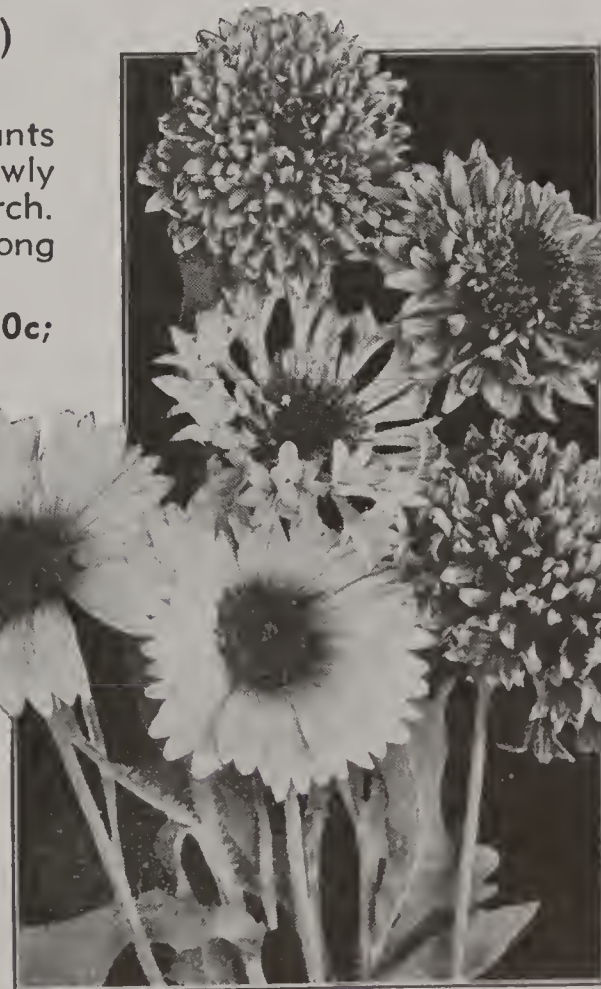

Gaillardia Picta



Helichrysum (Strawflower)



Hunnemannia Fumariaefolia

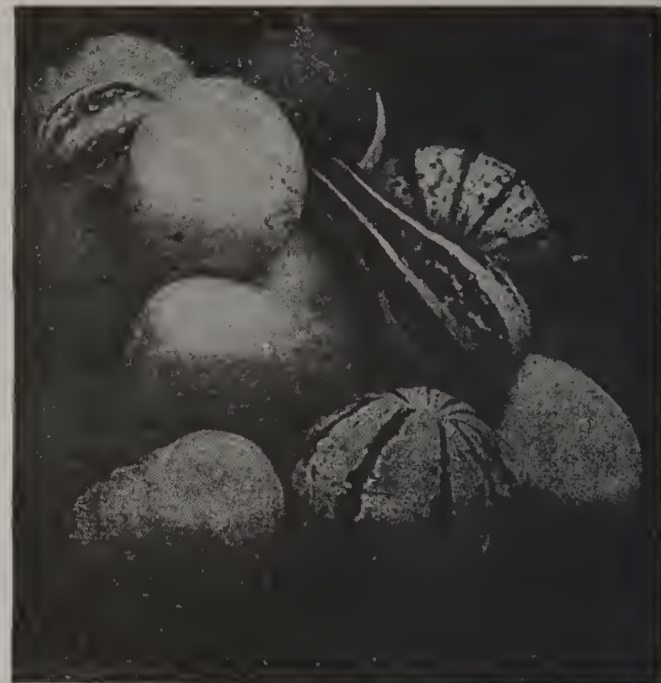

We have Gourds in all shapes

Gomphrena (Globe Amaranth)

488 MIXED COLORS. A tender annual plant, bearing globe-shaped everlasting flowers, often used, when dried, in winter bouquets. Blooms freely and is an excellent bedding plant. 1 1/2 feet. **Pkt., 10c.**

Gloxinia

One of the most beautiful greenhouse perennials. Give them a porous and well-enriched soil; a warm, moist atmosphere, and as soon as they begin to flower remove them to a cooler house, and afterwards dry them off gradually and keep them free from moisture until they again begin to grow. The seeds are small and should be sown on an even surface and slightly covered.

489 SPLENDID MIXTURE. A mixture of all classes unrivaled in richness of color. **Pkt., 25c.**

Godetia or Satin Flower

(Annual)

Showy garden annuals, they are of compact growth, about 1 foot high, bearing flowers 3 to 4 inches across, of exquisite colors and shades that glisten in the sunlight like satin. Splendid either bedded or grown in pots.

490 MIXED COLORS. Tall. Includes all varieties and the latest introductions. **Pkt., 10c; 1/4 oz., 25c.**

Gourds Are Popular

Ornamental, tender annual climbers. 10 to 20 feet.

491 APPLE-SHAPED. Small, striped. **Pkt., 10c.**

492 DIPPER. The fruit is of slender, neck-like form. **Pkt., 10c.**

493 DISH-CLOTH. Fruit large and elongated. **Pkt., 10c.**

494 EGG-SHAPED. **Pkt., 10c.**

496 MINIATURE BOTTLE SHAPED. **Pkt., 10c.**

497 ORANGE-SHAPED. **Pkt., 10c.**

498 PEAR-SHAPED. Green, white-striped. **Pkt., 10c.**

500 MIXED VARIETIES. Small sorts. **Pkt., 10c; 1/2 oz., 20c.**

Gypsophila (Baby's Breath)

Flowers very small, borne in loose, graceful panicles. Very largely used in bouquets with other cut flowers.

501 ELEGANS DEEP ROSE. H.A. **Pkt., 10c; 1/4 oz., 25c.**

505 ELEGANS GRANDIFLORA ALBA. White. An improved form of the annual Gypsophila. Grown by the acre for the London and Paris flower markets. **Pkt., 10c; 1/2 oz., 20c; oz., 35c; 1/4 lb., 75c.**

Grevillea

507 ROBUSTA (Silk Oak). The graceful evergreen, fernlike foliage combines admirably with palms and other massive-leaved plants. Excellent for table decorations. **Pkt., 10c; 1/8 oz., 30c.**

Helichrysum

(Strawflower; Everlasting)

One of the best everlasting flowers and an effective bedding plant, succeeding in any well enriched soil. If flowers are desired for winter use, they should be cut just as the buds are opening. Hardy annual. 2 feet.

515 DOUBLE MIXED COLORS (H. monstrosum fl. pl). Largest double flowers. **Pkt., 10c; 1/4 oz., 25c; 1/2 oz., 40c.**

Heliotrope

A well known favorite largely grown in pots, but thriving in the open border.

518 MIXED COLORS. Dark varieties mixed. **Pkt., 10c; 1/8 oz., 30c.**

519 LARGE-FLOWERING. Mixed colors. Heads of flowers nearly double the size of the old sorts. **Pkt., 10c; 1/8 oz., 30c.**

Hollyhock

534 EVERBLOOMING HYBRIDS (Annual Hollyhocks). Double, Semi-Double and Single. Mixed. A new strain, blooming the first season from seed. **Pkt., 10c; 1/4 oz., 25c.**

Humulus (Hop)

Rapid-growing climbers with attractive foliage. The Japanese variety is a hardy annual, the best for quickly covering unsightly objects.

537 VARIEGATA. Variegated foliage, green and white. **Pkt., 10c.**

Hunnemannia

540 FUMARIAEFOLIA (Giant Tall Poppy or Bush Eschscholtzia). A valuable plant of the Poppy family. A perennial, always treated as an annual. **Pkt., 10c; 1/8 oz., 25c.**

541 SUNLITE. Sunlite is a double-flowered Poppy which is different. Its extra band of petals is produced on the outside, rather than the inside of the tulip-shaped flowers, giving the impression of being open, even after the cuplike blossoms have closed for the night. The flowers are a bright canary-yellow, and the foliage of the two-foot bush is a light gray-green. They like a sunny position in a well drained border and flower freely in late summer. **Pkt., 10c; 1/8 oz., 40c; 1/4 oz., 75c.**

Ice Plant (Mesembryanthemum)

546 CRYSTALLINUM. A trailing plant, with succulent stems and leaves. Excellent for hanging baskets and rockwork. Tender annual. 9 inches. **Pkt., 10c; 1/8 oz., 20c.**

Ipomoea (Morning Glory)

The Ipomoea family includes the well-known Morning Glory, the Moonflower and the Cypress Vine. Rapid-growing climbers of easiest culture; bloom earlier and more profusely on rather poor soil, but of higher growth and more attractive foliage when grown on rich soil. Tender annuals. 15 to 30 feet.

549 CARDINAL CLIMBER (*Ipomoea quamoclit hybrida*).

Leaves are dark green, fernlike and deeply lacinated; bears a great profusion of fiery, cardinal-red flowers. Pkt., 10c.

550 BONA NOX (Evening Glory). Beautiful, large, violet-blue flowers which open at night. Rapid growth. Pkt., 10c.

552 ROSE MARIE. Double early flowering, clear deep rose. Pkt., 10c.

553 HEAVENLY BLUE (*Rubra-coerulea*). Large, heart-shaped leaves; 4 to 5 inches across. Pkt., 10c; ¼ oz., 35c.

Lobelia

Pretty little plants of easy culture, blooming profusely from June until frost. The dwarf varieties are useful for bedding and edging, the trailing variety is excellent for hanging baskets, vases and rock-work. Half-hardy annuals.

585 CRYSTAL PALACE COMPACTA. Rich blue flowers, dark foliage. Pkt., 10c; ⅛ oz., 50c.

586 WHITE LADY. White, dwarf; very profuse. Pkt., 10c.

587 GRACILIS. Light blue, trailing. Pkt., 10c.

Jerusalem Cherry (Solanum)

An ornamental and interesting genus of fruit-bearing plants; singularly bright in fruit and foliage. Popular for greenhouse or house decoration.

555 SOLANUM CAPSICASTRUM. Covered with scarlet fruit during the winter. 1½ feet. Pkt., 10c; ¼ oz., 35c; ½ oz., 60c.

Kochia

556 TRICOPHYLLA (Summer Cypress). A very quick-growing annual. Through the summer this is bright green, but commences in early fall to gradually take on a red tinge, becoming entirely red before it dies. 2½ feet. Pkt., 10c; ¼ oz., 20c.

Lantana

562 HYBRIDA FINEST MIXED. Shrubby, with many clusters of dainty flowers in yellow, orange, red, and pink. 18 inches. All summer. Fine for potting. Pkt., 10c; ⅛ oz., 25c.

Lavatera Trimestris

Beautiful and effective hardy annual, covered during the entire summer with pretty and showy blossoms.

576 Rose-Pink. 577 White. Pkt., 10c; ¼ oz., 20c.

Linum (Crimson Flax)

580 GRANDIFLORUM RUBRUM. The rich crimson flowers last only a day, but are borne continuously until frost. 15 to 18 inches. Pkt., 10c; ¼ oz., 25c.

Marigolds Are Beautiful and Easy to Grow

Favorite annual plant, blooming the entire summer; easily cultivated. The African varieties bear large yellow or orange flowers and the plants are usually tall. The French type is of dwarf habit and flowers are striped. Hardy annual, 1 to 3 feet.

600 YELLOW SUPREME. Very free flowering, 2 to 2½ ft. tall, bearing loosely ruffled, carnation flowered blossoms. The color is a creamy yellow and the flowers are somewhat larger than Guinea Gold. Pkt., 10c; ⅛ oz., 35c.

600A NEW MARIGOLD, GUINEA GOLD. Brilliant orange with double ruffled, loose-leaf petals. 2 to 2½ feet high, producing flowers 2 to 2½ inches across. Pkt., 10c; ⅛ oz., 25c; ¼ oz., 45c; ½ oz., 80c.

601 LEMON "ALL DOUBLE." Pkt., 10c; ⅛ oz., 40c.

601A ORANGE "ALL DOUBLE." Pkt., 10c; ⅛ oz., 40c.

602 GIGANTEA SUNSET GIANTS. A remarkably large flowered and fragrant Marigold originated in Mexico. The huge flowers of this hardy annual, averaging 5 inches or more across, are loosely formed, being very full centered, with broad, heavy petals gracefully overlapping to make a flower of great depth and even larger than Dahlia-Flowered Zinnias. Sunset Giants is a mixture ranging from deep orange through golden orange, deep golden yellow, light yellow, lemon yellow, and a delightful new shade of primrose. The plants attain a height of 4 feet or more and are covered with the flowers from midsummer until the arrival of frost. Start plants indoors early in spring. Pkt., 15c.

603 AFRICAN DOUBLE MIXED. All shades of the African type. Pkt., 10c; ¼ oz., 20c; ½ oz., 35c; oz., 60c.

SCOTCH MARIGOLD.

See Tagetes, page 49.

604 CROWN OF GOLD. A new type of Marigold with a chrysanthemum-like top or crown surrounded by a collar of big, broad petals of the same color—bright golden orange. Plants of this hardy annual grow to a height of 2 feet or more, bloom early, profusely and continuously until frost. Lovely in the garden; wonderful for cutting. The flowers have a delicate fragrance while the foliage is entirely odorless. Start plants indoors, early in spring. Pkt., 10c; ⅛ oz., 30c.

605 HARMONY. Double Dwarf French. Dwarf compact plants, flowers golden yellow bordered maroon-red, scabious-shaped. Pkt., 10c; ⅛ oz., 25c.

606 FRENCH DWARF DOUBLE, GOLD STRIPED. Deep brownish-red, striped yellow. Pkt., 10c; ⅛ oz., 20c.

607 FRENCH DOUBLE MIXED. Shades of yellow and brown. 2 feet. Pkt., 10c; ¼ oz., 20c.

608 LIEB'S WINTER FLOWERING. Maroon and golden yellow flowers, crested center, very late blooming, excellent for winter cut flowers when greenhouse grown. Pkt., 10c; ⅛ oz., 40c.

609 ROYAL SCOT. Large double flowers are produced in abundance on plants from 24 to 30 inches in height. The color is mahogany and gold in symmetrical stripes. Pkt., 10c; ⅛ oz., 35c.



Marigold, Crown of Gold



Marigold, Yellow Supreme

Worcester, Mass.

CROWN OF GOLD AND GIGANTEA SUNSET GIANTS ARE NEW—TRY THEM

Lunaria (Honesty)

589 BIENNIS. Hardy biennial, but grown as annuals, admired for their silvery, papery seed pods, which are used for house ornaments. 3 feet. Pkt., 10c; 1/8 oz., 20c.

Lupin

590 ANNUAL VARIETIES, MIXED. Easily grown plants, with long, graceful spikes of pea-shaped flowers of various colors. 2 feet. Pkt., 10c; 1/2 oz., 30c; oz., 50c.

Matthiola Bicornis (Night Scented Stock)

610 A hardy annual with rosy lavender flowers, giving forth a delightful fragrance—especially toward evening. 1 foot. Pkt., 10c; 1/4 oz., 20c.

Moonflower (Ipomoea)

635 GRANDIFLORA ALBA (Ipomoea noctiflora). Rapid-growing variety reaching the height of 30 feet. Large white flowers open in the evening and on cloudy days. Pkt., 10c.

635B PINK HYBRID MOONFLOWER. Color, soft lilac-pink. Vines are of rapid growth with large leaves. Blooms very profusely. Pkt., 10c.

Morning Glory (Convolvulus Major)

A well-known vine of easiest culture. Hardy annual. 10 feet.

636 MIXED COLORS. Pkt., 10c; 1/2 oz., 20c; oz., 35c.

637 JAPANESE GIANT MORNING GLORY. Flowers much larger than the common type, the range of colorings much greater. 8 feet. Pkt., 10c; 1/2 oz., 20c; oz., 35c.

MORNING GLORY, DWARF. See Convolvulus minor.

MOURNING BRIDE. See Scabiosa.

MUSK PLANT. See Mimulus.

Mignonette (Reseda Odorata)

A well-known and popular hardy annual, prized for its delightful fragrance. Seeds sown in autumn will bloom in early spring, and when sown the last of July will come into flower in a few weeks and continue until cut down by frost.

614 GOLDEN MACHET. Long, massive spikes, with fragrant golden yellow flowers. Pkt., 10c; 1/8 oz., 20c.

615 GRANDIFLORA. Improved, large-flowered, Sweet Mignonette. Pkt., 10c; 1/2 oz., 20c; oz., 35c.

616 DEFIANCE. Large spikes and extra-large individual florets. Pkt., 10c; 1/4 oz., 25c; oz., 75c.

617 GIANT PYRAMIDAL (Crimson Giant). Of branching growth; large, of reddish cast. Pkt., 10c; 1/4 oz., 20c; oz., 60c.

618 GOLDEN QUEEN. Golden yellow. Pkt., 10c; 1/4 oz., 20c; oz., 60c.

619 MACHET. Large thick spikes of reddish cast, of dwarf habit, dark foliage. One of the best for pots. Pkt., 10c; 1/4 oz., 25c.

620 GIANT WHITE. Fine mixed. Pkt., 10c; 1/4 oz., 20c; oz., 60c.

621 VICTORIA. Of deep reddish cast. Pkt., 10c; 1/4 oz., 20c; oz., 60c.

622 GOLIATH RED. Pkt., 10c; 1/8 oz., 25c.

625 MIXED VARIETIES. The above and other varieties. Pkt., 10c; 1/4 oz., 20c; oz., 60c.

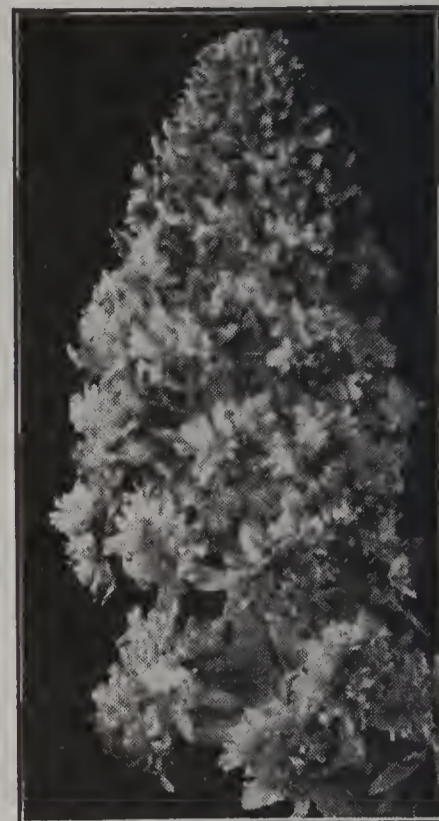

Mignonette

Ross' Colorful Nasturtiums

No other annual plant combines in so great a degree ease of culture, profusion of bloom and grace and beauty of flowers, as the Nasturtium.



Golden Gleam
Nasturtiums

Semi-Dwarf Nasturtium

Double Sweet Scented

708 GLEAM HYBRIDS. The Hybrids are a collection of gorgeously colored large, well formed flowers of such dazzling beauty that the mind hesitates to credit the evidence of the eye. Colors certainly never dreamed of before in a double Nasturtium, glorious flowers of salmon, golden yellow, orange-scarlet, cerise, cream-yellow, orange, crimson, and gold flushed scarlet. Pkt., 10c; oz., 20c.

709 SCARLET GLEAM. The flowers are a fiery orange-scarlet, a color comparable to the brilliance of Scarlet Sage. The individual blooms are of immense size, almost three inches across, much larger than any Nasturtium ever known. Pkt., 10c; oz., 25c.

710 GOLDEN GLEAM. It is hardy and free growing. The color is a most pleasing yellow. The large golden flowers average 2 1/2 to 3 inches across. They are borne on erect, stiff stems six inches long. The flowers stand well above the foliage. Pkt., 10c; oz., 20c.

711 GOLDEN GLOBE. Identical in color with the popular Golden Gleam. Uniformly dwarf and compact. Golden Globe is the first named color variety in the new gem type of Nasturtium. It is very free flowering, and well formed double flowers of deep golden yellow are delicately sweet scented. Pkt., 10c; 1/2 oz., 20c; oz., 35c.

711A DWARF DOUBLE GEM MIXTURE. Sweet scented. Pkt., 10c; oz., 35c.

Tall Nasturtiums

(*Tropaeolum majus*)

- 644 SCARLET.** Rosy scarlet.
646 DUNNETT'S ORANGE. Bright orange, blotched red.
648 EDWARD OTTO. Brownish lilac.
654 HEMISPHERICUM. Straw colored blotched rose.
656 KING THEODORE. Deep crimson-maroon; dark foliage.
658 JUPITER. Golden yellow, large flowers. Clear light yellow.
662 PEARL. Very pale yellow, nearest approach to white.
671 VESUVIUS. Salmon-rose, dark leaved.
 Each of the preceding varieties, pkt., 10c; oz., 20c; 2 ozs., 35c; ¼ lb., 60c.
672 CHOICE MIXED. Many varieties; a wide range of colors. Pkt., 10c; oz., 15c; 2 ozs., 25c; ¼ lb., 40c; lb., \$1.40. See also Worcester Mixed Tall Nasturtiums.
673 GIANT-FLOWERED TALL NASTURTIUMS MIXED. A choice selection of the largest flowered varieties and seedlings. Especially desirable for exhibition. Pkt., 10c; ½ oz., 15c; oz., 25c; 2 ozs., 40c; ¼ lb., 65c.

Lobb's Tall Nasturtium

(*Tropaeolum Lobbianum*)

While both flowers and foliage are slightly smaller than those of the preceding common Nasturtium this class is preferred by many because of the greater profusion of bloom and its more brilliant coloring.

- 685 GOLDEN QUEEN.** Clear, golden yellow.
687 KING OF THE BLACKS. Deep, rich maroon. Dark foliage.
689 SCHULTZI. Scarlet. Dark foliage.
700 LOBBIANUM. Choicest mixed. A mixture of all varieties of this desirable class. Pkt., 10c; oz., 20c; 2 ozs., 30c; ¼ lb., 50c.

Worcester Tall Mixed

- 705 WORCESTER MIXED TALL NASTURTIUMS.** Our own mixture of many varieties; comprises selections from all classes, including the New Variegated-Leaved or Queen, and choice mixture from different growers. Of the greatest possible diversity of colors and types, but well balanced, including larger proportions of the most desirable varieties. Pkt., 10c; oz., 20c; ¼ lb., 50c; lb., \$1.75.



Nasturtium, Golden Globe

Dwarf Nasturtiums are ideal for bedding



Dwarf, or Tom Thumb Nasturtium

The dwarf Nasturtium is not surpassed by any other annual plant for bedding, being of the easiest culture, thriving in nearly all soils and blooms profusely.

Except where otherwise noted, all of the following varieties at uniform prices. Pkt., 10c; oz., 20c; 2 ozs., 35c; ¼ lb., 60c.

- 712 BEAUTY.** Orange with scarlet markings.
714 BRONZE-COLORED. A very distinct and peculiar shade.
718 CLOTH OF GOLD. Brilliant scarlet, foliage golden-yellow.
722 CRYSTAL PALACE GEM. Rich, sulphur-yellow, spotted carmine.
724 EMPRESS OF INDIA. Dark scarlet, foliage distinct dark purplish green.
726 GOLDEN KING. Rich golden-yellow.
730 KING THEODORE. Dark maroon; dark foliage.
732 KING OF TOM THUMBS. Rich scarlet, dark foliage.
736 PEARL. Light cream, nearly white.
742 RUBY KING. Ruby-red, dark leaved.
744 VESUVIUS. Rich salmon-pink.
746 CHOICE MIXED. While not equal to the Worcester Mixed, of wide range of colors and will give pleasing results. Pkt., 10c; oz., 15c; 2 ozs., 25c; ¼ lb., 40c; lb., \$1.40.
749 VARIEGATED LEAVED OR QUEEN OF TOM THUMBS, MIXED. Shades, light primrose, deep scarlet, crimson and deep orange more or less veined or spotted with other colors. Pkt., 10c; ½ oz., 15c; oz., 25c.

Worcester Mixed Dwarf Nasturtium

- 747.** Like the Worcester Tall Mixed, this is of our own preparation and cannot be surpassed in diversity of colors and types; includes all the named varieties and classes here described and other choice mixtures of noted growers. Pkt., 10c; oz., 20c; ¼ lb., 50c; lb., \$1.75.

Nemesia

A very valuable introduction—long blooming annual with large flowers, varying from creamy white to deep orange and carmine. Most useful for bedding. 1½ ft.

- 756 STRUMOSA SUTTONI.** Pkt., 10c.



Fringed Petunia, Dainty Lady

Nemophila (Love Grove)

An attractive hardy annual, bearing cup-shaped flowers about an inch in diameter usually in shades of blue and white, often spotted with brown.

757 MIXED. Pkt., 10c; 1/4 oz., 20c.

Nicotiana

(Flowering Tobacco)

Handsome, effective, half hardy annuals, blooming profusely the entire season and thriving in all soils.

758 AFFINIS. White, starlike flowers, deliciously fragrant, expands fully in the evening. 2 to 3 feet. Pkt., 10c; 1/8 oz., 20c.

759 SANDERAE. Rose-carmine; remarkably profuse in bloom. Unlike the Affinis, is in full bloom during the day. 3 to 3 1/2 feet. Pkt., 10c; 1/8 oz., 25c.

760 SANDERAE HYBRIDS. New hybrids, comprising several distinct colors or shades. Pkt., 10c; 1/8 oz., 20c.

Nigella

(Love-in-a-Mist; Lady-in-Green; Devil-in-a-Bush)

The blue or white flowers are half hidden in the abundant finely cut foliage, hence its common names. 1 to 1 1/2 feet.

761 BLUE AND WHITE. Mixed. Pkt., 10c; 1/4 oz., 20c.

Ornamental Grasses

767 PENNISETUM LONGISTYLUM. Graceful drooping heads. Excellent for bouquets. 2 feet. Hardy annual. Pkt., 10c.

768 PENNISETUM RUPPELIANUM. Foliage long and slender, the silvery plumes tinged with violet. 3 feet. Hardy annual. Pkt., 10c.

Phlox Drummondii

Phlox is one of the easiest and most satisfactory of all the summer flowering annuals, even in poor or stony soil. Very free and continuous blooming throughout the summer. Sow seed early in spring in a sunny location.

830 MIXED COLORS. Pkt., 10c; 1/4 oz., 25c; oz., 70c.

831 LARGE FLOWERING. Extra choice. Mixed colors. Our own mixture of the choicest and best strains from different growers. Pkt., 10c; 1/4 oz., 30c; oz., \$1.00.

833 ISABELLINA. Pure yellow. Pkt., 10c; 1/8 oz., 30c.

841 DWARF (P. Drummondii nana compacta). 6 to 8 inches high. Mixed colors. Pkt., 10c; 1/8 oz., 30c.

843 STAR OR FRINGED (P. Drummondii cuspidata). Mixed colors. Pkt., 10c; 1/8 oz., 25c.

PETUNIAS

A Garden Favorite

Long a popular flower among all garden lovers, Petunias have won new favor in recent years. They are now one of the most universally used for window boxes, porch boxes, beds, borders, etc. No other bedding plant can make a more pleasing display. The plants make a strong, vigorous growth, blooming profusely from early summer until frost. Petunias prefer full sunlight but are also adapted for shady places. They will grow and bloom well in almost any kind of soil, even the poorest, and withstand drought to a remarkable degree. In places difficult to mow or cultivate such as steep banks, about rocks and other out-of-the-way places they will be found to be of great value and beauty.

812 CELESTIAL ROSE. Deep rose, compact. Pkt., 10c; 1/8 oz., 50c.

813 GRANDIFLORA SINGLE FRINGED DAINTY LADY. The plants are neat, compact, semi-dwarf and free flowering, bearing generous quantities of the medium sized, delicately fringed light golden yellow flowers throughout the summer. Pkt., 50c.

814 FINEST MIXED. A superior mixture. Pkt., 10c; 1/8 oz., 20c; 1/4 oz., 40c; oz., \$1.50.

814A SILVER BLUE (Heavenly blue). Light blue. Pkt., 10c; 1/8 oz., 50c.

816 HOWARD'S STAR. Rich shade of maroon, with five-pointed star of white. Very pretty. Pkt., 10c; 1/8 oz., 40c.

817 DWARF INIMITABLE MIXED COLORS. Dwarf, bushy plants, flowers mostly beautifully striped and blotched. Pkt., 10c; 1/8 oz., 40c.

817A ROSE OF HEAVEN. Brilliant rose, dwarf. Pkt., 10c; 1/8 oz., 50c.

818 ROSY MORN. A single flower, color, soft carmine-pink. A profuse bloomer. Pkt., 10c; 1/8 oz., 50c; 1/4 oz., 80c; 1/2 oz., \$1.40.

819 SETTING SUN. Dwarf rose, very free-flowering. Pkt., 40c.

820 ELK'S PRIDE. Largest and darkest velvety purple. Pkt., 25c.

820A FLAMING VELVET. Deep velvety blood-red, about 15 inches in height and the flowers are large and borne in great profusion. Pkt., 10c; 1/8 oz., 50c.

820B MARTHA WASHINGTON. Blush-pink deepening to dark violet throat, ruffled flowers, dwarf. Blooms about 3 inches in diameter. Pkt., 20c.

820C SNOW QUEEN. Large flowers, white. Pkt., 10c; 1/8 oz., 35c.

823 DWARF GIANTS OF CALIFORNIA. (Ramona Strain). Dark and light colors. Pkt., 25c.

824 GIANTS OF CALIFORNIA. A superb strain. Flowers are of remarkable substance, enormous size and many are beautifully fringed. Pkt., 25c; 1/16 oz., \$2.50.

All Double Petunias

Acknowledged by countless testimonials to be 100% double. Flowers frequently exceed five inches in diameter and are exquisitely ruffled and fringed in a vast range of brilliant intermediate colors.

821 TRIUMPHANT TALL. Pkt., \$1.00.

822 VICTORIOUS DWARF. Pkt., \$1.00.

825 DOUBLE, LARGE-FLOWERED, CHOICE MIXED. An excellent mixture comprising a large variety of colors, with a good percentage double flowers. Pkt., 50c.

826 BALCONY BLUE. Dwarf type for porch or window boxes. Pkt., 20c; 1/16 oz., 40c.

827 BALCONY ROSE. Pkt., 20c; 1/16 oz., 40c.

828 BALCONY WHITE. Pkt., 20c; 1/16 oz., 40c.

Portulaca

Well-known tender annuals, blooming profusely all summer. Thrive in most soils and locations, but succeed best in a light, sandy soil and sunny spot, enduring any amount of dry weather. Form a dazzling display when sown in masses.

894 DOUBLE CHOICE MIXED. Usually from fifty to sixty per cent of the flowers will come double. Pkt., 10c; 1/8 oz., 40c; 1/4 oz., 65c; 1/2 oz., \$1.15; oz., \$1.90.

895 SINGLE SCARLET. Pkt., 10c; 1/4 oz., 20c; 1/2 oz., 35c.

896 ROSE. Pkt., 10c; 1/4 oz., 20c; 1/2 oz., 35c.

899 SINGLE MIXED. Pkt., 10c; 1/4 oz., 25c; 1/2 oz., 40c.

Poppy

Well-known hardy plants of quick growth, blooming profusely for a considerable time.

SINGLE ANNUAL POPPIES

862 DANNEBROG OR DANISH CROSS. Brilliant scarlet with white spots at base of each petal. Pkt., 10c; 1/4 oz., 25c.

870 SHIRLEY. A lovely strain, delicate and rich shades, ranging from pure white through pink, rose, scarlet, and red to the deepest crimson. Pkt., 10c; 1/4 oz., 20c.

871 TRUE FLANDERS. The scarlet Poppy of the fields of Flanders. They do not attain as large a size as a well grown Shirley Poppy. They flower the first season from spring-sown seed. Pkt., 10c; 1/4 oz., 25c.

DOUBLE ANNUAL POPPIES

878 CARNATION-FLOWERED. Mixed. Fine, large, fringed flowers of many colors, a popular class. Pkt., 10c; oz., 30c.

880 CARDINAL. Very large, pure cardinal-red; deeply cut, dark green foliage; very attractive. Pkt., 10c; 1/4 oz., 30c.

884 PEONY-FLOWERED. Mixed. Large, globular flowers, resembling a Peony. Pkt., 10c; oz., 30c.

885 SHIRLEY. Double mixed. Pkt., 10c; 1/4 oz., 25c.

886 SNOWDRIFT OR DOUBLE WHITE FRINGED. Flowers from 3 to 4 inches across; very double and finely fringed. Pure white. Pkt., 10c.

888 WORCESTER MIXED. Our own mixture of single and double annual varieties. All types and colors. Pkt., 10c; 1/4 oz., 20c; oz., 60c.

CALIFORNIA POPPY. See Eschscholtzia.

Primula (Primrose)

PRIMULA SINENSIS (Chinese Primrose).

A beautiful winter-blossom greenhouse perennial blooming from December to spring.

900 CHOICEST MIXED. Comprises the finest fringed varieties. Pkt., 25c.

902 MALACOIDES. Lilac. Pkt., 25c.

Salpiglossis

(Velvet Flower; Painted Tongue)

Graceful, half-hardy annual, blooming from August to October. Seed may be sown in the house the last of March or in the open ground in May. The plant succeeds best in deep, rich, rather light loam of medium mixture. 2 feet.

928 GRANDIFLORA. Choicest mixed. Extra large flowered strain. Pkt., 10c; 1/8 oz., 25c.

929 EMPEROR. Mixed colors. New type with one thick leading stem, flowers large and distinct in their beautiful veinings of gold. Pkt., 10c; 1/8 oz., 30c.

Rhodanthe

One of the finest everlasting flowers and an excellent plant for garden decoration. If flowers are gathered before they are fully expanded and dried in the shade they will retain their color for years.

920 MIXED COLORS. All shades of pink, rose, crimson and white. Pkt., 10c.

Rudbeckia (Coneflower)

To this family belong the favorite plants Golden Glow and Black-Eyed Susan.

923 BICOLOR SUPERBA. Free-blooming annual of dense, bushy growth, bearing on long stems large, bright yellow flowers with velvety brown spots at base of petals and disc or cone of brown. Excellent for cutting. 2 feet. Pkt., 10c; 1/4 oz., 30c.



Annual Poppies are profuse bloomers

Salvia (Scarlet Sage)

A mass of bloom from late summer until killed by frost; tender perennial, treated as an annual. Seed should be sown early indoors, or in hotbed and the plants set out when the weather has become warm.

934 AMERICA, OR GLOBE OF FIRE. Semi-dwarf, rounded. Bushes brilliant scarlet. Scarlet flowers. Pkt., 10c; 1/8 oz., 40c.

935 SPLENDENS GRANDIFLORA. The well-known Scarlet Sage. 3 feet. Pkt., 10c; 1/8 oz., 40c.

936 BONFIRE (Clara Bedman). Compact, bushy growth, blooms earlier and more profusely. Intense scarlet. 2 feet. Pkt., 10c; 1/8 oz., 40c.

937 FARINACEA BLUE BEDDER. A perennial variety, but best grown as an annual. Seed sown in the open ground in May blooms from July to frost. The fine deep blue flowers are borne on long spikes held above the foliage. Pkt., 10c; 1/8 oz., 40c.

938 ZURICH. One of the best of recent introductions; dwarf, compact habit, producing long, thick spikes of brilliant scarlet flowers blooming in July. Pkt., 10c; 1/8 oz., 60c.

Ross' Multicolor Sweet Peas in a

Leading Spencer Varieties

All uniform price except where noted. Pkt., 10c; ½ oz., 20c; oz., 35c; ¼ lb., \$1.00, postpaid.

Multi-Color Shades

SUNKIST is a large rose picotee-edged on cream ground, giving a very beautiful effect, especially when used for table decorations. The large, bold flowers are well waved and borne on good, stout stems.

YOUTH. The color is an exquisite pink picotee edge on a pure white ground and a combination that cannot fail to excite enthusiasm on the part of all growers.

Blue Shades

BLUEBIRD. Pure violet-blue. A sort producing waxed flowers. An extremely popular variety.

HEAVENLY BLUE. A fine clear blue Spencer. This variety lacks the mauve shade which spoils so many blue Sweet Peas. It is of vigorous growth and carries well placed flowers on good long stems.

MRS. TOM JONES. Deep amethyst blue, very fine form, the best of the deep blues.

Cream and Primrose Shades

DOBBIE'S CREAM. Rich primrose, perfect form, waved edge, usually four flowers on a stem.

MARY PICKFORD. A beautiful dainty cream-pink with just the faintest suffusion of salmon, making the color combination hard to surpass. The flowers are perfectly formed with both standards and wings decidedly waved. "Mary Pickford" is a sturdy grower, producing an abundance of large, four-flowered sprays on long, stout stems.

Salmon and Orange Shades

BARBARA. An excellent sort for exhibition or table decoration; a large salmon-orange and much superior to Earl Spencer, as it retains its original color.

PRINCE OF ORANGE. Like all orange colored varieties, requires shading, but this extra labor is amply repaid by the brilliant, rich color. Prince of Orange is the deepest and richest orange colored Sweet Pea we have ever seen.



Spencer
Sweet
Pea,
Prince of
Orange

No. 1295

Rainbow Assortment of Our Best Mixed Sweet Peas

SPENCER VARIETIES

The varieties consist of Giant and Orchid-Flowered, both Spencer Unwin types and many other unnamed Spencers. A worth-while assortment that is priced below its real value. Pkt., 10c; oz., 25c; ¼ lb., 60c; lb., \$2.00.

No. 1296

Blue Ribbon Assortment of CHOICE Mixed Spencer Sweet Peas

Containing the new Orchid-Flowering and Eckford's Large-Flowering Hybrids in great variety with other older types of known popularity.

This Ross' own choice mixture is surely a temptation to every garden lover to plant freely these colorful messages of joy.

Price: Oz., 10c; ¼ lb., 35c; lb., \$1.15.



Wonderful Variety of Color Harmony

Crimson-Scarlet Shades

CRIMSON KING. The color is a solid, rich, deep, clear crimson throughout, becoming richer in the throat. Absolutely no distinguishing difference between the color of the standard and wings. The flowers are of precisely the same distinct color from bud to "passing off" stage. Entirely free from sunburn and wind scald at all times.

FIERY CROSS. The flowers are of good size and beautifully waved, but its greatest merit is its color, a brilliant fiery scarlet, and its well-deserved name is truly descriptive.

RED BOY. Pure rich crimson, long stems, vigorous.

KING EDWARD SPENCER. Rich crimson-scarlet, large and of fine form; the best of this color.

Lavender and Purple Shades

ASTA OHN. Large flowers, waved and fluted in the standard with very large wavy wings, lavender, suffused or tinted with mauve; superior to any other lavender.

AUSTIN FREDERICK IMPROVED. A very large and long-stemmed rosy lavender. A vigorous grower and producer. A wealth of fine bossoms.

POWERSCOURT. Clearest lavender. A vigorous variety extremely popular with fanciers as it produces exquisite frilled blossoms.

ROYAL PURPLE. A new shade in Sweet Peas, a rich purple and almost a true royal purple. The same shade effect does not exist in the grandiflora type.

Maroon and Chocolate Shades

HAWLMARK. Quite different from any other shade, which is a distinct maroon.

WARRIOR. Deep chocolate, almost black, unequalled for mixing with other shades for bouquets and table decorations. The darkest Sweet Pea introduced.

Pink Shades

APPLE BLOSSOM SPENCER. Bright rose standard with wings of very light primrose flushed or tinted rose-carmine. Very large Spencer form.

FLUFFY RUFFLES. Light cream-pink.

HAWLMARK PINK. Rose-pink.

PINKIE is by comparison the largest of all we have ever seen in the Deep Pink section of accepted, preferred varieties. A most vigorous grower, producing on long stout stems well waved, nicely placed flowers of a beautiful rose-pink shade.

MISS CALIFORNIA. Salmon-pink.

SUSAN. Blush-pink on cream.

White Shades

AVALANCHE. A white-seeded white. This grand white is outstanding because of the thick texture of the petals and the pureness of the color.

CONSTANCE HINTON. A beautiful white Spencer of enormous size. Young flowers usually tinted a trifle pink, but they soon turn pure white.

KING WHITE. Pure ivory-white. It is of excellent vigor and produces very large waxed flowers.

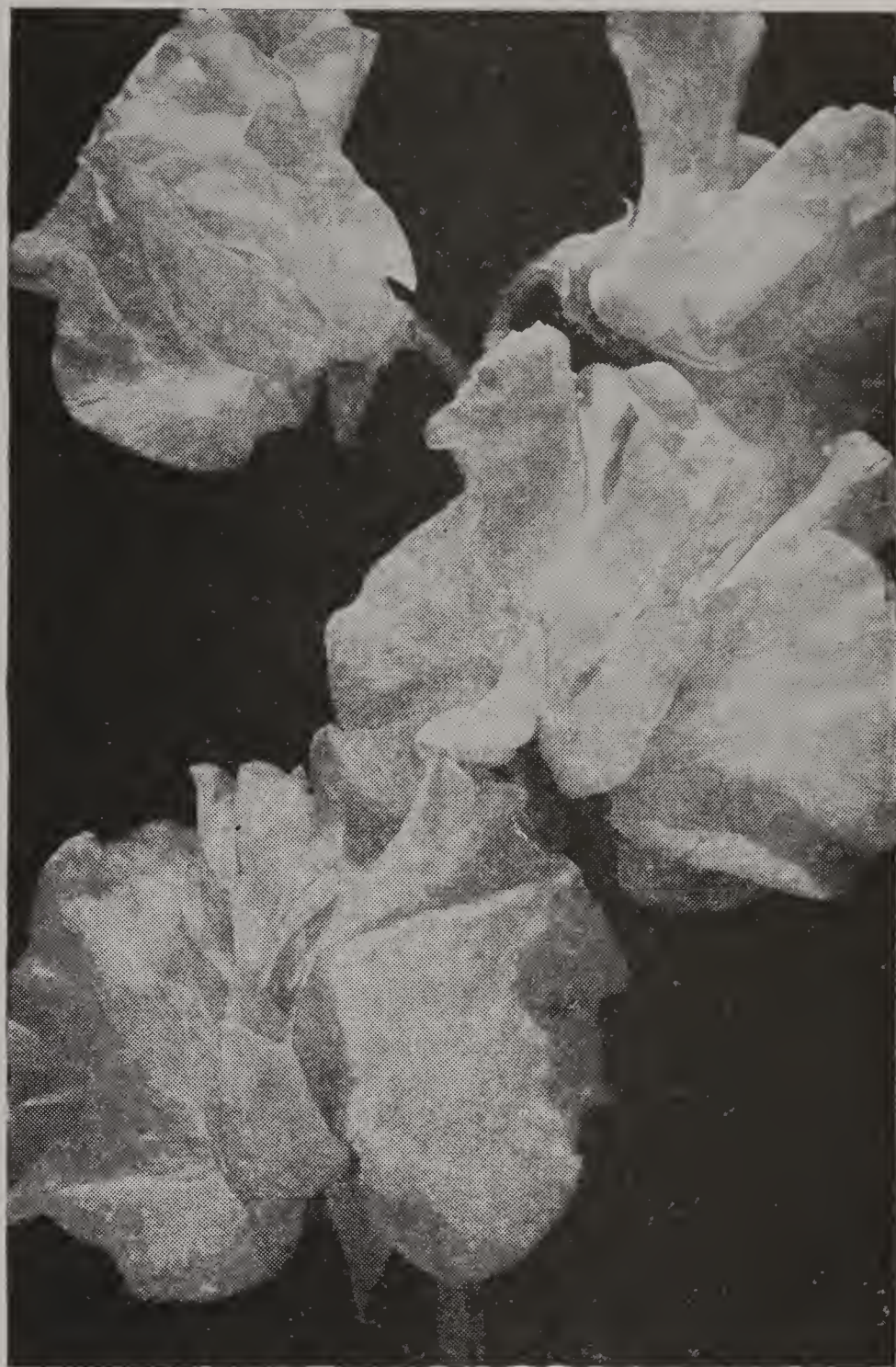

Spencer Sweet Pea, Pinkie

Early Flowering Spencers

EARLY BALL'S ORANGE. Rich orange. Pkt., 10c; 1/2 oz., 30c; oz., 50c.

EARLY BLUE BONNET. Best clear blue. Pkt., 10c; 1/2 oz., 30c; oz., 50c.

EARLY ALL WHITE. Largest pure white. Pkt., 10c; 1/2 oz., 30c; oz., 50c.

EARLY GIANT ROSE. Early. Largest of all rose-pink. Pkt., 10c; 1/2 oz., 30c; oz., 50c.

EARLY HARMONY. This is the outstanding lavender in early flowering Sweet Peas because of the vigor of growth and the wealth of blossoms produced. Pkt., 10c; 1/2 oz., 30c; oz., 50c.

EARLY MAJESTIC ROSE. Brilliant rose-pink, vigorous, long stems. Pkt., 10c; 1/2 oz., 30c; oz., 50c.

EARLY PROSPERITY. Rich salmon-pink on cream, long stems. Pkt., 10c; 1/2 oz., 30c; oz., 50c.

EARLY SHIRLEY TEMPLE. (New). Delightful soft rose-pink, fluted. Pkt., 10c; 1/2 oz., 30c; oz., 50c.

EARLY SILVER BLUE. This is a light blue-lavender and is very popular because the light blue-lavender shade harmonizes with all pink shades. Pkt., 10c; 1/2 oz., 30c; oz., 50c.

EARLY SUPERIOR PINK. Early. It is a beautiful shade of rose-pink slightly tinged with salmon, of perfect form and beautifully waved. Pkt., 10c; 1/2 oz., 30c; oz., 50c.

Sanvitalia

940. Double; fine for bedding, borders or rockeries. The flowers are bright yellow, bloom in six weeks time. Pkt., 10c; 1/8 oz., 25c.

Scabiosa (Mourning Bride)

The flowers are large and double, with a great variety of colors. Of easy culture and blooms freely from July until hard frost. Hardy annual. 2 1/2 feet.

945 **LARGE-FLOWERED.** Mixed colors. Fine, large double flowers in a wide range of colors. Pkt., 10c; 1/4 oz., 20c.

SCARLET RUNNER. See Beans—Ornamental Varieties.

Schizanthus

(Butterfly, or Fringe Flower)

Wonderfully showy half-hardy annuals, very decorative for garden beds and unsurpassed in pots for the conservatory. The seed germinates readily and in a few weeks' time the plant is a mass of brilliant flowers, in an extraordinary variety of colorings. The foliage of the plant is very delicate and fernlike and highly decorative in appearance.

948 **GRANDIFLORUS HYBRIDS.** Very fine varieties. Pkt., 10c; 1/8 oz., 25c.

949 **WISETONENSIS.** Containing the most beautiful shades of white, pink, rose and crimson. Excellent for pot culture. Pkt., 10c; 1/8 oz., 25c.

Sensitive Plant (Mimosa Pudica)

950 **PUDICA.** Globular heads of small pink flowers. Grown chiefly for the peculiar habit of the plant, the leaves closing and drooping at the slightest touch. Tender annual. 1 1/2 feet. Pkt., 10c; 1/4 oz., 30c.

Smilax

955. A climbing plant, unsurpassed for its graceful foliage and orange blossom fragrance of its flowers. Makes a fine pot or basket plant. Elegant for table decoration when cut. Pkt., 10c.

SNAPDRAGON. See Antirrhinum.

SOLANUM CAPSICASTRUM. See Jerusalem Cherry.



Ten Weeks' Stocks

Statice

Beautiful everlasting with spreading panicles of tube-like flowers that are decorative either in the garden or when cut. Their most effective use, however, is in bouquets for winter, either alone or with other dried flowers. Sow outside in May after danger from frost. Hardy annual.

956 **SUWOROWI PINK.** Pkt., 10c; 1/4 oz., 35c.

956A **SINUATA BLUE.** Pkt., 10c; 1/4 oz., 25c.

956B **SINUATA YELLOW.** Pkt., 10c; 1/4 oz., 25c.

956C **SINUATA WHITE.** Pkt., 10c; 1/4 oz., 25c.

Sweet William

1310 **ANNUAL FINEST MIXED.** Pkt., 10c; 1/4 oz., 35c.

Stock (Gilliflower)

One of the most popular annuals, remarkable for its profusion of bloom, brilliancy and diversity of colors and lasting quality of its flowers. Plants from seed sown inside in March or April commence to bloom in July and those from seed sown in the open ground in about ten weeks and continue until frost.

957 **BEAUTY OF NICE.** Mammoth flowering. Delicate flesh-pink, extra large spike. Pkt., 10c; 1/8 oz., 50c.

958 **MONT BLANC.** Purest white. Pkt., 10c; 1/16 oz., 25c.

959 **MONTE CARLO.** Canary-yellow. Pkt., 10c; 1/16 oz., 25c.

961 **SUMMER NIGHT.** Rich deep blue. Pkt., 10c; 1/16 oz., 25c.

DRESDEN PERPETUAL OR BRANCHING

(Cut-and-Come-Again)

A perpetual blooming class of branching habit; double fragrant flowers. 2 feet.

967 **CHOICEST MIXED.** Pkt., 10c; 1/16 oz., 25c; 1/8 oz., 40c.

971 **LARGE-FLOWERED DOUBLE TEN WEEKS.**

Seeds grown in the open ground instead of in pots, therefore cheaper. A good range of colors. 1 1/2 feet. Pkt., 10c; 1/8 oz., 25c; 1/4 oz., 40c.

972 **DOUBLE EARLY GIANT IMPERIAL MIXED.** (Imp. Bismarck). Pkt., 10c; 1/8 oz., 40c.

Sunflower (Helianthus)

The Sunflower grows well in all soils if fully exposed to the sun. The taller varieties make excellent background to other plants.

975 **CUCUMERIFOLIUS** (Miniature Sunflower). Small single flower, rich yellow. 4 feet. Pkt., 10c; 1/2 oz., 25c.

976 **GLOBOSUS FISTULOSUS** (Globe or Dahlia Sunflower). Flowers large, double, of a rich saffron color. 6 feet. Pkt., 10c; 1/2 oz., 25c.

977 **RED SUNFLOWER.** The new Red Sunflower is easily grown from seed the same as all of the Helianthus family. Pkt., 10c; 1/2 oz., 30c.

980 **NEW MINIATURE VARIETIES.** Colors of yellow and creamy white. Some are large, some have twisted petals and some black centers. Pkt., 10c; 1/2 oz., 25c.

984 **DOUBLE CHRYSANTHEMUM-FLOWERED.** Flowers larger than the preceding; full and double. Orange-yellow. 5 feet. Pkt., 10c; 1/2 oz., 35c.

986 **RUSSIAN MAMMOTH.** Very large. 7 to 9 feet. Pkt., 10c.

SWEET SULTAN. See Centaurea, page 36.

Silene (Catchfly)

Profuse flowering plants of easy culture. Seed of the annual sorts may be sown in the open ground early in spring or in the fall if early bloom is desired.

951 **ARMERIA** (Common Catchfly). Mixed. Annual; blooms from July to September. White, pink and red. 1 1/2 feet. Pkt., 10c; 1/8 oz., 20c.

953 **PENDULA COMPACTA.** Mixed colors. White, rose and red. Annual. Largely used for edgings. May to August. 6 inches. Pkt., 10c; 1/8 oz., 20c.

VINES THAT CLING AND CREEP

They are the Laces and Frills of Mother Nature's Dress.

Clematis (A Vine)

340 PANICULATA. One of the finest hardy perennial climbers. Of robust habit and covered from the ground to the summit with pure white, fragrant flowers. The flowers are followed by pretty seed pods of bronzy red. 12 feet. Pkt., 10c; ¼ oz., 30c.

Kudzu Vine (Pueraria)

560 THUNBERGIANA (Jack-and-the-Beanstalk-Vine). A vine of wonderfully rapid growth, when well-established, growing to the great height of 40 to 50 feet. Leaves are of enormous size. Hardy perennial. Pkt., 10c; ¼ oz., 25c; ½ oz., 40c.

Lathyrus Latifolius (Everlasting Sweet Pea)

An easily grown, hardy perennial climber, bearing freely flowers somewhat similar in form to the Sweet Pea. If grown on moist soil, will bloom nearly all summer. Colors: reddish purple, rose, and white. 6 to 8 ft.

570 MIXED COLORS. Pkt., 10c; ¼ oz., 20c; ½ oz., 35c.

Tagetes (Scotch Marigold)

1312 SIGNATA PUMILA, Little Giant. 6 to 8 inches. A bright yellow color. Pkt., 10c; ¼ oz., 30c.

Thunbergia

1315 MIXED. An annual vine, growing about 4 feet high, bearing medium-sized flowers, white, buff or orange, with dark eye. Largely used in hanging baskets or window boxes. Pkt., 10c; ¼ oz., 25c.

WORCESTER DOLLAR COLLECTION

Annual Chrysanthemum. Mixed colors.
Asters. Worcester mixed.
Balsam. Choice mixed.
Calendula. Choice mixed.
Carnation. Double fine mixed.
Cosmos. Large early flowering.
Helichrysum. Mixed colors.
Nasturtium. Dwarf mixed.
Pansy. Worcester mixed.
Phlox. Finest mixed.
Portulaca. Single mixed.
Salpiglossis. Mixed colors.
Scabiosa. Mixed.
Sweet Alyssum. Little Dorrit.
Verbena. Mixed colors.

**15 Packets
of Lovely
Annuals
Anyone Can
Grow**

**For only \$1.00
Postpaid**

Tithonia Speciosa

(Golden Flower of the Incas)

1316 ORANGE VERMILION. Resembling single African Marigolds, foliage and habit of growth like Dahlias. 10 ft. tall, blooming in the fall. Pkt., 10c.

1316A EARLY FLOWERING STRAIN. 10 days earlier, dwarfer, flowers slightly smaller than regular strain. Pkt., 10c.

1316B SPECIOSA GRANDIFLORA, FIREBALL. Brilliant shade of scarlet-orange, the petals in dazzling contrast to the clear yellow center. Single, very large, 4½ to 5 inches in diameter, and are carried on long stems. Eight to nine feet high, grayish green woolly foliage. Pkt., 15c.

Venidium

1318A FASTUOSUM. The plant bears deep orange, daisy-like flowers with reddish brown center, from three to four inches in diameter. Height 2 feet. Pkt., 20c.

Verbena

Favorite annuals, thriving in nearly all soils. Useful for beds, borders, carpeting ground and vases. Plants from seed sown in open ground in May will begin to bloom in August, and those sown inside in March will bloom from June until frost.

1319 MAMMOTH GOLDEN QUEEN. As in Asters it has been difficult to get a clear golden yellow. Golden Queen has medium size flowers borne on a vigorous vine that is of an everbearing nature. Pkt., 10c; ⅛ oz., 35c.

1320 MIXED COLORS. A good strain, all colors of old type. Pkt., 10c; ½ oz., 40c; oz., 70c.

1321 MAMMOTH MIXED COLORS. Best large flowering sorts of many colors. Pkt., 10c; ½ oz., 50c; oz., 90c.

1322 SCARLET DEFIANCE. Large trusses of deep, rich scarlet. Pkt., 10c; ⅛ oz., 35c.

1323 MAMMOTH WHITE. Truss and flowers large, fragrant. Pkt., 10c; ⅛ oz., 35c.

1324 ROYAL BOUQUET. Finest mixed. Upright, large flowers, auricula-eyed, especially good for pot culture. Pkt., 15c.

1325 MAMMOTH MAYFLOWER. Beautiful pink. Pkt., 10c; ⅛ oz., 30c.

1326 CRIMSON GLOW. Rich glowing crimson, the flowers are a solid mass of color, making a striking bed or border in the garden. The plants are semi-compact in habit with foliage of small type. Pkt., 15c.

1327 FIREBALL (Nana Compacta). A dwarf compact Verbena, growing about 6 inches high and covered with bright scarlet blooms. Excellent for borders, beds or pot plants. Pkt., 10c.

1328 HYBRID COMPACTA TYPE (Edging Verbenas)

These are distinct from all other types of Verbena, very compact, dwarf, and free flowering. The color range is very wide, in bright shades. They are excellent for the annual rock garden in a sunny position, for borders or edgings, or for window boxes or pots. Mixed colors. Pkt., 10c; ⅛ oz., 50c.

Wild Cucumber Vine

1346 WILD CUCUMBER (Echinocystis lobata). One of the most rapid growing climbers with white, fragrant flowers. Seed may be sown either in the fall or spring. Pkt., 10c; ½ oz., 20c; oz., 35c.

Of Special Interest to the Kiddies

1386 WILD FLOWER GARDEN MIXTURE. A mixture of many free-blooming annuals which, once sown, require little care, and sown in this way, almost none. In fact, with the exceptions of thinning out some plants where they grow too thickly and removing an occasional weed, the bed often looks better let alone, is more in keeping with its name, and more like some lovely spot where wild plants grow. Pkt., 10c; ½ oz., 20c; oz., 35c; ¼ lb., 80c.

1387 OLD FASHIONED FLOWER GARDEN MIXTURE. This is a mixture of old standard varieties of flower seeds which will give a supply of flowers for cutting throughout the entire season. Pkt., 10c.



Verbena, Mammoth White

ROSS' ZINNIAS

Most Useful of Flowers

The most gorgeous annuals with a wonderful range of color, flowers of velvety texture, extremely double with long stems and good keeping qualities.



Giant Dahlia-Flowered Zinnias are the foundation of the annual garden

1350 MIXED COLORS. Improved strain, all colors, large flowers. 2 feet. Pkt., 10c; ¼ oz., 20c; oz., 60c.

1350A LINEARIS. Dwarf early flowering. The single flowers are deep golden orange, with a delicate light yellow stripe which contrasts boldly with the dark center, plants 8 to 10 inches high with a spread of as much as 2 feet. Pkt., 15c; ⅛ oz., 40c.

Mammoth-Flowered Zinnia

Of the Giant or Mammoth flowering type and superior to the old-fashioned "Youth and Old Age."

The plants grow from 2½ to 3 feet high and are covered with myriads of densely double flowers, measuring from 4 to 6 inches in diameter.

1351 Mammoth Crimson. **1354 Mammoth Yellow.**

1352 Mammoth White. **1355 Burnt Orange.**

1353 Mammoth Scarlet. **1356 Deep Salmon Rose**
Each, pkt., 10c; ¼ oz., 35c.

1358 MAMMOTH. Mixed colors. Pkt., 10c; ¼ oz., 25c; oz., 75c.

Lilliput

(Pompon or Baby Zinnias)

The Lilliputs are fast supplanting all other types of Zinnias for cut flower use. The flowers are small, compact and symmetrical, on strong stems.

1359 GOLDEN GEM.

1360 ROSEBUD.

1361 SALMON ROSE.

1362 SCARLET GEM. (Red Riding Hood.)

Each, pkt., 10c; ¼ oz., 40c.

1363 FINEST MIXED. Pkt., 10c; ¼ oz., 25c.

1363A FANTASY STAR DUST. Shaggy-petaled, medium sized flower. The color is a rich deep golden yellow. 2½- to 3-ft. plants. Pkt., 15c; ⅛ oz., 40c.

1364 FANTASY MIXED. Double rounded flowers composed of a mass of shaggy raylike petals. The color range includes the brightest shades of red and orange, as well as the popular pastel pinks and cream. Pkt., 10c; ⅛ oz., 35c.

1365 SCABIOUS FLOWERED MIXTURE. Plants 2-2½ feet, bearing numerous medium sized flowers resembling the annual Scabiosa. Colors crimson, scarlet, orange, yellow, pink and white. Pkt., 10c; ⅛ oz., 40c.

Zinnia, New Giant Dahlia-Flowered

1366 CROWN O' GOLD. (Desert Gold). Deep golden yellow at the base of each petal, contrasted with light or deeper gold at the tip. Flowers large, double, and well formed, on good cutting stems. Plants 2½ to 3 feet high. Pkt., 15c; ⅛ oz., 40c.

1368 CRIMSON MONARCH. The largest and best of the red shades. Flowers often eight inches in diameter.

1370 DREAM. A fine, deep lavender, turning to purple (Mallow purple), a new, desirable shade in Zinnias.

1372 EXQUISITE. Dahlia-flowered in form and size. Color light rose, center a deep rose (Tyrian Rose).

1374 ORIOLE. The most beautiful of its class. Immense orange and gold bicolor, changing slightly as it ages.

1376 OLD ROSE. Real old rose shade; large and beautiful.

1378 POLAR BEAR. Large, pure white, the best in Zinnias. True Dahlia form.

Each of the above, pkt., 15c; ⅛ oz., 30c; ¼ oz., 45c.

1380 SPECIAL MIXTURE GOLD MEDAL STRAIN. A well blended mixture containing all the above novelties. Pkt., 15c; ⅛ oz., 25c; ¼ oz., 45c.

1388 LILLIPUT TOM THUMB. Mixed. Plants 4 to 6 inches, compact, covered with well-formed flowers of the Lilliput type. Pkt., 10c; ⅛ oz., 35c.

1390 GAILLARDIA FLOWERED. Finest mixed. (Navajo). Flowers resemble a Picta Double Gaillardia in both form and colorings. Pkt., 10c; ⅛ oz., 35c.

Ross' Flower Seeds

will fill your garden with color and fragrance



No. 1321—Verbena
Large flowering sorts. Mixed.
Pkt., 10c; 1/2 oz., 50c.

ALL 5 VARIETIES
on this page, 1 pkt.
of each, postpaid,

35c



No. 500—Gourds
Small ornamental varieties. Mixed. Pkt., 10c; 1/2 oz., 20c.

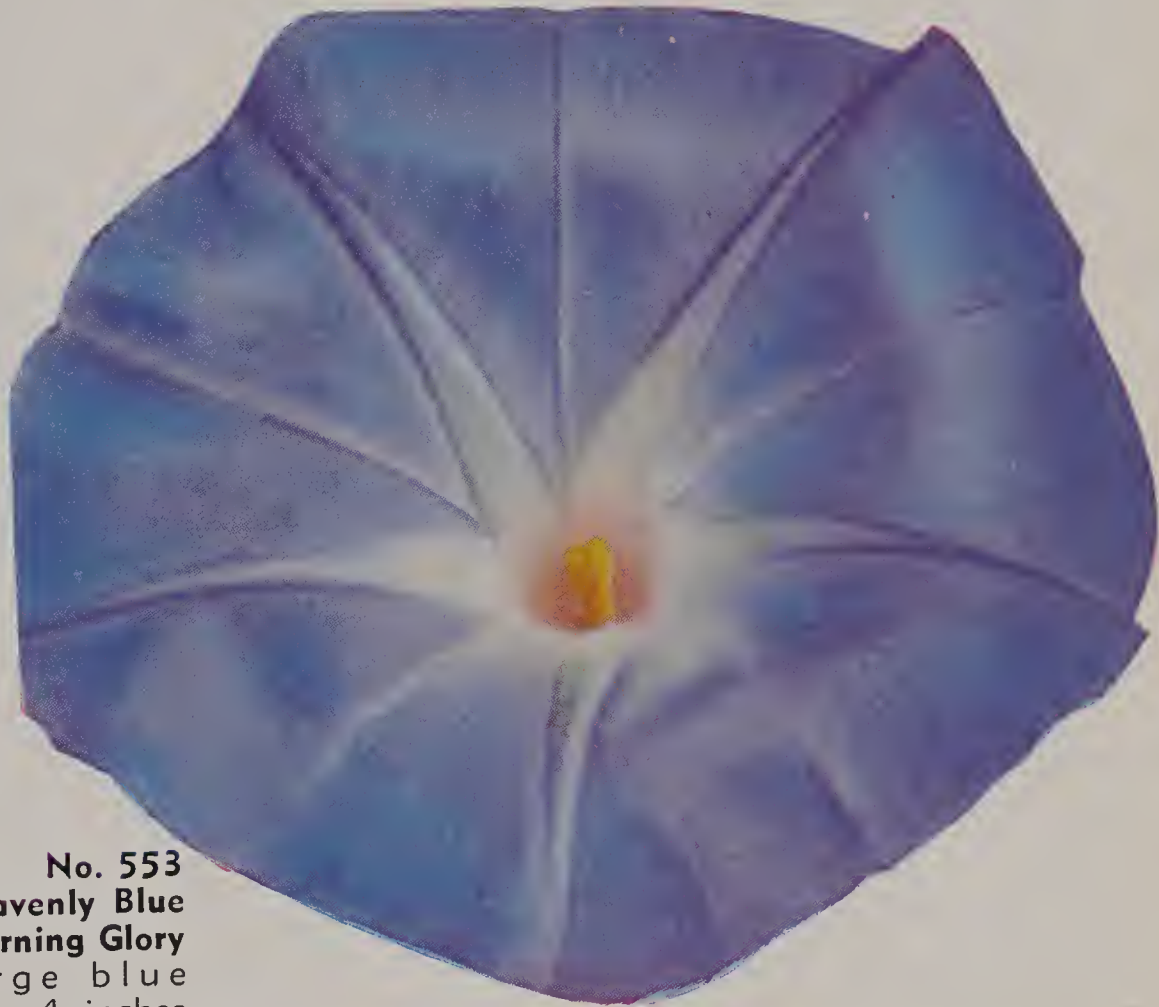

No. 553
Heavenly Blue
Morning Glory
Large blue
flowers, 4 inches
across. Pkt., 10c;
1/4 oz., 35c.



No. 256
Calendula,
Orange Shaggy
Deep orange
color with fringed
petaled flowers.
Pkt., 10c; 1/8
oz., 25c.

No. 945
Mourning Bride
Wide range of
double flowers.
Pkt., 10c; 1/4 oz.,
20c.



No. 256—Calendula, Orange Shaggy

No. 945—Mourning Bride, Mixed



No. 913—Pyrethrum
 Blooms June to September.
 Very decorative. **Pkt., 10c;**
 $\frac{1}{8}$ oz., 30c.

These
7
Varieties
sent to you
postpaid

1 packet
of each
for only
50c



No. 708—Nasturtium, Glorious Gleam Hybrids. Gorgeous colors and a really glorious flower. **Pkt., 10c; oz., 20c.**



No. 470—Gaillardia
 Single mixed colors. **Pkt., 10c; $\frac{1}{4}$ oz., 20c.**



No. 899—Portulaca
 Single mixed colors. Makes a dazzling display. **Pkt., 10c; $\frac{1}{4}$ oz., 25c.**



No. 1308
Double Sweet William
 Improved large flowers. **Pkt., 10c; $\frac{1}{4}$ oz., 25c.**



No. 364B—Cosmos, Sensation
 (New). Blooms 10 weeks from seed; large flowers, long stems; best for cutting. **Pkt., 10c.**

No. 365C
Cosmos, Extra Early Double Crested
 In three colors.
Pkt., 10c; $\frac{1}{8}$ oz., 40c; $\frac{1}{4}$ oz., 75c.

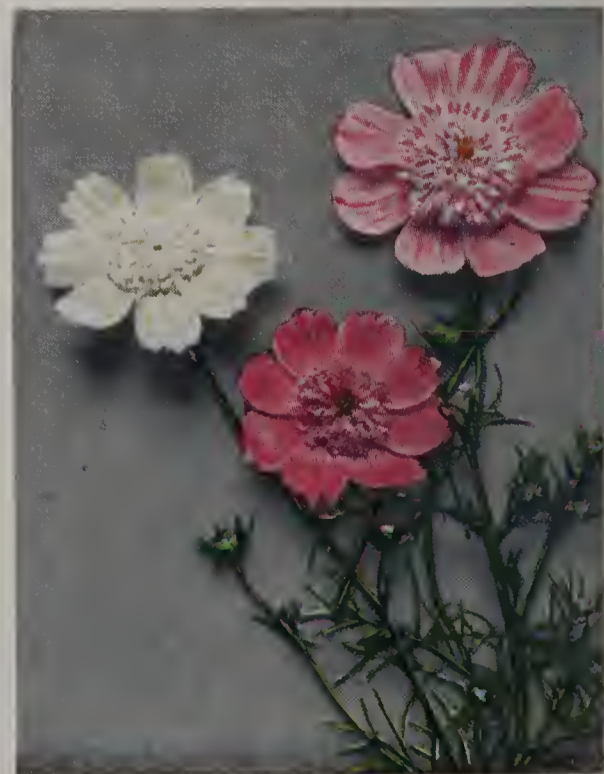



New!
**COLLARETTE MARIGOLD
 CROWN OF GOLD**

No. 604—Crown of Gold Marigold
 New Marigold last year, distinct type, bright golden orange. **Pkt., 10c; 1/8 oz., 30c.**

We Know ROSS' SEEDS

*will please
 you*

Plant early
 for best
 results



No. 605—Marigold, Harmony
 Dwarf, double French type. Flowers golden yellow bordered maroon-red. **Pkt., 10c; 1/8 oz., 25c.**



No. 585—Lobelia, Crystal Palace
 Bright blue; excellent for hanging baskets and rock gardens. **Pkt., 10c; 1/8 oz., 50c.**

Give your plants a good plant food after they are well rooted. It will pay you.



Nos. 826 Blue, 827 Rose, 828 White—Balcony Petunias
 This is an excellent type for porch or window boxes. Separate colors only. **Each, pkt., 20c; 1/16 oz., 40c.**

A Guarantee of Satisfaction

If the seeds you get from us do not grow, tell us about it. All our seeds are tested for germination and we wish to know if for any reason they fail to grow when planted.

We will send 1 packet each of the 8 varieties listed on this page post-paid for

75c



No. 894—Portulaca
 Double mixed colors. Sow in solid masses. They make a dazzling display. **Pkt., 10c; 1/8 oz., 40c; 1/4 oz., 65c; 1/2 oz., \$1.15.**



No. 320—Bachelor Button
 Single and double mixed colors. Fine for cutting and for display. **Pkt., 10c; 1/2 oz., 25c; oz., 50c.**



No. 330—Single Chrysanthemum (Painted Daisies)
Very free flowering; fine for cutting. Pkt., 10c; ¼ oz., 20c.



No. 591—Lupin
Mixed blue and white; popular for cutting at a time when few flowers are in bloom. Pkt., 10c; ½ oz., 30c; oz., 50c.



**No. 831
Phlox Drummondii**
A flower that cannot be surpassed for beauty and fragrance; fine assortment of colors. Pkt., 10c; ¼ oz., 30c.



**Ross'
Giant Exhibition Pansies**

Early Spring's Most Beautiful Flower
No. 780—Pansy, Ross' Giants Mixed

We claim this strain to be the world's best and do not hesitate to claim that there is no other Pansy that will compare with it in size, colors and sturdiness of plant. Pkt., 50c; 1/16 oz., 90c; 1/8 oz., \$1.50; ¼ oz., \$2.75; oz., \$10.00.

Ross' Good Seeds

*will fill your garden
with color and fragrance*



No. 51—El Monte, Super Giant Aster
The most fully double Aster known in this class. Color crimson. Pkt., 10c; 1/8 oz., 40c.

We will send post-paid one packet each of the nine varieties listed on these two pages for

\$1.00



No. 316A—Jubilee Gem (Bachelor Button)
A dwarf variety which makes a compact plant, covered with double dark blue flowers. Pkt., 15c; 1/8 oz., 50c.



No. 1380—Giant Dahlia-Flowered Zinnia
A well-blended mixture which includes all of the finest colors. Pkt., 15c; 1/8 oz., 25c; ¼ oz., 45c.



No. 442—California Poppies
Beautiful, easily grown annuals that will make a showy spot wherever planted. Pkt., 10c; ½ oz., 20c; oz., 35c.



No. 1364—Fantasy Zinnias
Mixed colors. This is one of the newest types of the Zinnias. Includes many colors; fine for cutting. Pkt., 10c; 1/8 oz., 35c.

Beautiful Flowers from

Ross' Seeds

will give your garden a wealth of color that will make gardening a pleasure.

One packet each of the seven varieties listed on this page will be sent to any address in the United States, postpaid, for 85c.



No. 259—Calendula
Mixed colors. This mixture includes nearly all of the listed varieties and many others. Pkt., 10c; 1/2 oz., 15c; oz., 25c.

No. 705—Worcester Tall Mixed Nasturtium
Our own mixture and includes all the colors of the old standard sorts. Pkt., 10c; oz., 20c; 1/4 lb., 50c.



No. 253—Calendula, Sunshine
Large, buttercup-yellow flowers with long loosely arranged petals. Pkt., 10c; 1/4 oz., 30c; 1/2 oz., 50c.



No. 928—Salpiglossis (Velvet Flower)
Extra large flowered strain with colors that are almost indescribable. Pkt., 10c; 1/8 oz., 25c.



No. 358—Coreopsis
Rich golden yellow flowers 3 inches across. Fine for cutting. Pkt., 10c; 1/4 oz., 30c; 1/2 oz., 50c.



No. 813—Petunia, Fringed Dainty Lady
Half-dwarf plant, very free flowering. Color light golden yellow. Pkt., 50c.



No. 820B—Martha Washington Petunia
Dwarf plant, flowers blush-pink to dark violet; blooms about 3 inches across. Pkt., 20c.



No. 230—Balsam, Double Mixed Colors
The colors are bright and varied. One of the showiest annuals. Pkt., 10c; ¼ oz., 20c; oz., 75c.



No. 116—Aster, American Branching Mixed
Beautiful double flowers; includes all colors; fine for cutting. Pkt., 10c; ⅛ oz., 40c; ¼ oz., 75c.

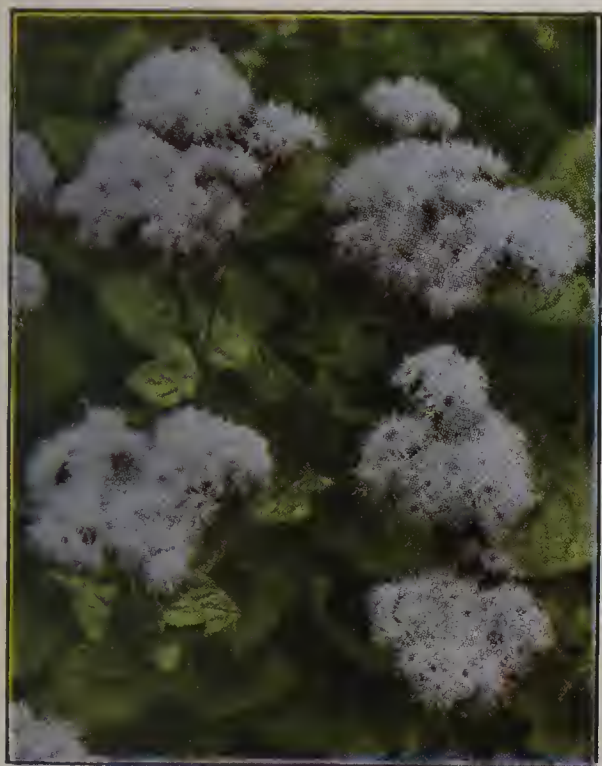

No. 155—Ageratum, Dwarf Blue Cap
It is one of the best types of this flower ever produced; deep blue. Pkt., 10c; ⅛ oz., 30c; ¼ oz., 50c.

For gorgeous colors
in the Garden
plant Ross' Asters

One packet each of the six varieties listed on this page will be sent postpaid for **50c**



No. 393—Delphinium, Gold Medal Strain

Beautiful double and single spikes with a wide variety of colors. Pkt., 25c; ⅛ oz., 60c.



No. 15—Aster, California Single Giant
Mixed. Large single 3- or 4-inch flowers, with 18- to 20-inch stems. Pkt., 10c; ⅛ oz., 35c; ¼ oz., 60c.



No. 260—Calliopsis, Mixed Colors
Blooms freely and until frost. Long stems, fine for cutting. Pkt., 10c; ½ oz., 30c; oz., 50c.

You Can't Beat Ross'
Flower Seeds



No. 204—Columbine
 Long-spurred flowers, many fine colors. Pkt., 15c; 1/8 oz., 40c.



No. 515—Helichrysum (Strawflower)
 One of the best everlasting flowers for cutting or bedding; double mixed. Pkt., 10c; 1/4 oz., 25c; 1/2 oz., 40c.



No. 280—Candytuft
 Mixed colors. An old favorite. Grows in any soil with little care. Pkt., 10c; 1/4 oz., 20c; oz., 50c.

No. 1295
RAINBOW Assortment
 of Our Best
Mixed Sweet Peas

Everybody loves Sweet Peas and for those who prefer a combination of beautiful mixed colors, this **Special Rainbow Assortment** of large flowering beauties should have a special appeal.

The varieties consist of Giant and Orchid-Flowered, both Spencer Unwin types and many other unnamed Spencers. A worth-while assortment that is priced below its real value. Pkt., 10c; oz., 25c; 1/4 lb., 60c; lb., \$2.00.

One packet each of these five varieties will be sent postpaid for only

40c



No. 42—Aster, Queen of the Market
 A very early blooming strain, wilt resistant; fine for early cutting. Mixed colors. Pkt., 10c; 1/8 oz., 40c; 1/4 oz., 75c.

ROSS' 1938 Unusual Offer

On this and the seven preceding pages we have listed 47 varieties of flower seeds which should be in every complete flower garden. These are priced at a total of \$6.20. We will send one packet each of these 47 varieties for

\$4.25





"Flowers Have Been Called the Smiles of God"

Hardy Perennials That Endure for Years

Achillea

135 PTARMICA (The Pearl). Bears clusters of pure white flowers abundantly all summer; fine for cutting; also for cemetery planting. 12 to 18 inches. **Pkt., 10c; 1/8 oz., 50c.**

Aconitum

136 NAPELLUS (Monkshood). Large, porcelain-blue hood-shaped flowers; very effective in borders; valuable for cutting. 1 1/2 feet high. **Pkt., 10c; 1/8 oz., 30c.**

Adlumia

140 CIRRHOSA (Mountain Fringe; Allegheny Vine). A beautiful, hardy, climbing biennial. The feathery foliage resembles that of the maidenhair fern. Rapid growth. Small, tube-shaped pink blossoms. Desirable for covering trellises, stumps, etc. 10 to 15 feet. **Pkt., 10c; 1/8 oz., 40c.**

Adonis

145 VERNALIS (Ox-Eye). Hardy perennial, blooming early in spring; when once established, may be easily increased by division. Flowers large, yellow. 18 inches. May and June. **Pkt., 10c; 1/8 oz., 40c.**

Agrostemma

Pretty, free-blooming plants of easy culture, especially desirable for dry situations. Excellent for cutting.
161 CORONARIA (Rose Campion). One of the earliest hardy perennials. 1 1/2 ft. **Pkt., 10c; 1/8 oz., 30c.**



Aquilegia

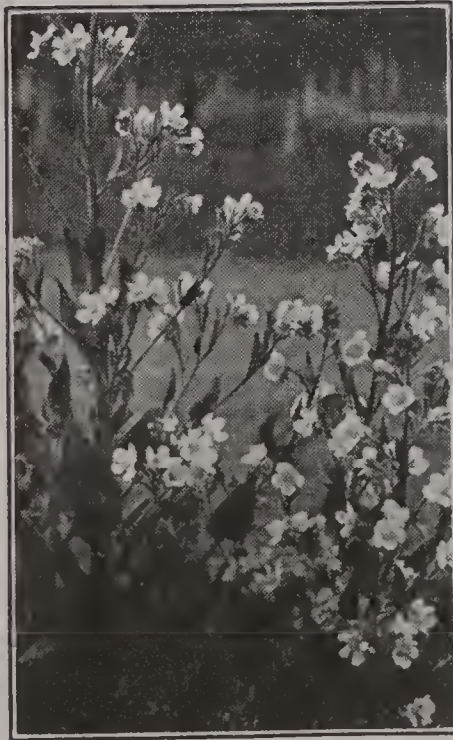

Anchusa Dropmore

Alyssum (Gold Dust)

170 SAXATILE COMPACTUM. Hardy, compact growth, producing a mass of golden yellow flowers in April. Height 1 ft. Of easy culture. Excellent for rockeries and borders. **Pkt., 10c; 1/8 oz., 25c.**

Ampelopsis

182 VEITCHI (Boston Ivy). **Pkt., 10c; 1/4 oz., 30c.**

Anchusa

186 DROPMORE VARIETY. This variety yields an abundance of brilliant blue flowers deep as the Blue Gentian. 4 feet. June and July. **Pkt., 10c; 1/8 oz., 30c.**

Anemone

A very popular, hardy garden perennial.

188 CORONARIA. Single, mixed colors. The well-known Poppy-flowered Anemone. 1 foot. **Pkt., 10c.**

189 CORONARIA, ST. BRIGID. An improved strain, bearing larger and more brilliant flowers and remaining in bloom longer. 1 foot. **Pkt., 10c.**

Anthemis

(Hardy Golden Marguerite)

A beautiful, hardy perennial; golden yellow, daisy-like flowers, excellent for cutting. Plants bushy and should stand at least 2 feet apart. Height 2 feet.

190 KELWAYI. **Pkt., 10c; 1/8 oz., 25c; 1/4 oz., 40c.**

Aquilegia

(Columbine)

Beautiful free flowering hardy perennials, blooming throughout the spring and early summer. Of easy cultivation and will thrive in partial shade. 1 to 3 feet.

200 SINGLE MIXED. **Pkt., 10c; 1/8 oz., 25c; 1/4 oz., 40c.**

202 DOUBLE MIXED. **Pkt., 10c; 1/8 oz., 30c; 1/4 oz., 50c.**

204 COERULEA HYBRIDA FL. PL. Long spurred, flowering hybrids in fine colors. **Pkt., 15c; 1/8 oz., 40c.**

Arabis (Rock Cress)

209 ALPINA. Charming low-growing, very early spring-flowering plant. Splendid for edging or for the rockery. Pure white flowers. 5 inches. April, May. **Pkt., 10c; 1/8 oz., 30c.**

Aristolochia

215 ELEGANS (Dutchman's Pipe). A hardy perennial vine of rapid growth with large, glossy heart-shaped leaves, bearing curious yellowish brown blossoms, somewhat resembling a pipe. 15 to 20 feet. **Pkt., 10c; 1/8 oz., 40c.**



Coreopsis Lanceolata Grandiflora



Grenadin Carnation



Canterbury Bells

Armeria

215A LAUCHEANA (Dwarf Thrift). Most of us know the Giant Thrift, but we have not yet become so familiar with the dwarf strain. Lauchiana is a very free flowering, dwarf variety, with medium sized flower heads of deep rose. They combine very nicely with Forget-me-nots in the rockery or dwarf border. 6 inches. **Pkt., 15c; 1/16 oz., 50c.**

Asperula

220 ODORATA (Sweet Woodruff). A hardy perennial, blooming freely and continuously in rather moist soil and a partially shaded location. The flowers are white, but the plant is largely grown for its fragrant leaves and stems, which are used when dried for the same purpose as those of lavender. 1 foot. **Pkt., 10c; 1/8 oz., 35c.**

Bellis Perennis (Double Daisy)

A perennial plant, bearing in early spring small double white or rose colored flowers. It succeeds best here in a rich, loamy soil, partially shaded. It is generally classed as hardy, but really needs a slight protection through the winter. 4 inches.

246 LONGFELLOW. Dark rose. **Pkt., 10c; 1/8 oz., 50c.**

247 SNOWBALL. Pure white. **Pkt., 10c; 1/8 oz., 50c.**

247A RED QUILLED. **Pkt., 10c; 1/8 oz., 50c.**

248 MONSTROSA DOUBLE MIXED. These new "Double" Daisies surpass all strains of this popular plant in strong, robust growth and abundance of large bloom. Each plant produces 12 to 15 flowers that measure 2 to 3 inches across, carried on long, strong stems. **Pkt., 10c; 1/8 oz., 50c.**

248A BELLIS BEATA, RED. A new Daisy that grows 8 inches high. Flower measure from 2 to 3 inches across on long strong stems. **Pkt., 15c.**

248B BELLIS BEATA. Finest Mixed. **Pkt., 15c.**

Bidens

249 HUMILIS (Miniature Cosmos). Yellow. 2 ft. **Pkt., 10c; 1/4 oz., 25c.**

Centaurea

328 MONTANA BLUE (Perennial Cornflower). Large violet-blue flowers. 2 feet. **Pkt., 10c; 1/8 oz., 30c.**

Cheiranthus

334 ALLIONI. (Siberian Wallflower). Brilliant orange. 1 ft. **Pkt., 10c; 1/4 oz., 25c.**

335 ALLIONI GOLDEN BEDDER. Golden yellow. **Pkt., 10c; 1/8 oz., 20c.**

Canterbury Bells

(Campanula Medium)

Well known, beautiful, hardy biennials. Like all of this class, may be sown where they are to remain any time after midsummer, or in beds in the spring for transplanting. The Calycanthema (Cup-and-Saucer) class is so named because of the broadening of the calyx into a saucer-shaped secondary flower. In permanent situations, plants should stand 18 to 20 inches apart. Succeed best in a rich, rather sandy, well-drained soil.

267 PRIZE MIXTURE. A superb mixture of all classes, single, double, and cup and saucer. **Pkt., 10c; 1/8 oz., 25c.**

268 SINGLE MIXED COLORS. **Pkt., 10c; 1/8 oz., 20c.**

269 DOUBLE MIXED COLORS. **Pkt., 10c; 1/8 oz., 25c.**

270 CALYCANTHEMA. Rose-pink. **Pkt., 10c; 1/8 oz., 30c.**

272 CALYCANTHEMA (Cup-and-Saucer). Mixed colors. **Pkt., 10c; 1/8 oz., 30c.**

273 CALYCANTHEMA. Blue. **Pkt., 10c; 1/8 oz., 30c.**

274 CALYCANTHEMA. White. **Pkt., 10c; 1/8 oz., 30c.**

Carnation (Hardy)

288 CHABAUD'S GIANT DOUBLE MIXED. A new strain, remarkable for its combination of earliness with the continuity of bloom and perfection of flowers of the perpetual type. Flowers large, a high percentage double. Deliciously fragrant and greatly varied in coloring. **Pkt., 10c; 1/8 oz., 30c.**

290 DWARF VIENNA. Blooms early the second summer from seed. The hardiest sort, said to stand the winter with slight protection. Flowers large, double, fragrant and of varied colors. **Pkt., 10c; 1/8 oz., 30c.**

292 GRENADIN FINEST MIXED. Early, free flowering, medium large, upright growing, long slender stemmed hardy Carnation. Foliage is grassy, of the Dianthus type. Does not bloom until the second year. **Pkt., 10c; 1/8 oz., 35c.**

COLUMBINE. See Aquilegia.

Coreopsis

For Annual Varieties, see Calliopsis.

358 LANCEOLATA GRANDIFLORA. The flowers are a rich golden yellow, often 3 inches in diameter, borne on fine, long stems; desirable for cutting. **Pkt., 10c; 1/4 oz., 30c; 1/2 oz., 50c.**

358A DOUBLE YELLOW. The flowers are immense and, while it is not a full double, it is a great improvement over the semi-double. **Pkt., 10c; 1/8 oz., 35c; 1/4 oz., 60c.**

Dahlia

One of our best autumnal flowering plants. Blooms until killed by frost; tuberous rooted, half-hardy perennials; blooming the first year from seed, if sown early. Protect the roots during winter in a dry cellar in peat moss or sand.

371 UNWIN'S DWARF GIANT-FLOWERED. Early flowering semi-double strain of Dahlias, producing gorgeous blossoms of almost every color combination from midsummer until late autumn. Pkt., 15c; 1/8 oz., 50c.

372 SPECIAL MIXTURE of Giant-Flowered Single Varieties. Comprises seed from noted English and Holland growers. Unsurpassed mixture of greatest possible diversity of color. Pkt., 10c; 1/8 oz., 35c; 1/4 oz., 60c.

373 DOUBLE LARGE-FLOWERED. Mixed colors. Saved from the finest show varieties. Pkt., 10c; 1/8 oz., 35c; 1/4 oz., 60c.

DAHLIA BULBS. See pages 68 and 69.

Daisy

378 SHASTA DAISY. Luther Burbank's wonderful hybrid Daisy. Large, pure white flowers blooming in great abundance all summer. 1 to 2 feet. Pkt., 10c; 1/16 oz., 25c; 1/8 oz., 40c.

MICHAELMAS DAISIES (Perennial Single Asters). Beautiful and showy, hardy perennials easily grown from seed, blooming profusely in the autumn months, and the first season if seed is sown early.

381 MIXED COLORS. Pkt., 10c; 1/16 oz., 35c.

For other flowers known as Daisies, see Anthemis, Brachycome and Chrysanthemums.

Dielytra

421 SPECTABILIS (Bleeding Heart). The flowers are heart shape, varying from light pink to rosy crimson. Leaves are light transparent green. Blossoms in April and May. Pkt., 25c.

Clove or Grass Pinks

(*Dianthus Plumarius*)

Improved forms of the old well known Clove Pink. They grow anywhere and bloom very profusely. Flowers of many pleasing colors and deliciously fragrant. Very useful for the hardy border.

416 SINGLE (Pheasant's Eye Pink). Mixed colors. Pkt., 10c; 1/8 oz., 20c.

417 DOUBLE AND SEMI-DOUBLE. Mixed colors. Pkt., 10c; 1/8 oz., 25c.

418 FLORIST'S PERPETUAL PINK (*D. semperflorens*). Double and semi-double; large flowers; very fragrant and many colors. Blooms nearly all summer and if sown in March will generally bloom the first season. Pkt., 10c; 1/8 oz., 30c.

Dianthus

419A LOVELINESS. This new garden pink is one of the finest of the newer cut flower varieties. The plants are 12 to 15 inches tall of good branching habit and very free flowering. The shaggy appearing finely fringed flowers of delicate rosy lilac are highly sweet scented and measure from 1 1/2 to 2 inches across. Pkt., 25c.

Digitalis (Foxglove)

Favorite hardy plants bearing in June and July tall flower spikes. Of easy culture. Well suited for background to other plants and for naturalizing in the edges of woods. Hardy biennial or perennial. 2 1/2 to 3 feet.

424 MONSTROSA. Mixed colors. Monstrous flowers. Attractive. Pkt., 10c; 1/8 oz., 25c.

426 GLOXINIAEFLORA, ISABELLINA. Yellow. Pkt., 10c; 1/8 oz., 25c.

427 GLOXINIAEFLORA. Purple. Pkt., 10c; 1/8 oz., 25c.

428 GLOXINIAEFLORA. Rose. Pkt., 10c; 1/8 oz., 25c.

429 GLOXINIAEFLORA. White. Pkt., 10c; 1/8 oz., 25c.

430 GLOXINIAEFLORA, THE SHIRLEY. Giant hybrids, spotted throats. Pkt., 10c; 1/8 oz., 25c.

431 GLOXINIAEFLORA. Finest spotted varieties. Mixed. Pkt., 10c; 1/8 oz., 20c; 1/4 oz., 35c.

Stately Delphiniums—Choicest Strains

Beautiful Long Spikes—Harmonies in Blue

393 GOLD MEDAL STRAIN. Seeds taken from the Gold Medal strain. Double and single and includes light blue, intense deep blue and many lighter shades. 6 to 8 ft. Pkt., 25c; 1/8 oz., 60c.

394 FORMOSUM. The large flowers are deep, rich blue, with white centers. 5 feet. Pkt., 10c; 1/8 oz., 30c.

395 BELLADONNA HYBRIDS. Mixed. Pkt., 10c; 1/8 oz., 30c.

396 DOUBLE HOLLYHOCK STRAIN. This strain is a fine mixture of all light shades, pale, clear blue predominating. The flowers are large, truly double, well placed on long spikes, their sturdy growth and general appearance reminding one of a Hollyhock. 6 ft. Pkt., 15c; 1/8 oz., 75c.

397 CHINENSE GRANDIFLORA (*Album compactum*). Pure white. Pkt., 10c; 1/8 oz., 30c.

397A NUDICAULE. Scarlet. 2 feet. Pkt., 10c; 1/8 oz., 50c.



Delphinium, Gold Medal Strain



Dianthus, Loveliness

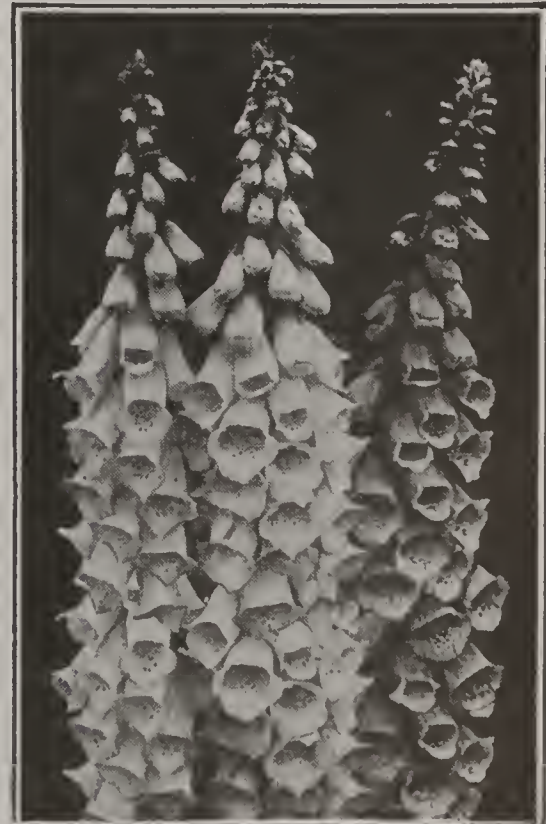

Digitalis Purpurea

Forget-Me-Not

(Myosotis)

Favorite half-hardy perennials, mostly treated as annuals; nearly all blooming the first season from seed sown early in the open ground. They succeed to a degree that warrants cultivation in average soil and open situation. 6 inches.

454 ALPESTRIS (Blue Alpine Forget-Me-Not). Pkt., 10c; 1/8 oz., 25c.

457 PALUSTRIS (True Forget-Me-Not). Dark blue; blooms the first season. Pkt., 10c; 1/8 oz., 30c.

459 PALUSTRIS SEMPERFLORENS. Blue. Blooms in eight to ten weeks from sowing. Pkt., 10c; 1/8 oz., 30c.

460 DISSITIFLORA PERFECTION. Large flowered, blue. Pkt., 10c; 1/8 oz., 60c.

461 VICTORIA. The flowers are large, bright azure-blue, with yellow centers. Best for edging. Pkt., 10c; 1/8 oz., 25c.

462 VICTORIA ROSEA. Rose, dwarf large-flowered. Pkt., 10c; 1/8 oz., 25c.

Geum

Free flowering, producing a wealth of attractive flowers much prized for cutting. They are of tufted habit of growth. Excellent for borders.

486 LADY STRATHEDEN. Flowers loosely double; a delightful shade of golden yellow. Pkt., 10c; 1/8 oz., 40c.

487 MRS. BRADSHAW. The double orange-scarlet flowers are very large and full. 2 feet. Pkt., 10c; 1/8 oz., 40c.



Chater's Double Hollyhocks

Gaillardia (Blanket Flower)

Hardy perennial Gaillardias thrive in nearly all soils. Flowers large, with rich shades of scarlet, orange and crimson, the three often combined in one flower. If sown early, will bloom in the first season. 1 1/2 to 2 feet.

478 GRANDIFLORA, LARGE FLOWERED CHOICE MIXED. A splendid mixture; comprises all the colorings known. Pkt., 10c; 1/8 oz., 25c.

478A BURGUNDY. Burgundy is the darkest and most brilliant of all perennial Gaillardias. It is coppery scarlet self colored similar to Indian Chief in the annual varieties. If started early indoors, flowers may be produced the first season from seed, after which the plants will bloom profusely throughout the summer months. Pkt., 10c; 1/8 oz., 40c.

Gypsophila

(Baby's Breath)

Very useful, free blooming plants of easiest culture. Flowers very small, borne in loose graceful panicles. Used in bouquets with other cut flowers, such as Sweet Peas, Roses, Carnations, etc. 2 feet.

502 PACIFICA. Rose, blooms when Paniculata varieties have passed. Excellent for cutting. Pkt., 15c.

504 PANICULATA FLORE PLENO. A fine, new double of the purest white, the flowers forming miniature balls of white petals. Pkt., 15c.

506 PANICULATA. White. The variety more generally known as Baby's Breath. Hardy perennial. Pkt., 10c; 1/4 oz., 25c; 1/2 oz., 40c.

Helenium

A very valuable hardy perennial, bearing in profusion in August and September, long-stemmed, single flowers; fine for cutting. Effective as a background.

510 AUTUMNALE SUPERBUM. Deep golden yellow. 5 to 6 feet. Pkt., 10c.

Heliopsis

516 LEMOINE STRAIN. Double and semi-double golden yellow flowers; blooms first year. Pkt., 10c; 1/8 oz., 35c.

Heuchera

525 SANGUINEA. A fine, hardy perennial, bearing in graceful spikes, rich crimson flowers. Useful for cutting. 1 foot. Pkt., 10c.

Hibiscus (Mallow Marvel)

Vigorous-growing plants, producing large, handsome flowers, often 6 inches across. Very desirable for mixed beds or borders.

526 GIANT FLOWERED. Finest mixed. Hardy perennial. 4 feet. Pkt., 10c; 1/8 oz., 25c.

Hollyhock

Very ornamental perennials, attractive in mixed borders, making an attractive background. Flowers about 3 inches across set as rosettes around strong growing stalks. Seeds sown in May or June make fine blooming plants the following season.

530 CHATER'S FINEST MIXED. Choicest double varieties, a large percentage of the flowers coming double. Pkt., 10c; 1/8 oz., 35c; 1/4 oz., 60c.

531 DOUBLE. Mixed colors. Pkt., 10c; 1/8 oz., 25c.

532 ALLEGHENY. Large, semi-double flowers, beautifully fringed, of silky texture and richly colored. Pkt., 10c; 1/8 oz., 25c.

534A DOUBLE IMPERATOR. Large fringed rosette flowers in charming color combination. Pkt., 15c.

CHATER'S DOUBLE. 535 Maroon. 535A Newport Pink. 536 Snow White. 536A Yellow. Pkt., 10c; 1/8 oz., 35c.

Humulus (Hop)

The Lupulus, or Common Hop is a hardy perennial, easily grown from seed and, when established, of very rapid growth. 10 to 20 feet.

538 LUPULUS. The Common Hop. Pkt., 10c.

Iberis

542 QUEEN OF ITALY. Dwarf, bushy habit. Pink flowers. Pkt., 10c; ¼ oz., 25c; ½ oz., 40c.

543 SEMPERVIRENS (Perennial Candytuft). A desirable hardy perennial of easiest culture. Dwarf spreading habit; suitable for rockeries. Flowers pure white. Pkt., 10c; ⅛ oz., 35c.

560 KUDZU VINE. See Vines, page 49.

570 LATHYRUS LATIFOLIUS. See Vines, page 49.

Lavender (Lavandula Vera)

575 VERA. A well-known hardy perennial grown chiefly for its lasting fragrance. Pkt., 10c; ⅛ oz., 20c.

Linum

582 FLAVUM. Yellow. Excellent early flowering rock garden plant. Pkt., 10c.

Lobelia

Handsome border plants, thriving in any ordinary garden soil, but preferring a moist, deep loam.

588 CARDINAL FLOWER (Cardinalis). Intense scarlet. 3 feet. Pkt., 10c.

Lupin

590A POLYPHYLLUS. Blue. Pkt., 10c; ½ oz., 30c; oz., 50c.

591 POLYPHYLLUS. Finest Mixed. Hardy plants of easy culture; useful as a background in the perennial border. Mixed blue and white. 2 to 4 feet. Pkt., 10c; ½ oz., 30c; oz., 50c.

Phlox

The seed we offer has been saved from the best varieties and is supplied in mixture only.

847 CHOICEST MIXED. Pkt., 10c; ⅛ oz., 50c.

Physalis

(Chinese Lantern Plant)

850 FRANCHETI. Bright orange, scarlet lantern-like fruits which are gathered in the fall and dried. Very attractive for winter bouquets. If seed is sown early will bloom the first year. Pkt., 10c; ⅛ oz., 25c.



Iberis Sempervirens



Physalis (Chinese Lantern Plant)

Annual and Perennial Climbers

140 **Adlumia.** 10 to 15 ft. P.

215 **Aristolochia.** 15 to 20 ft. P.

235 **Balloon Vine.** 10 to 15 ft. A.

240 **Beans, Scarlet.** 10 to 15 ft. A.

241 **Beans, White.** 10 to 15 ft. A.

275 **Canary Creeper.** 10 to 15 ft. A.

340 **Clematis.** 12 ft. P.

345 **Cobaea.** 20 to 30 ft. P.

370 **Cypress Vine.** 10 to 12 ft. A.

433 **Dolichos** 10 ft. A.

537 **Humulus.** 10 to 20 ft. A.

538 **Humulus.** 10 to 20 ft. P.

549 to 553 **Ipomoea.** 15 to 30 ft. A.

560 **Kudzu Vine.** 40 to 50 ft. P.

570 **Lathyrus Latifolius.** 6 to 8 ft. P.

635-635B **Moonflower.** 30 ft. A.

636 **Morning Glory.** 8 to 10 ft. A.

705 **Nasturtium, Tall.** A.

1315 **Thunbergia.** 4 ft. A.

1346 **Wild Cucumber Vine.** 15 to 20 ft. A.

For full description, see general list of Annual or Perennial Flower Seeds.

Lychnis

Perennial plants of easy culture, blooming the first season if sown early.

595 CHALCEDONICA (Burning Star). Bright scarlet flowers shaped like a Maltese Cross. Of fine color and thrifty growth; very effective in the perennial border. 2 feet. Pkt., 10c; ⅛ oz., 20c.

Mimulus

Bushy plants 1 foot high. Flowers various shades of yellow, spotted and marked crimson.

630 TIGRINUS (Monkey Flower). Handsome flowers with white, sulphur or yellow ground spotted with crimson, scarlet or pink. Pkt., 10c.

631 MOSCHATUS (Musk Plant). Small yellow flowers, musk-scented foliage, of trailing habit; excellent for hanging baskets. Pkt., 10c.

Nepeta

757A MUSSINI. A favorite perennial rock plant with blue-gray foliage and blue flowers. 9 inches. Pkt., 10c; ⅛ oz., 30c.

ROSS' EXHIBITION PANSIES

*Blooms Abundantly from Early Spring to Severe Frost
A Lovely, Velvety Assortment of Colors that Endures All Climates*

The Pansy stands in a class by itself. It is a flower that everyone admires, even if only a small place to raise them. The Pansy produces best results during the cool days of spring, and in a sandy loam, thoroughly prepared and supplied with well-rotted manure. To assist germination by retaining moisture, cover the seed bed with sheeting or single burlap, removing as soon as seedlings begin to appear. From this time on it is important never to let the soil become dry; to do so is fatal. Keep moist but not soaking wet. For early spring flowers, sow seed in August and protect during the winter.

770 BUGNOT'S SUPERB BLOTCHED. Rare shade of red, bronze or brown. Pkt., 10c; 1/8 oz., 40c; 1/4 oz., 75c.

771 CASSIER'S GIANT BLOTCHED. A very carefully selected strain of five-blotched varieties remarkable for the enormous size of the flowers and the many rare combinations of shades and colors. Pkt., 10c; 1/8 oz., 40c; 1/4 oz., 75c.

774 TRIMARDEAU PARISIAN, LARGE-STRAINED. A beautiful improved strain mostly white ground and five-blotched varieties. Pkt., 10c; 1/8 oz., 40c; 1/4 oz., 75c.

776 MADAME PERRET (Phenomena). A strain, distinctly beautiful pink, blotched or veined with rose, crimson or purple, the upper petals either self-colored with rich wine-red or deep purple or with a margin of white. Pkt., 10c; 1/8 oz., 40c; 1/4 oz., 75c.

778 MASTERPIECE (Ruffled Pansies). A strain having ruffled and curled petals, giving the flowers the appearance of being double. Colors rich and striking. Pkt., 10c; 1/8 oz., 40c; 1/4 oz., 75c.

779 WORCESTER GIANT MIXED. Our own selections of choice large-flowered strains and varieties, including

a proportion of all the preceding strains, the named separate sorts, and several choice strains of different growers. Wonderful colors, shades and markings representing nearly every type of Pansy. Pkt., 10c; 1/8 oz., 35c; 1/4 oz., 60c.

782 LARGE FLOWERED MIXED. Our own mixture of varieties. The range of colorings is excellent, and the mixture will be found very satisfactory. Pkt., 10c; 1/8 oz., 35c; 1/4 oz., 60c.

783 ENGLISH PRIZE MIXED. Includes many with face-like markings of various shades. Pkt. 10c; 1/8 oz., 35c; 1/4 oz., 60c.

785 CHOICE MIXED. A mixture of many varieties. Pkt., 10c; 1/8 oz., 30c; 1/4 oz., 50c.

786 GIANT ADONIS. Splendid light blue, with white center and dark blotches. Pkt., 10c; 1/8 oz., 35c; 1/4 oz., 60c.

788 GIANT CARDINAL. Brilliant red. Pkt., 10c; 1/4 oz., 60c.

792 GOLDEN QUEEN. Pure yellow. Pkt., 10c; 1/8 oz., 35c; 1/4 oz., 60c.

794 INDIGO BLUE. New rich shade. Pkt., 10c; 1/8 oz., 35c; 1/4 oz., 60c.

796 KING OF THE BLACKS. Pkt., 10c; 1/8 oz., 35c; 1/4 oz., 60c.

800 LORD BEACONSFIELD. Violet, shading to white at the top. Pkt., 10c; 1/8 oz., 35c; 1/4 oz., 60c.

804 PEACOCK. Rich blue and purple, edged with white; very striking. Pkt., 10c; 1/8 oz., 35c; 1/4 oz., 60c.

806 RUBY KING. Superb reddish shades. Pkt., 10c; 1/8 oz., 35c; 1/4 oz., 60c.

808 SNOW WHITE (Candidissima). Pkt., 10c; 1/8 oz., 35c; 1/4 oz., 60c.

811 YELLOW. With large, black eye. Pkt., 10c; 1/8 oz., 35c; 1/4 oz., 60c.

ROSS' GIANT PANSIES

**Outstanding in Color, Size
and Freedom of Bloom**

They are of enormous size with long stems and healthy foliage. The color combinations are new and very rare, including shades never before seen in Pansies—browns, salmons, pinks, reds, and wine colors. We do not hesitate to recommend this strain to the most critical grower.

Why buy ordinary seed when Ross' Selected Giants costs no more? One ounce of seed will produce as many as 20,000 plants. Try Ross' Selected Giant Seed this year for best results.

PRICE LIST OF ASSORTED COLORS:

780 Pkt., 50c; 1/16 oz., 90c; 1/8 oz., \$1.50; 1/4 oz., \$2.75; 1 oz., \$10.00; 1/4 lb., \$34.00; 1 lb., \$136.00.

These prices include free delivery in U.S.A.



A Ross Giant Pansy. They come in many colors

PANSIES ARE A ROSS SPECIALTY

ROSS BROS. CO.



Rudbeckia Purpurea

Platycodon (Chinese Bellflower)

855 GRANDIFLORUM. The propagation is more easily accomplished by seed than by division of the root. It is well adapted to the hardy border. Blooms from July to September. The flowers are large, steel-blue. 2 to 2½ ft. Pkt., 10c; ¼ oz., 40c.

Polemonium

857 COERULEUM. A hardy perennial. Easily grown from seed, preferably sown in the fall. Large heads of showy blue flowers from May to August. 2 feet. Pkt., 10c; ¼ oz., 25c.

Hardy Perennial Poppies

890 ICELAND POPPIES. White and shades of yellow and orange. Mixed. Pkt., 10c; ⅛ oz., 25c.

ORIENTAL POPPIES. Easily grown from seed sown either in late fall or early spring. They bloom the second spring from sowing.

892 ORIENTALE. Deep crimson flowers, with blotch of black on each petal. Pkt., 10c; ⅛ oz., 25c.

893 NEW ORIENTAL HYBRIDS. Flowers of enormous size, sometimes 6 inches or more in diameter and of many novel colors. Pkt., 10c; ⅛ oz., 25c.

Hardy Primroses

Although known as a hardy perennial, these require in this climate some protection. If protected with leaves covered by a box, they will live through our severest winters. They are early blooming plants.

ELATOR (Polyanthus). Excellent for either pot or outdoor culture. Colors mostly shades of yellow, and red and yellow.

903 CHOICEST MIXED. Pkt., 10c; ¼ oz., 85c.

904 VULGARIS. True, yellow English Primrose; canary yellow; fragrant. Pkt., 10c; ⅛ oz., 60c.

Pyrethrum

Hardy perennials of easy culture.

910 AUREUM (Golden Feather). Golden foliage; small, white flowers. 1 foot. Pkt., 10c; ¼ oz., 35c.

913 ROSEUM HYBRIDUM. Blooms freely from June to September, bearing large-flowering, daisy-like flowers ranging from light pink to deep red, with bright yellow center; excellent for cutting. Pkt., 10c; ⅛ oz., 30c.

Rocket, Sweet

(*Hesperis Matronalis*)

Hardy perennial plant of easy culture, bearing clusters of purple or white fragrant flowers. 1½ feet.

921 MIXED. Pkt., 10c; ¼ oz., 30c.

Rudbeckia (Coneflower)

Will grow in nearly all soils and situations, thriving in partial shade or fully exposed to the sun.

925 NEWMANNI. Large golden-yellow flowers, with maroon cone. Blooms for a long time. Hardy perennials. 2 feet. Pkt., 10c; ⅛ oz., 40c.

926 PURPUREA (Echinacea; Giant Purple Coneflower). Large flowers, about 4 inches in diameter; reddish purple, with large cone of brown. Hardy perennial. 3 feet. Pkt., 10c; ⅛ oz., 40c.

Scabiosa

947 NEW BLUE SCABIOSA. Hardy Perennial Scabiosa (Caucasica) (Blue Bonnet). One of the handsomest of hardy perennials, especially valuable for cutting, the blooms lasting a long time in water; color soft lavender-blue. 3 feet. Pkt., 10c; 1/16 oz., 30c.

947A NEW GIANT CAUCASICA HYBRIDS (Isaac House Strain). Each petal is beautifully ruffled and frilled. The predominating colors are delicate lilac and mauve but embracing shades from white to the darkest blue. Florists are finding this splendid for forcing under glass for cutting. Pkt., 15c; 1/16 oz., 50c.

Sedum

949A ACRE. H. P. Thrives well in poor soil. Fine for rockeries and for covering bare spots. Yellow blossoms. 3 inches. Pkt., 20c; ⅛ oz., \$1.25.

949B SPECTABILE (Showy Sedum). Large umbels of lavender-pink flowers. 1 to 1½ ft. Pkt., 20c; 1/16 oz., \$1.50.

Stokesia Cyanea (Cornflower Aster)

973 BLUE. Blooms from August to frost. 2 feet high. Pkt., 10c; ⅛ oz., 35c.

974 MIXED. Containing many new colors. Pkt., 10c; ⅛ oz., 35c.



New Hybrid Oriental Poppies

Sweet William - Dianthus Barbatius

A hardy biennial with large trusses of sweet scented flowers produced in abundance, suitable for rock gardens.

1300 SINGLE MIXED COLORS. Pkt., 10c; ¼ oz., 15c.

1302 HOLBORN GLORY. A new strain of the auricula-eyed section; both the head and individual flowers are of the largest size and each of the latter shows a clear white eye; of an exceedingly wide range of colors. Pkt., 10c; ¼ oz., 35c.

1308 DOUBLE LARGEST-FLOWERED. Choicest mixed. A greatly improved strain. Pkt., 10c; ¼ oz., 25c.

1309 SCARLET BEAUTY. A very effective rich, deep, scarlet variety. Pkt., 10c; ¼ oz., 35c.

1306 NEWPORT PINK. Pkt., 10c; ¼ oz., 35c.

Tritoma

1317 TRITOMA (Red-Hot Poker Plant or Flame Flower). H. P. Large spikes of orange-red flowers. Height 4 feet; effective in single clumps or among shrubbery. Pkt., 10c.

Trollius

1317A LEDEBOURI GOLDEN QUEEN. (New). Deep orange, late bloomer. Pkt., 25c.

Tunica

1318 SAXIFRAGA. Dwarf, hardy perennial. Pink blossoms; an excellent rock plant. Pkt., 10c; ⅛ oz., 25c.

Veronica

1330. Pretty blue flowers on long spikes. Pkt., 10c; ⅛ oz., 30c.

Viola Cornuta - Tufted Pansies

Flowers not so large as the Pansy. Blooms profusely; is quickly and easily grown. Seed sown in April will produce blooming plants in June and, if planted in cool, moist soil, partly shaded, nearly all summer. Hardy perennial.

1335 MIXED TUFTED PANSIES. Finest mixture of all colors. Pkt., 10c; ⅛ oz., 35c; ¼ oz., 60c.



Sweet Williams

Wallflower

Fine bedding plant, but more often grown as a pot plant. Shades of yellow, brown and reddish brown.

1340 SINGLE. Mixed colors. Pkt., 10c; ¼ oz., 30c.

1341 DOUBLE BRANCHING. Mixed colors. Pkt., 10c.

1342 PARIS EXTRA-EARLY. A new single-flowered strain, blooming throughout the season, from spring-sown seed. Colors light brown, brownish, red, yellow, and creamy white. Mixed. Pkt., 10c; ¼ oz., 20c.

America's Premier Gladiolus —

1938 Top-Notchers

AFLAME. Begonia-rose, shading to bright orange-flame near the edge. Back of petals brighter shade than front. Florets are 6½ inches across with 6 to 8 open at one time. **Each, 5c; doz., 40c; 100, \$3.00.**

AVE MARIA. Large florets of a near-blue color. Tall, straight spikes with many blooms open at a time, all facing one way, and well placed. **Each, 8c; doz., 70c; 100, \$5.00.**

BAGDAD. A dark smoky rose, with 4 or 5 very large florets open at once, on a tall, graceful spike. One of the tallest Glads. **Each, 8c; doz., 70c; 100, \$5.00.**

BERTY SNOW. A tall, straight spike, and healthy growing habit of this variety with its very large florets of beautiful clear lavender, makes this one of the very finest varieties. **Each, 5c; doz., 40c; 100, \$3.00.**

BETTY NUTHALL. Warm coral-pink with yellow throat markings and a slight tinge of orange. Six to eight medium large, well-placed blooms open at a time. **Each, 5c; doz., 40c; 100, \$3.00.**

BREAK O' DAY. Tall, very clear light pink. An early variety. **Each, 5c; doz., 40c; 100, \$3.00.**

CARMEN SYLVA. One of the best snow-white Glads. Large florets; tall grower, and is an extra fine cut flower. **Each, 5c; doz., 40c; 100, \$3.00.**

CAROLUS CLUSIUS. Light pink with several large blooms open on a tall spike. Early. **Each, 5c; doz., 40c; 100, \$3.00.**

CRIMSON GLOW. Glowing, velvety crimson, shading deeper in the center. Tall, strong grower. Florets large and well placed. Considered one of the best in its color. **Each, 5c; doz., 40c; 100, \$3.00.**

DECORATION. The florets are a beautiful shade of rosy pink, lighter at edges, with entire flower showing a glistening, sparkling luster. **Each, 5c; doz., 40c; 100, \$3.00.**

DR. MOODY. Light lavender, with very fine penciling of a deeper shade. Early. Long spike of bloom with many open at a time. **Each, 8c; doz., 70c; 100, \$5.00.**

E. I. FARRINGTON. A very beautiful new variety destined to become one of the most popular yellows. A very soft self-yellow. Florets of fair size, with six open on a 4-ft. spike. **Each, 8c; doz., 70c; 100, \$5.00.**

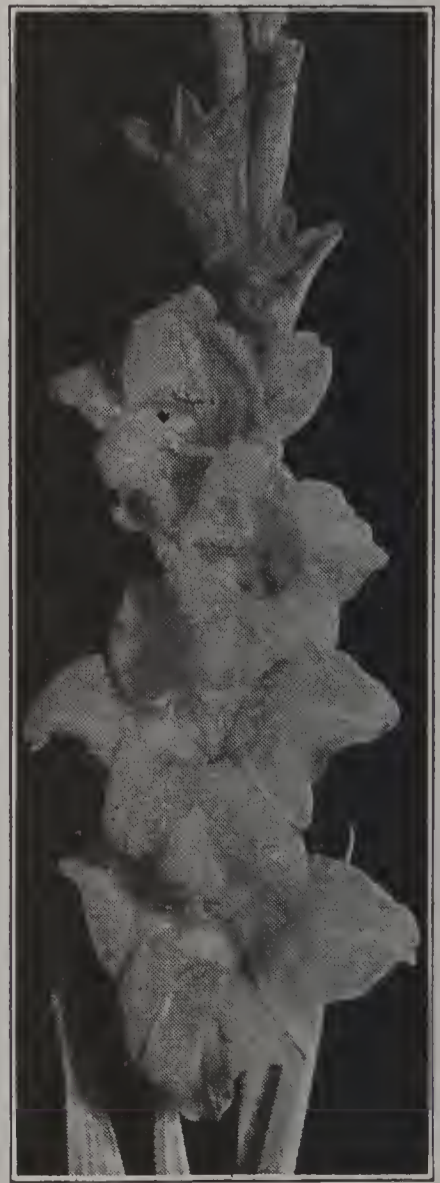

GLADIOLUS—Continued.



- GIANT NYMPH.** A giant in growth and flowers. Light, rosy pink with creamy yellow throat. Fine in every respect. **Each, 5c; doz., 40c; 100, \$3.00.**
- GOLD EAGLE.** Tall growing, very early, golden yellow. **Each, 5c; doz., 40c; 100, \$3.00.**
- GOLDEN DREAM.** Beautiful, clear, deep, medium sized, yellow; with 7 to 10 blooms open at a time. Tall, strong grower. Petals slightly recurved. **Each, 5c; doz., 40c; 100, \$3.00.**
- LA PALOMA.** Large, bright, vivid orange of heavy texture. A new and distinctive shade and one of the best orange varieties. **Each, 8c; doz., 70c; 100, \$5.00.**
- LOYALTY.** Large, clear, deep yellow. Very strong, husky plant with several florets open at a time. Ruffled. **Each, 8c; doz., 70c; 100, \$5.00.**
- MARGARET FULTON.** Superb, early, salmon-pink, decorative. A distinct shade, different than the color of any other variety. **Each, 8c; doz., 70c; 100, \$5.00.**
- MARMORA.** Immense, smoky lavender, from Australia. Many blooms open at a time on good, tall, straight spikes. **Each, 8c; doz., 70c; 100, \$5.00.**
- MISS JOY.** Beautiful, large, pink with yellow throat. Fine straight spike. **Each, 5c; doz., 40c; 100, \$3.00.**
- MRS. P. W. SISSON.** Cameo-pink. Several large open florets on a tall straight spike. **Each, 5c; doz., 40c; 100, \$3.00.**
- MOROCCO.** Deep red, flecked black, white midrib. About six 4½-inch blooms open on a tall, well-arranged spike. Buds almost black. **Each, 8c; doz., 70c; 100, \$5.00.**
- MOTHER MACHREE.** Soft, smoky lavender, with edges of petals overlaid with salmon-pink, flaked with orange-red; 6 to 8 wide open florets well placed on tall spike. **Each, 8c; doz., 70c; 100, \$5.00.**
- OLIVE GOODRICH.** White, tinted light pink; shading darker at the edges. Pale yellow throat. Six or more large blooms open at a time on a tall spike. **Each, 8c; doz., 70c; 100, \$5.00.**
- ORANGE QUEEN.** Beautiful, light orange, deeper at edge of petals. Orange-red lines in the throat. Tall, slender stems. **Each, 5c; doz., 40c; 100, \$3.00.**
- PICARDY.** Soft shrimp-pink without flecking. Blotch of light flesh-pink shading to shrimp-pink at edges. Inconspicuous feathering of begonia-rose. Seven to ten blooms open at a time, measuring 6 inches and more across. The most outstanding introduction in recent years. **Each, 8c; doz., 70c; 100, \$5.00.**
- PRIDE OF WANAKAH.** Very large, beautiful, deep lavender-rose. One of the best in its color. **Each, 5c; doz., 40c; 100, \$3.00.**
- WASAGA.** A glowing buff, with wide open ruffled blooms. Color is perfectly clear, with no throat markings or fleckings of any kind. Four to five open at a time. Many declare this variety the most beautiful Glad ever produced. **Each, 8c; doz., 70c; 100, \$5.00.**
- YVONNE.** Blush-white, or very pale pink with soft cerise spot in throat. Six to eight very large blooms on a tall, strong-growing plant. **Each, 8c; doz., 70c; 100, \$5.00.**
- MIXTURE.** A mixture of popular named varieties, selected from all classes; unsurpassed in diversity of colors, types and quality of blooms. **Doz., 35c; 100, \$2.50.**

All Gladiolus sent postpaid at prices quoted.

Best Quality Cannas

Dormant roots of the varieties listed below until May 1st only. Prepaid.

For a brilliant show all summer there is no plant excelling the Canna; it even surpasses the Geranium in its gorgeous display of brilliant colors, blooming continuously from the time of planting until cut down by frost. Plant 18 inches apart each way.

Prices of varieties listed below: Each, 10c; doz., \$1.00.

- APRICOT.** This recent introduction brings us a new shade of red and a most gorgeous flower. The blossoms are very large and of a clear, velvety shade of deep cerise. Deep green foliage.
- KING HUMBERT.** Truly a king among the Cannas. A massive coppery scarlet flower, broad, deep bronze foliage. Grows 4 feet high.
- THE PRESIDENT.** Height 4 feet. In color a rich glowing scarlet, Immense, firm, rounded flowers on strong, erect stalks.
- VENUS.** A dainty combination of rose-pink petals with a narrow border of cream-yellow. Three to four feet tall with bright green foliage.
- WYOMING.** Called King of the Giants. One of the most majestic, having a luxuriant growth of rich purple foliage. Above this are borne great plumes of massive orange-colored blossoms, true orchid-shaped, with large, rounded petals.
- WINTZER'S COLOSSAL.** 5 feet. Green foliage. A striking, vivid scarlet.
- YELLOW KING HUMBERT.** A sport of that most popular of all Cannas, King Humbert, producing large flowers of a beautiful shade of yellow, lightly spotted red, with green foliage. 5 to 6 clusters of flowers at a time.

ALL GLADIOLUS SENT POSTPAID AT PRICES QUOTED

Worcester, Mass.

Ross' Approved Giant Dahlias



Ross' Special Mixed Dahlias

Recent introductions of some of the very best large-flowering Dahlias ever grown. Try them and have a REAL Dahlia garden.

- ALYCE MARIE GALVIN.** White with faint tone of cameo-pink, a 12-inch flower. 50c each; 3 for \$1.25.
- AUTUMN BEAUTY.** A large golden yellow, fine form. 50c each; 3 for \$1.25; doz., \$5.00.
- CHARLOTTE ALEXANDER.** White with vein of purple at tips, a fine flower. Each, 25c; doz., \$2.50.
- COQUETTE.** One of the most beautiful red and gold combinations, a fine large flower. Each, 50c; doz., \$5.00.
- EASTERN STAR.** Saffron-yellow. Each, 25c; doz., \$2.50.
- GILDA GRAY.** Pure lilac shading to deep Tyrian rose. Each, 25c; doz., \$2.50.
- GIRL OF HILLCREST.** Apricot-buff, very large, free flowering. 75c each; 3 for \$2.00; doz., \$7.50.
- HARRY MAYER.** Pale rosaline purple and lavender. 50c each; doz., \$5.00.
- HERALD TRIBUNE.** White with a faint shading of pink. 50c each; doz., \$5.00.
- IDA PERKINS.** Large pure white, fine. 50c each; doz., \$5.00.
- IDA TARBELL.** Deep crimson, large and fine. 25c each; doz., \$2.50.
- JANE COWL.** Bronze-buff and old gold, fine and large. 25c each; doz., \$2.50.
- JERSEY'S BEACON.** Chinese scarlet, large. 25c each; doz., \$2.50.
- JERSEY'S BEAUTY.** True pink, a fine flower. 25c each; doz., \$2.50.
- MABLE GOODACRE.** Decorative. Soft pink and salmon suffused with orange, a fine large bloomer. 50c each; doz., \$5.00.

- MARGARET K. ALEXANDER.** Buff and burnt orange, large. 25c each; doz., \$2.50.
- MARGARET WOODROW WILSON.** Opalescent pink, large. 25c each; doz., \$2.50.
- MRS. A. B. SEAL.** Pure glowing old rose shading to violet-rose. 50c each; doz., \$5.00.
- MRS. IDA DE VER WARNER.** Deep mauve-pink, large and fine. 25c each; doz., \$2.50.
- MRS. R. T. EDWARDS.** Pink, reverse plum. 50c each; doz., \$5.00.
- PRIDE OF CALIFORNIA.** Crimson-red. 25c each; doz., \$2.50.
- PRIDE OF FT. MORGAN.** Crimson-red. 25c each; doz., \$2.50.
- PRIDE OF STRATFORD.** Cadmium-orange, large. 25c each; doz., \$2.50.
- SALEM PRIDE.** Rhodamine-purple flecked white, large and one of the best flowers grown. 50c each; doz., \$5.00.
- SOMERSET.** Salmon and old gold shades, a fine flower. 25c each; doz., \$2.50.
- THOMAS A. EDISON.** A large royal purple or petunia-violet. 50c each; doz., \$5.00.
- WALKOVER PRINCE.** Nopal red, each petal flecked deep orange. This is a noble flower, always full to center, a whale. 50c each; doz., \$5.00.
- WHITE WONDER.** Beautiful large white decorative. 50c each; doz., \$5.00.

Nature's Crowning Beauty for the Garden

New Decorative Dahlias for 1938

- CHAMPOEG.** I. D. This is one of the most beautiful Dahlias ever grown. It is a fine, large flower with three colors, the ground being lemon-yellow with suffusion of deep rose-pink splashed with soft carmine, a wonderful bloom. \$1.00 each; 3 for \$2.50.
- EASTLAND SUNBEAM.** I. D. One of the finest Dahlias, with large showy flowers on long stems, of deep cinnamon-red, an unusual shade. \$1.00 each; 3 for \$2.50.
- JANE ROSS.** Bright purplish crimson shading violet. \$1.00 each; 3 for \$2.50.
- JEAN TRIMBEE.** Large violet, long stems. 50c each; 3 for \$1.25.
- JIM MOORE.** Primrose-yellow, shading to gold. 50c each; 3 for \$1.25.
- J. K. ALEXANDER, JR.** The largest crimson-red Hybrid Decorative ever offered, even larger than Murphy's Masterpiece and ten times as good as Satan, with a yellow fleck in center. The flowers are 12 to 14 inches in diameter without disbudding, standing on top of stems and as free-flowering as a Pompon. It is a giant. \$1.00 each; 3 for \$2.50.
- PATRICIA WYMAN.** I. D. White with a soft cast of lavender veining in each flower, free flowering on top stems, a fine strong grower with some of the most beautiful blooms grown. \$1.00 each; 3 for \$2.50.

Cactus Dahlias

- CHEMAR'S MASTERPIECE.** A large orchid-pink. 50c each; doz., \$5.00.
- ELKRIDGE.** Splendid pure white. 50c each; doz., \$5.00.
- MRS. ETHEL F. T. SMITH.** A large white shading to lemon-yellow. 35c each; doz., \$3.50.
- ROYCROFT.** A golden bronze. 35c each; doz., \$3.50.
- SAMUEL T. ALEXANDER.** Japan rose. 50c each; doz., \$5.00.

Show and Fancy Dahlias

- A. D. LIVONI.** Soft pink. Each, 15c; doz., \$1.50.
JAMES VICK. Purple-crimson. Each, 15c; doz., \$1.50.
MAUDE ADAMS. Snow-white overlaid pink. Each, 25c; doz., \$2.50.
MRS. CLARA D. ANDERSON. Purple-crimson. Each, 25c; doz., \$2.50.
MISS HELEN HOLLIS. Deep scarlet. Each, 25c; doz., \$2.50.
VIVIAN. White edged rose-violet. Each, 25c; doz., \$2.50.
WHITE SWAN. White. Each, 15c; doz., \$1.50.

Pompon Dahlias

Select List

- AMBER QUEEN.** Clear amber shaded apricot. Each, 15c; doz., \$1.50.
GOLDEN QUEEN. Pure yellow, fine. Each, 25c; doz., \$2.50.
JESSICA. Yellow edged red. Each, 25c; doz., \$2.50.
JOHNNIE PEPPIN. Dark crimson-red. Each, 25c; doz., \$2.50.
LITTLE HERMAN. Red and white variegated. Each, 25c; doz., \$2.50.
LITTLE BEAUTY. Soft pink and white. Each, 25c; doz., \$2.50.
PRINCE CHARMING. Purple. Each, 15c; doz., \$1.50.
RAPHAEL. Dark maroon. Each, 15c; doz., \$1.50.
SNOWCLAD. Standard white. Each, 25c; doz., \$2.50.

Mixed Dahlias

Postpaid, \$1.00 per doz.; by express, 90c per doz., \$6.00 per 100.

Regal Lily (Lilium Myriophyllum)

Postpaid

It is a pure, waxy white, with a lemon-yellow throat and a trumpet about 6 inches long, and when the flower is fully developed it is about 7 inches across; 2 to 2½ inches in diameter. Each, 35c; doz., \$3.50. Smaller size flowering bulbs. Each, 25c; doz., \$2.50.



Lilium Speciosum Rubrum



Dahlia, Chemar's Masterpiece

Hardy Lilies

Postpaid

- AURATUM** (Golden Banded Lily). Enormous, measuring frequently 8 to 12 inches across; pure white, spotted crimson, each petal marked in the center with a band of yellow. Flowers in August; delightfully fragrant. Each, 25c; doz., \$2.50.
SPECIOSUM ALBUM. The best late flowering pure white; hardy garden Lily, of easy culture. The graceful stems and foliage are set off to wonderful advantage by the pure white blooms. Each, 25c; doz., \$2.50.
SPECIOSUM RUBRUM, OR ROSEUM. Delicate pink, almost white, spotted red; one of the old garden favorites. Height 3 feet. Flowers in August and September. Each, 25c; doz., \$2.50.

Tuberose

Bulbs may be started in the house for early flowers, or they may be planted in the open border, but not earlier than June in this latitude.

EXCELSIOR DWARF PEARL. Improved strain; plant of dwarf habit; blooms earlier and flowers are more double than old strain. Extra large bulbs, postpaid, 10c each; 3 for 25c; doz., 90c.

Begonias, Tuberous-Rooted

Desirable for shady places. Start in the house early and set plants in the open ground about the last of May. They will bloom soon and profusely and continuously until frost. Keep constantly moist.

SINGLE VARIETIES. Dark red, yellow, white, salmon, rose, copper and mixed colors. Price, 15c each; doz., \$1.60.

DOUBLE VARIETIES. Dark red, yellow, white, salmon, rose, copper and mixed colors. Price, 15c each; doz., \$1.60.

CINNAMON VINE. Grows 15 to 30 feet. The leaves are green, with a tinge of bronze. The flowers are white, borne in clusters. The vine dies at the end of the season, but the root is hardy. Postpaid, extra large roots, each, 10c; 3 for 25c; doz., 90c.

MADEIRA VINE. A rapid-growing climber with beautiful, thick, glossy waxlike leaves and bearing profusely in graceful, feathery racemes white flowers which have a fragrance resembling Mignonette. Plant when ground becomes warm. Store tubers in a cold, dry place during winter. Postpaid, each, 10c; doz., 90c.

Nursery Department

parcel post or express, depending on the size of shipment or distance from the nursery. If your express and post office address differ, please mark both on your order.

The nursery stock which we offer is well grown, of full size as advertised, and we guarantee delivery to the customer in good condition. All nursery stock listed here is for shipment direct from the nursery in Connecticut to the customer and will be sent transportation paid, either by

FLOWERING SHRUBS

Adapted to every home purpose for variety of color, berries and foliage contrast.

Each, 37c; three for \$1.06; six for \$1.90; twelve for \$3.70.

ALTHEA, PINK, PURPLE, or WHITE. One of the latest of flowering shrubs. Blooms are large and very attractive.

CORNUS ALBA SIBIRICA (Red Bark Dogwood). Blood-red branches, grows to 10 ft., spring bloom bluish white.

DEUTZIA CRENATA ROSEA. Flowers pure white, tinged rose. Height 6 to 8 feet. Blooms June and July.

DEUTZIA, PRIDE OF ROCHESTER. Pinkish white blossoms. Grows from 6 to 8 feet high. A very popular shrub.

EUONYMUS ALATUS (Burning Bush). Handsome shrub 6 to 8 feet with peculiar winged branches, light green foliage changing to crimson in autumn.

FORSYTHIA (Golden Bell). A profusion of brilliant yellow, bell-shaped flowers before the leaves appear. One of the earliest bloomers. A harbinger of spring. No planting complete without Forsythia.



White Snowberry

HONEYSUCKLE. Pink or White. Medium early bloomer, followed by a profusion of berries that attract robins and other berry-eating birds.

HYDRANGEA P. G. Large, pinkish white panicles which literally cover the bush. Blooms late. Very attractive.

HYDRANGEA A. G. (Hills of Snow). Ball-shaped, snow-white flowers.

JAPAN QUINCE. Showy scarlet flowers which often obscure the foliage and branches. Very attractive.

LILACS, PURPLE or WHITE. An old-fashioned shrub which requires no introduction.

PRUNUS PERSICA (Double Flowering Peach). Announces itself to the world with a burst of brilliant pink early in the spring. A striking specimen plant.

PRUNUS PISSARDI (Purple Leaf Plum). Its unusual purple foliage places it in a class by itself. Most attractive as a specimen plant or for use in groups and borders.

PRUNUS TRILOBA (Double Flowering Plum). A tree-like shrub which bears a profusion of pinkish white blossoms early in the spring.

SNOWBALL. A shrub readily recognized by both old and young. The name describes it.

SNOWBERRY, RED (Coralberry). Desired for its berries which traverse the stems in unique style. Attracts birds and feeds them abundantly.

SNOWBERRY, WHITE. Large, white berries that remain far into the winter. Like its companion, Red Snowberry, is especially adapted to shady places.

SPIREA FROEBELI. Red flowers. Medium grower and works in advantageously with other shrubs.

SPIREA TRICHOCARPA (Korean Spirea). An imported variety. Quite unusual. Beautiful white flowers.

All shrubs offered here are for shipment direct from the nursery—not in stock at our store.



Purple Lilacs

SPIREA THUNBERGI. Dwarf, bushy habit, about 3 feet in height. White flowers in April and May.

SPIREA VAN HOUTTE. The most popular of all shrubs. A mass of white blooms in May or early June. The King of all Spireas.

SYRINGA (Mock Orange). A tall growing, free flowering shrub of stately beauty and delicate fragrance. Large, white, starlike blooms with yellow center.

SYRINGA, VIRGINAL. Similar to Mock Orange but with larger blossoms. Does not grow quite so tall.

TAMARIX AFRICANA. Shrub or small tree with reddish brown bark, flowers pink. May and June.

VIBURNUM MOLLE. Upright bushy shrub. Flowers are showy and are followed by colored berries which stay until late winter.

VIBURNUM OPULUS (High Bush Cranberry). Will grow about 12 feet high, white blossoms May and June followed by red berries.

The beauty of Flowering Shrubs is beyond comparison.

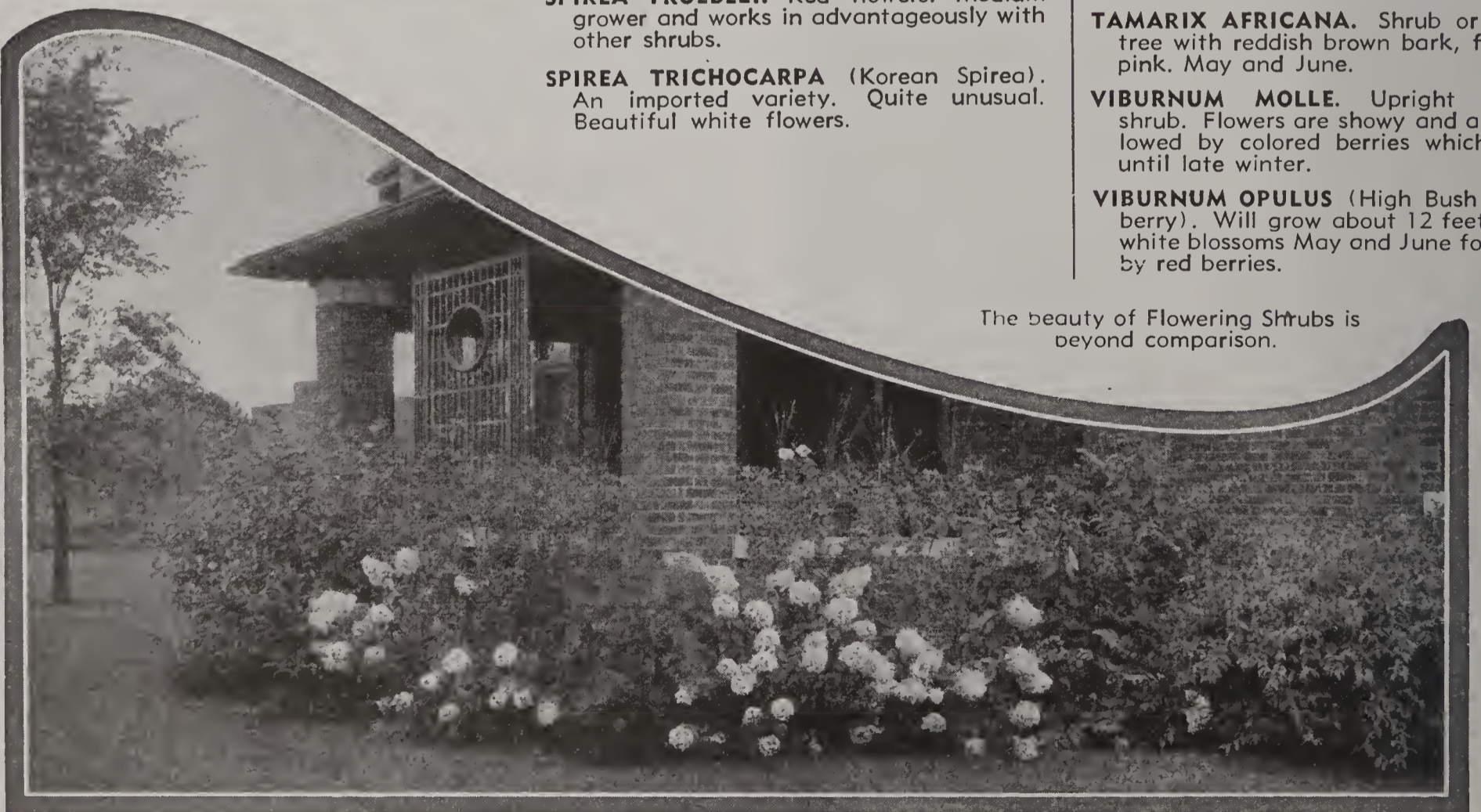

Lovely ROSES

Two-Year Field Grown Plants

Your
Choice of
Varieties

1 for .. \$0.39
3 for .. 1.10
6 for .. 2.15
12 for .. 4.20

EVERBLOOMING VARIETIES

All Roses offered here are for shipment direct from the nursery—not in stock at our store.

RED

- CERISE TALISMAN.** A red sport of Talisman.
CRUSADER. Rich crimson. Heavy grower.
ETOILE DE HOLLANDE. Dark red. Strong stems.
ETOILE DE FRANCE. Bright crimson. Open blooms.
FRANCIS SCOTT KEY. Dark red. Very double.
GRUSS AN TEPLITZ. Bright red. Continuous bloomer.
HADLEY. Rich velvety crimson. A leader.
HOOSIER BEAUTY. Large deep crimson.
MARGARET McGREDY. Brilliant red and bright gold.
RADIANCE, RED. The most popular red Rose grown.

PINK

- EDITH NELLIE PERKINS.** Light cerise and salmon.
J. L. MOCK. Deep pink outside and silver inside petals.
MME. F. KRUGER. Peach-pink. Extra large flowers.
RADIANCE, PINK. King of the pink Roses.

YELLOW

- BETTY GRACE CLARK.** Rich lemon-yellow.
DOROTHY PAGE-ROBERTS. Coppery pink and apricot.
GOLDEN DAWN. Yellow tinged with red.
LUXEMBOURG. Creamy yellow. A favorite.
PRESIDENT HERBERT HOOVER. Cerise, scarlet and yellow. Needs no introduction.
TALISMAN. Beautiful orange-scarlet buds touched with yellow, red and gold. One of the very choice varieties.

WHITE

- MME. JULES BOUCHE.** Large white with blush in center.

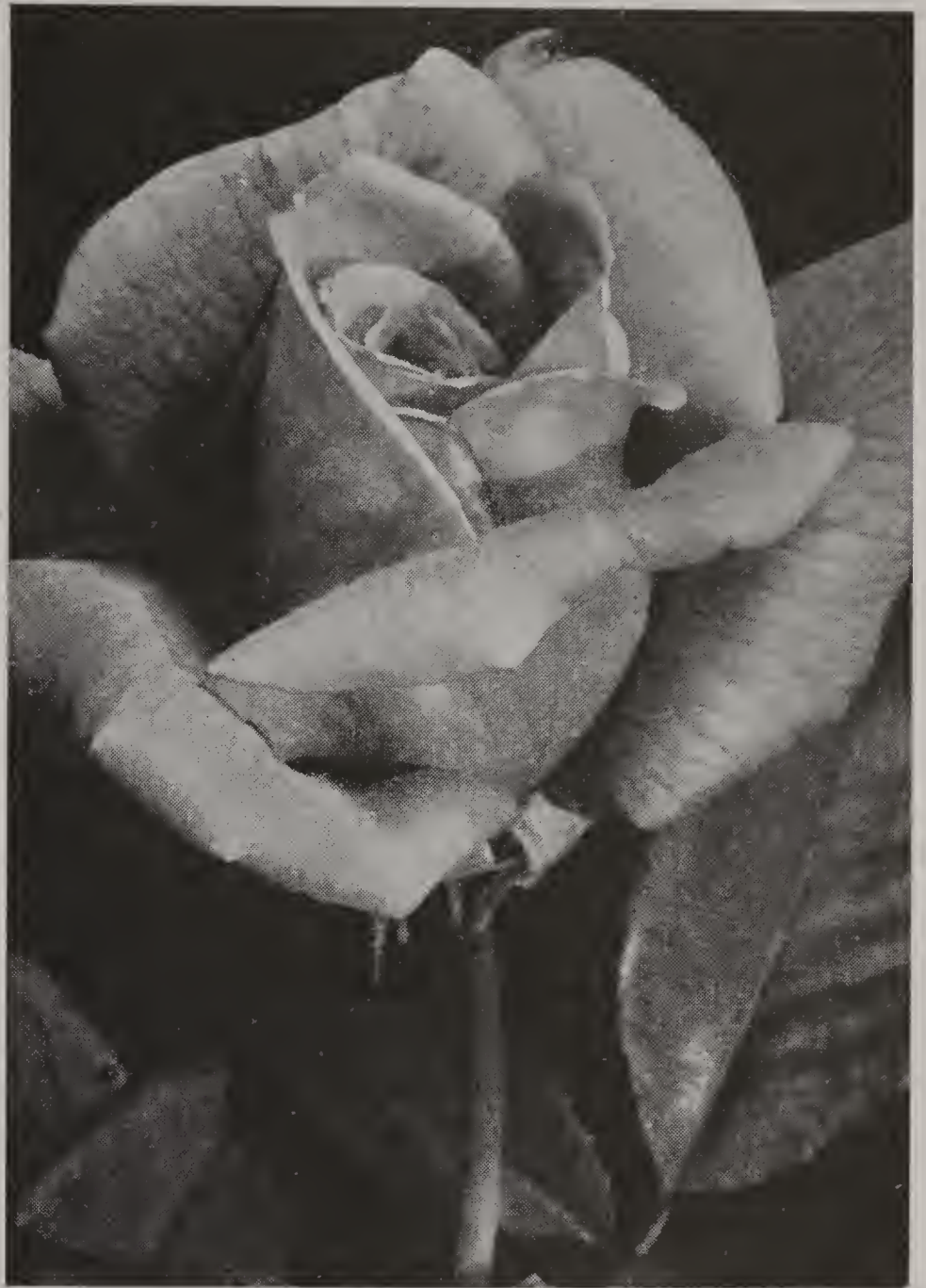

Margaret McGredy

JUNE-BLOOMING VARIETIES

- AMERICAN BEAUTY.** Dark pink shading to red.
CAPTAIN HAYWARD. Light crimson. Very large.
FRAU KARL DRUSCHKI (Snow Queen). Magnificent snow-white.
GENERAL JACK. Dark red. Very fragrant. Strong grower.
HARRISON YELLOW. Bright yellow. Semi-double.
MAGNA CHARTA. Bright pink. Very large.
PAUL NEYRON. Deep pink. Predominated in Grandmother's garden.
PERSIAN YELLOW. Small dark yellow flowers. Blooms early.

CLIMBING AND RAMBLER VARIETIES

- AMERICAN PILLAR.** Pink. (R).
AVIATOR BLERIOT. Yellow. (C).
CLIMBING AMERICAN BEAUTY. Red. (C).
DOROTHY PERKINS. Pink. (R).
DR. W. VAN FLEET. Pink. (C).
EXCELSA. Red. (R).
GARDENIA. Yellow. (R).
SILVER MOON. White. (C).
WHITE DOROTHY. (White). (R).
YELLOW RAMBLER. Yellow. (R).



Climbing American Beauty Rose

Worcester, Mass.

ROSES FOR THE NEW ENGLAND CLIMATE

Perennial Plants (Hardy Garden Flowers)

For Your Old Fashioned Garden

Two years. Several times transplanted. These are much larger and stronger plants than the ordinary run of perennials.

Ea. 19c 3 for 52c 6 for 95c 12 for \$1.75



Achillea



Oriental Poppies

- ACHILLEA.** Double white flowers. (R).
- ALYSSUM.** Compact masses of showy yellow flowers. Dwarf. (R).
- ANCHUSA.** Clusters of large gentian blue flowers. Excellent for cutting.
- AQUILEGIA** (Columbine). Mixed colors ranging from white to red and blue.
- ASTERS, Hardy.** Pink, Lilac, Lavender. Very showy. Excellent borders.
- CAMPANULA** (Canterbury Bell). Various colors.
- CENTAUREA, Montana.** Large blue flowers.
- CHINESE LANTERN PLANT.** Large orange seed pods in autumn. (R).
- COREOPSIS** (Tickseed). Bright yellow. Very hardy. A profuse bloomer.
- DELPHINIUM** (Larkspur). Various blue shades. Long handsome spikes.
- DIANTHUS** (Garden Pinks). Choice mixed colors. (R).
- DIGITALIS** (Foxglove). Various colors. Mammoth spikes.
- GAILLARDIA** (Blanket Flower). Yellow with brownish red center.
- GEUM.** Small fiery blossoms. Very showy and attractive. (R).
- GYPSOPHILA** (Baby's Breath). Small pure white flowers.
- HELIANTHUS** (Hardy Sunflower). Yellow. Tall growing.
- HIBISCUS** (Mallow Marvels). Pink, Red and White.
- HOLLYHOCK.** Crimson, Yellow, Rose-Pink and White. Double or single.
- IBERIS** (Candytuft). Dense heads of white flowers.
- IRIS, German.** Various shades. (R).
- IRIS, Japan.** Large flowers. Mixed colors. (R).
- LYCHNIS** (Ragged Robin). Scarlet Maltese Cross. Very desirable.
- PLATYCODON** (Balloon Flower). Blue and White. (R).
- PYRETHRUM** (Painted Daisy). Mixed colors. Blooms early.
- RUDBECKIA, Newmanni.** Dark orange-yellow. Resembles Black-Eyed Susan.
- SWEET WILLIAM.** Mixed colors. (R).
- TRITOMA** (Red Hot Poker). Long spikes of orange-scarlet.
- VERONICA** (Speedwell). Violet-blue flowers borne in masses.
- VIOLA** (Perennial Pansy). Bloom all summer. Yellow, Blue, Purple and White.
- YUCCA** (Adam's Needle). Tall spikes of cream-colored flowers.

(R) represents varieties adapted to Rock Gardens.



Hedge Plants

BARBERRY THUNBERGI

2-year heavy, well branched. 18-24 inch.

12 plants	\$1.70
25 plants	3.25
50 plants	6.15
100 plants	9.60

CALIFORNIA PRIVET

18-24 inch

12 plants	\$0.80
25 plants	1.50
50 plants	2.65
100 plants	4.50

California Privet makes a beautiful and economical trimmed hedge.



Paeonias—

The Rival of the Rose

Extra heavy—2-year—3 to 5 eyes

Easy to grow. Especially adapted to borders, beds and specimen plantings.

Each 38c 3 for \$1.00 6 for \$1.75 12 for \$3.25

- AMABILIS GRANDIFLORA.** White.
- B. ROTHSCHILD.** Salmon center with rose petals.
- CAROLINE MATHER.** Purple-crimson.
- COURONNE d'OR.** White, tinged with crimson.
- FELIX CROUSSE.** Bright red.
- FRANCOIS ORTEGAT.** Dark purplish crimson.
- HUMEI.** Rose-pink.
- TRIOMPHE du NORD.** Violet-rose.

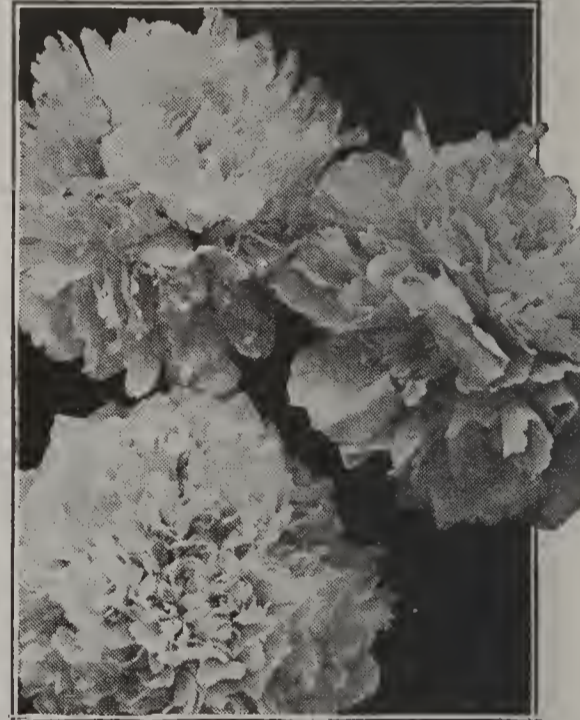

Peony, Couronne d'Or



Ampelopsis Veitchi

Climbing Vines

Each, 35c; 3 for \$1.00; 6 for \$1.85.

Very useful for porch shade and wall or fence covering.

- AMPELOPSIS VEITCHI** (Boston Ivy). Will cling to brick or concrete walls or chimneys.
- HALL'S JAPAN HONEYSUCKLE.** White blossoms turning to a bright yellow. Trumpet shape. A fast grower with dense foliage.
- SILVER LACE VINE.** Of strong vigorous growth, attaining a height of 25 feet or more, producing through summer and fall foamy sprays of white flowers that turn rose-colored as they begin to fade.
- AMERICAN PURPLE WISTERIA.** A strong, rapid-growing vine with light green foliage. (This is the Wisteria so well known among American home owners).

All items listed on pages 70, 71, 72, and 73, will be sent transportation paid at prices listed for each item.

Fruit Trees

APPLES

	Each	3 Trees	10 Trees	50 Trees
11/16 in., 4 1/2 ft. up.	\$0.79	\$2.30	\$7.60	\$37.00

BALDWIN. Red. Winter. An old favorite.
CORTLAND. Red. Autumn. Similar to McIntosh. Two weeks later.
EARLY McINTOSH. Red. Autumn. Ripens earlier than McIntosh.
GRAVENSTEIN. Autumn. Red striped with yellow. Excellent for pies.
JONATHAN. Red with yellow cheek. Winter. Excellent quality.
NORTHERN SPY. Winter. Red and yellow striped. One of the best eating apples.
RED DELICIOUS. Winter. Red. Superior to regular Delicious.
STAYMAN'S WINESAP. Winter. Red. Large and juicy.
McINTOSH. October to January. Red. One of the best.



The McIntosh Apple is one of the best

STRAWBERRY PLANTS

PRICES: 25, 50c; 50, 90c; 100, \$1.50; 500, \$6.00.

BIG JOE. (Per). Berries dark, glossy red, of fine appearance. Firm, a good shipper. Fine flavor. Late.
CATSKILL. Is a new midseason variety. It is a heavy bearer of large sized and attractive berries. It has extra long roots and will stand dry weather better than the average varieties. You will be pleased with this new berry. Order early as our supply is limited.
CORSICAN. (Per.). The flavor is mild, the berries extra large. One of the best. Good for home use, wayside stands or shipping. Midseason.
DORSETT. (Per.). New. Introduced by U. S. Dept. of Agriculture. A vigorous grower. Berries bright red, mild flavor. Early.
FAIRFAX. (Per.). New. Introduced by U. S. Dept of Agr. Makes few runners. Foliage large, dark green. Berries deep red, very sweet. Long bearing season. Early.
HOWARD 17. (Per.). One of the best early berries, bright red color, large size, very productive and firm.
MARSHALL. For years this berry has been considered the Aristocrat of New England. Berries extremely large and of the very finest flavor. Midseason.
WILLIAM BELT. (Per.). Considered the best flavored berry grown. Bears large crops of sweet, juicy berries and does extra well the second year. An old variety, but seems to become more popular each year. Late.

Everbearing Varieties

PRICES: 25, 75c; 50, \$1.25; 100, \$2.00; 500, \$8.00.

MASTODON. The berries are very large and hold their size well. Plants set in spring begin bearing in August and bear until the ground freezes.
PROGRESSIVE. An excellent berry for home use, of large size and beautiful, glossy appearance. Will yield good crop both in spring and fall.

CHERRIES

	Each	3 Trees	10 Trees	50 Trees
11/16 in., 4 1/2 ft. up.	\$1.15	\$3.35	\$11.00	\$54.00

BLACK TARTARIAN. Sweet. Black.
GOV. WOOD. Sweet. Red on white.
EARLY RICHMOND. Sour. Red.
LATE MONTMORENCY. Sour. Red.
ENGLISH MORELLO. Sour. Very late black.

PEARS

	Each	3 Trees	10 Trees	50 Trees
11/16 in., 4 1/2 ft. up.	\$0.96	\$2.85	\$9.40	\$45.60
9/16 in., 3-4 ft. up.	.54	1.50	4.60	22.00

BARTLETT. An every purpose Pear. Excellent for canning. Fruit large, pyramidal. August and September.
CLAPP'S FAVORITE. Early. Large, rich and juicy.
SHELDON. Round in form. Dark green covered with russet. Rich flavor. The tree is a vigorous grower. Unexcelled for home planting. October and November.

PEACHES

	Each	3 Trees	10 Trees	50 Trees
9/16 in., 3 1/2 ft. up.	\$0.42	\$1.22	\$4.00	\$19.30

BELLE OF GEORGIA. Yellow skin overspread with red. Flesh white and juicy. Excellent for canning. Early September.
CARMAN. Brilliant red splashed with yellow. Flesh white, juicy, pleasant and very tender. Very productive and well adapted to cold winters and dry summers. A very early variety. August.
CRAWFORD EARLY. Yellow, with heavy red blush. Flesh yellow. An old time favorite. Late August.
ELBERTA. Large yellow with red cheek. Flesh yellow. Heavy cropper. Hardy. Early September.
GOLDEN JUBILEE. large yellow overcast with red. Flesh yellow. One of the newer varieties. Late August.
J. H. HALE. Larger than Elberta. Deep golden yellow overlaid with deep carmine. Flesh deep yellow. Fine grained. Fuzzless. Early August.
SOUTH HAVEN. Another new variety. Very large. Flesh yellow. A very attractive and desirable peach. Early to medium season. September.

Strawberries from your own garden always taste better



General List of Fertilizers and Soil Builders

We make prompt delivery of fertilizers, insecticides, lawn grass and other materials, to all points within our suburban delivery area without additional charge.



\$2.00; per ton \$34.40.

Armour's 5-8-7. An ideal fertilizer for market gardeners. Price: Per 100 lbs. \$2.50; per ton \$38.45.

Armour's 4-8-4. High grade fertilizer. Price: 25 lbs. 75c; 50 lbs. \$1.20; 100 lbs.

FINE GROUND BONE. 2.47% nitrogen, 22% phosphoric acid. Price: Per 25 lbs. 95c, per 50 lbs. \$1.60, per 100 lbs. \$2.75, ton \$45.00.

TOBACCO DUST. Fine, ground; for greenhouse use this is one of the best articles for dusting all kinds of plants that are affected with insects of any kind. Per bag of 100 lbs. \$5.00, 50-lb. bag \$2.75, 5 lbs. 40c.

TOBACCO STEMS. Used for fumigating, also used by some as a top dressing for fertilizer. We can furnish these in any quantity. Prices: 5 lbs. 50c, 100 lbs. \$3.00.

STIM-U-PLANT tablets are designed for use by all who grow plants. Simply insert a tablet in the soil near each plant or dissolve four tablets per gallon of water. Price postpaid, 30 tablets 25c, 100 tablets 75c, 1000 tablets \$3.50.

Adco—For Making Artificial Manure

150 lbs. of Adco converts leaves, garden refuse or other waste vegetation into 3 tons of artificial manure by a simple composting method. Home owners, vegetable growers or florists can profit by its use. 7½-lb. pkg. \$1.00, 25-lb. bag \$2.00, 100 lbs. (4-25s) \$7.75.

IMPORTED GROUND PEAT FOR HORTICULTURISTS. Finely ground (granulated) peat is of recognized value to the florist, gardener or nurseryman. Price: Standard bale \$2.95.

CANADIAN ASHES, HARDWOOD. Valuable for potash, destroying insects and controlling diseases. For top dressing lawns; apply at rate of 1 to 2 tons per acre. 50 lbs. \$1.50, 100 lbs. \$2.50, ton \$40.00.

AGRICULTURAL GROUND LIMESTONE. Apply at the rate of 1 ton per acre. Prices: Per bag of 100 lbs. \$1.00, 500 lbs. \$3.50. Ton prices on request.

SURE CROP HYDRATED LIME. Price: 50-lb. bag 60c, 100 lbs. \$1.00. Ton prices on request.

SNOW FLUFF HYDRATED LIME. For spraying. Price: 50-lb. bag 65c, 100 lbs. \$1.15. Ton prices on request.

CLAY'S IMPORTED FERTILIZER. Highly concentrated. Sold only in original packages. 14-lb. bag \$2.00, 28-lb. bag \$3.50, 56-lb. bag \$6.50, 112-lb. bag \$12.00.

LAND PLASTER (Gypsum). For composting and dusting. Per bag of 100 lbs. \$1.25, per ton \$18.00.

ARCADIAN NITRATE OF SODA. An active, quickly soluble nitrogenous fertilizer stimulating leaf growth. For lawns, leafy vegetables, tomatoes and plants showing tardy growth. Price: 5 lbs. 30c, 25 lbs. 95c, 50 lbs. \$1.65, 100 lbs. \$2.95.

MURIATE OF POTASH 48%. A highly concentrated form of potash. Used in forcing vegetables and with a filler as a general fertilizer. Price: 100 lbs. \$2.95.

SULPHATE OF AMMONIA 20.56%. The most concentrated nitrogenous top dressing on the market. Price: 5 lbs. 35c, 25 lbs. \$1.00, 50 lbs. \$1.75, 100 lbs. \$3.00.

BLOOM AID. The complete plant food for flowers, vegetables, tubers, bulbs, shrubs and trees. A highly concentrated chemical fertilizer. 25-lb. bag \$1.50, 100-lb. bag \$4.00.

FAIRWAY FERTILIZER. Prepared especially for lawns and golf courses. Supplies food over a longer period; contains no filler; brings out that desired dark green shade on grass. 25-lb. bag \$1.50, 100-lb. bag \$4.00.

SULPHATE OF POTASH 48%. It is the most highly concentrated form in which this very important plant food element is obtainable. Price: 100 lbs. \$3.50.

Nit.	APA	Pot.	Ton	100 lbs.
6%	11%	10%	\$46.50	\$3.00
5%	8%	10%	40.40	2.75
8%	16%	14%	56.75	3.25
7%	6%	6%	40.80	2.75
4%	8%	7%	36.35	2.40
4%	16%	4%	39.20	2.75
16%	Acid Phosphate		22.50	1.45

Sold in 100-lb. bags only. All prices in this catalog subject to change without notice.



BOVUNG is COW MANURE in a CONVENIENT and CONCENTRATED FORM

- * BOVUNG is absolutely free of live weed seeds.
- * BOVUNG can be applied without fear of burning or harmful results.
- * BOVUNG supplies plant food as the plant needs it.
- * BOVUNG is clean, convenient to handle and is reasonable in price.

Prices: 25-lb. bag \$1.00, 50-lb. bag \$1.60, 100 lbs. \$3.00, 500 lbs. \$13.75, 1000 lbs. \$27.50, 1 ton \$50.00.

Lōma

THE PERFECT PLANT FOOD

For Beautiful Lawns



Loma, the scientifically prepared plant food, will give you results that are startling. Lawns velvety green; flowering plants sturdy, full-blomed and tall; vegetables such as you have never had before. Loma is rich in nitrogen. Agricultural experts will tell you that this is the most vital plant food. Loma works quickly. In a week's time you can see the difference in your lawn.

1-lb. canister for indoor plants	\$0.10
5-lb. carton, enough for 10 ft. x 10 ft.45
10-lb. bag, enough for 10 ft. x 20 ft.85
25-lb. bag, enough for 20 ft. x 25 ft.	1.50
50-lb. bag, enough for 25 ft. x 40 ft.	2.75
100-lb. bag, enough for 40 ft. x 50 ft.	4.25

SOIL- PREP

A HUMUS and FERTILIZER

Soil-Prep is rich in humus and plant food value. Will condition light, sandy and heavy clay soils. Far superior to manures and bone meal. Contains about twice the food value of refined sheep manure. Does not have unpleasant odor. Is free from weed seeds and contains no filler.

100-lb. bag	\$3.25
50-lb. bag	1.85
25-lb. bag	1.00
10-lb. bag50
5-lb. bag30

ROSS BROS. CO.

General List of Fertilizers and Soil Builders



KNOW the Joys of Successful Gardening

Have a beautiful, deep-green, weedless lawn . . . larger, more colorful flowers . . . healthy, full-foliaged shrubs and trees! You *can* have all these things if you feed VIGORO, the complete, scientific plant food made by Swift. It contains all 11 needed plant food elements.

Millions of gardeners rely on Vigoro every year. They like this clean, odorless plant food because it is so easy to use and yet gives assured results.

If you haven't tried Vigoro, we recommend that you try it this year. You'll be well rewarded if you do, because you'll find Vigoro the most effective and economical plant food you can buy. Only 4 pounds of Vigoro per 100 square feet gives a real square meal to your lawn or garden.

VIGORO

Complete plant food

100-lb. bag	\$4.25	10-lb. pkg.	\$0.85
50-lb. bag	2.75	5-lb. pkg.45
25-lb. bag	1.55	1-lb. pkg.10

Groz-It Brand Pulverized Sheep Manure

FOR MARKET GARDENERS AND SPECIALLY RECOMMENDED FOR LAWNS

Will not burn your plants, regardless of quantities used. Highly concentrated. Can be used safely at the rate of 50 lbs. per 1000 sq. ft., or as a general fertilizer for all crops from 1000 to 2000 lbs. per acre. It makes the richest and safest liquid manure, using 1 lb. to 5 gallons of water. Prices: 5 lbs. 30c, 10 lbs. 50c, 25-lb. bag 90c, 50-lb. bag \$1.60, 100-lb. bag \$2.75, ton (2000 lbs.) \$45.00.

Premier Poultry Manure

PULVERIZED POULTRY MANURE—NATURE'S BEST PLANT FOOD

Processed Poultry Manure is one of the safest and most reliable forms of plant food that can be applied to soil and will not burn or injure the most delicate and tender vegetation if used in reasonable amounts. Last, but not least, it possesses a bulk that adds available humus-forming material to the soil, and the plant food is not readily lost by leaching.

Prices: 5-lb. bag 30c, 10-lb. bag 50c, 25-lb. bag \$1.00, 50-lb. bag \$1.75, 100-lb. bag \$3.00, ton (2000 lbs.) \$50.00. Special prices in larger quantities.

SHREDDED CATTLE MANURE. 100-lb. bags \$3.00, ton \$50.00.

CALCIUM CHLORIDE. Dust layer and surface binder. One bag will cover about 50 square yards. Used also as an anti-freeze. Sold in 100-lb. bags only. 100-lb. bag, \$2.85. Prices for larger quantities on request.

Rogers & Hubbard

Bone Base Fertilizers

	100 lbs.	Ton
Hubbard's Top Dressing (8-5-8)	\$3.50	\$55.00
Hubbard's Seedling Fertilizer (3-7-6)	3.00	48.00
Hubbard's Potato Fertilizer (5-8-7)	2.95	42.00
Hubbard's Corn Fertilizer (4-8-7)	2.85	40.50

Prices on other analysis, fertilizers on request

Vigoro Spreaders

The Vigoro Spreader is an easy running, sturdy machine, built on the forced-feed principle. Every home owner needs a spreader to make his gardening more successful. It applies grass seed as well as fertilizer at a uniform rate.

16-in. Junior, 20-lb. capacity	\$ 6.50
24-in. Standard, 65-lb. capacity	11.95
36-in. Special, 100-lb. capacity	20.00
14-in. Model B, with wheels	3.00

Hotkaps



Hotkaps are waxed paper cones, easily set out in quantity over seed or growing plants. Hotkaps protect growing plants, increase yields, mature crops 2 to 3 weeks earlier, insure premium prices. Hotkap Home Garden Package. 25 Hotkaps and cardboard setter. 50c.

Special 100 package containing 100 Hotkaps, garden setter and tamper \$2.65.

Special 250 package containing 250 Hotkaps, garden setter and tamper \$3.85.

Steel Hotkap setter and tamper \$1.50.

Large package 1000 Hotkaps \$10.25 per M.

Osmo Watermat and Copper Alloy Saucer

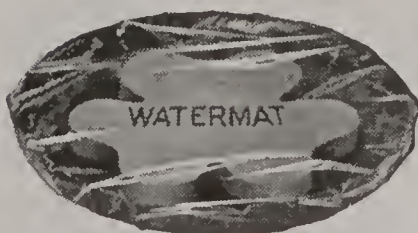

Osmo Watermat is sold in combination with a green, non-rusting copper alloy saucer.

Large or 6 inch	\$0.50
Medium or 4 1/2 inch40
Small or 3 1/2 inch35

Add 5c for Postage.

Remedies for Insects, Fungus, Etc.



NEW EVER GREEN SPRAY

Non-poisonous. Kills both chewing and sucking insects. Easy to use, just mix with water and spray. 1 oz. makes 6 gals. of spray for aphids. 1-oz. bottle 35c; 6-oz. can \$1.00; 16-oz. can \$2.00; 1-gal. can \$11.00; 5-gal. drum \$45.00.

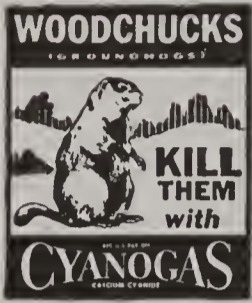

When exposed to the air, Cyanogas A-Dust gives off gas that kills these destructive pests almost instantly. One whiff is enough for any woodchuck. A heaping tablespoonful in each opening is sufficient. All openings should then be closed.

Cyanogas is also certain death to rats, moles and ground squirrels. 1/2-lb. can, 45c; 1-lb. can, 75c; 5-lb. can, \$3.00; 25-lb. can, \$10.00.

"Nico-Fume" Powder Pressure-Fumigator

"Nico-Fume" Powder is now packed in hermetically-sealed cans. It is packed in both one-half and one pound cans. Two holes are scored, ready to be punched out. A special lighter is attached to the can. 12 1-lb. tins to case, \$7.00; 6 1-lb. tins, \$3.75; 1-lb. tin, 75c; 12 1/2-lb. tins to case, \$4.20; 6 1/2-lb. tins, \$2.40; 1/2-lb. tin, 45c; Nico Fume Powder 10-lb. tin, \$5.85.

NICO-FUME LIQUID. An effective vaporizing liquid. 1 lb., \$2.25; 4 lbs., \$5.75; 8 lbs., \$10.00.

Kills Ants in the Nest



Ready Filled Set

ANTROL



Regular Set

Antrol is easy to use, economical, safe around children and pets. Consists of small glass containers from which worker ants carry special Antrol syrup to their nests for food. The whole ant family is quickly killed at the source—the only way to get permanent relief. Antrol containers are heavy glass, with rust-proof aluminum lids. Controls both sweet and grease-eating ants.

Ready Filled Sets, containing 4 filled feeders, 40c.

Regular Antrol Set, 4 containers and 4-oz. bottle syrup, 75c.

Syrup, 4-oz. bottles, 35c; pints, 85c; gallons, \$3.50.

Extra glass containers, 10c each.



Antrol Ant Traps

Kills both sweet and grease eating ants as it contains two kinds of specially prepared materials, ready to use by simply punching out the perforations on the side of the can. Antrol Ant Traps 15c each.

Stanley's Crow Repellent

The most effective way to prevent crows and other birds from pulling corn is to treat the seed with something that is repellent to them. Stanley's Crow Repellent is excellent for this purpose. The material is non-poisonous, easy to apply, will not injure seed of any kind and will not clog any planter. Directions for treating seed on each can.

1/2-pt. can, 60c. (Enough for 1 bu. corn).

1-pt. can, \$1.00. (Enough for 2 bus. corn).

1-qt. can, \$1.75. (Enough for 4 bus. corn).

Mailing weight, each 2 lbs.



ANTIPESTICK INSECT CONTROL



Spraying equipment with shut-off valve, arm extension and cartridge nozzle \$2.50.

ANTIPESTICK. Nicotine and fish oil soap. 3 cartridges \$1.00.

NODEW. Sulphur cartridges for mildew. 25c each.

FOODNDRINK. Nitrate of soda plant food. Box of 25 cartridges \$1.00.

ARSENATE OF LEAD cartridges. 20c each.



SNAROL. Cutworms, slugs, snails, grasshoppers, and other annoying pests are quickly exterminated by this amazing new preparation. Snarol is a ready prepared meal that you simply broadcast on the ground—under the flowers and plants. Water will not harm it. 1 1/2-lb. carton, 35c; 4-lb. carton, 85c; 15-lb. bag, \$3.00; 50-lb. bag, \$8.00.

Antrol Nicotine Aphis Spray

For Aphis, Thrip and Hoppers

1 1/4-oz bottle\$0.25



Antrol Pyrethrum Garden Spray

Kills both sucking and chewing insects. 1 1/4-oz. bottle, 25c; 4-oz. bottle, 75c.

Antrol Ant Powder

An improved fast-killing powder in an attractive handy shaker can. 1 1/4-oz. can, 15c; 3-oz. can, 35c.

Insecticide, Fungicide and Plant Stimulant in One Spray



TRI-GEN
Reg. U. S. Pat. Off.
The all-purpose spray

We highly recommend TRI-GEN for your roses—it not only protects them against all fungus diseases and insect pests, but it stimulates vigorous plant growth and assures healthy green foliage and luxuriant blooms.

Small kit, \$1.50 Medium kit, \$ 4.00
Large kit, \$6.00 Estate kit, \$20.00

INSECTROGEN. Kills most leaf-eating insects. Recommended to be used with Fungtrogen on roses and other plants. 4 ozs., 60c; 1/2 pt., \$1.00; 1 pt., \$1.75.

FUNGTROGEN. For mildew and black spot on roses and other plants. 4 ozs., 45c; 1/2 pt., 75c; 1 pt., \$1.25; 1 qt., \$2.00; 1 gal., \$6.00.

TEROGEN. Autumn-winter ground dressing and soil disinfectant, kills the larvae of insects, such as rose-pith borer, rose bugs, Japanese beetles, aphids and ants. 1-lb. tin, 75c; 2-lb. tin, \$1.25; 5-lb. tin, \$2.75.

MOLOGEN. (In powder form). Will in no way injure the grass or soil. Eliminates moles from lawns within two or three days. 1/2-lb. can, 50c; 1 1/2-lb. can, \$1.25; 5-lb. can, \$4.00.

Crow-Fez

Crow-Fez for use on seed corn gives the surest protection against corn pests. It protects corn during the period when it is most easily damaged, by ridding your fields of crows and other corn-pulling birds and rodents. It also helps seed rot and hastens germination.

1/2-pint can (enough for 1 bushel)\$0.35

1-pint can (enough for 2 bushels)50

1-quart can (enough for 4 bushels)75

Mailing weight, each 2 lbs.

ROSS BROS. CO.

Remedies for Insects, Fungus, Etc.

COAL TAR. For tarring corn to prevent crows from pulling it. $\frac{1}{2}$ pt., 15c; 1 pt., 25c; qt., 35c. Shipping weight, 2 lbs. and 4 lbs.

CREOSOTE FOR GYPSY MOTHS. For the destruction of the eggs of gypsy moth. Qt., 50c, shipping weight 3 lbs.; gal., \$1.25, weight, 9 lbs., 5-gal. can, \$4.50.

GRAFTEX. Scientific grafting compound. An ever-plastic compound. Endorsed by leading tree surgeons and agricultural authorities. $\frac{1}{2}$ -lb. can 50c, 5-lb. can \$4.25 each.

Kalco

KALCO (Calcium Caseinate) acts as a cohesion neutralizer. Kalco destroys the tendency toward cohesion and causes the material to spread evenly. Kalco Calcium Caseinate acts as a spreader and adhesive for spray materials. 2 lbs., 36c; 100 lbs., \$16.00.

DRY ARSENATE OF LEAD. The trade seems to demand this in the dry state as it has so many advantages over the paste. The dry will keep forever, is less bulky, does not freeze and spoil. 1-lb. canister, 35c; 4-lb. bag, 90c. Get our prices on large quantities.

Black Leaf 40

(Nicotine Sulphate, Nicotine 40 Per Cent)

BLACK LEAF 40 is the best known remedy for potato lice, thrips, leaf hoppers, etc., and other similar insects. Use about 1 to 1000 or 1 oz. will make 6 gallons of solution. 1 oz., 35c; 5 ozs., \$1.00; 1 lb., \$2.25; 2 lbs., \$3.25; 5 lbs., \$5.85; 10 lbs., \$10.60; 50-lb. drum, \$42.50.

TREE TANGLEFOOT. A safeguard against gypsy, brown-tail and tussock moth, canker worm, ants and all creeping things. 6 ozs., 35c; 1-lb. can, 75c; 5-lb. can, \$3.25; 10-lb. can, \$6.25; 25-lb. pail, \$12.00.

DRY BORDEAUX POWDER. For preventing blight on grapes, potatoes and other crops that are subject to rust, mildew and black rot; applied dry with bellows. Lb. canister, 35c; 4-lb. bag, 80c.

GRAFTING WAX. Prices: $\frac{1}{4}$ lb., 20c; $\frac{1}{2}$ lb., 30c; lb., 50c.

WILSON'S O. K. PLANT SPRAY. An excellent general contact spray for garden or greenhouse. Dilute 1 qt. to 10 gals. water. Kills aphid, thrip, red spider, lace wing fly on Rhododendrons, box mite, currant worms, etc. Prices: $\frac{1}{2}$ pt., 40c; 1 qt., \$1.00; 1 gal., \$3.00; 5 gals., \$12.00.

K-O FLY SPRAY for Cattle. Contains no tar, refuse or heavy dark oils. Will not taint milk when used as directed. Price: per gal., \$1.50. Weight 9 lbs.

IN-A-MINUTE. Will destroy bugs, roaches and similar vermin. Used for cleaning clothing, ink stains, etc. Price: 14-oz. bottle, 50c.

LIME-SULPHUR. Used for the same purpose and has the same effectiveness as the liquid form and is much easier to handle. 1-lb. cans, 35c; 5-lb. cans, \$1.35; 25 lbs., \$3.75; 100 lbs., \$10.00; 200 lbs., \$9.25 per 100.

CONCENTRATED LIQUID LIME-SULPHUR kills San Jose Scale, Oyster Shell, etc. An easily prepared spray which should be applied to trees any time between the autumn falling of leaves and the spring budding. It destroys growths injurious to the tree without in any way harming the tree itself. Simply dilute with water and apply. 1 gallon of Lime-Sulphur makes 10 gallons of spray. 1 qt., 50c, weight 3 lbs; 1 gal., \$1.00, weight 12 lbs.; 5 gals., \$3.25. 50-gal. barrel, price on application.

BUG DEATH. Reliable powder insecticide, contains no Arsenic or Paris Green. Effective against leaf-eating bugs and worms. 1-lb. pkg., 25c; 5-lb. pkg., 75c; 12 $\frac{1}{2}$ -lb. pkg., \$1.50; 100-lb. pkg., \$9.50.

GREENTOX—Rotenone Garden Spray. Controls leaf-eating and sucking insects on flowers, shrubs, fruits, etc. Kills 3 ways—by contact, by fumes, and by stomach poisoning. Greentox is non-poisonous to humans, animals, and birds. Oz., 35c; 6 ozs., \$1.00; 16 ozs., \$2.00; 32 ozs., \$3.50; gal., \$12.00.

FORMALDEHYDE. Prevents potato diseases and insures a big, healthy crop. 1 lb., 45c.

PARIS GREEN. A poisonous insoluble powder, for preventing the ravages of potato-bugs, codling moth, caterpillars, slugs. Mix 1 pound to 100 pounds of plaster, or 200 gallons of water. Lb., 50c; $\frac{1}{2}$ lb., 30c; $\frac{1}{4}$ lb., 20c.

PINE TAR. Used in the stable for cuts and bruises. $\frac{1}{2}$ pt., 20c; pt., 30c; qt., 40c.

SEMESAN. The Modern Seed Disinfectant for all agricultural purposes. Full directions with each can. Circulars mailed upon application. 2-oz. can, 35c; 1-lb. can, \$2.25; 5 lbs., \$9.90.

SEMESAN JR. For sweet and field corn diseases. 4 ozs. 35c; 1-lb. tins, \$1.00; 5 lbs., \$4.75.

SEMESAN BEL. For bulbs, roots, and tubers. 4 ozs., 45c; 1-lb. tins, \$1.50; 5 lbs., \$6.75. Semesan being a poisonous disinfectant is not available.

TOBACCO DUST. In 1-lb. package for dusting plants for lice, etc. 1 lb., 20c; 5 lbs., 40c.

FISH OIL SOAP. For destroying insects on plants, etc. Lb., 30c; 5 lbs., \$1.25; 10 lbs., \$2.00.

SLUG SHOT. A fine powder used for potato bugs and other insects. Recommended for cabbage worms. 5-lb. package, \$1.00; 1-lb. pkg., 25c.

GRAPE DUST. A readily diffusible, light weight powder Fungicide, very efficient in destroying powdery mildews and in preventing blights in greenhouses or in the open. Price: 5-lb. pkg., \$1.50; 1-lb. pkg., 40c.

CARBOLINEUM. Of the numerous preservative compounds on the market Carbolineum stands alone as time-tried and thoroughly tested. Gallon can, \$1.50, weight 11 lbs.; 5-gal. can, \$6.50.

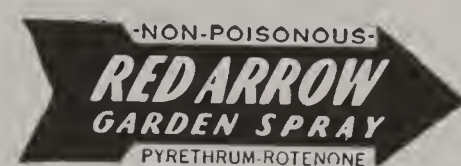

RED ARROW INSECT SPRAY.

Effective and non-poisonous. Will not stain or injure tender flowers. A contact spray that will kill both sucking and chewing insects. 1-oz. bottle, 35c; 4 ozs., \$1.00; 1 pt., \$2.70; 1 qt., \$4.80; 1 gal., \$12.50.

HERBICIDE. The original weed killer. A powerful chemical for destroying weeds and grass on roadways, paths, tennis courts, etc. Each gallon may be diluted with 50 gallons of water. 1-qt. can, 50c; 1-gal. can, \$1.50; 5-gal. drum, \$6.00; 10-gal. drum, \$10.00; 30-gal. drum, \$24.00; 55-gal. drum, \$33.00.

Dolge Weed Killer

Kills all growth on Tennis Courts, Walks and Drives. Destroys Ivy, etc., on walls, fences and courtyards.

1-qt. can (enough for 10 gals.)\$ 0.75
1-gal. can (enough for 40 gals.) 1.85
5-gal. can (enough for 200 gals.) 8.00
10-gal. can (enough for 400 gals.) 14.00
30-gal. bbl. (enough for 1200 gals.) 33.00
55-gal. bbl. (enough for 2000 gals.) 48.95

Sunoco Self-Emulsifying Spray

For scale insects, aphid and red mite on apple trees. The ideal petroleum spray is an oil that will form a perfect and permanent mixture with water. The most distinctive characteristic of SUNOCO SPRAY is that it forms a perfect, permanent emulsion and will carry to every recess and cavity of bark or foliage in which the insect pests choose to harbor.

50-gal. steel drums, per gal.\$0.31
30-gal. steel drums, per gal.36
15-gal. steel drums, per gal.44
5-gal. can, per gal. 1.00
1-gal. can, per gal. 1.25

SCALECIDE. The quality miscible oil. Dormant spray for trees, shrubs and vines. Used by leading fruit growers. Kills scale, insects, eggs, larvae and disease cankers and fungus spores wintering on the plant. Mixes instantly—dilute 1 to 15. 1 qt., weight 3 lbs., 65c; 1 gal., weight 9 lbs., \$1.55; 5 gals., \$5.50; 10 gals., \$9.50; 15 gals., \$13.25; 30 gals., \$21.00; 50 gals., \$29.00.

SULFOCIDE. A concentrated liquid sulphur fungicide. Used on both apples and peaches and all kinds of fruits, vegetables and flowers. Controls apple scab, brown rot of peaches, plums and cherries, blight and rot of potatoes, tomatoes, and melons. Used for mildew and rust on flowers and shrubs. Prices: 1 pt., 50c; 1 qt., 85c; 1 gal., \$2.25; 5 gals., \$7.50; 10 gals., \$13.50; 15 gals., \$18.50; 30 gals., \$33.00; 50 gals., \$50.00. Packages not returnable.

CUPROCIDE. (Red copper oxide). A seed disinfectant. Prevents damping-off and other fungous diseases. 4-oz. pkg., 35c; 1-lb. can, 90c; 5-lb. can, \$4.00.

TOPZOL RAT BAITS. Kills rats and mice only. Safe, economical and simple to use. Pkg., 15c.

DOGZIX. Dogs stay away. Protects shrubs, evergreens, ornamentals, etc. Dogzix is a liquid ready for instant use; simply put in clean sprayer and spray. 3-oz. bottles, 35c; 6-oz. bottles, 50c; 16-oz. bottles, \$1.00.



DOG-SKAT. Dogs and cats hate it, harmless to plants and foliage. Cut away small end of tube and suspend tube by its wire to the branches of tree or shrub. Tube, 30c each.

DOG-O-WAY. Keeps dogs away from evergreens and other plants. Harmless to children, plants and animals. Simply dust on foliage. Large size pkg., 25c.

Remedies for Insects, Rodents, Fungus, Etc.

The Sudbury Home Gardener's Soil Test Kit, \$2:00

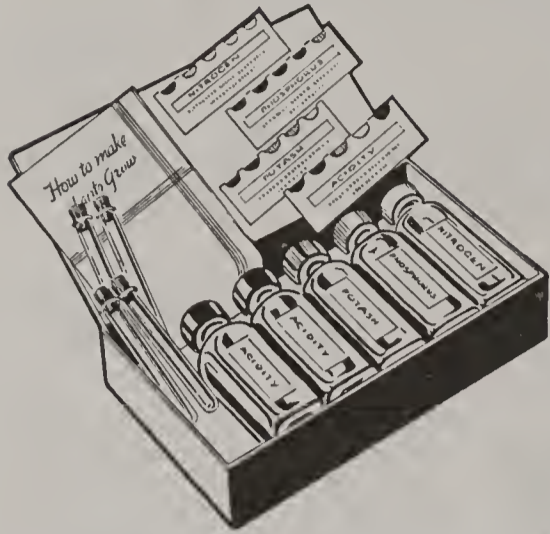

This simple, practical easy-to-use kit is your best insurance of gardening success. Made by the maker of professional field test kits used by nurserymen, growers and greenkeepers throughout the country. The Sudbury Home Gardener's Kit, an improved, larger model of the little outfit that has been so popular in the past, tests for nitrogen, phosphorus, potash and acidity. It will make at least three separate tests for each element, which means a whole year's soil testing

for most gardeners. The information will enable you to make intelligent adjustment of your soil to the requirements of your plants and grasses. No technical skill required. Results of tests are apparent immediately. The Sudbury Home Gardener's Soil Test Kit, complete with instructions and data on plant needs, \$2.00, postpaid. Horticultural Soil Test Kit (capacity 60 individual tests) \$9.75. Professional Soil Test (capacity 200 individual tests) \$18.50. Testing Fluid for Refill—Specify whether for nitrogen, phosphorus, potash, or acidity. 2 ozs. 75c, 6 ozs. \$1.50.

Pyrox

300-lb. drum \$30.00.

NICOTINE PYROX is the standard Pyrox with nicotine added to control sucking insects, as well as the chewing insects and blight. A complete spray. Prices: 17.6-oz. jar 49c, 5-lb. drum \$1.75, 10-lb. drum \$3.00, 25-lb. drum \$5.65, 50-lb. drum \$9.25.

Safe all-around spray for killing leaf-eating insects; prevents blight and fungus troubles on potatoes, vegetables, roses, fruit trees, etc. Prices: 25-lb. drum \$5.00, 50-lb. drum \$7.25, 100-lb. drum \$12.50,

ATLACIDE

CHLORATE WEED KILLER

Kills Poison Ivy and Other Weeds

5-lb. tin\$1.50
15-lb. drum 3.50

50-lb. drum, per lb.14
100-lb. drum, per lb.13 1/2
200-lb. drum, per lb.13

K-R-O

KILLS-RATS-ONLY

Will rid your premises without endangering your pets, livestock, poultry, etc. Harmless to animals other than rats and mice. Price: 2 ozs., 75c; postpaid, 80c. 4 ozs., \$1.25; postpaid, \$1.35.

Farm size, price: \$2.00; postpaid, \$2.10. K-R-O Ready Mixed, \$1.00; postpaid, \$1.10.

Magikil Jelly (Ant Bait)

Kills ants. Quick, sure, easy to use. Simply squeeze out small bits from handy tube on ant nests or where ants are running. Effective indoors or out. Garden tube, 35c. Estate tube, 85c. JUMBO tube, \$1.75. Also packed in safety traps, 3 for 25c.

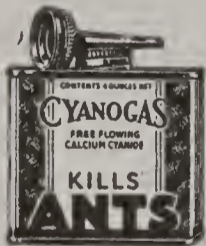

CYANOGENANTIC ANT KILLER. Ants die instantly when you drop a little Cyanogas Ant-Killer into the entrance of the nest. This 4-oz. size contains enough Cyanogas to kill a million ants. 4-oz. can, 30c.

Niagara Colloidal Spreader

With all combinations of sulphur fungicides and arsenicals, Colloidal Spreader improves the spread, increases the efficiency of the arsenical in the spray and aids in the prevention of arsenical injury. Use 1/2 lb. to 100 gals. of spray. When water is exceptionally hard, use 1 lb. to 150 gals. of spray. 1-lb. bag, 25c; case lots, 50 1-lb. bags, 21c per lb. bag; 100 1-lb. bags, 20c per lb. bag.

NIAGARA ROTENONE. (Non-poisonous). Dust or Spray. The safest bug killing dust or spray. A combination of Rotenone and Pyrethrum with a smooth, fast dissolving carrier. 1-lb. canister 55c; 4-lb. bag \$1.45.

NIAGARA BEAN BEETLE DESTROYER. Dust or Spray. This material contains sufficient Magnesium Arsenate to "knock them dead" without burning the foliage. 1-lb. canister 28c; 4-lb. bag 60c.



Pomo-Green

The Leaf Green ALL-IN-ONE Dust or Spray

A single all-purpose dust and spray which we can recommend. Because of its color it is practically invisible. Effective against both chewing and sucking insects (Aphis) and will positively control most of the diseases of flowering plants and shrubs. Highest rating given in tests conducted by American Rose Society.



PRICE:

1-lb. can Pomogreen with nicotine\$0.75
5-lb. can Pomogreen with nicotine 3.00
1-lb. can Pomogreen without nicotine50
5-lb. carton Pomogreen without nicotine 1.75

Niagara Kolofog

A highly effective sulphur spray for use on apples and peaches replacing lime and sulphur solution in all sprays following dormant or delayed dormant. Because of its great adhesiveness it makes an excellent carrier for Arsenate of Lead and is especially recommended for use in the calyx and first cover spray. Will not russet fruit or burn foliage. In the later sprays where the excellent sticking qualities of Kolofog may be objectionable, we recommend the use of Niagara Pre-Harvest Kolofog. Price: 48-lb. carton (8 6-lb. bags), \$4.50; 6-lb. bag, 75c.

Niagara Pre-Harvest Kolofog

A modified form of Kolofog containing more free sulphur and less colloidal sulphur. Because of the smooth almost invisible dusty coverage obtained with Pre-Harvest Kolofog, this material is recommended for use in all sprays following the first or second cover spray, no lime need be added. Price: 48-lb. carton (8 6-lb. bags), \$4.75; 6-lb. bag, 75c.

NIAGARA VITIDUST. The Standard Copper-Lime and Poison Dust for apples and grapes, used to control disease and chewing insects. Per 100-lb. drum, \$6.55.

NIAGARA D-18. The Standard Copper-Lime and Poison Dust used to control potato bugs and diseases on all truck crops. Per 100-lb. drum, \$7.50.

NIAGARA D-25. The Standard Copper-Lime Dust, used for the control of diseases only, on potato and truck crops. Per 100-lb. drum, \$6.25.

NIAGARA A-1 NICOTINE DUST. The Standard Contact Dust, used to control sucking insects, aphids, red bugs, pear psylla, etc. Per 100-lb. drum, \$10.30.

For small quantities of the four above materials, add \$1.50 per 100 lbs. for 50-lb. drums, and \$2.50 per 100 lbs. for 25-lb. drums.

NIAGARA KOLODUST. The New Exclusive NIAGARA Dust that "sticks through rain and wind." This is a fungicide only, used in the control of diseases on fruit and flowering plants. Per 100-lb. bag, \$5.15.

NIAGARA KOLOTEX. The New Exclusive NIAGARA Sulphur and Poison Dust that "sticks through rain and wind." This is a fungicide and stomach poison combined, used for the control of codling moth, strawberry weevil and diseases on apples, pears, etc. Per 100-lb. bag, \$6.55.

NIAGARA KOLOKIL. The New Exclusive NIAGARA Sulphur and Poison Dust containing extra large percentage of Arsenate of Lead. This material is used wherever extra heavy ravages of chewing insects prevail; also in controlling such diseases as may be present. Per 100-lb. bag, \$7.10.

NIAGARA DUO-BORDO. Makes a real Bordeaux Mixture. Packed in 50-lb. cartons consisting of 5 bags of bluestone and 5 bags of lime—enough for 250 gals. of spray. Price: per 50-lb. carton, \$4.00.

NIAGARA COPODUST. The New, Exclusive Niagara Copper-Lime Fungicide for potatoes and other field crops. Per 100-lb. drum, \$6.55.

NIAGARA COPOTEX. The New, Exclusive Niagara Copper-Lime Dust for field crops, with poison added, for potato bugs, etc. per 100-lb. drum, \$8.80.

ROSS BROS. CO.

Dusting Machines and Equipment

Niagara Dusters

ORCHARD POWER DUSTERS. From \$240.00 up.

CROP TRACTION AND POWER DUSTERS. From \$160.00 up.

Details and prices on request.

NIAGARA CRANK TYPE HAND-OPERATED DUSTERS. Continuous feed—best made. \$16.00.

FOUR NIAGARA PLUNGER TYPE HAND DUSTERS.

"Pint" Duster. Mailing weight 2 lbs. 75c.

"Pint" Extension Duster. Mailing weight 2 lbs. \$1.00.

"One Quart" Duster. Mailing weight 3 lbs. \$1.25.

"Two Quart" Duster. Mailing weight 4 lbs. \$2.50.

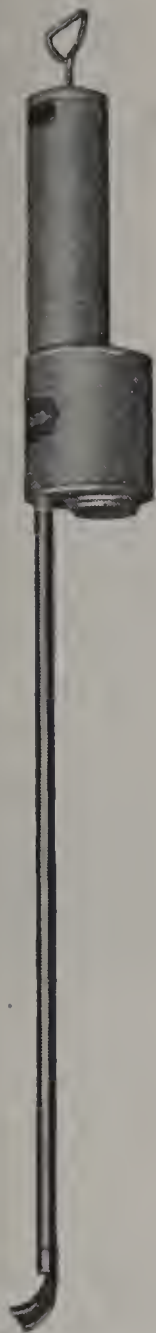

Savage Duster

Sprays Everything in Powder Form

Easy to carry and operate. Discharge tube may be raised or lowered for low or high plants or trees. Built of the finest material and workmanship and made to stand long, hard service. Price, \$20.00.

Platz Famous Hand Duster

Its agitator will crush and sift sulphur as well as the standard dusting materials. Capacity, one pound. Price, \$6.00.

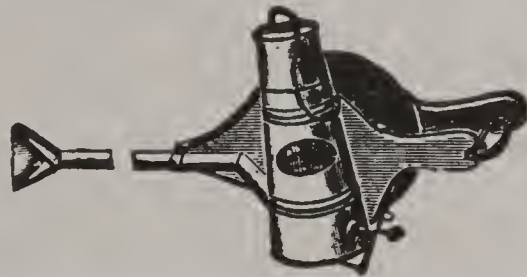

Platz Green Hand Duster

Not illustrated.

Price, \$7.00.

Acme Powder Gun

A simple, practical implement for the extermination of potato-bugs and all kinds of insects, flies, etc.; the pests of home and garden. Price, \$1.75. Mailing weight 4 lbs.

KILL DANDELIONS

Amazing new way to eradicate dandelions and other ugly lawn weeds. Kills roots completely for all time. Beautiful lawn thereafter. Wonderfully quick, easy method—merely touch the dandelion with our special No-Stoop Applicator and the entire plant DIES, dries up and blows away. Starts turning weed black within one hour after application.

No digging, no pulling, no stooping. . . . Dan-D-Lion Killer Kemical in the special No-Stoop Applicator does all the work! Complete satisfaction guaranteed or your money back.



SPECIAL "GET-ACQUAINTED OUTFIT"

No-Stoop Applicator . \$1.25

Killer Kemical (enough to kill 1500 weeds) 1.05

Regular Cost \$2.30

LIMITED OFFER. Complete, ONLY \$1.95

KILLER KEMICAL

(Without Applicator)

1/2-gal. can \$1.45

1-gal. can 2.35

5-gal. can 9.85

Also Available in 10, 30 and 55 Gallon Drums



Insecticides and Fungicides



PYROTE (Mechling's). Double acting concentrated insect spray for flowers, plants, fruits and vegetables. Harmless to humans and animals. Does not injure vegetation. Pyrote is a proper combination of pyrethrum and Rotenone with a neutral soap spreader. Kills chewing and sucking insects such as aphids, beetles, worms, etc. 1-oz. bottle, 35c; 6-oz. bottle, \$1.00; 1-pt. can, \$2.00; 1-qt. can, \$3.50; 1-gal. can, \$12.00.

MAGNESIUM ARSENATE (Mechling's). Used extensively for control of Mexican Bean Beetle. 2-lb. bag, 60c; case of 20 2-lb. bags, 50c per bag; 100-lb. drum, \$24.00.

MEXICAN BEAN BEETLE DESTROYER (Mechling's). Contains Magnesium Arsenate. Dust or spray. Effective control of Mexican bean beetle. A wonderful, smooth powder that can be dusted on plants or quickly made into a wet spray by the addition of water. 1-lb. can, 35c; 4-lb. bag, 75c.

Niagara Flower Garden Dust or Spray

An exceptionally economical insecticide and fungicide combined containing sulphur and lead arsenate in just the right proportion to kill all of the leaf and blooming insects and bugs. 1-lb. canister, 35c; 4-lb. bag, 90c.

Niagara Vegetable Garden Dust or Spray

A general purpose all-around material that can be dusted on the plants or mixed with water and sprayed. Just exactly the correct combination of Bordeaux and Calcium Arsenate to do the job. 1-lb. canister, 45c; 4-lb. bag, \$1.25.



CYANOGAS G-FUMIGANT. Scatter it over the greenhouse walks, and close the house for the night. One cent more than pays the cost of fumigating 1000 cubic feet in a greenhouse. Ask for "Cyanogas Handbook for Greenhouses and Nurseries" — contains complete directions. 5-lb. can, \$3.00; 25-lb. can, \$10.00.

AUXILIN

THE MIRACLE ROOT GROWER

Now Available

REAL ROOTS FROM CUTTINGS FASTER—Surer—CHEAPER

1/6 oz., 50c; will treat up to 600 cuttings. 1/2 oz., \$1.00; will treat up to 1,800 cuttings. 3 1/2 ozs., \$6.00; will

treat up to 12,000 cuttings. 8 ozs., \$12.00; will treat up to 30,000 cuttings. Difficult cuttings from plants, shrubs, trees root easily, quickly. See photograph of American Holly rooted in 6 weeks. You get more, larger and healthier roots. Less disease. You need no special skill or equipment. Complete with graduated phial and full directions. Add water only. Add 10c for postage.



ANSUL FORMALDEHYDE DUST. For perfect control of "damping off" diseases of flower and vegetable seedlings. Price: 1-lb. can, 75c; 5-lb. can, \$2.00.



McCormick-Deering Tractors - Plows - Harrows - Drills

Tractors

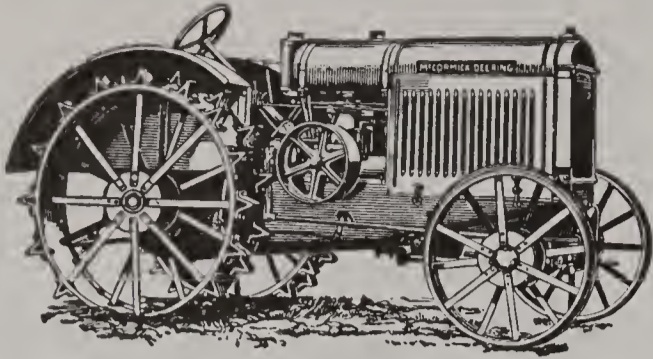

They have outstanding performance records in length of service, work accomplished, and low cost of operation in all types of farming and are now offered at new low prices. Come in and ask us all the questions you wish about these versatile profit-producing power plants. Illustrated circular on request.

PRICES: F.O.B. Boston.

10-20	\$ 990.95
F12 Farmall	647.00
F20 Farmall	1025.00
F12 Farmall with Rubber Tires	865.00

Little Genius Tractor Plow No. 8

No. 8 Little Genius plows are easy to set up and easy to adjust to varying plowing conditions. They can be equipped with any standard type of bottom—all McCormick-Deering tractor plow bottoms being interchangeable on the Little Genius beams. Equipped with 2 14-inch bottom plows (general purpose) combination coulter and jointer. Price \$132.50. 5% discount for cash.

Little Wonder Tractor Plow No. 2

For Small Tractors

Equipped with 2 14-inch bottom plows (general purpose) combination coulter and jointer. Weight 582 lbs. Price \$105.00. 5% discount for cash.

Tractor Disk Harrow

Built in 5, 6, 7, 8, 9, and 10-ft. sizes to fit any tractor. Prices on application.

Fertilizer Drill

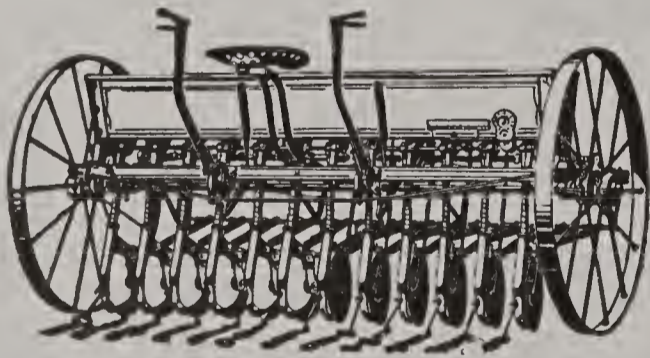

A Grain Drill will decrease the quantity of seeds used and increase the yield. Price on application.

All prices in this catalog are subject to change without notice.

Two-Way Success Sulky Plow No. 1

The ideal plow for irrigated fields and for sloping or hilly land where dead furrows mean undesirable ditches.

Quick-detachable shares, 13-inch rolling coulters, 2-horse steel evener. Price, \$115.00. 5% discount for cash.

Disk Harrow

Has 12 16-inch disks and weight boxes. Very strong and durable. Weight 387 lbs. Price includes weight boxes, scrapers and 2-horse hitch. Ask for price.

Knife Grinder

Price\$6.00

No. 3 Potato Digger



By the use of two front wheels, the crushing and mutilating of potatoes is avoided. Weight 153 lbs. Price, \$27.50. 5% discount for cash.

Potato Digger

McCormick-Deering Potato Digger will dig your crop quickly and economically. Less power, less labor, stronger construction, digging better potatoes that bring better prices.

These diggers get all the potatoes whole and unbruised. Regular equipment consists of vine turners, including kickers, shaker, 2 extra rollers, sprockets, wheel type truck, main wheel lugs, pole, neck-yoke and hitch. Price, No. 5 with rod link elevator, 6 ft., \$172.50. 5% discount for cash.

Chattanooga Hillside Plows

All sizes are equipped with chilled shares, one extra share shipped with each plow. Furnished in four sizes as follows:

No. 207. 1-horse, light, depth 4 in., width 8 in. with wheel, weight 65 lbs. Price \$14.75.

No. 208. 1-horse, regular, depth 5 in., width 9 in. with wheel, weight 75 lbs. Price, 16.50.

No. 209. 2-horse, regular, depth 6 in., width 12 in. with wheel and jointer, weight 130 lbs. Price, \$25.00.

No. 210. 2-horse, heavy, depth 7 in., width 14 in. with wheel and jointer, weight 157 lbs. Price, \$31.75.

5% discount for cash.

Nos. 207, 208, and 209 come regularly equipped with solid steel moldboards. A hard steel board can be furnished on special orders.

The beam is made of 2 flat steel bars, trussed together in such a way as to form a beam that is both light and strong. The beam and handles are long, giving good leverage, both while plowing and when reversing the bottom.

All Steel Manure Spreader



This wagon style of Manure Spreader will go through gates, barn doors, stables, etc. Easy to load. Easy to haul. The best, lowest in price, most durable Manure Spreader on the market.

Six conveyor speeds permit placing more or less manure on certain spots as desired. The driver can instantly regulate the quantity of flow while the spreader is in operation. The short wheelbase, tracking of the front and rear wheels, and the auto-steer front truck make the McCormick-Deering a strong, durable, light-draft spreader.

Weight 1500 lbs. Get our prices before purchasing.

Headquarters for McCormick-Deering Farm Equipment

ROSS BROS. CO.

McCormick-Deering Farm Equipment

Vertical Lift Mowers

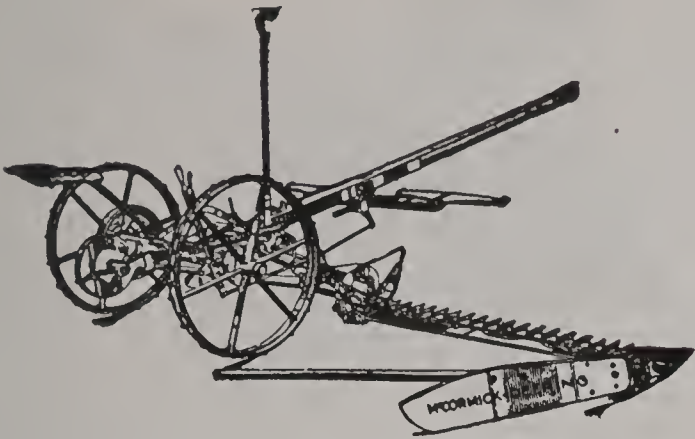

This mower, so well known by the farmer in general, is particularly adapted for New England use. The main lifting lever is equipped with automatic locking device. Equipped with tongue, neckyoke, whiffletrees, and 2 knives.

5-ft. Vertical Lift, 725 lbs.
6 ft. Regular Lift, 800 lbs.

Ask for price.

Vertical Lift One-Horse Mower

A One-Horse Mower practical for the farmer who has small acreage of hay to cut and for the truck farmer, the poultry farmer, the man who has large premises or yards; for use in large lawns, parks, orchards, cemeteries, golf grounds, etc.

4 ft., 570 lbs. Ask for price.

Mowing Machine Knife Sections

Per box of 25 sections, \$1.50.
Section rivets, 25c per lb.

Steel Frame Rake

8 ft., 25 teeth. Price, \$50.75. 5% discount for cash.

Windrow Hay Loader

A hay loader is just as essential as a side delivery rake for the economical handling of hay. It does quicker and better work and at the same time saves labor. Weight with forecarriage, 915 lbs. Ask for price.

Side Rake and Tedder

Weight 940 lbs. Ask for price.

Hay Tedder

Ask for price.

Spring Tooth Harrow

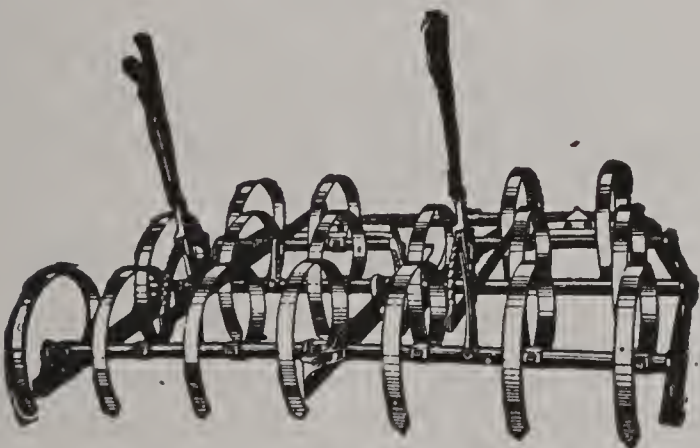

A harrow made for every kind of work. It will take hold and pulverize where other makes have failed.

9-tooth, 1-horse	\$18.50
15-tooth	28.00
17-tooth	30.00

5% discount for cash.

Spike-Tooth Smoothing Harrow

Designed as a leveling harrow and for covering all kinds of grain and grass seed; also largely used for cultivating corn and potatoes just after they come up. Price: 60 teeth, \$25.50. Weight 226 lbs. 5% discount for cash.

Pivot-axle Riding Cultivator

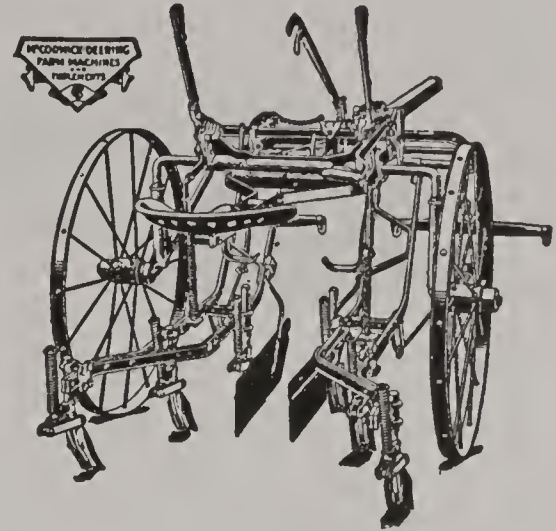

Equipped with 8 double-pointed shovels and trip-slotted shanks. This style is especially adapted for the Eastern States. Can be adjusted from deep to shallow work, wide and narrow cultivation, without leaving the seat. Equally good on Corn, Potatoes, Peas, Beans, etc. Weight 508 lbs., Price, \$78.50.

Disc Hillers complete, extra, per pair, \$5.25. 5% discount for cash.

5-Tooth One-Horse Cultivator

Price, \$12.00. 5% discount for cash.

Dixie Wonder Cultivator

Can be adjusted to throw the soil to the rows or away from them. An excellent soil mulcher and weed killer. With wheel, \$13.50. 5% discount for cash.

Fertilizer Distributor

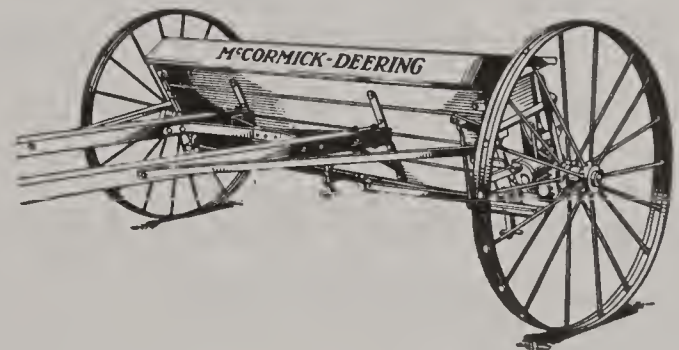

Distributes evenly all kinds of commercial fertilizers in large or small quantities. Limes 10 to 2350 pounds per acre. Instantly adjustable for different fertilizers and quantities without stopping machine. It is undoubtedly the lightest draft distributor on the market, light in weight, yet strongly built. The bottoms are lead-coated to resist corrosive action of fertilizer. One man can easily remove all distributing parts, clean and reassemble them in 5 to 10 minutes time. This machine can also be used as a broadcast seeder for sowing small grains, such as wheat, oats, barley, etc.

7-ft., weight 655 lbs., \$93.50.
9-ft., weight 729 lbs., \$110.00.

5% discount for cash.

Potato Planter

Plants a greater range of seed, both as to size and shape, than ever before and handles it with the least possible friction or wear.

List price, with fertilizer and attachments, and tongue truck wheel, \$165.00. 5% discount for cash. Weight 950 lbs.

Two-Row Corn Planter

Will plant in drills or hills and is adjustable for rows from 28 to 48 inches apart. Price quoted upon application.

The Banner Root and Vegetable Cutter

A self-feeder; separates the dirt from the cut feed, and leaves the cut feed in such condition that the stock cannot choke.

No. 20. For hand power	\$26.50
No. 16. Hand and power	44.00
No. 7. Hand power for poultry	9.00

Worcester, Mass.

Garden and Farm Equipment

Wiard Swivel Plows

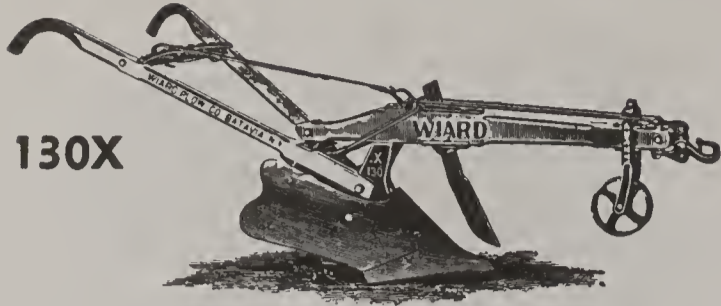

No. 130X

- No. 130X. Wood beam, medium 2-horse plow, steel moldboard\$28.25
- No. 140. Wood beam, medium, 2-horse plow, steel moldboard 30.00
- No. 120. Steel beam, medium, 2-horse plow, steel moldboard 31.25
- No. 126. Steel beam, heavy, 2-horse plow, steel moldboard 32.00
- No. 22. Wood beam, light 1-horse plow, cast moldboard .. 14.85
- No. 21. Wood beam, regular 1-horse plow, cast moldboard 15.95

5% discount for cash.

We also carry a full line of Wiard landside and contractors' plows. **Prices on application.**

The Wiard Reversible or Two-Way Power Sulky Plow

(Lift and trip operated by hand or foot)

With Shifting Pole, Automatic Shifting Clevis, and Adjustable Tilting Seat and Steel Wheels.

- No. 400A. 2 or 3-horse. Weight 550 lbs. Price: With chilled moldboards and point, \$121.00. Add for steel moldboards, \$3.00. 5% discount for cash.

Milk Cooling Equipment

Glenn Units and Tanks for Wet and Dry Installations
McCormick Deering Coolers

Ask us for information and prices.

Clark "Cutaway" Double Action Tractor Harrows

This harrow is the late model Flexible Tractor Harrow. Prices and folders on request.

- A-6. 24 16-inch discs, 6½-ft. cut, 790 lbs., rigid type. . \$118.75
 - A-6. 24 16-inch discs, 6½-ft. cut, 765 lbs., flexible type 120.50
- 5% discount for cash.

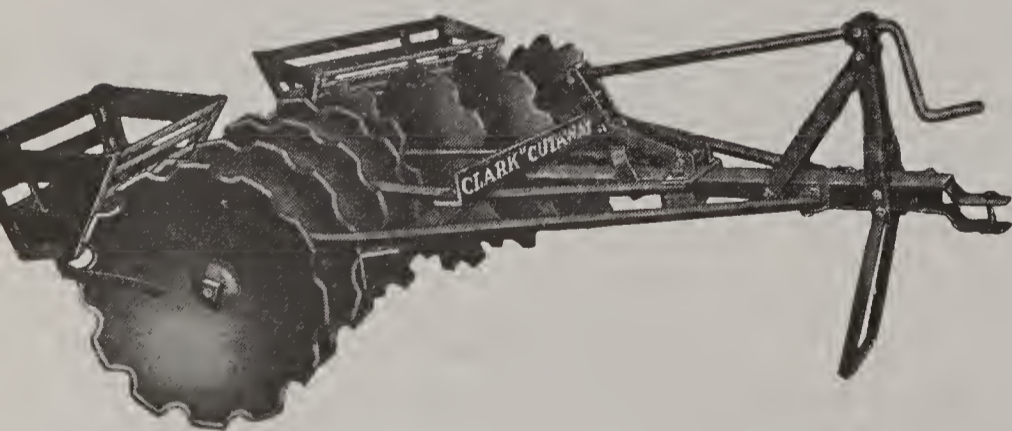

Clark "Cutaway" Wonder Disker

A remarkably efficient implement for subduing brush land, bog land, cleared woodland, drained swamps, etc. Ideal for thorough and economical orchard cultivation, including sod breaking and disking-in cover crops. Price: 8 24-in. disks, 6-ft. cut, adjustable tractor hitch reversing irons, weight carriers, \$127.85. 5% discount for cash.

Clark One-Horse Cutaway Harrow With Shifting Levers

Weight 245 lbs. Price, \$47.80. 5% discount for cash.

Clark's Utility One-Horse Cutaway Harrow

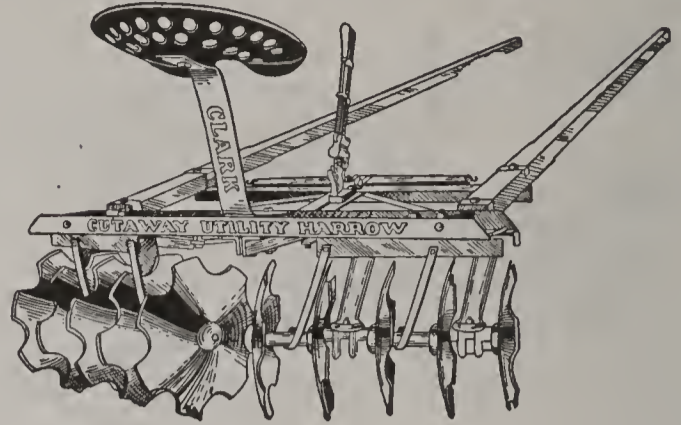

Adapted to the needs of small farmers and fruit growers. It has 10 14-inch cut-out steel discs.

No. of Discs.	Diam. of Discs.	Width of Cut.
10	14 in.	4 ft.

Price \$39.95. 5% discount for cash.

Clark Reversible Single Action Cutaway Harrow

Like those on all other Cutaway implements, the discs on this harrow are the famous Clark cutlery steel discs forged sharp.

No. of Machine	No. of Discs.	Diam. of Discs.	Width of Cut.
A-6	12	16 in.	6 ft.

2-H hitch. Shipping weight 315 lbs. Price, \$57.75. 5% discount for cash.

No. 8, One-Horse "Acme" Harrow

This style has 8 coulters, crushing shoes and seat; works 4 ft. 4 in. wide. Weight 90 lbs. Price, \$26.00. 5% discount for cash.

The Acme Pulverizing Harrow

A general purpose harrow that will crush, cut, lift, turn, smooth and level the soil to perfection all in one operation. It prepares a perfect seed bed, and also covers seed in the best manner.

No. 23. Regular size. 1 and 2-horse, made in 2 sections. Price \$33.50. 5% discount for cash.

"Wiard Yankee" Horse Rake, 25-Tooth

This type of rake has been used by New England farmers for half a century.

Ask for price.

Meeker Smoothing Harrow

The discs grind all lumps very fine and mash small stones below the surface better than any field roller.

- 4 ft. 6 in. x 4 ft. with 8-in. discs, 175 lbs.\$40.00
 - 6ft. 8 in. x 6 ft. with 8-in. discs, 200 lbs. 47.00
 - 8 ft. x 6 ft. with 8-in. discs, 300 lbs. 60.00
 - 6 ft. 8 in. x 6 ft. with 10-in. discs, 250 lbs. 50.00
 - 8 ft x 6 ft. with 10-in. discs, 350 lbs. 70.00
- 5% discount for cash.

Spike-Tooth Cultivator

This cultivator is designed for cultivating between small fruits. Price, \$10.50. 5% discount for cash.

The New England Cultivator

Heavier and more rigid than the ordinary cultivator. Equipped with the horse hoe and hilling attachment. Complete with expanding lever. Price, \$19.00. 5% discount for cash.

Galvanized Standard Hardware Cloth

Standard Widths 24 in. to 48 in. Inclusive.
Rolls of 100 lineal feet.

- 2 x2 Mesh, per 100 sq. ft.\$5.00
 - 2½x2½ Mesh, per 100 sq. ft. 5.25
 - 3 x3 Mesh, per 100 sq. ft. 5.30
 - 4 x4 Mesh, per 100 sq. ft. 5.60
 - 5 x5 Mesh, per 100 sq. ft. 5.70
- Per 100 Sq. Ft.
- For rolls 12 to 17 in. for 2x2 mesh only, add\$1.00
 - For rolls 18 to 23 in. for 2x2 mesh only, add75
 - For 50-ft. rolls add15
 - For 25-ft. rolls add30

ROSS BROS. CO.

Farm and Garden Equipment

"King of the Cornfield"



Corn, Pea Planter, and Fertilizer Distributor.

Does perfect work, not only in planting corn in hills or drills, but does equally as good work planting peas, beans and all similar seeds, putting in the fertilizer as well. **Price \$49.75. 5% discount for cash.**

Eclipse Corn Planter and Fertilizer Distributor

Plants field or ensilage corn, beans, peas or beet seeds in hills. It will drop 6, 12, 24, or 36 inches apart. **Price, complete, \$51.50. 5% discount for cash.**

The Goslee Improved Marker

Adjustable tooth spreads 2 to 4 ft. **Price, \$22.50. 5% discount for cash.**

Thompson's Grass Seeders



For broadcasting Grass, for sowing Red Top, Clover, Timothy, and all mixed seeds. Light, strong and simple.

SEEDER No. 5. Sows Clover, Timothy, Hungarian Millet, Alfalfa, chaffy seeds like Red Top, Orchard Grass and Kentucky Blue Grass. **Price, \$18.00.**

No. 4, GRAIN SEEDER BOX. 10 feet, for sowing all kinds of grain. Fits No. 5 Seeder, and with both boxes all kinds of grain and grass seeds can be sown. **Price, \$11.00.**

No. 5 SEEDER and No. 4 GRAIN BOX. **Price, \$29.00.**

Cahoon's Improved Broadcast Seed Sower

Will sow all kinds of grass and grain seeds from 4 to 8 acres per hour at a common walking gait. Heavy seeds, such as wheat, it will throw 40 feet (20 feet from each side of the operator); lighter seeds, of course, will not be thrown so far. **Price, \$4.25. 8 lbs.**

The Cyclone Broadcast Seeder

Will sow Timothy, Clover, Wheat, Oats, Rye, Buckwheat, Hungarian, Red Top, Millet and all other grains and seeds perfectly even. **Net price, \$2.75. Mailing weight 2 lbs.**

Wright's Animal Tether

Designed to obviate the danger of horses and other animals becoming entangled in the rope with which they are fastened. Consists of a pole about 10 feet in length, connected with an upright bar, upon which it turns in any direction. **Price, \$6.00.**

Kraut Cutters

Number	Knives	Size	Each
10B	3	9x26	\$1.75
65E	3	11x30	3.00

Fairbanks Portable Platform Scales

Number	Capacity	Price
1124	1000 lbs	\$24.20
1128	500 lbs.	21.10

Two-Horse Steel Land Roller

Runs on hardwood oiled bearings, which can be easily renewed in case of wear. An up-to-date roller in every respect. **Price, \$46.50. Less 5% for cash. 1-horse roller, 2-section, \$41.50.**

Buch Water Ballast Lawn Roller



The Buch water ballast lawn roller is electric welded making one solid drum. Can be filled with water or sand.

No.	Diam. Inches	Length Inches		Weight Empty	Filled With Water	Price Each
605	14	24	Plain	60	175	\$ 9.75
606	18	24	Bearing	82	265	11.50
608	24	24	"	105	420	15.20
602	18	24	Roller	85	265	13.50
603	24	24	Bearing	110	420	17.20
604	24	32	"	130	565	19.70

The Worcester Weeder

The best implement made for preparing a seed bed. Will pay for itself in one season. In cultivating corn it should be used before the crop is up and immediately after. Destroys the weeds but does not injure the crop. **Price, \$16.00. 5% discount for cash.**

Wood Beam Shovel Plow

Very handy for furrowing out rows and for hilling up. **Price, \$6.50.**

Steel beam shovel plow, \$6.50.
5% discount for cash.

Automatic Hand Corn Planter

Very handy for replanting and for small gardens. **Price, \$3.00. Mailing weight 5 lbs.**

The Segment One-Hand Corn Planter

Lightest, most accurate, strongest and most up-to-date planter on the market. **Price, \$2.00. Mailing weight 5 lbs.**

The Worcester Horse Hoe and Hiller With Steel Wings

The best implement made for furrowing, covering and hilling potatoes and similar crops. All potato growers know the value of this tool and none of them attempt to get along without it. It is necessary to cover young plants completely when just out of the ground. **Price, \$15.50.**

The Worcester Horse Hoe and Furrower with Disc Wings

The Worcester Horse Hoe and Hiller, with exception of discs, which are used in place of steel hillers or covered wings. All potato growers should have one of these two implements. **Price, \$16.75.**

Planet Jr. Farm and Garden Tools

No. 12 Planet Jr. Double and Single Wheel Hoe

Price, \$11.50



Planet Jr. Double Wheel Hoes are almost universally used by professional vegetable growers. They will straddle the crop, hoeing both sides of the row at once and until the plants are 20 inches high. The No. 12 includes all the equipment usually required for gardening—a pair of hoes for shallow cultivating and weeding, four steel cultivator teeth for general cultivation and a pair of plows for hilling, furrowing, etc. A long bolt and ferule are furnished for changing to a single wheel hoe for later cultivation.

No. 11 Planet Jr. Double Wheel Hoe—\$14.50

Same as the No. 12 but with additional equipment including a pair of 4½-inch hoes, a pair of 3-tooth rakes and a pair of 5-tooth rakes.

No. 13 Double Wheel Hoe—\$8.75

Same as No. 12 but equipped with one pair of hoes only. Used by thousands of market gardeners for weeding and shallow cultivation.

No. 16 Planet Jr. Single Wheel Hoe

Price, \$9.00



Planet Jr. Single Wheel Hoes are light, easily handled and do beautiful work. They are all steel except the handles—practically indestructible. Handles are adjustable for any height. No. 16 includes all equipment usually required in a garden—hoes for weeding and shallow cultivation—three steel cultivator teeth for general cultivation—a plow for furrowing, ridging etc.—one 3-tooth and one 5-tooth rake for fine cultivation, raking, etc.

No. 17 Planet Jr. Single Wheel Hoe—Price \$8.00

This is exactly the same machine as the No. 16 except that it does not have the leaf guards or the rakes. It is the most popular single wheel cultivator for home garden use.

No. 17½ Planet Jr. Single Wheel Hoe—\$7.00

Same as the No. 17 less the plow.

No. 18 Planet Jr. Single Wheel Hoe—\$6.00

Same as the No. 17½ less the cultivator teeth. Used extensively by market gardeners.

No. 119 Planet Jr. Garden Plow

A complete low-priced all-around Garden Plow. 24-inch Steel Wheel, 1¼-inch rim. Light, easy running and does fine work. Can be used for weeding, cultivating, furrowing, hilling, etc.

Price, \$4.00



No. 119W
Planet Jr.
Garden Plow,
\$4.50

Same as No. 119 but with a 5-prong forged spring steel weeder attachment in place of the reversible scuffle blade.

No. 4 Planet Jr. Combined Seeder and Single Wheel Hoe

Price, \$19.50



A combination of the most useful tools for a moderate sized garden. Plants almost all vegetable seeds in continuous rows or in hills 4, 6, 8, 12 or 24 inches apart. An adjustable plow opens a straight narrow furrow, the seeds are dropped in it, are covered and the soil firmed and the next row marked out all in the same operation. Converted into a single wheel hoe by changing one bolt. Cultivating equipment includes all the essential equipment for hoeing, weeding, cultivating, plowing, furrowing, ridging, etc. The tools are oil hardened and tempered and will wear almost indefinitely.

No. 4D Planet Jr. Seeder—\$15.50

Exactly the same as the No. 4 above but without the cultivating attachments.

No. 25 Planet Jr. Combined Seeder, Double and Single Wheel Hoe

Price, \$23.50

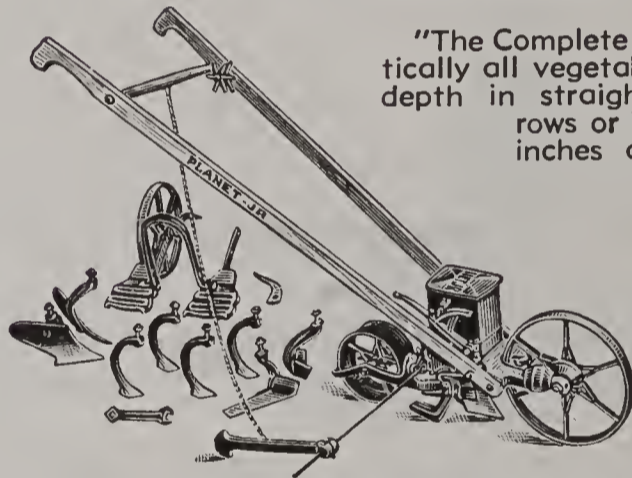

"The Complete Gardener" plants practically all vegetable seeds at the proper depth in straight, narrow continuous rows or in hills 4, 6, 8, 12 or 24 inches apart. Easily changed into a Double or Single Wheel Hoe. Attachments are those most needed—hoes for weeding and shallow cultivation—cultivator teeth for general and deeper cultivation—and plows for furrowing, covering and hilling.

No. 3 Seeder—\$19.00

Similar to No. 25 but used for seeding only.

No. 5 Seeder—\$21.00

Same as No. 3 but with a 5-quart hopper and larger driving wheel.

No. 300A Planet Jr. Seeder

Price, \$21.00



The No. 300A is rapidly becoming the most popular seeder for market gardeners. It is a plate seeder having three seeding plates each with 13 holes, giving ample adjustment for any size seed. Adjustments quickly and easily made. Hopper removable. Many exclusive features combine to make the No. 300A easy running, dependable and accurate. For use on ordinary soil.

No. 300 Planet Jr. Seeder—\$21.00

No. 300 Seeder same as No. 300A but with flat roller wheel 11 inches in diameter for use on muck soil and sandy soil.

ROSS BROS. CO.

Planet Jr. Farm and Garden Tools

No. 9 Planet Jr. Horse Hoe and Cultivator

Price, \$14.50



A sturdy and carefully constructed tool with features appealing to every farmer. It is light, easily and instantly adjustable for width, will cultivate perfectly and is strong enough to stand incredible strain. Handles are adjustable up and down and sidewise—especially useful in berries. Cultivator steels are beveled and especially hardened and tempered—assuring that they will be long wearing and constantly sharp.

No. 8 Horse Hoe \$16.75

Same as No. 9 but with the addition of a lever wheel and depth regulator.

No. 7 Horse Hoe \$15.75

Same as No. 8 less the depth regulator.

No. 82 Planet Jr. Horse Hoe and Cultivator

Price, \$16.00



A very popular machine because of the large amount and great variety of work that can be done with it. Finishes rows up to 42 inches apart and works the middle complete at one passage. Zig-zag frame is particularly strong and the seven teeth insure fine and thorough cultivation. In addition to regular equipment other widths of cultivator teeth, sweeps, furrowers and turning shovels can be added.

No. 91 Planet Jr. Harrow Price, \$13.00

This tool has become a special favorite with strawberry, tobacco and sugar beet growers, market gardeners, truckers and farmers, because of the fine work of the chisel-shaped teeth. Cultivates any width from 12 to 32 inches. Handles adjust up, down and sidewise—a great advantage in blackberries, raspberries, etc.

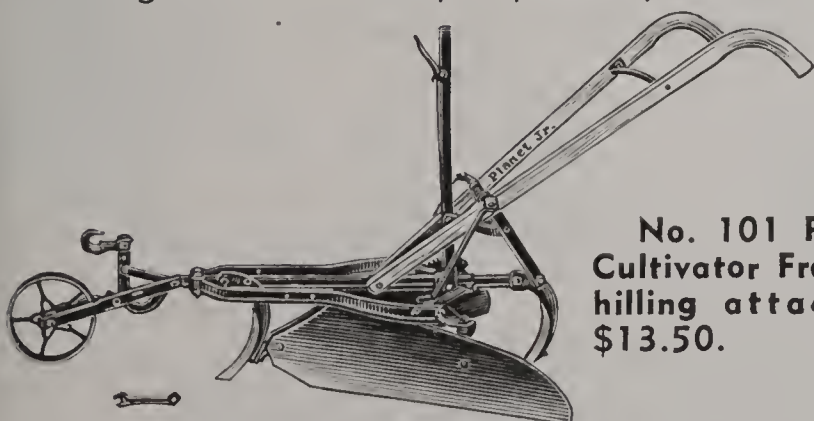

No. 101 Planet Jr. Cultivator Frame with hilling attachment. \$13.50.

No. 220 Planet Jr. Fertilizer Distributor Price, \$29.50

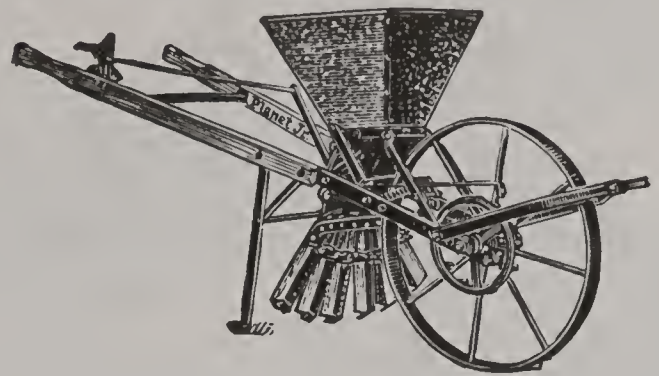

Capacity one bushel. Will distribute from 200 to 2000 pounds of commercial fertilizer to the acre. Six adjustable spouts spread it from 4 to 30 inches. Equipment includes plates for closing up four spouts or two or three spouts on either left or right side. Hopper placed well forward over wheel making lighter load and easier pushing. Feed can be opened and closed without stopping. Positive agitation.

No. 230 Planet Jr. Fertilizer Distributor and Cultivator Price, \$41.50

Same as the No. 220 but with the addition of a cultivator attachment which eliminates two operations. A furrow is opened next to the row, the fertilizer placed in it and thoroughly cultivated into the soil all at once. When there is much side-dressing to be done this distributor will pay for itself in a few working hours as it cuts labor and time to one-third.

Tilting Table Wood and Pole Saw

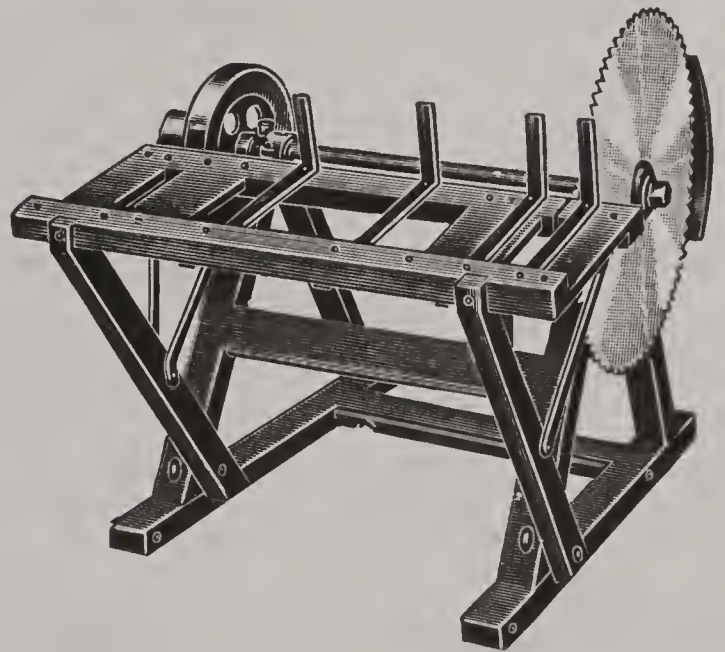

An excellent high type of saw, made of good material throughout and built sturdy. The arbors are of steel, the bearings long and well babbitted. The balance wheels are heavy and well balanced. This machine is finished in an attractive manner, with tilting table pivoted so that it balances perfectly. A great favorite with the sawyer. Weight 275 lbs.

BUCH'S No. 5 Tilting Table Wood Saw Frame with 65-lb. Balance Wheel, Less Saw \$26.50

WOOD SAWS, 1 3/8-INCH ARBOR

20 inch	\$3.95	26 inch	\$5.65
22 inch	4.50	28 inch	6.35
24 inch	5.25	30 inch	7.25

Tractor Saw Frames with Belt and 30-Inch Saw. Price \$55.00 each. 5% for cash. Specify make of tractor.

Garden and Farm Equipment

McCormick-Deering Type LA Gasoline Engines

1½ to 2½ and 3 to 5 Horse Power.

1½ to 2½ Horse Power. Weight 175 lbs.\$ 79.50
 3 to 5 Horse Power. Weight 260 lbs. 115.00
 5% discount for cash.

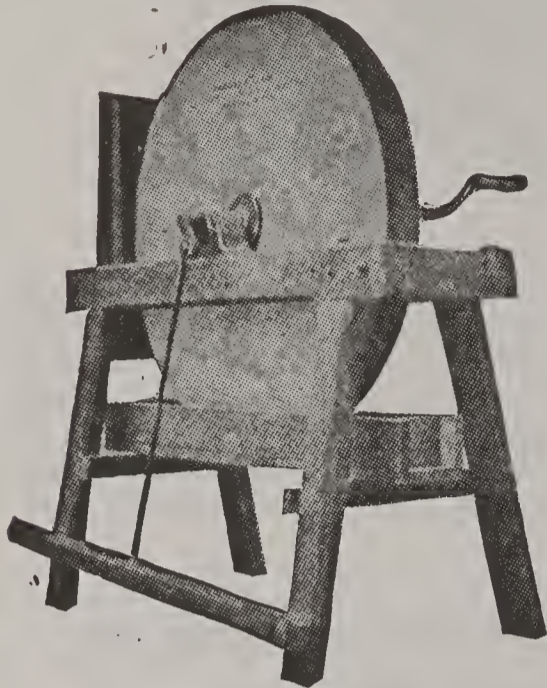

**Hecla
 Wood
 Frame
 Mounted
 Grind-
 stone**

The stones in these are best Nova Scotia Grit, mounted on heavy hardwood frame. It pays to buy a good article.

24x2\$21.50
 24x3 26.25
 26x2½ 26.50
 26x3 28.50

Victor Tubular Steel Frame Grindstone

With Foot-Treadle and Seat.

Adjustable seat, 4 to 5 inches, vertically. Stone movable forward and back on frame. Frame being slightly flexible, it adjusts itself to uneven floors or surfaces. Rigid and easily set up. Bi-treadle with power properly applied. Hinged connection with ball-bearings on crank. Ball-bearings in journals. Frame is narrow at top, making it convenient to apply power, and spread at base, giving greater rigidity. Crated complete, stone protected. Made in one size, about 100-lb. stone. Price, \$10.75.

Wilcox Mounted Grindstone

No. 1. About 100 lbs.\$ 9.75
 No. 2. About 120 lbs. 10.75
 No. 3. About 135 lbs. 11.75

McCormick-Deering Ensilage Cutter

Carefully designed and constructed to cut large quantities of ensilage with a minimum of power requirements. The cutting knives are secured on the flywheel. This design assures safety at all working speeds. No.12B, Mounted, \$395.00. 5% discount for cash.

On skids, G \$260.00; F \$205.00. 5% discount for cash.
 Mounted, G \$285.00; F \$230.00. 5% discount for cash.

Complete with 30 ft. pipe.

The McCormick-Deering Corn Binder

This Corn Binder picks up down and entangled corn. There is bound to be some down corn in practically every cornfield. It cuts and binds into even-sized bundles. Equipped with elevator chains to pick up down corn. No waste and you always get a neat job when you use the McCormick-Deering. Ask for price.



Harder Silos

WOOD—CEMENT

For many years Ross Bros. Co. has represented Harder Silo Co. in Worcester County. We solicit your silo inquiries.

*Harder Silo—
 "The Bulwark of
 the Paying Dairy"*

Binder Twine

Put up six balls to bale.
 Market Price.

Blizzard Cutters

Can be operated successfully with a small amount of power.

No.	Dimensions of Capacity		H.P.	Speed	Weight Lbs.
	Throat inches	Tons			
No. 400.	11x5½	7-14	7-14	800 r.p.m.	1500
No. 500.	13x6	10-20	10-20	750 r.p.m.	1750

Complete with 30-ft. pipe.

Price on application.

Red Warrior Heavy Service Belting

Developed from long continued tests and experiments under severest conditions. The body is of 32-oz. closely woven duck with a 22-lb. friction binder.

PRICE:

4 inches	4-ply	37c per foot
5 inches	4-ply	45c per foot
6 inches	4-ply	55c per foot

Horse Hay Fork Fixtures

No Barn is Complete Without One of These
 Reversible Steel Track Hay Carriers.

These carriers for rod, wood or steel track are the most durable and easiest rigs to operate of any on the market. Anyone with a hammer and wrench can rig his barn as well as an expert carpenter. We furnish everything necessary for rigging any style of barn. If you will send us the length and height of your barn and style of ridge pole, we will name you price for complete job.

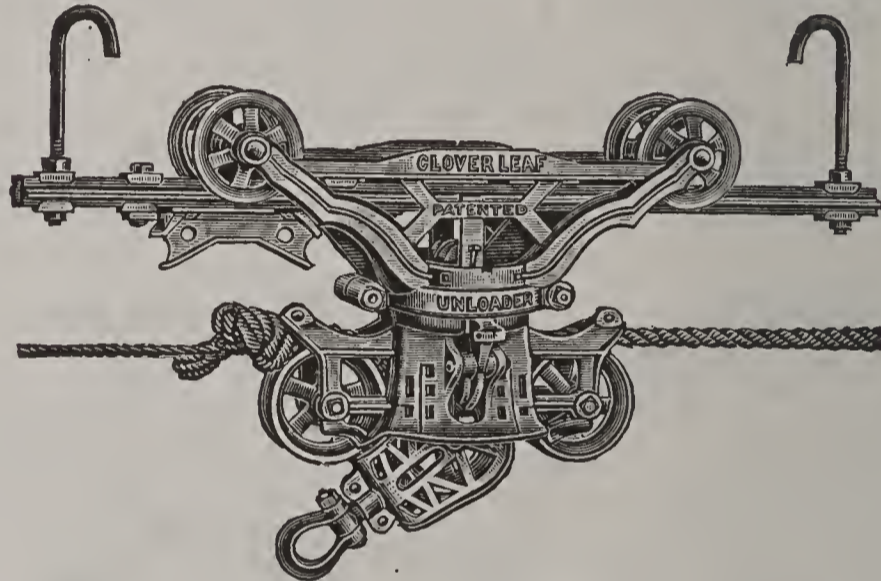

Double Steel Track. Per ft.	\$ 0.25
Hanger Hook. Each20
Pulley Hook. Each19
Hay Unloader. Each	12.00
Knot Passing Pulley. Each90
Two-Tine Harpoon. 25-in. Each	3.00
Two-Tine Harpoon Fork. 31-inch. Each	3.50
Four-Tine Grapple Fork	11.50
Six-Tine Grapple Fork	13.00
Rafter Bracket. Each05
Jointed Hanger Hooks. Each27½

TRUE TEMPER THREE-TINE HAY FORKS

No. 133½B	\$1.55
No. 134B	1.55
No. 134½B	1.60
No. 0134B Strapped	1.65
No. 0134½B Strapped	1.75
No. 0135B Strapped	1.85
No. P034B Strapped. Panther Brand	1.00

Lightning Hay Knife

Each, \$2.00.

Columbian Pure Manila Rope

	1 lb. equals	Price per lb.
¼ inch	51 feet	\$0.32
⅜ inch	24 feet 6 inches	.31
½ inch	13 feet 7 inches	.29
⅝ inch	7 feet 6 inches	.28½
¾ inch	6 feet 2 inches	.28
1 inch	3 feet 8 inches	.28

Full coils less 3c per pound.

Tarred Lath Yarn

In coils of about 50 lbs. wound in rope form. Each rope contains 130 ends. Per lb., 18c. Cut per lb., 22c.

ROSS BROS. CO.

Ross Poultry Supplies

Oakes Egg Scale

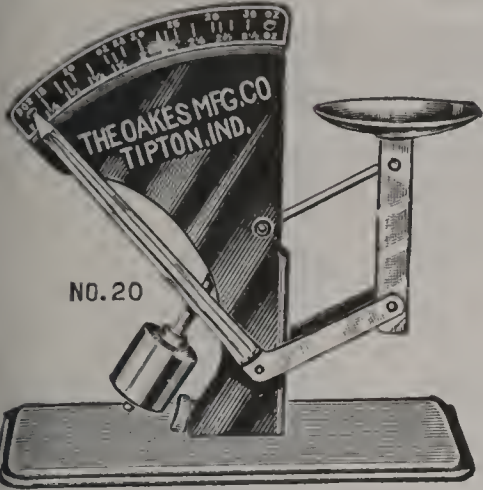

A real egg scale—accurate, dependable and fast.

No. 20S Egg Scale, with adjustable stop. Mailing weight 3 lbs. \$1.50 each.

The Acme Egg-Grading Scale

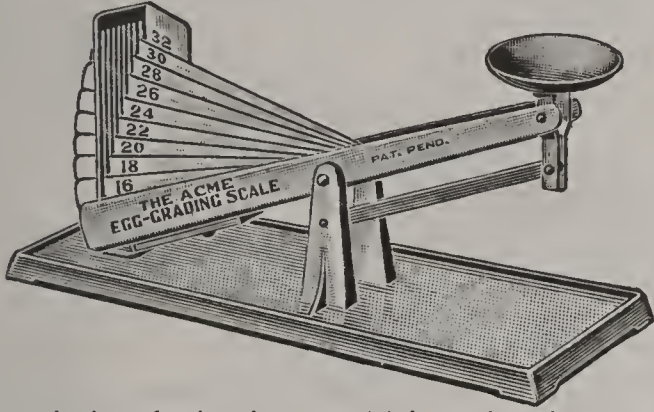

Is made entirely of aluminum, which makes it rust-proof and practically indestructible. Every part is accurately made and carefully tested and will meet the requirements of any state bureau of weights and measures.

No. 1 Grades 16 to 30 ounces
No. 3 Grades 19 to 30 ounces
Price, \$2.50, postpaid.

CELO-GLASS

CEL-O-GLASS is made in rolls, 1 yard wide and can be cut to any required size and installed with staples and a hammer. Construction on frames is advised for all installations. Price: Postpaid, 15c per sq. ft. By express, 25, 50, 100-ft. rolls, 13½c per sq. ft.

Glass Cloth

Not glass, but a specially processed strong fabric treated to render it transparent, weather-proof and water-proof, shutting out cold, snow, wind and rain; transparent to admit light and warmth, and the valuable Ultra Violet rays of the sun which are so necessary and beneficial to animal and vegetable life. **Prepaid prices: By parcel post or express.** We send the cheapest way. **Single yard 35c, 5 yards \$1.50, 10 yards \$3.00, 15 yards \$4.50, 50 yards \$12.50.** Add 2c per yard outside of United States.

Oakes Round Pan Snap-On Founts

An inexpensive fount for the brooder house. Ideal for chicks up to 8 weeks.

Made in two sizes

No. 81, 1 gal. Mailing wt. 4 lbs. \$0.70
No. 82, 2-gal Mailing wt. 5 lbs.90



Oakes Revolving Chimney Cap

Perfectly balanced. Revolves with slightest change in wind direction.

No. 84C. 4 inch \$0.60
No. 85C. 5 inch60
Mailing weight 2 lbs.

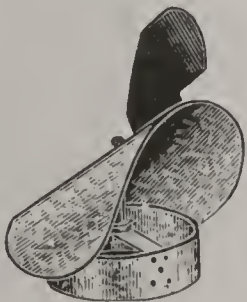

Oakes Wire Grill Chick Feeder

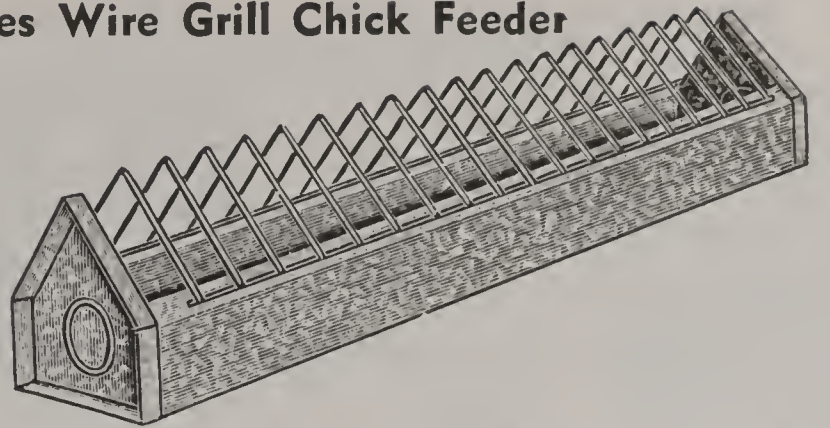

No. 212. 2 ft. Mailing weight 4 lbs. \$0.65
No. 213. 3 ft. Mailing weight 5 lbs.85
No. 214. 4 ft. Mailing weight 7 lbs. 1.00
No. 1342. Adjustable wire legs for above. Add 10c per feeder.

Oakes New Gro-Fast Feeder

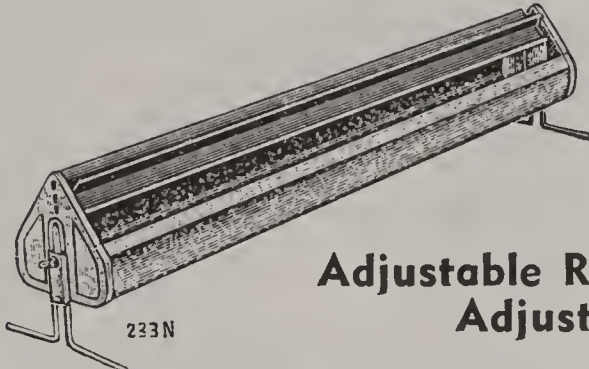

Adjustable Revolving Reel and Adjustable Stand

No. 233N. 36 inch. Mailing weight 6 lbs. ... \$0.85
No. 234N. 48 inch. Mailing weight 8 lbs. ... 1.00

Oakes Utility Chick Troughs

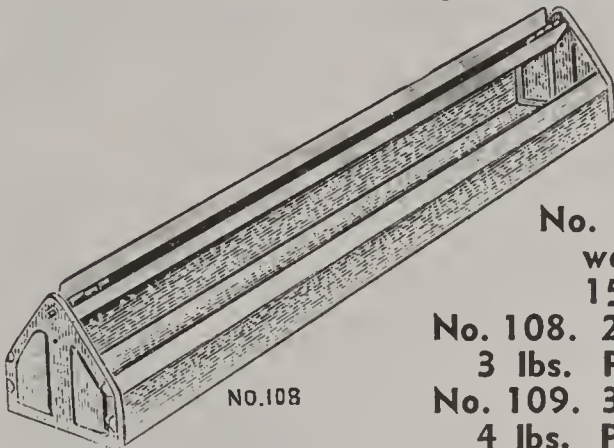

Metal "Z" reel, adjustable to two positions. A big value.

No. 107. 12 in. Mailing weight 2 lbs. Price, 15c.
No. 108. 24 in. Mailing weight 3 lbs. Price, 25c.
No. 109. 36 in. Mailing weight 4 lbs. Price, 35c.

Aluminized Metal Egg Crate FOR PARCEL POST

Size	Weight	Price
1-dozen size—all eggs,	1¾ pounds	\$1.00
2-dozen size—all eggs,	3 pounds	1.25
3-dozen size—all eggs,	4 pounds	1.50
4-dozen size—all eggs,	5 pounds	1.75
6-dozen size—all eggs,	6 pounds	2.00
9-dozen size—all eggs,	8 pounds	2.50
12-dozen size—all eggs,	10 pounds	3.00



Husky Day Old Chicks

Guaranteed safe arrival when shipped direct from our hatchery.

Our advice is to get your order in early for day-old chicks and not be disappointed.

"Winner" Chick Trough

One piece—Die Stamped

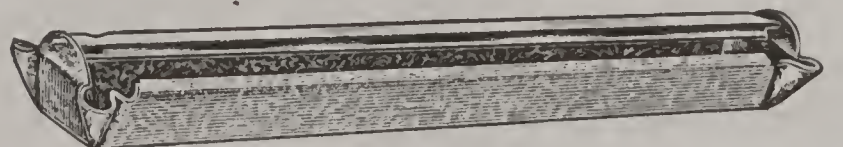

104-A. 12 inches. Mailing weight 2 lbs. \$0.12
105-A. 18 inches. Mailing weight 3 lbs.17
106-A. 24 inches. Mailing weight 4 lbs.23

Ross' Poultry Supplies

Newtown Coal Brooders Save Chicks Where Others Fail

You get more chick-raising ability and greater satisfaction, dollar for dollar, in a Newtown coal burning brooder than in any other kind ever built. That's a fact. Comparisons prove it. Here are two popular sizes.

No. 11. Capacity, 500 chicks; diameter of hover, 50 inches; shipping weight, 202 lbs. **Price, \$29.50.**

No. 12. Capacity, 1000 chicks; diameter of hover, 56 inches; shipping weight, 306 lbs. **Price, \$39.50.**

Oakes Coal Burning Brooder

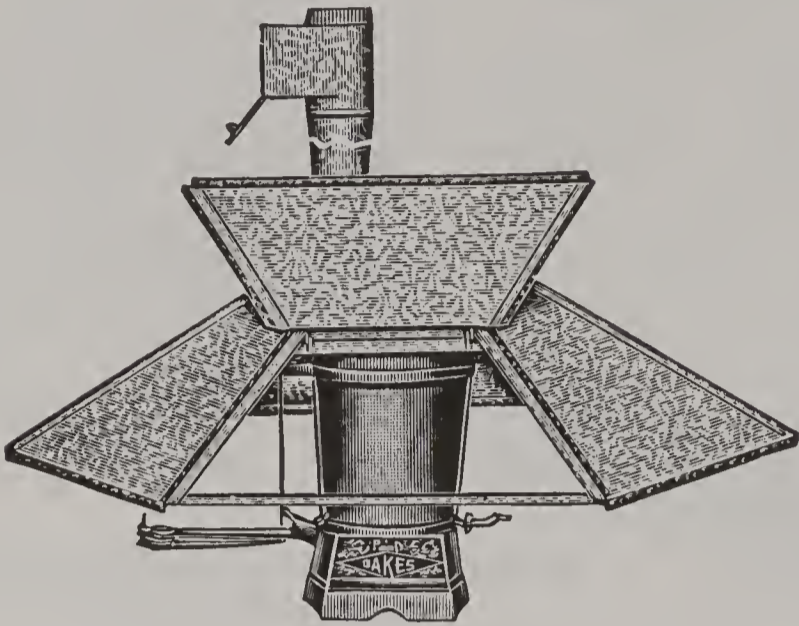

Red Oakes Brooders are noted for fuel economy, performance and long life. We recommend Oakes Brooders. Regardless of first cost, this stove will be most inexpensive over a period of years.

Model	Canopy	Chick Capacity	Coal Capacity	Weight	Price
No. X54	54 in.	750	40 lbs.	113 lbs.	\$19.95
No. X62	62 in.	1000	52 lbs.	135 lbs.	22.95
No. X162	62 in.	1200	72 lbs.	165 lbs.	26.95

Buckeye Coal Burning Brooder

Model No. 118-B.	54-inch diameter	\$19.50
Model No. 119-B.	62-inch diameter	23.00
Model No. 120-B.	62-inch diameter	26.50

Oakes No-Cold Oil Brooder

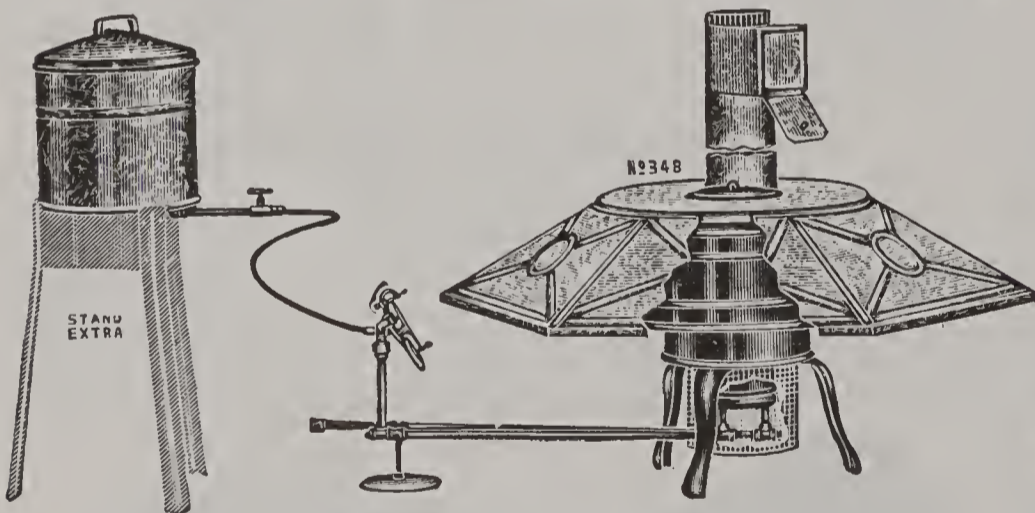

Maximum Safety—Low Cost.

No. 348—Canopy 42-inch, capacity 500	\$18.75
No. 360—Canopy 52-inch, capacity 750	20.10
No. 361—Fuel Tank Stand	.96

Oakes "Gro-Ezy" Electric Brooder

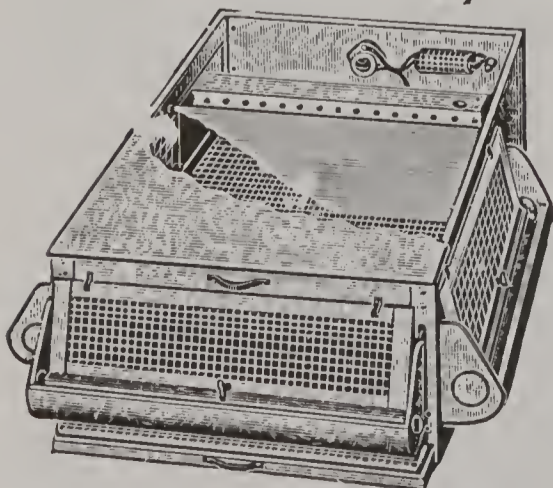

Gro-Ezy Brooders are made entirely of metal; easy to clean. Has guaranteed heater, 110-volt AC automatic thermostat, troughs and drop cord.

No. 801. Single unit, shipping weight, 42 lbs., \$9.90.

Oakes Chick Troughs

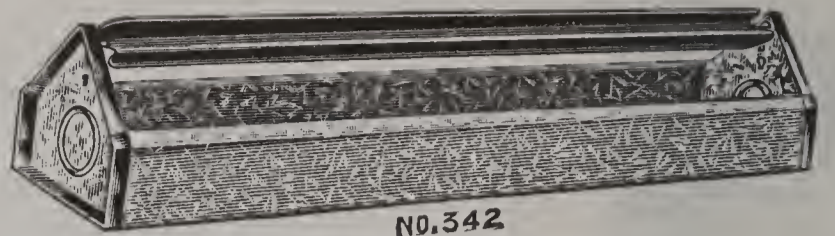

No. 342
With Metal "Z" Reel

Revolving metal reel prevents chicks roosting or getting into trough

No. 342. Length 2 ft. Mailing weight 3 lbs.	\$0.40
No. 343. Length 3 ft. Mailing weight 4 lbs.	.55
No. 344. Length 4 ft. Mailing weight 5 lbs.	.70
No. 1342. Adjustable wire legs for above add 10c per feeder.	

Oakes Broiler Feeder

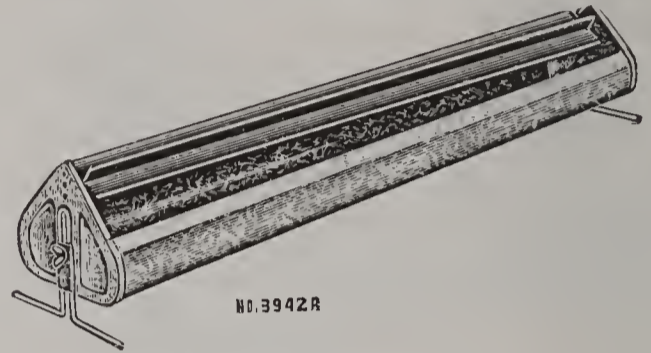

No. 3942R
With 4-Blade Metal Reel

Complete with adjustable wire legs. Feed capacity 10½ quarts.

No. 3942R. Length 42 inches. Mailing weight 10 lbs.	\$1.20
No. 3942W as above with wire grill	1.35

Dandy Coal Burning Brooder

Model	Diameter of Hover	Capacity Chicks	Coal Capacity	Shin. Wt.	Price
No. 35.	52 in.	500	40 lbs.	109 lbs.	\$17.80
No. 39.	56 in.	1000	62 lbs.	140 lbs.	21.35
No. 40.	62 in.	1200	75 lbs.	155 lbs.	24.75

Pilling's Caponizing Set

Lansdowne No. 1. Complete with instructions, \$5.00. We send book, "Complete Guide for Caponizing," with every set. Philadelphia set in velvet case, \$3.50, postpaid.

Oakes Dandy Wall Fountain



This new double wall fountain is top filled. Double wall helps to keep water cool in summer and retards freezing in winter.

No. 192. 2-gal., mailing weight, 6 lbs.	\$1.40
No. 93. 3-gal., mailing weight, 8 lbs.	1.65

Oakes Adjustable Roof Saddle

Pipe and Cap as shown.

No. 142. For 4-inch pipe. Mailing weight 5 lbs. \$1.45.

No. 143. For 5-inch pipe. Mailing weight 6 lbs. \$1.60.

Oakes Revolving Cap Roof Saddle

Same as shown, but with revolving cap as shown on page 87 in place of pipe cap.

No. 84. For 4-inch pipe. Mailing weight 5 lbs. \$1.80.

No. 85. For 5-inch pipe. Mailing weight 6 lbs. \$1.95.

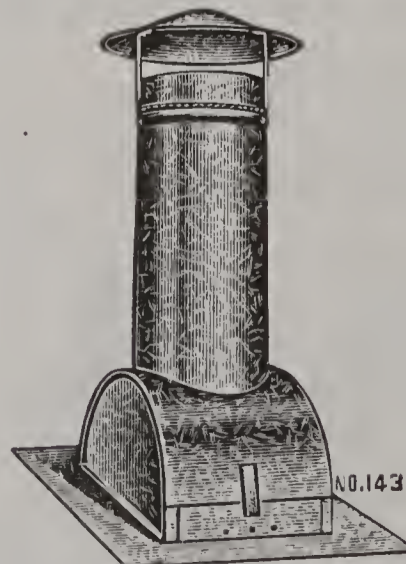

ROSS BROS. CO.

Ross' Poultry Supplies

Oakes All Metal Lice-Proof Nests

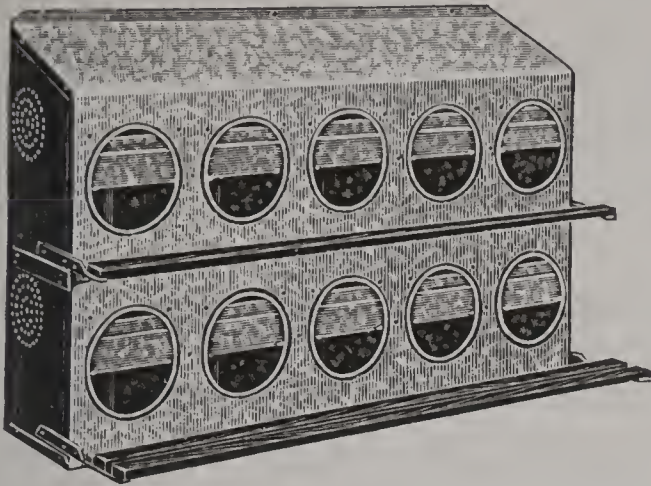

All-metal lice proof nests. They offer no hiding places for lice. A steep sloping roof keeps the hens from roosting on top. There should be a nest for every five hens.

- No. 576—6-hole nest, only\$6.00
Shipping weight 36 lbs.
- No. 580—10-hole nest only 8.60
Shipping weight 51 lbs.
- Traps extra. No. 590 Traps only for above. 5 in carton.
Set of 5 1.50
- Trap Nest Founts, No. 59R. 50c each; doz. 5.75

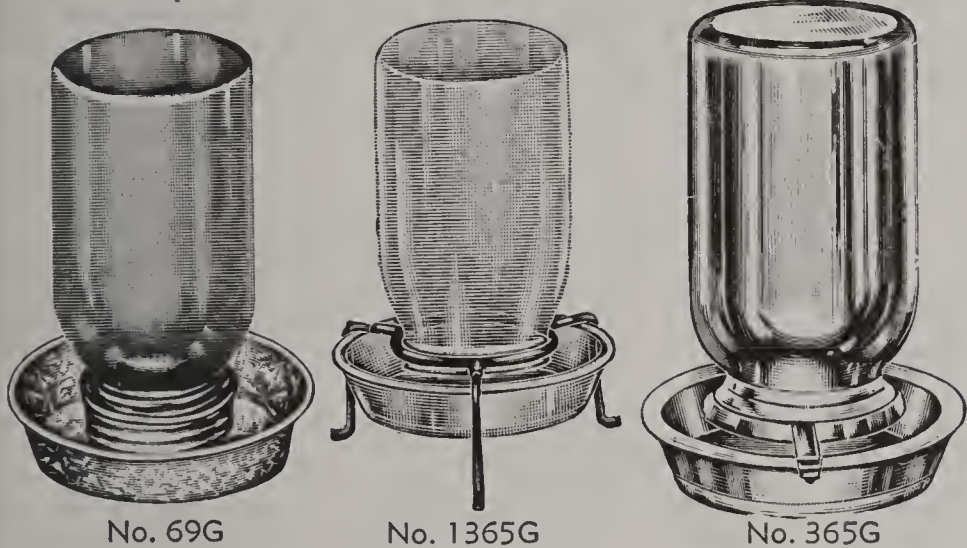

- No. 69G—Mason Jar Waterer. Galvanized pan. Mailing weight, per doz., 5 lbs. 10c each; doz.\$1.00
- No. 1365G—Green Glass Pan Fount with high leg stand. Mailing weight, per doz., 10 lbs. 15c each; doz. 1.50
- No. 365G—Green Glass Pan Fount with metal clip. Mailing weight, per doz., 10 lbs. 12c each; doz. 1.20

Trumbull Poultry Water Warmer. Automatic; electric, keeps drinking water at 50 degrees even in sub-zero weather. Use in open pans and fountains. No danger of electric shock and no fire hazard. Price \$3.00 each, postpaid.



Oakes Floor Type Flock Feeders

- No. 860T—Adjustable Legs. 5-ft. cap. 4½ pks. \$2.80.
- No. 896T—Adjustable Legs. 8-ft. cap. 7 pks. \$3.90.
(Advance Feeder with High Stand not shown).
- No. 860—5-ft. cap. 4½ pks. \$3.80.
- No. 896—8-ft. cap. 7 pks. \$5.45.

Oakes Red Top Wire Guards and Pans

- No. 614—Wire Guard. Diam. 14½ inches. 55c.
- No. 617—Wire Guard. Diam. 17 inches. 55c.
- No. 6140—Feed or Water Pan. Diam. 14 inches. 70c.
- No. 6170—Feed or Water Pan. Diam. 17 inches. 85c.

Earthen Pigeon Bowl

Each, 20c; per doz., \$2.00. Weight, each 4 lbs.

Imported Ground Peat for Poultry

Takes up moisture, prevents spread of disease and is superior to shavings or sawdust. Standard bale. Price \$2.95.

Oakes Two-Piece Chick Fountains

- No. 78—1-qt.\$0.30
- No. 79—2-qt.35
- No. 77—4-qt.50
- Mailing weight, 2 lbs.

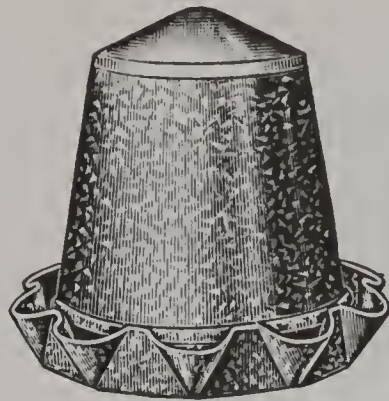

Oakes Double Wall E-Z Fill Fountain

- No. 31—3-gal. size. Mailing weight 10 lbs. \$2.20.
- No. 32—5-gal. size. Mailing weight 12 lbs. \$2.95.

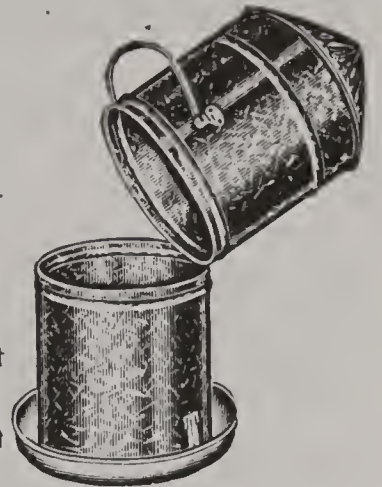

Oakes Acorn Waterer With Removable Drinking Pan Float Valve—Top Filled

- No. 405—5-gal. cap. fount only \$3.45 each.
- No. 408—8-gal. cap. fount only \$3.95 each.
- No. 43—Heater for either of above \$2.20 each.
- No. 197S—Stand for either of above \$1.75 each.
- No. 403—3-gal. cap. fount only \$1.88 each.
- No. 42—Heater for No. 403 or No. 31 Fount. \$1.80 each.

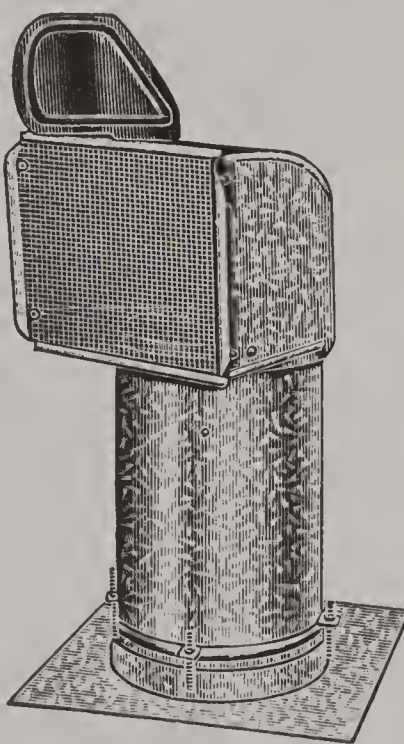

Oakes Monitor Type Ventilator

Adjustable base to fit any pitch roof.

- No. 1530—Shipping weight 33 lbs.\$6.75

Oakes Sturdy-Boy Wafer Thermostats

No. 416W. 3-inch double brass wafer for all coal brooders, many oil brooders and incubators. 28c each.

No. 16W. 3-inch double brass wafer for oil brooders, screw stud. 30c each.
Add 5c for postage.

- No. 1265. Oakes Brooder Thermometer\$0.35
- No. 1012. Wilder Incubator Thermometer75
Add 5c for postage.

Celluloid Bands

Assorted Colors.

	Doz.	100	1000
No. 4. Baby Chick	\$.10	\$0.35	\$2.40
No. 5. Pigeon	.10	.35	2.50
No. 6. Growing Chicks	.15	.40	3.00
No. 7. Bantams	.15	.45	3.50
No. 9. Leghorns	.15	.50	4.00
No. 10. Wyandottes	.15	.50	4.25
No. 11. Rocks, Reds	.15	.60	5.00
No. 12. Jersey Giants, Brahmas	.15	.75	5.50
No. 13. Large Cocks, Turkeys	.15	.75	6.00

Postpaid.

Champion Leg Bands

Numbered 1 to 100. Price, 75c, postpaid.

Conkey's-Pratt's-Hess' Poultry Remedies



Reliable Poultry Remedies The Conkey Line

DIATEX. (Formerly called White Diarrhea Remedy). An astringent tablet for drinking water of poultry and baby chicks. Play safe—keep this remedy in the drink water of all baby chicks until danger period of the first few weeks is past. **Prices:** Pkgs., 25c, 50c, \$1.00, all postpaid. Breeder size (1200 tablets), \$3.75; \$3.85, postpaid.

LICE POWDER. (Contains Sodium Fluoride). For dusting hens, nests, growing chicks, for use wherever body lice must be overcome. **Price:** 30c and 65c.

OLD RELIABLE POWDER. (Formerly Roup Remedy). Easily given in the drinking water. Let the birds help themselves. Keep it on hand for use in emergency or put it in drinking founts on cold, rainy days or when there is a sudden change in the weather. In mild doses it acts as a tonic. **Prices:** Pkgs., 25c, 50c, and \$1.00. 1½-lb. can, \$2.35, all postpaid. 5-lb. can, \$5.50; \$5.75, postpaid.

POULTRY PILLS. (Formerly called Roup Pills). Administer these pills twice daily, in extreme cases 3 times a day. **Prices:** Pkgs., 25c, 50c, and 1.00, all postpaid. Breeder size (1000 pills), \$2.75; \$3.00, postpaid.

POULTRY WORM REMEDY. For round worms, gizzard and caecal worms and flukes or leaf worms. **Prices:** Pkgs., 25c, 50c, or 30c, 55c, postpaid. Breeder size (5 lbs.), \$2.75; \$2.85, postpaid.

"Black Leaf" Worm Powder

An odorless, tasteless dry compound containing nicotine that remains insoluble in the mouth, throat, crop and gizzard, hence non-toxic to poultry.

"Black Leaf" worm powder is easily fed in mash. The dose is ¼ pound, mixed in gallon of mash, for 100 birds. 4-oz. pkg., 75c; 1½-lb. pkg., \$3.00; 3-lb. pkg., \$5.60.

"Black Leaf" Worm Pellets

100 pellets, 85c; 500 pellets, \$3.25; 1000 pellets, \$6.00.

Ful-O-Pep Poultry Feeds

Ful-O-Pep Poultry Feeds are manufactured by the Quaker Oats Co., whose many years' milling experience insures production of superior poultry feeds. See us for your Ful-O-Pep Poultry Feeds. **Sold always at market prices.**

Water Glass

This preparation is used by many in preference to the dry powder. The preservative will preserve eggs perfectly. **Price:** 1 pt., weight 3 lbs., 18c; 1 qt., weight 4 lbs., 25c; 1 gal., weight 14 lbs., 85c.



Leader Fountain

A new Sanitary Fountain, practical to use, easy to keep clean.

1½ gals. Mailing weight, 5 lbs. **Price, 85c.**

3 gals. Mailing weight, 3 lbs. **Price, \$1.50.**



Pratt's Poultry Remedies



POULTRY REGULATOR. Tones up systems, regulates bowels, aids digestion, sharpens appetite, wards off disease and increases vitality. Use it the year round for breeders, layers and growing stock. 4-lb. pkg., 55c; 12½-lb. pkg., \$1.60; 25-lb. pail, \$2.85.

POWDERED LICE KILLER. Is powerful, economical, non-poisonous and non-irritating. For use on poultry, in dustbaths, nests, on dogs, cats, horses, cattle, hogs, and sheep. **In sifter top cans at 30c and 60c. 35c and 65c, postpaid.**

CHICK TABLETS. Makes the drinking water safe, tones up the chicks and effectively treats most diarrhea troubles. **Prices:** 30c and 60c. Postpaid, 35c and 65c.

R-P TABLETS. (Formerly Pratt's Roup Tablets). For Adult Fowls. **Price:** 25c and 50c. Postpaid, 30c and 55c.

DISINFECTANT. Cheap, powerful, non-poisonous disinfectant. **Quart, weight 3 lbs., 50c. Gallon, weight 11 lbs., \$1.45.**

PRATT'S N-K TABLETS. For eradication of tape and round worms in poultry. **Adult size, 50 tablets, 85c; 100 tablets, \$1.50; 500 tablets, \$5.50. Chick size, 50 tablets, 55c; 100 tablets, \$1.00.**

Dr. Hess Remedies for Poultry



DIP AND DISINFECTANT. Valuable about barns and stables, kills hog lice and other parasites and keeps down foul odors. 1 qt., 3 lbs., 50c; 1 gal., 10 lbs., \$1.50.

POULTRY PAN-A-MIN. Pan-A-Min is of high value to moulting hens, in egg production, in reducing chick mortality, in bone and feather growth and in maintaining health. 1½ lbs., 25c; 3 lbs., 45c; 7 lbs., 95c; 15 lbs., \$1.90; 25 lbs., \$2.85.

POULTRY TABLETS. (Formerly Roup Tablets). Dr. Hess' Poultry Tablets are of high value in treating locally the swelling incident to Roup. 50c and \$1.00. Postpaid, 55c and \$1.10.

POULTRY WORM POWDER. For Flock Treatment. Expels Round Worms. 50-bird size (2 ozs.), 50c; 100-bird size (4 ozs.) 90c; 250-bird size (10 ozs.), \$1.90; 500-bird size (1¼ lbs.), \$3.00.

POULTRY WORM TABLETS. For individual treatment. 40-tablet pkg., 50c; 100-tablet pkg., \$1.00; 250-tablet pkg., \$2.00; 500-tablet pkg., \$3.50.



INSTANT LOUSE KILLER. Kills lice and bugs on poultry, cucumber, squash and melon vines—slugs on rose bushes. Non-poisonous, and may be used on edible plants with entire safety. 1 lb., 30c; 2½ lbs., 65c.

CHICK TABLETS. (Formerly White Diarrhea Tablets). Most diarrhea conditions in chicks, often mistaken for Biliary White Diarrhea, are the result of improper feeding or brooding and can be corrected with Chick Tablets. 50c and \$1.00 pkgs. Postpaid, 55c and \$1.10.

Oakes Snap-On Chick Waterer

No. 100-B. 1 gal. Mailing weight 4 lbs., 55c.

No. 100-C. 2 gal. Mailing weight 5 lbs., 80c.



ROSS BROS. CO.

Poultry Remedies and Supplies

Gold Leaf Tobacco Powder for Poultry Worms

The failure of young birds to develop properly and an unhealthy condition of the older birds, is often caused by the presence in their intestines of poultry round worms.

2-lb. pkg. Mixes with 100 lbs. of mash. \$0.25
 10-lb. pkg. Mixes with 500 lbs. of mash.85

Parke-Davis C-A Worm Capsules

Individual treatment, correct dose. Can be given any time. No setback in total egg production.

No. 196. For Turkeys and Adult Hens. \$1.00 for box of 50.
 No. 195. For Pullets under 4 months. 75c for box of 50.

Pikgards

Pikgards are metal devices easily and quickly attached to the beaks of fowls, four months or older, making it impossible to pick. Pikgards prevent losses from cannibalism, fighting and domineering, mash hopper waste. Packed 100 to box. Price, \$3.00 per 100; \$28.00 per 1000. Charges prepaid. Ask for descriptive circular.

Graylawn Farm Louse-Chase

Kills every louse at trifling cost. 5-oz. can, 40c; 12-oz. can, 65c; 22-oz. can, \$1.00.



Farm Disinfectant Dairy Sterilizer

A powerful, clean, non-poisonous germ killer. B-K cannot be sent by parcel post.

1-qt. bottle \$0.90
 1-gal. jugs 2.00
 5-gal. jugs 8.50
 1 3/4 -lb. bottle B-K Powder, \$1.50; postpaid 1.60
 9 1-3 oz. bottle B-K Powder, 75c; postpaid85

Carbola Paints and also Disinfects

Carbola is a white paint and powerful disinfectant combined in powder form. Easily and quickly applied to building interiors with brush or spray pump. Disinfects and dries pure white. One pound covers 100 sq. ft.

5 pounds (5 gals.) \$0.60
 10 pounds (10 gals.)98
 25 pounds (25 gals.) 1.90
 50 pounds (50 gals.) 3.50

Clinton Pigeon Feed

Made from clean, thoroughly dried grains. Mixed with or without corn. Market price.

Crushed Oyster Shell

For poultry or chicks. 100 lbs. \$1.00.

Poultry Grit

Cracked in three sizes: No. 1, fine; No. 2, medium; No. 3, coarse. 100 lbs., \$1.00.

Anderson Stickless Feed-O-Box

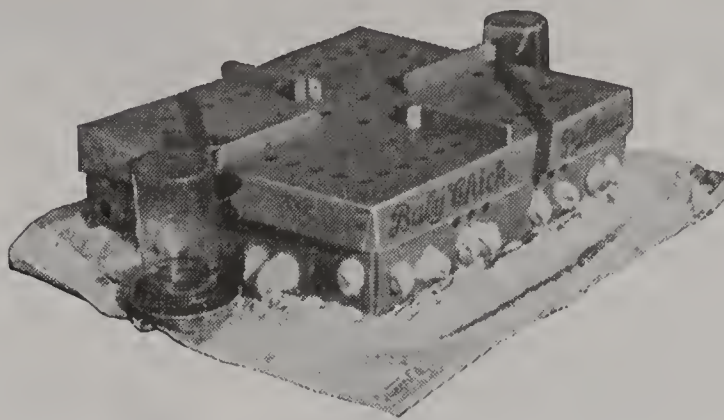

No sticks, no nails, no glue, Better ventilation. This stickless Feed-O-Box does the same work as a regular chick box and in addition it acts

as a starting brooder for the chicks on arrival.

No. SF-100 (100-chick size) 22x18x5 1/2 in., weight 215 lbs. per 100 boxes. Packed 30 in bundle. 120 boxes or over 17 1/2c each. Lots of 60 boxes 20c each. U-staples extra, \$1.25 per 1000, 15c per 100. By express or freight only.

3x4 Chip Egg Boxes Handy for Retail Trade

	Weight	Price
Dozen	2 lbs.	\$0.15
Bundle of 125	12 lbs.	1.00

Ask for prices in larger quantities.

Oakes Little Giant Oil Brooder Stove

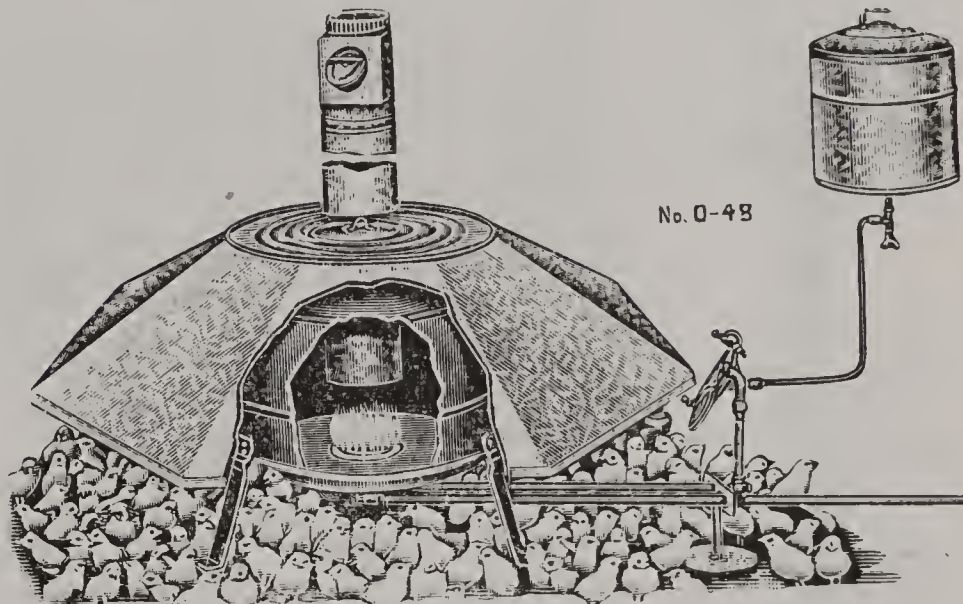

Outstanding Brooder Stove for 1938. For poultry men who brood up to 300 chicks. Hexagonal canopy. Diameter 48 inches. Fuel tank capacity 7 gals. Easy to adjust. Automatic control; same regulator as used on other Oakes stoves. No. 0-48. Price \$13.65.

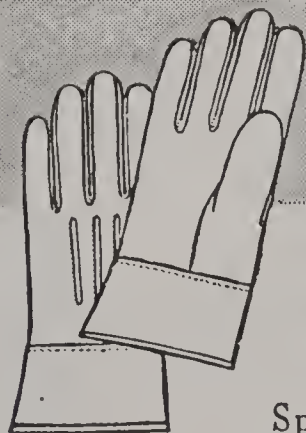

National Eezy Wear Garden Gloves

PROTECT YOUR HANDS with these

SOFT LEATHER GLOVES

Specially designed to give you everything you want in a garden glove.

All-Leather	DIRT-PROOF	Durable
SOFT AS KID	Easy to Wear	WASHABLE

Being all-leather, Eezy Wear gloves give complete protection against dirt, scratches, bruises, stains, infection. Yet their amazing softness and pliability, the result of a special processing, make them extra comfortable. Cling to the hands and practically give you BAREHAND FREEDOM.

Economical, too—outwear 6 pairs of ordinary fabric gloves, are washable and can be used the year round for GARAGE, HOUSEWORK, PAINTING, YARD, FURNACE, ETC. Sizes for WOMEN (small, medium, large) and MEN (small, medium, large). A real value at 75 cents a pair, postpaid. (2 prs. \$1.40.)

Ross' Strong and Durable Fences



Much American Fence
Still In Use Since
Spanish American War

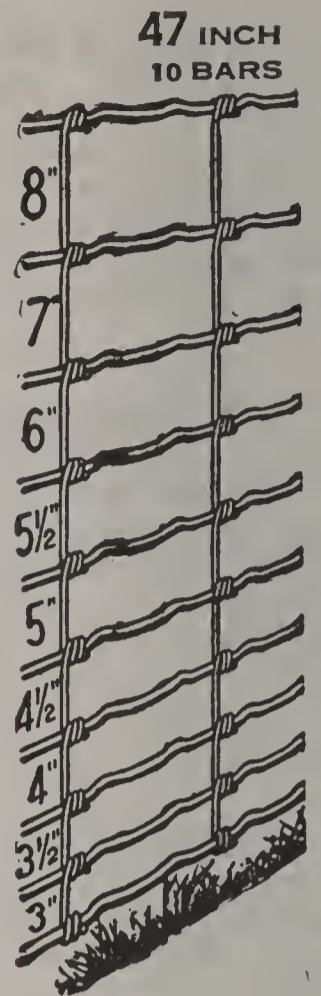

Our general purpose farm fence is the 1047x12, and the dimensions contained in the above figures are explained as follows: Figure 10 represents the number of horizontal wires, 47 represents the height in inches, and 12 represents the distance apart of the upright bars. The top bars are No. 9 wire, the bottom No. 10, and the intermediate bars and stays No. 11 wire. This makes an ideal up-to-date farm fence, strong enough for any use. It is heavily galvanized and will last for years and is much more sightly than the old ramshackle stone walls or wooden fences. When this fence is used in connection with steel posts, all of the weeds, etc., can be burned right up to the fence, which is another great advantage in keeping the field entirely free from refuse matter.

We have good stock on hand at all times of the following numbers.

1047x12, 10 rods	\$6.85
845x12, 10 rods	6.25
832x 6, 10 rods	7.25
1047x 6, 10 rods	8.75
635x12, 10 rods	4.95

Spec. 12 1/2 Lighter Wire

1047x 6, 10 rods	6.95
1047x12, 10 rods	5.35
832x 6, 10 rods	5.50

American Steel Fence Posts

Better — Stiffer — Heavier

7 1/2 ft., each	\$0.85
6 1/2 ft., each70

Prime Electric Fence Controller

Prime Electric one-wire Fence, positively holds all livestock. One one wire needed, saves time and hard work.

No. 400. Standard AC-110 volts	\$29.50
No. 460. Champion AC-110 volts	39.50
No. 600. Standard Battery, 6 volts ...	34.50

Complete information on all Prime controllers mailed on request.

American Poultry Fence

A Truly Defensive, Extra Heavy Galvanized Fence

Made of No. 11 and No. 14 wire. This fence is much stronger than any other fence sold as a poultry fence, the Top and Bottom Bars No 11 Galvanized Steel Wire, Intermediate Bars No. 13 Galvanized Steel Wire, Stay Wires No. 14 Galvanized Steel Wire.

At the bottom are four spaces of 1 1/2 inches each, the highest spaces graduated to 5 inches.	
No. 2158—21 bars, height 58 in., weight 129 lbs.—10 rods	\$7.95
No. 1948—19 bars, height 48 in., weight 115 lbs.—10 rods	7.25

Four-Point Barb Wire

Four-Point Lyman Cattle, 80-rod spools.	
Each	\$4.25
3 Spools or more, each	4.00

Two-Ply Twisted Wire

Two-Ply Twisted Wire, 80-rod spools.	
Each	\$3.90

Two-Point Barb Wire

Two-Point Cattle, 80-rod spools. Each . . .	\$4.00
---	--------

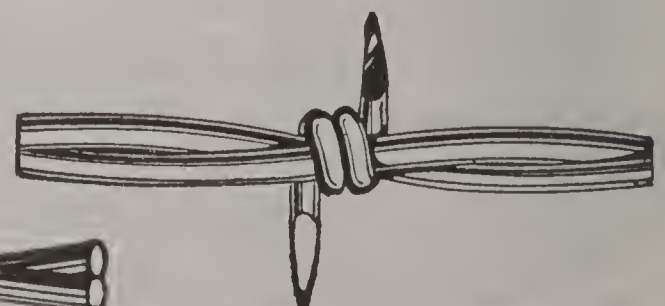

ROSS BROS. CO.

Ross' Strong and Durable Fences

Galvanized Poultry Netting

SUPERIOR
BRAND

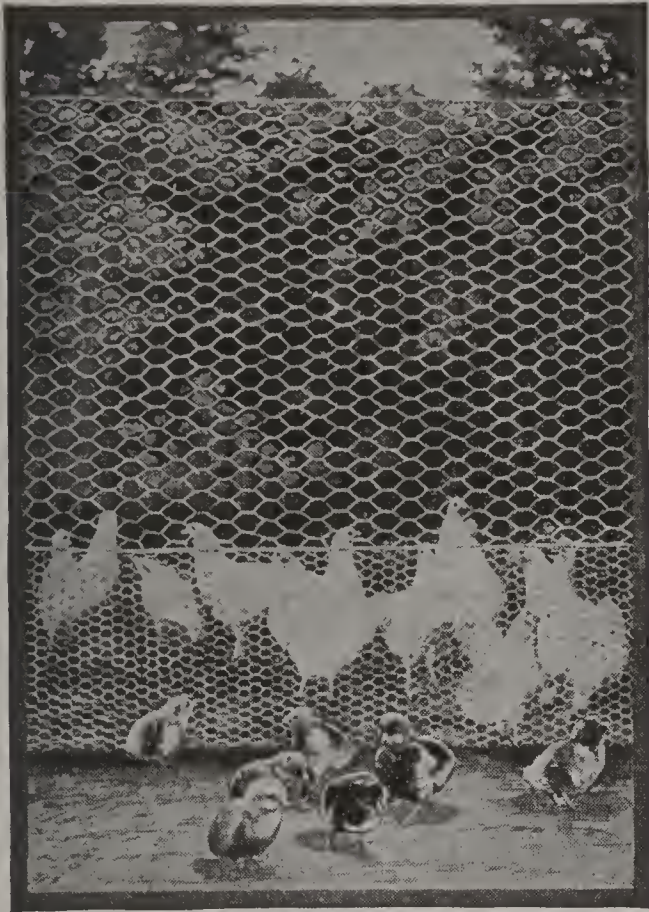

Price for roll of 150 running feet.

NO. 19 GAUGE WIRE

1 ft. 2 in. mesh	\$1.54
1½ ft. 2 in. mesh	2.09
2 ft. 2 in. mesh	2.70
2½ ft. 2 in. mesh	3.21
3 ft. 2 in. mesh	3.87
4 ft. 2 in. mesh	4.93
5 ft. 2 in. mesh	6.04
6 ft. 2 in. mesh	7.17
1 ft. 1 in. mesh	3.14
1½ ft. 1 in. mesh	4.47
2 ft. 1 in. mesh	5.80
2½ ft. 1 in. mesh	7.12
3 ft. 1 in. mesh	8.44

NO. 20 GAUGE WIRE

1 ft. 2 in. mesh	\$1.35
1½ ft. 2 in. mesh	1.84
2 ft. 2 in. mesh	2.32
2½ ft. 2 in. mesh	2.80
3 ft. 2 in. mesh	3.28
4 ft. 2 in. mesh	4.25
5 ft. 2 in. mesh	5.20
6 ft. 2 in. mesh	6.17
1 ft. 1 in. mesh	2.56
1½ ft. 1 in. mesh	3.68
2 ft. 1 in. mesh	4.82
2½ ft. 1 in. mesh	5.98
3 ft. 1 in. mesh	7.00

Bale Ties



We carry the 9-ft. No. 15 cross head ties in stock. We find this to be the most popular size, as it makes the most convenient bale of hay.

Per bundle of 250 wires, \$3.25. 5 bundles, \$3.00 per bundle.

Sweet's Steel Posts

Superior Strength — Attractive
Appearance — Maximum
Durability — Unequalled Economy

A special high carbon steel post of extreme rigidity, for all types of fence construction. The design of these posts is a flanged leg channel section which assures maximum strength.

No. 3. (B-C). 6½ ft., approx. wt. 8.31 lbs. Price: 45c each; 25 or more 43c each.

No. 3. (B-C). 7½ ft., approx. wt. 9.69 lbs. Price: 55c each; 25 or more 50c each.

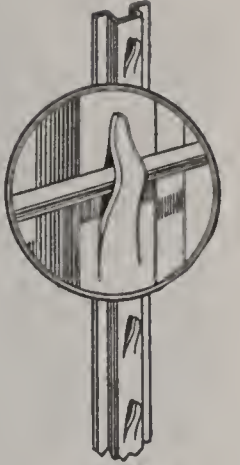

Ornamental Lawn Fence

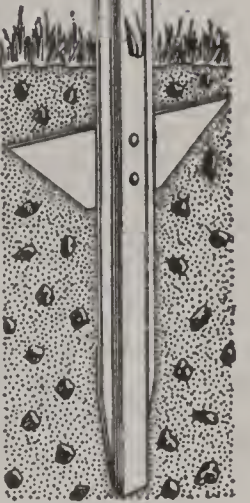
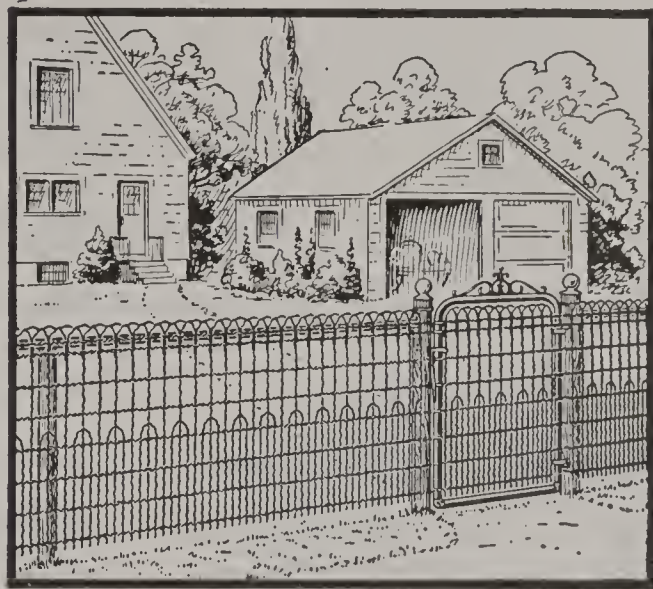

Sweet's
Steel
Post

The above cut shows the double style. Heavily galvanized steel wire used throughout. Popular heights: 36, 42 and 48 inch.

36 in., per ft.	\$0.14
42 in., per ft.15
48 in., per ft.17

Less 1c per ft. in full rolls.

We also carry the single style, same as double except additional lower picket not furnished.

36 in., per ft.	\$0.11
42 in., per ft.12
48 in., per ft.13

Less 1c per ft. in full rolls.

Trellis Wire

Double style. 18 in. wide, 10c per ft.
24 in. wide, 12c per ft.

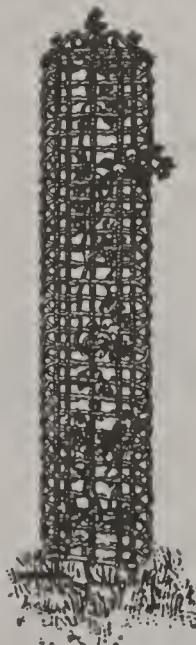

Trellis
Wire

Flower Bed Border



Fits any shape or size flower bed. Bottom left straight to be inserted in the ground. Standard specifications 16 in. height, 8c per ft. 22 in. height, 9c per ft. Specification B, 16 in. height, 6c per ft. 22 in. height, 7c per ft. Less 1c per ft. in full rolls.

Barn Equipment



Star Unit Stall No. 10

Milk and misery don't go together. The Star Unit Steel Stall gives the cow pasture-comfort. In this she can turn around to card herself—she can lie down with her head tucked against the side of her body, just as she sleeps out in a June pasture. Farmers who have used them say that cows will pay for the complete steel stalls and stanchions in 2 years out of the extra production the pasture-comfort makes possible.

Rust shield prevents partitions rusting off at floor line. Many other valuable features. Widths: 3 ft. 3 in., 3 ft. 4 in., 3 ft. 6 in. Finished grey enamel.

No. 10. Stall, less stanchion, sure stop, adjuster and rust shield
Each, \$9.25.

Star Adjustable Stanchions

	Each
No. 486. Giant wood lined with double lock and guide	\$5.70
No. 260W. Wood lined with single lock and guide	4.55
No. 252. Have maple upright, double lock and guide	3.55
No. 1211W. Wood lined with single lock and guide	3.75
No. 1211. Unlined all-steel with single lock and guide.	3.20

Stanchion fastenings extra. Specify for wood or concrete.

McCormick-Deering Ball Bearing Cream Separators

Skim Closer, Turn Easier, Last Longer

The McCormick-Deering line of cream separators with four ball bearings in each size is another step forward in the progressive program of building better dairy farm equipment.

FOR HAND OR POWER

No. 1. Capacity 350 lbs. per hour.	\$ 94.50
No. 2. Capacity 500 lbs. per hour.	103.50
No. 3. Capacity 750 lbs. per hour.	117.00
No. 4. Capacity 1050 lbs. per hour.	129.00

Alternating current motors for above 33.00

5% discount for cash.

McCormick-Deering Milking Machines

A mechanical milker, like any other machine on the farm, must be absolutely correct in design and carefully constructed if it is to perform accurately and efficiently under all conditions for a long period. With the McCormick-Deering milker this is made possible by the high-grade materials used in the construction of each part and the careful, watchful workmanship embodied in the assembly of every unit. There are no complicated parts and nothing to get out of order or adjustment. Ask us for a demonstration on your farm. Prices on application.

Dairy Scales

Milk scale brass front made especially for dairymen. Manufactured by Forschner.

No. 68MO. Weighs 30 lbs. by ounces	\$6.00
No. 68MD. Weighs 30 lbs. by 10ths	6.00
No. 69MO. Weighs 60 lbs. by ounces	6.50
No. 69MD. Weighs 60 lbs. by 10ths	6.50

Mailing weight 4 lbs.

Star Litter Carrier

The **No. 333** Litter Carrier. Quickest and easiest to raise and lower. Runs easily. Never in the way, always on the job.

Pays for itself in a year or two.

Hoisting shaft is a simple windlass without cogs or gears. Drive wheel bolted to shaft.

No. 6 Tub. Capacity 10 bushels \$51.00

No. 8 Tub. Capacity 12 bushels 53.00

No. 240 Star Water Bowl

Give the cows a fresh drink any time day or night, when they want it. A cow must drink 4½ gallons of water for every gallon of milk she produces. **Each, \$3.60.**

Warriner's Patent Chain Cattle Stanchions

Used in a large number of stables. A short chain secures the fastener to the top beam so that it suspends 1½ inches clear of the bottom sill. It is also fastened to the bottom sill by a chain to allow it a free and easy motion and rotation, giving the cattle freedom. **Each, \$2.75; doz lots, \$30.00.**

KOW KARE. Increases the flow of milk. It is for cows only. **65c,** mailing weight 2 lbs.; **\$1.25,** mailing weight 4 lbs.

BAG BALM. Cures caked bags and sore teats. Should be in every stable. **60c,** weight 1 lb.

CALF CORDIAL. Sure cure for scours and other similar complaints. **50c,** mailing weight 2 lbs.

WYANDOTTE DAIRYMAN'S CLEANER. An absolute necessity in every dairy. A powder, easy to use, and recommended by everyone that ever tried it. **Price: 5-lb. bag, 45c; 80-lb. keg, \$4.95; 280-lb. barrel, \$13.75.**

Moore Bros. "Purpul" Medicated Wax Teat Dilators

For obstructions, spiders, sores on end of teat, hard milkers, etc.

1½ doz. Dilators, 25c; 7 doz. Dilators, \$1.00, postpaid.

Dr. Naylor's Cow Remedies

MEDICATED TEAT DILATORS. 1½ doz. dilators in jar of ointment **50c; postpaid 60c;** 4 doz. dilators in jar of ointment **\$1.00; postpaid, \$1.10.**

LIQUID UDDER BALM. Price **\$1.00; postpaid \$1.10.**

CLERALAC. (Garget Treatment). Price **65c; postpaid, 75c.**

STOP-A-LEAK. Price **\$1.00; postpaid, \$1.10.**

LINITE. For canker, hoof rot, thrush. Price **\$1.00; postpaid, \$1.10.**

Cast Iron Feed Box

Price, **\$3.80.** Weight 31 lbs.

Corner Rack

Cast iron	\$6.00
Wrought iron	4.50

Roto Salt Bricks

Roto Salt Bricks. Weight 6 lbs. Price: **25c each, \$2.50 per doz.**

Roto Holders. Weight 6 lbs. Price: **50c each.**

Square Salt Bricks. Weight 5 lbs. Price: **25c each, \$2.50 per doz.**

Holdings. Weight 3 lbs. Price: **50c each.**

Breeders

Iodized Mineral Licks

1 doz. \$4.50, 3 doz. \$4.25 per doz., 6 doz. \$4.15 per doz.

12 doz. \$3.95 per doz.

Metal Lick Holders for above. For wood mountings, **25c each;** for tube mountings, **30c each.**

ROSS BROS. CO.

Ross' Farm and Dairy Equipment

Hinman "10 Star" Milker

Is supplied with seamless aluminum or steel tin-plated pail. The jug handle adds much to the simplicity and general satisfaction of the machine. The cover is sturdy, yet light in weight, requires no locking device and is easily changed from one pail to the other. The teat cups are fitted with one-piece inflations and due to the construction of the milk claw the cups are automatically shut off. This Milker works efficiently on 10 inches of vacuum. Low vacuum insures positive comfort to the cow resulting in complete response and absolute safety.

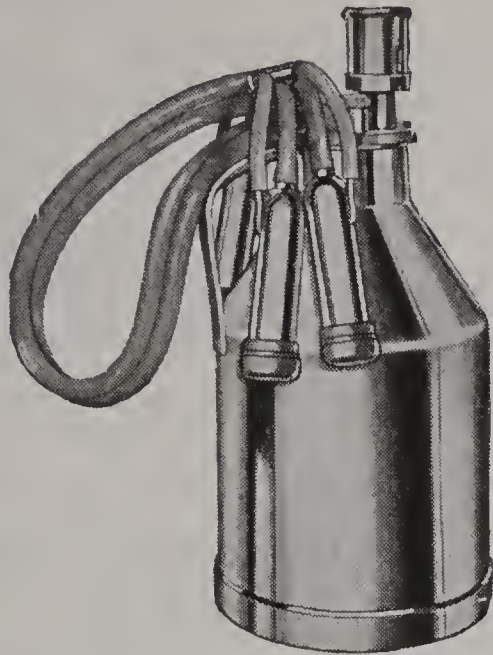

Hinman "10 Star" Power Units

Are made in two sizes and four models. The electric or gasoline motor is directly connected to a rotary type vacuum pump which is accurately balanced and operates on ball bearings. All moving parts are positively lubricated with an automatic oiler. Removable moisture trap, vacuum controlled and gauge are regular equipment.

Special Folder Giving All Details Furnished On Request

Hinman 10 Star Milker Unit, 18 qt. steel pail	\$ 55.00
Hinman 10 Star Milker Unit, 18 qt. aluminum pail ...	65.00
Hinman De Luxe Milker Unit, 40 lb. aluminum pail	88.00
Hinman No. 10 Electric Power Unit	120.00
Hinman No. 20 Electric Power Unit	170.00

The Rice Calf Weaner

Small, 50c; medium, 65c; large, 85c. Weight, each, 1 lb.

Old Hickory Smoked Salt (Sugar Cure)

Ready for use. For curing hams. 9-lb. can, \$1.00. Postage extra.

New Stewart Electric Clipmaster

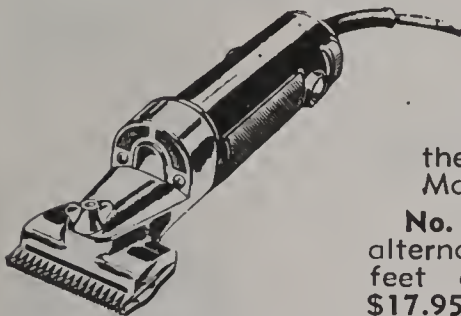

Smaller, more convenient handle, extra powerful ballbearing motor. Where electricity is available this is the easy, quick way to get all the advantages out of the market's best clipping machine. Mailing weight, 6 lbs.

No. 21 for 110/120-volt, direct or alternating current. Complete with 20 feet of rubber-covered cord. Price, \$17.95.

No. 21—220-volt	\$19.95
No. 71CM—Top Clipping Blade	1.85
No. 72M—Bottom Clipping Blade	1.35
Hand Power Clipper	13.45

Milk Bottle Cases

12 quart case, three wire, fully ironed, waterproofed.

No. BH135x3

12 quart case, two wire, fully ironed, waterproofed.

No. BL135x3

On twelve cases or more less 10c each and branding no charge. For rubber covering add 20c for two wire quarts; 25c for three wire quarts. Prices for pint and half pint cases, also for non waterproofed cases on request.

The Ideal Milk Cooler

Thoroughly cools the milk and at the same time aerates it perfectly, so that it is ready to ship or peddle at once. No time is lost in stirring morning's milk and getting it ready for customers, as it is cooled as fast as milked.

No. 2. Suitable for 10 to 15 cows

No. 3. Suitable for 25 to 40 cows

Varnished Cylinder Churns

Designed for those having a small dairy.

No. 0. Capacity 1 gallon. Weight 12 lbs.	\$3.75
No. 1. Capacity 2 gallons. Weight 13 lbs.	4.25
No. 2. Capacity 4 gallons. Weight 16 lbs.	4.85
No. 3. Capacity 6 gallons. Weight 18 lbs.	5.50
No. 4. Capacity 8 gallons. Weight 20 lbs.	6.50

Milk Jugs

Cleveland Pattern shown in cut. We can also supply other patterns. Price of Cleveland Pattern:

20-qt. size, umbrella cover, \$3.75 each. 25 or more, \$3.55.

40-qt. size, umbrella cover, \$5.00 each. 25 or more, \$4.80.

Embossing and marking extra. Prices as above, F.O.B. factory, with freight equalized.

Price from store stock: 20-qt., \$3.81; 40-qt., \$5.11.



Milk Pails

Very heavy tin milk or cream pails. Riveted ears.

12 quarts

14 quarts

Weight each, 5 lbs.

Mixing Can

Heavy Tin Mixing Can with removable strainer hoop and faucet. 6, 8, and 10 can.

6 can

8 can

10 can

Superior Seamless Strainers

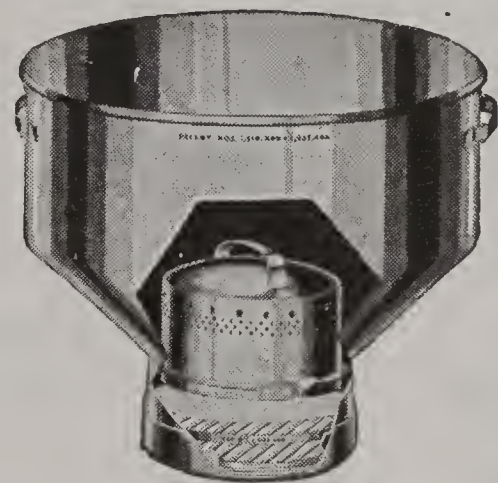

No. 616DR. Dome Grid with ring. 14 quart capacity. Top diameter 12 1/2 in. Neck diameter 5 3/4 in. Uses 6 in. discs or larger. Weight 6 lbs. Price \$2.75 each.

No. 621DR. Dome Grid with ring. 20 quart capacity. Top diameter 13 in. Neck diameter 5 3/4 in. Uses 6 in. discs or larger. Mailing weight 10 lbs. Price \$3.25 each.

No. 614 Perforated bottom, 6 in. neck, 12 quart capacity. Mailing weight 6 lbs. Price \$2.00 each.

Johnson & Johnson Cotton Discs

6 in. 300 to carton. Plain

6 1/2 in. 300 to carton. Plain

Mailing weight 3 lbs.

Buckley's Patent Watering Device

For Watering Stock in Stables.

Price: Each, \$2.65; per doz., \$30.00.

Quality Milk Strainer Pail

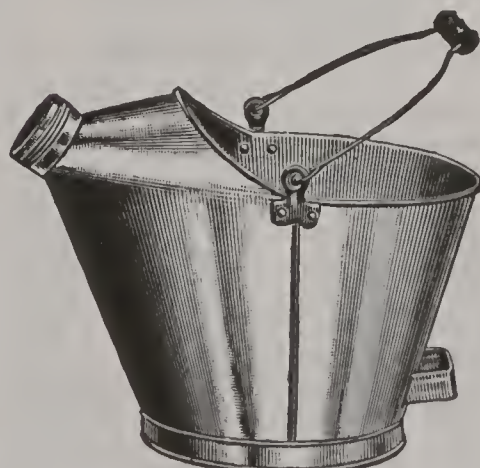

Screw Spout, made of extra heavy tin, easy to clean and keep in repair. Weight 6 lbs. Price, \$2.95.

Ross' Farm and Dairy Equipment

Milk Cans

Hi-Grade Cans with wood Bungs.

No. 1— 8 quarts Heavy	\$2.05
No. 1—10 quarts. Heavy	2.25
No. 3— 8 quarts. Light	1.75
No. 3—10 quarts. Light	1.95

Mailing weight, each 8 lbs.

If above cans are furnished with 3 3/16 in. Cap Neck, in place of wood bung, deduct 10c from above prices.

Milk Kettles

Bail Handle and Tin Top.

Mailing weight.

4 quarts.....	4 lbs.....	\$1.25
6 quarts.....	4 lbs.....	1.50
8 quarts.....	6 lbs.....	1.75
10 quarts.....	8 lbs.....	2.00

Savory Hooded Sanitary Milk Pail

Steel Clad Pattern. Heavy re-tinned wire bail. Hood is convex design and has approved 9 1/2 x 5 inch opening. 15-quart. Mailing weight 15 lbs. Price \$2.25.



Atlantic Dairy Pails

Steel Clad Pattern

No. 5634. 14 qt. Electric welded and seamless	\$2.50
Sanitary Dairy Pails soldered inside and outside.	
No. 2232. 12-qt.....	1.25
No. 2234. 14-qt.....	1.35
Mailing weight 7 lbs.	



Glass Churn

Whips cream, beats eggs, makes butter, etc.

2 quarts. Weight. 7 lbs.....	\$1.65
4 quarts. Weight 10 lbs.....	2.50

Extra glasses, 60c and \$1.00.

Universal Milk Bottles

1 quart	Doz. \$0.85	Gross
1 pint65	Ask
1/2 pint55	for
		Prices

Prices on plain and colored lettered ware quoted on request.



White Mountain Ice-Cream Freezer



Qt.	Weight	Price
1	6 lbs.	\$3.50
2	10 lbs.	4.45
3	12 lbs.	5.00
4	14 lbs.	6.25
6	20 lbs.	8.00

Bottle Brushes

Add for postage 5c each.

No. 305. 10 in. Hickory Handle Bristle Brush.....	\$0.45
No. 611. Grey Hair60
No. 309. Machine Brush, 5 in. grey hair, handle tapered..	.50

Leather Halters

No. 11. Russet Cow Halter, 1 1/4-inch, sewed and riveted. Weight 2 lbs.	\$1.90
No. 5. Russet Horse Halter, 1 1/4-inch, sewed and riveted. Weight 4 lbs.	\$2.95

Curry Combs

No. 8 SOLID BACK, ENAMELED CURRY COMB	\$0.30
No. 7 CURRY COMB. Three rows of crimped oval steel cleaners25
No. 125. 4 Coils, reversible spring steel, black handle30
Add postage, 5c each.	

Follansbee Seamless Dairy Pails

Made of the finest quality Follansbee Forge drawing quality sheets. Drawn of one piece. Both open and hooded patterns. New sanitary constructed bail extending beyond pouring edge of pail, also pouring handle and three bottom buttons that raise pail bottom, saving wear and tear at that point.

12 qt. with bail	Each \$2.00
14 qt. with bail	2.25
12 qt. with bail and hood	2.90
14 qt. with bail and hood	3.00

Twin Light Brand Cleansers

A quick positive cleanser and water softener. For use in dairies, ice cream plants, creameries, etc.

Twin light crystals. 100 lb. kegs.	\$10.00
5 lb. bags60
Twin light crystals No. 10. 100 lb. kegs.	7.50
Ask for prices in barrel lots or more.	

Seazone

Disinfectant deodorant. A disinfectant containing chlorine. For milking machines, pasteurizers, coolers, cans, strainers, pails, etc. Price 1 lb. box \$2.00; 5 lb. drum \$7.50; 10 lb. drum \$12.50.

Butter Paper

This parchment butter paper is used by most of the butter packers. Made of very strong fibre and will stand any amount of hard use.

Cut 9x12 in.	Per Lb. \$0.35
10 lbs.30

Bottle Caps



Design No. 1433



Design No. 1405

Stock printed designs, Pull Caps with wires.
Per box of 1000. Weight 3 lbs. \$0.70
Per box of 5000. Weight 15 lbs. 3.25
Pull Caps with wires. Packed in tubes of 500. Per 1000.
Weight 4 lbs.70

Prices on special printed caps packed in tubes or bulk for 50,000 or more quoted on request.

Blanchard's Butter Molds

Initial engraved, 25c extra per initial. Weight 1 lb.	
1/2 lb.	\$0.85
1 lb.	1.00
2 lbs.	1.50

Bottle Carriers

Flat Wire:	
6 1-qt. Bottle Carrier. Weight 5 lbs.	\$1.25
8 1-qt. Bottle Carrier. Weight 6 lbs.	1.40
Add postage for your zone.	

ROSS BROS. CO.

Sprayers for Garden and Farm Use

Myers Self-Oiling Junior Spray Outfit

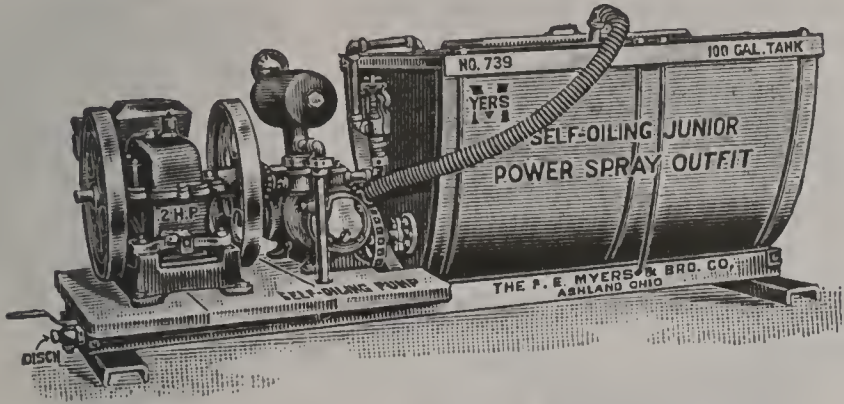

Fitted complete with 2 h.p. engine and self-oiling pump. Equipped with one spray gun, 50 feet of 1/2-inch high pressure hose, single cutoff for discharge lines, pressure gauge, rotary agitator, pressure regulating valve, strainer and suction hose. **No. 739. Myers Self-Oiling Junior Spray Outfit.** With 100-gal. Cypress Tank equipped as above. **Price, \$270.00. 5% discount for cash.**

Myers catalog, describing the above and all other power sprayers, sent on request.

The Myers Whitewash, Cold Water Painting Machine and General Purpose Sprayer

No. R329. Holds 7 gallons. Price, \$14.00.

Nozzles



Fembro 45 degree nozzle, **85c**; or **90c**, postpaid.



Fembro straight nozzle, **75c**; or **80c**, postpaid.

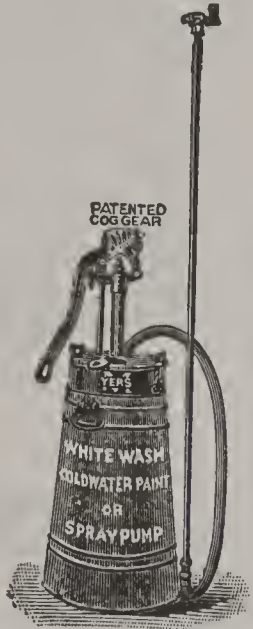

Bordeaux Nozzle for Spraying

This nozzle will throw a fine fan-shaped spray and will readily free itself should it become clogged by turning cock-handle. It will throw a solid stream or it may be shut off altogether if desired. **Price, \$1.20. Weight 1 lb.**



Brown's Electro-Weld Sprayer

Side and head seams electrically welded. Galvanized steel bottom securely attached and soldered. The safety lock on this sprayer is built into the funnel so that the pump cannot be removed until the pressure in the tank has been expelled. Non-clog nozzle and 24 in. brass extension.

No. 400D. Electro-weld 4 gal. galvanized tank. **Price \$5.60.** Shipping weight 10 1/2 lbs.

No. 400B. Solid brass 4 gal. brass tank. **Price \$8.95.** Shipping weight 10 1/2 lbs.

No. 350D. Dome top 3 1/2 gal. galvanized tank. Shipping weight 10 lbs. **\$3.95.** (Not shown).

Myers Kwikfill Compressed Air Sprayer

The tank is made of heavy galvanized iron or brass. The side wall is close riveted and soldered. The top and bottom are extra heavy galvanized material with flanged edge over which the side wall is turned and thoroughly soldered. Has 1 3/4-in. brass tube air pump. The air pump is attached to the tank by a heavy brass nut, the unscrewing of this brass nut by turning the handle permits the instant removal of the pump for filling the tank. Each sprayer has a 45-degree nozzle and 18-in. brass extension.

No. 2242. 4-gal. galv. tank **\$6.00**

No. 2242B. 4-gal. brass tank **10.50**
Shipping weight 13 lbs.

No. 2240. 2 1/2-gal. galv. tank **5.25**

No. 2240B. 2 1/2-gal. brass tank **9.50**
Shipping weight 10 lbs.



Brown's Siren Knapsack Outfit

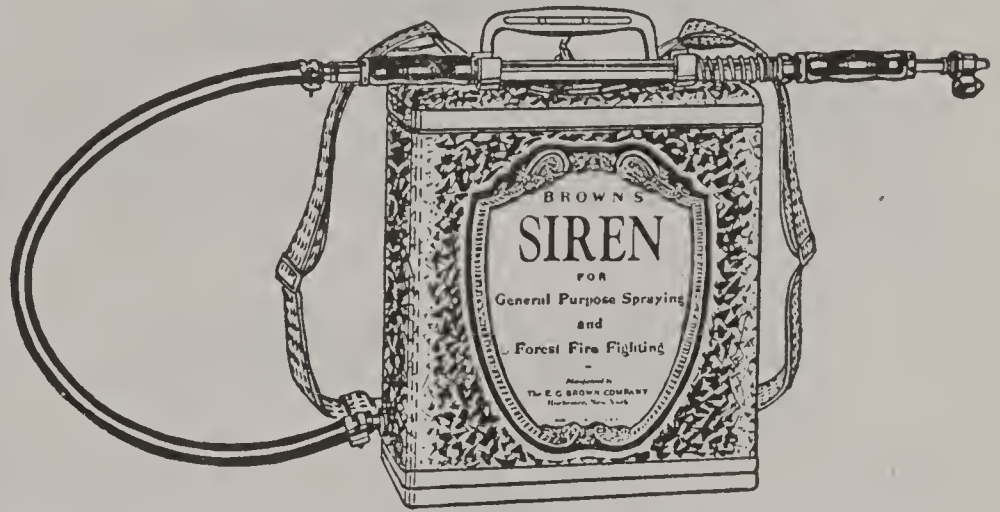

Dual purpose sprayer. Designed for fire fighting, but with a wide range of uses. An efficient agricultural and whitewash sprayer. Pump generates 200 lbs. pressure with little effort. Five-gallon capacity. Shipping weight 11 lbs. **Price \$11.90.**

Brown's Siren Pump

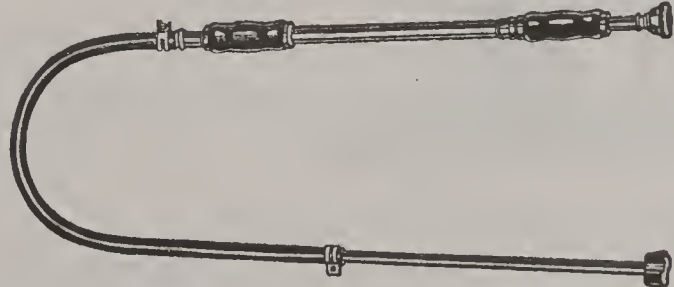

Complete with strainer pipe and nozzles for use with knapsack or bucket. Used for long or short range spraying. Shipping weight 4 lbs. **Price, \$4.95.**

Brown's Open-Hed Sprayer



This new Open-Hed Sprayer is entirely electrically welded. The metal at the seam, top and bottom joints is completely fused together to make a practically seamless tank, which will withstand 100 lbs. pressure. Tank opening is 5" diameter, easily filled and cleaned, can be wiped absolutely dry.

Open-Hed No. 4B. Brass-Copper alloy, 4 gals. **\$11.95.**

Open-Hed No. 4D. Heavy Steel, hot galvanized, 4 gals. **\$7.50.** Shipping weight 12 lbs.

Open-Hed No. 3D. Heavy Steel, hot galvanized, 3 gals. **\$6.75.** Shipping weight 9 lbs.

Sprayers for Garden and Farm Use

Myers Cog Gear Spray Pump Double Acting

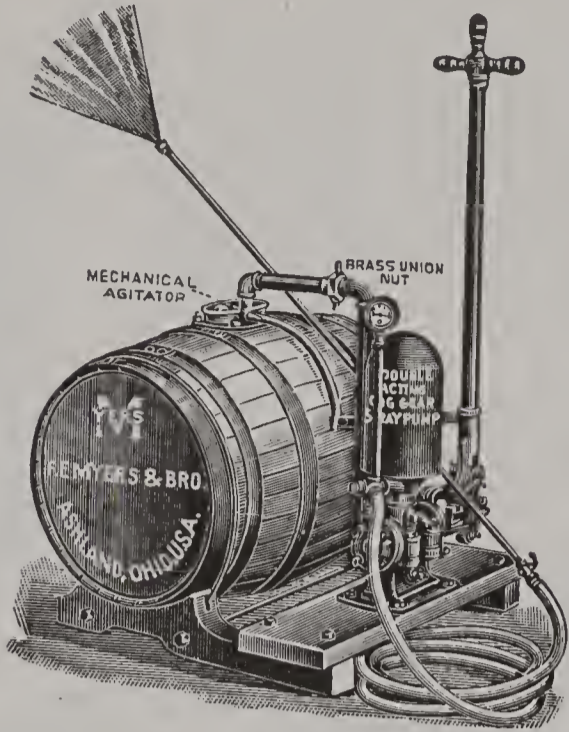

No. R316B. Pump complete, 50-gallon barrel mounted as shown, with pressure gauge, one 15-ft. lead of $\frac{3}{8}$ -inch 7-ply discharge hose, one Fembro Fig. 1290 nozzle, one 8-ft. pipe extension with lever shut-off and mechanical agitator. Price \$60.00.

The Myers Portable Sprayer

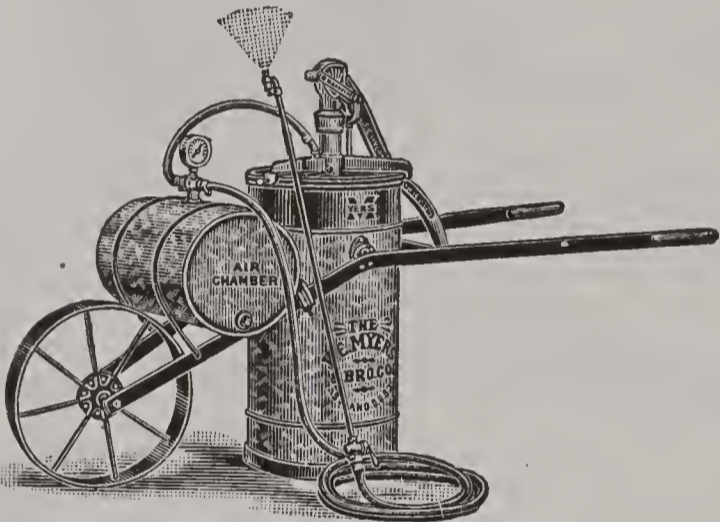

Portable Sprayer with 6-gallon Air Chamber which assists in keeping up a steady spray with less effort by the operator. It will hold the pressure and continue to spray for several minutes while the operator leaves the pump to cover nearby trees. The pump is fitted with cog gear handle, is securely attached to the tank by means of a clamp connected direct to the channel iron that surrounds the top of the tank, held in position by one thumbscrew. The handle can be located at any point desired.

No. R339 $\frac{1}{2}$ B. Myers Handy Portable Sprayer, complete as shown with air chamber, pressure gauge, dasher agitator, 15 feet $\frac{1}{2}$ -inch 5-ply discharge hose, 8-ft. pipe extension with lever cut-off and Vermorel nozzle, wheel 15 $\frac{1}{2}$ x3 inch. Price \$42.50.

No. R336 $\frac{1}{2}$ B. Without pressure tank. Price \$26.50.

Myers Spray Guns



Illustrates the Spray Gun. This gun discharges a long distance spray, by means of which the top of the highest fruit tree can be reached, a slight turn of the handle widens the spray and another short turn throws off spray entirely when ready to move to next tree.

- No. 12. Gun without hose swivel\$ 7.00
- No. 13. Gun with hose swivel 8.00
- No. 35. Triple spray gun without hose swivel 9.25
- No. 36. Triple spray gun with hose swivel 10.25
- No. 47. Quadruple spray gun without hose swivel 10.50
- No. 48. Quadruple spray gun with hose swivel 11.50

Myers Cog Gear Barrel Spray Pump

No. R318B. Myers Cog Gear Barrel Spray Pump. Complete, with one lead of 15 feet of $\frac{1}{2}$ -inch 5-ply discharge hose, graduating Vermorel nozzle and mechanical agitator. Price \$17.00. 8-ft. pipe extension extra, 80c. Price: Complete, all set in barrel, with 8-ft. extension, \$21.75.



The Myers Perfect Knapsack Spray Pump



No. 1330. Galvanized\$14.00
No. 1331. Brass 21.00
Weight 16 lbs.

Myers Little Giant Bucket Pump

No. 327 $\frac{1}{2}$. Little Giant Brass Spray Pump, with agitator complete with hose and Imperial combination fine, coarse spray and solid stream nozzle, with malleable foot rest. Price \$4.50. Weight 6 lbs.

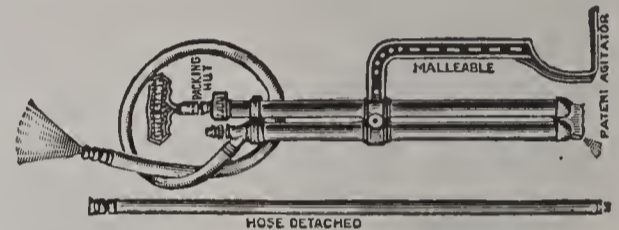

Brown's Dome Top Continuous Sprayers

No. 335. A one-qt. continuous sprayer of new dome top design with all brass seamless pump and copper container. Combination brass nozzle, brass siphon tube and brass ball valve are easily accessible for cleaning. This machine produces a fine spray especially adapted to general home and garden use. Price, \$1.95.
No. 325. The No. 325 sprayer possesses the same general features as the No. 335, but is made with a lithographed tin pump instead of brass. Price \$1.25.
No. 315. The No. 315 sprayer is the same as the No. 325, but with a tin container. Price 85c.
Mailing weights, 2 lbs.

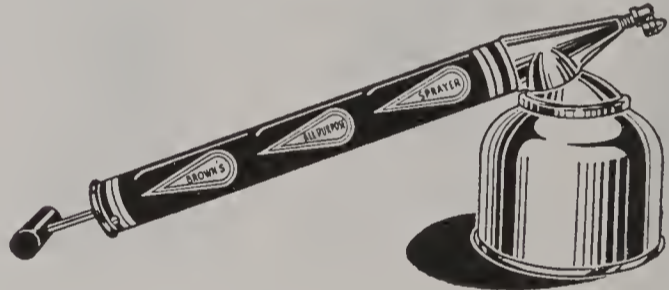

Brown's Dome Top Sprayers

No. 14. A single action sprayer of dome top design with one quart tin container and lithographed tin pump. An all-purpose Sprayer equipped with a drip return cup and simple one-quarter turn lock assuring dependable and economical operation. Ideal for home, garden, or poultry house. Mailing weight 2 lbs. Price, 40c.
No. 12. The No. 12 sprayer is of one-pint capacity, with same general specifications as the No. 14 sprayer. Mailing weight, 2 lbs. Price 30c.

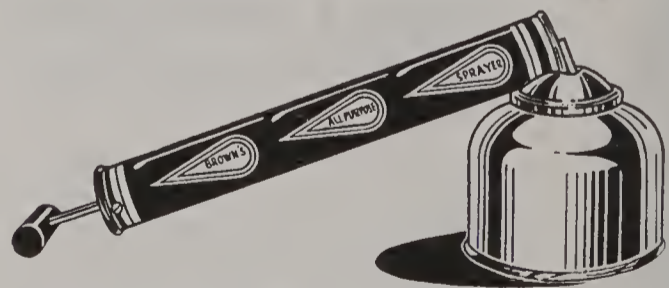

Brown's Single Action Sprayer

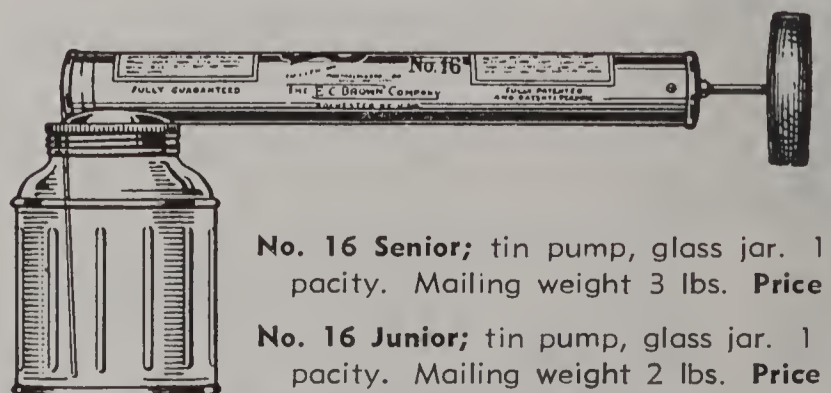

No. 16 Senior; tin pump, glass jar. 1 qt. capacity. Mailing weight 3 lbs. Price 35c.
No. 16 Junior; tin pump, glass jar. 1 pint capacity. Mailing weight 2 lbs. Price 30c.

ROSS BROS. CO.

Farm and Garden Implements

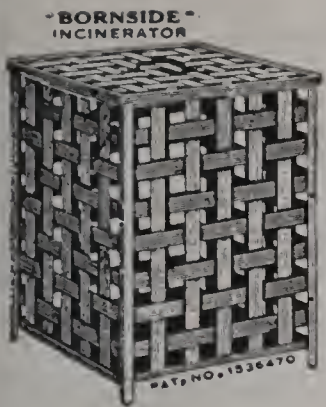

SKYSCRAPER Rubbish Burners

E.	27"x16"x16", wide mesh ..	\$ 3.00
DD.	27"x14"x14", close mesh ..	3.50
EE.	27"x16"x16", close mesh ..	4.00
3E.	30"x30"x20", close mesh ..	6.25
4E.	36"x24"x24", close mesh ..	11.25

Step Ladders

Paris Step Ladders. These ladders are made by the Paris Mfg. Co., which is sufficient guarantee for their adaptability and workmanship. Every ladder heavily trussed and reinforced. We carry all lengths.

3 ft.	\$1.95
4 ft.	2.60
5 ft.	3.25
6 ft.	3.90
7 ft.	4.55
8 ft.	5.20
10 ft.	6.50

Columbia Fruit Step Ladder

This fruit step is the latest, strongest, best and most practical fruit step on the market. Made from clear spruce; steps reinforced with truss rods. Made in 5, 6, 8, 10, and 12-ft. lengths. Per ft., 62c.

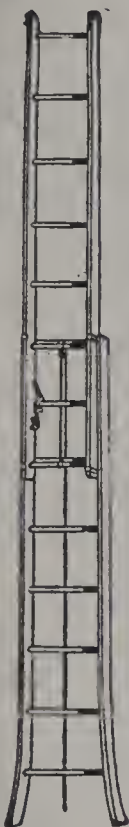

Extension Ladders

Made from white spruce and recommended by telephone and telegraph folks who use these. Allow 4 ft. for lap.

Ft.	Per Ft.
20 to 32	\$0.52
34 to 4454

Common Taper

Made of white spruce. Very strong and durable.

Ft.	Per Ft.
8 to 16	\$0.42
18 to 2243

Closed Top Fruit

This ladder manufactured purposely for fruit picking. Upper section closed or pointed at top to run up in thick branches of trees. 10 to 22 ft., per foot 42c.

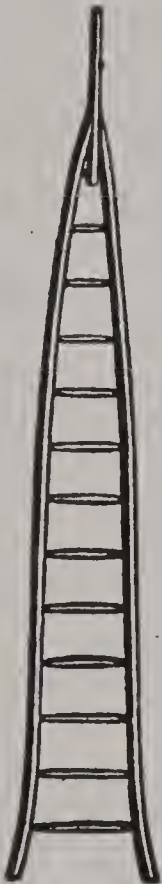

Spike Tamp

Spike Tamp is the most wonderful lawn tool ever produced. Spike Tamp soon pays for itself in saving seed, fertilizer, plant food, and water. Spike Tamp is very useful in the garden for cultivating, breaking up clods, and pulverizing the soil.

Price \$4.50.

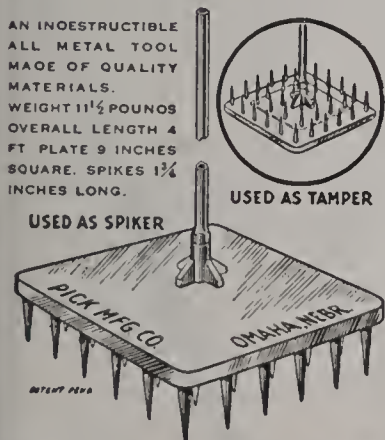

Galvanized Ash Cans

No. 1. 17x25. A medium weight can	Each \$2.00
No. 020. 17x25.	1.35
Ajax. 18x26. A heavy corrugated can	3.85
No. 1. Success Rotary Ash Sifter	2.95

Pruning Saws



No. D-27. 26 in. Mailing weight 3 lbs. \$3.50



No. 19. 18 in. Mailing weight 2 lbs. \$2.25



No. 15. Blade 14 in. Mailing weight 3 lbs. \$2.15
Extra blade25



No. 40. 16 in. Mailing weight 2 lbs. \$1.25
18 in. Mailing weight 2 lbs. 1.35

Tree Saws



Curtis Hollow Back Pattern. 5 ft., \$2.50; 5 1/2 ft., \$2.75; 6 ft., \$2.95.

Same as above, only two gages thinner on back. 5 ft., \$2.75; 5 1/2 ft., \$2.95; 6 ft., \$3.15.

Handles extra. 50c per pair.

Curtis One Man Saws



3 ft., \$2.50; 3 1/2 ft \$2.75; 4 ft., \$3.00.

Buck Saws

Great Northern Wood Saw. Natural wood, narrow blade... \$1.75
No. 305. Red frame. 2-inch blade \$1.25

Saw Bucks

Price: Each 75c.

The HKP Forester Pruner

The Forester has the patented slide-shift power slot (McKinney type). Powerful and ruggedly built for lifetime use.

No. 1. 20 in. long. Capacity 13/16 in. Wt. 2 lbs. 10 ozs. Each \$5.00.

No. 2. 27 in. long. Capacity 1 1/2 in. Wt. 4 lbs. 10 ozs. Each \$6.00.

No. 3. 34 in. long. Capacity 2 in. Wt. 7 lbs. 4 ozs. Each \$7.00.



Farm and Garden Tools

The Following is a Partial List of the Large Line of Hand Tools We Carry.

IN ORDERING, GIVE NAME, NUMBER AND SIZE.

TRUE TEMPER HOES

8-in. Field Socket	\$1.35
8-in. Field Shank	1.20
8-in. Meadow Socket	1.50
9-in. Meadow Socket	1.55
8-in. Meadow Shank	1.35
9-in. Meadow Shank	1.40
Ladies'	1.00
Boys'	1.10
Square Top Onion	1.10
9-in. Mortar	1.60
10-in. Mortar	1.70

SCUFFLE HOE

No. A2. Blade 7½ inches, 5-foot handle. (True Temper)	1.30
---	------

CHICKEN HOUSE OR BARN FLOOR SCRAPER

No. CH6113. Blade 13 inches wide; 4 inches deep. 6-foot handle ...	1.45
--	------

SUNNYSIDE HOE

The best strawberry hoe. Mailing weight 4 lbs.	1.30
---	------

TRUE TEMPER MANURE FORKS

5-Tine, Iron D handle. Plain	1.95
5-Tine, Long Handled, Strapped ...	2.05
5-Tine, Iron D Handle, Strapped ...	2.05
5-Tine, Wood D Handle. Strapped ..	2.35
6-Tine, Iron D Handle, Plain	2.10
6-Tine, Long Handle, Strapped ...	2.20
6-Tine, Iron D Handle, Strapped ..	2.20
6-Tine, Wood D Handle, Strapped..	2.50

TRUE TEMPER SPADING FORKS

4-Tine, Iron D Handle, Strapped ...	1.55
4-Tine, Wood D Handle, Strapped ..	1.85
4-Tine, Long Handle, Strapped	1.60
5-Tine, Iron D Handle. Strapped ...	2.65

GARDEN FORK

No. 300. 3-Tine. Mailing weight 2 lbs.50
---	-----

TRUE TEMPER COKE FORKS

10 Tines, 1¼ in. between tines ...	3.65
12 Tines, 1¼ in. between tines ...	4.20

GRASS SCYTHES

Mailing weight 3 lbs.

True Temper	1.85
Black Hawk	1.85

BUSH SCYTHES

Bush Scythes	1.85
--------------------	------

SCYTHE SNATHS

Ash Grass	1.50
Bush Snaths	1.75

TRUE TEMPER STEEL RAKES

12-Tooth	1.20
14-Tooth	1.25
16-Tooth	1.35

Add postage for your zone.

WOODEN RAKES

3 Steel Bow Hay Rake, 14 teeth ...	\$0.95
3 Steel Bow Lawn Rake, 28 teeth..	1.10
Drag Rake	2.00

WIRE LAWN RAKE

Queen Reversible Wire Lawn Rake with handle. Mailing weight 4 lbs.	1.00
--	------

GUMFINGER LAWN RAKE

The only rake with rubber teeth.	
16 in. Mailing weight 3 lbs.	1.00
20 in. Mailing weight 4 lbs.	1.25

LAWNCOMB RAKE

LC18 True Temper. 24 teeth. Mailing weight 5 lbs.	1.25
--	------

KLEEN SWEEP RAKE

No. 41 Kleen Sweep Lawn Rake, made by Rugg. 32 teeth. Mailing weight 5 lbs.85
--	-----

TURF EDGER

For lining walks, etc. Mailing weight 5 lbs.	1.25
---	------

BORDER AND LAWN SHEARS

Long Handle Border Shears with one wheel	4.25
Long Handle Lawn Shears with two wheels	4.50

GRASS SHEARS

Doo-Klip Grass Shears. Mailing weight 2 lbs.	1.50
Long Handle Doo-Klip Shears. Mailing weight 5 lbs.	2.50

GRASS SHEARS

No. H9. 12 in., bevel steel blades. Mailing weight 2 lbs.75
--	-----

GRASS SHEARS

35c and 75c.
Add 10c for postage.

GARDEN TROWEL

Solid steel with offset shank. Mailing weight 2 lbs.	1.00
---	------

STEEL GARDEN TROWEL

Long Handled. Mailing weight 2 lbs.	
No. 21240
Short Handled. Mailing weight 2 lbs.	
No. 21175

GARDEN TROWEL

No. 21235
Mailing weight 2 lbs.	

CHEAP TROWEL

6 in. Mailing weight 2 lbs. No. 700.	.10
--------------------------------------	-----

WEEDING HOOK

3-Tine No. E. Mailing weight 2 lbs.	.60
-------------------------------------	-----

LANG'S WEEDER

Postpaid30
----------------	-----

GARDEN SETS

No. 4PSF. Ladies' 4-piece True Temper	\$3.15
---	--------

NORCROSS GARDEN CULTIVATORS

No. 11. 3-prong short handle65
No. 33. 3-prong long handle	1.10
No. 55. 5-prong long handle	1.35

NEW BUSHNELL GARDEN CULTIVATORS

No. 3. 3-prong long handle95
No. 5. 5-prong long handle	1.15

DIBBLE

Cast75
With wood handle. Mailing weight 2 lbs.75

WATERING POTS

4 qt. Weight 3 lbs.75
6 qt. Weight 3 lbs.85
8 qt. Weight 4 lbs.95
10 qt. Weight 4 lbs.	1.00
12 qt. Weight 6 lbs.	1.15
16 qt. Weight 8 lbs.	1.45

GARDEN REEL

No. 1. Small. Mailing weight 4 lbs. ...	1.50
No. 2. Large. Mailing weight 5 lbs.	2.50

GARDEN LINE

96 ft. Mailing weight 1 lb.	1.00
----------------------------------	------

ASPARAGUS KNIFE

No. 94. Goodell. Mailing weight 1 lb.40
--	-----

STEEL BLADE TREE SCRAPER

Weight 2 lbs.	1.25
--------------------	------

STEEL GRAFTING CHISEL

Mailing weight 1 lb.	1.25
---------------------------	------

PEERLESS FRUIT PICKER

Mailing weight 3 lbs.60
----------------------------	-----

GRASS HOOKS

No. 11½. True Temper55
No. 1. Hand made40
Nolin's85
Mailing weight 2 lbs.	

PUSH BROOMS

5 rows, 16 in., Rattan	1.25
5 rows, 16 in., Bass	1.50
Mailing weight, each, 5 lbs.	

COW TIES

3½ ft. Mailing weight 3 lbs.50
4 ft. Mailing weight 3 lbs.55

CATTLE CARDS

Postage extra, 5c each	
No. 444. Small special fiber. 5¾x3½ ..	.25

CANT HOOKS

3½ ft.	2.35
4 ft.	2.50

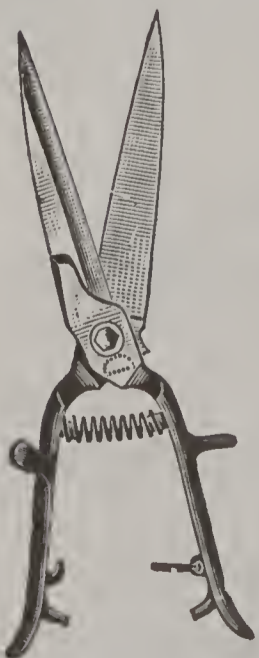

No. H9
Grass Shear



Lawncomb
Rake



Doo-Klip Grass Shear



Kleen Sweep Rake

ROSS BROS. CO.

Farm and Garden Implements

"Pexto" Pruning Shears



No. 5 Pruning Shears.

No. 5. 9 in. Cast iron handles, blue steel blade	Each	\$0.50
No. 5C. 9 in. Malleable iron handles, black tool steel blade		.75
No. 505. 9 in. Solid forged steel, red handles		1.00
No. R505. 9 in. With regulating ratchet bolt		1.00
No. R605. 9 in. Solid forged steel, red handles		1.35
No. 605. 9 in. Without regulating ratchet bolt		1.25



No. 50 Pruning Shears.

French Pruning Shears



Forged tool steel blade, drop forged handles.

7 in.	\$1.95
8 in.	2.00
9 in.	2.25
10 in.	2.50

"Tiffany" All Steel Tree Pruners



Cuts from both sides of the limb and does not bruise the bark. Cuts 1½-inch limbs with ease. Light, powerful and practical. The blade has the draw cut principle and cuts very smooth.

Length 20 in. Weight 2½ lbs. Postpaid	\$3.00
Length 24 in. Weight 3 lbs. Postpaid	3.00
Length 28 in. Weight 3½ lbs. Postpaid	3.50

Clyde Pruners

The Clyde Drawcut Pruners produce a powerful sliding cut movement of the blade. The blade hook and shank are forged from tool steel.

No. 5409½. 24 in. Strapped ash handles	\$2.00
No. 5403. 22 in. Drawcut, strapped ash handles	3.25
No. 5402. 24 in. Drawcut, strapped ash handles	3.75

Snap Cut Pruner

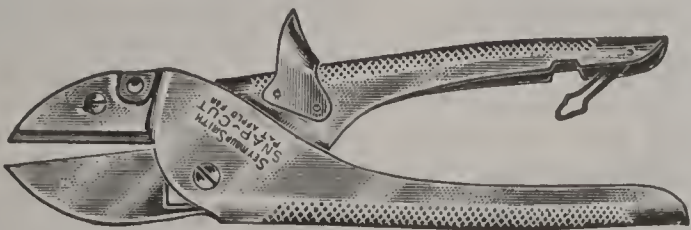

Orchardists, home and professional gardeners everywhere recognize the "Snap Cut" as the most efficient pruner on the market today.

No. 119. Length 8 in.	\$2.00
No. 118. Length 6 in.	1.50

Add 10c for postage.

Magic Weeder Hoes

REICHARD'S
COMBINATION SPRING-TOOTH
Magic Weeder Hoes

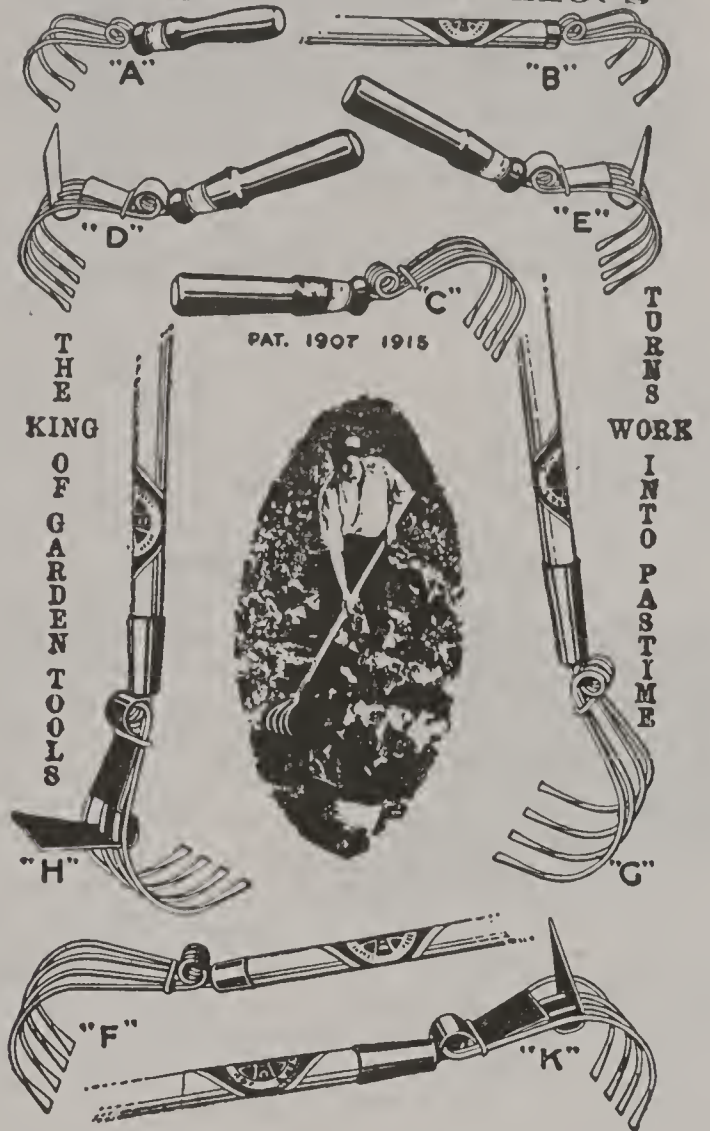

Specifications and List Prices:

Style	Length of Handles	Price each	Postpaid each
A	5¼ in.	\$0.10	\$0.15
B	18 in.	.15	.25
BB	36 in.	.25	.35
C	5¼ in.	.15	.25
D	6 in.	.25	.35
E	6 in.	.25	.35
F	42 in.	.65	.80
G	48 in.	.80	.95
H	48 in.	.90	1.05
K	48 in.	.90	1.05

Hedge Shears

No. 154N. 9 in. Notched and serrated, bolted handle	\$2.95
No. 54N. 9 in. Notched only, bolted handle	2.75
No. 4N. 8 in. Notched only. Handy hedge shears	1.25

Orchard Pruners

"The Pruner with the Sliding Handle"	
8 ft.	\$2.25
10 ft.	2.50
12 ft.	2.75
14 ft.	3.00

HKP Point Cut Pruner

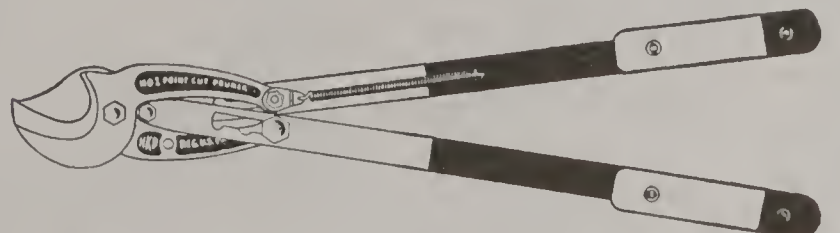

This new Porter tool is, we believe, the first perfect all-purpose pruner ever developed. Furnished in three length handles.

No. 120. 20 in. Weight 2 lbs. 12 oz.	\$5.00
No. 124. 24 in. Weight 3 lbs. 2 oz.	5.10
No. 127. 27 in. Weight 3 lbs. 7 oz.	5.20

Farm and Garden Implements

DELCO PUMPS AND COMPLETE WATER SYSTEMS

Write us for Information and Prices

Cincinnati Bucket Pump

We will guarantee it to purify any well in five days, or we will refund the money. Cannot freeze. Can be set up without going below platform.

For 10-ft. well.....\$12.50
For each additional foot of well add50

Furber Wood House Pump

6x6, 3 1/2 in. bore.

7 ft. Porcelain lined\$11.75
7 ft. Unlined 9.25
8 ft. Porcelain lined 12.50
8 ft. Unlined 10.00
Tubing, 4x4. Per ft..... .35
Coupling and bands for the above. Each..... 1.00

Garden Wheelbarrow

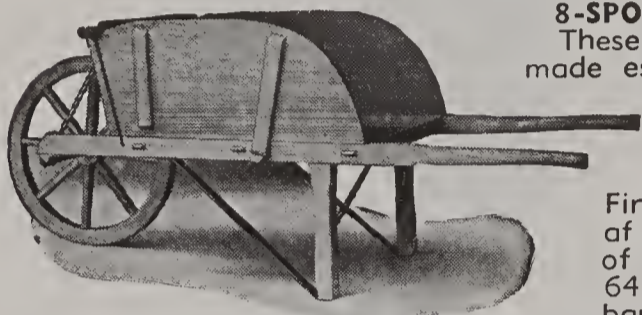

8-SPOKE WOOD WHEEL

These Wheelbarrows are made especially for us, are well constructed throughout, of hardwood, and strongly ironed. Finished with two coats of paint and one coat of varnish. This, No. 64, is the best garden barrow on the market.

No. 64 Barrow (as shown). Painted green. Price, \$6.95 each.
No. 5. New Special Garden Barrow (not shown). Painted green with steel wheel. Price, \$5.95.
No. 6B. Garden Barrow (not shown). Painted red with steel wheel. Price, \$4.95.
No. 64 Barrow with 16x4 pneumatic rubber tired wheel. Price, \$12.95 each.



General Utility Steel Tray Barrow

An exceptional Barrow for general use around the home or garden.

No. 21. Price, \$5.25 each.
Steel Tray Home Barrow. No. 20. Price, \$3.95.

Contractors Angle Leg Barrow



The very best all around contractor's Barrow made. Tray 27x32 at top. Frame of hardwood and thoroughly braced and bolted. 16 in. steel wheel; tire 1 3/4 x 5/16; 5/8 in. axle. Heavy rad rolled in edge. Weight 70 lbs. each.

No. 17B. Price, \$7.75 each.

TUBULAR ALL-STEEL BARROW. Not illustrated.
No. 25. Price, \$8.25 each.

Burlap Hotbed Mats

Made of burlap filled with hair felt. 76x76. Preferred by many market gardeners to the straw mats. Each.....\$3.50
Waterproof. 76x76. Each..... 4.00
Straw Hatbed Mats (not shown). 6x6. Each..... 2.50

No. 10 Garden Hose Reel

Undoubtedly the best garden hose reel on the market. Absolutely all metal, tubular steel rims and frame; corrugated galvanized drum. Frame and reel enameled green. Capacity 100 feet of 3/4-in. hose. Price, \$4.50.

All Steel Hose Reel

Well balanced, easy to operate, heavy gauge galvanized steel drum. Capacity 100 feet 5/8-in. hose. Price, \$1.35.

Picks, Mattocks

8-lb. Contractors' Picks\$1.65
9-lb. Contractors' Picks 1.80
6-lb. Pick Mattocks 1.45
6-lb. Lang Cutter Mattocks 1.35
4-lb. Bag Hoes 1.30

Corn Hooks

No. 2CH Yankee Corn Hook\$0.50
No. 6C Carver's Patent Plain Edge75
No. 8C Carver's Patent Serrated Edge80

Shovels

Pony and Branca Shovels are one piece solid shank shovels manufactured by the Ames Shovel Co. We also carry the Bantam and Fox, one piece, solid shank shovels, manufactured by the American Fork & Hoe Co.

No. 2 Pony Shovels, short or long handle, rd. or sq.\$1.60
No. 3 Branca Shovels, short or long handle, rd. or sq. 1.70
No. 2 Bantam Shovels, short or long handle, rd. or sq. 1.60
No. 3 Fox Shovels, short or long handle, rd. or sq. 1.70
No. 2 Bantam Spade, short or long handle 1.60

The Handiest Implement on the Farm

A Good Stone Boat

The front is of high grade tank quality carbon steel, 29 inches or 34 inches wide, firmly bolted and braced to the raves and bottom boards, which are of bone dry hardwood. The raves are painted red and varnished; the bottom boards are oiled with the best quality linseed oil.

29-inch Boat. Length 6 feet 1 inch. Weight 138 lbs. ...\$15.00
34-inch Boat. Length 7 feet 1 inch. Weight 178 lbs. ... 16.50

Steel Fronts

29-inch with balts. Weight 27 lbs.\$5.00
34-inch with balts. Weight 32 lbs. 5.25
40-inch with balts. Weight 37 lbs. 6.00

CAST IRON BOAT HEAD. Price, \$7.50 each. Bolts. \$1.00 per set.

Knot Klipper Axes

2 3/4, 3, 3 1/4 and 3 1/2 lbs. Absolutely guaranteed. Each ...\$1.90
Handled with extra 28-in. handle 2.35
Double Bit 2.25
Double Bit Handled 2.75
TRUE TEMPER AXES. 28-in. French handle 2.25
JIM DANDY AXES. 28-in. handles (a good cheap axe) ... 1.75
BOYS' HANDLE AXES. 26-in. handle 1.50
HOUSE AXES. 19-in. handle 1.50

Steel Scraper with Runners

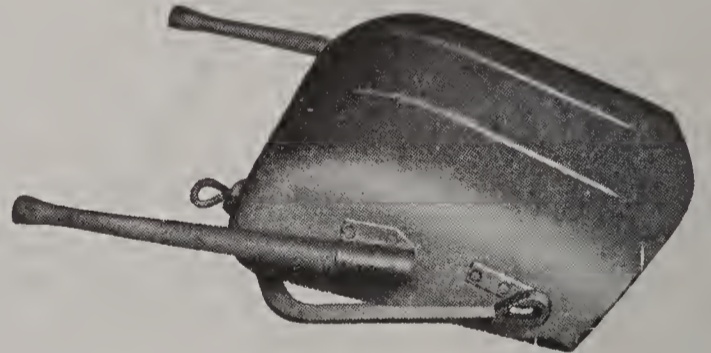

No. 1. Carries 7 ft. of earth\$10.75
No. 2. Carries 5 ft. of earth 10.50
No. 3. 10.00

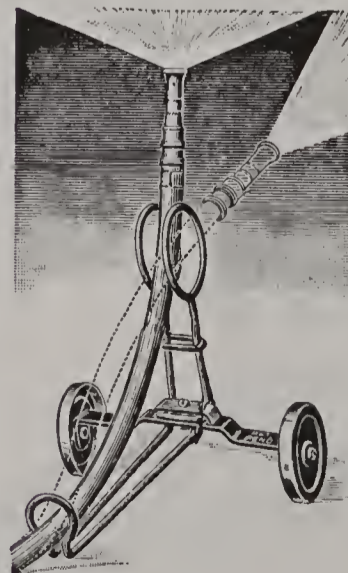

Hospray

Adjustable sprinkler. "Hospray" directs any spray at any angle. The usual hose nozzle is used, permitting a great variation of sprays which cannot be obtained with other sprinklers. Easily moved from place to place without the necessity of shutting off the water. Mailing weight 3 lbs. Price, 85c each.

Hotbed Sash

3 ft. x 6 ft. x 1 3/4 in. With sides projecting, glazed with thick glass, painted two coats. \$5.50 each; in lots of 6, \$63.00 per doz.

Asparagus Buncher

Mailing weight 5 lbs. Each.....\$4.25

ROSS BROS. CO.

Farm, Garden and Lawn Supplies

Richmond Plant Tub

Painted green, round wire hoops.



No.	Top Diam.	Bottom Diam.	Depth	Weight Lbs.	Price
1	6	5	6	1	\$0.65
2	7	5	7	1 1/2	.70
3	8	6	8	2 1/2	.75
4	9	7	9	2 3/4	.80
5	10	7 1/2	9	3	.95
6	11	8 1/2	10	4	1.15
7	12	9	11	4 1/2	1.40
8	13	10	12	5 1/2	1.75
9	14	11	13	7	2.00
10	15	11 1/2	14	8	2.20
11	16	12 1/2	15	9	2.50
12	17	13 1/2	16	12	2.95

A. B. C. Plant Protector

For Cabbage, Tomatoes and other plants. Packed 1000 in good strong fiber box. Price, per 1000 (mailing weight 10 lbs.), \$2.50.

Plant Sticks

For pot or garden use. Square, painted green.

Length	Each	100	Length	Each	100
1 ft.	\$0.02	\$1.50	3 ft.	\$0.07	\$6.25
1 1/2 ft.	.02	1.50	3 1/2 ft.	.09	7.95
2 ft.	.03	2.00	4 ft.	.12	10.00
2 1/2 ft.	.04	2.50	5 ft.	.16	14.95
			6 ft.	.18	16.75

VERANDA TRELLIS

High	Width	Each	High	Width	Each
3 ft.	10 in.	\$0.85	6 ft.	18 in.	\$1.80
4 ft.	11 in.	1.10	8 ft.	18 in.	2.40
5 ft.	18 in.	1.50	10 ft.	20 in.	3.00
			12 ft.	20 in.	3.60

Get prices for Fan Trellis.

Peerless Glazing Points

Per box, 1000 points\$0.75

Tomato Supports

34 inches high, 20 inches in diameter at the top. Price, 35c each; \$3.75 per doz.

Tree Labels

Copper wire, 3 1/2 inches. Weight 5 lbs. Per 1000.....\$2.75

Pot Labels

Wt. per 1000	100	1000
4 in. 4 lbs.	\$0.25	\$2.25
6 in. 5 lbs.	.35	2.85

Garden Labels

Wt per 1000	100	1000
8 in. 14 lbs.	\$0.75	\$6.00
10 in. 17 lbs.	.85	7.50

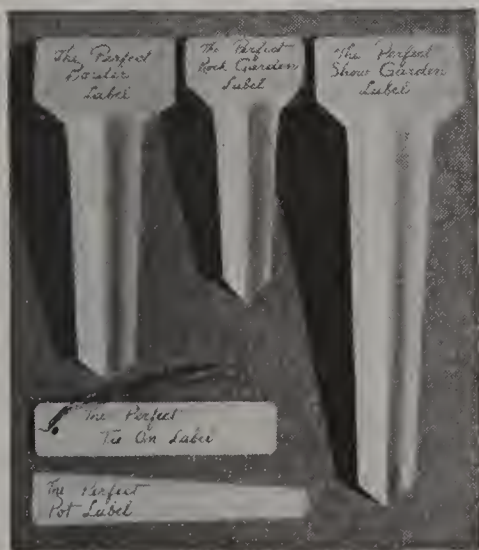

Perfect Garden Label

Accepted as the perfect garden label by all who have used them. Easily and permanently marked with ordinary lead pencil. The beautiful gray green color blends with the soil, foliage and rocks. Prices postpaid as follows:

SHOW GARDEN LABEL

(Length 7 in., width of marking space 2 1/8 in.)
12 Labels\$1.25
25 " 2.50
100 " 9.50

TIE-ON LABEL

(Length 3 1/2 in., width 3/4 in. Sturdy copper wires in convenient bundles ready bent for attaching.)
100 Labels in box ..\$3.00

POT LABEL

(Length 4 in., width 3/4 in. at wide end).
100 Labels in box ...\$2.50

BORDER LABEL

(Length 5 in., width of marking space 2 in.)
12 Labels\$ 1.00
25 " 2.00
100 " 7.75

ROCK GARDEN LABEL

(Length 4 in., width of marking space 1 3/4 in.)
12 Labels\$0.90
25 " 1.75
100 " 6.75

Garden Hose



Black Maxecon. This is the best lawn Hose of the B. F. Goodrich Rubber Co., and is featured by them.

25 ft. length, 5/8 in.\$3.15
50 ft. length, 5/8 in. 6.00

Garden Club (Black).

25 ft. length, 5/8 in. 2.65
50 ft length, 5/8 in. 5.00

Bull Dog Hose. A two-braided corrugated brown covered hose. Manufactured by the Boston Woven Hose & Rubber Co. 3/4 in. 50-ft. lengths, \$8.75.

Leader. 5-ply, 3/4 in. 50-ft. lengths, \$6.75; 25-ft. lengths, \$3.35.

Leader. 5-ply, 1/2 in. 50-ft. lengths, \$5.50; 25-ft. lengths, \$2.90.

Bull Dog Spray Hose. 1/2 in., for power spraying up to 500 lbs. pressure. 30c per ft., not coupled.

Milo Spray Hose. 1/2 in., for hand power. 15c per ft., not coupled.

Long Tail Couplings for spray hose. 65c per set.

SURE GRIP HOSE BAND. 1/2-in. and 3/4-in. 3c each; 2 for 5c, postpaid.

Boston Spray Nozzle

Will throw a spray, a large or a small solid stream. Price, 75c; postpaid, 80c.

Goodrich Multispray Outfit

This hose is the Goodrich 5/8-in. Maxecon Hose. A wonderful outfit for sprinkling lawns. The spray heads are built into the hose, similar to a tire valve. Four sprays are provided in the 50-ft. lengths. A stamped metal support fits over the spray heads and hose to keep it upright. A cap provides a shut-off on the male end. Price, 50 ft. complete unit, \$7.50.

The Ring Lawn Sprinkler

Weight 1 lb.\$1.00

FAMOUS Rain King LAWN SPRINKLERS

The Nationally Advertised Line

Model D Rain King

Double nozzles each a sprinkler in itself. Easily adjusted for distance, direction, volume. Throws any kind of spray. Columns, arms, nozzles, coupling solid brass. Balance rich red enamel. Bronze bearings. Price, \$2.85 each. Mailing weight 5 lbs.

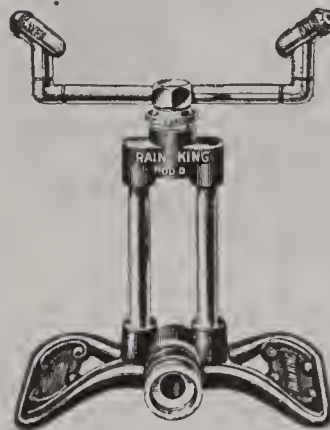

Model H Rain King Chrome-Plated

A large sprinkler—11 1/4 in. tall—with nozzles, lock wheel, uprights, coupling solid brass CHROMIUM PLATED. New type nozzles do not reduce volume of water when set for fine spray. Price, \$3.75 each. Mailing weight 5 lbs.

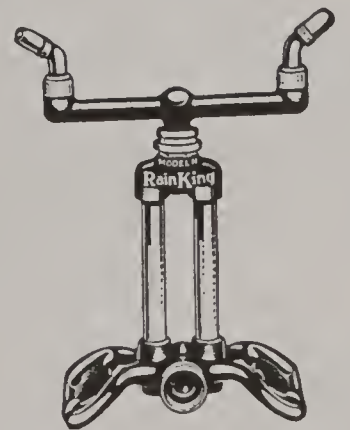

Model G Rain King

An entirely new type, slow revolving sprinkler—a golf course sprinkler for the home. Spinning eccentric prevents stalling, permits slow turning. Steel disc base. Solid brass coupling, upright, arm, nozzle. Bronze bearings. Rich green enamel finish. Price, \$3.95 each. Mailing weight 6 lbs.

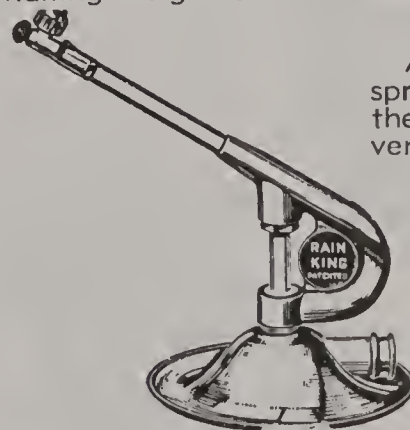

Rain King CHROMIUM Nozzle

One-piece construction, machined from solid brass. Full chromium plate—tarnish proof. 2-color counter display card packed with each lot. The market's fastest selling nozzle. Price, each 65c; postpaid 70c.

Power and Hand Lawn Mowers

Hand Lawn Mowers Knollwood Grand

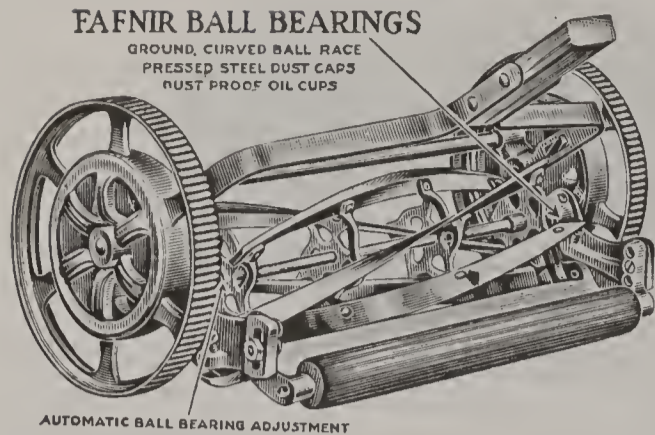

FAFNIR BALL BEARINGS
GROUND, CURVED BALL RACE
PRESSED STEEL DUST CAPS
RUST PROOF OIL CUPS

This machine has 11-inch wheels, 5 crucible steel draw-cut wiper blades revolving on Fafnir sealed and ground race ball bearings as illustrated. The under knife is constructed of the finest im-

ported Sheffield steel and has a heavy lipped edge. This machine is excellent for parks, cemeteries, large lawns and private homes where the very best in lawn mowers is required.

16 in.	\$10.95
18 in.	11.75
20 in.	12.50

Knollwood Junior

Same as "Grand" except that it has a 1-inch lower wheel and 4 blades.

14 in.	\$8.25
16 in.	8.50
18 in.	9.00
20 in.	9.50

Blair Draw-cut Leader

The Blair Draw-cut Leader is a 4-blade, ball bearing machine. Has 10-inch wheels. A wonderful value.

16 in. ..	\$6.75
18 in. ..	6.95

We also offer the Blair Draw-cut Leader in a 5-blade machine with 10-inch wheels and ball bearings.

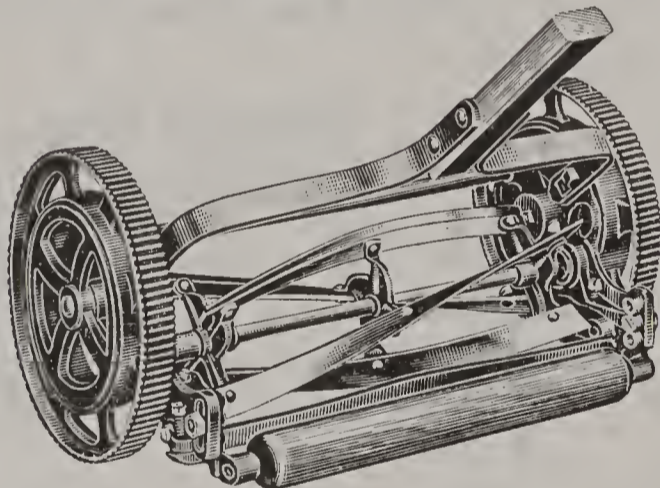

16 in.	\$6.95
18 in.	7.50

Bay State

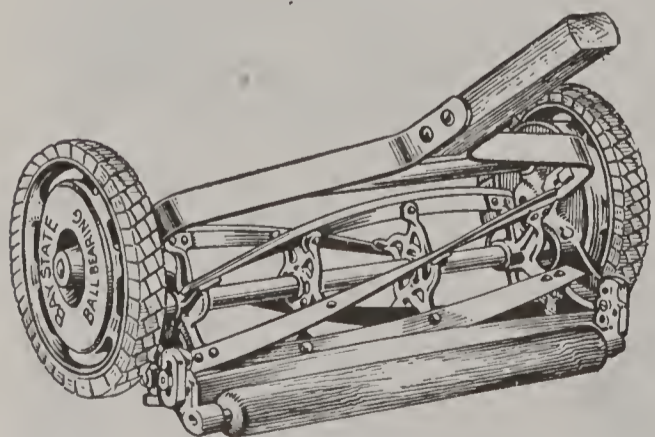

This mower is equipped with rubber tires, having non-skid automobile treads. 10-inch wheels, 5 blades, automatically adjusting ball bearings.

16 in. .	\$ 9.75
18 in. .	10.00

Easy Emptying Grass Catcher

Galvanized sheet steel bottom, heavy weight duck sides.

16-17G. For 12-17 in. mowers	\$1.00
18G. For 16-20 in. mowers	1.25
10G. For 12-18 in. mowers	1.50
12G. For 16-22 in. mowers	1.90

The Little Giant

The Little Giant is equipped with 8-inch closed wheels, four crucible steel draw-cut wiper blades, self-adjusting ball bearings. A very inexpensive machine of satisfactory service.

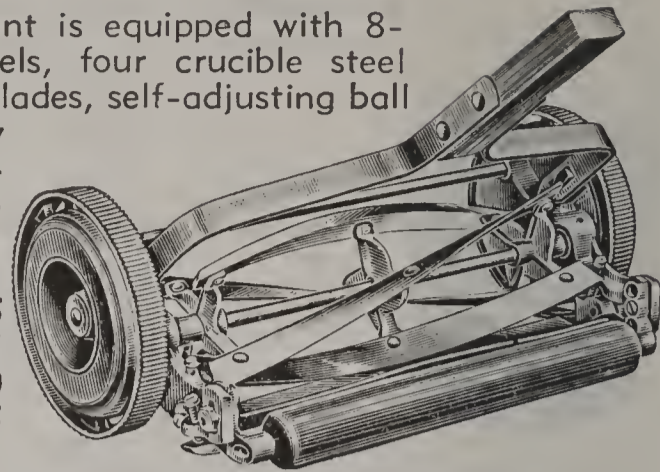

12 in.	\$5.95
14 in.	6.25
16 in.	6.50
18 in.	6.75

Blair Universal Lawn Trimmer

Price	\$6.25
-------------	--------

The Capitol Lawn Trimmer

Price, plain	\$6.95
Complete with Edger	7.95

Worcester Lawn Mowers

Invincible—Ball Bearing 10-in. Wheels.
Four Blades | Five Blades

16 in.	\$6.95	16 in.	\$7.50
18 in.	7.50	18 in.	7.95

WORCESTER "QUIET-MO" STANDARD LAWN MOWER

Noise-eliminated rubber-treaded wheels and rubber-covered roller. Five blades, 10-in. wheel, Ball Bearing.

16 in.	\$14.50
18 in.	15.25

Power Lawn Mowers

Information and prices given on request.

Osmo Tri-Pots



The three-in-one Pot for growing, shipping, planting. Osmo Tri-Pots are made of specially prepared Osmoss. (Not Paper).

PRICES

Price per 1000
2" Tri-Pot. \$7.50
Shipping weight
12 lbs.

3" Tri-Pot	\$9.25
Shipping weight 25 lbs.	
4" Tri-Pot	\$11.50
Shipping weight 40 lbs.	
Price per 100	
2" Tri-Pot	\$1.00
Shipping weight 2 lbs.	
3" Tri-Pot	\$1.15
Shipping weight 3 lbs.	
4" Tri-Pot	\$1.35
Shipping weight 4 lbs.	

Also in attractive packages for the home grower:

Fifty 2" Tri-Pots	\$0.50
Forty 3" Tri-Pots50
Thirty 4" Tri-Pots50

Postpaid, 55c.

Osmo Cedar Flat

12 1/2" x 12 1/2" x 2". Complete with thirty-six 2" Osmo pots. Ready to assemble. Grow healthier seedlings with these flats. Price, 60c each, complete. Mailing weight 4 lbs.

ROSS BROS. CO.

Baskets and Flower Pots

Strapped Bushel Basket

Size	Price
4 bushel	\$3.25
3 bushel	2.75
2 bushel	2.00
1 1/2 bushel	1.60
1 bushel	1.35



Woven Picking Basket

Size	Price
1/2 bushel, drop bail	\$0.75
1/4 bushel	.65

Diamond Market Basket

A cheap, all around basket; good for everything; indispensable in every household. 15c each; \$1.65 per doz.

Covered Lunch Baskets

No.	Dimensions	Price
1	9 1/2" x 6" x 5"	\$0.65
2	11" x 6 1/2" x 6"	.75
3	11 1/2" x 7" x 6 1/2"	.80
4	14" x 8 1/2" x 6 1/2"	.90
5	15 1/2" x 9" x 7 1/2"	1.05
6	17" x 10" x 8"	1.20

Standard Pots, Pans and Saucers

Inside measurements, width and depth equal.

	POTS			SAUCERS			BOTH		
	Ea.	Doz.	100	Ea.	Doz.	100	Ea.	Doz.	100
3 in.	\$0.05	\$0.35	\$2.50	\$0.05	\$0.30	\$2.35	\$0.08	\$0.60	\$4.35
4 in.	.07	.55	4.00	.05	.35	2.95	.10	.80	6.25
5 in.	.10	.95	7.00	.05	.50	3.90	.13	1.25	9.85
6 in.	.12	1.25	10.00	.07	.70	5.85	.17	1.75	14.00
7 in.	.20	2.25	17.50	.10	.95	7.80	.25	2.75	22.00
8 in.	.30	3.25	25.00	.12	1.25	10.72	.37	4.00	32.00
9 in.	.40	4.25		.18	1.80		.52	5.50	
10 in.	.60	6.25		.20	2.25		.75	7.50	
11 in.	1.00			.25			1.15		
12 in.	1.25			.28			1.35		
13 in.	1.35			.35			1.55		
14 in.	1.75			.45			2.00		

Positively no flower pots or saucers sent parcel post.

Bulb Pans

	Each	Doz.	100
6 in.	\$0.15	\$1.50	\$10.50
7 in.	.25	2.25	17.50
8 in.	.35	3.50	25.00
9 in.	.50	5.00	39.00
10 in.	.60	6.00	52.00
12 in.	1.00		
14 in.	1.75		

Neponset Red Paper Flower Pots

These pots are nested and packed in cases of 1000 each, except 4-, 5-, and 6-inch sizes, which are put up in cases of 500 each.



	Wt. per 1000 pots	Per 100	Per 1000
2 1/4 in. pots	12	\$0.50	\$ 3.75
2 1/2 in. pots	16	.55	3.85
3 in. pots	24	.65	4.75
3 1/2 in. pots	34	.80	6.00
4 in. pots	46	.95	7.50
5 in. pots	74	1.25	10.00
6 in. pots	102	1.60	13.50

Neponset Green Paper Flower Pots

Neponset Green Pots are especially adapted for growing. Every grower can reduce his growing, transplanting, storage and shipping costs by using these pots. Packed same as Red Pots.

	Wt. per 1000 pots	Per 100	Per 1000
2 1/2 in. pots	22	\$0.70	\$ 5.75
3 in. pots	28	.85	6.65
3 1/2 in. pots	39	1.10	8.95
4 in. pots	52	1.25	10.45
5 in. pots	88	1.80	15.75



Neponset Plant Boxes

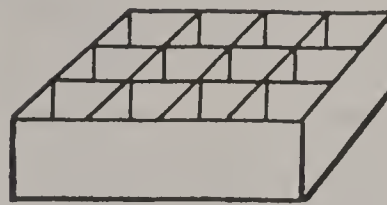

They are ideal containers in which to start such plants as tomatoes, peppers, lettuce, cabbage and all annual flowers. Twelve plants may be grown in compact space in individual, removable compartments. Shipped flat, the box and bands are set up by hand. Price, 15c, postpaid, 20c. 2 for 25c, postpaid 30c.

Old Trusty Dog Foods

	10 lbs.	25 lbs.	50 lbs.	100 lbs.
All Terrier Food	\$1.15	\$2.10	\$4.10	\$8.20
Top Notch	1.15	2.10	4.10	8.20
Puppy Biscuits	1.15	2.10	4.10	8.20
Dog Cakes	1.15	2.10	4.10	8.20

Baskets

VERBENA AND PANSY BASKET With Wire Handle.

Used largely for pansies. \$21.00 per 1000; \$2.35 per 100. Postage extra, 30c per 100.

FOUR-QUART VIRGINIA TILLS

For roadside container. \$19.50 per 1000; \$2.15 per 100. Postage extra, 50c per 100.

THREE-QUART VIRGINIA TILLS

\$18.00 per 1000; \$2.00 per 100. Postage extra, 35c per 100.

TWO-QUART MISSISSIPPI TILLS

\$16.00 per 1000; \$1.85 per 100. Postage extra, 35c per 100.

One Quart All Wood Berry Baskets

	1000
Utility Brand	\$6.75
Close Corner (For Blueberries)	8.25
Oval Pints	6.75

All of the above 90c per 100. Add 25c per 100 for postage.

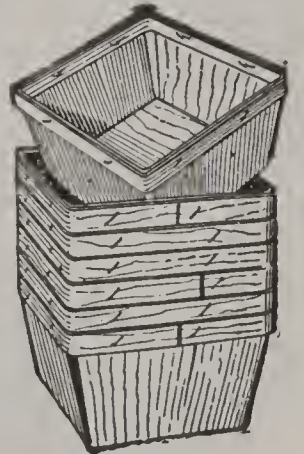

Metal Rim One Quart Berry Baskets

	100	1000
Price	\$0.90	\$7.50

Add 25c per 100 for postage.

Oxford Oak Basket

	Each
1 bushel	\$1.00
1/2 bushel, drop handle	.75
1/4 bushel, drop handle	.65

A very serviceable basket, and the 1/2 bushel is the best basket for picking peaches, as it does not bruise the fruit.

Wet Wash Clothes Basket

No.	Dimensions	Price
2	26" x 16" x 9"	\$1.55
3	28" x 18" x 10"	1.75
4	30" x 20" x 10"	2.00
5	32" x 20" x 10"	2.40

Standard Fruit Baskets



	100	1000
4 quart	\$5.00	\$47.50
8 quart	5.25	50.00
16 quart	6.00	55.00
4 qt. Veneer Bot.	4.00	35.00
8 qt. Veneer Bot.	4.50	40.00

Bale Handle Market Baskets

No.	Size	Dimensions	Price
1	1 pk.	18" x 10" x 6"	\$1.00
2	1/2 bu.	20" x 12" x 6 1/2"	1.10
3	3/4 bu.	23" x 13" x 7"	1.15
4	1 bu.	24" x 15" x 7 1/2"	1.35
5	1 1/2 bu.	25" x 16" x 8"	1.50

INDEX

Achillea	59	Cauliflower	16	Fennel	18	Linum	41, 63	Rhubarb	26
Acroclinium	31	Celeriac	15	Flax	26, 41	Lobelia	41, 63	Rocket, Sweet	65
Aconitum	59	Celery	15	Flower Collection	49	Lunaria	42	Rock Garden Flower	
Adlumia	59	Celsoia	36, 37	Flowering Shrubs	70	Lupin	42, 63	Seeds	38
Adonis	59	Centaurea	36, 60	Forget-Me-Not	62	Lychnis	63	Roses	71
Ageratum	31	Chieranthus	60	Four O' clock	39	Madeira Vine	69	Rudbeckia	45, 65
Agrostemma	31, 59	Chervil	16	Foxglove	61	Mangel Wurzels	13	Rye	6
Alfalfa	6	Chicory	16	Fringe Flower	48	Marigold	41	Salpiglossis	45
Alyssum	31, 59	Chinese Woolflower	36	Fruit Trees	73	Matthiola Bicornis	42	Salsify	26
Amaranthus	31	Chives	16	Gaillardia	39, 62	Melon	20	Salvia	45
Ampelopsis	59	Chrysanthemum	36	Geranium	39	Mignonette	42	Sanvitalia	48
Anchusa	31, 59	Cineraria	38	Geum	62	Millet	7	Scabiosa	48, 65
Anemone	59	Cinnamon Vine	69	Gladiolus	66, 67	Mimulus	63	Schizanthus	48
Anthemis	59	Clarkia	38	Globe Amaranth	40	Moonflower	42	Sedum	65
Antirrhinum	34	Clematis	49	Gloxinia	40	Morning Glory	37, 42	Seeds for Flavoring	26
Aquilegia	59	Cleome	38	Godetia	40	Mushrooms	18	Sensitive Plant	48
Arabis	59	Climbing Vines	72	Gomphrena	40	Mustard	18	Silene	48
Arctotis	34	Clovers	5	Gourds	40	Nasturtium	42, 43	Smilax	48
Aristolochia	59	Cobaea	35	Grasses	2, 3, 4	Nemesia	43	Snapdragon	34
Armeria	60	Cockscomb	37	Grasses, Ornamental	44	Nemophila	44	Spider Plant	38
Artichoke	10	Coix Lachryma	37	Grevillea	40	Nepeta	63	Spinach	26
Asparagus	10	Coleus	37	Gypsophila	40, 62	Nicotiana	44	Squash	27
Asparagus, Orna- mental	34	Collards	16	Hedge Plants	72	Nigella	44	Statice	48
Asperula	60	Collinsia	37	Helenium	62	Oats	6	Stock	48
Asters	32, 33	Convolvulus Minor	37	Helichrysum	40	Okra	18	Stokesia Cyanea	65
Baby's Breath	40, 62	Coreopsis	60	Heliopsis	62	Old-Fashioned Garden Mixture	49	Strawberry Plants	73
Balloon Vine	34	Corn, Dent	7, 8	Heliotrope	40	Onion	21	Sudan Grass	5
Balsam	34	Corn, Flint	8	Hemp	26	Onion Sets	21	Sunflower	5, 26, 48
Barley	5	Corn, Pop	9	Herbs	26	Paeonias	72	Sweet Peas	46, 47
Bartonia Aurea	34	Corn Salad	16	Heuchera	62	Parsley	21	Sweet William	48, 66
Beans, Garden	11, 12	Corn, Sweet	8, 9	Hibiscus	62	Parsnips	23	Swiss Chard	16
Beans, Ornamental	34	Corn, Sweet Fodder	8	Hollyhock	40, 62	Peanuts	23	Tagetes	49
Beans, Soy or Soja	7	Cornflower Aster	65	Home Garden Collection	18	Peas, Field	6	Thunbergia	49
Beet	13, 16	Cosmos	37	Honesty	42	Peas, Garden	22, 23	Tithonia	49
Begonia Bulbs	69	Cress	18	Hop	40, 63	Peppers	23	Tobacco	29
Bellis Perennis	60	Cucumber	17	Humulus	40, 63	Perennial Plants	72	Tomato	28
Bidens	60	Cyclamen	38	Hunnemania	40	Petunia	44	Tritoma	66
Bird Seed	26	Cynoglossum	38	Iberis	63	Phlox	44, 63	Trollius	66
Bleeding Heart	61	Cypress Vine	38	Ice Plant	40	Physalis	63	Tuberose	69
Brachycome	34	Dahlias	61, 68, 69	Ipomoea	41, 42	Platycodon	65	Tunica	66
Broccoli	10	Daisy	38, 61	Jerusalem Cherry	41	Polemonium	65	Turnip	29
Browallia	34	Dandelion	16	Job's Tears	37	Poppy	45, 65	Vegetable Collection	18
Brussels Sprouts	10	Datura	38	Kale	18	Portulaca	45	Venidium	49
Buckwheat	6	Delphinium	38, 61	Kochia	41	Potatoes	24	Verbena	49
Cabbage	14	Dianthus	39, 61	Kohlrabi	18	Primula	45	Veronica	66
Calendula	35	Didiscus	39	Kudzu Vine	49	Primrose	45, 65	Vetch	7
Calliopsis	35	Dielytra	61	Lantana	41	Pumpkin	25	Viola Cornuta	66
Canary	26	Digitalis	61	Larkspur	38	Pyrethrum	65	Wallflower	66
Canary Creeper	35	Dill	18	Lathyrus Latifolius	49	Radish	25	Wheat	7
Candytuft	35	Dimorphotheca	38	Lavatera Trimestris	41	Rainbow Corn	37	Wild Cucumber Vine	49
Cannas	35, 67	Dolichos	39	Lavender	63	Rape	5, 26	Wild Flower Garden Mixture	49
Canterbury Bells	35, 60	Dracaena	39	Leek	18	Reference Table	30	Worcester Dollar Collection	49
Carnation	36, 60	Eggplant	18	Lettuce	19, 26	Rhodanthe	45	Zinnia	50
Carrot	15	Endive	17	Lilies	69				
Castor Beans	36	Euphorbia	39						
		Eschscholtzia	39						

INDEX

Tools, Insecticides, Fertilizers and General Farm Requisites

Adco	74	Coolers, Milk	95	Hose, Garden	103	Pots, Watering	100	Silo	86
Antipestick	76	Cultivators	82, 85	Hotkaps	75	Poultry Supplies	87, 91	Snarol	76
Antrol	76	Curry Combs	96	Insecticides	76-78	Protectors, Plant	103	Snaths	100
Atomizers	98	Cutters, Ensilage	86	Jugs, Milk	95	Pruners	99, 101	Sowers, Fertilizer	81
Axes	102	Cutters, Kraut	83	Knives, Milk	95	Pumps, Water	102	Sowers, Seed	83, 84
Barn Equipment	86, 94	Cutters, Vegetable	81	Knives, Asparagus	100	Racks, Corner	94	Spike Tamp	99
Baskets	105	Dairy Supplies	95, 96	Knives, Hay	86	Raffia	24	Sprayers	97, 98
Belting	86	Dibbles	100	Kow Kare	94	Rakes	100	Spreaders, Manure	80
Binders, Corn	86	Diggers, Potato	80	Labels, Plant	103	Rakes, 1 or 2 Horse	81, 82	Sprinklers	103
B-K Solution	91	Distributors, Fertilizer	81	Ladders	99	Reels, Hose	102	Stanchions	94
Bloomaid	74	Drills	80	Lime	74	Reels, Garden	100	Sticks, Plant	103
Boat Head	102	Dusters	79	Loader, Hay	81	Remedies, Conkeys	90	Stim-U-Plant	74
Boats, Stone	102	Dusting Materials	78	Loma	74	Remedies, Cow	94	Strainers, Can	95
Border, Flower Bed	93	Edgers, Turf	100	Markers	83	Remedies, Dr. Hess	90	Supports, Tomato	103
Bottles, Milk	96	Engines	86	Mat, Hotbed	102	Remedies, Pratts	90	Tanglefoot, Tree	77
Bowls, Pigeon	89	Fairway	74	Milkers	94	Repellent, Crow	76	Tedders, Hay	81
Bowls, Watering	94, 95	Fence, Electric	92	Molds, Butter	96	Rollers, Land	83	Tethers	83
Boxes, Feed	94	Fencing	92, 93	Mowers, Lawn	104	Rollers, Lawn	83	Ties, Bale	93
Brooders	88, 91	Fertilizers	74, 75	Mowers, McCormick	81	Rope	86	Ties, Cow	100
Brooms, Push	100	Food, Old Trusty Dog	105	Netting, Poultry	93	Salt, Brick and Holders	94	Tobacco Dust	74, 91
Brushes, Bottle	96	Forks	86, 100	Nod-O-Gen	6, 29	Sash, Hotbed	102	Tractors	80
Bunchers, Asparagus	102	Freezers	96	Nozzles	97, 103	Saws	85, 99	Trellises	103
Burners, Rubbish	99	Garden Sets	100	Pails, Milk	95, 96	Saw Bucks	99	Trimmers, Lawn	104
Cans, Ash	99	Gloves	91	Paper, Butter	96	Saws, Tilting Table	85	Trowels	100
Cans, Milk	95, 96	Grinders, Knife	80	Peat Moss	74	Scales	83, 94	Tubs, Plant	103
Cans, Mixing	95	Grindstones	86	Picks	102	Scales, Egg	87	Twine, Binder	86
Caps, Bottle	96	Gun, Spray	98	Pickers, Fruit	100	Scrapers, Steel	102	Vigoro	75
Carbola	91	Halters	96	Planet Jr. Tools	84, 85	Scrapers, Tree	100	Wafers	89
Carbolineum	77	Hardware Cloth	82	Planters, Corn	81, 83	Scythes	100	Water Glass	90
Cards, Cattle	100	Harrows	80, 81, 82	Planters, Potato	81	Sections, Knife	81	Wax, Grafting	77, 78
Carriers, Bottle	96	Hoes	100	Plows	80, 82	Semesan	77	Wearers, Calf	95
Catchers, Grass	104	Hoes, Horse	83	Plows, Tractor	80	Shears, Grass	100	Weeders	100, 101
Cel-O-Glass	87	Hooks, Cant	100	Points, Glazing	103	Shears, Hedge	101	Weeders, Magic	101
Chisel, Grafting	100	Hooks, Corn	102	Posts, Fence	92, 93	Shears, Pruning	101	Weed killer	77, 78
Churns	95, 96	Hooks, Grass	100	Pots, Flower	104, 105	Shovels	102	Wheelbarrows	102
Cleaner, Wyandotte	94			Pots, Neponset Paper	105	Sifters, Ash	99	Wire, Barb	92
Clippers	95							Yarns, Tarrd Lath	86
Cloth, Glass	87								

8 Summer Vegetables

*That should be grown
in every garden*

For 70 cents We will send post-paid to any address in the United States, one packet each of the 8 varieties listed on this page, on receipt of order and remittance.

CARROT, Chantenay. Early, good color, fine flavor. Pkt., 10c; oz., 15c; ¼ lb., 40c.

PEAS, Laxtonian.

Dwarf vines, large Peas, early. Pkt., 15c; lb., 30c.

WAX BEANS, Sure Crop. Early, stringless, tender. Pkt., 15c; lb., 25c.

SWEET CORN, Early Golden Sunshine. A deliciously flavored variety. Pkt., 15c; lb., 25c.

BEEF, Crosby's Early Egyptian. Good color, sweet. Pkt., 10c; oz., 15c; ¼ lb., 40c.

RADISH, Scarlet Globe. Crisp; quick growing. Pkt., 10c; oz., 15c; ¼ lb., 35c.

TOMATO, John Baer. Earliest, solid, good color. Pkt., 10c; ½ oz., 25c.

MUSKMELON, Bender's Surprise. Early; thick salmon flesh; delicious. Pkt., 10c; oz., 15c.



Front Cover

COLLECTION OFFER

No. 1 Golden Bantam Sweet Corn	Pkt. \$0.15
No. 2 Colorado Cucumber	.10
No. 3 Early Wonder Beet	.10
No. 4 Early Yellow Globe Onion	.10
No. 5 Wonderful or New York Lettuce	.10
	<hr/> \$0.55

One packet each of the five varieties listed at left for only **40c**

Back Cover

COLLECTION OFFER

Dark Pod Telephone Peas	Pkt. \$0.15
Golden Early Market Sweet Corn	.15
Early Worcester Tomato	.25
	<hr/> \$0.55

One pkt. each of the three varieties listed above **40¢**

OR

One pkt. each of the eight varieties listed above **70¢**

SWEET CORN, Golden Early Market. Best extra early variety for home or market; large ears. Pkt., 15c; lb., 25c.

TOMATO, Early Worcester.

Early, dark solid fruit. A very heavy yielding variety. Pkt., 25c; 1/4 oz., 70c; 1/2 oz., \$1.00.

All items listed here are postpaid in the United States

PEAS, Dark Pod Telephone. A favorite for year Tall vines, large pods well filled. Pkt., 15c; lb., 25c.

