

Historic, Archive Document

Do not assume content reflects current scientific knowledge, policies, or practices.



62,73
"It's the
Crop
that
Counts"

GARDEN GUIDE 1939 SEED ANNUAL
ABEL'S SEED HOUSE

12 North Ninth Street (25 Steps From Penn) READING, PA.

Abel's New Novelty Flower Seeds for 1939



 **Scabiosa, Blue Moon**
Honorable Mention—1939 All-America Selections

SCABIOSA, BLUE MOON

This new type of Scabiosa has beehive shaped flowers composed entirely of heavy, wavy petals with the pin-cushion center completely eliminated. A rich deep lavender blue in color, it maintains its effectiveness indoors or out. Wiry stems, 27 inches, hold flowers erect on plants growing to 48 inches in height. **Packet, 25c.**

HOLLYHOCK, INDIAN SPRING

A new annual variety actually blooming in five months from seed, with secondary blooms developing on side shoots after main stem is cut away. Produces a continuous display of semi-double to double fringed flowers in shades of pink on a compact pyramidal plant four to five feet high. A novelty of exceptional merit. **Packet, 25c.**



 **Hollyhock, Indian Spring**
Silver Medal—1939 All-America Selections



Russell Lupins

RUSSELL LUPINS

These Lupins have created a sensation wherever shown. They easily out-class the older varieties in length of flower-spike, vigorous growth, and variety and richness of color. Spikes carried on 3½-foot stems are not unusual, the upper 26 inches a mass of color and 5 inches in diameter. Colors range from white and lemon, passing through yellows, pinks, apricots, reds, blues and blendings of these colors, to purples and maroons. **Packet, 25c.**

PETUNIA, ALL-DOUBLE "VICTORIOUS"

Dwarf. All double mixed. Height 12 to 13 inches. Special mixture blended from Amaranth Red, Clear Pink, Pure White, Purple, Rosy-Carmine and many other bright and intermediate shades of All-Double Dwarf Giant Fringed Petunias. 100 per cent double and nearly 100 per cent dwarf. **Packet, 50c.**



Petunia, New All Double "Victorious"

Gorgeous New Creations for Your Garden

PETUNIA, VELVET BALL

Bronze Medal—1939 All-America Selections

Ⓜ Large wavy flowers of mahogany red with violet hue are grown on dwarf, rather compact plants. It is a long season bloomer and excellent for bedding. **Packet, 25c.**

ZINNIA, FANTASY, WHITE LIGHT

Honorable Mention—1939 All-America Selections

Ⓜ As pure white as a Zinnia comes. This is a new separate color of the already popular mixed Fantasy. Produces medium-sized flowers of curled and crested petals on bushy plants two and one-half to three feet tall. **Packet, 25c.**



Ⓜ **Antirrhinum, Guinea Gold**
Bronze Medal—1939 All-America Selections

ANTIRRHINUM, GUINEA GOLD

A grand garden snapdragon with large flowers on compact spikes and lots of them. Guinea Gold is an ensemble of orange, gold and terra-cotta growing dwarf and bushy, 12 to 18 inches according to soil, and is a really striking addition for your garden. **Packet, 25c.**



Ⓜ **Marigold, Early Sunshine**
Bronze Medal—1939 All-America Selections

MARIGOLD, EARLY SUNSHINE

Freely produces chrysanthemumlike, incurved petal, lemon or sulphur yellow flowers 2½ inches across in 15 weeks. Foliage is yellowish green and plants grow two feet high and bushy. The earliest marigold for this section. **Packet, 25c.**



Ⓜ **China Aster, Light Blue**
Silver Medal—1939 All-America Selections

CHINA ASTER, LIGHT BLUE

An early giant, wilt-resistant variety, it produces beautiful big, light blue lacy flowers of the Giant Crego type. It is earlier blooming than other Giants. Interlaced petals in abundance for five-inch flower with good stems on three-foot branching plants. It is very popular for cut flowers. **Packet, 25c.**

MARIGOLD, GOLDEN GLOW

Honorable Mention—1939 All-America Selections

Ⓜ Golden yellow, closely packed, tubular petals with collar of guard petals gives a new flower form of odorless African type for cutting and bedding. The bushy two and one-half foot plants are very free-flowering. **Packet, 25c.**

CELOSIA, ROYAL VELVET

Honorable Mention—1939 All-America Selections

Ⓜ A large center head and numerous large longstemmed cockcombs of richest carmine or crimson color on basal branches are produced on this new variety. Combs are borne erect on two-foot symmetrical plants. Foliage is bronzy green with reddish margins. Very striking. **Packet, 25c.**

CYNOGLOSSUM, FIRMAMENT

Rich flowers of vivid indigo blue grow in profusion on this new dwarf type of Chinese Forget-Me-Not. The plants form healthy, leafy, compact bushes that grow from 15 to 18 inches tall. Beautiful for beds and borders. **Packet, 25c.**



Ⓜ **Cynoglossum, Firmament**
Bronze Medal—1939 All-America Selections

PETUNIA, ALL DOUBLE, APPLE BLOSSOM

Honorable Mention—1939 All-America Selections

Ⓜ Dwarf Victorious type with large, double fringed apple blossom pink flowers produced on 12 to 15 inch plants. **Packet, 25c.**



Ⓜ **Verbena, Blue Sentinel**
Bronze Medal—1939 All-America Selections

VERBENA, BLUE SENTINEL

Dwarf, compact and erect, this new flower possesses the finest plant habit of all Verbenas. The flowers are a rich navy blue self color with medium sized florets and trusses. Habit of growth, color and flowering are uniformly true. **Packet, 25c.**

THE HOUSE OF ABEL And Its Service to You



IN SENDING you this, our eleventh year Catalogue, we hope that it will serve as a guide for you in planning your gardens and outdoor work for spring. We also hope that you will find it valuable as a reference book and as a reminder of our assurance that you can always call on us for further advice and assistance.

We emphasize the fact that we want our customers satisfied, and we are ready and anxious at all times to give absolute satisfaction.

As we buy only the very best seeds, bulbs, and supplies from the largest and most reputable growers and manufacturers, you have their guarantee in addition to ours.

We thank our customers for the liberal support and patronage they gave us last year. We ask your continued support, and will more than appreciate it if you tell your neighbors and friends about ABEL'S SEEDS and ABEL'S SERVICE.

Sincerely yours,

Wilbert N. Abel.

ORDER EARLY

We will appreciate it if our customers will send us their orders for seeds, plants, bulbs, etc., during January and February. Your order can be filled at once and held for shipment when you wish same. No charge is made for boxes or packing, except for two bushel bags which are charged at cost and may be returned to us for credit.

SHIPPING INSTRUCTIONS

Always state by what method you wish goods forwarded, otherwise we will ship according to our best judgment.

Due to poor crop prospects in growing sections the harvest of seeds were found short in many cases and for this reason prices are subject to change without notice.

HOW TO SEND CASH

We prefer that you send either Post Office Money Order, check or Express Money Order for amounts above 50c and stamps, Money Order or check for less.

NON-WARRANTY

Wilbert N. Abel of Abel's Seed House gives no warranty, express or implied, as to description, quality, productiveness, or any other matter of any seeds, bulbs or plants they sell and will not be responsible for the crop. If the customer does not accept the goods on these terms they are at once to be returned and the amount paid for them will be refunded.

Sow Abel's Seeds and Reap the Profits

Annual and Perennial Flower Seeds

Among the flowers listed on the following pages will be found many annuals that bloom the first year from seed, but have to be resown the following year; some perennials that bloom the first year; and others that require a year's growth before blooming.

These are indicated in all instances. All three classes are needed to make up the attractive garden or border and help prolong the blooming season. The perennials increase in size and beauty from year to year and require but little attention.

Flower Seeds Require Ideal Conditions for Germination

The amateur gardener is frequently confronted with the fact that the flower seeds planted did not germinate and is unable to understand why. Many times the Seed House is condemned, but is this fair?

If the gardener will visit the Seed House and present the true situation, proper information will be given so there will not be a repetition of flower seeds not germinating. Why not ask for this information when first purchasing flower seeds?

Many flower seeds are exceedingly small and as they germinate slender shoots come forth which require delicate and gentle treatment.

SNAPDRAGONS, for instance, in the cultural directions, require that "the seed should be pressed firmly into the

top of well prepared soil and then covered with a cloth or burlap kept damp until the seed germinates."

Many people are so enthusiastic about getting the seed into the ground that they fail to carefully consider these instructions. When a good stand of plants fail to appear they are very much disappointed, and frequently condemn the seeds without considering the planting instructions.

The fact that the seeds have been properly planted is no guarantee that the gardener will be assured of a goodly supply of plants. The elements must be considered. A sudden heavy thunder storm with its accompanying downpour of rain may tear the young tender plants to pieces, and they will not have a chance of becoming established. Next, the soil must be considered. Usually the

soil is very hard and the effect of the rays from the hot sun tend to make it harder. This condition must be corrected by carefully loosening the soil and gently watering the plants, otherwise the tender surviving plants will burn off.

Since so many factors enter into the successful growing of plants, the gardener, who has carefully observed and applied all the rules, will be best rewarded.

Abel's Seed House offers you the benefit of its experience in the planting of flower seeds. This service is free—ask for it when buying seeds.

The above suggestions also apply in a general way to the planting of vegetable seeds. However, as vegetable seeds are more sturdy less difficulty will be encountered.

Abel's Glorious Asters

A continuous display of Asters from early summer until frost can be had by planting early, midseason, and late varieties. If you plant some very early Asters, we suggest that you have seedlings of later flowering Asters or other flowers coming along to take the place of the earlies when they are through blooming.

Asters are easy to grow. They prefer rich, well-drained soil, plenty of sunshine and ample moisture. Asters bloom from three to five months after seed is sown, varying according to type and climate. For early blooms sow seed indoors in boxes or pans six weeks before outdoor planting time.

ROYAL OR EARLY BRANCHING

An early, large-blooming type of Aster with elegant, well-rounded, double flowers on very long stems. The broad petals are medium-long, gracefully curving inward, except for the centermost petals, which usually form an attractive whorl. Royal Asters come into bloom when the "Queen of the Market" are at their best. Two feet.

Azure Blue (Dark Lavender)	Shell Pink Purple
Lavender-Pink (Peach Blossom)	Deep Rose White
Mixed Colors	

Any of the above Royal Asters: Pkt. 10c; 1/8oz. 35c; 1/4oz. 60c; 1/2oz. \$1.00.

AMERICAN BEAUTY ASTERS

Come into bloom shortly after the Giant Branching type. Plants are of branching habit, vigorous, 2 to 2 1/2 feet tall, and very profuse blooming. The flowers are globular, fully double, with incurved petals, and grow 4 inches or more across.

Black Prince Crimson Famous (Rose) Dark Lavender (Azure Blue)	Peach Blossom Shell Pink Purple Carmine-Rose White
Mixed Colors	

Any of the above American Beauty Asters: Pkt. 10c; 1/8oz. 35c; 1/4oz. 60c.

GIANT BRANCHING ASTERS AMERICAN, SEMPLE'S or VICK'S BRANCHING

From midseason until frost these Asters will produce a profusion of beautiful flowers. The blooms are quite large, 3 1/2 to 4 inches across, and fully double, with the petals somewhat incurved and massed so closely as to form a most attractive, globular flower. The plants grow 2 to 3 feet tall and branch freely, producing stems frequently 2 feet long, which makes this class especially fine for cutting. Nothing could be more dazzling than a blaze of color such as these giant flowers will give.

Azure Blue (Dark Lavender)	Shell Pink Purple
Blackish Blue Crimson Lavender	Deep Rose Light Rose
Peach Blossom	Sensation (Scarlet) White

Any of the above 11 separate colors: Pkt. 15c; 1/8oz. 30c; 1/4oz. 60c; 1/2oz. \$1.00.

MIXED COLORS. A very choice mixture of all wilt-resistant varieties in this universally popular class of Asters. Showy in garden or bouquets. Pkt. 10c; 1/8oz. 30c; 1/4oz. 50c; 1/2oz. 85c.

IMPROVED GIANT CREGO ASTERS GIANT BRANCHING COMET, Wilt-Resistant.

Very large, fully double flowers, 4 to 5 inches across, with long, ribbonlike petals gracefully curled and twisted, giving them a lovely fluffy appearance. The plants are strong growing, of branching habit, and about 2 feet tall. Long stemmed; fine for cutting. Midseason.

Azure Blue Blue Flame (Bright navy blue)	Purple (Dark Blue) Royal Purple Deep Rose
Crimson Peach Blossom Shell Pink	Salmon Queen Violet White

Any of the above separate colors: Pkt. 10c; 1/8oz. 35c; 1/4oz. 60c; 1/2oz. \$1.00.

MIXED COLORS. All the above. Pkt. 10c; 1/8oz. 30c; 1/4oz. 50c; 1/2oz. 85c.



American Beauty Aster

MAMMOTH PEONY-FLOWERED ASTERS

An exceptionally fine, late-flowering Aster. The immense double blooms measure 4 to 5 inches across, and are composed of numerous petals which fold gracefully toward the center, as in Peonies. Desirable for garden display and for cutting. The flowers are borne on sturdy stems 15 to 20 inches long, quite free from laterals. 2 1/2 to 3 feet tall.

Azure Fairy (Rich blue)	Maiden's Blush (Flesh)
Peach Blossom (Pink)	Purple Robe (Deep purple)
Rosebud (Clear, deep rose)	Silvery Rose (Bright rose with silvery sheen)
Swansdown (Pure white)	

Any of these seven lovely varieties: Pkt. 20c; 1/8oz. 50c; 1/4oz. 85c.

MIXED COLORS. All the above colors. Pkt. 15c; 1/8oz. 45c; 1/4oz. 75c; 1/2oz. \$1.35.

GIANT COMET ASTERS

Plants grow uniformly one foot tall, are upright and neat in appearance. They are extremely floriferous over a long period, making them most desirable for bedding, borders, edgings and rock gardens. Where medium-length stem flowers are wanted for cutting these are ideal.

Lobelia Blue	Bishop's Violet
Lilac Pink	Pure White
Rich Salmon Rose	Mixed Colors

Any of these six Giant Comet Asters. Pkt. 15c; 1/8oz. 35c; 1/4oz. 60c.

SUPER GIANT ASTERS

LOS ANGELES. Wonderful Aster, somewhat similar in form to the Giants of California, but earlier and much larger, with an unusual curling and interlacing of the petals. The color is a pure shell-pink. Stems are long and strong, and no disbudding is necessary due to the non-lateral habit of the plants, which grow 2 1/2 to 3 feet tall.

Pkt. 20c; 1/8oz. 50c; 1/4oz. 85c.

EL MONTE. Deep glowing crimson blooms composed of daintily interlaced, plumelike petals somewhat similar in form to Giants of California, but earlier and much larger. The huge flowers are borne on unusually heavy, non-lateral, base-branching stems and are produced quite early, beginning in August and continuing until late in the season. Probably the largest of all Asters.

Pkt. 20c; 1/8oz. 50c; 1/4oz. 85c.

CALIFORNIA GIANT DOUBLE ASTERS Curled and Interlaced

California Giants combine the fluffy or feathered type of flower with the long, straight stems of the Beauty class. The large, double flowers with long, attractively curled petals, rivaling Giant Japanese Chrysanthemums, grow 5 inches and more in diameter, on stems 1 1/2 to 2 feet

long. The vigorous freely branching plants grow 2 to 3 feet tall. Bloom from mid-season until frost.

Apple Blossom	Dark Purple
Light Blue	Light Purple
Peach Blossom	Carmine-Rose
(White, changing to peach-blossom pink)	Deep Rose
	White
	Mixed Colors

For a gorgeous display in the garden and masses of beautiful cut flowers we offer any of these. Pkt. 15c; 1/8oz. 50c; 1/4oz. 85c; 1/2oz. \$1.50.

OSTRICH PLUME ASTERS

Large, shaggy and fluffy flowers are produced in the greatest profusion on well-branched plants about 1 foot tall. Fine for beds, borders and cutting. We offer a very select range of colors. **MIXED COLORS.** Blend of all varieties.

Pkt. 15c; 1/8oz. 40c; 1/4oz. 70c.

GIANT CALIFORNIA SUNSHINE

Striking flowers, 4 inches and more across, are freely borne on stiff stems, 18 to 20 inches long. The long, loosely placed outer petals are of varying colors in lovely contrast to the creamy yellow or blue centers which are composed of many showy, tiny quills. Midseason. 2 1/2 feet. **MIXED COLORS.** Pkt. 10c; 1/8oz. 50c; 1/4oz. 85c.

QUILLED POMPON ASTERS

Plants are of compact, upright habit, 8 to 10 inches tall, well-branched and lovely for bedding, edgings, borders or pot-culture. The flowers are fully double, 1 1/2 to 2 inches across, composed of innumerable short, tightly quilled petals which insure good keeping qualities, especially when cut. Early and profuse blooming; each plant is a bouquet in itself.

MIXED COLORS. Pkt. 15c; 1/8oz. 50c; 1/4oz. 85c.

GIANTS OF CALIFORNIA

Single-Flowering Asters

Largest single Asters, 3 to 4 inches across, are made up of a row of long, rather narrow petals surrounding a small, yellow, contrasting center. Branching plants, 2 1/2 feet tall. Midseason. **MIXED COLORS.** Pkt. 10c; 1/8oz. 30c; 1/4oz. 50c.

QUEEN OF THE MARKET ASTERS

Plants are of open, spreading growth and branch freely near the ground, thereby giving long stems to the flowers, which are nearly round, fully double, and measure 3 inches across. What the flowers lack in size is made up in earliness. 15 to 18 inches.

Crimson	Scarlet
Flesh Pink	White
Purple	

Any of the above: Pkt. 10c; 1/8oz. 35c; 1/4oz. 60c. **Mixed Colors:** Pkt. 10c; 1/8oz. 30c; 1/4oz. 50c.



Super Giant Los Angeles
Award of Merit—All-America Selections

Abel's List of Annual Flowers

Annual flowers are those which live only one year. They grow, bloom, seed and die in one season. They are attractive in the garden—some for bedding, some for borders, some for rockeries and others for climbing. Many are invaluable for cutting. Some are grown only for their foliage effect. All are lovely. With proper selection, blooms can be had from early summer until frost.



Ageratum



Alyssum



Anemone—Windflower

ABRONIA. Sand Verbena. Umbellata Grandiflora—A quick-growing, trailing annual, excellent for growing in baskets, in the rockery, or in the open border. The trailing stems often reach a length of 3 to 5 ft. They carry an abundance of rosy lilac, Verbena-like flowers during the summer and fall. Pkt. 10c; ¼ oz. 30c; ½ oz. 50c.

ACHILLEA—Milfoil. Ptarmica fl. pl. The Pearl—Bears a profusion of small, double, white flowers on plants 2 feet tall. Blooms during summer. Pkt. 20c; 1/16 oz. 50c; ¼ oz. 85c.

AGERATUM. Floss Flower. One of the best plants for bedding, being literally covered with a mass of blooms from early summer until frost. The dwarf varieties are unsurpassed for porch boxes, potting and the rock garden.

Blue Cap. Large, rich blue flowers in dense heads completely cover the very dwarf, compact, dome-shaped plants. Grows 8 in. tall. Pkt. 10c; 1/16 oz. 45c; ½ oz. 80c.

Blue Ball. Compact ball-shaped plants, 6 to 8 in. tall, with deep, dark blue, cushionlike flowers. Pkt. 10c; ¼ oz. 25c; ½ oz. 40c.

Imperial Dwarf White. Pure white; 7 in. tall. Combines well with the Imperial Dwarf Blue. Pkt. 10c; ¼ oz. 25c; ½ oz. 40c.

Tall Blue. Bright azure-blue flowers in dense clusters. 2 ft. Pkt. 10c; ¼ oz. 30c; ½ oz. 50c.

ALYSSUM—Rock Madwort—Gold Dust. Saxatile Compactum (Basket of Gold). Brilliant golden yellow flowers borne profusely early in the spring on neat, rounded plants 9 to 12 in. tall. Very showy. Pkt. 10c; ¼ oz. 40c; ½ oz. 70c.

Sweet—Annual. An excellent low-growing, spreading border plant with pure white flowers in profusion from early spring till late fall. Pkt. 10c; ¼ oz. 40c; oz. 75c.

Little Gem—Annual. Grows only 4 inches high and is covered with small white flowers from early spring till late fall. Pkt. 10c; ¼ oz. 25c; ½ oz. 40c; oz. 75c.

Lilac Queen Improved—Lilac blooms changing to white on plants 6 to 8 in. tall. Pkt. 10c; ¼ oz. 25c; ½ oz. 40c; oz. 75c.

AMARANTHUS. Summer Poinsettia. Combustion—Originated by Luther Burbank, who described it as surprisingly brilliant, iridescent, fiery rosy crimson. Poinsettia-like tufts of flaming fire; 4 ft. tall. Showy from midsummer until frost. Pkt. 15c; ½ oz. 30c; ¼ oz. 50c.

ANEMONE—Windflower. Coronaria St. Brigid—An excellent early spring-blooming perennial, 12 inches tall, with large double and semi-double blooms in a wonderful array of bright colors. Pkt. 15c; ½ oz. 60c; ¼ oz. \$1.00.

ANCHUSA—Bugloss. Italica Dropmore Variety—A showy, tall-growing perennial, 5 feet in height. The plants bear a profusion of rich deep sky-blue blooms from June until August. Good for the back of the border. Pkt. 15c; ¼ oz. 35c; ½ oz. 60c.

Italica Lissadell. Beautiful, large, clear gentian-blue flowers. Blooms profusely during the summer. Pkt. 20c; ½ oz. 45c; ¼ oz. 75c.

AQUILEGIA—Columbine. Coerulea (The Rocky Mountain Columbine). Blue sepals, white corolla. Very beautiful. April to July; 1½ ft. Pkt. 10c; ½ oz. 50c; ¼ oz. 85c.

Long Spurred Hybrids. Many beautiful colors. Long-Spurred flowers. Pkt. 15c; ½ oz. 50c; ¼ oz. 85c.

Mrs. Scott Elliott Hybrids. This strain has achieved the enviable reputation of being the finest strain of Columbine ever offered. The plants are all vigorous and strong growing. They are 3 ft. tall and bear a profusion of large blooms exhibiting a marvelous range of splendid colors. Pkt. 10c; 1/16 oz. 60c; ¼ oz. \$1.00.

ARCTOTIS HYBRIDS. Another of the lovely flowers which have come to us lately from Africa. The hybrids come in a brilliant assortment of snowy daisy-like flowers predominating in orange and bronzy red shades, but also comprising many lovely shades of rose, cream, yellow and salmon. In the milder climates they may be classed as a perennial, but in the northern latitudes they are better treated as an annual. They flower within six months from seed, and bloom profusely through the hot summer season. Pkt. 25c; 1/16 oz. 90c; ¼ oz. \$1.50.

BABY'S BREATH. (Gypsophila Elegans Grandiflora). Annual. A rapid growing plant with small white flowers in profusion as long as the weather is cool. Fine to mix in bouquets. Pkt. 10c; ¼ oz. 25c.

BALLOON FLOWER. (Platycodon Grandiflorum Mariesi). Perennial. Often called Chinese Bellflower. Large, open, bell-shaped flowers of rich violet-blue. Dwarf, compact plant. Height 1½ ft. Pkt. 15c; 1/16 oz. 60c; ½ oz. \$1.10.

BALSAM—Lady Slipper. Bushy plants 2 to 3 ft. tall, carrying fine double blooms measuring 2½ inches across nestled among the rich green foliage. Easy to grow. Mixed Defiance—A remarkable mixture of colors. Pkt. 10c; ¼ oz. 40c; oz. 70c.

BELLIS PERENNIS FL. PL.—Double Giant English Daisy. This dwarf early flowering semi-hardy perennial will bloom for years if protected during the winter. They like a moist soil and are splendid for beds and borders.

Double Mixed. White and various shades of rose and red. Pkt. 10c, ½ oz. 40c; ¼ oz. 70c.

Double Quilled Mixed. In this strain the individual flowers have quilled petals. Many shades of rose, red and white. Pkt. 15c ½ oz. 60c; ¼ oz. \$1.00.

BLUE LACE FLOWER. Didicus Coeruleus—Large, lace-like, delicate lavender-blue flower-heads, 2½ inches across. Blooms all summer long; 1½ ft. Pkt. 10c; ½ oz. 30c; ¼ oz. 50c.

BRACHYCOME—Swan River Daisy. Iberidifolia, Mixed—Daisy-like blooms in many colors on compact plants growing about a foot tall. Blooms profusely throughout the summer. Pkt. 10c; ¼ oz. 40c; ½ oz. 70c.

CAMPANULA

CANTERBURY BELLS AND BELLFLOWERS—Single Canterbury Bells (Campanula Medium). Large, bell-shaped blooms during May and June. Grown as a biennial. Very showy; 2 to 3 ft. tall. Dark Blue, Light Blue, Rose, White. Any of the above. Pkt. 10c; ½ oz. 25c; ¼ oz. 40c.

Single Mixed. Includes all the fine colors of the Medium, Single type. Give a fine showy bed. Pkt. 10c; ¼ oz. 35c; ½ oz. 60c.

Double Canterbury Bells (Campanula Medium Flore Pleno). Fully double blooms in white and shades of blue and rose; 2 ft. tall. Blooms most profusely. Pkt. 10c; ½ oz. 30c; ¼ oz. 50c.

CUP-AND-SAUCER CANTERBURY BELLS—(Campanula Calycanthema). A very popular type of Campanula, blooming from June until August; 2½ ft. tall. Dark Blue, Light Blue, Rose, White. Any of these: Pkt. 15c; ½ oz. 40c; ¼ oz. 75c.

Mixed. All colors. Pkt. 10c; ½ oz. 35c; ¼ oz. 60c; oz. \$2.00.

ANNUAL CANTERBURY BELLS. Few flowers are more popular in the spring garden than Canterbury Bells, and we have always wished we might have them over a longer season. This is now possible, and without waiting a whole year for the first flowers from seed. The new Annual Canterbury Bells make a plant that is loaded with flowers less than five months after the seed is sown, and by making successive plantings all through the early spring we can have these lovely flowers all through the summer and early fall. The colors are the same as in the perennial type, including the various shades of blue, pink, rose and white. Pkt. 10c; ½ oz. 35c; ¼ oz. 60c.

CALENDULA—Scotch Marigold. Calendulas are very important and popular flowers for a garden display from early summer until frost. Even though the plants prefer a sunny location and rather dry soil, they will do well under widely different conditions, requiring little care to grow to perfection. They are also valuable for winter growing in the greenhouse.

Orange Fantasy. It is unique—a form never before seen in this favorite flower (Crested). Outer petals long, the inner petals short, curled and interlaced to form a heavy crest which surrounds a large, mahogany-bronze center. Flowers grow 3 3/4 inches across and are of a deep but pleasing bronzy or coppery orange with petals edged deep mahogany-red. 15 inches tall. Pkt. 25c.

Orange King (Select). Outstanding rich orange flowers of fully double, well-rounded form carried on long stems; 20 inches. Pkt. 10c; 1/2 oz. 60c; oz. \$1.00.

Ball's Supreme. A beautiful light orange with brown center. Of quite large size; 20 inches tall. Pkt. 20c; 1/4 oz. 75c; 1/2 oz. \$1.35; oz. \$2.50.

Golden Ball (Ball's Gold). Deep golden yellow of extra large size. Has remarkably long stems; 20 inches tall. Pkt. 20c; 1/4 oz. 75c; 1/2 oz. \$1.35; oz. \$2.50.

Lemon Queen. A rich lemon-yellow color with regularly placed, shingle-like petals. Massive, and carried on long stems. Pkt. 10c; 1/2 oz. 30c; oz. \$50.

Mixed. This mixture includes the very best varieties properly blended to get a fine display in the garden. Pkt. 10c; 1/2 oz. 25c; oz. 40c; 2 ozs. 70c; 4 ozs. \$1.25.

CALLIOPSIS—Tickseed. Easily grown and exceedingly showy annuals which do well in almost any location. They bloom continuously from early summer until frost. The tall varieties are fine for cutting and the dwarf ones give splendid beds or borders.

Tall Mixed. Contains large and small-flowered varieties in many colors. Pkt. 10c; 1/4 oz. 25c; 1/2 oz. 40c.

Dwarf Mixed. Yellow, orange mahogany and tigered flowers; 10 inches tall. Pkt. 10c; 1/4 oz. 30c; 1/2 oz. 50c.

CENTAUREA—Cornflowers—Sweet Sultans—Dusty Millers. These annuals are extremely popular for garden decoration and for cutting. The class of Centaureas includes a number of distinct types. Both the Double Cornflowers and the Sweet Sultans are great favorites with gardeners everywhere. The large showy colorful blooms of these two types are carried on long stems and are highly valued for cutting. They are easy to grow and never fail to attract attention with their loveliness. Centaurea Americana is by far the largest of the annual Cornflowers. The Dusty Millers, with their silvery white foliage, are excellent for use in borders and for edging.

Double Mixed Cornflowers (Centurea Cyanus). This mixture is most desirable in every way. A splendid selection of colors. Pkt. 10c; 1/4 oz. 20c; 1/2 oz. 35c; oz. 60c.

Gymnocarpa—Dusty Miller Centureas. Finely divided, silvery white leaves of a soft wooly texture. Grows 8 to 12 inches tall and bears light lavender blooms during the late summer and fall. Pkt. 10c; 1/4 oz. 30c; 1/2 oz. 50c; oz. 85c.

Giant Mixed Sweet Sultans (Centurea Imperialis). A mixture including all the lovely colors belonging to this splendid large-flowered type. Pkt. 10c; 1/4 oz. 30c; 1/2 oz. 50c; oz. 85c.

Sweet Sultans Mixed (Moschata). Somewhat smaller than the Giant Sweet Sultans. Includes many colors. Sweet scented. Pkt. 10c; 1/4 oz. 25c; 1/2 oz. 40c.

CARNATION—Chabaud Mixed. All colors belonging to this showy type of mixture. Pkt. 10c; 1/8 oz. 40c; 1/4 oz. 70c.

Perpetual or Tree Mixed. Immense flowers in many lovely shades are borne on long stems. Pkt. 15c; 1/8 oz. 50c; 1/4 oz. 85c.

CANDYTUFT—Iberis. The six colors that follow belong to the Umbellata type. They bloom continuously until frost. Fine for garden display and cutting; 1 ft. tall. Carmine, Dark Crimson, Flesh-Pink, Lilac, Rose-Cardinal, White. Any of these: Pkt. 10c; 1/4 oz. 25c; 1/2 oz. 40c; oz. 70c.

All Colors Mixed. Pkt. 10c; 1/2 oz. 25c; oz. 40c.

Giant Hyacinth—Flowered. Beautiful, large, long and thick, pure white flower-heads not unlike those of Hyacinths. Pkt. 10c; 1/4 oz. 25c; 1/2 oz. 40c; oz. 75c.

GIANT PLUMED CELOSIAS—Magnificent Plumed or Feathered Celosias. These make a splendid display in any garden. They are easy to grow and yield lots of cut-flowers. The plumed Celosias grow 3 to 4 ft. tall and each one of the many branches is covered by large, pointed, silky flower-heads.

Plumosa, Mixed. All colors belonging to this class. Pkt. 10c; 1/4 oz. 35c; 1/2 oz. 60c; oz. \$1.00.

CHINESE WOOLFLOWER—Celosia Childsii. A charming type of Celosia with large rounded wooly flower-heads borne on strong stems from midsummer until frost. The plants grow 2 ft. tall, and are completely covered with flowers. Splendid for garden display and highly valuable for cutting.

Woolflower, Mixed. A well balanced mixture of Crimson, Pink and Yellow. Pkt. 10c; 1/8 oz. 30c; 1/4 oz. 50c; 1/2 oz. 85c; oz. \$1.50.

CHINESE LANTERN PLANT. (Physalis Francheti). Perennial. Blooms first year if seed is sown early. White flowers in June and July, followed by showy scarlet seed pods which retain their color when dried; used in winter bouquets. Height 2 feet. Pkt. 10c; 1/4 oz. 40c; 1/2 oz. 70c.

CHRYSANTHEMUM. Early-flowering mixed. Annual. An excellent mixture of single, semi-double and double varieties 3 inches in diameter, and in many attractive colors. Bloom profusely from late August to October. Height 2 to 3 ft. Pkt. 10c; 1/4 oz. 25c.

CLARKIA. Finest Double Mixed. Of easy culture, growing into graceful bushy plants 18 to 24 inches tall. The individual double flowers resemble a small carnation in general appearance. Our mixture includes a splendid assortment of colors, pink, salmon, rose, rosy-purple and white. Pkt. 10c; 1/4 oz. 30c; 1/2 oz. 50c.

COCKSCOMB—Celosia Cristata. Tremendous showy flower-heads or combs of a velvety finish but strawy of texture. The heads often measure a foot in diameter or more.

Tall Mixed. A mixture of yellow, red, orange and purple. The plants grow 15 to 18 inches tall. Pkt. 10c; 1/8 oz. 30c; 1/4 oz. 50c.

Dwarf Mixed. Yellow, crimson, scarlet and orange blended. Height 10 inches. Pkt. 10c; 1/8 oz. 35c; 1/4 oz. 60c.

COLEUS—Burpee's Sunset (Fordhook Special). Beautiful plants of remarkable decorative value for beds and borders or as pot-plants. When planted in full sun the coloring is developed to perfection. This strain has a wonderful variety of shades and color combinations. The well-rounded plants grow 20 inches tall. Pkt. 35c; 1/32 oz. \$1.00; 1/16 oz. \$1.75; 1/8 oz. \$3.00.

Fine Mixed. A fine mixture, seed of which was saved from selected plants of good coloring, though it does not compare with Burpee's Sunset. Pkt. 20c; 1/32 oz. 75c; 1/16 oz. \$1.25; 1/8 oz. \$2.25.

COREOPSIS. (Coreopsis Grandiflora). Perennial. Deep yellow cup-shaped flowers on long stems all summer. Height 2 ft. Pkt. 10c; 1/4 oz. 25c; 1/2 oz. 40c.

AM This insignia beside a variety of flowers indicates it is a new variety that has received an award in the All-America Selections trials.



AM Calendula Orange Fantasy
Award of Merit—All-America Selections



AM Campanula, Annual Canterbury Bells Mixed
Gold Medal—All-America Selections



Celosia



Cosmos Sensation Pinkie



Euphorbia—Snow-on-the-Mountain



Delphinium

COSMOS. No garden is complete without Cosmos. These old favorites supply a gorgeous, colorful effect during late summer and fall. Cosmos is easy to grow.

Early Klondyke Orange Flare. Golden-orange blooms, 3 in. across within 90 days from seed. The fern-like foliaged plants continue to flower until frost. Desirable everywhere; specially valuable in cooler sections. Grows 3 ft. tall. Pkt. 10c; ¼ oz. 60c; ½ oz. \$1.00.

Sensation Pinkie. The Sensation type of Cosmos is today the favorite for cut flower use. The fact that the flowers are immense size 4 to 5 inches or more in diameter, with broad heavy fluted petals which slightly overlap, giving a very full single flower, make it ideal for cut flowers. Large flowers are carried on very long strong stems and are freely produced on plants which reach a height of 3 to 4 feet and have a heavy growth of foliage. Pinkie is a delightful rose pink shade. Pkt. 25c.

Early Crested. Showy plants, 3 to 4 feet tall, covered with a mass of lovely crested flowers. Particularly fine for cutting because the flowers last extra long. Our strain produces a large percentage of double blooms.

Early Double, Mixed. Contains all colors. Pkt. 10c; ¼ oz. 75c; ½ oz. \$1.25; oz. \$2.25.

Early Single. Grows 5 feet tall and blooms several weeks before the late-flowering varieties. Especially valuable in cooler sections with a short growing season.

Mixed, All Colors. Pkt. 10c; ¼ oz. 20c; ½ oz. 35c; oz. 60c.

Late Double Crested. Our strain of the Double Crested Cosmos produces a large percentage of double flowers, some with broad outer or guard petals, others round as a ball. Contains a wide variance of shapes, all very pretty, including even the large singles.

Late Double Crested, Mixed. A well-balanced blend, including Pink, Crimson and White. Pkt. 10c; ¼ oz. 50c; ½ oz. 85c.

Late Single. Handsome cosmos with blooms measuring 4 inches across, opening 2 to 4 weeks after the early varieties have started to bloom. Where the season is long enough they will make a marvelous display. The plants grow 6 ft. tall and flower most profusely.

Late Single, Mixed. The three splendid showy colors, Crimson, Pink and White. Pkt. 10c; ¼ oz. 25c; ½ oz. 40c; oz. 70c.

DAISY—African, Hybrids (Dimorphotheca Aurantiaca Hybrida) Annual. These hybrids come in a wide range of colors, including pure white, sulphur-yellow, lemon-yellow, golden yellow, light salmon, salmon-rose, ecru and apricot shades. Plants produce the large flowers very freely. Height 1 to 1½ ft. Pkt. 10c; ¼ oz. 40c.

DELPHINIUM—Hardy Larkspur. No other plant has obtained so prominent a place in the border or met with such universal approval as Delphinium. They are hardy and easy to grow.

Choicest Mixed, Gold Medal. Single flowers in many fine colors. Pkt. 15c; ½ oz. 60c; ¼ oz. \$1.00.

Floradale Hybrids. This is a glorious mixture with colors running from sky-blue through Cornflower-blue, mauve, heliotrope, to deep Pansy-purple, with many opaline variations and crested centers in white, cream and black. Spikes 4 to 6 ft. tall. Pkt. 15c; ½ oz. 60c; ¼ oz. \$1.00.

DIANTHUS—Annual Garden Pinks. Pinks are as popular today as they were in the garden of our grandparents, yet there is a decided difference between the old-fashioned Pinks and our improved modern varieties. Those we offer have large blooms, are more floriferous, and include many colors unknown to gardeners years ago, yet our modern Garden Pinks retain all the loveliness of the old fashioned kinds. They grow about 1 ft. tall and bloom all during the summer.

Chinensis, Double Mixed. A showy class with fine double blooms borne mostly in clusters on upright, strong stems. White, pink, scarlet, rose, crimson, as well as edged and bordered color combinations. Pkt. 10c; ¼ oz. 25c; ½ oz. 40c; oz. 70c.

Fordhook Favorites. A charming mixture of both single and double-flowered annual Garden Pinks. It includes only the best colors and types, giving a display that is unsurpassed all during the summer. Easy to grow and very showy. Pkt. 10c; ¼ oz. 30c; ½ oz. 50c; oz. 85c.

DIANTHUS—Hardy Garden Pinks. These are popular perennials, blooming during the spring and summer.

Plumarius Nanus, Double Dwarf Mixed. Many fine colors. Pkt. 15c; ½ oz. 50c; ¼ oz. 85c.

Plumarius, Single Mixed. Large single blooms in showy colors. Pkt. 10c; ¼ oz. 30c; ½ oz. 50c.

Plumarius, Double Mixed. Brilliant double blooms with spicy fragrance. Pkt. 10c; ½ oz. 35c.

EUPHORBIA. Marginata (Snow-on-the-Mountain). A splendid showy plant for beds and borders. From midsummer on the top leaves of every branch are attractively marked with white. 2 ft. tall. Pkt. 10c; ¼ oz. 25c; ½ oz. 40c.

ESCHSCHOLTZIA—California Poppies. Sunset Mixture. A bed of this mixture, which includes all the lovely colors described here, gives a sight that will last for months, as the plant will bloom profusely from midsummer until frost. They are splendid in beds, borders and in larger rock gardens. Pkt. 10c; ¼ oz. 25c; ½ oz. 40c; oz. 70c.

ESCHSCHOLTZIA RAMONA—(Frilled California Poppies). Ramona type California Poppies are beautifully frilled and fluted, in the russett and pinkish shades, on neat growing plants which form a compact mass of flowers. They are very effective when used as a border or as a ground cover in the rose garden. Pkt. 25c; ½ oz. 55c; ¼ oz. \$1.00.

FOXGLOVE—Digitalis. Biennial. Towering spikes of lovely bell-shaped flowers. Blooms early in summer from seed shown the previous spring or summer. Height 3 to 4 ft. Colors: White, Yellow, Rose or Mixed (all colors). Pkt. 10c; ½ oz. 25c; ¼ oz. 40c.

GAILLARDIA—Blanket Flower. Here is an annual which has been greatly neglected for no just reason. It is one of the most easily grown and colorful annuals which will stand hot weather better than most others. The plants grow 15 inches tall and bloom from July until frost.

Double Mixed (Picta Lorenziana). Yellow, red and white in mixture. Pkt. 10c; ¼ oz. 30c; ½ oz. 50c.

Picta, Single Mixed. These single-flowered annual Gaillardias are particularly bright and showy. They bloom profusely and continuously until frost. Pkt. 10c; ¼ oz. 25c; ½ oz. 40c.

GAILLARDIA—Blanket Flower. A very showy perennial growing 2 ft. tall. During the summer and fall the plants bear a profusion of long-stemmed flowers combining yellow and scarlet in good contrast.

Grandiflora Hybrids. Many showy combinations of yellow and scarlet. Very free blooming. Pkt. 10c; ¼ oz. 30c; ½ oz. 50c.

GEUM—Borealis. Orange scarlet flowers from June until frost; 15 inches tall. Pkt. 35c; 1/16 oz. 75c; ½ oz. \$1.25.

GOMPHRENA—Globe Amaranth. Mixed. Attractive, clover-like strawy flower-heads in white, red and orange tones. Blooms profusely from midsummer until frost. Grows 2 ft. tall and is splendid for garden display, for cutting, and for drying. Pkt. 10c; ¼ oz. 25c; ½ oz. 40c.

GODETIA—Satin Flower. Mixed. Beautiful silk-finished flowers in rose, carmine, pink, Cattleya-blue, and pure white. Blooms profusely during the summer and fall. 12 inches. Pkt. 10c; ¼ oz. 25c; ½ oz. 40c.

GOURDS—Ornamental. Spoon—Small, slender-necked green fruits marked with orange, white and light green. Pkt. 10c.

Nest-Egg. White, egg-shaped fruits. Easily dried. Pkt. 10c.

Sugar Trough. Bottle-shaped fruits with thick, durable skin. Easily dried. Pkt. 10c.

Dishcloth or Luffa. Fruits have sponge-like fibrous skeleton which may be used as a sponge. Let the fruits mature fully. Pkt. 10c.
Dipper. Will hold about one quart of water. Pkt. 10c.
Fine Mixed. All varieties in mixture. Pkt. 10c.

GYPSOPHILA PACIFICA—Paniculata. Pacifica is a good rose colored perennial baby's breath, coming into flower after the paniculata varieties have passed. Flowers are produced the first season from seed and it is perfectly hardy. The plant reaches a height of 3 1/2 to 4 feet, and is a veritable cloud of the numerous rose colored flowers, which are excellent in bouquets for a filler. Pkt. 15c; 1/2 oz. 40c; 1/4 oz. 70c.

HELICHRYSUM—Strawflowers. This is one of the most widely grown of all Everlastings. It will make a wonderful display in the garden, blooming profusely from midsummer until late fall. For drying cut the blooms before they have fully opened, choosing preferably the early morning hours, while they are still moist with dew, and hang them head down in a cool, shady and airy place until they are thoroughly dried. The plants grow 2 to 2 1/2 ft. tall and will give a splendid display in beds or tall borders. They do best where they get full sunlight all day.

Mixed Double. This mixture is truly wonderful. It has been carefully blended from eight colors in order to give a beautiful effect in the garden and yield lots of flowers for cutting and for winter bouquets. Every garden should include some of these wonderful large Strawflowers because they are so easy to grow, so free blooming, and serve so many different purposes. Our strain has been carefully selected for size and doubleness. Pkt. 10c; 1/4 oz. 30c; 1/2 oz. 50c; oz. 85c.

HELIOTROPE. Lemoine's Giant Hybrids, Mixed. Half-hardy Perennial. Immense heads of lovely, very fragrant, little flowers that range in color from white through shades of blue and violet. Sow indoors in February if a long season of bloom is desired. Height 2 ft. Pkt. 15c; 1/2 oz. 50c; 1/4 oz. 85c.

HIBISCUS. Mallow Marvels. Perennial; blooms first year from seed if planted early. A very hardy plant growing 4 to 6 feet tall, with immense flowers in various shades of pink, rose and crimson all summer. Pkt. 10c.

HEUCHERA—Coral Belle. Sanguinea Hybrids—Dwarf compact plants with numerous flower-spikes in white, pink, rose and crimson. Grows 12 to 18 inches tall. Blooms from June until September. Pkt. 25c; 1/16 oz. 85c; 1/2 oz. \$1.50.

HUNNEMANNIA—Santa Barbara Poppy. Fumariaefolia. Magnificent golden yellow, Poppy-like flowers borne erect on stiff stems 2 ft. tall. Easy to grow in well-limed soil, particularly if it is rather sandy. The plants bloom from July until frost. This is also known as Giant Yellow Tulip Poppy. Sow the seed where it is to bloom as they cannot stand transplanting. Pkt. 10c; 1/4 oz. 25c; 1/2 oz. 40c.

HUNNEMANNIA—Sunlite. Sunlite is a double flowered poppy which is different. Its extra band of petals is produced on the outside, rather than the inside of the tulip shaped flowers, giving the impression of being open, even after the cuplike blossoms have closed for the night. The flowers are bright canary yellow, and the foliage of the two foot bush is a light gray-green. They like a sunny position in a well drained border and flower freely in late summer. Pkt. 15c; 1/2 oz. 40c; 1/4 oz. 70c.

HOLLYHOCKS. (Althea Rosea). Perennial. Showy plants, 6 to 8 feet tall, blooming during June and July. Excellent as a background for other lower-growing plants. The colors vary from white to the deepest maroon and from cream to deep yellow. We have Single Mixed and Double Mixed. Pkt. 10c; 1/4 oz. 30c; 1/2 oz. 50c.

Scarlet Beauty Double, Annual (New). See page 3.

Bodger's Annual Double Scarlet Beauty. A fully double Chater-type Hollyhock which will flower six months from time seed is sown—the outstanding characteristic of Scarlet Beauty. Size of flower and plant habit identical with Chater Hollyhocks, but this new annual can be sown in spring for summer flowers the same year. Pure intense scarlet color, gorgeously highlighting the garden scene. Scarlet Beauty is first of what will later be a whole race of annual flowering double Hollyhocks of this type. In sections of country where Hollyhocks winter over with difficulty, Scarlet Beauty fills an important need, and will save a whole year's growing time. Will winter over where Chater type does, and is classed as perennial, blooming the first year from seed. Pkt. 25c.

IBERIS — Perennial Candytuft. Sem-pervirens—A favorite perennial for edging or rock gardens. Blooms from April to June and makes a wonderful show, with its white flowers borne profusely on plants 10 inches tall. An old-fashioned favorite. Pkt. 15c; 1/4 oz. 60c; 1/2 oz. \$1.00.

IVY—Kenilworth (Linaria Cymbalaria). Perennial. A fine trailing cover plant with small, bright green leaves and attractive little lilac-blue flowers. Forms a solid mass and is excellent for rock gardens. Pkt. 15c.

KOCHIA—Burning Bush. Giant Christmas. Symmetrical plants 3 ft. tall, resembling an ornamental Evergreen. Fine for hedges. Turns deep crimson-purple in late fall. Pkt. 10c; 1/4 oz. 20c; 1/2 oz. 30c.

LANTANA—Finest Mixed. Verbena-like flowers from midsummer until frost. Yellow, orange, red and pink shades. Height 18 inches. Slow germinating. Pkt. 10c; 1/4 oz. 30c; 1/2 oz. 50c.

LAVATERA—Annual Mallow—Loveliness. A splendid free-flowering annual, growing 2 ft. tall. Large, soft pink flowers shaded carmine. Blooms from midsummer until frost. Pkt. 10c; 1/4 oz. 25c; 1/2 oz. 40c.

LAVENDER—True (Lavandula Vera). Perennial. The lovely, sweet-scented, blue flowers are often dried for use in the linen-closet. Pkt. 10c; 1/4 oz. 35c; 1/2 oz. 60c.

ABEL'S ANNUAL LARKSPUR—Tall Branching Double Stock-Flowered. A magnificent type of larkspur growing 3 1/2 ft. tall and producing throughout the summer a glorious display of long-stemmed flower-spikes closely set with large double blooms. The plants are of branching habit and are splendid for the mixed border, for large beds, and for cutting.

Mixed. A blend of all the Tall Branching Double Stock-Flowered varieties including Flesh Pink, Orchid, Carmine, Sky-Blue, Rose White, Striped Light Blue and others belonging to this type. Pkt. 10c; 1/4 oz. 25c; 1/2 oz. 40c; oz. 70c.

GIANT IMPERIAL LARKSPUR—Upright Delphinium Form. This is the greatest improvement ever made in Larkspur. The plants are of an upright growth, as found in the perennial Delphinium. Each branch—and there are many to a plant—produces a solid spike of color. 3 to 4 ft. tall

Giant Imperial Mixed. A well-balanced mixture of all the colors belonging to this glorious new large-flowered type of Larkspur. Pkt. 15c; 1/4 oz. 30c; 1/2 oz. 50c; oz. 85c.

Giant Imperial Los Angeles Improved. This is the same color as that popular stock flowered variety, Los Angeles, but in the vastly improved giant imperial type. It is the best of this type on the market. For greenhouse use, or where a tall, compact growing strain is wanted in the garden, this variety is preferable. The spikes are long and without side branches, making it an excellent kind for cutting. The color is a brilliant rose on salmon. Pkt. 10c; 1/16 oz. 65c; 1/2 oz. \$1.00; 1/4 oz. \$1.50; 1/2 oz. \$2.50; oz. \$4.00.

Giant Imperial Blue Bell. Blue Bell is a fine medium blue Larkspur, deeper than sky blue, yet much lighter than lilac, a color up to this time lacking in the giant imperial type. The type is decidedly upright, with long basal branched flowering spikes, well adapted for cutting. Pkt. 10c; 1/16 oz. 65c; 1/2 oz. \$1.00; 1/4 oz. \$1.50; 1/2 oz. \$2.50; oz. \$4.00.

Stock Flowered Rosamond. Rosamond is a pure rose color, a shade which has been entirely lacking in Larkspurs up to this time. All other rose varieties have faded badly, but this one has that rare quality of holding the pure rose color until out of flower. It is very uniform in height, and comes into flower two weeks earlier than other stock flowered varieties. Pkt. 10c; 1/16 oz. 65c; 1/2 oz. \$1.00; 1/4 oz. \$1.50; 1/2 oz. \$2.50; oz. \$4.00.

LIATRIS—Kansas Gay Feather—Spicata. Elegant, fluffy, purplish rose flowers on long spikes. Blooms from July to September. 2 to 4 ft. Pkt. 15c; 1/16 oz. 40c; 1/2 oz. 70c.

LINUM—Perennial Flax—Perenne, Blue. Beautiful light blue flowers borne profusely from May until August, on graceful plants 2 ft. tall. Every day a new set of flowers opens up. Pkt. 10c; 1/4 oz. 30c; 1/2 oz. 50c.

LINUM—Crimson Flax—Grandiflorum Rubrum. An old favorite with large, rich crimson blooms borne profusely on plants growing 18 to 24 inches tall. Though the flowers last only one day, new ones appear every morning. Pkt. 10c; 1/4 oz. 25c; 1/2 oz. 40c.



Hollyhock Bodger's Annual Double Scarlet Beauty



Mixed Gourds

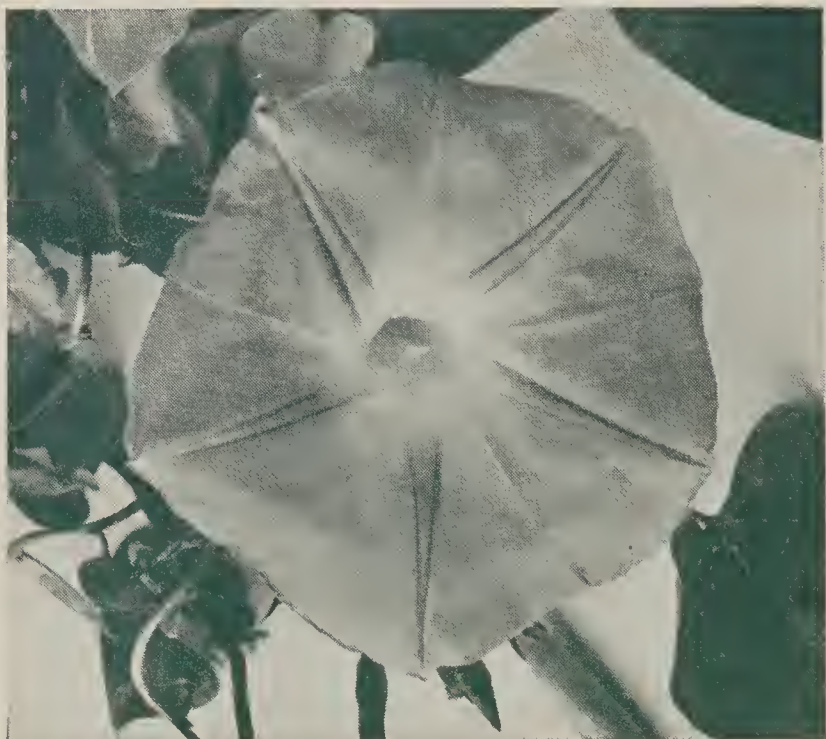

Moonflower—Heavenly Blue



Marigold Gigantea Sunset Giants

LOBELIA—For beds, borders, porch boxes, etc. The compact varieties are splendid for beds and borders. The spreading or hanging varieties cannot be surpassed for growing in porch or window boxes.

Erinus, Finest Mixed. All are of compact habit. Pkt. 10c; ½ oz. 35c; ¼ oz. 60c.

LUNARIA—Honesty or Money Wort—Biennis. These biennial plants will bloom the first year if sown early. Has beautiful, stock-like, sweet scented, light purple flowers followed by large round seed-pods, with a thin, silvery paper-like partition, which are splendid for winter bouquets. Pkt. 10c; ¼ oz. 30c; ½ oz. 50c.

LUPINES—Mixed—Annual. Free-flowering, easily grown plants with long, graceful spikes of rich, vari-colored, pea-shaped blooms. Height 2 ft. Our mixture includes Blue, White and Rose. Pkt. 10c; ¼ oz. 25c; ½ oz. 50c.

LUPINS HARTWEGI GIANTS MIXED. Annual Lupins are favorite garden flowers in almost all parts of the country, flowering freely without any special care. This improved new giant strain is over a foot taller than the ordinary strain, reaching a height of three or four feet. There are five or six long basal branched spikes to each plant, bearing closely placed giant blooms, in a color range including dark blue, sky blue, rose and white. Pkt. 15c; ¼ oz. 40c; ½ oz. 70c. Picture on page 20.

MARVEL-OF-PERU—Four-O'Clock. A favorite showy annual for beds and borders. Excellent for planting in front of the porch or alongside the house. The plants bloom freely from July until frost.

Tom Thumb Mixed. Compact plants 18 inches tall, having showy, variegated golden foliage and fine large blooms in many bright colors, including some beautifully striped blooms combining two or more colors. Pkt. 10c; oz. 30c; 4 ozs. 90c.

MOONFLOWER—Night Blooming. Quick growing climbers with beautiful, large flowers which open in the evening and close the next morning, unless day is cloudy. The luxuriant foliage affords splendid shade. July until frost. Plant in a sunny position. 15 feet or more.

Heavenly Blue (Early Blooming). Large bright sky-blue flowers, 5 in. across, with white throats. Exceptionally pretty; a sheet of blue when in full bloom. Flowers remain open until noon the next day, so that it is offered by some as a Morning Glory. Highly recommended. Pkt. 10c; ¼ oz. 40c; ½ oz. 70c.

Giant Pink. Lavender-pink. Large flowers and large subtropical foliage. Pkt. 10c; ½ oz. 35c; oz. 60c.

Giant White. Pure white flowers, often 6 in. across. Very free blooming. Pkt. 10c; ½ oz. 30c; oz. 50c.

Cross-Bred. White flowers, 4 to 6 in. across. Early and showy. Fragrant. Pkt. 10c; ½ oz. 30c; oz. 50c.

Sky Blue. Beautiful sky-blue flowers are borne most profusely. Handsome. Pkt. 15c; ¼ oz. 40c; ½ oz. 70c.

MIGNONETTE—Finest Mixed—Annual. This mixture includes those varieties with long, heavy spikes set closely with fine fragrant blooms in spring and fall. Plant in sandy soil to secure most fragrant flowers. Pkt. 10c; ¼ oz. 25c; ½ oz. 40c.

MYOSOTIS—Forget-Me-Not. Succeeds best in cool moist soils, blooming profusely during spring and summer. Excellent for edgings, borders, or plantings in semi-shaded places. The Alpestris varieties grow 12 inches tall and do best if grown like annuals. Palustris will live over winter.

Alpestris Mixed. Blue, White and Rose in mixture. Pkt. 10c; ¼ oz. 35c; ½ oz. 60c.

NIGELLA—Double Mixed. A mixture of rich cornflower—blue and pure white flowers. Easily grown and sure to bloom anywhere. Always admired. Pkt. 10c; ¼ oz. 20c; ½ oz. 30c; oz. 50c.

Nierembergia Hippomanica (New). See page 2.

OXALIS—Tropaeoloides—Annual. Good dwarf bedding plant with dark brown, clover-like foliage forming a dense mat, the small yellow flowers being inconspicuous. Height 4 inches. Pkt. 15c; 1/16 oz. 40c; ¼ oz. 70c.

MARIGOLDS. No garden is complete without Marigolds. They are easy to grow and bloom profusely from midsummer until after the first light frost.

Crown of Gold. All-America Gold Medal Winner of 1937. The first Marigold in cultivation with odorless foliage. This freedom from the usual Marigold odor and distinctly new Collarette or Crown form made Crown of Gold the most outstanding flower last year—more packets of seeds of it were planted last season than of any other new flower ever introduced. Flowers are sweetly fragrant, brilliant orange-gold, 2½ inches across, produced early and freely until frost. 2 ft. tall. Pkt. (200 seeds) 10c; ¼ oz. 25c; ½ oz. \$1.00.

Yellow Crown. The form of Yellow Crown is, like Crown of Gold, of the Collarette or Crown type, with a circle of broad rays on the outside (called the collar) and a crest or crown in the center which is made up of many artistically curled and interlaced florets resembling miniature Chrysanthemums. Both the collar and crown are of a clean, refreshing, cheerful shade of bright canary-yellow. Flowers 2½ inches across; plants 20 inches tall. Early and continuous blooming until frost. Odorless foliage. Pkt. (100 seeds) 25c; 200 seeds 50c; 500 seeds \$1.00.

King's Ransom. The same distinctive, artistic flowers as Crown of Gold; collar is a little less conspicuous and crown slightly larger. Glowing, bright golden orange, a delightful tone midway between Crown of Gold and Yellow Crown. Flowers 2½ to 3 inches across; plants 2 feet tall. Early and continuous blooming. The foliage is absolutely odorless. Pkt. (100 seeds) 25c; 200 seeds 50c; 500 seeds \$1.00.

Gigantea Sunset Giants. The flowers the largest ever known in the Marigold group, averaging 5 inches and some flowers attaining a size of 7½ inches, but they are produced in such profusion that a plant of Sunset Giants is one of the showiest spots in any garden. But most remarkable, instead of the usual Marigold odor these flowers have a definitely sweet fragrance. The flowers are loosely formed, very full centered, with broad, heavy petals gracefully overlapping to make a flower of great depth and even larger than Dahlia Flowered Zinnias. Sunset Giants is a mixture ranging from deep orange through golden orange, deep golden yellow, light yellow, lemon yellow, and a delightful new shade of primrose. The plants are usually from 3½ to 4 feet high, but under extremely favorable conditions have been known to grow as much as 7 feet. Pkt. 15c; 1/16 oz. 75c; ¼ oz. \$1.25.

New Guinea Gold Marigold. A distinct type of graceful, pyramidal habit, growing 2 to 2½ ft. high, and producing flowers 2 to 2½ inches across, of a brilliant orange with double ruffled, loose-leaf petals. This variety has been accepted as a valuable cut flower for florists' use and is now in great demand. Pkt. 10c; ½ oz. 50c; ¼ oz. 85c.

French Double Mixed. Dwarf varieties in shades of yellow, orange, and brown. Blooms freely from July until frost. Pkt. 10c; ¼ oz. 25c; ½ oz. 40c.

Legion of Honor (Little Brownie). A charming variety for dwarf beds or borders; 1 ft. tall. Single yellow flowers with brown center. Pkt. 10c; ¼ oz. 25c; ½ oz. 40c.

Tall Josephine. Single, golden yellow flowers with maroon center. Grows 2 ft. tall and blooms profusely until late fall. Pkt. 10c; ¼ oz. 25c; ½ oz. 40c.

Dwarf Orange Ball. Small, perfectly round flowers of glistening orange color. Pkt. 10c; ¼ oz. 25c; ½ oz. 40c.

Double Mixed. Well-balanced mixture of large-flowering Marigolds. Pkt. 10c; ¼ oz. 25c; ½ oz. 40c.

Orange King. Blooms very double, well rounded, carried on fine long stems. Pkt. 10c; ¼ oz. 50c; ½ oz. 85c.

African Orange Ball. Enormous, double flowers of rich orange from July until frost. Height 2½ feet. Pkt. 10c.

Ball's Orange (Ball's Special Strain). Similar to Orange King. Selected for indoor blooming. Pkt. 25c.

Lemon Queen. Very double, well rounded blooms of rich lemon-yellow on good long stems. Pkt. 10c; ¼ oz. 50c; ½ oz. 85c.

Double Mixed. Includes the very finest colors and varieties. Pkt. 10c; ¼ oz. 50c; ½ oz. 85c.

NASTURTIUM—Glorious Gleam Hybrids. New Double Sweet Scented. (Chosen for trial at Wisley.) The flowers are uniformly double, large, well formed and delightfully sweet scented, while the stems are long and wiry, bearing the numerous flowers well above the foliage. The color range is wide and well balanced, including glorious shades of salmon, golden yellow, orange scarlet, cerise, cream yellow, maroon, orange, crimson, and gold flushed scarlet. Natural color illustration on back cover. Pkt. 10c; 1 oz. 25c; ¼ lb. 75c.

Tall Mixed—Annual. These free-flowering plants grow and bloom in quite poor soils. They come in a great variety of colors and with many types of foliage. Fine for verandas, trellises, etc., reaching a height of 6 to 10 feet, or may be used to trail over the ground. Pkt. 5c; oz. 15c; ¼ lb. 40c; lb. \$1.25.

Dwarf, Gorgeous Mixed. A mixture of the most showy of the dwarf Nasturtiums, with both light and dark foliage, and extremely large flowers. Compact, bushy plants that bloom freely from June till frost. Height 1 ft. Pkt. 5c; oz. 15c; ¼ lb. 40c; lb. \$1.25.

NICOTIANA—Flowering Tobacco. Stately plants for background planting or for large beds. They range from 15 inches to 5 ft. tall and produce an abundance of large, sweet-scented blooms from midsummer until frost. Early sowing indoors insures a fine display of blooms. Do best in rich soil.

Crimson Bedder. Rich deep crimson blooms borne profusely on plants growing only 15 inches tall. A new variety. Pkt. 35c; ½ oz. 55c; ¼ oz. \$1.00.

Affinis, New Hybrids. Fragrant large blooms in shades of rose, red, crimson and creamy white. 2½ ft. tall. Pkt. 10c; ¼ oz. 35c; ½ oz. 60c.

Crimson King. Elegant, large, dark velvety crimson flowers borne profusely atop showy plants. Grows 2½ ft. tall. Pkt. 10c; ¼ oz. 40c; ½ oz. 70c.

ORNAMENTAL GRASSES—Beautiful in the Garden—Lovely for Winter Bouquets. With the renewed interest shown by gardeners in the Everlasting flowers, the Ornamental Grasses have again become fashionable. The effects that can be obtained with them as borders to the garden beds are by far too little appreciated by most gardeners. In addition to this, they are easily dried for winter bouquets, but should be cut early in the morning while they are still wet with dew and hung up to dry in a cool airy place. All of them are easy to grow in any garden soil.

Hardy Pampas Grass. A beautiful hardy grass with long purplish violet blooms turning to silky gray; 6 ft. Pkt. 10c; ¼ oz. 25c; ½ oz. 40c.

Plume Grass. Lovely pale pink blooms, excellent for borders and winter bouquets. The plants grow 2 ft. tall. Pkt. 10c; ¼ oz. 30c; ½ oz. 50c.

PETUNIAS—Balcony or Large-Flowered. A beautiful type of Petunias with large flowers. They are useful for planting in porch boxes, beds, terraces or among rock work, where the long slender branches can spread out and display their multitude of flowers. They can be depended upon to give a magnificent display throughout the summer and fall. Crimson, Rose and White. Any of the three: Pkt. 15c; 1/32 oz. 35c; 1/16 oz. 60c; ½ oz. \$1.00.

Star of California. A newer Balcony Petunia with velvety violet blooms shaded crimson and enhanced with white blotches. They present a charming effect. Pkt. 15c; 1/32 oz. 45c; 1/16 oz. 75c.

Berolina. Magnificent clear ultramarine-blue flowers of a color that attracts immediate attention. Pkt. 25c; 1/128 oz. 70c; 1/64 oz. \$1.25.

Balcony Mixed. A carefully compounded blend of all the above Balcony Petunias to give a showy, well-balanced color effect from midsummer until frost. Pkt. 15c; 1/16 oz. 60c; ½ oz. \$1.10.

BEDDING PETUNIAS—Hybrida or Spreading Varieties. A charming type for outdoor beds or borders where the plants have room enough to spread out and display their colorful blooms.

Scarlet Flare (New). See page 2.

General Dodds. Crimson flowers or unusual vivacity, larger than most others. Pkt. 10c; 1/16 oz. 30c; ½ oz. 50c.

Golden Rose. Brilliant pink blooms with yellow throat. Very free blooming. Pkt. 15c; 1/16 oz. 30c; ½ oz. 50c.

Rosy Morn. Lovely flowers of a delicate rose-pink with white throat. Pkt. 15c; 1/16 oz. 40c; ½ oz. 70c.

Howard's Star Improved. Shows a five-pointed white star on purple ground. Pkt. 15c; 1/16 oz. 30c; ½ oz. 50c.

Violacea. Deep violet blooms set against a background of rich green foliage. Pkt. 15c; 1/16 oz. 35c; ½ oz. 60c.

NANA COMPACTA VARIETIES. In contrast to the bedding Petunias, the nana compacta variety forms round, compact bushes growing about 8 inches tall and measuring 1 ft. across. They bloom profusely from midsummer until late fall.

Salmon Supreme. Brand new color in Petunias and one that has long been wanted. When first opening they are rich coral-salmon; as they mature, they change to a glistening soft salmon-pink. Flowers grow about 2 inches across, and are produced most freely on nicely rounded plants. Pkt. 35c; 2 pkts. 65c; 3 pkts. 95c.

New Miniature Petunia Royal Gem. Plants grow about 6 inches high and form perfect ball shaped mounds 6 inches across. Flowers are well formed and bold, about 2 inches across and of a rich rosy crimson-carmine deepening slightly at the base of the petals, all in sharp contrast to the pure white lightly veined carmine throat. Very desirable for borders and edgings. Pkt. 25c.

Royal Gem (New Miniature). See page 2.

Snowball. Lovely pure white flowers that cover the compact plants completely. Pkt. 10c; 1/16 oz. 30c; ½ oz. 50c.

Rose of Heaven. Excels by its marvelous color-rich brilliant rose, white throat. Pkt. 15c; 1/16 oz. 30c; ½ oz. 50c.

Enchantress Mixture. A splendid mixture of the nana compacta Petunias. Pkt. 10c; ½ oz. 50c; ¼ oz. 85c.

Burpee's Blue. The finest blue Petunia we have ever grown. Very profuse. Pkt. 25c; 1/32 oz. 50c; 1/16 oz. 85c.

Large Single Flowered Mixed. Fine large blooms in many brilliant colors. Blooms profusely from midsummer until frost. Pkt. 25c; 1/32 oz. 75c; 1/16 oz. \$1.35.

GIANT DOUBLE PETUNIAS. These Giant Double Petunias are exceedingly showy. They have been produced from hand-pollinized seed and give a high percentage of double blooms. As the seeds are small and expensive, care should be taken in sowing. Start them in a box or pan filled with good fine loose soil. Press them into the surface rather than covering them with soil and place a pane of glass over the box to retain the moisture. The slow-growing plants with crumpled foliage are the ones that usually give the finest flowers.

Fordhook Fancy Fringed Double. The beauty of our Fordhook Fancy Fringed Double Petunias is intriguing. To know that they have been produced from carefully hand-pollinized seeds adds to the interest in these gorgeous, colorful blooms. The color range is remarkable and varied. Pkt. 25c; 1/128 oz. \$2.50; 1/64 oz. \$4.75.

PANSIES—Annual. Easily grown plants that bloom profusely for many months. Sow seeds indoors early in March or outdoors as early as the ground can be prepared into a fine loose condition; if sown in August the plants will begin blooming very early in spring. Height 10 inches.

Giant Ruffled Masterpiece. Very large, ruffled flowers in many rich dark shades, bordered, blotched or marked in ray-like veinings with contrasting colors. Bloom freely and continuously. Pkt. 15c; ½ oz. 50c; ¼ oz. 85c; ½ oz. \$1.50.

Abel's Large Mixed. These are improved types of the old-fashioned Pansies. The size of the flowers is notable. Pkt. 10c; ½ oz. 35c; ¼ oz. 60c; ½ oz. \$1.00.

Trimardeau or Giant Mixed. An excellent mixture of all the giant-flowering varieties we offer. Pkt. 15c; ½ oz. 50c; ¼ oz. 85c; ½ oz. \$1.50.

Engelmann's Strains. Nowhere are Pansies more loved or better understood than in England, the home of Mr. Engelmann. In the Engelmann establishment an infinite amount of care is taken to produce nothing but the finest types of extra large Pansies in a great variety of shades. The Special Strain is the old Scottish Show type, reselected to a strain of immense flowers, in the bronze and reddish shades. The Giant strain has a wide range of colors, both dark and light. Both strains are compact and early flowering. Pkt. 15c; 1/16 oz. 65c; ½ oz. \$1.00; ¼ oz. \$1.75; ½ oz. \$3.00; oz. \$5.00.

St. Kund Giants. This magnificent strain of Giant Pansies is outstanding for its range of colors, compact growth, and free blooming character. The flowers contain an unusual amount of petal substance, so that the petals are not only thick but waved and frilled to the extreme. This gives the blooms a decidedly double appearance. The range of color combinations and markings are unlimited. Pkt. 40c; 1/16 oz. \$1.00; ½ oz. \$1.85; ¼ oz. \$3.50; ½ oz. \$6.50; oz. \$12.00.

PHLOX—Tall Finest Mixed—Annual. An excellent mixture of the very best varieties. It will produce a fine display of brilliant-colored, well-rounded, closely formed flower-heads on long stems. Height 15 inches. Pkt. 10c; ½ oz. 25c; ¼ oz. 40c; ½ oz. 70c.

Dwarf Mixed—Annual. Compact plants in many lovely colors. Fine for the front of the border. Height 5 inches. Pkt. 15c; ½ oz. 45c; ¼ oz. 85c; ½ oz. \$1.50.

Starred and Fringed—Annual. Flowers starred or fantastically fringed. They come in pink, rose, deep red and scarlet, all more or less bordered or edged white. Height 1 ft. Pkt. 15c; ½ oz. 45c; ¼ oz. 85c; ½ oz. \$1.50.

PINKS—Double Chinese Mixed—Annual. The flowers are borne in clusters on fine, upright, strong stems, and in addition to whites, pinks, rose, scarlet, crimson and maroon, many are attractively bordered with a narrow or broad white edge. Pkt. 10c; ¼ oz. 25c; ½ oz. 40c; oz. 70c.

Old Fashioned Mixed—Annual. An especially fine mixture of single and double varieties in an extra-good selection of colors. They are easily grown and the gay flowers form a beauty-spot in the garden all season. Height 1 ft. Pkt. 10c; ¼ oz. 30c; ½ oz. 50c; oz. 85c.



Petunia Salmon Supreme
Award of Merit—All-America Selections



Scabiosa



Salpiglossis

ABEL'S POPPIES—Papaver. The annual poppies are very easy to grow. All that is needed is to sow the seed thinly outdoors as soon as the ground has thawed out. They produce their gorgeous blooms for many weeks during the summer.

Fordhook Hybrids Mixed. You will agree with us that these are the most gorgeous of all Poppies with single, semi-double and double flowers in a truly riotous range of colors. Grows 18 inches tall. Pkt. 10c; ¼ oz. 30c; ½ oz. 50c; oz. 85c.

Dazzler. Brilliant double orange-scarlet blooms. Grows 18 inches tall. It will stand transplanting. Pkt. 25c; ¼ oz. 60c; ½ oz. \$1.00; oz. \$1.75.

Double Carnation—Flowered. Large carnation-like blooms in many colors. Three ft. tall. Pkt. 10c; ¼ oz. 15c; ½ oz. 25c; oz. 40c.

Double Peony—Flowered Mixed. Elegant large double Peony-like flowers in many bright colors. Three ft. Pkt. 10c; ¼ oz. 15c; ½ oz. 25c; oz. 40c.

CALIFORNIA POPPIES—Eschscholtzia. Charming annuals for beds, borders and rock gardens, blooming from early summer until frost. The plants are of strong growth, about 12 inches tall. They include both single and double flowers in showy colors.

Sunset Mixture. A bed of this mixture, which includes all the lovely colors gives a sight that will last for months, as the plant will bloom profusely from midsummer until frost. They are splendid in beds, borders and in larger rock gardens. Pkt. 10c; ¼ oz. 25c; ½ oz. 40c; oz. 70c.

PERENNIAL POPPIES—Papaver Orientale—Oriental Poppies. Huge, brightly colored flowers borne profusely during May and June. They grow 3 ft. tall. Sow where to bloom or transplant in August or September only.

Oriental—Orange-scarlet with brilliant purplish black blotch at base. Pkt. 10c; ½ oz. 30c; ¼ oz. 50c.

Choicest Mixed. Fiery red, scarlet, orange-scarlet, salmon and others. Pkt. 10c; ½ oz. 30c; ¼ oz. 50c.

PAPAVER NUDICAULE—Iceland Poppies. Graceful, light green tufts of leaves and gaily colored. Large blooms borne profusely through the summer. Grows 1 ft. tall and gives a splendid display in rockeries.

Yellow. Pkt. 10c; ½ oz. 30c; ¼ oz. 50c.

Mixed. Pkt. 10c; ½ oz. 25c; ¼ oz. 40c.

Double Mixed. Contains all colors. Pkt. 10c; ½ oz. 40c ¼ oz. 70c.

Fakenham Hybrids. Special colors. Pkt. 25c; 1/16 oz. 65c; ½ oz. \$1.20.

PORTULACA—Rose Moss. A beautiful hardy flower; unsurpassed in brilliancy by any other annual in cultivation. The plants are low-growing and creep all over the ground. They thrive well in almost any location, even in any sunny place among stones, and can withstand the hottest summer weather. They like the full sunlight, but the finest flowers are produced the latter part of August and in September, when there are heavy dews at night. This is particularly true of the double varieties.

Single Mixed. Large single blooms, including orange, white, red, buff, salmon and other fine colors. Pkt. 10c; ¼ oz. 30c; ½ oz. 50c; oz. 85c.

Double Mixed. The effect that this well-balanced mixture will give is charming and colorful. Sow it liberally. Pkt. 10c; ¼ oz. 50c; ½ oz. 85c; ¼ oz. \$1.50.

PRIMULA—Hardy Primroses—Auricula. Many bright colors including soft orange, copper-brown, and other pastel shades. Well adapted for naturalizing in the rock garden. The plants grow 6 in. tall and bloom during April and May. Pkt. 25c; 1/16 oz. 60c; ½ oz. \$1.00.

PRIMULA—Auricula. Half-hardy perennial. Flowers in copper, brown, orange and other pastel shades. Height 6 inches. Pkt. 15c; 1/16 oz. 50c; ½ oz. 85c.

Vulgaris (English Primrose). Large, rich yellow flowers in early spring. Height 6 to 8 inches. Pkt. 15c; 1/16 oz. 50c; ½ oz. 85c.

PYRETHRUM—Roseum Mixed—Perennial. Large, daisy-like flowers in lovely shades of rose, pink, red and white during May and June. Height 2 ft. Pkt. 25c; 1/16 oz. 70c; ½ oz. \$1.25.

Aureum—(Golden Feather). Half-hardy perennial. Rich yellow spring. Height 6 to 8 inches. Pkt. 10c; ¼ oz. 30c; ½ oz. 50c.

RICINUS—Castor Oil Bean. Showy ornamental plants doing well in a rich soil and a warm sunny location. The plants are of considerable height and of a beautiful tropical appearance.

Red Spire. Large palmate leaves of a purplish color when young, but changing to a bronzy green when older. The stems, stalks and veins are rich red. The seed spikes and seed-pods are a brilliant rosy crimson. A very showy variety. The plant grows from 3 to 4 ft. tall. Pkt. 10c; oz. 40c; 4 oz. \$1.25.

Mixed. This includes a wide range of varieties with beautiful large leaves in green, red and bronze. Pkt. 10c; oz. 20c; 4 oz. 60c.

RED-HOT POKER PLANT—Early Hybrid (Tritoma Hybrida) Half-hardy perennial. Massive orange-scarlet flower-spikes in August on plants 3 ft. tall. Needs winter protection against frost. Pkt. 20c; 1/16 oz. 50c; ½ oz. 90c.

SALPIGLOSSIS—Painted Tongue—Velvet Flower. Exceedingly showy plants, growing 2½ ft. tall and blooming continuously throughout the summer and fall. The large trumpet-shaped blooms come in a number of rich velvety colors.

Large-Flowered Mixed. A complete mixture of many fine colors. Pkt. 10c; ½ oz. 25c; ¼ oz. 40c.

SALVIA—Scarlet Sage. Everybody knows Scarlet Sage, with its brilliant rich red blooms. Gives a wonderful color accent to any garden during the summer and fall, but there are also lovely blue-flowered Sages which are far too little known. In order to have Salvia in bloom early the seeds should be sown indoors during late February and March.

Splendens (Large-Flowered Scarlet Sage). Scorching scarlet-red flower trusses borne profusely on plants growing 3 to 4 ft. tall. The most popular of all Scarlet Sages. Of unsurpassed brilliancy. Pkt. 10c; ½ oz. 40c; ¼ oz. 70c; ½ oz. \$1.25.

Bonfire or Clara Bedman. Erect plants, 2 ft. tall, with massive scarlet-red flower-spikes completely covering the sturdy plants. Pkt. 10c; ½ oz. 50c; ¼ oz. 85c; ½ oz. \$1.50.

America or Globe of Fire. Each spike is closely set with mammoth-size blooms of a scorching scarlet-red; 1½ ft. tall. Pkt. 20c; ½ oz. 75c; ¼ oz. \$1.35.

Blue Salvia. Plants are extremely free flowering and most attractive in borders and small beds. Blooms all summer and fall. 2½ feet tall. Perennial in mild climates.

Blue Bedder. Rich, deep blue flowers of the Farinacea type. Pkt. 10c; ½ oz. 60c; ¼ oz. \$1.00.

SCABIOSA—Mourning Bride—Pin-Cushion Flower. Caucasica—Perennial. Pleasing light blue flowers. The plants increase in beauty from year to year. Height 2 ft. Pkt. 15c; ½ oz. 60c; ¼ oz. \$1.00.

Large-Flowered Double Mixed. A mixture of all of the finest colors. Tall growing and free flowering. Pkt. 10c; ¼ oz. 25c; ½ oz. 40c; oz. 70c.

Dwarf Double Mixed. Dwarf plants bearing a wealth of brightly colored flowers. Excellent for beds and borders. Height 1 ft. Pkt. 10c; ¼ oz. 30c; ½ oz. 50c; oz. 85c.

SEDUM—Stonecrop. Coerulea. A lovely annual Sedum with large, dainty, pale blue flowers. The plants grow about 8 inches tall and are exceedingly pretty in the rock garden and as pot plants. Pkt. 25c; 1/32 oz. 60c; 1/16 oz. \$1.10.

SHASTA DAISY—Alaska. Our Floradale-grown seed produces immense white blooms in great profusion throughout the summer. Extremely hardy and of the easiest culture growing 2 to 3 ft. tall. Fine for garden display and for cutting. Pkt. 15c; ½ oz. 40c; ¼ oz. 70c.

SNAPDRAGONS—Antirrhinum—Giant Tall or Maximum (4 ft.). A beautiful strain of tall-growing Snapdragons with elegant large blooms closely set on a spike 4 ft. in height. The plants are a wonderful mass of color during July and August. Under shelter of glass they often grow 5 to 7 ft. tall. Besides their attractiveness in the garden, they are valued for winter blooming in the greenhouse.

Giant Mixed. A splendid mixture of all the tall-growing giant varieties. It will give a splendid garden display and cut-flowers. Pkt. 15c; 1/16 oz. 35c; ½ oz. 60c; ¼ oz. \$1.00.

NEW MAJESTIC—Semi-Tall Snapdragons. A giant flowering semi-tall strain with stocky flower-spikes 18 inches tall. Blooms profusely during July and August. Showy, well-rounded, symmetrical bushes. Fine for beds, borders and for cutting.

Avalanche. Beautiful pure white flowers. Pkt. 25c; 1/16 oz. 75c; ½ oz. \$1.25.

Delight. Salmon-pink shaded with Apricot. Very fine. Pkt. 20c; 1/16 oz. 60c; ½ oz. \$1.00.

Eldorado. Beautiful deep rich crimson flowers. Pkt. 25c; 1/16 oz. 75c; ½ oz. \$1.25.

Orange King. Terra cotta, shaded with orange. Pkt. 20c; 1/16 oz. 60c; ½ oz. \$1.00.

Red Chief. Scintillating deep scarlet blooms. Pkt. 25c; 1/16 oz. 60c; ½ oz. \$1.00.

Rose Beauty. Beautiful bright rose-pink flowers. Pkt. 35c; 1/16 oz. 90c; ½ oz. \$1.50.

Rose Marie. Salmon-rose with gold in center. Pkt. 30c; 1/16 oz. 90c; ½ oz. \$1.50.

Twilight. Delicate apricot shaded with salmon. Pkt. 25c; 1/16 oz. 60c; ½ oz. \$1.00.

Majestic Mixed. A blend of all colors. Pkt. 15c; 1/16 oz. 35c.

STATICE—Latifolia (Sea Lavender). Perennial. A quaint plant with masses of lavender blue flowers; attractive when dried for winter use. Height 15 in. Pkt. 10c; ½ oz. 35c; ¼ oz. 60c.

STEVIA—Serrata. Perennial. The small white flowers, in well-shaped heads, are borne very freely in the fall, and are agreeably fragrant. Height 2 ft. Pkt. 10c; ½ oz. 40c; ¼ oz. 70c.

STOCKS—Ten Weeks. Bushy plants, 15 to 18 inches tall, suitable for borders, florists, designs and pot culture. The sweet-scented double flowers are borne profusely on strong, stocky spikes. Pkt. 10c; 1/8 oz. 50c; 1/4 oz. 85c; 1/2 oz. \$1.50.

STOKESIA—Cyanea (Cornflower Aster). Perennial. Handsome cornflower-like, azure-blue flowers from July to frost. Height 2 ft. Pkt. 10c; 1/8 oz. 40c; 1/4 oz. 70c.

SUNFLOWER. Perennial (*Helianthus Rigidus*). The immense blooms vary in color from primrose-yellow to deep old-gold. Because of their great height they should be planted in the back of the border. Pkt. 15c; 1/8 oz. 60c; 1/4 oz. \$1.00.

SWEET ROCKET. Mixed. Perennial. Erect-growing plants with clusters of white or purple flowers, sweetly fragrant. Height 2 ft. Pkt. 10c; 1/4 oz. 20c; 1/2 oz. 30c.

SWEET PEAS. Sweet Peas do best during cool weather and for that reason, sow the seed as early in the spring as the ground can be prepared. Cover the seed with 2 inches of fine soil, and when the plants begin to vine, supply supports for them to climb upon. Deep preparation of the soil is a great advantage, though not necessary where the soil is naturally fertile and well drained. Water freely during dry spells. One ounce of seed will give a row about 15 ft. long.

Abel's Novelty Mixture. Composed of the latest and very finest varieties. Pkt. 5c; oz. 20c; 1/4 lb. 40c; lb. \$1.40.

Spencer Mixture. The best mixture on the market today. Many bright, showy colors. Pkt. 10c; oz. 25c; 1/4 lb. 60c; lb. \$2.00.

Perennial Sweet Peas (*Lathyrus Latifolius*). An excellent vining plant with stems 8 to 10 ft. long. Blooms very freely throughout the summer. Mixed (all colors). Pkt. 10c; 1/4 oz. 25c; 1/2 oz. 40c.

SWEET WILLIAM. Double Mixed (*Dianthus Barbatus*). Usually grown as biennials. Their showy heads of vari-colored bloom add much to the flower garden in May and June. Height 1 1/2 ft. Pkt. 10c; 1/8 oz. 25c; 1/4 oz. 40c.

Annual Mixed. An entirely new type of this popular flower. It blooms freely the first year from seed and dies down with the first frost. The range of colors included in our mixture is attractive, and includes self-colors, starred, mottled and eyed varieties. Height 15 inches. Pkt. 10c; 1/8 oz. 25c; 1/4 oz. 40c.

THUNBERGIA—(Black-eyer Susan Vine). An elegant, graceful and slender climber, producing bright cadmium-yellow blooms. Excellent for hanging-baskets and ground-covers. Of quick growth; blooming profusely from June until October. Pkt. 10c; 1/4 oz. 40c; 1/2 oz. 70c; oz. \$1.15.

TITHONIA SPECIOSA (Golden Flower of The Incas). Not new but very popular. Orange, vermillion, resembling single African Marigolds. Foliage and habit of growth like Dahlias. Early flowering. An excellent cut flower. Pkt. 10c; 1/4 oz. 40c.

Tithonia Speciosa Grandiflora Fireball. Dazzling as a ball of fire poised high above other flowers. Fireball is, undoubtedly, the last word in brilliance of color in fall blooming plants. Many who have known and enjoyed *Tithonia Speciosa* have considered it the brightest possible flower for fall use. Fireball is a very brilliant, vibrant shade of scarlet orange, the petals in dazzling contrast to the clear yellow center. Very large flowers 4 1/2 to 5 inches in diameter, and carried on fine long stems. Plants are tall some reaching a height of 8 to 9 feet with a fairly heavy growth of grayish green woolly foliage. Flowers will keep five or six days when cut. Pkt. 25c.

VENIDIUM—Monarch of the Veldt. *Fastuosum*. Large, brilliant orange flowers, 3 inches across, with a black-purple zone at the base of the ray-petals and a dark center with a gray-green, wool-like tuft. The plants grow 2 to 3 ft. tall and bloom from midsummer until frost. The foliage is a soft gray and forms a splendid background. Fine for garden display and for growing under glass. It is one of the most outstanding new flowers of recent introduction. Pkt. 35c; 1/16 oz. 90c; 1/8 oz. \$1.50; 1/4 oz. \$2.75.

VERBENAS—New Giant Verbenas. This glorious new type of Verbenas has become a great favorite because the flowers are of truly giant size. They combine into magnificent heads carried in great profusion on strong, vigorous plants. The individual blooms measure over an inch in diameter and the plants grow about 1 ft. tall. They are splendid for beds, borders and rock gardens, or in window boxes, blooming profusely from midsummer until late fall.

Giant Mixed. There are many gardeners who will want a bed of these new Giant Verbenas with all the colors found in this type and we are sure this mixture will please them immensely. Pkt. 10c; 1/8 oz. 50c; 1/4 oz. 85c; 1/2 oz. \$1.50; oz. \$2.50.

HARDY GARDEN VERBENAS—Venosa. A hardy garden Verbena of spreading habit, covered with large purplish blue flowers borne throughout the summer and fall. Grows 1 ft. tall. Quite hardy. Pkt. 10c; 1/8 oz. 30c; 1/4 oz. 50c.

VINCA—(Periwinkle). Mixed—Annual. Dark glossy green leaves and large, showy flowers 1 1/2 inches across during summer and fall. It comes in shades of rose and pink, also white. Height 15 inches. Pkt. 10c; 1/4 oz. 40c; 1/2 oz. 70c.

WALLFLOWER. Fine Double Mixed. Annual. Spikes of closely set flowers in chocolate, orange, crimson and bright red shades. Very showy. Height 2 ft. Pkt. 15c; 1/8 oz. 40c; 1/4 oz. 70c.

ZINNIAS. Zinnias are one of the most universally planted of all annuals. They are hardy and so easy to grow, doing well almost anywhere with little care. They offer many lovely colors, and their various types meet every garden need for beds, borders and cut-flowers. Zinnias flower profusely and continuously from midsummer until late fall. The foliage is substantial and decorative. For the finest double flowers, plant in a sunny location with good soil and plenty of water. Early blooms can be had by sowing the seed indoors about six weeks before outdoor planting time. Regular sowings should be made outdoors as soon as the soil is dry enough to be worked and all danger of frost has passed. Thin out the seedlings or transplant, allowing 18 to 24 inches between plants.

Fantasy. Mixed Colors. Well-rounded, medium-sized, double flowers, 3 to 3 1/2 in. across, composed of a mass of twisted, tubular petals which give them the appearance of a shaggy *Chrysanthemum*. The color range includes the brightest shades of red, yellow and orange, as well as many choice pastel shades, such as pink, lavender and cream. Plants grow about 2 ft. tall, and are very profuse blooming throughout the summer and fall. Very nice for table decorations and bouquets; attractive in the garden. Winner "All-America" Award of Merit. Pkt. 10c; 1/8 oz. 25c; 1/4 oz. 40c; 1/2 oz. 70c.

Gaillardia Flowered Finest Mixed. Strongly remind one of the *Picta Double Gaillardia*. Is said to be a cross between *Haageana* and *Elegans* types, resembling *Haageana* in flower form and *Elegans* in foliage and flower color. Medium size, very attractive flowers, about 2 inches in diameter, a good size for cutting, stems of medium length. Plants about 2 feet tall, very free flowering. Colors range through mellow tones of rose, pink, bronze, yellow, orange, lavender and combinations of these colors. Most flowers are two-toned with deeper color in center. Flowers will be produced about 45 days after seed is sown. Pkt. 15c.

Linearis. Most unusual and interesting of newer Zinnias is this little dwarf variety. Single flowers, a lovely shade of golden orange, with delicate lemon yellow stripe through each petal, center is dark brown in young flowers, turning golden orange as pollen develops. Extremely early blooming, commencing to flower when plants are 6 inches tall and keeping on through season until late frosts. Plants reach a height of 8 to 10 inches and with plenty of room may spread 2 feet by end of season. Flowers are produced in great profusion. Suitable for border or edging use, window boxes and where a dwarf growing brilliant colored plant is desired. Will start flowering about 6 weeks after seed is sown. Pkt. 15c.

Lilliput, Pastel Mixture. Are particularly fine for cutting, because of neat, symmetrical habit, also with their small size and stem length. In this mixture, very lovely soft shades of apricot, peach, creamy yellow, shell pink, delicate salmon, light rose and orchid have been incorporated. Plants are 12 to 15 inches in height, neat in habit, compact growing and very free flowering. One of the early blooming types, producing flowers about 45 days after seed is sown. Pkt. 15c.

Lilliput, Tom Thumb Mixture. Tom Thumb is without exception the very dwarfest zinnia known. The plants are rounded and compact, 4 to 6 inches high, literally covered with well formed flowers of the lilliput type. The color mixture includes red, orange, yellow, pink, rose and other pastel shades. It is a fine border plant, especially for the hot dry sections of the country and is the best zinnia to use in pots or window boxes. Pkt. 10c; 1/4 oz. 35c; 1/2 oz. 60c; oz. \$1.00.

Spun Gold, Pumila Dwarf Double. A new introduction, Spun Gold, is an entirely new color in this type, a delicate pastel shade of butter yellow—excellent for cut flower work. The flowers are rounded, 2 1/2 to 3 inches in diameter, on plants 12 to 18 inches in height, with strong, fairly long stems. The strain is very early flowering, coming into bloom about 45 days after planting a point which makes Spun Gold a valuable addition to the Zinnia group. Pkt. 15c; 1/16 oz. 65c; 1/8 oz. \$1.00.



Zinnia Pumila Dwarf Double Spun Gold



Zinnia, Giant Dahlia Flowered

NEW DAHLIA-FLOWERED ZINNIAS

- Buttercup. Well-formed, double flowers of deep creamy yellow.
 - Canary Bird. Bright primrose-yellow.
 - Crimson Monarch. Rich crimson-scarlet.
 - Dream. Distinct shade of deep lavender changing to a purple tint as the flower age.
 - Exquisite. Pleasing rose shade with deeper center.
 - Giant Attraction. Bright spectrum red.
 - Golden State. Rich golden yellow, shading to bright orange when the flowers reach their full size.
 - Illumination. Deep Tyrian-rose.
 - Old Rose. Lovely shade of old-rose.
 - Oriole. Bright glistening orange, shaded with liquid gold showing a coppery cast as the flowers age.
 - Polar Bear. Decidedly the best white Zinnia.
 - Scarlet Flame. Rich orange-scarlet of dazzling brightness.
- (Any of the above Zinnias—Pkt. 10c; 1/8 oz. 35c; 1/4 oz. 60c; 1/2 oz. \$1.00; 1 oz. \$1.50.)

Abel's New Dahlia-flowered Mixed. An excellent mixture of giant-flowering Zinnias in a great variety of colors, so proportioned as to make a beautiful show. Seed saved from extra-fine plants. Pkt. 10c; 1/8 oz. 35c; 1/4 oz. 60c; 1/2 oz. \$1.00; oz. \$1.50.

Curled and Crested—Mixed. The flowers produced by this mixture have elegantly curled and twisted petals and range in color from white through many shades of yellow, rose-pink, and salmon, to deepest crimson. Blooms all summer till frost. Height 1 1/2 ft. Pkt. 10c; 1/8 oz. 35c; 1/4 oz. 60c; 1/2 oz. \$1.00; oz. \$1.50.

Cut-and-Come-Again. A dwarf-growing type of Zinnias forming bushy, compact plants not over 2 ft. tall, with an abundance of well-rounded, double blooms 2 1/2 inches across. Especially recommended for bedding, and of great value for cutting. Golden Orange, Flesh-pink, Salmon-rose, Bright scarlet, White and Canary-yellow. Any of these varieties: Pkt. 10c; 1/4 oz. 30c; 1/2 oz. 50c; 1 oz. 70c.

Mixed Colors—Includes all the colors offered above in proper proportion. Pkt. 10c; 1/4 oz. 25c; oz. 70c.

Mexicana or Miniature. Mexicana, Double Mixed Colors. Flowers are 1 to 1 1/2 inches across and come in the most unique colors, many being two-toned. Extremely free flowering. Plants grow about one foot tall. Shades of yellow and orange. Our strain produces a high percentage of double flowers, the balance being semi-double, with a few singles. Pkt. 10c; 1/4 oz. 50c; 1/2 oz. 85c; oz. \$1.50.

Giant Mammoth. Our special strain of Giant Mammoth Zinnias has superb, massive flowers in many rich colors. The blooms are well formed, very double, 4 inches and more across, with petals thickly set in a shingle-like arrangement. The plants grow 2 1/2 to 3 ft. tall and are well branched, with long flower-stems.

Mixed Colors. A well balanced and complete mixture of showy colors that will delight you. Pkt. 10c; 1/4 oz. 35c; 1/2 oz. 85c; oz. \$1.50.

HARDY CHRYSANTHEMUMS

- Pollworth. Large yellow incurved. Oconto. Large white. Artus. Large red, gold shading. Rose Chochard. Large orchid. Blooms need protection. 50c a clump.
- Gov. Green. Large deep red with tan shading under the petals. Blooms need protection. 75c a clump.
- Tasvia White. Small white tree like plant. 35c a clump.
- Pollworth Cummings. Single, red with tinge of gold shading. Large clumps. 50c a clump.
- Pollworth Howell. Single red turning to a tan shade. 35c a clump.



Talisman



President Hoover

Abel's Perfected Roses

Highly vigorous plants with two or more strong canes and ready to bloom after you plant them. Ready to set out after danger from frost is over. These roses are not to be compared with the low priced bushes.

Hybrid Tea Roses

Rose bushes are extra large two-year-old plants. Being low-grafted roses are stronger coated hardier and more profuse bloomers than own root plants. For permanence, too, grafted plants are the better.

We have listed a few of our best sellers.

ETOILE DE HOLLAND. Considered best red variety, with brilliant scarlet, fragrant flowers of large size. \$1.00 each.

CRUSADER. Rich, velvety crimson, heavy grower, long stems. \$1.00 each.

GENERAL JACQUENIENOT. Dark red, rich color and very fragrant, a vigorous grower and one of the best. \$1.00 each.

HADLEY. A rich velvety crimson of unusual beauty, a strong and vigorous grower. \$1.00 each.

WILLOWMERE. Long coral red buds, developing into a large flower of a red shrimp pink, shaded yellow in center. \$1.00 each.

KILLARNEY PINK. A bright shell pink, a very distinctive rose, a strong and sturdy plant, fine grower. \$1.00 each.

MRS. HENRY MORSE. Bright pink with silver shadings inside and underlying yellow glow, large, double, fragrant flowers. \$1.00 each.

GOLDEN PERNET. Deep yellow painted buds, borne on long stems, a shade darker in color than the Claudius Pernet. \$1.00 each.

RADIANCE PINK. Bright rose pink, beautiful compact buds developing into globular blooms, an extremely popular favorite, fragrant. \$1.00 each.

PRESIDENT HOOVER. Riot of contrasting shades of maroon, orange and gold, continuous bloomer, exquisitely formed buds, strong stems. \$1.00 each.

TALISMAN. Brilliant orange red buds, opening a glowing golden yellow, tinted copper red and orange rose, truly a gorgeous rose, large and fragrant. \$1.00 each.

MARGARET McGRADY. Brilliant red petals on hinges of deep gold; buds upright, constant bloomer. Foliage resistance to black spot and mildew. \$1.00 each.

M. G. A. VAN ROSSEAU. Brownish yellow, shaded golden yellow, a beautiful rose, constant and vigorous grower. \$1.00 each.

MRS. PIERRE S. DU PONT. Most continuous blooming yellow, buds long pointed, rich reddish gold, almost orange in depths of petals. \$1.00 each.

KILLARNEY WHITE. Pure white double flowers, borne in great abundance. \$1.00 each.

MME. JULES BOUCHE. Full pearly white camellia like flower, tinged blush, most dependable. \$1.00 each.

BLAZE CLIMBER. Patented. A very hardy everblooming scarlet climber, extreme vigor and rapid grower. \$1.25 each.

GOLDEN CLIMBER. Patented. Golden yellow Hybrid Tea type flowers on long stems; buds are of pure golden yellow with heavy markings of orange scarlet, handsome, glossy, green foliage, a rapid grower, blooms throughout season. \$1.50 each.

MARY HART. Patented. Striking red sport of Talisman. Bud maroon-red, better than Talisman, sturdy and free blooming. \$1.00 each.

TEXAS CENTENNIAL. Patented. A sport of Hoover, color blood-red of unusual color, constant bloomer, very hardy. \$1.50 each.

If wanted by parcel post add 15c for the first plant and 5c each additional plant.



Speciosum Rubrum



Tiger Lily



Calla

ABEL'S HARDY LILIES

Lilies have been looked upon as the noblest of the garden plants. They like a sunny location, but mulch so the hot sun doesn't reach the soil around the base of the plant. All sizes supplied are of blooming sizes.

AURATUM. Golden Banded Lily of Japan. Gorgeous large white blooms spotted bright carmine and showing a yellow mid-rib running through the center of each petal. Plants grow 4 to 5 feet tall and bloom during July and August. Does best in a lime free, neutral soil. 40c each; 3 for \$1.10; 12 for \$4.00.

HANSON II. Yellow Japanese Lily. Large, six petaled orange-yellow flowers attractively spotted with purplish brown. Each stem carries 4 to 12 lovely, nodding blooms during June and July. Does well in partial shade. 4 to 5 feet. 40c each; 3 for \$1.10; 12 for \$4.00; 100 for \$30.00.

HENRY II. Yellow Show Lily. Brilliant salmon-orange with reddish brown spots. 4 to 6 ft. tall, blooming during late July and August. Sometimes called the yellow speciosum. 35c each; 3 for 95c; 12 for \$3.50; 100 for \$25.00.

REGALE (Regal Lily). Gorgeous, bell-shaped, white blooms with a touch of canary yellow in the throat and a shading of lilac-pink on the outside. Blooms during July. Sweet-scented. One of the most beautiful of all Lillies, the individual blooms of which measure about 6 in. in length by 4½ to 5 in. across. 5 to 6 ft. Large bulbs. 35c each; 3 for 95c; 12 for \$3.50; 100 for \$25.00.

SPECIOSUM ALBUM (White Show Lily). Elegant, large white blooms with golden green markings in the throat. Grows 3 ft. tall and blooms during August and September. Very graceful, hardy and free flowering. 40c each; 3 for \$1.10; 12 for \$4.00; 100 for \$30.00.

SPECIOSUM MELPOMENE. Crimson Show Lily. Rich carmine-crimson flowers spotted blood red and edged with white. The plants grow 3 to 4 ft. tall and bloom during August and September. Moderately rich, well-drained soil is required for best results. 40c each; 3 for \$1.10; 12 for \$4.00; 100 for \$30.00.

SPECIOSUM RUBRUM (Show Lily). Large white flowers suffused rose-pink and spotted crimson. The petals are gracefully reflexed. Blooms August and September, with many flowers on each stem. 3 to 4 ft. tall. 30c each; 3 for 85c; 12 for \$3.00; 100 for \$20.00.

SUPERBUM (Swamp Lily). Brilliant orange-scarlet, shaded and spotted with purplish crimson. 5 to 6 ft. tall and flowers from July until September. Does well in both dry and moist soil. Fine for mass planting and naturalizing. 20c each; 3 for 55c; 12 for \$2.00; 100 for \$14.00.

TIGRINUM FLORE PLENO (Double Tiger Lily). An excellent double Lily with bright salmon-red blooms spotted purplish black. Grows 4 ft. tall and flowers during August and September. Very popular and desirable. 20c each; 3 for 55c; 12 for \$2.00; 100 for \$4.00.

TIGRIDIA (Tigerflower). Mixed. One of the most outstanding of all bulbous plants, with brilliant, colorful blooms in yellow and orange, attractively marked with red, purple or mahogany. The huge flowers are of rather triangular form, having a deep, cup-like center from which radiate three ovate petals. Succeeds in ordinary soil and may be given the same culture as Gladiolus. Blooms all summer. 2 ft. 20c each; 3 for 55c; 12 for \$2.00; 100 for \$14.00.

ABEL'S BEAUTIFUL FLOWERING BULBS FOR HOME AND GARDEN

Some of the most beautiful flowering plants are grown from bulbs. Our bulbs are carefully selected and guaranteed to give complete satisfaction.

AMARYLLIS. Showy plants with large lily like flowers, easy to grow indoors in pots. Not hardy.

Giant American Hybrids. Remarkably fine assortment of large flowering in many beautiful colors. 60c each; 3 for \$1.65; 12 for \$6.00.

ANEMONE. Magnificent, colorful blooms during spring; equally fine for pot culture, borders and cutting. For warm soils in sheltered situations. Hardy, but needs winter protection in cold sections. 1 ft.

Poppy-Flowered De Caen. Large single flowers in a wide range of distinct and most exquisite colors. 3 for 25c; 12 for 70c; 100 for \$4.75.

St. Brigid. Beautiful semi-double and double blooms in many showy and bright colors. A favorite with many. 3 for 25c; 12 for 75c; 100 for \$5.50.

His Excellency. Large brilliant poppy-scarlet single blooms on strong vigorous plants. Very showy and desirable. 3 for 25c; 12 for 70c; 100 for \$4.75.

The Monarch. Very large blooms carried on extra strong stems. Includes many fine shades of light and dark colors. 3 for 25c; 12 for 85c; 100 for \$6.00.

TUBEROUS ROOTED BEGONIAS. Most decorative as pot plants, blooming for many weeks during spring and early summer. Plant outdoors in half shaded places and they will bloom until frost. Single Flowering. 25c each; 3 for 70c; 12 for \$2.50.

Orange, Pink, Rose, Salmon, Scarlet, White, Yellow. Double Flowering. 30c each; 3 for 85c; 12 for \$3.25.

Double Flowering. 30c each; 3 for 85c; 12 for \$3.25.

Orange, Pink, Rose Salmon, Scarlet, White, Yellow.

ABEL'S CANNAS. Stately plants with large foliage of tropical appearance and clusters of massive, well formed blooms on strong stems. For sunny situations and rich but not freshly manured garden loam. We suggest starting roots indoors. All colors. 10c each; 3 for 25c; 12 for \$1.00.

CALLA. White. Easy to grow indoors in pots, requiring a rich soil and plenty of moisture. Not hardy. 40c each; 3 for \$1.10; 12 for \$4.00.

CALADIUMS. Fancy Leaved. Very showy foliage plants with red, green and white variegated leaves. 35c each; 3 for 95c; 12 for \$3.50.

Esulentum. This is the well known Elephant's Ear. The plants produce large, broad, green leaves. Plant in spring after soil has become warm. Not hardy. 25c each; 3 for 70c; 12 for \$2.50.

ABEL'S GOLDEN MEDAL DAHLIAS. We have a list of Dahlia roots of over 200 varieties. Formal decorative, informal decorative, cactus and semi-cactus. We shall be pleased to mail you the list together with prices.

ELLIOTTIANA. (Yellow Calla Lilies.) Beautiful golden yellow blooms, green leaves spotted with white. Easily grown in pots or outdoors during the summer in rich soil and a sunny location. 35c each; 3 for 95c; 12 for \$3.50.

GLOXINIAS. This is not, as many believe a florist plant, but can easily be grown by anyone in a warm living room window. Plant in rich sandy loam. Keep soil moist but not wet. Don't moisten the foliage. Blooms for many weeks during the spring and early summer. Not hardy. Rose white border, pure white, purple, rich rose, scarlet, scarlet white border, purple white border. 40c each; 3 for \$1.00; 12 for \$3.75.

ABEL'S GLADIOLUS. They make an attractive display in the garden, planted either in beds or in groups here and there in the perennial or annual border. Write for our complete list together with prices.

ISMENE. Peruvian Daffodils. Showy sweet scented white flowers of quaint but attractive form. Treat the same as Gladiolus. Not hardy. 25c each; 3 for 60c; 12 for \$2.00.

Vegetable Chart and Planter's Guide

For Southeastern Pennsylvania and Equivalent Climate

Containing a monthly calendar of operations and some useful tables, arranged to help the gardener or farmer in the sowing of seeds or setting out of plants from February to October in the latitude of southeastern Pennsylvania.

VARIETY	Seed Required	Seed Required per Acre	Planting Distance			Maturity from Planting to Picking	February	March	April
			Apart in Row	Between Rows	Depth		Sow in Hotbed	Sow in Hotbed	Sow in Hotbed
Artichoke	1 oz. to 500 plants	1/2 lb.	1 1/2 to 2 ft.	4 ft.	1 in.	1 yr.	Broccoli	Early Beets	Cucumber
Asparagus, Seed	1 oz. to 800 plants	4 lbs.	3 to 6 ins.	1 1/2 ft.	1 in.	3 to 4 years	Early Cabbage	Brussels Sprouts	Eggplant
Asparagus, Roots	50 roots per 100 ft.	5445 roots	2 ft.	4 ft.	12 ins.	2 years	Forcing Carrot	Early Cabbage	Melon
Beans, Bush	1 lb. per 100 ft.	90 lbs.	2 to 3 ins.	2 to 2 1/2 ft.	1 1/2 to 2 ins.	6 to 8 weeks	Early Celery	Forcing Carrot	Pepper
Beans, Bush Lima	1 lb. per 100 ft.	60 lb.	6 ins.	3 ft.	1 1/2 to 2 ins.	10 to 12 weeks	Cucumber	Cauliflower	Tomato
Beans, Pole	1/2 lb. per 100 ft.	30 lbs.	6 ins.	3 to 4 ft.	1 1/2 to 2 ins.	9 to 10 weeks	Eggplant	Celery	
Beans, Pole Lima	1 lb. per 100 ft.	30 lbs.	6 ins.	4 ft.	1 1/2 to 2 ins.	12 to 14 weeks	Early Lettuce	Eggplant	In Open Ground
Beets	2 oz. per 100 ft.	8 to 12 lbs.	2 to 3 ins.	1 1/2 to 2 ft.	1/2 to 1 in.	8 to 10 weeks	Parsley	Kohl Rabi	Asparagus
Beets, Mangels	2 oz. per 100 ft.	8 to 10 lbs.	6 ins.	2 1/2 ft.	1/2 to 1 in.	14 to 16 weeks	Pepper	Lettuce	Beans
Broccoli, Heading	1 oz. to 2000 plants	4 oz.	1 1/2 to 2 ft.	2 to 3 ft.	1/2 in.	9 to 21 weeks	Radish	Parsley	Beets
Brussels Sprouts	1 oz. to 3000 plants	4 oz.	1 1/2 ft.	2 to 3 ft.	1/2 in.	13 to 14 weeks	Tomato	Radish	Brussels Sprouts
Cabbage, Early	1 oz. to 2000 plants	4 oz.	1 1/2 ft.	2 to 3 ft.	1/2 in.	10 to 12 weeks		Tomato	Early Cabbage
Cabbage, Late	1 oz. to 2000 plants	4 oz.	2 ft.	3 ft.	1/2 in.	14 to 16 weeks			Carrot
Carrot	1 oz. per 100 ft.	3 to 5 lbs.	1 to 3 ins.	1 to 2 ft.	1/2 in.	9 to 12 weeks			Cauliflower
Cauliflower	1 oz. to 2000 plants	4 oz.	1 1/2 to 2 ft.	2 1/2 ft.	1/2 in.	14 to 16 weeks		In Open Ground	Celery
Celery	1 oz. to 6000 plants	4 oz.	6 ins.	3 to 4 ft.	1/4 in.	16 to 19 weeks			Cress
Chicory	1 oz. per 100 ft.	5 lbs.	3 ins.	2 ft.	1/2 in.	15 to 17 weeks		Beets	Kohl Rabi
Collards	1 oz. to 2000 plants	4 oz.	1 1/2 to 2 ft.	2 1/2 ft.	1/2 in.	12 to 14 weeks		Carrot	Lettuce
Corn, Sweet	1/2 lb. per 100 ft.	12 lbs.	6 ins.	3 to 4 ft.	1 in.	10 to 13 weeks		Leek	Onion
Corn Salad	4 oz. per 100 ft.	10 lbs.	3 ins.	1 to 1 1/2 ft.	1/2 in.	6 to 7 weeks		Onion	Parsley
Cress	1 oz. per 100 ft.	10 lbs.	2 to 4 ins.	1 1/2 ft.	1/4 in.	5 to 6 weeks		Peas	Parsnip
Cucumber	1 oz. to 50 hills	2 lbs.	4 ft. hills	4 to 5 ft.	1/2 in.	8 to 10 weeks		Potatoes	Peas
Dandelion	1 oz. per 100 ft.	5 lbs.	6 ins.	1 to 1 1/2 ft.	1/2 in.	8 to 9 weeks		Radish	Potatoes
Dill	1/2 oz. per 100 ft.	5 lbs.	6 ins.	2 to 2 1/2 ft.	1/2 in.	10 weeks		Spinach	Radish
Egg Plant	1 oz. to 1000 plants	4 oz.	2 ft.	2 1/2 ft.	1/2 in.	16 to 18 weeks		Early Turnip	Spinach
Endive	1/2 oz. per 100 ft.	4 lbs.	8 to 12 ins.	1 1/2 ft.	1/2 in.	12 to 13 weeks			Early Turnip
Fennel	1 oz. per 100 ft.	4 lbs.	6 ins.	2 to 3 ft.	3/4 in.	9 weeks			
Kale	1/2 oz. per 100 ft.	3 lbs.	1 1/2 ft.	2 ft.	1/2 in.	8 to 9 weeks			
Kohl Rabi	1/2 oz. per 100 ft.	4 lbs.	3 to 6 ins.	1 1/2 ft.	1/2 in.	8 to 9 weeks			
Leek	1 oz. per 100 ft.	4 lbs.	2 to 3 ins.	1 1/2 ft.	1/2 in.	12 to 13 weeks			
Lettuce	1/2 oz. per 100 ft.	3 lbs.	6 to 10 ins.	1 1/2 ft.	1/2 in.	7 to 10 weeks			
Melon, Musk	1 oz. to 50 hills	3 lbs.	3 ft. hills	4 to 5 ft.	3/4 in.	12 to 14 weeks			
Melon, Water	1 oz. to 30 hills	4 lbs.	5 ft. hills	8 ft.	3/4 in.	12 to 14 weeks			
Mustard	1 oz. per 100 ft.	4 lbs.	4 to 6 ins.	1 ft.	1/2 in.	4 to 5 weeks			
Okra	2 oz. per 100 ft.	8 lbs.	1 1/2 ft.	3 ft.	1 in.	7 to 9 weeks			
Onion Seed	1 oz. per 100 ft.	5 lbs.	3 ins.	1 1/2 ft.	1/2 in.	13 to 16 weeks			
Onion Sets	2 qts. per 100 ft.	10 bus.	3 ins.	1 1/2 ft.	1/2 in.	5 to 6 weeks			
Parsley	1/2 oz. per 100 ft.	3 lbs.	4 to 6 ins.	1 ft.	1/2 in.	10 to 12 weeks			
Parsnip	1 oz. per 100 ft.	4 lbs.	4 ins.	1 1/2 to 2 ft.	1/2 in.	13 to 14 weeks			
Peas	1 to 2 lbs. per 100 ft.	120 lbs.	1 to 2 ins.	2 to 3 ft.	1 to 2 ins.	8 to 10 weeks			
Pepper	1 oz. to 1000 plants	3 oz.	1 1/2 ft.	2 1/2 ft.	1/2 in.	14 to 18 weeks			
Potatoes	7 1/2 lbs. per 100 ft.	10 bus.	15 ins.	3 ft.	3 ins.	10 to 12 weeks			
Potatoes, Sweet		9680 plants	3 ft. hills	3 ft.		18 to 20 weeks			
Pumpkin	1 oz. to 25 hills	4 lbs.	6 ft.	8 ft.	1 in.	15 to 16 weeks			
Radish, Early	1 oz. per 100 ft.	10 lbs.	1 in.	1 ft.	1/2 in.	3 to 4 weeks			
Radish, Winter	1 oz. per 100 ft.	8 lbs.	4 ins.	1 1/2 ft.	1/2 in.	7 to 8 weeks			
Rhubarb Roots	30 roots per 100 ft.	4840 roots	2 ft.	3 ft.	7 ins.	4 to 6 weeks			
Rutabaga	1 oz. per 100 ft.	2 lbs.	6 ins.	2 ft.	1/2 in.	12 to 14 weeks			
Salsify	2 oz. per 100 ft.	8 lbs.	4 ins.	1 1/2 to 2 ft.	1/2 in.	16 to 18 weeks			
Sorrel	1 oz. per 100 ft.	5 lbs.	3 ins.	1 to 1 1/2 ft.	1/2 in.				
Spinach	2 oz. per 100 ft.	20 lbs.	4 ins.	1 ft.	1/2 in.	6 to 7 weeks			
Spinach, New Zealand	1 oz. per 100 ft.	3 lbs.	8 ins.	2 1/2 ft.	1 in.	7 to 10 weeks			
Squash, Bush	1 oz. to 25 hills	4 lbs.	4 ft. hills	4 ft.	1 in.	7 to 8 weeks			
Squash, Vine	1 oz. to 15 hills	2 lbs.	6 ft. hills	8 ft.	1 in.	12 to 14 weeks			
Swiss Chard	2 oz. per 100 ft.	8 to 10 lbs.	6 ins.	1 1/2 to 2 ft.	1/2 to 1 in.	7 to 8 weeks			
Tomato	1 oz. to 3000 plants	2 oz.	3 1/2 ft.	4 ft.	1/2 in.	14 to 16 weeks			
Turnip	1 oz. per 100 ft.	2 lbs.	4 ins.	1 1/2 to 2 ft.	1/2 in.	7 to 10 weeks			

NOTE:—Differences in maturity vary with climate, season, soil, geographic location and elevation, and variety planted

Number of plants Required to the Acre		Number of Plants Produced From An Ounce of Seed	
Distance Apart	No. of Plants		
1 foot by 1 foot	43,560	Asparagus	about 300
1 1/2 feet by 1 1/2 feet	19,360	Broccoli	" 2,000
2 feet by 1 foot	21,780	Cabbage	" 2,000
2 feet by 2 feet	10,890	Cauliflower	" 2,000
2 1/2 feet by 2 1/2 feet	6,969	Celery	" 3,000
3 feet by 2 feet	7,600	Egg Plant	" 1,000
3 feet by 3 feet	4,840	Endive	" 3,000
4 feet by 4 feet	2,722	Kale	" 2,000
5 feet by 4 feet	2,178	Leek	" 1,000
5 feet by 5 feet	1,742	Lettuce	" 3,000
6 feet by 6 feet	1,210	Pepper	" 2,000
8 feet by 8 feet	680	Tomato	" 3,000
		Sage	" 1,000
		Thyme	" 5,000

May	June	July
In Open Ground	In Open Ground	In Open Ground
Artichoke	Beans, Lima and all other sorts	Beans
Asparagus	Beets	Beets
Beans, Bush and Running	Broccoli	Carrot
Beets	Brussels Sprouts	Sweet Corn
Brussels Sprouts	Late Cabbage	Corn Salad
Carrot	Carrot	Cress
Cauliflower	Cauliflower	Cucumber
Celery	Sweet Corn	Endive
Sweet Corn	Cress	Gherkin
Cress	Cucumber	Kale
Cucumber	Endive	Kohl Rabi
Kohl Rabi	Kale	Lettuce
Leek	Kohl Rabi	Nasturtium
Lettuce	Lettuce	Okra
Melon	Melon	Early Peas
Onion	Nasturtium	Melon
Parsley	Okra	Pumpkin
Parsnip	Early Peas	Radish
Peas	Potatoes	Spinach
Potatoes	Pumpkin	Squash
Radish	Radish	Turnip
Salsify	Salsify	Rutabaga
Spinach	Spinach	
Early Turnip	Squash	
	Herbs	

August	September	"It's the Crop That Counts" Plant Abel's Seeds
In Open Ground	In Open Ground	
Beans, Bush	Cabbage for cold frames	
Chervil	Cauliflower for cold frames	
Corn Salad	Chervil	
Cucumber	Corn Salad	
Endive	Cress	
Kale	Siberian Kale	
Lettuce	Lettuce	
Welsh Onion	Mustard	
Early Peas	Winter Radish	
Radish	Spinach	
Spinach	Turnip	
Turnip	Sweet Peas	
Rutabaga		

Abel's Quality Vegetable Seeds

ASPARAGUS



Martha Washington Rust-Resistant Asparagus. A variety bred up by the U. S. Department of Agriculture, at Washington, D. C., from a careful selection of plants of the Washington variety, and is now more popular and more widely grown than any other. It produces large, beautiful, straight, dark green tender shoots of the most delicious flavor.

Large Two-Year-Old Roots of Genuine Martha Washington. (Doz. 40c; 50 roots, \$1.35; 100, \$2.00; 1,000 \$12.00.

Martha Washington Seed—Can have a light cutting in 3 years. Pkt. 5c; oz. 15c; ¼ lb. 40c; ½ lb. 60c; lb. 90c.

BEANS

Plant beans after all danger of frost is passed, in warm, dry, well prepared soil. The rows should be 2 to 3 feet apart and the seeds covered 1½ to 2 inches deep. Thin the young plants to 3 to 6 inches apart in the rows.

Martha Washington Asparagus

Shallow cultivation should be frequent until blossoming; then stop to avoid injury to the roots. (Root injury causes the blossoms to fall off.) For succession plant every 2 weeks until mid-summer. Frequent picking of the crop insures long bearing. One quart of seed sows 100 feet, and 60 pounds sows 1 acre.

BUSH BEANS GREEN-PODDED

Abel's Tendergreen. Height 15 inches, dark coarse vines. Six inch round stringless green pod. Season 56 days to table. ½pt. 15c; pt. 25c; qt. 40c; pk. \$2.50; bus. \$9.00.

Abel's Stringless Black Valentine. Height 2 feet, heavy, very robust dark vine. Six inch dark green round stringless brittle pod of wonderful quality. Season 54 days to table. ½pt. 15c; pt. 25c; qt. 40c; pk. \$2.50; bus. \$9.00.

Burpee's Green Stringless. Pods round, slightly curved, stringless, 5 inches long. Very productive; 54 days from planting to table. ½pt. 15c; pt. 25c; qt. 40c; pk. \$2.50; bus. \$9.00.

Giant Stringless. Round, nearly straight, stringless, light green pods 6 inches long; 56 days from planting to table. ½pt. 15c; pt. 25c; qt. 40c; pk. \$2.50; bus. \$9.00.

Bountiful. Pods semi-round, straight, stringless; sweet flavor. 7½ inches long. ½pt. 15c; pt. 25c; qt. 40c; pk. \$2.50; bus. \$9.00.

Landreth's Stringless Green Pod. Pods 6 to 7 inches fairly straight ROUND dark green stringless. Season 54 days. ½pt. 15c; pt. 25c; qt. 40c; pk. \$2.50; bus. \$9.00.

SHELL

Red Kidney. A dwarf grower and very hardy. Pods 5 to 6 inches long. Season 62 days. ½ pt. 10c; pt. 20c; qt. 35c; pk. \$2.50; bus. \$9.00.

White Kidney. Same as above, only white-seeded. ½pt. 10c; pt. 20c; qt. 35c; pk. \$2.50; bus. \$9.00.

Easy Cook. Maturity 130 days. An edible soybean that can be cooked in half the time of other varieties. Used for human consumption in the green stage, as well as dried beans. Easy Cooks are in big demand among sanatoriums for grinding into flour for diabetic cases. A heavy yielder, similar in size to Mammoth Yellow, but lighter in color. This is an excellent cash crop to grow. Lb. 10c; 5 lbs. 40c; ½pk. 60c; pk. 95c; ½ bus. \$1.70; bus. \$3.10.

White Marrowfat Soup. Extra-fine Shell Bean. Pods large, flat, and straight, with 5 to 7 pure white seeds in each pod. ½pt. 10c; pt. 20c; qt. 35c; pk. \$2.25; bus. \$8.50.

Dwarf Horticultural (Bird Egg). Used both as Snap and Shell Beans. Pods 4 to 5 inches long, thick, flat, stringless. ½pt. 10c; pt. 20c; qt. 35c; pk. \$2.25; bus. \$8.50.

Robust Pea Beans (Navy Beans). Small, white baking Beans of extra-fine quality. ½pt. 15c; pt. 25c; qt. 40c; pk. \$2.50; bus. \$9.50.

NOTICE

In most every case a quart of beans equals two pounds.

WAX or YELLOW-PODDED

Burpee's Brittle Wax. One of the earliest of all Wax Beans. Vines are 15 inches high. Pods 5½ inches long, round, slightly curved, stringless, deep yellow; 62 days from planting to table. ½pt. 15c; pt. 25c; qt. 45c; pk. \$2.75; bus. \$10.00.

Burpee's Round-pod Kidney Wax. Very productive. Round pod, stringless. ½pt. 15c; pt. 25c; qt. 45c; pk. \$2.75; bus. \$10.00.

Burpee's German Black Wax. Extra-fine, 6½ inch round yellow pods. Seeds black, kidney-shape; 59 days from planting to table. ½pt. 15c; pt. 25c; qt. 45c; pk. \$2.75; bus. \$10.00.

Abel's Bountiful Wax. An entirely stringless variety, with long, 6½ inch flat handsome pods. A good yielder and one of the best Wax sorts. Matures in about 45 days. ½pt. 15c; pt. 25c; qt. 45c; pk. \$2.75; bus. \$10.00.

POLE BEANS Sow 1 quart to 150 hills

GREEN-PODDED

Kentucky Wonder. Pods so fleshy that they are greater in thickness than in breadth, being deeply creased and saddle-backed, very meaty, stringless when young and of finest quality, 7 to 9 inches long. ½pt. 15c; pt. 25c; qt. 40c; pk. \$2.50; bus. \$9.00.

Lazy Wife. A late variety excellent for snap-shorts or shelled. Pods about 6 inches long, thick, meaty, with fine flavor. ½pt. 15c; pt. 25c; qt. 40c; pk. \$2.50; bus. \$9.00.

Scarlet Runner. Mostly used as an ornamental climber but edible and may be cooked in same manner as other Snap Beans. ½pt. 15c; pt. 25c; qt. 45c; pk. \$3.25; bus. \$12.00.

Abel's Mammoth Horticultural (Wooster Pole). We have an exceptionally fine, choice, large-seeded, large-podded, high-colored stock of these Beans. They are the true old-fashioned type, hard to be found. ½pt. 15c; pt. 25c; qt. 45c; pk. \$3.50; bus. \$12.00.

White Dutch Runner is a hardy prolific plant, used quite extensively in the North for planting along fences because of its flowering bloom. It can also be used for a green bean, or a green shelled bean. It has much the same habit as Scarlet Runner, although the pods are larger and it has a white flower. Scarlet Runner has a six-inch flat oval pod, and can also be used as either shell bean or snap, and the flowers are scarlet. ½pt. 15c; pt. 25c; qt. 45c; pk. \$3.50; bus. \$12.00.

Tennessee Wonder (Egg Harbor Pole). A moderately prolific green podded sort, very similar to Kentucky Wonder, though earlier. The blossom is purple. The pods are extremely fleshy, twisted, and about nine inches long. Without doubt one of the best vining varieties. ½pt. 15c; pt. 25c; qt. 40c; pk. \$2.50; bus. \$9.00.

WAX-PODDED

Golden Cluster. Sweet, tasty, brittle pods, 6½ to 7½ inches long perfectly straight and flat, of fine quality. ½pt. 15c; pt. 25c; qt. 45c; pk. \$3.50; bus. \$12.00.

Kentucky Wonder Wax. Pods 8 to 9 inches long, thick, almost straight, of a light yellow color and very good flavor. ½pt. 15c; pt. 25c; qt. 45c; pk. \$3.50; bus. \$12.00.



Abel's Stringless Black Valentine

LIMA BEANS BUSH

Sow 1 quart to 150 feet of row

Abel's Nu-Green Lima. The new Bush Lima that is different and has real merit. Entirely new and different. Strong, stocky bush with big root-system. Small pod like a Baby Lima but Bean large, thick, Potato type. Will stand cold and wet weather in the spring much better than other large-seeded Limas. Will stand extreme heat in summer much better than other large-seeded Limas. Green-seeded, retaining a green tint when cooked. Dry seed small and shriveled, like a sugar pea, requiring less seed for planting than other large-seeded Limas. By weight, larger percentage of Beans and less percentage of pods than other large-seeded Limas. Unusually sweet flavor, different from any other Lima. Very prolific. $\frac{1}{2}$ pt. 15c; pt. 25c; qt. 45c; pk. \$3.25; bus. \$12.00.

Fordhook Bush. Pods borne in clusters of 4 to 8, each measuring 4 to 5 inches by $1\frac{1}{2}$ to $1\frac{1}{4}$ inches wide, and quite often $\frac{3}{4}$ inch thick, with 4 to 5 sweet, delicious Beans to a pod. $\frac{1}{2}$ pt. 15c; pt. 25c; qt. 45c; pk. \$3.25; bus. \$12.00.

Burpee's Improved Bush. Pods enormous (5 to 6 inches long by $1\frac{1}{4}$ inches wide), borne abundantly, and well filled with Beans larger and thicker than most Bush Limas and fully 8 days earlier. Matures in 85 to 95 days from date of sowing. $\frac{1}{2}$ pt. 15c; pt. 25c; qt. 45c; pk. \$3.25; bus. \$12.00.

Henderson's Bush. A small-podded, very early Sieva or Butter Bean of the South, growing in bush form. $\frac{1}{2}$ pt. 15c; pt. 25c; qt. 45c; pk. \$3.25; bus. \$12.00.

Dreer's Bush. Dwarf form of Dreer's Improved or Challenger Lima. $\frac{1}{2}$ pt. 15c; pt. 25c; qt. 45c; pk. \$3.25; bus. \$12.00.

Italian Fava. A bean similar to the English broad beans and very popular among the Italian trade. They are very late and produce a fine crop of dark green pods seven or eight inches long. They are much harder than other beans and should be planted early in the spring. Average four to six beans to a pod. $\frac{1}{2}$ lb. 15c; 1 lb. 25c; 5 lbs. \$1.00.

POLE

Sow 1 quart to 150 hills

Dreer's Pole. In some sections this variety is called Challenge or Potato Lima. Plants strong, medium late and very productive. Pods contains 4 or 5 thick light green beans, and shells out more beans from a given number of pods than any other pole lima bean. $\frac{1}{2}$ pt. 15c; pt. 25c; qt. 40c; pk. \$3.00; bus. \$11.00.

King of the Garden. Pods contain 4 or 5 Beans of excellent quality, easily shelled and of handsome appearance. $\frac{1}{2}$ pt. 15c; pt. 25c; qt. 40c; pk. \$3.00; bus. \$11.00.

Burpee's Giant-podded. One of the largest-podded Pole Limas, measuring 7 to 8 inches long and $1\frac{1}{2}$ inches wide. Beans extra large, of superb flavor. Vines grow 10 to 12 feet high. $\frac{1}{2}$ pt. 15c; pt. 25c; qt. 45c; pk. \$3.25; bus. \$12.00.

BROCCOLI

SPROUTING

Calabrese. Italian Green Sprouting Broccoli makes a large head of bright green, tender sprouts, which are cooked like Spinach or Brussels Sprouts and have a most delectable flavor. Sow the seed in May and harvest in August. Pkt. 10c; $\frac{1}{2}$ oz. 25c; oz. 40c; 4 ozs. \$1.15; $\frac{1}{2}$ lb. \$1.80; lb. \$3.25.

WINTER

St. Valentine. Large, white-headed varieties of splendid appearance and finest quality. Looks like Cauliflower but it requires a long season and cool weather. Pkt. 10c; $\frac{1}{2}$ oz. 25c; oz. 40c; 4 ozs. \$1.20; $\frac{1}{2}$ lb. \$2.20; lb. \$4.00.

BRUSSELS SPROUTS

One ounce of seed will plant a row 200 feet long and make 2000 to 3000 plants

Long Island Improved. A choice variety grown extensively on Long Island for the New York market, where it always brings a good price. Compact plants, 20 in. tall, with solid heavy sprouts measuring $1\frac{1}{4}$ to $1\frac{1}{2}$ in. in diameter. Pkt. 5c; oz. 25c; 4 oz. 75c; $\frac{1}{2}$ lb. \$1.25; lb. \$2.00.

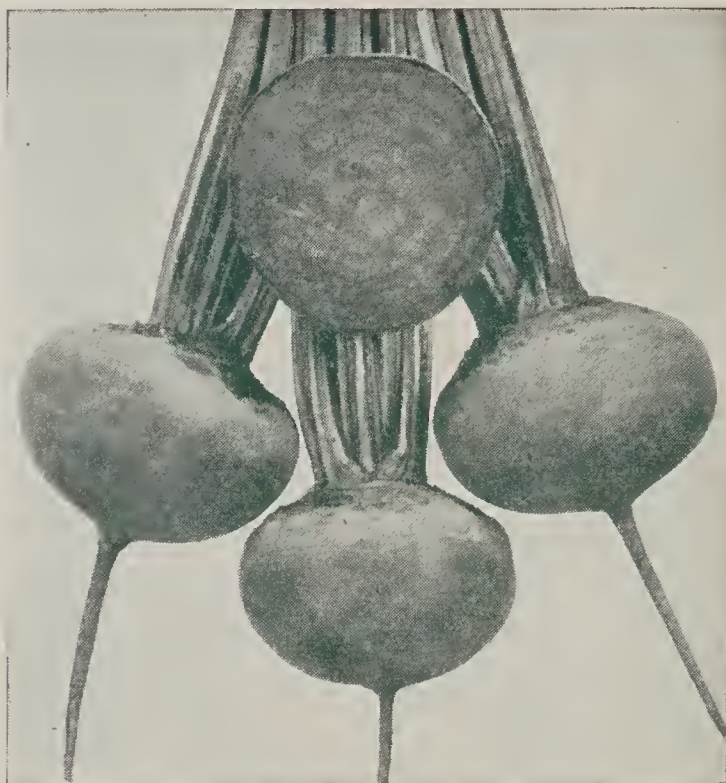

Berk's Favorite

BEETS

Sow 1 ounce to 50 feet of drill; 5 to 6 pounds per acre

Seed should be sown at the rate of one ounce to 100 feet of row. The rows should be spaced 18 to 24 inches apart. Work the soil well and cover the seeds about an inch deep. A rich sandy loam is most favorable but nearly all types of soil will produce beets if sufficiently fertilized and properly tilled.

When the seedlings are about an inch tall it is well to thin them to about one-half inch apart. Then they can be allowed to grow 5 or 6 inches when the alternate plants in the row may be pulled and used for greens. This practice can be repeated as often as the roots touch in the rows or until they reach good table size. Beets are usually most tender and succulent when about 2 inches in diameter.

By planting at intervals of two to three weeks until July a regular supply of greens and beets may be had until late fall. The roots from the later plantings may be stored and kept for winter use.

Abel's Early Wonder. Roots nearly globe-shaped, of uniform size, with little foliage. Skin deep red; flesh dark red with little zoning. Pkt. 5c; oz. 15c; $\frac{1}{4}$ lb. 30c; $\frac{1}{2}$ lb. 50c; 1 lb. 90c; 2 lbs. \$1.60.

Berk's Favorite Beet. 56 to 58 days. A pedigreed stock, the result of many years of pure-line breeding; unsurpassed in earliness, uniformity, and in depth of interior color. Tops medium, erect, uniform in size and color. Roots semi-globular, deep red, smooth, with small neck and tap root. Flesh purplish red with zones of slightly lighter shade; tender, and of excellent quality. Pkt. 10c; oz. 20c; $\frac{1}{4}$ lb. 50c; $\frac{1}{2}$ lb. 75c; lb. \$1.25; 2 lbs. \$2.30.

Burpee's Red Ball. Particularly fine beet which is remarkable for its uniform shape, deep colored flesh, and fine sweet flavor. The roots are perfectly globe shaped, growing to three inches in diameter and having a smooth deep red skin. The flesh is also extremely dark red, free from woody fiber, and very tasty. May be used while still quite young or left to reach full size. The quality is always the finest. Desirable for home or market. Pkt. 10c; oz. 20c; 4 ozs. 50c; $\frac{1}{2}$ lb. 75c; lb. \$1.25; 2 lbs. \$2.30; 5 lbs. \$5.50.

Crosby's Egyptian. An improved strain of Egyptian Beet. Rich dark red flesh, crisp and tender. An excellent early sort. Pkt. 5c; oz. 15c; $\frac{1}{4}$ lb. 30c; $\frac{1}{2}$ lb. 50c; 1 lb. 90c; 2 lbs. \$1.60.

Detroit Dark Red. Skin dark blood-red; flesh bright red, very tender and sweet. Fine round shape. Excellent for main crop. Pkt. 5c; oz. 15c; $\frac{1}{4}$ lb. 40c; $\frac{1}{2}$ lb. 70c; 1 lb. \$1.15; 2 lbs. \$2.10.

Abel's New Half-Long. One of the finest half-long Beets on the market. Flesh deep maroon-red, approaching black, free from toning. Pkt. 5c; oz. 15c; $\frac{1}{4}$ lb. 30c; $\frac{1}{2}$ lb. 50c; 1 lb. 90c; 2 lbs. \$1.60.

MANGEL-WURZEL and SUGAR BEETS

Mammoth Long Red. Enormous roots, averaging 30 to 50 tons per acre. Pkt. 5c; oz. 10c; $\frac{1}{4}$ lb. 20c; $\frac{1}{2}$ lb. 30c; lb. 50c; 5 lbs. \$2.25.

Golden Tankard. Bright yellow; large. Tends to give color to milk. Pkt. 5c; oz. 10c; $\frac{1}{4}$ lb. 20c; $\frac{1}{2}$ lb. 30c; lb. 50c; 5 lbs. \$2.25.

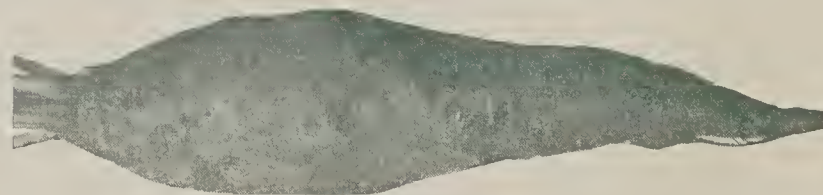

Mangel-Wurzel

Abel's New Century Beet

This most excellent main crop beet still holds first place among the growers in Berks and Lancaster Counties as well as the eastern part of Pennsylvania for its superb table qualities. The root is turnip or top shaped, tends to show considerable sideroot but not so much as some stock that we have seen of the variety is blood-red interior color, as a rule showing little or no Zonation and cooks a very deep, dark red. The tops or leaves are a conspicuously green top without a trace of any red coloring either in the leaves or stems, showing considerable foliage and standing somewhat taller than most varieties of garden beets. Pkt. 10c; oz. 20c; ¼lb. 40c; ½lb. 75c; lb. \$1.25; 2 lbs. \$2.30.



Abel's
New
Century
Beet

Following is a copy of one of the hundreds of testimonials we have received.

Abel's New Century Beet I tried out last year is the best winter beet I ever raised. I still have a good many stored for the market and they are just as tender as they were in the fall.

CABBAGE

One ounce of seed will produce about 3000 plants

For early cabbage in the North, plants may be started indoors or under glass as early as March 1st. They should be spaced 3 inches apart both ways when pricked out into boxes and should be gradually hardened off by exposure to cooler outdoor conditions. They may be transplanted in the open as soon as the ground can be properly prepared. In sections of the country where winters are not severe, seed may be planted as late as September. Such plantings will produce heads during the winter and early spring. One of our specialties. No better seed is obtainable than our pure bred strains.

Early Jersey Wakefield. Standard early variety. Conical heads with few outside leaves. Pkt. 5c; ½oz. 10c; oz. 20c; ¼lb. 65c; ½lb. \$1.15; lb. \$2.00.

Early Winnigstadt. Conical heads of very good quality. Pkt. 5c; ½oz. 10c; oz. 20c; ¼lb. 65c; ½lb. \$1.15; lb. \$2.00.

Abel's Golden Acre. Similar to the popular Copenhagen Market, but smaller and earlier, with uniform, tightly folded, well-balanced heads. Pkt. 5c; ½oz. 20c; oz. 35c; ¼lb. 95c; ½lb. \$1.50; lb. \$2.75.

Copenhagen Market. Very early. Round head; short-stemmed. Pkt. 5c; ½oz. 10c; oz. 20c; ¼lb. 65c; ½lb. \$1.15; lb. \$2.00.

Danish Ballhead Tall Stem or Hollander. A tall stemmed variety imported from Denmark. It has an extremely solid head, unexcelled keeping qualities and stands shipping well. Produces very heavy heads. Pkt. 5c; ½oz. 10c; oz. 20c; ¼lb. 65c; ½lb. \$1.15; lb. \$2.00.

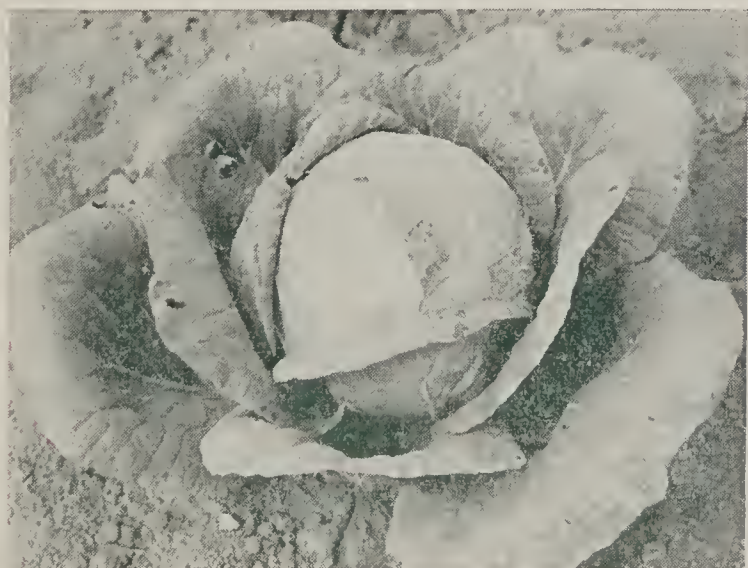

Copenhagen Market

Danish Ballhead Short Stem. Very round, solid winter sort. A fine shipper. Pkt. 5c; ½oz. 15c; oz. 25c; ¼lb. 75c; ½lb. \$1.50; lb. \$2.50.

Large Late Flat Dutch. Heads large and solid, with few outer leaves. Pkt. 5c; ½oz. 10c; oz. 20c; ¼lb. 65c; ½lb. \$1.15; lb. \$2.00.

Late American Drumhead. Savory leaf. One of the largest and best keeping varieties. Pkt. 5c; ½oz. 10c; oz. 20c; ¼lb. 65c; ½lb. \$1.15; lb. \$2.00.

Surehead. A sure-heading sort, resembling Large Late Flat Dutch. Pkt. 5c; ½oz. 10c; oz. 20c; ¼lb. 65c; ½lb. \$1.15; lb. \$2.00.

Mammoth Red Rock. The largest Red Cabbage, with more solid heads than others. Pkt. 5c; ½oz. 15c; oz. 25c; ¼lb. 75c; ½lb. \$1.10; lb. \$2.25.

Holmes Houser Cabbage. A main crop or winter storage cabbage, developed in Pennsylvania. It has a head varying from round to bluntly pointed, with a distinct type of foliage and a very small core; it is extremely hardy, doing well under difficult conditions; it develops a medium sized head with splendid keeping qualities. Pkt. 5c; oz. 30c; ¼lb. 90c; ½lb. \$1.40; lb. \$2.50.

Penn State Ballhead. This cabbage is the product of Dr. C. E. Myers of the Pennsylvania State College; it is of the Danish Ball Head type, but is somewhat larger and a trifle flatter than the usual ball-head type; it is a splendid main crop and winter storage cabbage, probably yielding the largest tonnage of any main crop cabbage. Our stock of this variety is certified, being sold in sealed packages with the recommendation of the Pennsylvania State College. Pkt. 5c; ½oz. 25c; oz. 40c; ¼lb. \$1.15; ½lb. \$2.00; lb. \$3.50.



Penn State Ballhead
All-America Selections—Award of Merit

Yellows Resistant Cabbage

"Yellows-Resistant" strains introduced by the Wisconsin Agricultural Experimental Station so that cabbages could be grown in localities where infected "cabbage-yellows" soil had prevented non-resistant varieties from producing a crop. If you live in such a locality and have had trouble, try the following varieties.

Early Jersey Wakefield. An improved strain especially selected for "yellows-resistance." The heads are of conical form, with a broad base and pointed top. Compact plants and very productive. About the first of this group to mature. Pkt. 10c; oz. 40c; 4 ozs. \$1.15; ½lb. \$1.90; lb. \$3.50.

Golden Acre. New "yellows-resistant" Golden Acre. Medium size, solid, round heads about six inches across; two weeks earlier than Marion Market. Plants are short-stemmed, of erect uniform growth, and have grayish green leaves. Pkt. 15c; oz. 55c; 4 ozs. \$1.65; ½lb. \$3.00; lb. \$5.50.

Wisconsin All Seasons. Bred from All Seasons and has inherited all the good qualities of that excellent cabbage. It is said to be the hardiest of all flat-head varieties and is much in demand for making kraut. Stands hot weather well. Pkt. 10c; oz. 35c; 4 ozs. \$1.00; ½lb. \$1.65; lb. \$3.00.

Wisconsin Hollander. Developed from the famous Danish Ballhead but requires about 10 days longer to come to maturity. Heads are large, round, flattened on top but quite deep. Pkt. 10c; oz. 40c; 4 ozs. \$1.15; ½lb. \$1.90; lb. \$3.50.

Chinese or Celery Cabbage

Not a true cabbage; resembles Cos lettuce somewhat. May be served like lettuce, or, when shredded, makes a delicious cole slaw. Boiled, it is far more palatable than ordinary cabbage. Where summers are cool, seed may be sown in spring, but in the vicinity of Philadelphia, seeds sown early in August have proved to give the best results. Makes full-size heads in about 70 days after sowing.

Pe-Tsai. Large, light green outer leaves. The thick, pure white heart is tender, juicy, and has an agreeably pungent flavor. Heads grow 10 to 12 inches tall. Pkt. 10c; oz. 20c; 4 ozs. 65c; ½lb. \$1.00; lb. \$1.75; 2 lbs. \$3.20.

Wong Bok. Short, broad, tightly folded, well-blanching heads 8 to 10 inches high. Excellent quality, crisp and delicious. Pkt. 10c; oz. 25c; 4 ozs. 75c; ½lb. \$1.15; lb. \$2.00; 2 lbs. \$3.70.

Chihli. Deserves to be largely planted, as it is an early and sure-heading Chinese Cabbage, growing 18 to 20 inches tall and about 3½ to 4 inches thick. The firm, well-blanching, white heads taper near the top. Leaves are broad, smooth and fringed at the edges. For market and roadside sales, Chihli is extensively grown, for the large attractive heads. Pkt. 5c; 4 ozs. 75c; ½lb. \$1.15; lb. \$2.00; 2 lbs. \$3.70.

CAULIFLOWER

One ounce of seed produces about 3000 plants

For many years cauliflower has been esteemed as one of the most delicious of vegetables but until recently it was erroneously regarded as very difficult to grow. It is known now that the same methods which produce good cabbage will yield cauliflower successfully. The only significant difference in culture is that the heads of cauliflower must be protected from sunlight in order to assure a white curd which is so desirable. This is most readily accomplished by gathering the tops of the leaves together loosely as soon as the heads begin to form. Shut off the light but do not cramp the head.

Extra-Early Snowball. One of the best for forcing or open ground. Pkt. 10c; ¼ oz. 60c; oz. \$1.90; ¼ lb. \$6.00.

Dry-Weather. This variety is especially adapted for long, dry seasons. Pkt. 10c; ¼ oz. 55c; ½ oz. \$1.00; oz. \$1.65; ¼ lb. \$5.50.

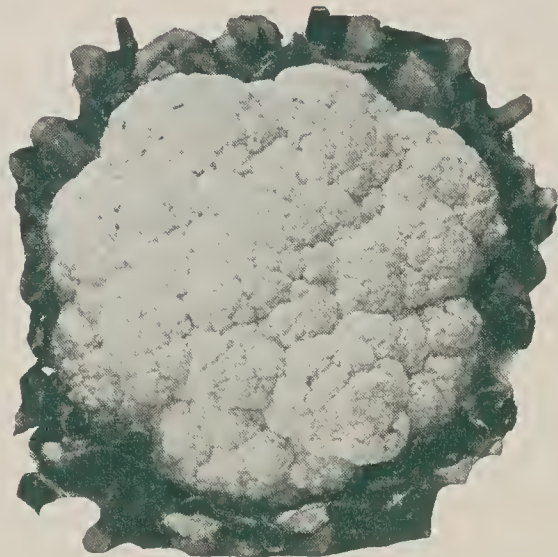

Extra Early Snowball

CARROTS

One ounce of seed will sow 200 feet of row

For several generations the carrot has been one of the common garden vegetables but only in recent years has it become to be recognized as one of the most nutritious and wholesome foods. Health authorities assert that carrots contain in high degree those elements which constitute a nourishing article of diet. The plant has no serious insect enemies and is rarely subject to disease. The culture of carrots is easy, being practically the same as that of beets. When practicable it is best to plant them in soil that has been richly fertilized the previous season. Freshly manured soil will often produce divided roots. Plant the seed one-half inch deep in loose, well-prepared soil, making rows 16 to 24 inches apart. Cultivate as soon as the plants are well established and thin to 2 to 4 inches in the row according to the size of the variety. Plantings may be made from early spring until mid-June. For winter storage the later date is advisable.

Abel's Golden Rod or Tender-sweet—Imperator. 77 days. An outstanding type bred for market garden use, and for shipping. Tops medium but strong enough for bunching. Roots have sloping shoulders, smooth, deep rich orange. Uniformly tapered to a semiblunt end. Flesh rich orange color, fine grained, tender and of excellent quality. Pkt. 5c; oz. 15c; ¼ lb. 45c; ½ lb. 75c; lb. \$1.30.

Abel's Red-Cored Chantenay. In size and shape this is practically the same as the old type but it has a darker, more attractive outside color and is decidedly superior in inside color and quality. It was bred to produce roots with smaller cores having the same deep orange color as the surrounding flesh, and in breeding for these qualities we also produced a more delicately flavored and sweeter Carrot. It is a few days earlier than the parent Chantenay. Pkt. 5c; oz. 15c; ¼ lb. 45c; ½ lb. 75c; lb. \$1.25.

Abel's Nantes. It is unsurpassed in quality, sweet, mild, is long, cylindrical, averages 7 inches long, 1¼ inch thick. Color orange scarlet. Core is so undefined that it is called coreless. Pkt. 5c; oz. 15c; ¼ lb. 45c; ½ lb. 75c; lb. \$1.25.

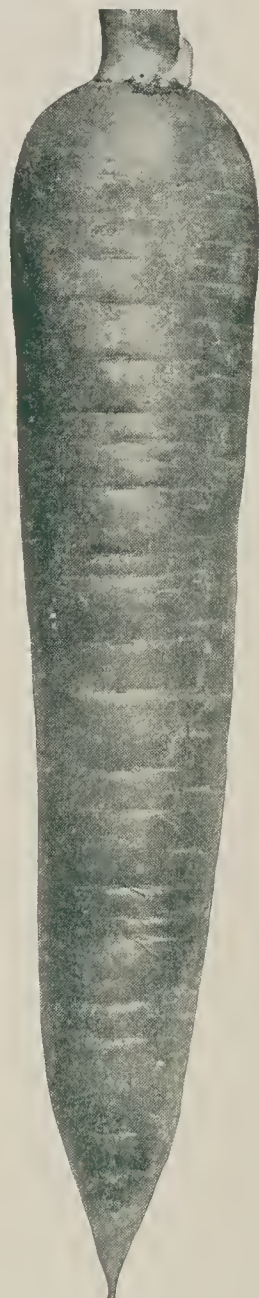

Imperator
All-America Selections—
Award of Merit

Danvers Half-long. Large roots of good quality. Productive. One of the most popular sorts. Pkt. 5c; oz. 15c; ¼ lb. 30c; ½ lb. 55c; lb. \$1.00.

Long Orange. The best variety for garden and field crops. Pkt. 5c; oz. 15c; ¼ lb. 30c; ½ lb. 55c; lb. \$1.00.

Pride of Denmark. A cross between the two well known varieties Nantes and Chantenay, this novelty unites the good qualities of both. Our Pride of Denmark will stand storing and shipping, at the same time retaining flavor and crispness of Nantes. The long obtuse cylindrical roots are, when grown in the proper soil, absolutely smooth, of a beautiful scarlet color, and practically coreless. Pkt. 5c; oz. 20c; ¼ lb. 50c; ½ lb. 90c; lb. \$1.75.

CELERY

One ounce will sow about 300 feet of row and produce about 5000 plants

A row of celery in the home garden will supply a family with a delicious vegetable until late in the fall. Its hardy qualities and adaptability to various soils and weather conditions make it a very desirable crop to grow.

Excellent results are obtained from constantly moist, rich, well prepared soil. Celery seed will sprout at comparatively low temperatures but requires constant and abundant moisture. It is slow to germinate and even under favorable conditions cannot be expected to start within 2 weeks. For fall and winter use in the North, celery may be planted from March 15th to April 15th. Plantings in other sections can be governed accordingly. The soil for starting plants should be fine and loose and seed must be covered only ¼ inch deep. Prick out about 3 inches apart each way when seedlings have 3 or 4 leaves started. Keep the soil well moistened at all times and transplant to open ground when plants are 75 to 90 days old. Space the rows according to the methods of blanching. 5 to 7 feet are required for soil blanching and 2 to 4 feet for other methods. Set the plants 8 to 12 inches apart to the row. To avoid pithiness or rotting of the stalk do not cover for blanching during warm weather.

Emperor (Fordhook). Dwarf, stocky variety, with large, light yellow heart; very crisp, good keeper. Pkt. 5c; ¼ oz. 10c; ½ oz. 20c; oz. 35c; ¼ lb. \$1.25; ½ lb. \$2.00; lb. \$3.50.

Abel's Golden Plume. Very early, beautiful golden yellow Celery of most delicious flavor. Its fine appearance, earliness, and high quality have made it most popular for home and market. Pkt. 10c; ¼ oz. 20c; ½ oz. 30c; oz. 55c; ¼ lb. \$1.75; lb. \$5.50.

Abel's Houser. A superlatively good green Celery of rich nutty flavor with meaty hearts and thick, luscious stems. One of the most popular varieties in the market. Pkt. 10c; ¼ oz. 35c; ½ oz. 60c; oz. \$1.00; ¼ lb. \$3.00.

Abel's Wonderful. An unusually thick-set compact Celery which attains exceptional weight. We have seen twelve stalks that weighed 72 pounds. It is a week earlier than Paris Golden, has no soft stalks, is free from strings, and is a perfect shipper. In making our selection, we have not sacrificed the girth in order to lengthen the first joint. For this reason, our Wonderful will yield a heavy crate. Our method of handling seed plants results in producing far fewer seeders than is generally the case, especially when one is trying to grow a late crop. This fact is acknowledged in all the large celery growing centers.

Abel's Fordhook Emperor
The rib is 9 to 10 inches to the first joint, is very hard, and its firmness makes it less susceptible to damage by heat or cold. Pkt. 10c; ½ oz. 50c; oz. 90c; ¼ lb. \$3.25; lb. \$10.00.

Columbia. An early maturing sort of most excellent shape and quality for the home market and private garden. It is extensively grown for shipment. The plant is of medium height but very stocky and heavy. The stalks are thick, almost round, resembling in shape those of Giant Pascal. The outer foliage of the plant when growing is rather light green with tinge of yellow, becoming when blanched yellow with tinge of green. The heart when properly blanched changes from yellow with tinge of green to a light golden yellow—in season it follows in close succession Golden Yellow Self-blanching. We consider it unsurpassed in its rich nutty flavor. Pkt. 5c; ¼ oz. 15c; ½ oz. 20c; oz. 40c; ¼ lb. \$1.25; lb. \$4.50.

Easy-blanching. A medium-dwarf sort that blanches very easily. Of good flavor and a fine keeper. Pkt. 5c; ¼ oz. 20c; ½ oz. 35c; oz. 60c; ¼ lb. \$2.00; lb. \$3.75.

Giant Pascal. Stalks solid, crisp with golden yellow heart. Pkt. 5c; ½ oz. 20c; oz. 30c; ¼ lb. 85c; lb. \$2.25.

Golden Self-blanching. Crisp, tender, and of fine flavor. Pkt. 5c; ½ oz. 25c; oz. 45c; ¼ lb. \$1.35; ½ lb. \$2.45; lb. \$4.50.

White Plume. Valuable early variety that requires very little blanching. Pkt. 5c; oz. 25c; ¼ lb. 75c; lb. \$2.50.

Winter Queen (Schumacher). Very large, solid green winter variety that blanches well. Pkt. 5c; oz. 30c; ¼ lb. 85c; ½ lb. \$1.25; lb. \$2.25.



Abel's Fordhook Emperor

SWEET CORN

Sow $1\frac{1}{2}$ pounds to 200 hills; 12 pounds for an acre. $\frac{3}{4}$ pound equals 1 pint; $1\frac{1}{2}$ pounds equal 1 quart

Golden Cross Bantam. A cross of two inbred Bantams developed at the Purdue Experiment Station, it is a midseason hybrid, typically 4 to 8 days later than Golden Bantam. Stalks average 6 feet in height and are sturdy and straight, and under favorable conditions two ears are usually produced on each stalk. The ears are about 8 inches long and have 10 to 14 rows of kernels. This hybrid is noted especially for its resistance to Stewart's disease and for the remarkable uniformity of its ears. Tests conducted over a period of three years in 23 states show that Golden Cross Bantam will give an average of 26 per cent greater yield of marketable ears than Golden Bantam. $\frac{1}{2}$ lb. 30c; lb. 50c; 2 lbs. 90c; 5 lbs. \$1.80; 10 lbs. or more at 33c per lb.

Abel's Earligold. One of the newest Hybrid Sweet Corns that has been developed for critical market gardeners who want earliness, ear size, wilt tolerant and improved quality in the first early Hybrid. Abel's Earligold matures in 72-75 days; producing 12-16 rowed, slightly tapering, well filled ears, $6\frac{1}{2}$ -7 inches long. Kernels medium depth and are lined in straight rows on the ear. Plant structure. Plants are sturdy, stalks few suckers, 5-5 $\frac{1}{2}$ feet tall. Intermediate between the Early Yellow Sensation and the Golden Market. The great merit with the Abel's Earligold is its special earliness, wilt tolerant, uniformity and ear size. $\frac{1}{2}$ lb. 30c; lb. 50c; 2 lbs. 90c; 5 lbs. \$1.80; 10 lbs. or more at 33c per lb.

Golden Bantam. America's favorite Sweet Corn. One of the sweetest Sweet Corns in existence. Has a rich, sweet and buttery flavor. Can be sown a week before any other variety. Ears are 5 to 6 inches long and closely set with deep, broad, luscious, golden yellow kernels. $\frac{1}{2}$ pt. 10c; pt. 15c; qt. 30c; pk. \$2.00; bus. \$7.50.

Golden Sunshine. An early yellow variety having splendid ears of excellent quality and flavor. 10-12 rowed, height of stalk 5 to 6 feet. Length of ear $6\frac{1}{2}$ to 7 inches. Planting to eating stage 76 days. $\frac{1}{2}$ pt. 10c; pt. 15c; qt. 30c; pk. \$2.00; bus. \$7.50.

Gill's Early Golden Market. An early golden variety, producing ears 9 inches long, with 12 or 14 rows. Grains large, sweet, of excellent quality. Two weeks earlier than Golden Bantam. $\frac{1}{2}$ pt. 10c; pt. 15c; qt. 30c; pk. \$2.00; bus. \$7.50.

Golden Country Gentleman (Shoe Peg). Very productive, and one of the sweetest of sweet corns. Mid-season variety with ears 7 to 8 inches long and irregular kernels. Lb. 35c; 2 lbs. 60c; 5 lbs. \$1.25; 10 lbs. \$2.25.

Golden Evergreen. Best and sweetest sugar corn of the late varieties. Better than Golden Bantam, a cross of Golden Bantam and Stowell's Evergreen retaining the quality of the Bantam and remarkable tenderness. $\frac{1}{2}$ pt. 10c; pt. 15c; qt. 30c; pk. \$2.00; bus. \$7.50.

Whipple's Early Yellow. Deservedly popular as a large eared second early sort, for home and market garden. Stalk sturdy and erect, ears 12 to 14 rowed. Strong husks, well filled at tips. Kernels golden yellow, fairly deep, sweet and of good flavor. Stalks $6\frac{1}{2}$ to 7 feet tall—ears 7 to $7\frac{1}{2}$ inches long. Days from planting to eating stage, 84. $\frac{1}{2}$ pt. 10c; pt. 15c; qt. 30c; pk. \$2.00; bus. \$7.50.

Golden Giant. Cross between Golden Bantam and Howling Mob. Matures a week after Golden Bantam. Delicious. $\frac{1}{2}$ pt. 10c; pt. 15c; qt. 30c; pk. \$2.00; bus. \$7.50.

Dwarf Extra-early Adams. This is not a Sweet or Sugar Corn, and the distinction should be kept carefully in mind. However, it is of good flavor, quite sweet and tender when young. $\frac{1}{2}$ pt. 10c; pt. 15c; qt. 20c; pk. \$1.50; bus. \$5.50.

Early Surprise. An outstanding early white sort. It surpasses others in ear size combined with extreme earliness. Very desirable for market gardeners for the earliest markets. Ears 8 to 12 rowed, well protected with strong husks. Stalks $4\frac{1}{2}$ to 5 feet tall—ears $6\frac{1}{2}$ to 7 inches long. Days from planting to eating stage, 72. $\frac{1}{2}$ pt. 15c; pt. 25c; qt. 40c; pk. \$2.50; bus. \$8.50.

Whipple's Early White Sweet Corn. Stalks 5 to 6 feet high, of vigorous growth, with ears produced about 3 feet from the ground, often two to the stalk. Ears about 8 inches long, rather blocky in form, 16- to 18- and often 20-rowed, filled to the end with rather narrow, deep, wedge-shaped grains of pearly whiteness when green, with high sugar content. $\frac{1}{2}$ pt. 10c; pt. 15c; qt. 30c; pk. \$2.00; bus. \$7.50.

Early Evergreen. Resembles Stowell's Evergreen but ready for use much earlier and remains in good condition equally as long. Ears grow to a good size—nearly 7 inches long. $\frac{1}{2}$ pt. 10c; pt. 15c; qt. 30c; pk. \$2.00; bus. \$7.50.

White Evergreen. This is a splendid white main-crop Sweet Corn for market use and home gardens. The ears are large, closely set with pearly white grains of rich and luscious flavor. It is a heavy yielder. Has larger ears and is earlier maturing than Stowell's Evergreen. Our stock is particularly fine. $\frac{1}{2}$ pt. 10c; pt. 15c; qt. 30c; pk. \$2.00; bus. \$7.50.

Stowell's Evergreen. Ears 8 to 9 inches long, usually with 16 to 18 rows of long, slender grains, entirely free from glaze. $\frac{1}{2}$ pt. 10c; pt. 15c; qt. 30c; pk. \$2.00; bus. \$7.50.

Kendel's Early Giant. A second early variety, several days earlier than Crosby. Ears average seven inches in length, thick through, with ten or more rows of large grains of rich, sugary flavor. $\frac{1}{2}$ pt. 10c; pt. 15c; qt. 30c; pk. \$2.00; bus. \$7.50.

Howling Mob. Ears 7 to 9 inches long, closely set with 12 to 14 rows of large, pearly white, very sweet grains. The earliest choice white Corn. $\frac{1}{2}$ pt. 10c; pt. 15c; qt. 30c; pk. \$2.00; bus. \$7.50.

Early Mammoth. A late ripening second-early variety. The ears are of large size, tapering well toward the point; kernels large and very sweet. $\frac{1}{2}$ pt. 10c; pt. 15c; qt. 30c; pk. \$2.00; bus. \$7.50.

Late Mammoth. A large-eared variety, maturing after Stowell's Evergreen. $\frac{1}{2}$ pt. 10c; pt. 15c; qt. 30c; pk. \$2.00; bus. \$7.50.

Country Gentleman (Shoe-Peg) Very productive mid-season variety with ears 7 to 8 inches long and irregularly arranged kernels. $\frac{1}{2}$ pt. 10c; pt. 15c; qt. 30c; pk. \$2.00; bus. \$7.50.

Black Mexican. Rightly popular for home and market garden use. Ears 8 rowed. Kernels tender, very sweet, white at eating stage, changing to blue black at maturity. Height of stalk 6 feet. Length of ears 7 to $7\frac{1}{2}$ inches. From planting to eating stage, 88 days. $\frac{1}{2}$ pt. 10c; pt. 15c; qt. 30c; pk. \$2.00; bus. \$7.50.

POP CORN

Whipple's Yellow

Monarch White Rice. This is the best Pop Corn for home or market. Select ears. $\frac{1}{2}$ lb. 15c; lb. 25c; 5 lbs. \$1.05; 10 lbs. \$1.95.

Queen's Golden. Stalks grow 6 feet high, with large ears produced in abundance. It pops perfectly white and a single kernel will expand to a diameter of nearly 1 inch. $\frac{1}{2}$ lb. 15c; lb. 25c; 5 lbs. \$1.05; 10 lbs. \$1.95.

CORN SALAD

Large Seeded, Large Leaved. This is a small, quick growing salad plant for late fall, winter, and spring use. The leaves are used as a substitute for lettuce and spinach. During August or September sow the seed in shallow drills about 1 foot apart, covering with about $\frac{1}{4}$ inch of fine soil firmly pressed down. On the approach of severe cold weather, cover with straw. Pkt. 5c; oz. 15c; $\frac{1}{4}$ lb. 45c; lb. \$1.20.

DANDELION

Sow early in spring, in very warm, rich soil, in drills 18 inches apart; thin to 5 inches and cultivate well; they will be fit for cutting the next spring. When grown for the roots, sow in September and cultivate well during the fall and the following summer; the roots will be fit to dig in October.

Improved Broad Leaved. Unsurpassed in thickness of leaf and deep green color. It is compact and forms an upright regular tuft at the center. This cabbaging sort is much superior to the common or uncultivated dandelion. Pkt. 10c; oz. 45c; $\frac{1}{4}$ lb. \$1.40; $\frac{1}{2}$ lb. \$2.60; lb. \$4.75.

KOHL-RABI

The edible part is the turnip-shaped bulb formed above the ground. It is tender and excellent when used before being fully grown, combining somewhat the flavors of cabbage and turnips. Seed should be sown in light, rich soil as early in spring as possible in rows $1\frac{1}{2}$ feet apart and when well established thin to 6 inches apart in the row. Plantings at intervals of 10 days will give a succession until hot weather, when they fail to grow well. Plantings made the latter part of July for fall use.

Early White Vienna. An early, smooth, white, medium-sized variety having few leaves. Ready for use in about 10 weeks. Pkt. 10c; oz. 20c; 4 oz. 65c; $\frac{1}{2}$ lb. 90c; lb. \$1.65.

Early Purple Vienna. Later than Early White Vienna. Pkt. 10c; oz. 20c; 4 oz. 65c; $\frac{1}{2}$ lb. 90c; lb. \$1.65.

CELERIAC (Turnip-rooted Celery)

Giant Prague. Roots of good size, round, smooth, with small tops. Pkt. 5c; $\frac{1}{4}$ oz. 10c; $\frac{1}{2}$ oz. 15c; oz. 25c; $\frac{1}{4}$ lb. 75c; lb. \$2.50.

CHICORY

Witloof, French Endive. Sow in May or June in drills; thin out or transplant 6 inches apart. Cultivate the same as endive. In the fall, hill up, to blanch the bases of the leaves. Pkt. 10c; oz. 25c; $\frac{1}{4}$ lb. 75c; $\frac{1}{2}$ lb. \$1.15; lb. \$2.00.

COLLARDS

Georgia. Produces a great quantity of large, succulent, cabbagelike leaves which make delicious greens. Extensively grown in place of cabbage in sections where the latter does not develop heads on account of hot weather. Three feet. Pkt. 5c; oz. 15c; 4 ozs. 25c; $\frac{1}{2}$ lb. 40c; lb. 65c.

CUCUMBERS



Straight "8"
All-America Selections—Gold Medal

In all of its various stages of development the cucumber finds a place on our table. Either raw or pickled it serves as an ingredient for salads and constitutes a tasty relish by itself. A fine crop may be easily grown wherever an openly exposed location of fairly rich soil is available. Planting should be delayed until all danger of frost is past. Soil for planting should be warm, fairly moist and loose. Seed must be covered about 1/2 inch deep. Plant in hills 3 by 5 feet apart, dropping 6 or 8 seeds to each hill. When 6 inches tall, thin to 3 in a hill.

Abel's Stays Green or Black Diamond. This is a dark green, medium-sized cucumber of the white spine class. The fruits are 7 to 8 inches long, cylindrical in shape, and a fine glossy green in color. They retain their fine color for a remarkably long time and on that account are very well adapted for shipping. The young fruits are desirable for small pickles and the mature fruits are very satisfactory in shape and size for packing. The variety is becoming popular with commercial growers and is proving a good home-garden sort. Pkt. 5c; oz. 20c; 1/4 lb. 50c; 1/2 lb. 85c; lb. \$1.50; 2 lbs. \$2.75; 5 lbs. \$6.50.

Abel's Banner Hybrid. We consider this the finest all around cucumber in existence. It has a long and straight, attractive shape, with a very rich green color, a fine lot of showy white spines. The color stays green for a week making it a fine shipper. Many Southern cucumber growers will use no other, which is indeed a fine testimonial for it. Pkt. 5c; oz. 25c; 1/4 lb. 75c; 1/2 lb. \$1.35; lb. \$2.50.

Abel's Early Fortune. A disease-resistant variety of attractive appearance. When fruits are fully grown they measure 9 inches long and 2 1/2 inches thick. Flesh is pure white and has a firm crisp texture. Juicy and refreshing. Pkt. 5c; oz. 20c; 1/4 lb. 50c; 1/2 lb. 75c; lb. \$1.25; 2 lbs. \$2.30; 5 lbs. \$5.50.

A. B. C. Cucumber. This is positively a new stock of Cucumber which we are offering and not a renamed variety, not an old variety remodeled. The grower of this variety has spent six years in developing this extraordinary strain and have been able to place small quantities of seed for test with various critical Cucumber growers. In every case they report that it is the finest they have ever seen. The vine in a good stock of Cucumber must be robust and resistant to disease. Cucumber A. B. C. will produce an abundance of fruit 10 inches long, not quite as thick as a great many other stocks, they will hold their greenness longer than any type we ever handled. The time of maturity is 60 days. We are very proud of A. B. C. Cucumber

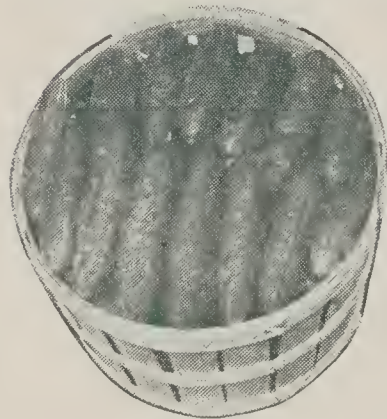

A. B. C. Cucumber

and suggest making it a point this coming season to give it a trial. Our supply of this seed for the next several years will be limited on account of the great demand and the limited amount available. Pkt. 10c; 1/2 oz. 15c; oz. 25c; 1/4 lb. 75c; 1/2 lb. \$1.25; lb. \$2.00.

Straight "8." An attractive long straight cylindrical, fruits about 8 inches long and 1 1/2 inches in diameter. Ideal shipper as well as a desirable home or market garden variety. Pkt. 5c; oz. 20c; 1/4 lb. 60c; 1/2 lb. 85c; lb. \$1.50; 2 lbs. \$2.75.

Arlington White Spine. The Cucumbers are very regular in outline, averaging 7 to 8 in. long, straight and of a rich green color. Pkt. 5c; oz. 20c; 1/4 lb. 50c; 1/2 lb. 75c; lb. \$1.25; 2 lbs., \$2.30; 5 lbs. \$5.50.

Early Jersey. Fruits are of a rich dark green color and average from 4 to 5 inches long. Fine for producing small pickles. Pkt. 5c; oz. 20c; 1/4 lb. 50c; 1/2 lb. 75c; lb. \$1.25; 2 lbs. \$2.30; 5 lbs. \$5.50.

London Long Green. Young fruit makes fine pickles. Skin rich green; flesh solid, crisp and very good quality. Pkt. 5c; oz. 20c; 1/4 lb. 65c; 1/2 lb. \$1.00; lb. \$1.75.

Davis Perfect. Long, even fruits of fine form with intensely dark, rich green skin. Its solid white flesh is very good for slicing. Pkt. 5c; oz. 20c; 1/4 lb. 50c; 1/2 lb. 75c; lb. \$1.25; 2 lbs. \$2.30.

Everbearing. Early, prolific variety, with fruits rich dark green, averaging 4 to 5 inches in length by 1 1/2 inches in diameter. Pkt. 5c; oz. 20c; 1/4 lb. 50c; 1/2 lb. 75c; lb. \$1.25; 2 lbs. \$2.30.

Early Green Cluster. Fruits slender and most desirable for pickling. Very prolific and set in clusters of two and three. If fruits are kept gathered the vines will continue long in bearing. Pkt. 5c; oz. 20c; 1/4 lb. 50c; 1/2 lb. 75c; lb. \$1.25; 2 lbs. \$2.30; 5 lbs. \$5.50.

Extra-early Green Prolific (Boston Pickling). Fruits average 4 to 5 inches in length when large enough for slicing and are of excellent quality. Used chiefly for producing medium-sized pickles. Pkt. 5c; oz. 20c; 1/4 lb. 50c; 1/2 lb. 75c; lb. \$1.25; 2 lbs. \$2.30; 5 lbs. \$5.50.

West India Gherkin. Small, suitable for pickling, borne most prolifically on vigorous vines. Pkt. 5c; oz. 20c; 1/4 lb. 65c; 1/2 lb. \$1.00; lb. \$1.75.

White Wonder. Popular as a novelty, on account of its color. Fruits weigh 2 pounds. White at all stages of growth, produced in clusters, chunky with round ends. Length of fruit 7 to 7 1/2 inches, diameter of fruit 2 1/2 inches. From planting to picking, 60 days. Pkt. 5c; oz. 20c; 1/4 lb. 50c; 1/2 lb. 80c; lb. \$1.35.

EGGPLANT

This is a semi-tropical plant which requires continuous warm weather for best results. The seed germinates slowly and should be started in a hot bed. The plants may be set out in the open ground when 2 inches tall if continued warm weather is in prospect. Space the plants 2 1/2 to 3 feet apart. Young plants should be shaded from hot sun and sprayed with Paris Green as a protection from potato bugs.

Black Beauty. Fully 10 days earlier than Improved New York Spineless. Healthy grower and large fruit. Pkt. 5c; 1/2 oz. 25c; oz. 40c; 1/4 lb. \$1.20; 1/2 lb. \$2.00; lb. \$3.75.

Extra Early Long Purple. A very early and productive variety with fruit eight inches long and about 2 1/2 inches thick. The color is very dark purple, almost black, and very smooth. It is difficult to find a good strain of this variety, and we have been very fortunate in obtaining our stock. It has pleased the most critical market gardening trade. Pkt. 10c; 1/2 oz. 25c; oz. 40c; 1/4 lb. \$1.20; 1/2 lb. \$2.00; lb. \$3.75.

Improved New York Spineless. Quite free from spines. Fruit of large size and perfect form. Two weeks earlier than the old variety. Pkt. 5c; 1/2 oz. 25c; oz. 40c; 1/4 lb. \$1.20; 1/2 lb. \$2.00; lb. \$3.75.

ENDIVE

One ounce of seed will sow 150 feet of drill

For early use sow about April 15th; for later supply sow in June or July in rows 14 to 20 inches apart and when well started thin the plants to 1 foot apart. When nearly full-grown tie the outer leaves together over the center in order to blanch the heart of the plant. By covering fresh plants every few days a succession may be maintained. Endive for winter use may be had by making 2 or 3 successive plantings at intervals of a week or 10 days during July. Just before killing frosts are due in the fall dig the plants, taking plenty of soil with the roots. Store in the cellar, packing the plants closely together and keep as dark as practicable. The plants must be harvested very carefully to avoid bruising the leaves and shaking the soil from the roots. When stored this way the plants will be self-blanching and of finer quality than when tied up and blanched out of doors. By arranging the storage space so that the earlier plantings can be used first, a supply can be provided until nearly spring.



Batavia Full Heart
All-America Selections—Award of Merit

Batavia Full Heart Broad Leaved—Escarole. (90-95 days.) One of the best varieties for salads. Leaves of upright growth, broad, more or less twisted and waved, bright deep green, with a nearly white midrib. Inner leaves form a fair head which blanches a creamy white. Pkt. 5c; oz. 10c; 1/4 oz. 40c; 1/2 oz. 70c; lb. \$1.25.

Green Curled. Hardy. Leaves dark green, tender. Pkt. 5c; oz. 10c; 1/4 lb. 35c; 1/2 lb. 60c; lb. \$1.10.

FENNEL

Florence Fennel—Finnocchio or Sweet Anise—Valuable for home and market garden and for shipping. Plants 30 to 36 inches tall with broad overlapping leaf stalks forming a bulb-like enlargement at the base of the stem. This bulb, frequently used as celery, is sweet and aromatic. Pkt. 10c; oz. 20c; 1/4 lb. 75c.

KALE or BORECOLE

This is a species of the cabbage family and is extensively grown for greens, especially in the South. Most varieties have heavy, densely curled foliage of beautiful green and the dwarf varieties are desirable for ornamental garden use. The culture is practically the same as that of late cabbage but as the plants will withstand several degrees of frost they can be allowed to grow late into the fall. They are regarded by many as at their best after the first heavy frosts.

Dwarf-curved Scotch Kale. This is the variety usually sown in the fall for spring market. It is low-growing with finely curled leaves of deep green. Pkt. 5c; oz. 15c; 1/4 lb. 40c; 1/2 lb. 60c; lb. 95c.

LEEK

One ounce will sow 100 feet of drill

This is a widely cultivated species of the onion family. It is highly esteemed as a fall and winter substitute for green onions. Also regarded by many as superior in tenderness and flavor when cooked. The leaves are flat and the stems are large, cylindrical and bulbous. Sow early in spring in rows 12 to 15 inches apart, covering $\frac{1}{2}$ inch deep. Thin the plants to 6 inches apart in the row and draw the earth about them when cultivating. If one desires very white and tender leeks, transplant when about 6 inches tall, setting 4 inches apart in trenches about 2 feet apart and gradually earth up like celery.

Large American Flag. The kind mostly grown for market. Pkt. 10c; oz. 25c; $\frac{1}{4}$ lb. 75c; $\frac{1}{2}$ lb. \$1.25; lb. \$2.00.

LETTUCE

One ounce of seed will sow 100 square feet or 120 feet of drill

Lettuce seed germinates quickly and may be planted as soon as the cold wet days of spring are past. The home gardener will find it best to sow seed in rows 15 to 18 inches apart, covering not more than $\frac{1}{2}$ inch deep. The loose leaved type may be thinned to an inch or so apart as soon as a few leaves are formed and when large enough for the table may be thinned as used. In this way space is provided at about the same rate as required for normal growth.

The conditions necessary to grow good head lettuce are rich soil, plenty of moisture, and steady growth from the time the seeds are planted until the heads are ready to use. A check in growth from lack of nourishment or moisture usually means no head.

The most satisfactory results will be obtained from growing lettuce in cool weather; the seed should therefore be sown in boxes indoors or in the hot bed and set out as soon as weather conditions are favorable. If this is not practicable sowing may be made in the open ground as soon as soil and weather conditions permit. The plants should be thinned to 10 inches apart in the row and thorough cultivation given to keep down the weeds and conserve moisture. A light application of fertilizer, such as nitrate of soda, used after the plants have made some growth will be found very beneficial.

No. 515 New York—Improved. An early variety well adapted to summer and early fall production, resistant to tipburn, slightly darker green than other varieties with somewhat more prominent ribs. Heads medium large, compact attractive, a development from New York No. 12 strain No. 199 of this variety is an improvement on the original introduction. Days from sowing seed to marketable stage, 75. Pkt. 5c; oz. 25c; $\frac{1}{4}$ lb. 75c; $\frac{1}{2}$ lb. \$1.25; lb. \$2.00.

May King. An extremely early, heading sort, for earliest outside planting, and for greenhouse forcing. Leaves yellowish green, tinged with brown at edges. Heads small, compact with golden yellow interior and buttery flavor of fine quality. Days from sowing to marketable stage, 63. Pkt. 5c; oz. 20c; $\frac{1}{4}$ lb. 35c; $\frac{1}{2}$ lb. 55c; lb. 90c.

Black-seeded Simpson. Quick-growing variety with a mass of light green, curly leaves of finest quality. A most popular Lettuce. Pkt. 5c; oz. 20c; $\frac{1}{4}$ lb. 35c; $\frac{1}{2}$ lb. 55c; lb. 90c.

Wayahead. Very early; close heading; large; of superior quality. Pkt. 5c; oz. 20c; $\frac{1}{4}$ lb. 35c; $\frac{1}{2}$ lb. 55c; lb. 90c.

Iceberg. Solid heads; blanches well. Pkt. 5c; oz. 20c; $\frac{1}{4}$ lb. 35c; $\frac{1}{2}$ lb. 55c; lb. 90c.

Improved Salamander. A large, compact variety that withstands hot weather remarkably well. Leaves large, broad, overlapping, with well-blanch heart. One of the best for summer planting. Pkt. 5c; oz. 20c; $\frac{1}{4}$ lb. 35c; $\frac{1}{2}$ lb. 55c; lb. 90c.

Hanson. A thin-leaved, curled, tight-heading, frilled-edge sort desirable for late summer planting, and remaining in condition a long time. Pkt. 5c; oz. 20c; $\frac{1}{4}$ lb. 35c; $\frac{1}{2}$ lb. 55c; lb. 90c.

Early Curled Silesia. A favorite curled or loose-leaved sort for the home garden. Pkt. 5c; oz. 20c; $\frac{1}{4}$ lb. 35c; $\frac{1}{2}$ lb. 55c; lb. 90c.

Grand Rapids. The crumpled leaves do not make a solid head. Forcing sort. Pkt. 5c; oz. 20c; $\frac{1}{4}$ lb. 35c; $\frac{1}{2}$ lb. 55c; lb. 90c.

Big Boston. Fine for coldframes or outdoors. Heads large and solid. Pkt. 5c; oz. 20c; $\frac{1}{4}$ lb. 35c; $\frac{1}{2}$ lb. 55c; lb. 90c.

New York. Also called Los Angeles and Wonderful. Large, compact head with frilled edge and dark green leaves. Pkt. 5c; oz. 20c; $\frac{1}{4}$ lb. 35c; $\frac{1}{2}$ lb. 55c; lb. 90c.

Abel's Brittle Ice. Fine, quick-growing variety with bright green leaves. Heart extremely tender, juicy and nearly white. Excellent for market gardeners. Pkt. 5c; oz. 20c; $\frac{1}{4}$ lb. 35c; $\frac{1}{2}$ lb. 55c; lb. 90c.

Abel's Prizehead. Large, loose heads of crimped and fringed leaves, heavily shaped brown. Pkt. 5c; oz. 20c; $\frac{1}{4}$ lb. 35c; $\frac{1}{2}$ lb. 55c; lb. 90c.



Grand Rapids Lettuce

New York No. 12. This is the product of a single plant selection and the result of many year's work. It is a pronounced improvement over other types of New York, as it is earlier, makes large, solid heads of the flat type, and is remarkably uniform in maturity. Several fields have produced a nearly 100 per cent cut of U. S. No. 1 heads in 65 days from sowing. Its sure-heading quality makes it unsurpassed for spring and summer. Pkt. 5c; oz. 20c; $\frac{1}{4}$ lb. 45c; $\frac{1}{2}$ lb. 70c; lb. \$1.25.

Abel's All the Year Round. A variety for sowing in the fall for wintering over to have early Head Lettuce the first thing in the spring. Finest quality, solid heads with creamy yellow center. Sow the seed about August 15 to September 10. About the end of October, set the plants to remain permanently in as warm and favorable situation as possible. Protect with straw during frosty weather. Heads begin to form in April. Pkt. 5c; oz. 25c; $\frac{1}{4}$ lb. 70c; $\frac{1}{2}$ lb. \$1.10; lb. \$1.75.

COS or ROMAINE

This class is quite distinct from the other classes of lettuce. It is frequently called celery lettuce on account of its erect habit of growth and because it possesses dark colored spatulate leaves with prominent midribs. For best results it should be planted for late summer or early fall use as it does not make solid heads in hot weather. When grown in the home garden each plant should have ample room and should be thinned to about 8 inches apart.

The earliest sowing may be made in February or March under glass, with slight heat. For later supply, sow in the open ground, and as soon as the season permits, thin out rows two feet apart and a foot between the plants. Requires good ground and abundant moisture.

Self-folding Cos or Romaine. Sow early and tie up to blanch. Long-leaved, crisp and tender. Pkt. 5c; oz. 20c; $\frac{1}{4}$ lb. 35c; $\frac{1}{2}$ lb. 55c; lb. 90c.



Cos Lettuce

MUSTARD

This is a very quick growing foliage plant that is raised principally for greens. It is related to the turnip and the leaves are much like turnip tops in flavor but are more tender and the stems are not so long nor so coarse. Mustard greens have a rich flavor and are fully as healthful and nutritious as spinach.

Seed may be sown from early spring to midsummer in rows 18 inches apart. Thin to 5 or 6 inches apart in the rows. The plants are in condition for use as soon as the leaves are the size of one's hand. Mustard runs to seed quickly, so successive plantings are necessary for a continuous supply.

Fordhook Fancy. The plume-like leaves of this variety are closely curled and finely fringed. The medium yellowish-green color and compact erect habit of growth lends a decorative touch to the garden and the tender quality and fine flavor of this variety render it one of the most desirable for salads and greens. Pkt. 5c; oz. 15c; $\frac{1}{4}$ lb. 25c; $\frac{1}{2}$ lb. 40c; lb. 65c.



Abel's Perfection

MUSKMELON

One ounce of seed will sow 80 hills; 2 to 3 pounds an acre

There are few products of the garden that give as much pleasure as ripe sweet melons fresh from the vines. With seedsmen and other plant breeders vying to produce the most delicious varieties it is now comparatively easy for the home gardener to enjoy this luscious garden prize at its best. Our list is made up of the most desirable varieties suited for growing wherever melons can be grown.

In sections where the summer is short, seed can be planted indoors or in hot beds by using small boxes, such as berry boxes. These can be transplanted to the garden when danger of frost is past. If practicable spade in a liberal fork full of well rotted manure at the bottom of each hill. The rows should be at least 6 feet apart and the hills 3 feet apart in the rows. In general the culture is practically the same as for cucumber.

Abel's Perfection. A large, main-crop variety, varying in shape from round to slightly oblong. Pale green skin distinctly ribbed and slightly netted; flesh deep salmon, sweet and spicy. Pkt. 5c; oz. 15c; ¼lb. 40c; ½lb. 60c; lb. \$1.00.

Banana. Melons 15 to 20 inches long and 4 to 6 inches in diameter. Thick salmon flesh of delicious flavor. Pkt. 5c; oz. 20c; ½lb. 80c; lb. \$1.35.

Bender's Surprise. Without doubt one of the finest flavored melons we have ever eaten; and we recommend it very strongly. When ripe, the skin is a light greenish yellow, the flesh a very deep salmon. Slightly oval in shape, with coarse netting. The vines are very productive, maturing fruit in about 80 days. Pkt. 5c; oz. 15c; ¼lb. 45c; ½lb. 70c; lb. \$1.25.

Emerald Gem. Early; small; flesh deep orange, very sweet. The best and most popular sort for this section. Pkt. 5c; oz. 15c; ¼lb. 40c; ½lb. 60c; lb. \$1.00.

Extra Early Hackensack. A well known first early sort for home garden and truckers for local markets. Fruits large, globular, flattened, weigh 2½ pounds, heavily ribbed with coarse netting. Flesh green, thick, of good quality. Pkt. 5c; oz. 15c; ¼lb. 40c; ½lb. 60c; lb. \$1.00.

Flat Jenny Lind. Heavily netted fruits, 3½ to 4½ inches in diameter, with crisp, light green flesh of rich flavor. Pkt. 5c; oz. 15c; ¼lb. 40c; ½lb. 60c; lb. \$1.00.

Fordhook. Melons grow to a handy size and are very attractive. They are round, flat, and thick, with bright orange-salmon flesh. Pkt. 5c; oz. 15c; ¼lb. 40c; ½lb. 60c; lb. \$1.00.

Hale's Best. Since its introduction this variety has displaced some of the older popular favorites by its outstanding merit. An early melon, ripening in 75 to 80 days. The nearly round fruits are normally 6 to 6½ inches long, densely covered with medium heavy netting and are almost devoid of ribbing. The flesh is very thick and fine grained, deep salmon-pink in color and richly flavored. Pkt. 5c; oz. 20c; ¼lb. 45c; ½lb. 70c; lb. \$1.25.

Hearts of Gold. One of the most popular medium sized melons. It follows the earlier varieties, and it is very fine to plant for succession as it ripens in about 100 days. The fruits are 5 to 6 inches in diameter. The smooth orange-salmon flesh is exceptionally thick and fine flavored. Pkt. 5c; oz. 20c; ¼lb. 45c; ½lb. 70c; lb. \$1.25.

Rocky Ford. Skin green, turning to a peculiar gray color when the melon is fit for use. It weighs about 1½ pounds. A firm, solid, sweet, tasty variety. Pkt. 5c; oz. 15c; ¼lb. 40c; ½lb. 60c; lb. \$1.00.

Spicy. Quite uniform fruits, measuring from 8 to 10 inches long and 6 to 7 inches in diameter. Flesh deep rich salmon and tender. Pkt. 5c; oz. 25c; ½lb. 80c; lb. \$1.50.

Osage or Miller's Cream. Excellent for home and market garden use for local markets, not a good shipper. Fruits oblong, weigh 6 pounds. Exterior very dark green, deeply ribbed, covered with slight grey netting. Flesh exceptionally thick, rich orange-salmon, tender, sweet, juicy. Length 7 inches, diameter 6 inches. Days from planting to picking, 95 days. Pkt. 5c; oz. 15c; ¼lb. 40c; ½lb. 60c; lb. \$1.00.

OKRA or GUMBO

This is commonly grown in the South where it is very popular. Seed does not germinate well at cool temperatures and planting should be delayed until the ground is warm. Plant in rows about 2½ feet apart, dropping 4 or 5 seeds to the foot and covering about an inch deep. Thin to about 1½ feet in the row and keep thoroughly cultivated. Okra is raised for the pods which are extensively used in soups, stews, catsup and other relishes. They are at their best when 1 to 3 inches long.

Kleckley's Favorite. The plants grow 2½ to 3 feet high, close-jointed, with ample foliage, and bear smooth white pods of the very finest quality at each leaf-joint. Pkt. 5c; oz. 15c; ¼lb. 25c; ½lb. 45c; lb. 75c.

ONIONS

One ounce of seed will sow 100 feet of drill; 5 pounds an acre

It is probable that no other garden vegetable is used in so many ways as the onion. Raw or cooked, alone or in combination with other vegetables, it is equally desirable. As an appetizer it has no superior and many of the housewife's cherished recipes would be incomplete without it.

A row or two of onions in the home garden will furnish a supply which will continue from midsummer to the following spring. Onions are very hardy and the seed will germinate in cool weather. It can be planted safely just as soon as the soil can be prepared. Shallow planting is advisable, ¼ to ½ inch being about right. When 2 or 3 inches tall the young plants can be thinned enough to prevent crowding. They may be thinned when 6 or 8 inches in height and the plants which are removed will be ready for use as green onions. From then on they can be used as needed and when fully ripened the unused bulbs can be stored for winter.

Wethersfield Large Red. The standard red market variety. Large, round, somewhat flattened; flesh purplish white; skin deep purplish red. Very productive. The best keeper and one of the most popular for general cultivation. Pkt. 5c; oz. 20c; ¼lb. 65c; lb. \$2.00.

Yellow Globe Danvers. An early and abundant cropper. Large, very thick bulb, flat or slightly convex bottom, full oval top, with small neck, and rich, brownish yellow skin. Pkt. 5c; oz. 20c; ¼lb. 65c; ½lb. \$1.20; lb. \$2.25.

Mammoth Prizetaker. Enormous bulb, averaging from 10 to 16 inches in circumference. A good winter keeper. The outside skin is of a rich yellow, while the flesh is white, sweet, and tender. Pkt. 5c; oz. 20c; ¼lb. 65c; ½lb. \$1.20; lb. \$2.25.

Mammoth Silver King. Enormous silvery white Onions of mild flavor. Quickly grows to maturity on rich soil and often attains a weight of 2 to 3 pounds. Pkt. 5c; oz. 20c; ¼lb. 65c; ½lb. \$1.20; lb. \$2.25.

Southport Yellow Globe. Form nearly ovoid, regular, and symmetrical; mild and pleasant flavor; slightly later than the other yellow sorts. Keeps well. Pkt. 5c; oz. 25c; ¼lb. 75c; ½lb. \$1.50; lb. \$2.75.

Southport White Globe. Handsome, uniformly globe-shaped bulbs with firm, fine-grained flesh of mild flavor. Yields abundantly. Pkt. 5c; oz. 25c; ¼lb. 75c; ½lb. \$1.50; lb. \$2.75.

Ebenezer or Japanese Onion. Not unlike Yellow Globe Danvers in shape and size but superior in flavor and a better keeper. Grown extensively for sets. Pkt. 5c; oz. 20c; ¼lb. 65c; ½lb. \$1.20; lb. \$2.25; 5 lbs. \$10.00.

Southport Red Globe. The deep color and symmetrical form of this onion make it very attractive. Bulbs reach full size within 110 days, keep well and are of superior quality. Very firm and of strong flavor. Pkt. 5c; oz. 20c; ¼lb. 65c; ½lb. \$1.20; lb. \$2.25.



Yellow Globe Danvers

ONIONS—(Continued)

- White Portugal (Silverskin).** Very early; rather flat in shape, mild flavored. Does not keep so well as most other varieties. Pkt. 5c; oz. 25c; ¼lb. 80c; ½lb. \$1.40; lb. \$2.50.
- Extra-early Barletta.** An Italian variety and the very earliest Onion in cultivation. Small, pure white; mild, delicate flavor. Makes a handsome and profitable bunching sort, especially if started indoors and transplanted. Pkt. 5c; oz. 20c; ¼lb. 80c; ½lb. \$1.40; lb. \$2.50.
- Abel's Bottle Onion.** Seed of this variety is very scarce and always in great demand. Bulb long or bottle-shaped; mild, pleasant flavor. Pkt. 10c; oz. 50c; ¼lb. \$1.50; lb. \$5.50.
- Sweet Spanish (Riverside Strain).** This finely bred strain is steadily increasing in popularity due to its large size, attractive yellowish-brown covering and excellent flavor. Under favorable conditions the globe shaped bulbs often weigh 2 pounds and always possess a most delicious mild flavor. It keeps well. Pkt. 5c; oz. 20c; ¼lb. 65c; ½lb. \$1.20; lb. \$2.25.
- Gigantic Gibraltar.** Produces perfectly globular Onions of enormous size. The skin is a pleasing light straw color, and extends evenly over the whole Onion. The flesh is white and astonishingly sweet. It is mild and tasty, and the texture is brittle, tender and juicy. These large handsome Onions mature very evenly. Pkt. 10c; oz. 35c; ¼lb. 85c; ½lb. \$1.40; lb. \$2.50.

ONION SETS

6 to 12 bushels (according to size) are required to set an acre in drills
Prices vary according to the market. Write for prices and samples.

PARSLEY

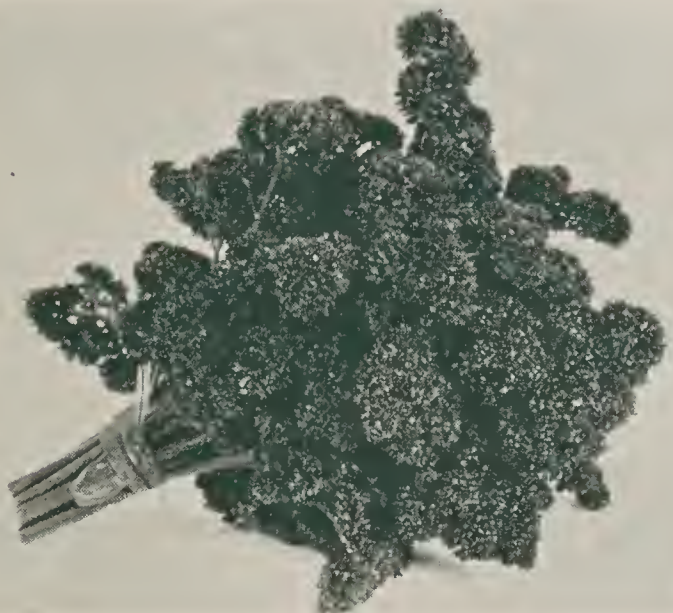

Ⓜ Paramount Parsley
All-America Selections—Award of Merit

- This well known vegetable is very useful for flavoring soups and for garnishing. The green leaves are used for flavoring or they may be dried crisp, rubbed to powder and kept in bottles until needed.
- Parsley succeeds best on rich, mellow soil. The seed is even slower than parsnips in germinating and should be sown as early as possible in the spring, in rows 1 to 2 feet apart, covering not more than ½ inch with fine soil firmly pressed down. When the plants are well up thin 8 to 12 inches apart in the row. When the plants of the curled varieties are about 3 inches high cut off all the leaves; the plant will then start new growth of leaves which will be brighter and better curled. Later, if these turn dull or brown they can be cut in the same way; every cutting will result in improvement of the quality of the leaves.
- Plain (Single).** Plain leaves of excellent flavor. Pkt. 5c; oz. 15c; ¼lb. 35c; ½lb. 55c; lb. 75c.
- Dark Moss-curved.** The leaves are of an extra-dark green color. Pkt. 5c; oz. 15c; ¼lb. 35c; ½lb. 55c; lb. 75c.
- Ⓜ **Paramount.** A recent introduction or triple curled type. Plant very dark green, 12 inches tall with stout stems for bunching, somewhat resistant to tip burn. Pkt. 5c; oz. 20c; ¼lb. 45c; ½lb. 70c; lb. \$1.15.
- Turnip-rooted (Hamburg).** The edible portion is the fleshy root which resembles a small parsnip, and is used for flavoring soups, stews, etc. Pkt. 5c; oz. 15c; ¼lb. 40c; ½lb. 60c; lb. \$1.00.

PARSNIP

Parsnips grow best in a loose rich sandy loam but will make good roots in any soil, that is reasonably rich and deep. Stony soil and coarse raw manure is apt to produce branched or misshapen roots. The seed requires steady and abundant moisture for germination and should be sown as early as practicable. Sow in rows 2 to 2½ feet apart and when well up, thin to about 5 inches apart in the row. Keep the ground moist if possible. Parsnips are improved rather than injured by freezing, and a portion of the crop can be left in the ground all winter to be used as a spring vegetable when the ground has thawed.

Long Smooth (Hollow Crown). A large cropper that is tender, sugary, and popular for general cultivation, but requires a deep soil. Pkt. 5c; oz. 10c; ¼lb. 25c; ½lb. 55c; lb. 90c.

PEPPERS

The garden varieties of pepper are divided into two classes, each of which has its special culinary uses. They generally are classified as "hot" and "sweet" peppers. The hot varieties are nearly all much smaller than the sweet ones and the smallest fruited varieties are usually the hottest. They are mostly used as condiments in various forms. The sweet peppers have thicker flesh, are larger and do not possess the pungent quality of the hot ones. They are becoming more popular for garnishing and in relishes, etc.

The culture is practically the same as that for egg plant and the soil and temperature requirements are about the same. A moderate dressing of guano, poultry manure or complete commercial fertilizer, hoed into the soil after the plants are 6 to 8 inches tall will be very beneficial. If fruits are kept picked, pepper plants will continue to bear all along as the weather is favorable.

- California Wonder.** This is unquestionably the leader of the sweet Peppers. Vigorous growing plants bear a heavy yield of handsome blocky fruits which reach a size of 5 inches in length and 4 inches across. The thickness of flesh alone, which is often ⅜ of an inch, places it above all other Peppers. There is not the least trace of pungency in the flesh, and it is crisp and juicy. In the home garden these are always an object of admiration, and they are equally pleasing when served on the table. Pkt. 5c; ¼oz. 15c; ½ oz. 25c; oz. 40c; ¼lb. \$1.35; ½lb. \$2.50.
- Harris' Early Giant.** This most admirable sort is especially adapted to northern growing because of its early maturity. The Peppers are larger than any other early sort, 3½ inches in diameter and 4½ inches long, while from 6 to 10 are produced on one plant. For unripe picking they are medium dark green and in maturity are bright red. The flesh is moderately thick and of excellent quality. It is a choice home-garden sort. Pkt. 5c; ¼oz. 15c; ½oz. 25c; oz. 40c; ¼lb. \$1.35; ½lb. \$2.50.
- World Beater.** Very large, thick-meated Pepper; mild flavor; bright red. Very productive. Pkt. 5c; ¼oz. 15c; ½oz. 25c; oz. 40c; ¼lb. \$1.35; ½lb. \$2.50.
- Sweet-Meat Glory.** A superior strain of the pimiento pepper with beautiful large heart shaped fruits of a bright crimson-scarlet color. Peppers are 2½ in. in diameter and measure about 3½ in. in length. Flesh is 5/16 in. thick. Sweet, mild and very tasty. Pkt. 5c; ½oz. 20c; oz. 30c; ¼lb. 90c; ½lb. \$1.40.
- Ruby King.** This pepper is still the foremost pepper for market gardeners. The large green fruits are 4 to 6 inches long and 4 inches thick, tapering gradually from the crown, turning ruby-red when ripe. Thick, firm, mild and sweet flesh. Pkt. 5c; ¼oz. 15c; ½oz. 25c; oz. 40c. ¼lb. \$1.35; ½lb. \$2.50.
- Ruby Giant.** A fine sweet pepper, somewhat similar to World Beater, with bright red color, superior flavor, and very productive. It stands shipping well. Pkt. 5c; ¼oz. 15c; ½oz. 25c; oz. 40c; ¼lb. \$1.35; ½lb. \$2.50.
- Neapolitan.** A variety of sweet Pepper which matures very early. It grows about 3 inches long. Pkt. 5c; oz. 35c; ¼lb. \$1.00; ½lb. \$1.65.
- Golden Queen.** Mild, sweet, yellow Pepper. Quite attractive. Pkt. 5c; ¼oz. 15c; ½oz. 25c; oz. 40c; ¼lb. \$1.35 ½lb. \$2.50.
- Tobasco.** Small and very hot. Used as a condiment either in vinegar or for making sauce. Pkt. 5c; ½oz. 35c; oz. 60c; ¼lb. \$1.80; ½lb. \$2.75.
- Chinese Giant.** The largest mild red Pepper; ideal for the home garden. Plants vigorous, of stocky habit, seldom more than 2 feet high. Fruit 4 to 5 inches broad at the top. All are uniformly of enormous size. Pkt. 5c; ¼oz. 15c; ½oz. 25c; oz. 40c; ¼lb. \$1.35; ½lb. \$2.50.
- Celestial.** Small, upright pods. Pkt. 10c; ½oz. 25c; oz. 40c; ¼lb. \$1.35.
- Red Cherry.** Very ornamental. Pkt. 10c; ½oz. 25c; oz. 40c; ¼lb. \$1.35.
- Large Bell (Bullnose).** Large, mild, bright red fruits largely used for pickling. Pkt. 10c; ½ oz. 20c; oz. 35c; ¼ lb. \$1.00; ½ lb. \$1.65.
- Oshkosh.** A medium early, attractive sort, deep glossy green in color turning to canary yellow at maturity. Fruits very sweet, smooth without lobes, broad at base tapering to blunt point, productive and attractive. Length 4½ inches, diameter at stem 3½ inches. Days from setting of plants to picking, 70. Pkt. 10c; ½oz. 30c; oz. 50c; 4 ozs. \$1.50; ½lb. \$2.75.
- Hungarian Yellow Wax (Hot Varieties).** A first early hot sort, valuable for market gardeners and canners. Plant dwarf and prolific. Fruits pendent medium slender, tapering, smooth and very pungent. Color waxy yellow changing to bright crimson at maturity. Length 5½ to 6½ inches, diameter at stem 1¼ to 1½ inches. Days from setting of plants to picking, 65. Pkt. 5c; ¼oz. 15c; ½oz. 25c; oz. 40c; ¼lb. \$1.35; ½lb. \$2.50.

California Wonder Pepper

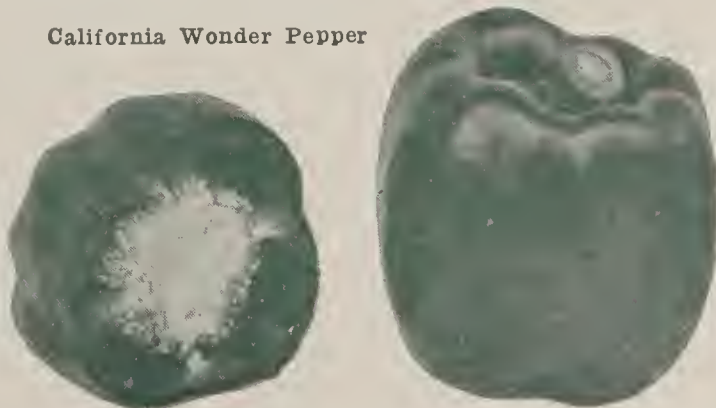

ABEL'S CHOICE PEAS

Peas require moderate temperature, plenty of moisture and increasing daylight for maximum development. They are immune from injury by light frosts and may be planted as early in the Spring as the condition of the soil will permit. The earliest plantings are usually the most successful. In most every case a quart of peas equals 1½ pounds.

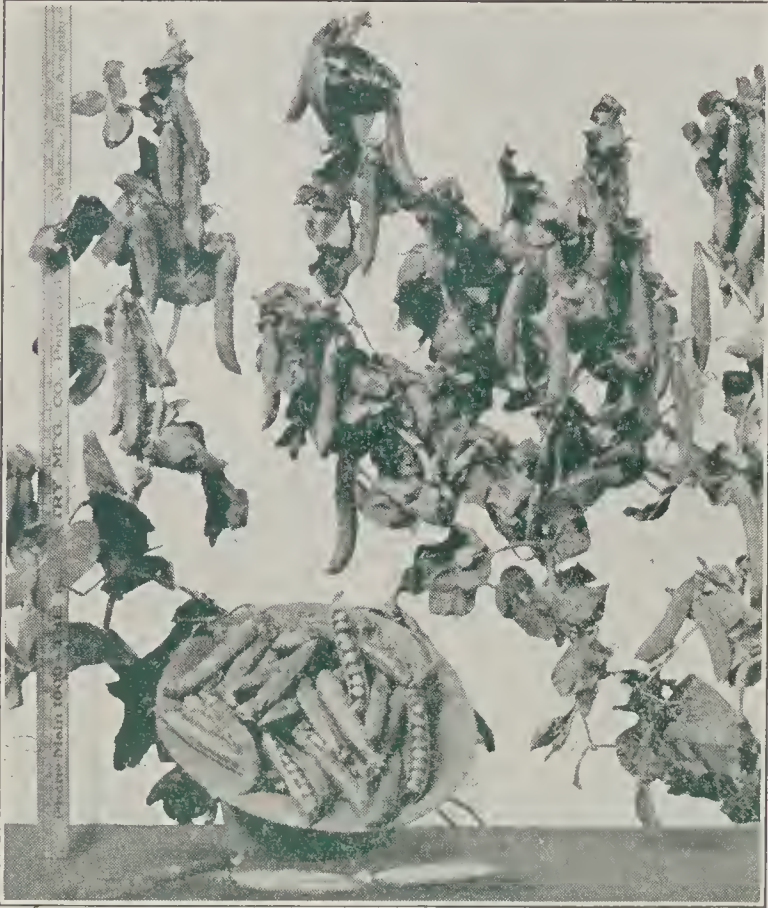

Abel's Wonder Wilt Resistant Peas—Gilbo

The time needed to reach table condition is so evenly graduated among the varieties that by planting some of the several varieties at the same time a well arranged succession can be obtained extending over a period of 30 days. Successive plantings of a desirable variety will also provide a succession but this cannot be extended over as long a period with as good results.

The seeds should be planted in rows at a depth of 1½ to 2 inches. The rows should be 21 to 28 inches apart for dwarf varieties and about 28 to 42 inches apart for the taller sorts.

Abel's Supreme—Wilt Resistant. A medium late sort, desirable for the trucker. Wilt resistant vine two feet high and dark green in color. Pods 4½ to 5 inches, dark and pointed. Season 74 days. Be sure to plant this variety for a trial this season. We are sure they will please you. ½ pt. 15c; pt. 25c; qt. 40c; pk. \$2.80; bus. \$9.50.

Abel's Wonder Wilt Resistant—Gilbo. Vines, 24 to 28 inches; dark green. Pod 5 to 6½ inches; dark green. Maturity about 75 days. Remains tender and sweet a week to 10 days after ready to pick. ½ pt. 15c; pt. 25c; qt. 40c; pk. \$2.80; bus. \$9.50.

Abel's Early Bird. The best-yielding, the hardiest, and the most prolific of the Laxtonian type. It is a semi-round-seeded Pea with a very large dark green pod of wonderful appearance and a very sturdy dwarf vine. Season 58 days. ½ pt. 10c; pt. 20c; qt. 35c; pk. \$2.40; bus. \$9.00.

Large Podded Alaska (Ameer). Vines 30 inches high unbranched, bearing four to seven 3-inch pods pointed and well filled with medium size dark green peas of excellent flavor. Season 58 to 60 days. ½ pt. 10c; pt. 15c; qt. 25c; pk. \$1.75; bus. \$6.50.

Buist's Extra-early Morning Star. The earliest Pea in the world. Ready for picking in 58 days. They are much hardier, more productive, and withstand greater changes of weather than any other variety. The largest-podded extra early, and entirely free from runners. So uniformly do they ripen that the entire crop can be taken off in two pickings. ½ pt. 10c; pt. 20c; qt. 35c; pk. \$2.40; bus. \$9.00.

American Wonder. The earliest wrinkled Pea. Vines grow 10 to 12 inches high and are very prolific in pods of striking form and size and of the finest flavor. If planted in June they mature in 33 days. Particularly adapted for family use, requiring no brush or other support. Season 60 days. ½ pt. 10c; pt. 20c; qt. 35c; pk. \$2.40; bus. \$9.00.

Nott's Excelsior. A fine, compact, dwarf grower, with pods one-third larger than those of American Wonder, and maturing almost as early (55 days). Pods well filled to the ends with from 7 to 9 Peas, of superior tenderness and flavor. Vines grow about 15 inches high. Season 59 days. ½ pt. 10c; pt. 20c; qt. 35c; pk. \$2.40; bus. \$9.00.

Abel's Giant Podded Hamper. A new pea introduced by our grower. Dark green foliage and pods, a vine 22 inches, heavy and dark in color, pods 4½ to 5 inches, pointed. Don't fail to plant Giant Hamper and we assure you that every year you will want Giant Hamper. Season 65 days. Seed large, wrinkled. ½ pt. 15c; pt. 25c; qt. 40c; pk. \$2.80; bus. \$10.75.

Gradus (Prosperity). An extra-early wrinkled Pea, hardy and very profitable, about 2½ feet high. One of the most widely known varieties in cultivation. The reason is that it produces a Telephone pod nearly as early as Alaska. Ready for market in 60 days. ½ pt. 10c; pt. 20c; qt. 35c; pk. \$2.40; bus. \$9.00.

Extra-early Blue Bantam. The best first-early dwarf wrinkled Pea. The dwarf, vigorous vines average 15 inches high and carry enormous crops of large, deep bluish green pods. Its pointed pods, generally borne singly, measure 4 to 4½ inches long and are tightly packed with 8 to 10 large, deep bluish green Peas. Season 60 days. ½ pt. 10c; pt. 20c; qt. 35c; pk. \$2.40; bus. \$9.00.

Little Marvel. Dwarf variety that resembles in size, quality, and quantity Nott's Excelsior, but has larger pods, which are set heavily on vigorous vines about 15 inches in height. Season 63 days. ½ pt. 10c; pt. 20c; qt. 35c; pk. \$2.40; bus. \$9.00.

Telephone. Medium-late, wrinkled, productive variety growing 4 feet high with long, slightly curved pods. Peas of large size and best quality. Season 72 days. ½ pt. 10c; pt. 20c; qt. 35c; pk. \$2.40; bus. \$9.00.

Alderman. Large-podded, wrinkled Pea of robust habit. Pods 5 to 6 inches long, well filled with Peas of excellent flavor. Grows 5 to 6 feet tall. Season 72 days. ½ pt. 10c; pt. 20c; qt. 35c; pk. \$2.40; bus. \$9.00.

Dwarf Telephone (Carter's Daisy). Dwarf, stocky, healthy, vigorous plants frequently bearing 5 to 7 pods, often 5 inches long, remarkably well filled, containing as many as 10 delicious Peas. Height 18 inches. Season 75 days. ½ pt. 10c; pt. 20c; qt. 35c; pk. \$2.40; bus. \$9.00.

Laxtonian. A giant-podded dwarf, extra-early wrinkled Pea that grows only 1½ feet high and requires no support. The enormous pods are dark green, well filled with Peas of fine flavor, and measure 4½ inches in length. Season 67 days. ½ pt. 10c; pt. 20c; qt. 35c; pk. \$2.40; bus. \$9.00.

Thomas Laxton. An early, large-podded Pea which is very hardy and a strong grower, producing pods in abundance. The habit and growth of vine resemble Gradus, although the color is darker and pods more blunt. Pods well filled with large, very sweet Peas. Matures as early as many of the smooth extra-early Peas and may be planted at same time. Season 62 days. Height 3 feet. ½ pt. 10c; pt. 20c; qt. 35c; pk. \$2.40; bus. \$9.00.

Laxton's Progress. Season 64 days. Vine 15 inch, dark and heavy. The pods are 4½ inches, dark pointed. ½ pt. 10c; pt. 20c; qt. 35c; pk. \$2.40; bus. \$9.00.

EDIBLE POD VARIETIES

The pods of this particular class are as easily cooked as snap beans and have all the sweetness and flavor of fresh green peas. Until the pods are partly filled out they are prepared in the same way as snap beans, and after the seeds are developed they are very good as shelled peas. Their excellent qualities are not generally known but wherever tried they become popular on account of their high quality and two-fold usefulness. We suggest that you become acquainted with one of the excellent varieties listed below.

Mammoth Melting Sugar Peas. (White blossom.) A fine new variety that produces an abundance of large, broad pods. Height 4 feet. Season 84 days. ½ pt. 15c; pt. 25c; qt. 40c; pk. \$2.80; bus. \$10.75.

Mammoth Luscious Sugar Peas. (Purple blossom.) Height 3 feet. Season 80 days. ½ pt. 15c; pt. 25c; qt. 40c; pk. \$2.80; bus. \$10.75.

Dwarf Gray Sugar Peas. (Purple blossom.) Height 2 feet. Season 62 days. ½ pt. 15c; pt. 25c; qt. 40c; pk. \$2.80; bus. \$10.75.

Dwarf White Blossom. Very sweet, light green pods. Seeds white. Grows about 20 inches. Season 62 days. ½ pt. 15c; pt. 25c; qt. 45c; pk. \$3.50; bus. \$12.00.

PUMPKINS

Pumpkins are less sensitive than melons or cucumbers to unfavorable conditions of soil and weather. Their cultural requirements are however, much the same. They are raised between hills of corn or in open field, but more properly belong to the farm than the garden as they occupy too much room for the ordinary yard. Wherever room is available a few hills of pumpkins should be planted as they are peculiar to American cookery and constitute one of our most nutritious and pleasing dishes.

Japanese. Similar to the Cushaw, but the skin is a deep green, with dark stripes, turning to a rich golden yellow. Fruits mature early. The large neck is solid and meaty. Flesh deep yellow. Pkt. 5c; oz. 15c; ¼ lb. 40c; ½ lb. 60c; lb. \$1.00.

White Cushaw (Jonathan). A popular crookneck with a hard, creamy white shell. Fruits 2 feet long, with long, solid, meaty neck. Thick flesh of fine quality. Price 5c; oz. 15c; ¼ lb. 40c; ½ lb. 60c; lb. \$1.00.

Yellow Cushaw. A crookneck variety of rich golden color and fine flavor. One of the best varieties for home use. Pkt. 5c; oz. 15c; ¼ lb. 40c; ½ lb. 60c; lb. \$1.00.

Striped Cushaw. Skin is striped with creamy white bands mottled green. Rich, yellow meat, tender, and of fine flavor. Pkt. 5c; oz. 15c; ¼ lb. 40c; ½ lb. 60c; lb. \$1.00.

Genuine Mammoth Jumbo (King of the Mammoths). Fruits grow 2 feet or more in diameter, and from 100 to 200 pounds in weight. Salmon-orange skin; very thick, bright yellow flesh, which is fine grained, tender, and of excellent quality for pies. Pkt. 5c; oz. 15c; ¼ lb. 45c; ½ lb. 70c; lb. \$1.25.

Small Sugar. Fruits average about 10 inches in diameter, of excellent keeping qualities, flattened or slightly ribbed. Skin deep orange-yellow; flesh very sweet. Pkt. 5c; oz. 10c; ¼ lb. 35c; ½ lb. 60c; lb. 90c.

Big Tom (Improved Large Field). Vines of strong, vigorous growth and wonderfully prolific. Fruits average 15 to 20 inches in diameter, round or slightly oval in form; reddish orange skin, slightly ribbed; rich orange-yellow flesh. Pkt. 5c; oz. 10c; ¼ lb. 30c; ½ lb. 50c; lb. 75c.

Large Cheese. Our pedigreed strain, exceptionally early and uniform is particularly valuable to market gardeners and canners. Fruits very flat, weigh 10 pounds, slightly ribbed, cream colored, flesh very thick, orange-yellow and of fine quality. Length 6 to 8 inches, diameter 12 inches. Pkt. 5c; oz. 15c; ¼ lb. 40c; ½ lb. 60c; lb. \$1.



Abel's Sparkler White Tip

RADISH

One ounce of seed will sow 100 feet of drill; 8 to 10 pounds an acre

The culture of radishes is so easy and the results so sure that they are probably found in more home gardens than any other vegetable. The varieties of radish differ so distinctly and cover such a wide range of choice that the home gardener is able to obtain almost anything he prefers in the way of shape, color, size and season.

The ground for growing radishes should be finely prepared and as free as possible of small stones and lumps. Plant seed about ½ inch deep in rows 12 to 18 inches apart and when up about an inch thin to 1 or 2 inches apart. Radishes are at their best when the growth is quick and steady. A moderate temperature and constant moisture are favorable for best results. Most varieties become pithy soon after reaching full size. In order to maintain a continued supply, successive plantings should be made.

Abel's Sparkler. Small, round roots with bright scarlet top, a clear white base, and small, slender tap-root. Flesh juicy, pure white, of agreeably snappy flavor. Pkt. 5c; oz. 10c; ¼ lb. 25c; ½ lb. 45c; lb. 75c; 2 lbs. \$1.25.

Abel's Rapid Red. Small, perfectly round, with thin, bright red skin; flesh pure white, crisp. Ready for market in 20 to 25 days. Pkt. 5c; oz. 10c; ¼ lb. 25c; ½ lb. 45c; lb. 75c; 2 lbs. \$1.25.

Crimson Giant Globe. Suitable both for forcing or planting outdoors. In shape it is round to oval and very attractive. The flesh is mild and tender. Grows to a larger radish than in its class yet retains its crispness and solidity. Pkt. 5c; oz. 10c; ¼ lb. 25c; ½ lb. 45c; lb. 75c; 2 lbs. \$1.25.

Olive Shaped Early Scarlet (Short Top). Our pedigreed stock of this popular variety is outstandingly good and well adapted to both field culture and greenhouse forcing. Roots globular, very slightly elongated with medium top, bright scarlet, crisp, tender and fine quality. Pkt. 5c; oz. 10c; ¼ lb. 25c; ½ lb. 45c; lb. 75c; 2 lbs. \$1.25.

White Pearl or Pearl Forcing. A beautiful pearly white, half stump-rooted Radish that is very firm and solid and remains in good condition for two weeks before becoming woody or showing any signs of going to seed. Pkt. 5c; oz. 10c; ¼ lb. 25c; ½ lb. 50c; lb. 90c; 2 lbs. \$1.70.

White Icicle. The finest of all long Radishes and quite distinct. Roots of good size, shaped like an icicle, straight, free from any side roots. Flesh crisp and tender, even when fully developed. For either spring or fall sowing. Pkt. 5c; oz. 10c; ¼ lb. 25c; ½ lb. 45c; lb. 75c; 2 lbs. \$1.25.

Long White Vienna (Lady Finger). Grows to good size without becoming pithy or tough. Flesh pure white, and juicy. Use rich, moist soil which has been prepared deeply. Pkt. 5c; oz. 10c; ¼ lb. 25c; ½ lb. 45c; lb. 75c; 2 lbs. \$1.25.

White Strasburg. Roots 4 to 5 inches long and 2 inches in diameter; flesh white, mild and crisp. Pkt. 5c; oz. 10c; ¼ lb. 25c; ½ lb. 45c; lb. 75c; 2 lbs. \$1.25.

Chartiers (Shepherd). Attractive roots of bright crimson, tipped with white; flesh white, crisp, and of fine flavor. Easily grown and very delicious, with agreeably snappy flavor. Pkt. 5c; oz. 10c; ¼ lb. 25c; ½ lb. 45c; lb. 75c; 2 lbs. \$1.25.

French Breakfast. Oval or olive-shaped; clear red, tipped white. Pkt. 5c; oz. 10c; ¼ lb. 25c; ½ lb. 45c; lb. 75c; 2 lbs. \$1.25.

Cincinnati Market. Clear bright rose-red counterpart of Icicle. Equally crisp and refreshing. Pkt. 5c; oz. 10c; ¼ lb. 25c; ½ lb. 45c; lb. 75c; 2 lbs. \$1.25.

California Mammoth White Radish. This is an exceptionally fine winter variety. Growing about 8 inches long and is about 2¼ inches thick and cylindrical. Pkt. 5c; oz. 10c; ¼ lb. 25c; ½ lb. 45c; lb. 75c; 2 lbs. \$1.25.

WINTER RADISHES

One ounce of seed will sow 100 feet of row

These require cool weather at the finish of their growing season, though they may be started during hot weather. Make your first planting the middle of June, second middle of July, third middle of August. Sow thinly in rows not less than 15 inches apart; thin out to stand 6 inches apart. Easily stored for winter use.

Chinese Rose (Scarlet China). Roots medium size, 4 to 5 inches long; skin deep rose; flesh white, firm, compact, free from any hard fiber or strings. Pkt. 5c; oz. 10c; ¼ lb. 25c; ½ lb. 45c; lb. 75c; 2 lbs. \$1.25.

Long Black Spanish. Roots 7 to 10 inches long, 2 to 3 inches thick; skin black; flesh pure white, firm, juicy, and has a good snappy flavor. Will keep in perfect condition all winter long if stored in a frostproof cellar. Pkt. 5c; oz. 10c; ¼ lb. 25c; ½ lb. 45c; lb. 75c; 2 lbs. \$1.25.

Round Black Spanish. Firm, crisp, white flesh. Skin black. Nearly round, four inches in diameter. Pkt. 5c; oz. 10c; ¼ lb. 25c; ½ lb. 45c; lb. 75c; 2 lbs. \$1.25.

White Chinese (Celestial). Roots cylindric, 12 to 15 inches long, with a diameter of 5 inches; flesh crisp, juicy, tender, agreeably mild in flavor. Pkt. 5c; oz. 10c; ¼ lb. 25c; ½ lb. 45c; lb. 75c; 2 lbs. \$1.25.

RUTABAGA

Improved Purple-top. This special strain of Rutabaga is remarkable for uniform shape and fine quality, and is also a splendid keeper. The roots grow to large size, skin smooth, and flesh beautiful yellow and fine grained. The flavor is good, being very sweet and tender. Pkt. 5c; oz. 10c; ¼ lb. 30c; lb. 80c.

Early Neckless Rutabaga. A new variety of Improved Purple Top Yellow Rutabaga, having no neck at all, and in our opinion, the finest table quality of Rutabaga on the market. It has the added feature that it grows in two to three weeks less time than most standard stocks of rutabaga, and it can therefore be planted two to three weeks later in the fall than the usual type. Pkt. 5c; oz. 10c; ¼ lb. 25c; ½ lb. 45c; lb. 75c.

RHUBARB

Good plants are easily grown in any good garden soil. Sow seed thinly in shallow drills a foot apart and thin to 4 to 5 inches. Keep soil loose and free from weeds. The plants vary considerably. Pick out the strongest and best. In fall or spring following, transplant to the permanent bed, 4 feet apart each way, in deep warm, rich soil. **Victoria.** The most popular variety. Comes quite true from seed. Pkt. 5c; oz. 15c; ¼ lb. 50c; lb. \$1.50.

SALSIFY

(Vegetable Oyster Plant)

One of the most desirable winter vegetables. The roots when cooked are very palatable and nutritious and are served in a variety of ways. The flavor is similar to oysters. Salsify succeeds best in a light, well enriched soil, which should be stirred to a good depth. Coarse and fresh manure should be avoided, as it will surely cause the roots to become irregular and much branched. Sow early and quite deep, giving the general culture recommended for parsnip. The roots are perfectly hardy and may remain out all winter, but should be dug early in spring as they deteriorate rapidly after growth commences. Frost does not injure the roots, but before the ground freezes a quantity for winter use may be stored in a pit or in a good cellar.

Mammoth Sandwich Island. Makes fine large roots of delicious flavor. The best variety. Pkt. 5c; oz. 15c; ¼ lb. 50c; lb. \$1.50.

SPINACH

Sow 1 ounce of seed to 100 feet of drill

Sow in rows 16 to 20 inches apart and thin to 6 inches apart in the row when leaves are an inch wide. In the North seed can be planted as soon as the ground can be prepared. In the South spinach will winter over with little or no protection. The soil for spinach should be as rich as practicable. The size and quality of the leaves is much increased by the richness of the soil.

Bloomsdale. Savoy-leaved, very early, and one of the best for fall or early spring planting. Leaves dark green, medium size, and crumpled. Pkt. 5c; oz. 10c; ¼ lb. 15c; lb. 35c; 5 lbs. \$1.00; 10 lbs. \$1.80.

Long Standing Bloomsdale. This rather new variety is becoming more popular each year and is very desirable where a curled, dark leaf spinach is desired; does not lay flat on the ground, for it has an upright compact growth. This variety has been bred to eliminate the early seeding. It will stand ten days longer than most varieties before bolting to seed. Pkt. 5c; oz. 10c; ¼ lb. 15c; lb. 35c; 5 lbs. \$1.00; 10 lbs. \$1.80.

Victoria. Leaves large, thick, dark green. Becomes fit for use early and remains in condition a long time. Pkt. 5c; oz. 10c; ¼ lb. 15c; lb. 35c; 5 lbs. \$1.00; 10 lbs. \$1.80.

New Zealand. Entirely distinct variety. Produces a large quantity of leaves. When cut, branches out and makes new growth, producing until frost. For summer use, sow early in spring. Pkt. 5c; oz. 15c; ¼ lb. 25c; lb. 50c; 5 lbs. \$2.00.

King of Denmark. The leaves are large, rounded somewhat, blistered and deep green in color. A rather slow growing variety but remains in good condition a week after some varieties have shot to seed. The plants resemble long season. Pkt. 5c; oz. 15c; lb. 35c; 5 lbs. \$1.00.

Aristocrat. This variety was one of the winners in the All-America trials and was awarded because of the outstanding qualities. The leaves are extremely large and heavy curled, the plants are of a deep dark green color and very slow in running to seed and have a compact habit. We consider this a first class variety for spring sowing. We suggest you try the Aristocrat and we are sure you will agree with us that it is the best type of savoy spinach existent. Pkt. 5c; oz. 15c; ¼ lb. 25c; lb. 50c; 5 lbs. \$2.00.

Virginia Blight Resistant Spinach. This variety only advisable in sections where soil is infested with mosaic blight or yellow. This type equal to Bloomsdale. Plants are quick in running to seed and not so suitable for spring planting. Pkt. 5c; oz. 10c; ¼ lb. 15c; lb. 35c; 5 lbs. \$1.00; 10 lbs. \$1.80.

SQUASH

Bush sorts: Sow 1 ounce to 50 hills; 6 pounds per acre
Running sorts: Sow 1 ounce to 16 hills; 4 pounds per acre



EARLY WHITE BUSH SCALLOP SQUASH

Early explorers of North America found squashes growing in widely separated regions. Like maize and potatoes they seem to be natives of this country. For generations squash and its near relative, the pumpkin, have been staple vegetables in the American household and have formed one of our most nutritious and valuable articles of food.

There are two distinct classifications of squash which, owing to their habits of

growth and difference in character, are generally referred to as "Summer" and "Winter" Squashes.

In general the culture of squashes is the same as that of pumpkins and melons, the trailing varieties requiring as much room as pumpkins and the bush varieties take about the same space as cucumbers.

Golden Summer Crookneck. Golden yellow fruit; early and prolific. Pkt. 5c; oz. 15c; ¼lb. 45c; ½lb. 80c; lb. \$1.50.

White Bush Scallop. Early. A good market sort. Pkt. 5c; oz. 15c; ¼lb. 45c; ½lb. 80c; lb. \$1.50.

Golden Hubbard. Similar to the standard sort except in color. Pkt. 5c; oz. 15c; ¼lb. 45c; ½lb. 80c; lb. \$1.50.

Hubbard. The standard winter Squash. Pkt. 5c; oz. 15c; ¼lb. 45c; ½lb. 80c; lb. \$1.50.

Fordhook's. Most desirable for both summer and winter use. Fruit oblong, 8 to 10 inches in length, slightly ridged; smooth, thin, yellowish skin; flesh very thick and of light straw-yellow. Pkt. 5c; oz. 15c; ¼lb. 45c; ½lb. 80c; lb. \$1.50.

Italian Vegetable Marrow (Cocozella). Produces a good crop of practically straight squash on a bush similar to Crookneck, but the leaves are somewhat different in appearance. The fruit is mottled dark and light green, later being marbled with yellow. Measure about 15 inches long. Pkt. 10c; oz. 20c; ¼lb. 55c; ½lb. 75c; lb. \$1.25.

SWISS CHARD or SPINACH BEET

Lucullus. The stalks are as thick and broad as those of rhubarb, being 1½ inches broad, heavily ribbed, and from 10 to 12 inches long below the leaf. The extra-large leaves of thick texture are heavily crumpled or "savoyed" and of fine flavor. Pkt. 5c; oz. 15c; ¼lb. 35c; ½lb. 50c; lb. 90c.

ABEL'S NORTHERN GROWN SEED POTATOES

Seed Potato Buyers Please Note.—At the time of going to press with this Catalogue the Potato Market is so unsettled that we are unable to name prices. Please write stating kind and quantity wanted and we will quote by letter.

Pure Early Rose, Bliss Early Triumph, Irish Cobbler, Green Mountain or Improved State of Maine, Spaulding Rose No. 4, Vermont Gold Coin, and Dibble's Russet.

QUAKER BRAND FIELD SEEDS

All our seeds have been re-cleaned and graded. If you have not sowed Abel's Quaker Brand Field Seeds before, don't put off until next season. Sow this season and see the difference in Quaker Brand.

We are unable to quote prices as Field Seeds are controlled by the market and subject to change without notice. Write us for samples and prices.

TOMATO

One ounce of seed will produce about 2000 plants

Of all vegetables, the long bearing season and productive capacity of the tomato together with its wide range of usefulness and high vitamin content make it one of the most valuable and helpful of cultivated plants. A portion of the garden devoted to tomatoes will furnish a constant supply of fresh fruit sufficiently for the family over a period of two months or more.

The seed is usually planted indoors about May 1st, using shallow boxes or flats and plant in rows about 2 inches apart. Any small container or pot will do at first for a small quantity. As soon as the seedlings are about an inch high they are "pricked out" into a larger box, spacing them about 4 inches apart; rich, loose soil is very helpful. When the weather has moderated they should be gradually hardened off or acclimated to the outside temperature. A warm, sheltered spot where they can be protected at night or in case of frost is highly desirable. About 6 weeks after seed is sown the plants are ready for setting in their permanent location. By making allowance for differences in climatic conditions, usually based on the probable date of the last killing frost in spring, every gardener can decide the approximate time for planting in his own neighborhood.

To insure early ripening and perfection of fruit it is advisable to train up and trim the vines. Unstaked they require spacing of 4 to 5 feet but staked plants may be set 2½ feet apart, since the growth is all upright.

Abel's Market Champion. This magnificent new main crop tomato possesses all the good qualities to make it the ideal tomato for market and the home garden. The vines are large, hardy and productive. The fruits are bright scarlet, oval and deep, exceptionally smooth, ripening evenly to the stem without cracking. This new introduction of ours is the best of all tomatoes for canning and is unsurpassed as a money-maker for the market gardener. Pkt. 5c; ½oz. 25c; oz. 50c; ¼lb. \$1.75; lb. \$6.00.

Abel's Oxheart. Delicious meaty variety with few seeds. Deep heart shape; smooth; rich pink. Pkt. 5c; ½oz. 35c; oz. 55c; ¼lb. \$1.65; ½lb. \$3.00.

Beefsteak. Large size, solid and smooth. Similar to Ponderosa except in color. Pkt. 5c; ½oz. 35c; oz. 55c; ¼lb. \$1.65; ½lb. \$3.00.

Bonny Best. As early as John Baer. Smooth, uniform fruit. Bears well until frost. Pkt. 5c; ½oz. 20c; oz. 30c; ¼lb. 90c; ½lb. \$1.75; lb. \$3.00.

Earliana. Earliest large red. Pkt. 5c; ½oz. 20c; oz. 30c; ¼lb. 90c; ½lb. \$1.75; lb. \$3.00.

Marglobe. Withstands long periods of wet and unfavorable weather, yet produces a maximum crop of large, well-rounded, scarlet-red fruits. Plants resistant to nail-head rust and fusarium wilt. Pkt. 5c; ½oz. 25c; oz. 40c; ¼lb. \$1.15; ½lb. \$1.90; lb. \$3.50.

Matchless. A very large sort. Foliage and habit of growth compact and upright. Fruit smooth, early, and purplish red. Pkt. 5c; ½oz. 20c; oz. 30c; ¼lb. 90c; ½lb. \$1.75; lb. \$3.00.

Rutgers Tomato. This tomato in shape is very similar to the Marglobe with the exception that it is somewhat flatter at the blossom end. The one distinct advantage with the Rutgers has over other varieties is that it ripens from the inside to the outside so that when the tomato is ripe on the outside you have a tomato ripe all of the way through. The foliage is heavy and it is a heavy cropper. Pkt. 5c; ½oz. 25c; oz. 40c; ¼lb. \$1.15; ½lb. \$1.90.

Pritchard or Scarlet Topper. 95 days. A scarlet, self-topping disease-resistant variety originated by the late Dr. F. J. Pritchard of the United States Department of Agriculture in 1931. It is a cross between Marglobe and Cooper's special. Fruits large, smooth, globular, solid with thick walls and cross sections, color light scarlet. Highly valuable for market garden use and long distance shipping. Pkt. 5c; ½oz. 25c; oz. 40c; ¼lb. \$1.15; ½lb. \$1.90.



Marglobe

WATERMELON

Sow 1 ounce of seed to 30 hills; 4 to 5 pounds per acre

The requirements for raising watermelons are practically the same as for muskmelon except that the vines are more spreading and require considerably more room.

If the hills are liberally manured and cultivation is careful and thorough any home gardener can have these delicious fruits fresh from his own patch.

Plant in hills as directed for muskmelon and treat the same in all respects except that the hills should be about 8 feet apart.

Cut-Red Watson. There has never been, so far, a Watermelon introduced that became as popular as the Watson. It will be planted commercially for a long time yet,—provided the seed planted are of known quality. Some complaint has been in evidence about the Watson variety cutting with hard centers and almost worthless for market, which caused me to work on this melon with the view of breeding up a type that eliminates the strain that produces hard white centers. I have been very successful in this work and have perfected a strain of Watson that cuts red and sweet and grows big, glossy green melons, frequently growing 50 to 60 pounds in weight; produces melons 18 to 24 inches long by 10 to 12 inches in diameter; seeds light brown smeared with darker brown; time for ripening, 95 days. Pkt. 5c; oz. 10c; ¼lb. 25c; ½lb. 45c; lb. 75c.

Stone Mountain. The originator of this outstanding variety combined extra-large size with earliness. In addition it combines nearly round, symmetrical shape with a very pleasing green color and produces a melon of unexcelled succulence and sweetness. Fruits weighing 60 to 80 pounds are produced in the South, and the 95 days required for maturity make it easily possible to produce correspondingly large fruits in the North. Pkt. 5c; oz. 10c; ¼lb. 25c; ½lb. 45c; lb. 75c.

Georgia Rattlesnake (Gypsy). This old southern favorite is one of the largest and best adapted for the home-garden. It has the most conspicuous striping of the oblong types. The rind is moderately thick and strong and the flesh is juicy and sweet. A very desirable white-seeded variety but useful only where summers are short. Pkt. 5c; oz. 10c; ¼lb. 25c; ½lb. 45c; lb. 75c.

Improved Kleckley's Sweet. Vines vigorous and productive. Flesh bright red and exceedingly sweet. Pkt. 5c; oz. 10c; ¼lb. 25c; ½lb. 45c; lb. 75c.

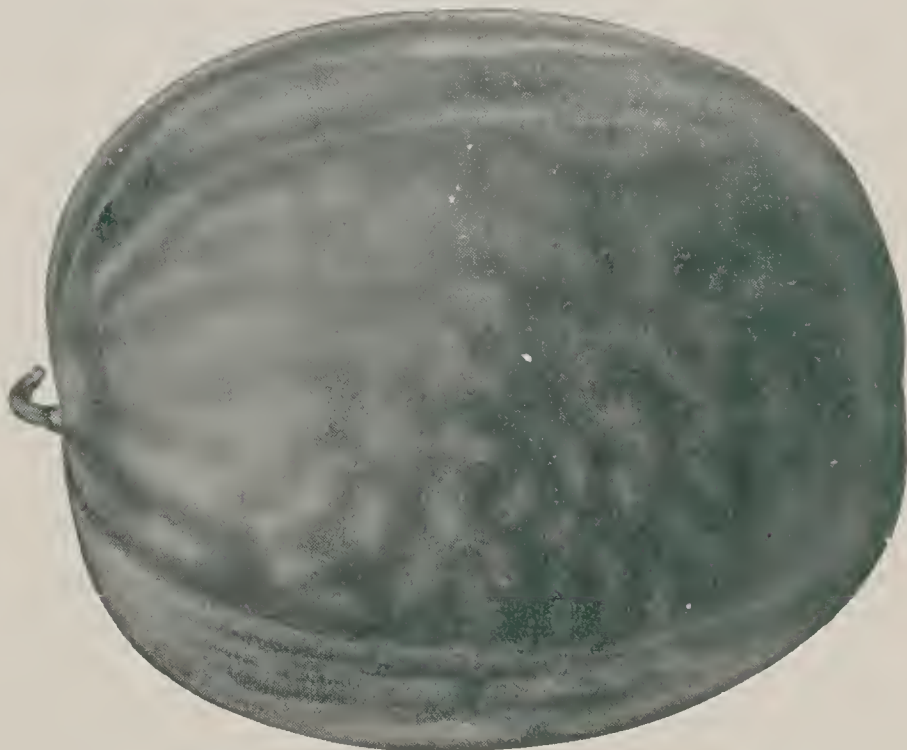

Stone Mountain

Abel's Sugar Stick. Vines strong, vigorous, setting many melons measuring from 20 to 24 inches in length, with an average weight of 30 pounds. Rind thin and tough; skin light grayish green with narrow darker green lines, giving a mottled effect of small half-inch squares; flesh deep, rich red, with broad, solid heart, crisp and sugary. Pkt. 5c; oz. 10c; ¼lb. 25c; ½lb. 45c; lb. 75c.

Sweetheart. Large, heavy, oval or round fruit; skin very pale green, with distinct netted lines of slightly darker shade; flesh solid, deep red. Bears shipping well. Pkt. 5c; oz. 10c; ¼lb. 25c; ½lb. 45c; lb. 75c.

Halbert Honey. Very large, long fruits, having blunt ends and often weighing 50 pounds. The dark green rind is very thin, while the flesh is a rich crimson. Very prolific. Pkt. 5c; oz. 10c; ¼lb. 25c; ½lb. 45c; lb. 75c.

Dixie. Large, oblong melons; skin dark green, with a remarkably thin rind; flesh intense deep bright scarlet, very sweet, tender and juicy. Quite early. Very productive. A fine shipper. Pkt. 5c; oz. 10c; ¼lb. 25c; ½lb. 45c; lb. 75c.

Burpee's Dwarf Giant. The largest fruited of all dwarf varieties, individual fruits often weighing from 10 to 20 ounces each. Pinkish red flesh, almost seedless, and rich purple-crimson skin. The flesh is "solid as a rock." Pkt. 10c; ½ oz. 40; oz. 65c; ¼ lb. \$1.95; ½ lb. \$3.35; lb. \$5.50.

Stone. A remarkable main-crop variety. Robust, solid, very little seed cavity; extremely productive. Pkt. 5c; ½oz. 20c; oz. 30c; ¼lb. 90c; ½lb. \$1.40; lb. \$2.50.

Dwarf Stone. Large, fruited dwarf sort; color bright scarlet. Pkt. 5c; ½oz. 25c; oz. 40c; ¼lb. \$1.15; ½lb. \$1.90; lb. \$3.50.

Ponderosa. The largest Tomato. Pkt. 5c; ½oz. 25c; oz. 40c; ¼lb. \$1.15; ½lb. \$1.90; lb. \$3.50.

Golden Queen. A large, smooth yellow variety. Pkt. 5c; ½ oz. 20c; oz. 35c; ¼lb. \$1.20; ½lb. \$2.20; lb. \$4.00.

Trucker's Favorite. Fruit of regular size and form, meaty, very evenly colored deep rich purplish red from stem to blossom end. Matures between the midseason and main-crop varieties. Pkt. 5c; ½ oz. 20c; oz. 30c; ¼ lb. 90c; ½ lb. \$1.75; lb. \$3.00.

Chalk's Early Jewel. The largest, smoothest, and finest flavored extra-early bright red Tomato. A heavy cropper throughout the season. Pkt. 5c; ½ oz. 20c; oz. 30c; ¼ lb. 90c; ½ lb. \$1.75; lb. \$3.00.

Abel's Greater Baltimore. A main-crop Tomato with large, scarlet-red fruits not unlike Matchless. Popular with canners because it yields heavily. Pkt. 5c; ½oz. 20c; oz. 30c; ¼lb. 90c; ½lb. \$1.40; lb. \$2.50.

John Baer. A few days later than Earliana but more uniform, attractive, and productive. The most profitable extra-early variety. Pkt. 5c; ½oz. 20c; oz. 35c; ¼lb. 90c; ½lb. \$1.40; lb. \$2.50.

Penn State (New). Developed by Dr. Myers of Penn State College. The plants are of the self-topping type, with short, thick vines, which allow them to be set close together. The medium sized, scarlet-red fruits are borne in clusters of 4 to 6 to a plant, and are smooth, slightly flattened, solid, and of superb quality. Pkt. 10c; ½oz. 45c; oz. 80c; 4 ozs. \$2.40; ½lb. \$4.40; lb. \$8.00.

PRESERVING TOMATOES

The following small-fruited varieties are used for making preserves and are quite ornamental: Pear-shaped Red, Pear-shaped Yellow, Yellow Plum, Yellow Cherry, Red Cherry, Red Currant, Red Peach, Strawberry or Ground Cherry. Each, pkt. 5c; ½ oz. 25c; oz. 40c; ¼ lb. \$1.35; lb. \$5.00.

TURNIP

A planting of turnips in the home garden will furnish a supply of nourishing greens during the summer months when the spring greens such as spinach and beets are usually exhausted. Turnips serve the dual purpose of providing quickly grown greens and a subsequent crop of useful roots.

For summer use sow early in spring in rows ½ to 2 feet apart. Plant seed about a half inch deep and press the soil down firmly and smoothly. When the seedlings appear give a liberal application of tobacco dust to prevent injury by flea-beetles and root maggots. As soon as the plants are about an inch tall thinning should be started and carried on as recommended for beets. For fall and winter use the seed may be planted as late as August.

Long White (Cow-Horn). Rather slender, tapering roots, 6 to 8 inches long, 1½ to 2 inches in diameter at the shoulder and usually slightly curved in form. The roots grow half their length above the surface, and are pure white, with crisp, sweet flesh. Pkt. 5c; oz. 10c; ¼lb. 20c; ½lb. 30c; lb. 50c; 5 lbs. \$2.00.

Orange Jelly or Golden Ball. This is the best and most deliciously flavored of the yellow-fleshed Turnips. It is small topped, of rapid growth, and keeps exceptionally well. The roots are of medium size, very smooth, and deep yellow skinned. Flesh is firm, crisp and of excellent quality. At a diameter of 3 inches the roots are prime for table use. Pkt. 5c; oz. 10c; ¼lb. 20c; ½lb. 30c; lb. 50c; 5 lbs. \$2.00.

Seven Top Turnip. A turnip that produces an abundance of spreading foliage, and is widely used in the South for the production of turnip greens, and also as stock feed. Though it produces a moderate sized bulb, it is more particularly used for its abundant foliage. Pkt. 5c; oz. 10c; ¼lb. 20c; ½lb. 30c; lb. 50c; 5 lbs. \$2.00.

Red or Purple-Top Flat Strap-leaved. Does well sown either broadcast or in drills, and will form good-sized bulbs. Pkt. 5c; oz. 10c; ¼lb. 20c; ½lb. 30c; lb. 50c; 5 lbs. \$2.00.

White Egg. A splendid table variety, growing to a good size. Skin clear white, tender, and most ornamental in appearance when washed for market. Flesh fine grained, of mild, sweet flavor. Pkt. 5c; oz. 10c; ¼lb. 20c; ½lb. 30c; lb. 50c; 5 lbs. \$2.00.

Red or Purple-Top White Globe. Grows very quickly to large size, measuring 6 inches and more in diameter, and of perfect globe form, the upper portion rich purplish red, and the lower half clear creamy white. Flesh white, firm and crisp, of mild flavor. Pkt. 5c; oz. 10c; ¼lb. 20c; ½lb. 30c; lb. 50c; 5 lbs. \$2.00.

Large Yellow (Amber Globe). An excellent Turnip with smooth, oval roots, thick and broad at the shoulder. Skin smooth, pale amber; flesh, rich creamy yellow of excellent flavor. Pkt. 5c; oz. 10c; ¼lb. 20c; ½lb. 30c; lb. 50c; 5 lbs. \$2.00.



Purple Top White Globe Turnip

ABEL'S INSECTICIDES AND FUNGICIDES

Due to fluctuating market, prices on Insecticides and Fungicides are subject to change without notice.



ANSUL FORMALDEHYDE DUST. Eliminate losses and poor stands of flowers and vegetables. Most soils contain the "damping-off" and root rotting germs. The best seeds planted in soil containing an abundance of these germs will germinate poorly and show poor stands. Treat with Ansul Formaldehyde Dust. It is safe, economical and easy to apply. Steam sterilization or seed treatment unnecessary. 1 lb. can 75c; 5 lb. can \$2.00; 25 lbs. \$5.50; 50 lbs. \$9.00.

ANTROL is easy to use, economical, and safe around children and pets. Can be used inside or outside the house. Consists of small glass containers from which the worker ants carry special Antrol Syrup to their nests for food. The whole ant family is quickly killed at the source—the only way to get permanent freedom from these pests. Antrol containers are practically unbreakable glass, with rust-proof, water-proof aluminum lids. Control both sweet and grease-eating ants. Prices—Antrol Ready-filled set, containing 4 filled feeders, 40c; Antrol Regular Set, 4 containers and 4-oz. bottle syrup—enough for two fillings, 75c; Antrol Syrup for refilling, 4-oz. bottle, 35c; Pint bottle, 85c.



APHISTROGEN should be used whenever aphids appear—two ounces to the gallon of water. Spray with pressure so that it may reach the lower parts of the foliage as well as the entire plant. Wet the insects. Two to three sprayings a day or two apart should eliminate the aphids. Aphistrogen is a contact spray. 2 oz. 50c; ½ lb. \$1.25; 1 lb. \$2.25; 2 lbs. \$3.50; 4 lbs. \$6.50; 12 lbs. \$15.00.

ARSENATE OF LEAD (Dry). Will destroy leaf-eating insects. Mix 2 pounds to 50 gallons water. Lb. 25c; 4 lbs. 70c; 10 lbs. \$1.70; 25 lbs. \$4.00; 100 lbs. \$16.50.

BARKA. A super corn-seed disinfectant for seed corn. 4 ozs. 50c; lb. \$1.75; 5 lbs. \$8.

BORDEAUX MIXTURE (Dry). For all fungoid diseases, mildew, and various rots of grape, etc. 1 lb. 30c; 4 lbs. 96c; 25 lbs. \$5.00; 100 lbs. \$17.00.

BLACK-LEAF 40 (Nicotine Sulphate). Destroys aphids, thrips, etc. 1-oz. bottle 35c; 5 oz. \$1.00; 1 lb. \$2.25; 2-lb. can \$3.25; 5 lbs. \$5.85; 10 lbs. \$10.60; 50 lbs. \$42.50.

CALCIUM ARSENATE. For spraying to kill potato beetles and cabbage worms, and for use on plants having hardy foliage, use 1½ to 2 pounds to 50 gallons water or 2 tablespoons to 1 gallon water. For dusting, dilute with an equal amount of hydrated lime and apply with duster. 1-lb. pack 25c; 4-lb. pack 59c.

C. P. O. (INSECTICIDAL SOAP SPREADER). Odorless, non-poisonous, liquid form. Dilute 1 to 80 to make nicotine, pyrethrum and other insecticidal poisons more effective. Can also be used without insecticidal poisons for control of JUNIPER SCALE, many forms of aphids and certain other insects infesting evergreens, flowering shrubs, fruits and vegetables. 3 ozs. 20c; pt. 60c; qt. \$1.00; 1 gal. \$2.25; 5 gals. \$7.50; 10 gals. \$12.00; 30 gals. \$30.00.



COPPER SOLUTION. The original ammoniated copper so highly recommended by Department of Agriculture as the most effective preventative for mildew, black spot, rust, etc., on roses, and other plants. Highly concentrated—stands dilution 80 to 1. Invisible on foliage or blooms. ½ pt. 50c; pt. 85c; qt. \$1.50; gal. \$4.60; 5 gals. \$20.00.

CYANOGEN A-DUST. For killing the following pests. Rats (in burrows; along ditch banks; in city dumps; under pavements and tight floors; in lumber piles; on poultry farms; in grain elevators and stockyards). Mice (field mice and pine mice.) Moles, Woodchucks (Groundhogs). Diseased bees, Wasps, Yellow Jackets and Hornets. Soil insects in lawns and golf greens. ½ lb. 45c; 1 lb. 75c; 5 lbs. \$3.00.

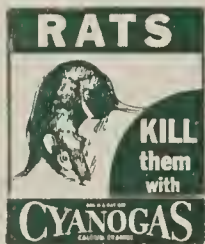

FISH-OIL SOAP. Commonly known as "Whale-oil Soap." Makes an excellent wash for trees and plants. Lb. 35c; 5 lbs. \$1.25.

FLOWERS OF SULPHUR. A staple preventive for mildew on grapes, roses, etc. Lb. 15c; 5 lbs. 50c; 10 lbs. 75c.

FUNGTROGEN, the spray for controlling mildew and black spot. It is well to spray regularly about every five days with this preparation in order to prevent mildew and black spot from getting control of your Roses. Use two ounces to the gallon of water. It is necessary to control mildew and black spot, as they will eventually destroy the plant, and when Fungtrogen is used, not only does it act as a preventive and remedy, but each time you spray with this material the plants are stimulated to better growth and foliage and consequently unusually fine blooms. ½ pt. 75c; pt. \$1.25; qt. \$2; ½ gal. \$3.50; gal. \$6.

GRAPE DUST. To kill mildew of grape-vines; also on other plants or trees affected with mold, mildew, and rust-mites. 5 lbs. \$1.50.

INSECTROGEN is intended for leaf-eating insects of all kinds, including caterpillars, beetles, worms, etc. Use two ounces to the gallon of water. Insectrogen stays on the foliage a long time and is not washed off after rains, placing a protective film on the foliage. Insectrogen is not only a destroyer of the leaf-eating type of insects, but is also a repellent. 4 ozs. 50c; ½ pt. \$1; pt. \$1.75; qt. \$2.75; ½ gal. \$4.50; gal. \$8.00.



CYANOGEN G-FUMIGANT. The positive fumigant for greenhouse fumigation, mushroom house fumigation, warehouse and flour mill fumigation, grain fumigation, seed fumigation, fumigation of growing and dormant nursery stock, soil sterilization (wireworms, millipedes, grubs, and other soil insects.) Fumigating bulbs in storage (gladioli, Narcissi, Iris, etc.) Fumigating tourists' camps, summer camps, bunk houses (for bedbugs, cockroaches, etc.) 5 lbs. \$2.95; 25 lbs. \$10.00; 100 lbs. \$25.00.

CYANOGEN ANT KILLER. Is not a bait! It is different. A small amount injected into the ant nest destroys the entire colony immediately. Spectacularly effective. This 4-oz. tin contains enough Cyanogas to kill a million ants. 4 oz. tin Cyanogas Ant Killer 30c each.



CUPROCIDE protects seeds from damping-off in the ground, prevents seedlings from damping-off above the ground. Use Cuprocide as a dust on seeds and as a spray on plant-bed soil and seedlings. 1 lb. 90c;

5 lbs. \$4.00; 20 lbs. \$14.00; 50 lbs. \$25.

DOG SKAT. Keeps dogs, cats and other animals away from trees, evergreens, roses, shrubbery, etc. Tube releases vapor offensive to animals, but not noticeable to humans. One large tube lasts a year. Large tube 30c.



EVER GREEN. Kills most plant insects, including lice, melon beetles, cabbage worms, mealy bugs, mites, etc. 1-oz. bottle 35c.

JAPANESE BEETLE CONTROL

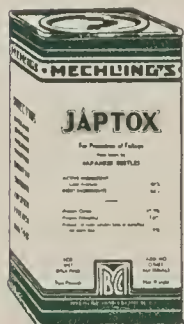

JAPTOX kills and repels Jap beetles. It is a fine powder containing arsenic which, when sprayed on foliage, establishes a very pronounced silvery coating which sticks longer than any other spray material known. Very easy to apply—no inconvenient paste to work with. Not recommended for peach trees. 1-lb. canisters 45c; 2-lb. canisters 85c; 8-lb. canisters \$3.00; 25-lb. drums \$6.50; 100-lb. drums \$18.00.

OLEATE COATED ARSENATE OF LEAD (paste). This is the paste material on which government scientists depended for many years in their fight against Japanese beetles. Not recommended for peach trees. 1-lb. glass jars 45c; 2½-lb. glass jars 90c; 10-lb. iron can \$2.70; 25-lb. drums \$6.00; 100-lb. drums \$16.00.

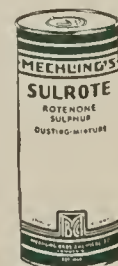

SULROTE is a non-poisonous rotenone-sulphur dusting mixture which has marked ability in repelling Japanese beetles. It is especially effective on roses and recommended in those gardens where poisonous materials are undesirable. 1-lb. canister 40c; 5-lb. bag \$1.00.



LETHANE 440 controls the "hard-to-kill" sucking insects—mealy bugs, scales, red spiders, mites, midges, thrips, white fly, leaf-hoppers, etc. Lethane 440 is quick acting, will not deteriorate, is economical to use. 2 ozs. 35c; 6 ozs. \$1.00; qt. \$3.00; gal. \$8.50; 5 gals. \$35.00.

LIME-SULPHUR (Dry). Widely recommended and known as one of the best preparations for San Jose scale, oyster-shell scale, etc. 1-lb. can 35c; 5 lbs. \$1.35; 12½-lb. bag \$2.00; 25 lbs. \$3.75.

MAGNESIUM ARSENATE. For dusting for control of Mexican bean beetle and for use on plants having tender foliage. Either as wet spray or dust should be applied to under side of leaves. Wet spray, use 4 pounds to 50 gallons water, 4 tablespoons per gallon; when applied as dust, about 12 to 15 pounds to acre. 1-lb. pack 25c; 4-lb. pack 75c.

NAPHTHALENE FLAKES. Useful in controlling Gladiolus thrips. Cyclamen thrips together with certain soil insects. Lb. 15c; 2 lbs. 28c; 10 lbs. \$1.25; 25 lbs. \$3.25.

ABEL'S INSECTICIDES AND FUNGICIDES

Due to fluctuating market, prices on Insecticides and Fungicides are subject to change without notice.

LUCKY STRIKE kills all plant insects on your flowers and vegetables. Lucky Strike is the revolutionary spray that has created a tremendous sensation among entomologists, florists, gardeners. In the opinion of many, it represents the greatest advance that has been made in an insecticide. Lucky Strike is the kind of spray you have long wanted. It contains a substance more deadly to insects than anything else ever discovered . . . yet it does not harm children, animals, or the plants and the delicate flowers on which it is sprayed. 1 oz. 35c makes 4-8 gals.; ¼ pt. 75c makes 15-30 gals.; ½ pt. \$1.25 makes 35-70 gals.; 1 pt. \$2.00 makes 70-140 gals.; 1 qt. \$3.75 makes 140-280 gals.; 1 gal. \$12.00 makes 500-1,000 gals.



LUCKY STRIKE—Concentrated treatment for Roses, Delphiniums, Hollyhocks, etc. Kills chewing and sucking insects both by contact and through stomach. Controls mildew, black spot and certain fungous diseases. Does not discolor or injure tender foliage and blooms. Simply mix with required amount of water and spray. Kit No. 1 makes 16 qts. finished spray 75c; Kit No. 2 makes 64 qts. of finished spray \$2.00.

NO-CROW. Crow repellent. Birds and animals will not bother seed corn or other grain treated with No-Crow. Protects corn and seeds from rot. Does not hinder germination. Not poisonous. One-half pint treats 1 bushel, pint treats 2 bushels, quart treats 4 bushels. ½ pt. 50c; qt. 85c; pt. \$1.25; gal. \$3.50.



NICO-FUME LIQUID. A highly refined solution of free nicotine guaranteed to contain fully 40 per cent nicotine. Used for destroying aphids, thrips, etc. Lb. \$2.25; 8 lbs. \$10.00.

NICO-FUME POWDER. For fumigating in greenhouses to destroy aphids, thrips, etc. 1 lb. can \$1.00; 5 lbs. \$3.35; 10 lbs. \$5.85.

PARIS GREEN. Superior quality. Lb. 45c; 5 lbs. \$2.

PARA-DICHLOROBENZINE (P. T. B.) For peach-tree borers. Lb. 45c; 5 lbs. \$2.00; 10 lbs. \$3.50.

PYROX

NICOTINE PYROX. The new Improved Pyrox. For the first time a spray that kills all garden bugs—both sucking and chewing insects. Controls diseases such as blight and other plant diseases. 10-oz. jars 50c; 5-lb. can \$1.75.

Just mix with water and spray. **SCALECIDE**—the quality miscible oil. Oldest and best known dormant or delayed dormant spray for fruit trees and ornamentals. Easy and pleasant to use. Use 1 to 15 for all deciduous trees, 1 to 20 for evergreens. Kills scale, aphid, red mite and other insects wintering on the trees. It is a complete dormant spray. Invigorates and kills insects. Fall spraying controls scale, peach leaf curl, pear psylla, bud moth case bearer, etc. Spring spraying controls scale, red mite, aphid, red bug, tent caterpillar, leaf miner, case bearer, etc. Qt. 65c; gal. \$1.55; 5 gals. \$5.50; 10 gals. \$9.50; 15 gals. \$13.25; 30 gals. \$21.50; 50 gals. \$29.00. 15, 30, 50 gal. drums refund when returned.



RED ARROW INSECT SPRAY (Pyrethrum Soap). A non-poisonous, efficient insecticide for use against sucking and chewing insects, such as Mexican bean beetles, Japanese beetles, rose-chafers, aphids (plant lice), leaf-hoppers, etc. Oz. 35c; 4 ozs. \$1.00; pt. \$2.00; qt. \$3.70; gal. \$9.50.

ROTENONE DUST. For farmers and commercial growers. Contains ¾% Rotenone. Use as a dust or spray. Leaves no poisonous residue. Kills bean beetles and other resistant crop pests. Lb. 15c; 5 lbs. 65c; 25 lbs. \$2.75; 50 lbs. \$5.25; 100 lbs. \$10.00.

SLUG SHOT DUST. The safe, non-poisonous, dusting insecticide. Kills chewing insects and controls fungus. Harmless to humans, plants and vegetables. Kills Mexican bean beetle, cabbage worms, beetles, potato bugs, green flies, slugs, etc. 1 lb. 25c; 5 lbs. \$1.00; 25 lbs. \$4.00; 125 lbs. \$18.00; 250 lbs. \$34.00.

SNAROL is a ready-prepared meal that you simply broadcast on the ground, under vegetation. Kills cutworms, sowbugs, grasshoppers, slugs, snails, earwigs, etc. It will not deteriorate from rain or sprinkling. Thus it lasts longer and is more economical. It is non-injurious to vegetation. Prices—1½-pound packages 35c; 4-pound packages 85c; 15-pound bags \$3.00; 50-pound bags \$8.00.

SUNOCO SPRAY OIL. For the control of scale insects, red spider, aphid, thrip, etc. Cheap, effective, and pleasant to handle. Gal. \$1.20; 5 gals. \$5.00; 15 gals. \$8.25; 30 gals. \$13.80; 50 gals. \$19.00.

TOBACCO DUST. If dusted on while the foliage is moist, it destroys rose-lice, cabbage and turnip fleas, etc. Also used as a fertilizer. Lb. 10c; 5 lbs. 35c; 10 lbs. 60c; 25 lbs. \$1.25; 100 lbs. \$4.00.



ABEL'S SPECIAL SWEDISH PEAT MOSS (Torf Mull) or German Peat Moss. (G. P. M.) Granulated Peat Moss should be used liberally about the garden or greenhouses, for pot-plants, window boxes, growing bulbs, etc. It is also useful for mulching perennial beds, lawns, roses, etc., and mixing with sandy or clayey soils. Large bale (13 cu. ft.) covers 240 sq. ft. 1 inch deep, \$3.25; 5 bale lots \$3.00 each.



TRI-GEN. The all-purpose spray. A positive plant protection. This complete rose garden spray treatment—Tri-ogen—offers the first definite mildew and black spot control combined with an insecticide. It kills all insects, including the sucking and leaf-eating types. It remains on foliage, repelling subsequent attacks. Tri-ogen also stimulates plant growth, resulting in fine foliage and luxuriant blooms. In four sizes: A. Small Kit (makes 16 quarts) \$1.50; B. Medium Kit (makes 64 quarts) \$4.00; C. Large Kit (makes 32 gallons) \$6.00; D. Estate Kit (makes 128 gallons) \$20.00.

TREE TANGLEFOOT. The best remedy against caterpillars and all tree-crawling insects. 1 lb. 58c; 5 lbs. \$2.75.

VOLCK. A powerful spray, effective on all ornamental and flowering plants for control of red spider, aphid, scale, etc. ½ pt. can 35c; qt. 75c; gal. \$2.00; 5 gals. \$6.25.

WILSON'S O. K. PLANT SPRAY. For inside and outside spraying. For aphid, thrip, mealy bug, scale, rose-bugs, and many other insects. The only insecticide recommended by the officers of the Garden Club of America. ½ pt. 40c; qt. \$1; gal. \$3; 5 gals. \$12; 10 gals. \$22; 25 gals. \$50.

WEED-KILLER. Used only on paths, drives, gutters, and places where no growth is wanted. Dilute 1 gallon with 40 gallons of water. Qt. 60c; gal. \$1.75; 5 gals. \$7.

MAKES GARDEN PEST CONTROL AS EASY AS WATERING YOUR LAWN



The "Arnold" Garden Hose Sprayer attaches to your garden hose in place of the regular nozzle. It consists of shutoff, Cartridge Chamber and extension Nozzle.

Special Soluble Cartridges (P-R Pyrethrum-Rotene, Colloidal Sulphur or Nicotine) fit the cartridge chamber. As water in hose passes

through sprayer, cartridge is slowly dissolved to make correct spray for control. One-half cartridge of each may be used at same time.

"Arnold Garden Hose Sprayer eliminates for good all measuring, mixing, straining, and hard work heretofore associated with spraying and makes insect and plant disease control as easy as watering your lawn. Price \$5.00 complete

For Insect Control—P-R Cartridges. A combination of Pyrethrum and Rotenone for aphid, thrip, red spider and all other eating and sucking insects, non-injurious to humans and pets. 35c each; 6 for \$2.

For Plant Disease Control—Colloidal Sulphur. For mildew, rust, scale, black spot and all other plant diseases. 35c each; 6 for \$2.00.

Nicotine. 35c each; 6 for \$2.00.

LUCKY STRIKE STAIN-LESS COW SPRAY—For general Farm and Dairy use. ODORLESS. \$1.25 per gal.; 30 gals. \$1.00 per gal.; 50 gals. 95c per gal.

ODOR \$1.00 per gal.; 30 gals. at 75c; 50 gals. 70c.

LUCKY STRIKE HIGH POWER HOUSEHOLD SPRAY Kills Flies, Mosquitoes, Moths, Bedbugs, Roaches, Wasps, Ants and many other household insects and their eggs. ½ pt. 24c; pt. 39c; qt. 75c; gal. \$1.98.

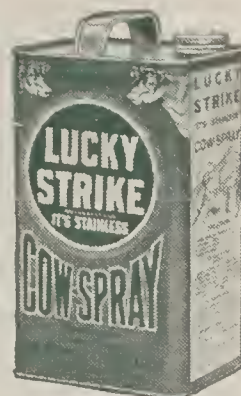

Abel's Insecticides and Disinfectants

Due to fluctuating market, prices on Insecticides and Fungicides are subject to change without notice.

KILL DANDELIONS

Amazing new way to eradicate dandelions and other ugly lawn weeds. Kills roots completely for all time. Beautiful lawn thereafter. Wonderfully quick, easy method—merely touch the dandelion with our special No-Stoop Applicator and the entire plant DIES, dries up and blows away. Starts turning weed black within one hour after application.

No digging, no pulling, no stooping... Dan-D-Lion Killer Kemical in the special No-Stoop Applicator does all the work! Complete satisfaction guaranteed or your money back.



SPECIAL "GET-ACQUAINTED OUTFIT"

No-Stoop Applicator\$1.25
 Killer Kemical (enough to kill 1500 weeds).... 1.05
 Regular Cost.....\$2.30
LIMITED OFFER, Complete, ONLY \$1.95

KILLER KEMICAL (Without Applicator)

1/2 gallon can.....\$1.45
 1 gallon can..... 2.35
 5 gallon can..... 9.85
 Also Available in 10, 30 and 55 Gallon Drums

IMPROVED CERESAN for seed treatment of small grains. Ceresan has proved effective in controlling such seed-borne diseases as bunt or stinking smut of wheat, stripe disease of barley, loose and covered smuts of barley and oats, and covered kernel smut of sorghum. It is the only dust treatment which has successfully controlled these destructive grain diseases. Ceresan does not injure the seed nor the grain-drill. Only 2 ounces of Ceresan required per bushel of wheat, rye or sorghum and 3 ounces for barley and oats. Easy to apply, economical to use.



PRICES
 1 lb.\$.70 100 lbs.\$49.00
 5 lbs. 3.00 300 lbs.144.00
 25 lbs. 12.50

TREAT BEFORE PLANTING WITH SEMESAN FOR DISEASE PROTECTION

Seed potato treatment will bring you more profit than ever before. New Improved Semesan Bel—the quick dip treatment—has cut treating costs to 1 1/2c to 3c per bushel of seed and gives equal or better control of seed-borne Rhizoctonia and scab than the old soak treatments. It protects seed pieces against rotting, insuring maximum stands; gives more consistent increases in yield and consequently larger profits. New Improved Semesan Bel costs less in time and labor than the old treatments. It is easily and quickly applied. Just mix one pound of Improved Semesan Bel with 7 1/2 gallons of water, dip your seed potatoes, drain, and plant. One pound of New Improved Semesan Bel treats 60-80 bushels of seed potatoes.

Prices: 4 oz. 45c; 1 lb. \$1.50. Free pamphlet.

POTATOES—2c a bushel now pays for easy Dip Treatment of Seed Potatoes with New Improved SEMESAN BEL.

TREAT BEFORE PLANTING WITH SEMESAN FOR DISEASE PROTECTION

Three bushels more corn can reasonably be expected by any farmer who treats seed corn before planting, Illinois Experiment Station tests show. Field or sweet seed corn dusted with Semesan Jr. is protected from the destructive Diplodia, Giberella, and Basisporium root rots carried by the seed and from rotting in cold, wet soil, consequently better germination, stands, and yields of improved quality are obtained. Treatment with Semesan Jr. costs less than 3c per acre and pays a splendid profit on the cost. Easily and quickly applied as a dust at the rate of 2 ounces per bushel of seed.

Prices: 4 oz. 35c; 1 lb. \$1.00; 5 lbs. \$4.75; 25 lbs. \$23.25. Free pamphlet.

CORN—Increase your Corn Yields 3 bushels an acre with SEMESAN JR.

TREAT BEFORE PLANTING WITH SEMESAN FOR DISEASE PROTECTION

Prevent the many damaging diseases of flowers and vegetables that are carried on the seed, by disinfection of the seed with Semesan. It destroys the destructive diseases on the seed and protects them from the rots in the soil, which results in increased stands of more vigorous, healthy plants that yield larger, quality crops. Sprinkling of the seedling beds with Semesan solution effectively prevents damping-off. Recommended especially for seeds, bulbs, gladiolus corms, dahlia tubers, and rose bushes. Easily applied as a liquid or dust. One ounce treats 15 to 30 pounds of seed. Directions in every can.

Prices: 2 oz. 50c; 1 lb. \$2.50; 5 lbs. \$11.75; 25 lbs. \$46.25. Free pamphlet.

VEGETABLES, FLOWERS—More Vegetables and better Flowers through controlling diseases with SEMESAN.

Garden Hose

HOSE, Clamps. 8c each; 75c per doz.
 Couplers. Brass; 3/4 in. 30c per pair; \$3 per doz. pairs.
 Menders, Iron. 10c each; \$1.25 per doz.
 Cooper's, Brass. 15c each; \$1.25 per doz.
 Perfection. 15c each; \$1.35 per doz.
 Nozzles, Peerless. 3/4 in.; cast brass. 75c each.
 Reels, Easy-Reel. Carries 100 ft. \$2.
 Rubber, Red, Goodyear. Extra-fine grade. 14c per ft.

Black. 12c per ft.
 Washers. 5c per doz.

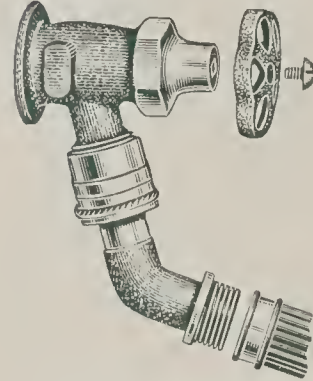

Brass Clinching Hose Coupling

A self fastening coupling that does not require extra bands, bolts or wire. Slip in the hose and hammer down. Price 35c

Brass Hose Couplings
 1/2 in., 3/4 in., 5/8 in. 25c complete set; 15c per section.

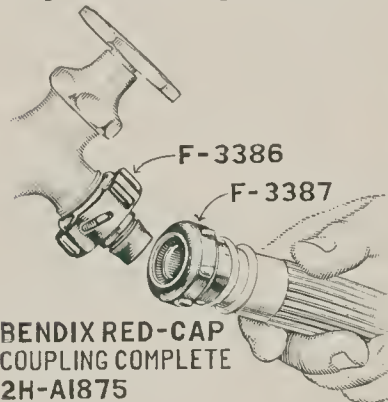

BENDIX RED-CAP COUPLING COMPLETE 2H-A1875

Siamese Hose Connections

The use of this device permits two sprinklers to run from one line of hose. Hose thread only. Price 75c.



Goose Neck Connection

A device which prevents the hose from kinking when attached to the sill cock or where a street washer is used. Price 75c.

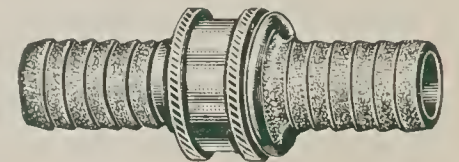
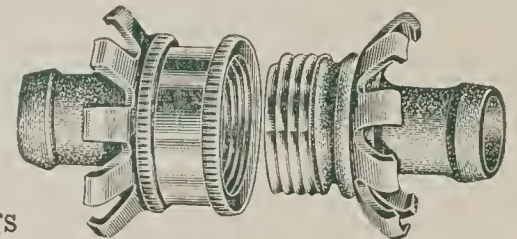

RED CAPS

Quick attachable hose couplings. Connects with a snap. Its a snap to connect. 60c.

Lawn Rollers

Buch's Water-Ballast. Fill with water or sand for weight. Adapted for rolling lawns, golf courses and tennis courts.

No. 601. Diam. 14 in.; length 24 in. Weight, empty, 70 lbs.; filled with water, 175 lbs.; with sand, 400 lbs. \$15.25.
 No. 602. Diam. 18 in.; length 24 in. Weight, empty, 85 lbs.; filled with water, 265 lbs.; with sand, 475 lbs. \$18.
 No. 603. Diam. 34 in.; length 24 in. Weight, empty, 110 lbs.; filled with water, 420 lbs.; with sand, 630 lbs. \$20.50.

Planet Jr. Tools

Products of 37 years' experience by a practical farmer and manufacturer who has made a science of tool-building. All guaranteed. Illustrated catalogue FREE. Prices subject to change.

NO. 4 PLANET JR. COMBINED HILL AND DRILL SEEDER, WHEEL HOE, CULTIVATOR, AND PLOW. Does the work of almost all garden tools combined. It sows accurately all garden seeds in drills or hills 4, 6, 8, 12, or 24 inches apart, cultivates.

No. 4. Complete\$19.50
 No. 4D. As a Seeder only..... 15.50

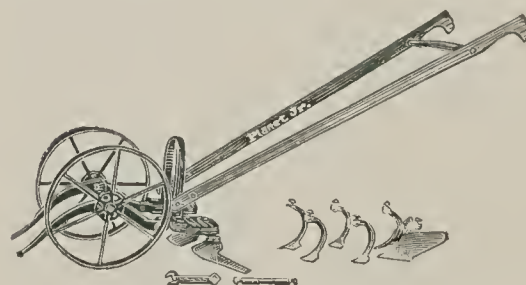

NO. 12 DOUBLE WHEEL HOE. This is identical with No. 11 Wheel Hoe, except that it has 1 pair plows, 1 pair hoes, 2 pairs cultivator teeth, and a pair of leaf-lifters only. Price \$11.50.

PLANET JR. NO. 2 LAWN EDGER. Everyone who uses a lawn mower should have a Planet Jr. No. 2

Lawn Edger. The cutting blade is made of the best quality steel and well sharpened. The handle is strong, being made of good quality wood. In order to have attractive lawns, keep the edges well trimmed. There is no better tool for this purpose than the Planet Jr. No. 2 Edger. Price \$1.60.

**MOTORIZED YOUR GARDENING AND
LAWN MOWING WITH THIS
BOLENS' POWER HOE**

It seeds—it weeds—it cultivates—it furrows and covers—it will push the largest size hand lawn mower. Attachments are instantly interchangeable without use of a wrench. It's fun to run a BOLENS Power Hoe.

\$88.50

F. O. B. Factory
Pneumatic tires \$13.00 extra. Lawn mowing attachment to push your mower, \$8.00.

Ask us about market gardener BOLENS, also about heavy duty BOLENS tractors for plowing, harrowing, field cultivating, mowing, as well as garden cultivating. BOLENS Hi-Wheel models with 2 speeds forward and reverse are easy to operate and will help to make a little farm pay.

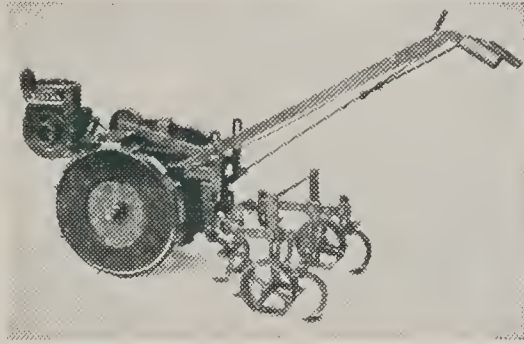

The ECLIPSE

**MODERNIZED
MOWING
FOR HOME
OWNERS**

\$77.50

**F. O. B.
FACTORY**

Winged Performance on Goodyear Semi-Pneumatic Tires!

Rocket demand has shown the greatest ownership desire since the coming of the automobile. Its appeal has been instantaneous because it keeps pace with the American mode of living. The Rocket is starred with features—full 20 in. cut, Briggs & Stratton motor, Timken bearings, Goodyear rubber tires, self sharpening. Now modernized and priced for the average family.

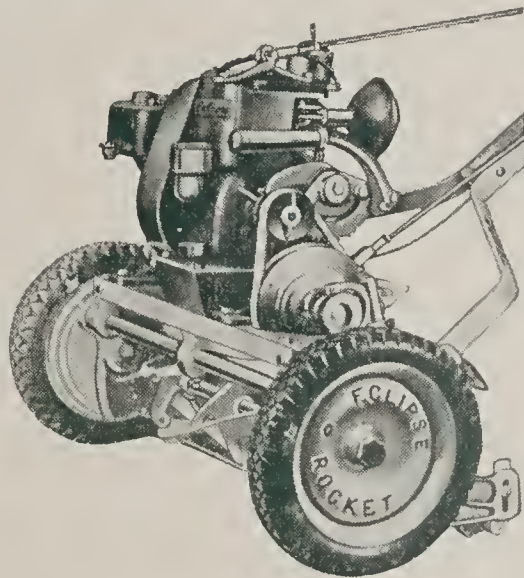

**Eclipse THE WORLD'S BEST
LAWN MOWER**

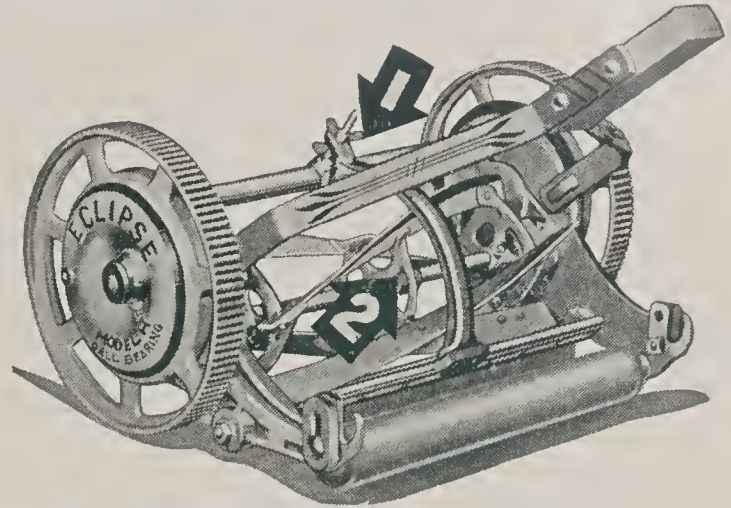

1

The Eclipse is always in perfect adjustment — no tinkering — no expense.

2

The Eclipse is always sharp. No expense — no attachments — no disassembly.

1 Eliminates the old screw driver method—easy finger-tip adjustment assures proper set of knives for sure cutting.

2 Eliminates that yearly sharpening cost—only Eclipse provides you automatic self-sharpening without use of tools, or disassembly.

Bendix Mowerake

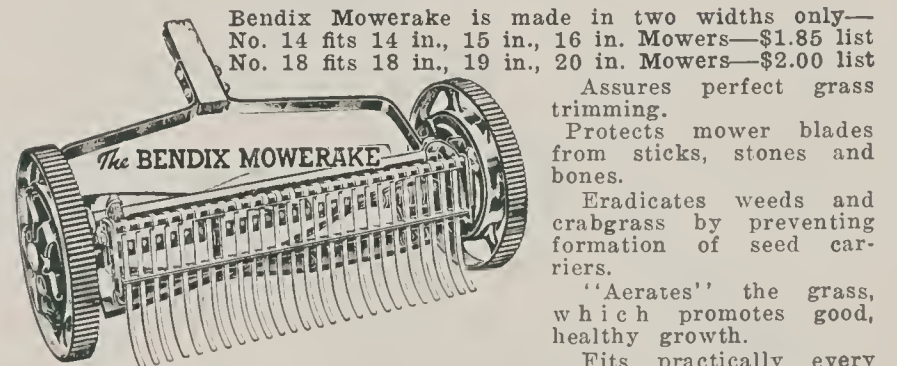

Bendix Mowerake is made in two widths only—No. 14 fits 14 in., 15 in., 16 in. Mowers—\$1.85 list No. 18 fits 18 in., 19 in., 20 in. Mowers—\$2.00 list

Assures perfect grass trimming.

Protects mower blades from sticks, stones and bones.

Eradicates weeds and crabgrass by preventing formation of seed carriers.

'Aerates' the grass, which promotes good, healthy growth.

Fits practically every lawn mower—takes only a few moments to install. Folds back out of the way when not in use.



Hydrospear

Open stop-cock and allow the amount of water desired to flow to the roots. After an application or two, the amount of time required for proper amount of water can be easily ascertained. After the proper amount of water is applied close stop-cock, pull point out, and proceed with the same operations as often as desired without detaching hose. \$3.75 each.



**CULTIHO
SAVES HALF YOUR TIME**

Tempered spring steel blade 6x1½ inches, cutting edge sharpened; malleable one-piece plate and shank. 4½-ft. handle. When using, draw Cultihoe towards you—it cuts all the weeds leaving a smooth, level mulch. No. 22, \$1.25.

Bailie Lawn Rake

This tool, fitted with 24 teeth, made from flat spring steel, is so well constructed and of such superior material that we believe it to be the best lawn rake available. Price \$1.75.

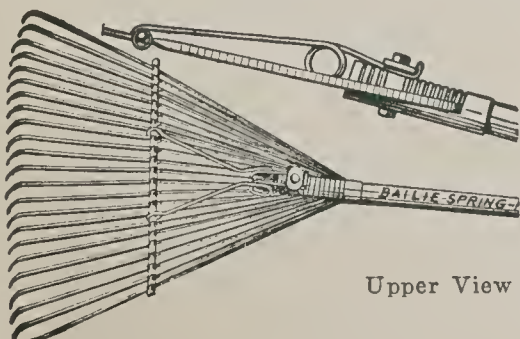

Upper View Shows Spring Construction

SPREADERS



Handy Spreader
14 in. \$2.50

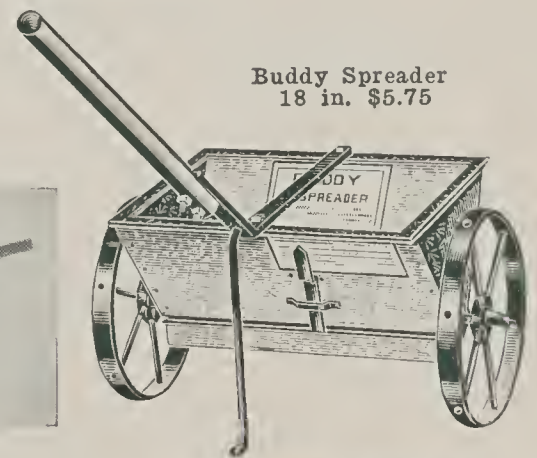

Buddy Spreader
18 in. \$5.75

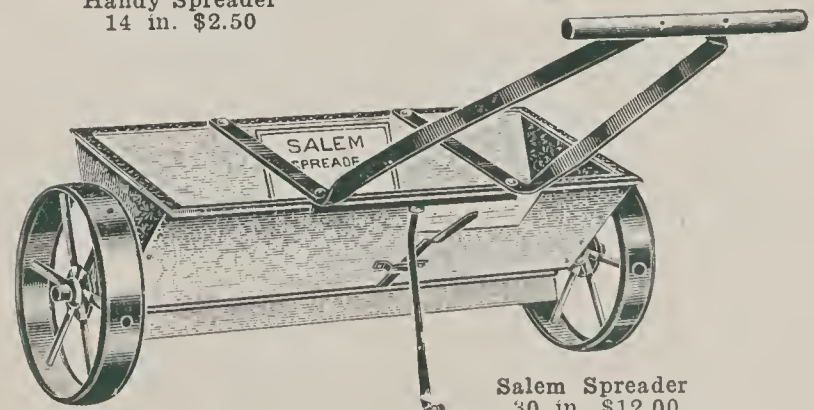

Salem Spreader
30 in. \$12.00

The above spreaders are well constructed to meet the current demand of the average home user who wishes to invest but little and wants to be assured of even spreading of fertilizer and lawn seeds.

TRIMMING AND PRUNING TOOLS, CULTIVATORS

HKP Gooseneck Pruner

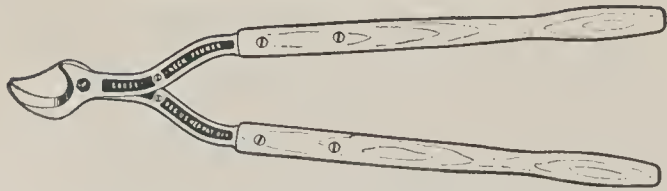

A light, strong pruner of the single-joint pivot type for those who prefer this style. Popular for citrus pruning. The jaws are of tough, alloy tool-steel, drop-forged and scientifically heat-treated. The sturdy handles are of hickory and the steel arms are deeply set in slots to give ample strength. The working heads are all of the same size, the overall lengths depending on the three different lengths of the handles.

- No. 220G 20-inch Cuts 1 3/8-inch green wood.....\$4.50
- No. 224G 24-inch Cuts 1 3/8-inch green wood..... 4.75
- No. 228G 28-inch Cuts 1 3/8-inch green wood..... 5.00

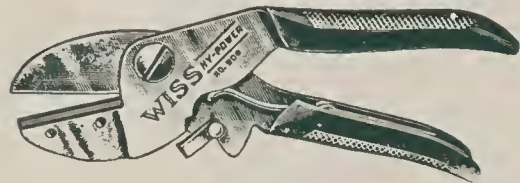

NO. 908 HY-POWER PRUNER. The easiest cutting pruner of its size.

NO. 906 HY-POWER PRUNER. A smaller edition of No. 908.

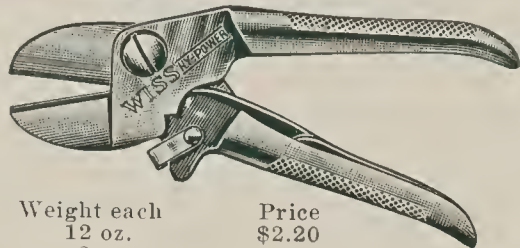

Number	Length	Weight each	Price
908	8 in.	12 oz.	\$2.20
906	6 in.	8 oz.	1.65

No. 5700. Pexto Pruner.
Price 75c up.



Budding Knife. 50c up.

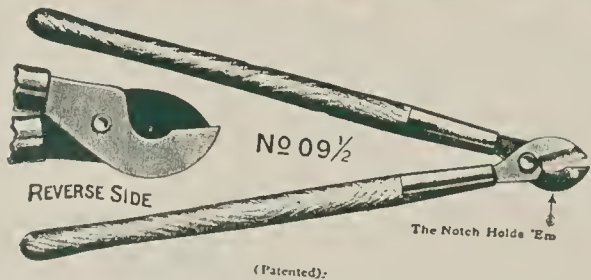
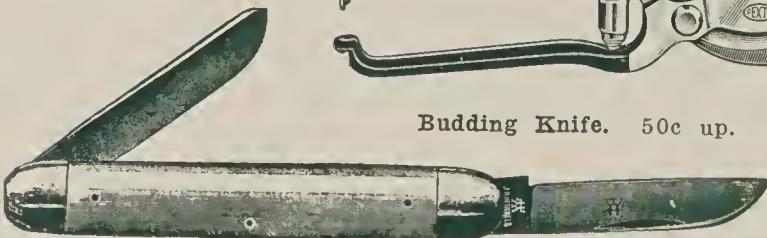

No. 09 1/2 Cronk's Wood Handle Pruners. Made with a notched hook (patented) which prevents slipping, gives greater leverage, and makes cutting easy. Blades of tool steel. Handles natural finish, polished and waxed, with steel ferrules. 85c.



Elmira Tree Pruner. The blade makes a clean cut, is designed to prevent clogging, and is opened and held ready for use by the coil spring. A saw can be bolted to the head and is easily detached. Cuts on the down stroke and will not kink. Saws weigh 5 pounds to the dozen. Furnished without saws unless otherwise ordered. 10-ft. \$2.25; 12-ft. \$2.50.



SHEARS. 50c to \$1 each.

NO. 600 GRASS SHEARS. Extra fine cutlery steel blades, professional pattern, two sizes, offset handles. Offset handles prevent striking knuckles when trimming close to walls, pavements, etc. No. 600, full length, 12 1/2 in., length of cut, 5 1/2 in., weight each, 1 lb. Price each \$1.65.



Can be resharpened. These new style "Wiss-Clipper" grass shears are equipped with adjusting nuts and swinging shackle which enables the blades to be spread apart for resharpening. Handles are curved to fit the hand and are knurled to prevent slipping. No. 700, length 12 in., weight each 1 lb. Price each \$1.40.

NO. 68 PRUNING SHEARS. Made to meet the demand for a very low priced pruner of quality. Similar pattern to No. 608. Will give useful service. Solid steel. Blue handles.



No. 68, full length, 8 1/4 in., weight per dozen, 9 lbs. Price each \$1.10.



The only hedge shears in the world with all these features — unbreakable drop forged handles, replaceable cutlery steel blades, one knife edge, one serrated edge, rubber shock absorber.

Length of blade		
8 in.	9 in.	10 in.
\$3.30	\$3.85	\$4.10

No. 309-B. Drop forged hardened and tempered. Brass leaf spring, castellated nut and catch, full polished finish, interchangeable blades forged extra thin. The No. 309-B pattern is unequalled in the medium priced pruners. Drop forged. All parts replaceable. No. 309-B, full length 9 in., weight per dozen, 11 1/2 lbs. Price each \$3.30.



Tree Surgery Chisels



STRAIGHT EDGE SOCKET CHISEL. Flat blade, 6 1/2 in. long, with beveled back as illustrated. Special temper; iron ring handle. 1/2 in. \$3.00 each; 1 in. \$3.50 each; 1 1/2 in. \$3.90 each.

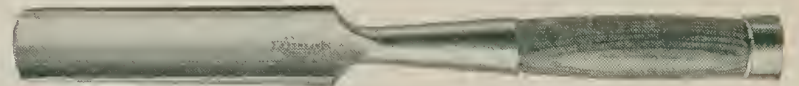

SOCKET FIRMER GOUGE. Outside bevel, iron ring handle. 1/2 in. \$3.00 each; 3/4 in. \$3.50 each; 1 inch \$4.00 each; 1 1/2 in. \$4.50 each.

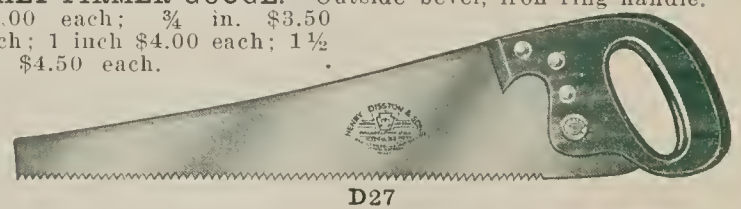

D27



No. 22

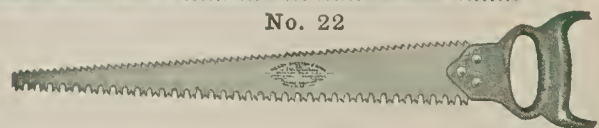

No. 40

PRUNING SAWS. D27. Beech handle, varnished edges, brass screws, narrow crucible steel blade, blued. Length of blade 26 in.; 6 in. wide at butt; 1 1/4 in. at point. Toothed 7 points to in. \$3.50.
No. 22. Narrow point crucible steel blade, copper handle and beechwood grip. 20 in. \$1.75.
No. 40. Cherry handle, carved and polished, crucible steel blade, double edge, adjustable lever tightener. 20 in. \$1.75.

Miscellaneous Garden Tools

This new Porter tool is, we believe, the first perfect all-purpose pruner ever developed. It is equally satisfactory for light or heavy work. The blades are so designed that suckers are cut ON THE POINT with minimum handle opening. To cut tough branches up to 1 1/4 inches in diameter, a 50 per cent to 100 per cent increase in power is instantly available in the patented shift.

Light in weight. Handy in size. Easy to use in close places. Strong, rugged construction. Will do the work of an ordinary 30-inch tool—do it easier, better and quicker.



Standard size, 20 inches long. Approximate weight, 2 lbs. 12 oz. List \$5.00

We can also furnish two SPECIAL LENGTHS for those who prefer longer tools.

24 inches long, approximate weight, 2 lbs. 2 oz. List.....\$5.10
27 inches long, approximate weight, 3 lbs. 7 oz. List..... 5.20



SHORT ARM LONG ARM

arm. Single and double pulley rig, easily attached. All parts are fully interchangeable. Poles are of solid, selected basswood.

Description	Number	6 ft.	8 ft.	10 ft.	12 ft.	14 ft.	16 ft.
LONG ARM—							
Complete Tool							
(no pulley)	7TR 89	\$5.75	\$6.00	\$6.50	\$6.75	\$7.25	\$7.50
(one pulley)	7TR 90	6.00	6.25	6.75	7.00	7.50	7.75
(two pulleys)	7TR 91	6.25	6.50	7.00	7.25	7.75	8.00
SHORT ARM—							
Complete Tool							
(no pulley)	7TQ 89	5.75	6.00	6.50	6.75	7.25	7.50
(one pulley)	7TQ 90	6.00	6.25	6.75	7.00	7.50	7.75
(two pulleys)	7TQ 91	6.25	6.50	7.00	7.25	7.75	8.00

The Three Power FORESTER



No.	Forester	Length	Capacity	Weight	Price
No. 1	Forester	20 in.	1 3/16 in.	2 lbs. 10 oz.	\$5.00
No. 2	Forester	27 in.	1 1/12 in.	4 lbs. 10 oz.	6.00
No. 3	Forester	34 in.	2 in.	7 lbs. 4 oz.	7.00

The Forester pruner is especially designed for the fruit growers, foresters and the large size No. 3 for hard wood such as oak, maples and beech. An excellent tool for reforestation work. Write for the illustrated circular on the above pruners.



Patent Pending

INTRODUCING
The World's Fastest Weed Puller
THE BAILIE AUTOMATIC WEEDER.
This weeder is not a wallflower, but a sturdy, practical tool 100 per cent perfect. (Has been tested for over two years.) Don't cut weeds, pull them out root and all. See illustration No. 4. By turning root upwards, weed automatically drops out as next one is jammed into the jaws, and so on. Unequaled for removing crab grass, dandelion, plantain, etc. Will last a lifetime. Cadmium plated, standard size. \$1.50.

- DIBBLES, Iron.** 55c.
- CULTIVATORS, Hand.** 5-tooth. \$1.25 to \$1.50.
- FORKS.** 4 tines; regular. \$1.50 to \$1.75.
- FRUIT-PICKER.** Wire, 50c each.
- GARDEN HOES.** 5-in. 80c:
Heavy Half-Moon. \$1.
Onion. 2-prong. 60c and \$1.25.
Scuffle. (Large assortment.) 4-in., 85c.
- GLAZING MATERIALS, Permanite (Black).** A glazing compound, composed of asbestos fiber and special long-life weather-resisting non-drying oils. Gal. \$2.50.
- White Garlanite.** The improved corking and glazing compound. Per gal. \$2.75.
- Permanite Gun.** This gun makes application easy. \$6.00 each.
- Glazing Points, Peerless.** Box (1000) 75c.
- GRAFTING WAX.** 1/4 lb. 20c; 1/2 lb. 30c; 1 lb. 55c.
- HOE HANDLES.** 35c.
- JUTE TWINE.** For tying plants and vegetables. We can furnish 2-, 3-, and 5-ply. Ball 15c, 2 for 25c.
- MOLE TRAP, Out-o-Sight.** \$1.75.
- PLANT TIE.** The Lightning Wire is a most convenient device for fastening flowering stems to supporting stakes. A slight squeeze between the fingers and the stem is definitely though inconspicuously tied. Use them with wire, bamboo, or wood stakes. Economical, may be used many times over. 100 for 80c postpaid; 1,000 for \$2.50 postpaid.
- RAFFIA.** Natural color, lb. 50c; dyed, lb. \$1.50.
- SCYTHES, English Lawn.** Riveted back. 30- and 32-in., \$1.50;
- SCYTHE STONES, English style,** 30c; **Darby,** 20c; **Carborundum,** 35c.
Snath. Improved pattern. \$1.50.
- SPRINKLER, Rubber Plant.** Pt. 85c; qt. \$1.25. Straight or crooked neck.
- TROWELS, Florists', Ladies' and Market-gardeners' styles.** Large assortment. 10c to \$1.50.
- WATERING CANS, Galvanized Oval.** For florists. Two copper-faced roses, one fine and one coarse, with each pot. 6-qt. \$5.50; 8-qt. \$5.75; 10-qt. \$6.25; 12-qt. \$6.75.



New Super-Speed Model. Trims hedges, shrubs, evergreens, terrace grass and borders. Saves hours of labor. Light, vibrationless—a professional shear that a woman can use. Trims any hedge or evergreen to sharp, beautiful outlines. Self sharpening. Works from any light socket. Weighs only 5 3/4 pounds. Electric hedgeshears have been proved in thousands of gardens. Price including 9 feet of cord \$29.50. Extra cord 100-foot length, 16-gauge, \$3.75 each.



NO. 2500 ASPARAGUS KNIVES OR WEEDERS. These knives are hammer forged, well hardened and tempered to stand rough usage. Used also as a weed cutter and dandelion digger. 7/16-inch round steel. "V" shape blade. Blade polished and enameled blue. 50c.



NO. 205 SOCKET GARDEN TROWEL, FORGED STEEL. This trowel is hammer forged—one piece—and has seamless socket. Full polished. Hardwood handle. Six-inch blade. Length over all, 13 1/2 inches. \$1.00.



NO. 211 GARDEN TROWEL, FORGED STEEL. The blade and shank are made of one piece of steel, being forged out in the same way as masons' brick trowels. The blade is finely polished. The rear part and shank are enameled blue. Polished hardwood handle. Heavy steel ferrule.

Size, inches	5	6	7
Weight per dozen, lbs.	7	9 1/2	10 1/4
Prices	\$.75	\$.85	\$.95

Brown's Open-Hed Sprayers

Large diameter opening compressed air sprayers, with electrically welded seams and galvanized after fabrication. Furnished with handy rubber grips, double action safety lock, adjustable removable carrying strap. Equipped with 2-foot brass extension, automatic shut-off and nonclog nozzle.

- No. 4D 4-gallon galvanized Open-hed Sprayer\$5.95
- Champ D 3 3/4-gallon galvanized Open-hed Sprayer\$4.95

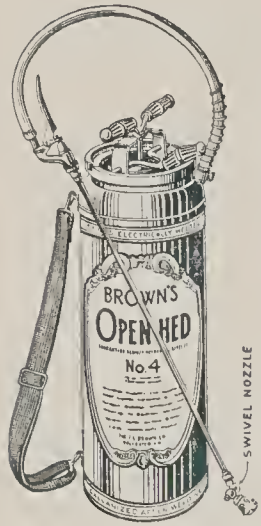

Brown's Funnel-Top Sprayer

The No. 350D Sprayer has side walls and head seams electrically welded. Funnel, lock, head and sides galvanized after fabrication. Durable and strong. Equipped with wooden

handle grip, safety lock, adjustable removable carrying strap, 18-in. angle extension, automatic shut-off and nonclog nozzle.

- No. 350D 3 1/2-gallon Funnel-top Sprayer.....\$3.75

Continuous Atomizers

Designed to handle all disinfectants and insecticides. Spray continuously on up and down stroke. No. 335 made with copper tank and brass pump; nontippable design; simple quarter turn lock; oil-resisting gasket; new one-point swivel nozzle.

No. 26BG made with lithographed tin pump, brass cone, and quart glass jar. Furnished with all-brass valve and new one-point swivel nozzle. An excellent glass jar continuous sprayer.

- No. 335 1-quart continuous sprayer\$1.75
- No. 26BG 1-quart continuous sprayer\$1.15

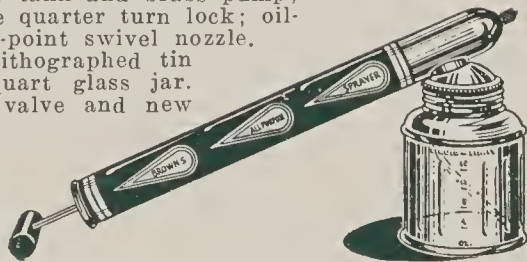

Single-Action Sprayer

Brown's No. 14 single-action sprayer is made with tin tank and lithographed tin pump. Nontippable design, quarter turn lock, return drip cup. Dependable and durable. Will spray to last drop.

- No. 14 1-quart single-action sprayer\$35

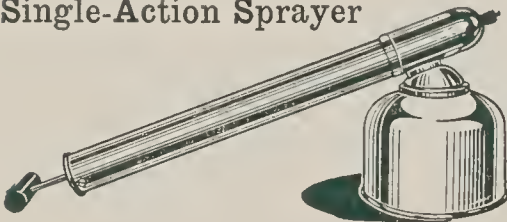

No. 57 Wheelbarrow Sprayer

Complete portable spraying unit for one man operation. Rigidly constructed, with 18-gallon galvanized tank, heavy duty pump. Five-gallon storage tank enables continuous spraying after cessation of pumping. Maintains 200 to 250 lb. pressure. All brass pump working parts. Equipped with automatic shut-off, angle nonclog nozzle and 12 1/2 feet of hose.

- No. 57, Wheelbarrow sprayer\$28.50

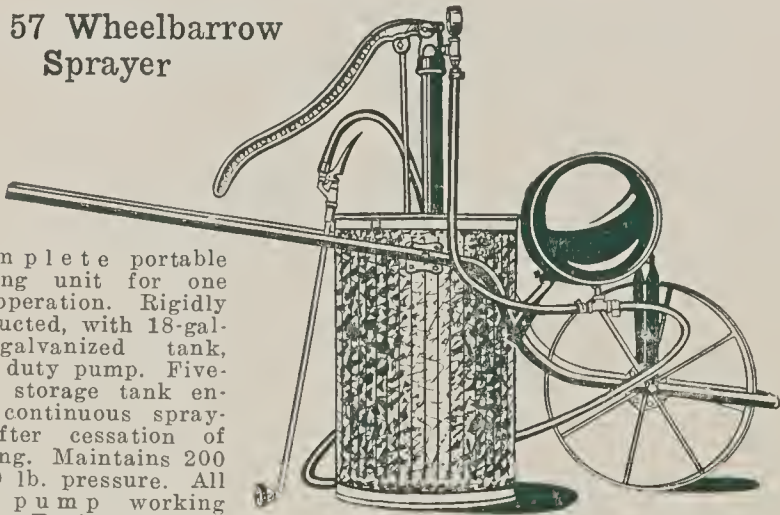

No. 49 Wheelbarrow Sprayer

Similar to the No. 57, except without air storage tank. Most efficiently operated with two operators. Maintains 200 lb. pressure. Rigidly constructed to withstand heavy use.

- No. 49 Wheelbarrow sprayer\$18.75

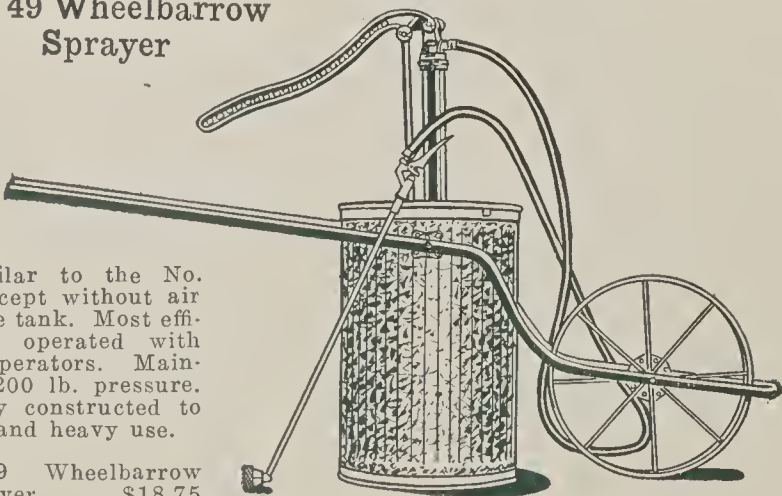

ROUND GALVANIZED WATERING POTS.

This style is specially adapted for the flower garden and hotbed. Made extra strong throughout, equipped with extra long spout and supplied with a fine copper faced rose for seedlings and a coarse copper faced rose for growing plants.

- | | List Each |
|-------------|-----------|
| 4 qt. | \$ 6.50 |
| 6 qt. | 7.00 |
| 8 qt. | 7.50 |
| 10 qt. | 8.00 |
| 12 qt. | 8.50 |
| 16 qt. | 11.00 |

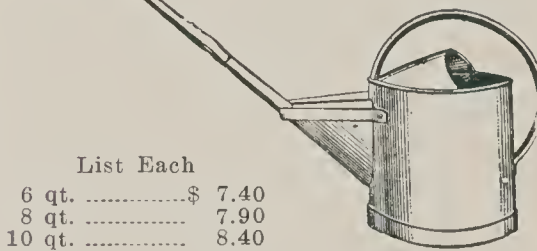
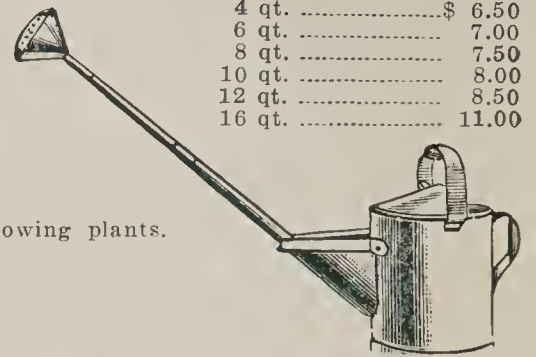

- | | List Each |
|-------------|-----------|
| 6 qt. | \$ 7.40 |
| 8 qt. | 7.90 |
| 10 qt. | 8.40 |
| 12 qt. | 9.40 |
| 16 qt. | 11.40 |

OVAL GALVANIZED WATERING POTS.

This style is specially adapted for greenhouse and conservatory. Extra length in spout is especially convenient where a long reach is required. Equipped with brass handle and 2 copper faced roses (one fine and one coarse).

WATER SPRAY SPRINKLER.

The ideal oscillating sprinkler for lawns, flower beds, rock gardens or newly seeded areas. Adjustable. Light in weight yet sturdy and durable. At 35 pounds pressure will cover 40x40 feet. For 3/4-inch hose connection. Price \$17.50.

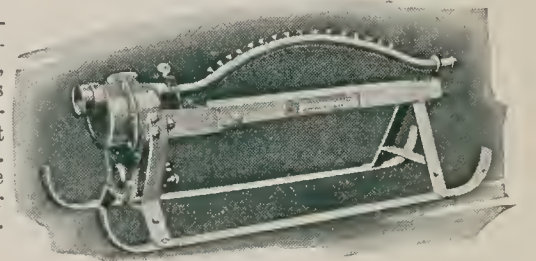

Model No. 7

THE WATERFAN

AN AUTOMATIC OSCILLATING RAINMAKING MACHINE

The Waterfan is a small (20x6 1/2x7 in.), light (6 1/2 lbs.) portable automatic oscillating lawn and garden sprinkler. It is a real rain-making machine consisting of a small turbine water motor closely connected to a short (16-in.) distribution pipe and is mounted on a triangular shape sledlike frame for easy pulling by the hose.

The distribution pipe is fitted with 17 small nozzles, all set in an even plane and at the proper angles for causing the sprays to be projected in the shape of an open fan, so when they are oscillated back and forth over the machine they will water a wide rectangular area.

Model	*Area Covered	Gallons Per Minute	Pressure for Best Results	Price f.o.b. Woodbury
No. 7	20x45 ft. 30x45 ft. 40x45 ft.	6	30 lbs.	\$15.00

*The No. 7 Waterfan is equipped with a curved or straight distribution pipe according to the width to be covered.

The 30 and 40 ft. widths use the curved distribution pipe.

The 20 ft. width uses the straight distribution pipe.

SPECIAL WIDTH: Nozzles can be set for covering any special width from 10 to 35 feet if the flowing water pressure is stated.

No. 4 Paragon Sprayer

Capacity 28 gallons. Equipment: 20-ft. Special Spray Hose, 10-ft. Spray Pipe, 1 Brass Mist Spray Nozzle, 1 Brass Straight Spray Nozzle, 1 Steel Spray Nozzle for whitewash, cold-water paint, etc., \$39.50 each.



The Cyclone Seed Sower

Best and cheapest crank seeder made, considering the quality of work done and durability. Will not get out of order nor be affected by damp weather. Distributes all kinds of fertilizer, land-plaster, ashes and seeds. Weight 6 pounds. \$2.75, not prepaid.

Apple Picking Bag

Also can be used for other tree fruits. Well made of heavy canvas. 10-oz. duck \$1.75. Bags with side supports \$2.00.



MISCELLANEOUS GARDEN SUPPLIES



National Eezy Wear Garden Gloves



All-Leather—DIRT-PROOF
SOFT AS KID—Extra Pliable

Ideal gloves for men and women, made from select imported leather processed to render it amazingly soft and pliable, as well as durable. Permit almost barehand freedom with perfect comfort, yet insure complete protection from dirt, scratches, bruises, stains. Economical—outwear 6 pairs of fabric gloves and are useful the year round for Garden, Housework, Painting, Yard, Furnace, Garage, etc. **WASHABLE!**

Sizes for women: "Small," "Medium," "Large"—for men: "Medium," and "Large." Price 75c a pair (2 pairs, \$1.40), postpaid.

Hotkaps

FROST can't hurt

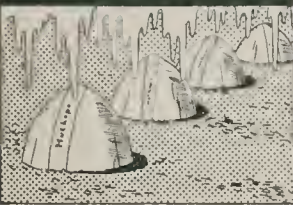

RAIN can't harm

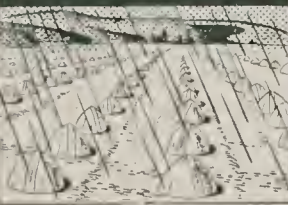

INSECTS can't touch



HOTKAPS protect plants against birds, insects, rain, frost, hail or wind. They force growth and bring maturity 2 to 3 weeks sooner. Yield is increased 10 to 25 per cent. Each **HOTKAP** is a miniature hot-house for the plant underneath.

*1,000 to Carton @.....	\$10.25	per m
5,000 @.....	10.15	" "
10,000 @.....	10.05	" "
25,000 @.....	9.95	" "
* 25 Package Complete.....	.50	
*100 Package Complete.....	2.65	
*250 Package Complete.....	3.85	
Steel Setter and Tamper.....	1.50	
Garden Setter alone.....	.50	
Steel Tamper alone.....	.25	



WHAT HORMODIN "A" IS

Hormodin "A" is the new root-inducing chemical that stimulates rapid root growth on leafy cuttings, being especially valuable for propagating all plants by cuttings, whether rooted with ease or normally rooted with difficulty. Many plants formerly impossible to propagate from cuttings may now be rooted with the aid of Hormodin.

The content of the \$1.00 package is sufficient to treat from 150 to 600 or more cuttings depending upon the required dilution. The \$2.00 size sufficient to treat from 400 to 1800 cuttings.

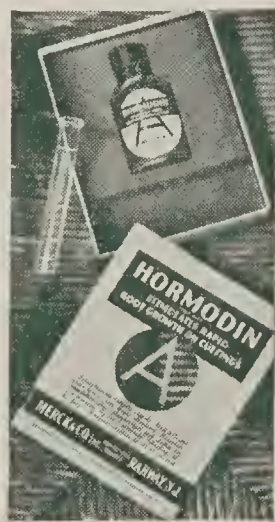
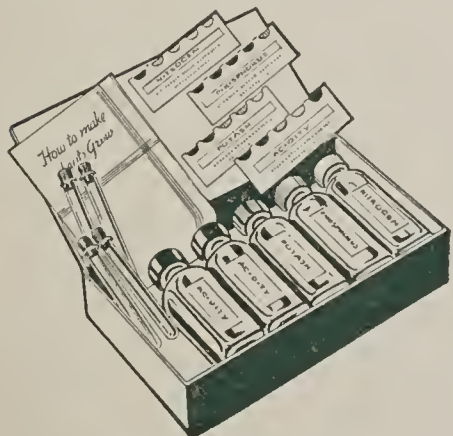

SOIL TEST KIT

Gives twenty individual tests for nitrogen, phosphorus, potash and acidity. \$2.00.

PLANT LABELS. Wood, pointed, for pot and garden plants.

Size	100	1000	Size	100	1000
4 x 5/8 inches.....	\$0.35	\$2.25	8 x 7/8 inches.....	\$0.75	\$6.00
4 1/2 x 5/8 inches.....	.35	2.40	10 x 5/8 inches.....	.65	5.00
5 x 5/8 inches.....	.40	2.50	10 x 7/8 inches.....	.85	7.00
6 x 5/8 inches.....	.45	2.75	12 x 1 1/8 inches.....	1.35	10.50

Wood, wired, 3 1/2 x 5/8 inches, for trees, shrubs, Dahlias and similar plants, 40c per 100; \$2.75 per 1000.

Stakes

HYACINTH STAKES. Used for staking hyacinths, tulips and slender plants. Wood (dyed green). 12 in. doz. 7c; 100 30c; 1000 \$1.50; 18 in. doz. 10c; 100 40c; 1000 \$2.25.

JAPANESE CANE STAKES. 6 ft. These are very attractive for all purposes of plant staking, thin and strong; used a lot for spray making. 1 bale of 2000 \$16; 1 bale of 1000 \$10; bundle of 250 \$3.25; bundle of 100 \$1.75. 10 ft. 15c each, 2 for 25c; \$1.50 per doz.; 25 to 100 @ 10c each.

CHINESE TONKIN BAMBOO STAKES. A heavy substantial stake for Dahlias, ivy, young trees, etc. 4 ft. high, 3/8 in. diameter, 12 for 45c; 100 for \$2.50. 6 ft. high, 5/8 to 3/4 in. diameter, 12 for \$1; 100 for \$6.00.

BAMBOO CANE STAKES. 3 1/2 ft. Used for spray making and staking. Dyed green. Hot water treated. 1 bale of 2000 \$10; 1000 \$6; 500 \$4; 250 \$2.50; 100 \$1.50.

Cedar Plant Tub

Made of white cedar, painted green and bound with strong electric-welded wire hoops which do not rust. Handles are sold separately at 30c per pair, not attached to tub.

No.	Inside Diam.	Depth	Each
No. 1	6 inches	6 inches.....	\$.60
No. 2	7 inches	7 inches.....	.70
No. 3	8 inches	8 inches.....	.75
No. 4	9 inches	9 inches.....	.85
No. 5	10 inches	9 inches.....	.95
No. 6	11 inches	10 inches.....	1.00
No. 7	12 inches	11 inches.....	1.25
No. 8	13 inches	12 inches.....	1.50
No. 9	14 inches	13 inches.....	1.70
No. 10	15 inches	14 inches.....	1.90
No. 11	16 inches	15 inches.....	2.00
No. 12	17 inches	16 inches.....	2.50
No. 13	18 inches	17 inches.....	2.75
No. 14	19 inches	18 inches.....	3.85

New York Cedar Tub with Feet

No.	Inside Top Diam.	Depth Inside	Each
No. 1	12 inches	10 1/2 inches.....	\$2.15
No. 2	14 1/2 inches	15 inches.....	2.80

Florists' Pots, Azalea and Bulb Pans

Height and Width Inside	Each	Doz.	100	1000
1 inch	\$.03	\$.19	\$ 1.48	\$13.50
2 inches02	.16	1.23	11.25
2 1/4 inches02	.18	1.40	12.75
2 1/2 inches03	.24	1.65	15.00
3 inches03	.28	2.14	19.20
4 inches05	.42	3.30	30.00
5 inches07	.78	5.94	54.00
6 inches10	1.08	8.91	81.00
7 inches17	1.62	14.85	
8 inches25	2.81	21.45	
9 inches39	4.32	33.00	
10 inches52	5.83	44.55	
11 inches78	8.64	66.00	
12 inches98	11.88	90.75	
14 inches	1.75	19.44	148.50	

Saucers

Each	Doz.	100	Each	Doz.	100		
4 inches	\$.04	\$.43	\$2.48	9 inches	\$.14	\$1.45	\$12.38
5 inches05	.55	3.30	10 inches18	2.02	14.85
6 inches07	.72	4.95	11 inches22	2.45	18.15
7 inches08	.86	6.60	12 inches26	2.88	22.28
8 inches10	1.15	9.08	14 inches44	4.90	37.13

WIRED TOOTH PICKS

3-in. white wired tooth picks—per bundle (250) 15c; per 1000 50c; per 10,000 \$3.50.
4-in. green wired tooth picks—per bundle (250) 25c; per 1000 95c; per 4500 \$4.00.
6-in. wired tooth picks—per bundle (250) 30c; per 1000 \$1.15; per 3000 \$3.25.

ABEL'S FLOWERING SHRUBS, EVER-GREENS AND SHADE TREES
An Extended Service to Our Patrons
Send for our booklet together with prices.

IMPLEMENT REPAIRS. Our service will try to obtain any part you may need at the right prices if we don't have it in our stock.

ABEL'S FERTILIZERS

Adco. A bacterial food for making artificial manure, by mixing it with leaves, grass cuttings, green weeds or, in fact all the many wastes that accumulate during the garden year and applying water, the product is a clean manure. 1 box Adco, makes about 300 lbs., \$1.00; 25 lb. bag sufficient to make one-half ton of manure, \$2.00; 150 lb. bag sufficient to make 3 tons of manure, \$10.50; 600 lbs., \$42.00; 2100 lbs. \$145.00.

Ashes, Hard Wood. Apply 1000 lbs. per acre. Indispensable for all crops requiring potash; excellent for mixing with potting soil. For top dressing lawns and grass fields it is applied to best advantage either in very early spring or late fall. 5 lbs. 25c; 10 lbs. 45c; 25 lbs. 85c; 50 lbs. \$1.50; 100 lbs. \$2.50; 200 lbs. \$4.00; 1000 lbs. \$18.00; per ton \$35.00.

Blood (Dried). For indoor culture of flowering plants, like roses, carnations, etc., its chief element being nitrogen. One of the quickest acting fertilizers. 5 lbs. 50c; 10 lbs. 85c; 25 lbs. \$1.50; 50 lbs. \$2.50; 100 lbs. \$4.50; 200 lbs. \$8.50; 500 lbs. \$20.00.

Bone Meal. Unusually rich in nitrogen and phosphoric acid, the two principal plant foods. We recommend this especially for lawns, gardens and greenhouses, or any purpose where a high class fertilizer counts. Apply 800 to 1000 lbs. per acre. 5 lbs. 25c; 10 lbs. 45c; 25 lbs. \$1.00; 50 lbs. \$1.75; 100 lbs. \$3.00; per ton, \$50.00.

BOVUNG

A rich manure from cows—the ideal fertilizer for New Lawns and for restoring the worn-out grass plot to its original vigor.

Through a special process practically all moisture is removed from Bovung soon after it has been taken from the barns.

Bovung is absolutely free of all live weed seeds, it can not bring plant diseases to your garden, and while a little goes far, no harm will occur through fertilizing your lawn or garden freely.

Bovung broadcasts as readily as grass seed and we suggest three applications upon your lawn throughout the year, in the early spring, again in midsummer, and finally early in the autumn.

Bovung, too, is an excellent fertilizer for the flower and vegetable garden, being of an organic nature it brings to the soil just those materials in which the average garden soil is lacking. 5 lbs. 25c; 10 lbs. 45c; 25 lbs. \$1.00; 50 lbs. \$1.50; 100 lbs. \$2.75; 500 lbs. \$12.50; 1,000 lbs. \$23.50; ton, \$42.50, not prepaid.



Clay's Fertilizer. An English chemical fertilizer, for forcing greenhouse plants and vegetables. It can be used in either dry or liquid form. 28 lbs. \$3.75; 56 lbs. \$6.25; 112 lbs. \$12.00.

Cottonseed Meal. Apply 800 pounds per acre. Exceedingly rich in potash and ammonia, making it excellent for use as a grass and grain fertilizer; for putting-greens it is invaluable. 5 lbs. 40c; 75c per 10 lbs.; 25 lbs. \$1.30; \$2.25 per 50 lbs.; 100 lbs. \$4.00; \$35.00 per 1/2 ton; ton \$65.00.

Cow or Cattle Manure (Shredded). One sack of this is equal to one carload of cow manure in regular form. Convenient to handle, making it possible for everyone to get this usually scarce article at all times. Especially suited for soil mixing, mulching and liquid manuring. Apply 1000 lbs. per acre. 5 lbs. 25c; 10 lbs. 45c; 25 lbs. \$1.00; 50 lbs. \$1.75; 100 lbs. \$3.00; 500 lbs. \$11.25; 1000 lbs. \$22.50; 2000 lbs. \$45.00.

Dutch Maid (Pulverized Form). For lawns, flowers, shrubs and vegetables. The use of DUTCH MAID will make lawns richer, give earlier flowers, make thrifty shrubs and larger yields of vegetables. DUTCH MAID is a specially prepared plant food that contains the essential ingredients—nitrogen, phosphoric acid and potash in the form that will give rapid growth and full development of the above plant life. Guaranteed analysis. Nitrogen 4 per cent, Avai. Phos. Acid 6 per cent, Potash 6 per cent. 5 lbs. 50c; 10 lbs. 85c; 25 lbs. \$1.50; 50 lbs. \$2.50; 100 lbs. \$4.00.

Terogen. A spring and summer ground dressing; reinforces any manure fertilizers you may use. Lb. 75c; 2 lbs. \$1.25; 5 lbs. \$2.75; 10 lbs. \$4.75; 25 lbs. \$11.00; 100 lbs. \$40.00.

Genuine Venezuelan Goat Manure. Pure animal manure, long recognized as the most valuable aid to plant-life under the control of man. It is gathered from the corrals in Venezuela, carried to the seacoast, and shipped to the factory. Litter is unknown in Venezuela, hence the absence of straw or other trash, usually found mixed with domestic animal manures. Coming from the hot, dry climate of Venezuela, this material is absolutely free from weed seeds of any sort. The readily available organic nitrogen will give your plants a good start, and the slower-acting elements will feed them throughout their growing season. 100 lbs. \$3.00; 500 lbs. \$11.50; 1,000 lbs. \$22.50; 2,000 lbs. \$45.00.

Horn Shavings. Used principally for mixing in potted soil; rich in ammonia, especially valuable in chrysanthemum growing. 5 lbs. 70c; 10 lbs. \$1.25; 25 lbs. \$2.00; 50 lbs. \$3.75; 100 lbs. \$7.00.

Hyper-Humus. An excellent article to incorporate with poor soil in the garden, greenhouse or in potting plants. When used in garden work, the ground should be covered with one-half to two inches of Humus and spaded in. 5 lbs. 25c; 10 lbs. 45c; 25 lbs. 85c; 50 lbs. \$1.35; 100 lbs. \$2.50; 500 lbs. \$11.25; 1000 lbs. \$18.00; 2000 lbs. \$30.00.

Lime (Hydrated or Powdered). This is a very fine article for distributing on grass. Promotes growth, gives the grass a rich color and has a tendency to prevent the growth of weeds. Apply one ton per acre. 10 lbs. 25c; 50 lbs. 60c; 500 lbs. \$4.50; 1000 lbs. \$8.00.

Muriate of Potash. Apply 100 to 150 lbs. per acre, usually with other fertilizers. Excellent for potatoes, corn and other grains. Analysis, equal to 50 per cent actual potash. 5 lbs. 35c; 10 lbs. 60c; 25 lbs. \$1.25; 50 lbs. \$2.00; 100 lbs. \$3.75; ton \$60.00.

Nitrate of Soda. Apply 100 to 150 lbs. per acre, mixing with land plaster or other fertilizers to render application more easy. Use only after plants are above ground. If used in liquid form dilute 2 ozs. to 1 gal. of water and do not apply oftener than twice a week. 5 lbs. 25c; 10 lbs. 45c; 25 lbs. \$1.00; 50 lbs. \$1.75; 100 lbs. \$3.00; ton \$50.00.

Phosphate. For all vegetable crops, grains, grass, etc. Apply 800 to 1,000 lbs. per acre broadcast. 5 lbs. 35c; 10 lbs. 60c; 25 lbs. \$1.00; 200 lbs. \$3.00; 1/2 ton \$12.00; ton \$22.00.

Phosphate, Super-Acid (16 per cent). Apply 1,000 pounds per acre. Used for mixing with other fertilizers to increase the phosphoric acid analysis. 5 lbs. 35c; 10 lbs. 60c; 25 lbs. \$1.00; 200 lbs. \$3.50; 1/2 ton \$13.00; ton \$25.00.

Sheep Manure. Apply 1000 lbs. per acre. One of the most extensively used of animal manures. The analysis shows it to be a perfectly balanced plant food. For garden, lawn or greenhouse use, nothing surpasses sheep manure; it is clean and easily handled, besides giving immediate results. 5 lbs. 25c; 10 lbs. 45c; 25 lbs. \$1.00; 50 lbs. \$1.75; 100 lbs. \$3.00; 500 lbs. \$11.25; 1000 lbs. \$22.50; 2000 lbs. \$45.00.

Soot (Scotch Imported). This is used principally for bringing a good healthy color into foliage of chrysanthemum and other greenhouse plants. Also destroys insects and grubs that work on top of and underneath the surface. 5 lbs. 60c; 10 lbs. \$1.00; 25 lbs. \$1.50; 100 lbs. \$5.00.

Sulphate of Aluminum. Especially adapted for fertilizing Rhododendrons, and other plants requiring an acid soil. 5 lbs. 40c; 10 lbs. 70c; 25 lbs. \$1.25; 100 lbs. \$4.00; 200 lbs. \$7.50.

Sulphate of Ammonia. Apply 75 to 100 lbs. per acre only with other fertilizers deficient in nitrogen. A valuable fertilizer for all plants in which a large leaf development or rapid growth is desired; will stimulate growth almost immediately. Analysis equal to 25% of ammonia. 3 lbs. 25c; 5 lbs. 35c; 10 lbs. 60c; 25 lbs. \$1.25; 50 lbs. \$2.00; 100 lbs. \$3.50; ton \$60.00.

Sulphate of Potash. Apply 100 to 125 lbs. per acre, usually with other fertilizers. On account of its great strength it must be used judiciously. Valuable for roots and grain crops. Analysis equal to 50% of actual potash. 5 lbs. 40c; 10 lbs. 70c; 25 lbs. \$1.25; 50 lbs. \$2.25; 100 lbs. \$4.00; 200 lbs. \$7.50.

Tankage. This is usually applied to plants such as roses, etc., under glass. It is similar to dried blood. 5 lbs. 40c; 70c per 10 lbs.; 25 lbs. \$1.25; \$2.00 per 50 lbs.; 100 lbs. \$3.50; \$6.50 per 200 lbs.; 1/2 ton \$28.00; \$55.00 per ton.

Tobacco Stems. For fumigating, mulching and fertilizing, these are invaluable. The chief fertilizing element in them is the potash. 5 lbs. 25c; 10 lbs. 50c; 50 lbs. \$1.75; 100 lbs. \$3.00.

Vigoro. A specially prepared plant food for lawns, vegetable and flower gardens, shrubbery, trees, etc. 5 lbs. 50c; 25 lbs. \$1.50; 50 lbs. \$2.50; 100 lbs. \$4.00.



V-C Fairway Fertilizer. For lawns and grass. To have a lawn of closer, faster-growing grass that resists drought, stays greener—constantly thickens and spreads—use V-C Fairway Fertilizer. This is the treatment now used on the lawns of country estates, polo fields and on the most famous golf courses. Fifteen times as rich as manure; costs not more than 10 cents for each 100 square feet to be treated. Practically no odor. 100-lb. bag (enough for 5,000 sq. ft.) \$4.00; 50-lb. bag (enough for 2,500 sq. ft.) \$2.50; 25-lb. bag (enough for 1,250 sq. ft.) \$1.50. Convenient, easy to handle. Complete directions for lawn treatment on every bag.



WONDERGRO is water-soluble and Odorless and may be used in tablet or liquid form. Per box of 40 tablets 25c (postpaid 30c); per can of 40 tablets 25c (postpaid 30c); per can of 100 tablets 50c (postpaid 65c); 1000 tablets \$3.25 (postpaid \$3.40). "Wondergro" is the new and better Plant Fertilizer sent postpaid with a little FREE BOOKLET on "How to Make a Success of the Window Garden."

ABEL'S QUALITY LAWN SEEDS

Abel's Evergreen Lawn Grass Seed is being used on the finest lawns in Berks County

ABEL'S EVERGREEN LAWN GRASS

This formula, after years of experimenting, has been blended carefully of grasses adapted to producing very thick growth and velvety appearance. Our grass seed is tested for purity and germination and each variety of grass in its composition is here for a special purpose—some for making fibrous roots which hold upon the soil and keep the turf in place; some of a sure creeping nature, filling up any bare spots; others for their color value; also for withstanding beating down by excessive rains.

One pound will usually seed a place of 10 by 10 feet; 1 peck a space of 1,000 square feet; 1 bushel a space of 4,000 square feet, or, say 40 by 100 feet. For a thicker, more permanent effect, more seed is better.

Lb. 45c; 5 lbs. \$2; bus. (20 lbs.) \$7.50; 100 lbs. \$35

Abel's Special Lawn Seed Including Bent Grasses

A perfect blend combination of the purest high test grass seed INCLUDING BENT GRASSES most suitable for the establishment of a luxuriant lawn. This mixture combines the qualities of quick growth, compactness and permanence, and is recommended to those who seek a beautiful lawn.

Lb. 55c; 5 lbs. \$2.50; 20 lbs. and up 45c per lb.

Penn's Common or City Park Lawn Grass

Contains only grasses suitable for the purpose of making a beautiful lawn. It germinates quickly and roots deeply, enabling it to withstand the intense heat of summer. This special mixture can be recommended very highly. However, the formula and purity test does not equal that of our Evergreen Lawn Grass. Lb. 35c; 5 lbs. \$1.50; bus. (20 lbs.) \$5.50; 100 lbs. \$25.00.

Abel's Terrace Mixture Lawn Grass

A special mixture of grasses for sowing on terraces and side hills—grasses that produce strong, spreading roots, thus preventing heavy rains from washing them out, that will withstand drought and exposure, thrive on shallow soils, and produce a rich, green turf throughout the season. Lb. 50c; 5 lbs. \$2.25; bus. (20 lbs.) \$8.00.

Abel's Shady Place Lawn Grass

Usually it is quite difficult to obtain a satisfactory growth of grass under trees and in shady places, and for sowing in such places we recommend the use of our special mixture. It will quickly produce an abundant and even growth of beautiful green grass. The grasses used in making this special mixture are those adapted for growing in shade. It has been successfully used on some large operations where greensward was desired on land partially shaded by old trees. Lb. 45c; 5 lbs. \$2; bus. (20 lbs.) \$7.50; 100 lbs. \$35.



Abel's Parkway Lawn Grass Seed

A mixture meeting the requirements of those desiring a moderately priced grass seed. A quick growing mixture producing a permanent sod. 1 lb. 25c; 5 lbs. \$1.10; bushel (20 lbs.) \$4.00; 100 lbs. \$18.00.

Abel's White Dutch Clover

Recleaned for sowing on lawns, pastures, etc. ¼ lb. 25c; ½ lb. 40c; 1 lb. 70c; 5 lbs. \$3.25; 10 lbs. \$6.00.

Kentucky Blue Grass

Forms a close, thick dark green turf and is very hardy. Heavy, fine, clean seed. Lb. 35c; 5 lbs. \$1.50; 10 lbs. and up 25c per lb.

Fancy Red-Top Grass

One of the Bent grasses. Used on golf courses and in all good lawn mixtures. Does well in wet places and under unfavorable conditions. Is drought-resistant. Lb. 35c; 5 lbs. \$1.50; 10 lbs. and up 25c per lb.



A REAL GRASS CUTTER The MOTO-MOWER

Over 150 satisfied users in Berk county.

Ask for separate catalog with prices showing different models.

1939

ALL-AMERICA SELECTIONS

Winners

New Flower You Will Enjoy Growing



 Morning Glory, Scarlett O'Hara
Gold Medal—1939 All-America Selections



 Phlox, Salmon Glory
Silver Medal—1939 All-America Selections



 Petunia, Hollywood Star
Silver Medal—1939 All-America Selections

MORNING GLORY, SCARLETT O'HARA

The flowers, rich dark wine red or deep crimson, are of good size, very showy and produce freely on fast growing vines. It stays open longer than others. Blooms until frost. Its fairly dark green foliage is quite distinct. Your garden will not be complete without Scarlett O'Hara. Packet, 25c.

PETUNIA, HOLLYWOOD STAR

This lovely new Petunia is a charming shade of rich rose with an amber throat. It is unique in the form of its flower which consists of a five pointed star. This is a very fine garden variety as it is early and free blooming and the strong, vigorous plant is so smothered with blooms that hardly any foliage shows. Packet, 25c.

PHLOX, SALMON GLORY

This huge flowered variety has soft but rich salmon-pink florets with wide creamy-white eyes. Florets measure $1\frac{1}{4}$ to $1\frac{1}{2}$ inches in diameter. Grows about ten inches high and is a prolific bloomer. A grand novelty and worthy variety for bedding, boxes and cutting. Packet, 25c.

The Plants We Sell Are Grown By Experienced Florists from Abel's Tested Seeds

ABEL'S SEED HOUSE

12 North Ninth Street (^{25 Steps} From Penn) READING, PA.