

## **Historic, archived document**

Do not assume content reflects current scientific knowledge, policies, or practices.

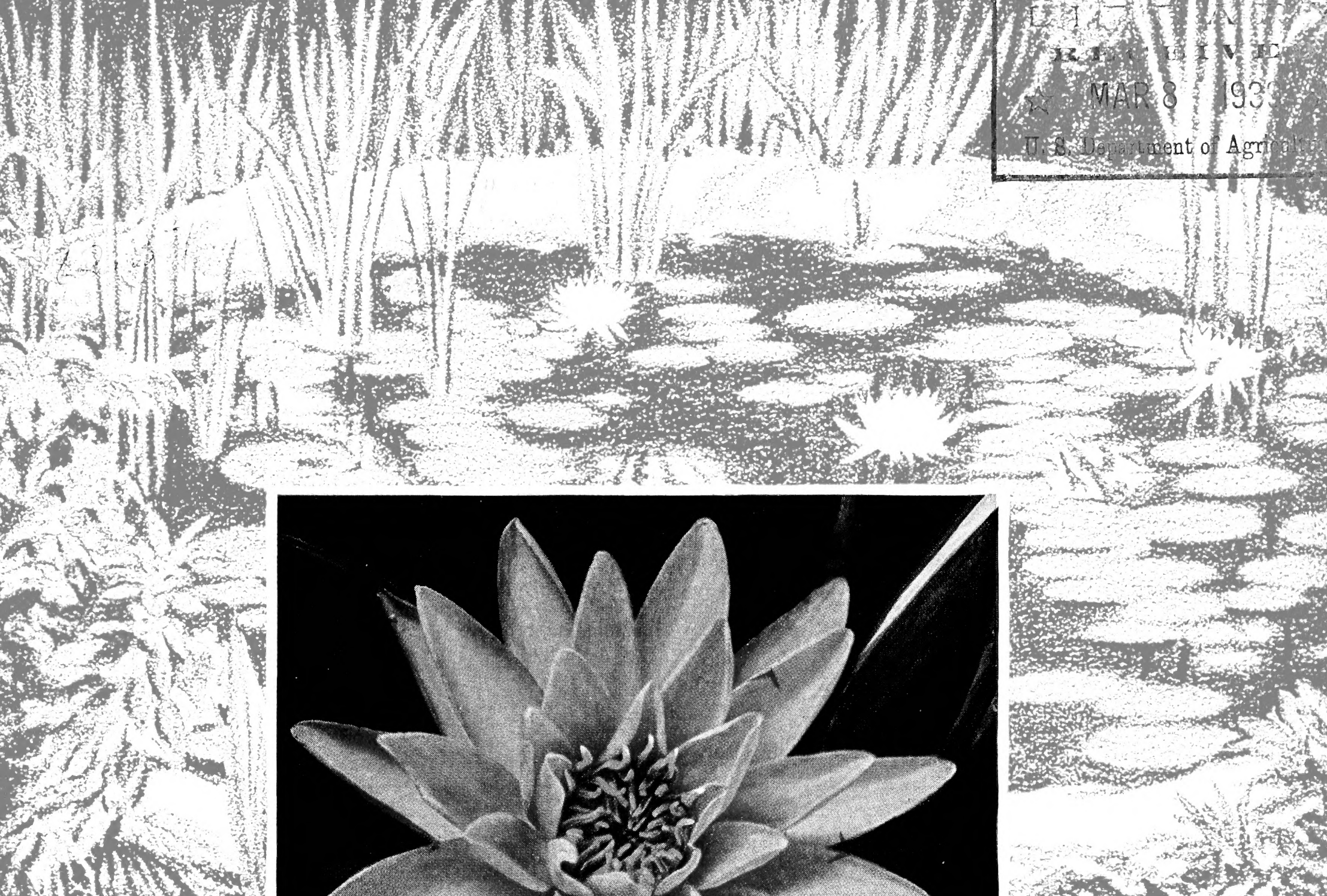

LIBRARY  
RECEIVED  
★ MAR 8 1933  
U. S. Department of Agriculture



CATALOG NO. 1039



ROSE AREY

LIBRARY  
RECEIVED  
★ MAR 5 1933  
U. S. Department of Agriculture

# Waterlilies

**AQUATIC PLANTS AND GOLDFISH  
FOR POOLS AND AQUARIUMS**



**THREE SPRINGS FISHERIES  
LILYPONS ♦ ♦ MARYLAND**



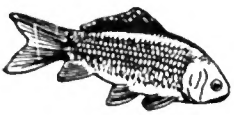

# THREE SPRINGS FISHERIES—LILYPONS

## *We Invite You to Visit*

the

# LARGEST LILY GARDENS

## *in the World*

**W**E invite you to visit the largest lily gardens in the world. Visitors are always welcome to our plants. In the sketch below, you will note that we have two plants. The larger plant, and the one which is most interesting, is the lily gardens and hatchery. All directions below are given to go to this plant. This is the largest plant of its kind in the world. We have many visitors every season from all parts of

the United States. Many come to our plant in the summer, and make their selections, and take these back with them. Our plant is open every day in the week and on Sundays. We will do all possible to show you around our plant, and we have many guides to direct you. We, however, ask that you call in the morning or before midafternoon, as the hardy lilies close in the afternoon.

## How to Reach Our Properties

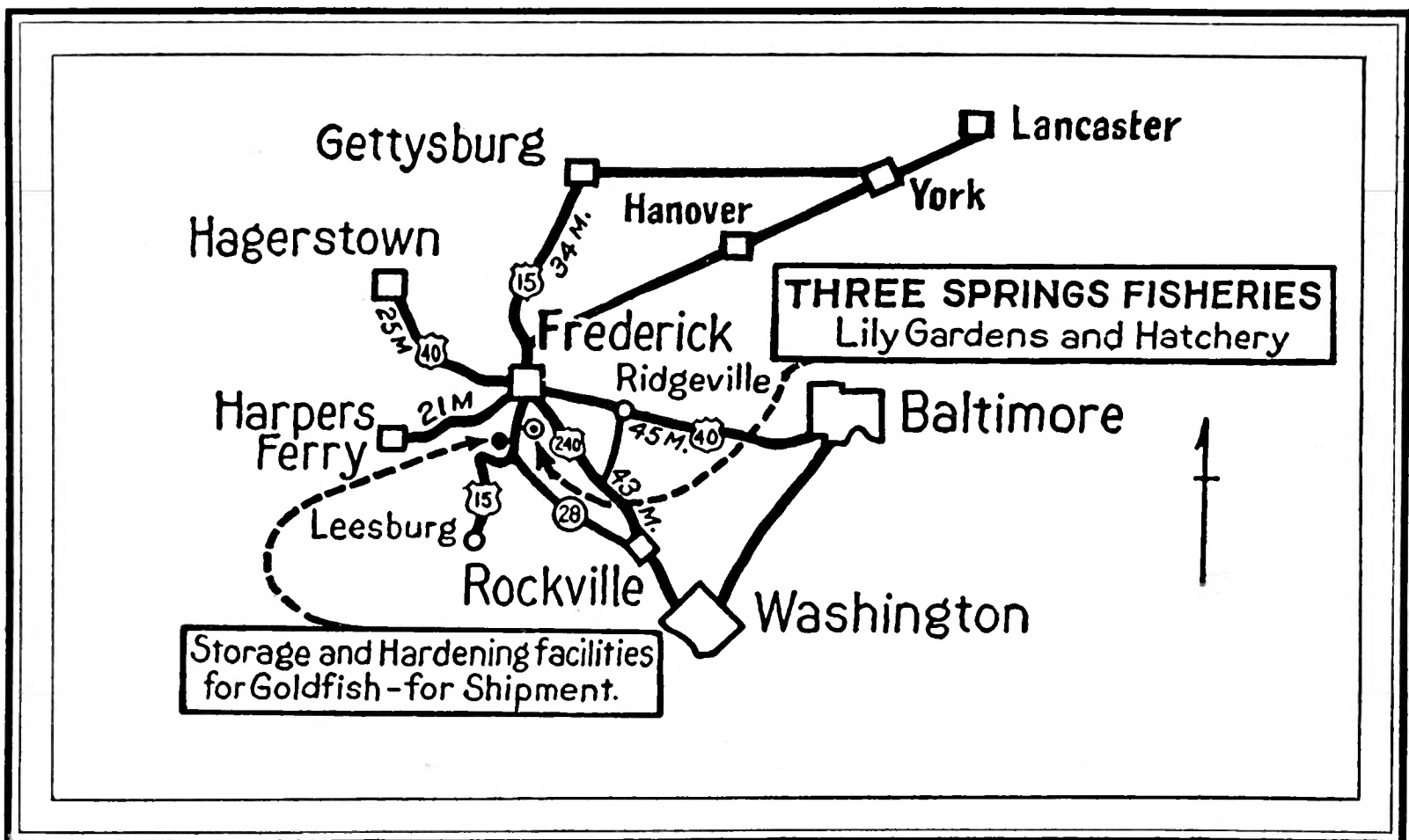

**FROM BALTIMORE, MARYLAND.** Take Frederick road, the National Pike, U. S. No. 40, to Frederick, Maryland, thence follow the directions from Frederick.

**FROM WASHINGTON, D. C.** Take Massachusetts Avenue to Wisconsin Avenue to and *straight through* Rockville, Darnestown, Dawsonville, Beallsville and Dickerson over the Monocacy River, thence the first macadam road to the right, at which point you will notice a large sign. Route U. S. No. 240 to Rockville, State No. 28 from Rockville to beyond the Monocacy River, thence north, towards Frederick, straight ahead, on U. S. No. 15 to the sign.

**FROM CUMBERLAND, MD., AND THE WEST.** Follow U. S. Route No. 40 east to Frederick, thence south on

U. S. Route No. 15, turning to the right in Frederick (see instructions from Frederick).

**FROM GETTYSBURG AND HARRISBURG.** Follow Route No. 15, south to and straight through Frederick.

**FROM HANOVER, YORK, LANCASTER.** The road via York, Hanover, Littlestown, Taneytown, Woodsboro, Walkersville to Frederick has been improved and is in excellent condition—is not only nearer but less traveled than via Gettysburg.

**FROM FREDERICK, MARYLAND.** Drive out South Market Street or Buckeystown Road. Just out of Frederick *be sure to follow the right fork* of the road or U. S. Route No. 15 through Buckeystown. Turn left at the first macadam road where there is a large sign and a small blacksmith shop.





**Please read carefully these two pages. They give you an idea who we are. Tell you how and when to order. Give you our terms, and policies which have made us the outstanding waterlily producers of the world.**

**O**UR FIRM is composed of three brothers who devote practically their entire time to this business. Every order receives the personal attention of one of the owners of this enormous plant. There is no other plant in the world like it—no other where you can see such an expanse of waterlilies and millions of gold-fish. Words simply cannot describe the vastness, or the gorgeousness of the masses of lily blooms during the blooming season.

Our business has been steadily growing. Year after year we show increased production and increased sales. The demand for our product has been steady and largely due to the praise of our customers, and the personal attention of the owners who have their customers' interests at heart. While other firms have been doing less business, our business has been going forward.

Our marvelous growth from a small beginning to the *World's Largest Producers* is due to our liberal policy. In dealing with us *you* are the judge. The customer must be pleased. We absolutely *guarantee our lilies to grow and produce blooms*. On the back of our order sheet for years has appeared the slogan "*We guarantee to our customers complete satisfaction.*" Is it any wonder that our business has shown such growth? With this liberal policy, while other producers are telling you what they will not do, we have been telling the public what our plants will do, and backing it up with the most liberal guarantee, "you must be satisfied," year after year, until we

are the *outstanding waterlily producers of the world*.

Pick up the average catalogue and read "We do not," or "We will not be responsible," or "We cannot," and then compare it with our positive, definite statements such as, we guarantee safe arrival, we prepay all charges, we guarantee our lilies and all aquatic plants to grow, and then that last guarantee "You must be satisfied." Compare these statements of ours with "We cannot be responsible for loss in transit," or "We are not liable," etc. Why not? Who knows how to grow and pack the goods better than the producer? If the producer has not faith in his product, or his packing, or the transportation, why should the buyer? Buy from the producer, the Three Springs Fisheries, who stand back of their product, is the answer. Our catalogue tells you what we do. It does not waste space and your time trying to discourage you by showing you how little faith we have in our product.

Being the World's largest producers of hardy waterlilies and aquatics, we have the largest stock from which to make selection. Any and all small inferior roots are discarded. Your plants thus chosen from the World's largest acreage assures you of the very best obtainable and enables us to make the unqualified guarantee, "You must be satisfied." The personal attention of the three owners, the large production from which your roots, only the best are chosen, assure you of lilies which will grow and

*(Continued on page 31)*

---

*The best lily roots from the best acreage in the world. Especially selected for size, quality, and bloom.*

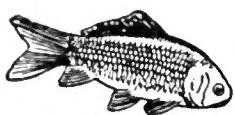

## THREE SPRINGS FISHERIES – LILYPONS

# A WATER GARDEN

## In a Wooden Tub or Tubs



**T**UB gardens are growing in demand. Because you live in a city, or on rented property, or for any reason do not wish to spend the money for a concrete pool, or build a pond, is no reason why you should not have the pleasure of the Water Lily and Goldfish. Many of the best Water Lilies are peculiarly adapted to Tub Culture, such as the Helen Fowler, Pink; the Odorata, White; the Chromatella, Yellow; the Paul Hariot, Changeable; all very pretty.

These tubs may be placed upon a block of wood above ground or sunk into the ground to any depth. They may be bought singly or in groups of two or three.

You may place into the tub an old dishpan filled with soil. In winter remove the pan to your cellar and upset the tub. Place the Goldfish in your aquarium in the house. Next season get the old pan, refill the tub and put out the goldfish and you are ready again. Your lily roots should be divided every few years. You may, if you prefer, omit the pan and place 6 to 8 inches of soil in the tub, plant your lily and fill with water.

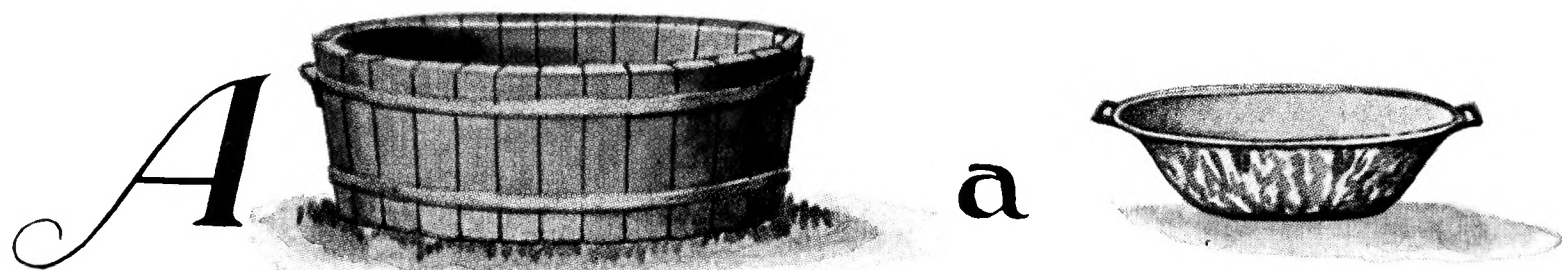
## TUB SUGGESTIONS



some  , some earth, manure and water – and combined we get

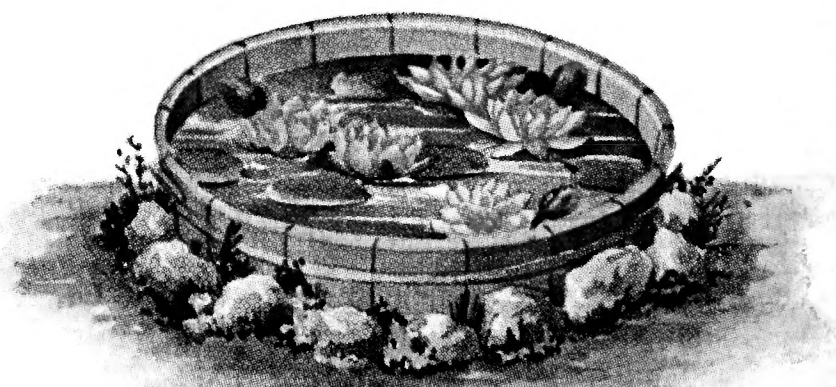
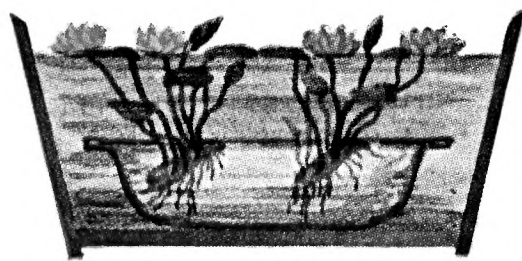

**TUB AND HOW TO MAKE IT.** For this we recommend a kerosene, linseed oil barrel or any kind of a vinegar or cider barrel. A barrel OF ABOUT 50 GALLONS should be sawed in half, making two tubs. Place one, not over two roots, in an old discarded wash pan which has been well filled with soil and manure, one part good rich cow manure to three parts soil. Over this place an inch or so of sand, if available. Place this into the half barrel and fill within an inch or two of the top. Only add enough water from time to time to take care of evaporation. In winter upset the barrel, remove the pan to your cellar or other place to prevent freezing. If you prefer you can place the soil directly into the tub or half barrel and plant in the soil. This would probably give more blooms, as there would be more soil.

**WHERE TO PUT IT.** About the only care that must be exercised in placing a tub is to put it where the sun will shine on it. If you live in a crowded or congested section you may place it on your front or back porch. It may be suspended or not. It requires very small space, only about 2½ feet square. No yard is too small for it. On either or both sides of the entrance to your home, it will be a source of endless admiration. When you bear in mind that it is not a monthly but a daily bloomer, you can see why lilies are becoming so popular. New flowers will open every day to greet you, and lilies will bloom from early Spring until killed by frost.

---

*The largest acreage in the world devoted to Water Lilies and Aquatics.*





**We offer the following  
TUB COLLECTIONS**

*We Give a Complete Tub and Garden for \$3.25 and up.*

For those who have their own tubs or half barrels we offer:

**TUB COLLECTION "A"** ..... **\$1.40**  
 2 lilies for..... **\$1.40**  
 Helen Fowler, Pink. See pages 9 and 10.  
 Odorata, White.  
 If wanted with tub add..... **\$2.00**

**TUB COLLECTION "B"** ..... **\$4.50**  
 For 2 tubs, 4 lilies:  
 Helen Fowler, Pink. See pages 9 and 10.  
 Odorata Gigantea, White.  
 James Brydon, Red. See below and page 11.  
 Marliac Chromatella, Yellow. See below and page 10.  
 With tubs add **\$2.00** for each tub.

**TUB COLLECTION "C"** ..... **\$3.00**  
 1 Lily, pink, white or yellow, your choice of color.  
 1 Lotus, pink or yellow. (We suggest pink Lily with yellow Lotus.) See page 17.

**TUB COLLECTION "C"—Continued**

6 Water Plants, some floating.  
 This is a fine collection for..... **\$3.00**  
 With tub complete..... **\$5.00**  
 For 1 pair selected common goldfish  
 (bucket 50c, fish **\$2.00**) add..... **\$2.50**

**TUB COLLECTION "D"** ..... **\$3.75**  
 For two tubs, four lilies:  
 Helen Fowler, Pink. See pages 9 and 10.  
 Odorata Gigantea, White.  
 Rose Arey, Dark Pink, almost Red. See page 8.  
 Marliac Chromatella, Yellow. See below.  
 This is an exceptional value at..... **\$3.75**

**TUB COLLECTION "F"** ..... **\$1.25**  
 Pink Opal, Dark Pink. See pages 9 and 10.  
 Odorata, White. These 2 for..... **\$1.25**

**EXTRA TUBS**

We furnish tubs 2 feet in diameter and 1 foot deep for **\$2.00 each**. They are made of white cedar and will last a long time. They may be used in pools as soil containers for your lilies and plants. Expressage collect on Tubs.

**James Brydon and Chromatella**

These two choice varieties are offered in both tub collection "B" and also alone as collection No. 50.

They are two of the very best lilies. There are none better, and the price is

**Only \$3.00**  
 for these two choice varieties.  
 Collection No. 50

**TWO BEAUTIES FOR LARGE TUBS**

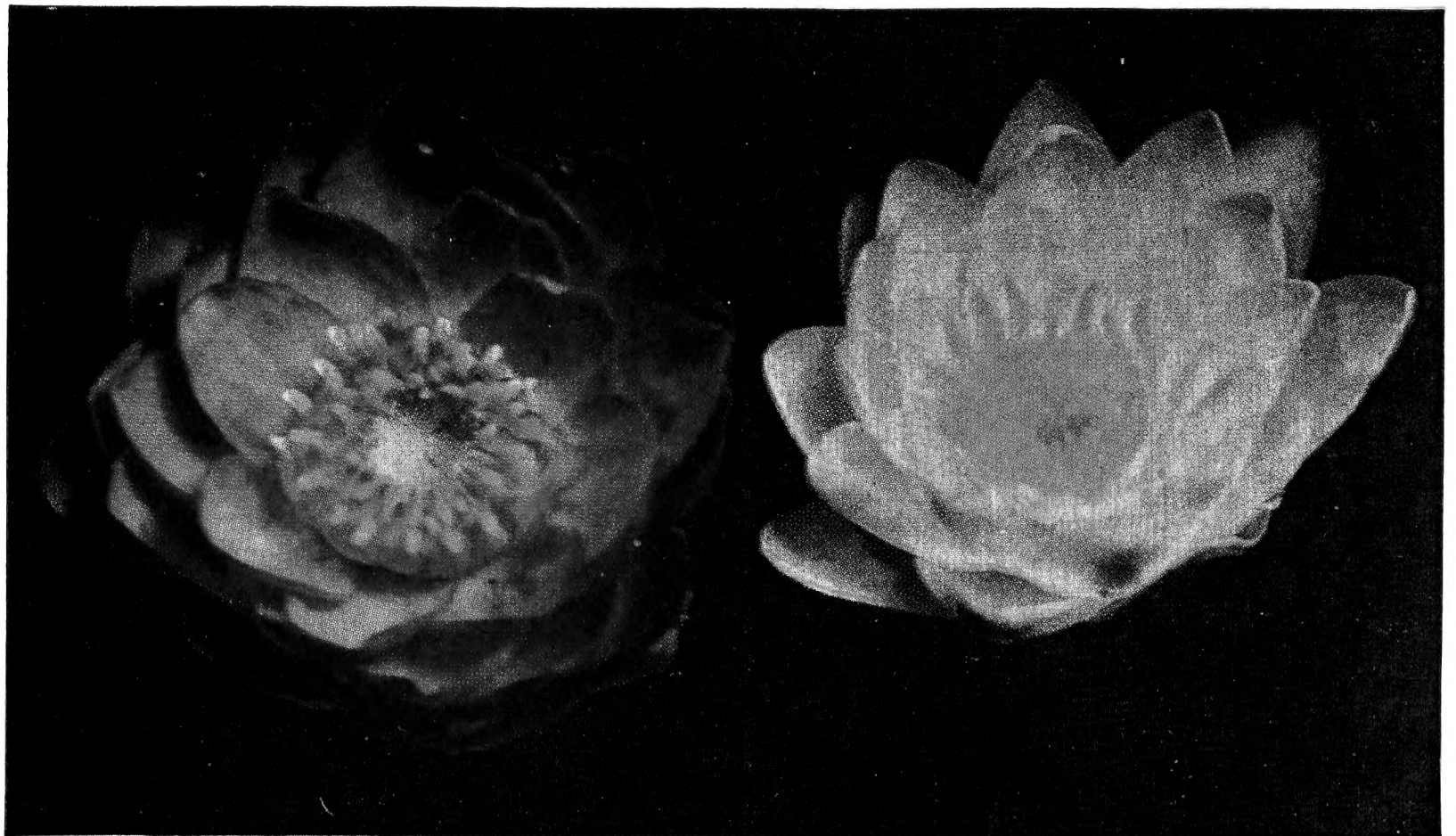

**JAMES BRYDON**

**MARLIACEA CHROMATELLA**

We offer these two choice lilies in our tub collection "B" (see above), or alone as Collection No. 50. These two superb lilies for **\$3.00**

*We grow our own products—both Water Lilies and Goldfish.*



*The*  
**FASCINA-  
 TION**  
*of the*  
**CULTURE**  
*of*  
**WATER**  
**LILIES** *and* **GOLDFISH**



POOL AT SEA ISLAND GOLF CLUB  
 Sea Island, Ga.

**T**HERE is nothing more beautiful nor fascinating than the lily pool or the lily tub. No part of your garden will be more frequented nor have such favorable comments—and yet it is within reach of everyone. The splendor of the water lily with its harmony of color and its sweet aroma or fra-

grance is yours for just a little trouble or work—then you have the exotic beauty of the tropics.

**EXPERIENCE.** No flower or plant is so easy to grow as the water lily. No experience whatever is necessary in order to be successful. The cost is so small that there is no reason why you should not have a garden distinctive; a little different from your neighbor; a little more attractive.

**REQUIREMENTS.** Oh, so easy. Sunshine, quiet water, and soil. Your pool or tub should be so located that it will not be shaded. If planted in a stream or brook, they should be planted in comparatively still water, not swift running water, and you should have good soil to get best results. **COULD ANYTHING BE SIMPLER OR EASIER?** For your pool you may have running water or not as you like.

**TIME OF PLANTING.** Probably the best time to plant water lilies is in April and May, though they may be planted as soon as they begin to show growth in the spring, and as late as in August.

**COLOR.** Water lilies can now be obtained in every shade, and in practically all colors—white, every shade of pink, red, yellow, blue, purple, etc.

**PLANTING, DEPTH OF WATER, AND SOIL.** Either of two methods may be followed. There are many failures in planting in too deep water. If you can regulate the water flow, we suggest that you cover the crown of the root about three inches. As the plant grows, add additional water from time to time. In this way your plants will grow much faster than by planting in deep water. Cover the cement with from nine inches to a foot of rich soil and plant the lilies in the soil, just leaving the tip of the plant protrude. The other method which we greatly prefer is to plant the roots in boxes and sink the boxes in the pool. This is easier to plant and easier to remove. We suggest about one part

*(Continued on page 30)*



POOL OF MRS. JOHN H. WILCOX  
 Easton, Md.

*You'll buy the finest pink, the Mrs. C. W. Thomas, eventually, why not buy it now?*

# OWN A LILY POOL

SO SIMPLE AND INEXPENSIVE TO  
BUILD—SO EASY AND INTER-  
ESTING TO CARE FOR

**N**O FLOWER can be produced at so little cost as the most fascinating and gorgeous Water Lily. Pools can now be built at so little expense that anyone who has the room and the sunshine may now have the oriental beauties of the water garden at their own home.

## SO EASY TO BUILD

With these sketches any handy man can with the ordinary laborer build pools at practically no expense other than the cost of material. No high-priced mechanic is necessary.

Pools may be constructed with straight or curved lines. If you have a good clay bottom you can lay the cement on the clay; if not, we suggest that you put in 6 inches of cinders beneath the cement bottom. Be sure to have the cinders well packed. The construction can be made by any cement worker. The overflow and drainage pipe should be the same. A short piece of pipe with thread on the end can be screwed into the drain pipe.

The ideal water pool is about two feet deep. The side walls should be about five inches in thickness, tapering to seven inches at the bottom. The bottom of the pool need not be more than six inches.

Good results can be obtained from a mixture of one part Portland cement, two parts sharp sand, and three parts half-inch gravel (if gravel is not available crushed stone may be used), mixed with water and poured over the bottom and up the sides. The rough places of the concrete may be smoothed down by applying a thin coat of cement with a trowel or paint brush. It is important to keep newly poured concrete moist for several days by sprinkling frequently several times over a period of ten days, before any fish or plants are placed in it, as the alkali may injure the fish and plants. (Your local cement dealer will gladly give you a pamphlet on "Cement Construction.")

It is also advisable to reinforce the construction by using hogwire fencing. This material is very easy to bend up the sides of the pool, being sure each strip of fencing overlaps the previous strip.

Your pool should be carefully washed out before planting. Should a green scum appear, this will be due to vegetable growth and will disappear in a short time. Do not change water and above all do not add chemicals, as these will injure both the plants and fish. If absolutely necessary flush the pool, and if this does not clear it up, use our algæ treatment.

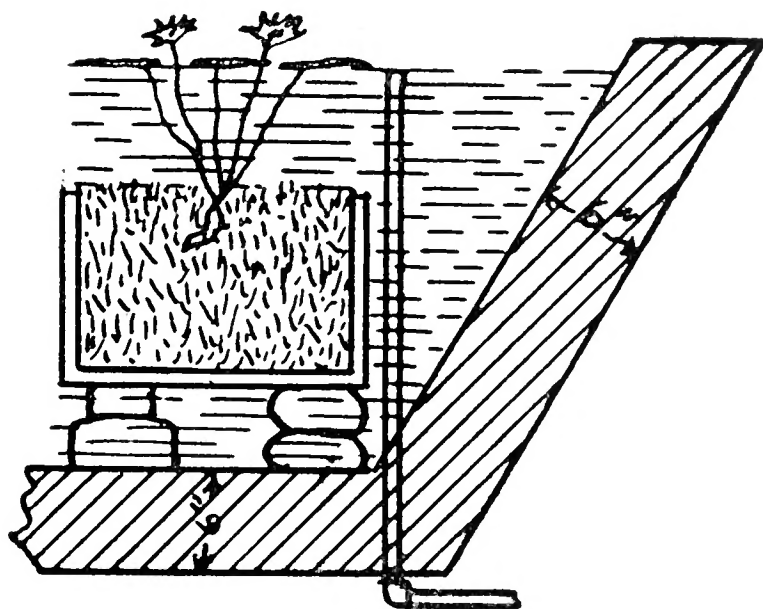
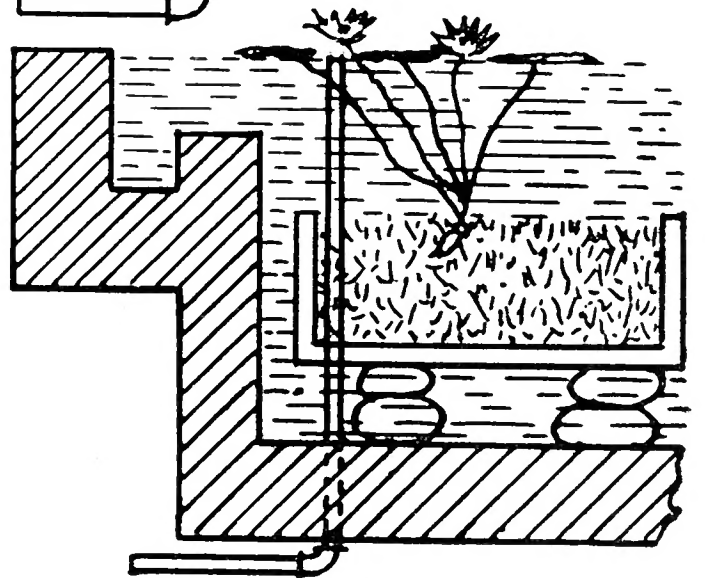
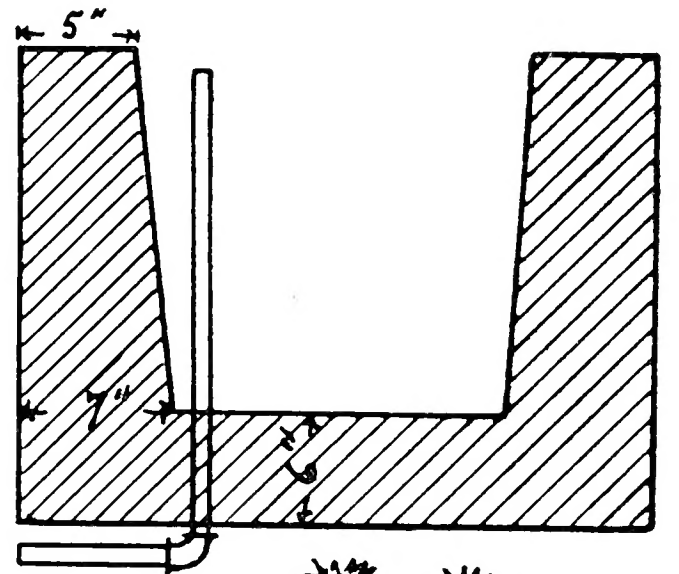



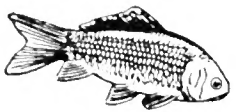

# THREE SPRINGS FISHERIES - LILYPONS

**I**N THIS basket is shown three of the most popular and most beautiful of all water lilies. This is an actual photograph of lilies picked from our large acreage and colored by the artist.

### Collection No. 5

- The Rose Arey (Pink) . . . \$1.75
- The James Brydon (Red) 2.50
- The Chromatella (Yellow) 1.25

Total value . . . . . \$5.50 for **\$4.50**

All standard and well recognized brands. We offer these three gorgeous varieties, this year for the first, in collection at the exceedingly low price of **\$4.50**

It is only due to our very large acreage, our enormous production, that we are able to offer such well known varieties in large, well developed plants at such prices. And, remember, you get the best grade and only selected stock.

To appreciate this great value you must read the description of each of these choice lilies on pages 10 and 11. In fact you must see them in all their beauty in order to fully appreciate what you will have.



### ROSE AREY



**ROSE AREY** (to left). Aside from the Mrs. C. W. Thomas, with its delicate shade of pink, there is no lily that can compare with the Rose Arey. Exceedingly fragrant, very large, a prolific bloomer. The most popular of all pinks. Read its full description on page 10. The lowest price at which this superb lily was ever offered, a special at **\$1.75**

**CHROMATELLA and JAMES BRYDON** (below). We offer these for those who only have room for two choice lilies. If you choose these you will not only have bloom, but you will have gorgeous colors and flowers to be proud of every day. See full description on pages 10 and 11.



As collection No. 50, we offer these two choice colored lilies for low price of **\$3.00**.

*A reputable, well rated house.*





# HARDY WATER LILIES



THERE is indeed a large class of many colors of Hardy Water Lilies. There is every known color, and every tint or shade to be found among the Hardy Water Lilies. These plants grow equally well whether in a pool or in tub, or in a quiet stream. Just a foot of water or so over the crown, together with sunshine, is all that is necessary. We have the purest Whites, all the various shades of Pinks, the dark Red to a bright Red, Yellow, and the Changeable colors.

If you wish the fragrant, sweet smelling lilies, you should choose those of the Odorata type, or those which are described as being fragrant. The Hardy Lilies offered are all day bloomers. They open in the early morning and close every afternoon. Each bloom lasts several days, and each is the developed full grown plant. The kind we sell should have several blooms every day. We recommend those in heavy type.

## WHITES

**GONNERE** One of the purest whites, very double, and free blooming. The flowers are so double that it looks like a large snowball. The choicest and best white grown.  
**Price, \$2.25 each.**

**ODORATA GIGANTEA** Very large, pure white, and very fragrant. Flowers are often 6 inches across. A free bloomer. The only thing cheap about it is the price.  
**Price, 50c each.**

**ODORATA MINOR.** This lily is especially valuable for tub culture. Flowers are small and very fragrant. From 2 to 3 inches in diameter. Suitable for planting at edge of ponds.  
**Price, 50c each.**

**MARLIAC ALBIDA.** Pure white flowers of large size with yellow stamens and quite fragrant. A free grower and blooms continuously the whole season. Sepals are tinted with pink, leaves deep green above and red beneath.  
**Price, \$1.00 each.**

**GLADSTONE.** This is the largest of the white lilies, and requires considerable space for its best development. The flowers are the purest white, cup-shaped, with golden yellow stamens. The plant blooms freely. Flowers often 6 to 8 inches across. The leaves are dark green.  
**Price, \$1.50 each.**

## Escarboucle and M. Rosea

We offer these two choice lilies, one a very brilliant shade of red, the other a beautiful shade of pink, in combination, **Price, \$2.80.**



**ESCARBOUCLE**

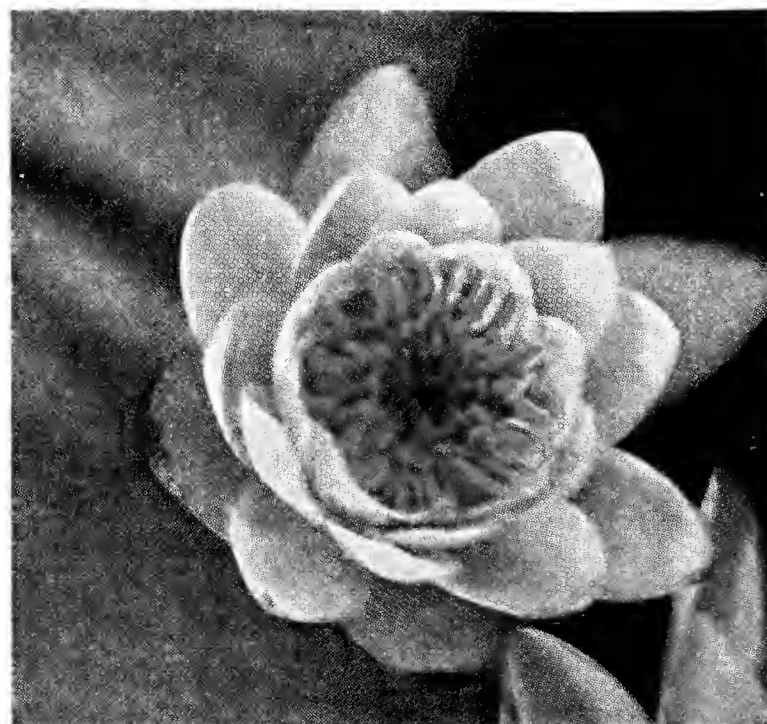

**MARLIAC ROSEA**

**Special Collection H 2.**

*This is truly one of the very best offers we have ever made, \$3.25.*

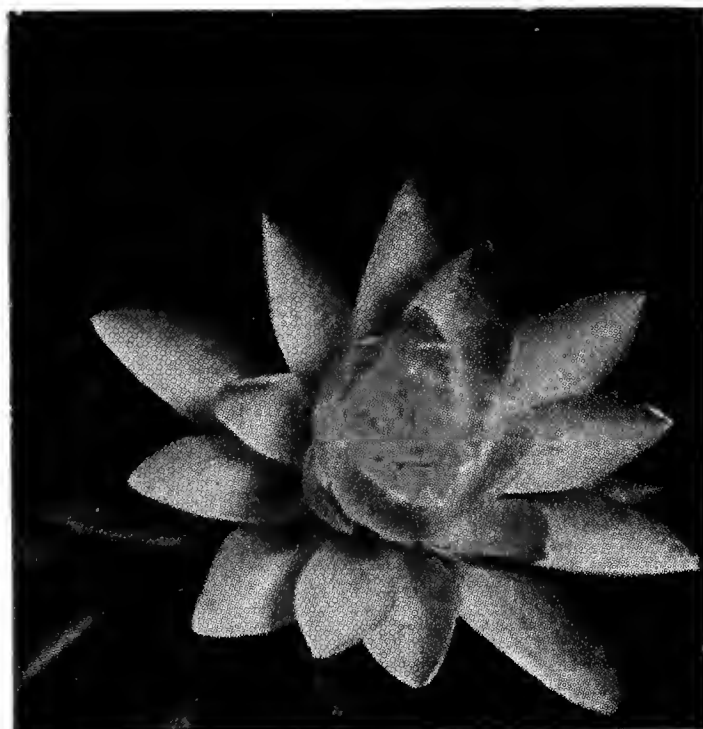

**PINK OPAL**

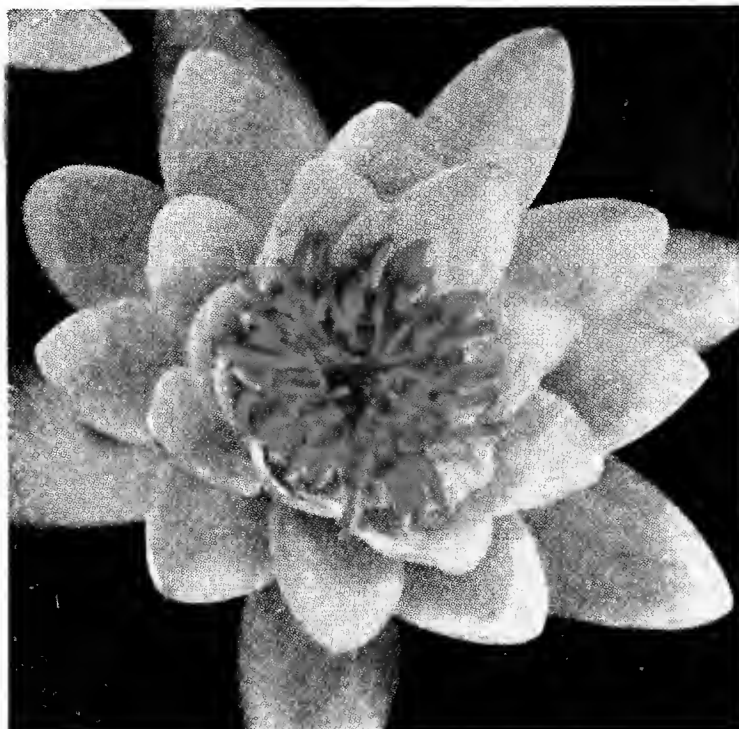

**HELEN FOWLER**

**Pink Opal and Helen Fowler**

To fully appreciate these two wonderful, fragrant flowers, it is necessary to see them. Both of them are very fragrant. One is a dark pink throughout, the other a fairly dark pink with a light center. Both are free bloomers. The Pink Opal is very well adapted for cut flowers.

*Special Collection H 3. We offer this choice collection for only \$1.85*

See back of order sheet, page 38, for instruction for ordering, etc.



# THREE SPRINGS FISHERIES—LILYPONS

## PINKS

**MRS. C. W. THOMAS** Be sure to read the *Special Description* of this lily, page 12. **Price, \$2.50 each.**

**ROSE AREY** We consider this the most desirable of any of the fragrant lilies. No collection is complete without this flower. It has a brilliant pink color. The petals are pointed and incurved. It has golden yellow stamen. One of the very best bloomers, producing very large flowers, often 7 to 8 inches in diameter. **IT IS BY FAR THE FINEST OF THE PINKS. ASIDE FROM THE MRS. C. W. THOMAS IT HAS NO EQUAL.** See color illustrations, pages 8 and 16. **Price, \$1.75 each.**

**HELEN FOWLER** This is another deep pink with lighter center with flowers borne well above the water. It is especially adapted to tub culture. Of all lilies this would be our choice for tub culture. It is very fragrant and a free bloomer. Flowers are not so large but sure to please. What it lacks in size is more than offset by its continuous blossoms and sweetness. See illustrations, pages 9 and 16. **Price, \$1.25 each.**

**EUGENIA DE LAND** An Odorata type. Flowers are extra large with long and lanceolate petals. A very beautiful color of deep rose pink or iridescent hue. Yellow stamen. Flowers float on the water. A very vigorous and free flowering variety. A very desirable plant. It was awarded the silver medal by the Newport Horticultural Society. **Price, \$1.50 each.**

**PINK OPAL.** An attractive deep pink, a medium size flower. It is one of the finest pink lilies for cut flower purposes. The buds are nearly round. When open the petals are short, and the flower stands well above the water. See illustration, page 9. **Price, \$1.00 each.**

**MARLIAC CARNEA.** Large soft flesh pink, deeper toward the center. Very free flowering, of a strong, vigorous growth, with large purplish red leaves changing to deep green. A free bloomer and one which exhales a sweet vanilla fragrance. **Price, \$1.25 each.**

**MARLIAC ROSEA.** This is similar to Carnea except that it is a deep pink. Large flowers of deep rose pink. Flowers 4 to 5 inches. See illustrations, pages 9 and 16. **Price, \$1.50 each.**

**SUMPTUOSA** This lily is of French origin and is very double. Its flowers are deep pink in the center, growing lighter toward the edges and lightly spotted with a deeper shade of color. The stamens are of a beautiful orange shade, and the color effect of the lily is most pleasing. **Price, \$2.25 each.**

**MASANIELLO.** Its flowers are cup shape. Very delicate shade of pink dotted with red. A strong grower and a free bloomer. **Price, \$1.75 each.**

**MORNING GLORY (Mary).** A beautiful soft pink of the Odorata or fragrant type with flowers often 5 inches across. Darker at the base, and shaded out to a light color to the petals. The stamens are yellow. **Price, \$2.00 each.**

## YELLOWS

**SUNRISE** One of the first lilies to open in the morning. A free bloomer of very large size, flowers frequently being 8 to 10 inches in diameter, and stand well above the water. It has long narrow petals. In color it is a clear sulphur yellow. It starts blooming early in the spring, and continues until late fall. Does well in any depth water and stands crowding. There is no other yellow lily that can compare with this superb variety. **Price, \$2.25 each.**

### MARLIAC CHROMATELLA

Flowers yellow, 4 to 6 inches. Leaves green, mottled with brown. A free bloomer. We consider this the finest of the Marliacs. This plant should be divided every few years. A charming canary yellow flower with bright yellow stamen. See illustrations, pages 5, 8 and 16. **Price, \$1.25 each.**

### ODORATA SULPHURIA GRANDIFLORA.

The flowers measure from 4 to 5 inches across and are of a deep sulphur yellow color standing 3 to 6 inches above the surface of the water. The stems are blotched with brown spots and float on the surface of the water. **Price, \$1.50 each.**



POOL AT DENBIGH HALL, Wilmington, Del.

Photo taken soon after planting and before Lilies had spread. Note Water Iris in bloom.

The pool is also filled with Gold Fish and the Lilies showing in photo are the ones purchased from you, which were greatly admired by all.

Sincerely yours,  
H. C. CORBIN, Mgr.

*Shipments direct from our large ponds or lakes. No reshipments.*





## REDS

**ATTRACTION** Where the pool is large enough we have no hesitation in giving this lily the first rank among the reds. It is a recent French introduction. On opening it is a garnet red, with almost white sepals and stamen of rich mahogany tipped with yellow. It is not only the largest lily in cultivation, often eight to ten inches across, but is one of the most beautiful. No pool of any size is complete without it.

Price, \$2.50 each.

**GLORIOSA.** A deep carmine rose color becoming deep red with age. A continuous bloomer, often reaching 5 to 6 inches in diameter. It is an ideal red lily for either pool or tub culture.

Price, \$2.25 each.

**JAMES BRYDON** This is a very fine hardy lily. Very free to bloom and a rapid grower. Flowers measure from 5 to 6 inches across. Broad, massive petals, concave and incurving, giving the flower a cup shape. It is a rich rose crimson. It is well adapted to either tub or pool culture. An early bloomer and you can count on it being in bloom every day. See illustrations, pages 5 and 8.

Price, \$2.50 each.

**ESCARBOUCLE.** This is the most brilliant of all of the reds. It is a bright intense red, a vermilion with garnet stamen. A strong grower and a free bloomer. It is unquestionably one of the best. To those who have never had this variety it will prove a rare treat. See illustrations, pages 9 and 16.

Price, \$2.50 each.

**CONQUEROR.** An immense flower. A robust grower of French origin. The flowers are a cherry red. Stamens are an orange yellow.

Price, \$2.00 each.

**NEWTON** A large flower with star shaped petals of the vermilion color. Sepals are white



POOL OF MR. C. R. DEATRICH  
Maugansville, Md.

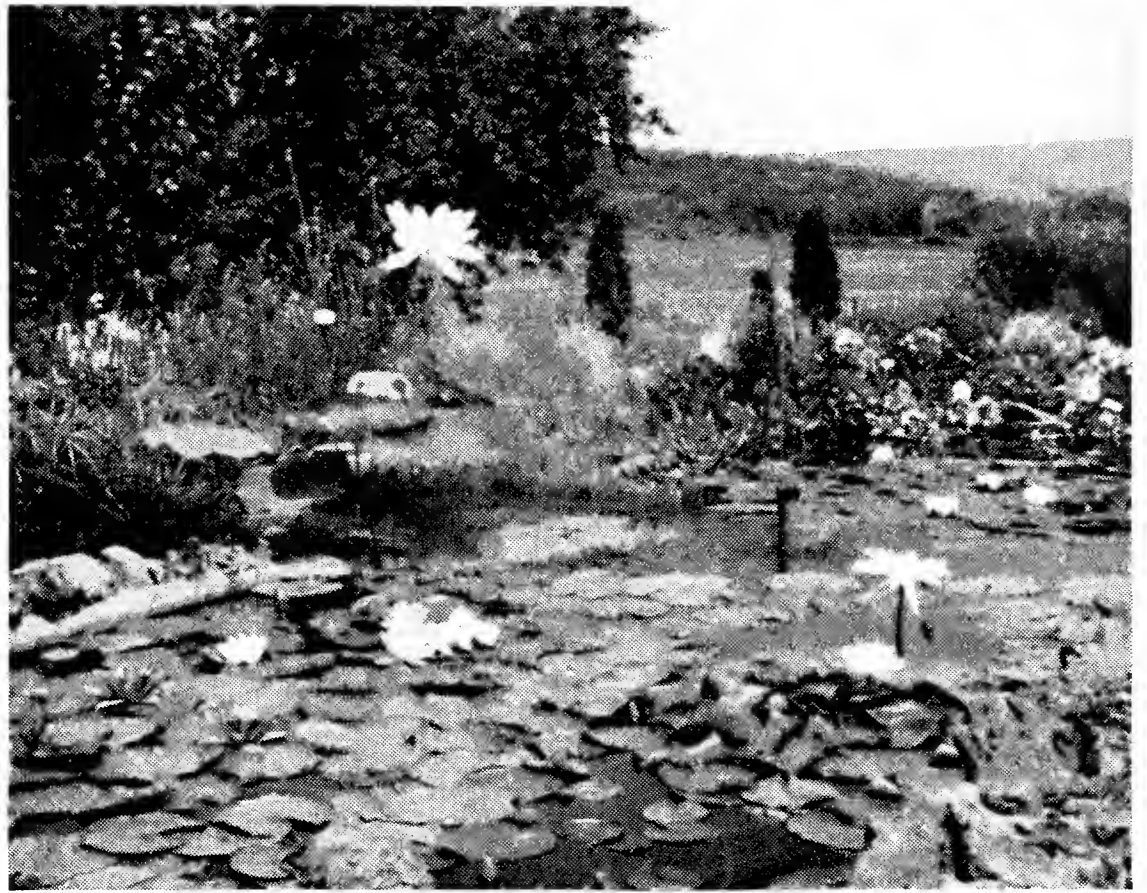

POOL OF MRS. H. S. CRISWELL  
Waynesboro, Pa.

with orange colored stamen. Flowers are borne above the water. Its general appearance is very much that of a tropical lily. A rather unique and beautiful variety. A free bloomer.

Price, \$2.00 each.

**SULTAN.** A large free blooming red flower of unusual merit. The sepals are white with red line. The flowers are of a very attractive red, deepening from rose to a cherry red towards the heart.

Price, \$3.00 each.

## CHANGEABLE COLORS

**PAUL HARIOT** A free bloomer; light yellow delicately shaded copper red. Flowers are large and cup shaped. A free bloomer.

Price, \$2.00 each.

**COMANCHE.** Large flowers of rich apricot color on opening, changing to a dark coppery-orange with flowing red as the flower ages. Leaves are an attractive olive green, flaked with brown.

Price, \$2.00 each.

**AURORA.** These flowers are creamy yellow on the first day. By the third day, they have changed to a dark red. This gives a variety of color daily.

Price, \$1.25 each.

**SIoux.** A changeable variety opening a clear yellow, shading to red as the flower ages. A free bloomer.

Price, \$1.75 each.

**SOLFATARE.** On opening the petals are yellow, with a slight rose cast, which deepens each day until the bloom is suffused with red. Very similar to the Paul Hariot only with softer tints.

Price, \$1.50 each.

**CHRYSANTHA.** One of the best of the changeable colors for tub culture. The flower opens a soft creamy yellow and darkens every day until it finally is a deep vermilion in color. It is especially adapted to small pools.

Price, \$1.50 each.

*No pool complete without goldfish. Try selected brood stock only.*



*The Mrs.  
C. W. Thomas*

**P**RODUCE large flowers, free-blooming, long season day flowering water lily. Very fragrant, partly double. A beautiful shell pink. Expert lily growers have pronounced this lily the most charming, the most delicate pink water lily as yet produced.

We offered this lily for the first time in 1931. For a number of years, we could not produce enough to meet the demands. This year we have a fair supply, and have been able to reduce the price to within reach of everyone. The new price is **\$2.50**.



**AN ACTUAL PHOTOGRAPH COLORED BY ARTIST FROM FLOWERS**



*Tropical  
Night Bloomer*

**Dentata Superba  
(Juno)**

**A** BEAUTIFUL pure white lily, measuring from 8 to 12 inches in diameter, with yellow stamens without any trace of purplish brown, making it the only one of this type that does not show the brown near the base of the stamens. The sepals are green, with faint greenish white stripes on the outside, the inner side being white. The leaves are large, deep glossy green, finely dentate. A free bloomer.

**Price — \$1.75**

*No flower so easy to grow as the Water Lily. No cultivation—no rake, no hoe, no water, just add enough to take care of evaporation.*

# Our Prize Collection

7 Lovely  
Lilies  
Pictured  
Here

PRIZE  
Collection  
No. 11

Only  
\$9.25



ONE EACH OF THESE CHOICE SEVEN (7) VARIETIES AS SHOWN FOR ONLY \$9.25

## OUR PRIZE COLLECTION

This remarkable collection of seven (7) of the very choicest Lilies. One of the very best of last year's offerings. So good that we are giving it one of our choicest positions this year.

Complete Prize  
Collection No. 11  
\$9.25

## A List of Hardy Lilies

*The varieties we consider the best are marked thus (\*)*

### WHITE

*Albida .....	\$1.00
*Gomere .....	2.25
*Gladstone .....	1.50
Odorata Gigantea .....	.50
Odorata Minor .....	.50

### PINK

*Helen Fowler .....	\$1.25
*Rose Arey .....	1.75
Marliac Rosea .....	1.50
Marliac Carnea .....	1.25
Pink Opal .....	1.00
*Eugenia De Land .....	1.50
Masaniello .....	1.75
*Somptuosa .....	2.25
Morning Glory .....	2.00
*MRS. C. W. THOMAS .....	2.50

### YELLOW

*Chromatella .....	\$1.25
*Sunrise .....	2.25
Odorata Sulphuria Grandiflora .....	1.50

### RED

*Attraction .....	\$2.50
*Escarboucle .....	2.50
*James Brydon .....	2.50
Gloriosa .....	2.25
Conqueror .....	2.00
Newton .....	2.00
Sultan .....	3.00

### CHANGEABLE COLORS

Chrysantha .....	\$1.50
Aurora .....	1.25
Comanche .....	2.00
*Paul Hariot .....	2.00
Sioux .....	1.75
Solfatare .....	1.50

*You'll have flowers every day—no work, no care, no worry and yet every day fresh flowers open to greet you each morning.*



# TROPICAL WATER LILIES

**T**ROPICAL water lilies produce much larger flowers than do the hardy water lilies. There are two distinct types of tender or tropical water lilies—the Day Blooming varieties and the Night Blooming varieties. **NO TROPICAL SHOULD BE PLANTED OUT UNTIL THE WEATHER HAS BECOME SETTLED AND WARM.** They grow rapidly, and flower from June until killed by the frost. When you see the immense size of the bloom, and the large quantity of bloom as well as the quality, you will not be satisfied until you have a tropical. Once you have them, your neighbor will want them, for there is no flower more economical and more beautiful than the tropical water lilies. We have all shades, practically all colors. Tropical lilies are also very much to be preferred for cut flower purposes.

It is possible to winter tropical lilies in the greenhouse where they will bloom all winter, but for those who do not have greenhouses, we suggest that the tropicals be treated as annuals.



Illustration courtesy De La Mare Co.

## DAY BLOOMERS

### WHITE

**MRS. GEO. H. PRING.** This is one of the new varieties, and by far the best pure white tropical lily. It produces large fragrant white flowers. **Price, \$1.50 each.**

**GRACILIS.** This is the tender white star-shaped lily of Mexico. The flowers are fragrant. Much smaller in size than the Mrs. Geo. H. Pring, and rise above the water from 12 to 15 inches. It is pure white with yellow stamens. **Price, \$1.50 each.**

### PINK

**MRS. C. W. WARD.** This is a deep rosy pink flower with golden yellow stamens tipped with pink. The flowers are from 8 to 10 inches across. It is a very strong plant and a very desirable variety. **Price, \$2.00 each.**

**GENERAL PERSHING.** This is one of the new lilies produced by Geo. Pring at the Missouri Botanical Gardens. The flowers are from 8 to 10 inches across and open from four to six days. This flower is rather unique in that it opens as early as 7 A. M. and remains open until 7 P. M. The flowers are very fragrant and are borne about 12 inches above the water. The buds are dark green, striped with dark purple. The flowers are delightfully fragrant, and are of a fine bright pink color. It is one of the best of the pinks. **Price, \$2.25 each.**

### BLUE

**PENNSYLVANIA.** (Blue Beauty.) This is one of the most popular of the blue lilies. The flowers are large and well borne above the water. The leaves are slightly speckled with

brown. It can be used for tub or pool. It blooms continuously from early in the summer until frost. It has yellow stamens tipped with blue. **Price, \$2.00 each.**

**MRS. ED. WHITAKER.** This is one of the newer hybrid water lilies. It is also a production of Mr. Pring of the Missouri Botanical Gardens. It is one of the largest of the day bloomers. The flowers are lavender blue on first opening, getting paler after the flower ages. They often reach 10 inches in diameter. The leaves are beautifully mottled and are streaked with dark red. One of the remarkable features of this lily is the fact that it opens as early as 6:30 in the morning, and does not close until 7:30 at night. There is no lily that remains open for so long a time. **Price, \$2.25 each.**

**HENRY SHAW.** A very popular sweet scented blue with chrome colored stamens. A very free bloomer. One plant alone may have from five to six blooms at one time. **Price, \$1.75 each.**

**DAUBEN.** This is a very light, rather small, blue lily. It is especially adapted for tub culture. It is a variety which will sprout additional lilies from the center of its leaves, and these new plants will often send forth bloom while they are still attached to the parent plant. **Price, \$1.25 each.**

**MRS. WOODROW WILSON.** A dark lavender blue with yellow stamens tipped with lavender. Flowers from 7 to 8 inches across. **Price, \$2.00 each.**

**ZANZABARIENSIS.** This is the best small dark blue water lily in cultivation. It is extremely free to flower and growth, the flowers are from 5 to 8 inches across. Petals are deep blue, sepals green on the outside, purplish blue on the inside. The flower is very fragrant, and blooms throughout the season. **Price, \$1.50 each.**

*Just a fine place to visit—open every day Sunday included to welcome visitors.*



**DAY BLOOMERS—Continued**

**PURPLE**

**PANAMA PACIFIC.** This is surely one of the most popular and promising of the day bloomers. It is a free bloomer, giving strong healthy plants. On first opening the flowers are rich rosy red; when fully opened the color is a deep reddish purple with yellow stamens. This plant also will throw young plants from its leaves which will frequently flower while still attached to the parent plant. **Price, \$2.00 each.**

**AUGUST KOCH.** Flowers are from 7 to 8 inches in diameter, and rise from 8 to 10 inches out of the water. The petals are a pale wisteria violet. It is an excellent variety, very free in bloom. It produces some young plants from the surface of the leaves. We recommend this as one of the easiest of the tropicals to grow as it requires very little attention. **Price, \$2.00 each.**

**WILLIAM STONE.** A star-shaped blue flower from 5 to 7 inches in diameter, borne well above the water. Especially good for cut flower. A very free bloomer. **Price, \$2.00 each.**



**COLLECTION NO. T 1. DAY BLOOMERS**

**SIX MOST POPULAR DAY BLOOMERS**

We offer the following six most popular tropical bloomers as our collection No. T 1, which gives every range of color.

Blue Beauty (Dark Blue).....	\$2.00
Mrs. Geo. H. Pring (White).....	1.50
Mrs. Ed. Whitaker (Lavender Blue).....	2.25
General Pershing (Pink).....	2.25
Panama Pacific (Reddish Purple).....	2.00
August Koch (Wisteria Violet).....	2.00

Total Value of..... \$12.00

**SPECIAL FOR \$10.00**

**NIGHT BLOOMERS**

**P**EOPL**E** are more and more asking for night bloomers. So many people like to have their pools in bloom in the evening. There is nothing nicer than to have some lilies opening when the others are going to sleep and have them remain open all night in their gorgeous colors. Then, too, night bloomers remain open in the morning until nearly noon. In the fall, when the weather turns cool, they remain open day and night. We recommend a few of the choicest varieties.

**WHITES**

**DENTATA SUPERBA (JUNO).** This is a very fine pure white water lily measuring from 10 to 12 inches in diameter, with yellow stamen. The leaves are large, deep glossy green. The plant flowers very freely, and blooms throughout the summer. This variety of pure white is of course very noticeable in the night, as the flowers stand well above the water. See illustration page 12. **Price, \$1.75 each.**

**LOTUS DENTATA.** This is the sacred or white lotus lily of the Nile. Flowers are white, from 6 to 10 inches, with broad petals sometimes tinted pink. The leaves are dark green, from 12 to 20 inches in diameter. The plant requires plenty of room. **Price, \$1.25 each.**

**PINKS**

**OMARANA.** Flowers from 8 to 12 inches across. Of a beautiful rosy pink color. The stamens are deep orange red. This is one of the best and free-flowering of all night bloomers. **Price, \$1.50 each.**

**STURTEVANT.** This lily is exceptionally desirable in large pools where it can have plenty of room. The flowers are from 8 to 12 inches, and of a beautiful rosy pink color; the petals are very broad and incurving, giving the bloom a fine cup shape. The stamens are orange brown. The leaves are large with the margins crumpled and wavy. It is a lily that requires a very warm temperature, and is only at its best in midsummer. **Price, \$1.75 each.**

**BISSET.** This is another very beautiful pink color, of beautiful form, measuring from 8 to 10 inches across. The petals are extremely wide, which gives the flower a cup shape effect. It is one of the best growers and bloomers. **Price, \$1.50 each.**

**REDS**

**FRANK TRELEASE.** The darkest of the reds, the flower being brilliant, glowing dark crimson, measuring from 8 to

10 inches across. The stamens are deep reddish brown. It is not as free blooming as some other reds. **Price, \$1.65 each.**

**RUBRA ROSEA.** Produces bloom from 6 to 10 inches across, of a deep, brilliant, rosy carmine color. The petals are wide at the base and taper to a point. Free blooming. This is a flower which will always be admired in the pool, as it will be always in bloom. **Price, \$1.50 each.**

**DEVONIENSIS.** This flower has a distinction of being the first hybrid among the beautiful night blooming water lilies. It is likewise one of the most desirable. Flowers are from 8 to 12 inches across, of a bright rosy red color, and are borne on stiff stems and above the water. The stamens are red. The plant is a free bloomer, several flowers in all stages of development being on the plant at the same time. **Price, \$1.50 each.**

**GEORGE HUSTER.** In color this resembles the Rubra Rosea, free in growth, and a free bloomer. In color it is a brilliant crimson, with flowers from 10 to 12 inches across. One of the best night bloomers. **Price, \$2.00 each.**

**COLLECTION NO. T 2. NIGHT BLOOMERS**

**FOUR OUTSTANDING VARIETIES OF NIGHT BLOOMERS**

We offer the following four outstanding night bloomers at the remarkable low price of

Lotus Dentata (White).....	\$1.25
Omarana (Rosy Pink).....	1.50
Bisset (Pink).....	1.50
Devoniensis (Red).....	1.50

Total Value ..... \$5.75

**We Offer all Four of These for \$4.75**

*We give an entire page to this collection on account of its great popularity. It is sure to please.*

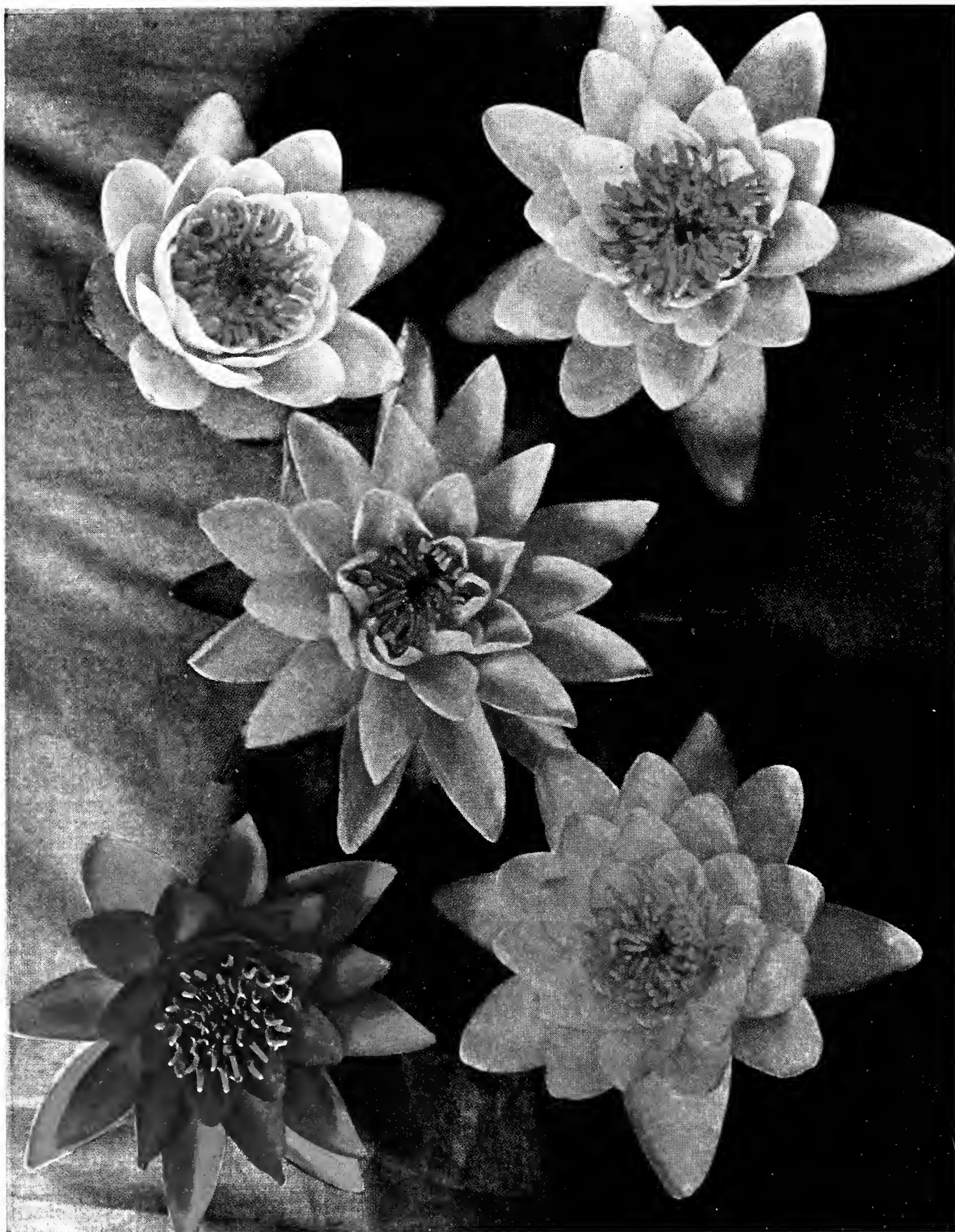

**THREE SPRINGS' MOST POPULAR COLLECTION**  
(Collection No. 8A.)

Think of these five superb Water Lilies! This is an actual photograph of lilies grown in our vast water gardens—the largest in the world. There can be no finer array of colors. Read the description of each variety listed on pages 10 and 11. This description and this hand-painted colored photo can give only a slight idea of the great beauty. You must see them to fully appreciate them.

All five for \$6.75

**ROSE AREY** (Center) Deep rosy pink; large, fragrant flowers.

**Chromatella** (Lower right) Deep yellow.

**Escarboucle** (Lower left) A brilliant red. None better.

**Marliac Rosea** (Upper left) Large, cup-shaped popular pink.

**Helen Fowler** (Upper right) A fragrant dark pink, shading toward center.



# THE SACRED LOTUS

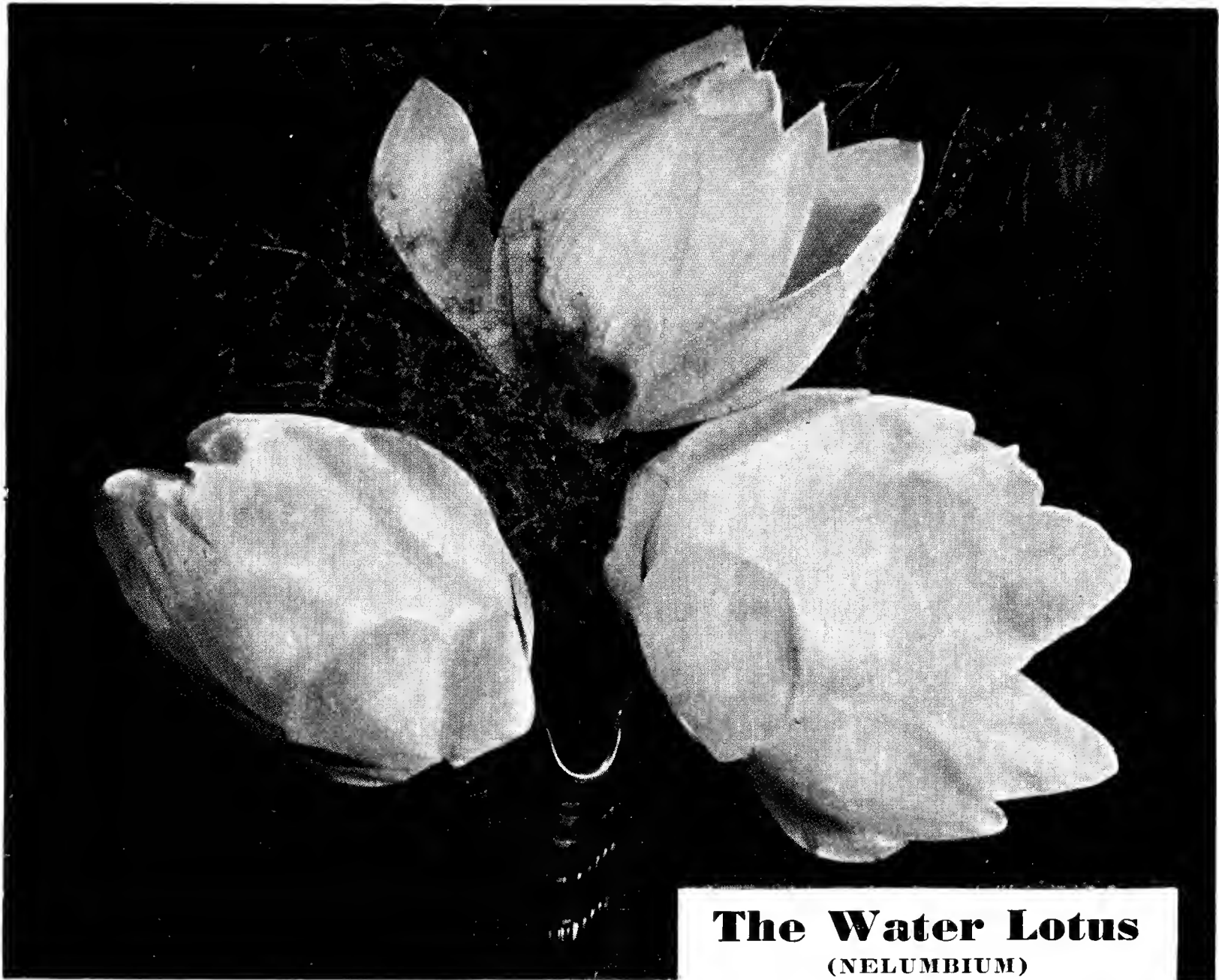

**The Water Lotus**  
(NELUMBIUM)

The sacred flower of the Egyptians always commands interest and admiration, because of its sacred history, and beautiful large flowers, which are borne on long stems. The large leaves, often 2 to 2½ feet in diameter, some floating on the water, others two or more feet above the water, and with the flowers still higher, form a never to be forgotten sight. No place in our large gardens is more visited than the lotus ponds. We consider no water garden complete without the lotus. See small photo this page. These flowers remain open day and night and can be grown in tubs or pools. We offer them as below.

If your pool is too full, you may still have a lotus. Plant it in a tub or half barrel.

*Collection 3, one pink and one yellow flower, as shown above . . . . . One each for \$3.25*

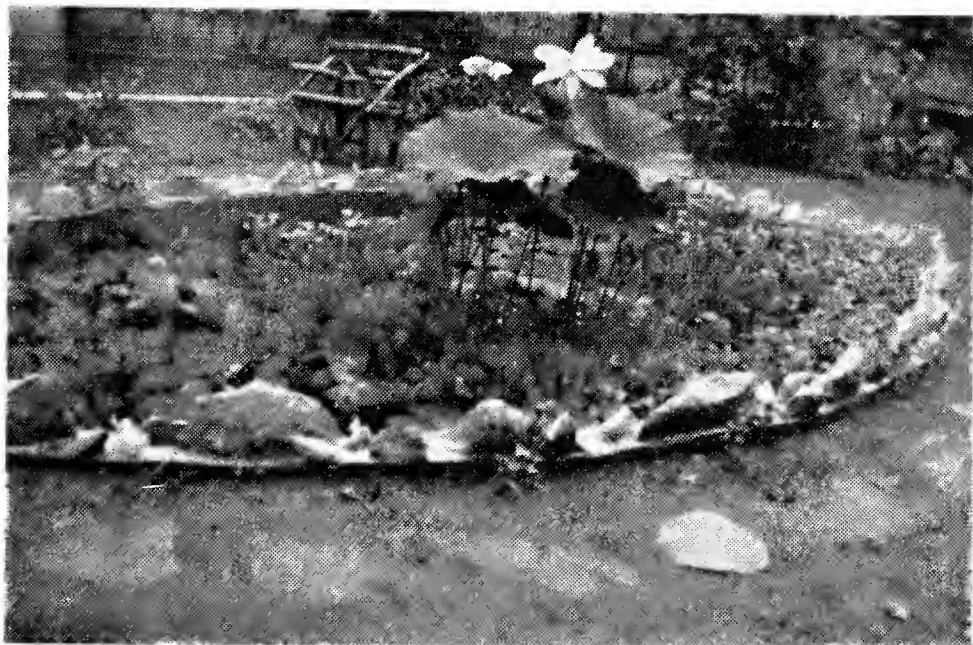

POOL OF WILLIAM F. KING  
Baltimore, Maryland.

**Speciosum.** The true flower of the Egyptians, large rosy pink, a free bloomer and hardy.

Price \$2.00 each

**Lutum.** This is the free blooming, large flowering native American Yellow Lotus.

Price \$2.00 each

**Japanese Lotus.** A fine variety of pure white lotus, large and free flowering.

Price \$2.00 each

**Roseum Plenum.** Large Double Pink Lotus. This flower attracted more attention last season than any plant on our place. Very double and free blooming. We have them in limited quantity and offer while they last at Price \$2.50 each

*Remember, in buying Lotus from us, you get larger tubers which will bloom the first year.*

*Potted plants after June 15th \$1.00 extra.*

*No Garden complete without the Golden, Yellow and Exquisite Pink Blossoms of the Mystic and Sacred Lotus.*



# THREE SPRINGS FISHERIES - LILYPONS

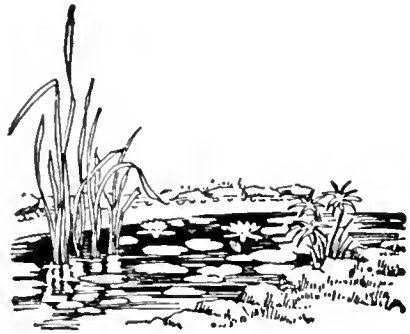

## ... OUR LILY

**I**N ORDERING please use both the collection number and the name when possible. See instructions on the back of the order sheet, page 38. The order sheet can be easily removed without doing any damage to the book. In small pools allow from eight to twelve square feet of water surface for each lily. If you are not sure what to order, write us, giving us a sketch and size of your pool, and tell us what colors you prefer. Write us fully, so that we will not have to write you again for information. Any and all inquiries are cheerfully answered, but give us all the information you can in your first letter. We will do the rest. It is only because of our immense production, having the largest acreage in the world, that we are enabled to offer you these collections of superior quality at the following very low prices. Never before have such values been offered.

### HARDY LILY COLLECTIONS

- COLLECTION NO. 30** ..... \$1.50  
 Odorata Gigantea—*Pure White* hardy variety.  
 Chromatella—The most popular *Yellow* variety.
- COLLECTION NO. 35** ..... \$1.85  
 Odorata Gigantea—*Pure White*, hardy, free blooming.  
 Rose Arey—*Dark Pink*, large, very fragrant.  
 We will substitute Pink Opal for Rose Arey if requested.
- COLLECTION NO. 40 (3 lilies)** ..... \$2.40  
 Odorata Gigantea—*White*, fragrant.  
 Helen Fowler—Popular, sweet-scented, free blooming *Pink*.  
 Chromatella—A free blooming, popular *Yellow*.
- COLLECTION NO. 45** ..... \$3.25  
 Paul Hariot—One of the best *Changeable* colors and free bloomer.  
 Eugenia De Land—*Light Pink*, fragrant, pointed petals.  
 Odorata Gigantea—*White*, fragrant, popular.
- COLLECTION NO. 50** ..... \$3.00  
 Chromatella—A very popular *Yellow* variety.  
 James Brydon—The most popular *Red* variety.  
 See pages 8, 10 and 11.
- COLLECTION NO. 20** ..... \$3.60  
 Pink Opal—*Dark Pink*, especially good for cut flowers.  
 Marliac White—A free blooming *Pure White*.  
 Helen Fowler—A popular, sweet-scented *Pink*.  
 Marliac Chromatella—A free blooming *Yellow*.
- COLLECTION NO. 60** ..... \$4.60  
 Aurora—A *Changeable* color.  
 Rose Arey—A *Dark Pink*, fragrant.  
 Sunrise—The best, largest *Yellow* lily.  
 Odorata Gigantea—A sweet-scented *White*.
- COLLECTION NO. 80** ..... \$6.50  
 James Brydon—*Red*.  
 Sumptuosa—*Pink*.  
 Chromatella—*Yellow*.  
 Comanche—*Changeable*.  
 All four taken from the very best varieties—all Marliac types—and all for the low price of \$6.50. A REAL BARGAIN.
- MOST POPULAR COLLECTION** ..... \$6.75  
 Collection No. 8A.  
 See page 16 for full description.
- OUR PRIZE COLLECTION** ..... \$9.25  
 Collection No. 11.  
 Rose Arey—*Dark Pink*, fragrant.  
 Gloriosa—*Red*.  
 Helen Fowler—*Pink*.  
 Chromatella—*Yellow*.  
 Pink Opal—*Dark Pink*.  
 Marliac Rosea—*Pink*.  
 James Brydon—*Red*.  
 See page 13. Refer to description on pages 10 and 11.

- OUR SUPERIOR QUALITY COLLECTION** .... \$9.20  
 Collection No. 25.  
 This has always been a very popular collection. We are able to offer it this year, due to our large production, at the marvelously low price of \$9.20. See full particulars on page 22.
- TEN GOOD HARDIES** ..... \$11.80  
 Collection No. 12.  
 Marliac Albida—*White*.  
 Odorata Gigantea—*White*.  
 Gladstone—*Snow White*.  
 Marliac Carnea—*Flesh Pink*.  
 Helen Fowler—*Pink*.  
 Rose Arey—*Dark Pink*.  
 Marliac Chromatella—*Yellow*.  
 James Brydon—*Red*.  
 Escarboucle—*Bright Red*.  
 Aurora—*Yellow to Red*.  
 With the above ten good Hardy Lilies, we will give you choice of 1 Lotus, yellow or pink;  
 10 Water Plants, all for.....\$13.50  
**This is a complete collection for a good size water pool or garden.**
- NONE SUCH COLLECTION** ..... \$12.60  
 Collection No. 65.  
 Marliac Albida—*White*.  
 Odorata Gigantea—*White*, fragrant.  
 Eugenia De Land—*Light Pink*, fragrant.  
 Helen Fowler—*Pink*, fragrant.  
 Pink Opal—Cup shaped, *Dark Pink*, fragrant.  
 Rose Arey—Large, pointed, *Dark Pink*, fragrant.  
 Paul Hariot—*Changeable* color.  
 Sioux—*Changeable* color.  
 James Brydon—*Red*.  
 Escarboucle—*Brilliant Red*.  
 With this collection we will give the following  
 20 Aquatic Plants, such as Water Hyacinths, Poppies, Saggitaria, Arrow Head, Pickerel Rush, Cat-tail, Water Plantain, Myriophyllum, Water Iris, etc., for.....\$14.10  
**This is a Complete Collection for a Large Pool.**
- OUR TEN BEST HARDIES** ..... \$14.25  
 Collection No. 55.  
 Sunrise—The best *Yellow* grown; a free bloomer.  
 Attraction—The best *Red*. A marvelous large red flower.  
 Rose Arey—The best *Pink*; large, sweet-scented.  
 Paul Hariot—The best *Changeable* color.  
 Marliac White—The best *White*.  
 Gladstone—The best *Snow White*.  
 James Brydon—The best *Red*.  
 Escarboucle—The best *Bright Red*.  
 Odorata Gigantea—*White*.  
 Chromatella—*Yellow*.  
 With this collection we will give 1 Lotus, yellow or pink, your choice, and 10 Water Plants, for.....\$1.75 extra  
**A Complete Collection for a Good Size Water Pool.**

See our Goldfish Collections, pages 26 and 27. No pool is complete without a few well selected Brood Fish. They'll produce young the first year.





# COLLECTIONS.

## MIXED COLLECTIONS HARDY AND TROPICAL

### RED, WHITE AND BLUE COLLECTION..... \$4.00

Collection M. 1.  
James Brydon—*Red Hardy*.  
Odorata Gigantea—*White Hardy*.  
Blue Beauty—*Blue Tropical*.

### SUGAR LOAF COLLECTION..... \$4.40

Collection M. 2.  
Chromatella—*Yellow Hardy*.  
Blue Beauty—*Blue Tropical*.  
Odorata Gigantea—*White Hardy*.  
Rose Arey—*Pink Hardy*.

### NATIONAL COLLECTION ..... \$5.00

Collection M. 3  
Lotus Dentata—*White Night Bloomer*.  
Rose Arey—*Pink Hardy*.  
Blue Beauty—*Blue Tropical Day Bloomer*.  
Chromatella—*Yellow Hardy*.  
With either White or Pink Lotus add \$1.60.

### SUPERB COLLECTION ..... \$9.20

Collection M. 4.  
James Brydon—*Red Hardy Day Bloomer*.  
Rose Arey—*Dark Pink Hardy Day Bloomer*.  
Helen Fowler—*Pink Hardy Day Bloomer*.  
Eugenia De Land—*Light Pink Hardy Day Bloomer*.  
Blue Beauty—*Blue Day Bloomer*.  
Lotus Dentata—*White Night Bloomer*.  
Aurora—*Changeable Day Bloomer*.

## TROPICAL COLLECTIONS

### SIX BEST DAY BLOOMERS.....\$10.00

Collection No. T. 1.  
See page 15.

### FOUR BEST NIGHT BLOOMERS..... \$4.75

Collection No. T. 2.  
Lotus Dentata (White).  
Omarana—Rose Pink.  
Bisset—Pink.  
Devoniensis—Red.

### THREE SPRINGS DAY AND NIGHT COLLECTION ..... \$5.40

Collection No. T. 5.  
In this we offer two of the best day bloomers and  
two of the best night bloomers. Lilies for flow-  
ers. Will bloom all summer.  
Blue Beauty—The best *Blue*.  
Panama Pacific—The best *Purple*.  
Lotus Dentata—The best *White*.  
Devoniensis—The best *Red*.

## LOTUS COLLECTION

### COLLECTION NO. 3 ..... \$3.25

1 Yellow ..... \$2.00  
1 Pink ..... 2.00

(See page 17) Value \$4.00 for \$3.25

## PLANT COLLECTIONS

### COLLECTION NO. 16..... \$1.75

#### FOR POOLS

3 Water Poppies  
3 Water Hyacinths  
3 Bunches Myriophyllum  
3 Yellow or Blue Iris  
2 Cattail (Typhal)  
1 Potamogeton (Pondweed)

15 plants in all.

You have never seen an equal assortment at such  
a price. Especially suitable for Small Pools.

### COLLECTION NO. 17..... \$1.00

#### FOR POOLS

Water Iris  
Cattail  
Water Plantain  
Water Poppy and  
Potamogeton.

### COLLECTION NO. 19..... \$2.00

#### SHALLOW WATER PLANTS

3 Arrow Heads  
3 Cattails  
3 Water Plantain  
3 Flag

### SCAVENGER COLLECTION NO. 13..... \$1.25

1 dozen Tadpoles  
1 dozen Snails





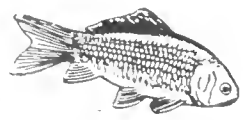

**POOL OF MRS. B. M. KUPPATRICK**  
Turtle Creek, Pa.

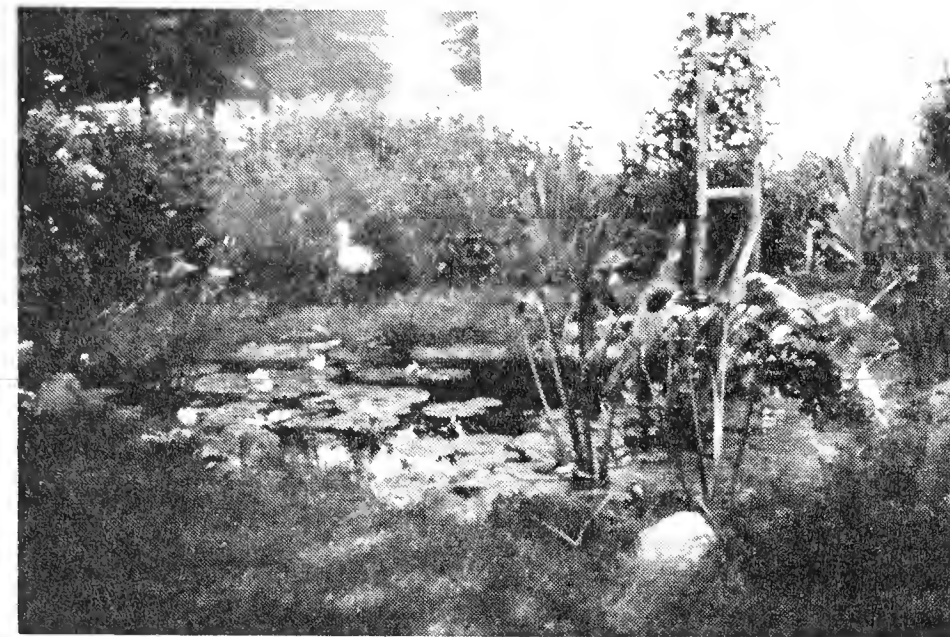

**POOL OF MRS. LILLIAN THOMPSON**, Haverhill, Mass.



**POOL OF MRS. W. H. FINNEY**, Old Greenwich, Conn.

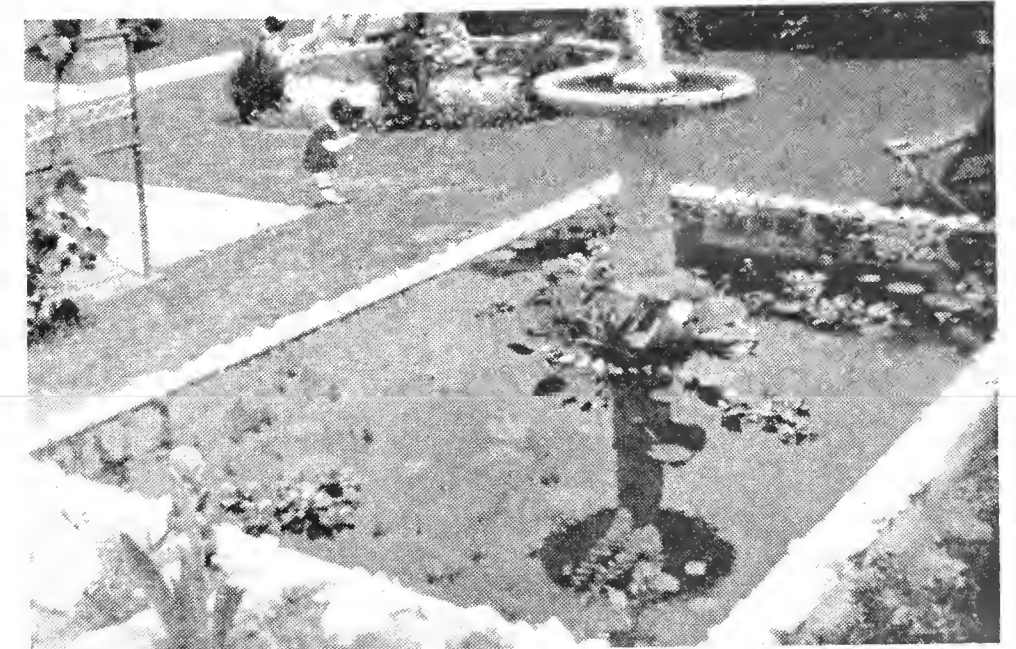

**POOL OF MR. HENRY LINDNER**, Box 2, Route 486,  
Stemmers Run, Md.

*few of*

## **OUR CUSTOMERS' POOLS**

**These photographs and all photographs of pools appearing in this catalog were sent to us from our satisfied customers. We give their names and addresses. In writing to them, inclose self-addressed stamped envelope for their reply.**

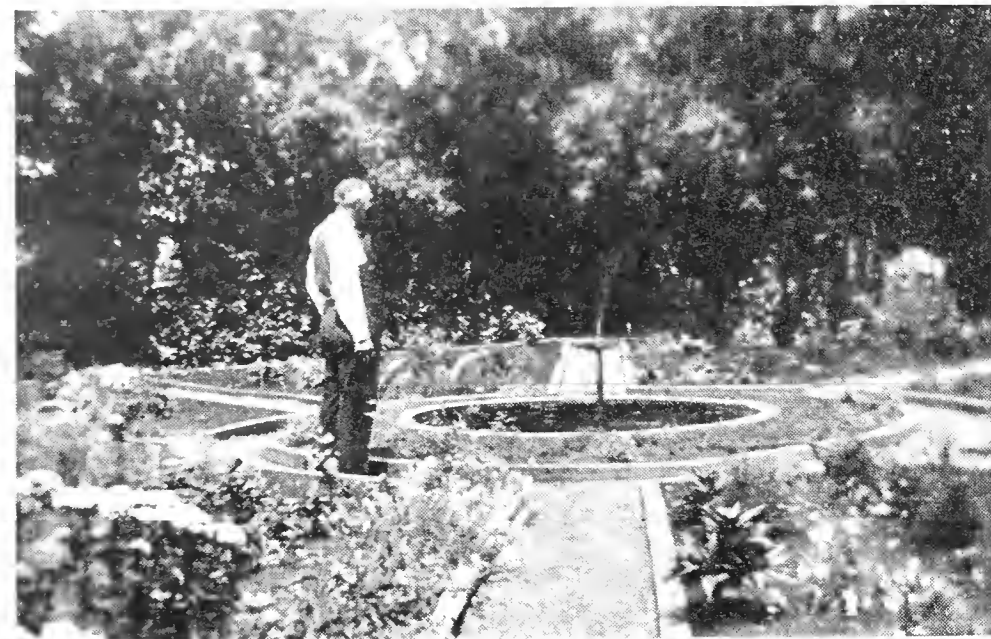

**POOL OF ROBERT MILLER**,  
Langenburg, Saskatchewan, Canada.



**POOL OF MRS. DAISY GROSS**, Baltimore, Md.



**POOL OF ELLA W. JOHNSON**, Newport, Del.



**POOL OF MRS. FRANK NEISS**, Hillsdale, Mich.



**POOL OF MRS. ROY COCHRAN**, Kearney, Nebr.



**POOL OF MRS. FRANK PHILLBROOK**, So. Weymouth, Mass.





# A Few Water Lilies of Superior Quality and Moderate Price

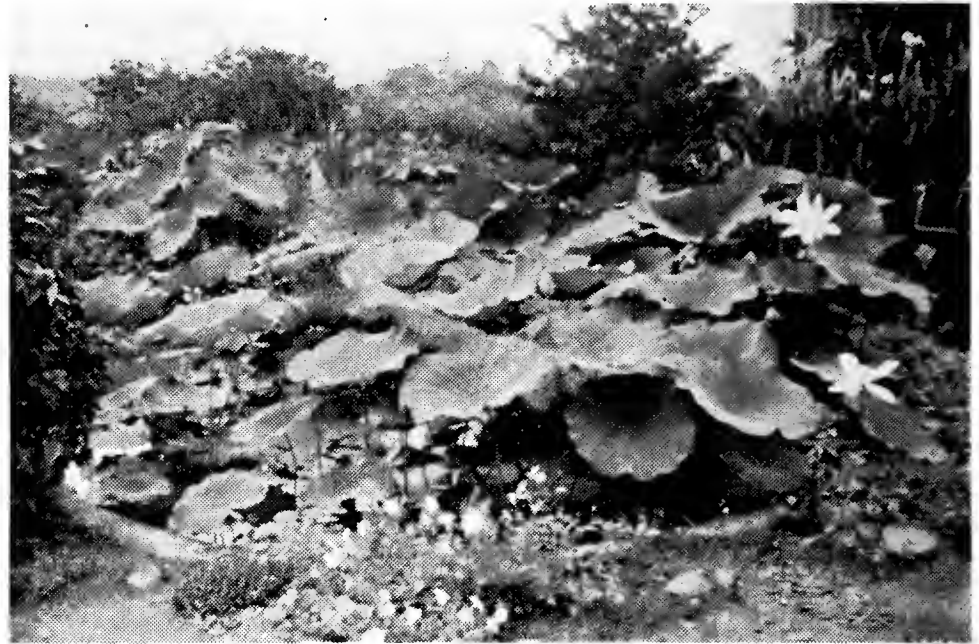

POOL OF G. K. EDWARDS  
Boonville, Ind.

WE HAVE chosen from the many different water lilies what we consider the six best varieties. We have included in this list only those lilies of popular prices. These lilies are well known, popular, and will give an endless amount of beauty and pleasure. They are easy to grow, well established varieties, good bloomers and lilies that have stood the test of time.

**“OUR SPECIAL COLLECTION NO. 25”**

**THE BEST SIX HARDY WATER LILIES, ONE OF EACH, TOTAL VALUE \$11.50. WE OFFER ONE OF EACH FOR \$9.20**

**ATTRACTION** Where the pool is large enough we have no hesitation in giving this lily the first rank among the reds. It is a recent French introduction. On opening it is a garnet red, with almost white sepals and stamen of rich mahogany tipped with yellow. It is not only the largest lily in cultivation, often eight to ten inches across, but is one of the most beautiful. No pool of any size is complete without it.  
Price, \$2.50 each.

**MARLIAC CHROMATELLA**

Flowers yellow, 4 to 6 inches. Leaves green mottled with brown. A free bloomer. We consider this the finest of the Marliacs. This plant should be divided every few years. A charming canary yellow flower with bright yellow stamen. See illustrations, pages 5, 8 and 16.  
Price, \$1.25 each.

**ROSE AREY** We consider this the most desirable of any of the fragrant lilies. No collection is complete without this flower. It has a brilliant pink color. The petals are pointed and incurved. It has golden yellow stamen. One of the very best bloom-

ers, producing very large flowers often 7 or 8 inches in diameter. It is by far the finest of the cheaper pinks. See color illustration, page 8. Price, \$1.75 each.

**EUGENIA DE LAND.** An Odorata type. Flowers are extra large with long and lanceolate petals. A very beautiful color of deep rose pink of iridescent hue. Yellow stamen. Flowers float on the water. A very vigorous and free flowering variety. A very desirable plant. It was awarded the silver medal by the Newport Horticultural Society. Price, \$1.50 each.

**PAUL HARIOT** A free bloomer; light yellow. Flowers are large and cup-shaped. A free bloomer. Price, \$2.00 each.

**ESCARBOUCLE** This is the most brilliant of all of the reds. It is a bright, intense red, a vermilion with garnet stamen. A strong grower and a free bloomer. It is unquestionably one of the best. To those who have never had this variety it will prove a rare treat. See illustration, pages 9 and 16. Price, \$2.50 each.

These are unquestionably the two best pinks, the two best reds, the best yellow, and the best changeable.

ATTRACTION (Red).....	\$2.50
CHROMATELLA (Yellow).....	1.25
ROSE AREY (Dark Pink).....	1.75
EUGENIA DE LAND (Pink).....	1.50
PAUL HARIOT (Changeable).....	2.00
ESCARBOUCLE (Red).....	2.50

\$11.50

**A Total Value of \$11.50 for Only \$9.20.**

**You may substitute the Mrs. C. W. Thomas (see page 12) for the Eugenia De Land and the price will then be \$10.25**

*In buying from us you are buying first hand. Buy your requirements from producers, direct from ponds to pool, and you'll be satisfied.*





**T**HE THREE SPRINGS FISHERIES feel justly proud of their plant. The proprietors own and operate more than fifteen hundred acres of land, over two hundred of which is actually under water, and devoted to the culture of goldfish, water lilies, and other aquatic plants. Situated in Frederick County, the home of the goldfish industry (as well as the home of Barbara Fritchie, Francis Scott Key, Admiral Schley and others), the Three Springs Fisheries have hundreds of ponds, varying in size from one-third of an acre to one pond of over eleven acres, which is probably the largest goldfish pond in the world. The Three Springs Fisheries grow millions of goldfish annually. Here we study the development of the goldfish from the egg to the fully matured fish. We have a fully equipped laboratory where scientific work is maintained. With our outlay we have no hesitancy in saying that we are better able to serve you than most growers.

The Three Springs Fisheries have especially constructed ponds in addition to their large ponds. We also have many

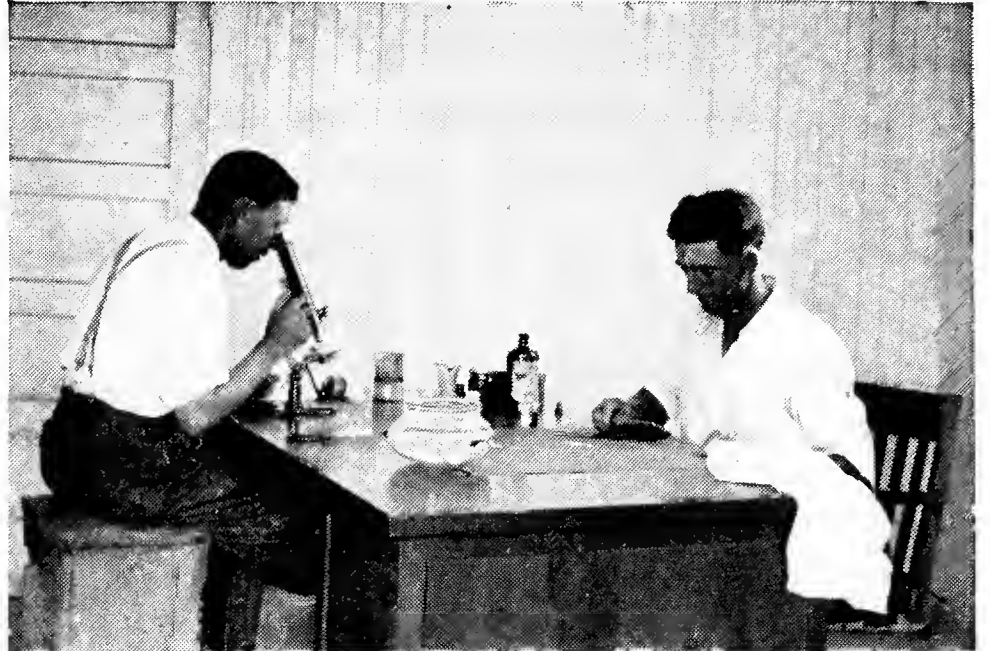

A laboratory scene showing the use of the microscope. Propagation of fancy goldfish is impossible without this instrument.



A photo showing newly spawned fish-eggs. Each of these nests will hatch many thousand fry—Small fish.

especially constructed cement hatching tanks where goldfish can be viewed any day, in every stage of development from the egg up. These eggs are gathered daily in the many thousands of nests which we maintain, and to see them in our hatchery and note the development of the fish is a treat for anyone. Our friends are invited.

The Three Springs Fisheries devote their time and energy to the raising and selling of goldfish and water plants. We feel justly proud of our plant, and we want to impress you with the fact that we are not distributors, but we are actual producers of both water lilies and goldfish.

We ship only selected brood fish (unless otherwise requested) for lily pools or ponds. These fish have been carefully sorted for sex, paired or mated, and will not only add distinctive color to the pool, but will spawn the first season. They are not to be compared with so-called brood fish which may be nothing other than discarded brood stock some of which may be barren or even diseased. With our fish you will have spawn the first season and every season. You will

be agreeably surprised to see literally hundreds or thousands of little fish turning gold as the season advances. By fall the baby fish should be nearly all turned gold.

The demand for our selected and paired brood stock is so great that the supply is always exhausted early in the season. We cannot manufacture them but must grow them. This takes time, and we will not give you inferior stock. We, therefore, urge that you place your order early.

A charge of 50 cents for the shipping can is made on small orders. On large orders we furnish a large shipping can which must be returned. We ask a deposit of \$4.00 on this large can, which, of course, we refund upon the return of the can, or upon sending us express receipt showing return of the can to Adamstown, Maryland. The return charges by express from any part of the United States is only 20 cents.

We show you just a few pictures of our plant as well as a few pictures and description of the various kinds or varieties of goldfish on this and the following pages.



This outfit has a capacity to cook 5 to 6 tons of feed daily for our millions of Goldfish.

**Try Our Fish Food for Ponds and Pools, 50c pound—Nothing So Good.**



# THREE SPRINGS FISHERIES—LILYPONS

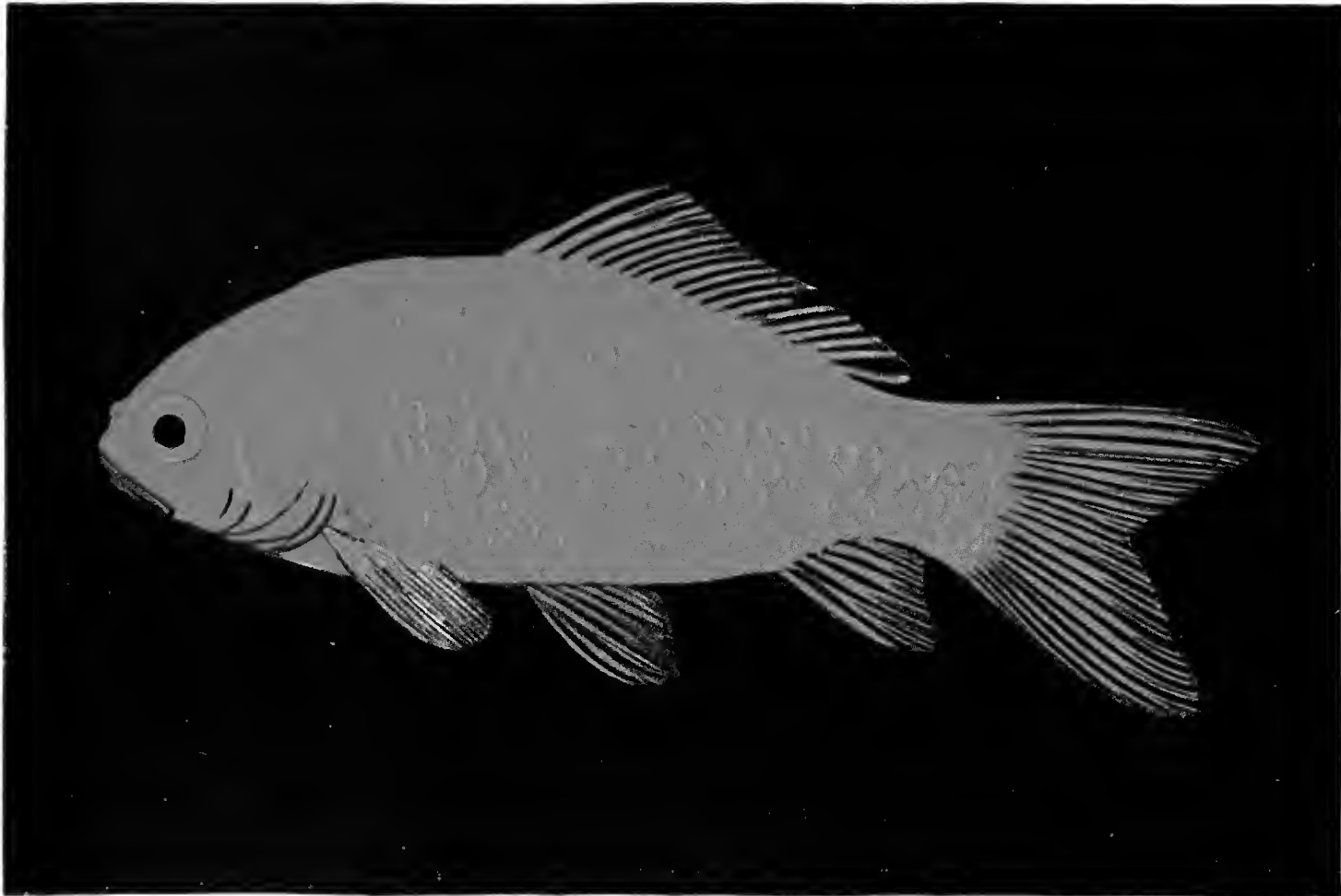

## COMMON GOLDFISH

**T**HE common goldfish, as the name indicates, is the most common of all varieties or species of goldfish. It was introduced into this country by Admiral Ammon in 1874 from Asia. The common goldfish is the parent of all other varieties of goldfish. It is not red when hatched. About 50% color the first year. The uncolored are usually sold for bait for fishing. This variety of fish is largely used in aquariums, large pools, also in lakes, and swampy places in order to keep down mosquitoes.

Their life in the aquarium, depending upon the care given, is from several months to several years. In pools or lakes, good healthy stock should live from fifteen to twenty years. **Price: Giants, per pair \$3.00, dozen \$15.00; Young Giants \$1.50 to \$2.00 per pair; dozen \$8.00 to \$10.00. See price list, page 26.**

## JAPANESE FANTAILS

**T**HE Fantails which we offer for sale should not be confused with the long bodied Tripod which are often called Fantails. Selected Japanese Fantails are very slow swimmers, and are very hard to grow and produce. They are, however, exceedingly ornamental in the pool, and in the aquarium no fish will attract so much attention as will the fancy varieties. Japanese Fantails have always been most highly prized. We pick from our enormous production of many millions of fish these selected Fantails

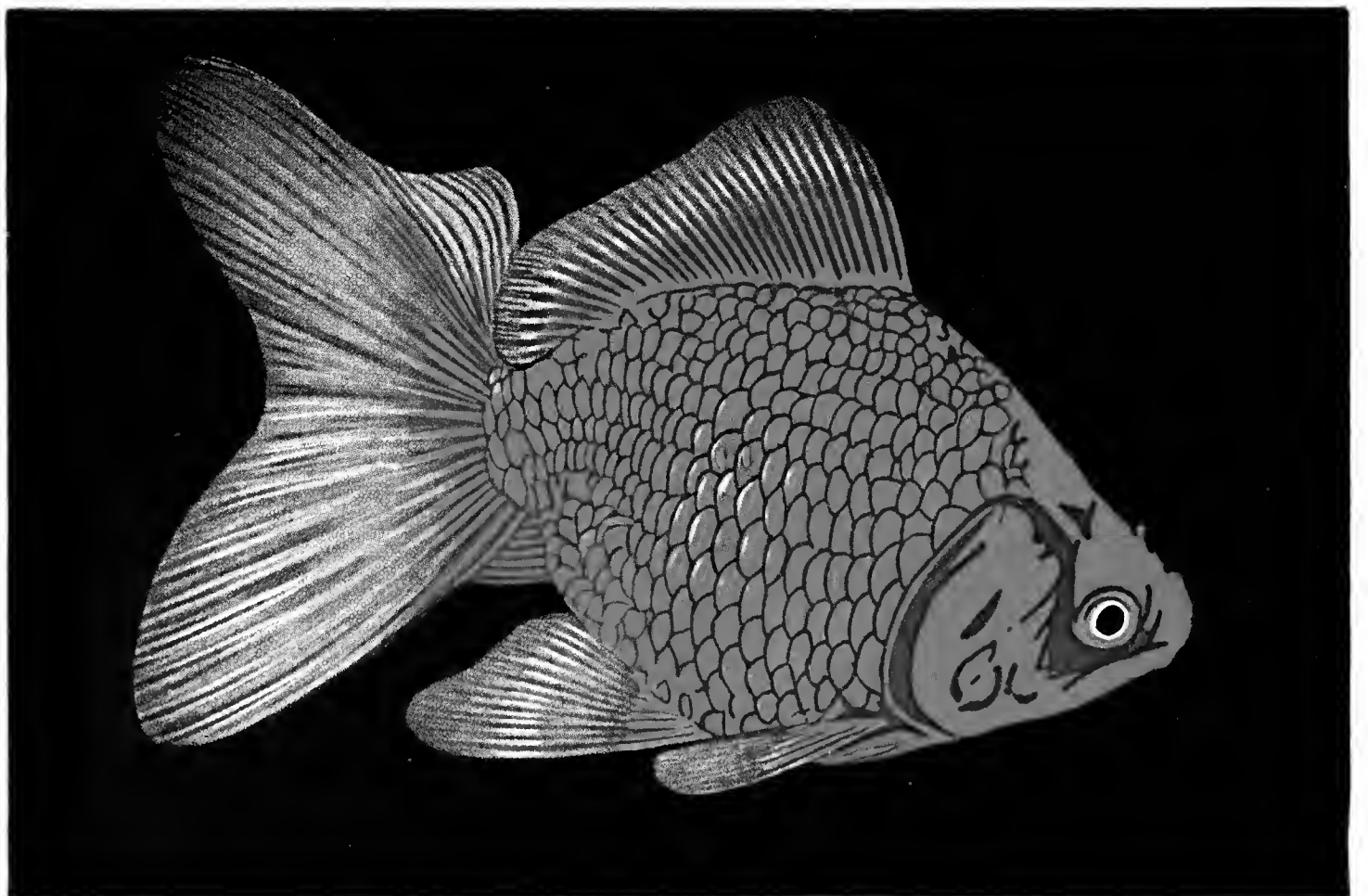

which we offer you for pools, lakes and show places. Your order placed with us assures you of the best. Remember, we are not distributors, but we are producers. Your fish are selected for tail and fin developments as well as for color and general shape, and productivity. We offer these selected at **\$0.50 to \$1.00 per pair. See price list, page 26.**

*A few good breeders in the Spring—Just Lots of Young all Summer.*





## COMETS

**T**HESE are goldfish with long tails and long fins. They are supposed to have originated in the pools of the Fish Commission at Washington, D. C., in the early '80s. The tail of this graceful fish is free flowing, and enables this variety to become rapid swimmers. As they dart to and fro between the lilies they never fail to attract attention, as they are the most rapid swimmers of all goldfish. You will never regret buying this variety. The stock which we will furnish you, as is all our stock, is selected from our large production of many millions, and they are especially chosen for tail and fin development. We offer these selected and paired.

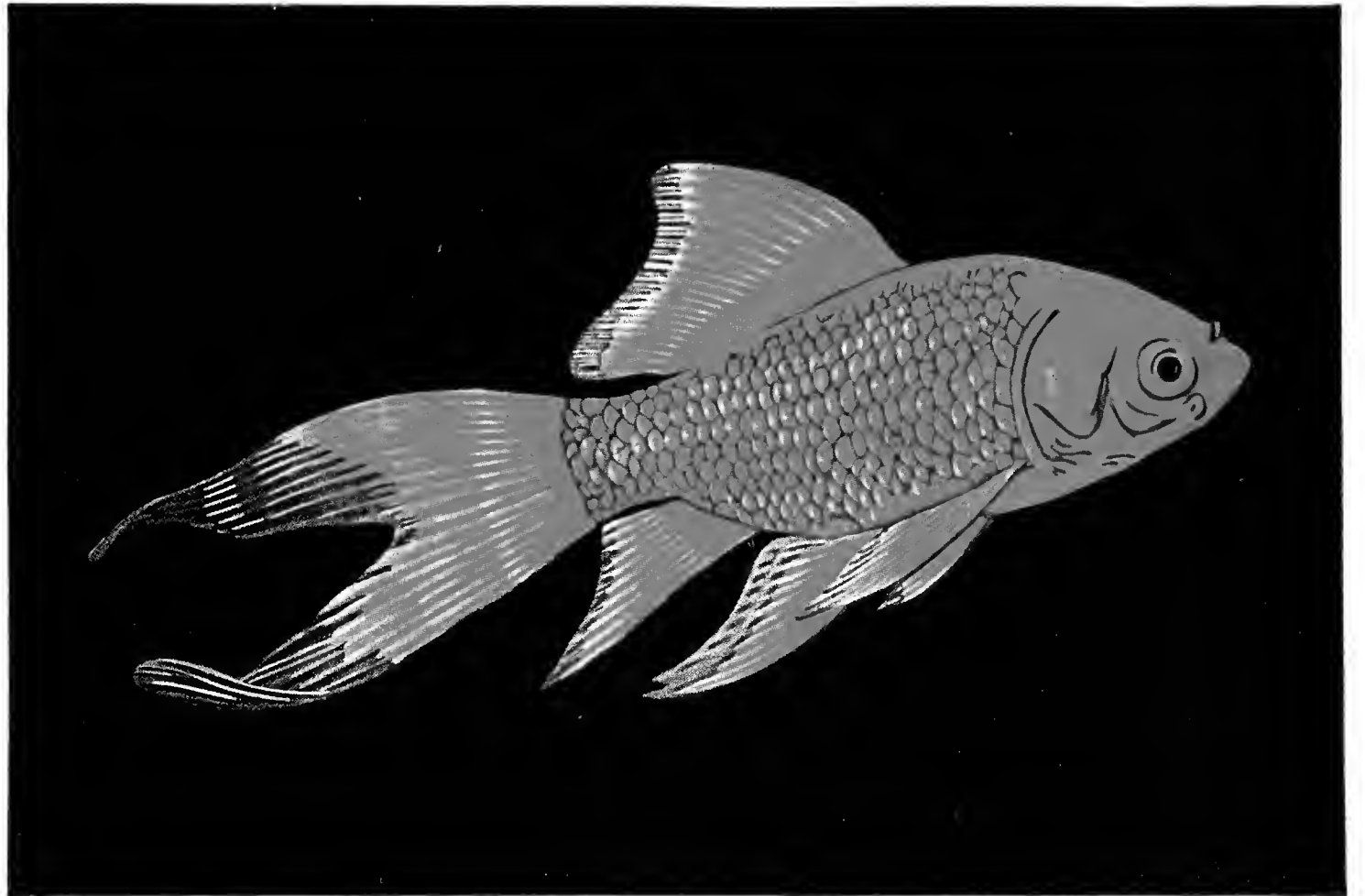

**Price:** Large size—for pools, \$4.00 per pair; dozen \$20.00. Smaller size—for tubs or small pools, \$1.25 per pair; dozen \$6.00. See price list, page 26.

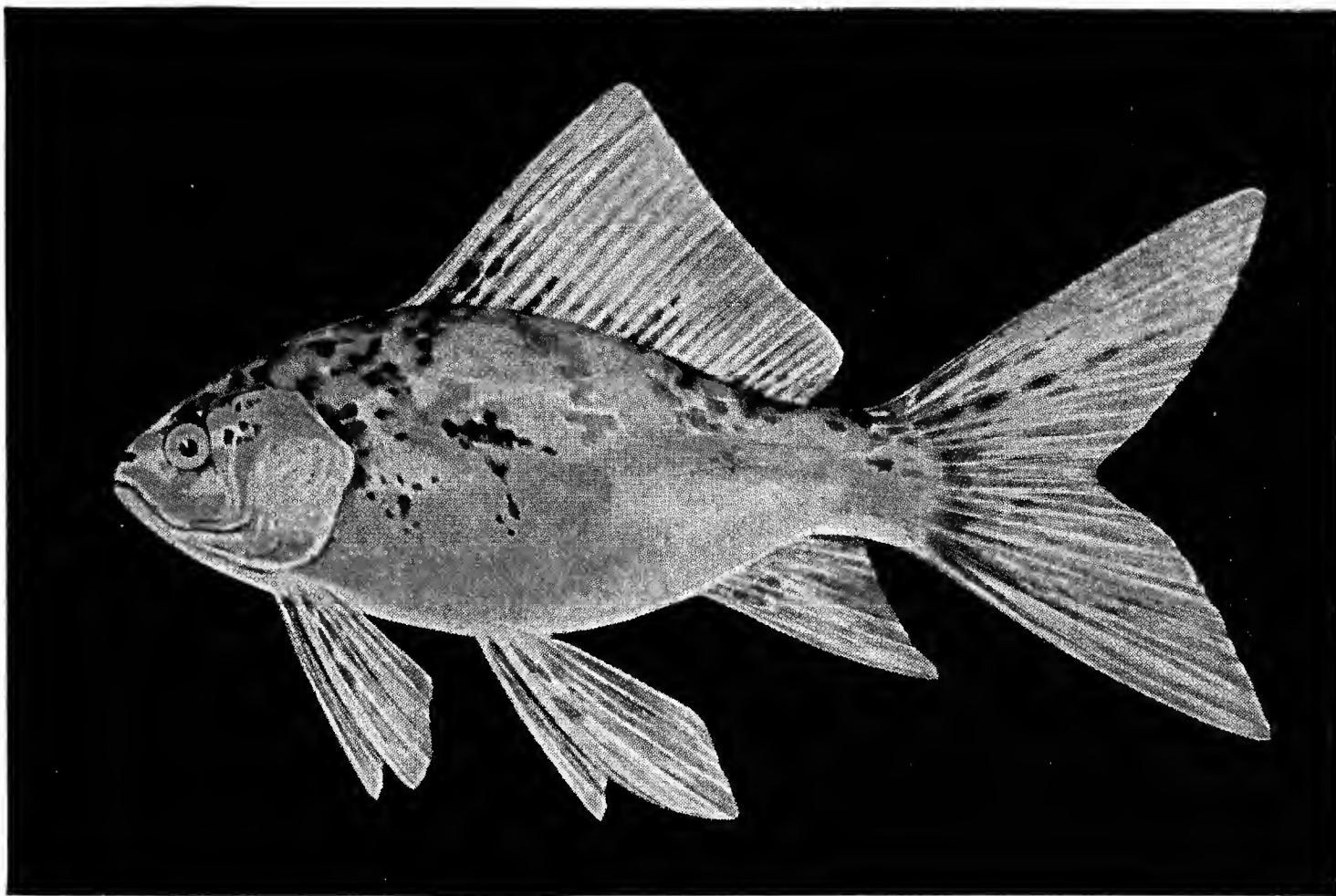

**Price:** Large Pool size, \$5.00 per pair; medium size, \$2.00 per pair. See price list, page 26.

## SHUBUNKINS

**T**HIS is one of the newer varieties of goldfish. Often entirely or nearly scaleless. Very beautiful with patches of red, black and blue on a pearl background. There are no two of these fish alike. They are the most striking varieties in color, and certainly make a most attractive pool fish. We choose those having a blue background, speckled and mottled with dark red, brown, yellow and black. No goldfish collection is complete without this variety. We choose these from our large production of goldfish so that you will be assured of the best when ordering from us. We never have sufficient of the large size of this variety to fill our orders.

*Selected Goldfish—nothing more beautiful or productive. They multiply rapidly in pool. Remember we grow our Goldfish and ship direct from our Hatcheries.*

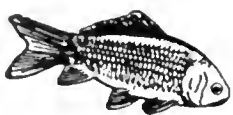

# THREE SPRINGS FISHERIES—LILYPONS

## Selected Goldfish for Breeding and Pool Purposes

### PRICES

<b>GIANT COMMON</b> (See page 24)	PAIR	DOZ.
Big fountain paired. Selected for Breeding or display. <b>Giant Common</b> .....	<b>\$3.00</b>	<b>\$15.00</b>
<b>YOUNG GIANT COMMON</b> (See page 24)		
Especially selected brood stock not so large as the Giants. You will be surprised at the number of small fish in your pool at end of year if you use Giant Breeders.		
<b>Young Giant Common over 8"</b> .....	<b>\$2.00</b>	<b>\$10.00</b>
<b>7 to 8 inches Common</b> .....	<b>1.50</b>	<b>8.00</b>
<b>6 to 7 inches Common</b> .....	<b>1.00</b>	<b>5.00</b>
<b>5 to 6 inches Common</b> .....	<b>.50</b>	<b>2.50</b>
<b>COMETS</b> (See page 25)		
This large and brilliant goldfish with its extra large tail and fin development is sure to please.		
<b>Giants, selected for pools</b> .....	<b>\$4.00</b>	<b>\$20.00</b>
<b>Large, and selected for tubs</b> .....	<b>2.00</b>	<b>10.00</b>
<b>Medium Large, over 6 inch</b> .....	<b>1.00</b>	<b>5.00</b>
<b>SHUBUNKINS</b> (See page 25)		
Fish combining the various colors—blue, red, gold, black, white, vari-colored.		
<b>Small Pool size 3"</b> .....		<b>\$1.50</b>
<b>Medium Pool size 4"</b> .....		<b>2.50</b>
<b>Large Pool size 5"</b> .....	<b>1.00</b>	<b>3.50</b>
<b>Extra Large Breeders 6"</b> .....	<b>3.00</b>	<b>15.00</b>
<b>Giant Breeders 8"</b> .....	<b>5.00</b>	<b>25.00</b>
<b>MOORS</b>		
Black velvety color, with fan tails and bulging eyes.		
<b>Small Pool size 3"</b> .....	<b>\$1.50</b>	<b>\$6.00</b>
<b>Medium Pool size 4"</b> .....	<b>2.00</b>	<b>10.00</b>
<b>Large Pool size 5"</b> .....	<b>3.00</b>	<b>15.00</b>

<b>TELESCOPES</b> (See page 28)	PAIR	DOZ.
Big double tails with fine eye development.		
<b>Small Pool size 3"</b> .....	<b>\$1.00</b>	<b>\$4.00</b>
<b>Medium Pool size 4"</b> .....	<b>1.50</b>	<b>6.25</b>
<b>Large Pool size 5"</b> .....	<b>2.00</b>	<b>10.00</b>
<b>FANTAILS</b> (See page 24)		
Especially selected stock; big tails and beautiful colors, paired.		
<b>Medium Pool size 3"</b> .....		<b>\$2.00</b>
<b>Large Pool size 4"</b> .....	<b>.75</b>	<b>3.50</b>
<b>Extra Large size 5" and over</b> .....	<b>1.00</b>	<b>5.00</b>
<b>CALICOS</b> (See page 28)		
The vari-colored, transparent scaled bulging eyes with fan tail. The fish you will want.		
<b>Medium Pool size</b> .....	<b>\$1.00</b>	<b>\$4.00</b>
<b>Large Pool size</b> .....	<b>1.50</b>	<b>7.50</b>
<b>Extra Large size</b> .....	<b>2.50</b>	<b>12.50</b>
<b>NYMPHS</b> (See page 28)		
<b>Medium Pool size 3"</b> .....	<b>\$ .50</b>	<b>\$2.00</b>
<b>Large Pool size 4"</b> .....	<b>.75</b>	<b>3.50</b>
<b>Extra Large Pool size 5"</b> .....	<b>1.00</b>	<b>5.00</b>
<b>VEILTALS</b>		
These are the choice of our crop. They are selected from our production of many millions. When buying from us remember you get the choice. We offer		
<b>Veiltail Telescopes</b> .....	<b>\$5.00 to</b>	<b>\$10.00</b>
<b>Veiltail Moors</b> .....	<b>5.00 to</b>	<b>10.00</b>
<b>Veiltail Calicos</b> .....	<b>5.00 to</b>	<b>10.00</b>
<b>Young Veiltails</b> .....	<b>2.00 to</b>	<b>5.00</b>
Prices according to size and quality.		

### GOLDFISH COLLECTIONS

#### OUR PRIZE GOLDFISH COLLECTION No. G-30

We recommend these for breeding purposes.

1 pair Giant Common Brood.....	<b>\$3.00</b>
1 pair Extra Comets Brood.....	<b>4.00</b>
1 pair Fantails Extra Large Brood.....	<b>1.00</b>
1 pair Calicos Brood.....	<b>2.50</b>
1 pair Shubunkins Large Broods.....	<b>1.00</b>
2 pair Snails.....	<b>.50</b>
1 dozen Sea Grass for Spawning.....	<b>1.00</b>

**\$13.00**

10 Big Fancy Brood Goldfish. All kinds.

**All for** ..... **\$10.50**

#### QUANTITY GOLDFISH COLLECTION No. G-31

So many people want a number of fish so that there will be some always visible.

70 Highly Colored Selected Common Goldfish.

10 Medium Japanese Fantails.

10 Medium Shubunkins.

10 Medium Comets.

100 Beauties, assorted, **for**..... **\$5.00**

These are Commercial Stock, not Paired Broods.

We do not recommend these for breeding purposes

though it is quite likely they will spawn for you.

These 100 fish will be an endless source of pleasure

to you. A moving object is always attractive. We

will furnish one-half amount **for**..... **\$3.00**

#### SELECT GOLDFISH COLLECTION No. G-32

1 pair each of the following:

Common, Comets, Fantails, Calicos and Shubun-

kins **for** ..... **\$9.00**

Not so large as Our Prize Collection, but one sure

to please you.

**FREE With Collection No. G-32 we include**

**25 Selected Fish and Scavengers. All for.... \$9.00**

The highest development in Goldfish is the **Veiltail**. When you put with this the colors of the rainbow we have the very finest of all. No pool or aquarium is complete without pair of Jap Veiltails or Calicos.

**BUY THE BEST FROM PRODUCERS**

*We have specially prepared, in dry form, a fish food, for pools and ponds. Feed them our food and watch the little fellows grow, 50c pound.*





## Goldfish Collections, Continued

### GOLDFISH COLLECTION No. G-33

2 Pair Select Common, 1 Pair Large Comets, 1 Pair Telescopes, 1 Pair Calicos for..... **\$7.25**  
Quite an assortment. Sure to please and produce young.

### OUR GIANT COLLECTION No. G-34

1 Pair Giant Common, Giant Comets, Giant Orioles

(black and red) and Giant Pearls (or Fans).  
8 Big Ones for..... **\$10.50**

### COLLECTION No. G-35

1 Pair each, Fans, Telescopes, Moors, Comets, Albinoes (white), and Calicos (12 in all) and twelve Scavengers. Small sizes for..... **\$9.00**

# Goldfish Prices

We offer below the same class of fish that we sell to the commercial trade. They are graded commercially by varieties and sizes, the length of the fish from tip to tip indicating the size.

All of our fish show wonderful coloring and vitality. Stock hatched in the spring is shipped the following fall and winter. We ship fish practically the entire year. The demand for our fish is so great that in the summer we are usually out of many sizes.

All shipments are made from our Hatchery at Adamstown, Maryland, by express, charges collect. On small orders a charge of 50 cents for each can. On large orders shipments in our cans which are to be returned, charges 20 cents prepaid. WE CANNOT FILL any orders from the following prices aggregating less than \$2.50. Orders for 100 to 200 fish, smaller sizes, go in a 50-cent can. All other orders in large cans.

These are Select Commercial Grade but not Select Brood Stock.

## GOLDFISH LIST PRICE

COMMON		Per Doz.	Per 100	TELESCOPES		Per Doz.	Per 100
Small, 1½ to 2 in.			<b>\$2.50</b>	Small, 2 in.			<b>\$10.00</b>
Medium, 2 to 2½ in.			<b>3.50</b>	Medium, 2½ in. \$.75 per pair	<b>\$3.50</b>		<b>15.00</b>
Medium Large, 2½ to 3 in.			<b>5.00</b>	Large, 3 to 4 in. \$1.25 per pair	<b>6.25</b>		<b>25.00</b>
Large, 3 to 4 in.	<b>\$1.00</b>		<b>7.50</b>	Extra Large, 4 to 5 in. \$2.00 per pair	<b>10.00</b>		<b>50.00</b>
Extra Large, 4 to 5 in.	<b>1.50</b>		<b>10.00</b>				
COMETS		Per Doz.	Per 100	MOORS		Per Doz.	Per 100
Small, 2 to 3 in.			<b>\$4.00</b>	Small, to 2 in.			<b>\$10.00</b>
Medium, 3 to 4 in.			<b>8.00</b>	Medium, 2½ in. \$1.00 pair	<b>\$4.00</b>		<b>15.00</b>
Large, 4 to 5 in.	<b>\$1.75</b>		<b>12.00</b>	Large, 3 to 4 in. \$1.50 pair	<b>7.50</b>		<b>25.00</b>
Extra Large, 5 to 6 in. \$1.00 per pair	<b>5.00</b>		<b>22.00</b>	Extra Large, 4 to 5 in. \$2.50 pair	<b>12.00</b>		<b>50.00</b>
NYMPHS		Per Doz.	Per 100	SHUBUNKINS		Per Doz.	Per 100
Small, 2½ in.			<b>\$4.00</b>	Small, to 2 in.			<b>\$4.00</b>
Medium, 2½ to 3 in.			<b>8.00</b>	Medium, 2 to 2½ in.			<b>8.00</b>
Large, 3 to 4 in.	<b>\$1.75</b>		<b>12.00</b>	Large, 2½ to 3½ in.	<b>\$1.50</b>		<b>10.00</b>
Extra Large, 4 to 5 in.	<b>3.00</b>		<b>18.00</b>	Extra Large, 3½ to 5 in.	<b>2.50</b>		<b>15.00</b>
				Selects, over 5 in. \$1.00 pair	<b>3.50</b>		<b>25.00</b>
FANTAILS		Per Doz.	Per 100	CALICOS		Per Doz.	Per 100
Small, 2 in.			<b>\$5.00</b>	Small, to 2 in.			<b>\$10.00</b>
Medium, 2 to 2½ in.			<b>10.00</b>	Medium, 2½ in. \$1.00 pair	<b>\$4.00</b>		<b>20.00</b>
Large, 2½ to 3½ in.	<b>\$2.00</b>		<b>15.00</b>	Large, 2½ to 3½ in. \$1.50 pair	<b>7.50</b>		<b>50.00</b>
Extra Large, 3½ to 5 in. .75 per pair	<b>3.50</b>		<b>25.00</b>	Extra Large, 4 to 5 in. \$2.50 pair	<b>12.00</b>		<b>75.00</b>
FANTAILS				AQUARIUM SUPPLIES		Per 100	
<b>Very Select</b>		Per Doz.	Per 100	Tadpoles	<b>50c doz.</b>		<b>\$2.00</b>
Small, 2 in.			<b>\$7.50</b>	Pond Snails	<b>4 for 25c; 60c doz.</b>		<b>4.00</b>
Medium, 2 to 2½ in.			<b>12.50</b>	Red Ramshorn			<b>15.00</b>
Large, 2½ to 3½ in.	<b>\$2.50</b>		<b>15.00</b>	Black Ramshorn	<b>4 for 25c; 60c doz.</b>		<b>4.00</b>
Extra Large, 3½ to 5 in. \$1.00 per pair	<b>4.00</b>		<b>30.00</b>	Black Japanese Snails	<b>25c pair; \$1.25 doz.</b>		<b>8.00</b>
				Salamanders	<b>50c pair; \$2.00 doz.</b>		<b>15.00</b>

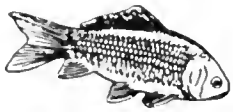

# THREE SPRINGS FISHERIES—LILYPONS

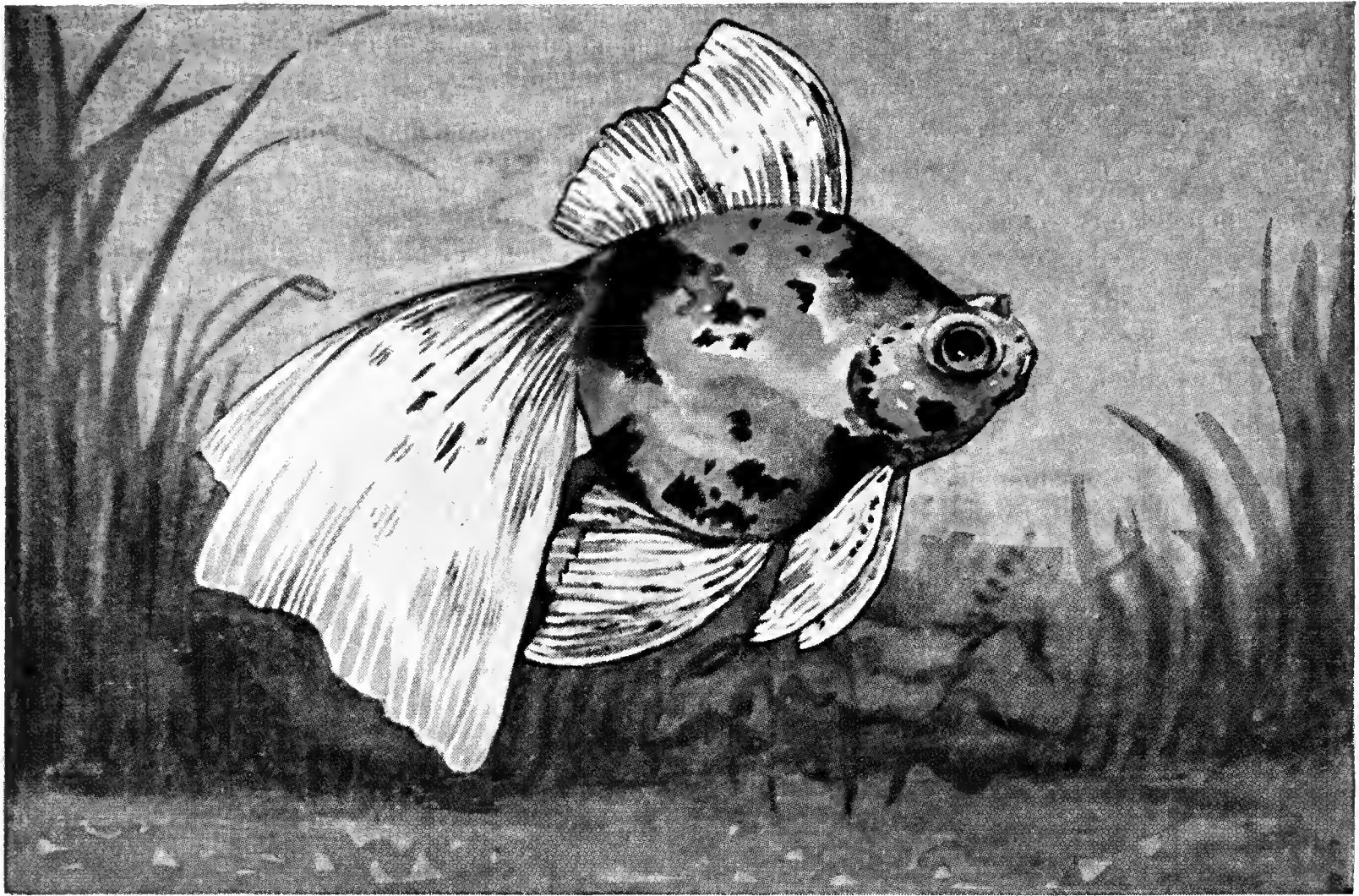

**CALICO.** This is undoubtedly the Prince of all Goldfish. If we were to write the entire page full of description, we could not tell you all the beauties of this fish. Its description of color and markings are similar to the Shubunkin. Its fin and tail development is that of the Fantail. No two fish are exactly alike. The fish has practically every color of the rainbow. It embodies all other choice breeds of goldfish. We have never had sufficient of this fish of any size to fill our orders. We cannot make these fish, we must grow them, and we will not give you inferior stock. We suggest that you therefore let us have your orders early. **Price: Large size \$1.50 per pair; dozen \$7.50; medium size \$1.00 per pair; dozen \$4.00. See price list, page 26.**

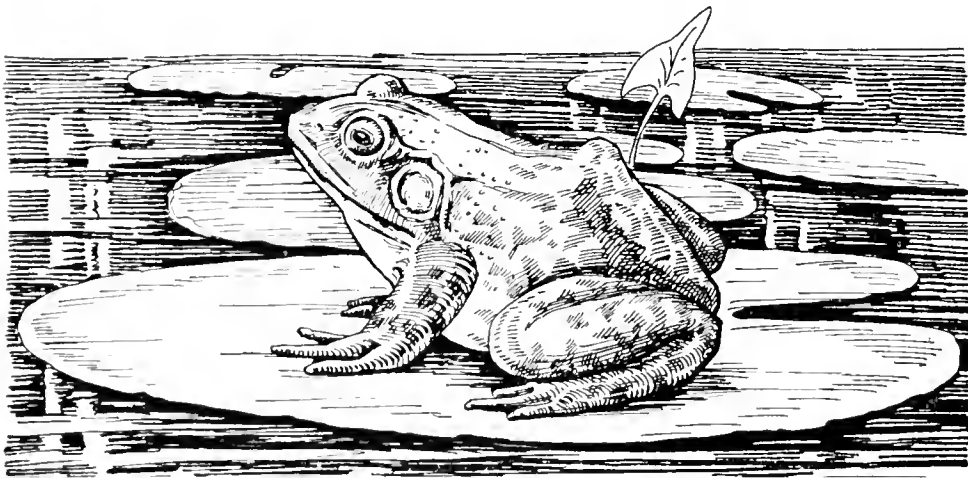

## FROGS

Every year brings more and more requests for Frogs. What a treat for those who have a few frogs in their pools! How natural to associate frogs with the lily pads and the pool! Think of the chorus coming from your pool expressing vibrant joy at the return of spring. They have no doubt spent the winter in the mud bottom of your pool or around the edge of the pool and are now calling to you with their melody of voices. All of them seem to be singing at once and you approach to see why they are so happy. All is quiet, but if your pool is filled what a thrill awaits you as you hear your pets hit the water and see the splash. As you stand looking after the merry fellows you are soon rewarded by seeing your pets staring back at you, with a pair of large protruding eyes, just extending above the water. If you remain perfectly quiet, soon your pets will have forgotten their scare and they will come marching out to the side of the pond or pool, or up on the lily pads, there to again express their great appreciation of the return of spring by their musical chorus.

Do not be alarmed or surprised if all of your frogs do not join in the chorus, for it is only the male frog that has a musical talent. The female frog, just as the female canary, never sings. Then, too, the males have yellow throats, whereas the female's throat is white and smooth.

The frog feeds upon only moving objects. The frog can only see moving objects, and it is therefore useless to attempt to feed frogs by placing fish food

in the water. Tadpoles, however, eat freely and grow rapidly on our regular prepared fish food. Insects, such as flies, gnats, bugs, etc., which the frog can catch on the jump, are the frog's relish.

No frog likes deep water, for it is there where lurk their enemies—large fish, crayfish, turtles, etc. While frogs do not like deep water, they do like to sit along the edge of the pool or on lily pads. If frogs cannot get out of the water they must drown. Frogs frequently become quite tame. A great many people become greatly attached to and highly value their frogs. Frogs may roam from home, but they like the water and damp surroundings, and it is a rare thing to lose a Frog. You should, however, not expect to keep just one, for it will go a-hunting for a mate. Buy in pairs only.

There are many who wish to artificially raise or produce Bullfrogs or Green Frogs, some for profit, others for pleasure, while still others combine business and pleasure. In a small pool you should be able to produce a great many tadpoles the first few months. Every living tadpole becomes a frog and so there you are. Most frogs reaching the commercial markets have been gaffed or gipped and are often held in wire crates or crowded in unsanitary conditions, and if introduced into your pool may bring disease. All of our Frogs, both the Bullfrogs and the Green Frogs, are carefully selected, caught and handled by hand, carefully sorted, graded and paired. We exercise the same care with our Frogs as with our Goldfish.

For those who desire to keep their frogs or to feed their frogs, or really for those who desire to know more about frogs, we offer a little pamphlet, which was compiled by Mr. C. C. Moler, of Hagerstown, Maryland. Mr. Moler, while an amateur, has acquired a very keen knowledge and insight into the propagation of frogs. He is the only person that we know of, who at this time, has a White Frog Colony. Some years ago he secured from our property several Albino Tadpoles of pure white variety, possessing bulging pink eyes and yellowish white skins. With the knowledge which he obtained in the handling of frogs, he was enabled to raise these tadpoles to large sized bullfrogs, and we believe that Mr. Moler is the only person in the world who possesses any live white bullfrogs.

With the knowledge which he has gained, he has compiled a little booklet on **HOW TO GROW FROGS**, which he is offering to the public at \$.25 a booklet. There are so many people who want to feed their frogs, and to have their frogs as pets. We have read this little booklet, and believe it worth the small fee of \$.25. These booklets are obtainable from us for 25 cents each.

**Giant Bullfrogs**—Large adult breeders paired—\$2.00 per pair, \$10.00 per dozen, \$75.00 per 100. **Large Giant Bullfrog Tadpoles**—Legs forming, ready to turn to small bullfrogs, 50c per dozen.

**Green Frogs:** Adult Breeders, any size, 50c per pair, or \$2.50 per dozen.

*Pinks are the most popular of all Colored Water Lilies. The three leaders, Mrs. C. W. Thomas, Rose Arey and Helen Fowler, all free bloomers, all fragrant. All three if you want them, Collection No. 70, for \$4.40.*





## Some of the Notables Attending the Dedication Ceremonies



*Left—*

*Dr. J. Horace McFarland, Pres.,  
American Rose Growers Association*

*Miss Lily Pons*

*Governor Harry W. Nice of  
Maryland*

*General Edgar T. Conley, Adjutant  
General, U. S. A.*

*Commander Allen Quynn, U. S. N.*



*Right—*

*Mr. G. L. Thomas, Pres.,  
Three Springs Fisheries*

*Miss Lily Pons*

*Dr. C. H. Conley, Former Candidate  
for Governor of Md.*

*Mrs. C. C. C. Thomas*

*Postmaster, C. C. C. Thomas*

*Why do such notables visit our gardens in preference to all others? The vast size,—the largest in the world, the gorgeous blooms. Nowhere else are to be found such large Lotus beds, such beautiful and fascinating lily gardens as at Lilypons, Md. Deal with the best, the largest.*



## WATER LILY CULTURE—(Cont'd)

(Continued from page 2)

cow manure to three parts soil. The best soil is a heavy fibrous loam clay, mixed with well-rotted cow manure, or bone meal. Do not use sand, leaf mould or peat; fresh manure must be avoided; its fermentation may sour the water or burn the roots. Cover the box with about two inches of sand. This will prevent the fish from disturbing the roots and also prevent discoloring the water.

**DURATION OF BLOOM.** Lilies start blooming in the early Spring and continue blooming until frost. The flowers open every morning (day bloomers) and close every afternoon. There are also night bloomers. You will be assured of several flowers from each root every day throughout the entire season. What can be more beautiful than a pool or a few tubs of these different colored lilies in bloom every day, and to think every morning they open to greet you.

**POOL OR TUB.** To those who have the room we recommend the pool. To those who do not have the room for a pool and want the beauties of the lilies we recommend the "tub" or half-barrel.

**THE KIND TO PLANT.** You too can enjoy the beauties of the tropics or of the Orient right in your own yard. You will have more variety of color, more flowers, and at less cost than any other plant or flower you can choose. So many think of the lily pool as an extravagant luxury suitable only for the large estate. If this booklet can do nothing more than correct this impression it will have added pleasure to all those who will be convinced. We assure you that no matter how small your property or how limited your income you can enjoy these beauties of the Orient and of the tropics, with all variety of color, and continuity of bloom.

No flower will give more profusion of bloom. No flower such fragrance. No flower such abundance of bloom, all for such little cost. All this beauty is yours, but it must be



POOL OF MR. EDGAR L. HOLLIDAY  
St. John's, Newfoundland

produced. All you need do is to make the start. The Three Springs Fisheries with their mammoth gardens and their numerous varieties offer you the very best. We select only the best, and our stock is the largest in the world. Your lilies are selected from this large, the largest stock. You are therefore assured of the best obtainable and this is the reason **OUR LILIES ARE SO EASY TO GROW, AND OUR LILIES BLOOM SO PROFUSELY. BUY FROM THE HOUSE WITH THE LARGEST STOCK TO CHOOSE FROM. WE WOULD SAY—PLANT RIGHT, AND YOU WILL GET RESULTS. YOU CAN ONLY BE ASSURED OF THIS CHOICE SELECTION OF PLANTS WHEN ORDERING FROM THE THREE SPRINGS FISHERIES.**

**WHAT TO ORDER.** We will be glad to recommend such varieties as will give best results. Many prefer to have us make selections. Send us a sketch of your pool or pond. Tell us the surroundings and we will be glad to serve you, free.

**FERTILIZER AND SOIL.** Use only the best soil. With it you may mix some well-rotted manure. Do not use fresh manure or it may burn the roots. See our article on fertilizer, page 35.

**WHEN TO EXPECT BLOOM.** This will largely depend upon the care exercised in selecting your plants. The sound, healthy plants selected by us from our large stock bloom earlier than others. By ordering from us you will be assured of early blossoms and of flowers until frost.

**CARE OF PLANTS IN WINTER.** Drain the water from the pool. Either remove the plants—boxes and all—to your cellar or cover them where they are with sufficient straw or leaves to prevent freezing.

**NATURAL PONDS OR STREAMS.** No better way to beautify a pond or stream than by planting Water Lilies. Simply plant them in the soil at the bottom of the pond or stream. Be careful to see that the root is firmly placed in the soil. If necessary lay a stone over the root until it attaches itself to the soil. Do not plant in water less than ½ foot or more than 2 feet deep, and never plant in a current. In this condition the roots need never be taken up, as they will not freeze.

**FISH WITH FLOWERS.** Everyone knows how fascinating are goldfish. To see these beautiful, graceful creatures swimming about amongst the flowers and leaves of the lilies is surely a most beautiful and interesting sight. Not only will it be an endless source of interest to your children but to every member of the family. Only those who have experienced the thrill can appreciate the great joys in store for those who have goldfish with their lilies, in both tubs and pools.

*Bear in mind we are not distributors, but the world's largest producers of Hardy Water Lilies and Aquatics.*



# MARYLAND—AQUATIC PLANTS AND GOLDFISH



(Continued from page 3)

bloom, and make you a "booster" of our product to your friends.

## PRICE

Our plants would be cheap at double the cost of many due to their superior quality and our liberal guarantee. Why take chances on inferior quality? *Our price, with 10% added for packing, etc., includes all transportation charges.* The price of plants and supplies (not fish) is the price delivered to your door. No unpleasant, unknown express charges to pay on delivery. No extra trip to the Express office if you chance to live beyond the Express delivery, but delivered by Parcel Post right to your door. The price includes safe delivery guarantee. No worry on your part collecting damages or loss claims from the Express Company and paying express rates.

The prices mentioned are definite, the exact amount you pay, and there is no more. Prices men-



POOL OF MR. RUFUS C. MATHERS  
Fredericksburg, Va.

tioned are effective at once. Terms are net cash with order. You will get an acknowledgment of the order just as soon as we get it and the goods will be shipped either at once or as soon as the season permits. We prefer that remittance be made by postal money order, drawn on Lilypons, Md., postoffice, though we will accept your check.

## Three Springs Fisheries Grow Hardy Water Lilies These Pools are All in Alaska

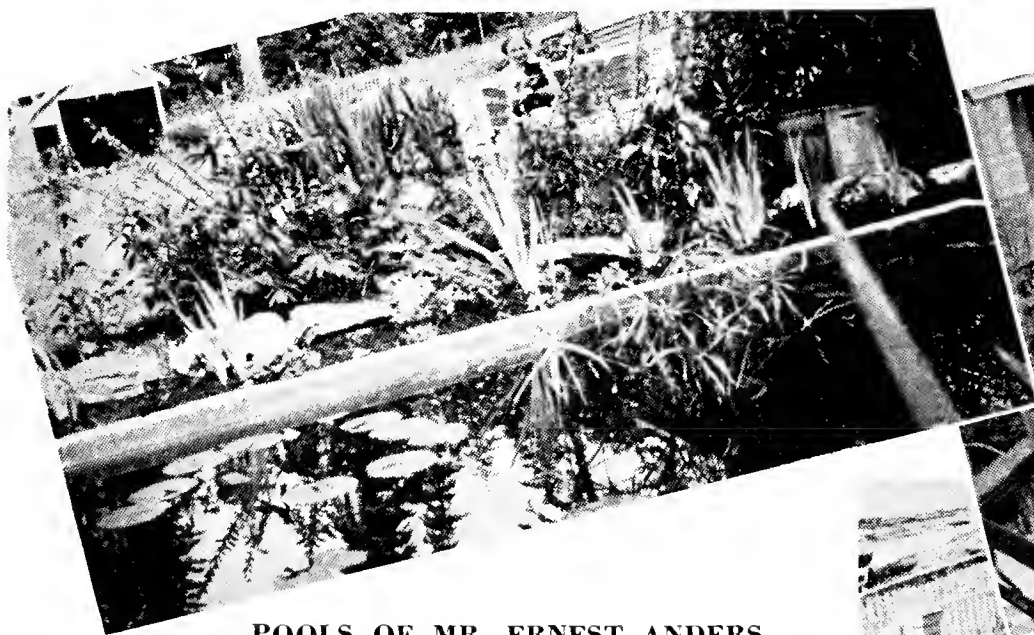

POOLS OF MR. ERNEST ANDERS  
Ketchikan, Alaska

Showing how hardy our lilies are. They grow in Canada and Alaska as well as in warmer places.





# THREE SPRINGS FISHERIES—LILYPONS

## Some Last Minute Collections

Why not buy your lilies from the world's largest hardy aquatic gardens? Our large stock, from which your order is selected, assures you of the very choicest, the very best obtainable, in the way of aquatics. Our quality is unexcelled. In buying from us you are not only assured of all this but in addition every shipment of lilies is guaranteed to arrive in good condition. Many would stop here, but we go further—YOU MUST BE SATISFIED. There are no reservations in making this guarantee. It is our enormous stock that enables us to make such a guarantee. With such enormous stock you get only the best, which insures you of success in your water gardening. Blooms and plenty of them, that's what you get with Three Springs lilies. Our many, many testimonials vouch for this.

### DARK PINK COLLECTION NO. H 21

Rose Arey, dark pink, almost red.  
Pink Opal, very good cut flower.  
Helen Fowler, very fragrant.

Think of these three choice, fragrant varieties offered at the exceedingly low price of

**\$3.25**

### LIGHT PINK COLLECTION NO. H 31

Eugenia de Land, light fragrant star-shaped.  
Morning Glory.  
Marliac Rosea, one of best of Marliacs.

At the price for these three light colored pinks you can afford to buy all three and divide with your neighbors. Never before have these choice varieties been offered at so low a price as

**\$4.00**

### COLLECTION NO. H 41

Helen Fowler, sweet scented pink lily.  
Aurora, a choice changeable.  
Odorata, a fragrant white.

These three choice lilies together with an assortment of 100 small fish. *A fine collection of Fish and Lilies for the low price of.....* Add 50c for can for fish.  
Lilies prepaid. Fish by express collect.

**\$3.75**

### COLLECTION NO. H 51

Chromatella, choice yellow.  
Rose Arey, fragrant dark pink.  
Sumptuosa, a beautiful Marliac Pink  
Odorata, fragrant white.

Just think of these four choice lilies, and with them *one pair of big common breeders and 50 smaller assorted fish* at the amazing low price of.....

**\$7.50**

Only our large production enables us to make such offers.

### COLLECTION NO. H 61

A real rainbow collection of both lilies and fish

Odorata gigantea.....1 White

Your choice of one of the following pinks:

Rose Arey  
Helen Fowler  
Eugenia de Land  
Pink Opal  
Sumptuosa .....1 Pink  
Chromatella.....1 Yellow

Your choice of any one of following reds:

James Brydon  
Gloriosa .....1 Red

Your choice of any one of following changeables:

Paul Hariot  
Sioux  
Aurora  
Comanche.....1 Changeable

Your choice of any one of following blues:

Pennsylvania  
Henry Shaw.....1 Blue

To the above six of the choicest lilies we add the following *Goldfish Collection No. G 33* and in addition *200 assorted varieties* of commercial goldfish.

All of this big collection for..... **\$16.95**

Without G 33 only..... **\$ 9.60**

### COLLECTION NO. H 71

*Lotus Collection No. 71*

Pink, Yellow and Double Red, all for..... **\$5.25**

This is a most excellent value and one which we cannot offer again at this price.

For \$2.00 additional you may add the Mrs. C. W. Thomas (see page 12) to any collection listed in this catalogue over \$3.00. We want you to have this choice lily. Send your order early, as our supply of the Mrs. C. W. Thomas is limited and we are offering it only as long as our supply lasts. Order early and be sure of getting one of these choice lilies.



---

# Where Shall I Place My Order?

- First:** Where the producer has a large stock to select from so that I get only the best.
- Second:** Where I can get my order filled promptly.
- Third:** Where I know the producer has confidence in his product and stands back of it.
- Fourth:** Where I know just what the plants cost me *delivered* to my door.
- Fifth:** Where I have no high Express charges or other charges to pay on delivery and where the producer *guarantees safe arrival*.
- Sixth:** Where the producer guarantees his product to give *entire satisfaction*.
- Seventh:** Where the production is large the cost must be less per root, and where I thus get the most for my money.

*The answer to "Where Shall I Place My Order?" from the above you will agree, is with the World's Largest Producers, The Three Springs Fisheries, Lilypons, Maryland.*

READ CAREFULLY PAGES 23, 30 AND 31

**We Invite You, Too, to Visit the Largest Lily Gardens in the World**



**Miss Lily Pons enjoying the beauty of the waterlilies on a Lily pond at Lilypons, Md.**



## Fish Food for Aquariums



**NATURAL  
FISH  
FOOD**

50c dozen, 30c half dozen.



**WAFER  
FISH  
FOOD**

50c dozen, 30c half dozen.

## Fish Food for Pools

**FOR BROOD AND SMALL FISH**  
1 quart size, 60c each.



This is a granular perfectly balanced fish food. Just what your brood need for spawning and what your small fish need for rapid growth. A large size quart package for the sum of 50c. It is the cheapest and best food obtainable.

**BABY FISH FOOD (FRY)**

You will find our Baby Fish Food the ideal food for the young fry or baby fish. It is very fine, just the right size so that the baby fish can eat it and the larger fish will not bother it.



50c a dozen 30c a half-dozen

## Health Dip and Fungus Remedy



25c each

Well fed and well kept fish should keep well; but fish ill kept or for one reason or another do sometimes become sick. They do for one cause or another get fungus or tail rot or similar disease where they should have some treatment. Our Health Dip is considered one of the best remedies known for the prevention of fungus or tail rot. Our Fungus Cure is especially prepared by us after years of experience in handling millions of goldfish annually. It should give satisfactory results if used in time, as it is the best that experience has taught.

Price of either Health Dip or Fungus Cure for one ounce package is 25c each, or \$2.50 per dozen boxes.



25c each

**ALGAE TREATMENT**



If your pool is not properly balanced, or if for some other reason, a green scum, or algae appear, you will want something to remove the same; and you will want to know that it will not injure the fish or lilies. This we have in our Algae Treatment. You may feel safe in using our treatment. Directions with each package.

25c each; 3 for 50c.

**LICE REMEDY**

We have had so many calls for a treatment for fish, which in a run-down condition become infested with lice. Lice are also introduced into your pool by buying cheap fish in a run-down condition. We have put up a preparation which, if used and the fish are not too weak, will kill the lice. Several treatments are necessary.

25c each; 6 for \$1.00.







## WATER IRIS

We are making a separate heading for this most beautiful of water garden flowers. It should be in every garden. None is complete without it. They are extremely easy to grow either in shallow water or in boxes above the surface or along the edge. They flower freely, having large blossoms borne on many flowered spikes. With different varieties you can have flowers over a long period.

- IRIS PSEUDACORUS (yellow). Bright yellow.....3 for 75c; 6 for \$1.35; dozen \$2.50
- IRIS VERSICOLOR (blue).....3 for 75c; 6 for \$1.35; dozen \$2.50
- IRIS ORIENTALIS (lavender and blue). Early.....3 for 75c; 6 for \$1.35; dozen \$2.50
- IRIS PUMILA (purple). A dwarf.....3 for 75c; 6 for \$1.35; dozen \$2.50

## SCAVENGERS

Goldfish are very beautiful, so are Water Lilies and all aquatic plants. Snails, tadpoles and fresh water mussels aid in purifying the water and sand. Just as the Goldfish eat insect life and mosquitoes, so do Snails consume algæ and green scum; Tadpoles eat decayed matter as well as the excrement of the fish. They are of inestimable value both in pools and aquariums.

The transformation of a tadpole to a frog is not only an interesting but an instructive natural phenomena. All will enjoy seeing the legs develop and the tail absorbed and finally the real frog.

You will surely want with your fish and lilies these scavengers to help keep the water pure and clean.

**TADPOLES.** One of the best scavengers. They do not eat fish eggs and are harmless to the fish. **Per dozen 50c**  
These can only be shipped in water and by express, charges collect.

**JAPANESE SNAILS.** Good in keeping the water clear of scum. We offer these at **25c pair; per dozen \$1.25.**

**BLACK RAMSHORN SNAILS.** 4 for 25c; 60c doz.

**SALAMANDER.** Sometimes called Newts. Brown with black dots. Very fond of insect life.

**50c per pair; dozen \$2.00.**

### Denso Sub-Aqua

THE UNDERWATER CONCRETE ENAMEL



DENSO SUB-AQUA is an especially formulated non-poisonous coating for use in aquariums, lily and swimming pools or any concrete surface which is constantly under water.

It greatly enhances the beauty of the pool or pond by taking away that drab appearance of unpainted concrete.

- Quart can .....\$1.25
- Half-gallon can ..... 2.35
- One gallon can..... 4.50

Express collect from our shipping point, Lilypons, Md.

### Water Lily Fertilizer

Growing the largest quantities of lilies produced in the world, we feel that we are especially prepared by knowledge and experience to produce a fertilizer which is especially adapted to the needs of water lilies. Our fertilizer is indeed most excellent for water lilies, and all aquatic plants. It is put up in one pound cans with full directions on each can.

We offer it as follows:

**1 pound, 35c; 5 pounds, \$1.50.**

**Extra cost for packing on one pound can, 10c.**

**No extra packing charge on 5 lbs.**

## Books on Goldfish and Water Gardening

You will no doubt want some good books on these subjects. We are glad to recommend the following written by the very best authorities:

**“WATER GARDENING”** By Dr. Peter Bisset, who is the Senior Horticulturist in charge of the U. S. Department of Agriculture, Washington, D. C. Over 205 pages profusely illustrated, with plans for pools, etc., cuts of various lilies and goldfish. A book brim full of illustrations and information. **Price, \$5.00.**

**“GOLDFISH VARIETIES AND TROPICAL AQUARIUM FISHES”**  
By Wm. T. Innes, former President of the Aquarium Society of Philadelphia. Three hundred pages with nearly as many illustrations. One chapter devoted to aquariums and concrete pools. A full discussion of the breeding, feeding, etc., of Tropicals and Goldfish, also of the enemies and diseases, cures, etc. A complete book. **Price, \$4.00.**

**“MODERN AQUARIUM”** By W. T. Innes, a 62-page booklet with photographic illustrations on the breeding habits and care of Goldfish and Tropicals. **Price, \$1.00.**

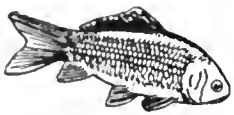

# THREE SPRINGS FISHERIES—LILYPONS

## Aquatic Plants

With your water lilies you will need other plants. Surely the Lotus and then other aquatics. We have the floating; the oxygenating or under-the-water plants; the shallow water plants; the marsh plants; the ferns and the perennial plants; for margins or borders. We do not attempt to list them all and thereby confuse you, but we do list the best of each.

### Floating Plants

**WATER HYACINTH.** A very showy, interesting floating plant. Glossy green leaves. Flowers are borne on a stem about one foot high. Six to eight flowers in a spike. Flowers are pale blue. Killed by frost and should be treated as an annual.

Price, 50c for 4; \$1.25 per dozen.

**WATER POPPY.** A very small plant producing large yellow poppy flowers. Its roots should be planted in the soil.

50c for 4; \$1.25 per dozen.

**WATER LETTUCE (Shell Flower).** A very ornamental aquatic plant. Floats on the surface and is four to six inches across. It likes the shade. It has blue green fluted leaves. Killed by frost.

50c for 3; \$1.50 per dozen.

### Oxygenating Plants

**ANACHARIS.** A rapid grower. Desirable for pools, tubs and aquariums.

Price, \$1.25 per dozen bunches.

**CABOMBA.** A splendid oxygenating plant; a rapid grower, roots easily and splendid for fish to spawn on.

Price, \$1.25 per dozen bunches.

**MYRIOPHYLLUM.** We sell only the red-stemmed. This is probably the best of all for goldfish spawning.

Price, \$1.25 per dozen bunches.

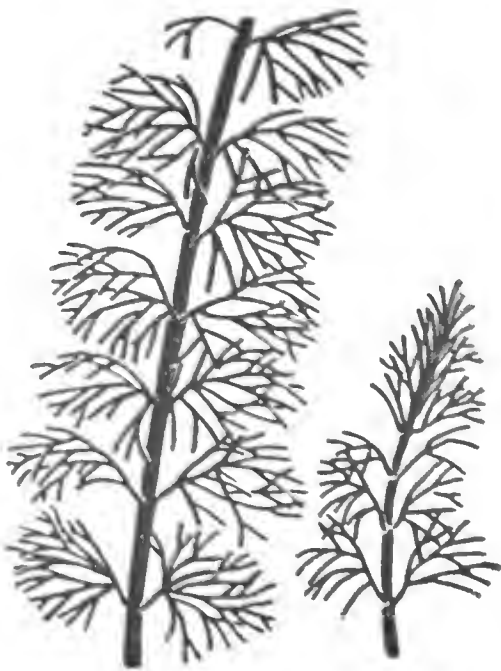

CABOMBA



WATER HYACINTH

### Shallow Water Plants

**ARROW-HEAD (Giant).** We have seen many of these, but we have yet to see any so large and thrifty as grow in our gardens. A hardy plant from 1 to 3 feet producing large spikes of white flowers.

50c each; 4 for \$1.00; \$2.50 per dozen.

**COMMON CATTAIL.** A favorite native swamp plant. Easy to grow and ornamental. Hardy.

4 for 50c; \$1.50 per dozen.

**PARROT FEATHER.** A rapid grower with feathery green stems. Hardy.

4 for 50c; \$1.50 per dozen.

**WATER PLANTAIN.** A plant along the edge in shallow water with heart-shaped leaves. Has tall branching spikes of white flowers. Hardy.

4 for \$1.00; \$2.50 per dozen.

**CALAMUS.** Grows to a height of 2 to 3 feet and has lance-shaped leaves. Its root is much admired for its flavor as well as its medicinal qualities. Hardy.

4 for \$1.00; \$2.00 per dozen.

**PICKEREL RUSH.** This is a fine native aquatic plant. The flowers are blue, borne on a close set spike. It is free blooming, and is a very useful plant in shallow water at the edge of the pond, one of the best shallow water plants. Hardy.

3 for 50c; \$2.50 per dozen.

**SAGITTARIA.** This is a very valuable plant. The leaves are broad sagittate. The flowers are pure white. It has a luxuriant growth at the margin of ponds or streams. It is also used in the aquarium. Hardy.

4 for 50c; \$1.50 per dozen.

**MARSH MARIGOLD.** This plant is especially adapted for moist wet ground or around the edge of the pool. It has clusters of large bright yellow flowers which are borne freely early in the spring. It is one of the most attractive of our native plants. Hardy.

3 for \$1.00; \$2.50 per dozen.





# General Instructions to Customers

## Read Carefully the Following :

**OUR GUARANTEE.** We have a tremendous plant, and a very large investment, which is a valuable asset. We guarantee to our customers complete satisfaction. We give superior quality, make prompt and efficient shipments, and answer promptly any and all correspondence. We give freely any and all information. We are the largest producers in the world devoted to the propagation of water lilies, by virtue of which you are assured of honest dealing, high quality, efficient service, and lowest prices.

**ORDER EARLY.** This is most important. Remember our guarantee. All we ask is your cooperation. We suggest that you order at once, and leave to us time of making shipments. All orders are shipped in rotation. While we have the largest acreage in the world devoted to the culture of water lilies and goldfish, yet there are certain varieties of fish and often water lilies which are short. It takes time to grow both of these products, for they cannot be manufactured.

**SHIPMENTS.** All plants, roots, etc., are carefully packed and leave our station in perfect condition. All fish are in perfect condition. We guarantee good arrival of both. All fish shipments are made by express collect unless otherwise indicated. Should any shipments arrive in bad condition, take a bad order report, and we will replace. We don't leave the matter to you. All plants guaranteed to arrive in perfect condition, and guaranteed to grow, and please you. Could any one do more?

**PRICES AND TERMS.** Our prices are net cash, and effective January 1, 1939. No orders are entered unless accompanied with funds to cover. We believe that our prices will be found as low as any offered by responsible growers. We ask that you bear in mind, when considering prices, that we only ship the best material selected from our large production, and that we are not distributors, *but actual producers*; and furthermore, that we stand squarely behind our products. Do others? Just compare and see.

Be sure to give us name in full, post office, R. F. D., street address, name of city or town and state.

---

---

<b>FREE</b>	WITH EVERY ORDER AMOUNTING TO \$3.00 AND UNDER \$5.00 WE WILL GIVE FREE A BEAUTIFUL BLUE WATER IRIS. WITH EVERY ORDER OF \$5.00 OR OVER WE WILL GIVE FREE 2 BEAUTIFUL BLUE WATER IRIS OR YOUR CHOICE OF ANY WATER PLANTS ON PAGE 36 AMOUNTING TO NOT OVER 50 CENTS.
-------------	---

---

---

**HAVE YOU FRIENDS WHO WOULD LIKE TO SEE OUR CATALOGUE?**

Name..... Address.....

Name..... Address.....

Name..... Address.....

Name..... Address.....



*An  
Airplane  
View of a Portion  
of the Ponds of the  
THREE SPRINGS  
FISHERIES*

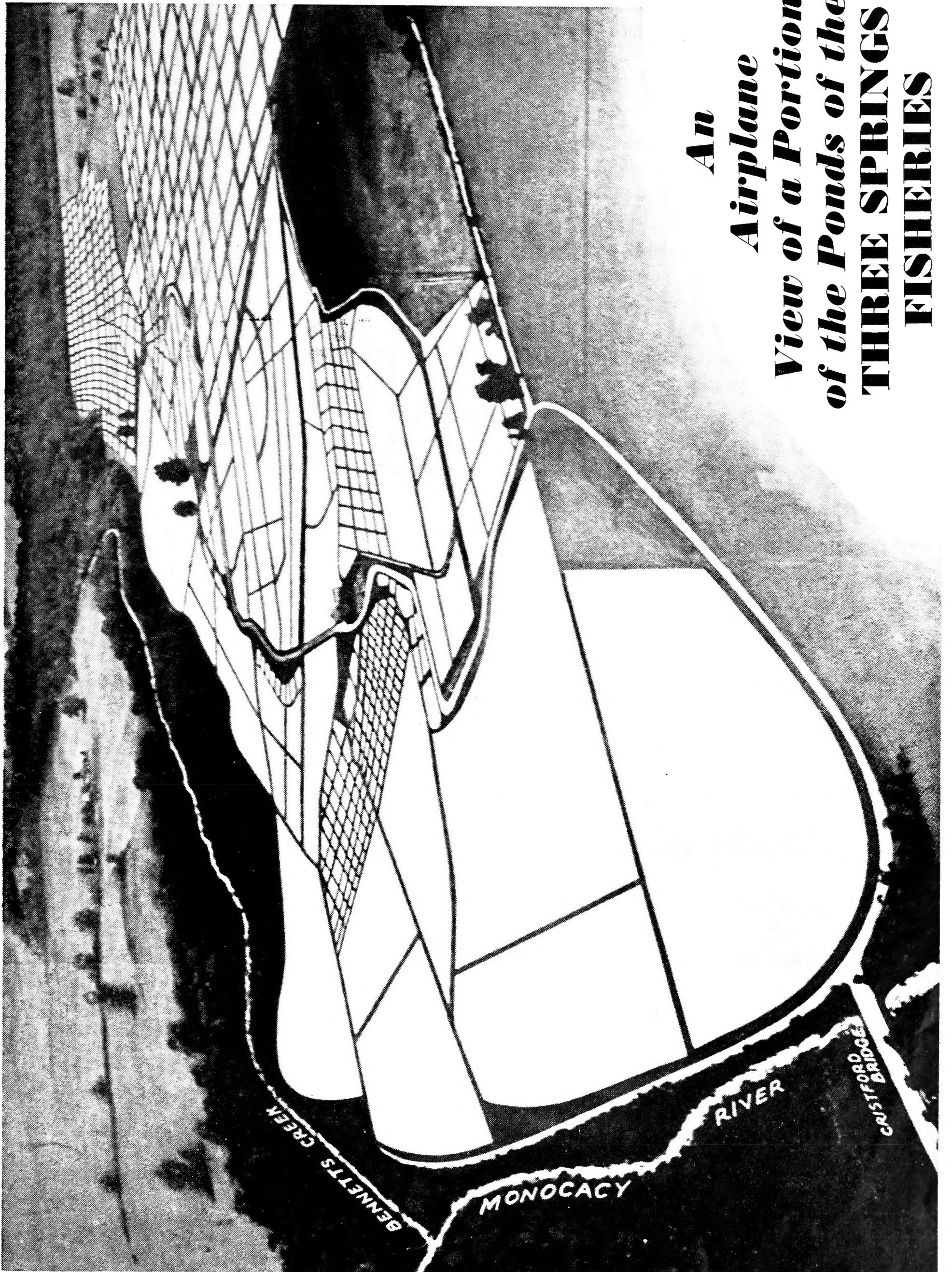





# WATERLILIES AND GOLDFISH



## Collection No. 5

The Rose Arey (Pink) . . . . . \$1.75  
The James Brydon (Red) . . . . . 2.50  
The Chromatella (Yellow) . . . . . 1.25

Total value . . . . . \$5.50

for \$4.50

All standard and well recognized brands. We offered this collection last year for the first time and it was so popular that we are repeating the offer.

