

Historic, Archive Document

Do not assume content reflects current scientific knowledge, policies, or practices.

62.83

1940

SATEX SEED CO.

**25TH
ANNIVERSARY**

FEB 16 1940 ☆
Department of Agriculture



**SEED
AND
POULTRY
SUPPLY
ANNUAL**

**529 S. FLORES ST.
SAN ANTONIO, TEXAS**

CONFIDENCE

"Why is it my neighbor's crops are so superior to mine?" I buy the same variety of seeds, use the same fertilizer and care he does, and still at harvest time his yield is far better."

The answer is simple. Your neighbor plants good seed. Just planting the same variety of seed does not spell success. You must plant good seed of a certain type if you expect a good crop. Poor seeds, regardless of care, will not produce good crops.

Experienced growers have learned that a few cents more for seeds of known quality produce more dollars on the returns. It is the policy of our company to offer you only such seed as we know to be of the highest quality and grown by the best and most dependable growers in the United States and foreign countries. We realize that quality merchandise creates customer confidence and repeat business.

You will make no mistake in planting.

SATEX QUALITY TESTED SEEDS

Seeds for the Critical gardener

HOW TO ORDER

You will find an order blank and addressed envelope envelop enclosed in this catalog. Write your name and address plainly. Be sure to specify how you want your order shipped unless it is a postpaid order. We fill all orders the day received, unless unable to supply same at the time, and will advise you accordingly, so do not hesitate to write us if the goods do not show up.

REMITTANCES should be made by Postoffice Money Order, Bank Draft or Personal Checks. On orders up to One Dollar, we will accept clean unused postage stamps. If currency is sent, letter should be registered. The proper way is to send remittances in full to cover order and postage. We send orders C.O.D. only if 25 per cent of the amount of order is enclosed. **PLANTS ARE NEVER SENT C.O.D.**

MEXICO CUSTOMERS — Add 20c for first pound and 11c for each extra pound to prices, also 15c for registration. We ship up to 20 pounds per package into Mexico.

ALL GARDEN AND FLOWER SEED listed in catalog are postpaid up to the fifth zone unless otherwise noted. Field Seeds, Bulbs, Poultry Supplies, Remedies, Insecticides, etc., are quoted F.O.B. San Antonio. If you desire same shipped by parcel post, see parcel post rate below for additional amount to be enclosed with order.

OUR GUARANTEE

We guarantee the safe delivery of all Seeds, Bulbs, Plants or merchandise that you order from us. We guarantee all merchandise to be exactly as illustrated, described and represented. Any item not found to be entirely satisfactory will be replaced free of charge, or we will refund you every cent you paid, including transportation charges both ways.

Even with the highest quality Seeds, Bulbs, and Plants, success in gardening or farming depends largely on cultivation, soil and weather conditions. Therefore —

SATEX SEED CO. gives no warranty, express or implied as to description, quality, productiveness, or any other matter of any Seeds, Bulbs, Plants, or Trees they send out, and will in no way be responsible for the crop. If the purchaser does not accept seeds on these terms, they are to be returned at once.

PARCEL POST RATES

ZONES

ZONES

Lbs.	1 & 2	3rd	4th	5th	6th	7th
1	\$0.08	\$0.09	\$0.10	\$0.11	\$0.12	\$0.14
2	.10	.11	.14	.17	.19	.23
3	.11	.13	.17	.22	.26	.32
4	.12	.15	.21	.27	.33	.41
5	.13	.17	.24	.33	.40	.50
6	.14	.19	.28	.38	.47	.59
7	.15	.21	.31	.43	.54	.68
8	.16	.23	.35	.49	.61	.77
9	.17	.25	.38	.54	.68	.86
10	.18	.27	.42	.59	.75	.95
11	.19	.29	.45	.64	.82	1.04
12	.21	.31	.49	.70	.89	1.13
13	.22	.33	.52	.75	.96	1.22
14	.23	.35	.56	.80	1.03	1.31
15	.24	.37	.59	.86	1.10	1.40
16	.25	.39	.63	.91	1.17	1.49
17	.26	.41	.66	.96	1.24	1.58
18	.27	.43	.70	1.02	1.31	1.67
19	.28	.45	.73	1.07	1.38	1.76
20	.29	.47	.77	1.12	1.45	1.85
21	.30	.49	.80	1.17	1.52	1.94
22	.32	.51	.84	1.23	1.59	2.03
23	.33	.53	.87	1.28	1.66	2.12
24	.34	.55	.91	1.33	1.73	2.21
25	.35	.57	.94	1.39	1.80	2.30
26	.36	.59	.98	1.44	1.87	2.39
27	.37	.61	1.01	1.49	1.94	2.48
28	.38	.63	1.05	1.55	2.01	2.57

Lbs.	1 & 2	3rd	4th	5th	6th	7th
29	.39	.65	1.08	1.60	2.08	2.66
30	.40	.67	1.12	1.65	2.15	2.75
31	.41	.69	1.15	1.70	2.22	2.84
32	.43	.71	1.19	1.76	2.29	2.93
33	.44	.73	1.22	1.81	2.36	3.02
34	.45	.75	1.26	1.86	2.43	3.11
35	.46	.77	1.29	1.92	2.50	3.20
36	.47	.79	1.33	1.97	2.57	3.29
37	.48	.81	1.36	2.02	2.64	3.38
38	.49	.83	1.40	2.08	2.71	3.47
39	.50	.85	1.43	2.13	2.78	3.56
40	.51	.87	1.47	2.18	2.85	3.65
41	.52	.89	1.50	2.23	2.92	3.74
42	.54	.91	1.54	2.29	2.99	3.83
43	.55	.93	1.57	2.34	3.06	3.92
44	.56	.95	1.61	2.39	3.13	4.01
45	.57	.97	1.64	2.45	3.20	4.10
46	.58	.99	1.68	2.50	3.27	4.19
47	.59	1.01	1.71	2.55	3.34	4.28
48	.60	1.03	1.75	2.61	3.41	4.37
49	.61	1.05	1.78	2.66	3.48	4.46
50	.62	1.07	1.82	2.71	3.55	4.55
55	.68	1.17				
60	.73	1.27				
65	.79	1.37				
70	.84	1.47				

Zones are based on the distance you are from shipping point, San Antonio, Texas. Up to 150 miles from San Antonio is the 1st and 2nd zones, which take the same rate; 150 to 300 miles is the 3rd zone; 300 to 600 is the 4th; 600 to 1000, the 5th; 1000 to 1400, the 6th; 1400 to 1800, the 7th; over 1800 miles, the 8th zone.

BEAUTIFY YOUR HOME WITH FLOWERS

There can be no greater joy than the planting of your own garden and certainly nothing more fascinating than actually growing from seed the plants and varieties desired. It is difficult to believe that anyone would contemplate leaving the grounds around their cherished home bare and unattractive, especially when so many beautiful flowers can be grown from seed, with so little effort and at such a small cost. Your home surrounded by a profusion of brilliantly colored and variously shaped flowers growing in neatly designed beds will delight your eye and as "Old Mother Earth" unfolds her beauty in all her majestic splendor you will be inspired with the feeling that the home is more beautiful than ever.

There is practically no limit to the beauty that may be built into your home grounds and at very small cost. **PLANT MORE FLOWERS!**

SOIL — A sandy loam is most preferable for flowers, but almost any type soil can be rendered suitable. If too heavy, add sand. Peat Moss will improve both light and heavy soils.

SOWING — After soil has been prepared, sow seed carefully either in rows or broadcast as you have decided, then **COVER LIGHTLY**. As a general rule most seeds are covered to a depth not exceeding four times the thickness of the seed. **DO NOT COVER SEED TOO DEEP** as they may not be able to come up. After covering **PRESS SOIL FIRMLY** with plank or flat side of hoe. Very small seeds should be sown on the surface of soil and merely **PRESSED IN**.

CULTIVATING — As soon as growth commences cultivate between rows and near plants to conserve moisture and permit the entrance of air but above all keep down weeds — which can truly be called the robbers of the soil. Cultivate deeply at first and then gradually more shallow as plants get larger so their roots may not be injured.

WATERING — The best and safest time to water is early in the morning or in the evening. The roots of plants may be irrigated at any time of the day. Remember that one thorough soaking will do more good than many scanty sprinklings.

STARTING PLANTS INDOORS — Half hardy or tender varieties or even hardy flowers requiring a long season to bloom should be started in boxes for earliest blooms. Procure best soil available especially rich in humus and plant as previously explained. Place boxes near window where sunlight may reach them but do not let inside room temperature get so high as to make plants grow rank and spindly. Keep soil moist but not wet. When three or four leaves have formed, transplant one inch apart in boxes or in open ground, if warm enough. Before setting plants in garden "harden off" by placing boxes outside on mild days until they are able to stand the weather without injury.



Balsam - Double Bush Flowering

AGERATUM

(FLOSS FLOWER)

Perennial. One of the best summer blooming plants grown from seed. Rapid growers, early and constant bloomers. During the hot, dry summer months their bright flowers are produced in the greatest profusion. Set the dwarf sorts 10 inches apart and they soon make a low mass of charming flowers.

MEXICANUM TALL BLUE — Light blue; about two feet high. Pkt. 10c; oz. 50c.

ALYSSUM — SWEET

A hardy annual used for borders and edging, comes early in the spring, covering itself with clusters of flowers.

LITTLE GEM (Carpet of snow) — A beautiful white sort for borders. Plants grow about 6 inches tall, produces an abundance of flowers. Pkt. 10c; oz. 50c, postpaid.

ASTERS (Wilt Resistant)

For early flowering, seed should be planted in hot beds in December and January, then transplanted as soon as danger of frost is over.

QUEEN OF THE MARKET — This is a good type for bedding, and also makes fine cut flowers. Plant grows about 15 inches high and produces beautiful double flowers in many colors, carried in long, slender, graceful stems.

CRIMSON — Pkt. 10c; oz. \$1.25, postpaid.

LIGHT BLUE — Pkt. 10c; oz. \$1.25, postpaid.

PEACH BLOSSOM — Pkt. 10c; oz. \$1.25 postpaid.

MIXED. Pkt. 10c; oz. \$1.00, postpaid.

ARCTOTIS (African Daisy)

Grandis (Blue-Eyed African Daisy) 3 ft. It forms bushes bearing 2 inch daisy flowers of pearly white with a gold band surrounding a delicate mauve center. It closes at evening and displays its lilac tinted undersides. Foliage gray green. Especially good cut flower. Pkt. 10c; oz. 45c, postpaid.

ANTIRRHINUM OR SNAPDRAGON

Snapdragons are very hardy and easy to grow and produce an abundance of flowers from the time they begin blooming in the Spring until frost. They are among our most popular flowers and are especially desirable for cutting. We carry only the best Rust-proof Strains.

MAXIMUM GRANDIFLORUM RUST-PROOF — This is the newest creation in Giant Snapdragons and is a marked advance over the old type in size and brilliancy of color and is immune to rust.

Loveliness—Soft
rosy pink—Pkt. 10c; ¼ oz. 75c

Apple Blossom—Rosy Pink,
white tube—Pkt. 10c; ¼ oz. 75c

Purple King—Deep glowing purple.
Pkt. 10c; ¼ oz. 75c

Copper King—Velvet copper scarlet
Pkt. 10c; ¼ oz. 75c

Alaska (Snowflake)—white
Pkt. 10c; ¼ oz. 75c

Canary Bird—Golden yellow center .
Pkt. 10c; ¼ oz. 75c

Christmas Candle—Flame scarlet cream throat
Pkt. 10c; ¼ oz. 75c

Rust-Proof Mixed—Contains wonderful range of all the most popular colors
Pkt. 10c; ¼ oz. 60c

BALSAM

(LADY SLIPPER)

Grows 18 inches to 2 feet tall, producing an abundance of brilliantly colored flowers. This plant also known as old-fashioned Touch-Me-Not.

DOUBLE CAMELIA MIXED.
Pkt. 10c; oz. 50c, postpaid.

ROSE FLOWERED — Double flowers, all colors. Pkt. 5c; oz. 50c, postpaid.

DOUBLE BUSH FLOWERING — A new type with flowers forming rich bouquets above the foliage. Bushy plants 12 to 15 inches tall. Pkt. 10c; oz. \$2.00.

BELLIS PERENNIS

(English Double Daisy)

These jolly little flowers are popular because of their bright color, their profuse long blooming period, and their dwarf compact growth. Pkt. 10c; oz. \$1.00, postpaid.

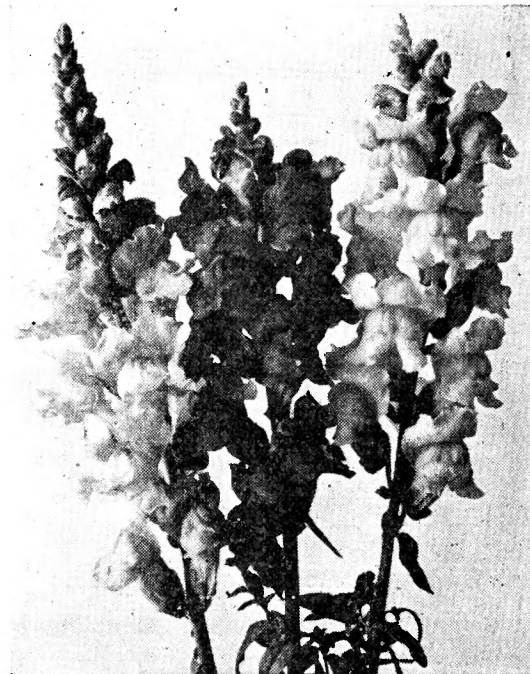

Antirrhinum or Snapdragon

TEXAS BLUEBONNET

(Lupinus Texensis)

A. The Texas State flower. Grows all over the prairies of Texas. As the seeds are very hard, puncture each seed with a sharp needle and soak overnight before planting. They bloom in Texas in March, April and May. After maturing seed, the plant dies and the seed falls on the ground and comes up again the next Spring.

TEXAS BLUE BONNET. Price, pkt. 10c; oz. 20c; ¼ lb. 50c; lb. \$1.50, postpaid.



ASTER-QUEEN OF THE MARKET

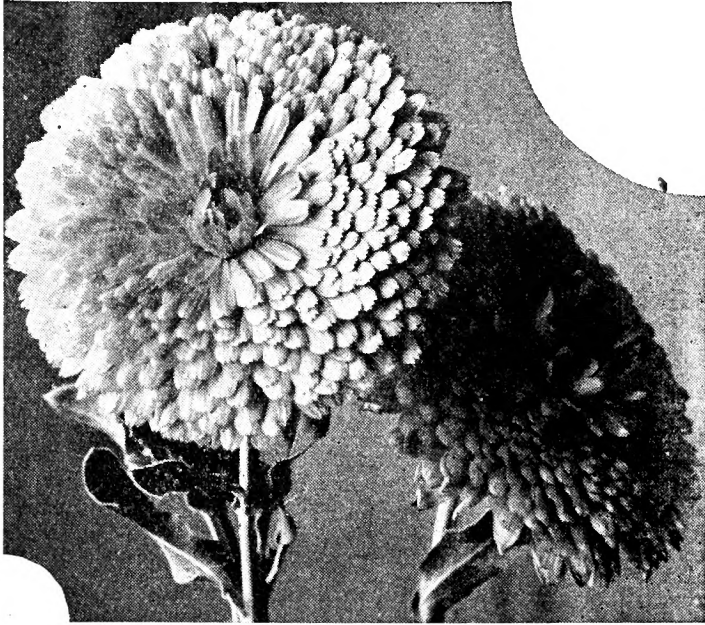

Calendula - Campfire

CAMPANULA

(Canterbury Bell)

Annual varieties of this splendid flower family bloom in about six months from seed, growing to 2½ ft., and bearing six to eight spikes of bloom. A splendid late summer border flower. Pkt. 10c; oz. 50c — postpaid.

CANDYTUFT

Prolific bloomers, bearing in profusion clusters of flowers in a wide range of colors. Indispensable for cutting, very effective in beds or borders; thin out to 4 inches in a row.

GIANT WHITE HYACINTH FLOWERED—This is an extra select strain of Candytuft, with enormous trusses of white blossoms, especially desirable for cutting. Grows about 18 inches high. Pkt. 10c; oz. 50c. Postpaid.

UMBELLATA—Finest mixed. Pkt. 5c; oz. 20c. Postpaid.

UMBELLATA—Rose Pkt. 10c; oz. 25c. Postpaid.

UMBELLATA—Lavender. Pkt. 10c; oz. 25c. Postpaid.

UMBELLATA—Rose Cardinal Pkt. 10c; oz. 35c. Postpaid.

UMBELLATA—Purple Pkt. 10c; oz. 25c. Postpaid.

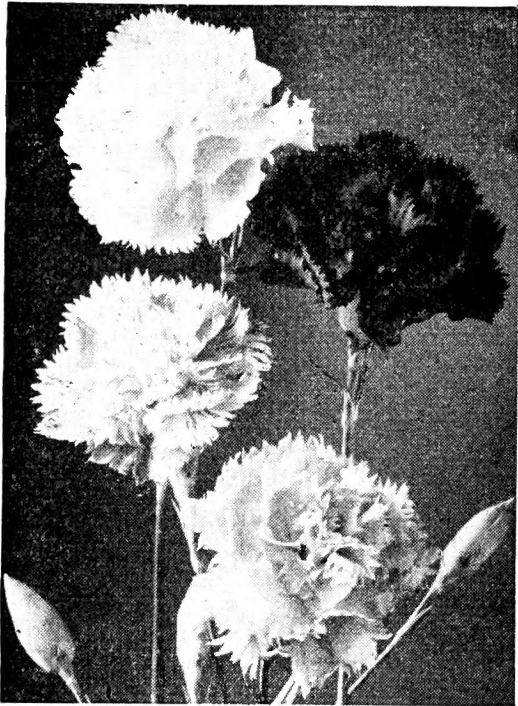

Carnation

CARNATION

Carnations are general favorites for their delicious fragrance and richness of color. They are indispensable both for greenhouse culture in winter and for the garden in summer; sow in the fall.

CHABAUD'S GIANT—Will come into bloom six months from seed and continue to bloom all summer; they form from 10 to 20 stalks bearing huge flowers of fine form. Colors; scarlet, yellow, dark red, white, and deep rose and mixed. Pkt. 10c; ¼ oz. 75c.

CALENDULA

POT MARIGOLD

One of the best and showiest free-blooming hardy annuals, growing in any good garden soil; producing a fine effect in beds or mixed borders, particularly bright in late Fall, continuing in bloom from early Summer until killed by frost; valuable also for pot culture, blooming freely in Winter and early Spring. Sow in Fall.

CAMPFIRE (Sensation)—The flowers are extremely large, very dark orange with a scarlet sheen.

Pkt., 10c; oz., 60c, postpaid.

BALLS GOLD—Similar to Campfire but a rich lemon-yellow. Pkt., 10c; oz., 60c, postpaid.

PASTEL BEDDING MIXTURE Contains all of the delicate shades of calendulas. Pkt., 10c;

CASTOR BEAN

RICINUS — The large ornamental variety. Pkt. 5c; oz. 15c.

COCKSCOMB

(Celosia Cristata)

An old and picturesque class of plants having colored foliage gracefully arranged like plumes and sometimes more dense, like a cock's comb. They are very easily grown and should be planted outdoors when the ground is warm; they make an extreme contrast to shrubbery planted here and there among them.

DWARF GIANT EMPRESS.—This beautiful dwarf plant has bronze leaves and forms very large, crimson combs; height usually about one foot. Pkt. 10c; oz. \$1.50.

PLUMOSA—Finest mixed. Choice mixed of many types. Pkt. 10c.

COLEUS

Large leaved (12 inch). These are the ornamental "foliage" plants so well adapted for growing in the house in winter. They can also be transplanted outdoors when the weather is warm, and for borders or window boxes in partial shade they are unexcelled. The leaves are of many shades and combinations of green, red, and yellow. Pkt. 10c; oz. \$4.50 — postpaid.

CORN-FLOWER

(DOUBLE)

Sometimes called Corn Flower or Bachelor's Button. This is an old-fashioned, hardy annual and still a great favorite for cutting purposes. Are very easily cultivated; the seed should be sown in the spring where they are to remain; thin out to 3 or 4 inches.

SNOW MAN—A new variety, absolutely pure white and very durable; splendid as a cut flower. Pkt. 10c; oz. 30c. Postpaid.

BLUE BOY—A pleasing shade of blue, much prettier than the single kinds; height 2 to 3 feet. Pkt. 10c; oz. 30c. Postpaid.

PINKIE—Beautiful bright pink shade. Pkt. 10c; oz. 30c. Postpaid.

RED BOY—A bright red. Pkt. 10c; oz. 30c.

BLACK BOY—Blackish Maroon. Pkt. 10c; oz. 30c, postpaid.

DOUBLE MIXED—All colors. Pkt. 10c; oz. 25c.

COREOPSIS

MAYFIELD GIANT

On long graceful stems these plants bear large daisy-like flowers with broad fluted petals. In color they are a rich, glossy chrome yellow. They bloom without interruption for a long season and are brilliant in the garden as well as for cutting. Pkt. 10c; oz. 45c, postpaid.

COSMOS

Hardy and fast growing. Plants 3 to 5 feet high, with feathery green foliage, producing in a variety of colors, single and double flowers on long, graceful stems. This is one of the best flowers to grow for cutting.

SENSATION—Finest Mixed. A tall, feathery, green stalk, bearing daisy-like flowers in all shades of lavender, pink, and white Blooms all summer. Pkt. 10c; oz. 75c. Postpaid

EARLY DOUBLE CRESTED (3 ft.). Some of the flowers have attractive, raised, central crests of small petals which completely cover the discs. Pkt. 10c; oz. \$2.50, postpaid.

DAHLIAS

Most flower lovers plant Dahlia Roots as they do not know that beautiful blooms can be successfully produced the same season from seed. There is real fascination in growing Dahlias from seed, as new varieties are originated in this manner.

UNWIN'S DWARF GIANT MIXED—A small dwarf Dahlia growing to a height of 12 to 15 inches. A free bloomer, which makes it an excellent bedding plant. Easily grown from seed.

Pkt. 20c; 3 pkts. 50c; ½ oz. \$1.50, postpaid.

DAISY (Shasta)

A splendid hardy variety with flowers rarely less than 4 inches across, of the purest glistening white with yellow center, broad, over-lapping petals and borne on long stems. A beautiful cut flower, remaining in good condition a week or more.

CONQUEROR—Flowers very large, pure white, stems about 2½ to 3 feet long. Pkt. 10c; oz. \$1.25.

DIENERS DOUBLE—Flower double very large, pure white, stems about 2½ to 3 feet long. Pkt. 25c; ¼ oz. \$4.00.

DELPHINIUM

The Chinese Delphinium blooms from seed the first year if sown early and may be treated as an annual; though it is a hardy perennial and plants will last many years. Fine for beds and border masses. Tall finest mixed. Pkt. 10c; oz. \$1.00, postpaid.



DIANTHUS OR PINKS

DIANTHUS OR PINKS

The family of Pinks is unrivalled for brilliancy and rich variety of color. The plants are bushy, of symmetrical form, blooming profusely until fall, rendering them very satisfactory for summer varieties.

CHINESE DOUBLE MIXED—This is a double annual sort of beautiful colors. Pkt. 10c; oz. 25c.

SWEET WIVELSFIELD—A new, very hardy annual that does exceptionally well here. Fine for borders and exceptionally good for cut flowers. Can also be used to a good advantage in rock gardens. Pkt. 10c; oz. 50c.

GAILLARDIA

GAILLARDIA (Blanket Flower) Tones of orange, yellow, red, and maroon, often beautifully combined in a single blossom, make these flowering plants gay ornaments of the garden all summer long. The foliage of soft green combines well with the flowers. The blossoms are 2 to 3 inches across. Both the annuals and perennials are favorites for the border. Pkt. 10c; oz. 45c, postpaid.

GERANIUM

This variety is very desirable for pot culture, flower boxes and bedding outdoors. Seed should be sown inside house in pots or boxes on rather light soil and should be kept moist. Seed is slow to germinate.

ZONALE MIXED — Pkt. 10c; oz. \$2.50.

GERBERA

(Transvaal Daisy) South African flower of unusual daintiness. The colors range from pale amber through salmon and rose to a rich ruby red. Pkt. 10c; 1000 Seeds \$4.00 postpaid.

GEUM

GEUM—Flowers like little double roses are poised on long stems over a thick rosette of strawberry-like leaves. Well suited for use in the perennial border and for bouquets. Pkt. 10c; oz. \$1.50, postpaid.

GYPSOPHILA
(BABY'S BREATH)

Delicate free-flowering plants covered with star-shaped flowers, valuable for mist-like effect and as trimming in bouquets; also for hanging baskets or edgings.
Paris Market — White --- Pkt. 10c; oz. 25c.
Rosea — Light Pink ----- Pkt. 10c; oz. 30c.

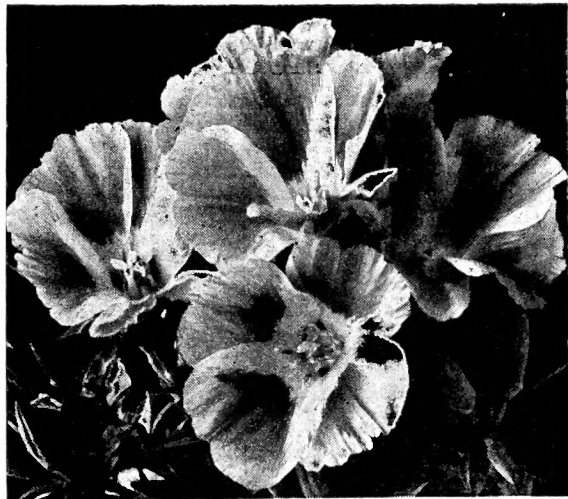

GODETIA—Upright Single

GODETIA

An attractive hardy annual, deserving more extensive cultivation. The plants bloom profusely and bear showy flowers of satiny texture in many rich and varied colors. They do best in a rather poor soil.

DUKE OF YORK—Rich scarlet on white. Pkt. 10c; oz. 60c, postpaid.
CHERRY RED—Bright red. Pkt. 10c; oz. 40c; postpaid.
SYBIL SHERWOOD—Bright salmon pink. Edged soft white. Pkt. 10c; oz. 75c postpaid.
TALL DOUBLE MIXED—Pkt. 10c; oz. 40c, postpaid.

GOURDS

Ornamental Gourds are very interesting climbers producing fruits of various shapes and marking. A coat of shellac applied to the matured fruits will add to their beauty, making attractive ornaments for house decorations through the winter. This old-fashioned vine grows 15 to 20 feet high.
SMALL VARIETIES MIXED—Pkt. 5c; oz. 25c.

GLOBE-AMARANTH
(GOMPHRENA)

A low-growing hardy annual. Everlasting or Straw Flower, about 8 inches high with globe-shaped flowers, in red, pink, white, and purple or orange. Mixed. Sow in the spring. Pkt. 10c; oz. 25.

HELIOTHROPE

Heliotrope is a universal favorite on account of its delightful fragrance and duration of bloom, flowering equally well as bedding plants in summer, or as pot plants in the house during the winter. Seeds sown in the spring make fine plants for bedding out, and are as easily grown as Verbenas. Pkt. 10c; oz. \$1.25 — postpaid.

HOLLYHOCK

Splendid background for flower gardens; shows up well along fences; bears open rose-shaped flowers; mixed. Single: Pkt. 5c; oz. 35c. Double: Pkt. 10c; oz. \$1.50.

LANTANA

Hybrida Mixed—Pkt. 10c; oz. 75c.

LARKSPUR
(DELPHINIUM)

TALL DOUBLE STOCK FLOWERED Annual varieties, the Larkspur is one of the handsomest and most useful of plants and for large gardens is invaluable. Sow in the fall to early spring.

Azure Blue or Sky Blue
Los Angeles, brilliant pink on salmon.
Lustrous Carmine, deep carmine rose, purple.
Purple or Dark Blue.
White.
Pkt. 10c; oz. 45c — postpaid.
Mixed colors. Pkt. 10c; oz. 35c, postpaid.

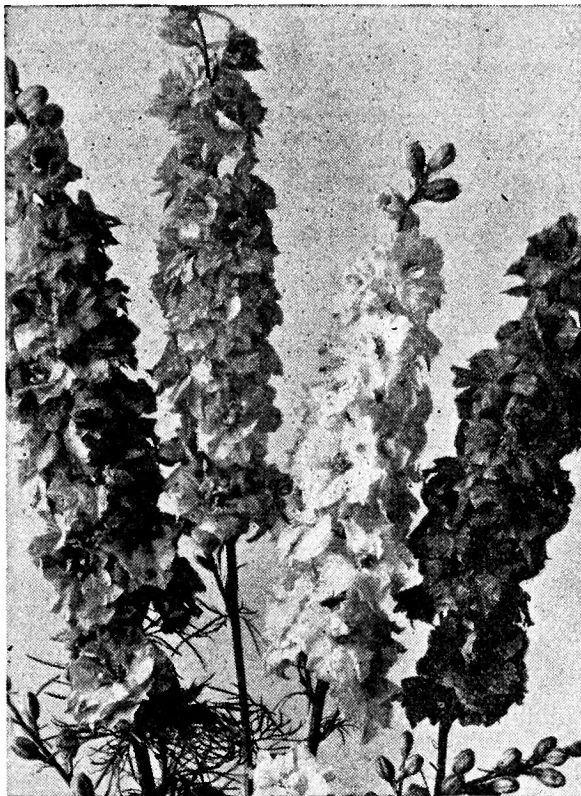

Larkspur - Giant Imperial

GIANT IMPERIAL LARKSPUR

This new type of larkspur is excellent for cut flowers, as the flower stems are from three to four feet long, branching from the base of the plant and more delphinium-like than the giant-flowering larkspur.

IMPERIAL BLUE SPIRE—This is an intense deep Oxford blue with the upright base branching habit. Pkt. 10c; oz. 70c.

IMPERIAL WHITE KING—A sensation in white larkspurs. Is very double and a dazzling pure white in color. Pkt. 10c; oz. 70c.

IMPERIAL CORAL KING—A rich bright rose, flushed salmon, one of the best for all purposes. Pkt. 10c; oz. 70c.

IMPERIAL BLUE BELL—Azure blue. Pkt. 10c; oz. 70c.

IMPERIAL CARMINE KING—Deep carmine rose. Pkt. 10c; oz. 70c.

IMPERIAL MIXED—All colors mixed. Pkt. 10c; oz. 60c.

LINARIAS

(Baby Snaps)

This is a hardy annual with small dainty flowers resembling miniature Snapdragons and in addition each flower has a long Columbine-like spur. It makes a nice cut flower and the clumps form an interesting feature of the annual border. Blooms in about eight weeks from seed. To get the best results seed should be sown thinly, the seedlings thinned out to about 18 inches. Pkt. 10c; oz. \$1.00 postpaid.

LUPINES (New)

NEW RUSSEL5S HYBRIDS MIXED—Guaranteed genuine Russels Lupin seed in originator's sealed packet. The hybrids are a treasure throve of color reaching in height from 2½ to 3½ feet with immense spikes of color ranging from the light shades of pink, salmon, and blue to the deeper colors of dark red and purple. These Perennials are very easily grown and should be in every flower garden. Chip or notch the seeds for quick germination.

Pkt.—10 seed ----- 15c
Pkt.—24 seed ----- 25c
Pkt.—80 seed ----- 65c

KOCHIA

MEXICAN FIRE BUSH
CHILDSII—2½ ft. It resembles a close-clipped ornamental evergreen. The pyramidal bushes are close and compact and of a pleasing light green. The plant may be grown singly or in the form of a

hedge or background and may be clipped to form a perfect substitute for boxwood to edge beds. In early autumn the whole bush becomes carmine or blood-red. Flowers small and numerous but not conspicuous. Pkt. 10c; oz. 20c, postpaid.

MARIGOLD

A showy plant with a profusion of flowers in brilliant colors of yellow and orange.

Tall Double Orange—A beautiful flower of gigantic size; a very bright orange color, plant usually growing about 2 to 3 feet high. A very popular sort. Pkt. 10c; oz. \$1.50.

Tall Double Lemon—A lemon shade that is beautiful.

Pkt. 10c; oz. \$1.50.
Mixed colors: Pkt. 10c.

CROWN OF GOLD (Collarette)—Flowers of Pompon type resembling a golden chrysanthemum. Height 24 inches. Pkt. 10c; oz. \$1.50.

GIGANTEA (Sunset Giants)—The largest marigold yet developed, many flowers averaging 5 inches in diameter. The definite sweet scent of the flowers adds to its value, as a cut flower. The color range includes deep orange, golden orange, deep golden yellow, light yellow and a delightful new shade of primrose. Height of plants, 3 to 4 feet. Pkt. 10c; oz. \$3.00

DWARF FRENCH DOUBLE MIXED

A fine mixture, having a wonderful lot of colors in it. Pkt. 10c; oz. 50c.

YELLOW SUPREME Fluffy flowers of light golden yellow. Foliage dark green with paler green stems. Has very little of the characteristic marigold odor and is even slightly fragrant. Does not grow quite so tall as others of this group. Pkt. 10c; oz. 60c, postpaid.

GUINEA GOLD—2 to 2½ ft. The original carnation-flowered type, producing flowers 2 to 2½ inches across, of brilliant orange flushed with gold. Practically 100% double. The characteristic Marigold odor is less pungent. This is an early flowering sort. Pkt. 10c; oz. 50c, postpaid.

HARMONY—A remarkable break which differs from others in habit, shape, and coloring. Flowers, in form suggesting a Scabiosa, are a bright golden-yellow bordered with a rich maroon-red. The plants being about 12 inches high, and very bushy habit, form excellent material for bedding. Pkt. 10c; oz. 60c, postpaid.

MATRICARIA
(Feverfew)

MATRICARIA CARPENSIS ALBA PLENA (Double White Feverfew)—Sometimes called button chrysanthemums and is a member of the mum family. Dozens of the small blooms are borne on a single stem of the plant and a few stems with a bit of fern will make a beautiful centerpiece. Grows 18 inches high. Pkt. 10c; oz. 75c, postpaid.

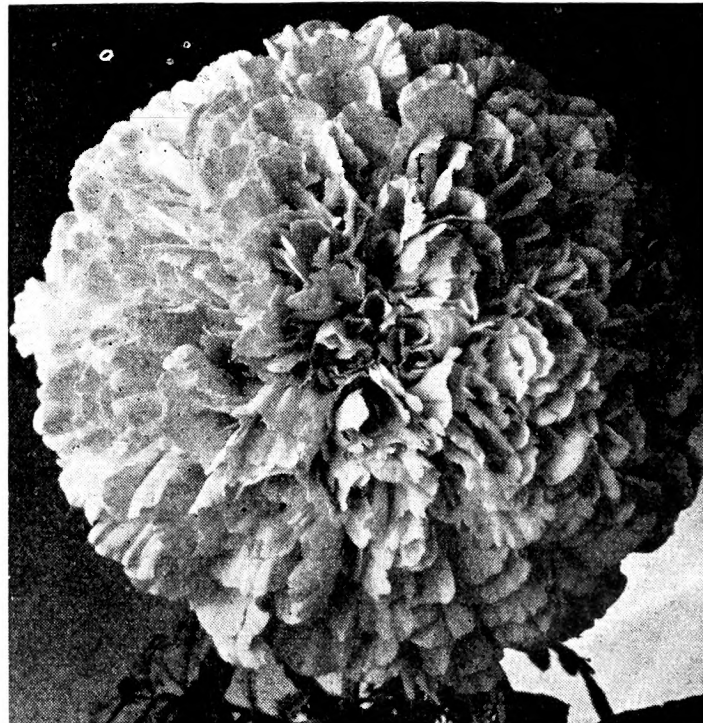

Marigold — Gigantea Sunset

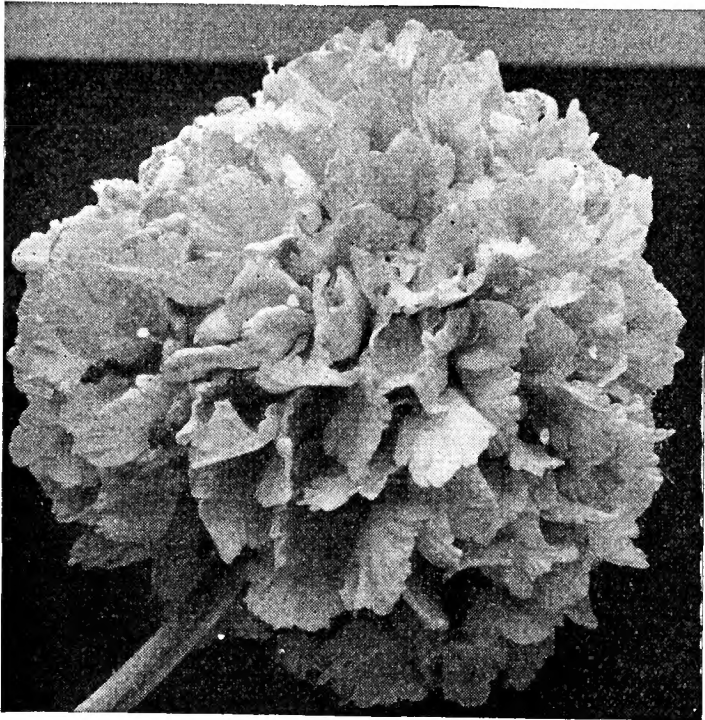

Scabiosa, Imperial Giant - Blue Moon

NASTURTIUM

SENSATIONAL NEW NASTURTIUMS—Giant, double, sweet-scented flowers of gorgeous new colors. Individual blooms are of immense size and produced on long, stiff stems. They are excellent for cutting as well as for garden decoration.

SCARLET GLEAM—Wonderfully sweet-scented double flowers of dazzling fiery orange-scarlet color. Pkt. 10c; oz. 15c.

GLEAM HYBRIDS—New colors, never before dreamed of in double Nasturtiums. Salmon, golden yellow, orange-scarlet, cerise, cream-yellow, orange, and crimson, all delightfully scented. Pkt. 10c; oz. 15c.

GOLDEN GLEAM—Acclaimed by garden lovers everywhere. Large, semi-double, golden yellow flowers averaging 3 inches across, deliciously sweet-scented. Pkt. 10c; oz. 15c.

PANSY

GIANT TRIMARDEAU—Flowers are well formed, of enormous size, in a great variety of colors, the very finest strain. Finest mixed. Pkt. 10c; oz. \$1.50.

NON PLUS ULTRA—The richest and most varied mixture possible, producing the largest flowers, consisting of the darker shades. Pkt. 10c; ¼ oz. \$1.25.

ENGELMANN'S GIANT—A special strain selected and developed by an English grower. The plants are dwarf and compact and the huge flowers, in many dark and light tones, appear early. Pkt. 10c; oz.—postpaid.

PETUNIA

Their richness of color, duration of bloom and easy culture will always make them popular.

DELUXE BEDDING MIXTURE—Large flowered dark sorts. Pkt. 10c; oz. \$2.00. Choice Mixed—Pkt. 10c; oz. 75c.

VICTORIOUS ALL DOUBLE DWARF GIANT FRINGED—The plants are remarkably uniform in habit, producing a wide assortment of brilliant and fancy colors. They produce very large, well fringed, fully double flowers and are extremely floriferous. Pkt. 50c.

PHLOX

DRUMMONDI — Grandiflora — This hardy annual is unequalled for the magnificent display of brilliant colors when used in beds. Will thrive in most any soil. Grows from 6 to 12 inches high. Colors: White, crimson, flesh, and mixed. Pkt. 10c; oz. \$1.50.

STAR—Choice mixed. Pkt. 10c; oz. \$1.50.

PHLOX DECUSSATA (Perennial) — Pkt. 10c; oz. \$2.50.

POPPIES

Should be planted in late Fall or very early in the spring, as in our section they burn out as Summer comes on.

CALIFORNIA POPPY—Eschscholtzia—A very beautiful annual with finely cut, feathery foliage, having a velvet, cup-shaped flower. All colors mixed. Pkt. 5c; oz. 25c.

SHIRLEY MIXED—This is a beautiful type of satiny flowers with a wide range of colors. Pkt. 5c; oz. 25c.

CARNATION - FLOWERED—Large size; flowers very double; of many colors. Pkt. 5c; oz. 20c.

PORTULACA (Moss Flower)

One of the best low-growing annuals for hot and sunny places; will grow and bloom profusely in the summer time when other flowers are dead. Sow after all danger of frost is over.

SINGLE MIXED—Many beautiful colors. Pkt. 10c; oz. 75c.

DOUBLE MIXED—Pkt. 10c; oz. \$2.00.

QUEEN ANNE LACE FLOWER

QUEEN ANNE LACE FLOWER (White)—A slender erect plant, with feathery fern-like foliage and small flowers clustered at the ends of the stalks. Very showy in mixed bouquets. Pkt. 10c; oz. 50c.

SALPIGLOSSIS

SALPIGLOSSIS (Painted Tongue) Large Flowered—From a low base of leaves rise slender wiry stalks which bear one or more large lily-like flowers in a magnificent range of colors. The gold veining of their deep throats is often pronounced and adds to their beauty. A great favorite in the open and for cutting. Mixed Pkt. 10c; oz. 75c, postpaid.

SCHIZANTHUS

SCHIZANTHUS (Poor Man's Orchid)—Myriads of dainty blossoms like butterflies or tiny orchids crowd these delightful plants. The seed germinates readily, and the plants start flowering within a few weeks. They are fine for picking. Pkt. 10c; oz. 40c, postpaid.

STATICE (Sinuata)

Our annual Statice is not only a beautiful flower in the border, but dries retaining its true colors, which are rare among everlastings, and have come to be indispensable in making winter bouquets. Pkt. 10c; oz. 20c, postpaid.

Kampfs, tall improved. Deepest blue, rosea superba, snow white, yellow (bondudelli). Choice mixed. Pkt. 10c, oz. 20c, postpaid.

SWEET PEAS

STANDARD SUPERB SPENCER — Sweet Peas will grow and blossom in any good garden soil. For best success sow early, in the fall or winter. Sow in trenches about 4 inches deep, covering the seeds about 1 inch, and fill in the trenches as the plants grow.

HIGHLANDER — clear lovely lavender.
RUFFLED CARMINE — ruffled carmine red.
FIERY CROSS — glowing orange cerise.
MISS CALIFORNIA — salmon cream pink.
PINKIE — large rose pink.
BRIDAL VEIL — large pure white (black seed).

CAPRI — clear silver blue.
BEGONIA ROSE — velvety begonia rose, duplexed.

CRONY — soft golden salmon.
SUPERB SPENCER MIXED — balanced mixture of many varieties.

FANTASY MIXED — veined and mottled varieties.

Prices on above; pkt. 10c; oz. 25c; excepting Superb Mixed, which are: pkt. 5c; oz. 15c; lb. \$1.25, postpaid.

SALVIA (Scarlet Sage)

SPLENDENS—Flowering sage, is a very ornamental plant, flowering in spikes of a rich red color. Pkt. 10c; oz. \$1.50.

SCABIOSA (Mourning Bride)

PIN CUSHION ASTER—Magnificent hardy; of easy cultivation; blooms freely during summer and fall; stands hot, dry summers better than almost any other flower. Flowers are large, very showy, on stalks 1½ to 2 feet high; very decorative for beds, invaluable for cutting. Pkt. 10c; oz. 35c.

IMPERIAL GIANTS BLUE MOON

This new type has flowers composed entirely of broad heavy, wavy petals, eliminating the pincushion center, which characterized the old type of Scabiosa, entirely thus the flower is literally fully double. The color is a rich deep lavender blue measuring 2¾ inches across and 2½ inches deep borne in long wiry stems which make them excellent for cutting. Received Honorable Mention, All American Selections 1939. Pkt. 25c; ¼ oz. \$1.00; oz. \$3.50.

STOCKS

MAMMOTH EARLY BRANCHING NICE—Plants grow about 1 foot high, making a compact bush covered with splendid spikes of most brilliant colors and varieties. Pkt. 10c; oz. \$1.50.

TEN WEEKS MIXED—Pkt. 10c; oz. \$1.25.

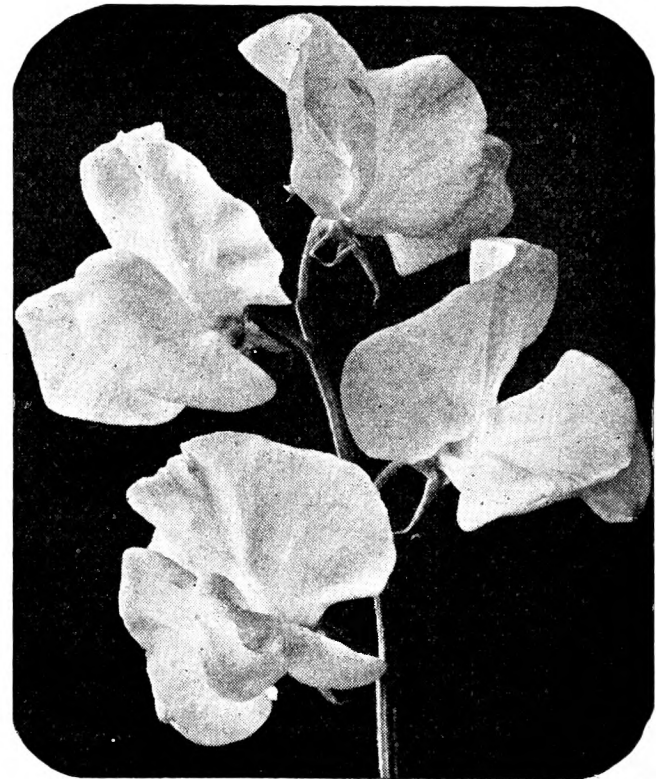

EARLY FLOWERING SPENCERS — This type of Sweet Pea deserves more attention from the home gardener. They come into bloom from four to six weeks earlier than the standard varieties and are well into flower before the dry summer weather begins. The flowers are equally as large as the standard Spencers with long stems and are beautifully ruffled.

BACCHUS — duplex violet-carmine.
BOON — deep salmon pink.
COLLEEN — rose suffused with gold.
EILEEN — rich begonia rose.
HERCULES — sparkling silvery pink.
HARMONY — clear lavender self.
HOPE — mammoth pure white.
GLITTERS — golden cerise.
MONTEREY — rich geranium pink.
SUSANNA — carmine red.
TOP HAT — deep velvety violet blue.
CHOICE MIXED

Prices on above; pkt. 10c; oz. 30c.

NOVELTIES FOR 1940
IRIS BLUE — broad wavy, deep iris blue.
TITIANA — mammoth deep rose self.
TREASURE ISLAND — very large golden orange.

Prices on above; pkt. 10c; oz. \$1.00.

SWEET WILLIAM

Beautiful flowering plant; produces a splendid effect in borders and beds with its rich and varied flowers.

DOUBLE MIXED—Perennial. Pkt. 5c; oz. 50c.
SINGLE MIXED— Pkt. 5c; oz. 30c.

TITHONIA

(Mexican Sunflower) — When seed is started indoors, this plant makes a brilliant showing about August 15 of the first year in the northern states. In mild climates it is perennial and can be planted outdoors spring or fall. The flowers of vivid orange-scarlet are 3 or 4 inches across. The leaves have an odd appearance as though they had been cut into irregular patterns with scissors. Pkt. 10c, oz. \$2.50, postpaid.

TRITOMA

RED HOT POKER — Very handsome and showy border plants. Flowers borne in compact form on stout 3 and 4 ft. stems having the appearance at a distance of orange and red colored spear heads. Require protection during winter, unless in a very sheltered position. Pkt. 10c; oz. \$1.25, postpaid.

VERBENAS

Very popular for massing in beds and flower boxes. Start blooming in early spring until late summer. Sow seed in January in boxes.

Gigantea Scarlet—Lucifer Pkt. 10c; oz. \$1.25
Gigantea Pink—Salmon pink Pkt. 10c; oz. 1.25
Gigantea White Pkt. 10c; oz. 1.25
Golden Queen—Mammoth
yellow Pkt. 10c; oz. 1.25
Purple Mantle—Mammoth
purple Pkt. 10c; oz. 1.25
Hybrida Mixed Pkt. 10c; oz. 1.00

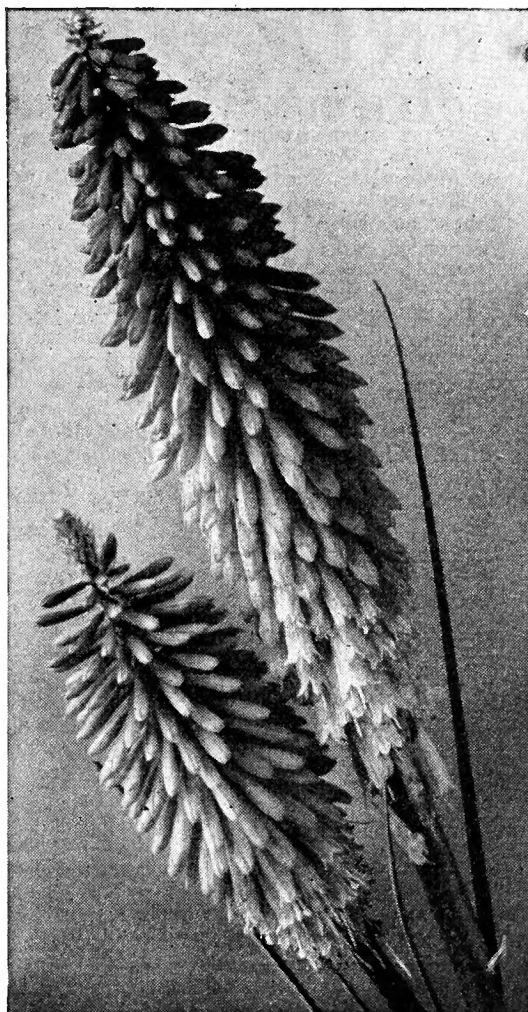

Tritoma

DON'T FAIL

TO INCLUDE AN ORDER FOR VITAMIN B-1 AND RAISE THE FINEST FLOWERS THAT YOU HAVE EVER PRODUCED. SEE PAGE 7 FOR COMPLETE INFORMATION.

VINCA (Periwinkle)

Highly ornamental, free-flowering, compact evergreen shrubs, with shining green foliage and handsome circular flowers. 18 inches high.

PURE WHITE—Beautiful pure white.

Pkt. 10c; oz. \$1.35, postpaid.

ROSEA—Rose, with crimson eye.

Pkt. 10c; oz. \$1.25, postpaid.

MIXED—Pkt. 10c; oz. \$1.25, postpaid.

VIOLET

THE CZAR — "Sweet Violet." A magnificent single, fine blue, long stems, very fragrant. Pkt. 10c; oz. \$1.50, postpaid.

FREE!

25¢ OF FLOWER SEEDS WITH EVERY ORDER OF FLOWER SEEDS AMOUNTING TO

\$1.00

in other words, order \$1.25 worth of Flower Seeds in Packets or Ounces and send us \$1.00 with your order.

This offer DOES NOT apply to Bulbs or Seeds by the pound.

ALL FLOWER SEEDS POSTPAID.

FLOWER SEED PLANTING CHART

(Symbols used: A—annual. B—biennial. P—perennial)

Name of Flower	Height of Plant	Good Cut Flowers	Best Use	Location Sun—Shady	When to Plant
Alyssum (A)	2-12 in.	Fair	Edging	Sunny	February to May
Antirrhinum (A)	1½-5 ft.	Yes	Bedding	Any	Jan. to May — Sept. to Nov.
Arctotis (A)	18-24 in.	Yes	Border	Sunny	Feb. to May
Asters (A)	12-30 in.	Yes	Bedding	Any	January to April
Balsam (A)	18-30 in.	Fair	Border	Sunny	February to April
Calendula (A)	12-36 in.	Yes	Bedding	Sunny	Jan. to April — Sept. to Nov.
Campanula (A)	18-42 in.	Fair	Border	Sunny	Feb. to May — Sept. to Oct.
Candytuft (A-P)	12-18 in.	Yes	Bedding	Sunny	Feb. to April — Sept. to Nov.
Carnation (A-P)	18-36 in.	Yes	Bedding	Sunny	Feb. to April — Sept. to Nov.
Celosia (A)	24-36 in.	Fair	Bedding	Sunny	February to May
Centaurea (A)	24-36 in.	Yes	Bedding	Sunny	Feb. to April — Sept. to Nov.
Coleus (A)	12-24 in.	No	Bedding	Sunny	Jan. to April
Coreopsis (P)	18-36 in.	Yes	Bedding	Sunny	Feb. to May — Sept. to Nov.
Cornflower (A)	1-3 ft.	Yes	Border	Sunny	Jan. to Feb. — Oct. to Nov.
Cosmos (A)	48-72 in.	Yes	Bedding	Sunny	March to May
Dahlia (P)	36-72 in.	Yes	Bedding	Sunny	February to April
Daisy (A-P)	10-30 in.	Yes	Edging	Any	Feb. to April — Sept. to Nov.
Delphinium (P)	36-60 in.	Yes	Border	Sunny	Jan. to March — Sept. to Oct.
Dianthus (A-B)	4-15 in.	Yes	Bedding	Sunny	Jan. to March — Sept. to Nov.
Eschscholtzia (A)	10-12 in.	Yes	Bedding	Sunny	February to May
Feverfew (P)	18-24 in.	Yes	Bedding	Sunny	February to May
Four O'Clock (A)	24-30 in.	No	Border	Sunny	March to May
Gaillardia (P)	18-30 in.	Yes	Bedding	Sunny	Feb. to May
Gerbera (P)	18-24 in.	Yes	Bedding	Sunny	Feb. to April
Geum (P)	18-24 in.	Yes	Bedding	Sunny	Feb. to April
Globe Amaranth (A)	12-18 in.	Yes	Bedding	Sunny	March to May
Godetia (A)	12-18 in.	yes	Border	Any	Feb. to May
Gypsophila (A-P)	18-24 in.	Yes	Border	Sunny	March to May
Heliotrope (P)	18-24 in.	Fair	Bedding	Shady	Feb. to May
Hollyhock (P)	5-8 ft.	Yes	Border	Moist	Jan. to March — Sept. to Oct.
Linarias (A)	12-18 in.	Yes	Rockery	Sunny	Mar. to May
Lantana (P)	24-36 in.	Yes	Bedding	Sunny	February to April
Larkspur (A)	36-48 in.	Yes	Bedding	Sunny	Jan. to April — Sept. to Nov.
Kochia (A)	36 in.	No	Border	Sunny	Mar. to May
Marigold (A)	8-30 in.	Yes	Bedding	Sunny	March to May
Mignonette (A)	10-12 in.	Yes	Edging	Sunny	March to May
Morning Glory (A)	20-50 ft.	No	For shade	Sunny	March to May
Pansy (P)	4-6 in.	Yes	Edging	Any	Jan. to Feb. — Oct. to Nov.
Petunia (A)	18-24 in.	Fair	Bedding	Any	January to May
Phlox (A)	12-18 in.	Yes	Bedding	Sunny	January to May
Poppy (A)	24-60 in.	Yes	Bedding	Sunny	Jan. to March — Sept. to Nov.
Portulaca (A)	4-6 in.	No	Edging	Sunny	March to May
Ricinus (A)	5-10 ft.	No	Massing	Sunny	March to May
Salvia (A)	24-42 in.	Yes	Bedding	Sunny	February to April
Salpiglossis (A)	18-30 in.	Yes	Border	Any	Feb. to May
Scabiosa (A-P)	24-30 in.	Yes	Bedding	Sunny	March to May
Statice (A)	12-18 in.	Yes	Bedding	Sunny	Mar. to May
Stocks (P)	24-30 in.	Yes	Bedding	Sunny	Feb. to April — Sept. to Nov.
Sunflower (P)	48-72 in.	Yes	Border	Sunny	March to May
Sweet Pea (A-P)	4-8 ft.	Yes	Cutting	Sunny	Jan. to March — Oct. to Dec.
Sweet William (P)	12-24 in.	Yes	Bedding	Sunny	Jan. to April — Oct. to Nov.
Verbena (A)	6-10 in.	Yes	Edging	Sunny	January to April
Vinca (P)	15-18 in.	Fair	Bedding	Sunny	March to May
Zinnia (A)	24-36 in.	Yes	Bedding	Sunny	March to August

SATEX CALIFORNIA GROWN ZINNIAS

GOLD MEDAL DAHLIA-FLOWERED ZINNIAS

The Dahlia-Flowered Zinnia is the latest thing in the Zinnia line and is undoubtedly the most handsome one that has been propagated so far by any grower. They are exceptionally large and the many shades and colors in which they come make them simply indescribable.

EXQUISITE—A light rose, deep rose center.

GOLDEN STATE—Yellow-orange in the bud, turning to orange.

DREAM—Deep rosy lavender.

POLAR BEAR—Large creamy white.

CRIMSON MONARCH—Deep crimson.

SPECIAL MIXTURE—Contains all of the above Dahlia-Flowered Zinnias and others we do not list.

Price on all of the above Dahlia-Flowered Zinnias: Pkt. 10c; oz. 90c.

CALIFORNIA GIANT ZINNIAS

or Mammoth Special Florist's Strains

The great advantage of this type is that the very large flowers are of enormous size and flat, getting away from the conical type of the Giants and eliminating the stiffness that has been so objectionable in Zinnias in the past. The flowers from the time they open are attractive, making them a good cut flower from the early bud until they are in full bloom. They are twice the size of the ordinary Giants.

BRIGHTNESS—Light rose, deep rose center.

VIOLET QUEEN—Deep lavender.

ORANGE KING—Cadmium or orange scarlet.

GRENADIER—Bright dark red.

SCARLET QUEEN—Glowing deep scarlet.

DAFODIL, IMPROVED—Canary yellow.

PURITY—Best white.

SPECIAL FLORISTS' MIXTURE—Pkt. 10c; ¼ oz. 25; oz. 90c.

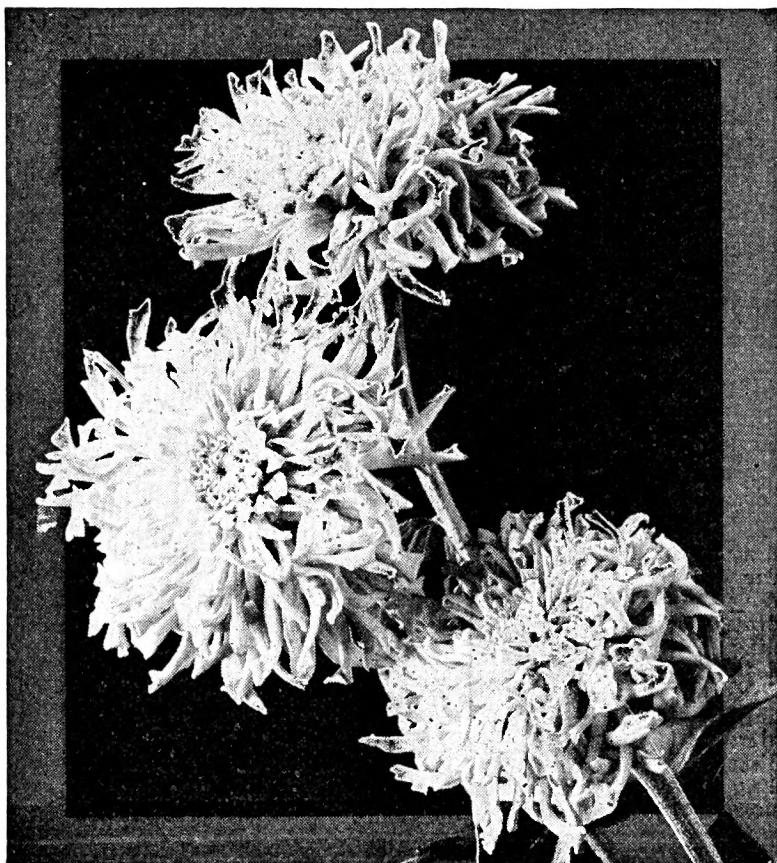
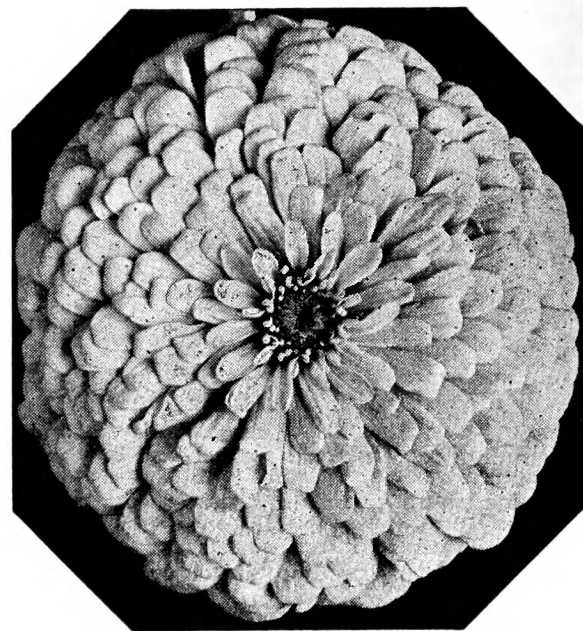

Zinnia - Fantasy

FANTASY ZINNIAS

Chrysanthemum Flowered ZINNIA FANTASY

or CHRYSANTHEMUM FLOWERED.

—Fantasy is the most fascinating new Zinnia type introduced to the flower world in many years. The very informal, shaggy-appearing flowers are graceful and interesting, quite distinct from the still, formal Zinnias to which we are accustomed. The rounded medium sized flowers are composed of a mass of shaggy ray-like petals which give a delicate and refined appearance.

STAR DUST—Rich deep golden yellow.

ROSALIE—Bright intense rose.

ORANGE LADY—Deep bright orange.

WHITE LIGHT—Pure white.

FINEST MIXED—A real bright colorful mixture Pkt. 10c; ¼ oz. 50c; oz. \$1.75.

LILLIPUT OR POMPON

The plants form handsome little bushes and fairly bristle with tiny, short-stemmed, very double flowers hardly exceeding a daisy flower in size. They are very pretty plants; bloom all Summer until late in the Fall.

PURPLE GEM—Lavender.

CANARY YELLOW

CRIMSON GEM

ROSEBUD—Rose pink

VALENCIA—Burnt orange

WHITE GEM

TOM THUMB MIXTURE

Pkt. 10c; ¼ oz. 25c; oz. 75c.

GAILLARDIA FLOWERED

NAVAJO—Dainty double flowers resemble the Picta Double Gaillardias in both form and coloring. Finest mixed. Pkt. 10c; ¼ oz. 35c; oz. \$1.00.

SUPER CROWN OF BOLD

Pastel Tints—NEW

A vastly improved strain of the Crown of Gold type, with large well formed flowers in soft pastel shades; each petal overlaid at the base with deep golden yellow. Pkt. 25c; ¼ oz. 60c; oz. \$2.00.

SCABIOUS FLOWERED

Zinnias resembling the annual Scabiosa and harmony marigold. Sunburst, bright canary yellow. Pkt. 10c.

Finest Mixed. Pkt. 10c.

CLIMBING VINES

We have listed below the best climbers for porches and trellises for our section.

CYPRESS VINE

A most beautiful rapid climber with delicate, dark green leaves and many bright star-shaped flowers.

MIXED COLORS—Pkt. 10c.

GOURDS

So many people desire Gourds where vines are desired quickly and we have made a mixture containing all sorts and types.

Ornamental Mixed: Pkt. 10c.

MEXICAN CORAL VINE

(ANTIGONON)

This popular vine is sometimes called Queen's Crown and has its origin in Mexico and does exceptionally well in our section. Pkt. 15c.

MEXICAN CORAL VINE—Large Roots, each 35c; 3 for \$1.00.

MINA LOBATA

Sometimes called the "Flag of Spain." A beautiful climber producing flowers of a brilliant red changing to a pale yellow. Pkt. 15c.

MOON FLOWER

WHITE MOONFLOWER (Ipomoea). This is a greatly improved variety of the popular Moonflower vine, producing much larger flowers in a greater profusion, with immense saucer-shaped flowers. Pkt. 10c.

MORNING GLORY

As Morning Glory seed are very hard, we advise soaking them in lukewarm water for several hours before sowing.

Scarlett O'Hara—NEW

An entirely new color in this popular garden flower, rich dark wine-red or rosy crimson. While the flowers are not quite as large as the Heavenly Blue Morning Glory, they are of good size, about four inches in diameter, freely produced on fast growing vines which start blooming within 65 days after seed is sown. The combination of Scarlett O'Hara and Heavenly Blue is very pleasing when planted together. Received the Gold Medal. All American Selections 1939. Pkt. 25c; ¼ oz. 60c; oz. \$2.00.

CLARK'S EARLY HEAVENLY BLUE—The blooms are a beautiful shade of blue. Its extra early flowering habit makes it particularly valuable in sections where other vines are too late. Our customers will be favorably impressed with it, for it is truly lovely. Pkt. 10c; oz. 90c.

IMPERIAL JAPANESE—Flowers are the largest of any Morning Glory and of the finest coloring. They have various shades, solid colors and variegated mixed colors. Pkt. 10c; oz. 35c.

NEW CORNELL

This new Morning Glory has been named Cornell, because it reproduces the colors of Cornell University. Giant carnelian red flowers with a pure white border measuring as much as 3½ inches across, approximately the same size as Heavenly Blue. Pkt. 10c; ¼ oz. 25c; oz. \$1.25

HYACINTH BEANS

(JACK BEANS)

Rapid climber; blooms and pods very ornamental. Colors: White, purple, or mixed. Pkt. 5c; oz. 15c.

ALAMO

(Or Mile a Minute Vine)

As the name will imply this little morning glory is a very fast growing and attractive vine which thrives with outstanding success in the hot dry southern parts of this country. The foliage is fine and multi-cut. Stems are rather wiry and the runners obtain a growth of as much as 20 feet or more in a season. Flowers creamy white, wine red at center. Pkt. 10c; oz. 30c, post-paid.

SATEX PRIZE WINNING DAHLIAS AND GLADIOLIS

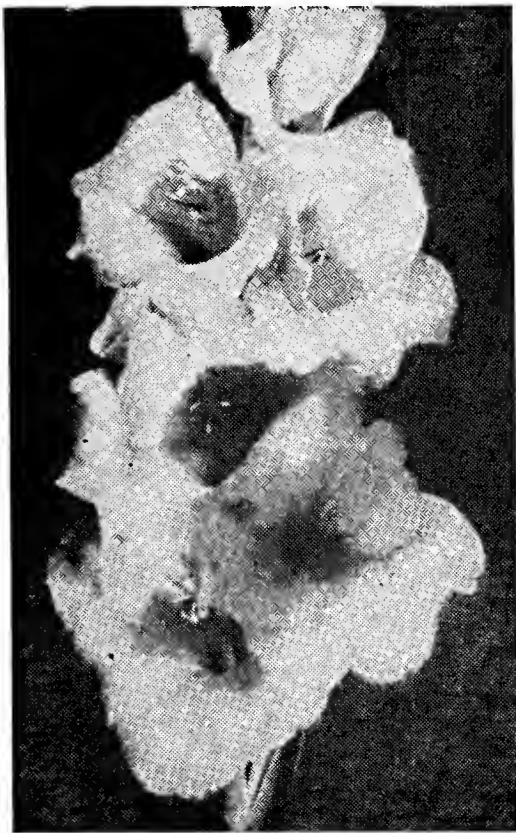

GLADIOLI BULBS

CULTURE—Spade soil not less than 8 to 10 inches deep. Make your rows 18 to 20 inches apart and set bulbs 4 inches in the ground and 8 inches apart. Cover bulbs with 1 inch of soil, then sprinkle lightly with fertilizer or bone meal, then fill in rest of trench with soil and firm down to eliminate air pockets around bulbs. Thoroughly soak plants when water is necessary. Do not sprinkle as it has a tendency to draw roots up to moisture. Keep cultivating. The more you do the better your plants and flowers.

DR. F. E. BENNET—One of the best scarlets, scarlet throat stippled with ruby and white. Tall and straight, many flowers open at once. Vigorous grower. Doz. 50c, postpaid.

YELLOW PERFECTION—Clear deep yellow. Doz. 60c, postpaid.

W. H. PHIPPS—Enormous flowers of La France pink, overlaid with salmon rose, lighter towards the center. Doz. 50c, postpaid.

PICARDY—The color is soft pink shading to deeper pink on the lower petals. Distinct markings in throat. Extremely long stems with many enormous size flowers open at the same time. Doz. 50c, postpaid.

COMMANDER KOEHL—A vividly scarlet flower with large throat, opening in a plume of color resembling its famous pink namesake, W. H. Phipps. Doz. 75c, postpaid.

ALBATROS—A pure white. Doz. 50c, postpaid.

MINUET—Lovejoy light lavender, blotched deeper lavender. Doz. 50c, postpaid.

AVE MARIA—An extremely good purple. Strong grower. Flowers well spaced. Doz. 60c, postpaid.

LA PALOMA—A large pure orange of the grandiflora type. Doz. 50c, postpaid.

BAGDAD—Very large smoky old rose. Doz. 50c, postpaid.

CHAS. DICKENS — Deep purple violet. Exhibition type. Doz. 60c, postpaid.

CHOICE MIXED—Made up from 300 standard varieties. All number one bulbs. No Culls. Doz. 40c, postpaid.

DAHLIA BULBS

CULTURE—Dahlias do well in any well drained fertile garden soil in an open sunny location, and are as easy to grow as potatoes.

Before planting spade the ground well to loosen the soil thoroughly to a depth of six to eight inches.

When soil is warm and danger of frost is past, dig holes five or six inches deep, two to three feet apart, in rows three to four feet apart.

Lay tuber on its side—never on end—with eye upward, and cover with good dirt in which is mixed a little wood ashes if possible. Mark place of hill with a small stick. Sprout should show within three weeks.

After plant is up, remove all but one sprout. When this has grown to be twelve to fifteen inches high, pinch out the top to encourage lower branching and make it unnecessary to stake plant to keep from breaking over by wind.

When buds show, remove all but one bud on a stem, removing shoots and leaves at base of bud to give a better stem. Allow five or six blooming stems to a plant, but keep all dead flowers trimmed off.

MRS. I. D. VER WARNER (D)—Mauve pink, large extra fine flowers on stiff stems. Free and continuous bloomer. Each 20c, postpaid.

JANE COWL (D)—Large glistening bronzy buff flowers with shades of salmon and old gold, held on long rigid stems. Each 20c, postpaid.

THOMAS EDISON (D)—Royal purple, large flowers. Strong vigorous grower. Each 30c, postpaid.

JERSEY BEAUTY (D)—Medium size, pure clear pink, long, stiff stems. Very free flowering. Each 20c, postpaid.

JEAN KERR (D)—Fine White Dahlia of medium size, very prolific with great keeping qualities. Each 20c, postpaid.

FRANCIS LARROCO (D) — Finest yellow. Vigorous grower, very strong stems. Each 20c, postpaid.

JERSEY BEACON (D)—Very vigorous, and a free and early bloomer. Brilliant scarlet with buff reflex, giving a beautiful two-tone effect. A very large deep shaggy dahlia with good stems. Each 25c, postpaid.

KENTUCKY (D) — Sport of Jersey's Beauty and of the same splendid habits—light salmon-orange shading to grenadin-orange. Great favorite. Each 25c, postpaid.

JERSEY MAMMOTH (D)—Giant mahogany and gold. Long stiff stems. Each 25c, postpaid.

BASHFUL GIANT (or Apricot Giant) (D) —A delicate apricot shading towards the edges of the petals to buff. Early. Each 25c, postpaid.



VERT

THE COMPLETE PLANT FOOD

Effective because it contains all of the elements of plant food required to produce early, vigorous growth and bring fruit, flowers and foliage to full development. Complete directions in every bag.

100-lb. bag	-----	\$3.50
50-lb. bag	-----	2.00
25-lb. bag	-----	1.25

RAFFIA

For bunching vegetables and tying flowers and vegetables to supports. We handle only the best grade. Lb. 45c; 5 lbs. \$1.75, postpaid. Not prepaid: 10 lbs. \$3.00; 25 lbs. \$6.50.

NO. 2 PLANET JR.

EDGER

Packed weight 3¾ Lbs.
Net 3¼ Lbs.

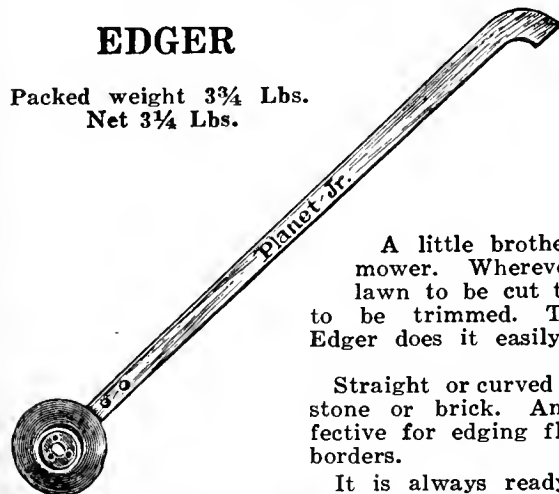

A little brother to the lawn mower. Wherever there is a lawn to be cut there are edges to be trimmed. The Planet Jr. Edger does it easily and quickly.

Straight or curved walks—cement, stone or brick. And just as effective for edging flower beds and borders.

It is always ready, for there is nothing to adjust or get out of order. And the cutting disc is well sharpened and tempered.
Each ----- \$1.65

TUBEROSES

MEXICAN EVERBLOOMING—The most beautiful Tuberose that was ever brought to our attention; it begins to produce its fragrant flowers in June and blooms continually until frost. Plant in good soil, and water occasionally during extreme warm weather, and an abundance of lovely flowers will be the reward. In the southern part of the State the bulbs may be left in the ground all winter. Doz. 30c; 100, \$1.75, postpaid.

KEME-KEL

Grow in Water Solution with **KEME-KEL**. — No soil Needed.

KEME-KEL contains eleven major and minor elements to make 7½ to 15 gallons of nutrient solutions to grow vegetables and flowers in water solutions. Try this new way of growing vegetables or flowers. Complete directions in each package. \$1.00 postpaid.



VITAMIN B-1 PURE CRYSTALLINE POWDER PRODUCES AMAZING REINVIGORATED ROOT GROWTH!

... Cattleya blooms twice normal size ... 5-inch tea rose buds ... Cottage tulips with 30-inch stems Hyacinths with flower heads over 12 inches long ... Snapdragons. 6½ feet tall ... Birds of Paradise with 16 hug flowers ... Daffodils bigger than a salad plate or a 42-inch stalk thicker than a man's thumb ... Roses transplanted while flowering ... Annuals, perennials and shrubs transplanted without soil on roots ... Root-rot stopped in valuable trees ...

100 mgm; 1/10 gram **1.00**

Makes 2000 gallons of solution; enough for a season in the average garden.



SATEX FRESH VEGETABLE SEEDS FOR 1940 SEASON

ASPARAGUS (Esparragos)

CULTURE—Sow seed thinly in drills 1 foot apart early in the spring or fall, after soaking seed in warm water for 1 hour. Use a rich well-worked light soil and when well up, thin plants to 1 inch apart and cultivate often until the plants are a year old.

Transplant or set out the roots in permanent bed, using the richest soil you have thoroughly prepared and worked very deep. Set roots 4 inches deep and 18 inches apart in rows 4 to 6 feet apart. Cultivate frequently until plants meet in the rows. Use plenty of stable manure or other fertilizer on bed before and after setting out roots, mixing well into soil.



Martha Washington

MARTHA WASHINGTON — Light green, heavy yielding early producing large, clear stalks of excellent quality. Very early.
Pkt. 5c; oz. 10c; ¼ lb. 30c; 1 lb. 75c.

BEANS (Green Bush Beans)

1 lb. to 100-ft. row

CULTURE—Plant beans after all danger of frost is past, in warm, dry, well-prepared soil. The rows should be 2 to 3 feet apart, and the seeds covered 1 to 1½ inches. Shallow cultivation should be frequent until blooming then stop, to avoid injury to the root. For succession, plant every two weeks until summer. Frequent picking of the crop insures long bearing.

BURPEE'S STRINGLESS GREEN POD — 52 days — The pods are medium green, 5 to 6 inches long, cylindrical, larger than those of the Red Valentine but not quite as fleshy, of equally high quality and remain crisp and tender longer. Absolutely stringless.
Pkt. 10c; lb. 30c, postpaid. 10 lbs. \$1.50, not postpaid.

GIANT STRINGLESS GREEN POD — 54 days — Another exceptionally fine bean for home or market, perfectly stringless, pods longer than Burpee's Stringless, strong, vigorous grower, and a continuous bearer of delicious beans for weeks.

Pkt. 10c; lb. 30c, postpaid. 10 lbs. \$1.50, not postpaid.

TENDERGREEN or NEW STRINGLESS GREEN POD — 52 days — Highly desirable for truckers and canners. Plant medium large, erect somewhat thick-stemmed, heavily productive. Pods nearly straight, dark green, round, meaty, succulent, absolutely stringless, of outstanding quality.

Pkt. 10c; lb. 35c, postpaid. 10 lbs. \$1.75, not postpaid.

RUBBER BANDS

Used very extensively to bunch green vegetables, etc. Easy to use. Make a good tight bunch and economical to use.
No. 3—About 1200 to the pound—lb. 40c not postpaid.
No. 5—About 700 to the pound—lb. 35c not postpaid.

Live at home this year and laugh at Old Man Depression. Any home that has a plot of ground 50x50 feet can produce enough by canning and storing, to supply a family of 4 or 5 with enough delicious vegetables to last throughout the entire year. SATEX high-tested garden seed offer you the best that years of experience can produce.

BUSH WAX BEANS (Yellow Pod Beans)

IMPROVED GOLDEN WAX — 49 days — One of the best beans in cultivation. Pods are long, nearly straight, broad and flat, and golden yellow; seed white, more or less covered with two shades of purplish red.
Pkt. 10c; lb. 30c, postpaid; 10 lbs. \$2.00, not postpaid.

PROLIFIC BLACK WAX — 51 days — Early; pods are round, about 5 inches long, fleshy, brittle and stringless, deep yellow in color and attractive. Standard sort.
Pkt. 10c; lb. 30c, postpaid; 10 lbs. \$2.00, not postpaid.

PENCIL POD WAX — 52 days — Early and very productive; pods large, 5 to 6 inches long, round, straight and creaseback, strictly stringless, free from fibre, fleshy and brittle; of highest quality; color very clear yellow.
Pkt. 10c; lb. 30c, postpaid; 10 lbs. \$2.00, not postpaid.

BUSH LIMA BEANS

HENDERSON'S DWARF LIMA — 66 days — The earliest variety of dwarf Lima Beans, fully 2 weeks earlier than any other variety. Plants about 16 inches high and very prolific. Beans are small. Recommended to anyone desiring early Lima Beans.
Pkt. 10c; lb. 30c, postpaid; 10 lbs. \$1.50, not postpaid.

SPECKLED BUSH LIMA — 65 days — This variety is generally known as "calico or speckled" butter bean. The beans are of fine quality, either green-shelled or dry. It is very prolific and does well in the driest weather. The seed is sort of a brownish color.
Pkt. 10c; lb. 35c, postpaid.

POLE LIMA BEANS

CAROLINA or SIEVA — 77 days — Beans are small and white on the order of Henderson Bush Lima. Plant of large growth, very early, vigorous and productive.
Pkt. 10c; lb. 35c, postpaid.

POLE SPECKLED LIMA — 78 days — This fine Butter Bean is better adapted for the wants of the Southern farmer than any other variety. It is a certain and abundant cropper. The vines are strong growers and cling well to the poles or trellis. Bear early and late. Both pods and beans are larger than the old white Carolina or Sieva Butter Beans; the beans are speckled in color, white splotched with red but are of the very highest quality, both in the green and dry state.
Pkt. 10c; lb. 35c, postpaid.

FIELD BEANS

PINTO BEANS — Grown mostly for a dry bean but makes a good snap bean when the pod is young and green. Pods are flat and tender.
Lb. 25c, postpaid.

PINK BEANS — These beans are grown as a dry bean and find a ready market.
Lb. 25c, postpaid.

POLE BEANS

½ lb. to 100-ft. row

IDEAL MARKET or BLACK-SEEDED POLE BEAN — 58 days — This bean is acknowledged to be the best pole bean in existence. It yields better than all other varieties and is very thrifty and extremely prolific. The pods are thick, stringless, meaty, tender and delicious.
Pkt. 10c; lb. 30c, postpaid.

STRIPED CREASEBACK — 72 days — A hardy and very productive green podded cornfield bean. The vines are sturdy and of good climbing habit, with small-medium, deep green leaves. The pods are long, about 6 inches, very cylindrical or completely rounded.
Large pkt. 10c; 1 lb. 30c, postpaid.

KENTUCKY WONDER — 65 days — An excellent green-podded variety; enormously productive, the long pods hanging in great clusters among the entire vine. They cook very tender and melting. Seed dark brown.
Pkt. 10c; lb. 30c, postpaid.

KENTUCKY WONDER (WAX) — 68 days — One of the earliest of the pole wax sorts. Pods 8 to 9 inches long, thick, decidedly creaseback; very fleshy, brittle, but stringy. Attractive and fair quality. Color light yellow.
Pkt. 10c; lb. 35c, postpaid.

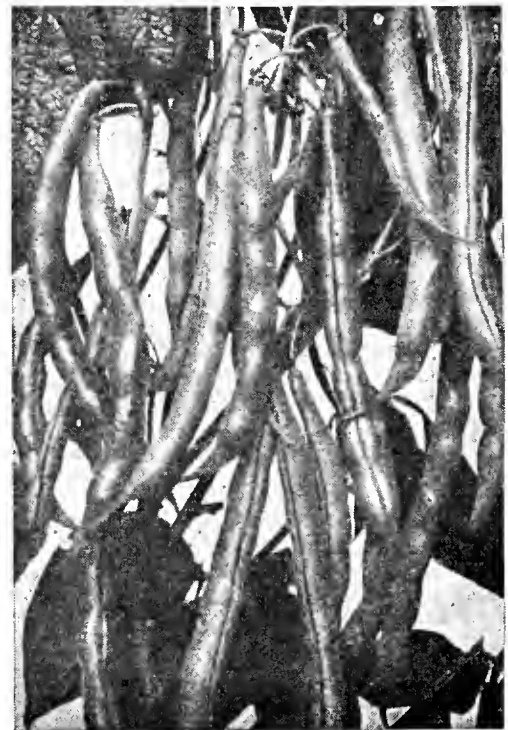

Stringless Green Pod

Inoculate Beans

With Nitragin D. Page 20.

DON'T BUY COMPLEXION, EAT IT, CHEMISTS SAY

The home garden is no friend of the beauty specialist where complexion is concerned, scientists tell us, because the properly balanced diet containing vitamin and mineral fresh vegetables will give nature its chance to do what was intended, bring health to the body, and with it, a good complexion.

Vegetables are not the only foods to produce such results, of course, but they are the "deficiency" types which supply the hidden food element slacking in so many other modern table deficiencies. The fact that they are grown at home and can be used fresh from the garden without the loss brought about by being kept out of the ground, makes them doubly valuable for the health and complexion-seeker.

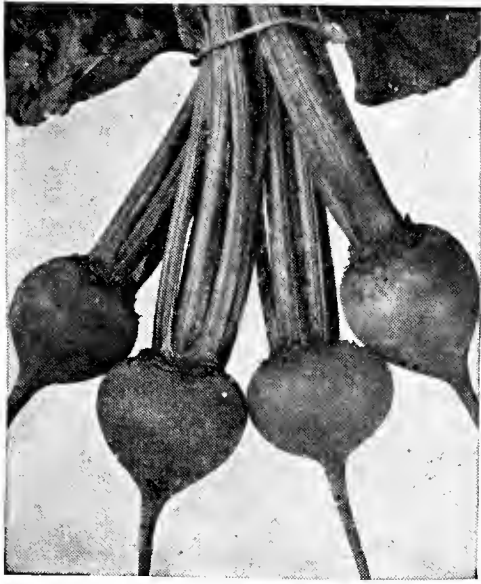

Detroit Dark Red

GARDEN BEETS

CULTURE — Plant Beets in rows 18 to 24 inches apart in well prepared soil. Cover seed about 1 inch and thin to a 4-inch stand when plants are up. Plant 1 ounce to 50-foot row; 5 pounds to acre.

CROSBY'S EGYPTIAN — 60 days — We have an unequalled strain of this superb, extra early sort. A flattened globe shape; skin very dark red, flesh a trifle lighter in color and slightly zoned. Tops small.
Pkt. 5c; oz. 10c; ¼ lb. 30c; lb. 80c, postpaid.

EXTRA EARLY LIGHT ECLIPSE — 65 days — A fine early table beet, top-shaped or tapering, globe shape. Flesh deep crimson, zoned with pink. Crisp and sweet.
Pkt. 5c; oz. 10c; ¼ lb. 30c; lb. 80c, postpaid.

DETROIT DARK RED TURNIP — 68 days — Roots are roundish, smooth; dark red; flesh is bright red zoned with lighter; crisp, tender, sweet; good keeper.
Pkt. 5c; oz. 10c; ¼ lb. 30c; lb. 80c, postpaid.

EARLY BLOOD TURNIP — 65 days — A standard, medium early variety of excellent quality; is also good for summer and fall use. The flesh is deep red zoned with a lighter shade; sweet, crisp and tender; nearly round.
Pkt. 5c; oz. 10c; ¼ lb. 30c; lb. 80c, postpaid.

FERRY'S CROSBY — 50 days — The flesh is bright vermillion red with fainter zoning. Tops are small, but fairly coarse. Root flattened, globe shape with small tap root.
Pkt. 5c; oz. 10c; ¼ lb. 35c; lb. 90c, postpaid.

SWISS CHARD

CULTURE — Assures an abundance and never-failing supply of fine "greens" all through the summer and fall months. Gives maximum returns for little care and space. Gather when half grown for best flavor. Cut close without injuring heart of plant, and another crop will spring up. Grows in any ordinary garden soil. In rich soil, however, and with good culture, it makes an amazingly luxuriant growth and furnishes an abundance of greens. Sow in rows 12 inches apart, and thin to 5 inches apart in the row. One ounce will sow 100 feet of row; 4 to 5 pounds per acre.

FORDHOOK GIANT — 50 days — No other garden vegetable will produce more nutritious food from a small space than Swiss Chard. Of rapid growth. Foliage and leaf stalks used same as Asparagus or Spinach.
Pkt. 5c; oz. 10c; ¼ lb. 35c; lb. 90c, postpaid.

LARGE-RIBBED WHITE — 50 days — Large, smooth leaves of thick texture grown mostly for the heavy main ribs which are prepared like Asparagus. The green succulent foliage is used like Spinach. An old standard variety which still is grown also quite extensively for its pearly white stalks.
Pkt. 5c; oz. 10c; ¼ lb. 35c; lb. 90c, postpaid.

MANGELS or STOCK BEETS

**ATTENTION!
FARMERS AND STOCK RAISERS**

Too much cannot be said about this wonderful feed and every dairy and every farm and every stock raiser should have at least an acre or two of Stock Beets — the returns will be surprising. Sow in the fall and spring, give the ground thorough cultivation. After first cultivation, thin out, so as to stand 6 inches apart in the row, then cultivate same as you would corn. Sow 5 pounds to the acre, in rows 2½ feet apart.

MAMMOTH LONG RED. No other variety of Mangels can compare with this in yield. It grows well above the ground, is easily harvested; the deep red roots are strong, well formed and solid. Especially well adapted for deep soil. On good soil they will sometimes grow 18 inches long, leaves are dark, the flesh white, being veined with rings of rose-pink. An excellent keeper and a wonderful milk producer when fed to dairy cows. Oz., 10c; ¼ lb., 25c; lb., 50c; 5 lbs., \$2.00, postpaid. Not prepaid, 10 lbs., \$3.50.

GIANT HALF SUGAR. This is considered by many the greatest beet for feeding stock; it is richer in sugar than the Mangels and not so rich as the Sugar Beet. It grows about one-half out of the ground and is an excellent feed. Oz., 10c; ¼ lb., 25c; lb., 50c; 5 lbs., \$2.00, postpaid. Not postpaid, 10 lbs., \$3.50.

BROCCOLI

CULTURE — Sow in seed-bed during July, August and September. Transplant in very rich soil in rows 2½ feet apart, 1½ feet between plants. Matures best during cool weather. We recommend 600 pounds 4-12-4 Fertilizer mixture applied when land is prepared. An extra top-dressing of nitrate of soda will stimulate growth. One ounce will produce 1,500 plants; 4 to 6 ounces, an acre.



Broccoli

CALABREZE GREEN SPROUTING — 65 days — This is a distinct variety grown by Italian market-gardeners for Italian trade only. The plant forms a large solid head which remains green. After this head is cut off, a number of smooth sprouts develop from the leaf-axes, each sprout terminating in a small head about 1 inch in diameter. Bunched and sold as a second crop. Sow seed in frames early in spring; market in June and July.
Pkt. 5c; oz. 25c; ¼ lb. 75c; lb. \$2.25, postpaid.

CABBAGE

CULTURE — For plants in hot-beds, sow seed early in January, then transplant in open in February and March. Later sow early varieties out-of-doors in March and April. For winter cabbage, sow seed in July, August and September, then transplant in October. One ounce of seed will produce about 3,000 plants; 10 ounces of seed will produce enough plants to set out an acre in rows 30 inches apart.

VOLGA or RUSSIAN — 85 days — A new medium sized sort with round, solid heads, which are deep through. It is extremely hardy.
Pkt. 5c; oz. 20c; ¼ lb. 65c; lb. \$2.00, postpaid.

RED ROCK — 110 days — The largest and surest heading cabbage, round, solid and dark red; medium to long stem.
Pkt. 5c; oz. 25c; ¼ lb. 75c; lb. \$2.00, postpaid.

EARLY JERSEY WAKEFIELD — 65 days — The most widely known and popular extra early variety. Heads solid; leaves numerous, deep green and coarsely crimped.
Pkt. 5c; oz. 20c; ¼ lb. 50c; lb. \$1.50, postpaid.

ALL-HEAD EARLY — 77 days — Deep flat heads slightly rounded at top, 8 to 9 inches broad, 6½ to 7 inches deep usually weigh about 6 pounds. Uniform in size and color. The solid heads are of the finest quality. A heavy yielder.
Pkt. 5c; oz. 15c; ¼ lb. 50c; lb. \$1.50 postpaid.



All Head Early

DRUMHEAD SAVOY — 90 days — Heads round, compact, solid; leaves numerous, deep green and coarsely crimped.
Pkt. 5c; oz. 20c; ¼ lb. 60c; lb. \$1.75, postpaid.

EARLY DRUMHEAD — 90 days — We recommend this sort for markets that require a very large and deep head. Plant large with few outside leaves, stem of medium length; a sure heading variety of excellent quality.
Pkt. 5c; oz. 15c; ¼ lb. 50c; lb. \$1.50, postpaid.

CHARLESTON WAKEFIELD — 75 days — About one week later than Early Jersey Wakefield, but the conical heads are fully one-half larger.
Pkt. 5c; oz. 20c; ¼ lb. 50c; lb. \$1.50, postpaid.

STEIN'S EARLY FLAT DUTCH — 90 days — An early and excellent type of Early Flat Dutch, with a medium stem. Heads round, flat and solid.
Pkt. 5c; oz. 15c; ¼ lb. 50c; lb. \$1.50, postpaid.

COPENHAGEN MARKET — 75 days — Very fine, stem short, heads large, round and solid, with few outer leaves of an upright growth. Nearly as early as Jersey Wakefield.
Pkt. 5c; oz. 15c; ¼ lb. 50c; lb. \$1.50, postpaid.

GLORY OF ENKHUIZEN — 85 days — A dependable variety heading right after Copenhagen Market.
Pkt. 5c; oz. 15c; ¼ lb. 50c; lb. \$1.50, postpaid.

CABBAGE (Continued)

CHINESE CABBAGE (Wong-Bok) — This wonderful variety produces a beautiful, crisp, celery-like head that bleaches easily. As a salad it rivals the finest lettuce grown; when cooked like spinach or cabbage makes excellent "greens." Sow seed in any good soil, making the rows 24 to 38 inches apart and thinning to 12 inches apart in the rows. It will not stand frost, so sow early in the fall and again in the spring. Be sure and try some of this wonderful variety, as it is easy to grow. Pkt. 10c; oz. 30c; ¼ lb. \$1.00; lb. \$3.00, postpaid.

CAULIFLOWER

CULTURE — Cauliflower can be planted in the open in the fall months or in hotbeds in the early spring months; transplant when 4 or 5 inches high and water frequently, especially in dry weather. ¼ oz. to 100 feet of row; 4 oz. to the acre.

WHITE WONDER — 55 days — We believe this to be the best variety in existence, about 7 days earlier than Early Snowball. It is early, of dwarf, compact growth and sure to produce fine heads. Very much depends on the quality of Cauliflower seed. We handle only the best Danish-grown seed from a well known, reputable grower, which we confidently recommend.

Pkt. 20c; oz. \$2.00; ¼ lb. \$6.00; lbs. \$20.00, postpaid.

EARLY SNOWBALL — 65 days — Popular extra early strain, of dwarf, compact growth. Every plant will make a fine solid head of good size, under favorable circumstances.

Pkt. 10c; ¼ oz. 50c; oz. \$2.00; ¼ lb. \$5.00; lb. \$15.00, postpaid.

CARROTS

CULTURE — Plant the seed ½ inch deep in loose, deep, well prepared soil, making rows 16 to 24 inches apart. Cultivate as soon as plants are established and thin to 2 to 4 inches in the rows, according to the size of the variety. One ounce will sow 100 feet of row; 3 to 4 pounds, an acre.

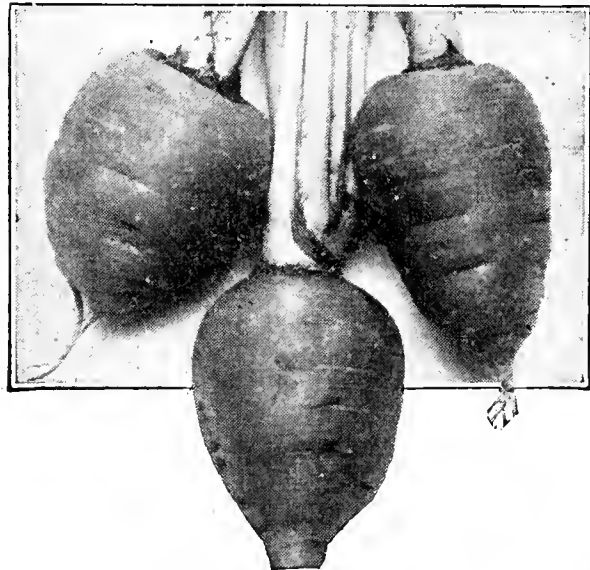

Oxheart

ORANGE DANVERS HALF LONG — 75 days — Broad shouldered, cylindrical, admirable in color. Always a favorite because reliable and attractive in form, color and weight. Most popular sort.

Pkt. 5c; oz. 10c; ¼ lb. 35c; lb. \$1.00, postpaid.

OXHEART or GUERANDE — 72 days — One of the most popular and best croppers among the short carrots. The shape is particularly desirable for heavy soil. The true type is about 4½ inches long and 3½ inches thick at the shoulder. It tapers slightly to the bottom and is very stump-rooted.

Pkt. 5c; oz. 10c; ¼ lb. 35c; lb. \$1.00, postpaid.

IMPERATOR—77 days. An outstanding strain bred for market-garden use and for shipping. It fills the demand for a longer type to compete on markets with California Carrots elongated under irrigation. The roots are 7 to 8½ inches long, graceful, smooth, and uniformly tapered to a semi-blunt end. Flesh is rich orange-red, extending to core. Pkt. 5c; oz. 15c; ¼ lb. 45c; lb. \$1.25 postpaid.

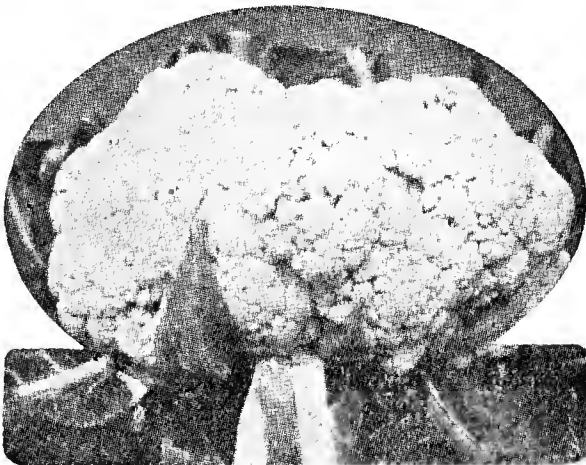

CHANTENAY — 72 days — One of the best carrots for all purposes. Roots about 6 inches long, blunt pointed, smooth, fine grained, sweet, a heavy yielder.

Pkt. 5c; oz. 10c; ¼ lb. 35c; lb. \$1.10 postpaid.

MORSE BUNCHING — 80 days — Tops short, foliage rather shortly cut, stems medium size and strong. Roots at maturity 1¼ — 1½ by 8 inches in size. Almost cylindrical with rounded shoulders and are well stumped.

Pkt. 5c; oz. 10c; ¼ lb. 35c; lb. \$1.10, postpaid.

CELERY

CULTURE — Start seed in partly shaded seed-beds of very rich fine loose soil. Cover seed not over ¼ inch. Transplant when 6 inches high, in rows 24 inches apart, and set the plants 6 inches apart in the rows. One ounce will produce 3,000 plants; 2 to 4 ounces will set an acre.



Golden Self-Blanching

GOLDEN SELF-BLANCHING — 120 days — The best market variety especially for early summer. The plant is naturally golden-yellow both stem and leaves but needs to be blanched to make it brittle; fit for table use; forms rather small bunch.

Pkt. 5c; oz. 35c; ¼ lb. \$1.00; lb. \$3.00, postpaid.

COLLARDS

CULTURE — Sow collards as you would cabbage, the plants should be spaced about 2 feet apart in rows. One ounce of seed will produce about 2,000 plants.

GEORGIA SOUTHERN — Plant 2 to 3 feet high, forming a cluster of tender undulated leaves at the top of its rather long stem; used as greens.

Pkt. 5c; oz. 15c; ¼ lb. 25c; lb. 75c, postpaid.

CANTALOUPE

CULTURE — Plant in hills 5 to 6 feet apart, dropping 10 seeds to the hill; thin out to three plants to the hill; cultivate until the vines cover the ground, and pinch the ends off the early shoots to induce early fruiting.

ROCKY FORD or NETTED GEM — 92 days — The most largely cultivated variety in use. Grown in great quantities in Colorado. Fruit is slightly oval, finely netted and slightly ribbed. Flesh thick, green, very sweet and of fine quality and high flavor.

Pkt. 5c; oz. 10c; 2 ozs. 15c; ¼ lb. 30c; lb. \$1.00, postpaid.

BURRELL'S SUPERFECTO — 90 days — A Muskmelon that has become very popular in the last few years. Almost round, heavily netted, slightly ribbed; a very good shipper.

Pkt. 5c; oz. 15c; ¼ lb. 40c; lb. \$1.25, postpaid.

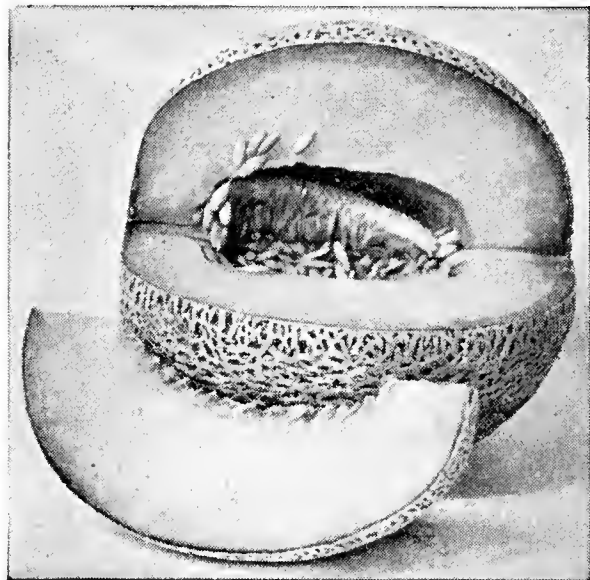

Superfecto

HONEY ROCK — 95 days — The flesh is deep, thick, of orange color, with a sugary and luscious flavor all its own. Rind is so tough, and the flesh so firm that it can be allowed to ripen on the vine and then shipped long distances and yet arrive in perfect condition. The fruits are nearly round, medium in size, with a heavy, coarse netting over a slate-colored skin. The strong vigorous vines do not show any trace of blight. It is one of the most prolific varieties grown.

Pkt. 5c; oz. 15c; ¼ lb. 45c; lb. \$1.25, postpaid.

HALE'S BEST No. 36—85 days—A variety of Cantaloupe which is grown quite extensively in the Imperial Valley of California. Very early and excellent for shipping. The flesh is salmon and the shape oval, with heavy netting and prominent ribs. Very sweet.

Pkt. 10c; oz. 20c; ¼ lb. 40c; lb. \$1.25, postpaid.

HALE'S BEST NO. 45—Mildew Resistant—85 days—A new variety of Cantaloupe which is grown quite extensively in the imperial Valley of California. Very early and excellent for shipping. The flesh is salmon and the shape oval, with heavy netting and prominent ribs. Very sweet.

Pkt. 10c; oz. 15c; ¼ lb. 40c; lb. \$1.25, postpaid.

HONEY DEW — 112 days — The delicious honey-like flavor of this new melon has met with instantaneous public favor and created a sensation wherever used. The fruit is of large size, weighing 8 to 10 pounds each. The rind is perfectly smooth and cream colored. The flesh is from 1½ to 2 inches thick, light green in color, very sweet and juicy.

Pkt. 5c; oz. 15c; ¼ lb. 50c; lb. \$1.50, postpaid.

BANANA CANTALOUPE — 90 days — An extremely long melon, attaining a length of 20 inches and 3 to 5 inches in diameter, weighing about 8 pounds, tapering at both ends, and shaped somewhat like the name it indicates. Lemon-colored skin when mature, with very attractive, thick, pink, or salmon-colored flesh of delicious eating quality.

Pkt. 10c; oz. 15c; ¼ lb. 30c; lb. \$1.00, postpaid.

CASABA

CASABA-GOLDEN BEAUTY — 110 days — Golden Beauty is bright yellow, about globular, with wrinkled skin, slightly pointed at stem end. The fruits are about 6 to 8 inches in diameter, the flesh pure white and very thick.

Pkt. 5c; oz. 20c; ¼ lb. 60c; lb. \$1.75, postpaid.

CORN (Sweet)

CULTURE — It is well to wait until the ground is warm before planting sweet corn as it is more susceptible to cold than field corn. Plant in rows 2½ to 3 feet apart and place seed 10 to 12 inches apart in the rows. Cover the seed 1 inch deep. Give frequent and shallow cultivation until tassels appear. Plant 1 lb. to 100-ft. row — 10 lbs. to an acre.

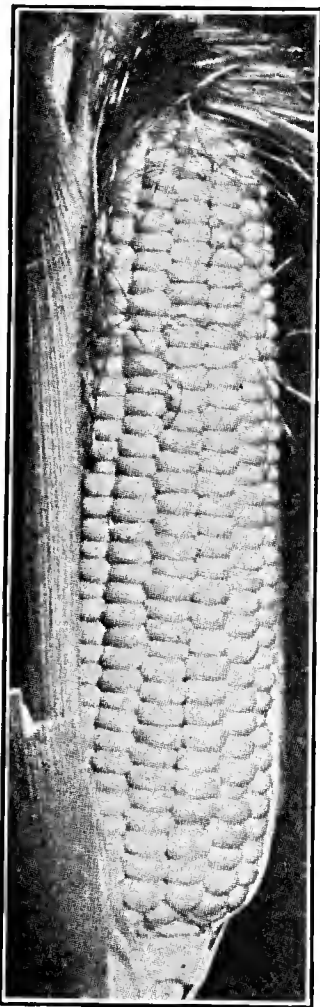

Golden Bantam

EXTRA EARLY ADAMS — 75 days — This is not a Sugar Corn, but is earlier. The ears are short, 12-rowed, and while in condition for roasting cannot be told from Sugar Corn. It will stand earlier planting than Sweet Corn and is a favorite wherever worms work badly on early corn.

Pkt. 10c; lb. 25c, postpaid.

GOLDEN BANTAM — 80 days — Early; golden yellow in color and of highest quality. Ears 6 to 7 inches long, 8-rowed, bearing from 2 to 4 ears to a stalk.

Pkt. 10c; lb. 30c, postpaid.

COUNTRY GENTLEMAN — 90 days — An especially fine quality corn, cob small, white and densely covered with long, slender, white grains without row formation.

Pkt. 10c; lb. 30c, postpaid.

TRUCKERS' FAVORITE — 85 days — A splendid early white corn, coming in directly after Adams Early but much larger. Has a deep white soft grain.

Pkt. 10c; lb. 30c, postpaid.

STOWELL'S EVERGREEN — 95 days — A standard main crop variety, much used for home garden, market and canning. Hardy and productive, very tender and sugary, remaining a long time in condition suitable for boiling.

Pkt. 10c; lb. 30c, postpaid.

TEXAS HONEY JUNE — Requires 87 days. A variety of Sweet Corn, especially adapted to growing in Texas. This corn was perfected by the Texas Experiment Station, at College Station, Texas. Has very heavy shucks, which makes it resistant to ear worm damage. Stalk about 6 feet tall. Ears, medium size, with 14 to 16 rows. We strongly recommend giving this wonderful corn a trial.

Pkt. 10c; lb. 35c, postpaid.



Straight Eight

CUCUMBER

CULTURE — Planting should be delayed until all danger of frost is past. Soil for planting should be warm, moist and loose. Cover seed about ½ inch. Plant in hills 3 to 4 feet apart, 5 or 6 seeds to the hill. When 6 inches tall, thin to 3 plants to the hill. One ounce will plant 100 hills or 2 pounds to the acre.

IMPROVED CHICAGO PICKLING — 59 days — Meets the most exacting requirements of critical pickle makers. Vines healthy and very productive. Fruit the right size, shape, color and quality.

Pkt. 5c; oz. 10c; ¼ lb. 35c; lb. \$1.00, postpaid.

STAY GREEN — 55 days — "Stay-Green" is the earliest of the White Spine type; fruit 7 to 8 inches long, cylindrical in shape. Color a beautiful dark green from stem to blossom and, which is retained longer than any variety we know of. Vigorous grower, enormous yield, shipping quality unexcelled, and always commands the highest market price.

Pkt. 5c; oz. 10c; ¼ lb. 35c; lb. \$1.00, postpaid.

STRAIGHT EIGHT — 65 days — Produces symmetrical, almost cylindrical fruits, well rounded at both ends, quite straight, regularly 8 inches in length and from 1¾ to 2 inches in diameter. Deep green color; usually free from objectionable pale striping and tipping.

Pkt. 5c; oz. 15c; ¼ lb. 45c; lb. \$1.25, postpaid.

IMPROVED LONG GREEN — 70 days — Uniform in size, straight, smooth; deep green in color and a great favorite for slicing.

Pkt. 5c; oz. 15c; ¼ lb. 45c; lb. \$1.25, postpaid.

DILL

DILL — Used for seasoning. Should be cut on a dry day just before they come into full blossom. Tie in bunches and keep where they will dry quickly.

Pkt. 5c; oz. 10c, postpaid.

EGG PLANT

CULTURE — Egg Plant seed germinates slowly and should be started in hot beds in February. Set the plants in open ground in April and May. Space the young plants 2½ to 3 feet apart in rows. One ounce of seed will produce 1,500 plants or more, a quarter pound of seed sufficient for an acre.

IMPROVED LARGE PURPLE (Spineless) — 83 days — This variety is a genuine favorite both for market and home garden. The plant is spineless, large and spreading, with light green foliage. It usually produces 4 to 6 large, oval fruits of a splendid dark purple color. The vigor and productiveness and fine quality of the fruit makes it a most profitable variety for market gardening.

Pkt. 5c; oz. 40c; ¼ lb. \$1.20; lb. \$3.50, postpaid.

BLACK BEAUTY — 81 days — Rich dark purple, large and symmetrical, maturing a little earlier than our Improved Large Purple, but usually not quite as large. Very desirable for the market, as the fruit holds its color for a long time.

Pkt. 5c; oz. 40c; ¼ lb. \$1.20; lb. \$3.50, postpaid.

EARLY FORTUNE — 65 days — Early, good dark color and prolific. Fruits average about 10 inches.

Pkt. 5c; oz. 10c; ¼ lb. 35c; lb. \$1.00, postpaid.

EXTRA LONG WHITE SPINE or EVER-GREEN — 65 days — A fine strain; smooth, frequently 10 inches long; round, handsome, very regular.

Pkt. 5c; oz. 15c; ¼ lb. 35c; lb. \$1.00, postpaid.

IMPROVED EARLY WHITE SPINE — 60 days — Vines vigorous, fruiting early and abundantly. Fruit good-sized, straight and smooth. Splendid for table use and especially desirable for pickles.

Pkt. 5c; oz. 10c; ¼ lb. 35c; lb. \$1.00, postpaid.

ENDIVE

CULTURE — One of the most piquant and tasty salads grown; makes a beautiful garnish, and is splendid for greens. Sow from August, in rows 18 inches apart, covering seed firmly with ½ inch of soil. Thin plants to 10 to 12 inches in the row. One ounce will sow 100 feet of row; 2 to 3 pounds for an acre.

LARGE GREEN CURLED — 95 days — Has very curly leaves, the mid-ribs being white and whitish, and the outer edges very much indented and crested. A very attractive plant and one of the best varieties.

Pkt. 5c; oz. 15c; ¼ lb. 30c; lb. 90c, postpaid.

EVER WHITE CURLED — 100 days — The plants are moderately dense, with divided leaves, which are very light yellowish green in color, even the outer ones being very light. This variety blanches readily to an attractive creamy white.

Pkt. 5c; oz. 15c; ¼ lb. 35c; lb. \$1.00, postpaid.



Black Beauty

KALE

CULTURE — Sow in drills 2 feet apart, thin out to 8 inches in the row and cultivate as cabbage. One ounce for 3,000 plants; 3 pounds to the acre.

DWARF CURLED SCOTCH — 55 days — A finely curled, spreading, low growing variety, very hardy and much used for greens. This sort, sometimes called "Norfolk," is grown extensively in the South for shipment, and is largely planted for the home garden. The leaves are long and attractive bright green. This sort is often used for garnishing. Pkt. 5c; oz. 10c; ¼ lb. 30c; lb. 90c, postpaid.

KOHL RABI

CULTURE — The edible part is the turnip-shaped bulb formed above the ground. It is tender and excellent when used before fully grown, combining the flavors of cabbage and turnip. Sow seed in early spring and when well established thin to 6 inches apart in the row. Plantings may be made in July for fall use. A packet will sow about 40 feet of drill; 1 ounce about 300 feet; 2 pounds sufficient for an acre.

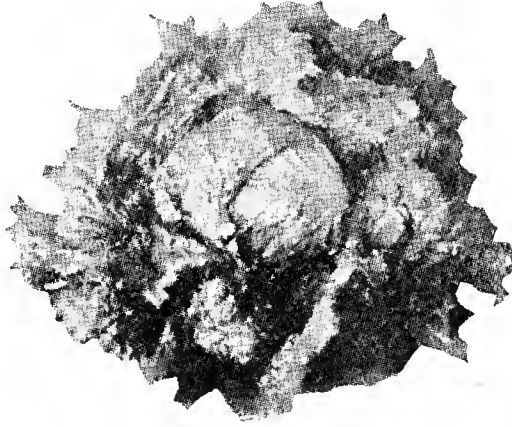

Imperial No. 847

BIG BOSTON — 76 days — A popular market variety used largely in the South to grow winter Lettuce for the northern markets. A light-green cabbage variety, slightly tinged with brown in the head. Has a fine golden buttery head. Pkt. 5c; oz. 15c; ¼ lb. 35c; lb. \$1.00, postpaid.



EARLY WHITE VIENNA — 55 days — A turnip-like bulb, formed above ground, combining somewhat the flavor of Cabbage and Turnips. The bulb is large enough to be used in 10 to 12 weeks from time of sowing, and is most tender and deliciously flavored before fully matured. Pkt. 5c; oz. 20c; ¼ lb. 60c; lb. \$1.75, postpaid.

LARGE GREEN — 65 days — This sort is also called Large White. It is hardy, quite late, and used for feeding stock. Bulbs large, weighing 8 to 10 pounds when fully grown; whitish green in color, leaves large and very numerous. Pkt. 5c; oz. 15c; ¼ lb. 50c; lb. \$1.50, postpaid.

LETTUCE

CULTURE — Lettuce can be started in cold frames in February and transplanted to open ground as soon as it can be worked. For late crop, sow the seed in open ground as soon as season permits in rows 15 to 18 inches apart; thin heading varieties 1 foot apart in the rows. Looseleaf sorts will stand closer growing. One ounce will plant 200-ft. row; 2 pounds will plant an acre.

EARLY PRIZE HEAD — Forms a mammoth plant, in which even the outer leaves are crisp and tender; color bright green tinted with brownish red. It is of superb flavor and very hardy. Pkt. 5c; oz. 15c; ¼ lb. 35c; lb. \$1.00, postpaid.

ICEBERG — 84 days — A large crisp lettuce, always tender. Iceberg stands hot weather remarkably. Give each head 14 inches in row. The color is light green lightly tinged with brown. Try this either for home or market garden. A little larger than Los Angeles and similar. Pkt. 5c; oz. 15c; ¼ lb. 35c; lb. \$1.00, postpaid.

COS — Forms oblong heads of large size. Considered as superior to any other kind. An entire distinct type of lettuce. Sometimes called "Romaine Celery Lettuce." Pkt. 5c; oz. 15c; ¼ lb. 35c; lb. \$1.00, postpaid.

IMPERIAL No. 847 — 80 days. Produces immense heads as solid as a cabbage. Blanches beautifully; crisp, tender, and free from bitterness. The perfect heads measure 12 to 15 inches across and frequently weigh 2 to 3 pounds each. Outer leaves tightly overlap and are an attractive rich green. The heart is creamy white and the quality superb.

Pkt. 5c; oz. 15c; ¼ lb. 45c; lb. \$1.25, postpaid.

HANSON — 80 days — A fine large-heading variety. Leaves curled on the edges, light yellowish-green in color. The head is crisp and brittle and flavor excellent. Stands warm weather extremely well.

Pkt. 5c; oz. 15c; ¼ lb. 40c; lb. \$1.00, postpaid.

NEW CHICKEN LETTUCE — Here is a genuine Lettuce which will yield as much or more chicken or rabbit feed as any "greens" plant. When once cut it start to grow again. The leaves can be pulled off each stem like a kale. Chicken Lettuce does not make a head, but sends up a stout stalk 3 to 4 feet high, just loaded with leaves.

Pkt. 5c; oz. 15c; ¼ lb. 35c; lb. \$1.00, postpaid.

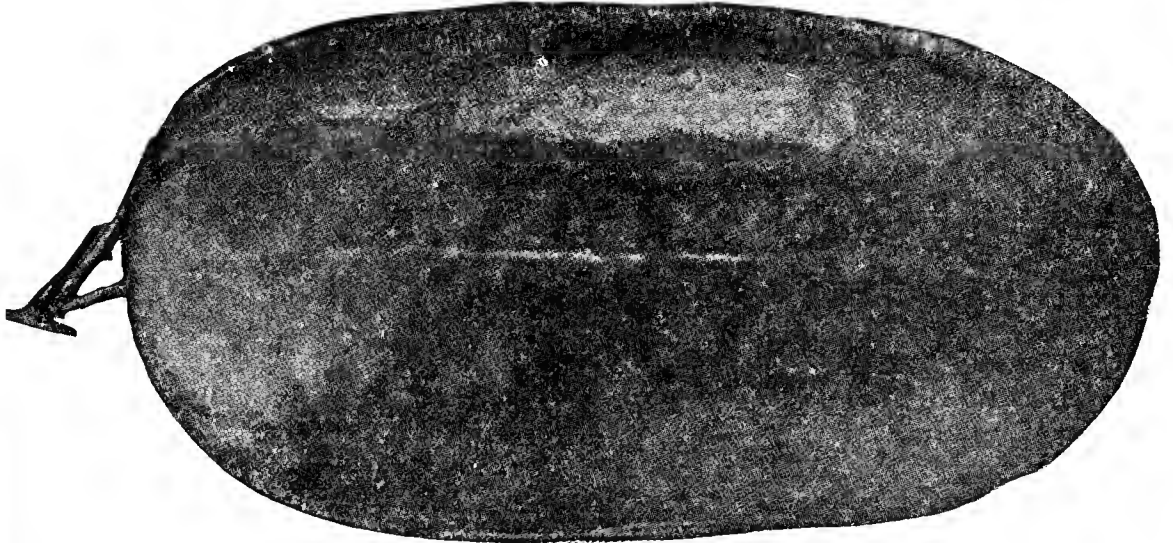

Wonder Melon

WATERMELON

CULTURE — The seed should be planted in hills about 8 feet apart and it is well to work into the soil an abundance of well-rotted manure. It is important that the seed should not be planted before the ground becomes warm and dry, as the young plants are very sensitive to cold and wet. Put 10 to 12 seeds in a hill. When the plants have formed the first pair of rough leaves, they should be thinned so as to leave 2 to 3 of the strongest and best to each hill. Cultivate until vines cover the ground. A packet will plant about 10 hills; an ounce 30 hills; 2 to 3 pounds per acre.

GYPSY or GEORGIA RATTLESNAKE — 90 days — The melon is long, smooth, distinctly striped with light, mottled and wavy green stripes; flesh bright scarlet, very sugary.

Pkt. 5c; oz. 10c; ¼ lb. 25c; lb. 75c, postpaid.

HALBERT'S HONEY — 85 days — Fully equal to Kleckley's Sweet, which it resembles. It is more even in outline, blunter at end; skin of a richer, darker color.

Pkt. 5c; oz. 10c; ¼ lb. 25c; lb. 75c, postpaid.

WONDER MELON — 85 days — Here is a watermelon that every grower in the South will plant sooner or later. In quality of flavor there is nothing that will compare with it. A large and long melon resembling the Tom Watson. The rind is rather thin but tough, cutting a big red heart of the finest melon meat that you have ever tasted. White seed, with few to the melon.

Pkt. 5c; oz. 10c; ¼ lb. 25c; lb. 75c, postpaid.

FLORIDA FAVORITE — 80 days — Fruit long, dark green, mottled and striped with a lighter shade, rind is thin but firm.

Pkt. 5c; oz. 10c; ¼ lb. 25c; lb. 75c, postpaid.

CUT RED TOM WATSON — 90 days — Without doubt the finest grade of Tom Watson seed ever offered the grower. The name represents everything that it stands for. The seed has been selected from only the finest and truest-to-type melons and only then from those that CUT RED from rind to rind. Regardless of what kind of melon you have been planting, it will pay you big dividends to plant some of this splendid seed.

Pkt. 5c; oz. 10c; ¼ lb. 25c; lb. 75c, postpaid.

KLECKLEY'S SWEET — 80 days — A very desirable variety for the home garden or nearby markets. Fruit medium-sized, oval and skin dark green, flesh bright red and sweet. Skin is brittle. It is the very sweet, honey-like flavor that makes it especially distinct from all other varieties.

Pkt. 5c; oz. 10c; ¼ lb. 25c; lb. 75c, postpaid.

CLETIX — 85 days — Similar in shape and size to the Tom Watson. Sometimes called Spotted Watson from the fact that it has light green stripes which appear to be spots. Flesh is red and firm, of splendid eating quality. Does not sunburn easily and is a splendid shipper. The seeds are brown to a brown smear.

Pkt. 5c; oz. 15c; ¼ lb. 50c; lb. \$1.50, postpaid.

IMPROVED KLONDYKE — 80 days — Among the leading shippers in all the melon growing districts of California this wonderful new melon has rightfully earned the reputation of being the best quality shipping melon in existence, and is being grown with equal success in other States regardless of the climatic conditions. The melons are oblong in shape and weigh from 20 to 35 pounds each. Rind is thin but tough, with attractive deep green. Flesh of the melon is a rich red. Without doubt one of the sweetest melons grown. Pkt. 5c; oz. 10c; ¼ lb. 35c; lb. \$1.00, postpaid.

WATERMELON (Continued)

DIXIE QUEEN — A new melon, round in shape, with white seed; often weighs as much as 60 pounds. Skin is striped dark green and greenish ivory; flesh is bright red, solid and of fine flavor. Rind thin, but strong. Uniform in shape, size, color and quality. Pkt. 5c; oz. 10c; ¼ lb. 35c; lb. \$1.00, postpaid.

STONE MOUNTAIN — 90 days — A new round watermelon showing slight ribs or lobes like a cantaloupe. The color of the smooth skin is light green. The flesh is a uniform beautiful DEEP CRIMSON without any white hearts or stringiness. The average fruit weighs about 45 pounds. Not suited for distance shipping. Pkt. 5c; oz. 10c; ¼ lb. 30c; lb. 90c, postpaid.

DALE — 90 days — This splendid melon is oblong in shape. The tough skin is a dark green color irregularly striped with lighter green. Flesh is dark red in color, fine grained, sweet and luscious. White seed. An excellent shipper. You will find our strain of this excellent melon to be the best. Pkt. 5c; oz. 10c; ¼ lb. 25c; lb. 75c, postpaid.

DALE (Special) — 90 days — This seed is selected from the finest melons in the field. Every melon being of very heavy weight and true to type. We can recommend this melon to any one desiring the best in Dale Watermelon seed. Pkt. 5c; oz. 15c; ¼ lb. 45c; lb. \$1.25, postpaid.

ALABAMA SWEET — 85 days — A very large, long melon of excellent quality; popular in the South, where it is grown extensively for shipping. The color is rather deep green, with dark, irregular striping. The rind is thin, but very tough. The flesh is bright red, fine grained and sweet. Pkt. 5c; oz. 10c; ¼ lb. 25c; lb. 75c, postpaid.

IRISH GREY — 90 days — A valuable melon, producing more melons under any condition than any other variety. Also a fine eating melon, and a grand shipper. The red flesh is very sweet and free from stringiness. The rind will not sunburn and will keep in excellent condition long after picking. Pkt. 5c; oz. 10c; ¼ lb. 25c; lb. 75c, postpaid.

FLORIDA GIANT — 90 days — One of the sweetest, largest and earliest watermelons. The fruit is almost round with rich dark green, medium thick rind and scarlet flesh of luscious sweetness. It has few seeds, is firm and solid, almost all heart. Will stand considerable handling making it an excellent shipper. Melons often weigh from 60 to 80 pounds. Pkt. 5c; oz. 15c; ¼ lb. 40c; lb. \$1.25, postpaid.

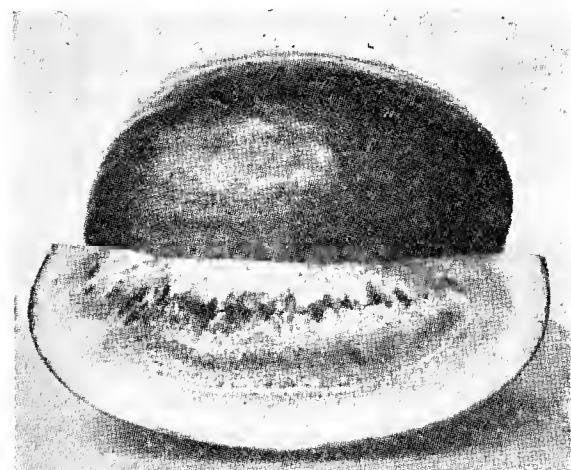

Florida Giant

GOLDEN HONEY — 90 days. Oblong, medium size. Flesh, beautiful glistening amber shade, very tender, delicious flavor. Has no hard core or stringy sections. Recommended for home use. Pkt. 10c; oz. 20c; ¼ lb. 40c; lb. \$1.10.

CITRON FOR PRESERVING — 95 days — A round light and dark-striped melon, meat greenish-white, used for preserving only. Seed red and small. Tough rind. Pkt. 5c; oz. 10c; ¼ lb. 30c; lb. 90c, postpaid.

GARLIC

GARLIC — Large, healthy bulbs for planting. Lb. 30c; 3 lbs. 75c, postpaid.

MUSTARD

CULTURE — Sow frequently in rows 12 to 18 inches apart, covering seed ½ inch deep. Thin plants to 5 to 6 inches apart in the rows. Give clean cultivation. The plants are in condition for use as soon as the leaves are the size of one's hand. Mustard runs to seed quickly, so that successive plantings are necessary for a continuous supply. One ounce will plant 100 feet-row; 2 to 3 pounds will plant an acre.

SOUTHERN GIANT CURLED — 30 days — Leaves are large, light green with tinge of yellow, much crimped and frilled at edges. Plant is upright and slightly spreading in growth. This variety is highly esteemed in the South for the market, as well as for the home garden on account of its vigorous growth, hardiness and good quality. Pkt. 5c; oz. 10c; ¼ lb. 20c; lb. 50c, postpaid.

LARGE SMOOTH-LEAVED — 30 days — An excellent sort with very large, light green, plain or comparatively smooth leaves, borne well above the ground. This sort is preferred by many, as it is more easily prepared for the table than the rougher-leaved varieties. Pkt. 5c; oz. 10c; ¼ lb. 20c; lb. 50c, postpaid.



Large Smooth-Leaved

CHINESE — Leaves twice the size of White English; sweet and pungent. Pkt. 5c; oz. 10c; ¼ lb. 25c; lb. 50c, postpaid.

MUSTARD — SPINACH

KOMATSUNA OR TENDERGREEN

JAPANESE MUSTARD-SPINACH — Offered by some dealers in the South as TENDERGREEN. A quick growing vegetable of Oriental origin. In Japan it takes the place of spinach, as it remains tender even in dry weather. It is virtually an all season plant. Withstands extreme summer heat, also resistant to cold weather. The large, oblong leaves are dark green in color with a very small center rib. The leaves are cooked and prepared for table the same as Spinach and Turnip or Mustard Greens. It compares favorably to these greens in eating qualities. Does not make roots like Turnips; only small thin roots, about 2 or 3 inches in length. Pkt. 5c; oz. 10c; ¼ lb. 30c; lb. 60c, postpaid.

ONION PLANTS

CRYSTAL WHITE WAX or YELLOW BERMUDA

100	-----	Postpaid	\$0.25
500	-----	Postpaid	.70
1000	-----	Postpaid	1.15

Write for larger quantity prices.

ONION SETS

CULTURE — Plant 4 inches apart in rows half an inch deep, and 1 foot between the rows, when cultivated by hand. Do not cover the sets entirely. All varieties can be set out in the fall as well as in the spring. One pound plants a 60 foot row.

Red Bottom Sets	-----	Lb. 30c; bu. \$3.50
White Bottom Sets	-----	Lb. 30c; bu. 3.75
Yellow Bottom Sets	-----	Lb. 30c; bu. 3.50

Pounds postpaid, bushels f.o.b. San Antonio.

OKRA

CULTURE — Plantings should be delayed until the soil is warm. Plant thinly, in rows 2½ feet apart, and cover seed about 1 inch deep. Thin to about 12 to 15 inches apart. Requires 8 to 10 weeks to mature. One ounce will sow 50 feet of row; 8 pounds, an acre.

KARGER'S

OKRA — Tender and very prolific. Extra early, at least two weeks earlier than most varieties. Bushes of uniform low or dwarf growth, pods thickly set and heavy bearing. Pods do not harden or become tough very readily. Pkt. 5c; oz. 10c; ¼ lb. 20c; lb. 50c, postpaid.

WHITE VELVET — Round, white, smooth pods of extra large size produced in abundance. Pkt. 5c; oz. 10c; ¼ lb. 20c; lb. 50c, postpaid.

PERKINS

MAMMOTH LONG POD

This variety is about three ft high, very early and productive. The pods are deep green, very long, slender, slightly corrugated, very tender and of good quality. Desirable market as well as home garden sort. Pkt. 5c; oz. 10c; ¼ lb. 20c; lb. 50c, postpaid.



White Velvet

BERMUDA ONION SEED

CULTURE — Plantings may be made from early September until March. Sow in rich soil, in rows 12 to 15 inches apart, and cover seed lightly. When 4 to 5 inches high, plants should be thinned to 3 to 4 inches apart in the row. Seed also can be sown in seed-beds and later transplanted to the field. Shallow cultivation should be practiced every week for 10 days. One ounce to 100-ft. row; 1 to 3 pounds to the acre.

YELLOW BERMUDA (Straw Color) — 95 days — This is the standard variety and is grown very largely among the large Texas onion growers. It is more hardy, less affected by disease, and more prolific than other onions. Pkt. 5c; oz. 25c; ¼ lb. 65c; lb. \$2.00, postpaid.

CRYSTAL WHITE WAX — 95 days — This is the wavy white onion seen in our markets in the early spring, and it is one of the most beautiful onions on the market. It is absolutely pure white, of the finest flavor, and will always command a premium on the market. Pkt. 5c; oz. 25c; ¼ lb. 65c; lb. \$2.00, postpaid.

MAMMOTH SILVER KING — 105 days — No other white Onion attains such mammoth size. The bulbs are of an attractive shape, flat but thick. Mammoth Silver King is mild in flavor and an excellent keeper. Pkt. 10c; oz. 25c; ¼ lb. 75c; lb. \$2.75, postpaid.

SHALLOTS

White, multiplying. Used very extensively in salads. Lbs. 25c, postpaid.

PARSNIP

CULTURE — Sow the seed in early spring, $\frac{1}{2}$ inch deep, in rows 12 to 18 inches apart. One ounce of seed for 200 feet of row; 5 pounds per acre.

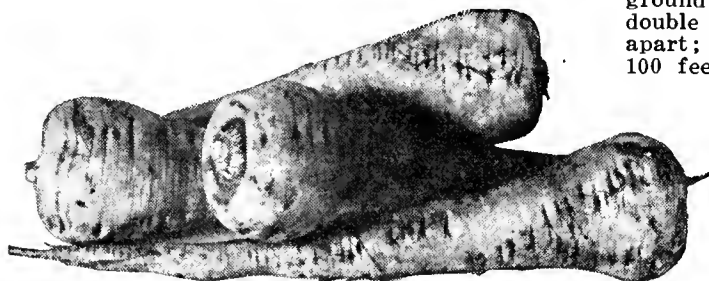

Short-Thick

SHORT-THICK — An excellent variety for the table. The roots are long, with smooth, white skin, uniform in shape, tender and of the best quality. The variety is easily distinguished by the leaves growing from the depression on top of crown of the root.

Pkt. 5c; oz. 10c; $\frac{1}{4}$ lb. 20c; lb. 65c, postpaid.

PARSLEY

CULTURE — Soak seed for several hours previous to sowing, in warm water, which will facilitate germination. Sow in border or frame. Thin rows to 8 inches each way. One ounce of seed to 150 feet of drill.

CHAMPION MOSS CURLED — A very curled green and very ornamental.
Pkt. 5c; oz. 10c; $\frac{1}{4}$ lb. 25c; lb. 75c, postpaid.

PLAIN or SINGLE — A very hardy variety. The leaves are flat and, not curled. The best flavored variety.

Pkt. 5c; oz. 10c; $\frac{1}{4}$ lb. 25c; lb. 75c, postpaid.

PEPPER (Sweet)

PEPPERS ARE SPLENDID IN SALADS
ALSO STUFFED

CULTURE — Plant seed $\frac{1}{2}$ inch deep in hot beds in January or in boxes in the house; when danger of frost is over transplant $1\frac{1}{2}$ feet apart in rows 3 feet wide. One ounce of seed will produce 500 plants.

CALIFORNIA WONDER — 75 days — A new variety which originated in California. It is one of the largest peppers grown and has remarkably thick and sweet flesh. Of excellent quality, a particularly heavy yielder.

Pkt. 5c; oz. 40c; $\frac{1}{4}$ lb. \$1.20; lb. \$3.50, postpaid.

WORLDBEATER — 75 days — This is without doubt, the finest introduction in peppers in ages. It is a cross between Chinese Giant and Ruby King, having the shape of the Ruby King, except that it is broader at the pointed end and almost the size of the Chinese Giant.

Pkt. 5c; oz. 35c; $\frac{1}{4}$ lb. \$1.00; lb. \$3.00 postpaid.

RUBY KING — 69 days — This variety grows to an extraordinary size. When ripe, a handsome, bright ruby color; remarkably mild and pleasant to the taste. For stuffing, no other variety can equal it.

Pkt. 5c; oz. 30c; $\frac{1}{4}$ lb. 85c; lb. \$2.50, postpaid.

PIMENTO or PERFECTION — 73 days — A medium early, prolific, perfectly mild variety with extremely thick flesh. On account of its thick flesh it will hold up for a long time; an excellent sort for canning whole.

Pkt. 5c; oz. 30c; $\frac{1}{4}$ lb. 85c; lb. \$2.50, postpaid.

ENGLISH PEAS ARE DELICIOUS

PEAS

CULTURE — Peas should be planted as early as the ground can be worked, in double rows 8 to 10 inches apart; 2 pounds of seed to 100 feet of drill, 60 pounds

per acre. You will have best results with early peas on light, warm soil, but the main will do better on a fairly heavy soil that will retain moisture.

LANDRETH'S EXTRA EARLY — 60 days — A critical gardener wants the best strain as respect earliness, size of pod, flavor, uniformity of ripening, vigor and uniformity in habit of the plant. All these desirable qualities can be found in this pea. This type will produce peas fit for table in 44 to 50 days, according to soil and climatic conditions of the season of their growth.

Pkt. 10c; lb. 35c, postpaid; 10 lbs. \$1.75, not postpaid.

BLISS EVERBEARING — 76 days — An old standard, late, main crop variety. Height 3 feet. Vine and foliage sturdy and strong, dark green; pods usually in pairs containing 4 to 5 light green peas of good quality; matures following Telephone.

Pkt. 10c; lb. 35c, postpaid; 10 lbs. \$1.75, not postpaid.

LAXTONIAN — 62 days — A dwarf pea with large, handsome pods. Slightly earlier than Gradus, maturing about the same time as Thomas Laxton. Vines medium dark green and heavy foliage. Pods $3\frac{1}{2}$ to 4 inches long slightly curved. Will bear more abundantly at top of vines, making it easy to pick, very heavy yielder, altogether a fine pea for private market gardeners.

Pkt. 10c; lb. 35c, postpaid; \$10 lbs. \$2.00, not postpaid.



California Wonder

PEPPER (Hot)

HOT OR PUNGENT VARIETIES

RED CHILI — 82 days — Rather small, bright red variety about 2 inches long and pointed. Pods are used in making Chili Sauce and are very pungent and hot.
Pkt. 5c; oz. 40c; $\frac{1}{4}$ lb. \$1.20; lb. \$3.50, postpaid.

LONG RED CAYENNE — 70 days — A strong, pungent variety, having well pointed fruit, which is bright scarlet when ripe. A very popular variety.
Pkt. 5c; oz. 40c; $\frac{1}{4}$ lb. \$1.20; lb. \$3.50, postpaid.

GREEN MEXICAN PICKLING — A variety widely grown in Mexico and used extensively for pickling and seasoning. The fruits are dark glossy green, thick meated, and very pungent and considered one of the hottest in cultivation. Length averages $1\frac{1}{2}$ to 2 inches and $1\frac{1}{4}$ inches in diameter. (Pkt. 5c; oz. 80c; $\frac{1}{4}$ lb. \$2.65; lb. \$8.00, postpaid.)

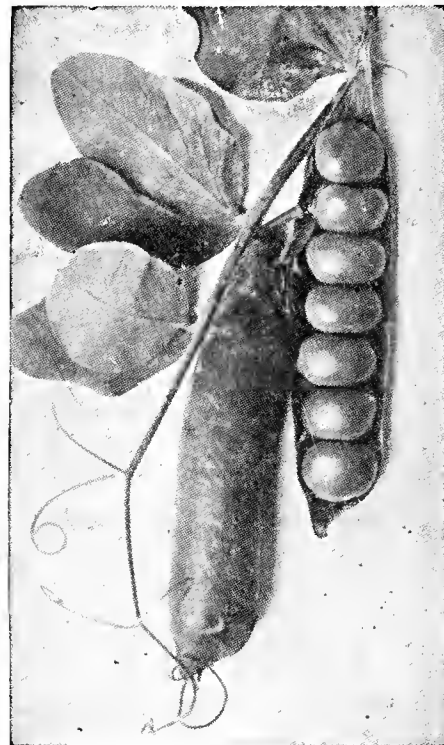

Thomas Laxton

LITTLE MARVEL — 62 days — The very dark green vines are about 18 inches high, very sturdy and vigorous, and loaded with pods. The pods are very deep green and about 3 inches long, blunt ended and closely packed with peas of medium size. The peas are extremely tender and unsurpassed in sweetness.
Pkt. 10c; lb. 30c, postpaid.

FIRST AND BEST — 60 days — One of the earliest tall varieties, with smooth, round peas, which ripen almost at one time. Grows 2 to $2\frac{1}{2}$ feet high, seed yellow-whitish, pods straight, short and well filled. Quality best of the smooth-seeded early varieties.
Pkt. 10c; lb. 35c, postpaid 10 lbs. \$1.75, not postpaid.

WHITE MARROWFAT — 88 days — This is a very heavy yielding late variety. Pods large and well filled. The dry peas are of large size and are excellent for cooking.
Pkt. 10c; lb. 30c, postpaid.

ALASKA — 54 days — Blue pea of excellent quality. Earliest of all the blue sorts. A desirable early pea for market gardeners, growing from 2 to $2\frac{1}{2}$ feet, and very productive.

Pkt. 10c; lb. 30c, postpaid; 10 lbs. \$1.50, not postpaid.

THOMAS LAXTON — 60 days — Excepting color of foliage and pods, in growth this is identical with the Gradus, 2 or 3 days late, but more productive.

Pkt. 10c; lb. 35c, postpaid; 10 lbs. \$2.00, not postpaid.

PUMPKIN

CULTURE — May be planted in middle of spring among corn or in hills 8 to 10 feet apart each way. Four seeds in a hill. If planted in hills, they are cultivated in the same manner as melons and cucumbers. For winter use gather before frost and store in a warm, dry place. Use a packet to 5 hills; 1 ounce for 25 hills; 3 to 4 pounds per acre.

CHEESE — 108 days — A very good table variety. Shape flat like a cheese box; a good keeper. Often 15 inches across the top.

Pkt. 5 c; oz. 10c; $\frac{1}{4}$ lb. 25c; lb. 75c, postpaid.

KENTUCKY FIELD — 120 days — Sometimes called large Cheese. A very large, flattened pumpkin, averaging about 2 feet through. When ripened the skin is a rich cream color. Flesh yellow and of fine quality.
Pkt. 5c; oz. 10c; $\frac{1}{4}$ lb. 20c; lb. 65c, postpaid.



Pie or Sugar

JAPANESE PIE — 115 days — Resembles the Cushaw in shape, but skin is dark green with lighter green stripes. Flesh deep yellow and of good quality. Weight about 12 pounds. Pkt. 5c; oz. 15c; ¼lb. 40c; lb. \$1.00, postpaid.

GREEN STRIPED CUSHAW — 115 days — Fruits very large, white crooked neck. Color, creamy white, irregularly striped or traced with green. Flesh light yellow, very thick, rather coarse but sweet. This sort is very productive and popular in some sections. Pkt. 5c; oz. 15c; ¼lb. 40c; lb. \$1.00, postpaid.

PIE PUMPKIN — 118 days — A small round, yellow sort, with fibre pinkish netting. Flesh is thick, sweet and of excellent quality. Pkt. 5c; oz. 10c; ¼ lb. 30c; lb. 90c, postpaid.

CERTIFIED SEED POTATOES

IT PAYS TO PLANT CERTIFIED SEED;
ALSO TREAT WITH SEMESAN BEL

The most successful potato growers use nothing but certified seed. Certification has done for potatoes what breeding has done for horses, cattle, hogs, etc. Less disease, more No. 1 potatoes and greater profit to the grower. Every bag carries the tag of the inspection authorities; this is an assurance that every safeguard has been applied to have them as pure as is humanly possible.

CULTURE — Seed potatoes should be cut with 1 or 2 good eyes to each piece and planted in rows 24 to 36 inches apart, dropping a cut piece from 8 to 12 inches apart in the rows. Cover pieces about 6 inches and cultivate well after they are up but not too close so as not to disturb the root. Potatoes keep best if they are dug when the vines are about half dead. Plant potatoes in well manured or fertilized soil. Buy Certified Stock as they are free of Scab, Spindletuber and Rhizostonia.

IRISH COBLERS — This variety is one of the most reliable and popular of the early varieties. It is of handsome creamy-white color and of excellent quality, making it most desirable for the best trade. It is a vigorous grower, ripens uniformly and a good keeper; in short, one of the best all-around early potatoes on the market. Peck 90c, not postpaid.

BLISS TRIUMPH or RED BLISS — This is the most standard red variety in the Southern States. It is very early and matures quickly. The potatoes are round and uniform in shape, eyes slightly depressed and a beautiful bright red in color. It is very hard, and not susceptible to disease. Peck 90c, not postpaid.

If you are a large grower of potatoes, write us for quantity price. Just drop us a postcard stating amount of potatoes you wish to plant and we will quote you by return mail. No obligation on your part to buy.

RADISH

CULTURE — Sow in drills 12 to 18 inches apart and thin out plants to stand about 2 inches apart. Give plenty of water to raise the best radishes. Successive plantings from 1 week to 10 days apart will keep you supplied with good fresh radishes. Sow 1 ounce to 100 feet, 5 to 6 pounds to the acre.

FRENCH BREAKFAST — 25 days — A quick growing, small olive shaped Radish about 1½ inches long by ⅝ to ¾ of an inch in diameter when fully grown. The color is beautiful deep rose scarlet except a little clear white about the tip. This is an excellent variety for planting outdoors for the home garden. Its small tops and earliness make it also desirable for growing under glass. Pkt. 5c; oz. 10c; 2 oz. 15c; ¼ lb. 20c; lb. 60c, postpaid.

VICK'S SCARLET GLOBE — 23 days — Most popular shipping variety. Roots are slightly olive-shaped and are a rich, bright scarlet in color. The flesh is white, crisp and tender. Tops are of nice size, about 6 inches or more; easy to bunch. Pkt. 5c; oz. 10c; ¼ lb. 25c; lb. 75c, postpaid.



Vicks Scarlet Globe

EARLY SCARLET TURNIP, WHITE TIPPED — 21 days — One of the most popular and attractive short varieties. It is globe-shaped, bright rose carmine with bottom and tip clear white. Stems and leaves are small. Very valuable for forcing, also for the garden and market. Pkt. 5c; oz. 10c; 2 oz. 15c; ¼ lb. 20c; lb. 60c, postpaid.

CRIMSON GIANT — 28 days — If you desire a radish of more than two bites you will find this your liking. Roots large globular, 1 to 1½ inches in diameter, deep crimson in color. The white flesh holds its firmness well and is of superior quality. Pkt. 5c; oz. 10c; ¼ lb. 30c; lb. 90c, postpaid.

SCARLET CHINA — 50 days — One of the best of winter varieties. The roots are cylindrical, or largest near the bottom, stump rooted or blunt at both ends. The skin is smooth and of a bright deep rose color. Pkt. 5c; oz. 10c; ¼ lb. 25c; lb. 75c, postpaid.

LONG WHITE VIENNA — 29 days — A very fine, long, white variety; quick growing, ready for use when very young. The flavor is mild and sweet. Pkt. 5c; oz. 10c; ¼ lb. 25c; lb. 75c, postpaid.

CHARTIER or SHEPHARD RADISH — 35 days — A variety of Long Scarlet; top deep crimson; almost white bottom. Pkt. 5c; oz. 10c; ¼ lb. 25c; lb. 75c, postpaid.

WONDERFUL HALF-LONG SCARLET — 26 days — So rapid in growth as to develop perfectly in 26 days. Grows about 2½ inches long, contrasting from a broad shoulder to a sharp point; very symmetrical and uniform in shape; color, bright scarlet; altogether a gem. Pkt. 5c; oz. 10c; ¼ lb. 25c; lb. 75c, postpaid.

LONG BLACK SPANISH — 55 days — One of the latest and hardiest long garden radishes; especially adapted for winter use. The roots are long, thick, almost black somewhat wrinkled. The flesh is white, of firm texture, decidedly pungent, but well flavored. The roots when matured are usually 7 to 9 inches long by 2 or 3 inches in diameter at the thickest part.

Pkt. 5c; oz. 10c; ¼ lb. 25c; lb. 75c, postpaid.

SPINACH

CULTURE — The seed should be planted in very rich ground in drills 16 to 20 inches apart, and the plants should be thinned out 6 inches apart in the row when the leaves are 1 inch wide. Spinach seed may also be sown broadcast. One ounce, 100 feet; 8 to 10 pounds per acre in drills; 12 to 15 pounds broadcast.

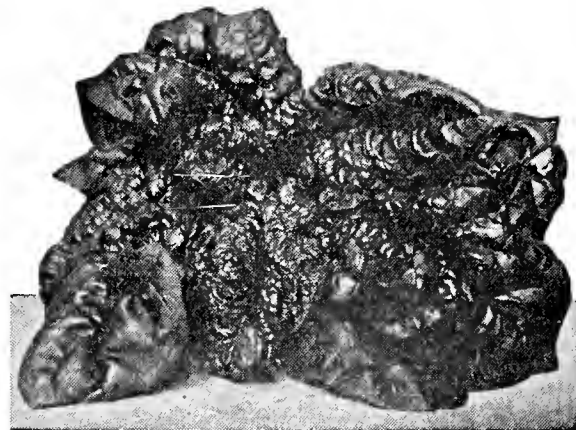

Bloomsdale

BLOOMSDALE — 39 days — As an autumn sort it is superior to all others; but in the spring is inclined to shoot early. The leaves are twisted and bloated, giving them, when ready for shipment, an elasticity adapting them for transportation to long distances and at the same time giving the crop large measuring qualities.

Pkt. 5c; oz. 10c; ¼ lb. 15c; lb. 35c, postpaid. 10 lbs. \$2.00, not postpaid.

NEW LONG-STANDING BLOOMSDALE — 42 days — Has all the good points of Bloomsdale, in addition it will withstand the summer heat and does not go to seed.

Pkt. 5c; ¼ lb. 20c; lb. 40c, postpaid; 10 lbs. \$2.75, not postpaid.

BROAD-LEAVED FLANDERS — 42 days — One of the most vigorous and strong growing varieties. The leaves are nearly round, uniformly deep green, quite thick and slightly crimped in the center.

Pkt. 5c; oz. 10c; ¼ lb. 15c; lb. 35c, postpaid; 10 lbs. \$1.75, not postpaid.

SQUASH

CULTURE — Squash are very sensitive and planting should be delayed until ground is warm and danger of frost is past. Plant in hills 4 feet apart each way, dropping about 6 seeds in each hill and thinning to 2 plants to a hill when they are up. One ounce plants 40 hills; 2 to 3 pounds to the acre.

YELLOW CROOKNECK — 50 days — The well known summer variety. Fruit long, skin very fine and tender when young.

Pkt. 5c; oz. 10c; ¼ lb. 30c; lb. 90c, postpaid.

IMPROVED HUBBARD — 105 days. Well known winter Squash. Vines of strong running growth; fruits large, olive shape, with dark green skin and very rich thick flesh. Of fine texture and it keeps very well. The rind is hard with a fair amount of warts. The fruits are pointed at both ends.

Pkt. 5c; oz. 10c; ¼ lb. 30c; lb. \$1.00, postpaid.

If you have a friend who would be interested in receiving this catalog, we would appreciate your sending us their name so we can mail them a copy.

SQUASH (Continued)



EARLY WHITE BUSH SCALLOP SQUASH

EARLY WHITE BUSH SCALLOP — 50 days — A very early variety, with flat, creamy white scalloped squashes 4 to 6 inches in diameter. Vine is bush in habit and rather dwarf. This variety is the common "patty pan" squash.

Pkt. 5c; oz. 10c; ¼ lb. 30c; lb. 90c, postpaid.

GREEN TINT WHITE BUSH or BENNING — 53 days — An excellent variety, popular on account of the greenish white color of the young fruits. Plants are of the bush type. Fruits somewhat warted and dull white at maturity.

Pkt. 5c; oz. 10c; ¼ lb. 30c; lb. 90c, postpaid.

MAMMOTH WHITE BUSH SCALLOP — 60 days — An early maturing, somewhat flattened, scallop bush squash of largest size, and the handsomest of the summer varieties for home garden and market. The vines are vigorous and productive.

Pkt. 5c; oz. 10c; ¼ lb. 35c; lb. \$1.00, postpaid.

COCOZELLE, ITALIAN VEGETABLE MARROW — 65 days — Oblong in shape, shell dark green. Cook and serve the same as other Squash.

Pkt. 5c; oz. 10c; ¼ lb. 35c; lb. \$1.00, postpaid.

GIANT YELLOW SUMMER STRAIGHT-NECK — 55 days — Plants are of the bush type. Fruits thick-necked, warted, straight, orange-yellow in color. Flesh greenish white and of excellent quality.

Pkt. 5c; oz. 10c; ¼ lb. 30c; lb. 90c, postpaid.

TOMATO

CULTURE — For early fruit, sow thinly in a hotbed or indoors in shallow boxes. Harden plants by exposing to the air occasionally. In about 6 weeks the plants will be ready to be set out, provided danger of frost is over. The rows should be 4 to 5 feet apart and the plants about 3 feet apart in the row. One ounce will produce 1,500 plants; 4 to 6 ounces required for an acre.

EARLIANA — 66 days — Very early. Habit of vine dwarf and compact. Fruit borne in clusters of from 10 to 15 in a bunch. A remarkable variety and one which is in good favor with market gardeners.

Pkt. 5c; oz. 40c; ¼ lb. \$1.20; lb. \$3.50, postpaid.

HYDRATED LIME

An occasional application of Hydrated Lime on the lawn will correct acidity in the soil. Acid soils are usually caused by constant sprinkling and very often in shaded places of the lawn will be found a surface growth of green moss. Hydrated Lime will correct this by simply being applied on the surface and sprinkled. It loosens up heavy soils and prevents packing, baking and cracking.

KARGER'S ROOT ROT RESISTANT — Many gardeners have been unable to grow tomatoes on account of root-rot in the soil. This variety has been developed by Mr. Geo. Karger and has proven highly resistant to root-rot. It is a strong vigorous grower with sturdy vines producing an enormous crop of large handsome fruit. The tomatoes are a rich scarlet red color, perfectly smooth, of even color, firm and solid. The skin is smooth and shiny, free from cracks or other irregularities. Has a delicious sub-acid and tasty flavor.

Pkt. containing about 400 seeds, 25c, postpaid.

CLARK'S SPECIAL EARLY — 81 days — New, excellent variety of tomato, now being used very extensively in the Rio Grande Valley section for shipping purposes. It is an early scarlet fruited variety, uniform in shape and carries well. Inclined to be globe-shaped and bears for a very long period. Truly an excellent variety for market gardeners.

Pkt. 5c; oz. 35c; ¼ lb. \$1.00; lb. \$3.00, postpaid.

RUTGERS — 73 days — It has thick outer and inner walls of solid meat, and therefore very small seed cavities and little seed. It is globe-shaped, scarlet-red color, resembling Marglobe. It ripens first in the center of the fruit, so that when red on the outside the tomatoes are ripe all through. In great demand for all purposes.

Pkt. 5c; oz. 40c; ¼ lb. \$1.20; lb. \$3.50, postpaid.

GROTHENS GLOBE — 73 days — Wilt resistant, globe shaped. Larger than Marglobe. Deep scarlet.

Pkt. 5c; oz. 35c; ¼ lb. \$1.00; lb. \$3.50.



John Baer

DWARF CHAMPION — 86 days — A dwarf variety sometimes called the tree tomato on account of its upright growth and its ability to stand alone without trellising. Fruit medium-sized, smooth, uniform and of a purplish-carmine color.

Pkt. 5c; oz. 40c; ¼ lb. \$1.20; lb. \$3.50, postpaid.

GULF STATE MARKET — 77 days — This globe shaped purplish-pink tomato has developed from Early Detroit and is as early as that variety. It is said to be especially adapted to the Gulf States and California. The fruits are large, showing little depression around the stem, and free from cracks.

Pkt. 5c; oz. 40c; ¼ lb. \$1.20; lb. \$3.50, postpaid.

CHALK'S EARLY JEWEL — 73 days — A wonderful new variety in that it is early and bears continuously throughout the season. The fruit is large, smooth, uniform and well ripened clear to the stem, and the flavor and quality are especially fine. Color bright scarlet.

Pkt. 5c; oz. 30c; ¼ lb. 90c; lb. \$2.50, postpaid.

PRITCHARD — 73 days — A scarlet self-topper, disease resistant variety. Fruits large, smooth, globular, solid with thick walls and cross sections. Color is brilliant red both exterior and interior. Highly productive, and has a fine flavor.

RED ROCK — 83 days — A mid-season variety resembling Matchless. Plant medium in growth. Fruits are medium large, thick, flat, deep scarlet, smooth and good quality. Pkt. 5c; oz. 30c; ¼ lb. 85c; lb. \$2.50, postpaid.

JUNE PINK — 69 days — A very early and productive pink form of Earliana. The best early pink on the market. Fruit solid and borne in profusion.

Pkt. 5c; oz. 40c; ¼ lb. \$1.20; lb. \$3.50, postpaid.

STONE — 86 days — The best main-crop tomato for all purposes, and largely used for canning. Vine tall and prolific. Fruits smooth, large and uniform. Color bright scarlet.

Pkt. 5c; oz. 20c; ¼ lb. 60c; lb. \$1.75, postpaid.

BREAK O'DAY — 70 days — Developed by F. J. Pritchard of Washington, D. C. A new wilt resistant tomato that is nearly as early as Earliana and as productive as Marglobe. Its fruits are large, smooth, meaty, red and globular, very similar to Marglobe but usually larger, used whole for salads or stuffed.

Pkt. 10c; oz. 60c; ¼ lb. \$1.75; lb. \$5.00, postpaid.

BONNY BEST — 73 days — Fruits of beautiful shape and color; good variety for early market and home use. Scarlet fruit with vigorous vine. Crops ripen uniformly.

Pkt. 5c; oz. 40c; ¼ lb. \$1.20; lb. \$3.50, postpaid.

MARGLOBE — 80 days — Tested repeatedly and approved by U. S. Dept. of Agriculture. Sure to be planted extensively before long. This is what the Department says about it: "Very productive, second early variety. Fruits large, smooth, meaty, red, globular. Highly resistant to wilt and somewhat resistant to blights."

Pkt. 5c; oz. 40c; ¼ lb. \$1.20; lb. \$3.50, postpaid.

JOHN BAER — 70 days — Early variety, maturing with Bonny Best producing fruit equally as good as Chalk's Jewel. Color bright scarlet; good size and smooth. The seed we offer was grown from the introducer's stock.

Pkt. 5c; oz. 25c; ¼ lb. 65c; lb. \$2.00, postpaid.

McGEE — 70 days — Well known in this State on account of its heavy-bearing qualities. It will yield splendid crops when all other varieties fail. Bright crimson, solid and good flavor.

Pkt. 5c; oz. 35c; ¼ lb. \$1.00; lb. \$3.00, postpaid.

YELLOW PLUM — 73 days — A small-fruited, bright golden yellow variety, very attractive; for salads or preserves.

Pkt. 5c; oz. 60c; ¼ lb. \$1.75, postpaid.

YELLOW PEAR — 73 days — Same as Yellow Plum, except that it is the shape of a pear and a trifle smaller.

Pkt. 5c; oz. 60c; ¼ lb. \$1.75, postpaid.



Clark's Special Early

RUTABAGA

CULTURE — Rutabagas require a longer growing season than turnips. Seed may be sown at the same time you plant turnips, in rows 2½ to 3 feet apart. Culture is practically the same as for turnips except the plants should be thinned to 8 to 10 inches apart in the row. One ounce will sow 400 feet of row; 1 to 2 pounds per acre.

AMERICAN PURPLE TOP or LONG ISLAND — 88 days — One of the best and most popular varieties, with yellow flesh. It is yellow below ground, with purple top above, and the leaves are small. A good stock-feeder or table variety. Pkt. 5c; oz. 10c; ¼ lb. 20c; lb. 60c, postpaid.

TURNIP

CULTURE — Sow in rows 18 inches apart, covering seed ½ inch deep, pressing the soil down firmly and smoothly. Plants should be thinned to 4 to 6 inches apart. Also sown broadcast. For best quality grow turnips in new ground. One ounce will sow 200 feet of row; 2 pounds an acre.

EXTRA EARLY PURPLE-TOP MILAM — 42 days — Excellent medium-sized turnip, almost as early as White Milam; smooth white surface, purple top, flat shape, white flesh; its growth is very uniform and quality the best. Pkt. 10c; oz. 20c; ¼ lb. 35c; lb. \$1.00, postpaid.

LOUSE RESISTANT — A splendid white globe turnip which grows well in hot and dry weather. Lice do not seem to attack this variety as quickly as other turnip greens. Pkt. 5c; oz. 10c; ¼ lb. 25c; lb. 60c, postpaid.

WHITE EGG — 55 days — A sort forming a root the shape and size of an egg in an incredibly short period after sowing. Flesh always palatable. Pkt. 5c; oz. 10c; ¼ lb. 20c; lb. 60c, postpaid.

PURPLE TOP-WHITE GLOBE — 50 days — An early medium-sized, globular shaped turnip of good quality for table or stock. Heavy producer, good quality while young. Pkt. 5c; oz. 10c; ¼ lb. 25c; lb. 60c, postpaid.

POMERANIAN WHITE GLOBE — 75 days — Large variety used largely for stock; is globe-shaped, large leaves, hardy. Pkt. 5c; oz. 10c; ¼ lb. 20c; lb. 60c, postpaid.

PURPLE TOP FLAT DUTCH — 46 days — Strap leaved; early flat variety. White with purple top. It matures quickly and has fine-grained flesh of fine flavor. It forms early a fine root, even in shape and of the best quality. Pkt. 5c; oz. 10c; ¼ lb. 25c; lb. 75c, postpaid.

COWHORN TURNIP — 70 days — This turnip grows very long, often 12 inches or more, and 2 inches in diameter and nearly half above ground. Very popular for stock feeding; is clear white except a little shade of green at top. Pkt. 5c; oz. 10c; ¼ lb. 30c; lb. 75c, postpaid.

YELLOW ABERDEEN — 70 days — A large sized, late maturing, long keeping, yellow fleshed turnip. It is hardy, productive, and valuable for stock feeding. The roots are yellow with purple top. The flesh is pale yellow, firm, tender and sweet. Pkt. 5c; oz. 10c; ¼ lb. 20c; lb. 60c postpaid.

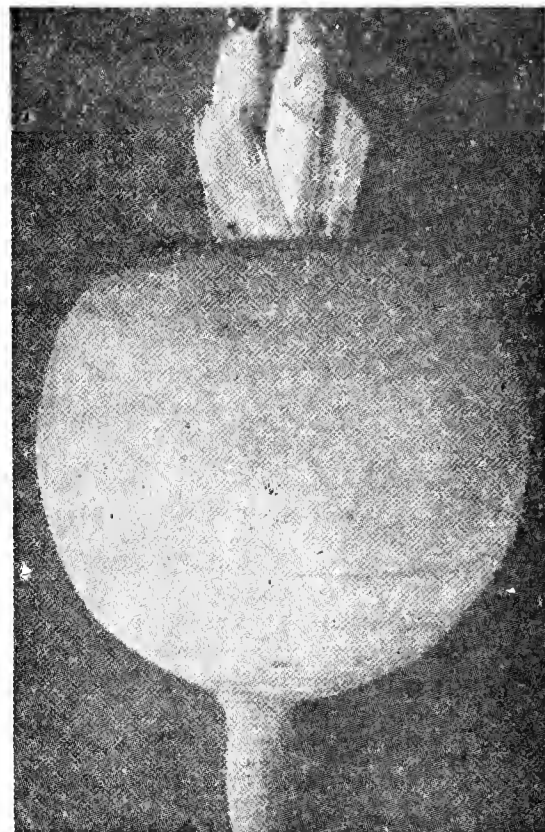

Purple Top White Globe

AUXILIN



MIRACLE ROOT GROWER FOR CUTTINGS — Many reasons for failure of rooting in the plants have been suggested. The discovery of AUXILIN now indicates that cuttings often fail to grow roots, either because this growth-stimulating chemical is not present or is trapped, and therefore unavailable to the cutting, or is present in less than effective quantities.

AUXILIN promotes vigorous and rapid growth of the plant itself, and if the cuttings are taken from woody plants, they usually produce stronger and more uniform specimens. For example, in the case of evergreen, new growth will follow the first year after the cuttings have rooted. Cuttings with flower buds on them will usually flower the same season.

AUXILIN treated cuttings mature sooner and flower earlier than plants grown from seed. A shrub rooted from cuttings, AUXILIN treated, will in the first year of growth represent a saving of several years growing time over a shrub grown from seed. Lilacs, if AUXILIN treated, can be rooted in July. In fact, most plant species can be rooted at any time during the year, regardless of their normal growing season, if given protection from adverse weather. Under the prevailing method of propagation, cuttings are usually rooted in those periods when the plants ordinarily make new growth.

1/6 oz. bottle, treats about 600 slips	\$.50
½ oz. bottle, treats about 1,800 slips	1.00
3½ oz. bottle, treats about 7,200 slips	6.00
8 oz. bottle, treats about 28,800 slips	12.00

AUXAN

AUXAN is a powder in which is incorporated a substance having a greatly stimulating effect on the rooting of cuttings or "slips" from the many types of plant-life which can be propagated in this way. AUXAN is prepared by a special process which insures uniformity of mixture and causes the active growth-substance to be readily available to the cutting. The formula used is one developed by extensive research and practical tests, and found to stimulate successfully, the rooting of a wide variety of plants and shrubs.



What Auxan Does

When cutting stems are dusted with AUXAN, a supply of growth-substance is made available to each individual cutting. Through the medium of the moisture in the rooting bed, the cutting slowly absorbs the active material from the powder, and the natural ability of the cutting to form roots is greatly stimulated. Quicker rooting and larger, and more vigorous root systems are the result.

¾ oz. size	\$.50
6 oz. size	2.50
16 oz. size	5.00

PROTECT YOUR GARDEN AGAINST

RAIN, WIND, BUGS, FROST
with
Hotkaps

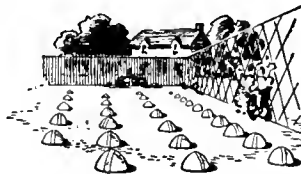

HOTKAPS are waxed paper cones, easily set out in quantity over seed or growing plants. They guard against rain, frost, cold, wind, hail, birds and insects, and maintain perfect mulch. Growth is forced and yield is increased 10 to 25%. Crops mature 2 to 3 weeks earlier and bring premium prices.

1,000 for \$10.25; 250 package with setter and tamper, \$3.65; 100 package with setter and tamper \$2.65; steel setter \$1.50; garden setter 50c. Postage extra.

Home Garden Set, 25 Hotkaps with Setter \$.50
Postpaid 65c

RAISE BETTER CHICKS AND PLANTS



It doesn't pay to turn your chick out in the spring rains, slush and snow to catch cold and die. Science has proved you cannot raise them successfully under glass. Put them in a brooder house with large FLEX-O-GLASS or VITAPANE windows that will admit plenty of unskimmed sunlight. Every chick will stay healthy, free from rickets (weak legs) and other diseases. Their fast, strong growth will be amazing. Also keep your hens in this coop next winter and gather eggs while they are high.

Hotbeds raise strong plants for transplanting. Frames are light, easily handled and hold heat better than glass.

1 Yard or more	per yard \$.35
5 Yard Roll	per roll 1.35
10 Yard Roll	per roll 2.70
15 Yard Roll	per roll 4.05
25 Yard Roll	per roll 6.75

VITAPANE

THE NEW SCIENTIFIC AND MODERN GLASS SUBSTITUTE

Vitapane is made from transparent cellulose acetate, reinforced with a tough netting fabric. The cellulose has already proved itself to be an ideal transparent material in a multitude of uses and under the most trying conditions. Because it has no foreign coatings or impregnations to wear off or become soiled, Vitapane always stays clear, clean, and new in appearance. Your Vitapane installations will not only be practical, durable and modern, but also attractive. Rolls 36. in. wide.

To install—merely tack down with strips of wood, allowing open spaces for water drainage. Price per square yard.....52½c



Alfalfa

CLOVER

Clover contains valuable minerals necessary for the growth and welfare of animals. Clover is a legume, and in its growth takes nitrogen from the air and stores it in the soil. Plant several clovers in your permanent pasture.

CALIFORNIA HULLED BUR CLOVER

INOCULATE SEED WITH NITRAGIN "A"
Bur Clover is used extensively and does well mixed with other clovers and grasses for permanent pastures. It also thrives on a wide range of soils, including sandy loams and lime-clad soils.

It is one of the finest crops for winter pasturage, and being a legume, it also places nitrogen in the soil while growing.

Bur Clover may be sown advantageously on Bermuda sod, the two plants furnishing almost continuous grazing. In this case the seeds are either sown early without covering, or else the Bermuda sod is so plowed as not to destroy the roots. Use four to six pounds of the hulled seed per acre for planting on Bermuda sod.

This variety of Clover is popular for sowing in mixtures of grasses and clovers, as the seed are out of the bur and more easily planted. Lb. 30c; 2 lbs. 55c, postpaid. Not postpaid, 10 lbs. \$1.75. Ask for prices in larger quantities.

MELILOTUS INDICA

(Annual Yellow Blossom Clover)
INOCULATE SEED WITH NITRAGIN "A"
Sometimes called Yellow Blossom Sweet Clover and also spoken of as Sour Clover. The chief use of this Clover has been for early pasturage and soil improvement, and is rapidly becoming recognized as a wonderful plant to plow under for green manure.

This plant, like many other clovers, thrives best on lime soils; however, it has been successfully grown on other types of soils. Its use should be extended more widely for winter pasturage and as a winter cover crop, especially on stiff lands.

The land is seldom prepared for Melilotus Indica. Instead, the seeds are sown with those of early fall grains or between the rows of some summer crop, or even broadcast over unplowed land.

Plant in September, October or November at the rate of 15 pounds to the acre, or about four pounds to the acre when planted with clovers and grasses. It will grow thru the entire winter and is just the plant to build up rundown soils. Lb. 25c; 2 lbs. 40c; postpaid. Ask for prices in larger quantities.

WHITE FLOWERING SWEET CLOVER—Thrives on practically all soils in Texas. Sweet Clover is a splendid soil builder and especially so when the entire crop is turned under. Every planter with cows should have a patch as it is a great milk producer. Sow at the rate of 15 to 20 pounds to the acre. Lb. 55c, not postpaid.

SATEX RECLEANED TESTED FIELD SEEDS

Scientifically Tested for Purity and Germination

Even in this past year of bountiful crops, there are a few items of field seeds that are somewhat short. This means changing prices. Therefore, all prices here listed are subject to change without notice.

You may rest assured that we will give you full value for your dollar on orders entrusted to us. If in doubt as to prices, send us a list of the field seeds you expect to purchase, showing the amount of each item and we will quote you by letter.

ALFALFA

HAIRY PERUVIAN—Is particularly recommended for our own State of Texas. As compared with common alfalfa, Hairy Peruvian is more upright, less branched and has fewer and somewhat coarser stems and smaller crown. It is also characterized by rapid growth, large amount of leaves, quick recovery after cutting and ability to make rapid growth in cool weather after ordinary alfalfa has ceased growing. Broadcast, 20 lbs. to 1 acre. Lb. 35c. not postpaid.

PERSIAN CLOVER

A marvelous new Clover that should be planted on every pasture in the South. Furnishes splendid grazing from December until June. Will carry 4 to 6 head of cattle per acre throughout the growing season. Yields 2 to 3 tons of rich, palatable hay per acre. Cures very quickly. Reseeds itself even when closely grazed and spreads rapidly. Grows 2 to 3 feet high, bears small pink flowers and seeds heavily. Will stand heavier, wetter lands than most Clovers. As a soil builder, many of our customers report that they have doubled their yields of corn after two years of this Clover.

Persian Clover grows well in mixtures, and is often planted with White Dutch, Bermuda and Dallis Grass. It has a deeper rooted system than White Dutch and requires less moisture for its success. It grows equally well on clay or loamy soils, other conditions being favorable. Sow 6 to 8 pounds per acre from September to November in the fall or early spring. Cover very lightly. Include this sensational new Clover in your pasture mixtures this spring. Seed should be inoculated with NITRAGIN. Lb. 55c; 5 lbs. \$2.50.

POPCORN

There is always a good market for Pop Corn, and every corn grower should plant it.

JAP-O-RICE—A newer variety. Cob small, grains long and slender. Used by nearly all commercial poppers. A really wonderful variety. Lb. 15c, not postpaid.

GIANT YELLOW or T.N.T.—Produces ears in great abundance on stalks nearly 6 feet high. It pops perfectly white. A single kernel will expand to nearly an inch in diameter. Lb. 15c, not postpaid.

SEED CORN

SURE CROPPER CORN—A truly remarkable drought resisting power. As old as is the history of corn growing in the South and Southwest is the search for a corn able to hold up and make a crop on the scanty moisture which we have in so many fields at some period of almost every season. In Sure Cropper we have found that corn. Lb. 10c, not postpaid.

GIANT WHITE RED COB—Makes a very large ear of the finest corn. Grains very large, deep, wide and thick, cob red, very popular wherever tried. We recommend this as being the finest variety of White Red Cob Corn. Has a very large, deep, wide, thick grain. Grain of medium size. Lb. 10c, not postpaid.

GIANT YELLOW — This beautiful yellow corn is deeply grained and very uniform in size. A sure cropper and good yielder. Matures in 90 to 100 days. Lb. 15c, postpaid.

IOWEALTH HYBRID No. 30 — This number has been a revelation to farmers in the southern part of the corn belt. It has the thick sturdy stalk and large showy ear characteristic of Midland Yellow Dent. Because of its uniformity and resistance to drouth, it has made friends wherever introduced and is one of the first hybrids to be sold in the southern corn belt which meets farmers' ideas of type as well as yield. The close fitting husk minimizes ear worm damage to this hybrid. It is a clean corn, very free from suckers, remarkably wind resistant and one of the best for drouthy areas. Lb. 20c not postpaid. Peck \$2.00; Bushel \$7.00.

NATIVE SQUAW CORN — A drought-resisting variety, plantable in the summer months. It has blue and white grains, therefore not so desirable by the market gardener. However, it makes a sweet and very juicy roasting ear. Lb. 10c, not postpaid.

TEXAS GROWN JUNE CORN—The stalks under favorable conditions grow from 7 to 8 feet high, and yield from 30 to 60 bushels to the acre. For best results it should not be planted until June or July, as it stands the hot weather better than any corn. Seed can be produced at any time after May 15th. Lb. 10c, not postpaid.

CHAMPION WHITE PEARL—An extra early pure white variety of dent corn. Matures in 100 days from time of planting, is very productive and the ears are exceedingly heavy. The grains are extra deep and white, and the cob is very small. A great favorite. Lb. 10c, not postpaid.

DROUGHT RESISTER CORN—It is a white, early maturing, deep rooted, drought resisting corn, with medium size stalk; a corn that is easy to get a stand of, for it is a very hardy variety and a fast grower. Drought Resister is an exceptionally deep-rooted corn with roots almost straight down, with an abundant root system, permitting plowing within 6 inches of stalk without disturbing the root system. It is almost impossible for a man to pull up a stalk of Drought Resister when in roasting ear. Lb. 10c, not postpaid.

TEXAS HONEY JUNE—Requires 87 days. A variety of Sweet Corn, especially adapted to growing in Texas. This corn was perfected by the Texas Experiment Station, at College Station, Texas. Has very heavy shucks, which makes it resistant to ear worm damage. Stalk about 6 feet tall. Ears, medium size, with 14 to 16 rows. We strongly recommend giving this wonderful corn a trial. Pkt. 10c; lb. 30c, not postpaid.

YELLOW SURE CROPPER—An excellent early Texas Yellow Corn, that matures in about 90 days, the ears measuring 10 to 12 inches and a big portion of the crop makes 2 ears to the stalk. It is a heavy yielder per acre and will stand a drought better than most varieties. Lb. 15c, not postpaid.

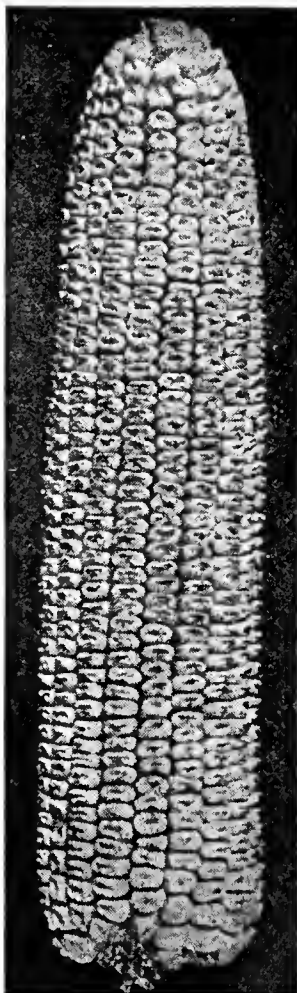

Texas King

BROOM CORN

OKLAHOMA DWARF — This type has much less seed on it, and is on the upper one-third of the brush, allowing much cleaner threshing and bales weigh fully one-third more and make the finest smooth parlor brooms, and also contain enough heavier, coarse brush for house brooms. Lb. 20c; not postpaid.

STANDARD EVERGREEN — Is very early and when properly planted and cultivated has beautiful green brush and commands the highest price. Harvested by cutting. Lb. 20c, not postpaid.



Cow Peas

COW PEAS

(Inoculate with Nitragin)

There is no cheaper means of improving our soils than by sowing Cow Peas. It is not necessary to turn under the crop of vines to improve the soil. More economical to cut off the vines and cure them as a hay crop, and then turn under the stubble and roots. Cow Peas make one of the largest yielding and most nutritious forage crops grown.

Sow broadcast in April, May, June or July, at the rate of 1 to 1½ bushels per acre, or they may be planted in drills, using from 12 to 15 pounds per acre.

BROWN CROWDER — This is a very fine, large variety of Peas and is popular as a table Pea throughout Texas and the Southwest. Lb. 15c, not postpaid.

BRAHAM — Seeds are similar in appearance to Whippoorwill, only much smaller and do not require to be seeded as thickly as other kinds. Are very resistant to disease, practically free from nematode, vigorous growth, holding their foliage well. Lb. 15c, not postpaid.

CALIFORNIA BLACK EYE. — The large Black Eye Peas are more prolific, better flavored and bring a higher price than most any other variety. Lb. 15c, not postpaid.

CLAY — Vines grow long and very leafy. One of the best for enriching soil. Lb. 15c, not postpaid.

CREAM OR LADY — This is a very fine variety for table use; is also a great soil builder. Lb. 15c, not postpaid.

WHIPPOORWILL — A favorite early, upright-growing variety, more largely used and sold than any other kind. Lb. 15c, not postpaid.

CHINESE RED — An excellent variety for soil improvement. Lb. 15c, not postpaid.

SPECKLED CROWDER PEAS — Similar to Brown Crowder, darker in color and speckled. Lb. 15c, not postpaid.

AUSTRIAN PEAS

This wonder plant makes a heavy vine growth that will decay very rapidly when plowed under.

As a cover crop, it only needs ten to twelve pounds of growth to each 10 feet square, to plow under for fertilizer. It therefore can be planted in South Texas as early as the first of January. Other crops planted on the same soil, following the plowing under of Austrian Peas, will show a tremendous increase in yield. Cattle, sheep and hogs will graze on a field of Austrian Peas and enjoy it. A greater tonnage of hay can be obtained when planted with oats, the oats acting as a support for the peas and encouraging their growth.

The most economical manner is to plant Austrian Peas in rows. In doing this, one should plant in three-foot rows such as in planting corn, then turn back and plant between the rows, thus giving you 8-inch rows when finished. It requires only 30 pounds to plant an acre in this way.

If wanted for pasture or hay, sow broadcast, 60 pounds to the acre; also 60 pounds to the acre when sown with an ordinary grain drill. Lb. 15c, not postpaid.

CANADA FIELD — Grows 4 to 6 feet high, and can be grazed when 6 to 10 inches high. Pasturizing the peas makes them stool out better. It is a good idea when sowing the peas to mix a bushel of oats, barley, or wheat with 50 pounds of peas per acre. This makes a fine mixture and makes good hay. If sown alone, sow about 75 pounds per acre, broadcast. Crop of this kind is splendid to plow under for green manure. Also used as a table pea and is only excelled by the English Pea. Lb. 15c, not postpaid.

If you want larger quantities of Peas, write us, stating quantity wanted and we will quote you lowest prices.

SOY BEANS

MAMMOTH YELLOW — Most popular, largest yielder. Grows 3 to 5 feet high. Should not be planted until danger of frost is past. For hay and as a soil builder sow 2½ bu. per acre broadcast; for beans plant 15 to 30 pounds per acre in drills 3 feet apart. Lb. 15c, not postpaid.

LAREDO SOY BEANS — A new variety of outstanding worth, particularly for making hay. The Laredo makes many slender branches and the plants are leafy, both of which go to make an ideal bean for hay. It is particularly adapted to sections where wilt and nematode are prevalent, as it has proven resistant to these troubles. Lb. 15c, not postpaid.

MAMLOXI — A large yellow bean, with a bright brown eye and shatters very little. A good crushing variety. Plant thick if wanted for hay purposes. Plant 30 to 45 pounds to acre for seed; 1½ bushels for hay. Lb. 25c.

VETCH

HAIRY VETCH — Ranks at the top as a winter legume — the champion soil-improving crop. Turned under at the proper time it will double and triple per acre yield of the following crop. Cut or grazed, combined with small grains, such as oats and rye, or seeded alone, it furnishes splendid winter and spring pasture. Makes wonderful hay, very rich in Protein; all stock relish it. Stands the severe winters in all parts of the South without injury. Withstands drought. Grows on practically all types of soils. Does surprisingly well on poor, thin land. Prevents soil erosion.

Sow during August through October at the rate of 20 pounds per acre in drills or 30 pounds broadcast. Lb. 15c, not postpaid.

A PROFITABLE INVESTMENT

Innoculate all Beans, Peas, Vetches, Cow Peas, Clover and Alfalfa with Nitragin. This inoculation will pay big returns on your original investment. See page 20 of this catalog for prices.

CHAPMAN RANCH COTTON SEED

(A Mebane Strain of Cotton)

1 — Chapman Ranch Cotton Planting Seed is pure bred and State certified.

2 — High gin turnouts, 38% to 43% lint, from clean dry seed cotton. Normal expectancy under average soil and weather conditions 40%.

3 — Big bolls, 50 to the pound, making easy and rapid picking at low cost.

4 — Good, hard, uniform cotton of desirable staple. A character of cotton that is always in demand and brings a premium.

5 — A high degree of storm proofness and drought resistance.

6 — Large acreage yield.

7 — Grown, ginned and prepared under the personal supervision of a competent cotton breeder. 3-bu. sacks.

1 Bushel ----- } Write
3-bu. Sack ----- } For Prices

GRASS SEED



Sudan

SUDAN GRASS — Stands dry weather and does not blight under ample rainfall. It is an annual, the seed having to be sown every year. Like the sorghum crops, it must be planted each spring, and dies when frost comes. The number of cuttings per season, therefore, depends on the length of the season. Usually matures in ninety days from first cutting. Its feeding values mark it as one of the dependable crops for every farmer. Stock of all kinds eat it readily and will leave other kinds of hay to eat it. Makes a splendid silage crop. In arid districts, it is usually planted in rows 36 inches apart. This requires five pounds of seed per acre. It is also sown broadcast where the rainfall is sufficient to produce corn. Sudan makes the highest yield and best quality of hay when sown broadcast, using from 25 to 50 pounds of seed per acre. Fancy seed. Lb. 10c, not postpaid.

BERMUDA GRASS — Almost everybody living in this section of the country knows this grass. It is planted as a lawn grass, and nothing will stand the sun better, or will make a prettier carpet, when kept short, than this grass. It is also very valuable as a pasture and hay grass, which heretofore had to be propagated by the roots. Lb. 60c; 10 lbs. \$5.50; 100 lbs. \$35.00, not postpaid.

GRASS (Continued)

FANCY HULLED BERMUDA GRASS — This is the same as our Fancy Bermuda Grass, but the hull is removed. This operation hastens germination. Many of our customers have reported to us that their plantings of the hulled seed have come up in seven to ten days after sowing. One of our customers who sows large quantities of Bermuda each season has written us that he will not use anything but the hulled seed in the future. He gave the hulled seed a fair trial and was certainly pleased and satisfied with the results. Lb. 75c, postpaid.

RYE GRASS (Lolium Italicum) — The seed we handle is American grown, of the Italian variety.

Of all the grasses for winter and spring pasture, we consider Rye Grass to be one of the best. Each plant, under favorable conditions, makes a round bunch with 20 or more shoots. Many varieties of Rye Grass are in use, but the American grown seed of the Italian variety is by far the best for the South. It is exceptionally hardy, standing very cold weather, and stays green all during the winter, spring and early summer.

Rye Grass is an annual, and, if allowed to go to seed, will re-seed itself and come up again when the weather gets cool in the fall. It makes excellent grazing for all kinds of livestock, and, if cut for hay, single cuttings will yield one to two tons of hay per acre. It grows from one and one-half to two and one-half feet high.

It is wonderful grass to include in mixtures with other grasses and clovers for permanent pastures, this applying especially where you are starting a new pasture.

Plant in fall and early spring, at the rate of 35 to 40 pounds per acre, or about one-quarter of this amount when planting with other grasses or clovers. Lb. 15c; 10 lbs. \$1.25; 100 lbs. \$9.00, not postpaid.

FANCY CARPET GRASS (Axonopus Compressus) — A perennial, spreading by creeping stems which root at every joint, thus forming a close, compact turf. Flourishes on land short in lime, thrives under grazing and trampling. Will stand more close grazing, trampling, grazing and overflow than any pasture grass known. On barren desert or piney woods plains will produce a perpetual grazing ground. It is not a weed or a pest; plowing under will destroy it completely. The Government says in any Southern coastal plains or flat woods country this grass is better than Bermuda Grass. Grows 2 to 2½ feet high. Can also be used with good results on lawns, also golf courses. Would advise all of our customers to give this wonderful grass a thorough trial. Sow in September or October; also in February, March and April at the rate of 10 to 15 pounds per acre. Lb. 40c; 10 lbs. \$3.50, not postpaid.

DALLIS GRASS

DALLIS GRASS (Paspalum Dilatatum) — Dallis Grass is a perennial, and is not a pest. It grows continuously, except in freezing weather, a smaller growth in proportion to the degree of dryness. While it does not grow in freezing weather, it comes nearer growing all the year around than any other grass. Dallis Grass will gradually choke out Johnson Grass and other weeds, if grazed fairly close. It needs only a start, in order to stop washes and gullies. It is very easy to eradicate, one plowing will kill it out. In our trial grounds we found it stood the hot, dry summer better than any other grass. Sow about 10 pounds per acre, or mixed with other grasses and clover most any time in the year. We find imported seed germinates much better than American grown seed. Fancy Seed: Lb. 35c; 10 lbs. \$3.00

RHODES GRASS

RHODES GRASS — (Chloris Gayana) — Rhodes Grass is a perennial hay and pasture crop. It is especially adapted to all sections of the South where the winter temperature does not go below 18 degrees. Colder than this it will probably winter-kill.

The grass spreads by runners on top of the ground. These runners may be six feet long, with joints every six inches or so, taking root and throwing up new plants. In this way it covers the ground rapidly. The frequent joints and the many crowns make it an ideal pasture crop. Broadcast 12 pounds of seed per acre, going over the field twice sowing 6 pounds each way. Lb. 55c; 10 lbs. \$5.00, not postpaid.

NON-SACCHARINE GRAIN SORGHUMS



Darso

DWARF BLACK HULL WHITE KAFIR — It grows from 4 to 5 feet high, making straight, upright growth, has a strong stem with enormous, wide leaves. The stalks keep green and are brittle, making an excellent fodder, either green or dried, for cattle and horses. The heads make the finest kind of feed. Sow in rows three feet apart, 5 to 10 pounds per acre. For fodder, sow one bushel per acre, broadcast. Requires 120 days to mature. Lb. 10c, not postpaid.

HEGARI — It makes an enormous yield of grain in most sections of the State and is more desirable for forage or silage than either Kafir or Feterita. It is dwarf in habit of growth, producing large heads of white grains that do not shatter. Plant 8 to 10 lbs. per acre. Stands dry weather well. Requires 114 days to full maturity. Lb. 10c, not postpaid.

ARIZONA GROWN HEGARI — The finest of Hegari grown. It will pay you big dividends to plant some of this splendid variety. Lb. 15c, not postpaid.

DWARF STRAIGHT NECK YELLOW MILO MAIZE — This variety is the most wonderful Milo Maize and stands the drought well. It is earlier than Kafir Corn and White Milo Maize, and very prolific. Stock seems to prefer it to corn, and it has a laxative effect on them, keeping them in good condition. Lb. 10c, not postpaid.

ARIZONA GROWN DOUBLE DWARF YELLOW MILO — Without a doubt the finest strain of Double Dwarf Maize that you can buy. You will find this seed as true to type as it is possible to produce same. Lb. 15c, not postpaid.

DOUBLE DWARF YELLOW MILO — Earlier than the old type Milo. The stalks are short, but large and stand remarkably well. The heads are large and the seed is larger or as large as the old type Milo. It will stand greater drought than most other sorghums and for that reason is adapted to dry farming. Should be extensively grown; in fact, every farmer should plant some of it. Lb. 10c, not postpaid.

Commercial Gardeners depend on us for tested varieties that will produce highest yields of marketable crops. Write for prices on large quantities.

FETERITA — The best drought-resistant non-saccharine Sorghum, and pretty well known in this State. Earlier than Kafir Corn, and a very heavy yielder. The grain is similar to Milo, but is pure white and also larger and softer. It does not shatter badly and yields as high as 80 bushels to the acre. Lb. 15c, not postpaid.

DARSO — Low growing, heavily foliaged with a large stalk, usually tinged with red. Its straight stalk is sweet and juicy, showing by chemical analysis to contain 12.76 per cent. saccharine in the juice, and analysis of the grain shows that the composition is very similar to that of Kafir. It matures earlier than Kafir, which fact has much to do with its drought resistance. Darso makes excellent silage, and can be used as a grain, forage or silage crop. It has given splendid results in Texas. Requires 110 days to full maturity. Lb. 10c, not postpaid.

ALGERIA or BISHOP KAFIR — A cross between Maize and Kafir. Livestock eat the entire stalk with relish. The stalk is sweet, containing a large amount of sugar, and grows from 4 to 5 feet tall, with leaves about twice the size of Indian Corn and form 15 to 19 leaves to the stalk. Algeria has a corn root, only it goes straight down instead of spreading, and will stand dry weather well, although it does exceptionally well in wet climates. Use about five pounds of seed per acre, thinning out to a stand similar to corn. It should be allowed to stool before working too much dirt to the roots. Requires 115 days to full maturity. Lb. 15c, not postpaid.

EGYPTIAN WHEAT (Shallu) — Is very productive, making an enormous yield of grain and fodder. Shallu or Egyptian Wheat should be sown in drills three feet apart, using from 5 to 10 pounds of seed per acre. Requires 120 days to full maturity. Lb. 10c, not postpaid.

SACCHARINE SORGHUMS

RED TOP or SUMAC CANE — This is the most popular variety for our State, and the one most generally planted. Seed is smaller than that of the Orange or Amber. Produces an immense quantity of fodder. Lb. 10c, not postpaid.

EARLY ORANGE — This variety has taller and heavier stalks than any variety of cane. It is not quite as early as the Early Amber, but is a better producer, and is better for syrup-making. Lb. 10c, not postpaid.

EARLY AMBER — This is the earliest sort, and makes fine hay, which is relished by all stock. Lb. 10c, not postpaid.

JAPANESE HONEY DRIP — Known in some sections as Japanese Seeded Ribbon Cane. It makes an unusually large stalk, sometimes as large in diameter as Ribbon Cane and much taller. Yields as much as four to five hundred gallons of the very best syrup to the acre. Lb. 15c, not postpaid.



Honey Drip

MILLET

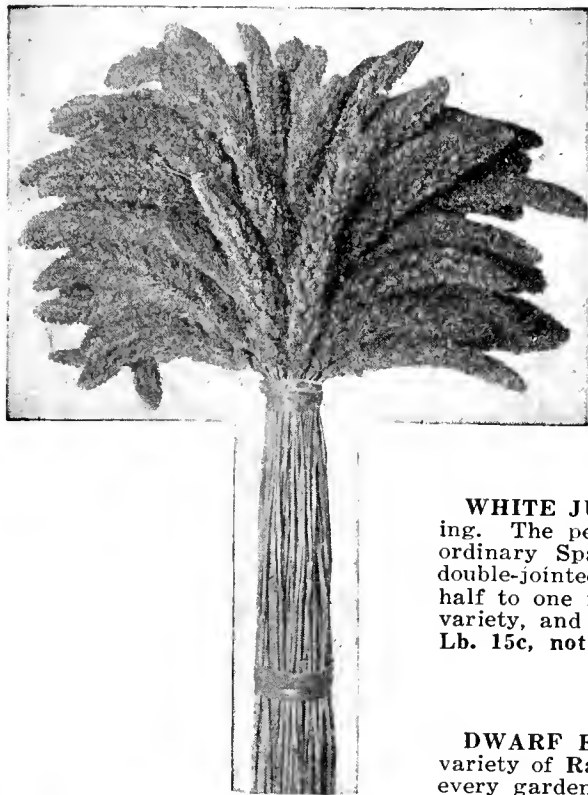

Millet

FANCY BIG GERMAN — The most popular of all the Millet for hay or seed. It matures in 6 to 8 weeks after planting. If wanted for hay it should be cut while in bloom, as the hay quality decreases as soon as the seed hardens in the head. Our variety of Millet is best and you will find it superior to any variety.
Lb. 20c, not postpaid.

HOG MILLET — The seed is large for a Millet and makes a rich food. Good for hogs or chickens. The seed ripens while the stem is yet green, so that if cut promptly you can get a crop of seed and also one of fodder or ensilage.
Lb. 20c, not postpaid.

PEANUTS

SPANISH — The earliest variety grown; pods are small, but remarkably well-filled and solid, and the yield per acre is very large. Can be cultivated with the plow. Because of its early habit and easy cultivation it is the best variety to grow for fattening hogs.
Lb. 10c, not postpaid.

WHITE JUMBO — This is the standard variety for roasting. The peanuts are three times as large as those of the ordinary Spanish peanut. The nuts proper grow in fine double-jointed hulls of beautiful appearance, are from one-half to one inch in length and of fine flavor. An excellent variety, and worthy of the highest recommendation.
Lb. 15c, not postpaid.

RAPE SEED

DWARF ESSEX — This is considered the most desirable variety of Rape, and should be planted on every farm and in every garden. Furnishes rich, nutritious pasture and green feed 6 to 7 weeks after planting.
Lb. 15c; 10 lbs. \$1.25, not postpaid.



Peanuts

SUNFLOWER

MAMMOTH RUSSIAN — Produces very large heads, sometimes 15 inches across. The seeds are valued very highly as a feed for poultry and can be planted on a waste piece of ground any time in the early spring and until the middle of July. Should be sown at the rate of about 3 pounds to the acre.
Lb. 15c; 10 lbs. \$1.00, not postpaid.



Here Is the Recommended Diet for Lawns and Flowers

● Plant food is a wise investment for every gardener. Properly fed plants grow so much better, are more hardy, and certainly are more beautiful. Because it supplies every one of the eleven different plant food elements plants require from the soil, **WE RECOMMEND** the use of **VIGORO**.

You'll be well satisfied with this complete plant food. It was created by scientists especially for feeding plants. Vigoro gives amazing results. It costs only 16c or less to feed properly 100 square feet of lawn or garden area. With Vigoro so economical, why deny your growing things a real square meal?



1 lb. pkg. -----	\$.10	25 lb. bag -----	\$1.50
5 lb. pkg. -----	.45	50 lb. bag -----	2.50
10 lb. pkg. -----	.85	100 lb. bag -----	4.00

ARMOUR'S 6-12-6 — A mixture for cotton and corn growers. Also used by truck farmers for potatoes, watermelons, tomatoes, etc.
Lb. 5c; 100 lbs. \$2.40.

ARMOUR'S 6-10-7 — A mixture for the grower who desires a lower phosphate content.
Lb. 5c; 100 lbs. \$2.35.

ARMOUR'S 4-8-4 — A good fertilizer for corn or cotton.
Lb. 3c; 100 lbs. \$1.75.

Protect tender young plants with **HOTKAPS**. Shield your plants from frost and wind. Full description and prices on page 23 of this catalog.

ARMOUR'S FERTILIZERS

Note: Prices on all fertilizers are subject to market changes. Write for quantity prices.

ARMOUR'S SPECIAL GARDEN FERTILIZER — This is a special prepared fertilizer for the home gardener containing the proper proportion of various ingredients to produce early, vigorous growth and bring vegetables, fruit, flowers and foliage to full development.
10 lb. bag 50c; 25 lb. bag \$1.00; 50 lb. bag \$1.50; 100 lb. bag \$2.50.

ACID PHOSPHATE — 16% — It gives excellent results on nearly all crops but is especially recommended for use on grains and grasses.
Lb. 4c; 100 lbs. \$1.50.

BONE MEAL — Ground very fine. Acts very quickly. There is no better fertilizer for the home garden than this splendid material. Splendid for rose beds, pot plants, etc.
Lb. 5c; 100 lbs. \$2.50.

NITRATE OF SODA — A fertilizer very quick in action and used for the nitrogen it contains. Will mature a crop several weeks earlier and greatly improve it.
Lb. 6c; 100 lbs. \$2.75.

MURIATE OF POTASH — To be used liberally, especially for root crops.
Lb. 5c; 100 lbs. \$3.25

AMMONIA SULPHATE — Contains approximately 25% ammonia (nitrogen). One of the highest nitrogen foods.
Lb. 6c; 100 lbs. \$2.75.

ARMOUR'S 5-15-5 — A mixture for the grower who desires a higher phosphate content.
Lb. 5c; 100 lbs. \$2.40

ARMOUR'S 10-20-10 — This brand has been especially prepared for such crops as require a quick, strong fertilizer. Especially recommended for potatoes, strawberries, watermelons, and all garden truck.
Lb. 6c; 100 lbs. \$3.50.

LIME (Hydrated) — For the sweetening and renovating of land that has become sour. It promotes growth and has a tendency to prevent weeds.
Lb. 2c; 40 lbs. 45c.

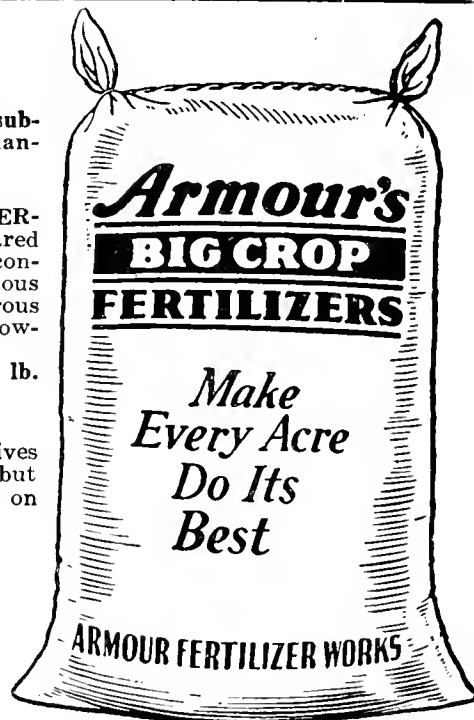

HERE IS THE SECRET OF MY SUCCESS, JOHN ROTATE WITH LEGUMES AND INOCULATE THEM WITH NITRAGIN

THANKS HENRY, I WISH I HAD KNOWN THAT YEARS AGO

NITRAGIN
over Forty Years of Service

RICH FERTILE FIELDS
Inoculated Legumes
GOOD CROPS
HIGH PROTEIN HAY
INCREASED SOIL FERTILITY
PROSPERITY

LOW PRODUING SOILS
POOR CROPS
LOW PROTEIN HAY
DECREASED SOIL FERTILITY
POVERTY

BUILD UP YOUR SOIL
Inoculate Your Legumes with NITRAGIN

Inoculate your Legume seeds even tho planted on fields that have been inoculated before. Field tests have shown that better crops are harvested when Legume seeds are inoculated even when planted on fields where inoculated seeds of the same Legume crops had grown the previous year.

INOCULATE WITH NITRAGIN

NITRAGIN is an approved, moist humus culture—tested and guaranteed—easy to apply—packed with Billions of fresh bacteria—the cheapest legume crop insurance money can buy. Directions on every can.

NITRAGIN INOCULATION PRICES

When Ordering, ALWAYS State Name of Seed

ALFALFA, all CLOVERS		LESPEDEZA Hulled or Unhulled	
Size	Retail	Size	Retail
1/2 bu. ea.	\$.30	1 bu. ea.	\$.30
1 bu. ea.	.50	2 bu. ea.	.50
2 1/2 bu. ea.	1.00	5 bu. ea.	1.00

PEAS (All Varieties)		SOYBEANS, LIMA BEANS, COW PEAS and PEANUTS	
Size	Retail	Size	Retail
1/2 bu. ea.	\$.25	1 bu. ea.	\$.30
1 bu. ea.	.40	2 bu. ea.	.50
1 3/4 bu. ea.	.60	5 bu. ea.	1.00
5 bu. ea.	1.70	10 bu. ea.	1.40
12 1/2 bu. ea.	4.00	25 bu. ea.	2.90

BEANS		GARDEN SIZE	
String, Wax, Kidney	Retail	Garden Peas and Beans	Retail
1/2 bu. ea.	\$.25	Sweet Peas and Lupines	Enough for 6 lbs. seed
1 bu. ea.	.40		Retail Price 10c each.
5 bu. ea.	1.70		

NITRAGIN — Oldest and Most Widely Used Inoculator in America

DUBAY SEED DISINFECTANTS
Prevent Disease Losses, Increase Stand and Yields



SEMESAN — For flower, vegetable and nursery crops. The protection afforded by Semesan against seed decay and damping off, assures the grower of better stands. Good stands of healthy, vigorous plants usually produce larger yields and better quality flowers, vegetables and fruits than thin stands of weak or stunted plants. For these reasons seeds treated with Semesan generally produce more profitable crops.

1 oz. treats 15 to 30 lbs. of seed by dust method; 40 to 60 lbs. by liquid method.
1/3 oz. pkt. 10c; 2 oz. 35c; 1 lb. \$2.25; 5 lbs. \$10.00

SEMESAN BEL — For seed potatoes. Controls scab and Rhizoctonia on white potatoes and prevents stem rot and scurf of sweet potatoes. 1 lb. treats 60 to 80 bushels.

In addition to killing seed-borne diseases, Improved Semesan Bel protects the seed pieces from rotting under cold, wet soil conditions, assuring better stands and larger yields. 1 lb. treats 60 to 80 bushels.

2 oz. 25c; 4 oz. 50c; 1 lb. \$1.50; 5 lbs. \$6.50.



2% CERESAN — For cotton, millets, peas, sorghums and narcissus. Controls surface seed-borne diseases and prevents seed rot. Reduces damping-off of seedlings. 2% Ceresan treated cotton seed in forty tests on farms produced almost 60% better stand before chopping than untreated seed. After chopping, the treated rows still had nearly 30% more plants than the untreated rows. At picking time, the treated rows outyielded the untreated by 16.2%. Almost one-sixth more seed cotton produced as a result of seed treatment with 2% Ceresan.

1 lb. treats from 5 to 8 bushels of seed.
1 lb. 70c; 5 lbs. \$3.00; 25 lbs. \$13.25; 100 lbs. \$50.00



NEW IMPROVED CERESAN — For wheat, oats and barley. Controls smuts of practically all kinds. In actual tests on farms, New Improved Ceresan treatment increased yields as follows:

Wheat — An average of more than a bushel per acre increase or nearly 6%.

Oats — 3.2 bushels per acre increase or over 18%.

Barley — Increase nearly 6% over untreated seed.

1 lb. treats 32 bushels of seed.
2 oz. 25c; 4 oz. 50c; 1 lb. \$1.50; 5 lbs. \$6.50.

SEMESAN JR. — For Seed Corn. Every grower knows the importance of securing good stands of healthy plants. But good stands, especially from early plantings when the soil is cold and wet, are hard to get.

New Improved Semesan Jr. helps to give you better stands by generally protecting the seed from rotting and the seedlings from blights and certain root-rots. 1 lb. treats 8 bushels of seed corn.

2 oz. pkt. 15c; 4 oz. 30c; 1 lb. 75c; 5 lbs. \$3.00.



TREE TANGLEFOOT

STOPS ALL CLIMBING INSECTS

TREE TANGLEFOOT — A sticky material for applying in bands around the trunks of trees and vines to combat the climbing and creeping type of destructive insect pests, effectively controlling Canker Worms, Climbing Cut Worms, Gypsy Moth Caterpillars, Browntail Moth Caterpillars, Tussock Moth Caterpillars, Bag or Basket Worms and Cut Ants. It remains effective three to four months, outlasting 10 to 20 times any other material.



RECOMMENDED BY AUTHORITIES

Forestry experts, government experiment stations and large commercial orchardists the country over are included in our list of users and enthusiastic boosters of TREE TANGLEFOOT. Safe, Dependable, Long Lasting.
6 oz. can 35c; 1 lb. can 65c; 5 lb. can \$2.75; 10 lb. can \$5.25; 25 lb. can \$13.00.

CROTOX

Bird and Rodent Repellant

Treats All Smooth Surface Seeds

Saves Seed Loss and Replanting

BONIDE CRO-TOX protects your seeds during the period when they are most easily damaged by ridding your fields of crows, doves, larks, starlings, blackbirds, pheasants and other seed-pulling birds and rodents, such as squirrels, woodchucks, moles, etc.

No need to replant seed when Bonide Cro-Tox is used. Birds and rodents will not molest seeds treated with Bonide Cro-Tox. Bonide Cro-Tox saves you expense and labor of replanting — assists you in preventing seed rot — aids and hastens germination. A guaranteed protection against seed pests at an insignificant cost of a few cents per acre.

1/2 Pt. can — treats 1 bushel seed	\$.60
1 Pt. can — treats 2 bushels seed	1.00
1 Qt. can — treats 4 bushels seed	1.50
1 Gal. can — treats 16 bushels seed	4.50



CUPROCID

SEED PROTECTANT

A safe and effective fungicide used as a seed treatment for the prevention of "damping off." Many vegetable and flowers seeds are difficult to grow without loss of many of the seedlings from the fungous disease known as "damping off." Many times the soil is so heavily infested with fungi that the seeds rot before they have time to sprout and come up. To combat this fungous disease, coat or dust the seed with Cuprocid, which will keep the fungi away from young plants.
Lb. 80c; 5 lbs. \$3.50

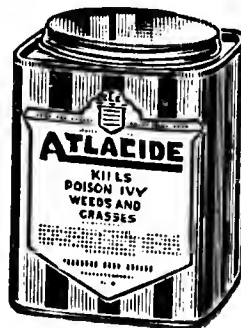

ATLACIDE
NON-POISONOUS WEED KILLER

KILLS JOHN-SON GRASS AND WEEDS

ATLACIDE NON-POISONOUS WEED KILLER — Exterminates all undesirable vegetation — including poison ivy, etc. — as easily as watering a garden, without poison hazard to humans or animals. Simply mix water and apply on any vegetation — weeds, grass, etc., with a sprinkling can or sprayer. Especially recommended for obtaining weed-free driveways, paths, tennis courts and gutters.
1 lb. 20c; 10 lbs. \$1.50, not postpaid.



SPRAYING PAYS

ACME Insecticides and Fungicides



A RELIABLE BRAND

WRITE FOR FREE SPRAYING GUIDE

ACME NIK-EMO



Here is an improved nicotine garden spray combining nicotine in its most active form with Emo, a summer oil emulsion spray of the finest quality. For control of aphids, mealy bugs, red spiders, thrip, white flies, rust mites, mildew, certain scale insects and certain other garden pests.
4½ oz. 35c; pint 65c; quart 95c.

ACME GARDEN GUARD — For use on cabbage, cauliflower and other vegetables, flowers and shrubs of many kinds.
1 lb. can, 35c; 4 lbs. \$1.00, not prepaid.

ACME TWO-WAY SPRAY — A balanced insecticide and fungicide containing 14% arsenate of lead and 83% Bordeaux Mixture. Two results with one application.
½ lb. 20c; 1 lb. 30c; 4 lbs. 80c.

ACME ALL ROUND SPRAY — All round spray contains the three leading remedies used by all large growers: Arsenate of Lead, Nicotine Sulphate and Bordeaux Mixture.
¼ lb. 35c; 1 lb. 80c.

ACME PARIS GREEN — A rich emerald color and of fine fluffy physical character. Containing 55% arsenious oxide, it will give quickest control where extreme measures are necessary.
¼ lb. 18c; 1 lb. 50c; 5 lbs. \$2.25; 14 lbs. \$4.75; 100 lbs \$32.25.

ACME DRY LIME SULPHUR — For use in dormant spraying against scale, peach blight, leaf curl and twig borer. Summer spraying against scab, soot, blotch, red spider and mite.
1 lb. 35c; 5 lbs. \$1.45; 25 lbs. \$4.00; 100 lbs. \$12.50.

ACME FISH SOAP — A (fish oil) soap effective in destroying many sucking insects and lice on plants, trees, ferns, etc.
Its use with Nicotine greatly increases the value of that spray.
1 lb. 30c; 5 lbs. \$1.25; 10 lbs. \$2.25.

ACME LONDON PURPLE — A favored insecticide for 50 years. Now stronger and better than ever.
¼ lb. 15c; 1 lb. 30c; 4 lbs. 50c.

ACME ARSENATE OF LEAD — The most favored arsenical insecticide found on the American market. It is safest to use on tender foliage and sticks well on the leaves.
½ lb. 18c; 1 lb. 30c; 4 lbs. 70c; 100 lbs. \$15.00.

ACME BORDEAUX MIXTURE — Prevents large losses caused by blight, rot, mildew, scab, anthracnose, and certain other fungous diseases. It stimulates plant growth and greatly increases the harvests.
1 lb. 30c; 4 lbs. 70c.

ACME CALCIUM ARSENATE — The cheapest arsenical insecticide on the market but of great economy and efficiency for certain purposes. The accepted dust for boll weevil poisoning on cotton; also recommended to combat chewing insects.
½ lb. 15c; 1 lb. 25c; 4 lbs. 50c; 100 lbs. \$7.50.

ACME DUSTING SULPHUR — For mildew, black spot on roses and other plant diseases.
2 lb. pkt. 25c.

APHIS SPRAY — A combination of Nicotine Sulphate 40% and Fish oil Soap for use on vegetables, roses, vines, flowers and shrubs to control aphids, thrip, leaf hopper and young scale.
3 oz. Tube 35c; 12 oz. Tube 90c.

BLACK LEAF 40

"BLACK LEAF 40" — A highly concentrated nicotine solution for spraying. Kills aphids, thrips, leafhoppers and many other insects. Does not injure foliage. World's leading garden insecticide. Used and endorsed by Experiment Stations and leading growers. We have an enormous demand for this article.

1 oz. bottle 35c; 5 oz. bottle \$1.00; 1 lb. \$2.25; 2 lb. tin \$3.25; 5 lbs. \$5.85; 10 lb. tin \$10.60.



TOBACCO DUST — For fumigating and dusting plants.
Lb. 20c; 10 lbs. \$1.50; 25 lbs. \$2.50, prepaid.

COPPER SULPHATE (Blue Stone) — Used for making Bordeaux Mixture.
Lb. 15c; 10 lbs. \$1.25; 25 lbs. \$2.60; 100 lbs. \$10.00.

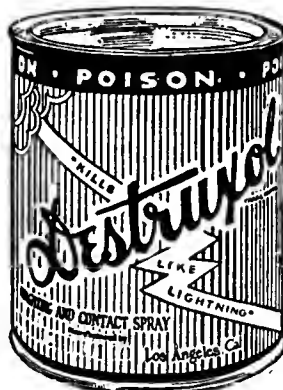

DESTRUXOL

One of the finest sprays for use against aphids, thrip, lice, red spider, leaf roller hoppers and mildew. It contains Nicotine Sulphate, Cyanide, etc., the Cyanide giving off fumes which reach insect life on underside of foliage.

1 oz. makes 5 gallons	-----	\$.40
2 oz. makes 10 gallons	-----	.65
4 oz. makes 25 gallons	-----	.90
½ pt. makes 50 gallons	-----	1.55
1 pt. makes 100 gallons	-----	2.25
1 qt. makes 200 gallons	-----	4.00

FUNGUSOL

FUNGUSOL EMULSION — A stable emulsion containing free nicotine, copper sulphates and oils; is especially effective in the control of mildew and other fungous diseases. Also very effective in the control of thrips.

4 oz. makes 5 gallons spray	-----	\$.45
½ pt. makes 10 gallons spray	-----	.65
1 pt. makes 20 gallons spray	-----	1.00
1 qt. makes 40 gallons spray	-----	1.65
1 gallon makes 160 gallons spray	-----	4.25



DESTRUXOL PREMEER POWDER

DESTRUXOL PREMEER POWDER — For the control of Snails, Slugs, Ants, and Sow-Bugs. Sprinkle the ground around the plant as well as underneath and on top of the leaves of the plants. Harmless to both plant and bird life.

1 lb. PREMEER POWDER to make 25 gallons diluted spray --- \$.90
3½ oz. PREMEER POWDER to make 5 gallons diluted spray -- .35
1 Heaping Tablespoon PREMEER POWDER makes 1 Gal. diluted spray.

SUPER DESTRUXOL EMULSION

DestruXol Emulsion contains the constituents of DestruXol, to which has been added neutral mineral oils in the form of a stable emulsion. Very effective in the control of scale, red spider and aphids on citrus and other trees.

½ pt. makes 3 gals. spray	-----	\$.45
1 qt. makes 12½ gals. spray	-----	1.15
1 gal. makes 50 gals. spray	-----	2.25

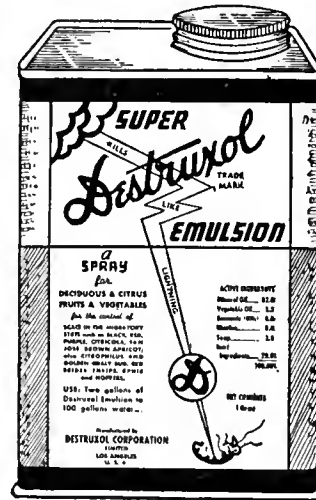

KOPPERSOL

For the control of mildew, blight and other rusts and fungous diseases as well as for Red Spider. One gallon makes 150 gallons of diluted spray.
One Gallon \$2.50.

LAWN-AGEN

LAWN-AGEN — A product which will combat Wire Worms, Nematodes and Brown Lawn Web-worm. Is definite and constructive in eliminating these pests, and at the same time protects your lawn to a great degree against Brown Rot and fungus diseases.

DIRECTIONS: One gallon diluted spray will cover a sprinkled area of ten square feet.
4 oz. 60c; 8 oz. 90c; 1 pt. \$1.50; 1 qt. \$2.50.

NEW EVERGREEN

KILL GARDEN INSECTS — NEW EASY WAY
New Ever Green Spray is the only spray 95% of gardeners ever need. No complicated instructions. Simply mix with water and spray. Harmless to plants, men and animals. Pyrethrin content deadly to both chewing and sucking insects. Economical.
1 oz. bottle 35c; 6 oz. bottle \$1.00; 16 oz. bottle \$2.00; 1 gallon bottle \$11.00.





BUFF COLOR CALGREEN

BUFF COLOR CALGREEN is the cheapest form in which the average cotton grower can buy Paris Green and calcium arsenate mixed in the same proportion as in Buff Color Calgreen. This is due to the economies possible through volume factory manufacture.

4 lb. pkg. 50c; 100 lb. drum \$11.50.

NON-POISONOUS INSECTICIDES

CUBOR SPRAY

A NON POISONOUS INSECTICIDE

Adapted for the control of a wider range of leaf-eating and sap-sucking insects than any other single product. As a single broad use product, it replaces a majority of the minerals formerly needed for specific pests. One pound will make from 25 to 100 gallons of spray according to the strength needed.

½ oz. pkg. 10c; 2 oz. pkg. 35c; 1 lb. pkg. 90c; 4 lb. pkg. \$2.40.



CUBOR DUST "50"

CUBOR DUST "50" containing 50% rotenone, for cabbage and cauliflower worms and other tender insects.

1 lb. 15c; 4 lbs. 50c; 100 lbs. \$9.00.

ACME KOPPER QUEEN

(Mildew Spray)

A strong liquid copper spray for the control of mildew, leaf spot, and black spot on rose bushes, flowers, and many other kinds of foliage. Stainless, leaves no unsightly residue which detracts so much from the appearance of flowers and ornamentals in your yard. Use as a liquid spray replacing Bordeaux Mixture and Sulphur.

½ pint 35c; pint 60c; quart 90c; gallon \$2.25.



RED ARROW GARDEN SPRAY

"America's FIRST-Aid to Gardens"

Kills Mexican Bean Beetles, Aphids, Rose Bugs, Aster and Dahlia Beetles, Cabbage and Tomato Worms, Japanese Beetles, Ants in lawns and gardens, Thrips, Leaf Hoppers and many other varieties of chewing and sucking insects. Safe, Leaves no Poison Residue, Effective and Economical.

1 oz. 35c; 4 oz. \$1.00; Pt. \$2.85; Qt. \$5.40.

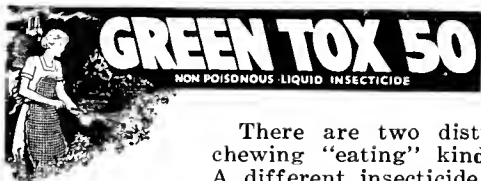

GREEN TOX 50
NON POISONOUS LIQUID INSECTICIDE

KILLS
Leaf-Eating and Sucking
Insects

There are two distinct classes of insects — the chewing "eating" kind and the sap "sucking" kind. A different insecticide used to be necessary for each class. Now "Green Tox 50" kills both. It kills the sap-sucking kind by contact and the chewing kind by stomach poisoning.

"Green Tox 50" is non-poisonous to humans, animals and birds, but sure death to "chewing" and "sucking" insects. No danger from eating fruit or vegetables sprayed with "Green Tox 50."

1 oz. (makes 30 quarts)	-----	\$.35
6 oz. (makes 45 gallons)	-----	1.00
1 pt. (makes 120 gallons)	-----	2.00
1 qt. (makes 240 gallons)	-----	3.50

Mailable



SNAROL

SNAROL — Kills Cutworms, Sowbugs, Snails, Grasshoppers, etc. A ready-prepared bait meal. Is not injurious to vegetation. Will not deteriorate from rain or sprinkling.

1½ lb pkg. 35c; 3 lb. pkg. 60c; 15 lb. bag \$3.00; 50 lb. bag \$8.00.



ANTROL ANT TRAPS

SAFE TO USE AROUND CHILDREN AND PETS

Can Be Used Inside or Outside the House
ANTROL ANT TRAPS — Kills both sweet and grease eating ants, contains two kinds of specially prepared material.
Each 15c.

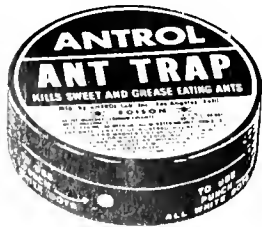

ANTROL

KILLS ANTS IN THEIR NEST

A Scientific Method Safe, Sure, Permanent

Antrol is easy to use, economical, safe around children and pets. Consists of small glass containers from which worker ants carry special Antrol Syrup to their nests for food. The whole ant family is quickly killed at the source — the only way to get permanent relief. Control's both sweet and grease-eating ants. Guaranteed. Proved in over a million homes.

Antrol Ready Filled Set containing four filled feeders, wt. 1 lb. -- 40c
Antrol Syrup for refilling, 4 oz. bottle ----- 35c



ANT-ZIX
THE KNOCK OUT BLOW
for ANTS!

DEPENDABLE
QUICK ACTION

KILLS CERTAIN ANTS BY THE THOUSAND

ANT-ZIX contains a new poison, tasteless and odorless, combined with the most attractive ant lures known. It attracts certain sweet-eating ants and then destroys them like nothing else will.

ANT-ZIX is a syrup packed in convenient tubes ready for instant use. No expensive accessories needed. Used as it comes from the tube. Tube 25c.

SULPHUR

WETTABLE SULPHUR — To be used in water for the control of such fungicidal disease as are susceptible to sulphur. For stone fruit, use 2 to 4 pounds to 50 gallons of water. For apple and pear, use 3 to 8 pounds in 50 gallons of water.

Lb. 15c; 10 lbs. \$1.10; 100 lbs. \$9.50.

DRY MILLED SULPHUR — Used as a fungicide, also for blight or mildew on roses.

Lb. 10c; 3 lbs. 25c; 14 lbs. \$1.00; 100 lbs. \$5.00.

COMMERCIAL SULPHUR — Especially valuable as an insecticide and splendid for soil treatment.

Lb. 5c; 10 lbs. 45c; 100 lbs. \$3.25

DUSTING SULPHUR — The standard dust-control of red spider, mildew, leaf-spot, and rust. The grade we offer is very fine and fluffy, will not clog.

Lb. 5c; 10 lbs. 45c; 25 lbs. 95c; 100 lbs. \$3.25.

ZINC SULPHATE — Used to control Rossette in Pecan trees. May be used in the soil or by placing in trunk of tree. Best results however are obtained by spraying leaves. Use 1 to 1½ lbs. to 50 gallons of water when leaves are about ½ inch long, 2 to 3 lbs. to 50 gallons of water when leaves are fully matured.

Lb. 10c; 10 lbs. 90c; 25 lbs. \$2.00; 100 lbs. \$7.50.

ALUMINUM SULPHATE — For making the soil acid for Azaleas and Camillias. Used also to change the color of Hydrangeas.

Lb. 15c; 2 lbs. 25c; 10 lbs. \$1.00, not prepaid.

GROUND PYRETHRUM FLOWERS — Dust directly on ants, also a splendid ingredient for killing flies, mosquitoes, roaches, etc. We recommend this preparation where a powder is desired. It is very effective and most economical to use.

Lb. 50c; 10 lbs. \$4.50.

BEE BRAND POWDER — For mosquitoes, roaches, flies.
2¼ oz. 25c; 6 oz. 50c.

FORMALDEHYDE — Used to disinfect incubators and to control seed-borne diseases on certain sorghums and seed potatoes.

Pints 35c; Quarts 65c; ½ Gallon \$1.20; 1 Gallon \$2.25.

COPPERAS (Sulphate of Iron) — Copperas is used to put the color in the foliage and blossom of the plant. It also aids them in blooming. If your shrubs or other plants have a pale, sickly green color they need Copperas. A splendid neutralizer of alkali in the soil. Use 200 to 400 pounds per acre; also fine for lawns.

Lb. 5c; 10 lbs. 45c; 25 lbs. \$1.00; 100 lbs. \$3.00.

BETTER PLANTS AND FLOWERS



USE GRANULATED PEAT MOSS

Something new which is just coming into general use. Imported Peat Moss is a brown, soft and spongy matter, formed years ago by the decay of mosses and other vegetable matter. It has high fertilizing value; holds moisture and is especially valuable for waxy lands. One bale is sufficient to cover 240 square feet one inch deep. The bale weighs approximately 140 pounds. Ideal for potting bulbs, either to be grown in water or under soil conditions.

5c per lb.; \$3.75 per bale, f. o. b. San Antonio.

**SATEX
ROACH POWDER**



SATEX ROACH POWDER is a combination of Pyrethrum, a non-poisonous powder that kills through suffocation and contact. Derris Eleptica, a non-poisonous ingredient that is only deadly to cold blooded insects and kills through contact by paralysis, and Blue Sodium Fluoride, a mild poison that acts both as a stomach and contact poison. These three ingredients have been properly blended to make the most effective and lasting roach destroyer on the market today. With the use of some dust gun, SATEX ROACH POWDER should be thoroughly dusted over the shelves of pantries, cupboards, backs of sinks, under tables, back of baseboards and hiding places of roaches. The immediate effect is to cause the insects to come out of their retreats and rush more or less blindly, showing evidence of discomfort to be followed in a few hours by their death. SATEX ROACH POWDER is 100% active and is sold on a money back guarantee.
4 oz. can 20c; 8 oz. can 30c, or 40c postpaid.

BLUE DEATH RAT KILLER



**A GUARANTEED RAT
KILLER**

BLUE DEATH — A new scientific rat exterminator that rats cannot resist. It attracts the wily, shy old fellow from their lairs and gets every last one. Blue Death contains pure,

sweet, clean natural products that rats really like and eat voraciously. Blue Death is more toxic than arsenic, barium, strychnine and red squill. It is a slow acting poison and the time required to kill is from 8 to 14 hours. Its slow killing action allows rats to escape out in the open to die.
1 1/4 oz. tube 35c; postpaid 45c.

TOPZOL

NON-POISONOUS

TOPZOL — A new EXTERMINATOR that is NON-POISONOUS to humans, domestic animals, poultry, dogs or cats; but will kill rats and mice quick. TOPZOL drives them outdoors to die. Numerous materials and contrivances have been designed for the destruction of rats and mice, but few of them have proved to be of outstanding usefulness. When using a deadly rat poison the danger of poisoning one's self as well as livestock, poultry, pet dog or cat, is always present. This danger is done away with when using TOPZOL as a rat and mouse killer, as it contains no deadly poison; having the distinct advantage of being relatively HARMLESS TO HUMANS AND DOMESTIC ANIMALS and therefore can be used with assured safety around the home, barn, poultry house, warehouse or any rat or mouse infested building.
2 oz. can 25c; postpaid 35c.

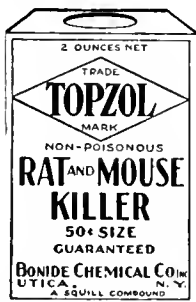

**TOPZOL
prepared
RAT BAIT**
READY FOR INSTANT USE

Package of Ten Prepared Baits Ready To Use. No Mixing. No Muss.

Pkg. ----- 15c
Postpaid ----- 20c

CYANO GAS

**KILL RATS, MOLES, ANTS,
WITH CYNOGAS**

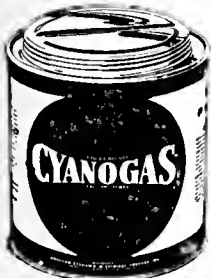

A gray powder giving off a poisonous gas when coming in contact with air. Kills ants, rats, moles and other rodents.
1/2 lb. 45c; 1 lb. 75c; 5 lbs. \$3.00.

PARADICHLOROBENZENE

Peach Borer — Weevil Control

A government-recommended control of the peach borer. Clean gum away from the tree trunk. Encircle the tree, 2 inches away from the trunk, with 1 ounce of P.D.B. and cover with fine dirt. Tramp down firmly. A weevil control (non-explosive) and more economical to use than High Life. Use 2 to 3 ounces in a barrel of grain. Should not be used on beans or peas that you desire for eating. Also recommended to oust moths out of bee hives and clothes; acts as a deodorant.
1/4 lb. 15c; 1/2 lb. 25c; 1 lb. 45c.

CARBON BISULPHIDE

CARBON BISULPHIDE (High Life) — Used very extensively in fighting harvester and cut ants. Most effective if used after a good rain, pour carbon bisulphide into nest opening late in the evening and close up opening. Use from 1 quart to gallon depending upon size of nests. As a weevil control use 2 to 3 ounces to a 50-gallon drum.
Qts. 55c; gal. \$1.75, not mailable.



**ACME
DAWG-GONE**

The purpose of Dawg-Gone is to keep dogs away from evergreens. Evergreens and especially arbor vitae are very easily

burned, leaving them greatly disfigured if not entirely killed. DAWG-GONE is a combination of rare chemicals releasing odor very distasteful to dogs.
Packed in tubes; per tube ----- \$.25

ACME KOPPER SHIELD PRUNING PAINT

A specially prepared liquid paint containing 2% copper for treating wounds left by pruning, storms or accident, to prevent such diseases as European Canker Fungus, Hard Rot, and certain other fungi. Forms a protective shield while the tree is naturally overcoming the shock. Covers twice as much surface as the ordinary bituminous tree compound.
1/2 pint 25c; pint 40c.



GARDENER'S SPRAYING GUIDE

Description of Injury, Insect or Disease	Spray or Dust
Aphids are small soft-bodied sucking insects 1/10 inch long, clustered together on flowers, leaves and stems.	Acme Aphid Spray, Destruxol, Evergreen, Acme All Round Spray, Green Tox "50", Aphid Spray.
Thrip are tiny black or yellowish elongated winged or wingless insects. Thrips rasp flowers and leaves, causing them to brown and die.	Acme All Round Spray, Arsenate of Lead, Acme Garden Guard, Green Tox "50", Evergreen.
Leafhoppers are wedge-shaped insects 1/8 to 3/8 inch long, winged or wingless; rear legs are very long. When disturbed they walk sideways.	Snarol, or Destruxol, Preemer Powder.
Beetles are hard-shelled insects of various colors and sizes which eat into or entirely consume leaves and flowers.	Acme All Round Spray, Fungusol Emulsion, Acme M-S-R Dusting Sulphur.
Caterpillars are fuzzy or hairless worm-like insects eating away at buds, flowers and foliage. They may occur singly or in colonies rolling leaves together or spinning webs.	Destruxol Emulsion, Acme Dry Lime Sulphur.
Cutworms pierce or cut off leaves or main stem of seedlings near the ground line.	Destruxol Emulsion, Koppersol Dusting Sulphur.
Sowbugs are dark gray oval-shaped, 14 legged creatures 1/2 inch long; if disturbed they curl up like a pill. Sowbugs feed upon seedlings and tender plants.	
Slugs are soft-bodied, slimy and legless, rasping away at upper leaf surfaces or eating out holes.	
Rust is a disease that causes leaves or stems to be rusty brown or yellowish, in streaks or in patches.	
Mildew shows powdery or felt-like patches on leaves and stems, causing leaves to curl up and drop.	
Leafspot is the cause of small spots on leaves or masses of spots, usually brown. Sometimes centers of spots fall out leaving leaf-holes.	
Scale insects are minute bark-like scales on branches, stems, or leaves.	
Red Spider are tiny mites that cause minute spider web tangles about leaves causing them to dry up and the tree to die.	

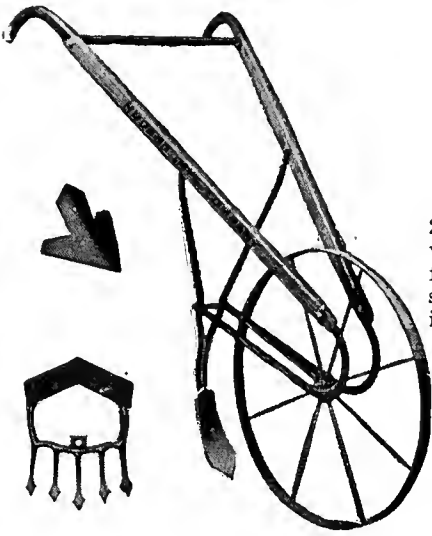

**HUDSON
GARDEN PLOW**

A counterbalance plow, with a 24 inch high wheel made of the very best material and most careful workmanship. This is a good strong, durable tool and can be used in the largest gardens. Is very popular and the best of its kind. Shipped with tools as shown.

Weight 28 pounds.

No. 242 ----- each \$3.75

**PLANET JR. NO. 4 COMBINED HILL
AND DRILL SEEDER**

The No. 4 is a combination of the most useful tools for a moderate sized garden. It plants almost all vegetable seed in continuous rows or in hills 4, 6, 8, 12 or 24 inches apart. A plow adjustable for depth opens a straight narrow furrow, the seeds are dropped in it, are covered and the soil is firmed and the next row marked out all in the same operation. Converted into a Single-Wheel Hoe by changing 1 bolt.

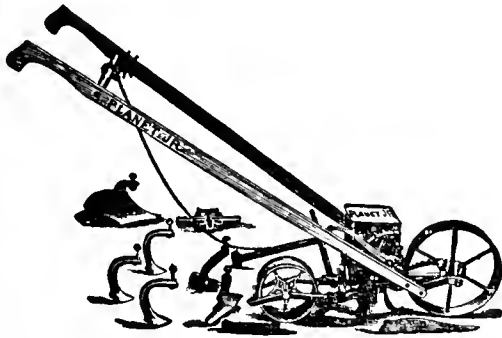

Cultivating equipment includes all the essential equipment for hoeing, weeding, cultivating, plowing, furrowing, ridging, etc. The tools are oil hardened and tempered and will wear almost indefinitely.

No. 4 — Complete ----- \$19.00
No. 4D — Planter only ----- \$15.00

PLANET JR. NO. 300-A SEEDER

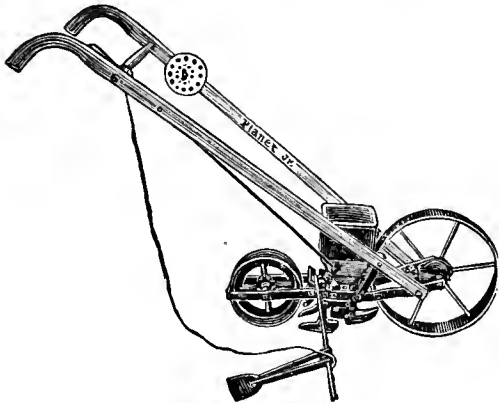

The No. 300-A sows through holes in a thin seeding plate; 3 plates each with 13 holes provides ample adjustment for any seed. Many exclusive features contribute to make this the most accurate and satisfactory seeder for commercial growers.

No. 300A — Planter only
Price ----- \$20.00

**CYCLONE
SEED SOWER**

A machine of very simple construction. This seeder will sow any seed that is sown broadcast, such as Oats, Wheat, Rye, Millet, Clovers, Grass Seeds, etc. It can be very easily adjusted to suit seed being sown. We sell a world of them every year and our customers say they give good satisfaction. \$2.75 each, customers paying transportation charges.

Mailing weight: 6 pounds.

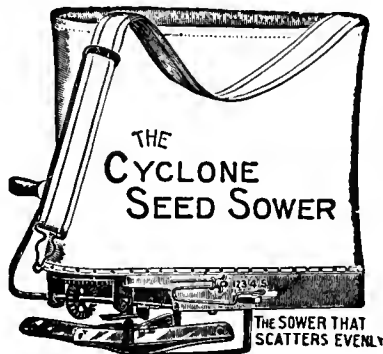

PRUNING SHEARS

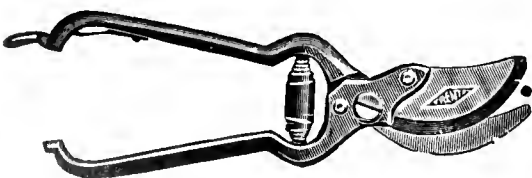

California pattern. Length, 9 inches, tempered tool steel blade. Volute spring. Adjustable ratchet nut. Black Japaned handles. Wt. 1 pound.
No. 313 ----- Each \$.60

GARDEN TROWELS

No. 80 — Garden Trowel. One piece pressed steel. Handsomely finished in baked enamel. Length of blade 6 inches. Ground and polished points. Each: 10c. Shipping weight 8 ounces.



GARDEN WEEDER

No. 82 — Garden Weeder. One-piece pressed steel. Handsomely finished in black baked enamel. Has five steel fingers, and is one of the most useful and handiest garden tools made. Ground and polished points. Each 10c. Shipping weight: 7 ounces.



TRANSPLANTING TROWELS

No. 81 — Transplanting Trowel. One-piece pressed steel. Handsomely finished in black and baked in enamel. Length of blade, 6 inches. Width 1 3/4 inches. Ground and polished points. Each 10c. Shipping weight: 7 ounces.



MAGIC GARDEN HOSE SPRAYER

SPRAY
THE MODERN WAY

- ★ NO MIX
- ★ NO MUSS
- ★ NO MUSCLE



Radically different in design and operation, easily attached to the ordinary garden hose, providing a simple and effective method of controlling insect pests in both lawn and garden.

All brass construction, heavily chrome plated, fitted with a transparent cartridge chamber, enabling the operator at all times to observe the condition of the cartridge contained within. Change from ordinary hose nozzle to sprayer or viceversa can be made almost instantly and as an added convenience the necessity of preparing messy spraying solutions is entirely eliminated. Each, \$3.25, postpaid.

**COLLOIDAL SULPHUR CARTRIDGE
FOR MAGIC GARDEN HOSE SPRAYER**

Colloidal sulphur concentrate, a most effective agent in combatting blight and fungus diseases, in convenient cartridge form ready for instant use in the Magic Garden Hose Sprayer. No mixing or other preparation necessary. 35c each, postpaid.

**PYRETHRUM-ROTENONE CARTRIDGE
FOR MAGIC GARDEN HOSE SPRAYER**

One of the most powerful and certain destroyers of all forms of harmful insects, both chewing and sucking. Pyrethrum and Rotenone highly concentrated in cartridge form designed to be used most effectively with the Magic Hose Sprayer. 35c each, postpaid.

HUDSON BANTAM SPRAYER

A small, efficient pattern for household use. Pump 1 1/4 inches in diameter, 8 inches long. Fitted with screw cap and syphon tube.

Tank is detachable. Can be capped and set away with liquid if desired.

No. F3 1/2 Bantam — 5 1/2 ounce ----- \$.20

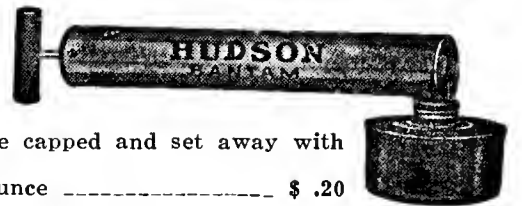

GLASS JAR SPRAYER NO. G3 1/2

An outstanding pattern for household use. Detachable glass container safely handles solutions which destroy metals. Pump, 1 1/4 inches diameter, 8 inches long, curved syphon tube.

Glass container shows nature and amount of contents. Can be capped if desired.

No. G3 1/2 Glass Jar Sprayer — 4 1/2 ounces ----- \$.20

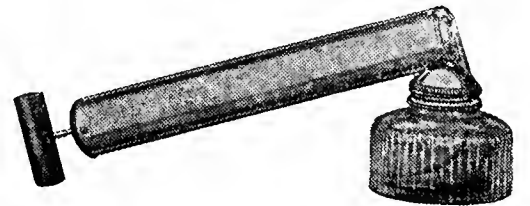

HUDSON MISTY SPRAYER

A popular pattern for back-yard garden, poultry house and similar use. The point of pump passes through top of tank and is securely soldered, making a very sturdy construction. Pump is heavy tin, 1 1/2 inches diameter, 14 inches long. Tank is heavy tin, lock seamed and thoroughly leak-proof.

No. 452 Misty—1 quart ----- \$.45

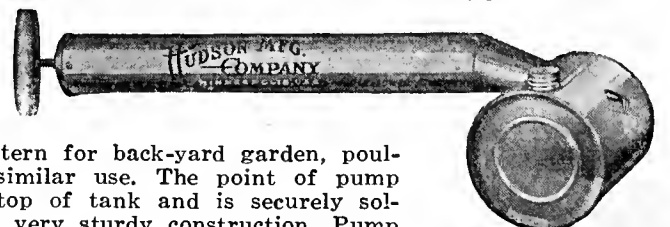

HUDSON HANDY SPRAYER



Another popular pattern for the yard, garden, poultry house, etc. Carefully made of good material, thoroughly tested. Pump is heavy tin, 1½ inches diameter, 14 inches long. Tank is heavy tin, lock seamed and thoroughly leak-proof.

No. 440 Handy — 1 quart \$.35
 No. 222 Vapor — ¾ pint, pump 1¼ in. diameter. 10 inches long25

HUDSON CONTINUOUS SPRAYER

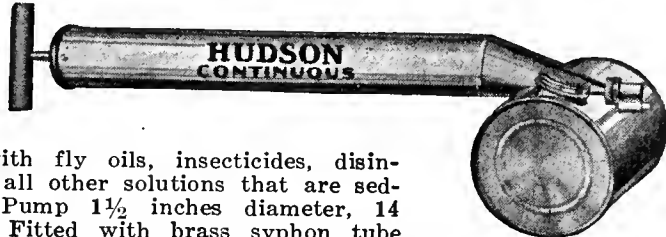

For use with fly oils, insecticides, disinfectants and all other solutions that are sediment free. Pump 1½ inches diameter, 14 inches long. Fitted with brass syphon tube and nozzle to prevent corrosion. Adjustable for any type of spray from fog to solid stream. Absolutely will not spit. Weight 13½ lbs.

No. 432—Tin Container, 1 quart \$.75

HUDSON SIGNAL DUSTER



For use with powder insecticides in and about the home. Heavy tin pump 1½x7 inches. Fitted with Hudson AIR-PAK plunger. Powder reservoir 1½x3 inches. Large, easily removed cap with discharge tube to drive the powder into cracks and crevices. Air valve prevents powder escaping back into cylinder.

No. 660 Signal Duster, \$.30
 No. 651 Corporal — 5 in. stroke, 3 in. powder reservoir, 1¼ in. diam. .20
 No. 663 Cadet — 8 in. stroke, 5 in. powder reservoir, 1¼ in. diam. .40

HUDSON PATROL DUSTER

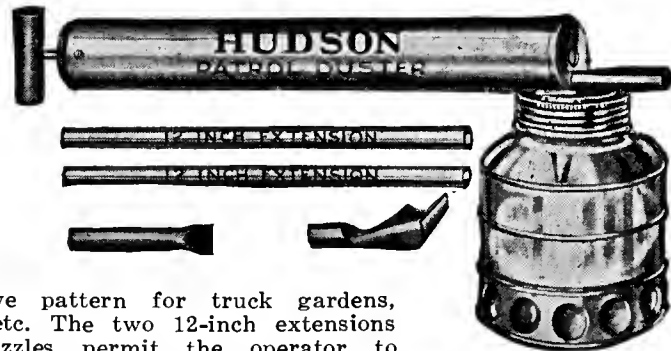

An effective pattern for truck gardens, field crops, etc. The two 12-inch extensions and two nozzles permit the operator to reach all parts of the plant. Positive force feed construction absolutely prevents clogging.

Pump, 1¾x15 inches. Fitted with special cupped plunger leather. Powder reservoir, glass, specially designed. Contents always visible. Wide mouth permits easy filling or cleaning. Any standard Mason jar can be substituted if desired. Discharge equipment, two 12-in. extension pipes and two nozzles.

No. 612 Patrol Duster \$1.00

HUDSON CAPITAL SPRAYER PUMP



For Fly Oils, repellants and similar preparations in dairy barn, poultry house, hog pen, as well as for janitor and commercial exterminators. High pressure insures forceful spray, properly atomized. Shut-off valve controlled by touch of finger prevents waste of solution. Each sprayer individually air tested.

Tank galvanized steel, 5½ inches diameter, 6¾ inches long, double seamed and thoroughly soldered, large filler screw cap.

Pump 1½ inches diameter, 17 inches long, fitted with Perfection air valve. Securely anchored to tank. Combined brace and hand grip.

No. 437 — Capacity 3 quarts. One in carton \$2.25

HUDSON PERFECTION

The Open-Top Perfection offers greater value, greater individuality, better performance. Designed by engineers, built by craftsmen. Tested and proven under every conceivable condition. Pump and top assembly lock securely in operating position by means of four steel locking fingers which insure positive seal. Impossible to release and remove pump before pressure is exhausted.

Tank: 7½x21 inches. Capacity full 4 gallons. Galvanized or copper sheet. Securely riveted and heavily soldered throughout. Tested to 100 pounds pressure. Wide opening makes easy filling, emptying or cleaning. Pump: Seamless brass tubing, 1¾x15½ inches Air-Pak plunger. Perfection Air Valve. Cylinder screws into steel top cap. Discharge equipment: 27 inches high pressure spray hose; all brass Perfection shutoff valve which locks open for continuous discharge; 24 inch brass extension; all brass nozzle adjustable to any angle.

Shipping Weight: about 4 pounds.

No. 240G—Galvanized tank, 2½ gal. lons \$4.40
 No. 240B—Brass tank, 2½ gal. 7.40
 No. 210G—Galvanized tank, 4 gal. 6.50
 No. 210B—Br ss t nk, 4 gal. 10.50



HUDSON STERLING

4 GALLON — OPEN TOP

The Sterling is a 4 gallon Open-Top at a moderate price. Large 5 inch opening provides easy filling, emptying or cleaning. Pump and top assembly lock securely in operating position by four steel fingers, controlled by turning malleable pump handle. Adapted for whitewash, cold-water paints, agricultural insecticides, etc.

Tank: 7½x21 inches. Capacity full 4 gallons. Galvanized or copper sheet. Securely riveted and soldered throughout. Tested to 100 pounds pressure. Pump: Seamless brass tubing, 1¾x14 inches. Air-Pak Plunger. Perfection Air Valve. Cylinder screws into steel top cap. Discharge Equipment: 24 inches high pressure spray hose. All brass Perfection shut-off valve which locks open for continuous discharge. 21 inch brass extension. All brass angle spray nozzle.

Shipping weight: About 9½ pounds.

No. 215G — Sterling, galvanized tank, \$5.50
 No. 215B — Sterling, copper tank --- 8.75



HUDSON LEADER

3½ Gallon Funnel Top

A full 3½ gallon capacity sprayer with Saf-T-Kam lock and funnel top. Large capacity and high pressure adapt it for all work.

Tank galvanized steel, capacity 3½ gallons; diameter 7½ inches, height 20 inches. Seams riveted and soldered. Top and bottom double beaded for extra strength and safety. Tested at 100 pounds pressure.

Pump seamless brass tubing, 1¾x14 inches; seals into tank by steel Saf-T-Kam lock. Locks or releases by half turn of malleable "D" handle. Cannot be removed before pressure is exhausted.

Discharge equipment includes 24 inches high pressure spray hose; Perfection automatic shut-off valve which locks open for continuous spraying; 21 inch brass extension rod, all brass nozzle.

No. 192G — Galvanized \$3.25



HUDSON MODOC BUCKET PUMP

The No. 122 Modoc is a sturdy, all-brass, double-acting continuous spray pump. Adapted for spraying fruit trees, vines, gardens, ornamental shrubs and hedges, washing automobiles, wagons, windows or as a fire pump. Handles stock dips, cold water paints, insecticides, disinfectants, etc. Develops 150 pounds nozzle pressure. Discharge equipment consists of 3 feet of ¾-inch special spray hose, 12 inch curved brass extension rod and disc type all-purpose nozzle.

No. 122 Modoc Spray Pump \$3.75

No. 112 Marvel Spray Pump 2.80

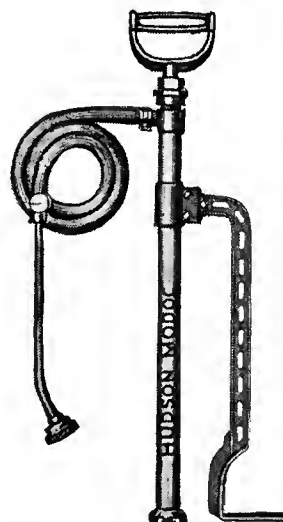

HUDSON DU-MORE SPRAYER



A new continuous, high-pressure Knapsack Sprayer with large air chamber made of brass.

Capacity 4 gallons. Discharge equipment, 3 ft. spray hose, 2 ft. iron extension rod, shut-off valve and brass angle fog nozzle. Shipping weight 10 pounds. No. 147G — Galvanized tank
No. 147B — Copper tank

\$15.00
21.25

HUDSON SUNSHINE SPRAYER

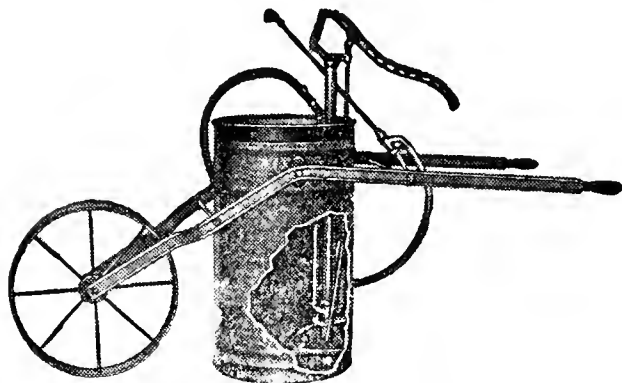

Adapted for small orchards, vineyards, truck gardens, berry bushes, as well as for use by florists, nurserymen and greenhouses. Handles insecticides, disinfectants, whitewash, cold water paints and similar preparations.

Pump is No. 126SA Moro, easily removable. Fitted with non-

clogging tubular brass intake strainer which has fifteen times the area of the ordinary strainer. Dasher agitator cleans it thoroughly at each stroke preventing clogging.

Tank is heavy gauge galvanized steel, reinforced at top and bottom. Frame is heavy channel steel with channel iron cross braces. Strong and sturdy. Wheel 16 inches high with 2-inch tire.

Fitted with 6 feet of discharge hose, 3 feet iron extension rod, brass angle nozzle and Perfection shut-off valve. No. 36S Sunshine Sprayer — 12½ gallon as shown; weight 40 pounds

\$12.75

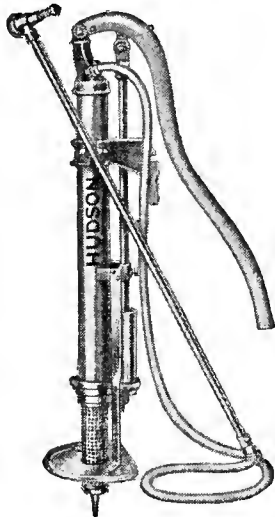

HUDSON BARREL SPRAY PUMP

Handles whitewash, cold water paints, caustic mixtures, agricultural insecticides, etc. Pump cylindrical seamless brass tubing, 1¾ x 7 inches. Air chamber high carbon steel, 2 x 27 inches, light strong and sturdy. Tubular brass intake strainer provides strainer area fifteen times that of ordinary type. Dasher agitation cleans as at each stroke, absolutely preventing clogging. Entire valve assembly, including the intake strainer, accessible from outside of pump without dismantling. Fitted with 6 feet iron extension rod, and brass angle spray nozzle. Wt. 30 pounds.

No. 4SA Barrel Pump — Complete as shown

\$12.00

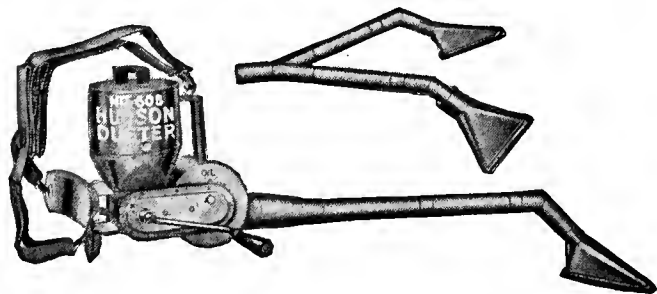

ROTO-POWER CRANK DUSTER

For truck gardens, vineyards, small orchards, etc., as well as clubs, city parks, cemeteries and similar places. Sturdily built. Enclosed machine cut gears, running in oil. Discharge equipment: two nozzles; two elbows, a wye connection and four 15-in. tubes. Feed regulator quickly adjusted for any desired volume of dust. Rotary screw agitator, feeds powder into moving air stream and through fan. No powder is fed when fan is not moving. Equipment can be arranged to dust plants from above, from under side as for aphids, bushes, trees, etc.

No. 608 Crank Duster

\$12.50

HUDSON SPRAY PUMP REPAIR PARTS

(See pages 25 and 26 for Pumps)



No. 166

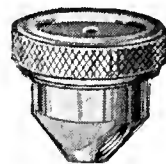

No. 168

Hudson Fog Nozzles are made entirely of brass, all parts carefully machined. Practical for all general spray work. Equipped with removable brass screen and reversible spray disc. Threaded with ¼ inch standard taper pipe thread.

No. 166 Straight Fog Nozzle, each \$.60
No. 168 Angle Fog Nozzle, each60

No.	Price
P 1 — Valve Spring	\$.10
P 2 — Valve Disc	.20
P 3 — Gasket 2¾" O.D., 1-11/16" I.D.	.10
P 7 — Plunger Leathers 1¾"	.10
P 11 — Check Valve Spring	.10
P 13 — Gasket 2¾" O.D., 1-13/16" I.D.	.10
P 21 — Metal Expanders	.03
P 23 — Gasket 2¼" O.D., 1-11/16" I.D.	.10
P 26 — Valve Check	.15
P 27 — Check Valve Cage Housing	.20
1N — Fog Nozzle Cap	.30
2N — Fog Nozzle Washer	.03
3N — Fog Nozzle Outside Disc, Regular	.05
3NF — Fog Nozzle Outside Disc, Fine	.05
4N — Fog Nozzle Inside Disc, Regular	.05
4NF — Fog Nozzle Inside Disc, for whitewash	.05
5N — Fog Nozzle Screen	.05
2X — Shut-off Valve Handle	.15
2XD — Shut-off Valve Handle, Drilled	.15
3X — Shut-off Valve Nipple	.10
4X — Shut-off Valve Packing Nut	.20
5X — Inside Gland Washer	.03
6N — Shut-off Valve Spring	.25
7X — Shut-off Valve Pin	.25
7XD — Shut-off Valve Pin, Drilled	.25
62N — Nozzle Washer	.03
¾" Spray Hose, per foot	.16

LEE'S POULTRY SYRINGE

Many times in treating sick chickens it becomes necessary to give individual doses of medicine, and if the birds refuse to eat, this can only be done by the use of Lee's Poultry Syringe. Here are a few of its many uses: Individual treatment of sick chickens; individual doses of epsom salts; washing out crop with Germozone in limberneck; doses of castor oil, sweet oil, or mineral oil; feeding milk or thin gruel to sick chickens. 1 oz. capacity, 25c; postpaid 30c.

LEE'S NASAL SYRINGE

In swelled head and other very serious diseases of this type, the upper air passages of the head become filled with mucus. Medicine, to be effective, must come in direct contact with the affected membrane lining.

With this syringe the medicine is forced into the head right where it will get direct action against the disease and, at the same time, this forcing of the medicine into the nasal passages also forces the mucus out of the head. The mucus will come through the nose and eye sockets.

Each \$0.75



QUITMAN METAL SYRINGE



All metal syringe used to inject Avian Bacterins. 5 c.c. Capacity. Packed with two needles \$1.50

B. D. METAL CHAMPION SYRINGE

Heavy metal syringe with protected glass cylinder marked for doses. Plunger adjustable to proper pressure for injection. 10cc capacity. Each \$2.10; Syringe Needles, 19G or 16G each 25c.

VETERINARY DOSING SYRINGE

1-oz. capacity; to be used in giving Lee's Hog Oil Wormer to hogs \$1.25

OAKES' BLUE FLAME BROODER REPAIR PARTS

BF-1T—Glass Oil Tank Complete with Valve	\$1.25
BF-2V—Valve only for oil tank	.50
BF-3W—Double 3" Brass Wafer	.27
BF-5A—Adjusting Screw with Lock Nut	.25
BF-7W—Wick	.15
BF-8N—Needle for Valve	.25
BF-9S—Spring for Valve	.10

WINNER CHICK TROUGH

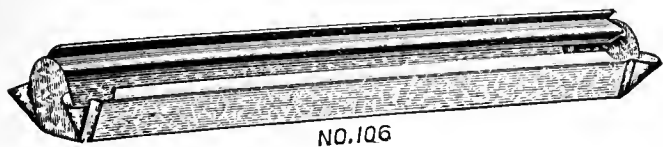

NO. 106

Trough is made of heavy gauge galvanized steel; die stamped in one piece; holds either feed or water; turned flange along trough edge is folded — no sharp edge. Flange prevents feeding waste.

Revolving metal reel is "Z-shaped" for strength; will not warp or stick; prevents chicks from roosting or getting into trough.

Trough is 1½ inch deep, 2½ inches wide at bottom and 3 1/2 inches wide at flange upturn. A big value. The price is surprisingly low.

- No. 104A—12 in. long, each \$.15
- No. 105A—18 in. long, each20
- No. 106A—24 in. long, each25

ENFOLD CHICK TROUGH

For starting chicks and feeding the first 5 to 6 weeks. Metal Z reel is adjustable to two positions. Revolves to prevent roosting. Trough is 1¾ in. deep and 3½ in. wide. Smooth turned flange to prevent waste of feed. Made of heavy galvanized steel.

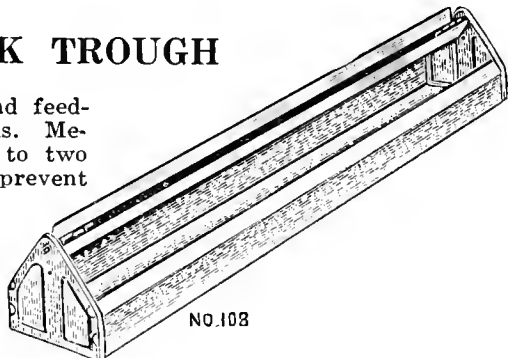

NO. 108

- No. 107 — 12 inches, each \$.17
- No. 108 — 24 inches, each25
- No. 109 — 36 inches, each35

SQUARE BOTTOM CHICK TROUGH WITH METAL Z REEL

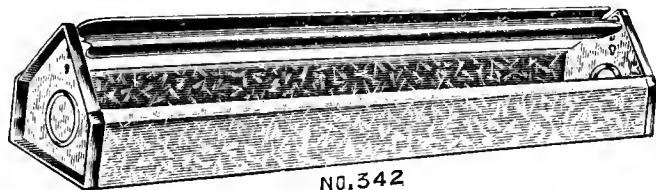

NO. 342

Revolving metal reel prevents chicks roosting or getting into trough; reel adjustable to 3 positions; will feed day-old chicks or 8-weeks old; a real all purpose feeder at a low price.

Trough of 26-gauge galvanized steel is 4 inches wide and 2 inches deep; turned flanges along trough edges prevent feed waste.

- No. 342 — 2 feet long, each \$.40
- No. 343 — 3 feet long, each55
- No. 344 — 4 feet long, each70

GROWING CHICK FEED TROUGH



Made of steel, 4 feet in length, capacity about 12 qts. Wires 2 inches apart prevent fowls getting into trough.

- No. 6A — Without lid, each \$1.00

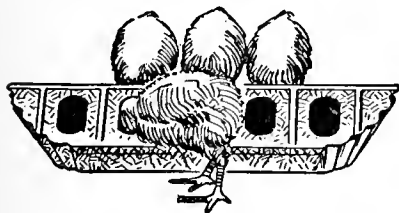

CHICK FEED TROUGH

These troughs are ideal for feeding chick starter to baby chicks. Trough is stamped out of one piece of heavy galvanized steel without seams. Very easy to keep clean. The grate is a separate piece and slides on and off easily. Prevents

waste of feed. Made of galvanized steel for dry feed and heavy charcoal tin for feeding milk.

MASH FEEDER

- No. 71 — Galvanized, 10-inch, each \$.15
- No. 72 — Galvanized, 20 inch, each20
- No. 71A — Tin, 10, inch, each20
- No. 72A — Tin, 20-inch, each30

ROUND BOTTOM CHICK TROUGH



A new inexpensive chick trough. Made of galvanized iron with galvanized cross wire welded on. Ends are soldered on so that trough can be used for either feed

- or water. Easy to fill and clean. Cross wire prevents chicks from getting into trough or soiling feed.
- No. 5120 — 18-inch, each \$.25
- No. 5124 — 22 inch, each30

CAPACITY CHICK FEEDER

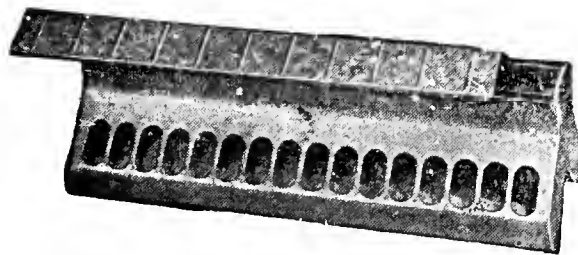

This feeder is made in one size, 42 inches in length. Sloping top prevents roosting and slides off for filling or cleaning. V-shaped bottom throws feed toward the outside and prevents clogging. Has 68 feeding spaces.

- No. 375 — 42 inches long, each \$2.00

WIRE GUARDED CHICK FEEDER

This feeder will accommodate a large number of chicks at one time. The open trough principle is featured in this feeder. It accommodates a larger number of chicks at one time than a covered trough with individual feeding holes. The wire bar extends the full length of the trough. Adjustable up and down to regulate the width of the feeding space from chick size to pullet size.

With Adjustable Wire Guard

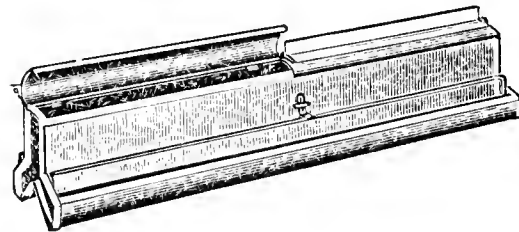

- No. 634 — 35 inches long, 18-qt. capacity, shipping weight 10 lbs., each \$1.95

GRO-FAST FEEDER

ALL PURPOSE FEEDER

The Gro-Fast Feeder Trough provides sanitary feeding conditions for chicks of all ages — from day old to broiler size. A wonderful all purpose feeder. The trough is heavy gauge galvanized steel with spot-welded ends. Flaring sides increase feed capacity. Smooth double fold edges are turned in at just the right angle to prevent feed waste. Trough is 4¼ inches wide at top edge, 3½ inches at bottom. Depth 2¼ inches.

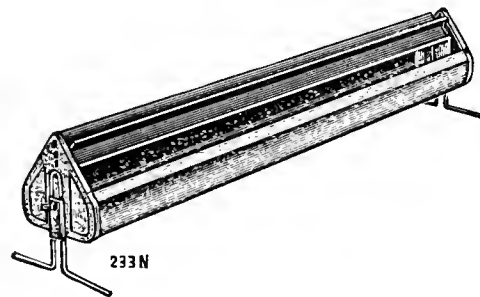

233N

The adjustable stand is made of heavy wire which slides up and down and is held in place by friction. The several corrugations in the end of the trough determine the different heights. Trough stays set when adjustment is made. Trough is adjustable to 6 positions; height at trough edges ranges from 2½ to 5 inches.

- No. 233 — 3 feet long, each \$.90
- No. 234 — 4 feet long, each 1.10

GRILL TOP BROILER FEEDER

A convenient and durable feeder for growing chicks. The galvanized wire grill is hinged and swings back for filling and cleaning.

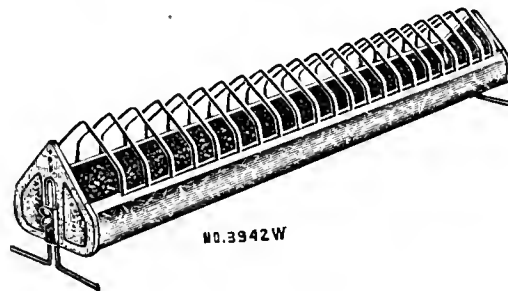

NO. 3942W

Trough is 6¼ inches wide and 3 inches deep. It is made in heavy galvanized iron or in bright charcoal dairy tin for milk feeding.

- No. 3942W — 42 inches long, galvanized, each \$1.35 (With Adjustable Legs)

NEW STREAMLINED CHICK TROUGH

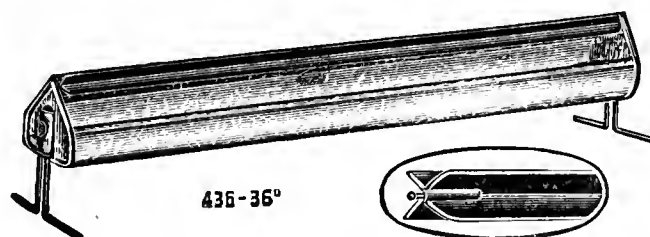

436-35°

This series has rounded edge. No sharp corners for feed to lodge and become stale. Trough of 26 gauge galvanized iron, 4 in wide and 2 in. deep. Turned flange along trough edge to prevent feed waste. Reel adjustable to 3 positions. Complete with adjustable legs.

- No. 424 — 2 feet long \$.60
- No. 436 — 3 feet long70
- No. 448 — 4 feet long85

NEW GIANT FLOCK FEEDER

Nothing flimsy about this feeder. GIANT in construction and proportions. Built to give efficient, profitable service for a long time. Trough body is a heavy 24-gauge galvanized steel with die-stamped ends. Trough is 11 in. at greatest width. Outside top width 10 in. Depth 5 in. Turned flanges, 1-inch wide, along trough edge prevent billing out of feed and provide a perfect support for roost-proof wire grill. Sturdy stand has 1/8-in. angle iron legs bolted to trough body, and angle iron cross members for perch support; strongest possible construction. Always rigid. Adjustable perches of clear lumber 3 inches wide, may be moved in or out for pullets or mature birds. Perch height, 18 inches to eliminate vent-pecking and permit full advantage of floor space under trough.

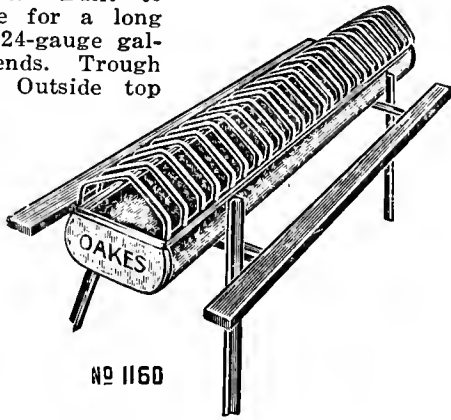

No. 1160

No. 1160 — 5 feet, capacity, 5 1/2 pecks mash, 42 feeding spaces, each ----- \$4.60

No. 1196 — 8 feet, capacity, 8-4/5 pecks mash, 64 feeding places, each ----- 6.40

MAMMOTH ROUND FEED HOPPER

A compact, convenient hopper for feeding dry mash to large flocks. Round shape accommodates more fowls with less fighting and less muss. Seamless steel trough, 22 inches in diameter, 3 1/2 inches deep, divided by partitions to prevent waste of feed. Capacity, 100 lbs.

No. 10 — 65 qt., without stand ----- \$5.00

No. 11 — 65 qt. with stand as shown -- \$6.00

No. 511 — 36 qt., without stand -- \$2.50



MASON JAR FOUNTAIN

Made from two materials, extra heavy galvanized iron, charcoal tin. No solder used; very substantial pan with heavy rolled edge; electric welded center; can be used for chick feed as well as water. Charcoal Tin fountain is designed for dispensing buttermilk and sour milk especially. We do not furnish the glass jars.

No. 69G — Galvanized; shipping weight 8 oz.; each ----- \$.10
3 for ----- .25

No. 69T — Charcoal Tin; shipping weight 7 oz.; each ----- \$.10



GLASS JAR FOUNTAIN

FOR USE OF MASON JARS

The drinking pan is of heavy glass with smooth edge. The Mason Jar screws into the metal clip and is held firmly in position. The clip snaps over the outer edge of the pan. Jar and pan are quickly detached from the pan for filling or cleaning. An ideal fount for feeding buttermilk or medicated water. Saucer is 6 inches in diameter. Chicks cannot get into the pan.

No. 65G — ----- Each \$.15
(Glass Jar not included)
2 for 25c

No. 67G — Galvanized pan with metal clip, each ----- \$.10
3 for 25c

No. 67T — Charcoal tin pan with metal clip, each ----- .12

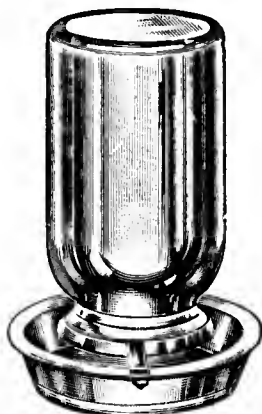

JAR FOUNT AND STAND

This fount is similar to the above Mason Jar Founts with the exception that the clips have wire leg extensions. The high legs lift saucer up out of the litter and keep it clean. Not too high for day-old chicks, but it puts the fount up where the chicks cannot wade in the saucer.

No. 1365G — Glass Pan ----- Each \$.15
No. 167G — Galvanized Pan ----- .12
No. 167T — Charcoal Tin Pan ----- .13

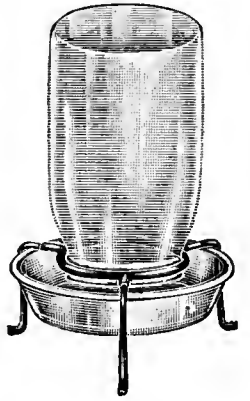

MASON JAR FOUNT

WITH ATTACHED WIRE LEGS

Sturdy wire legs are rigidly folded into curled rim of drinking pan and are a part of the fount. Keeps litter out of pan. Screw cap fits any size Mason jar.

No. 17G Galvanized ----- 10c
No. 17E Blue Air Dry Enamel fin. ----- 10c

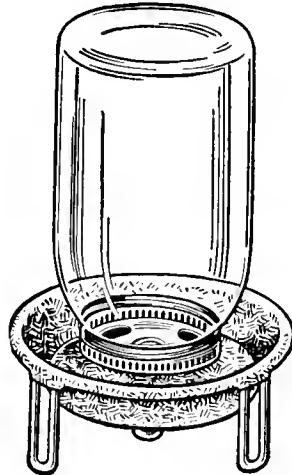

BUTTER MILK FEEDER

A perfect feeder for sour milk, buttermilk, water, hard grain or grit. The container is made of aluminum, the only metal in which sour milk can be fed with safety. It is rust-proof and non-corroding. The Handy Holder is adjustable. Shipping weight, 1 lb.

Each 25c

No. 70A — Holds 1-quart jar.



BOTTOM FILLED FOUNTAIN

Consists of a cone-shaped can and a stamped pan, which forms trough from which the fowls drink. Both parts made of galvanized sheet metal and well soldered.

No. 78 — 1 qt., each 25c ----- \$.19
No. 79 — 2 qt., each 35c ----- .25
No. 50 — 2 gal., each \$1.25 ----- .75



OAKES' SNAP-ON FOUNT

Made from heavy galvanized iron in two pieces. Top made with handle for carrying. Base pulls off to fill. Pressure of air and grooves in pan hold weight of water and fountain may be carried by handle without fear of spilling.

No. 100B — 1 gallon; shipping weight 4 lbs., each ----- \$.50
No. 100C — 2 gallons; shipping weight 6 lbs., each ----- .75

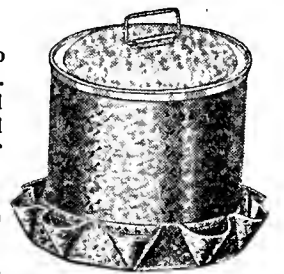

DANDY DOUBLE WALL FOUNTAIN

This new double wall fountain is top filled. Double wall helps to keep water cool in summer and retards freezing in winter; operated on the vacuum principle. No corks or valves. Easy to fill or clean; just lift off the outer can by the convenient handle. Outer can locks to inner can so it may be carried by handle when filled.

Die-drawn modernistic top slopes sharply to prevent roosting. Drinking pan is seamless, die-drawn with smooth rolled edge; securely soldered to inner can. Pan is 1 1/2 inches deep. Clearance between tank and pan edge is 1 inch. Baby chicks cannot drown in this pan.

No. 92 — 2 gallon size, each ----- 1.45
No. 93 — 3 gallon size, each ----- 1.70

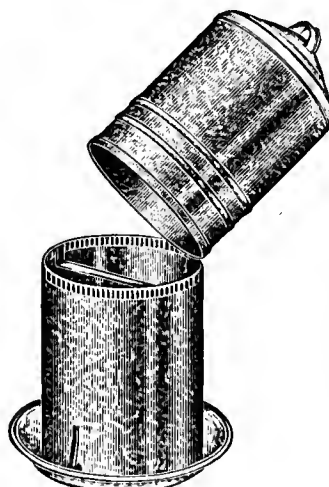

**DOUBLE WALL
E-Z FILL FOUNTAIN**



This extra heavy durable fountain is one of the most popular in our line. The heavy bail makes it convenient to carry water in the outer tank; bail is held up out of the drinking pan when waterer is not in use.

Inner tank has handle; this part of the fountain may be used to carry water also. When the outer tank slides into place, it pushes in a spring lever that releases the water which is held at the proper level of the trough through the vacuum principle.

Valve closes when outer tank is removed so that drinking pan does not overflow when filled.

Tanks are heavy 26 gauge and drinking pan is 24 gauge seamless, die-drawn with smooth curled edge.

No. 31 — 3 gallon size, each ----- \$2.00
No. 235 — 5 gallon size, each ----- 2.85

CONE TOP SNAP-ON FOUNT

Made of heavy gauge galvanized steel, all seams soldered water tight. Tank snaps onto pan on three metal clips fastened to pan holding tank in place by friction. Drinking space one inch wide all around pan. Depth of pan 1½ inches. Small chicks cannot get into water and drown.

No. 81 — 1 gallon size, each ----- \$.65
No. 82 — 2 gallon size, each ----- .85

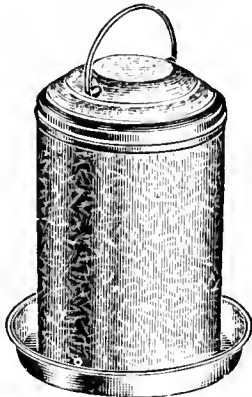

FLOAT VALVE FOUNTAIN

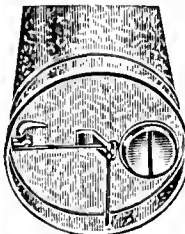

No. 403

Heavy 26 gauge galvanized steel tank rests in loose drinking pan. Convenient bail for carrying. Roost-proof die drawn top is quickly removed for easy filling. Float locking device closes valve when tank is removed from pan for quick and easy cleaning. Pan may be washed like a saucer. Big brass float controls positive operating valve mechanism. Correct water level always maintained in drinking pan. Brass screen insures perfect operation of valve. A heavy duty

outfit which gives real satisfaction. Actually pays for itself in extra egg production.

Positive float valve shown at right. Big brass float. Powerful leverage on valve. Locking device raises float, closes valve when tank is removed for cleaning pan.

Pan diameter 15 inches; tank diameter, 12 inches.
No. 403 — 3 gallon capacity, each ----- \$1.95

FLOAT VALVE FOUNTAIN

Single wall top filled fountain. Die-stamped drinking pan 13½ inches in diameter with smooth, curled edge. Three friction lugs spot welded to pan, engage side wall for perfect, quick snap-on attachment of pan. No hooks to catch chicks. Sharply sloping die-drawn cone top prevents roosting. Heavy wire bail with notch for wire or rope to hang from rafters. Double-acting brass float valve in center of tank shut flow when pan is removed for cleaning. Keeps water at constant level in pan—positive action, does not overflow. Easy to clean.

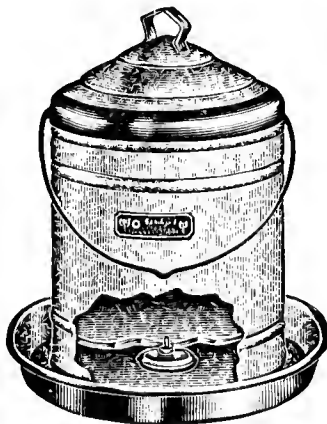

No. 413 — Float Fountain, 13 qt. capacity ----- \$1.90

FOUNTAIN HEATER

Also used as Brooder Heater

Suitable for any kind of drinking fountain and for any size up to four gallons. Insures warm drinking water at all times. Heater of galvanized iron with chimneyless kerosene burner—stands firmly, and fowls cannot overturn it.

No. 44, each ----- \$1.90



RED TOP

WIRE GUARDS

FOR CROCKS AND PANS

Red Top Wire Guards are made in three sizes and can be used as a guard for crocks or galvanized feeding or watering pans. Made of 10 gauge galvanized wire, electrically spot welded. Wires are strongly welded to a die drawn conical top for greater strength and rigidity.

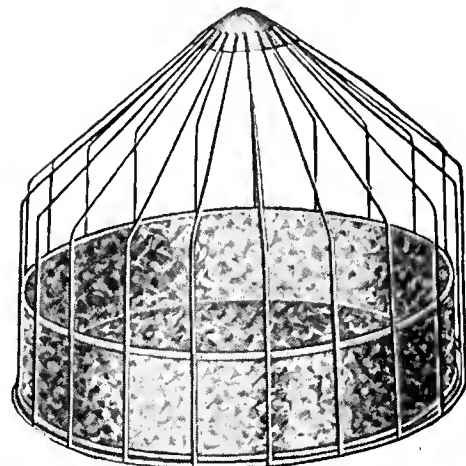

No.	Diameter	Height	Width of Spaces	Price
612	12½ in.	13½ in.	1-5/8 in.	55c
614	14½ in.	14½ in.	2-5/8 in.	60c
617	17 in.	15 in.	3-3/8 in.	65c

PANS FOR FEED OR WATER

Heavy 26-gauge galvanized steel pans with double lock-seam bottom and rolled-top edge. Soldered water-tight. Makes an ideal feed or water pan. Made in three sizes.

No.	Diameter	Depth	Fits Wire Guard	Price
6120	12 in.	4 in.	612	60c
6140	14 in.	4 in.	614	75c
6170	17 in.	4 in.	617	90c

ADJUSTABLE FLOAT VALVE

This Simple Valve SOLVES the Watering Problem

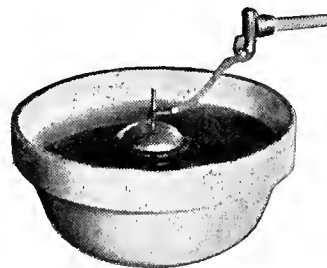

At last, a trouble-proof water valve that works automatically! It is so simple in design, so perfect in operation you will marvel you did not think of it yourself. Easy to attach — nothing to get out of order. A hollow metal float rests on the surface of the water, and as level rises and falls, the valve automatically closes and opens. This insures a constant supply of pure, clean drinking water — a vital factor in successful poultry and small stock raising.

No. 904 — Each ----- \$1.00

GRIT AND SHELL BOXES

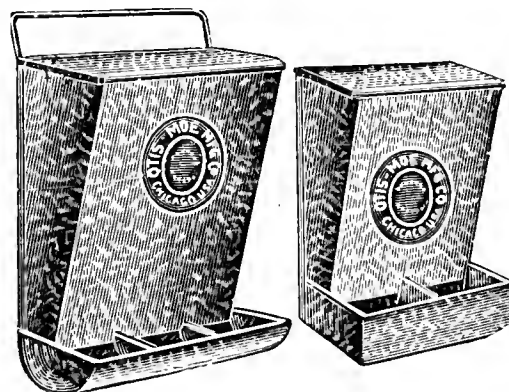

Grit, shell and charcoal have now become a recognized essential part of the diet insuring healthy fowls. they cannot be more economically supplied than in one of our inexpensive compartment boxes. Can also be used as a feed hopper for little chicks. Shipping wt., 3 pounds.

No. 73 — For baby chicks, each ----- \$.85
No. 46 — For grown birds, each ----- 1.30

EGG COOLING BASKET

Made of Galvanized Wire For gathering and quick cooling of eggs. The quicker the eggs can be cooled the better they will be. Clean, fresh flavored eggs always bring premium prices. Store eggs in wire cooling baskets in a room temperature of 60 degrees for best results.

Oakes' Wire Egg Cooling Baskets have a perforated metal bottom to permit free circulation of air. This bottom protects eggs from wet litter or wet grass when the basket is used for gathering the eggs. Galvanized wire finish does not mark the eggs.

Very sturdy and substantial. Bail, top and bottom rings are No. 6 wire. Side stays are No. 10. No weave or sway to this basket.
No. 15 — Galvanized Egg Baskets, each ----- \$.95



LEG BANDS FOR POULTRY

BANDETTES



Bandettes are easily applied single-handed, simply open out Bandette, hook it on leg, and allow it to close around the bird's leg; should not fit tight.

Bandettes are made in 5 colors: blue, red, yellow, green and pink.

Two sizes: No. 9 for Leghorns, and No. 11 for Rocks, Reds, etc.

Bandettes are sold in unbroken sets of 25 in one color: 1-25, 26-50, 51-75, 76-100, and so on.

25	-----	\$.60
50	-----	1.10
100	-----	2.00
500	-----	9.50
1000	-----	18.00

COLORED LEG BANDS



Made of celluloid, in fast colors. Keep their shape. Light in weight and very durable. Quickly put on or removed. Put up regularly 50 bands of a size and color in a bundle. Colors: white, black, red, pink, green, blue, purple and yellow.

		50	100	1000
No. 4 — For Baby Chicks	-----	\$.25	\$.40	\$3.50
No. 7 — For Bantam	-----	.35	.60	5.00
No. 8 — For Leghorns and Anconas	-----	.35	.60	5.00
No. 11 — For Large American	-----	.40	.75	6.00
No. 12 — For Asiatic Hens	-----	.45	.80	6.50

ECONOMY POULTRY BANDS



Poultry Sizes — The Standard poultry sizes with two large black numbers from 1 to 100, with black ink on celluloid. Size No. 2 (for Pigeons), Size No. 3 (for Leghorn hens), 3c each. Size No. 4 (for Rhode Island Red, Plymouth Rock, and Orpington Females and Leghorn males); 1/2 inch wide, 2 1/2 inches long from slot to shoulder. 3c each; 100, \$2.25. Shipping weight, 8 oz

ALUMINUM LEG BANDS

No. 130
POSTPAID PRICES



Made of sheet aluminum with large raised numbers, easy to read. Adjustable for any size fowl. Numbered 1 to 4,999, as wanted. Come 100 to box in numbers above 100. Do not break boxes.

12 bands	-----	\$.15	100 bands	-----	\$.60
25 bands	-----	.25	500 bands	-----	2.75
50 bands	-----	.40	1000 bands	-----	5.00

WING BANDS

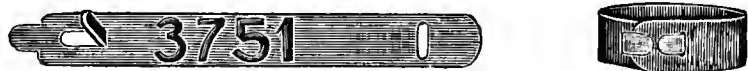

Numbered or unnumbered, packed 100 to the package, no packages broken. Numbered 1-100; 101-200, etc.

1/2 inch in diameter		100	500	1000
Sealed Wing Bands, Numbered	-----	\$1.00	\$4.00	\$7.00
Sealed Wing Bands, Unnumbered	-----	.95	3.75	6.50
Double End Clinch, Numbered	-----	.60	2.40	4.60
Double End Clinch, Unnumbered	-----	.55	2.15	4.10

Double end clinch bands furnished in round end as illustrated.

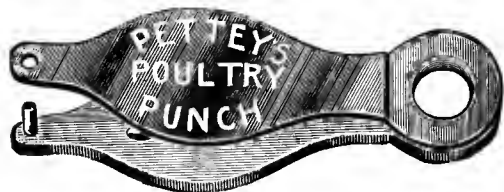

POULTRY PUNCH

A popular and practical punch. Makes a clean perforation and does not bruise the foot.

No. 38 — Oakes' Punch, each, 2 oz. ----- \$.20

IDEAL POULTRY PUNCH

A new improved punch. Works easily, cuts clean, and does not pinch the foot. Length 3 1/2 in. Nickel plated.

No. 39 — Moe's Ideal Punch;

Each ----- \$.35

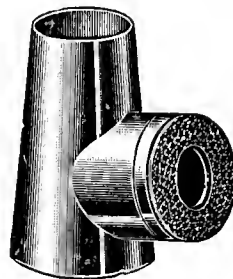
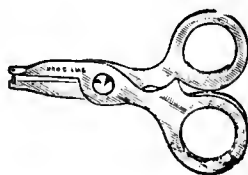

EGG TESTER

K-131 — Used to test fertility of eggs during first week of incubation. Use on an ordinary lamp No. 2 burner, in a dark room. It will illuminate interior of egg so that you will know if the chick is alive. Also shows size of air cell. Each, 25c.

Shipping weight, 1 lb.

GLASS NEST EGGS

Made of white porcelain, natural in appearance, and uniform in size. Will not easily break. They induce the hen to lay where she should — in the nest.

Per dozen ----- \$.25

Weight, 1 pound.

HUMPTY DUMPTY EGG CARRIER

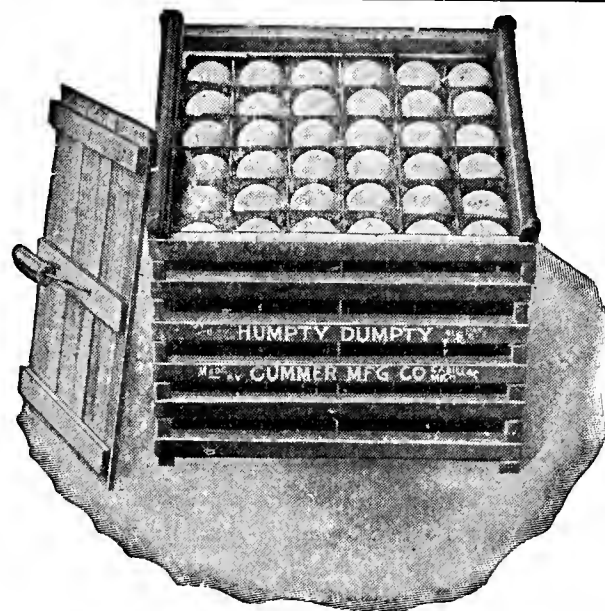

A very light, strong and convenient egg crate and carrier. Made of hard wood slots securely fastened. The lid with handle, springs into position when crate is filled. Parcel post weight, 7 lbs. 12-dozen size, collapsible ----- \$.90

INCUBATOR, BROODER AND ROOM THERMOMETERS

No. 5776
Tycos Incubation-Zone Thermometer

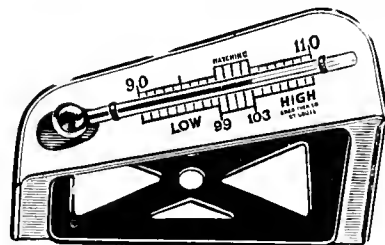

No. 5776 — Incubator Thermometer — Genuine "Tycos" on flexible brass legs. White figures and graduations on black finished scale. Packed 1 in box, shipping weight 6 ozs. Each ----- 75c

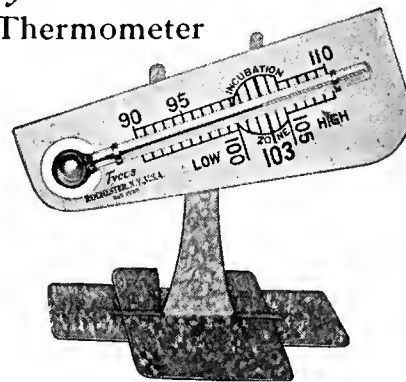

When used with Stand

No. 800 — Incubator Thermometer — Mounted on porcelain stand and frame, with black engraving. Easy to read. Packed 1 in box, shipping wt., 6 ozs. Each ----- 75c

No. 3001 — Incubator Thermometer — Each ----- 50c

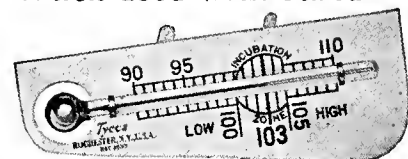

When used without Stand

No. 5792 — Genuine "Tycos" Thermometer. — To be inserted through hole in top of the brooder so bulb is in actual brooder temperature, and scale is outside for easy reading. Weight, 6 oz. Each ----- \$.75

No. 54404 — Brooder Thermometer — To be hung on the canopy. Each ----- .45

No. 125 — Buckeye Brooder Thermometer. Each ----- 1.25

No. 741 — Heavy gauge metal finished in baked enamel, guarded bulb, to be hung on canopy. Each ----- 35

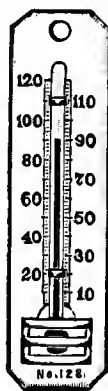

PATTERSON AND YOUNG MOISTURE GUIDE

This moisture guide solves the moisture problem with your incubator. The holder is fastened to the egg tray and the guide is filled with water to the top line. The graduated scale shows how much moisture should evaporate from the egg each day. If evaporation is too fast moisture should be added; if too slow, more air should be given. Full directions go with each guide. Attachments are included for all turning trays. Every owner of an incubator should have this moisture guide. Weight 3 oz. Each, \$1.00.

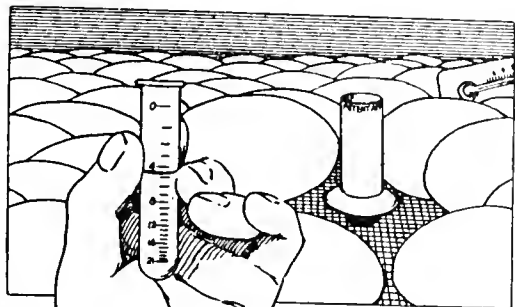

MEASURE
THE EVAPORATION
IN YOUR INCUBATOR
with the
MOISTURE GUIDE.
IT "SOLVES THE MOISTURE PROBLEM"

OAKES' EGG SCALES



In many localities eggs are now being bought and sold according to weight. Indiana has been using 22 ounces to the dozen eggs; just right for our No. F-53, while No. F-54 will fit any standard. Oakes' Egg Scales are durable (constructed of steel) and simple; no springs — nothing to get out of order.

No. 55 — Oakes' Graduated Egg Scale, each \$.55



NO 20S EGG SCALE

A real egg scale; accurate, dependable and fast. New angle dial is easy to read whether seated or standing. Individual egg weight and weight per dozen are indicated on the double dial. Dial is black with figures in white. Easy to read in candle room. Adjustable stop can be set for grading eggs of any weight. Egg cup, lever parts and counterweight are chromium plated. Bearing pins are brass.

No danger of working parts rusting and affecting accuracy of scale. Base and dial support are attractively finished in Red Duco. Scale base 6 1/4 x 3 1/4; height 6-1/4 inches.

No. 20S — Egg Scale with adjustable stop \$1.45

EGG BOXES FOR RETAIL TRADE

This is an ideal box for the retail egg trade, holding 1 dozen, presenting the goods to the customer in an attractive package with the minimum amount of trouble for the seller. They knock down in very compact shape.

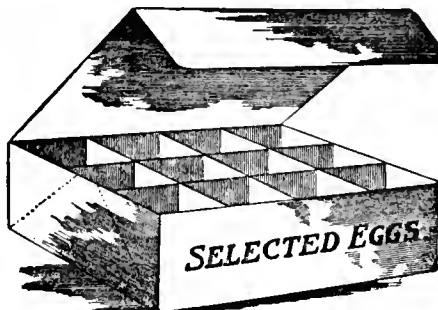

3 x 4 Eagle, weight 12 lbs., per 100 \$ 1.00
3 x 4 Eagle, weight 105 lbs., per 1000 8.50
2 x 6 Seminole, weight 17 lbs., per 100 1.50
2 x 6 Seminole, weight 155 lbs., per 100 12.50

ZENITH BURNER

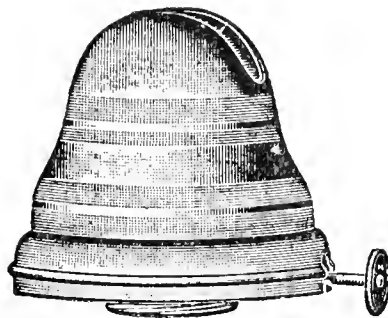

The most satisfactory burner for heating poultry fountains. Requires no chimney. Delivers a large volume of heat. Flame spreader has special air passages to prevent over-heating. Top lifts off for easy cleaning or trimming of wick. Wick tube is heavy sheet brass. Made in single wick only. Each burner complete with red felt wick.

No. 2 — 7/8 inch, each \$.75
No. 3 — 1 1/2 inches, each 1.05

SUN HINGE BURNER

For Incubators or Brooders. So designed that perfect combustion is assured. Burner dome held in place by spring catch. Dome lifts for cleaning and trimming the wick.

No. 3 — Double Wick, 1 1/4 inches, each \$.90

INCUBATOR LAMP WICKS

Made of felt. The best wick to use in your incubator lamp. State width of wick when ordering; weight 2 oz.

Each \$.05
Dozen50

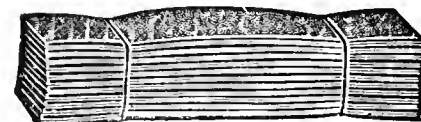

LAMP BOWLS

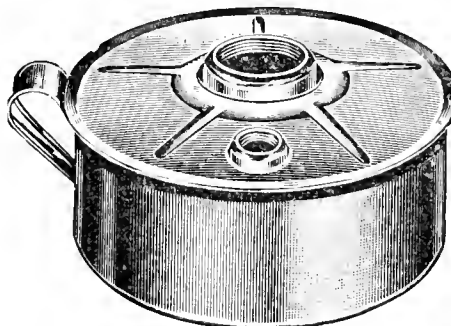

Lamp bowls are of seamless one-piece construction. Die-drawn from heavy terne plate. Reinforced tops are double-seamed and slope from the burner collar to the edge so that no oil can accumulate on the top even if spilled when filling. No give or spring to the top or bottom.

No. 205 — No. 2 Burner size, 1 qt. capacity, each \$.65
No. 220 — No. 3 Burner size, 2 qt. capacity, each80

SURE-TRIP TRAP NEST FRONTS



The Practical Trap Nest is a profitable addition to every poultry plant, because it weeds out the drones and cuts down the feed bills for the man who wants to keep only those birds that produce. Strongly built of good lumber, as light in weight as consistent with strength and durability — with a trap that works noiselessly and surely.

Each, 35c; 100, \$30.00. Weight, 1 lb. each.

SMALL BROODER HEATING ELEMENTS

May be used in battery brooders instead of bulb. Puts out more heat and uses very little more electricity, 110 volts. Can furnish in 25-watt, 60-watt or 600-watt — the latter being used principally for small room.

O-60 — 60-watt heating element, each \$0.55
O-100 — 100-watt heating element, each65

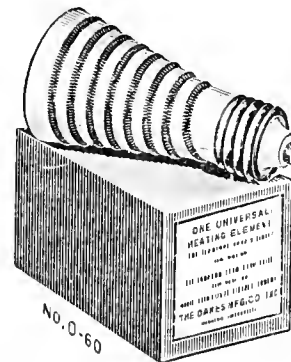

ECONOMY HOVER

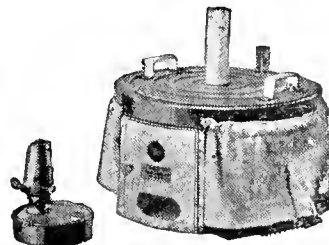

LAMP HEATED. Simple in construction, made of steel throughout, and durable. Can be lifted by its two handles without disturbing the lamp and used anywhere with perfect safety as it stands on a level floor; no platform or other preparation necessary. Only a small flame is required, as the lamp is inside and no heat is lost. The curtain is double and made of outing flannel.

No. K-102 — 18-in. drum, 50 to 75 chicks \$5.40
No. K-103 — 22-in. drum, 100 to 125 chicks 8.10

GRO-EZY ELECTRIC BROODER

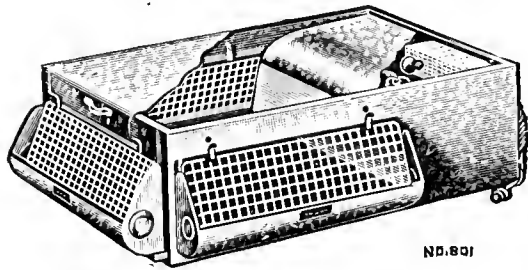

NO. 801

Each drawer slides out of the frame as a complete unit. The woven wire floor of 1/2-inch mesh is finished in bright tin. This floor is not to be compared with the dingy hardware cloth ordinarily used. Droppings cannot catch and hold on wire intersections. A deep dropping pan is just underneath the floor with 1 1/2 inches of clearance. Pan is easily removed.

The chicks eat from open troughs. Every chick has a chance to get its fill. A chick will go to an open trough every time in preference to eating or drinking through holes or between wires, or bars. In each "Gro-Ezy" drawer there are two 20-inch feed troughs and one 20-inch water trough. These troughs are open their entire length. The feed is easily accessible and yet the chicks cannot get into it or foul it.

Chicks always see the feed but no feed is wasted. Doors lift up and drop into slots in the ends of the trough, providing an adjustment of the feeding space from 1/2 inch to 1 1/2 inches in width. This is ample room for chicks from a day old to ten weeks old. Each drawer is 35 inches deep, 22 1/2 inches wide, and 9 1/2 inches high. Chicks can be carried to 8 weeks.

The lid is removable. Canvas curtain is attached to lid and divides the drawer into two parts. Electric heating elements and Thermostatic Control are attached to back panel behind the canvas curtain.

- No. 801—Drawer only; complete with heating element, automatic thermostatic control and plug socket, weight 34 pounds, each ----- \$10.00
- No. 801G—Same as 801, but heated with No. 2 Zenith Burner Oil Bowl, each ----- 9.50

HAPPY CHICK METAL BROODERS

For 50--day-old chicks —10x22x6 inches inside. Hardware cloth floor, drop pan removable. Two-foot electric cord. Adjustable holes over troughs. Hardware cloth floor has 2 cross wire supports. Dropping pan pulls out front. Feeder trough extends across front. Water trough at rear, left. Adjustable slides control openings through which chicks eat and drink. Lid in two sections. Well ventilated. Electric bulb NOT FURNISHED.

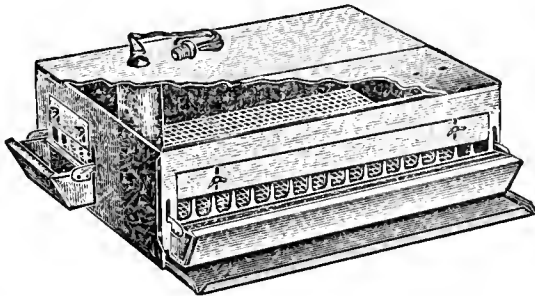

- No. 375 — Metal Box Brooder, 1 in carton, 15 lbs., each ----- \$3.00

LIV-AN-GRO BROODER

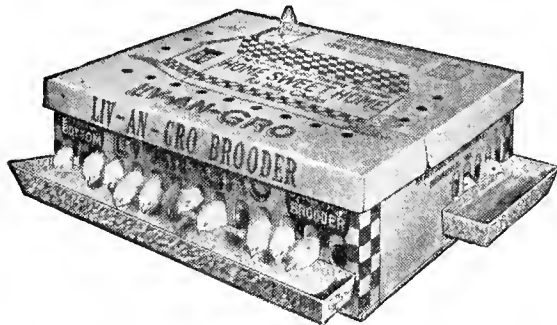

These brooders are built to raise a small flock of chicks of not more than 50. Where a person does not desire to go to a great expense for brooder when they only wish to raise a small flock. Side walls and top are constructed of heavy corrugated cardboard with a smooth finish. Bottom is made of hardware cloth so that chicks are kept off the floor and creates a sanitary condition. Brooders come equipped with water and feed trough. May be heated with charcoal or electric current. If you have electric current, advise the electric heat. This brooder comes equipped with a complete drop with 8 foot of cord. Size of brooder is 18x22x6. Kindly specify kind of heat desired when ordering, charcoal or electric. Each ----- \$2.10

Each ----- \$2.10
Dozen ----- \$24.12

CHARCOAL STICKS

FOR LIVE-AN-GRO BROODERS

Each ----- \$.10
Dozen ----- \$.80

OAKES' BLUE FLAME OIL BURNER BROODER

Giant 5-inch Burner, Automatic Heat Control, Heat Equalizer, Rigid Burner and Oil Reservoir are a few of the many outstanding features of Oakes Blue Flame Brooders. The most completely trouble-free brooder of its type on the market.

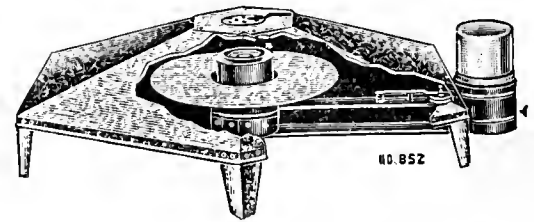

NO. 852

The 5-inch Burner produces an abundance of heat. Self-centering chimney drops right into place. No smoky flames as result of misplaced chimney. Burner and Oil Reservoir are rigidly mounted in metal housing. Burner is always level. Does not tilt. Perfect combustion results. Flame is always even on all sides. No raising or lowering of burner. Can't get out of adjustment. No rocking of fuel reservoir. It's rigid, and stays put.

AUTOMATIC HEAT CONTROL

Fuel feed to burner is controlled by a simple, positive acting efficient needle valve operated by Sturdy-Boy Brass Wafer. The thermostat opens and closes the needle valve by lever action. As the temperature rises the flow of oil in the burner is reduced by expansion of thermostat which closes the valve. If it turns colder, the valve is opened. Valve body of brass with small by-pass to allow sufficient flow of oil to keep burner from going out.

HEAT EQUALIZER

Patented heat equalizer fits burner collar below flame level. This spreads and equalizes the heat so that chicks can hover near the burner in comfort. No hot spot at center of canopy. Heat is delivered to edge of canopy. Less than 5 degrees difference in temperature at burner and canopy edge. Brood more chicks.

Oil Brooders without this feature require an intense heat at the burner (150 degrees or more) to produce a temperature of 90 degrees at edge of canopy.

CANOPY—Heavy gauge galvanized steel canopy, hexagon shaped. Very rigid and substantial. Ventilator in top plus heat equalizer prevents pocketing of heat in peak of canopy.

Thermostat located at edge of canopy. Controls heat at point and insures a comfortable brooding temperature.

Oakes Blue Flame Oil Brooders are the greatest value ever offered in this type. Burns less fuel, produce controlled heat and brood more chicks. The real brooder value of the year.

- No. 832—32-inch canopy, no heat equalizer; shipping weight 39 1/2 pounds ----- \$10.50
- No. 842—42-inch canopy, shipping weight 41 1/2 lbs. ----- 11.50
- No. 852—52-inch canopy, shipping weight 43 1/2 lbs. ----- 12.25

BUCKEYE COLONY BROODER

The Buckeye Oil-Burning Brooder has the new improved Burner that gives the maximum amount of heat with the minimum consumption of oil. It is a wick burner and the oil is fed by gravity. Buckeye is self-feeding and self-regulating; it doesn't clog, it doesn't flare up; it doesn't go out.

Can be safely operated on any floor. Has "Diafram" Heat Conveyor, so attached to the canopy that it insures the radiation of heat to the very outside of the brooding area.

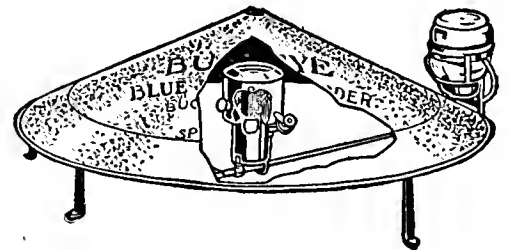

	Capacity	Canopy	Shipping Weight	Price
No. 27-A	250 chicks	34-inch	49 lbs.	\$12.00

BUCKEYE ELECTRIC BROODER

	No. 91	No. 92
Chick capacity	100	200
Diameter of canopy	36 in.	46 in.
Price, each	\$12.50	\$17.50

BUCKEYE BROODER WICKS

Buckeye Kerogas No. 20	\$.25
Buckeye Kerogas No. 45	.45
Buckeye Loraine	.30

OAKE'S NO-COLD OIL BROODER

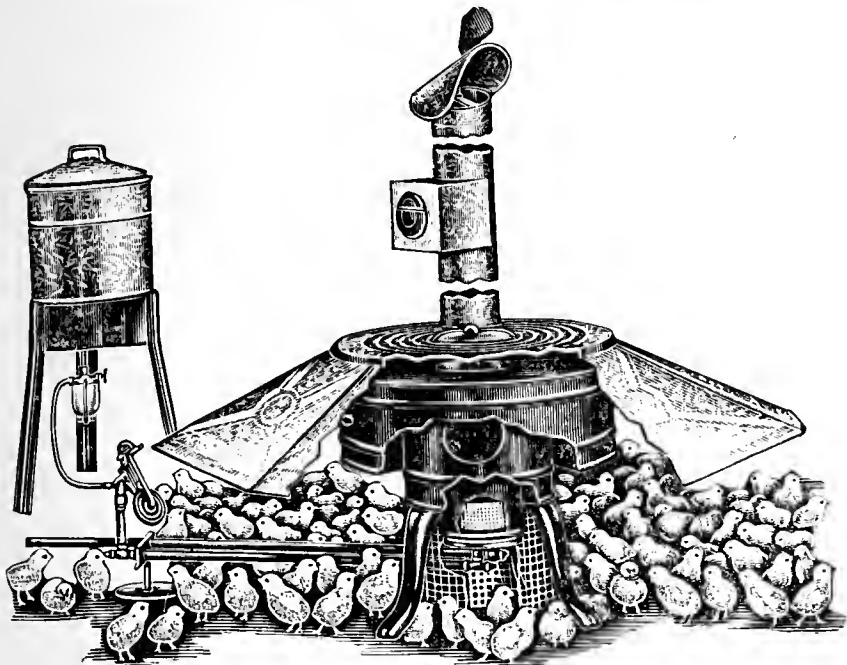

12 Outstanding Features

1. Burns Kerosene or Distillate.
2. Big Heater Drum 22 $\frac{3}{4}$ " diameter.
3. Drum is 7 $\frac{3}{4}$ " deep. Well baffled.
4. Almost 7 ft. flame travel in Drum.
5. Automatic Thermostat Regulator.
6. Efficient AIR-FED Burner.
7. Automatic Draft Equalizer.
8. Fuel Reservoir, 6-gallon capacity.
9. Safety Overflow Pipe.
10. Safety Wire Guard around Burner.
11. Cast Iron Legs on Stove.
12. Low Fuel Consumption.

Heavy gauge heater drum 22 $\frac{3}{4}$ inches in diameter by 7 $\frac{3}{4}$ inches deep in natural blue steel finish. Baffled to provide 7 feet of flame travel for heat radiation. Galvanized steel deflector top rests on top of drum with 2-inch clearance for air and circulation. Hexagonal canopy made of die stamped sections bolted together.

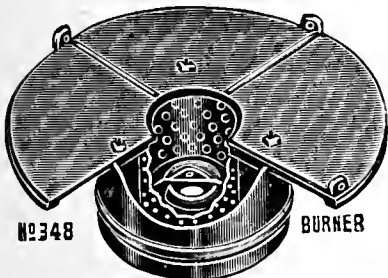

AIR FED BURNER

Cut-away section shown at right. Perforated central section feeds a continuous stream of fresh air to the burner. Has extra deep oil well with heavy cast steel generating plate. This AIR-FED burner provides perfect combustion conditions so that minimum of soot or carbon accumulates. It burns kerosene or distillate; easy to keep clean.

AUTOMATIC REGULATOR

Heat is automatically regulated by flow of oil. Patented sight drip shows rapidly of oil flow. Convenient in adjusting. Positive fast and slow feed adjusting screws at top of regulator. Wafer thermostat controls temperature once adjusted. Spring valve has special seat; cannot stick.

EACH STOVE COMPLETE

EACH STOVE assembly comes complete with cast iron legs, 6-gallon fuel supply tank, automatic thermostat control, necessary copper tubing, globe valve for fuel tank, fuel pipe support, canopy, heat deflector top, draft equalizer, overflow pipe and $\frac{1}{4}$ -inch fuel supply pipe with all necessary fittings. FUEL TANK STAND EXTRA. TWO canopy sizes. Canopy dimensions from flat side to flat side. From point to point, measure 6 inches more.

No. 348—Canopy, 42-inch from side to side; 500 chick capacity; shipping weight 70 pounds.....\$19.50

No. 360—Canopy, 52-inch from side to side; 750 chick capacity; shipping weight 80 pounds..... 21.00

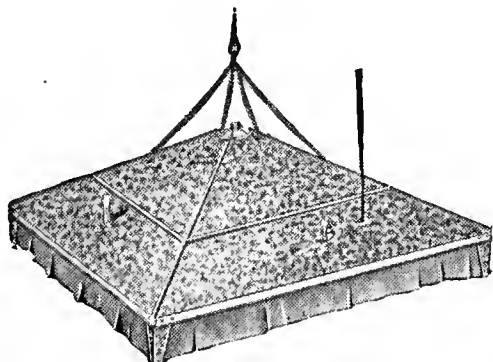

OAKE'S WOOD BURNING BROODER

Licensed Under Patent No. 2013638

In sections of the country where wood is to be had for the cutting, this stove broods your chicks with practically no fuel cost. You can use any kind of wood—dry or green or scrap lumber. Regardless of outside weather you can maintain adequate brooding temperatures. The stove seldom needs refueling more than 2 times in 24 hours. In some cases the stove will keep fire as long as 24 hours.

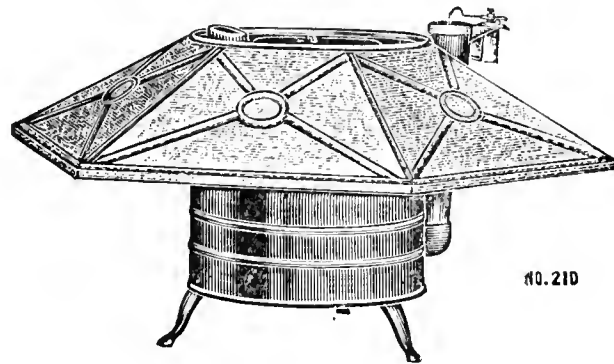

No. 210

THERMOSTAT CONTROL

Dixie Wood stoves have "down draft" fresh air intake. Same as used on millions of home heaters. Patented thermostat assembly automatically controls the fire through the down draft pipe—just the right amount of fresh air is fed to the fire box to produce a slow, even burning fire. Maintains an even heat at all times regardless of fuel used. Air intake at one side of stove body with chimney at opposite side. Fresh air down from above canopy. No direct draft on the chicks under hover.

BIG STOVE BODY

Round stove body of 24 gauge special blue steel with 20 gauge black iron inner liner. Reinforced bottom and top. Fuel door, 12" diameter, in top of stove; safety feature—no sparks or coals can fall into the litter. Heater sets on 6 inch cast iron legs so that chicks have access to entire heated area under the canopy. Excess heat from bottom of the heater is prevented by 2 inches of sand or ashes in bottom of stove. Remove ash accumulation every 10 days to 2 weeks.

Stove body 22 $\frac{1}{2}$ -in. diameter; 23-in. high; overall height 28 $\frac{1}{2}$ -inches. Chimney 6-in. Fuel capacity 5 cu. ft. wood up to 20-in. long

HEXAGONAL CANOPY

Heavy gauge galvanized steel canopy rests on top rolled rim of stove body. Measures 52 inches from flat side to flat side or 60 inches diameter. Provides a wide hover area for radiation and distribution of heat. Insures feed economy, dependability and even performance of the stove.

BROOD CHICKS AT LOW COST

Fuel operating cost of an oil or coal brooder will pay for a Dixie Wood Brooder Stove in about one season. Enjoy low cost brooding this year and increase your profits. Each stove complete in one carton. Easily assembled.

No. 210—DIXIE WOOD BROODER STOVE, complete with canopy and automatic thermostat control, shipping weight 66 lbs.\$18.00

OAKES' IMPROVED ELECTRIC BROODERS

The canopy and legs are made of high quality galvanized steel of four pieces bolted and spot-welded together. The 32-inch canopy will support the weight of an average-sized man. Top is lined with asbestos and has Celotex deck above the heating element to retain the heat, in the 32 and 42-inch sizes. In addition to the Celotex insulation there is a metal heat deflector which distributes the heat.

Ventilation is provided through a series of draft chutes located above the heating element.

Each brooder is equipped with special Wafer thermostat and electric cut-off switch provides automatic regulation of the heat at all time.

Special thermometer, 8 feet of drop cord, curtains, and pilot light furnished as regular equipment with all brooders.

No. 722—22-in. Brooder complete, 75 chick\$ 9.00

No. 732—32-in. Brooder complete, 150 chick13.50

Automatic Heat Control — No Attention Required

RAISE BETTER CHICKS WITH PROPER BROODING

LITTLE GIANT OIL BROODER

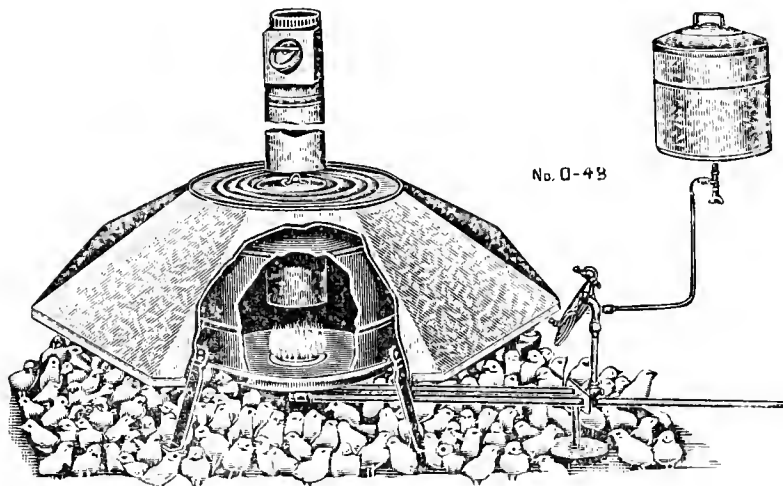

Thousands have found this stove a real brooder—economical to operate. Introduced last year, it satisfied a long felt need for a dependable, smooth operating stove at a very low price. Ideal for brooding small lots of chicks up to 350.

BIG DRUM-CAST IRON BURNER

Heater Drum—Heavy gauge blue steel with lock seamed top and bottom; beaded for extra strength; diameter 16", depth 15". Overall height 22½". Steel legs support drum 7½" from floor. Really radiates and distributes heat effectively, economically. Chimney pipe is 5".

Cast Iron Burner—Heavy assembly, 11" diameter. Mounted in bottom drum. Wickless type, cast iron flame spreader removable for quick cleaning. Burns with an exceptionally clean flame to produce an abundance of controlled heat.

Automatic Control—Draft equalizer. Sight feed valve with wafer thermostat controls flow of oil to burner. 5" draft equalizer is included to insure smooth operation and prevent back drafts.

Galvanized Steel Canopy Hexagonal—Diameter 48". Suspended from top of stove. Each stove complete with 7 gallon fuel tank—no stand—tubing, shut-off valve, fuel and overflow pipes, pipe support drum and draft equalizer.

No. O-48—Brooder Stove with 48" canopy, one in carton, shipping weight 62 lbs. ----- \$15.00

NEW TOM THUMB OIL BROODER



- 1 Burns kerosene or 38/40 distillate.
- 2 AUTOMATIC fuel and temperature control.
- 3 SAFETY overflow pipe.
- 4 HEAVY hexagonal canopy, galvanized steel.
- 5 GALVANIZED steel fuel tank, 4½ gallon.
- 6 BIG cast iron burner, perfect combustion.

A POWERFUL HEATER—This new TOM THUMB brooder is especially designed for small brooder houses and small lots of chicks. Ideal for southern climate for broods up to 350 chicks. New CAST-IRON burner uses kerosene or distillate to produce a clean hot flame with little soot or carbon accumulation. A real heater. Throttles down to low-burning speed, too. Flame deflector removable giving instant access to burner for any necessary cleaning operations.

STEEL HEATER DRUM—Made of heavy gauge steel, natural blue finish. Drum lock seamed top and bottom—beaded for strength. DRUM diameter 13¼ in.; height 13¼ in. Steel legs bolted to drum—overall height 20 in. Scientifically directed flame travel for maximum benefit of heat produced. Chimney pipe is 5-inch.

AUTOMATIC CONTROL—Double disc 3" brass wafer operates valve which controls flow of oil to burner. Sight drip feed. Valve carefully machined with brass needle valve. Responds quickly to temperature changes and maintains even temperature day and night.

GALVANIZED FUEL TANK—CANOPY—Fuel tank has shut-off valve; capacity 18 quarts. Tank should be placed 24" above floor. No tank stand furnished. Steel tubing connects tank with regulator. Hexagonal Canopy of heavy galvanized steel supported by top rolled edge of drum. From flat side to flat side 36 inches. Diameter 42 in. Deflects heat to floor for economy.

EASY TO INSTALL—Each Tom Thumb stove complete in one carton. Fuel tank, pipe and tubing, canopy and drum. NO DRAFT EQUALIZER is included at the special LOW PRICE. We recommend and urge you to use Equalizer No. 155 shown on this page of catalog for perfect, satisfactory operation.

No. 36—TOM THUMB oil brooder with 42" canopy complete. Shipping weight 56 pounds. Each ----- \$10.75

E-CON-O ELECTRIC BROODER

BROODS UP TO 150 CHICKS

32" wide hover of strong fiberboard with top side overcoated with an aluminum finish; does a real job brooding chicks. Metal legs, metal heat radiator. Complete with curtains, bulb socket, cord and plug. Weight 6 lbs. Easy to set up. Runs at low cost from one 100-watt bulb. (Bulb not furnished).



Each ----- \$1.70

DRAFT EQUALIZER

Insures a steady continuous draft for all types of brooder stoves when a strong wind is blowing. Helps to prevent back drafts. Prevents coal from burning too fast and smooths the operation of any oil brooder stove. 8 inches long. Heavy galvanized steel. For pipe.

No. 155—5 in. ----- \$0.70

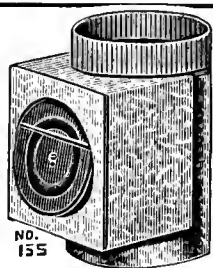

REVOLVING CHIMNEY CAP

Made to fit any 4 or 5-inch pipe. Perfectly balanced. Revolves with slightest change in wind direction.

Helps to prevent back drafts on any coal or oil brooder. Every brooder stove operator should have one of these for the brooder chimney. Made of heavy gauge galvanized steel and will not stick when stove is in operation.

No. 85C—5-inch ----- \$0.60

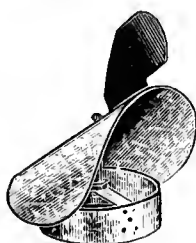

GOOD CHICKS

DESERVE A FAIR START IN LIFE — BE PREPARED

Get your brooder stove set up. Get enough starting troughs, water founts, feed and litter, BEFORE you get your chicks. Set the table—have dinner all ready — when the chicks are received.

STONEWARE FOR POULTRY

	Each
2 gallon 2-piece Fount -----	\$0.80
1 gallon 2-piece Buttermilk Fount -----	.50
2 gallon 2-piece Buttermilk Fount -----	.75
1 gallon 2-piece Non-Splash Buttermilk Fount -----	.80
Round Crock with Lip for Rabbits -----	.20

POULTRY LITTER

In General Use by Progressive Poultrymen

This litter does away with the lack of sanitation that is usually evident in poultry houses. It is a labor-saver; prevents dampness; is absolutely sanitary, prevents the spread of disease, absorbs offensive odors; keeps the birds clean; makes an ideal dust bath; keeps the house warmer in winter and cooler in summer. It is economical. Though the original cost may be slightly higher than other litters, it outlasts others two or three times and saves the labor of handling. It prevents fire because it will not blaze. It takes an intense heat even to make this litter smoulder. After being used in the poultry house, it makes a most valuable fertilizer. Many poultrymen sell their O. K. Poultry Litter manure mixture to gardeners, florists and nurserymen at a high price. It does not injure the birds if eaten. One bale will cover 240 square feet with 1-inch of litter. Bales weigh approximately 140 pounds.

F. O. B. San Antonio, Texas, per bale ----- \$3.75



OAKES NEW GAS BROODER
BURNS NATURAL, ARTIFICIAL OR BUTANE GAS

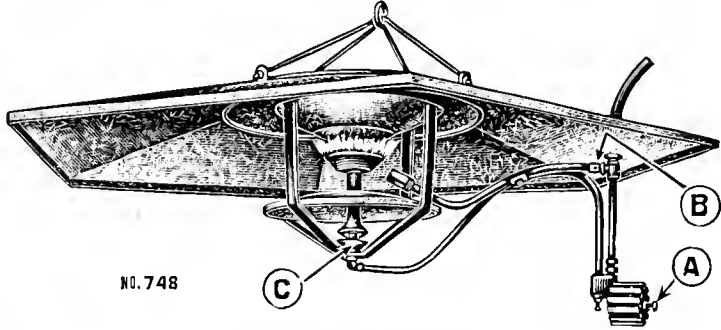

NO. 748

Oakes Gas brooders have burner assembly rigidly mounted in hexagonal canopy of heavy galvanized steel. Heat deflector above burner to radiate and distribute heat over widest possible area. Baffle plate below the burner prevents hot spot in center of canopy; permits hanging brooder closer to floor in early brooding without any fire hazard. Adjustable balancing rods for leveling canopy. Hangs from ceiling. Very sturdy canopy measures 48 inches from flat side to flat side with 54 inch diameter. The Gas Regulator valve is operated by a double disc 3 inch wafer thermostat which is very responsive to slightest temperature changes; located at edge of canopy to insure an even brooding temperature. Valve unit made entirely of brass; carefully machined parts; does not stick or fail in operation. Working parts protected from damage by a metal cage. By-pass permits just enough gas to keep pilot flame burning constantly.

No. 748 — Oakes Gas Brooder, weight 30 lbs. \$13.25

ANDERSON STICKLESS FEED-O-BOX

NO STICKS NO NAILS NO GLUE

Good hatchery managers like to know that their chicks are being delivered in the best possible manner. By standardizing on Stickless Feed-O-Boxes you know that every box taken out of your hatchery, whether for distant shipment or for local delivery, is provided with adequate ventilation.

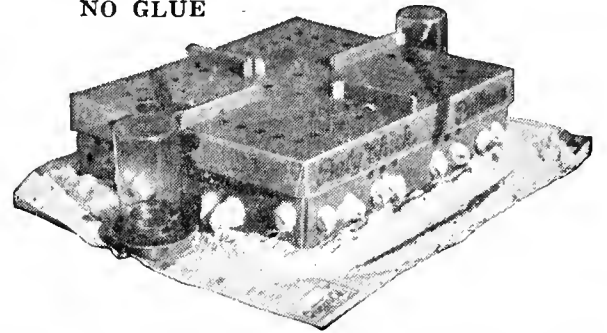

The partitions which extend above the lid of the box, separating one box from another, give an inch space of ventilation between boxes. The bowed covers of the box prevent the shutting off of ventilation when boxes are stacked against wall or against other boxes. The Feed-O-Box punching itself provides additional ventilation in part when necessary.

Certainly during a busy hatching season every minute counts and the time and labor saved by using Stickless Feed-O-Boxes will mean many dollars saved for you.

30 Boxes per bundle.

Capacity	Dimensions	Up to 100	100 to 500	500 to 2000
SF-100—100 Chick	22x18x5½	.23	.20½	18½
SFH-100—100 Chick Summer	24x18x6	.24¾	.22½	.20¾

ANDERSON BLUE RIBBON PULLMAN CHICK BOXES



The boxes are made of high grade, strong corrugated board with weather-proof Kraft outside and dark blue chip liner.

Pleasingly printed in red and blue—corners slotted to make assembly more attractive.

All folds perfectly scored—Partitions scored so they turn in one direction on one side and in the reverse direction on the other side. Insides slightly scored where partitions attach to box.

All holes perfectly and uniformly semi-punched to give complete control of ventilation.

Chick boxes, wrapped 30 to bundle; 3 week boxes, 10 to bundle; 6 week boxes, 10 to bundle. We do not break bundles.

Delivered to Destination in 100 lb. Shipments; Small Quantities F. O. B. San Antonio, Texas

Capacity	Dimensions	Shpg. Wt. Per Bdle.	Up to 100 Each	100 to 500 Each	500 to 2000 Each
A-100—100 Chicks	22x18x5½	54 lbs.	\$.21½	\$.19	\$.17
AH- 50—50 Chicks	18x12x5½	32 lbs.	.14¾	.13	.11½
AH- 25—25 Chicks	12x 9 x5½	20 lbs.	.09¾	.08½	.07¾
HW-100 100 Chicks Summer	24x18x6	64 lbs.	.23¼	.21	.19¾
O-100—Oversize	24x20x6		.24¼	.21¾	.20
3WK- 50—3 Week Chicks	24x22x9	62 lbs.	.32¼	.28¼	.25
PB-1 —12 Week Pullets	36x18x11	34 lbs.	.50	.48	.46

STICKLESS-STAPLESS CHICK BOXES

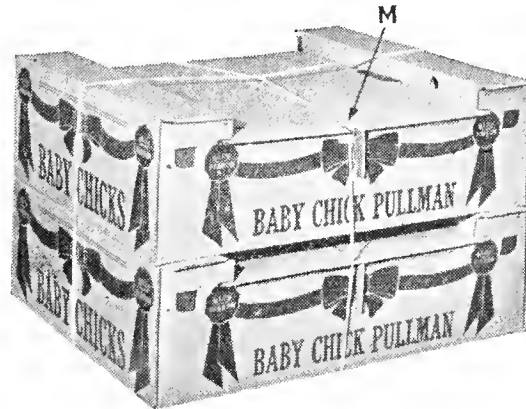

- 1 Easy to set up.
- 2 Saving in time, labor and material.
- 3 Easier to handle in the incubator and hatchery than other types of Stickless Stapless boxes.
- 4 Ideal ventilation — strong, sturdy construction.
- 5 Made of Anderson strong Kraft outside liner with attractive blue inside liner — Another Pullman that will help you merchandise your chicks.

Labor is reduced—Staples are eliminated—Sticks are eliminated—Glue or brads are eliminated—Twine is eliminated—Stapling equipment repairs are eliminated.

Packed 30 to bundle. No bundles broken. Small quantities F. O. B. San Antonio, Texas.

Capacity	Dimensions	Shpg. Wt. Per Bdl.	Up to 100 Each	100 to 500 Each	500 to 2000 Each
SS-100—100 Chick	22x18x5½	64 lbs.	.23	.20½	.18½
SSH-100—100 Chick Summer	24x18x6	72 lbs.	.24¾	.22½	.20¾

WRITE FOR PRICES IN LARGER QUANTITIES

ANDERSON LOCAL DELIVERY BOXES
CORRUGATED

A good corrugated box, in standard sizes, but of lighter weight material than the Standard Stapled Box.

Designed for local deliveries, it offers a saving to the hatcheryman who does a lot of custom hatching or who sells most of his chicks near home.

SEMI-PUNCHED FOR TRI-LOK SPACERS

Home Town Box Lids are semi-punched to receive Tri-Lok Spacers —another economy—Tri-Lok Spacers may be inserted in the slots to furnish ventilation while chicks are stacked in the hatchery or sales room, then removed when the box is delivered to the local customer and used repeatedly in other boxes or they may be left in place if needed during transportation.

Capacity	Dimensions	Shpg. Wt. Per Bdle.	up to 100 Each	100 to 500 Each	500 to 2000 Each
100 Chick	22x18x5½	48	\$.18½	\$.16	\$.14
100 Chick Summer	24x18x6	51	.20¼	.18	.16¼

Tri-Lok Spacer, 1000 to a bundle, shipping weight 34 lbs. 1 to 10 Bdles. \$2.75 per bdl, or over \$2.65 per bdl.

SMALL LOCAL COUNTER CHICK BOXES

L-15—15-Chick size, per 100	\$3.30
L-25—25-Chick size, per 100	4.35
L-50—50-Chick size, per 100	7.30

Full freight allowed on Chick Boxes provided shipment weighs 100 pounds or more. Freight allowance does not apply on Chick Box Supplies.

STAPLERS AND STAPLES

ACME No. 11—Hand Powered Stapler, holds 100 staples automatic feed, anti-clogging device, shipping weight 9 pounds; price \$9.00

No. XX—Staples, box of 5,000	1.55	5 Boxes \$1.65
No. 61—Staples, box of 5,000	1.75	
No. 700—Staples, box of 5,000	1.75	
Tin Hand Staples, per box of 1,000	.90	
Piercing Tool for use with tin or copper-coated staples, to guide the staples into the box; each	.40	
Master Breeder 6-in. Redwood Sticks, per 1,000	2.60	
Cardboard Sticks, per 1,000	2.70	
Master Breeder Stick Glue, per 1-gallon can	1.00	
Wood-Wool Pads, 9x11, per 1,000	9.00	
Wood-Wool, per bale, per lb.	.04½	
Gummed Paper Tape, 2-in., per roll	.40	
Tri-Lok Spacers, per 1000	2.75	

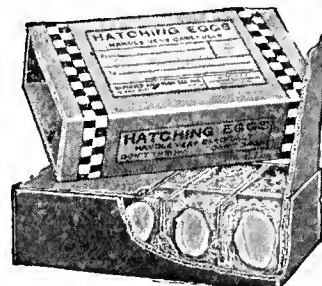

ANDERSON EGG BOXES FOR SHIPPING

Made of extra heavy corrugated cardboard; built so as to stand rough handling and carry your setting eggs safely.

15-egg size, weight 1½ lbs., each	\$0.30
15-egg size, weight 15 lbs., doz.	3.00
30-egg size, weight 2½ lbs., each	.35
30-egg size, weight 26 lbs., doz.	3.60
50-egg size, weight 3½ lbs., each	.50
50-egg size, weight 39 lbs., doz.	4.50

LeGEAR'S GALL SALVE

Recommended for sore backs, caused by collars and saddle galls, scratches, sore teats on cows, and minor sores on live stock. Keeps sore softened and you can continue working the horse while using Dr. LeGear's Gall Salve.

2-oz. can ----- 25c



LeGEAR'S ANTISEPTIC POWDER

Promotes Healing—It is an excellent antiseptic preparation for treating cuts and sores, barbed wire cuts, saddle, harness and collar galls. Keeps off flies. For flesh wounds and abrasions, livestock breeders find LeGear's Antiseptic Powder a splendid preparation. Put up in sifter-top cans. Easy to apply—simply dust on.

Small can ----- 25c
Large can ----- 50c

LICE POWDER

For chickens, turkeys and live stock. Is a quick, easy and effective way to get rid of lice. Valuable to use in your poultry dust bath for flock treatment. It contains Sodium Fluoride, Sulphur, and Nicotine. Put up in 14-oz. handy sifter top cans.

Price ----- \$.25

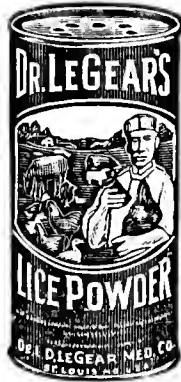

LeGEAR'S SCREW WORM KILLER

A THREE-IN-ONE preparation. It not only kills Screw Worms, but keeps the flies away and promotes healing. It has a sprinkler stopper, which makes it very easy to apply, right into the wound.

2-oz. bottle -- 25c; 6-oz. bottle 45c



LeGEAR'S LINIMENT

This preparation is a white penetrating liniment, and an efficient counter-irritant for sprains, bruises and muscular soreness and lameness of live-stock. Also for muscular aches and pains of man.

2 oz. bottle 30c; 6 oz. bottle 60c.



LeGEAR'S BLISTER

Will be found to be an effective blistering ointment for Spavin, Splint of Curb. It will not kill the hair or blemish when used according to directions. We have hundreds of testimonials that it has given entire satisfaction.

Dr. LeGear's Blister is an ointment, and is easy to apply.

2-oz. bottle ----- \$.75

LeGEAR'S CHICK TABLETS

An intestinal astringent. Helps chicks to get the right start! When dissolved in the drinking water it has a mild antiseptic effect on the water which is very beneficial to all baby chicks as an intestinal astringent. Cans contain 80 tablets ----- \$.50

LeGEAR'S COLIC MEDICINE

Recommended for all cases of flatulent colic in live-stock. You will find in the majority of cases it will relieve your horse in 2 or 3 hours.

4-oz. bottle ----- \$.75



DR. LeGEAR'S POULTRY ANTISEPTIC TABLETS

For the treatment of external swellings of roup, simple catarrh (colds) and to prevent transmitting disease from one bird to another through the drinking water. Every package contains complete directions.

25 tablets ----- 25c
60 tablets ----- 50c

LeGEAR'S DIP AND DISINFECTANT

An excellent antiseptic, disinfectant, germicide and deodorant for both home and stable use. Good for lice, fleas, sheep scab, and many forms of ticks, itch and mange on horses, cattle, hogs, goats, dogs and poultry.

Put up in 8-oz. bottle 25c; quart 50c; gallon \$1.50.

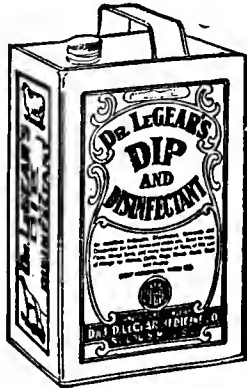

LeGEAR'S NICOTINE KAMALA PILLS (Adult Size)

—An effective preparation against large round worms and also tape worms—a very easy simple individual treatment—no fasting necessary—as the pill is to be given on full crop.

50 Pills ----- \$.75
100 Pills ----- 1.25



DR. LeGEAR'S UDDER OINTMENT

A soothing, penetrating ointment. Acts as a local anodyne, relieving local irritation and congestion of the udders of cows and mares. For treating sore teats, cuts, bruises and chapping.

7-oz. cans ----- 50c



DR. LeGEAR'S ANTISEPTIC OIL

For treating burns, cuts, scratches, insect bites, and numerous skin irritations. An economical and efficient antiseptic which promotes healing, and is fully as useful in the household as in the stable. Used extensively for chapped hands, etc.

2 oz. 25c; 5 oz. ----- 50c

DR. LeGEAR'S COW PRESCRIPTION

DR. LeGEAR'S COW PRESCRIPTION—It is scientifically balanced to make an efficient tonic, appetizer and conditioner for milk cows, heifers and calves. 2 lbs. 50c.



DR. LeGEAR'S HOG PRESCRIPTION

A tonic and conditioner. It thus aids assimilation. The advantage of this powder when fed with the slops or in a self-feeder is that it does not throw the hogs off their feed. It furnishes the suckling sows the necessary minerals thereby giving the pigs the right start during first 6 months of their life.

A pig should have these mineral to facilitate proper growth and get him ready for the market in the Fall. 25c, 50c, \$1.00 sizes; 25 lb. pkg. \$3.00.

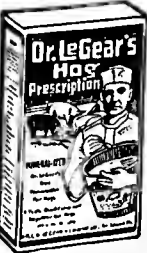

LeGEAR'S POULTRY PRESCRIPTION

Helps to make hens lay to keep poultry health. A good general tonic and remedy for many ailments of poultry. It is especially beneficial during the moult, in the breeding season and during the winter time. 25c, 50c, and \$1.00 sizes; 25-lb. drum \$3.00; 100-lb. bag \$10.00

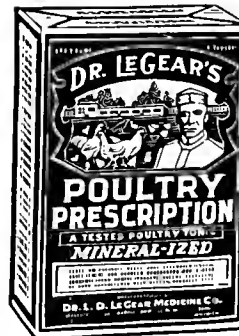

DR. LeGEAR'S STOCK TONIC

Has been used and recommended by leading farmers and stock breeders for 40 years. It contains mineral and vegetable ingredients

scientifically compounded to produce an effective tonic, appetizer and conditioner for cows, horses, mules, sheep and hogs.

Small size pkg. ----- \$.25
Medium size pkg. ----- .50
Large size pkg. ----- 1.00
25-lb. pkg. ----- 3.00
100-lb. bag ----- 10.00

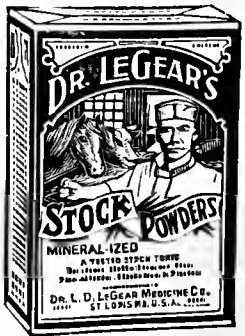

LeGEAR'S DOG REMEDIES

Contains the Most Effective Ingredients Known to Modern Veterinary Science



Tape Worm Tablets ----- \$.50
Mange Prescription ----- .50
Tonic Condition Tablets ----- .30
Kennel Disinfectant ----- .50
Flea and Lice Powder ----- .25
Flea and Shampoo Soap ----- .50
Laxative Tablets ----- .50
Pepsin Compound Tablets ----- .50
Special Tablets (for reducing fever) --- 1.00
Nerve Sedative Tablets ----- 1.00
Eye Lotion ----- .50
Cod Liver Oil Concentrate Tablets ----- 50c and \$1.00
Round and Hook Worm Capsules for small dogs ----- .50
Round and Hook Worm Capsules for Medium-Large Dogs ----- .50

BEE BRAND INSECT SPRAY

A RELIABLE HOUSEHOLD INSECTICIDE

Destroys flies, moths, mosquitoes, bedbugs, beetles, silverfish, fleas, chicken lice, mites and their eggs. Bee brand insect spray sprayed thoroughly within the house is a sanitary measure insuring against contagion. Bee brand insect spray is 100% active and non-poisonous. Will not stain the daintiest fabrics. No unpleasant odor. Use Bee brand insect spray freely during spring and summer months.

½ Pint Cans ----- \$.15
Pint Cans ----- .25
Quart Cans ----- .42

DR. HESS REMEDIES

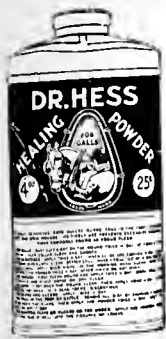

DR. HESS HEALING POWDER

An Antiseptic Treatment for Open Wounds and Abrasions. For veterinary use it is a recognized remedy for galls, cuts, thrush, mud sores, burns, wire cuts, ulcers, foul in the feet, fistula, chapped teats and surface wounds of every description. It also prevents proud flesh. Being a powder, stable dirt and dust will not stick to it.

Put up in handy adjustable, sifting-top can.
 10-oz. can ----- \$0.50
 4-oz. can ----- .25

DR. HESS UDDER OINTMENT

Especially prepared for treatment of injuries and congestion of the udder and teats. Penetrating, soothing, healing. Large handy can 50c.



DR. HESS POULTRY PAN-A-MIN

Helps make poultry healthier and to make hens lay. Not a stimulant, but a tonic that tones up the dormant organs, brings back the scratch and cackle, and compels each hen to put her share of eggs in the market basket.

100-lb. Drum ----- \$10.80
 25-lb. Pail ----- 3.30
 15-lb. Pkg. ----- 2.20
 7-lb. Pkg. ----- 1.15
 3-lb. Pkg. ----- .55
 1½-lb. Pkg. ----- .30

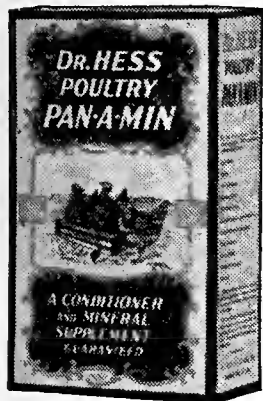

DR. HESS STOCK TONIC

IMPROVED—With Minerals Added—A Conditioner and Worm Expeller—Promotes health, makes hogs, cows and sheep more profitable—keeps horses and mules in good condition. Rids hogs of worms, makes the runts thrive and the whole herd gain faster.

Contains tonics to whet the appetite of cows, laxatives to keep the bowels in order, diuretics for the kidneys, and the needed minerals usually lacking in ordinary rations.

100-lb. Drum ----- \$10.80
 25-lb. Pail ----- 3.30
 15-lb. Pkg. ----- 2.20
 5-lb. Pkg. ----- .75
 3-lb. Pkg. ----- .55
 1½-lb. Pkg. ----- .30

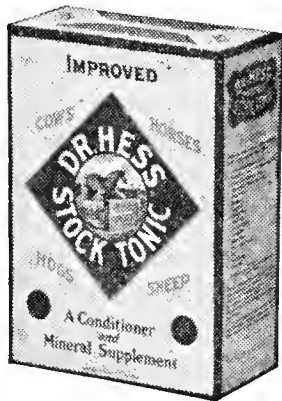

DR. HESS HOG SPECIAL

A Splendid Conditioner and Worm Expeller for Hogs—Rids hogs of worms. Makes the runts thrive and the whole herd gain faster. Contains tonics to whet the appetite, laxatives to keep the bowels in order, diuretics for the kidneys, and needed minerals usually needed in ordinary rations.

100-lb. Drum ----- \$10.80
 25-lb. Pail ----- 3.30
 15-lb. Pkg. ----- 2.20
 7-lb. Pkg. ----- 1.15
 3-lb. Pkg. ----- .55
 1¼-lb. Pkg. ----- .30

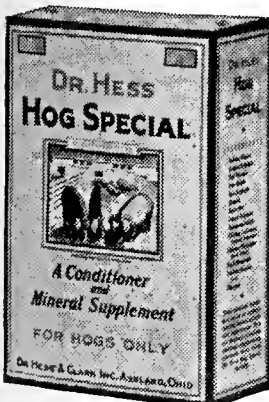

DR. HESS DIP AND DISINFECTANT

Kills hog lice, sheep ticks and other animal parasites. For general disinfecting about stables, dairy barns, poultry houses and the household. It is standardized, always uniform in strength. Makes a milky-white emulsion.

Pints ----- \$0.35
 Quarts ----- .60
 ½ Gallon ----- .90
 1 Gallon ----- 1.50
 5 Gallons ----- 6.50

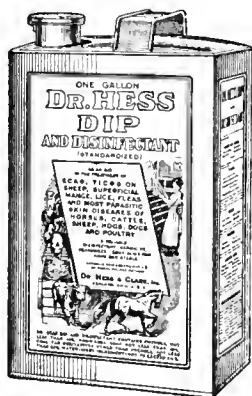

DR. HESS LOUSE KILLER

Kills lice on poultry, horses and cattle; sheep ticks; bugs on cucumber, squash, and melon vines; slugs on rose bushes; ants. Non-poisonous; can be used in safety on edible plants. Sold in sifting-top cans.

1 -lb. can ----- \$0.30
 2½-lb. can ----- .60



45 Tablets ----- \$0.25
 100 Tablets ----- .50

DR. HESS CHICK TABLETS

For common diarrhoea, bacillary white diarrhoea, coccidiosis, or any form of bowel trouble affecting poultry. Used as a preventive and as a treatment. Given in the drinking water.

45 Tablets ----- \$0.25
 100 Tablets ----- .50

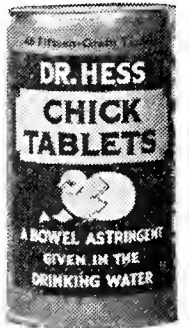

DR. HESS POULTRY TABLETS

Of high value in treating roup; slightly astringent, non-irritating and healing. Use as a local antiseptic and to medicate drinking water. Thus used they aid in preventing the disease. Once dissolved they remain in solution. The water needs no further stirring.

45 Tablets ----- \$0.25
 100 Tablets ----- .50



DR. HESS POULTRY WORM TABLETS

The active ingredients of Dr. Hess Poultry Worm Powder in tablet form for individual treatment.

40 Tablets, pkg. ----- \$0.50
 100 Tablets, pkg. ----- 1.00
 250 Tablets, pkg. ----- 2.00
 500 Tablets, pkg. ----- 3.50
 1000 Tablets, pkg. ----- 6.50

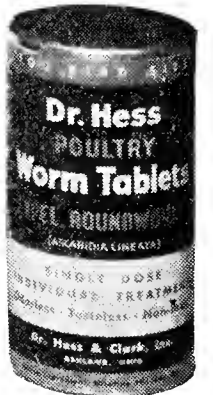

DR. HESS POULTRY WORM POWDER

A proved single-dose flock treatment for round worms. Given in mash the expulsion of worms starts in a few hours and is usually completed in from 24 to 36 hours. No fasting or laxatives required. Does not check egg production.

50 Adult Bird size ----- \$0.50
 100 Adult Bird size ----- .90
 250 Adult Bird size ----- 1.90
 500 Adult Bird size ----- 3.00
 1000 Adult Bird size ----- 5.40

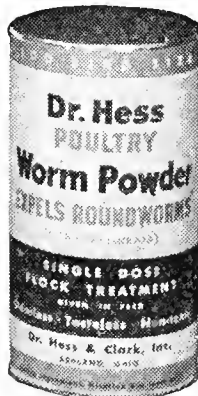

DR. HESS FLY SPRAY

Has the odor of the pines.—Pleasant to folks, but repelling to flies and mosquitoes. Prevents the summer milk slump. Besides being a most efficient fly repellent it is a disinfectant and deodorant. Will not taint the milk; will not stain or gum the hair. It is a skin cleanser.

1 Gallon ----- \$1.50
 5 Gallons ----- 6.50



SUPER-OL

Kills chicken mites, fowl ticks or "Blue Bugs." A dependable wood preservative. Protects against rot and premature decay. Protects wood from destruction by white ants (Termites).

On practically every kind of farm building, it may be used as a paint. It is less expensive than paint, easy to apply and prevents decay.

1 gallon ----- \$1.75



CARBOLINEUM

Is a pure, unadulterated high boiling anthracene oil—a carbolineum of the highest grade—meeting Uncle Sam's requirements in every respect and it is



SURE DEATH TO MITES AND BLUE BUGS.

Can be applied with a brush like paint, or sprayed on as preferred. It should not be applied to the chickens. One gallon will go over an ordinary chicken house, size 8x12. ¼ gal. 50c; ½ gal. 90c; 1 gal. \$1.50; 5 gal. \$7.25

GEO. H. LEE'S REMEDIES



LEE'S GERMOZONE

A most effective remedy for diseases affecting the skin and semi-exterior mucuous membrane of man, fowl or beast.

For Poultry—Roup, colds, canker, chicken-pox, sore head, swelled head, cholera, bowel trouble, etc.

For Stock—Cuts, sores, wounds, sore eyes or mouth, saddle or harness galls swelling skin diseases, etc.

4 oz. at	\$0.40
12 oz. at75
Quart size	1.50
½ Gallon	2.50
Gallon	4.50

ACIDOX

Acidox is a controlled acid preparation. It is given as easily as Germozone—just a little in the drinking water every other day. The birds like the Acidox water and drink plenty of it, and it does not throw them off their feed. They relish their sugar-mash, and from it and from the Acidox and Germozone they get the help they need so badly. Use Acidox in the proportion recommended.

4 oz. Bottle	\$0.50
12-oz. Bottle	1.00
32-oz. Bottle	2.00

Good News

FOR CHICK RAISERS



(We can now supply Acidox for use in the treatment of Coccidiosis.)

The new Acidox Treatment has proved on over 70 thousand birds that deaths and later losses can now be largely avoided.

Acidox does not throw birds off feed. It is used in the drink on alternate days with Germozone. A 50c bottle treats 100 little chicks or 50 eight-week birds.

FREE Booklet: "Coccidiosis — and What to Do About It."

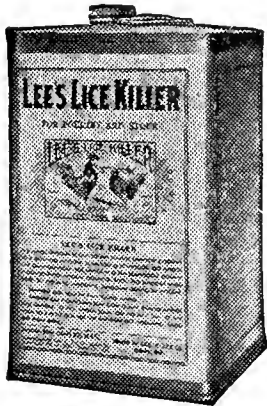

LEE'S LICE KILLER

It kills by vapor and contact. It gives double service. Painted on the roost it kills insects with which it comes in contact, and the vapor arising kills lice on the bodies of the chickens as they roost over night, also the insect causing scaly leg. Not mailable. Price—Quart can, 60c; ½ gallon, 90c; gallon can \$1.50.

LEE'S GIZZARD CAPSULES

An insoluble capsule carrying a triple combination worm medicine for Tapeworms, Round Worms and Pin Worms. Being insoluble, it passes through the mouth, throat, crop and stomach of the fowl to the gizzard where it is ground up like a grain of corn, pouring the full strength, undiluted medicine directly into the intestines upon the worms.

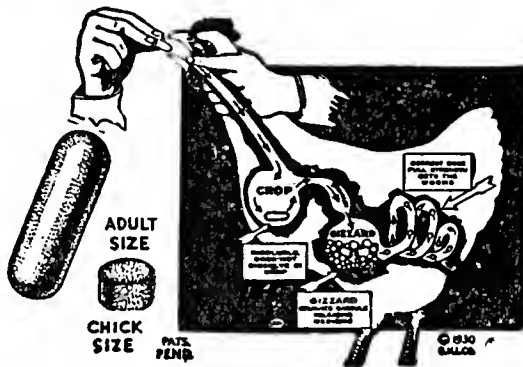

ADULT SIZE	
50 Capsules, pkg.	\$0.75
100 Capsules, pkg.	1.25
500 Capsules, pkg.	5.50
1000 Capsules, pkg.	10.00

CHICK SIZE		PULLET SIZE	
50 Capsules, pkg.	\$0.40	50 Capsules, pkg.	\$0.50
100 Capsules, pkg.75	100 Capsules, pkg.	1.00
500 Capsules, pkg.	3.25	500 Capsules, pkg.	4.50
1000 Capsules, pkg.	6.00	1000 Capsules, pkg.	8.50

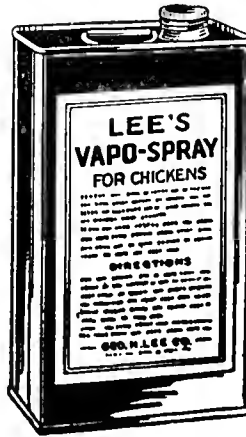

LEE'S VAPO SPRAY

A combination of healing oils, is sprayed in the air in the hen house at night. Its vapor is breathed into the nasal passages, throat, windpipe and lungs and acts directly on the inflamed parts. Also recommended for hogs.

1-Qt. can	\$0.75
½-Gal. can	1.25
1-Gal. can	2.00

LEE'S EMULSION

A cough medicine for poultry and hogs; acts much the same as a cough syrup in human beings.

It may be administered in water, thick slop, wet mash, or soaked grain (soaked oats preferred).

INGREDIENTS: Oil Eucalyptus, Oil Pine Tar, Oil Anise, Beechwood Creosote, Chloroform, Camphor, Turpentine, Linseed Oil, Sodium Chloride, Water and Emulsive.

4-oz. Bottle	\$0.50
13-oz. Bottle	1.00

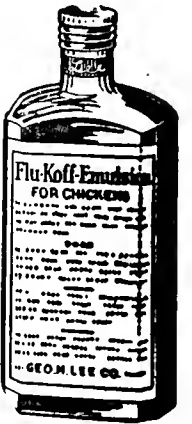

LEE'S PICK PASTE

Lee's Pickpaste is manufactured for controlling and overcoming the vicious habit of toe, wing and vent picking of chicks. It is also soothing and healing.

2-oz. Tube	\$0.25
6-oz. Jar60

LEE'S HOG OIL WORMER

There are three methods of treating hogs for large round worms (Ascaridia): Feeding of Powder, the Capsule Method, and the Oil Method. The Oil Method is by far the most satisfactory. In Lee's Hog Oil Wormer, Oil of Chenopodium and other ingredients in proper and effective proportions are incorporated in a bland oil base. This oil base gets away from the irritating effect which Chenopodium has when given full strength in capsules. The medicine is given with a Lee Veterinary dosing syringe or it may be given in a wet feed or a slop.

Dosage and Prices:

No. of Doses for 40-lb. Pigs.		
12-oz. Bottle	16	\$1.00
1 Quart	42	2.00
½ Gallon	85	3.50



LEE'S DRI-RUB

A COLD WEATHER SUBSTITUTE FOR DIP

Lee's Dri-Rub contains in powder form ingredients similar to the active ingredients in Lee's Dip and Disinfectant. It is valuable and convenient for delousing hogs and other animals. Simply sprinkle freely on the animals and in bedding.

Lee's Dri-Rub is good for disinfecting poultry houses in cold weather. Remove all litter, clean and scrape the floors. Then sprinkle Lee's Dri-Rub liberally and, with a broom, work it into the cracks of the floor. Scatter new litter and sprinkle Lee's Dri-Rub in it. Effective and much cheaper than louse powder for hens' dust baths.

3-lb. can	45c
-----------------	-----

LEE'S PERCH PAINT

Lee's Perch Paint is a nicotine preparation for controlling body lice by painting it on only the top side of the perch poles. The nicotine is carried in a specially processed base which, in itself and like Lee's Lice Killer, has the property of killing lice by fumigation. It adds to the lice killing power of the nicotine. With Lee's Perch Paint, no special scraping or cleaning of the perches is necessary. And the product is designed to minimize staining of white birds.

½ pint can85
1 pint can	\$1.50

LEE'S TONAX

TONAX contains organic astringents to help offset the forces causing Diarrhea.

The Blood Building Elements in TONAX are Manganese, Iron, Cobalt, and Copper. These are very helpful because the blood of fowls is not so highly developed as that of animals and man.

Control of intestinal parasites (coccidia and round and pin worms) is aided by Nicotine and a combination of Pyridine and Sulphur. In TONAX you get this combination. That is one reason why TONAX is of prime importance in the case of growing stock.

Nux Vomica Alkaloids tone up the general system of the birds. They also have a very favorable influence on egg production. TONAX is recommended especially in the case of unseasonal slumps in production.

12-oz. can30
2-lb. can75
6-lb. can	\$2.00

DR. SALSBUARY REMEDIES

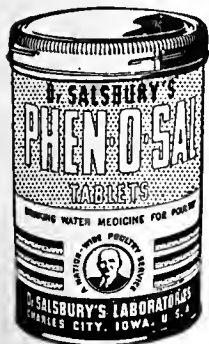

PHEN-O-SAL

Excellent aid in the treatment of diarrhoea and coccidiosis of chicks, fowl typhoid, fowl cholera, enteritis, irritation from worms, blackhead in turkeys, also duck and goose cholera. Figure one tablet per chick as a five-day treatment.

25 Tablets	-----	\$.25
50 Tablets	-----	.50
125 Tablets	-----	1.00
300 Tablets	-----	2.00
500 Tablets	-----	3.00
1000 Tablets	-----	5.50

AVITONE

Flock treatment for round worms, worm preventive and general tonic. For baby chicks and turkeys, growing stock and laying flocks. In powder form.

10-oz. Pkg.	No. of Birds		Price
	Growing	Adult	
-----	30	20	\$.25
3-lb. Pkg.-----	150	100	1.10
6-lb. Pkg.-----	300	200	2.00
15-lb. Pkg.-----	750	500	4.75
25-lb. Pkg.-----	1,250	825	7.50
50-lb. Pkg.-----	2 500	1,650	14.00
100-lb. Pkg.-----	5,000	3,300	27.00

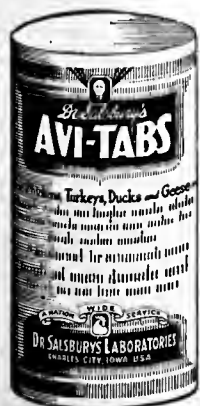

AVI-TAB KRUMBLES

A general flock treatment for birds infested with the microscopic varieties of tape worms often associated with paralysis. For treatment at any time where a flock medication is preferred to the individual Caps. Excellent tonic for increasing the appetite. An aid in treating blackhead, thrush and mycosis. May be used in combination with Rakos and Phen-O-Sal.

4 Oz.	No. of Birds		Price
	Growing	Adult	
-----	80	40	\$.65
8 Oz.-----	165	83	1.20
1 Lb.-----	330	166	2.25
3 Lbs.-----	1000	500	6.00

CAM-PHO-SAL

For roup, cold, flu, gapes, bronchitis, brooder pneumonia, etc., in fowls of all ages. Has three times the germ killing strength of carbolic acid.

2 Oz. Bottle	-----	\$.45
4 Oz. Bottle	-----	.75
8 Oz. Bottle	-----	1.10
16 Oz. Bottle	-----	1.85



RAKOS

A concentrated liquid antiseptic and astringent for aid in treatment of coccidiosis in chickens and turkeys of all ages. An appetizer and tonic.

8 Oz. Bottle	-----	\$.75
16 Oz. Bottle	-----	1.25
32 Oz. Bottle	-----	2.00

MIXED BACTERIN FOWL

Cholera-Typhoid Bacterin

A preventive and curative treatment against croup, colds and related diseases affecting the head of chickens and turkeys.

60 Doses—60 c.c. Bottle	-----	\$0.85
250 Doses—250 c.c. Bottle	-----	3.00



FOWL POX VACCINE

To prevent chicken-pox by feather follicle or stick method of vaccination. Specify chicken strain for growing stock and permanent immunity and pigeon strain for laying stock.

100-dose Pkg.	-----	\$0.75
---------------	-------	--------

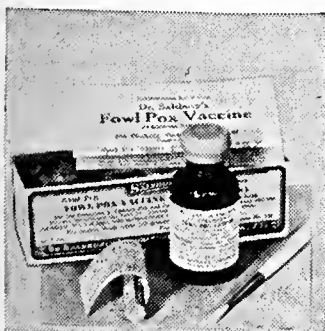

MARTIN'S SCREW WORM KILLER

A three-in-one preparation. It not only kills Screw Worms but keeps the flies away and promotes healing. It has a sprinkler stopper, which makes it very easy to apply right into the wound.

2½-oz. Can	-----	\$.25
------------	-------	--------

ROTA CAPS



Dr. Salsbury's ROTA CAP have a TRIPLE ACTION that makes them hard on worms, yet easy on the birds: (1) they get large round worms; (2) they remove large tape worms (Tetragona), heads and all, instead of merely desegmenting them. They create their own mild, controlled laxative action.

50 Caps	Pullet		Adult
	Size	Size	
-----	\$.50	\$.75	
100 Caps-----	.90	1.35	
200 Caps-----	1.75	2.50	
500 Caps-----	3.50	5.00	
1000 Caps-----	6.00	9.00	

KILL ROUNDWORMS

Don't waste feed on round worms—kill them. Just feed—

"BLACK LEAF" WORM POWDER

ONCE IN MASH

Single dose does the work. Easy, economical and effective. Saves time, trouble and money. Increases production. Harmless to birds. No odor, taste or bother. We highly recommend "Black Leaf" Worm Powder. Ask for circular.

4 -oz. Pkg. 100 hen size	-----	\$.75
1½-lb Pkg. 600 hen size	-----	2.90
3 lb. Pkg. 1,200 hen size	-----	5.40



"GOLD LEAF" TOBACCO POWDER

CONTROLS POULTRY ROUND WORM

Mix two pounds of "Gold Leaf" Tobacco Powder with 100 pounds of dry mash. With the large 100-lb. bag, 800 birds can be treated for about 12 cents a day, or at the rate of about 70 birds for 1 cent a day, during treatment period.

2 Lbs.	-----	\$.30
10 Lbs.	-----	1.00
100 Lbs.	-----	6.25



Rids poultry of all blood sucking lice, mites, fleas, blue bugs, cleans them of all intestinal worms and parasites. It is also a wonderful poultry tonic, blood purifier, health builder and egg producer. It contains lots of sulphur, compounded scientifically with other health building ingredients. Known remedies for preventing disease. "Prevention is cheaper than cure." Keep your flocks free of insects and intestinal worms and their system in good condition through the winter and you will get good hatchings and strong chicks in the spring. A supply to last you through the winter and spring will cost very little. Give it a six days' trial at our risk. Money back if not pleased. 50c and \$1.00 per bottle.

FOR COLDS IN POULTRY

Group-Over



Use Group-Over at the very first symptoms of Roup or colds in your flock. It clears the air passages and brings relief with magic quickness. Easily used, both for individual treatment and in the drinking water for flock prevention.

Price 50c; large size (3 times 50c size) \$1.00.

PEERLESS SCREW WORM KILLER

Kills the worms quickly without any bad effects on the wounds and assists in healing. Sprinkler top.

4-oz. size	-----	\$.25
8-oz. size	-----	.50
Pints	-----	1.00
Quarts	-----	1.50



DON SUNG

Chinese for Egg-Laying

It is a concentrated medicine—no needless bulk or filler—ready to add to your mash feed. It has a direct tonic action on the egg-laying organs and doesn't force or hurt the hens in any way. It produces more eggs by first putting the hen in good health, and then helping to maintain their health.

Small size ----- \$.50
Large size (3 times the 50c size) ----- 1.00

AVICOL

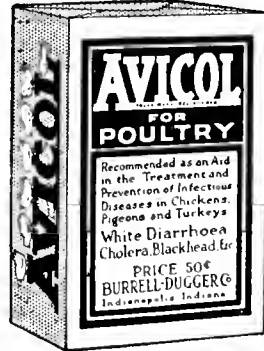

For White Diarrhoea in Chicks, and Blackhead in Turkeys

Avicol does the work in 48 hours. Almost from the very moment you drop the first Avicol tablet in the drinking water, the sick chicks start to get well. Usually, in a short time, the very ones that seemed too weak and sick to live another day, are running around as lively as crickets, full of pep, hungry, hearty, scratching and pushing for a place at the feeding trough.

Price, 50c; special large size (almost three times 50c size), \$1.00.



COCCIDIOSIS REMEDY

Stops Losses Now!

Dead Chicks Lose You Money

S-P Coccidiosis Remedy Will Keep Them Alive

Given in the drinking water. No starving of birds—no inconvenience. Easy to apply, is an excellent preventive. One box treats 100 to 125 chicks. Simply dissolve in the water.

Price per box, postpaid ----- \$1.00

NICOTINE POULTRY DELOUSER

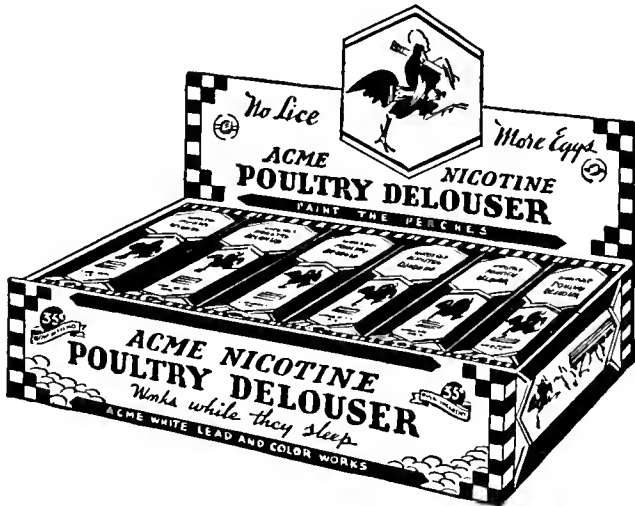

ACME NICOTINE POULTRY DELOUSER is made on a patented formula, which causes the fuming of nicotine to be retarded, making it last longer. The insects succumb to this more prolonged action as well, or better, than to a brief, powerful fumigation. Just paint on the roost.

2-oz. Tubes, each ----- \$.35
5-oz. Tubes, each ----- .85
Pints (1 1/4 lbs. net), each ----- 2.00
Quarts (2 1/2 lbs. net), each ----- 3.00

SODIUM FLUORIDE

A preparation highly recommended by the U. S. Government for the control of poultry lice. Also a splendid item for roach control. May be used as a dip or dust. Lb. 30c.

Poultrymen—Dairymen—Rabbit Breeders—Farmers
Homemakers

USE AND RECOMMEND

B-K

Disinfectant — Antiseptic — Deodorant — Purifier

Because it is absolutely dependable in helping to prevent the spread of infectious diseases, and because it is so inexpensive to use. They know it is a powerful non-poisonous disinfectant, easy to apply—that has proved its efficacy as a germ killer for twenty years.

You, too, will find it helpful to use B-K to prevent the spread of infectious diseases.

Full directions come with every bottle.
4-oz. 30c; 10-oz. 50c; 1 qt. 90c; 1 gal. \$2.00;
5 gal. \$8.50.

B-K POWDER

B-K in powder form, reduces the expense of shipping it around the country. It is of course not quite so convenient to use as in the liquid form. Full directions for its use come with each bottle.



2.66-oz. can 25c; 9 1-3 oz. bottle, 75c; 1 3-4 lb. bottle (makes 3 gallons of 3 1/2 per cent sodium hypochlorite solution).
\$1.50, each, postpaid.

UDDER HELP



Udder Help is the ideal all-purpose ointment for livestock. Its healing, antiseptic properties make it useful in all cases for cuts, sores, bruises, cracked or chapped teats, treating non-contagious garget. Use freely to massage sprained or stiff muscles and joints.

8-oz. tube 50c; 1-lb. can 90c; 5-lb. can \$4.25.

WALKO TABLETS

Especially valuable for white diarrhoea among incubator chicks. Tends to increase strength and vitality and should be given in drinking water as a preventive from the time chicks are out of the shell. 50c and \$1.00 pkgs.

EGG-O-LATUM

EGG PRESERVATIVES

Rub a fresh egg with Egg-o-latum. Set it away on end in a cool dry cellar and it will keep perfectly fresh for one year. Price 50c, postpaid.

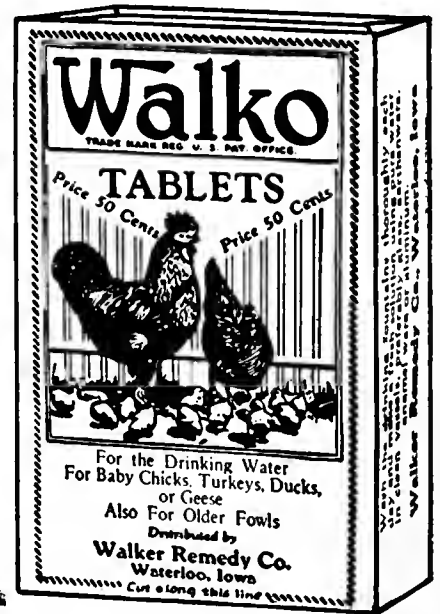

RUTLAND'S WATER GLASS

One can is sufficient to preserve from 16 to 20 dozen eggs. Price per can 50c.

PINE TAR

Has many uses. Used very extensively by stockmen for treating cuts on livestock as a smear to repel flies. Splendid for tree surgery, etc. Pints 25c; Quarts 35c.

MASH-NIC

For Poultry Round Worm Control

MASH-NIC is a scientifically prepared Nicotine compound, to be mixed in the feed, for controlling poultry roundworm. MASH-NIC is guaranteed to contain 1.25% Nicotine, in an insoluble, odorless, tasteless and non-volatile form. MASH-NIC does not lose strength with age or when mixed with feed. MASH-NIC does not lower food consumption or egg production and does not retard the growth and development of chicks. Full directions for use are set forth on the labels.

2-lb. Pkg. ----- \$.45
10-lb. Pkg. ----- 1.75
100-lb. Bag ----- 10.00

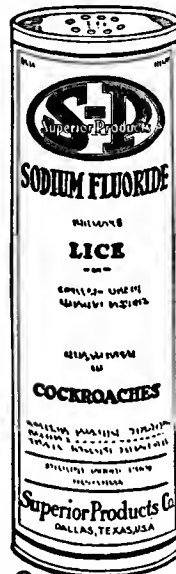

BIOTOL

A NEW ECONOMICAL SOURCE OF VITAMIN D

Every poultryman knows the value of Vitamin D in a well-balanced poultry ration. Even under the most favorable conditions, it is essential for strong bone structure and high egg production.

In BIOTOL biologically tested Vitamin D Oil, you get this new high-potency Vitamin D carrier at its very best—and at lowest possible cost.

BIOTOL is highest grade, selected sardine oil, produced by the California Packing Corporation with the same care which has made its DEL MONTE Brand Food Products world-famous for quality.

Quart	-----	\$0.40
1/2 Gallon	-----	.70
1 Gallon	-----	1.25
5 Gallons	-----	5.50

COD LIVER OIL

To be used in poultry mashes: Experience has proven that Cod Liver Oil is very beneficial to poultry when mixed in fresh with mashes, but is of no value where it is mixed in and exposed to the air for a considerable length of time.

1/4 gal 60c; 1/2 gal. \$1.10; 1 gal. \$2.00; 5 gal \$8.50.

NUX VOMICA

To be mixed with poultry feed to kill hawks and rats. Will not affect poultry. Lb. 40c.

POTASSIUM PERMANGANATE

An excellent germicide used extensively in drinking water for poultry to keep them in healthy condition. Has a very soothing effect on the membranes and linings of chickens' throat and intestines and therefore very extensively used in curing the diseases of these tracts. Price per pound 65c.

FORMALDEHYDE

Used to disinfect incubators and to control seed-borne diseases on certain sorghums and seed potatoes.

Pints	-----	\$0.35	1/2 Gallon	-----	\$1.20
Quarts	-----	.65	1 Gallon	-----	2.25

INCUBATOR FUMIGATION—For such fumigation, where there are no chicks present, we recommend formaldehyde at the rate of one pint, and potassium permanganate eight ounces to each 1,000 cubic feet of air space in the hatchery room.

LACTIC

A Pure Edible Lactic Acid

LACTIC gives the handler of live poultry all the active appetizing digestive and medicinal principles of Buttermilk in a concentrated form, free from all objectionable features of buttermilk. One 6-ounce bottle of LACTIC contains the equivalent of the lactic acid of 30 gallons of buttermilk. 6-oz. bottle 30c.



SATEX INSECT SPRAY

A RELIABLE HOUSEHOLD INSECTICIDE

Destroys flies, moths, mosquitoes, bedbugs, beetles, silverfish, fleas, chicken lice, mites and their eggs. Flyrol, sprayed thoroughly within the house is a sanitary measure insuring against contagion. Flyrol is 100% active and non-poisonous. Will not stain the daintiest fabrics. No unpleasant odor. Use Flyrol freely during spring and summer months.

Pint cans	-----	\$.30
Quart cans	-----	.50
Gallon cans	-----	1.50
5-Gallon cans	-----	6.25

BULK DIP AND DISINFECTANT

2 to 3 Co-efficient—Used as a disinfectant, germicide, insecticide and antiseptic for poultry houses, kennels, barns and household uses. Diluted with water or oil.

1/4 Gallon	-----	\$0.45
1/2 Gallon	-----	.75
1 Gallon	-----	1.35
5 Gallons	-----	6.25

CREOSOTE DIP

15% Crude Carbolic Acid—An excellent liquid spray or paint to put on your poultry house to keep them free from all vermin.

1/4 Gallon	-----	\$0.35
1/2 Gallon	-----	.65
1 Gallon	-----	1.00

DRENCH AND DIP SHEEP

TO CONTROL WORMS, LICE, TICKS AND SCAB

DRENCH—Mix 1 ounce of Black Leaf "40" in 1 1/2 gallons of water. Add 2 ounces of Copper Sulphate. Stir until Copper Sulphate is dissolved. Dose for sheep varies, 1 to 4 ounces, depending upon size and condition of animal.

DIPPING—For sheep; Mix 1 pt. of Black Leaf "40" to 90 gallons of water and add 1 lb. of lye (Caustic Soda).

Write for complete directions.



TO CONTROL LICE ON POULTRY JUST PAINT "BLACK LEAF 40" ON ROOST

1-oz. Bottle	-----	\$ 0.35
Covers 12 to 15 running feet of roost.		
5-oz. Bottle	-----	1.00
Covers 60 to 75 running feet of roost.		
1-lb. Bottle	-----	2.25
Covers 180 to 240 running feet of roost.		
2-lb. Tin	-----	3.25
Covers 385 to 480 running feet of roost.		
5-lb. Tin	-----	5.85
Covers 900 to 1,200 running feet of roost.		
10-lb. Tin	-----	10.60
Covers 1,900 to 2,400 running feet of roost.		

E-Z-GIVE PREPARATION

WORMER—TONIC—CONDITIONER

For

Sheep — Goats — Poultry — Turkeys — Horses & Dogs



Goat and Sheep Raisers!—Why drench or capsule your livestock for worms, which is only a temporary relief from worm infestation?

Eliminate all the labor of catching your sheep or goats and treating them individually, by using E-Z-Give Preparation. Just add one pound package to each 50 lbs. of salt and feed this mixture every other week. Not only rids your livestock of worms, but keeps them healthy and thrifty and costs less than 4 1/2c per head per year to use it.

Poultrymen!—Keep your flocks of poultry or turkeys thrifty and healthy with E-Z-Give. Just mix E-Z-Give Preparation with your mash and feed as directed. Will keep your flock free of worms; does not curtail egg production, and costs less than 4 1/2c per head per year to use. Complete directions printed on each box for worming sheep, goats, lambs, poultry, turkeys, horses or dogs.

1-lb. Pkg. \$2.00; 10-lb. Pkg. \$19.50; 25-1-lb. Pkgs. \$47.50; 100-1-lb. Pkgs. \$175.00.

Q-W DOG REMEDIES



Q-W Flea Powder	-----	\$1.00
Q-W Mange Soap	-----	1.00
Q-W Flea Oil and Coat Grower	-----	1.00
Q-W Eye Salve	-----	1.00
Q-W Diarrhoea and Dysentery Tablets	-----	1.25
Q-W Fit and Sedative Tablets	-----	1.25
Q-W Red Blood Builder	-----	1.00
Q-W Constipation Pills	-----	1.00
Q-W Ear Canker Lotion	-----	1.25
Q-W Worm Capsules	-----	.65
Q-W Healing Salve	-----	1.00

CLAYTON'S CAT REMEDIES

Cat Distemperine Tablets	-----	\$.60
Cat Laxative Tablets	-----	.60
Cat Digestive Tablets	-----	.60
Cat Tape Worm Expeller Tablets	-----	.60
Cat Vermifuge (liquid)	-----	.60
Cat Canker Lotion Tablets	-----	.60
Cat Fit Tablets	-----	.60
Cat Diarrhoea Tablets	-----	.60
Cat Wash and Disinfectant	-----	.25
Cat Mouth Wash	-----	.60
Cat Eye Lotion	-----	.60
Cat Cough Remedy	-----	.60
Cat Soap	-----	.25

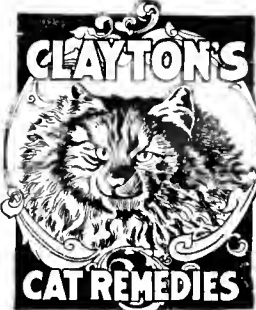

MILK BOTTLE CAPS—Will fit any standard milk bottle. 30c per lb.; 10 lbs. \$2.75.

BUTTER CARTONS—85c per 100, weight 3 lbs.; \$7.50 per 1,000, weight 30 lbs.

BUTTER PAPER—For wrapping 1-lb. moulded butter. 35c per lb.; 3 lbs., \$1.00.

FLOWERED SULPHUR—For feeding with salt, etc. 1 lb. 10c; 10 lbs. 75c; 100 lbs. \$5.00.

EPSOM SALTS—Well known cathartic. Bowel regulator for stock and poultry. 1 lb. .06c; 5 lbs. 25c; 25 lbs. \$1.15; 100 lbs. \$4.00.

ONE-RUB FLEAFINISH

ONE-RUB FLEAFINISH is the latest discovery for the complete extermination of fleas and lice on dogs, cats or any other animal. **One-Rub** differs from the general run of flea powders in that it is not just another flea powder, but an absolutely guaranteed flea killer and the most economical because it only requires a small quantity on the animal's back between the shoulders rubbed in on the skin, and in less than 24 hours every flea on the animal will be dead.

ONE-RUB need only be rubbed in on the back between the shoulders to kill all fleas. For lice, powder the animal all over. **ONE-RUB** is not a poison and is harmless to human beings, domestic animals and poultry, but is too strong for use on canaries, as they sleep with head under wing.

1 -oz. Sifter Top Can\$0.25
2 3/4 -oz. Sifter Top Can50

STOP CANNIBALISM

In Baby Chicks With

McCLELLAN'S TOE PICK

McClellan's Toe Pick is manufactured for controlling and overcoming the vicious habit of toe, wing and vent picking of chicks. It is also soothing and healing.

15-oz. can\$0.80

All Items Marked with an Asterisk (*)

is merchandise that is being discontinued and which we will no longer stock. In order to close out this merchandise in its entirety, we are offering same at prices below replacement cost and all offers are subject to merchandise listed being unsold at the time we receive your orders.



*** SODIUM FLUORIDE LICE POWDER (FOR POULTRY)**

McClellan's Compound Sodium Fluoride Lice Powder is a very high grade preparation made for dusting fowls. Unequalled insofar as efficiency in killing and eradicating lice on poultry is concerned.

15 oz. Pkg. 30c Value\$.15
2 1/2 -lb. Pkg. 70c Value35

*** McCLELLAN'S PINEASAN**

(A Soluble Pine Oil Deodorant)

McClellan's Pineasan is a very high deodorant and cleaner. To be used in hospitals, jails, schools, hotels, kennels, stables, ranches, etc. To be used where a creosote disinfectant cannot be used. McClellan's Pineasan can be used in the scrub water as a cleaner.

Pint can\$0.75 Value\$0.40
Quart can 1.00 Value50
1/2-gallon can 1.75 Value90
1-gallon can 3.00 Value 1.50

*** McCLELLAN'S BRONKI-OL INHALANT**

(FOR POULTRY AND RABBITS)

McClellan's Bronki-Ol Inhalant, when used as a nasal spray, is a cooling, soothing, beneficial therapeutic for throat and nostrils. It is being used continuously by many of the leading chicken, turkey and rabbit raisers in the United States and Canada, and has become established as one of the most popular, efficient and satisfactory preparations of the well known "McClellan" line.

8-oz. bottle\$0.50 Value\$.25
Pint can75 Value40
Quart can 1.25 Value65
1/2-gallon can 2.00 Value 1.00
1-gallon can 3.25 Value 1.65
5-gallon can 15.00 Value 7.50



*** McCLELLAN'S SEPT-A-SOIL**

(An Iodized and Cresylated Disinfectant)

For spraying over soil, dirt, ground and all premises which have been used by infected or unhealthy poultry or stock.

1-Gallon can, \$3.25 Value\$1.20



*** McCLELLAN'S LIQUID CREXA-FOWL POULTRY TONIC**

McClellan's Liquid Crexa-Fowl is a scientific mineral conditioner for poultry, ducks, turkeys, geese and young fowl, especially indicated for baby chicks as well as an excellent fattener for use by feeding stations. A splendid stimulating conditioner for moulting hens. Makes hens lay and pay.

8-oz bottle\$0.50 Value\$0.25
16-oz. bottle75 Value40
Quart bottle 1.00 Value50
1/2-gallon bottle 1.75 Value90
1-gallon bottle 3.00 Value 1.50
5-gallon bottle 12.50 Value 6.25

*** McCLELLAN'S CREXA-FOWL POULTRY POWDER**

Compound for the same purpose as Crexa-Fowl Liquid, but put in powder form.

1 1/2 -lb. \$0.30 Value\$0.15
5 -lb. .85 Value45
12 -lb. 1.85 Value95
30 -lb. galvanized pail 4.25 Value 2.25
100 -lb. barrel 12.00 Value 6.00

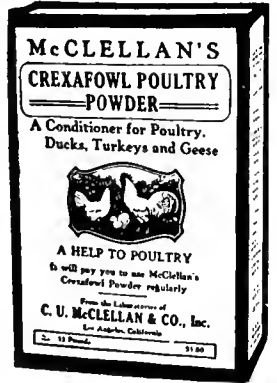

*** McCLELLAN'S STOCK TONIC**

Promotes health, makes hogs, cows and sheep more profitable—keeps horses and mules in good condition. Rids hogs of worms, makes the runts thrive and the whole herd gain faster.

Contains tonics to whet the appetite of cows, laxatives to keep the bowels in order, diuretics for the kidneys, and the needed minerals usually lacking in ordinary rations.

3 1/2 -lb. Pkg. \$0.65 Value\$0.35
10 -lb. Pkg. 1.50 Value75
30 -lb. pail 4.25 Value 2.25

*** McCLELLAN'S POULTRY PRESCRIPTION "999"**



McCLELLAN'S POULTRY PRESCRIPTION "999"—Tonic and Worm Powder—An efficient and very successful flock treatment for internal parasites, such as tapeworms and large round worms. It is a scientifically and properly balanced compound of vital minerals together with several very expensive and proven worm expellents. Harmless in effect upon the bird. Will not retard egg production, will not cause birds to go into moult, but on the contrary increases egg output and acts as builder of the body, blood and vitality. It can easily be mixed with the feed or given in individual treatments as preferred.

4 -oz. Pkg. \$0.75 Value\$0.30
12 -oz. Pkg. 1.75 Value60
1 1/2 -lb. Pkg. 3.00 Value 1.00
3 -lb. Pkg. 5.50 Value 1.80
5 -lb. Pkg. 7.50 Value 2.60

*** McCLELLAN'S NOX-INFECTO**

McClellan's N. I. is a sodium hypochlorite solution. It is a non-poisonous but powerful sterilizer, deodorant, disinfectant and antiseptic, recommended for hospitals, dairies, schools, depots, bottling plants, poultry ranches, etc.

Great household purifier, cleanser, deodorant germ destroyer.

Non-poisonous, colorless, leaves no odor. Circular on request.

12-oz. bottle\$0.50 Value\$0.25
1-qt. bottle90 Value45
1-gal. bottle 2.00 Value85
5-gal. bottle 8.50 Value 3.40

McCLELLAN'S

"N I"

NOX INFECTO

Disinfectant Bleacher
Deodorant Cleanser
Antiseptic Purifier

Active Ingredients Sodium Hypochlorite.....5.62
Inert Ingredients.....94.38
Total 100%.....100.00

From the Laboratories of
C. U. McCLELLAN CORP.
LOS ANGELES, CALIFORNIA
NET CONTENTS

*** BARNES EMULSION**



Is a positive control for poultry worms. If fed according to directions, based on the condition of your flock, you will have no trouble getting this situation well in hand. It will be well worth your while to make a careful test on your birds of this product. No honest test of this emulsion has failed to get results. Write for booklet, "Common Sense vs. Worms" for full information. It will be sent you free of charge.

Barnes Emulsion not only controls worms but builds the vitality of your poultry. Based on our nine years' experience with this product we unhesitatingly recommend it.

Quarts \$1.00 Value\$0.50
Gallons, 3.00 Value 1.50

*** McCLELLAN'S UDDER BALM**

Soothing, penetrating ointment for many affections of the bag such as Bunches, Caked Bags, Cuts, Sore Teats, Chapping, Inflammation.

10-oz. cans, 60c Value\$0.30

*** McCLELLAN'S DOG SHAMPOO**

McClellan's Dog Shampoo, 50c Value\$0.20

*** McCLELLAN'S FLEA POWDER**

McClellan's Flea Powder is entirely different from all other flea powders on the market for the reason we have perfumed it with a very delicate perfume so after using on the animals it will leave a very pleasant odor instead of the smell of disagreeable chemicals as most all other flea powders leave. We have also used every precaution in selecting a powder that would be non-injurious to the animals as most dogs and cats clean themselves often.

3-oz. cans 50c Value\$0.15

*** VERNOX — A POULTRY WORMER**

For both tape and round worm in poultry. A special preparation of Kamala combined with other drugs so prepared that they are not dissolved until reaching the parts inhabited by the worms. Same formula as recommended by agricultural college experts.

Package of 50, \$1.00 Value\$0.50



*** TALCUMIZED SODIUM FLUORIDE**

It kills both old and young lice, including unhatched lice present at the time of treatment. Talcumized Sodium Fluoride (called "T. S. F.") is made especially for poultry use. It is less irritating than straight Sodium Fluoride, penetrates the plumage more thoroughly, and comes packed in a moisture-proof, shaker-

top package bearing the U. S. Government's directions for using.
1-lb. can \$0.60 size\$0.25
5-lb. can 2.50 size 1.15



*** BAG OINTMENT**

Pratt's Bag Ointment—50c Value\$0.30



*** COW TONIC**

This splendid tonic is made especially for cows. It contains no filler and no antimony, arsenic or dangerous minerals. Mixed with the feed it helps the digestion, regulates the bowels, tones up the reproductive system, helps prevent abortion, costs little and pays you big profits. Absolutely guaranteed. Try it.
50c Value\$0.30

*** CONKEY'S POULTRY REMEDIES**

Conkey's Poultry Conditioner Pkg. 25c, 50c
Conkey's Poultry Laxative Pkg. 25c
Conkey's Scaly Leg Remedy Pkg. 25c
Conkey's Gape Remedy Pkg. 25c
Conkey's Pills (Roup Pills) Pkg. 1.00
Conkey's Diatex (White Diarrhoea Remedy) Pkg. 50c
Conkey's Cholera Remedy Pkg. 25c, 50c, 1.00
Conkey's Balmo (Canker Special) Pkg. 50c
Conkey's Old Reliable Powder (Roup Remedy) Pkg. 1.00
CONKEY'S POULTRY WORMER Pkg. 25c, 50c
25c Size 12c 50c Size 50c \$1.00 Size 50c

CLAYTON'S DOG REMEDIES



Kill Flea Powder\$0.35
Kill Flea Soap25
Ceoline Dog Soap25
Condition Pills60
Puppy Tonic60
Distemperine60
Distemperine Tablets60
Worm Bullets60
Worm Pills60
Diarrhoea Tablets60
Blood Pills60
Vermifuge Capsules60
Vermifuge Liquid60
Tape Worm Expeller60
Mange Medicine60
Digestive Tablets60
Laxative Pills60
Canker Lotion60
Fit Remedy60
Skin Medicine, toy dogs60
Cod Liver Oil with Hypophosphates of Lime and Soda 1.00

GLOVER'S DOG REMEDIES

Glover's Nerve Sedative\$0.65
Glover's Sore Foot Medicine65
Glover's Diarrhoea Medicine65
Glover's Vermifuge65
Glover's Sulphur Tablets65
Glover's Medicated Soap25
Glover's Condition Pills65

FISH FOODS

Spratt's Wafer\$0.08
Spratt's Granulated10
Zeke Turtle Food10
Spratt's Ant Eggs25

Sergeant's DOG FOOD

DOG MEDICINES

Nerve Sedative (Run-Fit) Medicine\$1.20
Special (Distemper) Medicine 1.20
Mange Medicine60
Mange Medicine (no tar odor)75
Condition Pills60
Sure Shot Capsules for Worms60
Sure Shot Liquid for Worms60
Tape Worm Medicine60
Arsenate and Iron Pills60
Canker Wash for the Ear60
Mouth Wash (for the mouth)60
Pepsin Tablets (for indigestion)60
Intestinal Astringent (Diarrhoea) Medicine60
Expectorant (Cough Medicine) for Colds60
Diuretic (Rheumatic) Pills60
Dog Rub, a liniment60
Eye Wash60
Constipation Capsules60
Carbolic Tar Soap25
Skip Flea Soap, for fleas and lice25
Skip Flea Powder25
Puppy Worm Capsules60
Shampoo Soap25
Disinfectant, 4-oz. bottle25

RED CHAIN DOG NUGGETS

A perfectly balanced food that is not only a complete ration but is so economical that it is easily afforded by any dog owner. Composed of such ingredients as dried ground meat, dried skim milk, ground wheat, cornmeal, steam cooked oatmeal, corn germ oil meal, cod liver meal. Compressed into nugget form, they supply food in a more natural form.

1 Pound\$.10
3 Pounds25
25 Pounds 1.50
100 Pounds 5.50

DELCREO DOG REMEDIES

Delcreo Tonic and Conditioner\$.75
Delcreo Vermifuge60
Delcreo Laxative35
Delcreo Worm Tablets65
Delcreo Distemper 1.50
Delcreo Worm Tablets, toy dogs65

BIRD FEED AND REMEDIES

Care of Birds

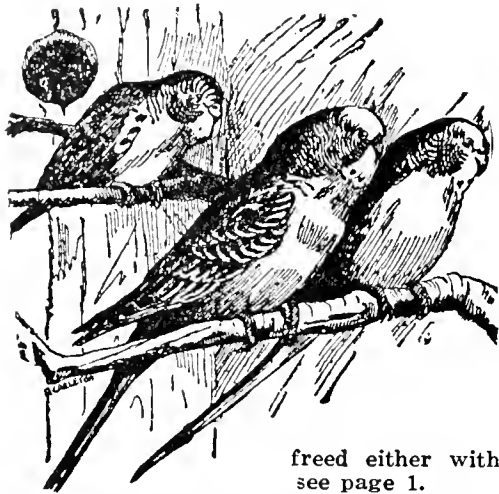

freed either with scalding water or sprayed with Flyrol. For prompt service and sufficient postage for delivery see page 1.

The care of birds of all kinds is extremely simple. Proper food, plenty of fresh water, absolute cage sanitation—and your bird will live its allotted life. Care should of course be used to see that birds are not placed in draughts. Cage birds are not accustomed to draughts and cannot endure them without developing colds and often pneumonia.

The dealer from whom you purchase your bird is the logical party to tell you what to feed it and how to take care of it—and you should be sure to ask for this information.

Cage sanitation implies a daily change and cleaning of the cage. For the smaller birds, sand should be kept in the bottom of the cage, and this sand should be changed daily. Parrots should have grit in the bottom of their cage, and this should be changed daily. If you use a litter in the bottom of the cage, we suggest that a small cup of grit be made available for the bird, also. Fresh water is essential. All birds must have water and it should be furnished fresh daily or twice a day. Birds should be kept free from mites, lice, etc. These pests will kill your pets if allowed to breed without disturbance. Mite powders applied to the birds are good. Cages should also be

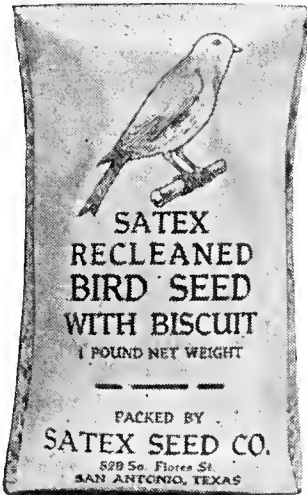

SATEX MIXED BIRD SEED

A blend of the finest seeds to be found on the market double recleaned in order to remove all foreign particles and dust, containing Sicilian Canary, Bird Rape and Millet, mixed in the proper proportions for your bird's health and song. Each package is packed with bird exercise ball.

- 1-lb. Pkg. with exercise ball.....\$0.15
- Postpaid25
- Love Bird Mixture: per lb.10
- Sicilian Canary Seed: per lb.15
- Hemp: per lb.15
- Maw or Poppy Seed, per lb.40
- Millet, per lb.10

- Bird Rape, per lb.15
- Sunflower Seed, per lb.15

SPRATT'S BIRD REMEDIES

- Spratt's Egg-Flake and Fruit, 1-lb. Pkg. 25c
- Spratt's Sing Song, per tin 15c
- 2 for 25c
- Spratt's Orange Color Food, Pkg. 25c
- Spratt's Moulting Food, Pkg. 25c
- Spratt's Cod Liver Oil Cage Bird and Nestling Food, Pkg. 15c
- Spratt's Parrot Tonic 25c
- Spratt's Mocking Bird Food 25c

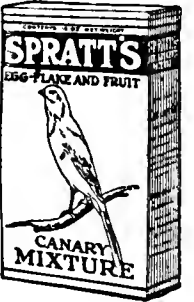

CUTTLE FISH BONE

- Oz. 10c
- Lb. 65c

HALLER'S BIRD REMEDIES

- Mocking Bird Food 35c
- Scaly Leg Oil 25c
- Feather Restorer 25c
- Health Food 25c
- Bird Cage Wash 25c
- Bird Bath 25c
- Bird Tonic 25c
- Bird Nesting 10c
- Lice Powder 25c
- Moulting Food 25c
- Bird Bitters 25c
- Nesting Food 15c
- Poppy Seed 25c
- Hemp and Pepper 10c
- Health Grits 10c
- Burnett's Louse Powder 25c
- Burnett's Bird Tonic 15c



MAGIC SONG RESTORER

THE IDEAL SONG AND HEALTH FOOD

A mixture which we are glad to recommend to our customers as producing the best results. Containing more expensive ingredients than other song restorers. Contains egg flakes unexcelled for young birds.

- 1 1/4-oz. Pkg. \$0.10
- 3 1/2-oz. Pkg.20
- 5 -oz. Pkg.30

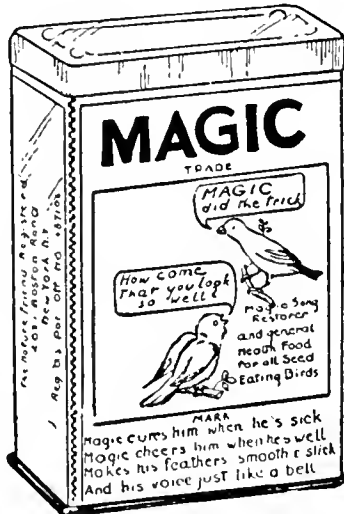

FRENCH'S BIRD FEEDS AND REMEDIES



- French's Mixed Bird Seed 12c
- French's Gravel 10c
- French's Bird Charcoal 10c
- French's Parrot Medicine 25c
- Burnett's Bird Gravel 18c

PHILADELPHIA BIRD FOOD CO.

- Red Gravel, small size 15c
- Red Gravel large size 25c
- Silver Gravel, small size 15c
- Silver Gravel, large size 25c
- Song Restorer Drahotas 15c
- Mite Powder for Birds 25c
- Nesting Hair in boxes 10c
- Nesting Food, box 25c
- Orange Color Food 25c
- Moulting Pepper 25c

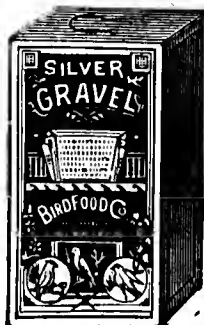

BIRD CAGE SUPPLIES

- Feed Cup, Crystal. Open or closed top, ea. \$0.10
- Non-breakable Feed Cups20
- Nesting Hair10
- Perch Stock, per foot10
- Leg Bands, each01
- Cage Swings10
- Spratt's Mite Traps25
- Canary Bath House, each75
- Egg Food Cup, each05
- Opal Bath Tubs, 4 1/2 inches, each10
- Opal Bath Tubs, 5 1/4 inches, each15
- Wall Brackets, nickel, 12 in., Style Q, ea. .20
- Wall Brackets, brass, 12 in., Style I, ea. .25
- Cage Springs, Medium, No. 16, each15
- Cage Springs, Small, No. 145, each10
- No. 282, Brass Chains and Springs, each30
- Feed Cup, Opal, Open or Closed Top, each15



CLOSING OUT BIRD CAGES AND STANDS

We Carry a Complete Stock of BIRD CAGES and STANDS and will quote you prices upon request.

THE PLANTER'S GUIDE

NUMBER OF PLANTS PRODUCED FROM AN OUNCE OF SEED

Asparagus	About 300
Cabbage	About 2,000
Cauliflower	About 2,000
Celery	About 3,000
Egg Plant	About 1,000
Endive	About 3,000
Kale	About 2,000
Lettuce	About 3,000
Pepper	About 2,000
Tomato	About 3,000

AVERAGE TIME REQUIRED FOR GARDEN SEED TO GERMINATE

Beans	5 to 10 days
Beet	7 to 10 days
Cabbage	5 to 10 days
Carrot	12 to 18 days
Cauliflower	5 to 10 days
Corn	5 to 8 days
Cucumber	6 to 10 days
Endive	5 to 10 days
Lettuce	6 to 8 days
Onion	7 to 10 days
Peas	6 to 10 days
Parsnip	10 to 20 days
Parsley	15 to 21 days
Pepper	9 to 14 days
Radish	3 to 6 days
Spinach	7 to 12 days
Salsify	7 to 12 days
Tomato	6 to 12 days
Turnip	4 to 8 days

TIME REQUIRED FOR MATURITY OF DIFFERENT GARDEN CROPS RECKONED FROM DAY OF PLANTING THE SEED

Beans—String	45 to 65 days
Beans—Shell	65 to 75 days
Beets—Table	65 days
Beets—Stock	150 days
Cabbage—Early	105 days
Cabbage—Late	150 days
Cauliflower	110 days
Corn	70 to 120 days
Egg Plant	150 to 160 days
Lettuce—Heading	65 days
Melon—Water	120 to 140 days
Melon—Musk	120 to 140 days
Onion	135 to 150 days
Pepper	140 to 150 days
Radish	30 to 40 days
Squash—Summer	60 to 65 days
Squash—Winter	125 days
Tomato	125 to 150 days
Turnip	60 to 70 days
Spinach, Av. Time	45 to 65 days

HEALTH VALUE OF FRESH VEGETABLES

The following table is the health value of fresh vegetables based on one pound:

NAME	Calories	Vitamins	Protein	Carbohydrates	Fats	Calcium	Iron
ASPARAGUS	100	A. B.	1.8%	3.3%	.2%	.025%	.00096%
BEANS, Green and Wax	184	A. B. C.	2.3%	7.4%	.3%	.045%	.00098%
BEANS, Lima	570	A. B.	7.1%	22.0%	.7%	—	.0024%
BEETS	209	A. B. C.	2.3%	9.7%	.1%	.029%	.00085%
SWISS CHARD	178	A. B.	3.2%	5.0%	.6%	—	.00309%
CABBAGE	145	A. B. C.	1.6%	5.6%	.2%	.045%	.00043%
CARROT	204	A. B. C.	1.1%	9.5%	.2%	.056%	.00064%
CAULIFLOWER	139	A. B. C.	1.8%	4.7%	.5%	.123%	.00094%
CELERY	84	A. B.	1.1%	3.3%	.1%	.078%	.00062%
COLLARDS	225	A. B. C.	4.5%	6.3%	.6%	—	.0016%
CORN, Sweet	470	A. B. C.	3.1%	19.7%	1.1%	—	.0008%
CUCUMBER	79	A. B. C.	.8%	3.1%	.2%	.016%	.00033%
EGG PLANT	126	A. B.	1.2%	5.1%	.3%	.011%	.00047%
ENDIVE	—	A. C.	—	—	—	.104%	.000123%
KALE	—	A.	—	—	—	—	.00254%
KOHL-RABI	140	C.	2.0%	5.5%	.1%	.077%	.00061%
LEEK	150	A. B. C.	1.2%	5.0%	.5%	—	.00048%
LETTUCE	87	A. B. C. G.	1.2%	2.9%	.3%	.043%	.001%
MUSKMELON	185	A. B. C.	.6%	9.3%	—	—	.00039%
WATERMELON	140	—	.4%	6.7%	.2%	—	.00023%
OKRA	172	B.	1.6%	7.4%	.2%	.071%	.00063%
ONION	220	A. B. C. G.	1.6%	9.9%	.3%	.034%	.00048%
PARSNIP	294	A. B.	1.6%	13.5%	.5%	.059%	.00077%
PEAS	454	A. B. C. G.	7.0%	16.9%	.5%	.028%	.00057%
PEPPER	109	A. B. C.	1.1%	4.6%	.1%	.006%	.0004%
POTATOES	385	A. B. C.	2.2%	18.4%	.1%	—	.00091%
PUMPKIN	117	A. B. C.	1.0%	5.2%	.1%	.023%	.00093%
RADISH	188	A. B. C.	1.3%	5.8%	.1%	.021%	.00083%
RHUBARB	105	C.	.6%	6.6%	.7%	.044%	.00056%
SPINACH	109	A. B. C. G.	2.1%	3.2%	.3%	.018%	.00255%
SQUASH	209	A.	1.4%	9.0%	.5%	.018%	.00035%
TOMATO	104	A. B. C. G.	.9%	3.9%	.4%	.011%	.00044%
TURNIP	178	A. B. C. G.	1.3%	8.1%	.2%	.064%	.00052%

DIRECTIONS FOR USING FERTILIZER

FLOWERS AND VEGETABLES—Broadcast 4 to 6 lbs., over each 100 square feet and work well into several days before sowing seed or setting out plants. For larger vegetables in rows apply 2 to 3 lbs., for 50 feet of row. Water in. Use half these amounts for additional feedings every 4 to 6 weeks during the growing season. Soak in with heavy sprinklings. Be sure that the plant food is mixed well with the soil and does not come in direct contact with the seed or plants.

POTTED PLANTS—One-half teaspoonful mixed in top soil is usually sufficient for plant in 6-inch pot. Vary quantity according to size of pot. **WATER IN IMMEDIATELY.** Repeat in 30 days.

TREES AND SHRUBS—Work several handfuls in soil around each shrub or small tree. For larger shrubs or trees increase application according to size and distribute in soil around trunk as far as branches spread. Water in.

IN BUILDING A NEW LAWN, save six or eight inches of the top soil and carefully replace after grading. Harrow and rake this top soil until fine and level, then apply Vigoro Plant Food at the rate of 4 lbs. to 100 square feet, sow the grass seed, then rake or harrow and roll if possible. Keep the ground well watered and apply Vigoro at least twice during the first season. This work may be done either in Spring or Fall.

TO FEED ESTABLISHED LAWNS—Apply broadcast 3 to 4 lbs. per 100 square feet early in the spring before the grass begins to grow. Make additional applications throughout the growing season at the rate of 1 to 2 pounds per 100 square feet every 4 to 6 weeks. These later applications may be mixed with dry sand, rich top soil or humus to form a compost. After applying, soak in thoroughly with heavy sprinkling to carry food down to feeding roots. This is very important.

VEGETABLE PLANTING SCHEDULE

Name of Vegetable	Quantity required for 100 feet of row	Quantity required for one acre	Distances apart in inches		Depth of planting in inches	Time of Planting	Mature in days—except as noted
			Rows	In Rows			
Asparagus Plants	60 to 80	9,680	36	15 to 20	8 to 10	January and February	1 year
Beans, Snap	1 lb.	30 to 60 lbs.	20	3 to 4	1	Mar. to May; Aug. to Oct.	40 to 60
Beans, Pole	1/2 lb.	15 to 20 lbs.	36	12 to 15	1	Mar. to May; Aug. to Oct.	50 to 80
Beans, Lima, Bush	1 lb.	30 to 60 lbs.	20	3 to 4	1	Mar. to May; Aug. to Sept.	60 to 90
Beans, Lima, Pole	1/2 lb.	15 to 20 lbs.	36	12 to 15	1	Mar. to May; Aug. to Oct.	60 to 80
Beets	2 oz.	4 to 5 lbs.	12	1 to 3	1 to 2	Feb. to May; Sept. to Oct.	60 to 80
Broccoli	1/4 oz.	1/4 lb.	30	24	1 1/2	April to July	112 to 126
Cabbage, Early	1/4 oz.	1/4 lb.	24 to 30	12 to 18	1 1/2	October to December	90 to 130
Cabbage, Late	1/4 oz.	1/4 lb.	24 to 36	16 to 24	1 1/2	June and July	90 to 130
Cabbage Plants	1/4 oz.	3 to 4 lbs.	24	12 to 15	2 to 4	Feb. to May; Aug. to Sept.	75 to 120
Carrots	1 oz.	3 to 4 lbs.	15	1 to 2	1 1/2	Feb. to Apr.; Aug. to Oct.	60 to 110
Cauliflower	1/4 oz.	1/4 lb.	20	10 to 12	1 1/2	Feb. to Apr.; Aug. to Sept.	100 to 125
Celery	1/4 oz.	1/4 lb.	20	4 to 8	1 1/2	August to October	120 to 150
Collards	1/2 oz.	1/2 lb.	20	10 to 12	1 1/2	September to May	100 to 125
Corn, Pop	1/2 lb.	6 lbs.	36	12	1	March to July	90 to 100
Corn, Sweet	1 lb.	7 to 10 lbs.	24	24 to 36	1 to 2	Feb. to April; August	60 to 75
Cucumber	1/2 oz.	1 to 2 lbs.	48	36 to 48	1	March to May; August	60 to 80
Egg Plant Seed	1/8 oz.	1/4 lb.	24 to 30	18 to 24	1/2 to 1	January to July	100 to 140
Egg Plant Plants	50 to 65	7,260	24	18 to 24	2 to 3	March to July	100 to 150
Endive	1 oz.	1/2 to 1 lbs.	18	4 to 6	1 1/2	Feb. to April; August	85 to 175
Horseradish Roots	100	10,000	24	12 to 18	3 to 4	February and March	1 to 2 years
Kale	1 oz.	1/2 to 1 lb.	15	2 to 3	1 1/2	October to March	85 to 125
Kohlrabi	1/2 oz.	1 to 2 lbs.	15	2 to 3	1 1/2	September to March	60 to 80
Lettuce	1/2 oz.	1 to 2 lbs.	12	4 to 6	1 1/2	September to March	60 to 90
Muskmelon or Cantaloupe	1 oz.	1 to 2 lbs.	48 to 60	Hills 36	1	March to May; July to Nov.	100 to 135
Mustard	2 oz.	2 to 3 lbs.	12	1/2	1/4	March to July	40 to 60
Okra	1 oz.	3 to 5 lbs.	24 to 30	10 to 12	1/2 to 1	October to April	90 to 125
Onion Seed	300	1 to 3 lbs.	12	1 to 2	1/2 to 1	January to May	125 to 150
Onion Plants	2 lbs.	1 to 3 lbs.	15	3 to 4	2 to 3	Jan. to Apr.; Aug. to Sept.	125 to 150
Onion Sets	2 lbs.	1 to 3 lbs.	12 to 15	2 to 3	1 to 2	September to May	75 to 100
Parsley	1/2 oz.	3 to 5 lbs.	12	1 to 2	1/4	September to May	90 to 110
Parsnips	1/2 oz.	3 to 5 lbs.	12 to 15	3 to 4	1/2 to 1	Feb., March and Sept.	125 to 150
Peas	1 to 2 lbs.	30 to 60 lbs.	15 to 18	1 to 2	3 to 4	Jan. to Mar.; Aug. to Nov.	40 to 75
Pepper Seed	1/8 oz.	1/4 lb.	18 to 24	15 to 18	1/2	December to March	100 to 140
Pepper Plants	80 to 100	9,680	18	15 to 15	2 to 3	March to June	90 to 130
Potato, Irish	5 to 6 lbs.	600 lbs.	24	12 to 15	6 to 8	February to April	80 to 125
Potato, Sweet, Slips	65	10,000	36 to 48	18	2 to 3	March to July	125 to 150
Pumpkin	1/2 oz.	1 to 2 lbs.	60 to 72	60 to 72	1	March to July	100 to 150
Radish	2 oz.	8 to 10 lbs.	12	1 to 1 1/2	1/4 to 1/2	September to May	20 to 50
Rhubarb Roots	35	4,000	36	36	3 to 4	January, February, March	1 to 3 years
Salsify	1 oz.	2 to 5 lbs.	15	1 to 2	1 1/2	February to May	115 to 175
Spinach	1/4 lb.	10 to 25 lbs.	12	1	1	Feb. to April; Sept. to Nov.	50 to 70
Squash, Bush	1 oz.	2 to 3 lbs.	24	24	1	March to September	60 to 80
Squash, Late	1 oz.	2 to 3 lbs.	36 to 48	36	1	April to August 15th	100 to 140
Tomato Seed	1/8 oz.	1/4 lb.	36 to 48	36	1/2 to 1	December to July	100 to 140
Tomato Plants	50 to 65	2,725	24	18 to 24	3 to 4	April and May	85 to 100
Turnips	1 oz.	1 to 2 lbs.	15	1 to 3	1/4 to 1/2	Feb. to May; July to Nov.	50 to 80
Watermelon	1/2 oz.	1 to 3 lbs.	60 to 72	72	1	March to May	115 to 150

S A T E X S E E D C O M P A N Y

529 South Flores Street

San Antonio, Texas

ALPHABETICAL INDEX

Page		Page		Page		
- F -						
Alfalfa	19	Fertilizers	21	Peas	14	
Antrol	24	Field Seeds	18-21	Peat Moss	24	
Antzix	24	Fish Food	45	Peat Poultry Litter	36	
Aphis Spray	23	Fish Oil Soap	23	Peerless Screw Worm Killer	41	
Arsenate of Lead	23	Flex-O-Glass	17	Pepper	14	
Asparagus	8	Flower Pots	15	Permanganate of Potash	43	
Atlacide	23	Flower Seeds	1 to 6	Pine Tar	42	
Auxilin	17	Flower Seed Planting Chart	5	Planet Jr. Seeders	26	
Avian Bacterin	41	Flu-Koff Remedy	40	Plows, Garden	26	
Avicol	42	Fog Nozzles	28	Poultry Remedies	38-43	
Aluminum Sulphate	24	Fungicides	23-24	Poultry Supplies	29-37	
- G -						
Bacilli Kill—B-K	42	Formaldehyde	24-43	Poultry Toe Punch	32	
Beans, Garden	8	Fungusol	23	Potatoes	15	
Beets	9	Float Valve	31	Pumpkins	14-15	
Biotol	43	- H -			Pruning Shears	26
Bird Cage Supplies	46	Garden Tools	26	Pyrethrum Flowers, Ground	24	
Bird Remedies	46	Garlic	13	- R -		
Black Leaf "40"	23-43	Gladioli	7	Radish	15	
Black Leaf Worm Powder	41	Gold Leaf Tobacco Powder	41	Raffia	7	
Bordeaux Mixture	23	Grass Seed	20-21	Rape	21	
Broccoli	9	Green Tox	24	Rat Poison	25	
Brooders	33-36	Grit Boxes	31	Roach Powder	25	
Butter Cartons	44	Group-Over	41	Rubber Bands	8	
Butter Paper	44	- I -			Rutabaga	17
Burrel Dugger Remedies	42	Hatcherymen's Supplies	37	- S -		
Bulbs	7	Hatching Egg Boxes	37	Salsbury Poultry Remedies	41	
- J -					Screw Worm Killer	41
Cabbage	9-10	Hog Wormer	40	Seed Corn	18	
Cabbage Plants	8	Hose Sprayer	26	Seed Sower	26	
Calcium Arsenate	23	Hotkaps	17	Semesan	22	
Calgreen	23	- K -			Snarol	24
Canary Feeds	46	Kale	12	Sodium Fluoride	42	
Canary Remedies	46	Kohl Rabi	12	Sorghums	20	
Cantaloupes	10-11	Koppersol	23	Soy Beans	20	
Carbolineum	39	Kemekel	7	Spinach	15	
Carbon Bisulphide	25	Kopper Queen	24	Spray Pumps	26-28	
Carrots	10	- L -			Squash	15-16
Cat Remedies	43	Lactic	43	Star Parasite Remover	41	
Cauliflower	10	Lawngen	23	Storage Brooders	34	
Celery	10	Leg Bands	32	Sulphur	23-24	
Chard, Swiss	9	Lee's Poultry Remedies	40	Sunflower	21	
Chick Boxes	37	LeGear's Remedies	38	Super-Oil	39	
Chick Feeders	29-30	Lettuce	12	Sweet Peas	13	
Clover	19	Lime Sulphur	23	Swiss Chard	9	
Coccidiosis Remedy	42	London Purple	23	Spray Pump Repair Parts	28	
Cod Liver Oil	43	- M -			Syringe	38-39
Collards	10	Mangel Wurzel	9	- T -		
Copper Sulphate	23	Martin's Screw Worm Killer	41	Tanglefoot	22	
Copperas	24	Mash Hoppers	30	Tendergreen	13	
Cotton	17	Mash-Nic	42	Thermometers	32	
Corn, Field	19	Milk Bottle Caps	44	Tobacco Dust	23	
Corn, Broom	20	Millet	21	Tobaccoes	16	
Corn, Sweet	11	Moisture Gauge	33	Topzol	25	
Cow Peas	20	Muskmelon	10-11	Trap Nest Fronts	33	
Creosote Dip	43	Mustard	13	Tree Tanglefoot	22	
Crotox	22	- N -			Trowels	26
Crude Carbolic Acid	43	Nasal Syringe	28	Turnips	17	
Cubor Spray	24	Nest Egg	32	Tuberosc Bulbs	7	
Cucumbers	11	Nikemo	23	- U -		
Cuprocide	22	Nitragin	22	Udder Help	42	
Cyanogas	25	Nux Vomica	43	- V -		
- D -						
Dahlia Bulbs	7	- O -			Vapo Spray	40
Daw-Gone	25	Okra	13	Vert	7	
Destruol	23	One Rub Flea Finish	44	Vetch	20	
Dip and Disinfectant	43	Onion Plants	13	Vigoro	21	
Dog Bread	45	Onion Seeds	13	Vitapane	17	
Dog Remedies	43-45	Onion Sets	13	- W -		
Don Snug	42	- P -			Walko Tablets	42
Dr. Hess Remedies	39	Paradichlorobenzol	25	Watermelons	12-13	
Drinking Founts	30-31	Paris Green	23	Water Glass	42	
- E -					Weed Killer	22
Egg Baskets	31	Parsley	14	Weeder	26	
Egg Boxes	33	Parsnip	14	Wing Bands	32	
Egg Carriers	22	Peanuts	21	- Y -		
Egg Plant	11	- Q -			Yard Egg Boxes	33
Egg Scale	33	Okra	13	- Z -		
Egg Tester	32	One Rub Flea Finish	44	Zinnias	6	
Endive	11	Onion Plants	13	Zinc Sulphate	24	
Epsom Salts	44	Onion Seeds	13			
Evergreen	23	Onion Sets	13			
E-Z-Give Preparation	43	Paradichlorobenzol	25			

BEAUTIFY YOUR HOME WITH FLOWERS

PLANT SOME OF THESE
NEW VARIETIES

BALSAM

Double Bush Flowering

See page 1

LUPINES

Genuine Russel's Hybrid Mixed

See page 3

SCABIOSA

Imperial Giant Blue Moon

See page 4

ZINNIAS

Fantasy — Crown of Gold

See page 6

MORNING GLORY

Scarlett O'Hara — New Cornell

See page 6

GLADIOLI AND DAHLIA BULBS

See page 7

2 Stores to Serve You

529 So. Flores St. — G-9231

Branch Store — 1626 Fredericksburg Road

SATEX SEED CO.

SAN ANTONIO, TEXAS