

Historic, Archive Document

Do not assume content reflects current scientific knowledge, policies, or practices.

62,73

LIBRARY RECEIVED
★
culture

Scott's SEEDS

Telephone:
ATlantic
2022

MAIL and
TELEPHONE
ORDERS



ESTABLISHED
1876

The I. W. SCOTT COMPANY

1945

500 LIBERTY AVE. • 113 DIAMOND ST. • PITTSBURGH 22, PA.

NOTICE TO CUSTOMERS.—No price for any article listed or described herein exceeds the ceiling price for that article as determined under the applicable maximum price regulation issued by the Office of Price Administration. As required by that Office, we will, upon request, furnish you with a statement of our maximum prices on any of the commodities listed about which you inquire.

THE I. W. SCOTT CO.

VEGETABLES
are tops this year!

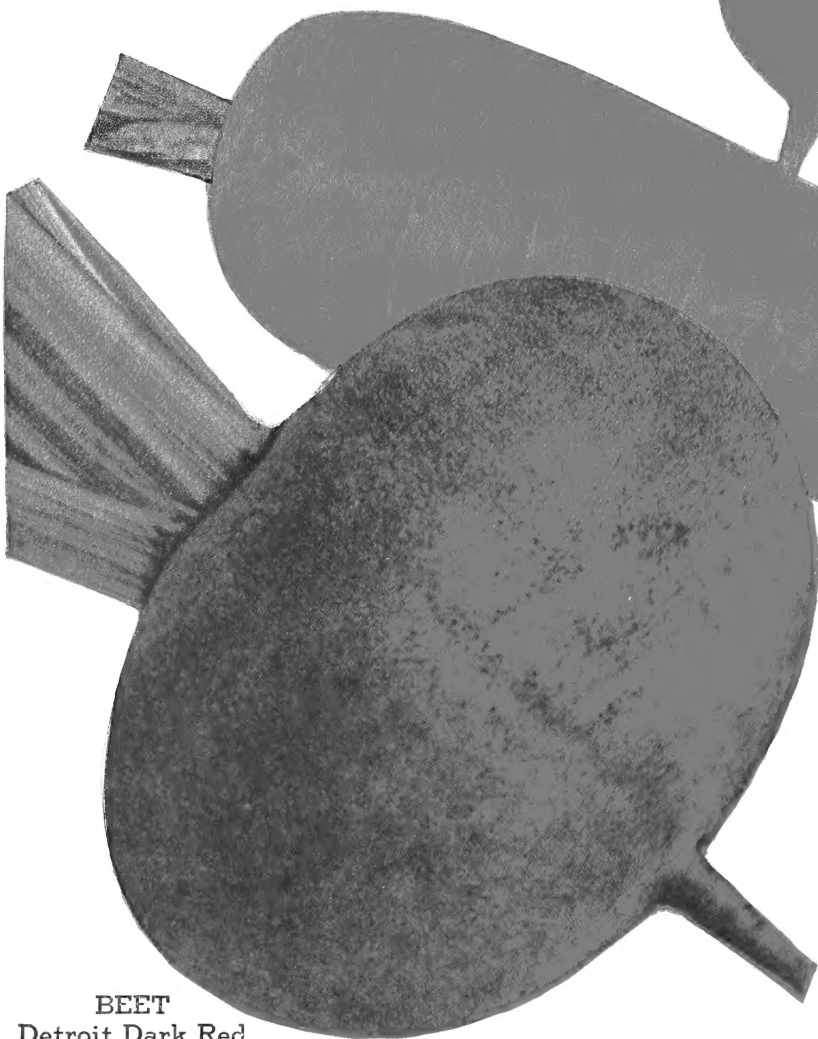

BEET
Detroit Dark Red
Pkt. 10 cts., oz. 30 cts.

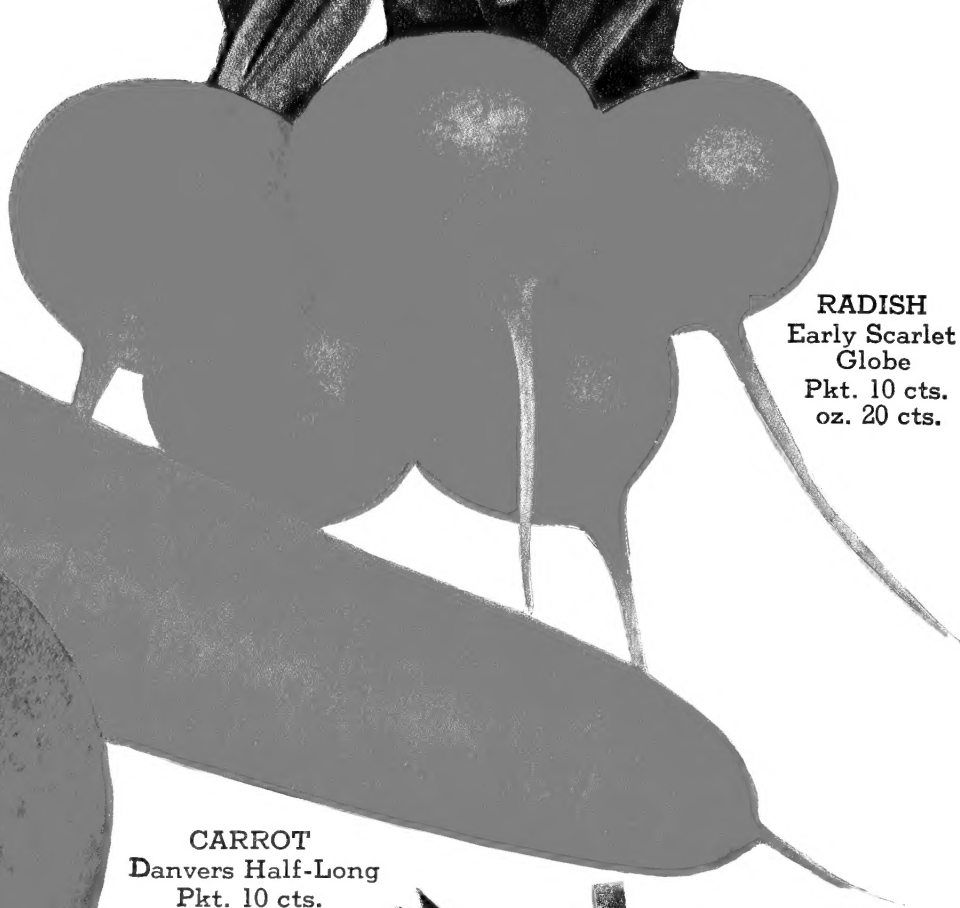

RADISH
Early Scarlet
Globe
Pkt. 10 cts.
oz. 20 cts.

CARROT
Danvers Half-Long
Pkt. 10 cts.
oz. 35 cts.

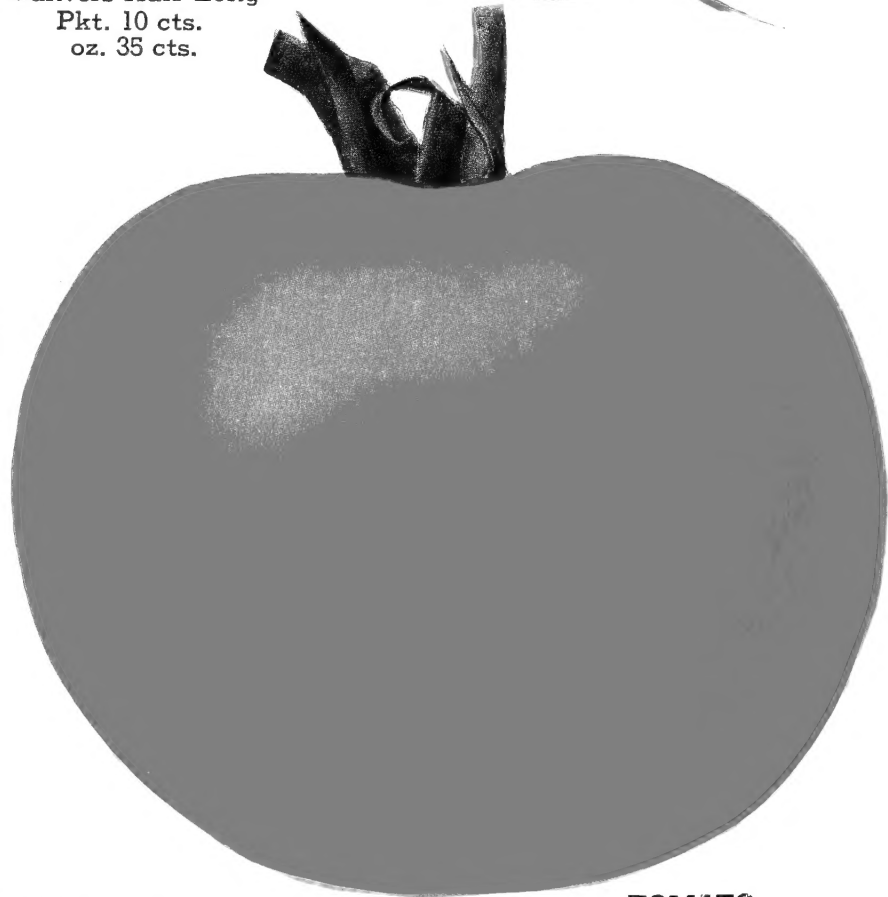

TOMATO
Rutgers
Pkt. 10 cts., 1/2oz. 35 cts.

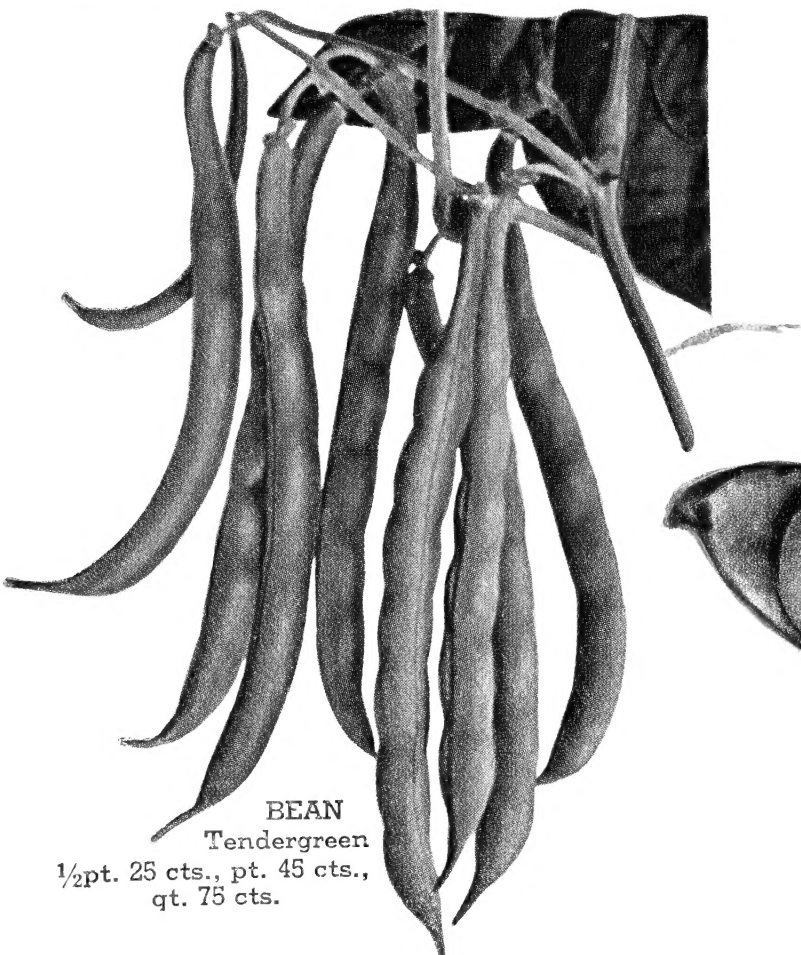

BEAN
Tendergreen
1/2pt. 25 cts., pt. 45 cts.,
qt. 75 cts.

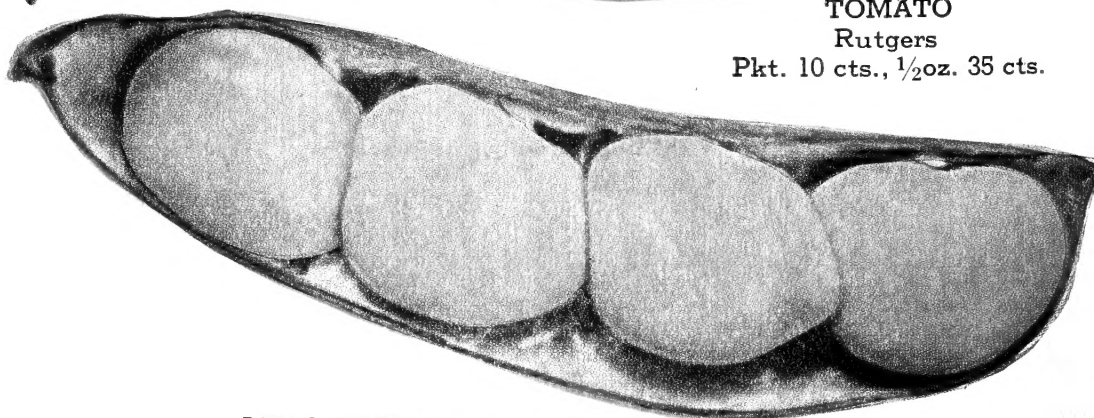

LIMA BEAN, Fordhook Bush
1/2pt. 25 cts., pt. 45 cts., qt. 75 cts.

Serving Three Generations

Since 1876—for nearly 70 years—the facilities of our company have been dedicated to helping farmers, home- and market-gardeners, and poultry raisers to become more successful. Throughout these many years, we have been enjoying a constantly growing patronage. This has made it possible for us to render our customers and friends an interested personal service with no compromise in quality or substitute for loyalty.

Our supplies of seeds, fertilizers, insecticides, poultry equipment, and many other lines for 1945 will be ample to meet all expected demands, but due to wartime conditions, we cannot promise you everything you may want at all times. We do, however, promise this: consistent with government regulations, we shall spare no effort to provide for you all the necessary requirements that are obtainable.

We have many items in stock that are not shown in this Catalogue because the available supply is not sufficient to satisfy the demand. If the article you want is not listed, please come to the store or get in touch with us. We may have a limited stock of it.

We want to thank all of our friends and customers for their confidence in us these many years, and for 1945 we pledge all of you our very best efforts.

Sincerely yours,



President

January 20, 1945

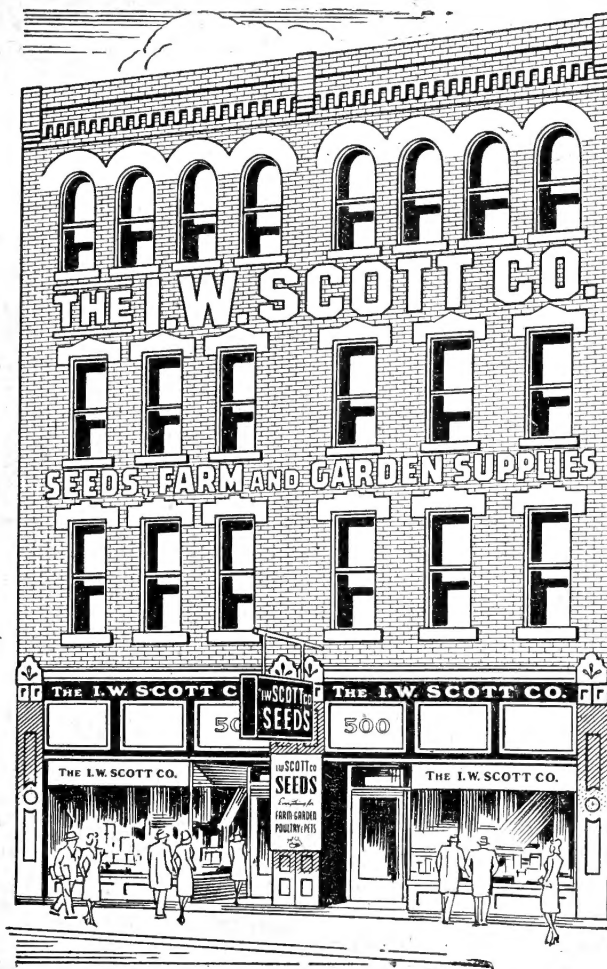

OUR STORE, 500 LIBERTY AVENUE

Planting a vegetable garden in 1945 is one of the most important contributions you can make to your country at war. Food raised in Victory Gardens the last two years helped considerably to ease shortages that otherwise would have affected everyone. This year the need is just as urgent or even more so, because stocks of many foods are low. Grow your own vegetables to be sure of having all you need. Plan at once and order early.

GENERAL INFORMATION AND SUGGESTIONS

FREE DELIVERY

At prices named in this Catalogue, on Vegetable Seeds, Flower Seeds, Grass Seeds, and Bulbs, *We Deliver Free* anywhere in the United States.

On other goods where the order amounts to \$2 or more (except where priced otherwise), *We Deliver Free* in Pennsylvania, Ohio, and West Virginia. Customer pays transportation charges on orders less than \$2.

Free deliveries are made at our option by truck, or by mail, express, or freight to your nearest post office, express office, or freight station.

PARCEL POST SHIPMENTS

Where the Catalogue provides that postage be added to the remittance, include for postage as follows:

Less than 1-lb. package.....	\$0 08	20-lb. package.....	\$0 30
1-lb. package.....	10	25-lb. package.....	37
2-lb. package.....	11	50-lb. package.....	65
3-lb. package.....	12	Less than 1-pt. package.	08
4-lb. package.....	13	1-pt. package.....	10
5-lb. package.....	14	1-qt. package.....	15
10-lb. package.....	19	½-gal. package.....	20
15-lb. package.....	25	1-gal. package.....	25

C. O. D.

We will accept orders for shipment C.O.D. except on nursery stock, roses, strawberry plants, or other perishable goods.

ORDER IN ADVANCE

We cannot urge too strongly the necessity of anticipating your requirements as far in advance as possible. The cooperation of our customers in this respect will be appreciated.

PRICE CHANGES

All prices printed in this Catalogue conform to O. P. A. price regulations. However, prices are still subject to change without notice. Should the price of any commodity be reduced, the difference in price will be refunded, or in case of advance, the customer will be notified before shipping.

QUANTITY RATES ON VEGETABLE SEEDS

Half-bushels will be furnished at bushel rates; half-pecks at the peck rate; and half-pounds at the pound rate.

TERMS

Our terms are cash and prices are net, with no discounts. To persons and firms with established credit we are glad to extend the convenience of a charge account. Usual credit references are required.

MAIL AND TELEPHONE ORDERS

We are organized to give mail and telephone orders the same personal attention as orders placed in our store. If it is not convenient to come to the store we will appreciate your order either by mail or telephone.

REMITTANCES

These should be sent by money order, registered letter, bank draft, or check. Amounts less than \$1 may be sent in postage stamps.

NON-WARRANTY

The I. W. Scott Company gives no warranty, express or implied, as to the productiveness of any seeds or bulbs it sells and will not be in any way responsible for the crop. Our liability, in all instances, is limited to the purchase price of the seed.

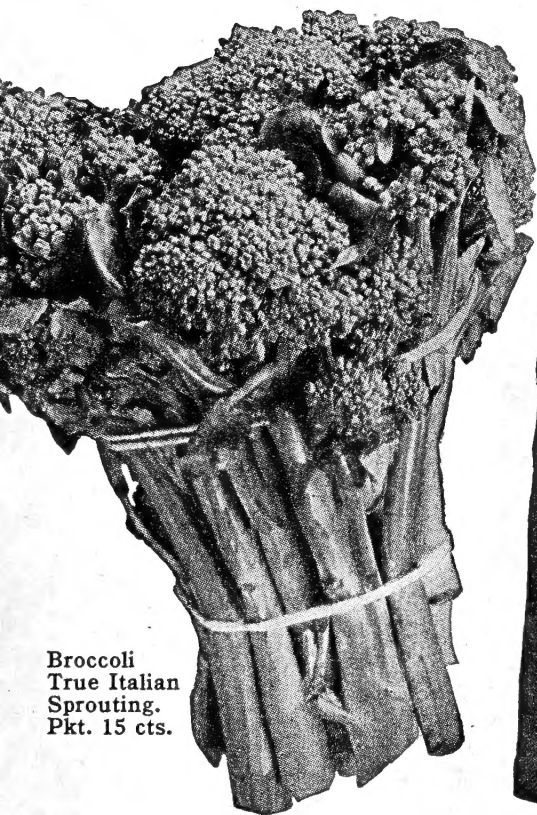

Artichoke, Large Green Globe. Pkt. 15 cts.

Broccoli
True Italian
Sprouting.
Pkt. 15 cts.Brussels Sprouts, Half-Dwarf
Improved. Pkt. 15 cts.Asparagus, Mary Washington
2-yr. roots, 75 cts. per doz.

Days to Maturity

In connection with most varieties of vegetable seeds listed in the catalog, we have indicated the number of days required from the time the seed is sown until vegetables are ready for use. The number of days given can be depended upon under normal conditions in this section, and we feel that this information will be particularly helpful to our customers in selecting the variety best suited to their needs.

★ WHEN IN DOUBT, ORDER THE STAR VARIETIES

ASPARAGUS

Equally good results may be secured by planting seed or roots; seed is cheaper but from one to two years' time is saved by starting with roots.

Sow seed early in the spring, in shallow drills 12 to 15 inches apart, and when the plants are 4 inches high, thin out to 3 inches apart; transplant to the permanent bed the following spring.

An Asparagus bed should be deeply dug and plenty of manure worked in. Set the plants so that the crown is about 3 inches below the bed-level, in rows at least 3 feet apart and 1½ to 2 feet apart in the row. Barely cover at first, filling in as the plants grow. Do not cut the first year.

*One ounce of seed will sow a 100-foot row;
5 pounds will sow an acre*

Mary Washington. ★ Plants vigorous, very productive and nearly rust-free. Shoots dark green with heavy purple overtone and of excellent quality. By far the most extensively grown variety. Seed, pkt. 10 cts., oz. 25 cts., ¼lb. 60 cts., lb. \$2.00.

Two-year-old roots, 75 cts. per doz., \$2.00 for 50, \$3.50 per 100, \$12.00 for 500, \$22.00 per 1,000.

BROCCOLI

Resembles cauliflower except in color. Suitable for home-garden, market, or freezing. For an early crop, sow the seed in a hot-bed in March and transplant seedlings in the open ground after frost. For late crop, sow the seed in the open ground in April and transplant in May or June. Days to maturity are figured from the time the plants are set in the garden.

An ounce of seed will produce about 3,000 plants

True Italian Sprouting. 70 days. A distinct variety with large, solid heads that stay green. Many sprouts develop from the leaf-axils after the heads are cut, and each terminates in a small head which is also edible. Pkt. 15 cts., oz. 50 cts., ¼lb. \$1.50.

FRENCH ARTICHOKE

This highly prized salad can be grown in our climate, provided the plants are given light protection over winter. Start the seed indoors and give the same treatment as you would tomatoes, transplanting to the garden in May. The plants are perennial.

An ounce of seed will produce 500 plants

Large Green Globe. The best variety. Pkt. 15 cts., oz. 75 cts., ¼lb. \$2.50, lb. \$8.00.

BRUSSELS SPROUTS

The "sprouts" are like miniature cabbages growing along the main stem. Takes the same culture as cabbage.

An ounce of seed will produce 2,000 plants

Half-Dwarf Improved. Compact plants about 2 feet tall. Pkt. 15 cts., ¼oz. 35 cts., oz. \$1.00, ¼lb. \$3.00.

BEANS

Everyone Can Grow Beans

DWARF GREEN-PODDED AND WAX BEANS

Although the pods of Wax Beans are considered more attractive than those of the green-podded sorts, there is no difference in quality, and personal choice, or market demand, must decide which to grow; both are delicious and both yield bountiful returns from limited space. Home gardeners will want some of both types. As soon as the ground warms up, plant the Beans 1½ to 2 inches deep and 2 to 3 inches apart in rows 2 to 2½ feet apart. Later plantings should be covered 2½ to 3 inches deep. For a constant supply, plant every two weeks from May to August.

**For Increased Yield
Inoculate This Seed
with LEGUME-AID.**

A pint of seed will sow 150 feet of furrow; 1 to 1½ bushels, depending on variety, will be required for an acre when the seed is planted in drills.

Dwarf Green-podded Beans

- Bountiful.** ★ 48 days. A splendid variety, well named, for it is extremely productive and always reliable. The pods are flat, of good size, and handsome appearance, always stringless, tender until full grown and of excellent flavor. Pkt. 10 cts., ½pt. 25 cts., pt. 45 cts., qt. 75 cts., pk. \$4.65, bus. \$16.80.
- Burpee's Stringless Green-Pod.** 50 days. Very productive, with pods round, thick, very meaty and perfectly stringless. An old favorite with many people. ½pt. 25 cts., pt. 45 cts., qt. 75 cts., pk. \$4.65, bus. \$16.80.
- Giant Stringless Green-Pod.** ★ 53 days. A very dependable producer. The pods are long, dark green, round, always stringless and very tender. Extensively used for canning. Pkt. 10 cts., ½pt. 25 cts., pt. 45 cts., qt. 75 cts., pk. \$4.65, bus. \$16.80.
- Italian Black-Eye.** 70 days. A very prolific yielder with long, round, slender pods, dark green in color and stringless. ½pt. 25 cts., pt. 45 cts., qt. 75 cts., pk. \$4.65, bus. \$16.80.
- Plentiful.** 50 days. Very productive and of excellent quality. Pods long, flat, straight, medium deep green, brittle, stringless, and of a distinctive flavor. Notably resistant to common rusts. A splendid variety for home-garden or market. ½pt. 25 cts., pt. 45 cts., qt. 75 cts., pk. \$4.65, bus. \$16.80.
- Streamliner.** 50 days. Ideal where a flat, heavy-yielding Bean is desired. Pods are long, straight, flat and perfectly stringless at all stages of growth. ½pt. 25 cts., pt. 45 cts., qt. 75 cts., pk. \$4.65, bus. \$16.80.
- Stringless Black Valentine.** ★ 52 days. A heavy yielder, round, stringless, with fine quality and delicate flavor. Popular with market-gardeners but equally good for home-gardens. ½pt. 25 cts., pt. 45 cts., qt. 75 cts., pk. \$4.65, bus. \$16.80.
- Stringless Red Valentine.** 52 days. Pods round, stringless, meaty, tender and of rich flavor. Unusually hardy. ½pt. 25 cts., pt. 45 cts., qt. 75 cts., pk. \$4.65, bus. \$16.80.
- Tendergreen.** ★ 53 days. Has perfectly round pods 6½ to 7 inches long, quite slender, straight, light green, tender, absolutely stringless, meaty, and of high quality. A very popular variety with home-gardeners. Ideal for canning and freezing. ½pt. 25 cts., pt. 45 cts., qt. 75 cts., pk. \$4.65, bus. \$16.80.

Dwarf Wax-podded Beans

- Improved Golden Wax.** 51 days. Pods are thick and flat, creamy yellow in color and stringless. Hardy and prolific. ½pt. 25 cts., pt. 45 cts., qt. 75 cts., pk. \$4.65, bus. \$16.80.
- Pencil-Pod Black Wax.** 54 days. Pods round, long, slender, golden yellow, and of fine quality. Bears profusely over a long period. Desirable for home, market-garden, and canning. ½pt. 25 cts., pt. 45 cts., qt. 75 cts., pk. \$4.65, bus. \$16.80.
- Round-Pod Brittle Wax.** ★ 58 days. This Bean is superior in flavor, remarkably brittle and tender, and absolutely stringless. The pods are long, round and bright yellow. ½pt. 25 cts., pt. 45 cts., qt. 75 cts., pk. \$4.65, bus. \$16.80.

Dwarf Wax-podded Beans continued on page 5

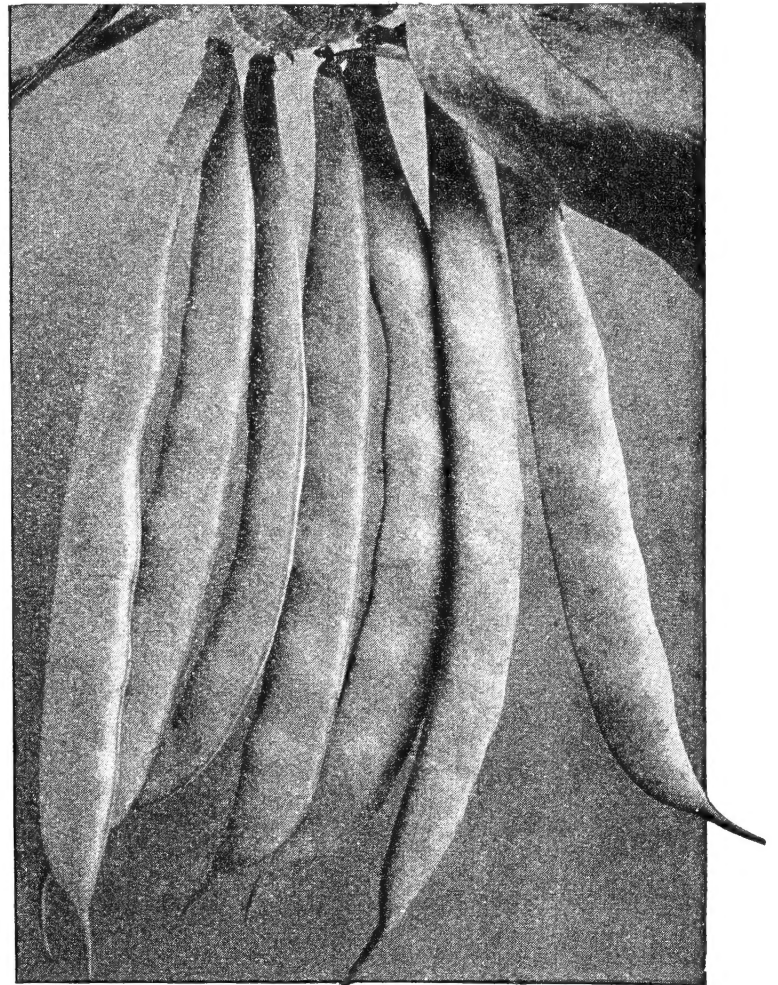

Beans, Bountiful. Pkt. 10 cts., ½pt. 25 cts., pt. 45 cts., qt. 75 cts.

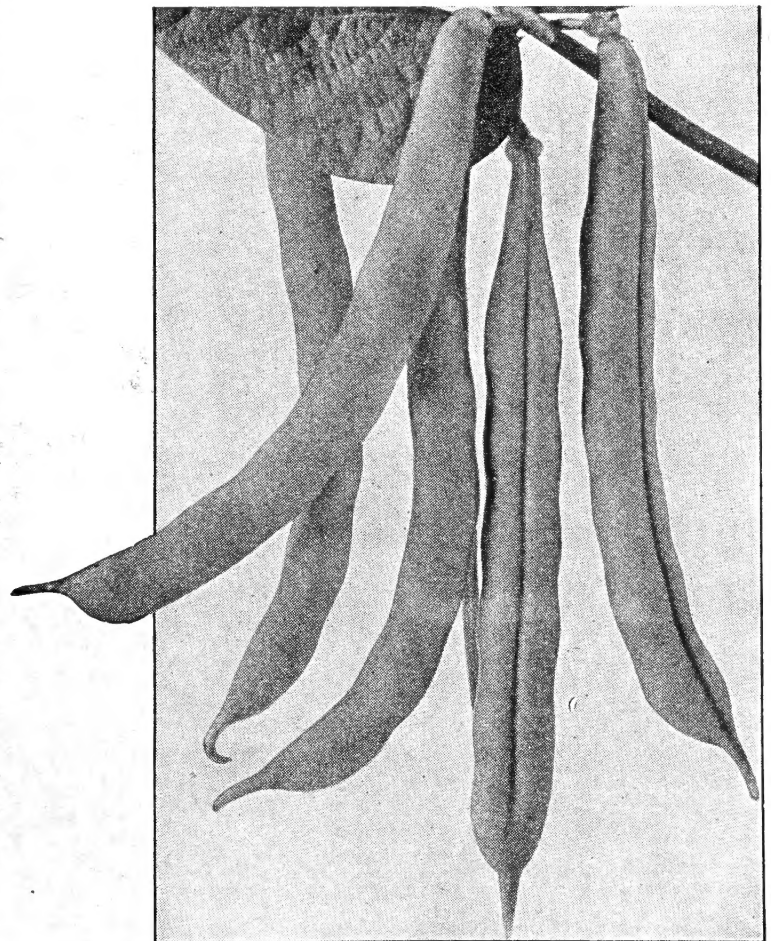

Beans, Tendergreen. ½pt. 25 cts., pt. 45 cts., qt. 75 cts.

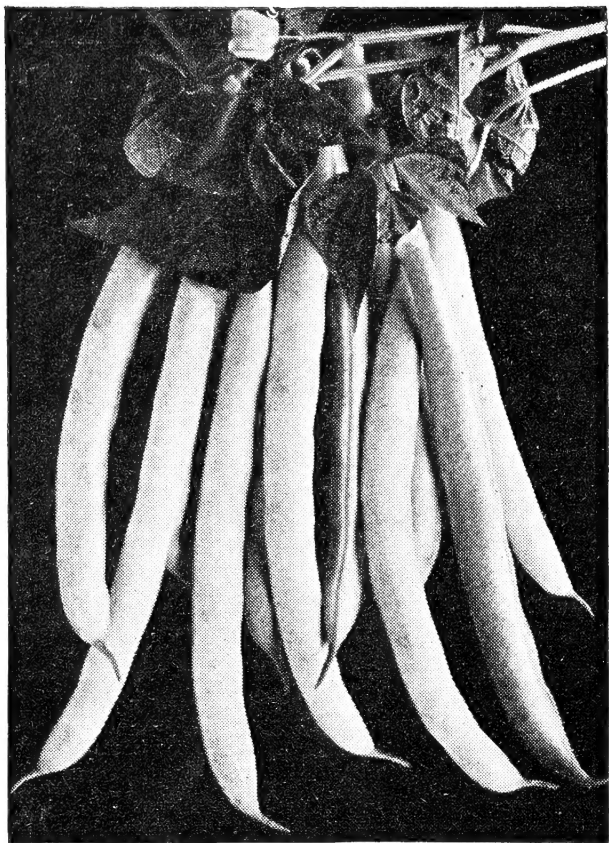

Beans, Sure-Crop Stringless Wax
Pkt. 10 cts., 1/2pt. 25 cts., pt. 45 cts., qt. 75 cts.

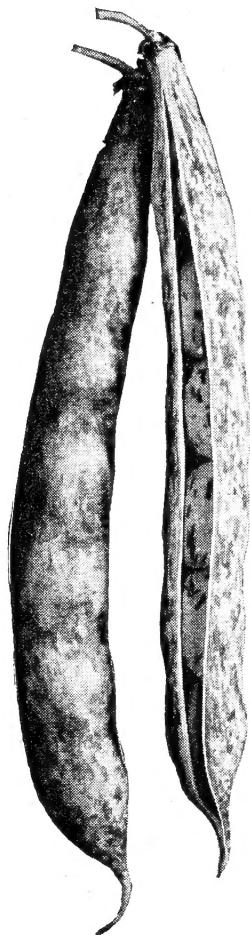

Beans, Dwarf Horticultural
1/2pt. 25 cts., pt. 45 cts.

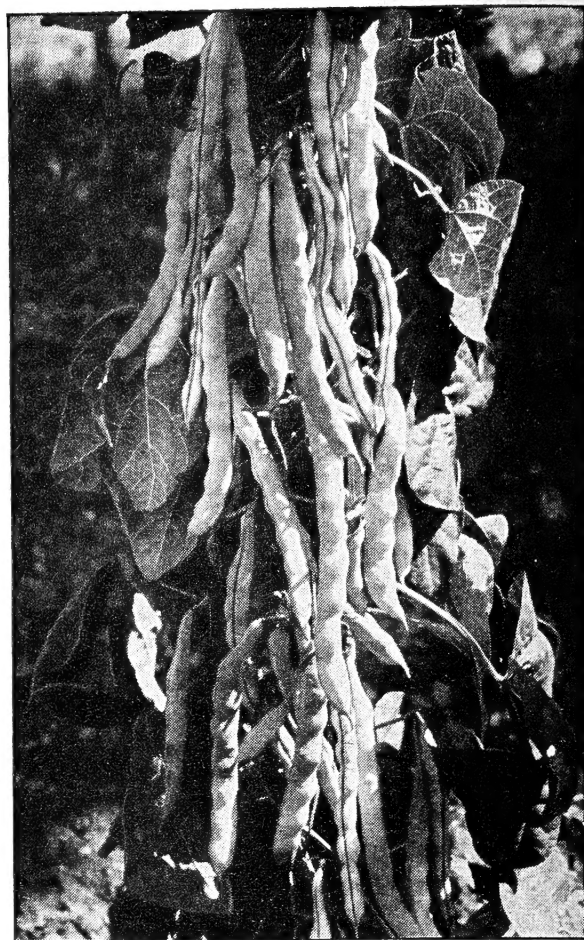

Beans, Kentucky Wonder
Pkt. 10 cts., 1/2pt. 25 cts., pt. 45 cts., qt. 75 cts.

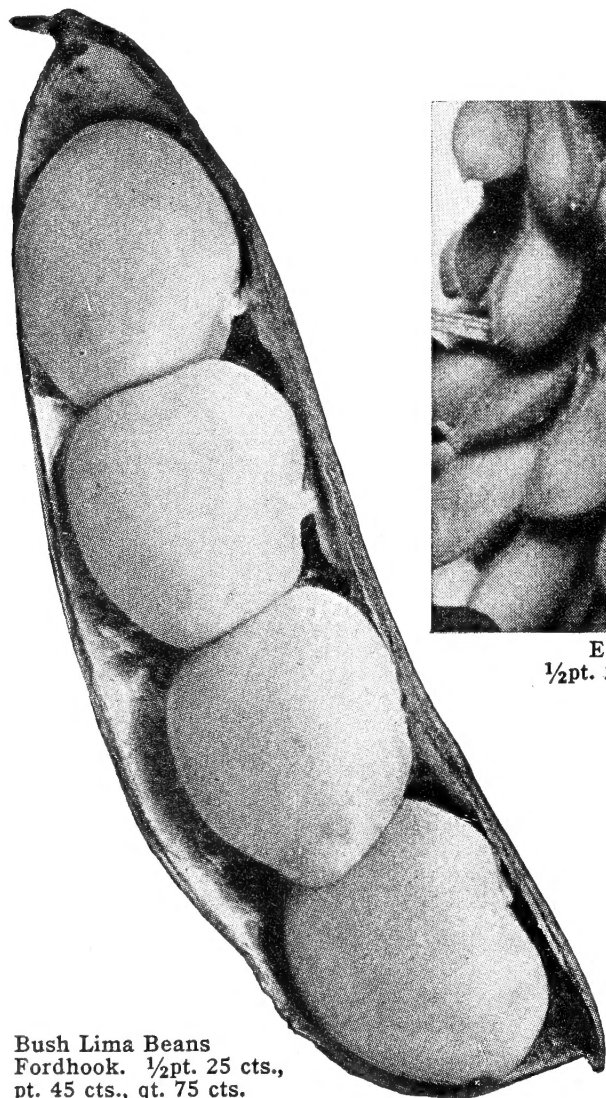

Bush Lima Beans
Fordhook. 1/2pt. 25 cts.,
pt. 45 cts., qt. 75 cts.



Edible Soy Beans, Bansei
1/2pt. 25 cts., pt. 40 cts., qt. 65 cts.

Beans are a stand-by in every home-garden. There are so many different types, all of high food value, that they may be enjoyed in a variety of ways. Plant succession crops in order always to have Beans at their best.

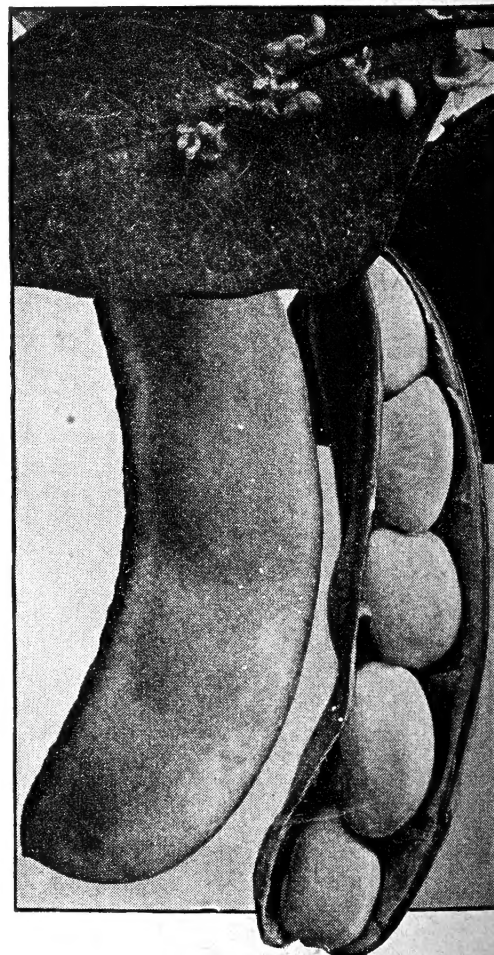

Pole Lima Beans, King of the Garden
1/2pt. 25 cts., pt. 45 cts., qt. 75 cts.

DWARF WAX-PODDED BEANS, continued

Sure-Crop Stringless Wax. ★ 53 days. Also known as Yellow Bountiful. The pods are of good size, broad, thick-flat, and bright yellow in color, entirely stringless and of fine quality. Very productive and excellent for both home and market-garden. Without a doubt the most popular yellow variety. Pkt. 10 cts., ½pt. 25 cts., pt. 45 cts., qt. 75 cts., pk. \$4.65, bus. \$16.80.

Top Notch Wax. 50 days. Rather small, compact plant with creamy yellow pods. Pods flat-oval, straight, stringless, and brittle. Valued because of its freedom from rust and other diseases. ½pt. 25 cts., pt. 45 cts., qt. 75 cts., pk. \$4.65, bus. \$16.80.

Wax- and Green-podded Pole Beans

Do not plant until the weather is really warm, then cover 6 to 10 Beans 2 inches deep in hills 3 to 4 feet apart, thinning out to 3 or 4 plants to each pole.

A quart of seed will plant 100 to 150 hills; from 12 to 16 quarts will plant an acre, depending upon the size of the Beans

Asparagus, or Yard-Long. 72 days. Pods round, slender and 2 feet or more in length. Generally grown as a novelty. ½pt. 45 cts., pt. 75 cts., qt. \$1.25.

Burger's Green-Pod Stringless. 64 days. Also known as White-Seeded Kentucky Wonder. Very prolific, bearing round, brittle pods of fine quality. ½pt. 25 cts., pt. 45 cts., qt. 75 cts., pk. \$4.65, bus. \$16.80.

Kentucky Wonder. ★ 65 days. Reliable under all conditions, and immensely productive, bearing long, round, dark green pods of fine quality. An old variety that continues to be the most popular of the Pole Beans. Pkt. 10 cts., ½pt. 25 cts., pt. 45 cts., qt. 75 cts., pk. \$4.65, bus. \$16.80.

Kentucky Wonder Wax. ★ 67 days. A Wax Bean similar in productiveness to the green-podded variety. Pkt. 10 cts., ½pt. 25 cts., pt. 45 cts., qt. 75 cts., pk. \$4.80, bus. \$17.40.

Lazy Wife. 75 days. Late sort with great clusters of richly flavored green pods which are 5 to 6 inches long. Useful also as a Shell Bean. Seeds are white. ½pt. 25 cts., pt. 45 cts., qt. 75 cts., pk. \$4.65, bus. \$16.80.

Pole Horticultural. 70 days. Also known as Pole Roman Bean or Speckled Cranberry. Very productive. Generally used as a Shell Bean, either green or dried. ½pt. 25 cts., pt. 45 cts., qt. 75 cts., pk. \$4.65, bus. \$16.80.

Scarlet Runner. 90 days. An ornamental climber whose bright scarlet blossoms are most attractive. The dried Beans are used like Limas. ½pt. 25 cts., pt. 45 cts., qt. 75 cts., pk. \$4.65, bus. \$16.80.

Dwarf Shell Beans

Dwarf Horticultural. Also known as Roman Bean. Snap 54 days, green shelled 65 days. A fine producer of String and Shell Beans. Pods are about 4 inches long, wide, flat, stringless; light green with stripe of red at maturity. The ripe Beans are oval; brown, speckled with purplish red. ½pt. 25 cts., pt. 45 cts., qt. 75 cts., pk. \$4.65, bus. \$16.80.

French Horticultural. Snap 62 days, green shelled 72 days. Pods about 6 inches long, flat, stringy when mature and deep green in snap stage turning to light buff with heavy splashing of deep carmine. Plant very prolific with short runners. ½pt. 25 cts., pt. 45 cts., qt. 75 cts., pk. \$4.80, bus. \$17.40.

Red Kidney. 95 days. Resembles the White Kidney except that the ripe Beans are red in color. ½pt. 25 cts., pt. 45 cts., qt. 75 cts., pk. \$4.65, bus. \$16.80.

White Kidney. 100 days. Largely grown for dry Shell Beans. The ripe Beans are large, kidney-shaped, pure white and do not discolor when cooked. ½pt. 25 cts., pt. 45 cts., qt. 75 cts., pk. \$4.65, bus. \$16.80.

White Marrowfat. 100 days. The favorite Bean for baking. A good producer of large, white Beans of fine quality. ½pt. 25 cts., pt. 45 cts., qt. 75 cts., pk. \$4.65, bus. \$16.80.

White Navy, or Pea Bean. 95 days. Used mostly for field planting; a sure cropper and extremely prolific. The dried Beans are small, round, and white. ½pt. 25 cts., pt. 40 cts., qt. 65 cts., pk. \$3.90, bus. \$13.80.

Bush Lima Beans

Never plant Bush Lima Beans until the weather is really warm. Plant on edge, with the eye down, 4 to 5 inches apart and 1 inch deep, in rows 2½ to 3 feet apart; thin the plants to 8 to 10 inches apart.

*A pint of seed will sow 100 feet of furrow;
a bushel will sow an acre*

Baby Fordhook. 70 days. A thick-seeded, small Lima Bean of excellent quality which remains green a long time. Extra-heavy cropper; especially suitable for canning. ½pt. 25 cts., pt. 45 cts., qt. 75 cts., pk. \$4.65, bus. \$16.80.

Burpee Improved. ★ 75 days. The large bushes bear loads of big, broad pods, each containing 4 or 5 Beans of the largest size and finest quality. ½pt. 25 cts., pt. 45 cts., qt. 75 cts., pk. \$4.80, bus. \$17.40.

Fordhook. ★ 75 days. Extremely prolific, bearing good-sized pods which contain 3 to 5 large, thick, meaty Beans of delicious flavor. Its fine quality, attractive appearance, and large pods rate it as the best dwarf Lima Bean for either home-garden or commercial use. ½pt. 25 cts., pt. 45 cts., qt. 75 cts., pk. \$4.80, bus. \$17.40.

Pole Lima Beans

These take longer to bear than the Bush Limas, but yield larger crops and continue to bear for a longer period. The seed is usually planted in hills, at least 3 feet apart each way, dropping 4 to 6 Beans to the hill. Set poles 8 to 10 feet long in each hill to support the vines.

A quart of seed will plant 100 hills; 20 quarts will plant one acre

Carpinteria. 90 days. Large pods, containing 3 to 5 Beans which are very thick and mealy and retain their green color even when ripe. ½pt. 25 cts., pt. 45 cts., qt. 75 cts., pk. \$4.65, bus. \$16.80.

Challenger. ★ 92 days. A vigorous grower, hardy, and very productive. Pods are 5 to 6 inches long and filled with 4 or 5 thick, plump Beans of delicious flavor. ½pt. 25 cts., pt. 45 cts., qt. 75 cts., pk. \$4.65, bus. \$16.80.

King of the Garden. ★ 88 days. Broad pods 5 to 6 inches long, containing 4 or 5 large, flat Beans. Probably the leading Pole Lima Bean for both home and market-gardeners. Allow only two vines to each pole. ½pt. 25 cts., pt. 45 cts., qt. 75 cts., pk. \$4.65, bus. \$16.80.

Leviathan. ★ 85 days. A general favorite, being early and productive, bearing loads of giant pods, well filled with large tender Beans. ½pt. 25 cts., pt. 45 cts., qt. 75 cts., pk. \$4.65, bus. \$16.80.

Edible Soy Beans

Bansei. 90 days. A very popular variety of vegetable-type Soy Beans. Early and extremely productive. They are delicious when eaten green or dry. Seeds are bright green while young and yellow when mature. ½pt. 25 cts., pt. 40 cts., qt. 65 cts., pk. \$3.30, bus. \$11.40.

NOTE: One pint of Beans weighs about 1 lb., 1 quart about 2 lbs., and 1 bushel, 60 lbs.

CHICORY

The Large-rooted variety is grown for its roots, which may be cooked and served like turnips.

The Witloof variety is highly esteemed as a winter salad, for which purpose the plants are taken up in the fall, cut back nearly to the top of the root, and then covered with soil in a box or trench in a warm cellar. The new leaves which grow from the old roots in about a month's time are nearly white, crisp and of a fine, piquant flavor.

Sow Chicory seed in April or May, in shallow drills in rows about 18 inches apart and thin the plants to stand 4 to 6 inches apart.

An ounce will sow about 400 feet of drill

Large-rooted. Roots 12 to 14 inches long, 2 inches in diameter at top, and tapered. Pkt. 10 cts., oz. 50 cts., ¼lb. \$1.50, lb. \$5.00.

Witloof. Sometimes called French Endive. Pkt. 10 cts., oz. 75 cts., ¼lb. \$2.25, lb. \$7.50.

BEETS

Sow seed as early in the spring as possible, in drills 15 to 18 inches apart, covering about 1 inch deep, and thin the plants to 2 to 3 inches apart. Plantings every three weeks until mid-July will furnish a supply of fresh Beets until late fall. Late in June make a large planting to produce Beets for winter use. Harvest before frost and store in pits outdoors, or in a dry cellar. For an extra-early crop start the seed under glass.

An ounce of seed will sow about 100 feet of drill; 6 pounds an acre

Crosby's Extra-Early. ★ 55 days. Dark red skin and deep red flesh; very uniform in shape and size. Pkt. 10 cts., oz. 25 cts., $\frac{1}{4}$ lb. 75 cts., lb. \$2.50.

Detroit Dark Red. ★ 60 days. Smooth, and uniformly globe-shaped, with dark red skin and flesh, fine-grained, tender and sweet. The standard variety for home-gardeners. Pkt. 10 cts., oz. 30 cts., $\frac{1}{4}$ lb. 90 cts., lb. \$3.00.

Early Blood Turnip. 55 days. Dark red skin and bright red flesh of good quality. Pkt. 10 cts., oz. 25 cts., $\frac{1}{4}$ lb. 75 cts., lb. \$2.50.

Early Red Chief. 50 days. The roots are smooth, perfectly globular, deep dark red all the way through, without zoning, of uniform shape and size. Pkt. 10 cts., oz. 25 cts., $\frac{1}{4}$ lb. 75 cts., lb. \$2.50.

Early Wonder. ★ 50 days. The most desirable variety for market-gardeners. Roots round, deep red, smooth, tender and of excellent quality. Unsurpassed in uniformity and depth of interior color. Pkt. 10 cts., oz. 25 cts., $\frac{1}{4}$ lb. 75 cts., lb. \$2.50.

Extra-Early Egyptian. 53 days. One of the earliest. Medium-sized, flat, smooth roots with dark crimson skin and flesh. Pkt. 10 cts., oz. 25 cts., $\frac{1}{4}$ lb. 75 cts., lb. \$2.50.

Perfected Detroit. 60 days. Roots globular, medium smooth, deep red; flesh dark red and practically free from zoning. Good quality. Pkt. 10 cts., oz. 30 cts., $\frac{1}{4}$ lb. 90 cts., lb. \$3.00.

MANGEL-WURZEL or CATTLE BEETS

Generally used for winter feeding of poultry and live stock.

Sow the seed in April or early May in rows 2 to 3 feet apart and when the plants are 2 to 3 inches high, thin them out to stand 8 to 10 inches apart. Harvest before frost and store in pits outdoors or in a dry, frost-proof cellar.

Four to 5 pounds of seed will sow an acre in drills

Golden Tankard. ★ Large, long roots unusually high in feeding value. Oz. 20 cts., $\frac{1}{4}$ lb. 65 cts., lb. \$2.00, 5 lbs. \$9.50.

Long Red Mammoth. ★ Enormous roots which grow largely above ground and are easy to harvest. Oz. 20 cts., $\frac{1}{4}$ lb. 65 cts., lb. \$2.00, 5 lbs. \$9.50.

White Sugar. Very productive, rich in sugar and especially good for stock-feeding. Oz. 20 cts., $\frac{1}{4}$ lb. 65 cts., lb. \$2.00, 5 lbs. \$9.50.

SWISS CHARD

One of the best of the vegetables grown for "greens." It takes the same culture as Beets except that the plants should be thinned to stand 8 inches apart. Pull the leaves off as they become ready and new ones will grow in their place.

An ounce of seed will sow about 150 feet of drill

Fordhook Giant. ★ 58 days. An outstanding variety with curly, rich dark green leaves and broad white ribs, of a quality better than spinach. Pkt. 10 cts., oz. 25 cts., $\frac{1}{4}$ lb. 75 cts., lb. \$2.25.

Lucullus Giant. 58 days. A tall variety with light green, deeply wrinkled and crumpled leaves. Pkt. 10 cts., oz. 25 cts., $\frac{1}{4}$ lb. 75 cts., lb. \$2.25.

Rhubarb Chard. ★ 58 days. Stalks glowing but delicate crimson; the rich red color extends through the veins into the dark green, heavily crumpled leaves. Has a delicious flavor. Pkt. 15 cts., oz. 50 cts.

CABBAGE

Early Cabbage should be started under glass in February or early March, and transplanted to the open ground as soon as the weather is suitable. For late Cabbage sow the seed outdoors about May 1. Plants should stand $1\frac{1}{2}$ to 2 feet apart, according to variety. Number of days shown indicate days to maturity from the time the plants are set in the garden. Allow about 40 days to produce plants from seed.

An ounce of seed will produce about 2,000 plants

Copenhagen Market. ★ 68 days. The heads are round, extremely solid, with small core and of excellent quality. The most popular early sort for both home and market-gardens. Pkt. 10 cts., oz. 60 cts., $\frac{1}{4}$ lb. \$1.60, lb. \$5.50.

Early Jersey Wakefield. 63 days. Heads rather small, pointed, solid, crisp and tender. The best early, pointed-head variety. Pkt. 10 cts., oz. 60 cts., $\frac{1}{4}$ lb. \$1.60, lb. \$5.50.

Glory of Enkhuizen. ★ 80 days. A very attractive second-early variety. Heads large, round, solid and of excellent quality. A good keeper. Pkt. 10 cts., oz. 60 cts., $\frac{1}{4}$ lb. \$1.60, lb. \$5.50.

Golden Acre. 64 days. An early strain of the Copenhagen type. Heads small, uniformly round, firm and solid; crisp, tender and of fine quality. Especially valuable for early market. Pkt. 10 cts., oz. 70 cts., $\frac{1}{4}$ lb. \$1.75, lb. \$6.00.

Hollander, or Danish Ballhead. ★ 95 days. Most widely used and best all-purpose variety for market, kraut or storage. Heads are medium size, deep round, very hard, crisp, tender and of fine quality. Pkt. 10 cts., oz. 70 cts., $\frac{1}{4}$ lb. \$1.75, lb. \$6.00.

Penn State Ballhead. ★ 100 days. The hard, tight heads weigh one-third more than ordinary heads of same size and are good keepers. Pkt. 15 cts., oz. 70 cts., $\frac{1}{4}$ lb. \$1.75, lb. \$6.00.

Premium Flat Dutch. 105 days. A heavy yielder, producing large, heavy, flat heads which keep well until late in winter. Pkt. 10 cts., oz. 60 cts., $\frac{1}{4}$ lb. \$1.60, lb. \$5.50.

Yellows-Resistant Varieties

Specially selected strains of Cabbage developed for use on yellows-infested soil.

Detroit. 64 days. Yellows-resistant strain of Golden Acre. Heads medium sized, round, solid, crisp and of excellent quality. Sold out.

Globe. 85 days. A yellows-resistant strain of Glory of Enkhuizen. Pkt. 15 cts., oz. 70 cts., $\frac{1}{4}$ lb. \$1.75, lb. \$6.00.

Jersey Queen. 65 days. A pointed-head type selected from Early Jersey Wakefield for disease resistance. Pkt. 15 cts., oz. 70 cts., $\frac{1}{4}$ lb. \$1.90, lb. \$6.50.

Marion Market. ★ 78 days. A development from Copenhagen Market but later maturing and slightly larger head. Pkt. 15 cts., oz. 70 cts., $\frac{1}{4}$ lb. \$1.75, lb. \$6.00.

Wisconsin All Season. 92 days. A hardy drumhead variety which stands hot weather unusually well and is highly resistant to "yellows." Heads are semi-flat, solid and compact, and of fine quality. Pkt. 15 cts., oz. 70 cts., $\frac{1}{4}$ lb. \$1.90, lb. \$6.50.

Wisconsin Hollander No. 8. ★ 105 days. Of the Danish Ballhead type. Popular late variety for yellows-infested soil. Pkt. 15 cts., oz. 70 cts., $\frac{1}{4}$ lb. \$1.90, lb. \$6.50.

Red Cabbage

Mammoth Rock Red. 100 days. Heads flattened and very large. Pkt. 10 cts., oz. 70 cts., $\frac{1}{4}$ lb. \$1.75, lb. \$6.00.

Red Hollander. (Yellows-resistant.) 100 days. Head round, hard and of medium size. Pkt. 15 cts., oz. \$1.30, $\frac{1}{4}$ lb. \$4.00.

Savoy Cabbage

The leaves are curled and crinkled and the heads are firm and solid. They are best late in the season after a heavy frost.

Chieftain. 90 days. Solid heads with nicely savoyed leaves. Pkt. 15 cts., oz. 70 cts., $\frac{1}{4}$ lb. \$1.75, lb. \$6.00.

Drumhead Savoy. 95 days. Large, solid heads and few outer leaves. Pkt. 10 cts., oz. 70 cts., $\frac{1}{4}$ lb. \$1.75, lb. \$6.00.

★WHEN IN DOUBT, ORDER THE STAR VARIETIES

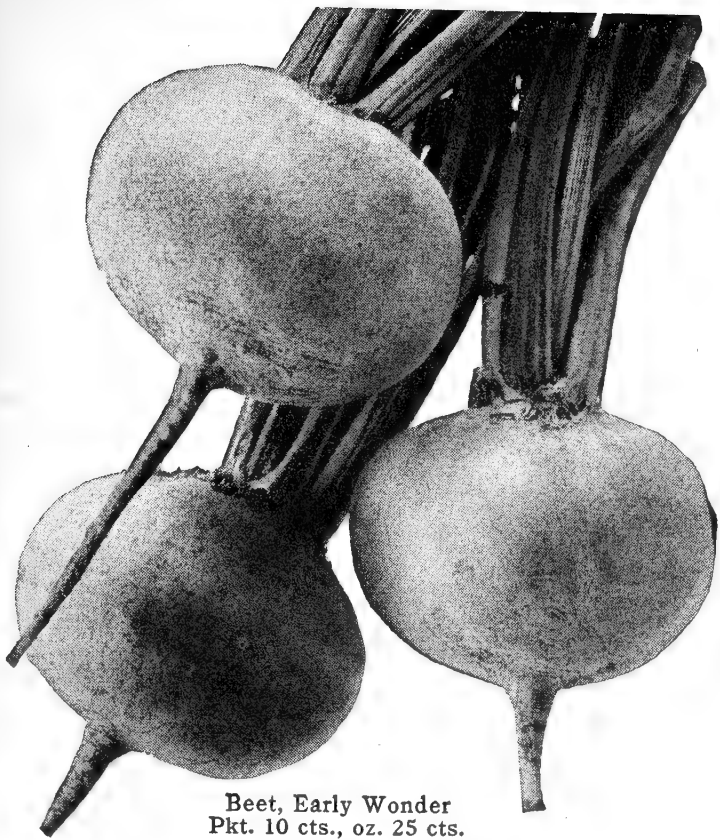

Beet, Early Wonder
Pkt. 10 cts., oz. 25 cts.

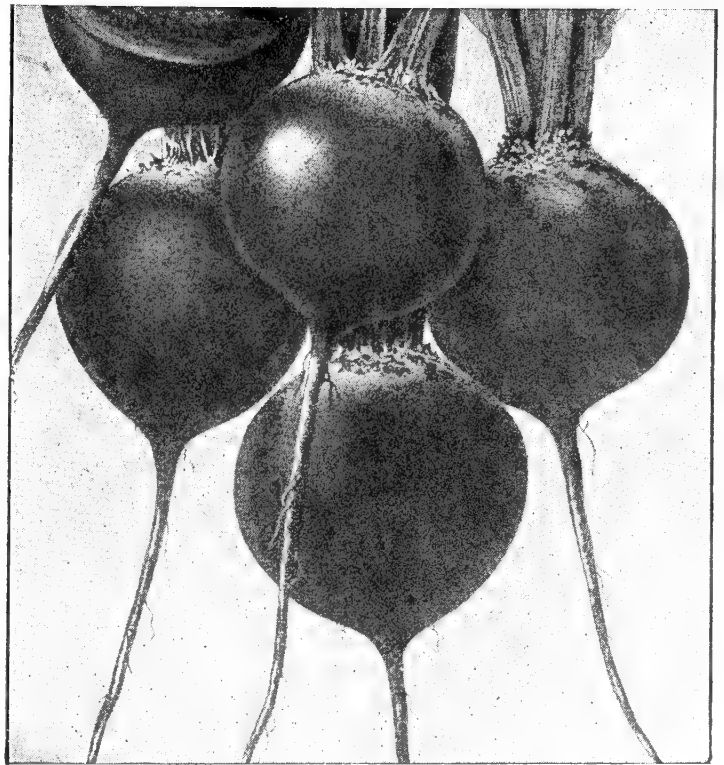

Beet, Detroit Dark Red. Pkt. 10 cts., oz. 30 cts.

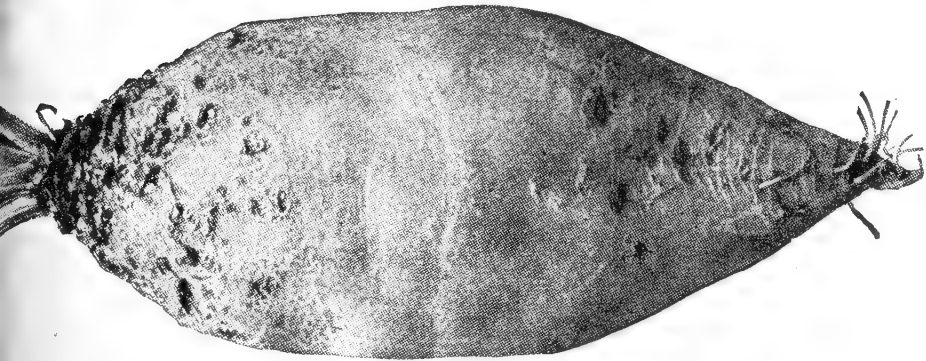

Mangel-Wurzel, Long Red Mammoth. Oz. 20 cts., 1/4lb. 65 cts.

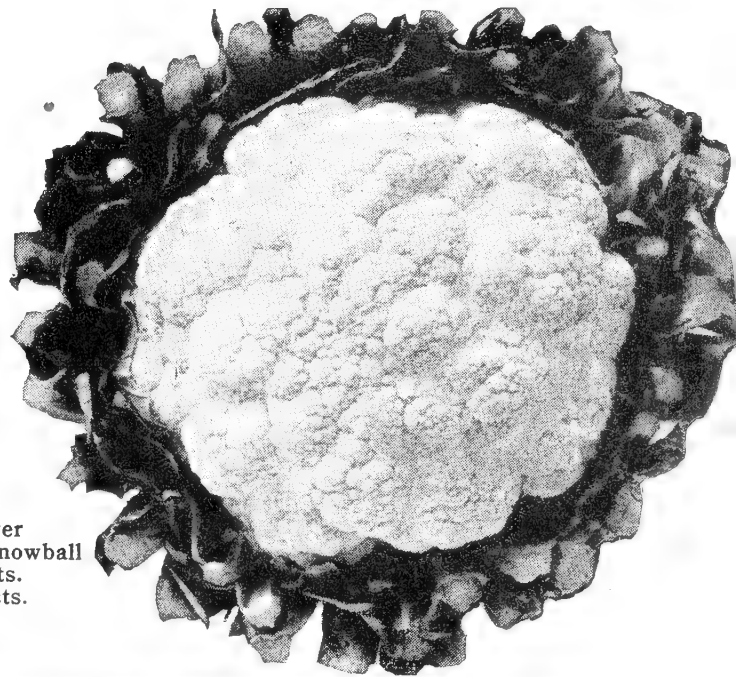

Cauliflower
Select Early Snowball
Pkt. 25 cts.
1/4oz. 90 cts.

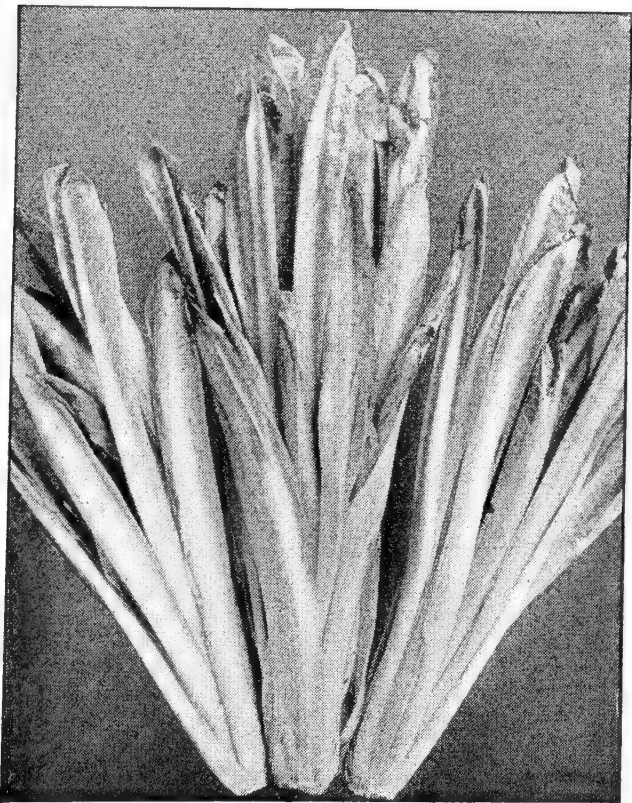

Chicory, Witloof. Pkt. 10 cts., oz. 75 cts.



Swiss Chard, Fordhook Giant. Pkt. 10 cts., oz. 25 cts.



Cabbage, Hollander. Pkt. 10 cts., oz. 70 cts.

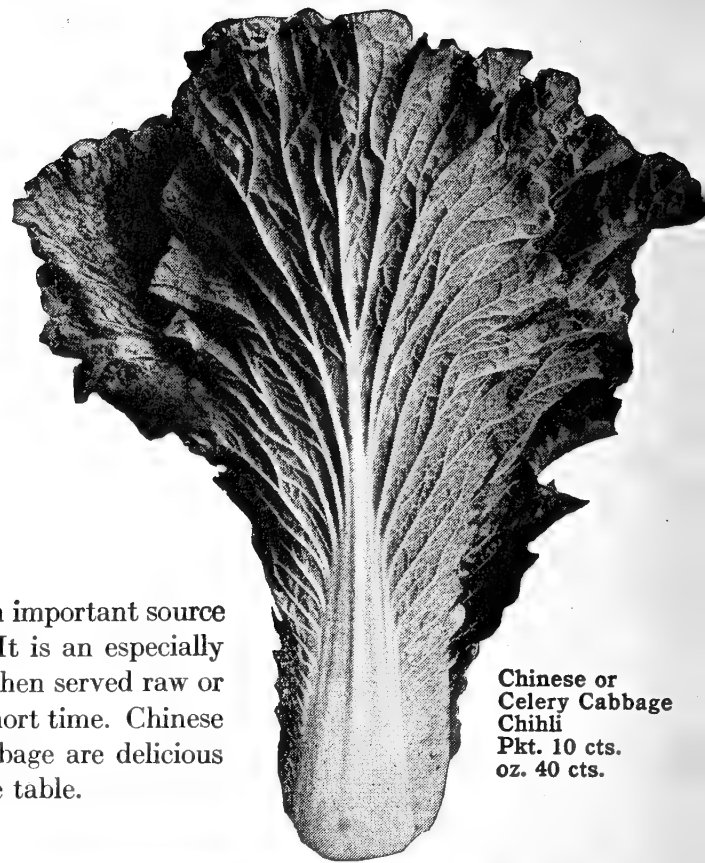

Chinese or
Celery Cabbage
Chihli
Pkt. 10 cts.
oz. 40 cts.

Cabbage is an important source of vitamin C. It is an especially valuable food when served raw or cooked only a short time. Chinese and Savoy Cabbage are delicious novelties for the table.

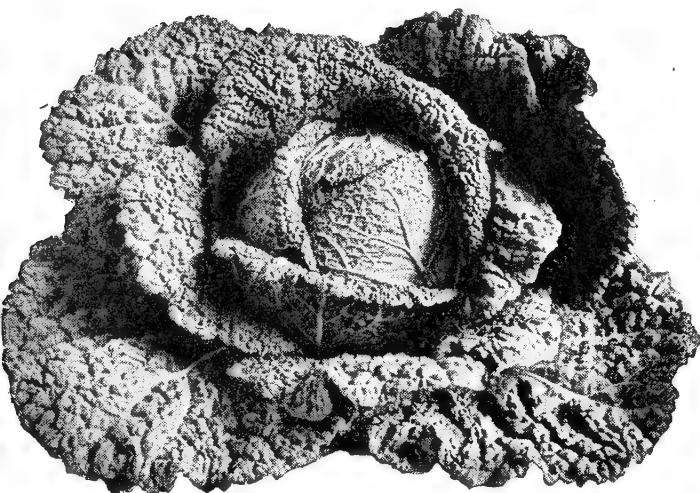

Savoy Cabbage, Chieftain. Pkt. 15 cts., oz. 70 cts.



Cabbage, Copenhagen Market. Pkt. 10 cts., oz. 60 cts.

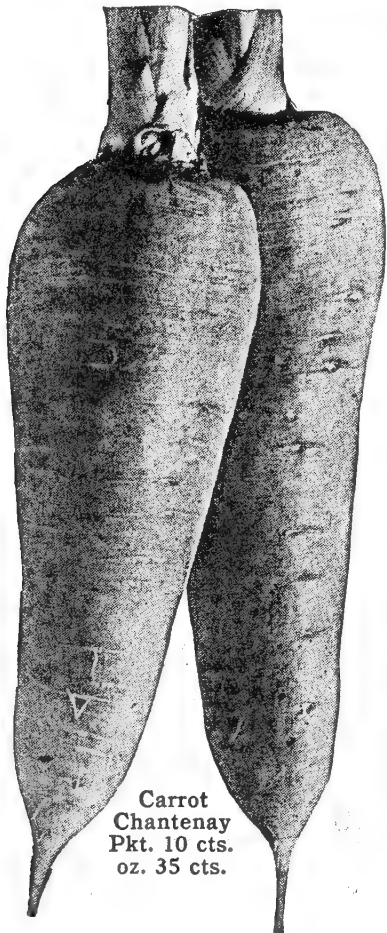

Carrot
Chantenay
Pkt. 10 cts.
oz. 35 cts.

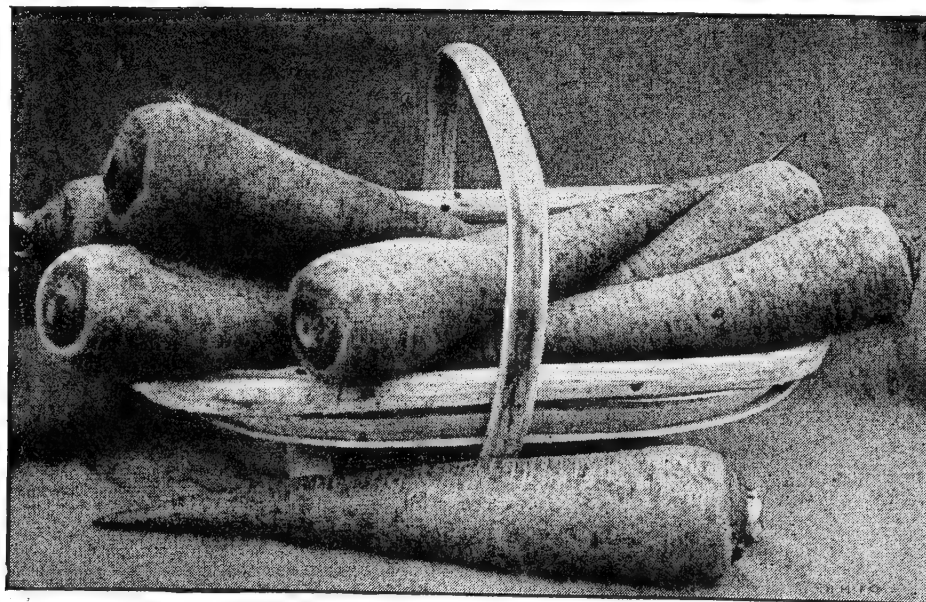

Carrot, Improved Long Orange. Pkt. 10 cts., oz. 35 cts.



Carrot, Danvers Half-Long
Pkt. 10 cts., oz. 35 cts.

CARROTS

Carrots succeed in any good garden soil. Sow the seed any time after the frost is out of the ground in rows about 15 inches apart, covering it about $\frac{1}{2}$ inch deep and pressing down firmly. Thin the seedlings to 2 inches apart in the row. Make sowings every 3 to 4 weeks from late March to the end of June. Carrots for winter storage should be sown in early June.

*An ounce of seed will sow about 200 feet of drill;
3 to 4 pounds are required to sow an acre*

- Chantenay.** ★ 70 days. The roots are broad at the top, tapering to an abrupt point. It produces heavy yields on comparatively shallow soils. Pkt. 10 cts., oz. 35 cts., $\frac{1}{4}$ lb. \$1.00, lb. \$3.00.
- Danvers Half-Long.** ★ 75 days. The roots are smooth, nearly cylindrical, bluntly pointed, and in good soil will attain a length of 6 to 8 inches. The skin and flesh are bright orange-red, fine-grained and tender. Pkt. 10 cts., oz. 35 cts., $\frac{1}{4}$ lb. \$1.00, lb. \$3.00.
- Imperator.** 77 days. Roots deep rich orange, smooth, about 8 inches long and uniformly tapered to a semi-blunt end. Flesh rich orange, fine grained, tender and of excellent quality. Meets the most exacting demand for a long, smooth, handsome Carrot. Pkt. 10 cts., oz. 35 cts., $\frac{1}{4}$ lb. \$1.00, lb. \$3.00.
- Improved Long Orange.** 85 days. Large, tapering roots, 12 to 14 inches long, smooth, bright orange in color and of good quality. Pkt. 10 cts., oz. 35 cts., $\frac{1}{4}$ lb. \$1.00, lb. \$3.00.
- Morse's Bunching.** 77 days. Roots rich even reddish orange, small core; 8 inches long, sweet, tender; short, strong tops. Pkt. 10 cts., oz. 35 cts., $\frac{1}{4}$ lb. \$1.00, lb. \$3.00.
- Oxheart.** 75 days. Thick, blunt, bright orange roots. Grown largely for stock feed. Prolific and a good keeper. Pkt. 10 cts., oz. 35 cts., $\frac{1}{4}$ lb. \$1.00, lb. \$3.00.
- Red-Cored Chantenay.** 70 days. A rich orange color, decidedly deeper than the ordinary Chantenay. Roots are uniform in size and appearance, and a little earlier in maturity than ordinary Chantenay. Pkt. 10 cts., oz. 35 cts., $\frac{1}{4}$ lb. \$1.00, lb. \$3.00.
- Supreme Half-Long.** 75 days. Cylindrical roots 6 to 7 inches long, rich deep orange, with uniformly small orange-red core. Tops short but sturdy. Recommended for shipping, or for the home or market-garden. Pkt. 10 cts., oz. 35 cts., $\frac{1}{4}$ lb. \$1.00, lb. \$3.00.

CAULIFLOWER

Sow the seed and treat the young plants exactly as you would cabbage, starting the spring crop in flats indoors or in the hotbed early in February and transplanting to the garden in May after danger from frost is past. Sow for fall crop in coldframe or seedbed in May and transplant in June. Set the plants $1\frac{1}{2}$ feet apart, digging in plenty of manure if it is available. When the plants show signs of heading, water them freely. Finally, when the heads are about 2 inches in diameter, tie the outer leaves loosely together over the top with soft twine, to protect them from the sun and blanch them white. Days to maturity are from the time the plants are set in the garden. Allow about 30 days to produce the plants from seed.

An ounce of seed will produce about 4,000 plants

- Danish Giant, or Dry Weather.** 70 days. A little later than Snowball and the plants are larger. Preferred in some sections because it will grow and head during dry weather. Pkt. 25 cts., $\frac{1}{4}$ oz. 90 cts., oz. \$2.50.
- Select Early Snowball.** ★ 60 days. Extra-early and one of the surest headers. It produces deep, solid heads of medium size, pure white, and of fine quality. Being compact in growth, the plants can be set close together. Pkt. 25 cts., $\frac{1}{4}$ oz. 90 cts., oz. \$2.50.
- Snowdrift.** ★ 60 days. Somewhat more vigorous than Snowball and selected to produce a larger head without losing materially in earliness. The pure white heads are remarkable for their great depth and unexcelled white color, and the curd is of fine texture and free from small protruding leaves. Very productive and one of the surest headers known. Pkt. 25 cts., $\frac{1}{4}$ oz. \$1.00, oz. \$3.00.

CELERY

Celery wants plenty of fertilizer—enrich the spot where you are going to grow it with manure, humus, or rich compost, or if you lack these, with a commercial fertilizer high in nitrogen. For early crops sow indoors or in a hotbed about April 1, barely covering the seed with soil. When the seedlings are 2 to 3 inches high, thin out or transplant $1\frac{1}{2}$ to 2 inches apart. Set out by the end of May. For winter Celery, sow seed in a coldframe or sheltered spot in the garden about mid-April and reset in the trenches about July 1. It is a good plan to cut off the tops of the plants when they are 4 to 5 inches high to make them more stocky.

An ounce of seed will produce about 7,500 plants

- Easy Blanching.** ★ The stalks are of medium height, thick through, and brittle; the heart is heavy, blanching quickly to a clear light yellow. Good for both early and late crop. Pkt. 10 cts., oz. 70 cts., $\frac{1}{4}$ lb. \$2.00, lb. \$7.00.
- Fordhook.** Stalks smooth, entirely free from stringy fibers, and $1\frac{1}{2}$ inches through when cut. Blanches pure white but heart has a tinge of light, buttery yellow. Crisp, nutty flavor. Pkt. 10 cts., oz. 70 cts., $\frac{1}{4}$ lb. \$2.00, lb. \$7.00.
- Giant Pascal.** ★ A fine, late Celery with broad, thick, heavy stalks of superb nutty flavor; blanches yellowish white. A good winter keeper, retaining its flavor and crispness in storage. Pkt. 10 cts., oz. 70 cts., $\frac{1}{4}$ lb. \$2.00, lb. \$7.00.
- Golden Phenomenal.** Grows 27 to 28 inches over all, and from 8 to 9 inches to the joint. Plants are heavy, compact, and full-hearted. The stems are broad and thick, brittle and of fine flavor. Pkt. 15 cts., oz. 70 cts., $\frac{1}{4}$ lb. \$2.00, lb. \$7.00.
- Golden Plume, or Wonderful.** ★ Resembles Golden Self-blanching in crispness and flavor, but much larger, blanches quicker and matures earlier. Desirable for market-gardeners. Pkt. 15 cts., oz. 80 cts., $\frac{1}{4}$ lb. \$2.25, lb. \$8.00.
- Golden Self-Blanching.** It is rather low and compact in growth, with thick, round stalks and heavy heart, blanching easily to a rich golden yellow. In flavor and quality it is unsurpassed. Pkt. 10 cts., oz. 80 cts., $\frac{1}{4}$ lb. \$2.25, lb. \$8.00.
- Summer Pascal.** ★ An early variety of excellent quality. Plant not tall but sturdy and robust. Stems are thick, tender, stringless and of rich flavor. Pkt. 25 cts., oz. \$1.50, $\frac{1}{4}$ lb. \$5.00.
- White Plume.** A very early, easily grown variety with tall, handsome stalks which blanch quickly to a silvery white. A favorite. Pkt. 10 cts., oz. 70 cts., $\frac{1}{4}$ lb. \$2.00, lb. \$7.00.

CELERIAC or TURNIP-ROOTED CELERY

The roots—not the stalks—are the edible portion of this plant. They are used for flavoring soups and in stews, in place of Celery or Celery seed, and are also cooked or used as a salad. Grown like Celery but does not require blanching. Roots may be stored as you would beets and carrots, and used throughout the winter.

- Large Prague.** A productive variety with large, round roots. Pkt. 10 cts., oz. 70 cts., $\frac{1}{4}$ lb. \$2.00.

Chinese or Celery Cabbage

A most palatable and wholesome vegetable which may be served raw as salad or cole slaw, or it may be cooked like cabbage. Sow the seed the last of June or early in July, in shallow drills about 2 feet apart, and thin or transplant the seedlings to stand about 15 inches apart.

- Chihli.** 75 days. Produces heads about 18 inches high and 4 inches or more in diameter. Very firm, crisp, sweet and tender. Pkt. 10 cts., oz. 40 cts., $\frac{1}{4}$ lb. \$1.15, lb. \$3.50.

CELTUCE

An appetizing vegetable novelty from China. Seed is sown outdoors and the young plants thinned to 6 inches apart. Grows about a foot high. Young leaves are used as salad; the stalk eaten raw or cooked. Pkt. 15 cts., oz. \$1.00, $\frac{1}{4}$ lb. \$3.00.

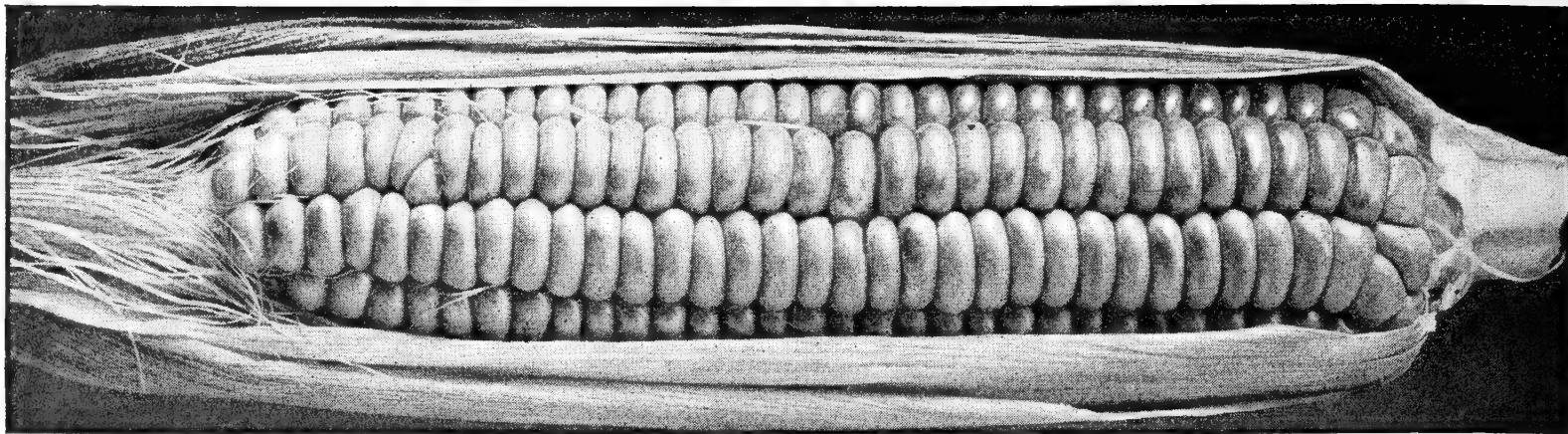

Corn, Golden Bantam. $\frac{1}{2}$ pt. 20 cts., pt. 35 cts., qt. 60 cts.

We have an excellent line of Sweet Corn, and recommend that you try some of the hybrid varieties developed in recent years for disease resistance and high yields.

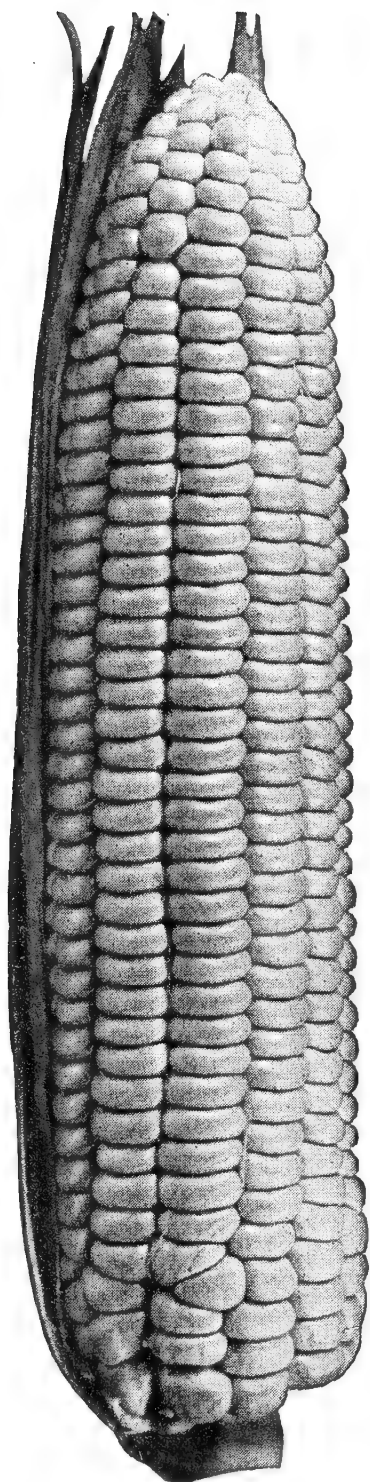

Corn, Golden Evergreen
 $\frac{1}{2}$ pt. 20 cts., pt. 35 cts., qt. 60 cts.

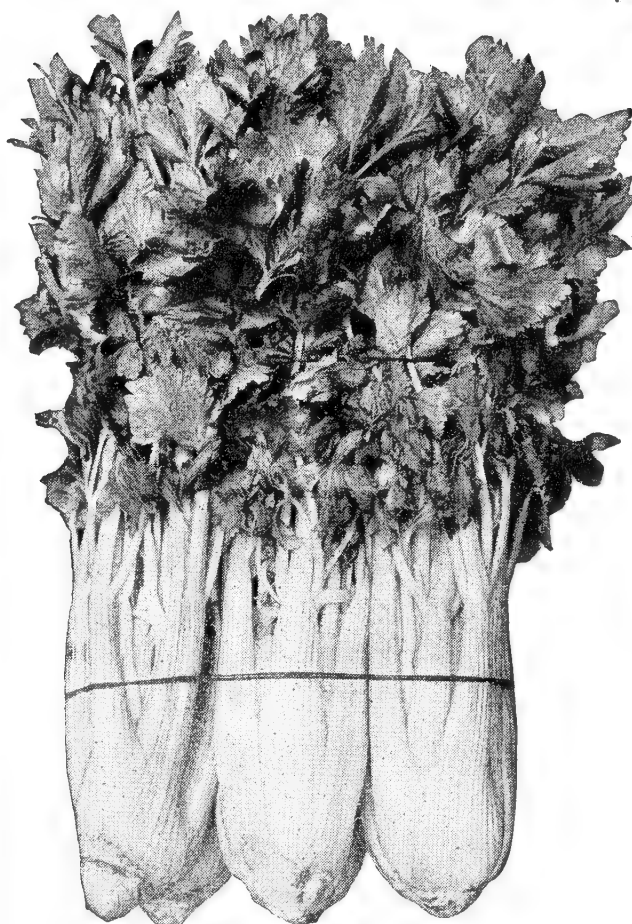

Celery, Golden Plume or Wonderful
Pkt. 15 cts., oz. 80 cts.



Celeriac or Turnip-Rooted Celery
Large Prague. Pkt. 10 cts., oz. 70 cts.

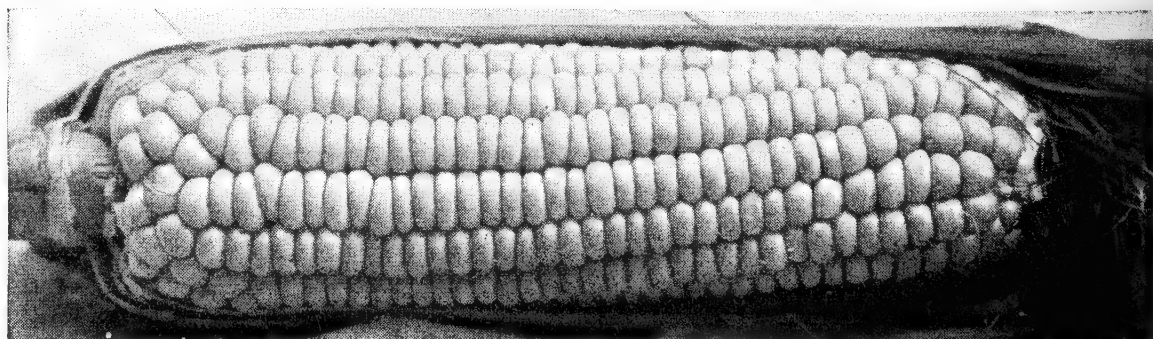

Corn, Marcross C13.6. $\frac{1}{2}$ pt. 30 cts., pt. 50 cts., qt. 90 cts.

SWEET CORN

Do not make the first sowing until the soil is warm and comparatively dry—the middle of May is usually the earliest it is safe to sow Corn in this section. Plant every 2 weeks until early July. It can be grown in hills or in rows. Hills are placed 2 to 3 feet apart each way, dropping about six seeds in each hill and, when the plants are about 8 inches high, pulling out all but the three or four strongest. Rows are spaced 2½ to 3½ feet apart and the plants thinned to stand 12 to 15 inches apart in the rows. In planting, cover the seed about 2 inches deep. In order that the ears may develop perfectly they must receive plenty of pollen from near-by stalks; consequently, it is always best to plant Sweet Corn in several short rows, side by side, rather than in one or two long rows. If you want to enjoy Sweet Corn far sweeter and richer than any you have ever been able to buy, grow it yourself and pick it just before it is to be cooked.

*One pint of seed will plant about 150 hills or 300 feet of row;
6 to 8 quarts will plant an acre*

Early Varieties

- Burbank's Bantam.** ★ 70 days. The ear is 7 to 8 inches long, with 12 to 16 rows of delicious yellow kernels. The earliest of the yellow varieties. ½pt. 20 cts., pt. 35 cts., qt. 60 cts., pk. \$3.50, bus. \$13.00.
- Early Mayflower.** 70 days. Ears 7 inches long with 8 or 10 rows of broad, tender, pure white kernels. Fine for first early. ½pt. 20 cts., pt. 35 cts., qt. 60 cts., pk. \$3.50, bus. \$13.00.
- Extra-Early Adams.** 70 days. Not a true Sweet Corn but extremely hardy and early. ½pt. 20 cts., pt. 35 cts., qt. 60 cts., pk. \$2.75, bus. \$10.00.
- Golden Bantam.** ★ 80 days. For many years the most popular variety in the country—a distinction which it still retains and deservedly so, for no other variety can surpass it for quality and sweetness. The ears are slender, about 6 inches long, and well filled with golden kernels of the most delicious flavor. Everyone likes Golden Bantam. Pkt. 10 cts., ½pt. 20 cts., pt. 35 cts., qt. 60 cts., pk. \$3.50, bus. \$13.00.
- Golden Sunshine.** ★ 75 days. An improvement on Golden Bantam in that the ears are an inch longer and 12-rowed instead of 8-rowed. A very popular variety because of its sweetness and flavor combined with its extreme earliness. ½pt. 20 cts., pt. 35 cts., qt. 60 cts., pk. \$3.50, bus. \$13.00.

Medium-Early Varieties

- Barden's Wonder Bantam.** 85 days. A strain of Golden Bantam. Ears 8-rowed, about 8 inches long; kernels rich golden yellow, deliciously sweet and tender. ½pt. 20 cts., pt. 35 cts., qt. 60 cts., pk. \$3.50, bus. \$13.00.
- Black Mexican.** 88 days. The ears are of good size with broad kernels which are bluish white when they reach the edible stage and turn violet when cooked. Very sweet and tender. ½pt. 20 cts., pt. 35 cts., qt. 60 cts., pk. \$3.50, bus. \$13.00.
- Early Evergreen.** 95 days. Not quite so tall but several days earlier than Stowell's, bearing large ears of typical Evergreen type and quality. ½pt. 20 cts., pt. 35 cts., qt. 60 cts., pk. \$3.50, bus. \$13.00.
- Golden Giant.** ★ 85 days. As sweet, tender, and rich in flavor as the famous Golden Bantam, practically as early, more productive, and much larger. ½pt. 20 cts., pt. 35 cts., qt. 60 cts., pk. \$3.50, bus. \$13.00.
- Howling Mob.** ★ 85 days. Unusually large ear for so early a sort and not surpassed in quality by any other white Sweet Corn. ½pt. 20 cts., pt. 35 cts., qt. 60 cts., pk. \$3.50, bus. \$13.00.
- Whipple's Early White.** 85 days. Matures about a week later than the small extra-early sorts. Ears 8 to 9 inches long with 16 or 18 rows of pearly white and sweet grains. ½pt. 20 cts., pt. 35 cts., qt. 60 cts., pk. \$3.50, bus. \$13.00.
- Whipple's Early Yellow.** ★ 85 days. Ears about 7 inches long with 12 or 14 rows of golden yellow kernels, fairly deep, sweet and of delicious flavor. Popular home and market-garden variety. ½pt. 20 cts., pt. 35 cts., qt. 60 cts., pk. \$3.50, bus. \$13.00.

Late Varieties

- Country Gentleman.** 95 days. Fine rich flavor. The ears are 7 to 8 inches long with long, narrow kernels set densely and irregularly on a very small cob. Often called "Shoe-Peg." Pkt. 10 cts., ½pt. 20 cts., pt. 35 cts., qt. 60 cts., pk. \$3.50, bus. \$13.00.
- Golden Colonel.** 95 days. Given award of merit in All-America Seed Selections for 1936. Like Country Gentleman except color, which is brilliant yellow. The only yellow Sweet Corn ripening with main-crop sorts. ½pt. 20 cts., pt. 35 cts., qt. 60 cts., pk. \$3.50, bus. \$13.00.
- Golden Evergreen.** ★ 95 days. Also known as Bantam Evergreen. One of the best of the medium-late varieties. Ears 8 to 9 inches long, 12 to 14-rowed; kernels rich golden yellow, deep, tender, sweet and of excellent quality. Remains tender and sweet for a long time after it reaches full size. ½pt. 20 cts., pt. 35 cts., qt. 60 cts., pk. \$3.50, bus. \$13.00.
- Late Mammoth.** ★ 100 days. Noted for its exceptionally large ears, which are often 12 inches long. Ears are well filled with 14 or more rows of deep, white narrow kernels. ½pt. 20 cts., pt. 35 cts., qt. 60 cts., pk. \$3.50, bus. \$13.00.
- Stowell's Evergreen.** ★ 100 days. The ears are 8 to 10 inches long with 16 or 18 rows of very deep, white sweet kernels. It remains tender and sweet for a long time. Pkt. 10 cts., ½pt. 20 cts., pt. 35 cts., qt. 60 cts., pk. \$3.50, bus. \$13.00.

Hybrid Sweet Corn

- Hybrid varieties can be depended on to produce crops of better quality and larger yields. They are extremely uniform in ear characteristics and in maturity and are resistant to disease.
- Carmelcross.** 80 days. Fine 8-inch ears with 10 to 14 rows of deep yellow kernels of super quality. Wonderfully sweet. ½pt. 30 cts., pt. 50 cts., qt. 90 cts., pk. \$5.75, bus. \$21.00.
- Golden Cross Bantam.** ★ 88 days. Ears 10 to 14-rowed, 7½ to 8 inches long, and of excellent quality. Kernels light yellow, medium in width and depth. ½pt. 30 cts., pt. 50 cts., qt. 90 cts., pk. \$5.75, bus. \$21.00.
- Golden Evergreen Hybrid.** ★ 95 days. Kernels golden yellow, medium wide and deep, sweet and of fine quality. Ears average about 10 inches long, 14 or 16-rowed. ½pt. 30 cts., pt. 50 cts., qt. 90 cts., pk. \$5.75, bus. \$21.00.
- Ioana.** 87 days. Very productive and highly resistant to wilt. Ears 7 to 8 inches, 12 to 14-rowed, well filled with light yellow kernels. Excellent for home-gardens. ½pt. 30 cts., pt. 50 cts., qt. 90 cts., pk. \$5.75, bus. \$21.00.
- Lincoln.** ★ 85 days. Ears large, 12 to 16-rowed and of good quality. Kernels bright golden and narrow. Desirable for both home and market use. ½pt. 35 cts., pt. 60 cts., qt. \$1.10, pk. \$7.00.
- Marcross C 13.6.** ★ 74 days. An outstanding early variety. Large, thick ears and very uniform. Kernels golden yellow and of good quality. ½pt. 30 cts., pt. 50 cts., qt. 90 cts., pk. \$5.75, bus. \$21.00.
- Marcross P 39.** 85 days. A very productive main-crop variety. Kernels a golden yellow. Characters about the same as Golden Cross Bantam but slightly shorter ear. ½pt. 30 cts., pt. 50 cts., qt. 90 cts., pk. \$5.75, bus. \$21.00.
- Spancross C 13.4.** 72 days. An early golden yellow variety of good quality and yield. Ears slender, 10 to 14-rowed and well filled, uniform and attractive. ½pt. 35 cts., pt. 60 cts., qt. \$1.10, pk. \$7.00.
- Stowell's Evergreen Hybrid.** 95 days. The leading white hybrid variety. Ears extra-large, often 9 inches long, with 14 to 18 rows of deep, narrow, white kernels of fine texture and flavor. ½pt. 40 cts., pt. 75 cts., qt. \$1.25, pk. \$8.00.
- Whipcross.** 90 days. Ears 7 to 8 inches long with 14 or 16 rows well filled with dark yellow kernels. ½pt. 35 cts., pt. 60 cts., qt. \$1.10, pk. \$7.00.

NOTE: One pint of Corn weighs about ¾ pound, one quart about 1½ pounds, and one bushel about 48 pounds.

CUCUMBERS

For an extra-early crop, start indoors or in a frame about April 1, sowing the seed in paper pots or dirt-bands and transplant to the garden the latter part of May, disturbing the roots as little as possible. Sow the main crop directly in the garden late in May, and, for a continuous supply, make additional sowings every two weeks up to the middle or latter part of July. Prepare hills 4 to 6 feet apart, digging up the soil to a depth of a foot or more and mixing in plenty of manure or compost. Leave the soil in the hills loose and a little higher than the general level of the garden. Sow eight to ten seeds in each hill and thin out all but the strongest three or four plants. Do not disturb the vines after they have started to spread. If the striped beetles interfere with the development of the young plants, spray them with Nicotine Pyrox or dust with Rotenone Dust. See insecticide pages.

An ounce of seed will plant about fifty hills; 2 pounds of seed will be required for an acre

- A and C.** ★ 68 days. Fruits deep green color, slightly tapered at neck and moderately pointed, 8 to 9 inches long; white spined. Especially recommended for market-gardeners. Pkt. 10 cts., oz. 35 cts., $\frac{1}{4}$ lb. \$1.00, lb. \$3.00.
- Black Diamond.** 60 days. The earliest White Spine Cucumber. Fruits dark green, 7 to 8 inches long, perfectly smooth, of handsome appearance. Pkt. 10 cts., oz. 30 cts., $\frac{1}{4}$ lb. 85 cts., lb. \$2.50.
- Cool and Crisp.** 60 days. Fruits about 8 inches long, thick at the middle but tapering off at the ends; light green in color; quality good. Pkt. 10 cts., oz. 25 cts., $\frac{1}{4}$ lb. 65 cts., lb. \$2.00.
- Davis Perfect.** ★ 62 days. A dependable producer of very long, slender fruits which are rich dark green color and of finest quality. It holds its deep green color for a long time. Very popular with home-gardeners. Pkt. 10 cts., oz. 30 cts., $\frac{1}{4}$ lb. 85 cts., lb. \$2.50.
- Early Fortune.** 62 days. Long, slender fruits, deep green in color and exceedingly uniform in size and shape, with crisp, firm flesh and few seeds. Early. Pkt. 10 cts., oz. 30 cts., $\frac{1}{4}$ lb. 85 cts., lb. \$2.50.
- Evergreen White Spine.** 66 days. Fruits 10 to 12 inches long, dark green in color, smooth, and of splendid quality. Good for late crop. Pkt. 10 cts., oz. 30 cts., $\frac{1}{4}$ lb. 85 cts., lb. \$2.50.
- Fordhook Famous.** 65 days. The fruits are of giant size, often 15 inches long, thick through and slightly tapered at the ends, dark green in color and with crisp, solid flesh and few seeds. Pkt. 10 cts., oz. 25 cts., $\frac{1}{4}$ lb. 65 cts., lb. \$2.00.
- Improved Early White Spine.** ★ 60 days. Extra early and prolific. Produces medium-sized, light green fruits of fine quality for slicing or pickles. A popular variety because of its quality and productiveness. Pkt. 10 cts., oz. 30 cts., $\frac{1}{4}$ lb. 85 cts., lb. \$2.50.

Japanese Climbing. 65 days. A good Cucumber for the small garden as the vines can be trained on fence or trellis; in fact, it requires some sort of support. Fruits long and thick, crisp, tender and of fine quality. Pkt. 10 cts., oz. 35 cts., $\frac{1}{4}$ lb. \$1.00, lb. \$3.00.

Klondike. 65 days. Unusual dark green color which it holds for a long time even under the hottest sun. Fruits of good size and shape. Pkt. 10 cts., oz. 25 cts., $\frac{1}{4}$ lb. 65 cts., lb. \$2.00.

Long Green Turkey. ★ 70 days. Very productive. Fruits 12 to 14 inches long, straight and slender, slightly warted, dark green with crisp white flesh. Desirable for home-gardens because of its slicing qualities. Pkt. 10 cts., oz. 35 cts., $\frac{1}{4}$ lb. \$1.00, lb. \$3.00.

Longfellow. ★ 70 days. Fruits 12 to 15 inches long, dark green, uniform, straight, and attractive, holds color and crispness well after being picked. Not as heavy a bearer as some varieties but this is overcome by the quality, attractiveness and size of the fruit. Pkt. 10 cts., oz. 30 cts., $\frac{1}{4}$ lb. 85 cts., lb. \$2.50.

Straight-8. ★ 65 days. The Cucumbers are straight, 8 to 10 inches long, smooth, and deep green in color. The flesh is crisp, white, and of fine quality. A heavy yielder and one of the leading varieties for market-gardeners. Pkt. 10 cts., oz. 35 cts., $\frac{1}{4}$ lb. \$1.00, lb. \$3.00.

Pickling Varieties

Jersey Pickling. ★ 62 days. The fruits are slender and tapering, growing 6 inches long, medium green in color. Extremely prolific. A standard pickling variety for many years. Pkt. 10 cts., oz. 25 cts., $\frac{1}{4}$ lb. 65 cts., lb. \$2.00.

Green Prolific. 58 days. Also known as Boston Pickling. For small pickles. Produces short, thick, bright green fruits, smooth and symmetrical. Pkt. 10 cts., oz. 25 cts., $\frac{1}{4}$ lb. 65 cts., lb. \$2.00.

Heinz Pickle. 60 days. A dependable plant that bears excellent crops of well-formed fruits when other varieties fail. The Cucumbers are blunt at both ends, dark green, and get large when mature. Pkt. 10 cts., oz. 25 cts., $\frac{1}{4}$ lb. 65 cts., lb. \$2.00.

National Pickling. ★ 55 days. A high-yielding variety especially bred for pickling in the small sizes. Fruits deep green, straight, symmetrical, blunt-ended, but not chunky. Pack without waste space. Makes firm, crisp pickles. The leading variety with market-gardeners. Pkt. 10 cts., oz. 30 cts., $\frac{1}{4}$ lb. 85 cts., lb. \$2.50.

West India Gherkin, or Bur. 60 days. Not a true pickle but used for pickling. The vines are luxuriant, bearing quantities of small, nearly round fruits, light green and covered with spines. Pkt. 10 cts., oz. 30 cts., $\frac{1}{4}$ lb. 85 cts., lb. \$2.50.

CORN SALAD

A hardy, quick-growing plant, popular as a substitute for lettuce in late fall and early winter. Sow the seed early in the fall in shallow drills, and give plenty of water. Late plants, covered with a light mulch of straw or leaves, will be suitable for use in early spring.

An ounce of seed sows about 100 feet of drill

Large-seeded. Pkt. 10 cts., $\frac{1}{2}$ oz. 25 cts., oz. 45 cts., $\frac{1}{4}$ lb. \$1.25, lb. \$4.00.

CRESS

(For peppery salads and garnishes)

Fine-Curled Pepper Grass. Sow the seed any time from early spring on. It need not be grown in rows and requires no thinning. The leaves can be cut several times before the plants begin to form seed. Make sowings every week or ten days, a small patch at a time, for a continuous supply. Pkt. 10 cts., oz. 60 cts., $\frac{1}{4}$ lb. \$1.75, lb. \$6.00.

Water Cress. (True.) Grows in damp places. Sow the seed in shallow water along the bank of a stream. No further care is required after sowing. Sold out and none to offer.

CARDOON

Grown somewhat like celery and served like asparagus. Large, fleshy plants used as a winter vegetable. The blanched stalks and ribs of the inner leaves are tender and of a fine flavor when cooked. Pkt. 10 cts., $\frac{1}{2}$ oz. 60 cts., oz. \$1.00, $\frac{1}{4}$ lb. \$3.00, lb. \$10.00.

COLLARDS

Georgia, or Southern. Non-heading form of the cabbage family. Largely grown for "greens" in the southern states. Sow outdoors in the spring and give the plants plenty of room to develop. Pkt. 10 cts., oz. 15 cts., $\frac{1}{4}$ lb. 30 cts., lb. 90 cts.

POP-CORN

Golden Queen. Large golden yellow kernels. Pops pure white. Lb. 30 cts., 2 lbs. 55 cts.

White Rice. The most popular sort for general use. Productive; popping quality excellent. Lb. 30 cts., 2 lbs. 55 cts.

★ WHEN IN DOUBT, ORDER THE STAR VARIETIES

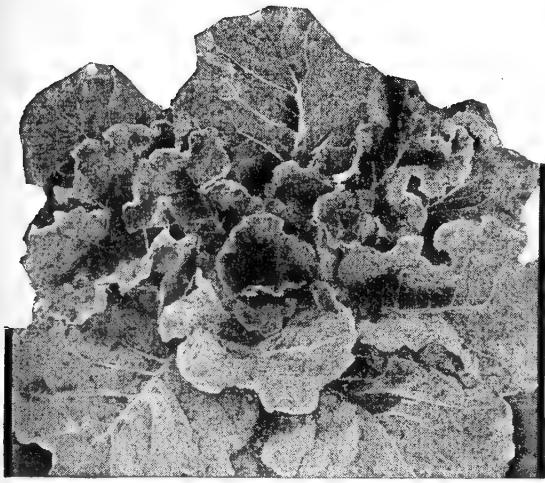

Collards, Georgia or Southern
Pkt. 10 cts., oz. 15 cts.



Corn Salad, Large-seeded. Pkt. 10 cts., 1/2oz. 25 cts.

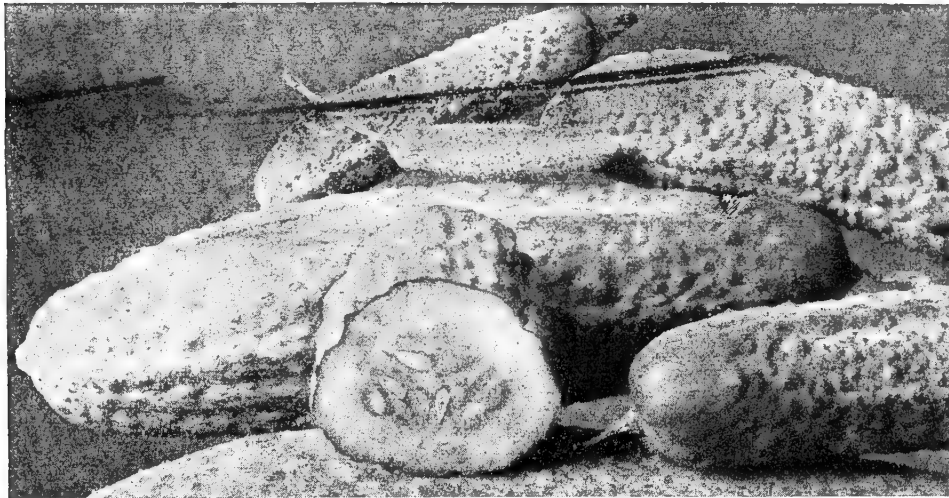

Cucumber, National Pickling. Pkt. 10 cts., oz. 30 cts.

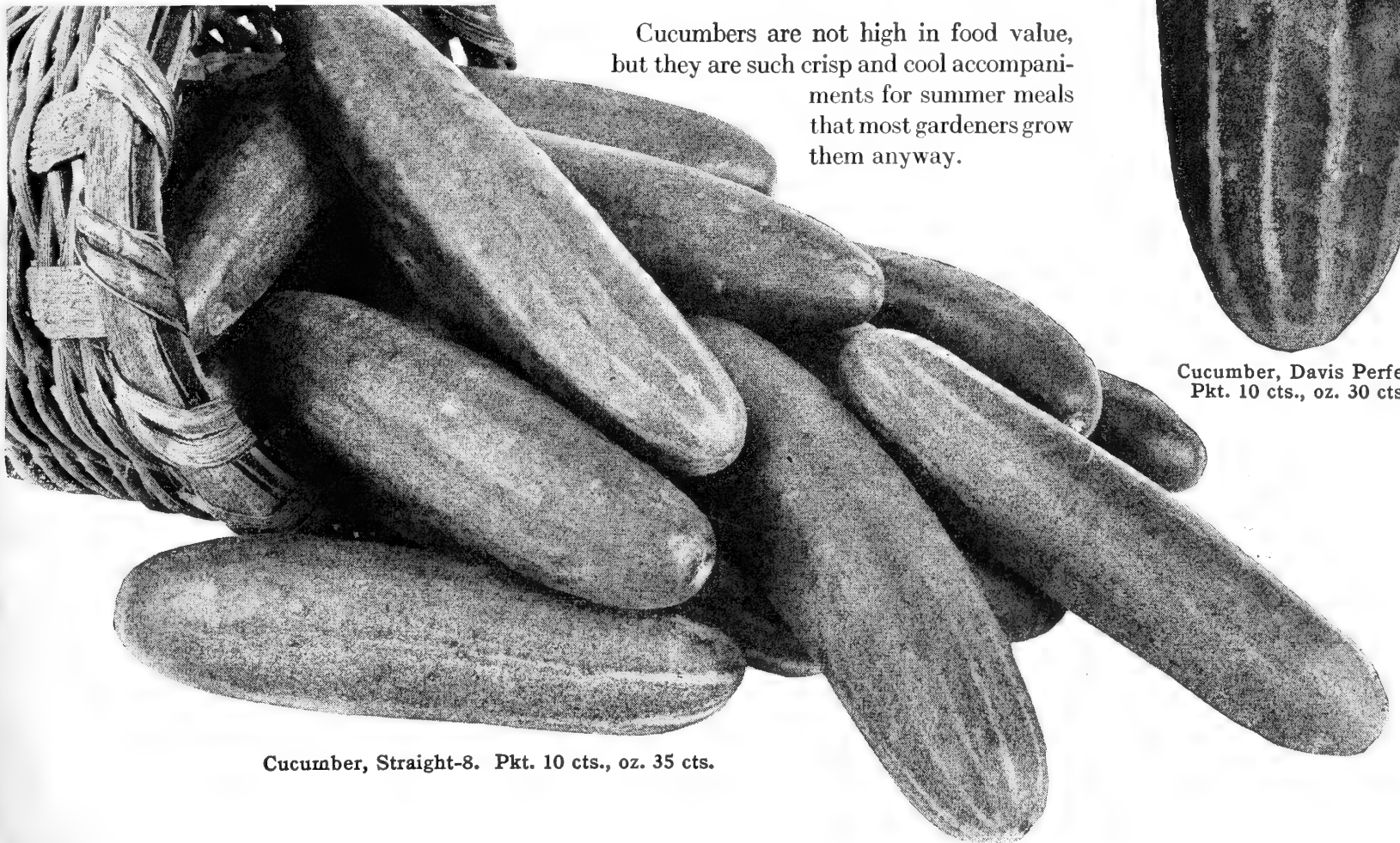

Cucumber, Straight-8. Pkt. 10 cts., oz. 35 cts.

Cucumbers are not high in food value, but they are such crisp and cool accompaniments for summer meals that most gardeners grow them anyway.

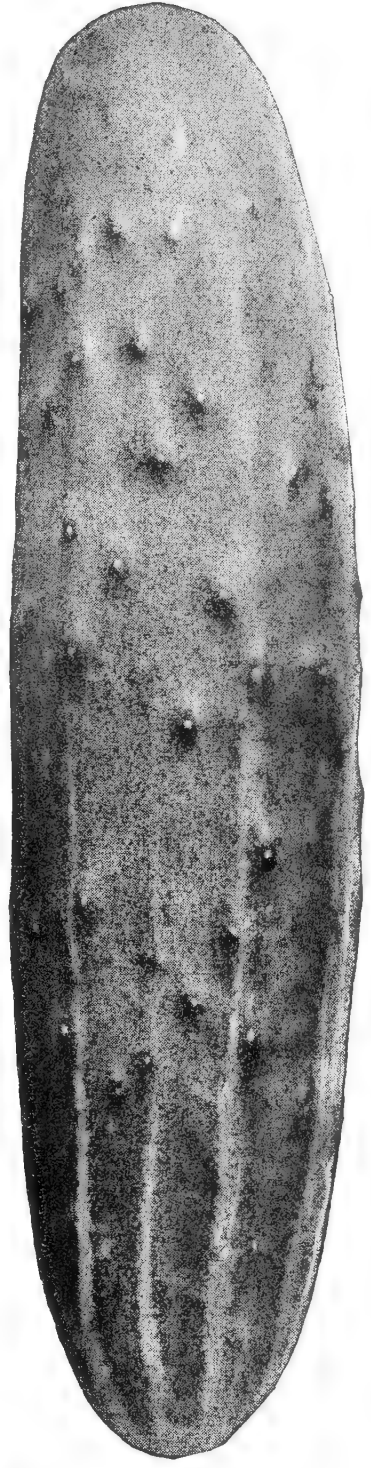

Cucumber, Davis Perfect
Pkt. 10 cts., oz. 30 cts.

EGGPLANT

Start the seed in March, in hotbeds or boxes indoors. Push the seedlings along with plenty of light, heat, and moisture, and when they are about 3 inches high, transplant them to 3 to 4-inch paper pots or dirt-bands. Set out in the garden about June 1, spacing 2 to 2½ feet apart each way. Disturb the roots as little as possible in transplanting, and water freely. Days to maturity are from the time the plants are set in the garden. Allow about 50 days to produce the plants from seed.

An ounce of seed will produce about 2,000 plants

Black Beauty. ★ 80 days. Fruits are of enormous size, smooth, purplish black, and of fine quality. Very prolific and the leading variety for both home and market-gardeners. Pkt. 10 cts., oz. 60 cts., ¼lb. \$1.75, lb. \$6.00.

New Hampshire Hybrid. 75 days. Pear-shaped fruit of dark purple. Very early and a heavy producer. For home and market. Pkt. 10 cts., oz. 60 cts., ¼lb. \$1.75, lb. \$6.00.

New York Improved Spineless. 85 days. Large, smooth, dark purple fruits of good quality, six to eight fruits to the plant. Free from spines and of excellent quality. Pkt. 10 cts., oz. 60 cts., ¼lb. \$1.75, lb. \$6.00.

ENDIVE

Sow the seed any time from early April to the end of July. Plant in shallow drills, about 15 inches apart, and thin the plants to stand 10 to 12 inches apart in the rows. When full grown, tie the tips of the outer leaves together over the center of the plant to blanch the heart, which will take about a week's time.

An ounce of seed will sow 300 feet of row; 3 pounds will sow an acre

Full Heart. ★ 90 days. An improved strain of Broad-leaved with larger leaf and broader, more compact head. Partially self-blanching. Very good quality. Pkt. 10 cts., oz. 25 cts., ¼lb. 65 cts., lb. \$2.00.

Broad-leaved (Escarolle). 90 days. The leaves are broad and quite thick and heavy, slightly twisted and scalloped. Medium green in color. Pkt. 10 cts., oz. 25 cts., ¼lb. 65 cts., lb. \$2.00.

Florida Deep Heart. 90 days. An improved strain with large, broad, thick leaf of upright growth. Blanching easily and of good quality. Pkt. 10 cts., oz. 25 cts., ¼lb. 65 cts., lb. \$2.00.

Green Curled. ★ 90 days. The plants are large and handsome, with finely cut and fringed, dark green leaves. Blanching easily to clear white. Good fall variety. Pkt. 10 cts., oz. 25 cts., ¼lb. 65 cts., lb. \$2.00.

Large Curled Pancalier. 90 days. A vigorous grower with thick curled leaves and midribs tinged with rose. Pkt. 10 cts., oz. 25 cts., ¼lb. 65 cts., lb. \$2.00.

White Curled. 90 days. Foliage is a little finer than the Green Curled and the inner leaves become creamy white without blanching. Pkt. 10 cts., oz. 25 cts., ¼lb. 65 cts., lb. \$2.00.

DANDELION

If the leaves are tied together, the center of the plant will blanch as white and clear as endive. Sow the seed early in shallow drills, in rich soil, and thin the plants to stand about 1 foot apart. If desired for early spring use, the seed may be sown later and the plants covered lightly over winter.

An ounce of seed will sow about 300 feet of drill

Improved French. Pkt. 20 cts., oz. \$1.00, ¼lb. \$3.00, lb. \$10.00

HORSE RADISH ROOTS

Maliner Kren. The largest and most vigorous variety. Plant in early spring in rich, moist soil. Will produce a good crop in one season. Roots, 50 cts. per doz., \$2.25 per 100, \$15.00 per 1,000.

★ WHEN IN DOUBT, ORDER THE STAR VARIETIES

HERBS

Grandmother's garden always had a little patch of herbs and, doubtless, much of the savoriness of grandmother's cooking as well as the effectiveness of her home remedies was derived from her store of "yarbs." Most of the commoner herbs are perennials, although they last but a few seasons in ordinary situations. Any odd corner will do, provided it is sunny and the soil not too hard or poor. Sow seed in early spring, thinning out as needed.

Anise. The seeds are used for flavoring candy and pastries, and the leaves for garnishing and adding to salads. Pkt. 10 cts., ½oz. 30 cts., oz. 50 cts., ¼lb. \$1.50.

Balm. The lemon-scented leaves are used for making a medicinal tea, as well as for salads and flavoring vinegar and wines. Pkt. 15 cts., ½oz. 50 cts., oz. 90 cts., ¼lb. \$2.50.

Basil, Sweet. A highly aromatic herb whose leaves and tops are used for seasonings and, in a limited way, in salads. Pkt. 10 cts., ½oz. 30 cts., oz. 50 cts.

Basil, Sweet, Small-Leaf. An annual whose small leaves are valued for flavoring soups, etc. Pkt. 10 cts., ½oz. 30 cts., oz. 50 cts.

Borage. An annual plant that is used freely by bee-keepers. Pkt. 10 cts., ½oz. 40 cts., oz. 75 cts., ¼lb. \$2.00.

Caraway. The seeds of this plant are used for culinary purposes, in confectionery and also in medicines. Pkt. 10 cts., ½oz. 30 cts., oz. 50 cts., ¼lb. \$1.50.

Chives. Used as a substitute for onions in soups and salads. Pkt. 25 cts., ½oz. \$1.25, oz. \$2.00.

Chervil, Curled. Leaves of Chervil very much resemble those of parsley and are used in a similar way. Pkt. 10 cts., ½oz. 30 cts., oz. 50 cts., ¼lb. \$1.50.

Coriander. An annual whose seeds are strongly aromatic. Used in cooking and candy making. Pkt. 10 cts., ½oz. 40 cts., oz. 75 cts., ¼lb. \$2.00.

Dill. An annual plant, seeds of which are used as a seasoning and also in the preparation of Dill pickles. The leaves are used for garnishing and in making vinegar. Pkt. 10 cts., oz. 30 cts., ¼lb. 90 cts., lb. \$2.50.

Fennel, Florence. A very delicious salad vegetable. It can be served like celery or boiled. Pkt. 10 cts., ½oz. 30 cts., oz. 50 cts., ¼lb. \$1.50.

Fennel, Sweet. The leaves are finely cut and are used for garnishing. Pkt. 10 cts., ½oz. 30 cts., oz. 50 cts.

Horehound. Chiefly used for medicinal purposes, as it has strong tonic properties. Pkt. 10 cts., ½oz. 40 cts., oz. 75 cts.

Lavender. Dried flowers impart a pleasing odor to the contents of linen-chests. Pkt. 15 cts., ½oz. 60 cts., oz. \$1.00.

Marjoram, Sweet. Pleasingly fragrant leaves of particular value as a seasoning and in salads. Pkt. 10 cts., ½oz. 60 cts., oz. \$1.00, ¼lb. \$3.00.

Peppermint. A perennial used for flavoring and for its pungent oil. Sold out.

Rue. A medicinal plant of extremely pungent taste. Pkt. 10 cts., ½oz. 60 cts., oz. \$1.00.

Saffron. Cultivated for medicinal purposes. Pkt. 10 cts., ½oz. 75 cts., oz. \$1.25, ¼lb. \$4.00.

Sage. An old familiar herb with a pungent odor. The dried leaves are commonly used to flavor stuffings and sauces. Pkt. 25 cts., ½oz. \$1.50, oz. \$2.50.

Savory, Summer. Dried foliage used for flavoring during the winter months. Pkt. 10 cts., ½oz. 45 cts., oz. 75 cts., ¼lb. \$2.50.

Tansy. A 3-foot perennial with strongly scented yellow flowers. Used for seasoning and as a meat preservative. Pkt. 15 cts., ½oz. 85 cts., oz. \$1.50.

Tarragon. A perennial used for flavoring vinegar and salads. 2 ft. Sold out.

Thyme. The leaves and young branches are used for seasoning. Pkt. 10 cts., ½oz. 50 cts., oz. 90 cts., ¼lb. \$2.50.

Wormwood. Has medicinal qualities. Pkt. 25 cts., ½oz. \$1.25, oz. \$2.00.

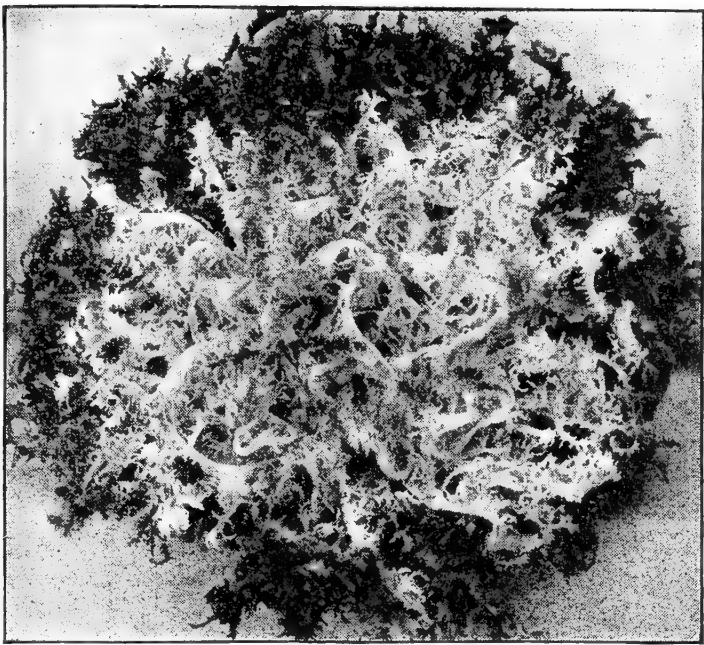

Endive, Green Curled. Pkt. 10 cts., oz. 25 cts.

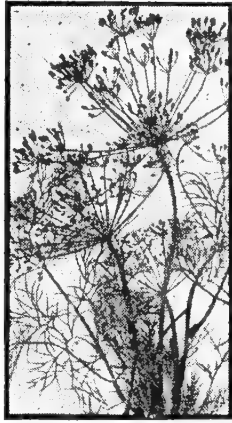

Dill. Pkt. 10 cts.

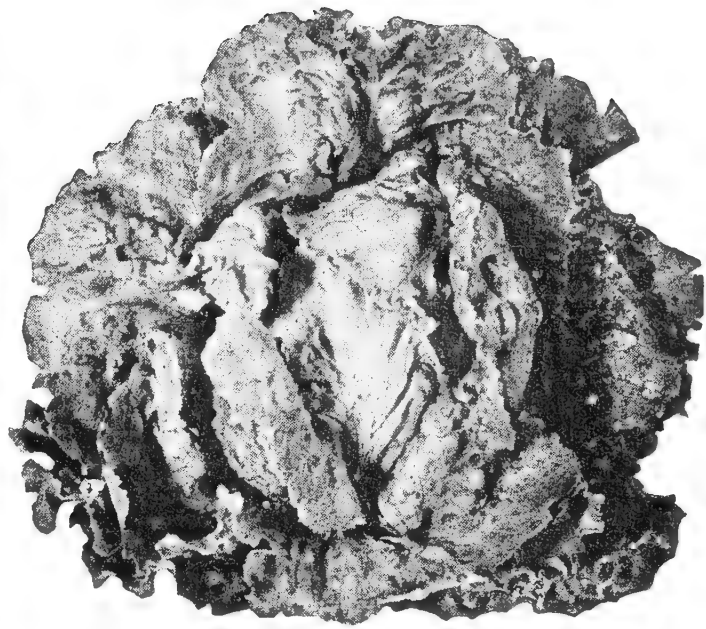

Lettuce, New York or Wonderful. Pkt. 10 cts., oz. 40 cts.

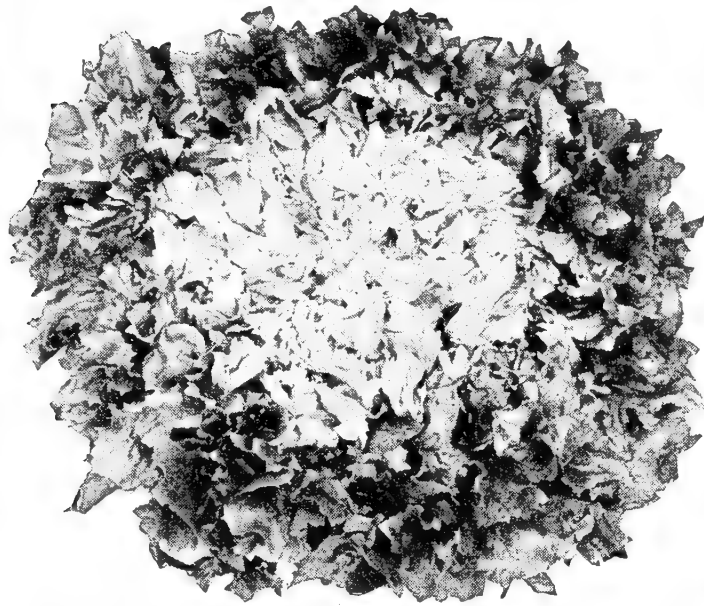

Endive, Broad-leaved (Escarolle). Pkt. 10 cts., oz. 25 cts.

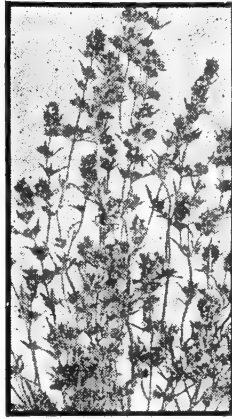

Sweet Marjoram
Pkt. 10 cts.



Eggplant, Black Beauty. Pkt. 10 cts., oz. 60 cts.



Sage. Pkt. 25 cts.

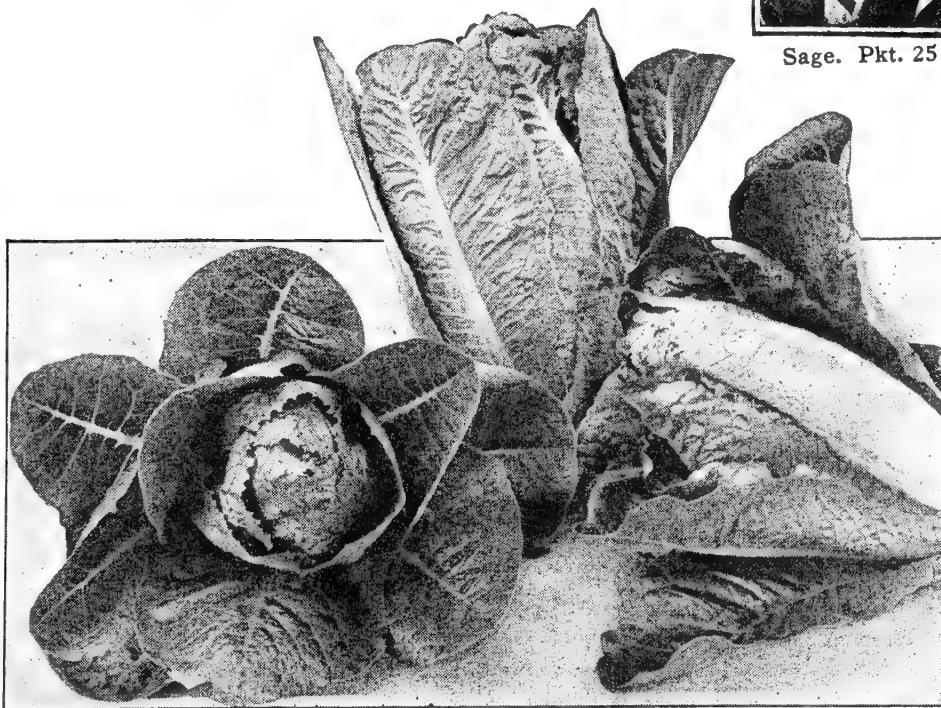

Lettuce, Dark Green Cos. Pkt. 10 cts., oz. 30 cts.

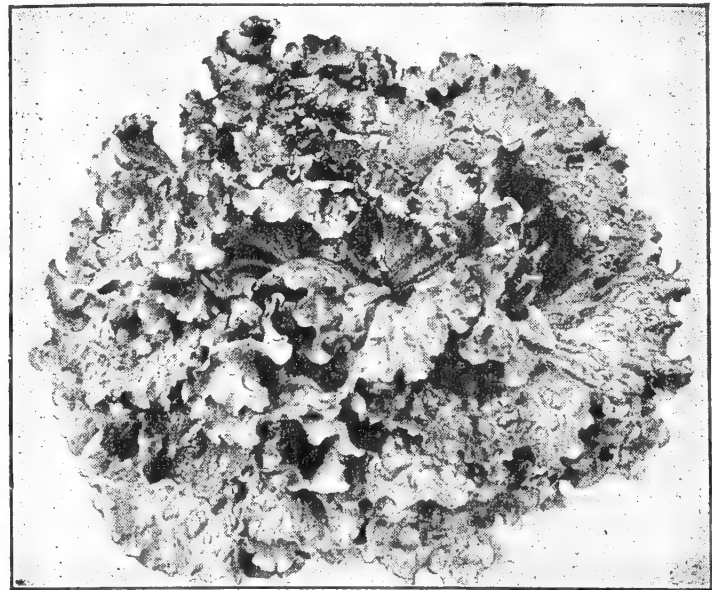

Lettuce, Black-seeded Simpson. Pkt. 10 cts., oz. 25 cts.

LETTUCE

By starting seed for the first crop in the hotbed or in flats in the house in February or early March, and by carefully choosing varieties which will furnish a succession of crops in the garden, one may have fresh Lettuce for the table from May to November. Make the first sowing outdoors as soon as the ground can be put in shape, making the seed-bed as fine and mellow as possible. Scatter the seed in shallow furrows at least 15 inches apart, and cover lightly. As soon as the plants are big enough, thin them out to stand 3 to 4 inches apart. Then, when they begin to touch each other in the row, use alternate plants, leaving them 8 to 12 inches apart. Cultivate constantly.

An ounce of seed will sow about 300 feet of row

Loose-leaved Varieties

All varieties of loose-leaved Lettuce are edible in about 45 days.

Black-Seeded Simpson. ★ The plants are large, with broad, beautifully crumpled and frilled leaves, light green in color and of good quality. Stands more heat than others of its class. The most popular variety of loose-leaved Lettuce. Pkt. 10 cts., oz. 25 cts., $\frac{1}{4}$ lb. 75 cts., lb. \$2.10.

Chicken. A hardy, tall-growing, non-heading, dark green variety, producing the largest amount of leaves of any Lettuce. Grown exclusively for feeding to poultry and rabbits. Pkt. 10 cts., oz. 25 cts., $\frac{1}{4}$ lb. 75 cts., lb. \$2.10.

Deer Tongue. A distinctly different Lettuce, crisp and tender. May be planted early and stands hot weather well. Pkt. 15 cts., $\frac{1}{2}$ oz. 30 cts., oz. 50 cts., $\frac{1}{4}$ lb. \$1.25, lb. \$4.00.

Early Curled Simpson. Early, medium large, with yellowish green, crumpled and frilled leaves of excellent quality. Pkt. 10 cts., oz. 25 cts., $\frac{1}{4}$ lb. 75 cts., lb. \$2.10.

Grand Rapids. ★ An extremely early variety good for first spring crop in the garden; also grown in greenhouses for winter market. The plants are large, with bright green, intensely curled and crinkled leaves. Stands the heat well in summer. Pkt. 10 cts., oz. 25 cts., $\frac{1}{4}$ lb. 75 cts., lb. \$2.10.

Prizehead. A quick-growing sort with broad, crumpled, frilled, green leaves, tinged red on outside; crisp and sweet. Pkt. 10 cts., oz. 25 cts., $\frac{1}{4}$ lb. 75 cts., lb. \$2.10.

Heading Varieties

All heading varieties of Lettuce mature in 65 to 75 days.

Big Boston. ★ Large, compact heads of rich buttery quality, but will not ordinarily "head up" for the home-gardener unless it is started indoors or sown very early so as to mature before warm weather. Pkt. 10 cts., oz. 25 cts., $\frac{1}{4}$ lb. 75 cts., lb. \$2.10.

KALE (Borecole)

Makes delicious "greens" for fall and early spring use. Sow seed in the open from early spring until the middle of August. The early sowings give fully grown plants, whereas the later sowings will furnish delicious small tender leaves. Sow seed in shallow drills and thin or transplant to stand about 2 feet apart each way. Late plantings can be sown broadcast like spinach. Light frost will not injure Kale but will improve its flavor.

*An ounce will sow about 300 feet of drill;
4 pounds will sow an acre*

Dwarf Blue Scotch. ★ 55 days. Dwarf, compact plants with finely curled bluish green leaves, retaining their color after cutting. One of the handsomest varieties. Pkt. 10 cts., oz. 40 cts., $\frac{1}{4}$ lb. \$1.25, lb. \$4.00.

Dwarf Curled Scotch. ★ 55 days. Extremely hardy and fine for early winter use. Grows 15 to 18 inches high and produces a heavy crop of beautifully curled, bright green leaves, tender and of fine flavor. Pkt. 10 cts., oz. 40 cts., $\frac{1}{4}$ lb. \$1.25, lb. \$4.00.

Dwarf German. 60 days. Low and compact in growth, with finely curled, yellowish green leaves. Nice for garnishing. Pkt. 10 cts., oz. 20 cts., $\frac{1}{4}$ lb. 65 cts., lb. \$2.00.

HEADING VARIETIES, continued

Crisp-As-Ice. Makes a solid head of medium size. Unusually hardy, it is desirable for fall sowing. The outer leaves are dark bronzy green, crumpled and heavy in texture; inner leaves creamy yellow, crisp and sweet. Pkt. 10 cts., oz. 30 cts., $\frac{1}{4}$ lb. 90 cts., lb. \$2.60.

Great Lakes. ★ An excellent new variety becoming popular. The crisp cream-white head of the Iceberg type develops easily. Slow in bolting to seed. Pkt. 15 cts., oz. 60 cts., $\frac{1}{4}$ lb. \$1.75, lb. \$6.00.

Iceberg. Outer leaves light green, tinged with brown at the edges; inner leaves white, crisp, firm and sweet. Choice home-garden variety. Pkt. 10 cts., oz. 30 cts., $\frac{1}{4}$ lb. 90 cts., lb. \$2.60.

Imperial 44. ★ An Iceberg type particularly adapted to eastern conditions. The heads are solid, uniform, very crisp and of the finest quality. Recommended for early and late planting. Pkt. 10 cts., oz. 40 cts., $\frac{1}{4}$ lb. \$1.10, lb. \$3.40.

Improved Hanson. ★ The plants are of good size; outer leaves medium green, somewhat crinkled; inner leaves blanched white. Because of its quality, a favorite for home-gardens. Pkt. 10 cts., oz. 25 cts., $\frac{1}{4}$ lb. 75 cts., lb. \$2.10.

May King. An early Butterhead Lettuce of superb quality, and an ideal sort for early spring planting. Solid heads of medium size, with light green outer leaves and rich golden yellow hearts. Pkt. 10 cts., oz. 25 cts., $\frac{1}{4}$ lb. 75 cts., lb. \$2.10.

New York, or Wonderful. ★ It grows slowly but makes a fine heavy head. The outer leaves are dark green; the inner blanch to creamy white. The most popular variety of Iceberg-type Lettuce. Pkt. 10 cts., oz. 40 cts., $\frac{1}{4}$ lb. \$1.10, lb. \$3.40.

Oak Leaf. A distinct type of Lettuce. It forms a close center with rather loose outer leaves. The leaves are deeply lobed. It is the one variety that is excellent late in the summer when other varieties are bitter. Pkt. 10 cts., oz. 40 cts., $\frac{1}{4}$ lb. \$1.10, lb. \$3.40.

White Boston. ★ The best variety of the Butterhead type. Our strain is very uniform in size and a high percentage of the plants will form solid heads. Head of medium size and compact, with creamy yellow heart. Excellent quality. Pkt. 10 cts., oz. 25 cts., $\frac{1}{4}$ lb. 75 cts., lb. \$2.10.

Dark Green Cos, or Romaine. Leaves green and when fully blanched are white with only the faintest tinge of green. Pkt. 10 cts., oz. 30 cts., $\frac{1}{4}$ lb. 90 cts., lb. \$2.60.

White Paris Cos, or Romaine. The best and most widely grown Romaine Lettuce. Heads medium large, medium green, upright, firm, exceptionally crisp, tender and of excellent flavor. Pkt. 10 cts., oz. 30 cts., $\frac{1}{4}$ lb. 90 cts., lb. \$2.60.

KALE, continued

Tall Curled Scotch. 80 days. Like the dwarf form but grows about 2½ feet high. Hardy and particularly good for late planting. Pkt. 10 cts., oz. 40 cts., $\frac{1}{4}$ lb. \$1.25, lb. \$4.00.

KOHLRABI

Sometimes called Turnip-rooted Cabbage. Sow the seed in shallow drills in April, or for extra-early crop start in the hotbed in March. Thin or transplant the plants about 6 inches apart. Kohlrabi grows rapidly and should be used when about half grown, 2 to 2½ inches in diameter. Can be sown up to the middle of July.

An ounce of seed will sow about 250 feet of drill

Purple Vienna. 60 days. A little later and larger than the White Vienna, and a reliable sort. Skin purple; flesh white. Pkt. 10 cts., oz. 70 cts., $\frac{1}{4}$ lb. \$1.75, lb. \$6.00.

White Vienna. ★ 55 days. The quickest growing and most popular kind for table use. Leaves few and small; bulbs of medium size with white skin and flesh, tender and of delicate flavor. Pkt. 10 cts., oz. 60 cts., $\frac{1}{4}$ lb. \$1.50, lb. \$5.00.

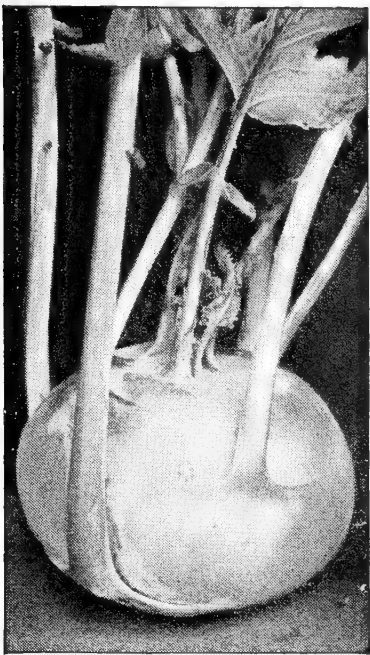

Kohlrabi, White Vienna
Pkt. 10 cts., oz. 60 cts.

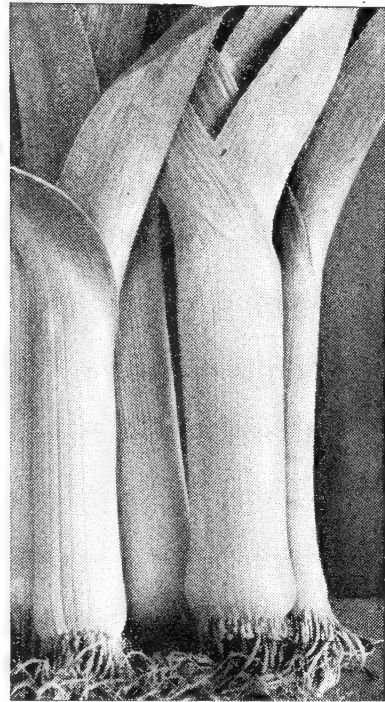

Leek, Large London Flag
Pkt. 10 cts., oz. \$1.00

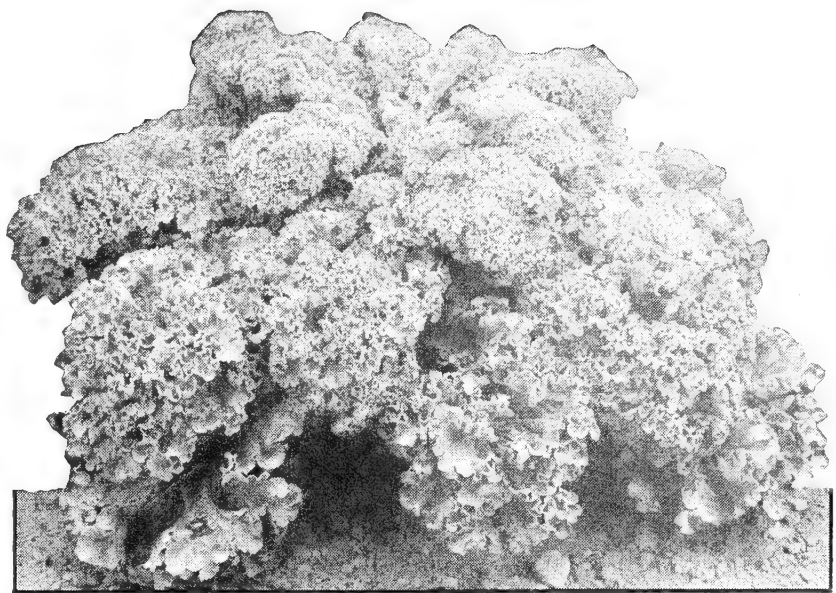

Kale, Dwarf Curled Scotch. Pkt. 10 cts., oz. 40 cts.

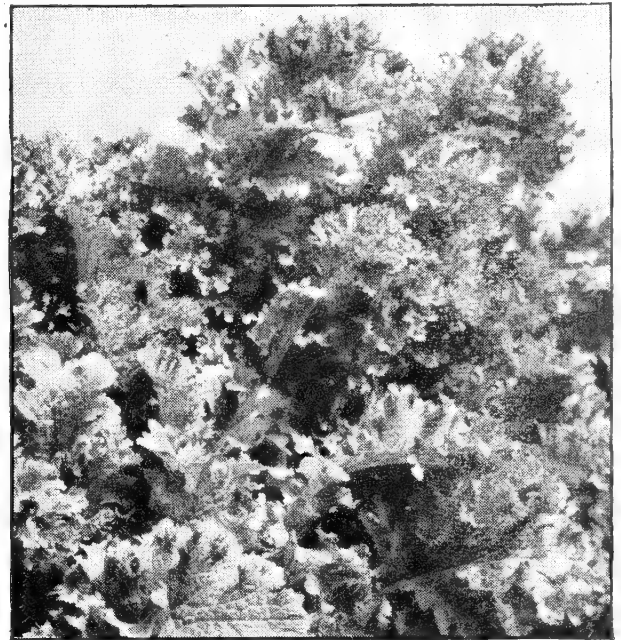

Mustard, Southern Giant. Pkt. 10 cts., oz. 20 cts.

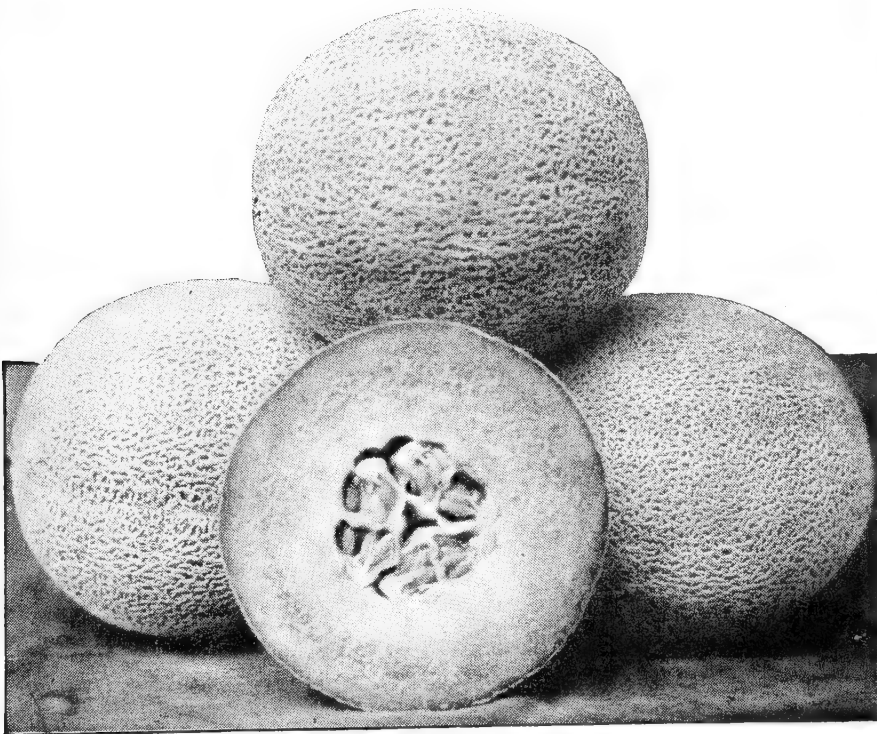

Muskmelon, Tip-Top. Pkt. 10 cts., oz. 30 cts.



Watermelon, Cole's Early. Pkt. 10 cts., oz. 30 cts.

Melons need rich soil, with plenty of warmth and moisture. Watch the vines for the first evidence of beetles and borers, and get rid of them promptly.

On this page are pictured some of the less-common vegetables such as Kale, Kohlrabi, and Mustard. Try some of them this year, and you will probably be delighted with the new flavors that will find their way to your table.

MUSKMELON or Cantaloupe

Sow the seed after the soil has warmed up in hills 5 to 6 feet apart, digging the soil to a depth of a foot and mixing in plenty of manure or fertilizer with the bottom soil. No more than 3 or 4 strong plants should be left in each hill. Since Muskmelons require a long growing season, it is a good plan to start the seed in a hotbed or box indoors, using dirt bands or pots, and setting them in the garden after the soil has become warm.

*An ounce of seed will plant about 50 hills;
2 to 3 pounds will plant an acre*

- Emerald Gem.** ★ 85 days. An early, prolific melon. The fruits are small, decidedly flattened and deeply ribbed; the skin is dark green and the flesh is unusually deep and solid, bright orange in color clear to the rind, and of remarkably fine quality. Pkt. 10 cts., oz. 30 cts., $\frac{1}{4}$ lb. 90 cts., lb. \$2.50.
- Extra-Early Hackensack.** 80 days. A large, round melon, slightly flattened at the ends. The skin is ribbed and netted; the flesh is thick, light green in color, and of good quality. Pkt. 10 cts., oz. 30 cts., $\frac{1}{4}$ lb. 90 cts., lb. \$2.50.
- Honey Dew.** 110 days. The fruits are very large, with thin, hard, smooth, pale green rind and thick green flesh which remains firm and crisp for a long time. Juicy and tender. Pkt. 10 cts., oz. 30 cts., $\frac{1}{4}$ lb. 90 cts., lb. \$2.50.
- Honey Rock.** 85 days. Skin gray-green, covered with coarse, sparse netting. Flesh orange-salmon, thick and juicy, with very fine flavor. Good for home use and local early markets. Pkt. 10 cts., oz. 30 cts., $\frac{1}{4}$ lb. 90 cts., lb. \$2.50.
- Imperial.** ★ 90 days. Netted yellow fruit with orange flesh. A fine cropper, even in hot, dry seasons. Pkt. 10 cts., oz. 30 cts., $\frac{1}{4}$ lb. 90 cts., lb. \$2.50.
- Osage, or Miller's Cream.** 95 days. The fruits are large, slightly elongated, with lightly netted dark green skin and thick, firm, orange flesh. Pkt. 10 cts., oz. 30 cts., $\frac{1}{4}$ lb. 90 cts., lb. \$2.50.
- Rocky Ford.** 90 days. The fruits are medium small, oval in shape, slightly ribbed and covered with a coarse, gray netting. Flesh green and remarkably sweet. Pkt. 10 cts., oz. 30 cts., $\frac{1}{4}$ lb. 90 cts., lb. \$2.50.
- Tip-Top.** ★ 90 days. Probably the most dependable melon for this region. Medium early and productive, bearing large, round, ribbed and netted fruits with thick, sweet, orange flesh. Pkt. 10 cts., oz. 30 cts., $\frac{1}{4}$ lb. 90 cts., lb. \$2.50.

MUSHROOMS

Anyone who has a cellar or dark room where the temperature can be kept at from 50 to 60 degrees, can grow Mushrooms of surpassing tenderness and flavor. We furnish special printed directions free with each order, or for 25 cents we will send, post-paid, an illustrated booklet on Mushroom culture which gives the latest improved methods of growing as well as full instructions for preparing for market and recipes for cooking.

Spore-Culture Mushroom Spawn, Northern-Grown. Pure and vigorous. In the form of compressed bricks, each of which will plant about 16 square feet of bed. Brick 30 cts., 10 bricks \$2.50, 50 bricks \$11.00, 100 bricks \$20.00.

LEEK

Sow the seed in shallow drills early in the spring and when the plants are about 5 inches high, transplant them 6 to 8 inches apart in rows, and cultivate frequently. At the time of transplanting it is a good plan to cut back the plants a third. The stalks are best when blanched by drawing earth up around them.

An ounce of seed will sow 300 feet of row; 2 pounds will produce sufficient plants for an acre

- Large London Flag.** 140 days. The hardiest and most generally cultivated variety. Broad stalks of strong flavor. Pkt. 10 cts., oz. \$1.00, $\frac{1}{4}$ lb. \$3.00.
- Musselburg.** 140 days. Grows larger and is milder in flavor than the preceding. Pkt. 10 cts., oz. \$1.00, $\frac{1}{4}$ lb. \$3.00.

WATERMELON

In general, Watermelons require the same treatment as muskmelons. It is not safe to sow seed outdoors until the last of May. Prepare the hills carefully, spacing them 6 to 8 feet apart and digging them deep, mixing in each a couple of shovelfuls of manure or a little commercial fertilizer. Thin to 2 or 3 plants in each hill. Water freely in dry spells.

An ounce will plant about 20 hills; 4 pounds will plant an acre

- Cole's Early.** ★ 80 days. The best variety for home-gardens. Fruits medium size, almost round, with alternate dark and light green stripes. Flesh rich red, firm, fine grained and of good sweet flavor. Seeds black. Pkt. 10 cts., oz. 30 cts., $\frac{1}{4}$ lb. 90 cts., lb. \$2.50.
- Kleckley Sweets.** 85 days. The fruits grow about 20 inches long and 10 inches in diameter, with thin green rind and bright scarlet flesh. White seeds. Pkt. 10 cts., oz. 30 cts., $\frac{1}{4}$ lb. 90 cts., lb. \$2.50.
- Sweetheart.** ★ 85 days. Large, heavy fruits, nearly round, with a thick, mottled light and dark green rind and firm red flesh. Black seeds. Pkt. 10 cts., oz. 30 cts., $\frac{1}{4}$ lb. 90 cts., lb. \$2.50.
- Tom Watson.** 95 days. Fruits 24 inches long and about 12 inches in diameter, with a thin, tough, mottled green rind and rich red flesh of good quality. Brown seeds. Pkt. 10 cts., oz. 30 cts., $\frac{1}{4}$ lb. 90 cts., lb. \$2.50.

CITRON

A form of melon used only for preserving, as the flesh is not edible when raw, Citrons are grown in the same way as watermelons; they are prolific and not so particular as to soil. Home-preserved Citron is much superior to that handled in the stores in a dried or candied form.

- Green-Seeded.** 90 days. Also called "Colorado Preserving." Fruits large and oblong. Pkt. 10 cts., oz. 30 cts., $\frac{1}{4}$ lb. 90 cts., lb. \$2.50.
- Red-Seeded.** 90 days. Flesh firm, with comparatively few seeds. Fruits round. Pkt. 10 cts., oz. 30 cts., $\frac{1}{4}$ lb. 90 cts., lb. \$2.50.

MUSTARD

The young, tender leaves make piquant salads and are delicious as well as healthful as boiled "greens." Seed can be sown any time from April 1 to the middle of August. Sow thinly in shallow drills 12 to 15 inches apart. Mustard can also be forced in frames or in the greenhouse during winter.

An ounce of seed will sow about 200 feet of drill

- Fordhook Fancy.** 40 days. A dark green variety of robust growth, more curled on the edges than any other sort. Pkt. 10 cts., oz. 20 cts., $\frac{1}{4}$ lb. 50 cts., lb. \$1.50.
- Southern Giant Long Standing.** ★ 35 days. The plants grow 2 to 3 feet high, producing quantities of broad, succulent leaves which are handsomely curled and fringed. Pkt. 10 cts., oz. 20 cts., $\frac{1}{4}$ lb. 50 cts., lb. \$1.50.
- Spinach Mustard, Tendergreen.** 30 days. A rapid-growing Mustard with narrow, thick, dark green leaves. Has a delicious spinach flavor. Pkt. 10 cts., oz. 25 cts., $\frac{1}{4}$ lb. 75 cts., lb. \$2.00.

OKRA or GUMBO

Grown for its seed-pods, which are pickled when young, before they get tough, and used for flavoring and thickening soups. Sow late in May, in drills about an inch deep and 2½ feet apart and thin out to about 1 foot apart in the row. For an early crop, start seed in the hotbed late in March.

*One ounce will sow about 100 feet of row;
8 pounds will sow an acre*

- White Velvet.** 65 days. An early, low-growing variety. Pods of medium size; light green. Very productive. Pkt. 10 cts., oz. 20 cts., $\frac{1}{4}$ lb. 50 cts., lb. \$1.50.
- Long Green.** ★ 60 days. A tall-growing variety which bears quantities of deep green pods that average 6 to 7 inches in length at the edible stage. Slow to ripen. Pkt. 10 cts., oz. 20 cts., $\frac{1}{4}$ lb. 50 cts., lb. \$1.50.

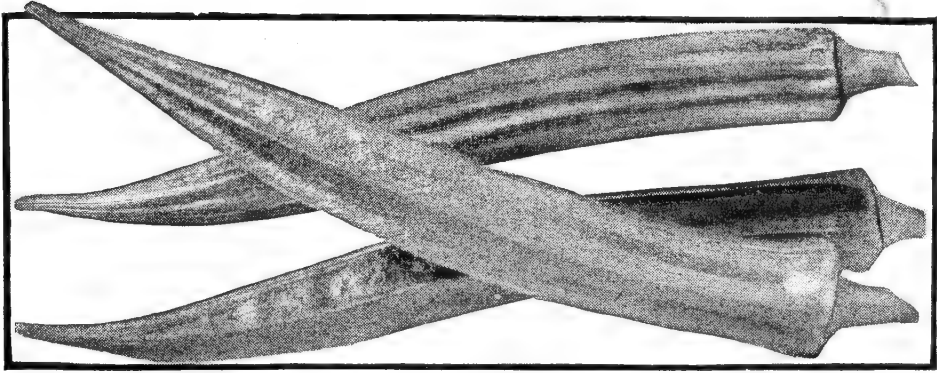

Okra, Long Green. Pkt. 10 cts., oz. 20 cts.

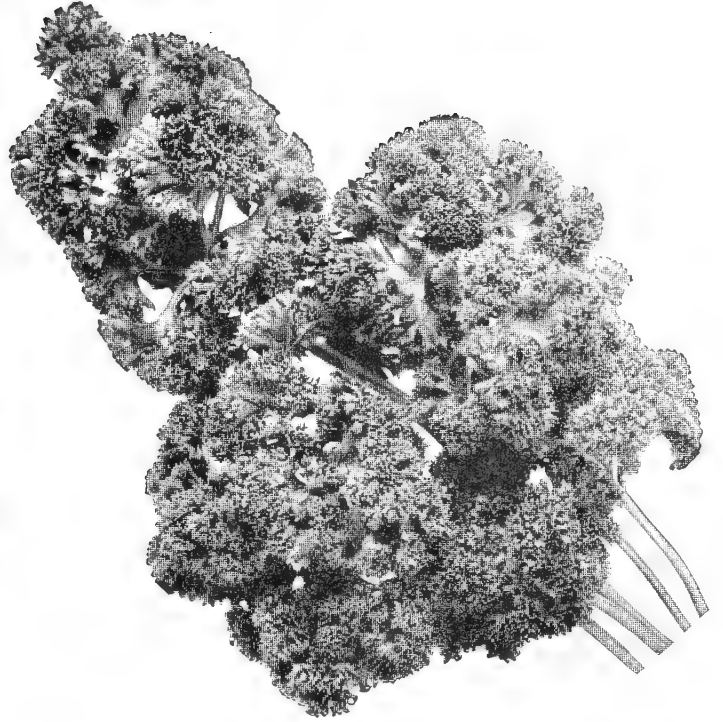

Parsley, Double-Curled. Pkt. 10 cts., oz. 20 cts.

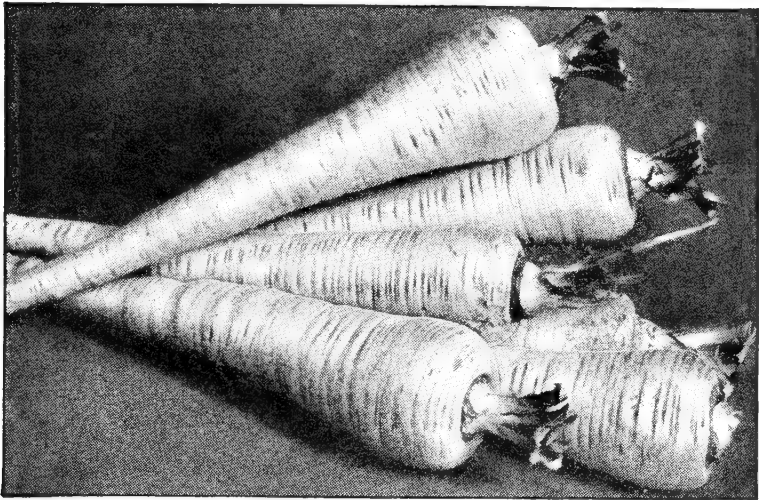

Parsnip, Hollow Crown. Pkt. 10 cts., oz. 30 cts.



Pepper, Ruby King
Pkt. 10 cts., oz. 50 cts.



Hot Pepper, Hungarian Wax.
Pkt. 10 cts., oz. 60 cts.

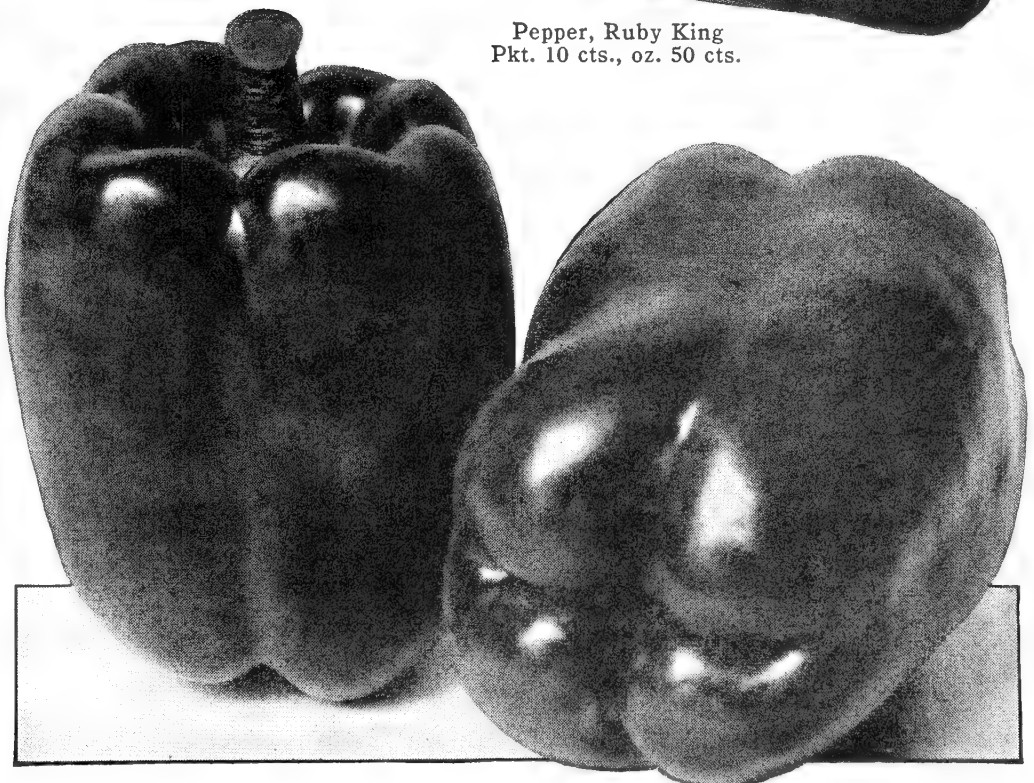

Pepper, California Wonder. Pkt. 10 cts., oz. 60 cts.

ONION

Green Onions from Seed. Easily grown from seed sown in fine, well-prepared soil early in the spring. Sow thinly in rows 12 to 15 inches apart, covering the seed with about $\frac{1}{2}$ inch of soil. Onions are ready in about 50 days. An ounce of seed will sow about 100 feet of row; 5 to 6 pounds will sow an acre.

Dry Onions from Seed. If possible sow seed in hotbeds in March, thinning the seedlings enough to prevent crowding. Transplant to the open ground in April or May, spacing them 3 to 4 inches apart, depending on variety. If hotbeds are not available sow the seed in the garden as early as the soil can be put in shape. Thin promptly. An ounce of seed will sow about 300 feet of row; 2 to 3 pounds will sow an acre.

Days given are from sowing of seed to dry Onion stage.

Ailsa Craig. 105 days. One of the largest Onions grown. Globular in form, with pale straw-colored skin and crisp white flesh very mild in flavor. A heavy cropper and an excellent keeper. Pkt. 10 cts., oz. 60 cts., $\frac{1}{4}$ lb. \$1.90, lb. \$6.50.

Crystal White Wax. 95 days. A mild and sweet Onion of the Bermuda type. Excellent for slicing. Bulbs medium sized and flat; flesh white, sweet and of delicious flavor. Not suitable for long storage. Pkt. 10 cts., oz. 80 cts., $\frac{1}{4}$ lb. \$2.50, lb. \$9.00.

Large Red Wethersfield. 110 days. Standard late variety of splendid keeping quality. Bulbs large, flat but rather deep; skin deep purplish red; strong white flesh with faint pink flush. Excellent for sets and for mature bulbs. Pkt. 10 cts., oz. 60 cts., $\frac{1}{4}$ lb. \$1.90, lb. \$6.50.

Prizetaker. ★ 105 days. A fine selection of the giant Spanish Onion, which will, if planted early, produce bulbs 4 inches or more in diameter. It makes handsome, uniform, globe-shaped bulbs with thin, pale yellow skin and mild, sweet, white flesh. Pkt. 10 cts., oz. 80 cts., $\frac{1}{4}$ lb. \$2.50, lb. \$9.00.

Southport White Globe. ★ 115 days. The largest and handsomest of the white Onions, also the best keeper. The bulbs are uniformly globe-shaped with pure white skin and fine-grained, solid flesh of sweet, mild flavor. One of the best varieties for green Onions. Pkt. 10 cts., oz. 80 cts., $\frac{1}{4}$ lb. \$2.50, lb. \$9.00.

White Bunching. ★ A very quick-growing Onion of mild flavor. Grown almost exclusively for an early bunching or "green" Onion. Skin and flesh pure white. Pkt. 10 cts., oz. 70 cts., $\frac{1}{4}$ lb. \$2.35, lb. \$8.50.

White Portugal, or Silverskin. 100 days. Most widely used white Onion for sets, pickling Onions, mature bulbs and for green Onions from seed. Bulbs of medium size, flat but fairly deep, pure white; flesh fine grained, firm and hard. A splendid keeper. Pkt. 10 cts., oz. 70 cts., $\frac{1}{4}$ lb. \$2.35, lb. \$8.50.

White Sweet Spanish. 110 days. Similar to Yellow Sweet Spanish in type, but having clear white skin and white flesh. Pkt. 10 cts., oz. 80 cts., $\frac{1}{4}$ lb. \$2.50, lb. \$9.00.

Yellow Globe Danvers. ★ 110 days. Productive and medium early; bulbs large, solid, nearly globe-shaped, with yellowish brown skin and pure white flesh, crisp, sweet, and mild in flavor. Pkt. 10 cts., oz. 60 cts., $\frac{1}{4}$ lb. \$1.90, lb. \$6.50.

Yellow Sweet Spanish. 110 days. A popular large yellow variety of Spanish origin. Globular in shape with golden yellow skin and clear white flesh. Very sweet and of pleasing flavor, firm and mild. Good winter keeper. Pkt. 10 cts., oz. 80 cts., $\frac{1}{4}$ lb. \$2.50, lb. \$9.00.

ONION SETS

By starting with sets, small green Onions can be produced very early and large dry Onions can be harvested sometime during August. Plant sets as soon as the ground is ready in rows about 15 inches apart and 1 inch deep. For green Onions, space them 1 inch apart in the row, and for dry Onions about 3 inches apart.

Our sets are grown especially for us in the best Onion-set-growing section of the country. They are well cured, dried and carefully machine cleaned, graded and sized on the most modern equipment.

Yellow or White. Qt. 50 cts., postpaid.

Garlic Sets or Bulbs. Qt. 50 cts.

Prices on larger quantities quoted on request

BERMUDA ONION PLANTS

These are field-grown plants, grown out-of-doors in the South during the winter, and are perfectly hardy and ready to plant early. Mature Onions are flat and of medium size; flesh mild, sweet and of delicious flavor, making an excellent slicing Onion.

Available April 1 to May 10

1 bunch (75 to 100 plants) 35 cts., 10 bunches \$3.00, postpaid.

PARSLEY

Used mostly for seasoning and garnishing. Seed should be sown as early in the spring as possible, as it is very slow to germinate. Sow thinly in rows about 15 inches apart and cover about $\frac{1}{2}$ inch. Use the outer branches and it will continue to produce all season.

An ounce of seed will sow 200 feet of row; 8 pounds will sow an acre

Champion Moss Curled. Leaves attractively crimped and curled. Pkt. 10 cts., oz. 20 cts., $\frac{1}{4}$ lb. 50 cts., lb. \$1.50.

Double-Curled. ★ Unusually rich dark green foliage, tightly curled. Ideally suited for home and market-gardens. Pkt. 10 cts., oz. 20 cts., $\frac{1}{4}$ lb. 50 cts., lb. \$1.50.

Hamburg Parsnip-rooted. ★ Grown for its roots, which resemble parsnips and are highly flavored; useful in soups and stews. Can be stored for winter use. Sow in rows 15 inches apart and thin to stand 3 to 4 inches apart in the row. Pkt. 10 cts., oz. 20 cts., $\frac{1}{4}$ lb. 50 cts., lb. \$1.50.

Paramount. An improved strain of curled Parsley with unusually dark green, densely curled foliage. Pkt. 10 cts., oz. 20 cts., $\frac{1}{4}$ lb. 50 cts., lb. \$1.50.

Plain or Single. ★ The leaves are deeply cut but not curled. Stronger flavor than the curled, and preferred for soups, etc. Pkt. 10 cts., oz. 20 cts., $\frac{1}{4}$ lb. 50 cts., lb. \$1.50.

PARSNIP

Parsnips must be sown in the early spring as soon as the ground can be prepared. Sow the seed $\frac{1}{2}$ inch deep in rows about 15 inches apart, and when the plants are well up thin to 3 to 4 inches apart. The roots mature in the fall and, being perfectly hardy, may be left in the ground all winter, to be dug as needed. Their flavor is improved by freezing.

An ounce of seed will sow 200 feet of drill; 5 pounds will sow an acre

All-American. The white roots are large and broad-shouldered, of medium length and fine texture, with small core. Very free from side rootlets. An excellent variety. Pkt. 10 cts., oz. 30 cts., $\frac{1}{4}$ lb. 90 cts., lb. \$2.50.

Hollow Crown. ★ Long, smooth roots with white skin and fine-grained flesh. Most commonly used of all varieties. Pkt. 10 cts., oz. 30 cts., $\frac{1}{4}$ lb. 90 cts., lb. \$2.50.

The cost of the vegetable seed is such a small part of the total investment made in your garden that it pays to plant the very best. Make your time and labor count by planting Scott seeds.

★ WHEN IN DOUBT, ORDER THE STAR VARIETIES

PEPPER

Peppers require a moderately rich and light soil, a long growing season, and plenty of warmth at all stages. Grow them like egg-plants, starting the seed indoors or in the hotbed in March, transplanting to pots or dirt-bands when the second or third leaf has developed. Set the plants in the garden early in June in rows $2\frac{1}{2}$ to 3 feet apart and spaced 2 feet apart in the row. Days to maturity are figured from the time the plants are set in the garden.

An ounce of seed will produce about 1,500 plants

Sweet Peppers

California Wonder. ★ 75 days. Peppers are of good size, with heavy thick walls, sweet, tender and of excellent flavor. The skin is very smooth, glossy green, turning to bright crimson when ripe. The best all-round sweet Pepper. Pkt. 10 cts., oz. 60 cts., $\frac{1}{4}$ lb. \$1.75, lb. \$6.00.

Calwonder, Early. 67 days. An early strain of California Wonder but fruits slightly smaller. Pkt. 10 cts., oz. 70 cts., $\frac{1}{4}$ lb. \$2.00, lb. \$7.00.

Chinese Giant. 80 days. The largest of all Peppers, often measuring 5 inches in length and diameter. Flesh thick and very mild and sweet; deep red when ripe. Pkt. 10 cts., oz. 60 cts., $\frac{1}{4}$ lb. \$1.75, lb. \$6.00.

Early Giant. 65 days. Large, early variety about 4 inches long by 3 inches through. It is deep green, turning to red, and of sweet flavor. Pkt. 10 cts., oz. 60 cts., $\frac{1}{4}$ lb. \$1.75, lb. \$6.00.

Golden Queen. 80 days. The largest and finest yellow-fruited Pepper. Very heavy, meaty, and strictly mild. Glossy golden yellow skin. Pkt. 10 cts., oz. 60 cts., $\frac{1}{4}$ lb. \$1.75, lb. \$6.00.

King of the North. 65 days. Very early, productive, mild and sweet. Fruits enormous, 5 inches long and 3 inches through; dark green coloring to a bright red earlier than any other large variety. Pkt. 10 cts., oz. 50 cts., $\frac{1}{4}$ lb. \$1.50, lb. \$5.00.

Pimiento. 75 days. Fruits are heart-shaped, smooth, dark green changing to crimson; flesh thick, sweet and mild. Grown for canning whole. Pkt. 10 cts., oz. 60 cts., $\frac{1}{4}$ lb. \$1.75, lb. \$6.00.

Ruby Giant. ★ 75 days. Thick-fleshed and one of the largest of the early sweet Peppers. Deep green, changing to rich red when ripe. Pkt. 10 cts., oz. 50 cts., $\frac{1}{4}$ lb. \$1.50, lb. \$5.00.

Ruby King. 68 days. Early and productive. Dark green turning to bright red at maturity, averaging 4 inches in length and 3 inches in diameter, tapering to a blunt point. The flesh is thick and sweet. Pkt. 10 cts., oz. 50 cts., $\frac{1}{4}$ lb. \$1.50, lb. \$5.00.

Squash or Tomato. 75 days. Flesh thick and mild; shaped like a tomato; 2 to 3 inches in diameter. Glossy green changing to deep red at maturity. Generally used for canning and pickling. Pkt. 10 cts., oz. 60 cts., $\frac{1}{4}$ lb. \$1.75, lb. \$6.00.

World Beater. ★ 75 days. Fruits large, oblong, deep green becoming bright deep red; thick flesh, mild and sweet. Plants very productive. Pkt. 10 cts., oz. 50 cts., $\frac{1}{4}$ lb. \$1.50, lb. \$5.00.

Hot Peppers

Anaheim Chili. 80 days. Late, hot variety for canning and drying. Fruits 6 to 8 inches long, 1 inch diameter. Pkt. 10 cts., oz. 50 cts., $\frac{1}{4}$ lb. \$1.50, lb. \$5.00.

Bull Nose. ★ 70 days. Scarlet when mature; medium size, square and blunt-pointed. Generally considered sweet but is sometimes quite hot. Pkt. 10 cts., oz. 50 cts., $\frac{1}{4}$ lb. \$1.50, lb. \$5.00.

Hungarian Wax. ★ 60 days. Fruits about 5 inches long and $1\frac{1}{2}$ inches in diameter at stem end, tapered; waxy yellow and red when ripe. Hot. Desirable for both home-and market-gardeners. Pkt. 10 cts., oz. 60 cts., $\frac{1}{4}$ lb. \$1.75, lb. \$6.00.

Large Red Cherry. 82 days. Fruits erect, round or cherry-shape; very hot. Pkt. 10 cts., oz. 60 cts., $\frac{1}{4}$ lb. \$1.75, lb. \$6.00.

Long Red Cayenne. ★ 70 days. Pods about 6 inches long, slender and pointed, dark green turning to bright scarlet; flesh very hot in taste and pungent in odor. Pkt. 10 cts., oz. 60 cts., $\frac{1}{4}$ lb. \$1.75, lb. \$6.00.

Red Chili. 82 days. Fruits about $2\frac{1}{2}$ inches long, $\frac{3}{8}$ inch in diameter at shoulder, and tapering to point. Light green turning to deep red; thin fleshed. A really hot variety. Used extensively for Pepper sauces, pickling and drying. Pkt. 10 cts., oz. 60 cts., $\frac{1}{4}$ lb. \$1.75, lb. \$6.00.

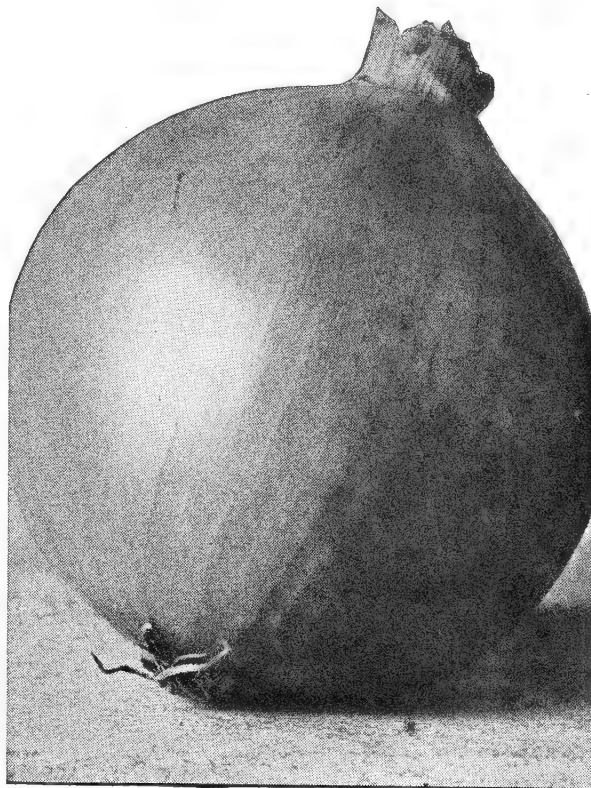

Onion, Yellow Globe Danvers
Pkt. 10 cts., oz. 60 cts.

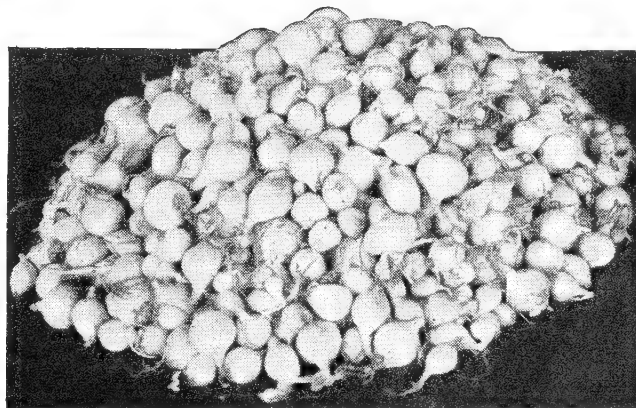

Onion Sets, Yellow or White. Qt. 50 cts., postpaid

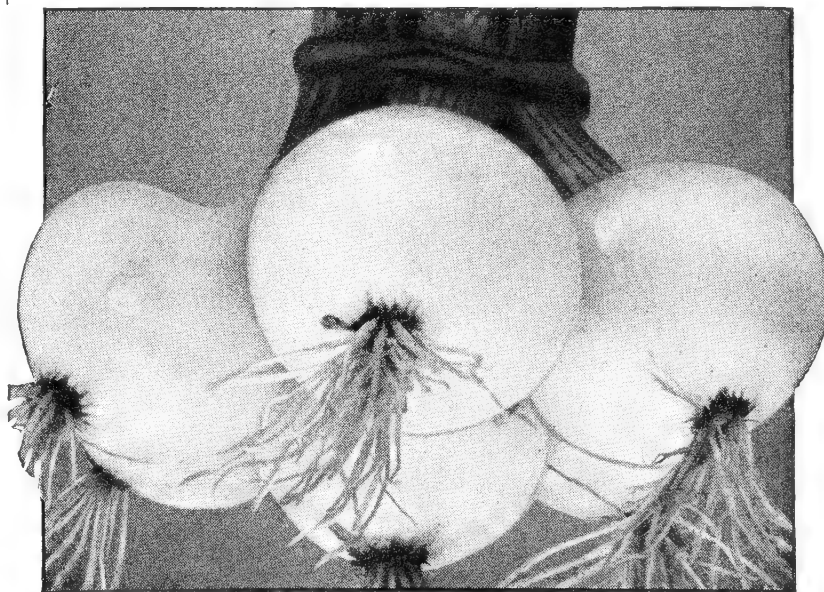

Onion, Southport White Globe in Bunching Stage
Pkt. 10 cts., oz. 80 cts.

GARDEN PEAS

Peas can be sown very early in the spring, the early smooth-seeded varieties even as early as March 1. For the first sowings use the smooth or round-seeded sorts, but after the first of April change to the wrinkled kinds which, although not so hardy, are much superior in quality. Make additional sowings every two weeks up to June 1 for a continuous supply, but arrange to put the later plantings on deep, rich soil where you can conveniently water them during dry weather. Plant dwarf varieties in rows 2 to 2½ feet apart, tall varieties about 3 feet apart. Cover both kinds about 2 inches and thin to stand 3 inches apart in the row. The tall varieties do best for late planting, and while some people prefer to provide supports for them they are really not necessary.

For Increased Yield
Inoculate This Seed
with LEGUME-AID.

A pint of seed will sow 100 feet of row;
1 to 1½ bushels will sow an acre

Early Smooth-Seeded Peas

Alaska. 54 days. A very productive smooth Pea, long in favor with canners and home-gardeners for a first-early variety. About 2 feet tall; pods rather small, ripening all at once; Peas small and of medium quality. ½pt. 25 cts., pt. 40 cts., qt. 75 cts., pk. \$3.40, bus. \$12.00.

Mammoth-Podded Extra Early. 58 days. A very prolific early, smooth-seeded variety valuable for its large pods. Vines medium dark green, 30 inches tall; pods 3 inches long, medium green, with 6 to 7 Peas in each pod. Popular in many home and market-gardens. ½pt. 25 cts., pt. 40 cts., qt. 75 cts., pk. \$3.40, bus. \$12.00.

Market Surprise. 54 days. An extra-early sort, growing about 2½ feet tall. It is about the same season as Alaska, but the pods are larger and Peas of better quality. ½pt. 25 cts., pt. 40 cts., qt. 75 cts., pk. \$3.40, bus. \$12.00.

Early Wrinkled-Seeded Peas

Gradus, or Extra-Early Telephone. 62 days. A grand old standby and a most dependable producer. Vines 3 feet high; pods about 4 inches long, broad and slightly curved, containing 7 to 9 Peas of excellent quality. ½pt. 25 cts., pt. 40 cts., qt. 75 cts., pk. \$3.40, bus. \$12.00.

Laxtonian. ★ 64 days. Also known as Blue Bantam. A dwarf, heavy-yielding variety that bears over a long season. Pods are dark green and contain 7 to 8 large succulent Peas. Unequaled for its combination of extreme earliness, superb quality, and unusual productiveness, and the best all-round variety for both home and market-gardens. Pkt. 10 cts., ½pt. 25 cts., pt. 40 cts., qt. 75 cts., pk. \$3.40, bus. \$12.00.

Laxton's Progress. ★ 62 days. Slightly larger podded than Laxtonian. The Peas are deep green, of excellent flavor, fully wrinkled, and average 9 or 10 to the pod. Grows 18 inches high. Desirable for both home and market-gardens. ½pt. 25 cts., pt. 40 cts., qt. 75 cts., pk. \$3.40, bus. \$12.00.

Little Marvel. ★ 62 days. The vines grow about 18 inches high and bear big crops of 3¼-inch pods, containing large Peas of excellent flavor. It is unsurpassed by any other variety in its class and is the variety we recommend for home-gardens. Pkt. 10 cts., ½pt. 25 cts., pt. 40 cts., qt. 75 cts., pk. \$3.40, bus. \$12.00.

Nott's Excelsior. 60 days. Also known as American Wonder. A dwarf variety, growing about 14 inches tall. Pods are about 3 inches long and well filled with 6 or 7 large, sweet Peas in every pod. A vigorous grower and very prolific. ½pt. 25 cts., pt. 40 cts., qt. 75 cts., pk. \$3.40, bus. \$12.00.

Thomas Laxton. 62 days. Vines grow 3 feet tall and are very prolific. Pods are rich deep green and contain 7 or 8 large, tender Peas of splendid quality. Unsurpassed as an early, all-purpose variety. ½pt. 25 cts., pt. 40 cts., qt. 75 cts., pk. \$3.40, bus. \$12.00.

World's Record. 60 days. Vines about 2½ feet tall and moderately productive. Pods 3¼ inches long, light green and contain 7 to 8 large tender Peas of good quality. ½pt. 25 cts., pt. 40 cts., qt. 75 cts., pk. \$3.40, bus. \$12.00.

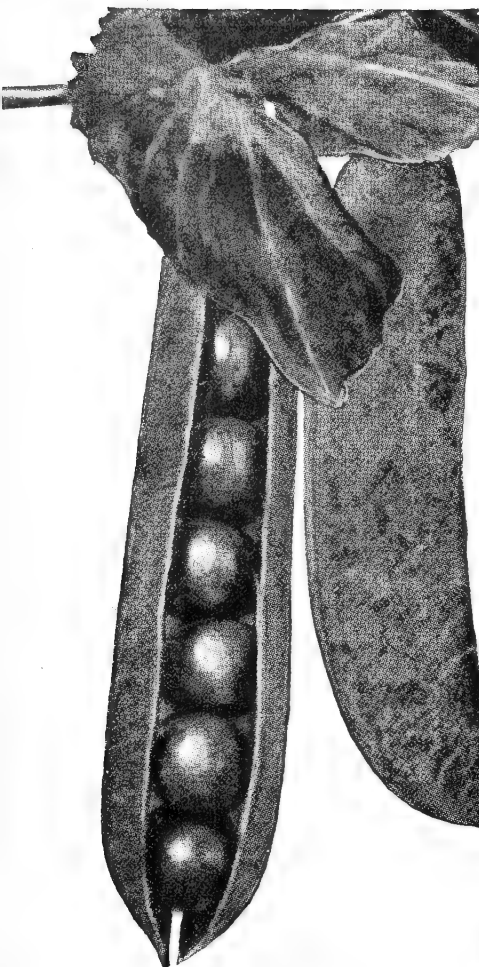

Peas, Laxtonian.
Pkt. 10 cts., ½pt. 25 cts.
pt. 40 cts., qt. 75 cts.

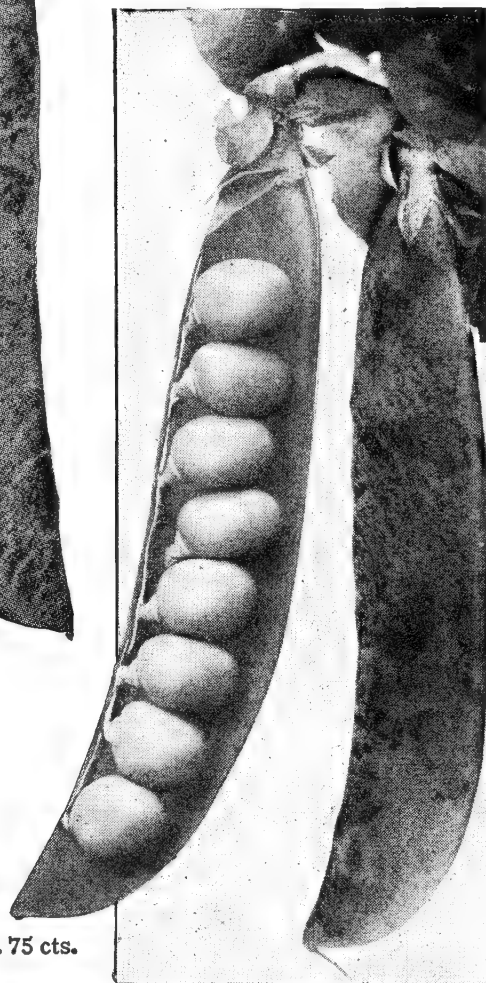

Peas, Potlatch
½pt. 25 cts., pt. 40 cts., qt. 75 cts.

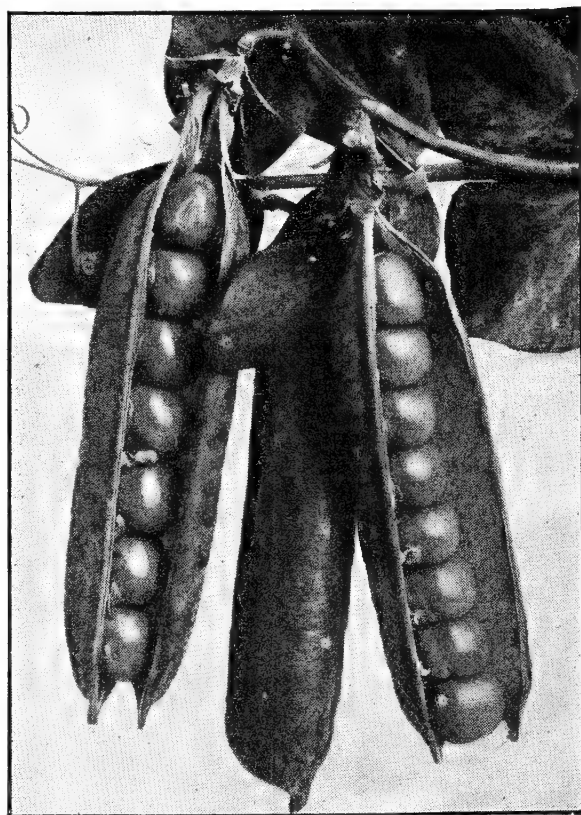

Peas, Little Marvel
Pkt. 10 cts., ½pt. 25 cts., pt. 40 cts., qt. 75 cts.

Main-Crop Varieties

Alderman. ★ 75 days. Vines about 4 feet high, strong and vigorous; leaves and pods rich dark green; productive; quality the finest. Pods are 4½ to 5½ inches long, handsome and well filled with 8 to 10 extra-large Peas. ½pt. 25 cts., pt. 40 cts., qt. 75 cts., pk. \$3.40, bus. \$12.00.

Dwarf Telephone. 77 days. Also known as "Daisy." Grows 2½ feet tall, with 4½-inch pods, containing 7 or 8 Peas of the very best quality. ½pt. 25 cts., pt. 40 cts., qt. 75 cts., pk. \$3.40, bus. \$12.00.

Improved Telephone. 75 days. Grows 4 feet high; pods 4½ inches long, with 8 to 10 extra-large Peas. Bears several pickings. ½pt. 25 cts., pt. 40 cts., qt. 75 cts., pk. \$3.40, bus. \$12.00.

Mammoth-Podded Sugar. 75 days. A tall, late, prolific variety which produces big, broad pods, so tender and sweet that the whole pod can be cooked and served like snap beans. If you have not grown sugar-pod Peas, be sure to try them this year. ½pt. 30 cts., pt. 45 cts., qt. 90 cts., pk. \$3.90, bus. \$14.00.

Potlatch. ★ 80 days. Dwarf growth and extra-fine quality. Vines luxuriant, 2 feet high; pods deep green, 5 inches long and quite broad; Peas large and tender, often 10 to a pod. A superior variety for home- and market-gardens. ½pt. 25 cts., pt. 40 cts., qt. 75 cts., pk. \$3.40, bus. \$12.00.

Wyoming Wonder. 73 days. Vine is dark green and about 28 inches tall. Pods are dark green, 5 to 6 inches long, each one containing 8 to 10 large Peas of unusually fine flavor. Remains sweet and tender a week to 10 days after reaching the picking stage. An excellent market-gardener's variety. ½pt. 25 cts., pt. 45 cts., qt. 75 cts., pk. \$3.40, bus. \$12.00.

NOTE: One pint of Peas weighs about 1 lb. and 1 quart about 2 lbs. One bushel of round-seeded varieties weighs 60 lbs. and 1 bus. wrinkled varieties weighs 56 lbs.

PUMPKIN

The seed should be sown as soon as the ground gets warm, in hills 6 to 8 feet apart, dropping from four to eight seeds in each hill, and thin out to 3 or 4 plants to each hill. Since Pumpkins require a lot of space they are generally grown with corn. Sow after the corn is up.

*One ounce of seed will plant about 25 hills;
4 to 5 pounds will plant an acre*

Connecticut Field. ★ 120 days. Very productive; fruits oblong with bright yellow skin and rather coarse flesh. Usually grown for stock. An old and popular variety. Pkt. 10 cts., oz. 20 cts., ¼lb. 50 cts., lb. \$1.50, 5 lbs. \$7.00.

Kentucky Field. 120 days. A heavy-yielding variety used principally for stock feed. Fruits large, variable in shape, deep orange; flesh deep yellow, coarse, and of good flavor. Pkt. 10 cts., oz. 20 cts., ¼lb. 50 cts., lb. \$1.50, 5 lbs. \$7.00.

King of Mammoths. ★ 120 days. Round, flattened at the ends; skin yellow mottled with orange and deep yellow flesh of fair quality. Grows to an enormous size. Very attractive and a good keeper. Pkt. 10 cts., oz. 25 cts., ¼lb. 75 cts., lb. \$2.00.

Large Cheese. 110 days. Big, flat, uniform Pumpkins with light buff skin and thick yellow flesh, deep rib, hard shell and fair quality. Pkt. 10 cts., oz. 20 cts., ¼lb. 50 cts., lb. \$1.50.

Mammoth Golden Cushaw. 110 days. A large crookneck with golden orange skin and deep, rich yellow flesh of the very finest quality. Pkt. 10 cts., oz. 20 cts., ¼lb. 50 cts., lb. \$1.50.

Small Sugar. ★ 105 days. Small but productive and of splendid quality. Fruits round with bright orange skin and thick, sweet flesh. Never coarse or stringy; a good keeper and the best for pies. Pkt. 10 cts., oz. 20 cts., ¼lb. 50 cts., lb. \$1.50.

Striped Cushaw. 110 days. Crookneck shape; smooth white skin with mottled green stripes; flesh yellow, fine-grained and sweet. Pkt. 10 cts., oz. 20 cts., ¼lb. 50 cts., lb. \$1.50.

Tennessee Sweet Potato. 110 days. Sweet, tender, yellow flesh. One of the extra-good pie Pumpkins. Bell-shaped in form. Pkt. 10 cts., oz. 20 cts., ¼lb. 50 cts., lb. \$1.50.

Winter Luxury. ★ 100 days. Flesh golden russet color, of extra-fine flavor. Pumpkins medium size, with netted skin. Recommended for home-gardens, being good for canning and pie-making. Pkt. 10 cts., oz. 20 cts., ¼lb. 50 cts., lb. \$1.50.

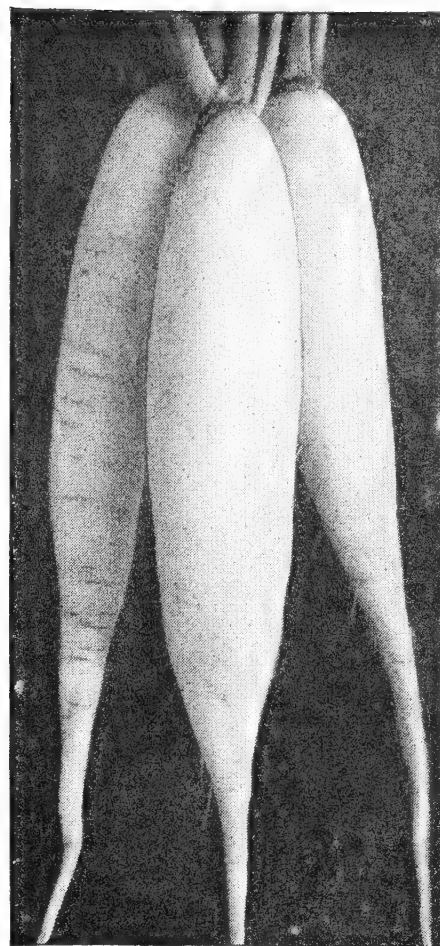

Radish, White Icicle
Pkt. 10 cts., oz. 20 cts.

Such quick-growing crops as Radishes and leaf Lettuce may be grown between rows of vegetables requiring a longer season. By the time the main crop needs the full space allotted to it, the quicker one has already been gathered. Everyone with limited garden space should follow this method.

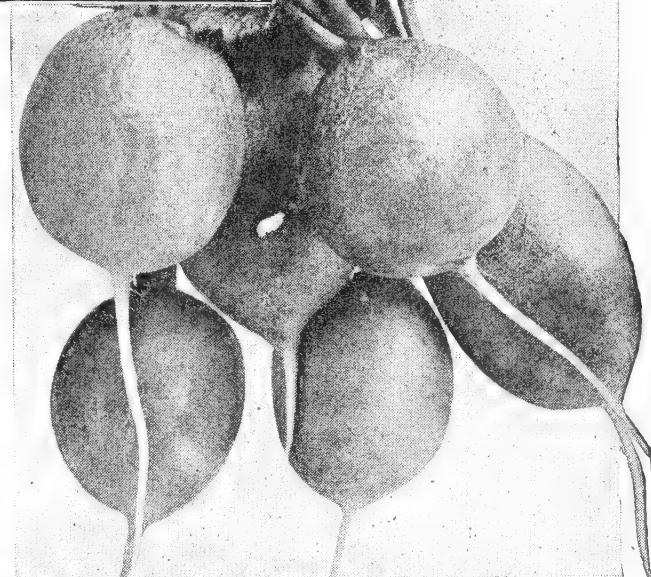

Radish, Early
Scarlet Globe
Pkt. 10 cts.
oz. 20 cts.

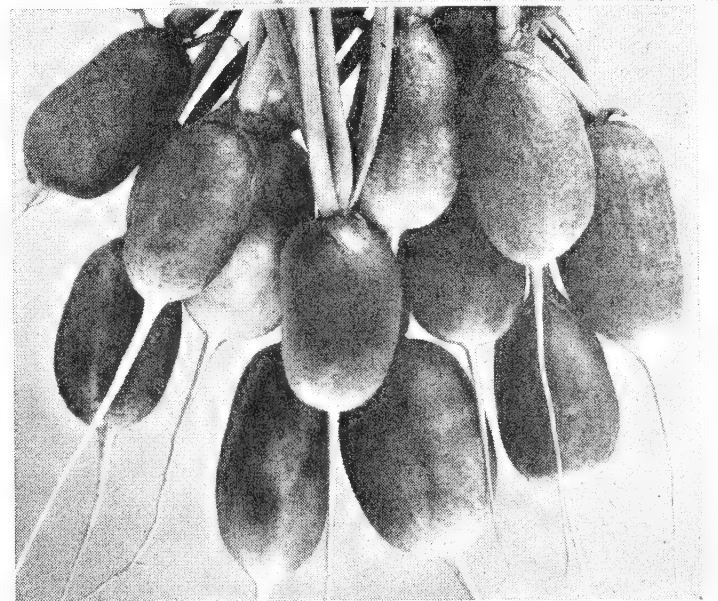

Radish, French Breakfast. Pkt. 10 cts., oz. 20 cts.

RADISHES

Start outdoors as soon as the ground can be put in shape and sow seed of any of the quick-growing round or olive-shaped sorts, not too thick, in drills $\frac{1}{2}$ inch deep and 1 to $1\frac{1}{2}$ feet apart. Thin out the seedlings promptly to stand about an inch apart in the rows. If not thinned out they will only produce tops and not develop a bulb. After putting in seed for the first crop, make additional sowings every ten days to two weeks, but for the later crops, which will ripen in warm weather, use the long varieties.

For late summer and fall use, sow the Summer and Winter Radishes which are larger and slower growing but will, unlike the early round Radishes, thrive in hot weather. The Summer Radishes may be sown any time up to August 1. The big Winter Radishes should be sown late in June to attain full size before frost.

*One ounce of seed will sow about 100 feet of drill;
8 to 10 pounds will sow an acre*

Early Radishes

Cincinnati Market. ★ 35 days. A popular home and market-garden variety. Roots long; skin deep red; flesh clear white, very brittle and mild. Popular for forcing. The best long red early Radish. Pkt. 10 cts., oz. 20 cts., $\frac{1}{4}$ lb. 50 cts., lb. \$1.50.

Crimson Giant. ★ 30 days. The largest of the early, round Radishes. Handsome, deep red, globe-shaped roots. Will retain its crispness longer than any other Radish of its type. Pkt. 10 cts., oz. 20 cts., $\frac{1}{4}$ lb. 50 cts., lb. \$1.50.

Early Scarlet Globe. ★ 25 days. Medium-sized, very uniform, globe-shaped, bright scarlet roots. Flesh white, mild and crisp. The best variety of its kind for home and market-gardens. Pkt. 10 cts., oz. 20 cts., $\frac{1}{4}$ lb. 50 cts., lb. \$1.50.

Early Scarlet Turnip. 25 days. Roots of medium size, round, smooth, bright red; tops small. Pkt. 10 cts., oz. 20 cts., $\frac{1}{4}$ lb. 50 cts., lb. \$1.50.

French Breakfast. 27 days. An oblong or olive-shaped Radish of very fine quality. Bright scarlet skin with clear white tip. The flesh is white, firm, crisp and tender. Pkt. 10 cts., oz. 20 cts., $\frac{1}{4}$ lb. 50 cts., lb. \$1.50.

Iceberg. ★ 35 days. It grows quickly, making handsome, smooth roots 5 to 6 inches long with pure white skin and crisp, mild flesh. Reliable for either spring or summer use. Retains its crispness longer than most other varieties. The best long white Radish. Pkt. 10 cts., oz. 20 cts., $\frac{1}{4}$ lb. 50 cts., lb. \$1.50.

RHUBARB

It is cheapest to start with seed but only a percentage of the plants grown from seed will be worth saving. Sow early in the spring, in drills an inch deep and a foot apart, and thin the plants to stand about 5 inches apart. The following spring, reset the best plants 3 to 4 feet part each way. If you start with roots, plant them with the crown about 1 inch below the surface. Give water, if needed, while the plants are producing and dress with manure every year after the cutting season is over.

Victoria. Broad, thick, tender stalks shaded red. Very productive. Seed, pkt. 10 cts., oz. 20 cts., $\frac{1}{4}$ lb. 60 cts. Roots, 20 cts. each, \$2.10 per doz.

Mac Donald. Stalks brilliant red, tender and of excellent flavor and quality. A new variety well adapted to the northern section of the country. Roots, 40 cts. each, \$4.00 per doz.

SALSIFY

Often called "Vegetable Oyster" or "Oyster Plant" on account of its flavor. Sow the seed early, as the plants require a long season to attain full size; cover about an inch deep and thin to 3 inches apart. The roots mature in the fall, and being perfectly hardy, may be left in the ground all winter and dug as needed.

*One ounce of seed will sow about 100 feet of drill;
10 pounds will sow an acre*

Mammoth Sandwich Island. The best variety. Roots often 10 to 12 inches long, tender, and of delicious flavor. Pkt. 10 cts., oz. 50 cts., $\frac{1}{4}$ lb. \$1.50, lb. \$5.00.

Sparkler (White Tip). 25 days. Tops small; roots globe shape, bright scarlet with pronounced white tip. Crisp and of splendid quality until fairly large. Pkt. 10 cts., oz. 20 cts., $\frac{1}{4}$ lb. 50 cts., lb. \$1.50.

Summer Radishes

Chartier, Improved. 38 days. Intermediate in season between the early and the summer Radishes. Roots 7 to 8 inches long, 1 inch thick, bright rose with white tip. Pkt. 10 cts., oz. 20 cts., $\frac{1}{4}$ lb. 50 cts., lb. \$1.50.

White Strasburg. ★ 40 days. Roots about 5 inches long, $1\frac{1}{2}$ inches thick at the shoulder, tapering and smooth. Skin and flesh pure white; remains firm and brittle longer than most sorts. Pkt. 10 cts., oz. 20 cts., $\frac{1}{4}$ lb. 50 cts., lb. \$1.50.

White Stuttgart. ★ 55 days. A large, late, pure white kind, with almost round or turnip-shaped roots 3 inches in diameter. Of good quality and a good keeper. Pkt. 10 cts., oz. 20 cts., $\frac{1}{4}$ lb. 50 cts., lb. \$1.50.

Winter Radishes

Celestial, or White Chinese. ★ 60 days. Cylindrical in shape, often 8 inches long and 3 inches in diameter; skin and flesh pure white. Of fine quality and a good keeper. Pkt. 10 cts., oz. 20 cts., $\frac{1}{4}$ lb. 50 cts., lb. \$1.50.

Chinese Rose. 55 days. Roots 4 to 5 inches long, 2 inches in diameter, cylindrical but thicker near the bottom; skin smooth, bright rose in color; flesh white, crisp and tender. Pkt. 10 cts., oz. 20 cts., $\frac{1}{4}$ lb. 50 cts., lb. \$1.50.

Long Black Spanish. 60 days. Roots 7 to 9 inches long and 2 to 3 inches in diameter at the top, tapering to an abrupt point. Skin black, flesh clear white and of fine quality. Pkt. 10 cts., oz. 20 cts., $\frac{1}{4}$ lb. 50 cts., lb. \$1.50.

Long White Spanish. 60 days. Exactly like the preceding except in color of skin. Pkt. 10 cts., oz. 20 cts., $\frac{1}{4}$ lb. 50 cts., lb. \$1.50.

Round Black Spanish. ★ 60 days. Roots nearly round, 3 to 4 inches in diameter; skin black; flesh white and crisp. Pkt. 10 cts., oz. 20 cts., $\frac{1}{4}$ lb. 50 cts., lb. \$1.50.

SPINACH

Spinach is a cool-weather crop and may be sown as soon as the ground can be made ready in the spring and followed with successive sowings every ten days up to the middle of May. Make additional sowings in August and September for fall use. Sow in drills $\frac{1}{2}$ inch deep, in rows about 12 inches apart, and thin the plants to stand about 2 inches apart.

To provide Spinach during hot weather, when ordinary varieties do not thrive, make a sowing of the heat-resistant New Zealand Spinach in April. Sow in rows 3 feet apart and let the plants stand about 1 foot apart in the row.

NOTE—The time from sowing of seed to cutting of plants varies considerably with the season of the year in which sowings are made. Days given apply to spring sowings.

*One ounce of seed will sow about 100 feet of drill;
14 to 15 pounds will sow an acre*

Bloomsdale Savoy-Leaved. ★ 40 days. (Reselected.) Very hardy and consequently most desirable for autumn and early spring use. The plants are upright and vigorous, with heavily crumpled, dark green leaves. Oz. 15 cts., $\frac{1}{4}$ lb. 30 cts., lb. 85 cts., 5 lbs. \$3.75, 10 lbs. \$7.00, 25 lbs. \$16.25.

Bloomsdale Long-Standing. ★ 43 days. A quick-growing, blight-resistant hardy sort that is much planted for market and canning. Leaves curled and wrinkled. Remains edible longer than other varieties. Oz. 15 cts., $\frac{1}{4}$ lb. 30 cts., lb. 85 cts., 5 lbs. \$3.75, 10 lbs. \$7.00, 25 lbs. \$16.25.

Spinach continued on next page

SPINACH, continued

Improved Thick-Leaved. 45 days. A hardy, vigorous sort, particularly valuable for spring sowing. Leaves deeply crumpled and dark green. Oz. 15 cts., $\frac{1}{4}$ lb. 30 cts., lb. 85 cts., 5 lbs. \$3.75, 10 lbs. \$7.00, 25 lbs. \$16.25.

Juliana. ★ 50 days. Grows close to the ground and has dark green, crumpled leaves that keep fresh-looking and retain their crispness a long time. Oz. 15 cts., $\frac{1}{4}$ lb. 30 cts., lb. 85 cts., 5 lbs. \$3.75, 10 lbs. \$7.00, 25 lbs. \$16.25.

King of Denmark. 48 days. Leaves are thick, crumpled, and dark green. Does not go to seed as quickly as most varieties. Oz. 15 cts., $\frac{1}{4}$ lb. 30 cts., lb. 85 cts., 5 lbs. \$3.75, 10 lbs. \$7.00, 25 lbs. \$16.25.

Virginia Blight-Resistant. 45 days. This is a cool-weather variety that is resistant to "yellows" and mosaic disease, and has moderately savoyed leaves. Being resistant to cold weather, it is a desirable variety for fall planting. Oz. 15 cts., $\frac{1}{4}$ lb. 30 cts., lb. 85 cts., 5 lbs. \$3.75, 10 lbs. \$7.00, 25 lbs. \$16.25.

New Zealand. 70 days. Often called "Summer Spinach." A distinct type of Spinach which makes large, bushy plants, often 3 feet in diameter. Only the young leaves and tips of the branches are used and the more they are picked, the faster the plant seems to grow. Thrives in hot, dry weather. Pkt. 10 cts., oz. 30 cts., $\frac{1}{4}$ lb. 90 cts., lb. \$2.50.



Spinach, New Zealand
Pkt. 10 cts., oz. 30 cts.

★ WHEN IN DOUBT ORDER THE STAR VARIETIES

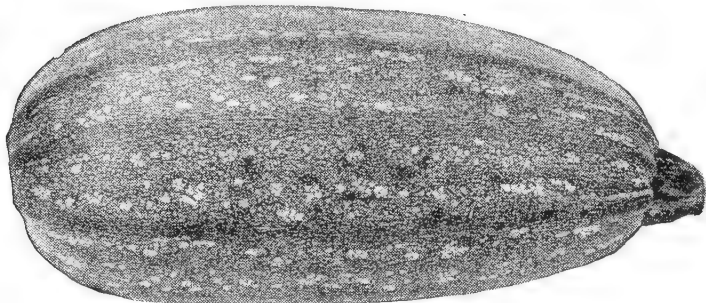

Squash, Cocoselle. Pkt. 10 cts., oz. 25 cts.

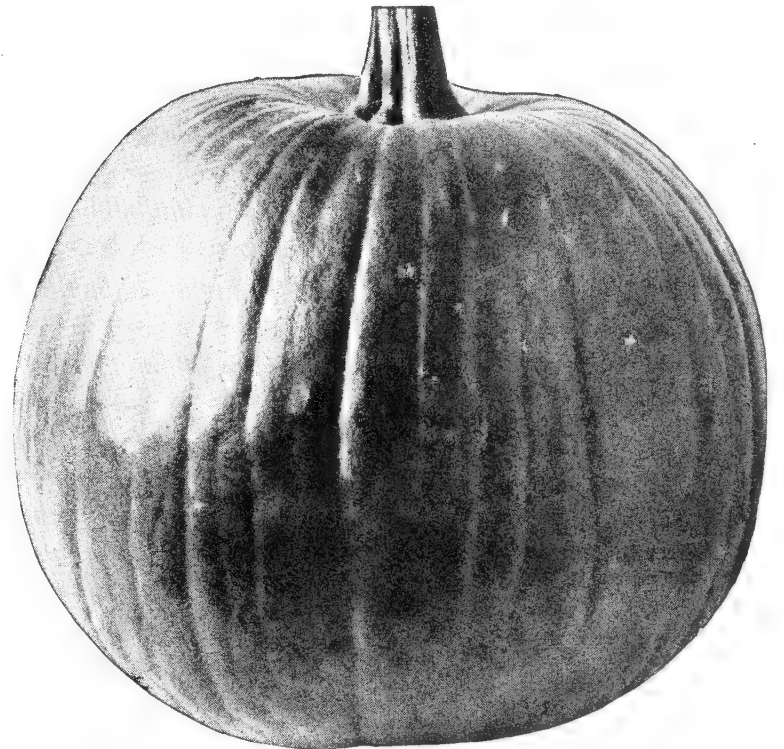

Pumpkin, Small Sugar. Pkt. 10 cts., oz. 20 cts.

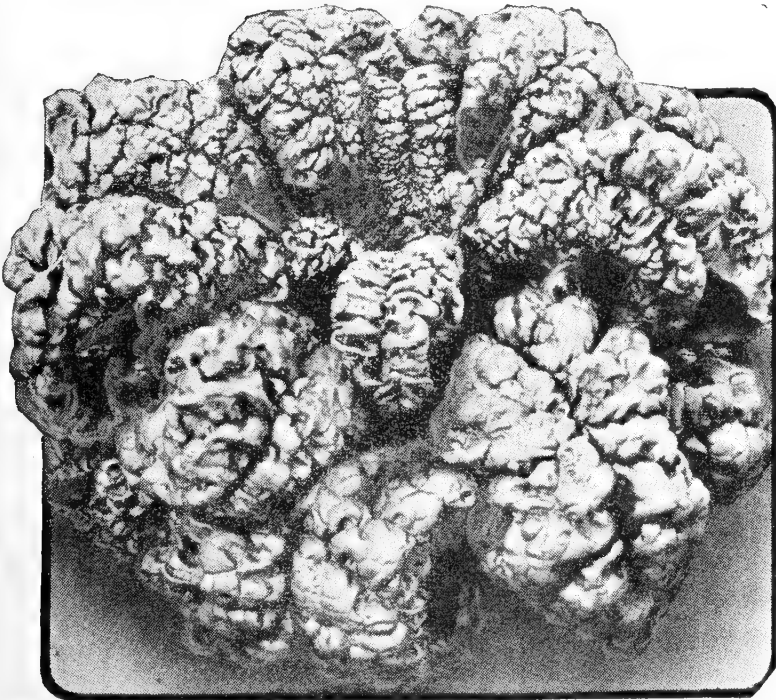

Spinach, Bloomsdale Long-standing. Oz. 15 cts., $\frac{1}{4}$ lb. 30 cts.



Squash, Mammoth White Bush. Pkt. 10 cts., oz. 25 cts.

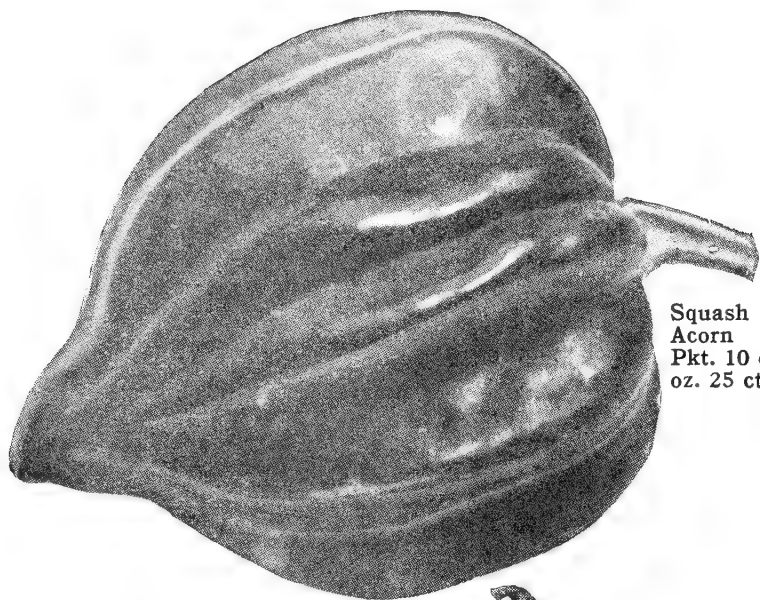

Squash
Acorn
Pkt. 10 cts.
oz. 25 cts.

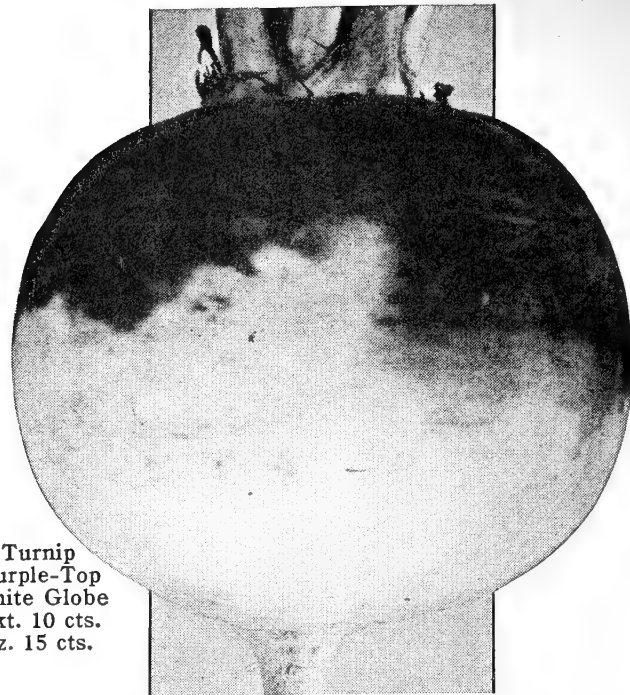

Turnip
Purple-Top
White Globe
Pkt. 10 cts.
oz. 15 cts.

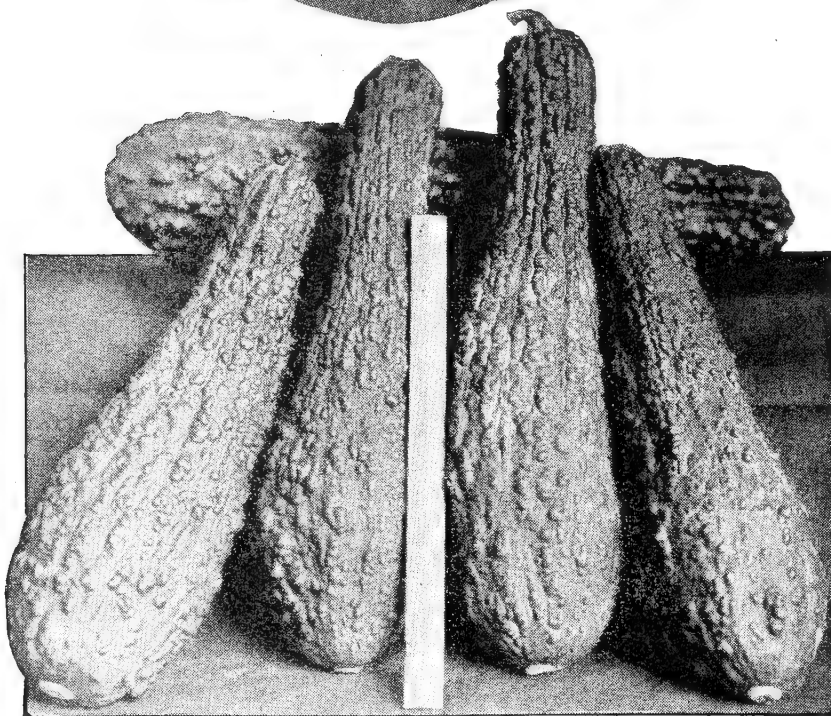

Squash, Yellow Summer Straightneck. Pkt. 10 cts., oz. 25 cts.

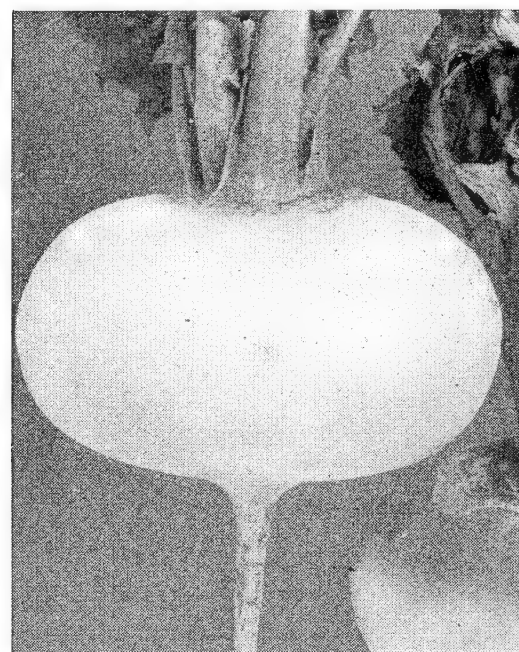

Turnip, Extra-Early White Milan
Pkt. 10 cts., oz. 20 cts.

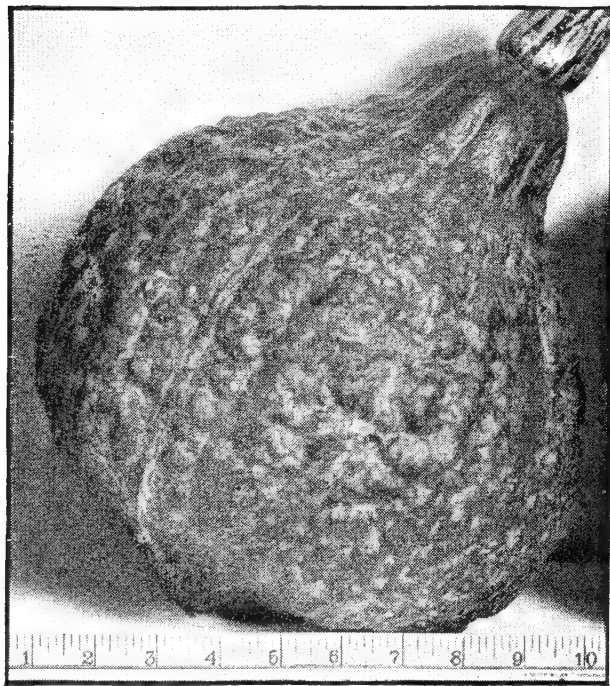

Squash, Golden Hubbard. Pkt. 10 cts., oz. 30 cts.

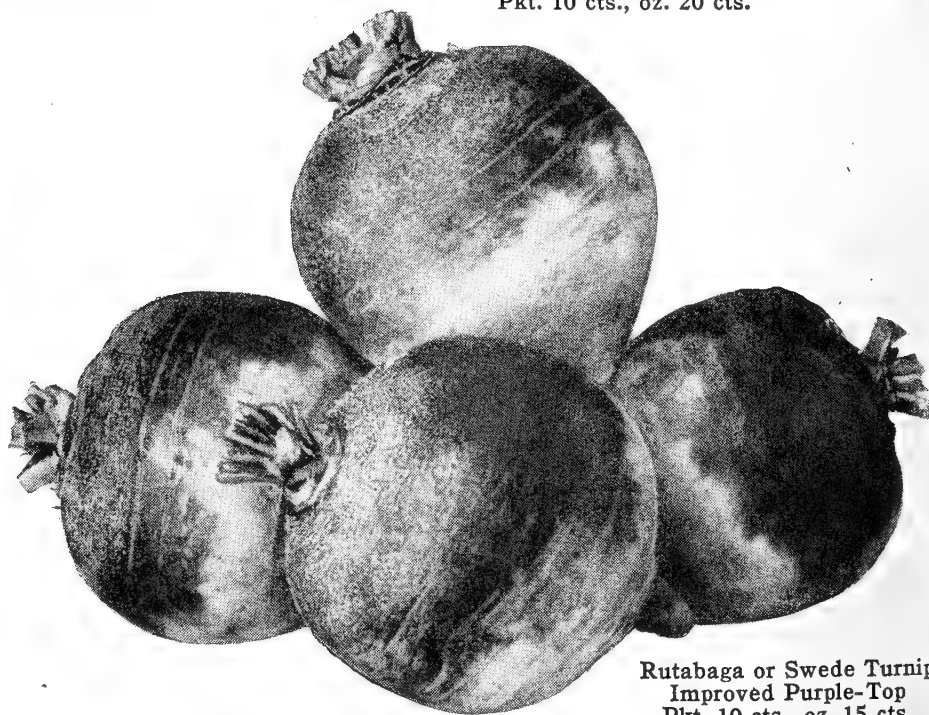

Rutabaga or Swede Turnip
Improved Purple-Top
Pkt. 10 cts., oz. 15 cts.

SQUASH

SUMMER SQUASH. Sow the seed in fertile, deep soil when the ground is warm and dry and after all danger of frost has passed, in hills about 4 feet apart each way. Allow about 4 plants to remain in each hill.

WINTER SQUASH. Plant in hills 8 to 10 feet apart each way and when the plants are about 5 inches tall, thin to 3 plants to the hill. Allow the Squash to remain on the vine until fully matured. Keep in a moderately warm, dry place during the winter.

*One ounce of Squash seed will plant 15 to 20 hills;
3 to 5 pounds will plant an acre, according to variety*

Summer or Bush Squash

Black Zucchini. ★ 65 days. Cylindrical and of uniform thickness; rind dark green; flesh firm and of delicate flavor. Easy to grow, and very prolific. Pkt. 10 cts., oz. 25 cts., $\frac{1}{4}$ lb. 75 cts., lb. \$2.00.

Cocozelle (Italian Vegetable Marrow.) 65 days. Bushy plants, requiring little space, produce many oblong fruits averaging a foot long and 4 inches in diameter; green skin, mottled and striped with yellow and darker green. Quality extra-fine. Becoming better known every year. Pkt. 10 cts., oz. 25 cts., $\frac{1}{4}$ lb. 75 cts., lb. \$2.00.

Mammoth White Bush. ★ 55 days. One of the earliest. Compact in growth and prolific, with round, ivory-white fruits, with scalloped edges. Bears throughout the season if kept gathered. A very popular sort because of its fine flavor. Pkt. 10 cts., oz. 25 cts., $\frac{1}{4}$ lb. 75 cts., lb. \$2.00.

Yellow Summer Crookneck. 62 days. Long, curved fruits with thin, golden yellow, warted skin; sweet, tender flesh. Pkt. 10 cts., oz. 25 cts., $\frac{1}{4}$ lb. 75 cts., lb. \$2.00.

Yellow Summer Straightneck. ★ 62 days. Similar to Yellow Summer Crookneck except that it is straight and smoother. Fruits are golden yellow, about 10 inches long and 3 inches in diameter at the blossom end, thickly warted; flesh golden yellow, thick and fine flavored. Pkt. 10 cts., oz. 25 cts., $\frac{1}{4}$ lb. 75 cts., lb. \$2.00.

Winter or Vining Squash

Acorn (Table Queen). ★ 85 days. An early-maturing variety which can also be planted for summer use. Fruits pointed acorn shape, 5 inches long and 4 inches through. Skin smooth, dark green; shell thin; flesh light yellow, mealy and of wonderful flavor. Pkt. 10 cts., oz. 25 cts., $\frac{1}{4}$ lb. 75 cts., lb. \$2.00.

Boston Marrow. 95 days. A productive late variety, shaped like the well-known Hubbard, with orange skin and thick, yellow flesh. A good keeper. Pkt. 10 cts., oz. 25 cts., $\frac{1}{4}$ lb. 75 cts., lb. \$2.00.

Fordhook. 85 days. An excellent variety that is suitable for both summer and winter use. The fruits are oblong averaging 8 to 10 inches long, with thin, light yellow skin and thick, straw-colored flesh. Pkt. 10 cts., oz. 25 cts., $\frac{1}{4}$ lb. 75 cts., lb. \$2.00.

Golden Hubbard. ★ 100 days. True Hubbard shape but earlier, a trifle smaller, and the skin is a rich orange-red in color. Flesh deep orange, dry and sweet; an excellent keeper. May be used either as a vegetable or for pie. Pkt. 10 cts., oz. 30 cts., $\frac{1}{4}$ lb. 90 cts., lb. \$2.50.

Improved Hubbard. 110 days. A selection from the old Hubbard, with more vigorous vine and slightly larger fruits. Skin smooth, dark green; flesh deep yellow and of superb quality. Pkt. 10 cts., oz. 30 cts., $\frac{1}{4}$ lb. 90 cts., lb. \$2.50.

Warted Hubbard. ★ 115 days. Fruits weigh around 15 pounds, are globular in shape and pointed at both ends; shell thick and hard; skin is heavily warted and very dark green in color. Flesh is orange-yellow, very thick, dry, fine grained and of excellent flavor. If properly stored will keep until spring. Makes excellent "pumpkin" pies. Pkt. 10 cts., oz. 30 cts., $\frac{1}{4}$ lb. 90 cts., lb. \$2.50.

TURNIPI

The main crop is usually sown in July or August, to mature during the fall, but early-season crops can be obtained by sowing the quick-maturing varieties as soon as the ground can be prepared in the spring. Sow the seed thinly in rows 15 inches apart, and cover with $\frac{1}{2}$ inch of soil. Thin the early sorts to stand 3 to 4 inches apart in the rows and the large main-crop Turnips about 6 inches. If not thinned out they will produce only tops and will not develop roots.

*An ounce of seed will sow about 300 feet of drill;
a pound will sow an acre*

Cow Horn. 75 days. Roots shaped rather like a carrot, often over a foot long and 3 inches in diameter. Skin and flesh white. Pkt. 10 cts., oz. 15 cts., $\frac{1}{4}$ lb. 40 cts., lb. \$1.00, 5 lbs. \$4.50.

Extra-Early White Milan. 45 days. The quickest growing of the Turnips. The roots are small and flat with pure white skin and flesh; mild and sweet. Most desirable variety for early sowing. Pkt. 10 cts., oz. 20 cts., $\frac{1}{4}$ lb. 55 cts., lb. \$1.75.

Purple-Top Strap-Leaf. ★ 50 days. The roots are flat and quite large; skin white except for a ring of purple around the top; flesh white, fine-grained and of excellent table quality. Pkt. 10 cts., oz. 15 cts., $\frac{1}{4}$ lb. 40 cts., lb. \$1.00, 5 lbs. \$4.50.

Purple-Top White Globe. ★ 60 days. The roots are large, nearly round, white with upper third purple. The flesh is firm and of good quality. Productive and a splendid keeper. Pkt. 10 cts., oz. 15 cts., $\frac{1}{4}$ lb. 40 cts., lb. \$1.00, 5 lbs. \$4.50.

Seventop. Grown principally for greens. The young shoots are very tender. Roots tough and not edible. Pkt. 10 cts., oz. 15 cts., $\frac{1}{4}$ lb. 40 cts., lb. \$1.00.

Yellow Globe. 80 days. Round, smooth roots of medium size, with light yellow skin and flesh. Used chiefly for stock feed, but suitable for table use when young. Pkt. 10 cts., oz. 15 cts., $\frac{1}{4}$ lb. 40 cts., lb. \$1.00.

RUTABAGA or Swede Turnip

The flavor of Rutabagas is preferred by many to that of Turnips. They are grown much like Turnips but they require a longer season and attain a larger size. Sow during June or early July in rows 18 inches apart. Cover the seed with $\frac{1}{2}$ inch of fine soil and thin out the seedlings to 8 to 10 inches. They may be stored in a cool cellar or pit for winter use.

*An ounce of seed will sow about 400 feet of drill;
a pound will sow an acre*

Improved Purple-Top. ★ 90 days. Large, globular roots. Skin smooth, light yellow with purple top; flesh yellow, firm, and of fine quality. Good winter keeper. Pkt. 10 cts., oz. 15 cts., $\frac{1}{4}$ lb. 40 cts., lb. \$1.00.

Sweet German. 90 days. A large, globe-shaped variety with white skin and flesh. Fine-grained, solid and sweet. Pkt. 10 cts., oz. 15 cts., $\frac{1}{4}$ lb. 40 cts., lb. \$1.00.

TAMPALA

A new leafy green vegetable prepared and served like spinach, but with a distinctive flavor. The tender leaves need to be cooked only five minutes. Stands hot weather well. Sow the seed outdoors when the soil has become warm in the spring; the young leaves will be ready for picking in six to eight weeks. Pkt. 15 cts.

TOBACCO

For best results, Tobacco requires a rich, mellow soil and careful cultivation. Sow the seed in frames or a fine seed-bed early in April and reset the plants in the open ground late in May or early in June, spacing them 2 feet apart in rows 4 feet apart. Cultivate frequently.

Connecticut Seed-Leaf. One of the hardiest and most popular sorts. Pkt. 10 cts., $\frac{1}{4}$ oz. 25 cts., $\frac{1}{2}$ oz. 40 cts., oz. 75 cts.

Havana. True type; productive and of finest quality. Pkt. 10 cts., $\frac{1}{4}$ oz. 25 cts., $\frac{1}{2}$ oz. 40 cts., oz. 75 cts.

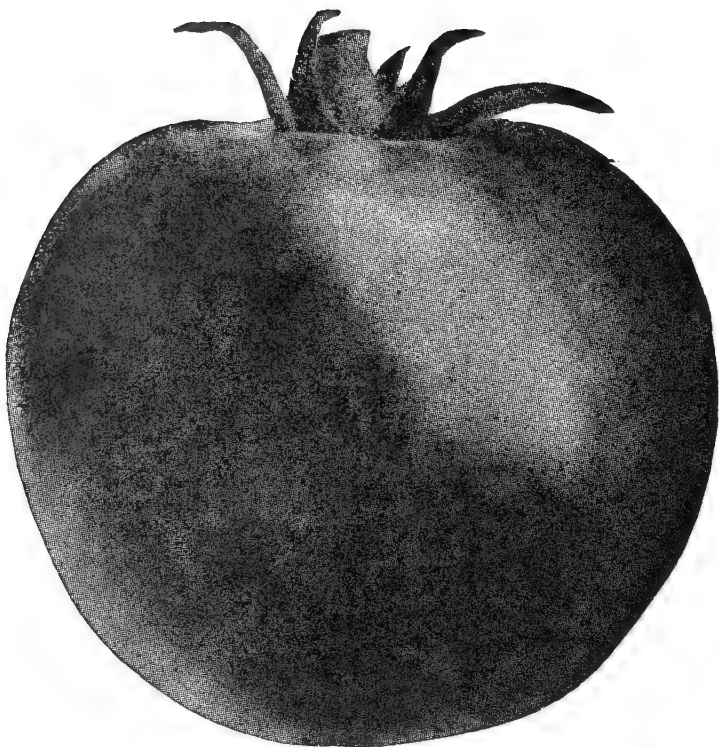

Tomato, Rutgers. Pkt. 10 cts., 1/2oz. 35 cts.

Undoubtedly Tomatoes are the most valuable vegetable in the garden. They give greater returns for the space they occupy than anything else that can be grown. With most families they are a favorite all during their season, and the surplus is easily canned or made into juice. Tomatoes are not only good; they are also good for you, since they are high in vitamin C.

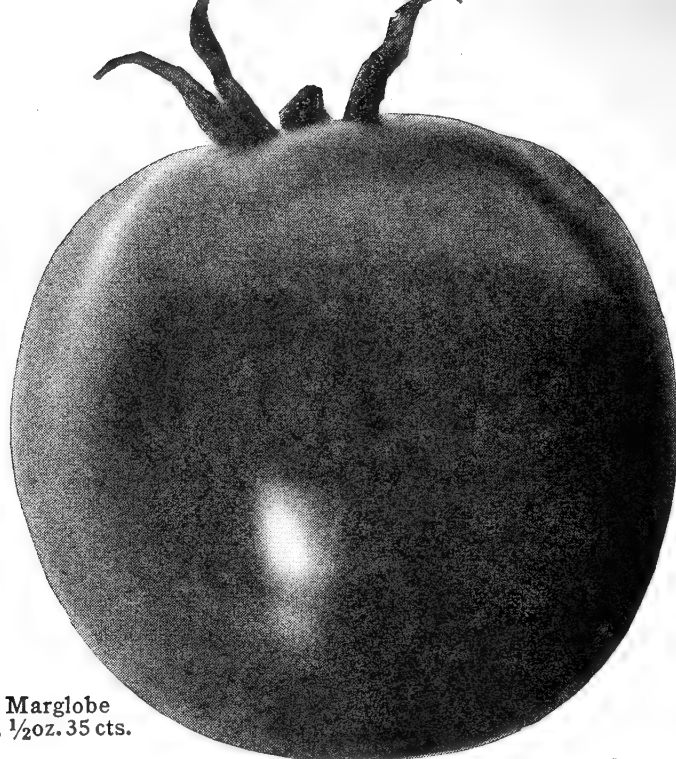

Tomato, Marglobe
Pkt. 10 cts., 1/2oz. 35 cts.



Tomato, Bonny Best. Pkt. 10 cts., 1/2oz. 35 cts.

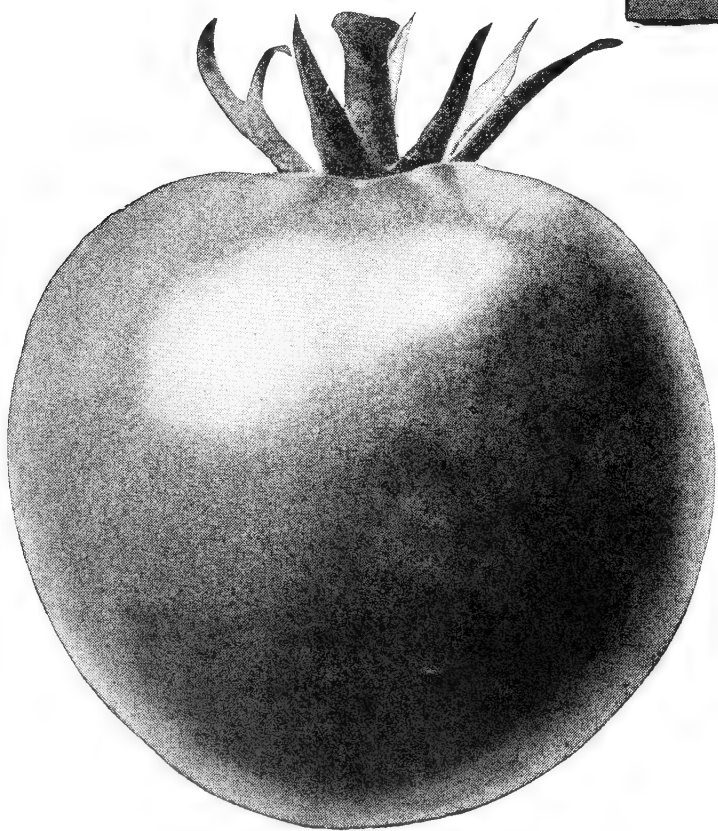

Tomato, Pritchard. Pkt. 10 cts., 1/2oz. 35 cts.

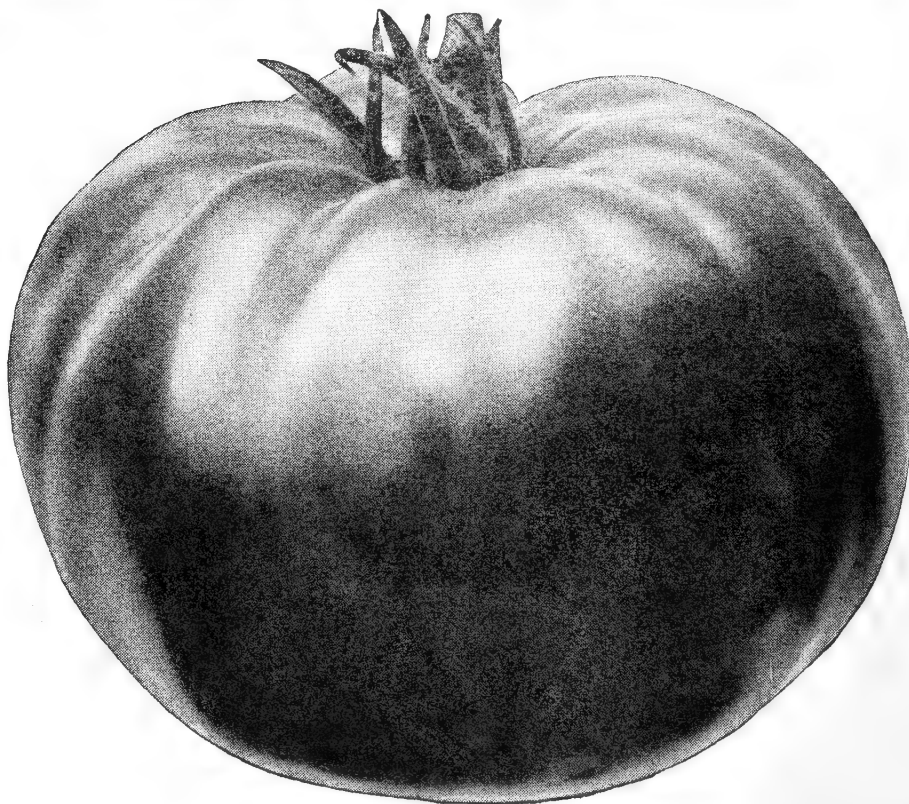

Tomato, Ponderosa. Pkt. 10 cts., 1/2oz. 60 cts.

TOMATOES

The seed should be sown indoors in late February or March, in shallow boxes or pots placed in a warm, sunny window. As soon as the little plants are strong enough, thin or transplant them to stand 3 to 4 inches apart; then when they are about 3 inches high transfer them to small paper pots or dirt-bands. To secure extra-strong, stocky plants, transfer them again, when 6 to 8 inches tall, to larger pots. When all danger from frost is past, set them out in the garden, spacing them about 4 feet apart each way.

Treat the seed with Semesan to prevent damping-off of seedlings. Use Transplantone when transplanting the plants to the garden. (See fertilizer pages.) To guard against blight, spray the plants with Bordeaux Mixture or Sulfocide two or three times during the season; arsenate of lead will kill the Tomato worms. Nicotine Pyrox will control both blight and insects.

Days to maturity are figured from the time the plants are set in the garden.

An ounce of seed will produce about 2,000 plants

Early Varieties

Bonny Best. ★ 70 days. It is remarkably productive with large, round, smooth fruits in handsome clusters. Uniform in size and shape, solid, free from cracks, bright scarlet in color. Pkt. 10 cts., ½oz. 35 cts., oz. 60 cts., ¼lb. \$1.75, lb. \$6.00.

Break O'Day. ★ 68 days. Fruits orange-red, smooth and of good size. Very productive and a good early market-gardeners' variety. Pkt. 10 cts., ½oz. 40 cts., oz. 75 cts., ¼lb. \$2.25, lb. \$8.00.

Earliana. 66 days. The plants are compact, with light foliage; the fruits are of good size, bright red, and quite solid. Pkt. 10 cts., ½oz. 40 cts., oz. 75 cts., ¼lb. \$2.25, lb. \$8.00.

John Baer. ★ 70 days. The fruits are of good size, perfectly smooth, and nearly globe-shaped, with brilliant scarlet skin and firm flesh, entirely free from core and with few seeds. The flavor is mild and deliciously sweet. Pkt. 10 cts., ½oz. 35 cts., oz. 60 cts., ¼lb. \$1.75, lb. \$6.00.

June Pink. 70 days. The earliest of the pink-fruited varieties. Fruits of medium size, somewhat flattened, smooth, solid and meaty. Pkt. 10 cts., ½oz. 40 cts., oz. 75 cts., ¼lb. \$2.25, lb. \$8.00.

Marhio. 75 days. Fruit of a very attractive deep pink. A vigorous grower, heavy cropper, and wilt-resistant. Fruits globe shaped, medium sized, smooth, firm and free from cracks. A good forcing variety. Pkt. 15 cts., ½oz. 35 cts., oz. 60 cts., ¼lb. \$1.75, lb. \$6.00.

Pritchard. ★ 75 days. Fruits scarlet, medium size, globe shaped, smooth, solid and of the finest quality. Vines compact and very productive. A good home-garden variety. Pkt. 10 cts., ½oz. 35 cts., oz. 60 cts., ¼lb. \$1.75, lb. \$6.00.

Victor. 65 days. Fruits bright scarlet, globular, medium size, smooth and of fair quality. Plants are very productive and bear all their fruit in the first few weeks of the picking season. Because of their compact growth plants can be set 2 feet apart in the row. An extra-early market-gardeners' variety. Pkt. 15 cts., ½oz. 40 cts., oz. 75 cts., ¼lb. \$2.25, lb. \$8.00.

Second-Early and Main-Crop Varieties

Beefsteak. ★ 90 days. Late; purplish pink; vines strong and vigorous; very little seed; large, solid fruit. An old favorite with home-gardeners. Pkt. 10 cts., ½oz. 60 cts., oz. \$1.00, ¼lb. \$3.00, lb. \$10.00.

Dwarf Stone. 85 days. Bushy, compact plants, bearing solid bright red fruits. Medium early. Pkt. 10 cts., ½oz. 40 cts., oz. 75 cts., ¼lb. \$2.25, lb. \$8.00.

SECOND-EARLY and MAIN-CROP VARIETIES, con.

Greater Baltimore. Noted for its deep red color throughout. Fruits are large, flattened globe in shape, solid and of good quality. Vines vigorous and very productive. Pkt. 10 cts., ½oz. 35 cts., oz. 60 cts., ¼lb. \$1.75, lb. \$6.00.

Greater Marglobe. ★ 78 days. As a result of extensive breeding work, this strain shows vast improvement over the original Marglobe in size and uniformity of fruits. We recommend it as the finest stock of this variety of Tomato. Pkt. 15 cts., ½oz. 40 cts., oz. 75 cts., ¼lb. \$2.25, lb. \$8.00.

Livingston's Globe. ★ 82 days. Heavy crops of good-sized, uniform, distinctly globe-shaped fruits with smooth, glossy, deep pink skin. Pkt. 10 cts., ½oz. 40 cts., oz. 75 cts., ¼lb. \$2.25, lb. \$8.00.

Marglobe. ★ 78 days. The most popular variety with both home and market-gardeners. Fruits large, deep scarlet, very uniform, globe shaped, smooth, with thick walls and small seed cells. Delicious and mild flavor. Plants vigorous, productive, disease-resistant and of long bearing period. Pkt. 10 cts., ½oz. 35 cts., oz. 60 cts., ¼lb. \$1.75, lb. \$6.00.

Matchless. 85 days. A main-crop Tomato with bright red, solid fruits of excellent quality. Pkt. 10 cts., ½oz. 35 cts., oz. 60 cts., ¼lb. \$1.75, lb. \$6.00.

Oxheart. 90 days. A main-crop, pink-fruited variety. Fruits are extra large, heart-shaped, heavy and solid. Choice variety for salads and slicing. Pkt. 15 cts., ½oz. 60 cts., oz. \$1.00, ¼lb. \$3.00, lb. \$10.00.

Ponderosa. ★ 88 days. One of the largest pink-fruited Tomatoes. Somewhat irregular in shape but extremely solid and with very few seeds. Has a delightful mild flavor. Plants are large and very productive. Pkt. 10 cts., ½oz. 60 cts., oz. \$1.00, ¼lb. \$3.00, lb. \$10.00.

Rutgers. ★ 85 days. The best all-purpose Tomato. Fruits uniform, large, globular, bright red, very smooth, meaty, and of mild flavor. Vines large, dense, and resistant to disease. Yields an abundance of handsome and delicious fruit; ideal for canning and slicing. Pkt. 10 cts., ½oz. 35 cts., oz. 60 cts., ¼lb. \$1.75, lb. \$6.00.

Stokesdale. 78 days. The fruits are smooth, brilliant red, with a very solid interior. A heavy yielder; excellent for canning and for making juice. Pkt. 10 cts., ½oz. 35 cts., oz. 60 cts., ¼lb. \$1.75, lb. \$6.00.

Stone. 85 days. An unusually productive, smooth, bright red Tomato. It is a favorite for canning and a most dependable sort for main crop in both market and home-gardens. Pkt. 10 cts., ½oz. 40 cts., oz. 75 cts., ¼lb. \$2.25, lb. \$8.00.

Yellow Varieties

Golden Queen. 83 days. Good-sized, round, smooth fruits, bright yellow in color, solid and of splendid quality. Pkt. 10 cts., ½oz. 40 cts., oz. 75 cts., ¼lb. \$2.25, lb. \$8.00.

Golden Jubilee. 75 days. A smooth, bright golden orange Tomato. Fruits are medium size, firm, deep globe shaped, with solid interior and small seed pockets. A really fine-flavored and delicious Tomato. Plants bear over a long season. Pkt. 15 cts., ½oz. 65 cts., ¼oz. \$1.10, oz. \$2.00.

Yellow Plum. 75 days. The fruits resemble a plum in size and shape but are bright yellow in color. Enormously prolific; in great demand for preserving. Pkt. 10 cts., ½oz. 60 cts., oz. \$1.00, ¼lb. \$3.00, lb. \$10.00.

Yellow Ponderosa. 88 days. A very large, mild-flavored sort, desirable for the home-garden. Skin clear golden yellow; flesh pale yellow, solid and meaty, mild and sweet. Pkt. 10 cts., ½oz. 40 cts., oz. 75 cts., ¼lb. \$2.25, lb. \$8.00.

Growing Flowers FROM SEED

To start seeds indoors, use a shallow box filled with light, rich soil not likely to bake or form a crust when the surface dries, and which has been treated with Formaldehyde or Semesan. Tamp firmly, so that the level is about half an inch below the top of the box. Make shallow furrows crossways, about an inch apart. Very fine seeds, like Petunias and Portulacas, need merely marks; large seeds, like Scabiosas, Lupines, and Four o'Clocks, should have furrows a half-inch deep. Sow the seed thinly in the rows, and label each row. Sift fine soil, mixed with sand, over the seeds, covering them to the soil level. Then press the surface with a board or a brick and water with a very fine nozzle or sprinkle the surface with a whisk-broom dipped in water. Cover the box with a sheet of glass and newspaper, and set it in a warm position, watching from day to day to see that the surface does not get dry or become soggy.

As soon as the seedlings break through the ground, the newspaper must be removed and the box set where it will receive the largest amount of sunlight. When the first leaves are fully formed, remove the glass or tilt it to admit air; when the seedlings are all up and gathering strength, take off the glass.

Special care will be needed in watering. If too much water is used, the seedlings are likely to damp off; if not enough, they will not grow rapidly.

Transplant once before moving to garden.

Perennials require exactly the same treatment, except that sowing may be delayed until the annuals are out of the way.

Good results can also be obtained by sowing most annuals outdoors any time from early April to June.

Alyssum saxatile

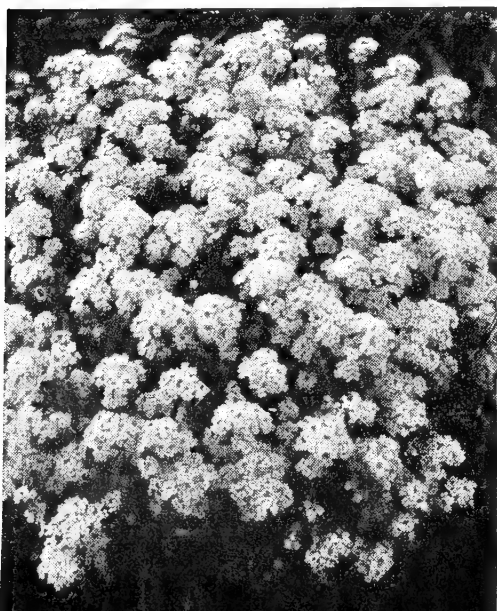

Scott's Flower Seeds



Acroclinium

Annual

Double Large-flowering Hybrids. Beautiful Everlasting Flowers in salmon, apricot, pink, rose and cerise, white and creamy tones with golden centers. For drying, cut as soon as they open. Pkt. 10 cts., $\frac{1}{4}$ oz. 25 cts.

Ageratum • Floss Flower

Annual

Excellent for low borders and edging, and is often used for porch-boxes. Can be sown outdoors in May, but to have blooms earlier start indoors in March.

Blue Perfection. Pretty, deep lavender-blue flowers. Plants grow about 15 inches high. Pkt. 10 cts., $\frac{1}{4}$ oz. 40 cts.

Dwarf Blue Boy. A new variety only about 4 inches high. Very uniform growth, completely covered with bloom in rich shades of blue. Pkt. 10 cts., $\frac{1}{4}$ oz. 75 cts.

Imperial Dwarf Blue. Perfectly formed little plants about 8 inches tall, with flowers of clear blue. Pkt. 10 cts., $\frac{1}{4}$ oz. 75 cts.

Little Blue Star. Tiny plants, not over 5 inches high, covered with masses of bright blue flowers. Pkt. 25 cts., $\frac{1}{4}$ oz. \$1.50.

Alyssum

Annuals and Perennials

The ever-popular and always satisfactory flower for edging beds or planting in porch-boxes or rockeries. Sow the seed in the open ground any time from early April to June. Blooms all summer.

Violet Queen. Annual. Dwarf, compact plants rarely 6 inches high. Flowers deep lavender-lilac. A very pretty variety. Pkt. 10 cts., $\frac{1}{4}$ oz. 50 cts., oz. \$1.50.

Little Gem. Annual. A dwarf form which makes dense, round, little bushes about 6 inches high, covered with very white flowers. Pkt. 10 cts., $\frac{1}{4}$ oz. 25 cts., oz. 75 cts.

Saxatile compactum, Blanket of Gold. Perennial. Bushy plants a foot high. Tiny bright yellow flowers in clusters. A good rock-plant. Pkt. 10 cts., $\frac{1}{4}$ oz. 40 cts., oz. \$1.25.

White Carpet. Annual. The name describes it—a carpet of white only 2 to 3 inches high. Pkt. 10 cts., $\frac{1}{4}$ oz. 25 cts., oz. 75 cts.

White Sweet. Annual. The old-fashioned variety. Low-growing and spreading. Sweet-scented, pure white flowers. Pkt. 10 cts., $\frac{1}{4}$ oz. 15 cts., oz. 50 cts.

Antirrhinums · Snapdragons

Annual

A free-blooming garden flower of the easiest culture, producing its spikes of lovely flowers all summer and fall.

Sow the seed in April, transplanting when 2 to 3 inches high, to the garden.

TALL GIANT-FLOWERED. A fine strain for bedding or cutting as the spikes are heavy and long.

Apple Blossom. Soft apple-blossom-pink.

Canary Bird. Brilliant canary-yellow with deeper yellow lip.

Cattleya. Fine spikes of orchid-lavender—a lovely shade.

Copper King. Velvety bronzy copper.

Old-Gold. Rich old-gold, flushed rose.

Orchid. That peculiar shade known by this name.

Ruby. Rich velvety ruby-red.

Snowflake. Pure white, with yellow lip.

The Rose. Deep rose-pink.

Finest Mixed. A mixture of all the colors.

All Tall Giant-flowered Antirrhinums, pkt. 25 cts., ¼oz. \$1, oz. \$3

HALF-DWARF LARGE-FLOWERING, MIXED. A nice strain for bedding, with heavy spikes of good length for cutting. Good mixture of colors. Pkt. 10 cts., ¼oz. 25 cts., oz. 75 cts.

GIANT-FLOWERED, MAJESTIC TYPE (RUSTPROOF), MIXED. Our new rustproof strain of the Tall Large-flowered type. Try these where rust has been troublesome. A fine mixture of all colors in this type. Pkt. 25 cts., ¼oz. 75 cts., oz. \$2.50.



Arctotis

Amaranthus

Annual

Start seed in house or hotbed early in spring, or in a special seed-bed outdoors later on and transplant to place where they are to bloom.

Molten Fire. One of the most beautiful foliage plants. Grows 4 feet high and each lateral produces a poinsettia-like tuft of flaming fire. Pkt. 15 cts., ¼oz. 75 cts.

Sunrise. Crimson foliage with a strong tinge of bronze. A cluster of bright scarlet leaves grows at the end of each branch. Extremely showy. Pkt. 25 cts., ¼oz. \$1.

Tricolor. Joseph's Coat. Tall, erect plants with luxuriant foliage gorgeously marked with scarlet, yellow, and green. Pkt. 10 cts., ¼oz. 25 cts., oz. 75 cts.

Aquilegia · Columbine

Perennial

Favorite border perennials, blooming in May and June and thriving best in moist, partially shaded spots. Sow seed from May to August. Plants require no protection over winter.

Long-spurred Hybrids, Mixed. These are the finest of the Columbines, producing large flowers in a great variety of delightful colors. Pkt. 10 cts., ¼oz. 75 cts., oz. \$2.50.

Long-spurred Hybrids, Mrs. Scott Elliott's Strain, Mixed. From May to midsummer these will give a wonderful show of color. Plants grow about 3 feet high and flower profusely. Mixed colors, pkt. 25 cts., ¼oz. \$1, oz. \$3.50.

Arabis · Rock Cress

Perennial

Alpina. Mountain Rock-Cress. Excellent rock-garden or edging plant. Foliage gray-green. Flowers white, in early spring. Pkt. 10 cts., ¼oz. 50 cts.

Ageratum. See page 30.

Arctotis

Annual

Its rich and abundant blooming makes it a very desirable plant for cutting.

Giant Hybrids. A brilliant assortment of orange and bronzy red shades, rose, cream, yellow and salmon. Should be started indoors early. Pkt. 25 cts.

Grandis. Blue-eyed African Daisy. Plants 2 feet high, with silvery white foliage and 2½-inch, daisy-like, silvery white flowers with sky-blue eyes. Pkt. 10 cts., ¼oz. 25 cts.

Armeria · Sea-Pink

Perennial

Rock-garden or edging plant making handsome, evergreen, mossy tufts from which rise clustered flowers like clover blossoms.

Cephalotes. Giant Thrift. Rose and White. Pkt. 10 cts., ¼oz. 75 cts.

Lauchena. Dwarf Thrift. Bright rose. Pkt. 25 cts., ¼oz. \$2.

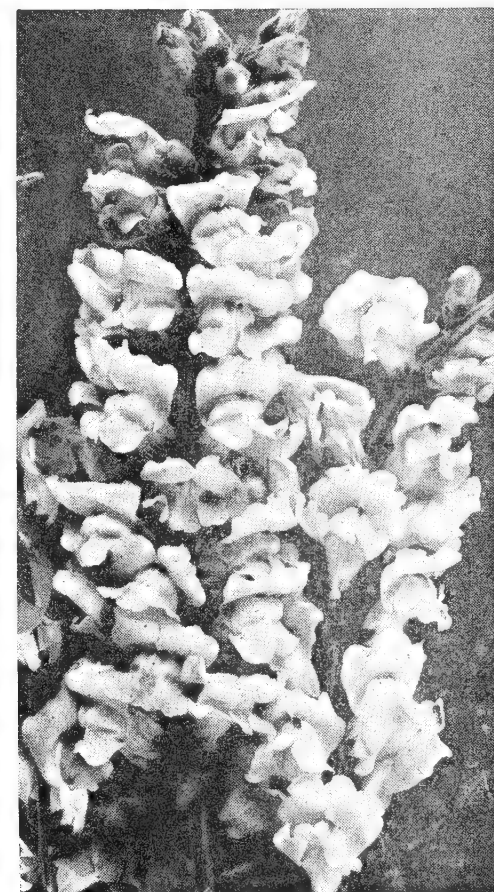

Antirrhinum (Snapdragon)

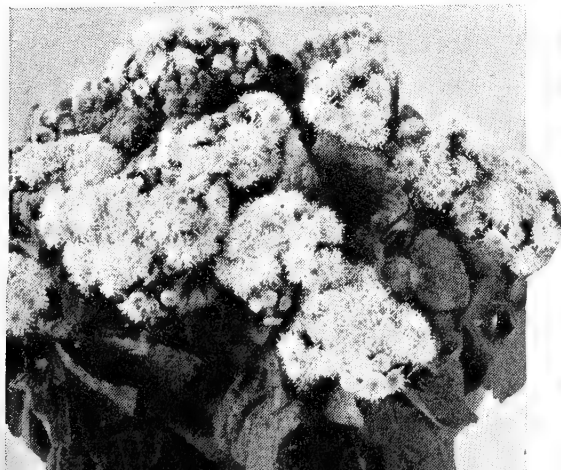

Molten Fire Amaranthus

There are many summer-flowering bulbs that will lend new interest to your summer garden. Why not plant several groups of Summer Hyacinths or Peruvian Daffodils or Montbretias? Tigridias are always spectacular and Tuberoses are delightfully fragrant.

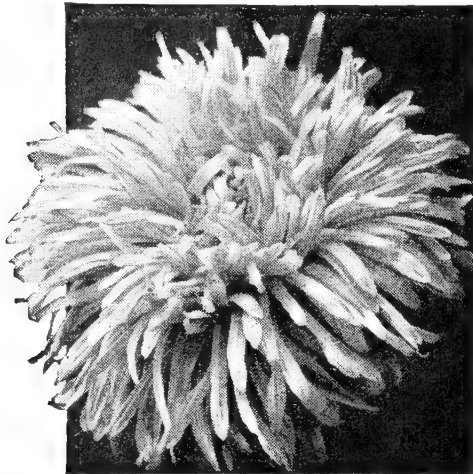

Aster, California Giant

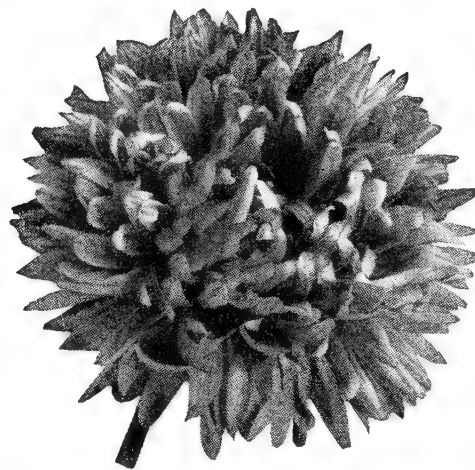

Aster, Heart of France



Giant California Sunshine Asters

Asters *Annual*

Asters prefer an open, sunny situation and they respond amazingly to fertilizers and good cultivation. It is advisable to change the location of the Aster-bed each year if you want large flowers and lots of them. For early bloom, start the seed in a window-box or hotbed, in March, giving the little plants plenty of light and water as required, and thinning 3 to 4 inches apart, or transplanting them when a few inches high to small pots. Set them out after danger from frost is past. For solid beds of color, set the plants 8 to 10 inches apart, but if large flowers and long stems are wanted for cutting, plant at least 1 foot apart in rows 1½ to 2 feet apart. The seed may be sown outdoors in early May with good results except that the plants will bloom later.

EARLY-BLOOMING

Queen of the Market. (Wilt-resistant Strain.) Low, bushy plants bearing quantities of large flowers from July on.

- | | |
|---------|--------------|
| White | Lavender |
| Pink | Purple |
| Crimson | Mixed Colors |

All Queen of the Market Asters, pkt. 10 cts., ¼oz. 50 cts., oz. \$1.50

MIDSEASON BLOOMING

Improved Crego. (Wilt-resistant Strain.) Large flowers, often 5 inches across, with twisted and curled petals, are freely produced on long stems. They bloom just after the early varieties.

- | | |
|-------------------|---------------|
| Blue Flame | Light Blue |
| Cattleya (orchid) | Peach Blossom |
| Crimson | Shell-Pink |
| Dark Violet | White |
| Deep Rose | Mixed |

All Improved Crego Asters, pkt. 10 cts., ¼oz. 50 cts., oz. \$1.50



Aster, Aurora

GIANTS OF CALIFORNIA IMPROVED. Large, full flowers of the Crego type, with curled and interlaced petals, on long, heavy stems. Strong, upright plants that bloom from late summer until frost.

- | | |
|--------------|---------------|
| Carmine-Rose | Light Blue |
| Dark Purple | Peach Blossom |
| Light Purple | White |

Mixed

All Giants of California Improved Asters, pkt. 25 cts., ¼oz. 75 cts., oz. \$2.50

CALIFORNIA SUNSHINE, MIXED.

Immense, single flowers, 4 to 5 inches across, with a single row of petals surrounding large yellow quill-like center discs. Branching plants 2 to 3 feet tall. Excellent for cutting. Mixed colors, pkt. 25 cts., ¼oz. \$1, oz. \$3.

GIANT BRANCHING LATE-BLOOMING. (Wilt-resistant Strain.) A wilt-resistant strain of late-blooming Asters. Valuable to finish the season. Long, strong stems carrying large flowers with broad, incurved petals. A great cutting Aster.

- | | |
|-----------|-----------|
| Crimson | Deep Rose |
| Dark Blue | White |

Mixed

All Giant Branching Late-blooming Asters, pkt. 10 cts., ¼oz. 50 cts., oz. \$1.50

MISCELLANEOUS TYPES

AURORA. A free-flowering Aster with large, full flowers, quilled centers and outer band of broad petals. Quite distinct from all other Asters. Plants are of medium height and should be in bloom by Labor Day.

Blue. Light blue, yellow center. Pkt. 25 cts.

Golden Sheaf. (Wilt-resistant.) Double; yellow. Pkt. 25 cts.

Heart of France. (Wilt-resistant.) Medium-sized flowers of rich dark red. Branching plants 1½ to 2 feet high. Blooms in late August. Pkt. 25 cts., ¼oz. 75 cts., oz. \$2.50.

Super Giant, El Monte. This fine Aster received special mention in the 1936 All-America Selections. Large crimson flowers, with interlaced, plume-like petals. Each plant produces 6 to 8 of these huge flowers. Pkt. 25 cts., ¼oz. \$1, oz. \$3.

Asters

Perennial

Michaelmas Daisies. Tall, autumn-flowering Daisies in various shades. **Mixed Colors.** Pkt. 15 cts., ¼oz. 75 cts., oz. \$2.50.

Balloon Vine • Love-in-a-Puff

Annual

A rapid-growing annual climber with dark green leaves and small white flowers, followed by curious balloon-like seed-pods. Pkt. 5 cts., ½oz. 25 cts.

Balsam • Lady's Slipper

Annual

Tall Double, Mixed. Large flowers, resembling camellias, in self colors, as well as spotted and blotched varieties. The seed should either be started inside or sown outdoors late in May when the soil and weather are warm. Pkt. 10 cts., ¼oz. 25 cts., oz. 75 cts.

Begonia

Tender Perennial

The Begonias are great favorites, both as pot-plants in the home in winter and for outdoor bedding during the summer. Seed is fine and must be sown on well-prepared, rich soil in the greenhouse or in shallow boxes placed in a warm, sunny window.

Gracilis, Luminosa. Large bright scarlet flowers. Pkt. 25 cts.

Prima Donna. Light rose-pink flowers. Extra fine. Pkt. 25 cts.

Tuberous-rooted Begonia Bulbs. See page 46.

Bellis • English Daisy

Biennial

Double Giant-flowered, Mixed. Useful for beds and edging, thriving in partial shade or full sun. Will bloom the first year if seed is planted very early under glass but best results are obtained by sowing seed in late summer and carrying over winter in a cold-frame. Fine mixture of colors. Pkt. 10 cts., ¼oz. \$5.



Annual Calliopsis

Calliopsis (Coreopsis) Tickseed

Annual

Easy to grow, free-blooming, and a favorite for cutting. Especially nice for edging beds or for planting in pots. Sow in April or May and thin to stand 6 to 8 inches apart.

Crimson King. Deep crimson, yellow backs.

Drummond. Golden Wave. Medium tall, covered with bright golden yellow flowers with brown centers.

Golden Ray. Golden yellow.

Tiger Star. Yellow and brown.

Mixed. A variety of colors.

All Calliopsis, pkt. 10 cts., 1/4oz. 25 cts., oz. 75 cts.

Cannas

Annual

Large-flowered, Dwarf, Mixed. Saved from brilliantly colored varieties, including red, yellow, and various striking combinations. Pkt. 10 cts., 1/4oz. 25 cts., oz. 75 cts.

For Canna Roots, see page 47.

Campanula Medium Canterbury Bells

Biennial

Lovely, bell-shaped flowers. One of the finest border plants. Sow the seed any time from early June to August, and protect the plants with straw or leaves over winter.

Single Varieties, Mixed. The true "Canterbury Bells." Good mixture of colors. Pkt. 10 cts., 1/4oz. 25 cts., oz. 75 cts.

Calycanthema, Mixed. Cup-and-Saucer. A very pretty double form in a good mixture of colors. Pkt. 15 cts., 1/4oz. 75 cts., oz. \$2.50.



Calendula, Campfire

Calendula • Pot Marigold

Annual

Among the brightest and easiest to grow of all garden annuals. They prefer a sunny location but will thrive on any soil. Sow the seed during April or May and thin the plants to 8 to 10 inches.

Campfire. A vigorous grower with large, brilliant orange flowers having a scarlet sheen and a full yellow center. Pkt. 10 cts., 1/4oz. 25 cts., oz. 75 cts.

Chrysantha (Sunshine). Superb new variety with rich, gleaming yellow flowers like quilled Chrysanthemums. The rays are long and slender, curving inward. Pkt. 10 cts., 1/4oz. 25 cts., oz. 75 cts.

Lemon Queen. Like Orange King but the flowers are clear lemon-yellow. Pkt. 10 cts., 1/4oz. 20 cts., oz. 60 cts.

Orange King. Large, double flowers of deep glowing orange. Pkt. 10 cts., 1/4oz. 20 cts., oz. 60 cts.

Orange Shaggy. Deep orange color, shading lighter at the center of flower. Long, fringed, overlapping petals make the blooms graceful and attractive. Pkt. 10 cts., 1/4oz. 35 cts., oz. \$1.

Radio. A new type. Full flowers with quilled petals; rich glowing orange. Pkt. 10 cts., 1/4oz. 25 cts., oz. 75 cts.

Double Mixed. Pkt. 10 cts., 1/4oz. 20 cts., oz. 60 cts.

Canary-Bird Vine

Tropaeolum peregrinum

Annual

A quick-growing, slender annual vine with light green, fern-like leaves and brilliant yellow flowers. Pkt. 10 cts., 1/2oz. 40 cts., oz. 75 cts.

Carnations

Early Dwarf Double, Mixed. Biennial. Dwarf, erect, free-flowering strain. Extremely hardy. Grows 15 to 18 inches tall. Comes in a wide range of colors. Pkt. 25 cts., 1/4oz. \$1, oz. \$3.

Enfant de Nice, Mixed. Annual. The plants are robust and upright, with long, strong stems and flowers 2 1/2 to 3 inches in diameter. It is the last word in this popular flower. Good mixture of colors. Pkt. 25 cts., 1/8oz. 75 cts.

Grenadin, Cardinal-Red. Perennial. An early-flowering type with large brilliant scarlet blooms. Pkt. 25 cts., 1/4oz. \$1, oz. \$3.

Marguerite, Mixed. Annual. An improved, large-flowering strain. The flowers are very fragrant, and last for a long time when cut. Sow early in May. Pkt. 10 cts., 1/4oz. 60 cts., oz. \$2.



Giant Hyacinth-flowered Candytuft

Candytuft • Iberis

One of the best of all low-growing plants for beds and edging. Sow the seed early in the spring, and when the seedlings are strong enough, thin them to stand 6 to 8 inches apart.

ANNUAL VARIETIES

Giant Empress. Extra-large, pure white flowers. Nice for cutting as well as bedding. Pkt. 10 cts., 1/4oz. 25 cts., oz. 65 cts.

Giant White Hyacinth-flowered. Immense, pure white spikes with large individual bracts. Strong plants. An improved florists' variety for cutting or pot-culture. Pkt. 10 cts., 1/4oz. 25 cts., oz. 65 cts.

Umbellata. Blooms quickly from seed. The flowers are in flat clusters and are produced for many weeks.

Lilac
Rose

Crimson
Mixed

Each, pkt. 10 cts., 1/4oz. 25 cts., oz. 65 cts.

PERENNIAL VARIETIES

Gibraltarica Hybrids. A compact form with lilac flowers. Pkt. 10 cts., 1/4oz. 50 cts., oz. \$1.50.

Sempervirens. Perennial or Evergreen Candytuft. Bears pure white flowers in the spring and the leaves are dark glossy green the year round. Fine for edging. Pkt. 15 cts., 1/4oz. \$1.50, oz. \$5.



Carnation

Cardinal Climber

Annual

A slender, quick-growing vine with exceedingly ornamental, deeply cut leaves, and small, star-shaped flowers of a brilliant cardinal-red, borne in the greatest profusion. Sow after the weather and soil are warm. Pkt. 15 cts., ¼oz. 50 cts., oz. \$1.50.

Castor-Oil Bean • Ricinus

Annual

Extremely large plants that may be used for ornamental hedges, for the center of beds of cannas, and as individual specimens wherever a tropical effect is wanted. Sow in May.

Zanzibarensis. A giant strain, that sometimes grows 12 feet high. Dark green, bronze, or reddish foliage. Pkt. 5 cts., oz. 25 cts., ¼lb. 75 cts., lb. \$2.50.

Finest Mixed. Many different types, varying in color of leaf, stalks, fruit, etc. All large. Pkt. 5 cts., oz. 20 cts., ¼lb. 65 cts., lb. \$2.

Celosia Annual

These make gorgeous beds and are useful also for borders where bright colors and mass effect are desired. The seed should be started indoors in April or sown in well-prepared soil outdoors late in May.

Childsi, Mixed. Chinese Woolflower. A profusion of massive, wool-like flowers in shades of red and pink. Height 3 feet. Sow seed outdoors after danger of frost is past. Pkt. 10 cts., ¼oz. 50 cts., oz. \$1.50.

Cristata, Finest Mixed. Cockscomb. Showy, comb-like heads in a variety of rich colors. Pkt. 10 cts., ¼oz. 50 cts., oz. \$1.50.

CRISTATA PLUMOSA. IMPROVED FEATHER TYPE.

Pride of Castle Gould. Pyramidal growth with large, painted plumes of brilliant red. Fine for either bedding or pot-culture. Pkt. 15 cts., ¼oz. \$1.50.

Scarlet. A brilliant scarlet selection of the lovely feather type. Pkt. 15 cts., ¼oz. \$1.

Cerastium

Perennial

Tomentosum. Snow-in-Summer. A perennial rock-plant with white foliage and starry white flowers. Pkt. 10 cts., ¼oz. 50 cts., oz. \$1.50.

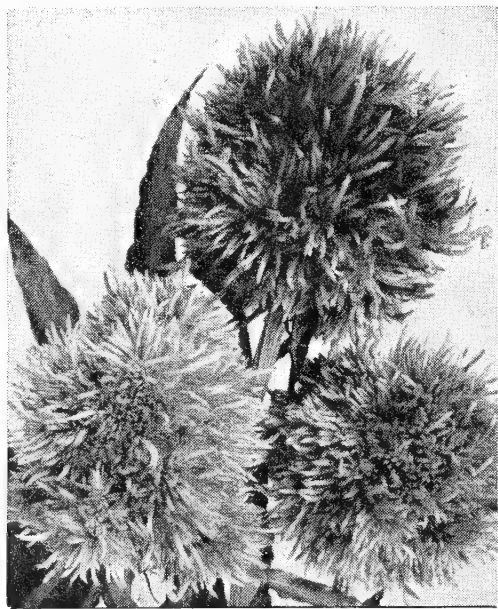

Celosia Childsi (Woolflower)

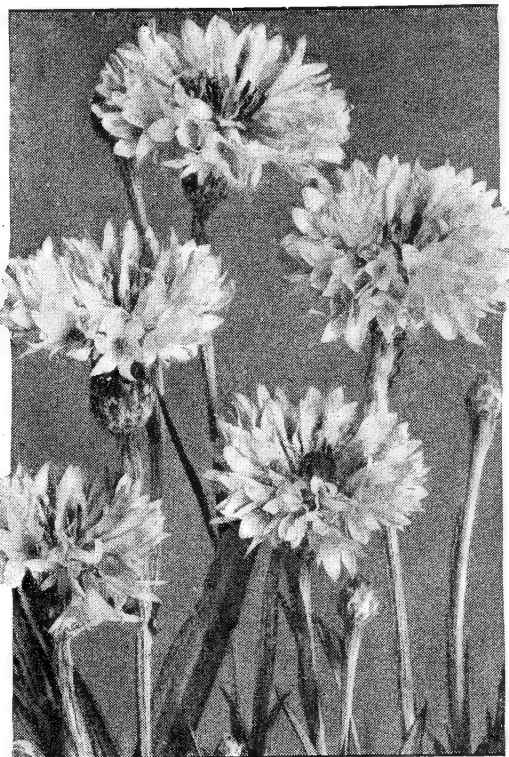

Centaurea cyanus

Centaurea Annual

A family of very popular and easy-to-grow flowers.

CYANUS. Familiarly known as "Cornflower," "Ragged Sailor," or "Bachelor's Button." About 1½ feet tall, thriving in almost any situation and blooming freely for a long season.

Double Blue. Deep blue Cornflower.

Double Maroon. Fine for a mixed bouquet.

Double Rose-Pink. A lovely shade for cutting.

Double White. A pure white Cornflower.

Double, Mixed. A select mixture of many colors.

All above, pkt. 10 cts., ¼oz. 25 cts., oz. 75 cts.

Jubilee Gem. Silver Medal. Plants 12 to 15 inches with double flowers of cornflower-blue. Pkt. 15 cts., ¼oz. 50 cts., oz. \$1.75.

IMPERIALIS. The Giant Sweet Sultan, one of the largest of the Centaurea family and the finest for cut-flowers. The large blooms are borne on long stems and are very fragrant.

Lavender Purple White
Lilac Rose Mixed

All above, pkt. 10 cts., ¼oz. 35 cts., oz. \$1

GYMNOCARPA. Dusty Miller. Grows but a foot high. Excellent for edging beds and borders. Foliage is fern-like and of silvery gray color. Pkt. 10 cts., ¼oz. 35 cts., oz. \$1.

Chrysanthemums

Chrysanthemums thrive in rich soil in any sunny situation and bloom very freely. They require plenty of water.

Coronarum, Double Annual, Mixed. Full-centered flowers in shades of cream, lemon, and gold. Pkt. 10 cts., ¼oz. 35 cts., oz. \$1.

Leucanthemum. Shasta Daisy. Perennial. Hardy plants with lovely white flowers for cutting.

Alaska. Magnificent single flowers of pure white, 5 inches or more in diameter. Pkt. 10 cts., ¼oz. 75 cts., oz. \$2.50.

Alaska, Double. A double form of the above, with beautiful shaggy white flowers. Pkt. 25 cts.

Clarkia

Annual

Elegans. An attractive variety that makes loose, shrubby plants 2 to 3 feet high, covered with dainty flowers. Nice for cutting.

Double and Single, Mixed. Pkt. 10 cts., ¼oz. 30 cts., oz. 75 cts.

Cobaea

Annual

Scandens. Cup-and-Saucer Vine. An annual climber that grows quickly and makes a good screen of foliage. The flowers are large and bell-shaped, blue in color. Pkt. 10 cts., ¼oz. 30 cts., oz. 75 cts.

Coleus

Annual

Choice Mixed. Popular bedding plants grown for their ornamental variegated foliage. Sow seed in boxes indoors and transplant to the open late in May. Pkt. 25 cts.

Coreopsis

Perennial

Double Sunburst. Large, golden yellow, fully double flowers 3 to 3½ inches in diameter. A superb cut-flower, or a mass of garden color. Pkt. 15 cts., ¼oz. 35 cts., oz. \$1.

Grandiflora. Easily grown from seed sown any time during late spring or summer and, being perfectly hardy, the plants require no protection in winter and will live for years. Pkt. 10 cts., ¼oz. 25 cts., oz. 75 cts.

Corn, Ornamental Indian

Annual

The kernels are of various bright colors and are used in making Charm or Patio Strings. Pkt. 10 cts., ½oz. 40 cts., oz. 75 cts.

Cypress Vine

Annual

Finest Mixed. A graceful, slender climber with very finely cut foliage and bright little flowers which are produced in the greatest profusion. Pkt. 10 cts., ¼oz. 60 cts., oz. \$2.



Cerastium tomentosum



Cosmos

Cosmos

Annual

Their free-blooming habit and graceful flowers make the Cosmos one of the most popular flowers for late summer and fall use. Sow seed outdoors about May 1, or, if possible, start the seed indoors in early March.

Early Klondyke, Orange Flare. Gold Medal, 1935 All-America Selections. Deep brilliant orange flowers, borne on long stems. Nice for cutting. Plants 2 to 3 feet high. Pkt. 15 cts., $\frac{1}{4}$ oz. 50 cts., oz. \$1.50.

Extra-Early, Double-crested. An improved strain of the double-flowering form of Cosmos, and while the flowers vary in degree of doubleness, all are beautiful.

Pink Beauty. Soft rosy pink.

Crimson King. Deep rose-crimson.

White Queen. Pure white.

Finest Mixed. All colors.

All Double-crested Cosmos, pkt. 15 cts., $\frac{1}{4}$ oz. 85 cts., oz. \$2.75

Lady Lenox. Blooms enormous, of a most attractive shade of shell-pink. Pkt. 10 cts., $\frac{1}{4}$ oz. 25 cts., oz. 75 cts.

Mammoth Early-flowering, Mixed. Large-flowered strain which blooms early. Best to use for late sowings outdoors. Pkt. 10 cts., $\frac{1}{4}$ oz. 25 cts., oz. 75 cts.

Mammoth Late-flowering, Mixed. Plants 6 to 8 feet, blooming in September. Large flowers 4 to 5 inches across. Pkt. 10 cts., $\frac{1}{4}$ oz. 25 cts., oz. 75 cts.

Sensation. Award of Merit, 1936 All-America Selections. Flowers 4 to 5 inches across, on long stems, from 4-foot plants. Blooms for 10 weeks from sowing. Flowers Pink and White. Pkt. 15 cts., $\frac{1}{4}$ oz. 85 cts., oz. \$3.

Cynoglossum

Chinese Forget-Me-Not

Amabile, Blue Bird. Splendid plants growing $1\frac{1}{2}$ to 2 feet tall and bearing a profusion of bloom from May until frost. The Forget-me-not-like flowers are a fine shade of bright blue and are in nice sprays suitable for cutting. Pkt. 10 cts., $\frac{1}{4}$ oz. 60 cts., oz. \$2.

Dahlias

Annual

It is easy to raise Dahlias from seed, if started early in spring in hotbed or in a warm window. Set plants out late in May in sunny location, a foot or more apart.

Cactus-flowered, Mixed. Seed saved from the best Cactus type. Pkt. 25 cts.

Double, Finest Mixed. Seed saved from some of the best named sorts. Pkt. 10 cts., $\frac{1}{4}$ oz. 75 cts., oz. \$2.50.

Single, Fine Mixed. Seed saved from select flowers of single varieties. Pkt. 10 cts., $\frac{1}{4}$ oz. 30 cts., oz. \$1.

UNWIN'S DWARF HYBRIDS. Blooms in sixty days from seed sown in the garden. Easily grown and unsurpassed as cut-flowers. Flowers are semi-double, 3 inches in diameter, and come in a range of colors. Pkt. 10 cts.

Delphinium Perennial Larkspur

The finest of blue flowers for the hardy border are the Perennial Larkspurs. Sow the seed in May or June and transplant about 1 foot apart in early September.

Belladonna. Long, loose spikes of delicate light blue flowers, of supreme value for cutting. Pkt. 25 cts., $\frac{1}{8}$ oz. 75 cts., $\frac{1}{4}$ oz. \$1.25.

Bellamosa. This is a taller, straighter plant than Belladonna, and the flowers are rich clear blue, several shades darker. Pkt. 25 cts., $\frac{1}{8}$ oz. 75 cts., $\frac{1}{4}$ oz. \$1.25.

Blackmore & Langdon Strain, Mixed. Lovely flowers in a wide range of colors. Strong plants with excellent spikes. Pkt. 50 cts.

Cardinale. A native Delphinium with long-spurred brilliant scarlet flowers on 3-foot plants. Pkt. 25 cts., $\frac{1}{8}$ oz. 75 cts., $\frac{1}{4}$ oz. \$1.25.

Kelway's Gold Medal Hybrids. A famous English strain of great size and vigor, producing flowers in all shades of blue. Pkt. 25 cts., $\frac{1}{8}$ oz. 50 cts., $\frac{1}{4}$ oz. 75 cts., oz. \$2.25.

Pacific Giants. Flowers are of immense size, tightly set on straight, strong stems. White. Pkt. 50 cts.

Mixed Colors. Shades of blue, lavender, pink, and clear white. Pkt. 50 cts., $\frac{1}{8}$ oz. \$1.25, $\frac{1}{4}$ oz. \$2, $\frac{1}{2}$ oz. \$3.50, oz. \$6.

Wrexham (Hollyhock Strain). Sturdy plants producing conical spikes of flowers 2 inches or more across, and $2\frac{1}{2}$ to 3 feet long. Colors range from clear light blues and lavenders to shades of deep blue, purple, and mauve. Pkt. 25 cts., $\frac{1}{8}$ oz. \$1.25, $\frac{1}{4}$ oz. \$2.

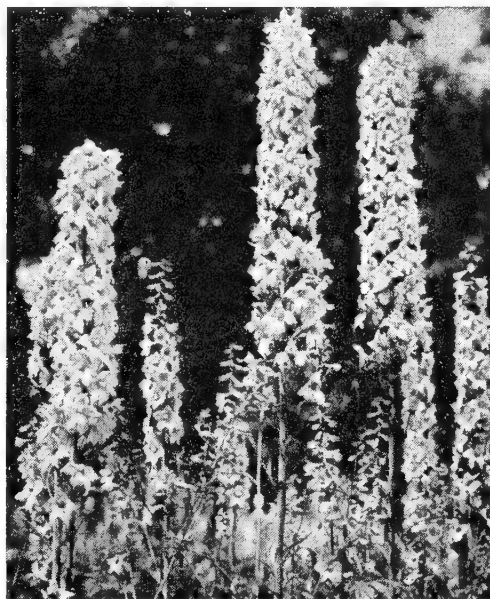

Delphiniums

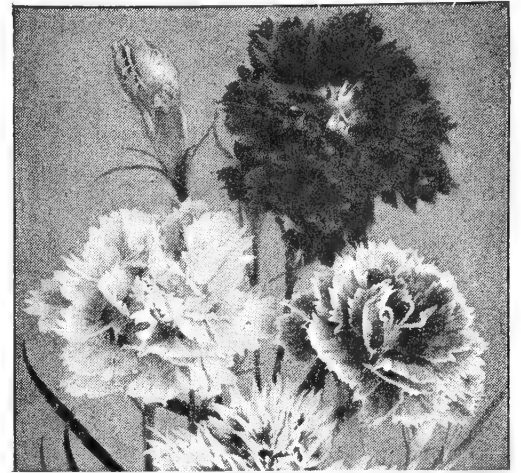

Dianthus Heddewigi

Didiscus

Annual

Cærulea. Blue Lace Flower. Exquisite, lacelike flower-heads of dainty azure-blue, gracefully borne on long stems. Sow seed in March in hotbed and outdoors in May and June. Pkt. 10 cts., $\frac{1}{4}$ oz. 35 cts., oz. \$1.

Dianthus

A large family of easily grown flowers loved for their fragrance and all-round usefulness.

Chinensis, Double. China Pink. Annual. All plants 20 inches high, with flowers in clusters, in many bright colors. Free-blooming type. Pkt. 10 cts., $\frac{1}{4}$ oz. 35 cts., oz. \$1.

Deltoides. Maiden Pink. Perennial. A creeping rock-garden plant with deep rose-colored flowers on 8-inch stems in midsummer. Pkt. 15 cts., $\frac{1}{4}$ oz. 75 cts., oz. \$2.50.

Heddewigi. Japanese Pinks. Annual. Dwarf, compact plants 10 to 12 inches tall, with large, spectacular flowers, fine for cutting as well as making a grand garden display.

Double, Fireball. Crimson.

Double, Mourning Cloak. Blackish maroon, margined white.

Double, Violet Queen. Violet.

Double, Mixed. All colors.

All Heddewigi, pkt. 10 cts., $\frac{1}{4}$ oz. 40 cts., oz. \$1.25

Single, Mixed. Pkt. 10 cts., $\frac{1}{4}$ oz. 25 cts., oz. 75 cts.

Plumarius. Garden Grass Pinks. Perennial. The Pheasant-Eye, or Clove Pink should be in every garden. Plants 8 to 10 inches, with grass-like foliage and fragrant, fringed flowers. Sow from April to August.

Single, Mixed. Many beautiful colors. Pkt. 10 cts., $\frac{1}{4}$ oz. 35 cts., oz. \$1.

Digitalis • Foxglove

Biennial

A plant for the back of the border. Spikes of thin, tubular flowers on plants 3 to 4 feet tall, during June and July. Sow in early summer and transplant in the fall.

Hybrida Lutzii. Magnificent, 4-foot plants with lovely salmon flowers. Pkt. 15 cts., $\frac{1}{4}$ oz. 75 cts.

Isabelina. Fine spikes of yellow blossoms that deepen to chamois. Sold out.

The Shirley, Giant Hybrids. An excellent strain with large flowers ranging in color from white to dark rose, each with throats spotted with crimson, maroon or chocolate. Plants 5 to 7 feet tall, with 4-foot spikes of bloom. Pkt. 15 cts., $\frac{1}{4}$ oz. 75 cts.

Finest Mixed. All types and colors. Pkt. 10 cts., $\frac{1}{4}$ oz. 50 cts., oz. \$1.50.



Dimorphotheca

Dimorphotheca African Daisy

Annual

Dwarf plants, 12 to 15 inches high, with foliage close to the ground. Daisy-like flowers 2 to 3 inches across, with narrow petals. Flowers close toward evening.

Aurantiaca, Mixed. Shades of yellow, orange, and white. Pkt. 10 cts., $\frac{1}{4}$ oz. 35 cts., oz. \$1.

Aurantiaca, Orange, Improved. An improved strain of the original orange variety. Pkt. 10 cts., $\frac{1}{4}$ oz. 35 cts., oz. \$1.

Dolichos • Hyacinth Bean

Annual

Lablab, Mixed. Very pretty annual climber quickly growing 8 to 10 feet and bearing quantities of clustered flowers like pea blossoms, followed by lustrous purple pods. Good mixture of colors. Sow the seed in late May. Pkt. 10 cts., $\frac{1}{2}$ oz. 30 cts.

Eschscholtzia California Poppy

Annual

These hardy little annuals make very bright beds and bloom from June until frost. Flowers resemble single Poppies. Sow in early spring, where they are to bloom.

SPREADING VARIETIES

Aurantiaca. Orange.

Carmine King. Deep carmine.

Chrome Queen. Amber-yellow.

Mikado. Orange-crimson.

The Geisha. Brilliant gold inside, orange-crimson outside, fluted.

All Eschscholtzias, pkt. 10 cts., $\frac{1}{4}$ oz. 35 cts., oz. \$1

Mixed. All colors. Pkt. 10 cts., $\frac{1}{4}$ oz. 20 cts., oz. 60 cts.

ERECT VARIETY

Ramona. Golden bronze, coppery rose outside, frilled and incurved. Sold out.

Euphorbia

Annual

Variegata. "Snow-on-the-Mountain." Showy plants growing about 2 feet high, with ornamental deep green foliage, bordered and marked with white. Seed should be sown during May. Pkt. 10 cts., $\frac{1}{4}$ oz. 20 cts., oz. 60 cts.



Eschscholtzia, Ramona

Four o'Clock • Mirabilis

Annual

Jalapa, Mixed. "Marvel of Peru." Makes most effective beds and annual hedges. The plants grow about 2 feet tall, bearing quantities of fragrant flowers which open late in the afternoon. Pkt. 10 cts., oz. 25 cts., $\frac{1}{4}$ lb. 75 cts., lb. \$2.50.

Gaillardia • Blanket Flower

Extra-good bedding plants, and especially desirable cut-flowers.

Burgundy. Perennial. A new variety with large, wine-colored flowers. Very choice. Pkt. 25 cts., $\frac{1}{4}$ oz. 90 cts., oz. \$3.

Maxima aurea. Perennial. Rich golden yellow flowers with a large red eye. Pkt. 25 cts., $\frac{1}{4}$ oz. 75 cts., oz. \$2.50.

Picta, Mixed. Annual varieties in various colors. Pkt. 10 cts., $\frac{1}{4}$ oz. 25 cts., oz. 75 cts.

The Dazzler. Perennial. Very large flowers of blazing orange-scarlet, illumined by a brilliant yellow edge at the tip of each ray or petal. Pkt. 25 cts., $\frac{1}{4}$ oz. 75 cts., oz. \$2.50.

Geranium

Annual

Fine Mixed. Great favorites for bedding and window-boxes. Seed saved from the choicest varieties. Pkt. 25 cts., $\frac{1}{4}$ oz. \$1, oz. \$3.



Geum, Mrs. Bradshaw



Gaillardia, The Dazzler

Geum • Avens

Perennial

Lady Stratheden. Practically the same plant as Mrs. Bradshaw, except that the flowers are shining golden yellow. Pkt. 10 cts., $\frac{1}{4}$ oz. 75 cts., oz. \$3.

Mrs. Bradshaw. Handsome, fairly dwarf border plant with attractive foliage, and double scarlet flowers with crimped and ruffled petals. Pkt. 10 cts., $\frac{1}{4}$ oz. 75 cts., oz. \$3.

Globe Amaranth Gomphrena

Annual

Mixed Colors. The plants grow 2 to 3 feet tall, with globe-shaped flowers which may be cut and dried in their natural color for winter bouquets. Pkt. 10 cts., $\frac{1}{4}$ oz. 25 cts., oz. 75 cts.

Godetia • Satin Flower

Annual

The plants are bushy, with attractive foliage, and the flowers are quite large, somewhat resembling single hollyhocks. Godetias make fine pot-plants.

Dwarf Double Azalea-flowered, Mixed. Lovely azalea-like flowers in various brilliant colors. Pkt. 10 cts., $\frac{1}{4}$ oz. 25 cts., oz. 75 cts.

Sybil Sherwood. An upright plant with single flowers of bright salmon-pink. Pkt. 10 cts., $\frac{1}{4}$ oz. 50 cts., oz. \$1.50.

Gourds

Annual

In addition to their interesting fruit, many of which are useful as well as ornamental, the vines have large foliage excellent for covering fences, stumps, trellises, etc. Sow the latter part of May.

Calabash Pipe or Powder-Horn. An intriguing pipe-shaped variety. Pkt. 10 cts., oz. 40 cts., $\frac{1}{4}$ lb. \$1.

Cave-Man's Club. Dark green; knobby; club-shaped. Pkt. 10 cts., oz. 40 cts., $\frac{1}{4}$ lb. \$1.

Dipper. The ripe fruits, cut away and cleaned out, make very serviceable dippers. Pkt. 10 cts., oz. 40 cts., $\frac{1}{4}$ lb. \$1.

Dish-Cloth. Sometimes called Sponge Gourd. Pkt. 10 cts., oz. 40 cts., $\frac{1}{4}$ lb. \$1.

Ornamental, Mixed. Includes a great number of interesting and diverse forms. Pkt. 10 cts., oz. 40 cts., $\frac{1}{4}$ lb. \$1.

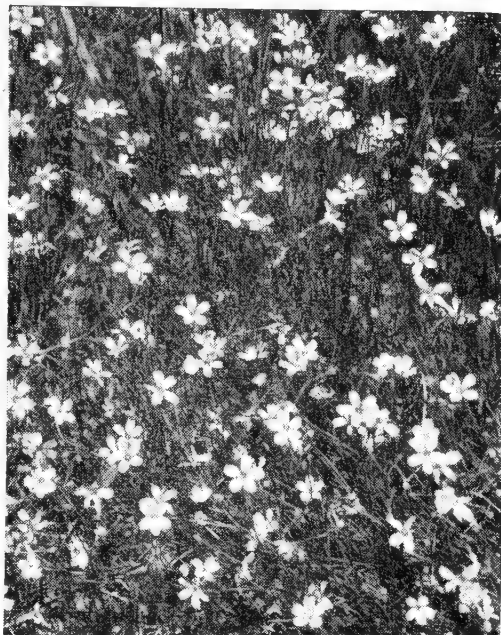

Gypsophila elegans alba grandiflora

Gypsophila • Baby's Breath

These are largely used in making up bouquets and are also most attractive garden plants.

Elegans alba grandiflora. Annual Baby's Breath. An improved strain with pure white flowers. Pkt. 10 cts., $\frac{1}{4}$ oz. 20 cts., oz. 60 cts.

Paniculata alba, Single. Perennial. Tiny white flowers in airy sprays. Excellent for cutting. Pkt. 10 cts., $\frac{1}{4}$ oz. 25 cts., oz. 75 cts.

Paniculata alba, Double. Fine sprays of little, double, pure white flowers. Dries nicely for winter bouquets. Pkt. 25 cts., $\frac{1}{8}$ oz. \$1.

Repens alba. Perennial. A trailing variety, not over 6 inches high, with white flowers in July and August. Pkt. 10 cts., $\frac{1}{4}$ oz. 50 cts., oz. \$1.50.

Repens rosea. Perennial. Rose-colored variety of the above. Pkt. 10 cts., $\frac{1}{4}$ oz. 50 cts., oz. \$1.50.

Helianthemum • Sun Rose

Perennial

Mutabile, Mixed. Rock-plant of shrubby habit, growing 8 to 12 inches high. Foliage evergreen. Flowers of pastel shades. Pkt. 10 cts., $\frac{1}{4}$ oz. 50 cts., oz. \$1.50.

Helianthus • Sunflower

Annual

Sow the seed in April or May and give the plants plenty of room. Fine for massive borders and backgrounds.

Dwarf Double Chrysanthemum-flowered. Strong plants, growing 4 to 5 feet high, with many branches bearing big, double flowers like golden chrysanthemums. Pkt. 10 cts., $\frac{1}{4}$ oz. 25 cts., oz. 75 cts.

Mammoth Russian. The common variety and the largest and most productive, growing to a height of 6 to 8 feet. Oz. 10 cts., $\frac{1}{4}$ lb. 20 cts., lb. 50 cts.

Maroon Prince. Single red flowers on 4-foot plants. The best red Sunflower. Pkt. 10 cts., $\frac{1}{4}$ oz. 35 cts., oz. \$1.

Miniature (*H. cucumerifolius*). Single bright yellow flowers, with dark brown centers. Fine for cutting as well as display. Pkt. 10 cts., $\frac{1}{4}$ oz. 25 cts., oz. 75 cts.

Helichrysum • Everlasting

Annual

The best of the "Straw Flowers." To preserve the flowers for permanent bouquets, pick them when half opened and hang them by the stems, head down, to dry in a shady place. Double, bright-colored flowers.

Fireball or Scarlet **Salmon Queen**
Goldenball **Silverball**
Rose Queen **Violet Queen**
 Finest Mixed

All Helichrysums, pkt. 10 cts., $\frac{1}{4}$ oz. 25 cts., oz. 75 cts.

Heliotrope

Annual

Choice Mixed Colors. Prized for its delightful fragrance. Can be grown in pots or in the garden. Start the seed indoors in March, or sow outdoors after the soil and weather are warm. Pkt. 15 cts., $\frac{1}{4}$ oz. \$1.50.

Hesperis • Rocket

Perennial

Matronalis. Sweet Rocket. The plants make large clumps 2 to 3 feet high, with showy spikes of red flowers. Pkt. 10 cts., $\frac{1}{4}$ oz. 35 cts., oz. \$1.

Hibiscus • Marsh-Mallow

Perennial

Finest Mixed. Shrubby perennials 4 to 6 feet tall with large foliage and immense, funnel-shaped flowers 6 to 12 inches across. Fine mixture of colors. Pkt. 10 cts., $\frac{1}{4}$ oz. 35 cts., oz. \$1.

Hollyhock

Wherever tall-growing plants can be used these are wonderfully effective, with a charm all their own. A favorite for the old-fashioned garden.

Chater's Double, Mixed. Perennial. An extra-fine strain in many bright colors. Pkt. 10 cts., $\frac{1}{4}$ oz. 60 cts., oz. \$2.

Indian Spring. Annual. Silver Medal, 1939 All-America Selections. Semi-double, frilled pink flowers in 5 months from seed. Plants 4 to 5 feet tall. A splendid novelty. Pkt. 15 cts.

Single, Finest Mixed. Perennial. Lovely single flowers in a wide range of colors. Pkt. 10 cts., $\frac{1}{4}$ oz. 25 cts., oz. 75 cts.

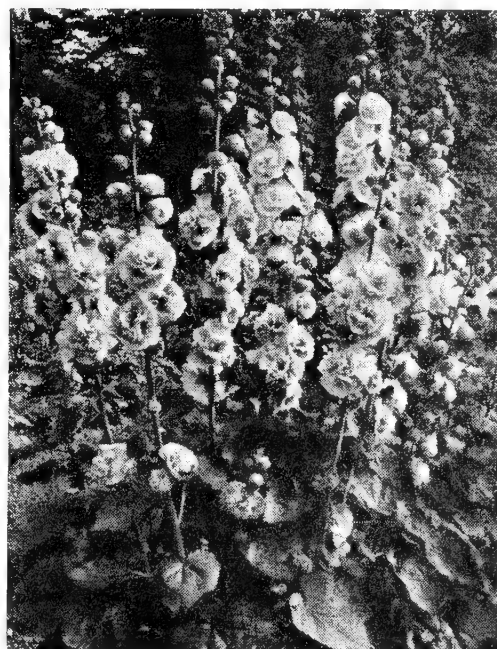

Double Hollyhocks

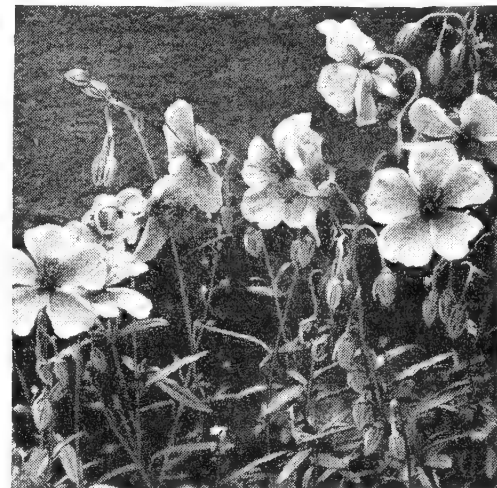

Helianthemum mutabile

Honesty • Lunaria

Biennial

An easily grown plant, about 1 $\frac{1}{2}$ feet high. The blooms may be dried for winter bouquets. Violet or White, pkt. 15 cts., $\frac{1}{4}$ oz. 60 cts., oz. \$2.

Humulus • Hop Vine

Annual

A very rapid-growing annual vine which, on account of its dense, attractive foliage, is valuable for porch-screens and arbors.

Green-leaved or **Variegated-leaved.** Pkt. 10 cts., $\frac{1}{4}$ oz. 25 cts., oz. 60 cts.

Hunnemannia • Tulip Poppy

Annual

Sunlite. Semi-double flowers of clear canary-yellow. Very desirable. Grows 1 $\frac{1}{2}$ to 2 feet tall, with many blooms all summer. Pkt. 10 cts., $\frac{1}{4}$ oz. 35 cts., oz. \$1.

Ipomoea • Morning-Glory

Annual

Fine for covering fences and trellises on account of their rapid, luxuriant growth. They bloom freely all summer. The seed may be soaked in warm water over night to hasten germination.

Heavenly Blue. Blue Moonflower. An early strain of this lovely flower. Deep sky-blue flowers of large size from mid-summer until frost. Start seeds under glass, early. Pkt. 15 cts., $\frac{1}{4}$ oz. 35 cts., $\frac{1}{2}$ oz. 60 cts., oz. \$1.

Imperial Mixed. Large flowers of various pleasing colors. Sow as soon as ground gets warm. Pkt. 10 cts., oz. 40 cts., $\frac{1}{4}$ lb. \$1.25, lb. \$4.

Noctiflora. White Moonflower. Large white flowers. Pkt. 10 cts., $\frac{1}{4}$ oz. 20 cts., oz. 50 cts.

Pearly Gates. A satiny white sport of Heavenly Blue. The 3-inch trumpets are perfect companions for the blue parent. Blooms early. Pkt. 25 cts.

Scarlett O'Hara. Large flowers 3 $\frac{1}{2}$ inches across, of bright carmine, are freely produced on vigorous twining vines from early summer until late fall. Pkt. 15 cts., $\frac{1}{4}$ oz. 75 cts., $\frac{1}{2}$ oz. \$1.25, oz. \$2.25.

Job's Tears • Coix

Annual

Lacryma. An ornamental grass which grows 2 to 3 feet high and bears large, ivory-white seeds from which it gets its name. The children make necklaces from the hard seeds. Pkt. 10 cts., $\frac{1}{4}$ oz. 20 cts., oz. 50 cts.

Kochia*Annual*

Scoparia trichophylla. Summer Cypress; Mexican Firebush. Grows about 2 feet high making beautifully rounded bushes like clipped evergreens. In summer, foliage is bright, light green but in fall the whole plant is a ball of crimson. Sow seed in late May. Pkt. 10 cts., $\frac{1}{4}$ oz. 25 cts., oz. 75 cts.

Lantana*Annual*

Dwarf Hybrids, Mixed. Desirable bedding plants, giving a mass of color; also useful in porch-boxes and pots. Flowers are in clusters. Blooms constantly. Pkt. 15 cts., $\frac{1}{4}$ oz. 60 cts., oz. \$1.75.

Larkspur*Annual*

Favorite, easy-to-grow annuals, producing their tall spikes very freely for several weeks during summer. They are most effective planted in the border in groups among lower-growing flowers. Sow the seed in April and thin or transplant to stand 8 to 10 inches apart.

GIANT IMPERIAL. A new strain of annual Larkspurs that grows 3 to 4 feet high. Fine well-filled spikes.

Blue Bell. Deep sky-blue.

Blue Spire. Clear violet-blue.

Carmine King. Deep, glowing pink with a fiery sheen, almost scarlet.

Daintiness. Delicate lavender.

Miss California. Brilliant rose-pink.

White King. Pure white.

Mixed. All colors.

All above Larkspurs, pkt. 25 cts., $\frac{1}{4}$ oz. 75 cts.

Pink Perfection. Lovely, long-lasting flowers of clear pink. Pkt. 25 cts.

TALL DOUBLE STOCK-FLOWERED. Plants 3 feet tall, with candelabra-like branches and long spikes closely set with large, double flowers.

Rosamond. A lovely shade of pure bright rose. Pkt. 25 cts., $\frac{1}{4}$ oz. \$1.

Fine, Mixed. All the colors of this type. Pkt. 10 cts., $\frac{1}{4}$ oz. 25 cts., oz. 75 cts.

DWARF EMPEROR, MIXED. A dwarf, compact strain not over 2 feet tall in an unusual range of colors. Pkt. 10 cts., $\frac{1}{4}$ oz. 25 cts., oz. 75 cts.

For Hardy Larkspur, see Delphiniums, page 35.



Lupinus

Lathyrus**Everlasting or Hardy Sweet Pea***Perennial*

Finest Mixed. Hardy climbers, attaining a height of 5 to 6 feet each season and living from year to year. Flowers resemble the old-fashioned Sweet Peas except that they have no fragrance. Pkt. 10 cts., $\frac{1}{2}$ oz. 45 cts., oz. 75 cts.

Lily • Lilium*Perennial*

Regale. Most popular and easiest to grow of all Lilies, flowering abundantly within 18 months from seed. Perfectly hardy. Pkt. 25 cts.

For Lily Bulbs, see page 47.

Linum • Flax*Perennial*

Showy plant with gray-green foliage and flowers of great delicacy and beauty.

Perenne, Blue. Perennial. Very graceful, bright blue flowers.

Grandiflorum rubrum. Annual. Very showy crimson-scarlet flowers. Blooms all summer.

Either of above, pkt. 10 cts., $\frac{1}{4}$ oz. 25 cts., oz. 75 cts.

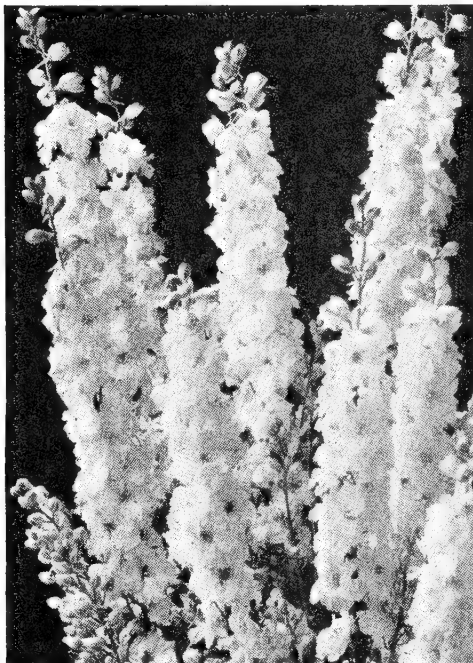

Larkspur, Giant Imperial

Linaria • Toadflax*Annual*

Slender little plants a foot high, bearing dainty, miniature Snapdragons of pink and purple. Excellent for edging.

Maroccana, Fairy Bouquet, Mixed. Compact, 8-inch plants with flowers of various pastel shades. Pkt. 25 cts.

Maroccana, Hybrid Excelsior, Mixed. Plants 1 foot high, with flowers of bright shades. Pkt. 10 cts., $\frac{1}{4}$ oz. 25 cts.

Lobelia*Annual*

Crystal Palace Compacta. Rich dark blue flowers. Dark green foliage. Dainty little plants, popular for porch-boxes, vases, and low beds. Seed should be started indoors in February or March and the plants set out in May. Pkt. 15 cts., $\frac{1}{4}$ oz. \$1.50.

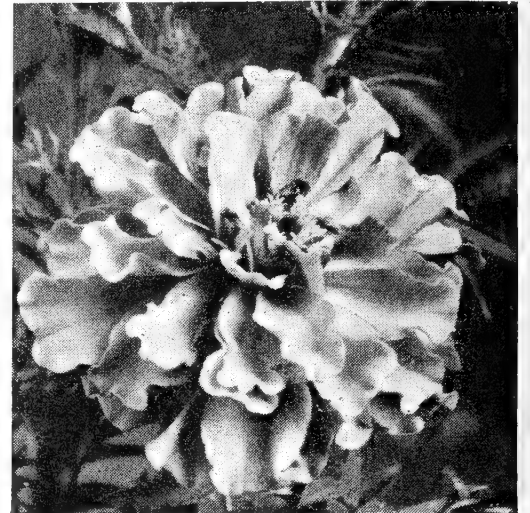

Marigold, Guinea Gold. See page 39

Lupinus • Lupin

The Lupins do well in any good garden soil, preferably with a little shade. They make bushy plants with very attractive leaves and long spikes, closely set with blossoms. Give them plenty of lime, wood-ashes, bonemeal, or other soil-sweetening fertilizers.

Hartwegi, Mixed Colors. Annual. Quick-growing annuals with woolly foliage and stems. Erect spikes with pea-shaped flowers. Pkt. 10 cts., $\frac{1}{4}$ oz. 25 cts., oz. 75 cts.

Polyphyllus, Mixed Colors. Perennial. Grows 2 $\frac{1}{2}$ to 3 feet tall. Sow in May or June and thin to 1 $\frac{1}{2}$ feet apart. Pkt. 10 cts., $\frac{1}{4}$ oz. 25 cts., oz. 75 cts.

Russell. A new English strain with large flowers in colors of rich yellows, oranges, red, and bicolors. Pkt. 25 cts.

Mesembryanthemum*Annual*

Crystallinum. Ice Plant. Dwarf annual with tender stems and leaves, portions of which are transparent and resemble little icicles. Pkt. 10 cts., $\frac{1}{4}$ oz. 25 cts., oz. 75 cts.

Tricolor. Brilliant red and white, with black centers. Pkt. 10 cts., $\frac{1}{4}$ oz. 50 cts., oz. \$1.50.

Mignonette • Reseda*Annual*

Highly valued for its distinct fragrance.

Giant Machet. An improved strain with giant spikes of reddish green florets. Pkt. 10 cts., $\frac{1}{4}$ oz. 25 cts., oz. 75 cts.

Machet, Special Mixed. Contains all the Machet varieties. Pkt. 10 cts., $\frac{1}{4}$ oz. 20 cts., oz. 60 cts.

Matricaria • Feverfew*Annual*

Double, white, button-shaped flowers on aromatic plants. Pkt. 10 cts., $\frac{1}{4}$ oz. 35 cts., oz. \$1.

Mimulus*Annual*

Moschatus. Musk Plant. Musk-scented foliage and small yellow flowers. Nice for baskets and vases. Pkt. 10 cts., $\frac{1}{8}$ oz. \$2.

Myosotis • Forget-me-not*Biennial*

Alpestris. A biennial but it will bloom the first summer from seed sown in early spring. If early spring flowers are wanted, sow in July and transplant the young plants to their permanent bed about the middle of September. Pkt. 10 cts., $\frac{1}{8}$ oz. 75 cts.

MARIGOLD • Tagetes (Annual)

Vigorous, free-blooming annuals, thriving on any soil but preferring plenty of sunlight. The African Marigolds grow about 3 feet tall with immense, globular blooms, while the dwarf French kinds are only about 10 inches high with smaller flowers but more of them.

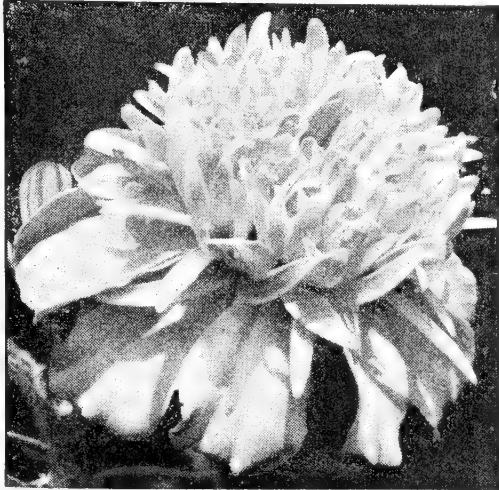

Marigold, Crown of Gold

Double Tall African Marigold

Dixie Sunshine. All-America Winner. A tall, late-blooming variety with ball-shaped flowers of golden yellow. Pkt. 25 cts., $\frac{1}{4}$ oz. 75 cts., oz. \$2.

Guinea Gold. All-America Winner. Double, ruffled flowers of pure deep golden yellow, fragrant. Pkt. 10 cts., $\frac{1}{4}$ oz. 35 cts., oz. \$1.

Lemon Queen. A companion to Prince of Orange, but clear lemon-yellow. Pkt. 10 cts., $\frac{1}{4}$ oz. 75 cts., oz. \$2.

Prince of Orange. Very large and double; deep glowing orange. Pkt. 10 cts., $\frac{1}{4}$ oz. 50 cts., oz. \$1.50.

Yellow Supreme. All-America Winner. Extra-large flowers, 3 inches or more across, brilliant lemon-yellow. Pkt. 15 cts., $\frac{1}{4}$ oz. 50 cts., oz. \$1.50.

Mixed. Shades of orange and yellow. Pkt. 10 cts., $\frac{1}{4}$ oz. 35 cts., oz. \$1.

French Marigolds

Ferdinand. A tall French Marigold with brown rays and golden tufts. Pkt. 15 cts., $\frac{1}{4}$ oz. 50 cts., oz. \$1.50.

Harmony, Dwarf Double. An extra-early variety, making 12-inch mounds of bloom. The flowers are a large-crested cushion of golden yellow petals surrounded by mahogany ray petals. Pkt. 10 cts., $\frac{1}{4}$ oz. 50 cts., oz. \$1.50.

Legion of Honor, Dwarf Single. Bushy. Flowers gold and brown. Pkt. 10 cts., $\frac{1}{4}$ oz. 35 cts., oz. \$1.

Royal Scot, Tall Double. Large flowers of mahogany and gold in symmetrical stripes on 30-inch plants. Pkt. 15 cts., $\frac{1}{4}$ oz. 50 cts., oz. \$1.50.

Royal Scot, Dwarf Double. Plants 12 to 15 inches tall with flat flowers irregularly striped brown and gold. Pkt. 15 cts., $\frac{1}{4}$ oz. 50 cts., oz. \$1.50.

Finest Mixed, Dwarf Double. Double flowers of orange and yellow, variously striped and marked with reddish brown. Pkt. 10 cts., $\frac{1}{4}$ oz. 35 cts., oz. \$1.

Other Marigolds

Collarette, Crown of Gold. Gold Medal, 1937 All-America Selections. Chrysanthemum-type flowers of deep orange surrounded by a collar of flat guard petals. Scentless foliage. Pkt. 10 cts., $\frac{1}{4}$ oz. 50 cts., oz. \$1.50.

MARIGOLD, continued

Early Sunrise. Chrysanthemum-flowered golden yellow. Pkt. 25 cts., $\frac{1}{4}$ oz. 75 cts., oz. \$2.

Orange Sunset. Immense, rich orange flowers of the Gigantea type. A glorious Marigold. Pkt. 15 cts., $\frac{1}{4}$ oz. 75 cts., oz. \$2.50.

Pot O'Gold. Dwarf plants 15 inches tall, bearing 4-inch blooms of deep golden orange. The little plants will carry a dozen blooms at a time. Pkt. 25 cts.

Signata Pumila, Little Giant. Spreading plants 6 inches high, covered with lovely little single flowers of golden yellow. Pkt. 15 cts., $\frac{1}{4}$ oz. 75 cts., oz. \$2.

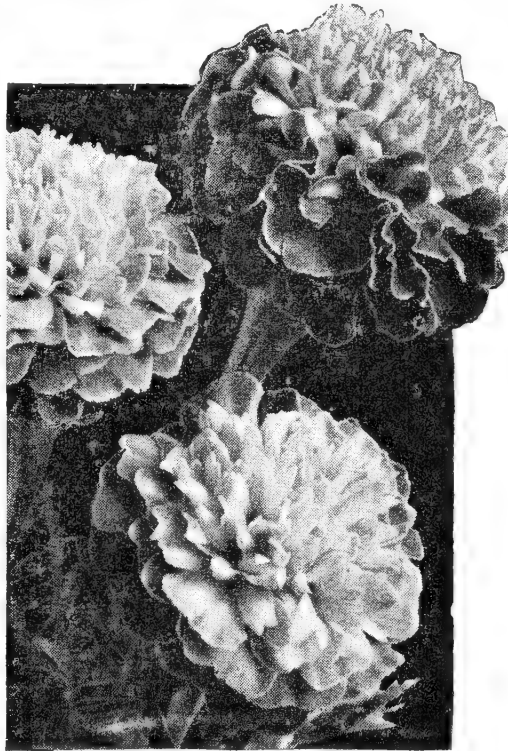

Marigold, Harmony

Momordica

Annual

Vigorous climbing vines with ornamental fruits, and foliage that is dense enough to make a pleasant shade.

Balsamina. Balsam Apple. Flowers yellow, with dark centers. Fruits orange. Pkt. 10 cts., $\frac{1}{4}$ oz. 25 cts., oz. 75 cts.

Charantia. Balsam Pear. Pear-shaped fruits. Dense foliage. Pkt. 10 cts., $\frac{1}{4}$ oz. 25 cts., oz. 75 cts.

Nicotiana

Sweet-scented Tobacco

Annual

Fine annuals for the tall border, thriving best on a deep, rich soil. They grow about 2½ feet high, with large, attractive foliage at the base and clusters of delicately fragrant trumpet-shaped flowers on long stems.

Affinis Hybrids. Pink and red shades in addition to white. A fine sweet-scented strain. Pkt. 10 cts., $\frac{1}{4}$ oz. 35 cts., oz. \$1.

Sanderæ Hybrids. The flowers are larger than the preceding and come in white and shades of pink and red. Pkt. 10 cts., $\frac{1}{4}$ oz. 35 cts., oz. \$1.

Nasturtiums

Annual

We know of no flowers that are easier to grow or give more general satisfaction than Nasturtiums. They do best in poor soil and they flower all summer long in all kinds of weather.

SEMI-DOUBLE VARIETIES

Dwarf Golden Globe. All-America Winner. Flowers deep golden yellow, sweet scented. Plants produce a great number of blooms which resemble the famous Golden Gleam.

Glorious Gleam Hybrids. All-America Winner. From Golden Gleam and Scarlet Gleam has been derived this remarkable new strain with glorious, semi-double flowers in a beautiful array of brilliant colors, all very sweetly scented. Every plant is a profuse bloomer.

Golden Gleam. All-America Winner. Compact plants 1 to 1½ feet high, with clear, golden yellow, semi-double flowers. In addition to the remarkable doubling of the bloom, the flowers possess a delicate scent which lacks the usual coarseness of the Nasturtium odor.

Scarlet Gleam. All-America Winner. A worthy companion to the famous Golden Gleam. The large, semi-double, fragrant flowers are dazzling scarlet. The dwarf, vigorous plants are profuse bloomers all season long.

All Semi-Double Nasturtiums, pkt. 10 cts., oz. 30 cts., $\frac{1}{4}$ lb. \$1, lb. \$3.50

SINGLE VARIETIES

Dwarf Fine Mixed Colors. Fine for beds and edging, any place where masses of color are desired. The plants are covered with flowers in a wide range of colors from June until frost.

Tall Fine Mixed Colors. The tall or climbing Nasturtiums are useful for covering fences, or may be allowed to trail over stumps and rockwork.

All Single Nasturtiums, pkt. 5 cts., oz. 25 cts., $\frac{1}{4}$ lb. 90 cts., lb. \$3

Nigella • Love-in-a-Mist

Annual

Pretty annual 1½ feet high, for bedding and cutting, easily and quickly grown from seed in any sunny spot.

Miss Jekyll, Blue. Fine double azure-blue. Pkt. 10 cts., $\frac{1}{4}$ oz. 25 cts., oz. 75 cts.

Miss Jekyll, White. Flowers pure white. Double. Pkt. 10 cts., $\frac{1}{4}$ oz. 25 cts., oz. 75 cts.

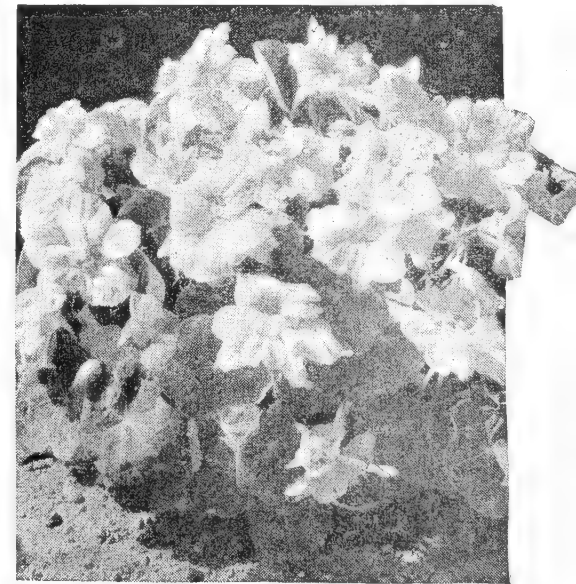

Nasturtium, Glorious Gleam Hybrids

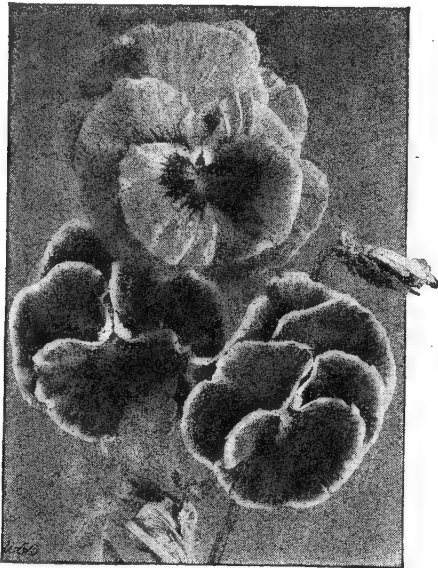

Pansies

Pansies

The best results are secured by sowing in late July or August and protecting the young plants over winter with a covering of straw manure or a deep blanket of leaves. They will then be ready to begin blooming as soon as the weather opens up in the spring and will continue to flower until hot weather. The next best time to sow is very early in the spring, in February or March, starting the seed in a box indoors or in a coldframe and setting the plants outdoors the latter part of April. If set out in a spot that is shaded part of the day, where the soil is deep and moist, and the flowers picked daily, the plants may be kept blooming all summer.

Giants of California, Mixed. A special mixture of giant types. Pkt. 20 cts., $\frac{1}{4}$ oz. \$2.50, oz. \$9.

Mastodon, Finest Mixed. An American strain with flowers often $2\frac{1}{2}$ inches in diameter. Strong in red and purple shades. Pkt. 20 cts., $\frac{1}{4}$ oz. \$2.50, oz. \$9.

Roggli Giant Blotched, Mixed. A Swiss strain with especially fine coloring. Pkt. 20 cts., $\frac{1}{4}$ oz. \$2.50, oz. \$9.

Superfine Giants, Mixed. A fine strain with jazzy colors, rich in yellow, with many five-blotched types. Pkt. 25 cts., $\frac{1}{8}$ oz. \$1.50, $\frac{1}{4}$ oz. \$2.50, oz. \$9.

Fine Mixed Colors. A fine assortment of select varieties for bedding, including many bright and beautiful colors. Pkt. 10 cts., $\frac{1}{4}$ oz. \$2, oz. \$7.

Physalis

Perennial

Francheti. Chinese Lantern Plant. Flowers yellow with dark centers, and fruits with blood-red inflated calyx which turn bright red when ripe and resemble Chinese lanterns. Attractive when dried for winter use. Pkt. 15 cts., $\frac{1}{4}$ oz. 60 cts., oz. \$2.

Platycodon • Balloon Flower

Perennial

Erect, leafy plants bearing a profusion of inflated, balloon-like buds, opening to wide, saucer-shaped flowers. Good border perennial for late summer blooming.

Grandiflorum. Steel-blue. Pkt. 10 cts., $\frac{1}{4}$ oz. \$1, oz. \$3.

Grandiflorum album. White. Sold out.

Petunias *Annual*

For solid beds of color, borders and edging, vases and porch-boxes, in fact, for every purpose, the Petunias are surpassed by few if any of the easily grown garden annuals. They come into bloom early and continue to flower profusely all summer long, thriving on poor soil and in the hottest weather. Sow the seed in April or May, scattering it thinly on fine sifted soil and, instead of covering it, press it firmly into contact with the earth with a smooth board. When the seedlings are about 2 inches high, transplant them to the place where you want them to bloom. For extra-early flowers, start seed indoors in March or April.

LARGE-FLOWERING SINGLE FRINGED VARIETIES

Dainty Lady. An entirely new variety, with light golden yellow flowers—a shade previously unknown in Petunias. Pkt. 50 cts.

Dwarf Giants of California, Mixed. (Ramona Strain.) An improved new dwarf strain of the well-known California Giants. Flowers are large and beautifully colored, with open throats, well marked and veined. Pkt. 50 cts.

Elk's Pride. Large and very dark purple, plain edged. Pkt. 25 cts.

Pink Beauty. Clear light pink. Pkt. 25 cts.

Pride of Portland. Deep glowing rose. Pkt. 25 cts.

Scarlet Beauty. Crimson-scarlet. Pkt. 25 cts.

White Beauty. Snowy white. Pkt. 25 cts.

Ruffled Giants, Mixed Colors. Immense single flowers with ruffled and fringed petals, in all colors. Pkt. 25 cts.

SINGLE BEDDING VARIETIES

Blue Bedder. Dwarf, compact, erect plants with fine flowers of mid-blue. Pkt. 15 cts., $\frac{1}{8}$ oz. 50 cts., oz. \$2.50.

Flaming Velvet. All-America Winner. The large, showy flowers are brilliant velvety blood-red or scarlet. Pkt. 25 cts.

Hollywood Star. Silver Medal, 1939 All-America Selections. A distinct Petunia with lobes coming to needle points, making a lovely five-pointed star. The color is rich rose and the throat is amber. Compact, dwarf plants. Pkt. 25 cts.

Martha Washington. Blooms are about 3 inches across, with ruffled edges, bluish-pink, shading to dark violet in the throat; veins wine-red. Pkt. 25 cts.

Pink Gem. Grows 5 to 6 inches high, forming a compact ball completely covered with deep pink blooms 2 inches across. Pkt. 25 cts.

Rose of Heaven. Brilliant fiery rose, similar to Rosy Morn, but more brilliant. The best dwarf pink variety. Pkt. 10 cts., $\frac{1}{8}$ oz. 50 cts., oz. \$3.

Rosy Morn. Vigorous plants, 10 inches tall, compact and free-flowering. Flowers soft carmine-pink with white throat. Pkt. 10 cts., $\frac{1}{8}$ oz. 50 cts., oz. \$3.

Snow Queen. Plants of the Nana Compacta type. Cover themselves with snow-white flowers all summer and fall. A lovely variety. Pkt. 15 cts., $\frac{1}{8}$ oz. 50 cts., oz. \$3.

Violacea, Blue Bird. Violet-blue. Extra fine. Pkt. 10 cts., $\frac{1}{8}$ oz. 50 cts., oz. \$3.

Striped and Blotched, Mixed. Compact plants with flowers striped and blotched. Very striking. Pkt. 10 cts., $\frac{1}{8}$ oz. 50 cts., oz. \$3.

Single, Fine Mixed. An excellent assortment for bedding, including many fine colors. Pkt. 10 cts., $\frac{1}{8}$ oz. 50 cts., oz. \$3.

LARGE-FLOWERING DOUBLE FRINGED VARIETIES

Alldouble Giant Fringed, Mixed. A magnificent strain produced by careful hand hybridizing. The flowers are large and have beautifully frilled and crinkled petals. These Petunias make splendid pot-plants. Pkt. \$1.

Large, Double-flowering Fringed, Mixed. A fancy mixture which produces a large percentage of doubles. Pkt. 50 cts.



Petunia, Flaming Velvet

Portulaca *Annual*

The Portulacas will grow on soil too poor and in places too hot and sunny for any other flower. The plants are low and spreading, commencing to bloom in July and blooming profusely all summer. Sow the seed when the ground gets warm. Flowers like little roses.

Double, Mixed. Pkt. 10 cts., $\frac{1}{8}$ oz. 90 cts., $\frac{1}{4}$ oz. \$1.50, oz. \$5.

Single, Mixed. Very bright and attractive. Good mixture of colors. Pkt. 10 cts., $\frac{1}{4}$ oz. 90 cts., $\frac{1}{2}$ oz. \$1.50, oz. \$2.50.

Primula • Primrose

Perennial

Auricula, Large-flowering, Mixed. Fine free-blooming flower for the rockery and perennial border. Blooms in early spring. The plants are tender and should be given light protection over winter. Seed germinates slowly; may be in the ground a year before it sprouts. Pkt. 50 cts.

Pyrethrum

Perennial

Very easy to grow from seed sown any time from early spring to late summer. Seed started under glass in February will give blooming plants the first summer. Set them in full sun in fertile soil. The 2-foot flower stems make them excellent for cutting and they last very well. By cutting off the first crop of flowers a second crop will be produced in the fall.

Aureum. Golden Feather. Grown mostly for its showy golden yellow lacinated foliage. Nice for borders. Pkt. 10 cts. $\frac{1}{4}$ oz. \$1, oz. \$3.

Roseum, Mixed. Large, daisy-like flowers of many colors. An excellent cut-flower. Pkt. 10 cts., $\frac{1}{8}$ oz. \$1.25, $\frac{1}{4}$ oz. \$2.

Garden Flowers in Color. Has 320 pages, 350 photographs in color with brief cultural directions. \$1.98.

Phlox Drummondii

Annual

Blooming in midsummer, these easily grown flowers make the most brilliant of beds. They prefer an open, sunny situation, but are not particular as to soil and will give good results under almost any conditions. Sow the seed in April or early May and thin the plants to stand about 4 inches apart.

TALL VARIETIES (about 15 in. high)

Crimson	Violet, white eye
Lilac	White
Rose, dark eye	Yellow
Finest Mixed	

All Tall Phlox, pkt. 10 cts., 1/4oz. \$2

Gigantea, Art Shades. All-America Winner. A lovely strain with flowers over an inch in diameter of soft pastel shades, each with a distinctive eye. Bushy plants about 10 inches high. Pkt. 25 cts., 1/4oz. \$2,

DWARF VARIETIES Annual

Nana compacta, Mixed. These grow about 8 inches high and quite bushy, making fine borders and ribbon beds. Mixed colors. Sold out.

HARDY VARIETIES Perennial

Finest Mixed. Produces large heads of brilliantly colored flowers of many shades. Plants grow 2 to 4 feet high. Sold out.

Poppy • Papaver

Although the Poppies last for only a short time, while they are in bloom no flowers can rival them in brilliant colors. The seed is fine and should be scattered thinly in the place where the plants are wanted to bloom, as they do not transplant well. Height, 2 feet. Sow the annual sorts in April and the perennial kinds June to September.

ANNUAL VARIETIES

Double Shirley, Dazzler. Double flowers of vivid orange-scarlet. Pkt. 10 cts., 1/4oz. 25 cts.

Double Shirley, Sweet Briar. Double flowers of the same color as the Single Wild-Rose-Pink. Pkt. 10 cts., 1/4oz. 25 cts.

Shirley, American Legion. Brilliant scarlet, single blooms. An improved Flanders Poppy. Pkt. 10 cts., 1/4oz. 25 cts.

Shirley, Wild-Rose-Pink. Single flowers of soft wild-rose-pink. A beautiful flower. Pkt. 10 cts., 1/4oz. 25 cts.

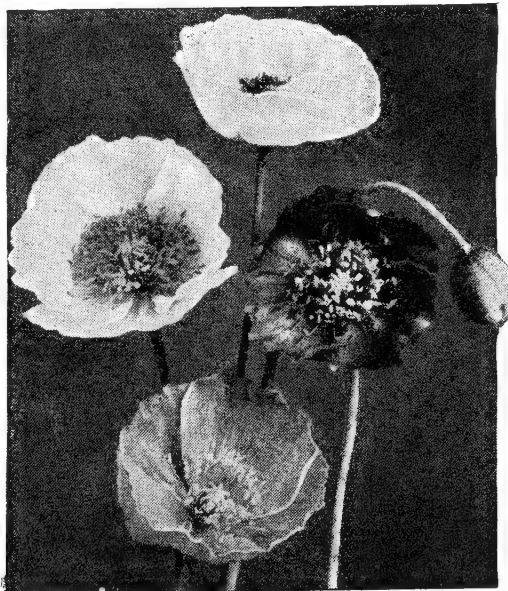

Papaver nudicaule

POPPIES, continued

Shirley, Mixed Colors. Probably the finest strain of annual, single-flowered Poppies. White and pale pink to bright scarlet and deep crimson, including rose with white edge, red with white edge, etc. Very showy. Pkt. 10 cts., 1/4oz. 20 cts.

Tall Peony-flowered, Mixed. Large, double flowers with plain edges in a wide range of colors. Pkt. 10 cts., 1/4oz. 20 cts.

Tulip Poppy (P. glaucum). Dazzling scarlet with a black maltese cross at center. Pkt. 10 cts., 1/4oz. 25 cts.

PERENNIAL VARIETIES

Nudicaule, El Monte. Large flowers of deep tangerine-orange. Pkt. 25 cts., 1/4oz. 75 cts.

Nudicaule, Sunbeam Hybrids, Mixed. A fine strain of Iceland Poppies in shades of yellow and orange. Pkt. 10 cts., 1/4oz. 75 cts.

Oriente, Scarlet. The big, bright scarlet Decoration Day Poppy. A hardy perennial form bearing immense single flowers. Pkt. 10 cts., 1/4oz. \$1.

Oriente, Mixed. A fine mixture of the various Oriental Poppy colors. Pkt. 10 cts., 1/4oz. \$2.

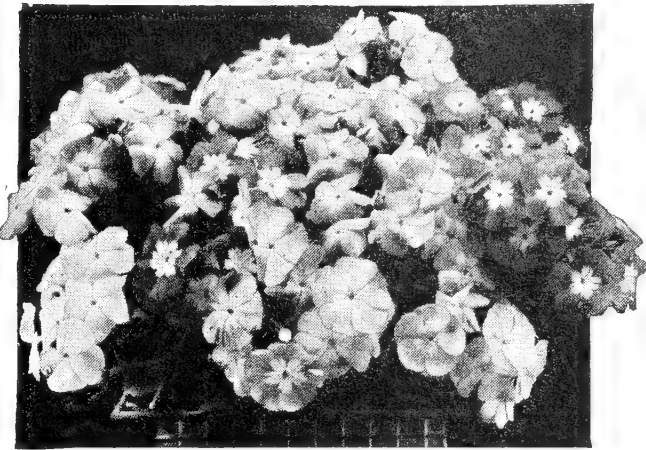

Phlox Drummondii, Art Shades

Salvia • Sage

Start the seed indoors or in hotbeds very early, during January or February if possible. When 2 to 3 inches high transplant into small pots or space to 6 inches apart. Transplant to the garden in late May, in a sunny location and rich, deeply dug soil, setting the plants at least 1 1/2 feet apart.

America. Annual. Grows about 1 1/2 feet tall. Plants a mass of light blazing scarlet. Profuse bloomer. Pkt. 10 cts., 1/4oz. \$1.50, oz. \$5.

Bonfire. Annual. A select strain, fine for mass planting, as it is very compact in growth and has exceedingly brilliant scarlet flowers. Pkt. 10 cts., 1/4oz. \$1.50, oz. \$5.

Farinacea, Blue Bedder. A fine perennial with light blue flowers on spikes about 2 feet long. Seed sown in early May should give plants that bloom from July to frost. Pkt. 15 cts., 1/8oz. \$1.10, 1/4oz. \$1.75, oz. \$6.

Splendens. Annual. The original Scarlet Sage. It grows about 2 feet tall and is covered with large, bright red blossoms all summer long. Pkt. 10 cts., 1/4oz. \$1.50, oz. \$5.

Zurich. Annual. An early variety only 1 foot high. Pkt. 10 cts., 1/4oz. \$1.50, oz. \$5.

Scabiosa • Mourning Bride

Annual

One of the finest annuals for cutting. Grows in almost any situation; 2 1/2 to 3 feet high; blooms for a long season.

Azure Fairy. Azure-blue.

Black Prince. A very dark purple.

Cherry-Red. A nice shade of red.

Loveliness. Soft salmon-rose.

Peach Blossom. Peach-blossom-pink.

Shasta. Pure white.

Above Scabiosa, pkt. 15 cts., 1/4oz. 25 cts., oz. 75 cts.

Blue Moon. Honorable Mention, 1939 All-America Selections. Erect, free-blooming plants with thick heads of deep lavender-blue. Pkt. 25 cts., 1/4oz. 60 cts., 1/2oz. \$1.

Giant-flowered, Mixed. Pkt. 10 cts., 1/4oz. 25 cts., oz. 75 cts.

Schizanthus • Butterfly-Flower

Annual

Wisetonensis Excelsior compactus. A dainty little plant 6 inches high, adapted to bedding and borders. Blooms freely during the entire summer. An excellent pot-plant. Finest mixed, pkt. 15 cts., 1/4oz. \$1.25.

Stock • Gilliflower Annual

Large-flowering, Mixed. The old-fashioned Ten-Weeks Stocks are beautiful, free-flowering, sweet-scented annuals, requiring a mellow soil. Sow the seed in April or May and give the plants 12 to 15 inches of space. Pkt. 10 cts., 1/4oz. \$1.25, oz. \$2.50.

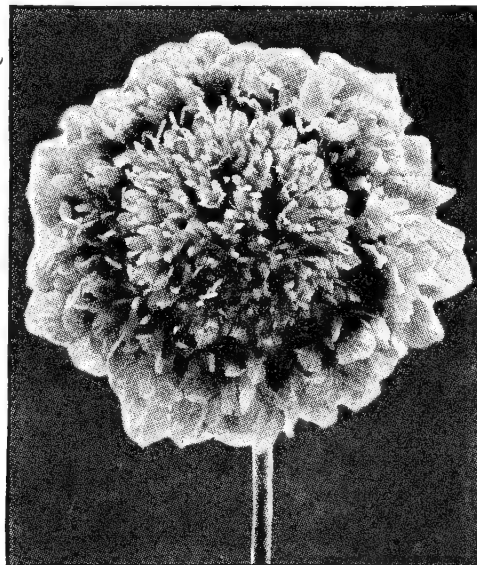

Scabiosa, Peach Blossom

Rhodanthe Swan River Everlasting

Annual

Mixed Colors. Can be dried in its natural colors for winter bouquets. It is an easily grown annual, about 1 1/2 feet tall, with silvery gray leaves and very pretty, little, double flowers. Pkt. 10 cts., 1/4oz. 25 cts., oz. 75 cts.

Salpiglossis • Painted Tongue

Annual

A popular, easily grown garden annual, richly colored and fine for cutting. The flowers are borne in clusters at the top of long stems and are produced very freely from midsummer to fall. Sow the seed in late April or May and thin the plants to stand about 10 inches apart.

Brown and Gold	Scarlet and Gold
Golden Yellow	Velvety Red
Light Blue and Gold	Finest Mixed

All Salpiglossis, pkt. 15 cts., 1/4oz. 35 cts., oz. \$1

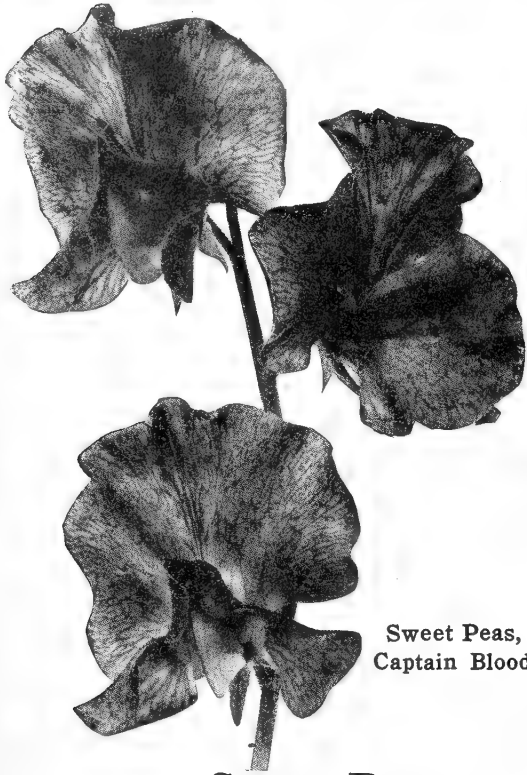
Sweet Peas,
Captain Blood

Sweet Peas

Annual

Sweet Peas bloom best in an open, sunny situation. Keeping the flowers picked as fast as they open prolongs the period of bloom. The old-fashioned or Grandiflora type of Sweet Peas are hardy and very floriferous and the flowers are heavily scented, although of only medium size and rather stiff in form. The new Spencer or Waved Sweet Peas are much larger and finer in form as well as colors, but not quite so free-blooming. Modern gardeners and florists as a rule grow only the Spencer varieties. Plant as early as the ground can be worked, in deeply prepared rich soil. Never allow the soil to dry out after the plants appear.

Scott's Summer-flowering Spencers

Distinguished by giant size, often measuring 2 inches in diameter, and by beautifully waved petals. Hundreds of varieties are known to specialists and new sorts are being constantly produced by English and American breeders, but we believe that the varieties we offer comprise the best and most satisfactory of the new as well as old, in all of the favorite colors.

One ounce of seed will plant a row about 15 feet long

- Ambition.** Rosy lavender.
- Avalanche.** Glistening white.
- Black Diamond.** Dark maroon.
- Campfire.** Vivid scarlet.
- Captain Blood.** Brilliant scarlet.
- Damask Rose.** Deep rose.
- Fiery Cross.** Orange-cerise.
- Fluffy Ruffles.** Light cream-pink.
- Gigantic.** Best white.
- Gleneagles.** Large; pale lavender.
- Grand Slam.** Cerise-scarlet.
- Jubilee.** Scarlet.
- Leviathan.** Rich maroon.
- Mastercream.** Cream.
- Mrs. A. Searles.** Bright salmon.
- Prince of Orange.** Deep orange.
- Pinkie.** Large; rose-pink.
- Reflection.** Clear blue.
- Ruffled Mauve.** Pure mauve.
- The Admiral.** Violet-blue.
- Welcome.** Dazzling scarlet.

All Spencer Sweet Peas, pkt. 10 cts., oz. 30 cts., ¼lb. \$1, lb. \$3

Sweet Pea Mixture

Scott's Finest Mixed Spencers. A wonderful mixture of finest varieties in many beautiful colors. Pkt. 10 cts., oz. 25 cts., ¼lb. 60 cts., lb. \$2.

Scott's Finest Mixed Grandiflora. The old-fashioned, deliciously fragrant kind. Oz. 10 cts., ¼lb. 30 cts., lb. \$1.

Sweet William *Dianthus barbatus*

Biennial

A great favorite in all gardens. Easily grown from seed. The flowers are borne in large trusses and are delightfully fragrant. Sow any time from early spring to July. The plants should stand at least 8 inches apart.

Double Varieties, Mixed Colors. The double flowers are very attractive in form as well as colors. Pkt. 10 cts., ¼oz. 60 cts., oz. \$2.

Newport Pink, Single. A single variety of a salmon-rose shade. Fine cut-flower. Pkt. 10 cts., ¼oz. \$1, oz. \$3.

Single Varieties, Mixed Colors. A wide range of colors, many with distinct "eyes" or margins of a different shade. Pkt. 10 cts., ¼oz. 25 cts., oz. 75 cts.

Thunbergia • Black-eyed Susan

Annual

A slender climbing or trailing annual with many little flowers, varying from palest primrose to deep buff-yellow, all with dark centers, from which it derives its common name. Start indoors in February or March. Pkt. 10 cts., ¼oz. 35 cts., oz. \$1.

Tithonia • Mexican Sunflower

Annual

Speciosa. A tall, branching, half-hardy annual with very striking rich orange-scarlet flowers. Fine for clumps in the tall border. Grows 6 feet or more high. Pkt. 15 cts., ¼oz. 50 cts., oz. \$1.75.

Verbena

Annual

Low, spreading plants with handsome dark green foliage and great clusters of sweet-scented flowers all summer long. Old favorites for low beds and edging, also for boxes and vases. Sow indoors in February or March.

GRANDIFLORA GIGANTEA HYBRIDS. A showy type with giant flowers in fine heads. The colors are brilliant and stand out against the lovely green foliage. A continuous bloomer from midsummer on.

Beauty of Oxford. Spectacular heads of nice form. The color-range is from rose-pink to rose-red.

Lavender Glory. Large flowers of pure lavender with a creamy white eye.

Royale. Royal blue, creamy yellow eye.

Scarlet Queen. Rosy scarlet, large white eye.

Spectrum Red. Intense bright red.

All Grandiflora Gigantea Hybrids, pkt. 15 cts., ¼oz. 75 cts., oz. \$2.50

MAMMOTH HYBRIDS. These varieties produce extra-large flower-heads with individual florets often measuring an inch across.

Auricula-Eyed, Mixed.

Blue Shades.

Defiance. Scarlet.

Italian, Striped, Mixed.

Lucifer. Brilliant scarlet.

Pink and Rose Shades.

White.

Mammoth, Mixed.

All Mammoth Hybrid Verbenas, pkt. 10 cts., ¼oz. 35 cts., oz. \$1

Choice Mixed. Pkt. 10 cts., ¼oz. 25 cts., oz. 75 cts.

Veronica • Speedwell

Perennial

Spicata. Sturdy plants bearing erect spikes of dark blue flowers in midsummer. A good low perennial about 18 inches tall, useful for garden decoration and cutting. Pkt. 10 cts., ¼oz. \$1.50, oz. \$5.

Vinca rosea Madagascar Periwinkle

Annual

Forms handsome, bushy bedding plants that bloom profusely all summer from seed sown indoors in February or March, and is fine for pot-culture. Height, 1 to 1½ feet.

Finest Mixed. An excellent assortment of Red, White with Rose center, Pure White, and Pink. Pkt. 10 cts., ¼oz. 75 cts., oz. \$2.50.

Viola

Perennial

Finest Mixed. The most attractive colors of this desirable spring flower. Pkt. 25 cts., ¼oz. 75 cts., oz. \$2.50.

Wallflower Perennial

The Wallflowers are perennials but in our rigorous climate they require protection over winter and are best carried over in a cold-frame. Sow the seed indoors in March or outdoors late in May and space the plants about 8 inches apart. The flowers are clustered on spikes 1½ feet tall, and are very fragrant.

Double Varieties, Extra-Fine Mixed. Artistic shades of coppery red, bright brown, bronzy yellow, etc. Pkt. 10 cts., ¼oz. 75 cts., oz. \$2.

Wild Cucumber Vine

Annual

Lobata. A very rapid-growing, vigorous climber, often running 30 to 40 feet in a season. It bears small, white, slightly fragrant flowers, followed by spiny seed-pods. Pkt. 10 cts., ¼oz. 20 cts., oz. 60 cts.

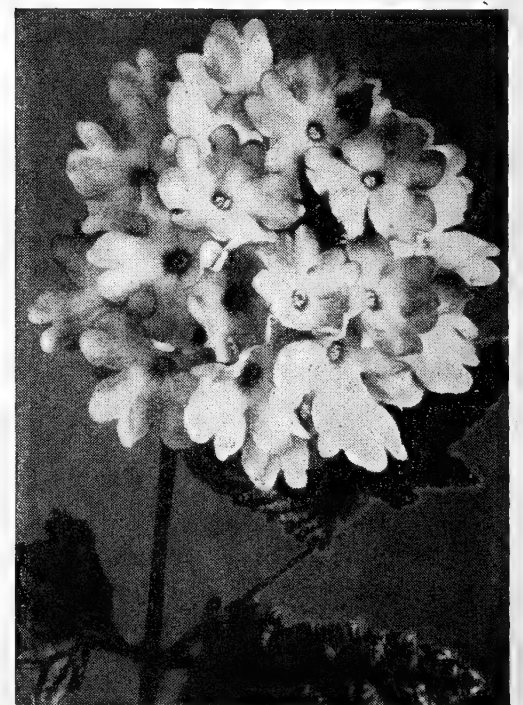

Verbena, Beauty of Oxford

ZINNIAS • Youth and Old Age

Few flowers provide a more gorgeous display with less care or attention; all they require is a sunny spot to cause them to grow and bloom vigorously from early summer until frost. The seed may be sown in the garden any time during April or May and the plants

thinned or transplanted to stand 8 to 18 inches apart, according to variety. The largest specimen blooms are produced on plants that are grown on a mellow, moderately rich soil and given ample room to develop.

GIANT DOUBLE DAHLIA-FLOWERED VARIETIES. Plants 2½ to 3 feet high, bearing huge, double flowers resembling the Show type of Dahlia.

- Crimson Monarch.** Deep crimson.
- Dream.** Deep rosy lavender.
- Exquisite.** Light rose, deep rose center.
- Giant Attraction.** Brick-red.
- Golden Dawn.** Golden yellow.
- Illumination.** Deep rose.
- Oriole.** Orange and gold bicolor.
- Polar Bear.** Pure white.
- Scarlet Flame.** Bright scarlet.
- Will Rogers.** Brilliant scarlet-red.
- Finest Mixed.** All colors.

All above, pkt. 15 cts., ¼oz. 50 cts., oz. \$1.50

ELEGANS, CURLED AND CRESTED. Tall, double flowers with the petals artistically twisted and curled. Pkt. 10 cts., ¼oz. 35 cts., oz. \$1.

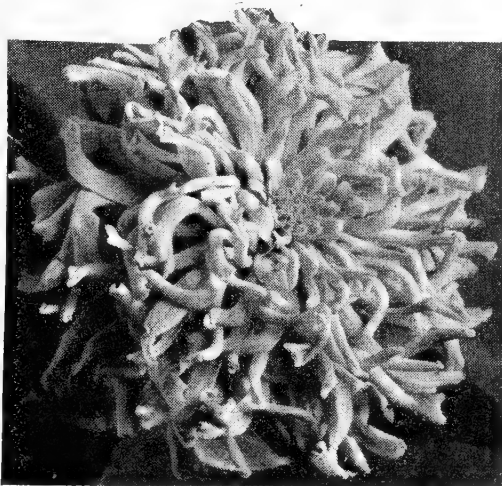

Zinnia, Fantasy

FANTASY

A novelty that has created a sensation wherever shown. Stems long and strong.

Rosalie. Fantasy type flowers in various shades of rose and pink. Free-blooming plants. Pkt. 15 cts., ¼oz. 90 cts., oz. \$3.

Star Dust. Clear golden yellow flowers. Blooms early and generously. Pkt. 15 cts., ¼oz. 60 cts., oz. \$2.

Fantasy Mixed. Striking rich colors; medium-sized flowers. Splendid cutting material. Pkt. 10 cts., ¼oz. 50 cts.

DOUBLE GIANT VARIETIES. Large, very double flowers, fine for cutting.

Canary-Yellow, Crimson, Deep Rose, Purple, Scarlet, White or Mixed. Pkt. 10 cts., ¼oz. 35 cts., oz. \$1.

DOUBLE MEXICAN HYBRIDS

Haageana, Finest Mixed. Small flowers on low, bushy plants, making a fine display over a long season. Stems are long enough for cutting. Pkt. 15 cts., ¼oz. 40 cts., oz. \$1.25.

DWARF DOUBLE VARIETY. Cut-and-Come-Again. An excellent bedding type not over 2 feet tall. Distinct colors. Finest Mixed. Pkt. 10 cts., ¼oz. 35 cts., oz. \$1.

POMPON or BABY DWARF VARIETIES. A popular type for cutting. Small compact flowers. Plants 1½ to 2 feet tall.

Canary Gem, Salmon Gem, Crimson Gem, Lilac Gem, Purple Gem, Rosebud, Scarlet Gem, Valencia (Orange) or Mixed. Pkt. 10 cts., ¼oz. 35 cts., oz. \$1.

SCABIOSA-FLOWERED. Resembles the annual Scabiosa, with ray petals surrounding a large cushion.

Giant Crested. A new large-flowered crested variety with shades of orange, yellow, scarlet, maize, rose, and crimson predominating. Lovely for cutting and garden decoration. Pkt. 25 cts.

Finest Mixed. Pkt. 15 cts., ¼oz. 75 cts.



Double Dahlia-flowered Zinnia

Flower Seed Mixtures Scott's Annual Cut-Flower

Here is a mixture of annuals that we do not hesitate to recommend. Anyone is sure to have success with it, and it provides continuous bloom all summer. Pkt. 10 cts., ½oz. 25 cts., oz. 45 cts., ¼lb. \$1.50.

Scott's Annual Rock-Garden

A carefully selected assortment suitable for the rockery. Especially useful to fill vacancies. Pkt. 10 cts., ¼oz. 35 cts., oz. \$1.

Scott's Perennial Rock-Garden

A fine collection for permanent plants for the rock-garden. Recommended to the beginner. Pkt. 25 cts., ¼oz. 75 cts., oz. \$2.50.

GARDEN BOOKS

Five Popular Garden Books

VEGETABLE GARDENING IN COLOR. By Daniel J. Foley. Expert and practical directions for growing all the common vegetables, herbs, and berries. Has chapters on insects and diseases and winter storage. A valuable guide for home-gardeners. 256 pages; 150 pictures in full color. \$2.50.

1001 GARDEN QUESTIONS ANSWERED. By Alfred C. Hottes. Answers all kinds of garden questions and gives very useful information for the amateur gardener. 388 pages; 160 illustrations. Cloth, \$2.50.

GARDEN GUIDE. A most complete book for the amateur. Written by 28 authors. Covers the entire place from landscaping through the finished garden, both fruit, vegetable, and flower. Chapters on soils, fertilizers, diseases, insects, propagation, transplanting, pruning, winter protection, etc. 576 pages; over 300 illustrations. Cloth, \$2.

WHAT EVERY ROSE-GROWER SHOULD KNOW. Prepared for the American Rose Society as a primer for beginners. Tells all the steps in rose-growing from preparing the ground, through planting, protection against insects and diseases, summer care, pruning, and winter protection. The various types of Roses are discussed and described, with emphasis on the kinds most suitable for various parts of the country. 80 pages; 4 illustrations in color, 5 in black and white, and numerous sketches. \$1.

GARDEN FLOWERS IN COLOR. By Daniel J. Foley. Here is the only book to show the important garden flowers in accurately colored photographs—350 of them. It identifies each plant, and gives brief and adequate cultural directions. A guide book for the beginner and a reference book for the advanced gardener. \$1.98.

GARDEN BULBS IN COLOR. By McFarland, Hatton and Foley. Has 275 color plates and 100 beautiful half-tones. Complete cultural notes are included. 296 pages. \$1.98.

LAWNS. By F. F. Rockwell. Shows both how to start a lawn right and how to keep it smooth. 87 pages; 39 illustrations. \$1.25.

CLIMBING ROSES. By G. A. Stevens. A companion volume to "How to Grow Roses." 31 color-plates and 32 half-tone illustrations. Cloth, \$2.

THE BOOK OF ANNUALS. By Alfred C. Hottes. 180 pages; 158 illustrations. Cloth, \$1.50.

PERENNIAL GARDENS. By H. S. Orloff. 90 pages; 18 illustrations. \$1.25.

THE BOOK OF PERENNIALS. By Alfred C. Hottes. 280 pages; over 100 illustrations. Cloth, \$2.

THE BOOK OF SHRUBS. By Alfred C. Hottes. 448 pages; 190 illustrations. Cloth, \$3.

THE BOOK OF BULBS. By F. F. Rockwell. Here is the "last word" on bulbs and how to grow them, both outdoors and inside the home. 264 pages; 187 illustrations. \$3.

ALL ABOUT FLOWERING BULBS. By T. A. Weston. 184 pages; 8 full-page color-plates; 68 illustrations. Cloth, \$2.

MODERN DAHLIA CULTURE. By W. H. Waite. 134 pages; 6 full-page color-plates and 24 half-tones. Cloth binding. \$1.50.

GLADIOLUS. By F. F. Rockwell. 79 pages; 45 illustrations. \$1.25.

PRINCIPLES OF FRUIT GROWING. By L. H. Bailey. Tells how to plant, cultivate, prune, and spray. 186 illustrations; 432 pages. \$3.50.

PEONIES. By F. F. Rockwell. Tells all about peonies, where and how to grow them, their planting, care, cultivation, propagation, and protection. Illustrated with photographs and drawings. \$1.25.

WATER GARDENS AND GOLDFISH. By R. V. Sawyer and E. H. Perkins. 272 pages; 126 illustrations. Cloth, \$2.

LANDSCAPING THE SMALL HOME. By Edward W. Olver. 160 pages; 90 illustrations. \$1.

ANNUALS FOR YOUR GARDEN. By Daniel J. Foley. Contains full cultural directions for 90 annual flowers. 97 pages, 32 full color-plates. \$1.

PLANT PROPAGATION. By Alfred C. Hottes. Easily understood by the amateur but covers propagation by all the approved commercial methods. Revised edition. 238 pages; 136 illustrations. Cloth, \$2.

PEST CONTROL IN THE HOME GARDEN. By Louis Pyenson. An invaluable book for those who are striving to grow healthy plants and take pride in good crops. Has chapters on fruit trees, small fruit, and vegetables. 190 pages; 111 illustrations. \$2.

If the book you are wanting is not listed, give us the subject and we will be glad to tell you what is available, and the price

The Finest Lawns
in
Western Pennsylvania
are made with
SCOTT'S LAWN SEED

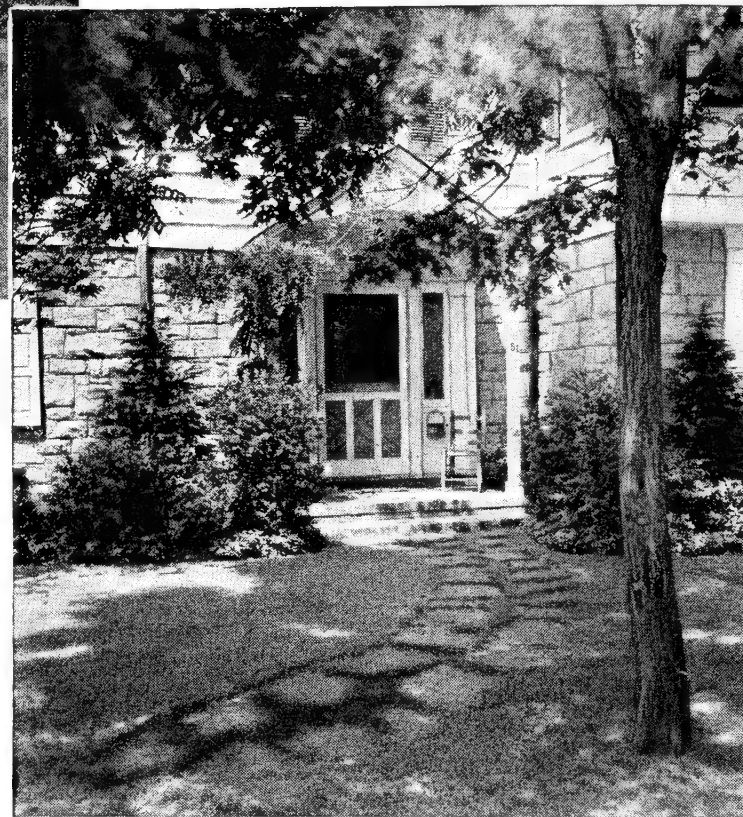
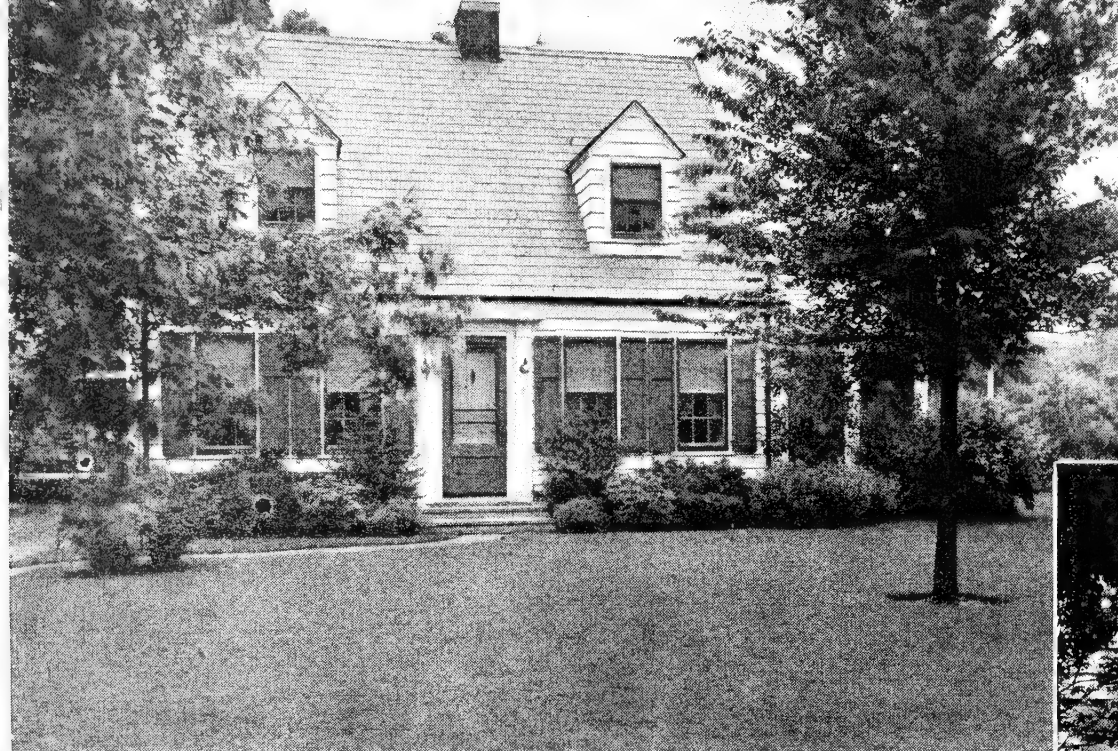

SCOTT'S "PURITY" LAWN GRASS SEED

This is the mixture we recommend for general lawn sowing. It has proved satisfactory to our customers for many years. Produces a lustrous, well-established turf of an even tone of rich green that, with proper care, will last for many years. Composed of the highest grades of re-cleaned seeds procurable. Thousands of beautiful lawns attest the quality of this mixture.

For new lawns, sow at the rate of 1 pound to each 250 square feet, or 150 pounds per acre. For lawn maintenance, sow about 1 pound to each 400 square feet or about 100 pounds per acre.

1/2 lb. 35 cts., 1 lb. 60 cts., 2 lbs. \$1.10, 5 lbs. \$2.65, 10 lbs. \$5, 25 lbs. \$12, 50 lbs. \$23.50, 100 lbs. \$45.

SCOTT'S "SUPERFINE" LAWN SEED

For those who prefer a lawn with Bent Grass we offer our Superfine Lawn Seed Mixture. The mixture consists of extra-heavy weight Kentucky Blue Grass, Fancy re-cleaned Red-Top and Colonial Bent Grass and mixed in the correct proportions to produce a luxuriant, velvety and permanent turf. It is 98% pure.

One pound sows 400 square feet, 100 pounds an acre. A measured bushel weighs about 32 pounds.

1/2 lb. 40 cts., 1 lb. 75 cts., 2 lbs. \$1.40, 5 lbs. \$3.35, 10 lbs. \$6.50, 25 lbs. \$14, 50 lbs. \$27, 100 lbs. \$52.

SCOTT'S "EVERGREEN" LAWN GRASS MIXTURE

This mixture has been prepared for those requiring a moderate-priced lawn grass seed. We believe it is unequalled at the price.

1/2 lb. 30 cts., 1 lb. 50 cts., 2 lbs. 90 cts., 5 lbs. \$2.10, 10 lbs. \$4, 25 lbs. \$9.50, 50 lbs. \$18.50, 100 lbs. \$35.

SCOTT'S "SHADY" LAWN MIXTURE

There are only a few good grasses thriving in shade so we have put them all together here. We believe you will get surprisingly good results from this mixture. Use same quantities as Scott's Purity.

1/2 lb. 45 cts., 1 lb. 85 cts., 2 lbs. \$1.60, 5 lbs. \$3.85, 10 lbs. \$7.25, 25 lbs. \$16, 50 lbs. \$31, 100 lbs. \$60.

SCOTT'S "FAIRWAY" MIXTURE

Down the fairway the turf must be pleasing to the eye and tough enough to stand close clipping and considerable wear and tear. Our mixture answers those requirements.

Fairways do best when seeded liberally.

5 lbs. \$3.25, 10 lbs. \$6, 25 lbs. \$12.50, 50 lbs. \$24, 100 lbs. \$46.

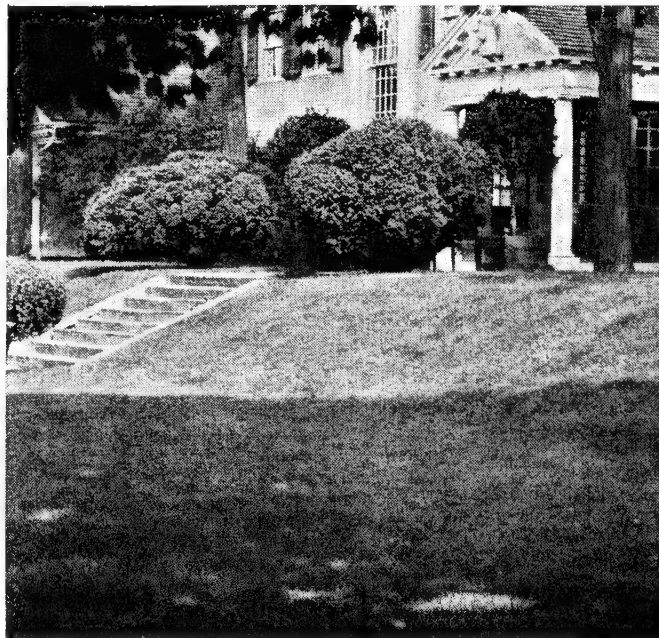

SCOTT'S "TERRACE" LAWN MIXTURE

Grasses with strong, well-developed root-systems quickly established, have been selected for difficult terraces where this mixture has given unqualified satisfaction for several years.

1/2 lb. 35 cts., 1 lb. 60 cts., 2 lbs. \$1.10, 5 lbs. \$2.65, 10 lbs. \$5, 25 lbs. \$12, 50 lbs. \$23.50, 100 lbs. \$45.

SCOTT'S "ATHLETIC FIELD" MIXTURE

This calls for good appearance and the toughness of an elephant's hide. Our mixture produces a turf that is just that, standing the gouging of cleated shoes and the pounding of running feet. Seed liberally.

5 lbs. \$3.75, 10 lbs. \$6.75, 25 lbs. \$14.75, 50 lbs. \$28.50, 100 lbs. \$55.

SEPARATE VARIETIES OF GRASS SEEDS

All Recleaned and of Highest Quality

MIXED CREEPING BENT. A superior Grass for putting-greens on account of its dwarf growth and its narrow leaves. It will grow and make good turf in good or bad soils, and dry weather or heavy rains seem to have no serious effects. About forty pounds of seed are required for an acre. Lb. \$1.35, 5 lbs. \$6.25, 10 lbs. \$12, 25 lbs. \$27.25.

COOS COUNTY BENT or SEASIDE BENT (*Agrostis alba maritima*). A fine-leaved bright green Grass used principally on golf-courses for putting-greens. Its texture is fine and uniform, and under good cultural conditions, on soils of reasonable fertility, it will form a sod very quickly. It makes a very good growth in rather dense shade, and spreads with great rapidity. Lb. \$1.35, 5 lbs. \$6.25, 10 lbs. \$12, 25 lbs. \$27.50.

COLONIAL BENT (*Agrostis tenuis*). A tight, thick turf, permanent under close mowing. For putting-greens and fairway mixtures. Lb. \$1.35, 5 lbs. \$6.25, 10 lbs. \$12, 25 lbs. \$27.

ASTORIA BENT (*Agrostis tenuis; Astoriana*). An underground creeper making a deep, heavy sod of fine texture and color. Lb. \$1.35, 5 lbs. \$6.25, 10 lbs. \$12, 25 lbs. \$27.

RED-TOP (*Agrostis alba*). A valuable Grass for hay, pasture or lawn. About fifteen to twenty pounds of seed will be required for an acre. Lb. 50 cts., 10 lbs. \$4.50, 25 lbs. \$10.

KENTUCKY BLUE GRASS (*Poa pratensis*). Kentucky Blue Grass is most valuable for pastures and lawn planting. For lawns it is indispensable and, when well established, the lawn will last for years, as the Grass makes an extra-close fine-textured turf. The seed should be mixed with other Grasses that mature earlier, for Blue Grass is very slow in both germinating and maturing. Lb. 65 cts., 10 lbs. \$6, 25 lbs. \$13.75.

PERENNIAL RYE GRASS (*Lolium perenne*). A fine-leaved Grass, not as coarse as the ordinary variety and more resistant to cold. An excellent grass on fairways or anywhere that a quick-growing sod is needed. An excellent nurse Grass for slow-germinating Grasses. Lb. 50 cts., 10 lbs. \$4.50, 25 lbs. \$10.

DOMESTIC RYE GRASS. A mixture of Italian and English Rye Grass grown in the United States. Quick-growing; often used for a temporary turf. Lb. 35 cts., 10 lbs. \$3, 25 lbs. \$4.75.

ITALIAN RYE GRASS (*Lolium italicum*). Makes a dense turf when sown thickly or mixed with other Grasses. It is most useful on medium moist soils and grows very rapidly into a bright green sod. None to offer. Domestic Rye Grass a suitable substitute.

CREEPING RED FESCUE (*Festuca rubra*). A creeping, turf-forming Grass especially valuable for lawns. Color is deep green, with fine, needle-like leaves and a strong creeping root system. Thrives on all types of soil and is well adapted to shady situations. Lb. \$1.35, 5 lbs. \$6.25, 10 lbs. \$12, 25 lbs. \$25.

CHEWING'S FESCUE (*Festuca rubra fallax*). A fine, needle-like sod excellent for putting-greens and lawns. Resistant to heat, drought, and hard wear. Lb. \$1.20, 5 lbs. \$5.75, 10 lbs. \$11, 25 lbs. \$25.

TIMOTHY (*Phleum pratense*). One of the most important hay Grasses, sometimes used to nurse lawns made on rough soil. Lb. 25 cts., 5 lbs. \$1, 10 lbs. \$1.65.

WHITE DUTCH CLOVER (*Trifolium repens*). Valuable for quick lawns and permanent pastures. $\frac{1}{4}$ lb. 45 cts., $\frac{1}{2}$ lb. 80 cts., lb. \$1.40, 5 lbs. \$6.50, 10 lbs. \$12.

Prices on larger quantities quoted on request. Above prices subject to market changes.

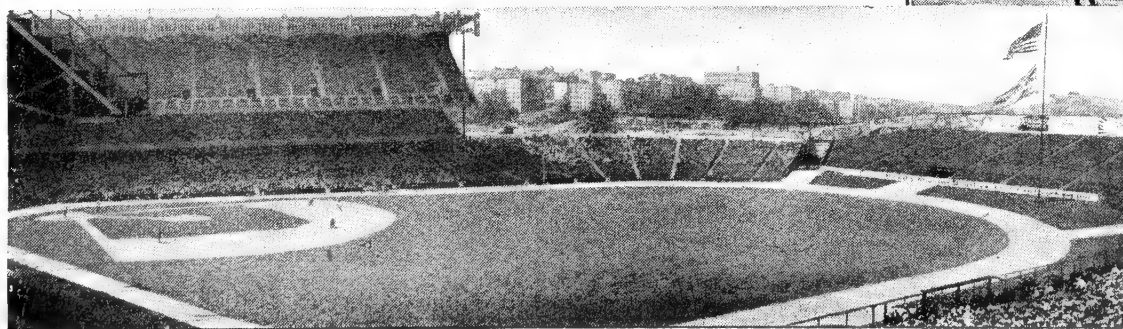
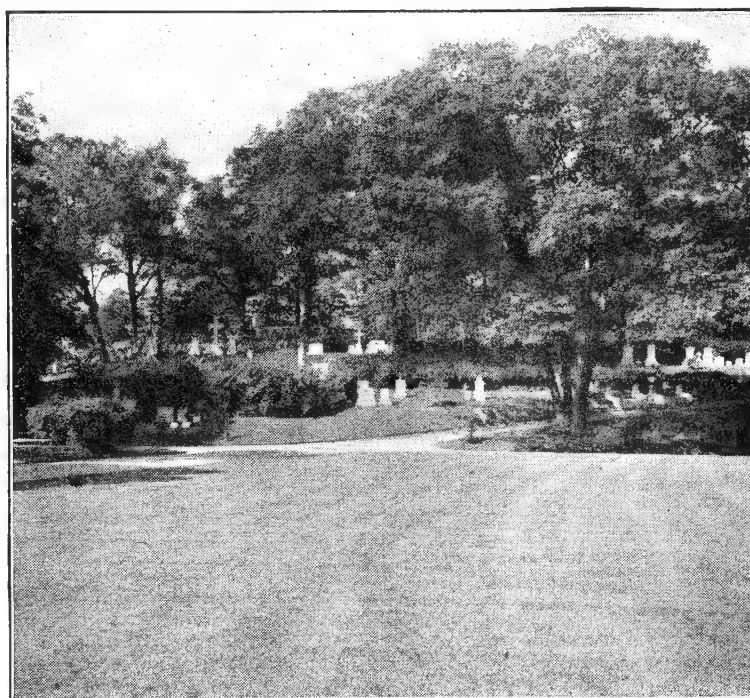
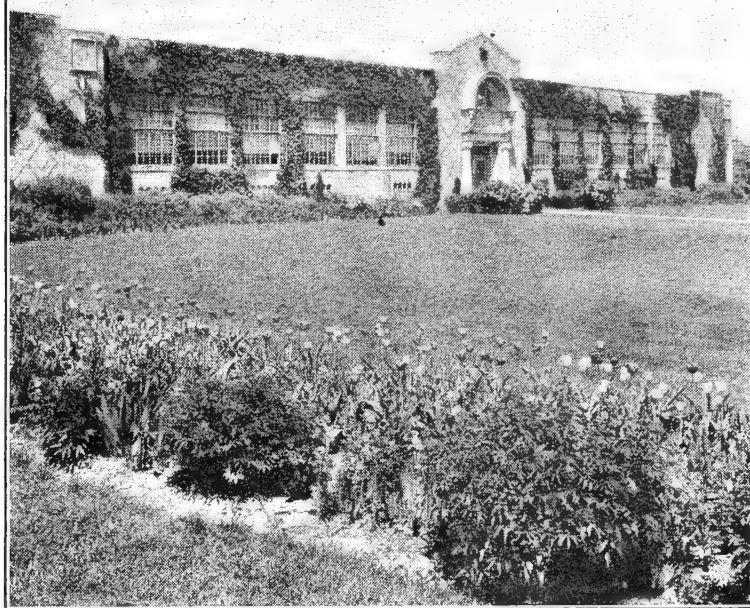

SUMMER-FLOWERING BULBS

All Bulbs Sent Postpaid at Prices Quoted



Anemone, St. Brigid

Anemone • Windflower

Suitable for pot or border culture and for massing. Soak bulbs 24 hours before planting.

Blue Poppy. A newer variety of a sky-blue color.

De Caen. A very large-flowered, single strain of unique beauty. All colors.

His Excellency. Rich crimson flowers from June until frost.

St. Brigid. Very large, vivid flowers of scarlet, pink, purple, etc.

All Anemones, 10 cts. each, \$1 per doz., \$7 per 100

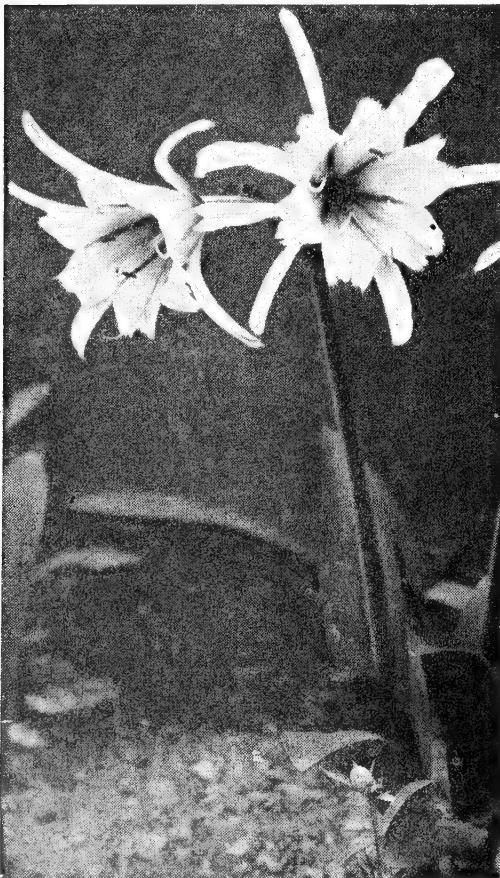

Ismene calathina

Begonias, Tuberous-rooted

Do best in shady or semi-shady places.

Bulbs are hollowed on one side and in planting the hollowed side must be up. They make strong, fleshy stems a foot or more high, with big, bristly, very beautiful leaves, crowned by flowers of enormous size and almost unbelievable brilliance. Blooms 4½ to 5 inches across are not unusual. They should be started in pots or pans indoors in February or March, and transplanted to the garden about the time that corn is growing well. They may also be started outdoors at the same time but will bloom later.

Single varieties. White, scarlet, pink, or yellow flowers.

Double varieties. Red, salmon, rose, or orange flowers.

All above varieties, 25 cts. each, \$2.50 per doz., \$20 per 100.

Caladium esculentum

Elephant's Ear

For imposing masses of tropical foliage there is nothing so effective or so easily grown as the Elephant's Ear. The plants grow from 3 to 5 feet high. Plant the bulbs late in May, after all danger from frost is past, spacing them 2 to 4 feet apart and covering them a few inches deep. The larger the bulb, the larger the plant and the more space required. If extra-large plants are desired, start the bulbs indoors in pots or large boxes, in March or early April, and transplant to the open about June 1. Give plenty of water throughout the season; liquid manure is very beneficial.

	Each	Doz.	100
7 to 9-in. circ.....	\$0 25	\$2 50	\$15 00
9 to 11-in. circ.....	35	3 50	25 00

Gloxinia

Beautiful velvety flowers of trumpet shape produced by tender, tropical bulbs which may be grown in pots or greenhouse benches. The large foliage is covered with plush-like hairs, and should not be wet. Keep them warm at all times.

Crimson **Rose** **White**
Mottled **Violet** **Mixed Colors**

All Gloxinias, 50 cts. each, \$5 per doz.

Hyacinthus candicans

Summer Hyacinth

Tall spikes with scores of drooping, bell-shaped white flowers in midsummer. Very attractive and unusual. Handle like gladiolus. 10 cts. each, \$1 per doz., \$7 per 100.

Ismene calathina

Peruvian Daffodil

Enormous, richly fragrant white flowers of the amaryllis type, curiously cupped and most attractive. Grow in warm, sunny soil and treat like gladiolus, except that they cannot be set out until corn is growing outdoors, and the bulbs should be kept warm in winter. 30 cts. each, \$3.00 per doz.

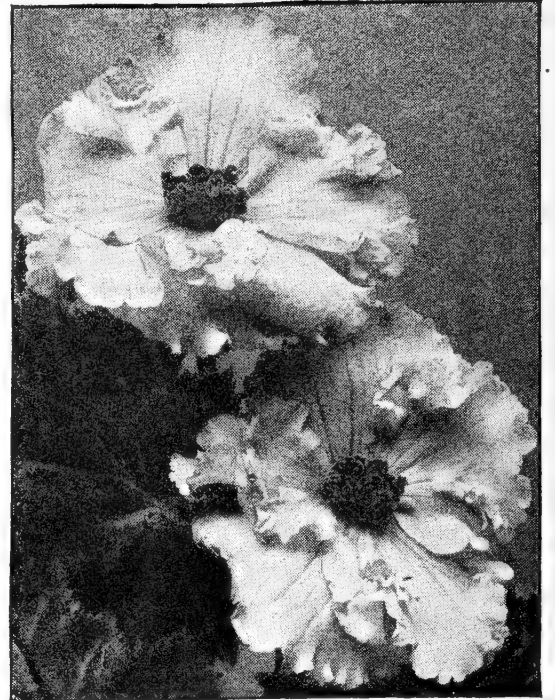

Tuberous-rooted Begonias

Summer-blooming Oxalis

Charming low, bushy plants for growing in pots or borders, with clover-like leaves and round, cheerful flowers of various shades of pink and crimson which close at night. Continue in bloom for many weeks. 10 cts. for 10 bulbs, 90 cts. per 100.

Ranunculus

Finest Mixed. Fine, brilliantly colored, double flowers on stems over a foot long for cutting. Double and semi-double, and produced in abundance. 10 cts. each, \$1 per doz., \$7 per 100.

Tuberose

Old-fashioned flowers valued for their fragrance. Start the bulbs indoors in March and transplant to the open in early May.

White Pearl. The best variety. Flowers creamy white, large, and double.

Each Doz. 100
First-Size Bulbs...\$0 25 \$2 50 \$16 00

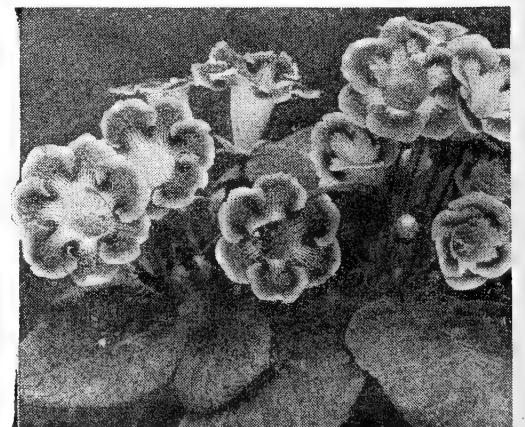

Gloxinia

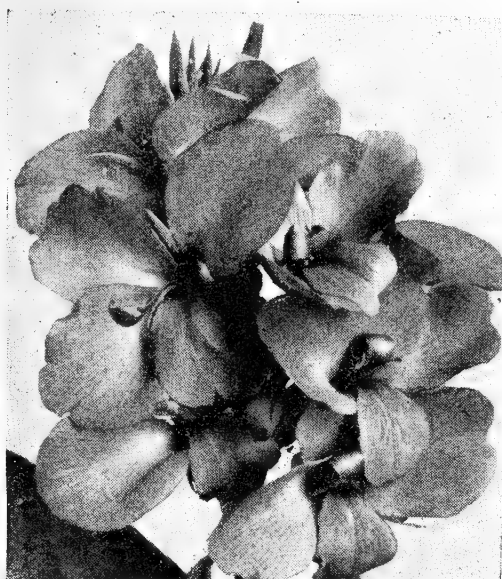

Canna

Cannas

Roots may be started indoors in pots or shallow boxes in March or April and planted out late in May. Dormant roots should not be planted outdoors until the ground warms up.

For best results beds should be dug at least 18 inches deep and generous quantities of manure well mixed with the soil.

15 cts. each, \$1.50 per doz., \$10 per 100

City of Portland. Clear glowing rosy pink flowers of unusually large size. Broad, rich green leaves. Wonderfully effective and the best Canna of its color. Height 3½ feet.

Eureka. The best white-flowering Canna for bedding. Height 4½ feet.

King Humbert. On account of its rich purplish bronze foliage, one of the most handsome. Flowers orange-scarlet, freely produced for a long season. Height 4½ feet.



Lilium regale

The President. Enormous glowing scarlet flowers of wonderful substance borne erect on strong stems; luxuriant deep green foliage. Blooms continuously from midsummer until frost. Height 4 feet.

Yellow King Humbert. A large-flowered yellow variety, popular for tall beds. Flowers deep yellow, blotched with red; leaves dark green. Height 5 feet.

Hardy Lilies

Showy garden flowers of the utmost beauty and stateliness, which are enormously popular just now. Plant them 6 to 8 inches deep and as early as possible in well-drained unfertilized soil, and let them alone. Spread an inch of sharp sand under each bulb to provide drainage. Cover with litter when hard frosts come.

Regale (The Royal Lily). Enormous, trumpet-shaped flowers with waxen white petals suffused with gold inside and stained with purple outside; fragrant. Does well in almost any situation, growing 2 to 4 feet high and bearing its blooms in a whorl at the top. 75 cts. each, \$7.50 per doz.

Tenuifolium (Coral Lily). Small flowers of bright coral-scarlet, produced in generous quantities on 1½-foot plants in June. 35 cts. each, \$3.50 per doz.

Tigrinum splendens (Tiger Lily). Grows 4 to 6 feet tall; flowers orange-red and brown. 35 cts. each, \$3.50 per doz.

Umbellatum. Sturdy, 2-foot plants bearing umbellate heads of erect, spreading flowers of rich orange. Easy to grow. June bloom. 35 cts. each, \$3.50 per doz.

Hardy Perennials

DAPHNE Cneorum. Garland Flower. Unusually attractive, dwarf, bushy evergreen plant bearing bright pink flowers at tip of every branch during May and August. 7 to 9 inches. \$1.50 each.

DICENTRA spectabilis. Bleeding-Heart. An old-fashioned favorite. Its long racemes of graceful, heart-shaped pink flowers are always attractive. 60 cts. each, \$1.65 for 3.

eximia. Finely cut foliage and showy racemes of pretty pink flowers. Low-growing. 50 cts. each, \$1.35 for 3.

IRIS vulgaris. Flag. Superbly colored varieties of this popular garden plant. 20 cts. each, 50 cts. for 3, \$1.75 per doz.

LILY-OF-THE-VALLEY. A dainty plant for shady places. Fragrant, bell-like, white flowers in May. A good ground-cover. Large clumps. 50 cts. each, 3 for \$1.35.

VINCA minor. Hardy Myrtle. A tufted, evergreen, half-trailing plant. Dark, leathery foliage with purple-blue flowers. Useful in dry, shady places. Large clumps, 20 cts. each, \$2 per doz.

YUCCA filamentosa. Adam's Needle. Broad, sword-like, evergreen foliage and large, drooping, creamy white flowers on stems about 6 feet high. 75 cts. each.

filamentosa Hockeri. Variegated leaves. \$1 each.

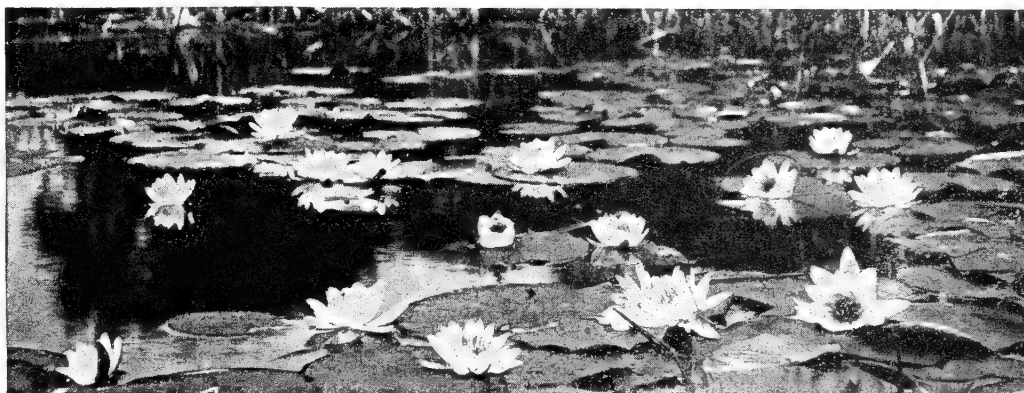

Pond and Marsh Plants

Hardy Water-Lilies require little care and may be left without disturbing for several years. A few ornamental fish in the pool add to interest and keep mosquitoes under control and a few snails will keep the water clean.

Hardy Water-Lilies

	Each ppd.
Blue Beauty. (Tropical) Day blooming. Glorious rich blue	\$2 50
Chromatella. Rich canary-yellow.	2 00
Comanche. Sunset shade.	2 50
Firecrest. Pink.	2 00
General Pershing. (Tropical)	
Light pink.	2 75
Gladstone. Pure white; large.	2 00
Gloriosa. Red. Very free bloomer.	3 00
Mrs. George Pring. (Tropical)	
White	2 25
Panama-Pacific. (Tropical) Day blooming. Purple.	2 25

Marsh or Bog-Plants

Anacharis. Oxygenating plant.	
	15 cts. each
Blue Flag.	3 for \$1
Giant Arrowhead.	3 for 75 cts.
Graceful Cattail.	3 for 75 cts.
Parrot Feather.	2 for 25 cts.
Pickerel Rush.	35 cts. each, 3 for \$1
Primrose Creeper.	25 cts. each
Umbrella Palm.	35 cts. each, 3 for \$1
Variegated Sweet Flag.	3 for \$1
Water Hyacinth.	2 for 25 cts.
Water Poppy.	2 for 25 cts.
Yellow Flag.	3 for 75 cts.

GLADIOLUS

*Few flowers are lovelier
or easier to grow*



There are few flowers to compare with the Gladiolus for all-round usefulness in the home-garden. Their graceful form, attractive colors, and characteristic markings have given them the popular name of "Garden Orchids." Plant the bulbs any time after mid-April up to the end of June, setting them about 4 inches deep and 6 inches apart. For a constant supply of flowers for cutting from August to frost, make plantings every week or ten days. Our bulbs average 1½ inches and over in diameter, which is considered the very best flowering size. Thrips are, possibly, the greatest enemy of Gladiolus and we recommend that the bulbs be treated with Semesan before planting. When the growth is about 6 inches high, begin spraying with Nicotine Pyrox and continue spraying at 10-day intervals to protect new growth.

9 cts. each, 85 cts. per doz., \$6 per 100, except as noted

Red Shades

Aflame. Huge begonia-rose bloom with back of petals brighter than the face. Very popular variety.

Beacon. A beautiful light red with a large, clear blotch. Very striking. 12 cts. each, \$1.10 per doz., \$8 per 100.

Commander Koehl. Dark scarlet-red without markings or blotches. Large spike. 12 cts. each, \$1.10 per doz., \$8 per 100.

Crimson Glow. Unique in its dark velvety red color. Not a new variety but still the best of its class.

Dr. F. E. Bennett. Peach-red, overlaid with flame-scarlet; throat speckled ruby and creamy white. Sturdy grower.

Dream O'Beauty. Giant American-Beauty-rose-red, with slightly deeper throat. Grows 5 feet tall. Because of its vivid coloring this variety is an especial favorite.

Excellence. Deep orange-vermilion, self color in effect with faint throat markings of slightly deeper shade. Everyone that sees this variety in blooms marvels at its gorgeous color. 15 cts. each, \$1.50 per doz., \$11.50 per 100.

Red Lory. Long, straight spike with flowers of rich orange-crimson.

Red Phipps. A glowing bright red of translucent texture. Straight spike.

Scarlet Wonder. Pure deep scarlet. Mammoth flowers, many open at a time on tall, stiff stems.

Wuertembergia. Very fine large red with white blotch. A newer imported variety. 12 cts. each, \$1.10 per doz., \$8 per 100.

Salmon and Pink Shades

Betty Nuthall. Flower-spikes long and graceful. Warm coral-pink, with pale orange throat.

Camellia. Tall, blush-white tinted pink with small scarlet blotch. Very beautiful. 12 cts. each, \$1.10 per doz., \$8 per 100.

Debonair. La-France-pink with a creamy throat touched with crimson. Fine straight spike.

Giant Nymph. Large; light salmon-rose. Considered one of the very best commercial and exhibition pinks.

SALMON AND PINK SHADES, continued

Margaret Fulton. Beautiful rich dark salmon of distinctive form. A wonderful cut-flower as well as decorative type. Early and has ability to withstand heat.

Odin. Orange-pink. Fine for early cut-flowers.

Peach Rose. Lovely rose-colored variety. Blended just enough to be classified as peach-color. Large flower.

Peggy Lou. Soft pink flowers with tall spikes and florets well placed. 12 cts. each, \$1.10 per doz., \$8 per 100.

Picardy. One of the best of the new Glads. The blooms are large, slightly ruffled, and a charming apricot-pink color.

Pride of Wanakah. One of the most beautiful rose-colored varieties. It is very dark rose almost light red. One of the best all-round Gladiolus.

Rose of Lima. Very tall and early show variety. Flower is lovely light rose. 12 cts. each, \$1.10 per doz., \$8 per 100.

Smiling Maestro. Large flowers of salmon-rose. Many florets open at once. 12 cts. each, \$1.10 per doz., \$8 per 100.

Sonatine. Bright clear pure pink with inconspicuous throat-marking. Very tall grower and a fine cut-flower.

Orange Shades

Bit O'Heaven. Medium-sized florets of orange with a yellow throat. Tall, straight plant opening 9 to 12 flowers. 12 cts. each, \$1.10 per doz., \$8 per 100.

Paradise. Large apricot flower. Many open at one time. Florets are well placed. Makes a splendid cut-flower variety. Tall strong spike, rich and refined. Early.

Token. One of the newer orange varieties. Tall spike. Fine for cutting.

Wasaga. Somewhat ruffled blooms of the softest apricot with a buff throat.

Yellow Shades

Gate of Heaven. Beautiful ruffled deep yellow blooms. Medium height.

Gold Dust. New deep yellow variety. Makes a long good spike. Very popular with all growers who have tried it. 12 cts. each, \$1.10 per doz., \$8 per 100.

Golden Dream. A very large golden yellow flower. By many growers still considered the best yellow. Straight tall spike of high quality for cut-flower as well as decorative purpose.

Miss Bloomington. A fine variety with 6 to 8 light yellow florets open on tall plants. Very late.

YELLOW SHADES, continued

Yellow Wonder. Buttercup-yellow, slightly deeper in the throat.

Blue, Lilac, and Purple Shades

Anna Eberius. An immense flower of brilliant velvety plum-purple. A substantial bloom on a very fine spike. Unique in its plum-color appearance.

Bagdad. Immense, smoky old-rose bloom somewhat darker toward the edges and lighter toward the throat.

Blue Admiral. A good rich dark blue with long spikes. One of the best varieties in its color. 12 cts. each, \$1.10 per doz., \$8 per 100.

Charles Dickens. Purple-violet. A very good grower and choice variety.

King Arthur. Lovely lavender-pink. Ruffled and fluted edges give it a distinct and beautiful appearance.

Marmora. Lavender-gray, with petunia-colored blotch. Ten to twelve very large flowers open at once.

Minuet. Beautiful clear, light lavender. The leading standard lavender for many years.

Pelegrina. Deep violet-blue with a deeper violet throat. There is a dark blue velvety sheen over all.

Purple Heart. Large, light purple with a deep purple heart. Many florets open at a time. 12 cts. each, \$1.10 per doz., \$8 per 100.

Vagabond Prince. The loveliest of the "smokies." Garnet-brown with a glowing scarlet spot on lower petals. Appreciated by everyone. 12 cts. each, \$1.10 per doz., \$8 per 100.

White Shades

Maid of Orleans. Creamy white with light cream shade in throat. Large flower.

Pearl Harbor. Large white flower. Claimed to be the best white on the market. 15 cts. each, \$1.50 per doz., \$11.50 per 100.

Polar Ice. Pure white. Flowers grow straight and are of good shape and size. Very early. 12 cts. each, \$1.10 per doz., \$8 per 100.

SCOTT'S GARDEN MIXTURE.

This mixture of standard varieties in many beautiful colors will make an excellent showing in the garden or for cut-flowers. Large, healthy bulbs, 7 cts. each, 75 cts. per doz., \$5 per 100.

See Gladiolus Collection Offer on 3d cover.

25 Bulbs of a variety at 100 rates. Prices are postpaid.

Dahlias

It is doubtful if there are any flowers that afford as much general satisfaction as Dahlias. The ease with which they can be grown in any sunny situation, their freedom from pests and blights, their endless variety of color, size, and form, and their great usefulness for cutting as well as garden decoration insure them a permanent place in popular favor, while their low cost makes it easy for everyone to start a collection which can be added to year after year. The roots or tubers should be planted about 4 inches deep in well-dug soil during May or June. Allow at least 2 feet of space between plants. Trim out all but the strongest two or three shoots and when these are about 4 feet

high pinch off the tips to encourage branching. If extra-large exhibition blooms are wanted, remove all but one or two of the top buds on each stem. Tall plants should be tied to stakes for support. Dig roots when frost has killed the foliage in the fall, and store in sand or soil in a cool but frost-proof cellar.

The Cactus Dahlias are distinguished by narrow, quilled petals which are often curved and twisted in various forms. Decorative Dahlias include the old-fashioned formal and rather stiff show or "ball" Dahlias, and the newer broad-petaled types of enormous size.

In the following list, B indicates Ball or Show; C, Cactus; D, Decorative

All varieties offered are tubers (root divisions). Price, 25 cts. each, \$2.50 per doz.

Aida. (D.) Maroon.

Avalon. (D.) Large yellow.

Bashful Giant. (D.) Apricot.

Bonnie Blue. (B.) Bluish lilac.

Commodore. (D.) Canary-yellow.

Ellinor Vanderveer. (D.) Rose-pink.

Gertrude Brinton. (D.) Red.

Hillcrest Mandarin. (D.) Red and yellow. Flashy and very large.

Jane Cowl. (D.) Bronzy buff and salmon. One of the best and a winner of as many prizes as any Dahlia ever grown.

Jean Kerr. (D.) Pure white.

Jersey's Beacon. (D.) Scarlet and buff. Very spectacular and a prolific bloomer.

Jersey's Beauty. (D.) Beautiful pink. Ideal cut-flower variety and a good keeper.

Judge Marean. (D.) Orange and red.

Le Toreador. (D.) Brilliant red.

Margaret Woodrow Wilson. (D.) Opalescent pink. Huge flowers of exhibition type. Very attractive.

Melody. (C.) Yellow.

Minamoto. (C.) Scarlet.

Mrs. C. D. Anderson. (B.) Crimson.

Mrs. Carl Salbach. (D.) Lavender-pink.

Penn Charter. (D.) Buff tinted apricot. A fine cut-flower.

Purity. (D.) White.

Rose Glory. (D.) Rose-lavender.

Rosemawr. (D.) Rose-pink.

Sanhican's Bluebird. (D.) Bright violet-blue. A splendid variety.

Starlight. (D.) Large; golden yellow.

Whitecap. (D.) Large; white.

Yellow Duke. (B.) Yellow.

Prices given are postpaid. Half-dozen roots, any assortment of varieties, at dozen rates



Cactus Dahlias

Peonies

Peonies are among the most gorgeous plants that can be grown in a garden. Given a deep, rich soil and a sunny situation they will thrive anywhere. A mulch of manure each fall will help to maintain them. Plant the roots so that the eyes will be about

1/2 inch below the surface of the ground. We offer strong divisions with 3 to 5 eyes, and plenty of roots, and are larger than usually offered.

Price, 60 cts. each, \$6 per doz.

Asa Gray. Pale pink, lilac dotted. Fine cut-flower variety.

Edulis Superba. Bright old-rose to pink. Very fragrant. Blooms extra early.

E. G. Hill. Large; light red. A really lovely variety.

Felix Crousse. Flame-red. Large, bomb-shaped. Late midseason.

Festiva Maxima. White; very large, globular. Still one of the best. Early.

Fragrans. Small, dark rose-pink flowers. Very beautiful cut-flower variety. Late.

Grover Cleveland. One of the finest dark crimson sorts. Late midseason.

Gypsy. Very attractive single pink.

Karl Rosenfield. Dark crimson, very brilliant and striking in color. Blooms are of semi-rose type. Midseason.

Madame de Verneville. White with blush-white center. Strong grower and reliable bloomer. Early.

Marie Crousse. Globe-shaped blooms rather loose in form. Color pale lilac-rose. Plants tall and free blooming. Midseason.

Liberty. Beautiful dark rose-red, edged and tipped pale buff-yellow. Considered one of the best single red varieties.

Mme. Ducl. Light mauve-rose with a silvery reflex. Globe-shaped blooms, slightly fragrant. An extra-fine variety.

Mons. Jules Elie. A large flower with a high crown. Color pale lilac-rose, with an amber-yellow collar; fragrant. Early.

Princess Beatrice. Guard and crown petals violet-rose; collar creamy white with crimson flecks. An extra-good variety blooming in midseason.

Reine Hortense. Large; rose-pink. Deliciously fragrant. Midseason.

Souvenir de Louis Bigot. Vivid rose-pink, brightening to shell-pink in center. A gorgeous variety. Midseason.

Victory. Attractive single pink.

PEONIES BY COLOR. Strong-growing roots of selected varieties. Named to color, red, white, or pink. 50 cts. each, \$5 per doz.

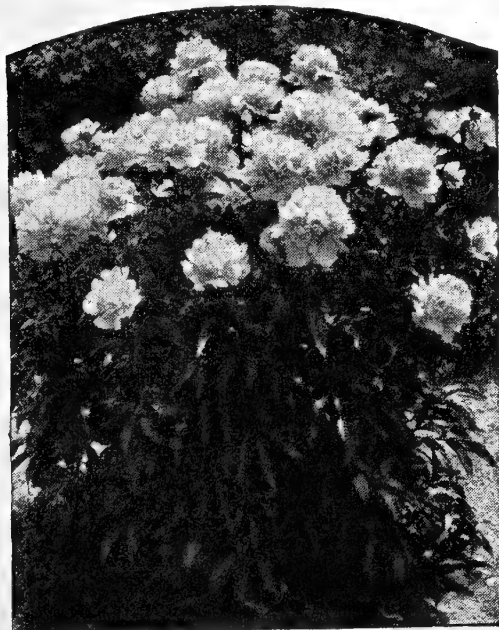

Peonies



The Queen of Flowers

The Rose has been for thousands of years the queen of flowers, and no garden can be complete without representatives of the different types of these lovely blooms. We list here only the best varieties of the different classes of Roses, in a quality of plant which will give the best service to our customer.

For exhibition and cut-flower purposes, the Hybrid Teas are

unsurpassed. For a sheer mass of color in the garden there is nothing like the Polyanthas. The Hybrid Perpetuals will give you quantities of large, fragrant flowers in June. Climbing Roses can serve many purposes, and every garden should have a few of the old Moss Roses and that splendid shrub Rose, *Rosa Hugonis*.

Hybrid Tea Roses

These popular flowers are crosses between the fragrant and hardy Hybrid Perpetuals and the old tender Tea Roses. They give quantities of bloom of cut-flower quality on plants which are hardy with a little protection during the winter.

They begin blooming in late May or early June, depending on the locality, and if given plenty of water, occasional applications of fertilizer, and are kept sprayed or dusted so that the foliage is free of disease or insects, will bloom practically continuously until stopped by frosts.

All of the Roses we offer are No. 1 grade, 2-year-old, hardy, northern, field-grown plants.

Red Varieties

Ami Quinard. One of the darkest Roses in existence. Velvety crimson-maroon with a soft black luster. Averages 17 petals. Carries the real old Rose fragrance. Strong-growing plants. \$1.25 each.

Charlotte Armstrong. Plant Patent No. 455. Beautiful blood-red buds opening to very fine flowers that become cerise in hot weather. Vigorous, free-branching plant that blooms very freely; foliage plentiful and disease-resistant. \$1.50 each.



Charlotte Armstrong

Christopher Stone. Large, loose flowers of brilliant scarlet-crimson; rich old-time fragrance. Healthy, bushy plants which bloom all the time. \$1.25 each.

Crimson Glory. Plant Patent No. 105. Gorgeous crimson flowers shaded red and with a nap so deep the shadows are black. Grand form and unforgettable fragrance. Healthy plants of medium height bloom generously. \$1.50 each.

Dicksons Red. Plant Patent No. 376. Large, cupped flowers of flashing scarlet-red; highly perfumed. An early and abundant producer of bloom. Strong plant with healthy foliage. Stands hot sun without fading. \$1.25 each.

Etoile de Hollande. The best red Rose for garden use. Its flowers are gigantic, beautifully frilled, fragrant, and the color is deep unfading crimson. \$1.25 each.

Grande Duchesse Charlotte. Propagation rights reserved. Rich claret-colored buds gradually changing to a lovely begonia-rose. Streamlined, in form, with healthy, dark green foliage. Tall and upright. \$1.50 each.

Heart's Desire. Plant Patent No. 501. Slender dark red buds and beautiful 4-inch blooms of rich scarlet-red, a color which is retained. Delicious old-time real Rose fragrance. Strong, free-blooming plants. 25 petals. \$1.50 each.

McGredy's Scarlet. An excellent garden Rose which is a nice shade of red, instead of scarlet, as the name would indicate. Flowers are freely produced on very vigorous, healthy plants. \$1.25 each.

Poinsettia. This is the nearest to clear scarlet of any double Rose. The flowers are beautifully formed of 35 velvety petals and carry real old Tea fragrance. Plants are tall with healthy foliage. \$1.25 each.

Red Radiance. A sport of Radiance and equally good, differing only in the beautiful deep red color of the large globular flowers. Very hardy and of the greatest garden value. Fine fragrance. \$1.25 each.

Texas Centennial. Plant Patent No. 162. A sport of President Herbert Hoover, exactly like its parent in plant and shape of flower. The color, however, is vermilion-red with a touch of gold at the base of the petals. Flowers age a deep shade of pink. \$1.25 each.

Pink Varieties

Editor McFarland. Brilliant pink flowers that hold their form and color very well after being cut. Fragrant and beautifully shaped. Strong, healthy plant bearing its blooms on good stems. \$1.25 each.

Good News. Plant Patent No. 426. A full, well-formed flower with 50 crimped petals, peach-pink in color, opening silvery pink. Tea fragrance. Dark green foliage on a hardy plant that reaches about 2½ feet in height. \$1.50 each.

Lady Ashtown. The large, long-pointed buds open to double, fragrant flowers of perfect form. The color is carmine-pink with a golden underglow. Vigorous plant with rich green foliage. \$1.25 each.

Mary Margaret McBride. Plant Patent No. 537. Large, double blooms of perfect form. Pointed buds with a high center are clear deep coral-pink, with gold tones showing at the base of the petals; the color lightens with age. Long stems and strong, hardy plants. \$1.50 each.

Mme. Cochet-Cochet. Plant Patent No. 129. Strong plants that are very free with their shapely flowers of coppery pink warmed with orange. \$1.25 each.

Pink Dawn. A splendid new double Rose with rose-colored buds opening to lovely pink flowers tinted with orange at base of petals; sweetly fragrant. Strong, upright growth. \$1.25 each.

Pink Pearl. This is a grand clear pink Rose on long, clean stems and is freely produced on attractive plants. It is fully double and is one of the sweetest of all. You will like it to cut. \$1.25 each.

President Macia. Long pink buds open to great loose, fragrant flowers 5 to 6 inches across of pale flesh with a deep pink reverse. Low spreading plants with good foliage. 25 petals. \$1.25 each.

Radiance. Large, strongly fragrant, light silvery pink to salmon-pink flowers, borne profusely all summer on long, strong stems. \$1.25 each.

Sterling. Plant Patent No. 21. One of the most beautiful of all pink Roses. Large, fragrant flowers on long stems. Strong branching plants that bloom abundantly. A great Rose. \$1.25 each.

Yellow Varieties

Eclipse. Exquisite long, tapering buds that are perfect for boutonnières. Long sepals enclose each golden yellow bud. The strong plants are prolific with their bloom on firm, upright stems. Foliage is disease-proof. \$1.25 each.

Golden Dawn. One of the best garden Roses, with large, very double and very fragrant flowers of pale straw-yellow. The plants are low but spreading, with beautiful foliage. \$1.25 each.

Golden Sastago. A buttercup-yellow sport of Condesa de Sastago with the same fine plant as the parent. The large cupped blooms are fragrant and are freely produced. 35 petals. \$1.25 each.

Joanna Hill. A favorite cut-flower variety with shapely buds and high-centered open flowers of pale yellow; mildly fragrant. Healthy plants of medium growth. \$1.25 each.

McGredy's Sunset. Plant Patent No. 317. Glowing gold and yellow flowers that hold their form very well. The buds are exquisitely shaped, and have a mild fragrance. Blooms freely, and is resistant to both disease and hot weather. \$1.25 each.

McGredy's Yellow. A cupped flower of bright buttercup-yellow, large and really exquisite. Bud is of long-pointed form, borne on a dark red stem. Glossy dark bronzy foliage; growth vigorous. \$1.25 each.

Mrs. Erskine Pembroke Thom. Best of the clear unshaded yellow Roses. Flowers well shaped, of medium size, and richly yellow. Fine foliage and growth vigorous. Free flowering. \$1.25 each.

Mrs. Pierre S. du Pont. A deep yellow Rose that shows no signs of fading. Good foliage and a prolific bloomer. \$1.25 each.

Roslyn. Bud deep orange, becoming golden yellow as it unfolds, with the reverse of the petals more orange than the inside. Large and semi-double in shape, with slight fragrance. Vigorous, compact plant. \$1.25 each.



Mrs. Erskine Pembroke Thom

Bicolor Varieties

Angels Mateu. Plant Patent No. 174. A very distinctive shade—orange-rose. Large blooms, full-petaled and with the fragrance of red raspberries. Makes a fine exhibition flower. \$1.25 each.

Autumn. A richly colored double flower of burnt-orange red, orange, and pink. Plants of medium height. A striking Rose in the fall. \$1.25 each.

California. Plant Patent No. 449. A warm shade of orange toned saffron-yellow, with the reverse of the petals overlaid saffron-rose. Very large blooms, 5 to 6 inches across. Glossy, disease-resistant foliage; vigorous growth. \$1.50 each.

Condesa de Sastago. This spectacular cupped bloom is burning copper inside and golden yellow on the reverse. It is fragrant and produced on strong, upright plants. 50 petals. \$1.25 each.



Mary Margaret McBride

Countess Vandal! Plant Patent No. 38. Stunning new Rose of coppery pink, strongly tinted with ruddy shades in the bud, opening to big, handsomely shaped flowers of striking color. \$1.25 each.

Duquesa de Penaranda. Great double flowers of a brownish peach-color that is distinct and beautiful. They are sweetly fragrant, too. Upright, generous-blooming plants. \$1.25 each.

Edith Nellie Perkins. One of the finest of the two-tone pink Roses, with rosy carmine on the reverse of the petals and salmon inside, all overspread with a thin golden sheen. Splendid plants, blooming freely. \$1.25 each.

Girona. Tall, healthy plants with long-stemmed blooms of Tyrian-rose and golden yellow. They are not only beautiful but wonderfully fragrant. A great Rose you will like. 30 petals. \$1.25 each.

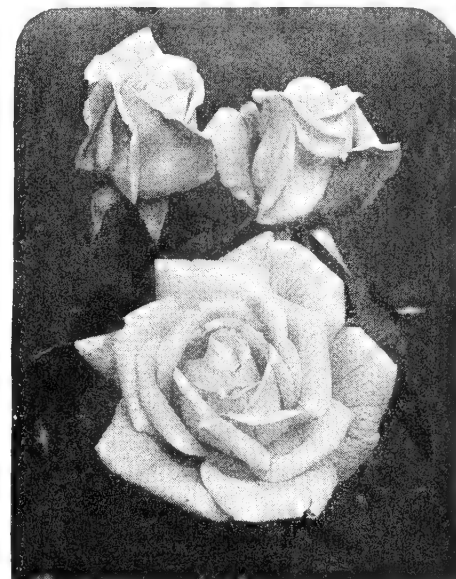

Autumn

Heinrich Wendland. One of the most spectacular of all Roses, with fragrant, unfading flowers of nasturtium-red, with a deep golden yellow reverse. \$1.25 each.

Mme. Henri Guillot. Plant Patent No. 337. Raspberry to watermelon-pink. Petals are broad, firm, and arranged somewhat in urn shape, and later the bloom resembles a large camellia in form. Very fragrant. Long, strong stems. \$1.25 each.

President Herbert Hoover. Enormous flowers of ever-changing color. Deep copper-red in bud, golden in the center, with deep pink outer petals. In autumn it is superb. Plants very strong, with good foliage, blooming early and often. \$1.25 each.

Signora. Plant Patent No. 201. A great new Rose of fine form on long stems. Deep orange, heavily veined carmine, edges of petals brick-orange. Fruit fragrance. 45 petals. \$1.25 each.

Talisman. The great florists' Rose with spectacular blooms of yellow, orange, and scarlet, changing with the season. Fragrant flowers on fine stems for cutting. \$1.25 each.

The Chief. Plant Patent No. 456. Magnificent full flowers of carmine-pink overspread with an orange flush and golden base to petals. Fruity fragrance. Strong bushy plants. 30 petals. \$1.25 each.

White Varieties

Kaiserin Auguste Viktoria. This old Rose is the finest of all the whites. It has form, fragrance, and is fully double. Plants are of average height and bloom. \$1.25 each.

Snowbird. Fully double blooms of snowy white with a creamy center. Deliciously fragrant. Plants are of moderate growth with profuse attractive healthy foliage and a continuous crop of bloom all season. The best white bedding Rose. \$1.25 each.

QUANTITY PRICES. All varieties, except Patented ones, \$13.50 per dozen; half-dozen plants, any assortment of varieties, at dozen rates. Prices given are prepaid when the order amounts to \$2 or more. See page 1.

SHORT SUPPLY. Rose bushes are in short supply for 1945. We suggest that orders be placed early, and that you name a second choice of varieties on your order.

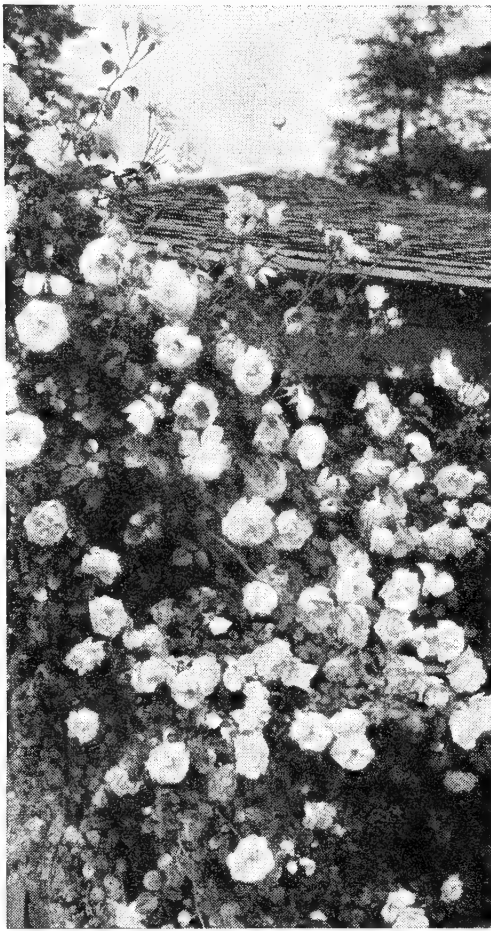

New Dawn

Climbing Roses

The modern Climbing Rose is one of the most adaptable and most satisfactory of all flowering plants. There are many types to choose from and for covering trellises, arches, fences, walls, or sides of buildings, they are unsurpassed. Even the home with practically no space for a garden can find room for a Climbing Rose.

Blaze. Plant Patent No. 10. The blazing red blooms are produced in clusters for several weeks during the Rose season, and a second crop of flowers may be expected before freezing weather arrives. \$1.25 each.

Climbing American Beauty. Moderately fragrant, rich rosy carmine, 3 to 4-inch blooms on long stems, on a vigorous, hardy plant. \$1.25 each.

Doubloons. Plant Patent No. 152. A handsome yellow Climber developed from the native Prairie Rose, which makes it harder than any other yellow Climber. \$1.50 each.

Flash. Plant Patent No. 396. Large, double flowers, orange-scarlet inside with a yellowish reverse. \$1.25 each.

New Dawn. Plant Patent No. 1. The blooms are produced freely from the opening of the season in June until cold weather. The color is a delicate blush-pink, and long stems make the clusters desirable for interior decorations. Foliage is dark green and glossy. \$1.50 each.

Paul's Scarlet Climber. Clusters of semi-double, vivid scarlet flowers shaded crimson, that retain their color till they fall. Hardy and floriferous. \$1.25 each.

Polyantha Roses

These dwarf Roses produce an abundance of bloom all season. The plants average 18 inches in height and are especially valuable for a hedge or border or for massing.

Price, \$1.25 each

Betty Prior. Plant Patent No. 340. Single; shell-pink on face, a red reverse. Blooms in clusters on a 3-foot plant.

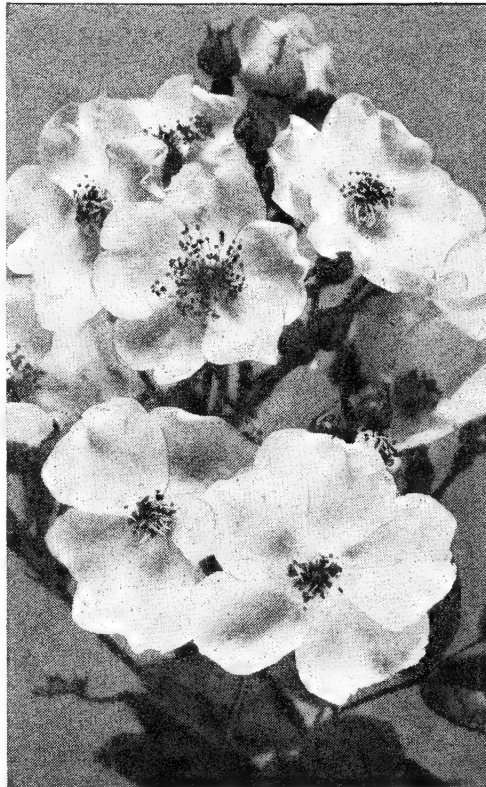

Betty Prior

Chatillon. Semi-double, bright pink flowers, slightly fragrant. Plant 1 to 2 feet high.

Donald Prior. Plant Patent No. 377. Deep red, 3-inch blooms of 8 petals borne in clusters on 3-foot plants.

Miss Edith Cavell. Large clusters of small, semi-double, brilliant scarlet-red flowers, shaded darker.

Orange Triumph. Double pompons of brick-red in huge clusters. Bushy plants 2 feet high. A fine Polyantha.

Permanent Wave. Plant Patent No. 107. Blooms are large, semi-double, fragrant, and carried in clusters on long stems. The color is a brilliant carmine.

Summer Snow. Plant Patent No. 416. Snow-white flowers almost covering a dwarf, hardy bush. Blooms abundantly for about five months.

World's Fair. Plant Patent No. 362. Fragrant, velvety crimson blooms. A prolific producer all season. Plants 3 feet high, very hardy.

Hybrid Perpetual Roses

These are much hardier, stronger growing plants than the Hybrid Teas and bear an immense crop of bloom in June.

Price, \$1.25 each

Frau Karl Druschki. An immense, pure white, perfectly double Rose, which blooms all season.

Henry Nevard. Nicely formed blooms of crimson-scarlet. Sweetly fragrant. Fine plants.

Georg Arends. Immense, soft pink, fragrant blooms of fine form. Called a "Pink Druschki." A beautiful Rose.

Mme. Albert Barbier. Soft fawn-yellow flowers, paling to white, with pinkish shades in center; double; cupped.

Ulrich Brunner. Large, cupped flowers of carmine-red, deliciously fragrant.

Shrub Rose

Rosa Hugonis. Flowers light yellow, about 2 inches across, borne on long, slender branches. Generally in full bloom Decoration Day. \$1.25 each.

Trailing Rose

R. Wichuraiana. Pliable canes with small shiny foliage and small white fragrant flowers. A fine bank-cover. \$1.25 each.

Moss Roses

A group of old-fashioned Roses of moderate growth, readily recognized by the mossy coating which surrounds the calyx of the bloom. Very attractive.

Price, \$1.25 each

Crested Moss. Beautifully mossed pink buds and double pink flowers.

Salet Moss. Large, full flat blooms of rosy pink.



Frau Karl Druschki



Clematis

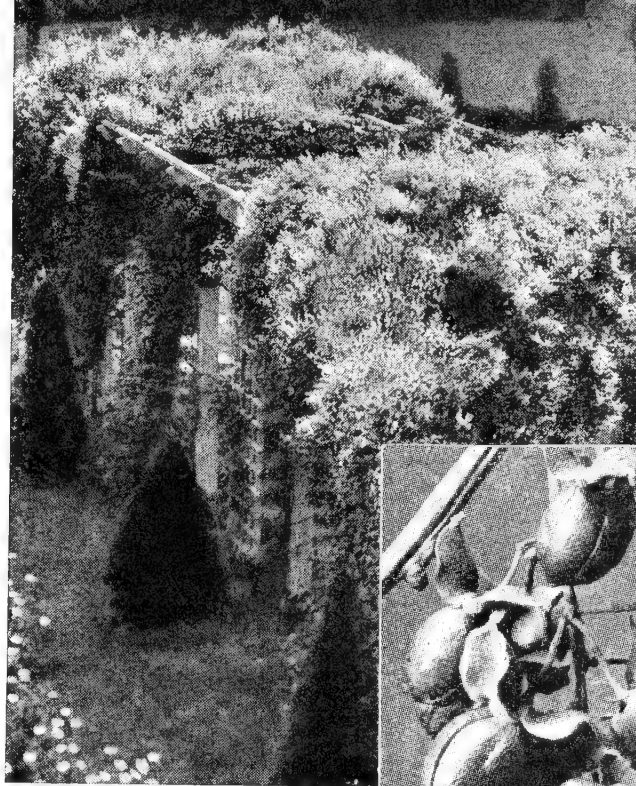

Silver Lace Vine

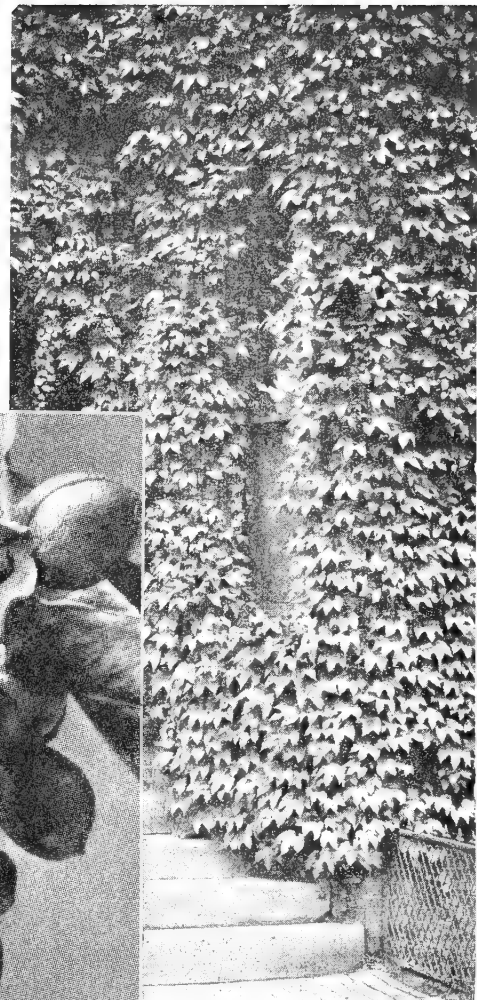

Boston Ivy



Bittersweet

VINES

Nothing adds more to the grace and charm of a planting around a porch than a few well-chosen vines. Most home-gardens have some unattractive corners that can be greatly improved by vines, for they have a softening effect not easily obtainable otherwise. Vine-draped trees and pergolas have a peculiar beauty, and some vines like Honeysuckle are especially valuable as ground and bank-covers. The following are highly desirable vines. They are all strong, 2-year-old No. 1, field-grown plants, with good root-systems, except Cinnamon Vine and Madeira Vine, which are roots.

BITTERSWEET (*Celastrus scandens*). Large foliage hung in autumn with clusters of orange and yellow berries which are very decorative all winter. 75 cts. each, \$2 for 3.

BOSTON IVY (*Ampelopsis Veitchii*). High-climbing, clinging, deciduous vine with lustrous, three-pointed leaves 2 to 4 inches across. 75 cts. each, \$2 for 3.

CINNAMON VINE. Vigorous climber with broad heart-shaped leaves and clusters of white, cinnamon-scented flowers. Dies to the ground each winter but comes up again very quickly in the spring. Large roots, 12 cts. each, \$1.25 per doz., \$9 per 100.

CLEMATIS Jackmani. Large, flat, 3 to 4-inch, velvety purple flowers, freely produced. \$1.25 each.

paniculata. Sweet Autumn Clematis. In August or September the plants are densely covered with fragrant white flowers, followed by seeds, each of which has a grayish, fuzzy plume which gives the plant the appearance of being in bloom until winter comes. 75 cts. each, \$2 for 3.

Mme. Edouard Andre. Large bright carmine-violet flowers. Unusual and distinct. \$1.25 each.

DUTCHMAN'S PIPE (*Aristolochia Siphon*). Fast-growing; 6 to 15-inch broadly reniform leaves and pipe-like flowers. \$1.50 each.

SCARLET TRUMPET VINE. Vigorous climber. Handsome, trumpet-shaped, reddish orange flowers in midsummer. 75 cts. each, \$2 for 3.

HONEYSUCKLE (Lonicera), Halliana. Sweetly scented flowers from July to frost. Desirable for trailing over fences, arbors, and as a ground-cover for banks. 45 cts. each, \$1.25 for 3.

KUDZU VINE. Fast-growing hardy vine. Foliage large. Rosy purple, pea-shaped flowers in August. Fine for permanently covering verandas, dead trees, etc. 75 cts. each, \$2 for 3.

MADEIRA VINE. Rapid-growing climber that quickly covers porch, trellis, etc. Foliage light green; flowers white, small and feathery, delightfully fragrant. Plant roots in May. Large roots, 10 cts. each, 25 cts. for 3, 75 cts. per doz.

SILVER LACE VINE (*Polygonum Auberti*). Rapid climber. Light green, waxy foliage. Curious, stringy clusters of crystal-white flowers of irregular shape. 90 cts. each, \$2.40 for 3.

TRUMPET CREEPER (*Bignonia radicans*). The Bignonias are very useful for covering unsightly places, stumps, rockwork, or for planting in crevices in ledges. Large, attractive, scarlet flowers are borne in profusion. 75 cts. each, \$2 for 3.

VIRGINIA CREEPER (*Ampelopsis quinquefolia*). One of the best and quickest-growing vines for covering trees, trellises, arbors, etc. The large deep green foliage turns yellow, crimson and scarlet in fall. 75 cts. each, \$2 for 3.

WISTERIA sinensis. Handsome, showy, pea-like pale blue flowers in large grape-like clusters. Well adapted for training on porches, arbors, trellises, or trees. They require a deep rich soil. Strong, 2-yr., grafted plants, \$1.25 each.

HEDGE PLANTS

As a boundary between properties, or as an enclosure for the outdoor living-room, you will find hedges invaluable. Once planted they require little attention. The plants we offer are strong and well shaped, making fine lawn specimens as well.

CALIFORNIA PRIVET (*Ligustrum ovalifolium*). A rapid grower with dark green foliage that persists until early winter. May be pruned to any shape. Unpruned, it assumes an upright, spreading habit, about 10 feet tall. 12 to 18-in. plants, \$3 for 25, \$10 per 100, \$47.50 for 500.

IBOLIUM PRIVET. A hybrid of California and Iboya Privet and is hardier than either. Fast upright grower. Dark green foliage. May be trimmed to any shape. 12 to 18-in. plants, \$3.50 for 25, \$12 per 100.

BARBERRY (*Berberis Thunbergii*). Compact-growing, much-branched low shrub with many spines. Its red berries persist until spring. 12 to 18-in. transplanted plants, \$3 for 10, \$13.50 for 50, \$25 per 100.

RED-LEAVED BARBERRY (*Berberis Thunbergii atropurpurea*). Foliage is rich crimson, becoming scarlet when the sun falls on it. 18 to 24-in. plants, 65 cts. each, \$6 for 10.

Prices given are prepaid where the order amounts to \$2 or more. See page 1

HARDY FLOWERING SHRUBS

Flowering Shrubs bring the greatest return on investment that one can put into the home-grounds. They thrive with but little care, are attractive even in winter when the branches are without foliage, and when they do burst into bloom transform the grounds into bowers of scented beauty. In addition to their lovely flowers many shrubs develop attractive fruit which lasts well into the winter.

We offer a fine list for planting this spring.

ABELIA grandiflora. The Bush Arbutus is a medium-sized shrub with lovely glossy foliage and tubular flowers of pinkish white. Graceful when grown naturally and can be sheared to any height. Makes a grand hedge. \$3 each.

ALTHÆA. Rose of Sharon. A very useful shrub with large, single or double flowers in great profusion in late summer, a time when flowering shrubs are scarce.

Pink, Purple, Red, White, or Variegated. 2 to 3 ft., 75 cts. each, \$2 for 3.

ALMOND, Flowering (*Amygdalus*). Double fragrant flowers in May. **Pink or White.** 2 to 3 ft., \$1 each, \$2.75 for 3.

ARONIA arbutifolia brilliantissima. The Crimson Chokeberry has bright red berries and crimson leaves in fall. Grows 10 to 12 feet. 1½ to 2 ft., \$1 each.

melanocarpa. The Black Chokeberry grows slightly lower and bears glossy black berries. 2 to 3 ft., \$1 each.

AZALEAS. These hardy Azaleas bloom with the utmost freedom, becoming solid masses of flowers at their season, and continuing in splendor for several weeks. Plant in slight shade and shelter from severe winter.

Amœna. Brilliant reddish purple flowers completely cover every twig. Very showy. Evergreen. B&B. \$5 each.

Hinodegiri. A sparkling red variation of Amœna, with no trace of the purple. Evergreen. B&B. \$5 each.

mollis. A dwarf, very bushy, deciduous variety. Flowers light yellow to apricot and deep orange. B&B. \$4 each.

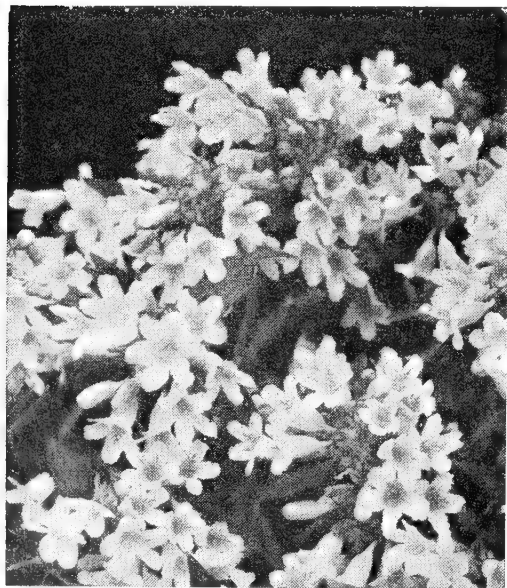

Beauty Bush

BEAUTY BUSH. An exceedingly handsome ornamental shrub. The foliage and habit are attractive when the bush is out of flower and it is perfectly hardy. It grows 6 to 9 feet high when mature, with long, arching branches. Covered in spring with clusters of small, tubular flowers of the honeysuckle type, borne in such profusion that the bush is one cloud of delicate pink. 2 to 3 ft., \$1.25 each.

BUDDLEIA, Ile de France. A new variety with fragrant, rosy purple flowers suffused with violet, borne in spikes 6 to 9 inches long. The symmetrical bushes are 3 to 4 feet high. 75 cts. each, \$2 for 3.

CALYCANTHUS floridus. Sweet Shrub. This is the popular old-fashioned "Strawberry Shrub," with brown, slightly scented, starry flowers, followed by pods of smooth brown seeds. 2 to 3 ft., 90 cts. each.

COTONEASTER divaricata. The Spreading Cotoneaster will grow to 6 feet and as wide. Pink flowers are followed by red fruit and foliage turns red in fall. 15 to 18 in., B&B. \$2.50 each.

DEUTZIA, Pride of Rochester. A very popular blush-white form, growing taller and bushier than *D. gracilis*. 2 to 3 ft., 90 cts. each, \$2.40 for 3.

gracilis. A small shrub covered with pure white flowers in graceful nodding racemes. Good for edging borders. 15 to 18 in., 75 cts. each, \$2 for 3.

DOGWOOD (*Cornus sanguinea*). Blood-twigged Dogwood. An upright shrub having bright coral-red branches with dark green leaves, pale beneath, and creamy white flowers in numerous flat-topped clusters, followed by bluish fruits. 2 to 3 ft., 75 cts. each, \$2 for 3.

florida. The well-known White-flowering Dogwood. Big, spreading shrub or small tree with large white flowers in spring. Foliage scarlet in autumn. Rich red berries. B&B. \$3 each.

florida rubra. One of the loveliest flowering trees. Blooms glowing peach-blossom-pink, tinged darker. A specimen in full bloom is a magnificent spectacle. 3 to 4 ft., B&B. \$4 each.

EUONYMUS alatus. Winged Burning Bush. Bushy shrub with corky winged branches. A fine shrub for specimen planting. Leaves turn to rich red and crimson in autumn. 2 to 3 ft., \$1.50 each.

europæus. A strong-growing shrub or small tree with finely toothed foliage and pink fruit. 2 to 3 ft., 90 cts. each.

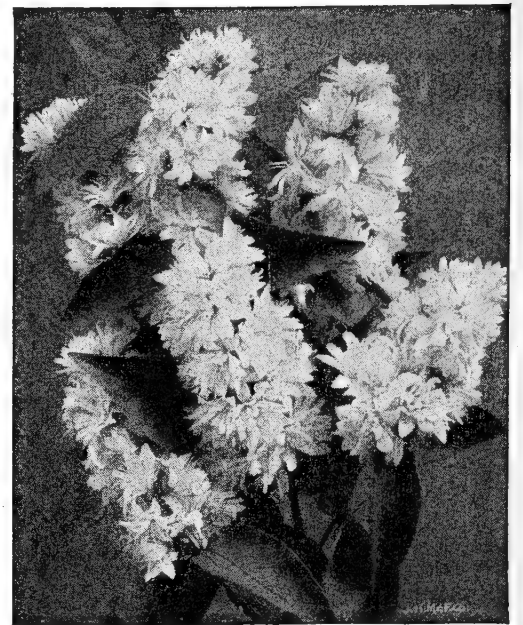

Deutzia gracilis

ELÆAGNUS argentea. Silverberry. Fragrant flowers and attractive foliage, silvery on both sides, on a 10-foot shrub. 2 to 3 ft., 90 cts. each.

FORSYTHIA. One of the very earliest shrubs to bloom and unsurpassed in splendor and brilliancy by other spring-flowering varieties.

spectabilis. Sturdy, erect bush with an unbelievable abundance of golden yellow flowers a shade or two darker yellow than any other variety. 2 to 3 ft., 75 cts. each, \$2 for 3.

suspensa Fortunei. A tall, willowy shrub literally covered with golden bells in early spring. 75 cts. each, \$2 for 3.

HONEYSUCKLE, Red Tatarian (*Lonicera tatarica sibirica*). A bushy shrub, reaching 10 feet, with crimson flowers in June, followed by red fruits. 2 to 3 ft., 75 cts. each, \$2 for 3.

White Tatarian (*L. tatarica alba*). About the same as the above except that the flowers are white. 2 to 3 ft., 75 cts. each, \$2 for 3.

HYDRANGEA, Nicko. Blue Hydrangea. One of the most showy of all plants. When planted in moist soil, flowers may assume a pinkish hue, but blue flowers may be assured by mixing alum with the soil. 1½ to 2 ft., B&B. \$2 each.

paniculata grandiflora. Big conical trusses of white flowers that soon assume rose and bronze tones, are borne in late summer and last till frost. Severe pruning in early spring brings big trusses of bloom. 18 to 24 in., 75 cts. each, \$2 for 3. 2 to 3 ft., 90 cts. each, \$2.40 for 3.

INDIAN CURRANT (*Symphoricarpos vulgaris*). Tall, slender shrub, with coral-red fruits. 2 to 3 ft., 75 cts. each, \$2 for 3.

JAPAN QUINCE (*Cydonia japonica*). Often called "Fire Bush." Scarlet and vivid pink flowers. Very early. 1½ to 2 ft., 75 cts. each, \$2 for 3.

Prices on Shrubs and Trees are prepaid where the order amounts to \$2 or more. See page 1

KERRIA japonica. From June to October this shrub is a golden yellow bouquet, 3 to 4 feet high. Smooth green bark. 1½ to 2 ft., \$1 each.

LILAC (*Syringa*).

Persica. Persian Lilac. Lavender-blue flowers in loose panicles. Delightfully different. 2 to 3 ft., \$1 each.

Vulgaris. The fragrant old Lilac found blooming in May in old gardens.

Purple. 2 to 3 ft., 90 cts. each.

White. 2 to 3 ft., \$1 each.

Lilac, Named French Varieties:

Belle de Nancy. Double flowers of satiny rose in long clusters.

Ludwig Spaeth. Deep reddish purple flowers in long clusters. Very unusual.

Mme. Lemoine. Narrow clusters of double flowers of purest white.

President Grevy. Double, rosy blue flowers in pyramidal clusters.

Above 4 Lilacs, Bush Form, \$1.50 each

MOCK ORANGE, Virginal (*Philadelphus virginialis*). A vigorous, tall grower, with very large, double-crested, pure white, sweetly scented flowers. A decided improvement over the old-fashioned Mock Orange. 2 to 3 ft., 90c. each; 3 to 4 ft., \$1 each.

PUSSY WILLOW. Furry catkins so popular in early spring for table decoration. 3 to 4 ft., \$1 each.

RHAMNUS Frangula. Glossy Buckthorn. Large shrub with glossy leaves and red fruit eventually turning black. 2 to 3 ft., 90 cts. each.

RHODOTYPOS kerrioides. White Kerria. Very ornamental, medium-sized shrub with pretty foliage and large, single white flowers in late May. Black berries. 2 to 3 ft., 90 cts. each.

SNOWBALL (*Viburnum opulus sterile*). The old-fashioned Snowball. White flowers in May and June. Very decorative. 1½ to 2 ft., 90 cts. each.

Oriental (*V. tomentosum plicatum*). Large, globular, pure white flowers in May and June. The fall foliage is especially fine. 2 to 3 ft., \$1 each.

SNOWBERRY (*Symphoricarpos racemosus*). Small, rose-colored flowers in June and July followed by large clusters of pearly white fruit which endure into the winter. 2 to 3 ft., 75 cts. each, \$2 for 3.

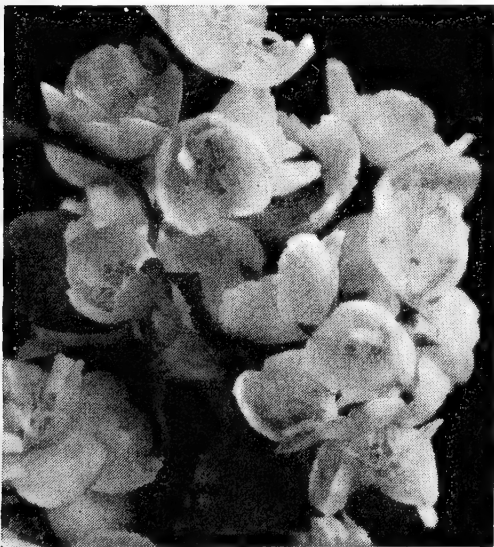

Mock Orange, Virginal

SPIRÆA, Anthony Waterer. Bright rosy crimson flowers in dense corymbs produced abundantly from July till frost. Fine for facing plantings of larger shrubs or edging walks. 1 to 1½ ft., 60 cts. each, \$1.65 for 3.

Van Houttei. The arching branches bend to the ground under many corymbs of small white flowers. 2 to 3 ft., 65 cts. each, \$1.75 for 3.

STEPHANANDRA flexuosa. A graceful shrub seldom more than a few feet high. An excellent plant for growing in the shade of other shrubs or trees. 2 to 3 ft., 75 cts. each, \$2 for 3.

TAMARIX africana. A very distinct variety covered with sprays of delicate soft pink flowers during July and August, when few other shrubs are blooming. 2 to 3 ft., 75 cts. each.

VIBURNUM acerifolium. Shrub, attaining 5 feet, with slender, upright branches. Flowers yellowish white; fruit almost black. Grows well under trees. Foliage dark purple in autumn. 2 to 3 ft., \$1.25 each.

americana. Cymes of white flowers in May and June followed by brilliant scarlet fruit. Grows to 10 feet. \$1 each.

Carlesi. Fragrant Viburnum. Clusters of fragrant pink flowers appear in May. Plant grows to about 6 feet high. 1½ to 2 ft., B&B. \$3 each.

Opulus. High-Bush Cranberry. Maple-like foliage and large heads of white flowers in May or June followed by scarlet berries. 2 to 3 ft., 90 cts. each.

WEIGELA, Abel Carriere. Brilliant deep pink. Blooms in May and June and again in the fall. Dark green foliage. 2 to 3 ft., 90 cts. each.

Eva Rathke. An upright shrub 5 to 6 feet high, covered in late May with an abundance of rich reddish purple, trumpet-shaped flowers. 2 to 3 ft., \$1 each.

floribunda. A tall, graceful shrub bearing lovely dark crimson flowers. 2 to 3 ft., 90 cts. each.

Hendersoni. Very large flowers of pink and white. A vigorous, tall-growing, nicely shaped bush. 2 to 3 ft., 75 cts. each, \$2 for 3.

WINTERBERRY (*Ilex verticillata*). Brilliant berries in great profusion. Especially attractive after the foliage drops. 1½ to 2 ft., 75 cts. each.

Ornamental and Shade Trees

CATALPA Bungei. Umbrella-shaped trees on straight trunks. Heart-shaped leaves. Good for formal effects. 5 to 6 ft., \$2.50 each.

CHERRY, Flowering. Spring-flowering, bearing a profusion of blossoms of exquisite effect. Very popular.

James H. Veitch. Double; pink.

Kwanzan. Double; dark pink.

Mt. Fuji. Double; pure white.

All Flowering Cherries, 3 to 4 ft., \$2.50 each

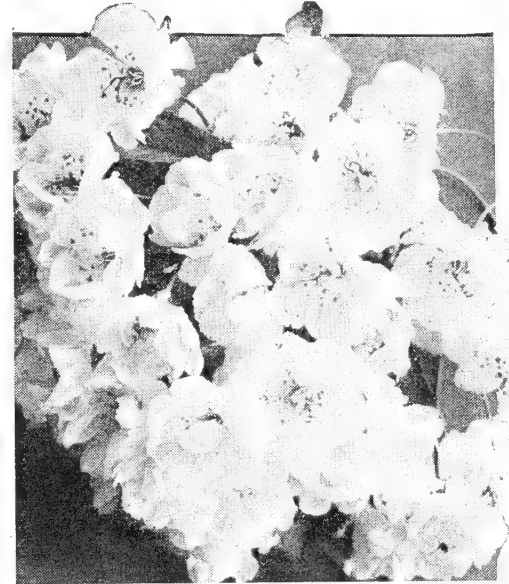

Flowering Cherry Blossoms

CHERRY, Weeping. Round-headed tree with drooping branches; resembles an open umbrella. 2-yr. heads, 5 to 6-ft. stem, \$4.50 each.

CRAB, Bechtel's Double-flowering (*Malus*). Delicate pink blossoms in the spring and handsome fruits in the fall, which are attractive to the birds. 3 to 4 ft., \$2 each.

ELM, Chinese. A quick-growing Elm of pleasing form and apparent freedom from blight. 8 to 10 ft., \$3.50 each.

Vase. A type developed from the American Elm. Largely used for street planting and the home-grounds. 8 to 10 ft., \$3.50 each.

JUDAS TREE (*Cercis canadensis*). The American Redbud is a fine small tree with masses of rosy pink flowers before the foliage. 3 to 4 ft., \$1.50 each.

MAGNOLIA Soulangeana. Immense saucer-shaped flowers, purplish pink on the outside and white inside. 2 to 3 ft., B&B. \$5 each.

MAPLE, Norway. 8 to 10 ft. \$4 each.

Silver. Noble 80-foot shade tree with dense branches and beautiful pointed foliage silvery on the under side. 8 to 10 ft., \$2.50 each.

MOUNTAIN-ASH. 8 to 10 ft., \$3.50 each.

PLUM, Red-Leaf (*Prunus, Newport*). This little tree has deep purple leaves which retain their color until fall. In the spring it is covered with fine deep pink flowers. 4 to 5 ft., \$1.50 each.

POPLAR, Bolleana. A columnar tree with foliage silvery gray underneath. 6 to 8 ft., \$1.75 each.

Lombardy. Slender, erect trees, planted for landscape effect and screens. 8 to 10 ft., \$1.50 each.

SYCAMORE or PLANE, European (*Platanus orientalis*). Useful for street and specimen planting. Bright green foliage. 8 to 10 ft., \$3.50 each.

WILLOW (*Salix babylonica*). The Weeping Willow is our most graceful tree for moist ground, especially fine near a pool or brook. 8 to 10 ft., \$3 each.

FRUIT TREES . . .

Even the smallest garden can find room for one Fruit Tree to furnish shade as well as delicious fruit. We offer a selected list of Fruits which will not disappoint you. All Fruit Trees offered are No. 1 grade, two-year-old budded trees. Prices given are prepaid when the order amounts to \$2 or more. See page 1.

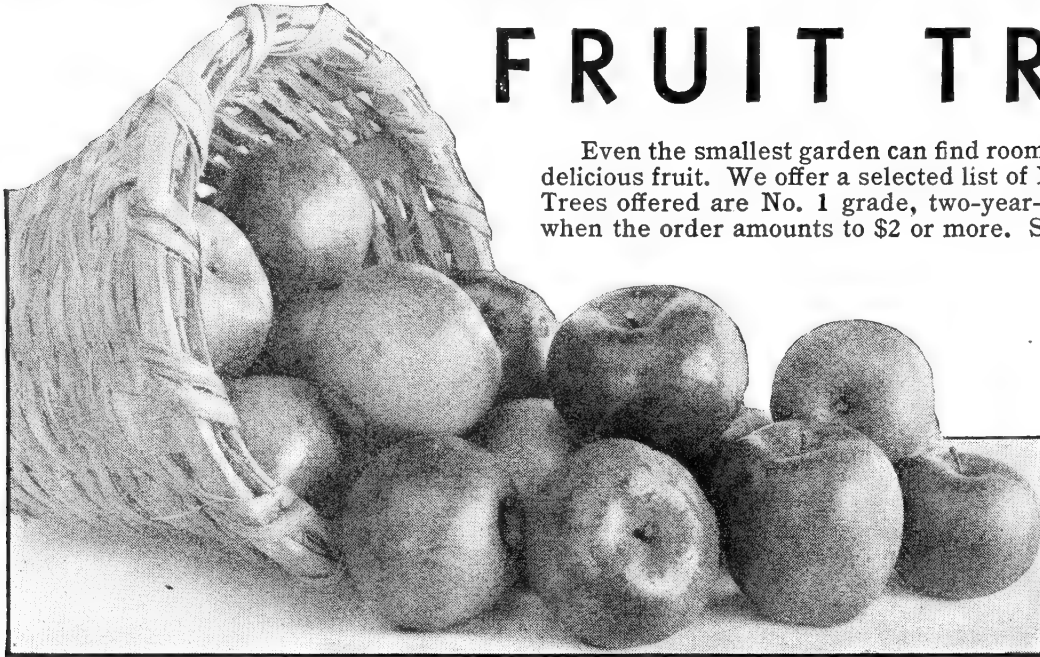

Baldwin Apples

Apples

\$1.75 each, \$16.50 for 10

- Baldwin.** Best all-round winter Apple.
Jonathan. Bright solid red; firm and crisp. Good keeper.
McIntosh. Beautiful red; flesh crisp and spicy. Ripens in September.
Northern Spy. Large, red winter Apple; crisp and juicy.
Red Astrachan. Best summer eating and cooking Apple.
Red Delicious. A splendid winter eating Apple.
Rome Beauty. Large round winter sort. Good late keeper.
Stayman Winesap. Large, dark red; desirable cooking and eating winter variety.
Wealthy. Red streaked with white. Heavy yielder and of good quality. Early fall.
Yellow Transparent. Earliest ripening Apple. Excellent for cooking and eating.
Hyslop Crab. Fruit dark red. The best crabapple variety.

Plums

\$2 each, \$19 for 10

- Bradshaw.** Very large; skin dark violet-red; yellowish green, juicy flesh. Early August.
German Prune. Medium dark blue; rich flavor. September.
Italian Prune (Fellenberg). Medium size, dark purple, juicy and delicious. Fine for canning.
Lombard. Skin reddish; flesh yellow, juicy and delicious.
Shropshire Damson. Dark purple and very productive. Fine for butter. Late September.
Stanley Prune. Dark blue skin; flesh golden yellow and of mild sweet flavor. Excellent for eating or canning.

Pears

\$2 each, \$19 for 10

- Bartlett.** Large, yellow with red cheek, tender, juicy and delicious. Very popular.
Clapp's Favorite. Large, yellow with dull red skin; delicate flavor. August.
Kieffer. Rich golden yellow. Good keeper. Late fall.
Seckel. Juicy and of rich flavor. September.

Sweet Cherries

\$2.50 each, \$24 for 10

- Black Tartarian.** Very large; purplish black. Very popular. Late June.
Governor Wood. Large; russet-yellow, juicy and delicious. June.
Napoleon. Yellow with bright red cheeks; flesh firm, juicy and sweet. Late June.
Windsor. Large, liver-colored; flesh firm and juicy; very prolific. Early July.

Sour Cherries

\$2 each, \$19 for 10

- Early Richmond.** Fruit medium size, round, bright red; good for pies. Early June.
Montmorency. Best and largest Sour Cherry. Fruit dark red, firm and of fine flavor. Late June.

Peaches

\$1.25 each, \$11.50 for 10

- Champion.** Good white variety. August. Freestone.
Crawford Late. Fruits large, yellow and of fine flavor. Late September.
Elberta. The standard yellow. Fruits yellow with red cheek; flesh yellow, firm, juicy and of high quality. Early September.
Golden Jubilee. An excellent variety for the home orchard. Fruit large, yellow; flesh golden yellow, juicy, tender and sweet. Early August.
Hale-Haven. Fruits large, beautiful yellow, and of good flavor. Very hardy and a heavy bearer. Late August.
South Haven. Fruits large, yellow with red blush, juicy and deliciously sweet. Late August.

- APRICOT, Hungaria.** Fruit large, good quality, with yellow flesh of very fine flavor. \$2 each.

Quince

\$2 each

- Orange.** A mighty fine-quality variety and extremely popular.



Elberta Peaches

STRAWBERRY PLANTS

Everybody loves Strawberries and they are never as good as when freshly picked in your own garden. By all means have a Strawberry-patch if you have room.

Strawberries are easy to grow in any good well-drained soil.

Set the plants as early in the spring as the ground can be prepared. If the ground has not been recently manured, mix a little bone-meal in the soil under each plant when planting or top dress around the plants with a fertilizer high in phosphorus and potash just as soon as the plants start to grow. Keep the plants cultivated and free of grass.

Our plants are "New-ground plants" from a famous plant-growing district and being strong and well-developed will go right to work. The varieties we offer were selected as the best in their class and we know they are dependable and profitable.

In general, plants are set in rows 3½ to 4 feet apart and 1½ feet apart in the row. In home-gardens or where space is limited, the rows can be 2½ feet apart. Set the plants with the bud just at the surface of the ground. Strawberry plants should be set early in the spring so they can become established while the soil is still cool and moist. Frequent cultivation will produce a better crop of berries.

Extra-Early

Premier. It is the earliest of all Strawberries, has a long fruiting season, and bears unusually large crops of bright, glossy, firm, red berries above the average in size. Excellent shipper.

Fairfax. Large, sweet, richly flavored dark red berries. Vigorous grower and disease-resistant. Not quite so productive as Dorsett but berries are larger and of better quality.

Dorsett. A vigorous plant-maker with bright red berries of wonderfully high flavor. Excellent for table and home use. A very dependable all-round variety.

Robinson. Berries of fine flavor, glossy red, firm and large. For home use its quality and flavor are unsurpassed. A strong vigorous grower and heavy yielder.

Second-Early

Senator Dunlap. For many years has been grown as the main-crop berry. A very heavy bearer of good-sized, uniformly shaped berries of a dark red color. Splendid for canning as it holds its shape, rich color and flavor long after canning.

Medium Late

Catskill. By far the best new midseason berry that has been introduced recently. Fruit is extra large and the plant is a heavy bearer and vigorous grower. Can be depended on for good crops and the quality is excellent.

Everbearing

Mastodon. Very productive; unusually large size; brilliant, attractive color; and excellent shipping qualities. Produces fruit ninety days from planting. Pick the first crop from July to killing frosts; the second crop the following June; and the third crop from August to killing frosts in late autumn.

Minnesota 1166. The large berries are rich solid dark red, with a rich, sweet flavor. Ripens from July to November. A few plants in the garden will keep you supplied.

PRICES

	Per 25	Per 50	Per 100	Per 250
Premier	\$1 50	\$2 45	\$3 85	\$7 65
Fairfax	1 35	2 20	3 50	6 90
Dorsett	1 35	2 20	3 50	6 90
Robinson	1 50	2 45	3 85	7 65
Senator Dunlap	1 20	1 95	3 00	5 90
Catskill	1 50	2 45	3 85	7 65
Mastodon	2 65	4 55	7 25	13 65
Minnesota 1166	3 25	5 50	8 75	

All orders shipped direct from nursery to customer. Prices given are postpaid. Strawberry plants are in short supply. Orders should be placed early.

Mastodon Strawberries

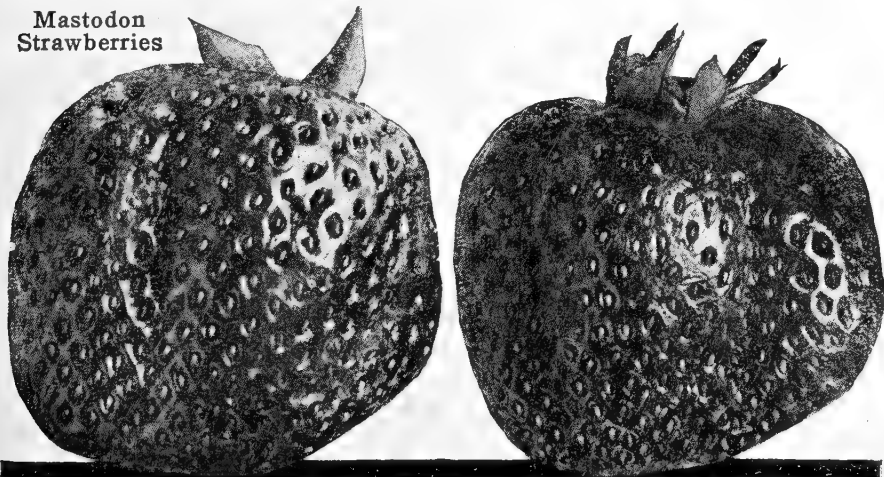

CURRENTS

2-yr. plants, 60 cts. each, \$5.75 for 10

Fay's Prolific. Medium to long clusters of dark red, juicy fruits.

Perfection. Large, bright red fruits; big clusters.

Wilder. Medium-sized, mildly acid red berries in large clusters.

GRAPES

2-yr. plants, 55 cts. each, \$5.25 for 10, unless noted

Brighton. Big red berries of excellent flavor; productive and vigorous.

Catawba. Luscious dark red berries; late ripening and keeps well.

Concord. The standard Grape. Rich, sweet juicy fruits. 45 cts. each, \$4.25 for 10.

Delaware. Red, sweet and delicious.

Moore's Early. Like Concord, but two weeks earlier.

Niagara. An extra fine, sweet, white Grape.

Worden. Large bunches of big, black berries of high quality. Earlier than Concord.

GOOSEBERRIES

2-yr. plants, 85 cts. each, \$8 for 10

Downing. Whitish green. The most widely planted and highly prized sort.

Red Jacket. Large reddish green fruits.

BOYSENBERRY

Delicious berries 1½ to 2 inches long and 1 inch in diameter of dark reddish purple. Exceptionally good for home-gardens, being unbeaten for jellies, jams and pies. 1-yr., No. 1, Tip-rooted Plants, 3 for \$1.35, doz. \$4.75, postpaid

RED RASPBERRIES

Chief. The best early red. Heavy yielder.

Latham. Best late sort. Very productive.

BLACK RASPBERRY

Cumberland. Berries large, with delicious flavor.

BLACKBERRY

Eldorado. Of best quality and always dependable.

Raspberries	Per 12	Per 25	Per 50	Per 100
Chief	None to offer.			
Latham	None to offer.			
Cumberland	\$1 90	\$3 00	\$4 90	\$7 00

Blackberry	Per 12	Per 25	Per 50	Per 100
Eldorado	1 90	3 00	4 90	7 00

One-year No. 1 plants. Prices given are postpaid.

All orders shipped direct from nursery to customer.

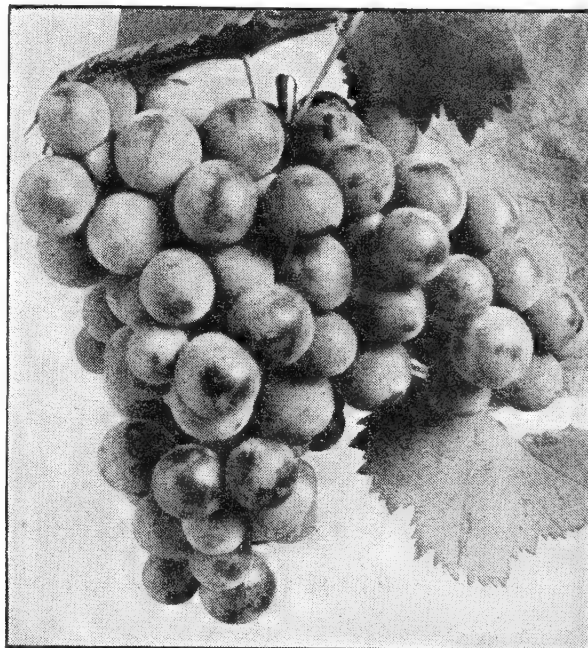

Concord Grapes

SCOTT'S

Farm Seeds

*For increased yields inoculate
Clover and Alfalfa with Legume Aid.
See page 69.*

Good pasturage increases milk production and produces more beef

For nearly 70 years it has been our policy to supply the very best of everything we sell, and farm seeds are no exception. Not only is every lot of seed offered selected for purity, freedom from weed seed, and high germination but the origin is also considered. This is very important with many kinds of seed, particularly the Clovers and Alfalfa. When estimating your seed requirements, consider your crops and decide that you want the very best—and with this in mind you will order Scott's Seeds. Remember we promise to furnish plump, clean, healthy seeds that you can depend upon for hardiness, vitality, and stamina—seeds that have made money for successful farmers for nearly 70 years.

CLOVERS

MEDIUM RED. Most popular Clover for short rotations. When grown with timothy it usually makes two good hay crops. Plants grow 2 feet or more in height. Sow seed in late winter on winter grains or on a firm seed-bed with spring grain. Sow 8 to 10 pounds with timothy, or 15 to 18 pounds alone.

MAMMOTH RED. Also called Sapling Clover. This Clover cuts a heavier first crop of hay, does better on poorer, drier soils, and is more persistent than Medium Red. Valuable for the grower who needs maximum organic matter to plow down.

ALSIKE. A favorite with timothy on acid soils, thin soils, and for wet sites. It may be sown in spring or late summer and is perfectly hardy. Flowers are sweet-scented and attractive to bees, are larger and more pink than White Clover. Adapted only to short rotations. Sow 8 to 10 pounds to the acre alone, or 3 to 6 pounds in mixtures.

SWEET CLOVER. The biennial form is most popular for soil improvements, pasture, or hay. It does best on sweet (neutral) soils and will grow luxuriantly on land too poor for Red Clover or alfalfa. It reseeds itself the year after sowing if not cut. Annual forms of this legume do not do well this far north. Seed should be inoculated. Sow 10 to 20 pounds to the acre, the heavier rate if seeded alone.

CRIMSON. Popular in southern part of region for green-manure crop and soil improvement. Often sown in corn at last cultivation for winter cover-crop. For hay, plants should be cut in pre-bloom stage. Seed 20 pounds to the acre any time after April 1. Plants are annual, requiring reseeding each year.

LADINO. A giant form of White Clover with heavy stems which hug the ground and take root at the nodes (joints). Very popular, nutritious, and high-yielding when properly used as pasture for poultry, dairy cattle, beef, sheep, and hogs. A favorite as a cover-crop in sod orchards. Requires fertile soil and good management. Generally sown with other pasture grasses at the rate of 2 pounds per acre.

WHITE DUTCH. A small, low-growing White Clover used principally in lawn and pasture mixtures. Less productive than Ladino for hay and pasture. Succeeds in nearly all types of soil and is quite persistent. Use 3 to 5 pounds to the acre in mixtures.

WILD WHITE. A dwarf variety of White Clover, hardy and excellent for permanent pasture. Handle like White Clover.

ALFALFA

Alfalfa is of importance as a forage crop because of its high nutritive value, its palatability, productiveness, drought resistance, and long liveability. There is no other forage crop that will produce such an abundance of high-class protein feed. For all classes of live-stock it is considered the best hay obtainable. It requires a well-drained neutral or alkaline soil and high fertility. If lime is needed, it should be applied before the seed is sown. Alfalfa is used alone and in mixtures with other grasses. It is usually seeded in the spring with fall- or spring-sown grains, but in some sections late summer seedings are popular. It will provide two or three cuttings of hay in a season, and also makes excellent pasture for all kinds of live-stock. Seed should be inoculated. From 12 to 15 pounds of seed are usually sown to the acre when grown alone; half this quantity in mixtures. We can furnish Northwestern Common and Grimm.

Northwestern Common. Grown successfully and entirely satisfactorily in this area.

Grimm. Generally considered longer-lived and better adapted to severe winter weather.

PERMANENT PASTURE MIXTURE

A well-balanced pasture-producing mixture made up of the very highest grades of re-cleaned grass and clover seeds, which will produce an abundant and nutritious food-supply for all kinds of stock. The land should be plowed in the fall, left rough over winter, and prepared in the spring, making the seed-beds as fine as possible by repeated harrowing. Sow 40 pounds to the acre. 5 lbs. \$2.75, 10 lbs. \$4.75, 25 lbs. \$11, 50 lbs. \$21, 100 lbs. \$40.

Cyclone Seed Sower

This Seed Sower can be used for sowing clover, timothy, lawn grass seed, and all other seeds that can be sown broadcast. Has positive force-feed and is quickly adjusted for different seeds. The touch of a lever will start or stop the flow of seed. Seed cannot clog or rush. Container is made of heavy canvas ducking and holds about ½ bushel. Price, \$2.75, post-paid.



LATEST PRICE-LIST OF FARM SEEDS GLADLY SENT ON REQUEST

TIMOTHY

Description of this old familiar hay-making grass is unnecessary here. Its feeding value is not quite equal to red clover or alfalfa, but it fits in well with almost any crop-rotation program and for this reason is probably the most extensively grown of all the grasses. It can be sown in the spring or fall and may be sown alone or with alfalfa, red clover, alsike clover, or with other grasses. If sown alone, 12 to 15 pounds are usually sown to the acre; with other grasses 3 to 6 pounds to the acre.

KENTUCKY BLUEGRASS. One of the best-known perennial grasses for permanent pasture. Requires rich soil and stands heavy close grazing. It starts early and furnishes grazing well into the fall but tends to be "dormant" during dry hot summer weather. Add 6 to 8 pounds to the acre to mixture of clovers and other grasses.

RED TOP. This grass is well adapted to soils that are inclined to be wet or acid. It is not so palatable as Kentucky Bluegrass nor is it so permanent. Alsike or Ladino clover do well with Red Top. Under fertile soil conditions Red Top will be replaced by heavier grasses. Use 2 to 4 pounds to the acre in mixtures.

PERENNIAL RYE GRASS. This grass is a very rapid grower. It will produce pasture in six to eight weeks, and will last several years. It is well adapted to fertile moist soils and stands close grazing but should be seeded only in mixtures. Use 4 to 6 pounds to the acre in mixtures.

DOMESTIC RYE GRASS. A quick-growing grass that is valuable for pasture and relished by all livestock. For a winter cover-crop seed can be sown at the last cultivation of corn or after the harvest of an early crop. Makes good late fall pasture when used as cover-crop in corn. Broadcast seed at the rate of 20 to 25 pounds per acre.

ORCHARD GRASS. This is a long-lived bunch-type grass which produces maximum summer grazing. Does best in combination with long-lived legumes like Ladino clover and alfalfa. It makes good hay if cut in pre-bloom stage and makes heavy yields of silage. Use 4 to 6 pounds to the acre in mixtures; 12 to 14 pounds when seeded alone.

SUDAN GRASS. A high-yielding, quick-growing annual grass most valuable for summer pasture, but will make good hay when sown with soy beans and cut when soy beans are well formed. It can be pastured when 15 to 18 inches tall and it is very drought-tolerant. Grows to a height of 5 to 9 feet. Sow 35 pounds to the acre broadcast; 25 pounds drilled.

MILLET. A quick-growing annual generally used for an emergency hay crop or pasture. For hay it should be cut while the plants are in bloom. Sow in May or early June at the rate of 30 to 40 pounds of seed to the acre.

DWARF ESSEX RAPE. Furnishes quick and inexpensive pasture for hogs and sheep. Sow 10 pounds of seed to the acre if sown broadcast; 5 pounds if drilled.

LESPEDEZA. Popular in southern states for hay, pasture, and seed. Annual types persist only through natural reseeding.

SORGHUM or AMBER CANE. Used principally as a summer fodder for cattle. Growth is rapid. If carefully cured it will make an excellent dry fodder. May be sown in drills about 30 inches apart, at the rate of 5 to 6 pounds of seed for an acre. If sown broadcast, about 75 pounds of seed are generally used.

COWPEAS. Grown mainly for green manure but makes good pasture or hay. Sow in May or June. Use 1 to 1½ bushels of seed to the acre when sown broadcast.

CANADA FIELD PEAS. Used for hay and pasture as well as soil improvement. Sow as early as possible in the spring, either alone or with oats. When sown broadcast alone, sow 2 bushels to the acre, or with oats 1½ bushels of Peas and 1 bushel of oats.

WINTER or HAIRY VETCH. One of the best legumes and largely used in this section for soil-improvement. Because of the great length of Vetch plants, it is best to furnish a support for the plants by sowing rye, barley, or oats with it. When drilled use 1 bushel of grain and 20 to 30 pounds of Vetch to the acre.

FARM SEEDS



Vicland Oats



Sudan Grass

Harvesting Alfalfa



FIELD CORN

10 to 14 pounds of Seed Corn required to seed an acre

HYBRID KINDS

The acreage planted to Hybrid Corn in recent years proves conclusively that the hybrids are far more satisfactory than the open-pollinated varieties. They have more vigor, produce larger yields, and are more drought and storm-resistant than open-pollinated varieties.

The hybrids we offer have been selected from a large group for their outstanding performances and superiority over other varieties, and in our opinion are the best adapted to this section.

If you have not been growing any of the hybrids, we recommend that you try at least one of them this year.

OHIO W17. Well adapted to this section, and a heavy yielder. Stalks are leafy and of medium height, ear about 8 inches in length, and kernel light yellow in color. Maturity 100 to 105 days. A very popular hybrid with many farmers.

IOWA 939. Adapted to a wide range of conditions and probably the best-known hybrid. Has stiff stalk, medium in height; ears have 16 rows with somewhat rough, soft, rich yellow kernels. Maturity 100 to 105 days.

OHIO K23. An early hybrid adaptable for use in the better soils. Stalks are short, deep green, and leafy; ears are medium in size, with 16 to 18 rows. Maturity 90 to 95 days.



Iowa 939 Hybrid
Field Corn

OPEN-POLLINATED VARIETIES

For the farmer who prefers the open-pollinated varieties, we offer the following. All are selected with the utmost care. They are carefully cleaned and graded, of high germination, and of the best possible quality.

SCOTT'S SURE-CROP. The tremendous quantity of shelled Corn this variety produces to the acre surprises everyone who grows it. Ears are medium long, cob thin, kernels long and of a rich, deep yellow.

GOLDEN SURPRISE. Ears are good size, with 14 to 18 rows of long, light orange kernels. Matures in 90 to 95 days. An excellent Corn for the crib.

PRIDE OF THE NORTH. Ears 8 to 10 inches long, with 16 rows on the ear. Cob small, grain above medium size and closely set. One of the hardiest. Matures in 90 days.

IMPROVED LEAMING. Produces a good-sized ear with deep, broad grains. Matures in 105 days.

WHITE-CAP YELLOW DENT. Particularly suited for light soil. Ears about 10 inches long, well filled, with 16 or 18 rows; grain is yellow with white tip. Ripens in about 115 days.

All of our Seed Corn is selected with the utmost care. The ears are carefully hand-selected before they are shelled and the grain is carefully graded on the most modern grading equipment. It is thoroughly dried, of high germination, and of the best possible quality.

ENSILAGE CORN

LANCASTER COUNTY SURE-CROP. The leading ensilage variety. Ears are long, with yellow grains, and not proportionately thick. Stalks are quite tall and very leafy. An extremely heavy yielder and a most desirable ensilage variety.

EUREKA. Produces unusually heavy foliage and often grows 16 to 18 feet tall. Ears are very long; grain is large, broad, and ivory-white.

U. S. 13 HYBRID. One of the highest yielding of all hybrid varieties for both grain and silage. The stocks are medium tall and lodge-resistant; ears medium long, with 20 to 22 rows of deep grains. Matures in 110 to 115 days.

Treat Seed Corn with Semesan Jr. See page 69.

*Write for special prices and samples
of Field Seeds and Grains.
Specify quantities
wanted.*

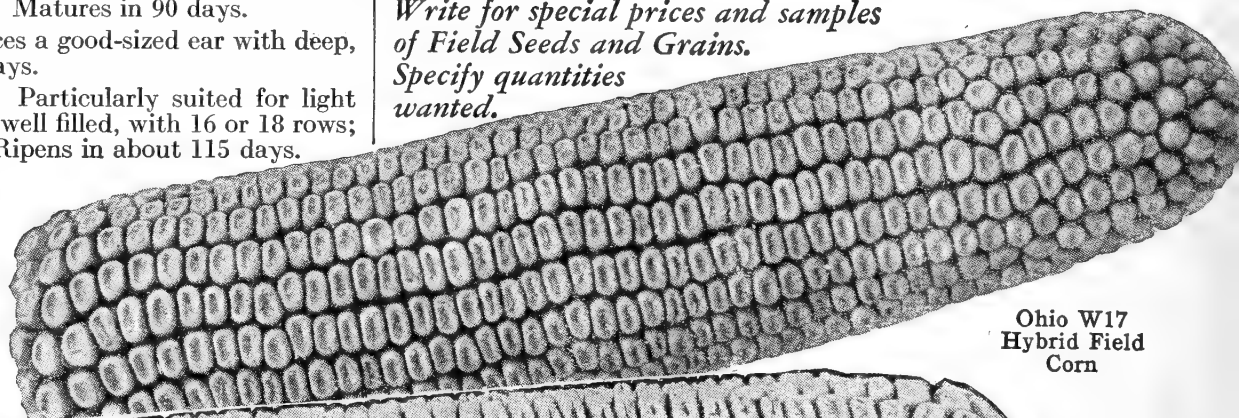

Ohio W17
Hybrid Field
Corn

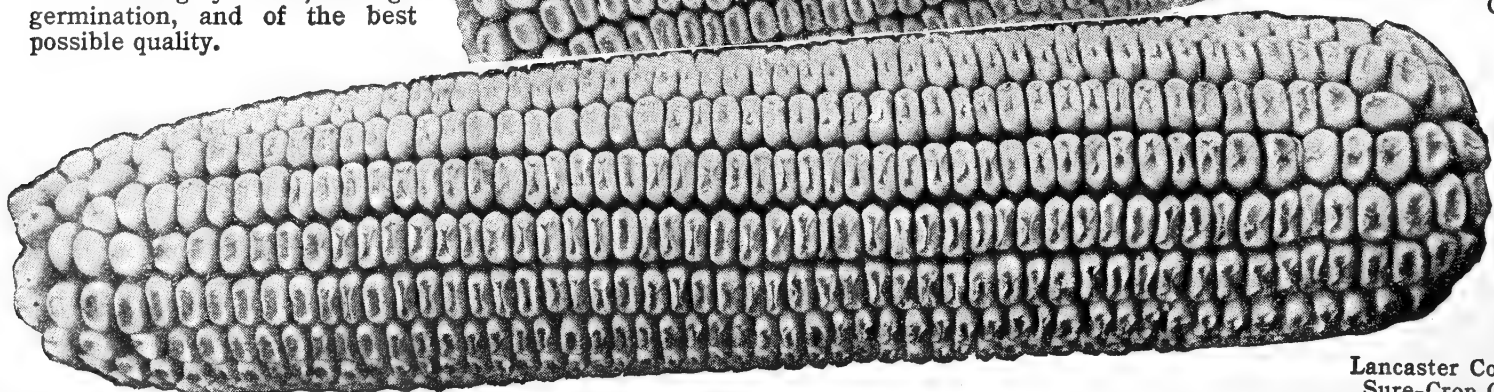

Lancaster County
Sure-Crop Corn

SOY BEANS

A good soil-builder when plowed under for green manure. Makes excellent hay or silage but is little used for pasture except for hogs. Sow when ground is thoroughly warm, in May or June. If used for hay, cut after the pods form. Use 2 bushels to the acre broadcast; $1\frac{1}{2}$ bushels when drilled. Seed should be inoculated.

We offer two varieties—**Wilson Black** and **Manchu**. Both are suitable for hay, silage, or soil improvement. **Manchu**. Stalk is large and bushy and a heavy producer of both foliage and beans. Seed is yellow. **Wilson**. Not quite so rank a grower as Manchu. Does well on most any type of soil. The most popular variety in this section.

OATS

Alfalfa, red clover, permanent grass and clover mixtures can all be satisfactorily sown with Oats. Sow during April or early May at the rate of 2 to 3 bushels by weight to the acre.

VICLAND. By all odds the best grain Oats for this section. In comparison with other varieties it has out-performed them all. Kernels plump and heavy; straw stiff and strong. Early maturing and resistant to rusts and smuts. A good yielder and because of its short straw is not likely to lodge. Does best in good soil. The seed we offer is Wisconsin-grown, thoroughly cleaned and graded, and of high germination.

SWEDISH SELECT. A well-known variety preferred by many farmers. Kernels very thick, with thin shuck; straw stiff and of medium height. Late maturing.

STORM KING. A side Oats that has been grown successfully for many years. Has long, strong straw that will stand the most severe winds without lodging; heads long, containing an unusually large number of grains.

SPRING BARLEY. Valuable either as a grain crop or as a nurse crop for clover or alfalfa. We have the Oderbrucker variety, a six-rowed, bearded Barley, and a good producer of both grain and straw. Requires 2 bushels of seed for an acre.

BUCKWHEAT. A dependable crop for poor land. Matures in about two months and makes an excellent feed for poultry. Sow during June or early July, using 1 bushel of seed to the acre.

WINTER WHEAT. We can supply the leading sorts of Winter Wheat. Write us for samples and prices before seeding time.

SPRING WHEAT. Grain is smaller and harder than Winter Wheat. Not so popular as Winter Wheat but gives a satisfactory yield and makes excellent flour. Sow in early spring, about 2 bushels to the acre.

WINTER RYE. Grown principally for a winter cover-crop, sometimes for winter pasture or cut for hay. Can be sown up to the middle of November. Requires about 2 bushels of seed for an acre; for small garden plots, about 5 or 6 quarts for 2,500 square feet.

SPRING RYE. Makes an excellent green food when cut, or will supply pasturage for several weeks. Sow early.

SEED POTATOES

The stock we offer is raised by experienced growers in the cold North and Northwest. It is grown especially for seed purposes, and is certified stock, U. S. Standard No. 1, high quality, true to type and free from disease. Experience has shown that northern-grown stock moved only a few hundred miles south often produces double the crop of home-grown seed.

Early Varieties

EARLY OHIO. An early sort that is well known by market-gardeners who want a first-early Potato for home trade. The tubers are almost round, with pink skin, and of excellent quality.

IRISH COBBLER. An extra-early, round, white Potato with rather deep eyes. Vines yield heavily and the tubers are of extremely fine quality. A most dependable variety, either for the home-garden or for growing commercially.

CHIPPEWA. About ten days later than Irish Cobbler but superior in smoothness and whiteness, and eyes are not quite so deep. Has desirable cooking qualities.

Late Varieties

KATAHDIN. A handsome, shallow-eyed, glossy, white-skinned variety of fine table quality. It is roundish-oval in shape and very uniform in both shape and size. Gaining in popularity every year. Good yielder.

RUSSET. Tubers round to oblong, of good size, with pure white flesh, russet skin, and few shallow eyes. Excellent table quality, good keeper, and very productive. Vines are strong and disease-resistant.

SEBAGO. A high-yielding, smooth, white, shallow-eyed variety of excellent table quality. A strong grower highly resistant to blight. Very late.

Latest Price-List of Farm Seeds gladly sent on request

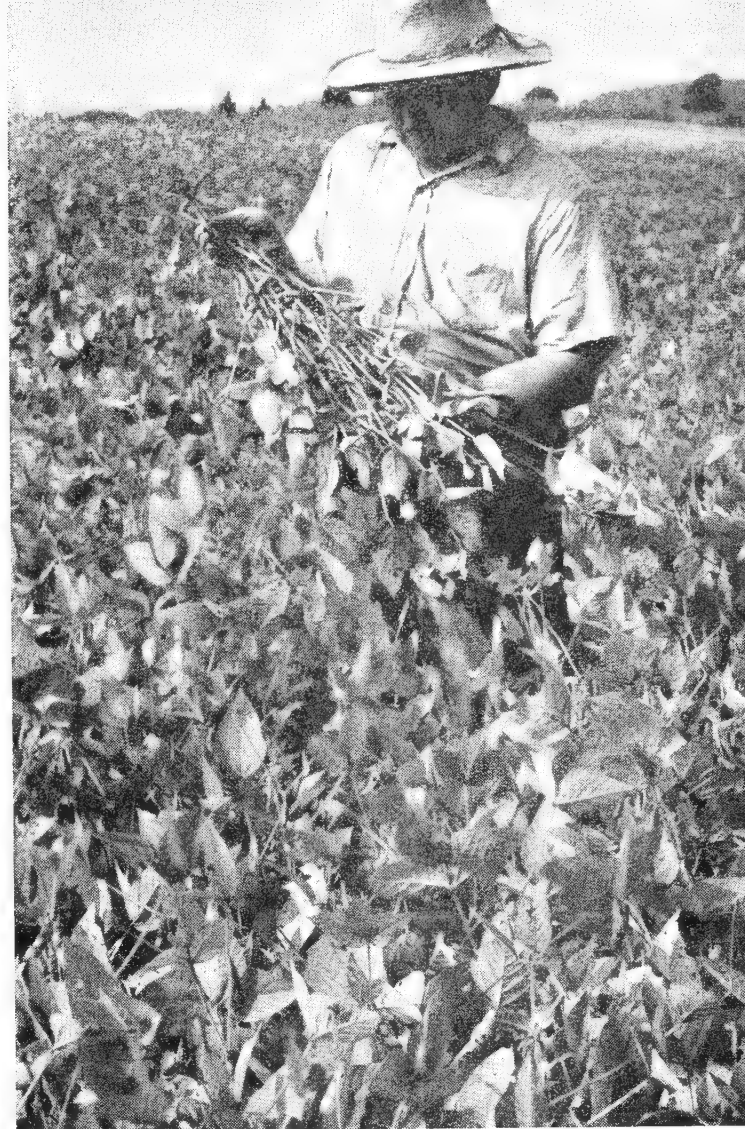

SOY BEANS



AGRICO

THE NATION'S LEADING
FERTILIZER



THIS year's food-production job is every bit as important as 1944's. And there's only one way these essential wartime goals can be reached—that is, by each farmer making each acre he plants produce to the topmost limit. Top acre yields call for plenty of the right kind of plant-food, and that is why it will pay you well to use Agrico.

Agrico is specially formulated for each crop and each major farming section, and what a difference Agrico makes in both crop yield and quality! Often the extra crop increases pro-

duced by Agrico more than pay the entire cost of the Agrico application. It's a great crop-producer and money-maker for the farmer, this Agrico; and you'll say so yourself when you use it.

This year get Agrico for all your crops, and be on the safe side by ordering early. Take delivery soon, and store your Agrico away in a good dry place. In that way you will protect yourself against wartime delays and be sure to have your Agrico on hand when you need it.



AGRICO FOR TRUCK

(5-10-5)

Specially made for market produce and canning crops. Noted for high yields of better quality truck and earlier maturity for the higher-priced markets.

In 100-lb. paper bags
\$42.75 per ton



AGRICO FOR CORN

(3-12-6)

Carefully formulated to ensure vigorous root-growth, sturdier stalks, and ears filled with good, hard corn. Extra yields per acre for lower-cost feed.

In 100-lb. paper bags
\$40.35 per ton



AGRICO FOR POTATOES

(4-12-12)

Used by the nation's leading growers of seed and table stock, because side-by-side tests have proved Agrico produces more No. 1's of uniform size and quality.

In 100-lb. paper bags
\$47.25 per ton

THERE'S AN
AGRICO
SPECIALLY
MADE
FOR EACH
CROP



AGRICO FOR TOMATOES

(4-12-8)

Try this Agrico specially formulated for tomato production and see how it increases tonnage, boosts the grading, and increases acre returns.

In 100-lb. paper bags
\$44.25 per ton

All prices on this page are f.o.b. our warehouse or cars Pittsburgh, and are subject to 10 per cent discount for cash with order. Transportation charges are additional on orders for local delivery or rail shipment.



AGRICO FOR GRAIN

(3-12-6)

Specially formulated for wheat, oats, and other small grains. Noted for extra yields of quality grain that weighs heavy and grades high in quality.

In 100-lb. paper bags
\$40.35 per ton



AGRICO FOR TOP-DRESSING

(7-7-7)

Apply this complete, well-balanced Agrico on your permanent pastures and haylands. Pays for itself over and over in increased growth of roughage. Higher in protein and minerals.

In 100-lb. paper bags
\$46.65 per ton



AGRICO FOR FRUIT

(10-6-4)

Orchards thrive on this complete, well-balanced fertilizer. Use Agrico and profit by heavier yields of premium-quality fruit.

In 100-lb. paper bags
\$48.75 per ton

Fertilizers described on this page offered subject to War Food Administration Order No. 5

AGRICO is manufactured only by THE AMERICAN AGRICULTURAL CHEMICAL CO., 129 Lewis St., Buffalo, N. Y.

For Better Lawns and Gardens



AGRICO FOR LAWNS, TREES AND SHRUBS

(Also for Flowers)

If you have a good lawn, keep it that way by feeding it with Agrico every spring and fall. In repairing or rebuilding a lawn, use Agrico to insure your investment in seed and labor. And don't forget to feed your trees and shrubs.

5-lb. bag...\$0 45	50-lb. bag..\$2 50
10-lb. bag... 80	100-lb. bag.. 4 00
25-lb. bag... 1 50	500 lbs.....18 00

SPECIALLY MADE FOR GOLF COURSES

Under Government regulations, each manufacturer can make only one grade of specialty fertilizer, and we decided on a 6-10-4 analysis with golf courses in mind. This Agrico Country Club Fertilizer will do a splendid job on both greens and fairways, until the regular Agrico golf-course grades are again available.

500 lbs...\$15 75	2000 lbs...\$56 40
1000 lbs... 29 60	

Larger quantities quoted on request



Your lawns, trees, and shrubs are an important investment . . . they add much to the appearance and value of your home. Protect that investment by fertilizing with **Agrico for Lawns, Trees and Shrubs**. This complete plant-food is specially formulated to provide **all** the needed plant-foods in just the right proportions to stimulate a thick, lush growth of deep-rooted lawn grass. And it does an equally good job on trees and shrubs, which have just about the same plant-food requirements as lawn grass. Use this Agrico for flower gardens, too.

For vegetable production, use **Agrico for Gardens**. This particular Agrico is specially formulated for vegetable gardens and provides all the needed plant-foods in proper proportions for healthy, vigorous growth of heavy-bearing plants. Pays for itself over and over, in more and better vegetables, richer in minerals and vitamins.

WHEN YOU NEED SUPER-PHOSPHATE, USE

18% Normal

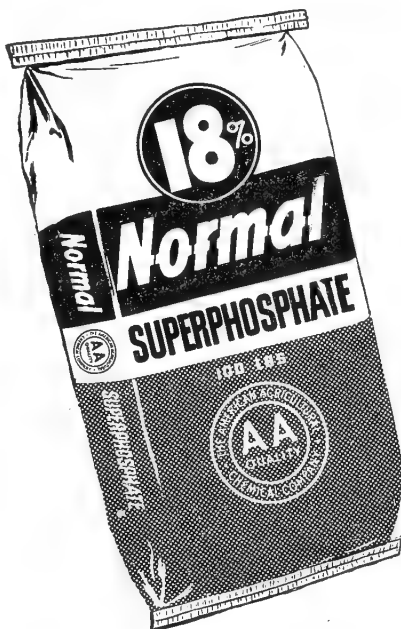

18% Normal is Superphosphate produced the "normal" way, without the addition of fillers or reduction in valuable calcium and sulphur content. *And 18% Normal is more economical per unit of available phosphorus.* In addition to its many uses in the field, add **18% Normal** Superphosphate to manure, to reduce nitrogen loss, increase the phosphorus content, and improve manure's crop-producing power. Sprinkle in barn gutters. Apply in manure pit, or add to spreader load before hauling to field. Makes the manure pile go twice as far and do a better job.

5 lbs.....\$0 45	50 lbs.....\$1 70
10 lbs..... 65	100 lbs..... 2 70
25 lbs..... 1 20	500 lbs.....12 75

Larger quantities quoted on request



AGRICO FOR GARDENS

(For food production only)

Fertilize with Agrico for larger yields of vegetables richer in minerals and vitamins. Broadcast Agrico three or four days before planting . . . and don't forget to side-dress vegetables with Agrico every thirty days, to encourage steady growth and maximum yield.

5-lb. bag...\$0 45	50-lb. bag..\$2 20
10-lb. bag... 80	100-lb. bag.. 3 50
25-lb. bag... 1 40	500 lbs.....15 75

AGRICO FOR COMMERCIAL GROWERS

This Agrico is used by many of the nation's largest and most outstanding greenhouses. See for yourself how it gets plantings off to a better start. Specially made for this purpose, with both organic and inorganic nitrogen in exactly the right proportions for best greenhouse results.

100 lbs.....\$3 35	1000 lbs...\$29 25
500 lbs.....15 65	2000 lbs... 55 50



All prices on this page include local delivery in quantities of 50 pounds or more

Ideal for Lawns, Gardens, Trees and Shrubs



**FOR LAWNS
APPLY SPRING
AND FALL**



**FOR FLOWERS
OR VEGETABLES
RAKE INTO SOIL**



**FOR SHRUBS
RAKE IN CIRCLE**



**FOR TREES
POUR IN HOLES**

**SAFE—NON-BURNING
EASY TO APPLY**

MILORGANITE

All-Organic Natural Fertilizer

Lawns, flowers, trees, shrubs and vegetables can still get a square meal—even during wartime. This dependable, safe and easy-to-use fertilizer will carpet your lawn with dense weed-free turf. Grass will stay green longer. You can grow more delicious vegetables, finer flowers, and better trees and shrubs by using Milorganite.

A Natural Organic Food.

Besides containing all the basic fertilizer elements, Milorganite is rich in the trace elements, too.

Effects Longer Lasting.

Milorganite promotes continuous healthy growth over long periods. Its water-insoluble, organic nitrogen is released slowly as needed. That's why Milorganite-fed lawns stay green longer. Soluble mineral fertilizer acts quicker, but effects are short-lived.

Easy and Safe to Use.

Clean and free flowing because every particle is a distinct granule—therefore easy to apply. No burning, so immediate watering is unnecessary to avoid scorching of foliage—hence safe to use.

Keeps Indefinitely.

Never cakes or hardens during storage—does not rot the bag. So any unused portion can be stored indefinitely for future use.

25-lb. bag.....	\$1 10
50-lb. bag.....	1 85
100-lb. bag.....	3 10

500 lbs.....	\$13 40
1000 lbs.....	24 75
2000 lbs.....	46 50

HYPONEX COMPLETE AND BALANCED PLANT FOOD

A complete, balanced, scientific plant-food for either indoor or outdoor use. It can be used on vegetable crops, flowers, lawns, trees or plants in pots. Hyponex is also invaluable for rooting cuttings and in transplanting. It speeds up growth and produces strong, lusty plants. Contains chemical nitrogen. One pound makes 100 gallons of liquid plant-food. 3-oz. can 25 cts., 1-lb. can \$1, 10-lb. drum \$8, 25-lb. drum \$15, 50-lb. drum \$25, 100-lb. drum \$40.



Use Transplantone when transplanting tomato, cabbage, pepper, eggplant, and all vegetable and flower seedlings. Soak hardy plants, roses, and shrubs overnight in Transplantone solution before planting. It starts them sooner into active growth and prevents wilting and delay in development. Widely used by nurserymen and growers. 1/2-oz. pkt. 25 cts., 3-oz. can \$1, 1-lb. can \$4.

Lawn and Garden Bone-Meal

Especially adapted for lawns, gardens, and greenhouses. Nitrogen, 1.75 per cent; total Phosphoric Acid, 20 per cent.

5 lbs.....	\$0 40	100-lb. bag..	\$4 00
10 lbs.....	75	500 lbs.....	17 75
25 lbs.....	1 50	1,000 lbs.....	33 50
50 lbs.....	2 50	2,000 lbs.....	64 00

Nitrate of Soda

16% Nitrogen

Lb.....	\$0 15	25 lbs.....	\$1 50
5 lbs.....	45	50 lbs.....	2 50
10 lbs.....	75	100 lbs.....	3 40

Larger quantities quoted on request

Bald Eagle Hydrated Lime

Minimum Calcium Oxide, 70.00
Minimum Magnesium Oxide, .70

Prepared especially for vegetable gardens, lawns, greenhouses, whitewash, and kindred uses, besides all the various other purposes for which Lime is essential. It corrects the sour condition which exists in many soils, especially those shaded by houses or trees. For the treatment of lawns and gardens, apply in the late fall or early spring at the rate of 5 pounds per 100 square feet of space. Broadcast the Lime over the surface as evenly as possible and thoroughly rake into the prepared top-soil a few days before planting.

10-lb. bag..	\$0 25	500 lbs.....	\$6 75
25-lb. bag..	45	1,000 lbs.....	11 50
50-lb. bag..	80	2,000 lbs.....	20 00
100 lbs.....	1 50		

Alfalfa Brand Agricultural Limestone

Minimum Calcium Carbonate, 96.00
Minimum Magnesium Carbonate, 1.00

100 per cent passing 20 mesh; 70 per cent passing 100 mesh

Pure ground Limestone, artificially dried and very finely pulverized. Use 15 to 20 pounds per 100 square feet.

80-lb. bag...	\$1 05	960 lbs.....	\$7 50
480 lbs.....	4 80	2,000 lbs.....	12 50

Humus

An organic material used principally as a soil-conditioner and for mixing with potting soil. Recommended for lawns, flower-beds and gardens.

Large bag (about 100 lbs.).....	\$2 00
5 bags.....	9 00
10 bags.....	17 00

Agricultural Gypsum

Agricultural Gypsum (land plaster) is an untreated, ground, natural rock fertilizer, consisting mainly of hydrated calcium sulphate. It therefore bears two essential plant-foods, calcium and sulphur. It is also used as a carrier of insecticides, such as paris green, calcium arsenate, etc.

Put up in 100-lb. paper bags

100 lbs.....	\$1 50	1,000 lbs....	\$10 50
500 lbs.....	6 00	2,000 lbs....	18 00

Ask for booklet, "How and Why of Gypsum"

Aluminum Sulphate

Experiments have shown that soil acidity is required for rhododendrons, azaleas and all other evergreens. Apply at the rate of about one-half pound per square yard.

1 lb.....	\$0 15	25 lbs.....	\$1 50
5 lbs.....	50	50 lbs.....	2 40
10 lbs.....	75	100 lbs.....	4 25

Sudbury Junior Professional Model Soil-Test Kit

This new model makes 50 individual tests for nitrogen, phosphorus, potash and acidity, showing how to lime and fertilize for best results. Easy to use. Comes in handsome, sturdy, leatherette case. Complete with instructions and helpful chart. \$4.75.

Sudbury Home Model Soil-Test Kit. Makes 10 tests for each element. \$2.

Sudbury Deluxe Model Soil-Test Kit. Makes 200 tests for each element. In mahogany case. \$22.50.

Testing Fluid for Refill. (Specify whether for nitrogen, phosphorus, potash, or acidity.) 2 ozs. 75 cts., 6 ozs. \$1.50.

All prices on this page include local delivery in quantities of 50 pounds or more



Triple Action Plant Food

For Lawns and Flowers

Shrubs, Trees and Vegetables

You get added value and greater effectiveness from Wizard Natural Plant Food, because of these three distinctive and important features:

- 1. All Plant Food Elements.**
Wizard supplies in a safe natural form all the elements needed to make plants thrive.
- 2. Soil Building Humus.**
Humus is a vital need of all soils and is supplied in abundance by Wizard. Humus is only supplied by Natural Organic Plant Foods.
- 3. Beneficial Bacterial Action.**
The vast store of plant food locked-up in all soils is liberated and made available to plants by the bacterial action that Wizard promotes.

Wizard improves the physical condition and puts new life into worn-out soils. It is safe, absolutely weedless and lasting in effect.

Lawns.

Six to ten pounds to 100 sq. ft. in Spring and Fall will produce a thick green turf.

Flowers.

A handful mixed with soil under each new plant or 10 lbs. to 100 sq. ft. of bed area will insure luxuriant green foliage and an abundance of bloom.

Vegetables.

Wizard promotes quick, tender growth of high quality vegetables. Apply in hill or row or broadcast at rate of 5 lbs. to 100 sq. ft.

Shrubs and Trees.

The lasting qualities of Wizard make it the ideal food for trees and shrubs. It releases plant food continuously over a long period.

PRICES

2 lbs.....	\$0 20
5 lbs.....	30
10 lbs.....	50
25 lbs.....	1 10
50 lbs.....	1 90
100 lbs.....	3 25
500 lbs.....	14 00
1000 lbs.....	26 00
2000 lbs.....	49 00

Prices include local delivery in quantities of 50 pounds or more. Call orders and rail shipments in quantities of 500 pounds or more quoted on request.

Nature's Perfect Soil Builder

WIZARD SHEEP OR COW

BRAND MANURE

TRADE MARK

Complete Weedless Natural Plant Food



For Greener Lawns--Better Vegetables

Use VIGORO!

Any home can have the extra beauty that a lovely lawn provides . . . thanks to Vigoro. Vegetable yields will be bigger, too, for Vigoro supplies all the food elements growing things need from the soil. Use Vigoro on everything you grow for finest results.

5-lb. carton.....	\$0 45	50-lb. bag.....	\$2 50
10-lb. bag.....	85	100-lb. bag.....	4 00
25-lb. bag.....	1 50	500 lbs.....	18 00

MASTERS FERTILIZER DISTRIBUTORS

Simple, sturdy, and efficient machines for the even distribution of dry commercial fertilizer, grass seed, top-dressing and similar material. Revolving agitator insures free-flowing material. Shut-off control on handle.

These are heavy-duty models suitable for large estates, cemeteries, golf courses, landscape gardeners, etc.

Model	Spreading width	Hopper capacity	Price
M180	18-in.	50 lbs.	\$11 50
M240	24-in.	75 lbs.	14 50
M361	36-in.	100 lbs.	22 75

Model M361 has double-disc wheels; other two models have single-disc wheels.

Saves Time, Labor, Material

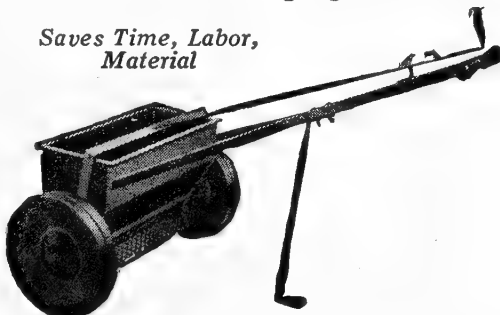

Mackwin Vitamin B₁ Liquid

A growth-stimulant for indoor and outdoor plants. 1/2-oz. bottle (makes 120 gallons of solution) 35 cts., 2-oz. bottle (makes 800 gallons of solution) \$1.

Plan Tabbs

A complete balanced plant-food in tablet form, plus Vitamin B₁. Can be used both in the garden and on house-plants. 30 tablets 25 cts., 75 tablets 50 cts., 200 tablets \$1, 1000 tablets \$3.50.

Pioneer Garden Peat Moss

This true sphagnum Peat Moss is all-organic and makes a most economical source of humus for loosening heavy clay soils, gives body to sandy soils, stores up valuable moisture, promotes the development of vigorous root-growth. It aerates the soil and prevents baking and crusting.

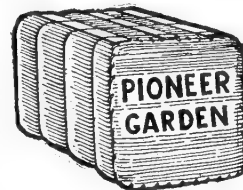

As a Protective Mulch against extreme heat of summer and freezing blasts of winter, spread it around base of plants to a depth of 3 to 4 inches.

1/2-bu. bag 35 cts., 1-bu. bag 60 cts., 1/4-bale sack \$1.60, 1/2-bale \$2.75, large bale \$4.50, 5-bale lots, \$4.35 per bale.

Turn Garden Rubbish Into "Rich Fertilizer"

Use Adco

Field and garden wastes—grass cuttings, leaves, etc.—contain everything needed by growing things, but they cannot be used in their "raw" state. Mixed with a small proportion of Adco, they are speedily converted into rich plant-food. It's easy to do—and inexpensive.

7 1/2-lb. carton (enough to treat about 100 lbs. dry material).....	\$1 00
25-lb. bag (enough for 12 wheelbarrow loads of garden waste, making about 1/2 ton of manure).....	2 25
150-lb. bag (enough for a heap 10 x 10 x 6 ft., making about 3 tons of manure).....	10 50

Insecticides and Fungicides

The Insecticides and machines for applying them, described in this Catalogue, are not novelties in the experimental stage, but have been thoroughly tested and found reliable for the uses for which they are intended.

Customers using large quantities of Insecticides are requested to write to us for special prices, specifying the quantities wanted. Prices quoted are subject to change.

TO CONTROL CHEWING AND SUCKING INSECTS

Bowker's Powdered Arsenate of Lead

Can be used either as a spray or as a dust for external chewing insects. It will not burn or injure your crop. It is the fineness of Bowker's Arsenate of Lead that causes it not only to spread and to stick better, but to kill better. Mixes easily, stays well in suspension, with no trouble from clogged nozzles.

Also used extensively for soil-treatment of golf greens and lawns to control white grubs and beetles that infest the sod and eat the roots of grass. Use 4 to 8 pounds for each 1,000 square feet of surface, mixed with top-soil, loam, or fine sand. Use 4 pounds of Arsenate to about 1 bushel of soil.

1-lb. pkg. 30 cts., 4-lb. pkg. 80 cts., 48 lbs. (12 4-lb. pkgs.) \$7.92.

"AA" Quality Calcium Arsenate

Excellent for potatoes and truck crops; it is cheaper than lead arsenate. Use it to kill such pests as potato bugs, bean beetles, and other leaf-chewing insects. May be applied either wet or dry.

1-lb. pkg. 25 cts., 4-lb. pkg. 50 cts., 48 lbs. (12 4-lb. pkgs.) \$5.04.

Paris Green

1/4-lb. carton. \$0 20
1-lb. carton. 60
5-lb. carton. 2 50

Dow's Magnesium Arsenate

Dow's Magnesium Arsenate is an effective insecticide for the control of the Mexican bean beetle and other chewing insects. It proves fully effective without damage to tender bean foliage. As a spray, use 6 teaspoonfuls to 1 gallon of water. For dusting, use 1 part Magnesium Arsenate to 3 parts hydrated lime. 12-oz. can 40 cts., 2-lb. bag 65 cts., 100-lb. drum \$22.50.

Bowker's Pyrox

Kills Bugs—Prevents Blights

A combined insecticide and fungicide containing arsenic and copper in the most effective forms for the control of almost all chewing insects and plant diseases. It makes a fine mist and covers the foliage completely, sticking to the leaves even through the hardest rains.

Pyrox is especially recommended for potatoes. Thorough and frequent spraying will keep the vines healthy. Even when insects and diseases are not troublesome, Pyrox will stimulate the growth of the vines and increase yields. One pound makes 4 to 6 gallons of spray.

25 lbs. \$5.75, 50 lbs. \$8.35, 100 lbs. \$14, 300-lb. barrel \$34.50.

Hammond's Slug-Shot

Hammond's Slug-Shot is used from ocean to ocean. A light, composite, fine powder, it is easily distributed either by dusters, bellows, or in water and sprayed. It is thoroughly reliable in killing the Mexican bean beetle, and other leaf-chewing insects.

Lb. 30 cts., 5 lbs. \$1.20, 25-lb. bag \$4.75.

Grasselli's Dutox Barium Fluosilicate

A Control for Mexican Bean Beetle and Other Pests

An effective control for beetles and leaf-eating insects on vegetables, fruit, etc. It does not injure plants nor impair fertility of the soil. Used as a dust, it is applied either alone or diluted with inert ingredients, or it may be applied as a spray.

1-lb. bag . . . \$0 35 | 6-lb. bag . . . \$1 35
Case, six 6-lb. bags. 6 48

Powdered Hellebore

1/2-lb. box . . . \$0 35 | 1-lb. box . . . \$0 60

Tartar Emetic

Used in a spray mixture to control gladiolus thrip. Use 1/2 pound Tartar Emetic and 1 pound brown sugar to 25 gallons of water.

1/4-lb. 50 cts., lb. \$1.50, 5 lbs. \$4.90, 25 lbs. \$19.

Black-Leaf 40

Nicotine Sulphate

Recommended by experiment stations and by spraying experts throughout the United States and the Dominion of Canada.

The standard contact insecticide for spraying vegetables, fruits, flowers, and plants to destroy aphid, most thrips, leaf-hoppers, and similar "sucking" insects. Also effective for dipping purposes. One ounce makes 6 gallons of spray.

1-oz. bottle. . \$0 35 | 2-lb. can. . . \$3 57
5-oz. bottle. . 1 05 | 5-lb. can. . . 6 70
1-lb. bottle. . . 2 42 | 10-lb. can. . . 11 65

Rotecide Extra

This Extra Rotenone spray kills aphid, beetles, thrip and many other chewing and sucking insects. Can be used with safety on garden crops or in the greenhouse.

1-gal. can \$8, 5-gal. drum \$35.

Alorco Cryolite

Very effective in controlling the Mexican bean beetle, cabbage worm and many other chewing insects. Can be used as a spray or dust. Safe and easy to apply. A proved insecticide for both commercial growers and home gardeners. 1-lb. can 35 cts., 6-lb. bag \$1.25, case (8 6-lb. bags) \$7.84.

Rotenone Dust

Kills the Mexican Bean Beetle

A general-purpose Dust that controls the Mexican bean beetle and most species of aphids, thrips, leaf-worms, beetles, larvæ, and other sucking and leaf-eating insects on vegetables, small fruit, etc. Does not contain arsenic. Requires 15 to 25 pounds to the acre.

1/2% Rotenone Content. Lb. 30 cts., 4 lbs. 80 cts., 50 lbs. \$7.75, 100 lbs. (2 50-lb. bags) \$14.50.

3/4% Rotenone Content. (Sold only in 50-lb. bags.) 50 lbs. \$8.50, 100 lbs. (2 50-lb. bags) \$16.

Volck Nursery and Garden Spray

A Summer Oil Spray and Spray Carrier

A contact insecticide for the control of scale insects, red spider, white flies and mealy bugs on trees, plants, shrubs and evergreens. Can be combined with nicotine, rotenone, pyrethrum, or arsenate of lead to control aphid, thrips, and certain leaf-eating insects.

4-oz. bottle. . \$0 25 | 5-gal. drum. \$8 50
16-oz. bottle. . 50 | 54-gal. drum. 48 50
1-gal. bottle. . 2 25

Pomo-Green With and Without Nicotine

The Tri-Purpose Dust or Spray Leaf Green in Color

Pomo-Green prevents and controls black-spot, mildew, chewing insects and sucking insects on plants, shrubs, and roses quickly and effectively.

Protect new growth by dusting or spraying with Pomo-Green once each week throughout the growing season.

Pomo-Green with Nicotine. The all-in-one material. 1-lb. can 80 cts., 5 lbs. \$3.30.

Pomo-Green without Nicotine. Used to control diseases and leaf-eating insects only. 1-lb. can 55 cts., 5-lb. carton \$1.85.

Kryocide D-50

A ready-mixed dust containing natural cryolite and sulphur. It effectively controls most chewing insects and plant diseases. Particularly recommended for the home vegetable and flower garden.

1-lb. shaker canister 50 cts.; 3-lb. bag 85 cts.

Kryocide C. An insecticide and fungicide containing natural cryolite and copper. May be used either as a dust or as a spray in water.

1-lb. shaker canister 55 cts.; 3-lb. bag 90 cts.

Ogen's Corn Ear Worm Drops

Simple and effective media for the control of the corn ear worm. Apply several drops to each ear after the silks have been pollinated.

2-oz. bottle with applicator 35 cts.

DELIVERY: Refer to bottom of page 70

To Control Fungus, Mildew, Black-Spot, and Rust



Bowker's Powdered Bordeaux Mixture

A powerful fungicide for the control of blights, rusts, and rots on any crops where Bordeaux is recommended by the experiment stations or other agricultural authorities. Fine, light, and fluffy, Bowker's Bordeaux mixes easily and completely. Hence it covers evenly and sticks well to the foliage.

1-lb. pkg. 30 cts., 4-lb. bag 80 cts., 48 lbs. (12 4-lb. pkgs.) \$7.92.

Cupro-K

Recommended as a spray for control of leaf-spot (shot-hole) on sour cherry trees. Is more effective than lime-sulphur and easier to use. Also used as a spray or dust for control of foliage diseases of certain vegetables, such as wilt and leaf-spots on cucumbers, and blight and leaf-spot on tomatoes. 3-lb. bag 75 cts., case (16 3-lb. bags) \$8.40.

"Bell-Mine" Rotary Kiln Lime

Used in spraying mixtures. Endorsed by leading agricultural authorities for Bordeaux Mixtures and for all other home-mixed insecticides and fungicides. Furnished in either pulverized, pebble, or lump form. 80-lb. paper bag \$1.25. Larger quantities quoted on request.

Superfine Dusting Sulphur

Controls mildew, black-spot, leaf-spot, and other fungous diseases on roses, chrysanthemums, phlox, delphiniums, snapdragons, and many other plants. 2-lb. sifter carton 30 cts., 10 lbs. 85 cts., 25 lbs. \$1.65, 50 lbs. \$2.75, 100 lbs. \$5.

Dow "Mike" Wettable Sulphur

Goes into suspension instantly and used as a spray. 10-lb. bag \$1.35, case (6 10-lb. bags) \$7.25.

Copper Sulphate (Blue Vitriol)

For making Bordeaux Mixture solution. Lb. 18c., 5 lbs. 65 cts., 10 lbs. \$1.10, 50 lbs. \$4.25, 100 lbs. \$8.

Monohydrated Copper Sulphate

For use in all home-mixed dusts requiring Copper Sulphate. It contains about 35 per cent Metallic Copper. 12½-lb. bag \$2, 100 lbs. (8 12½-lb. bags) \$14.

Tri-Ogen

Tri-Ogen gives protection against many plant insects and fungous pests. It is especially recommended for control of insects, mildew and black-spot on roses. The fact that it does three separate jobs in one spraying is perhaps the reason for its great and ever-increasing popularity.

Protects for season

E. Kit.	6 to 10 roses . . .	\$0 90
A. Small Kit.	12 to 20 roses . . .	1 50
B. Medium Kit.	50 to 80 roses . . .	4 00
C. Large Kit.	100 to 160 roses . . .	6 00
D. Estate Kit.	400 to 600 roses . . .	20 00

Tri-Ogen Dust

A combination insecticide and fungicide for those who prefer dusting to spraying. Same result accomplished as with Tri-Ogen in liquid form. 1-lb. pkg. 65 cts., 5-lb. pkg. \$3.

Dormant Sprays for Control of Scale

Scalecide

Scalecide has proved to be the most effective and safest oil spray for insects and fungous diseases that pass the winter on trees, evergreens, shrubs, and vines. For further description see page 72.

1-qt. can. . . . \$0 75 | 5-gal. can. . . \$6 35
1-gal. can. . . . 1 75 | 15-gal. drum. 14 95

Sunoco Self Emulsifying Spray Oil

Scale insects include some of the most dangerous enemies of horticulture. They are small, but propagate so rapidly that neglected trees quickly become incrustated with them. Do not allow these scales to gain a foothold. Sunoco applied as a dormant spray will control most all kinds of scale. Rusty evergreens, caused by red spider, may be prevented by using Sunoco Spray in May or June.

1-gal. can. \$1 30 | 55-gal. drum. \$26 75
55-gal. drums returnable at \$3 each.

Du Pont's Liquid Lime-Sulphur Concentrated

Prepared from the highest grade of lime and the purest sulphur, combined in especially designed apparatus and in quantities so large as to allow plenty of time for storage and settling. Thus, the solution which reaches you is cherry-red in color, clear and sparkling. It will not crystallize, thicken up in the barrel, or clog the finest nozzles. If used according to directions, will kill every scale that it touches. For dormant spraying use 1 gallon to 8 or 9 gallons of water.

50-gal. bbl. \$12.

F.O.B. our warehouse, 50-gal. bbl. \$10.50, 3 50-gal. bbls. \$30. Containers not returnable.

Agricultural Sulphur

Especially prepared for making Lime-Sulphur solution. 99½ per cent pure, 90 per cent through 80 mesh. 100 lbs. \$3.85, 500 lbs. \$18.30, 1,000 lbs. \$34.60, 2,000 lbs. \$63.20.

Dow's Dry Lime-Sulphur

Dow's Dry Lime-Sulphur is made by a special patented process which keeps the product in good physical condition, thus insuring its going into suspension quickly. It is used either as a dormant spray to kill scale or as a summer spray to control fungous diseases such as scab, rot, etc. For dormant spraying use 24 to 30 pounds in 100 gallons of water. For summer spraying use 5 to 8 pounds in 100 gallons of water.

1-lb. pkg. 35 cts., 5-lb. pkg. \$1.50, 12½-lb. bag \$1.75, 100 lbs. (8 12½-lb. bags) \$11.

DN-Dry Mix (Wettable)

Dinitro-O-Cresol

A spring dormant spray recommended for use alone in water or in combination with oil sprays. When added to oil it increases the toxicity of the spray to certain scale insects.

1-lb. bag 80 cts., case (24 1-lb. bags) \$15.60.

Greenhouse Insecticides and Fungicides

Nico-Fume Pressure Fumigator

Nico-Fume Powder packed in hermetically sealed cans. An effective greenhouse fumigant to destroy aphids, thrips, midge, etc. ½-lb. tin 45 cts. each, \$2.45 for 6, \$4.35 per doz.

1-lb. tin, 75 cts. each, \$3.90 for 6, \$7.35 per doz.

Nico-Fume Liquid

A highly refined solution of free nicotine, guaranteed to contain fully 40 per cent of nicotine. Extensively used for spraying or vaporizing in greenhouses to destroy aphids, thrips, etc.

1-lb. tin \$2.40, 4-lb. tin \$6.35, 8-lb. tin \$11.10.

DELIVERY: Refer to bottom of page 70

Selocide for Red Spiders

A powerful insecticide for the control of red spiders. Circular on request. 1 gal. \$3, 5 gals. \$13.50, 10 gals. \$24.50.

Bonide Syntox

A thiocyanate contact insecticide for the control of mealy bugs, red spider, chrysanthemum midge, thrips, cyclamen mite and aphids. 1-pt. bottle \$1.95, 1-qt. bottle \$3.35, 1-gal. bottle \$11.50.

Du Pont Spreader-Sticker

Increases the effectiveness of contact sprays by making possible more thorough wetting of foliage and insects. 1-pt. bottle 75 cts., 1-gal. bottle \$4.95.

McConnon 114Y

A highly concentrated and efficient contact insecticide made especially for greenhouse crops. Controls red spider, thrips, white fly, and aphids. Does not require any additional soap or other spreader.

1-qt. can. . . . \$2 50 | 5-gal. can. . \$37 50
1-gal. can . . . 8 50

CYANOGAS G. Fumigant. Fine for greenhouse and mushroom-house fumigation. In the greenhouse, ¼ ounce per 1,000 cubic feet will control aphids, white fly, soft scale, thrips, and other greenhouse pests. (Booklet on request.)

5-lb. tin . . . \$3 00 | 100-lb. drum \$25 00
25-lb. pail. . . 10 00 | Not mailable.

To Control Ants, Moles, Rats, Mice, Groundhogs, Etc.

Terro Ant Killer

Will drive ants in 24 hours from pantries, refrigerators, plants, flowers or any other place infested with them. A clean preparation in syrup form that cannot be blown into food or about the house and can be used without soiling or discoloring floors or receptacles. Terro is guaranteed to do the work or money back. Small size 25 cts., large size 50 cts. Postage 10 cts. extra.

Antrol Ant Killers

Antrol is easy to use, economical, and safe around children and pets. It consists of small glass containers from which the worker ants carry Antrol Syrup to their nests for food. The whole ant family is quickly killed at the source—the only way to get permanent freedom from these pests.

The containers may be refilled and used year after year. Adapted to any size home or garden. Guaranteed.

Antrol Ready-Filled Set consists of 4 special glass "feeders" containing regular Antrol Syrup. 40 cts. per set. Postage 10 cts. extra.

Antrol Syrup. 4-oz. bottle 20 cts., gal. \$2.75.



Cyanogas Ant-Killer

Ants die instantly when you drop a little Cyanogas Ant-Killer into the entrance to the nest. It is simple and sure. The gas does the work—penetrates all through the nest. 4-oz. tin 30 cts. (Not available.)

Magikil Jelly (Ant Bait)

A jelly bait that needs no feeders or traps. Simply place small doses in infested areas. Does not melt at ordinary temperatures. Endorsed by many state experiment stations. Garden tube 35 cts., estate tube 85 cts.



Remo Roach Destroyer

Will destroy roaches and other insects in a few minutes. 8-oz. pkg. 65 cts., 1-lb. pkg. \$1.20.



Albee Garden Gloves

Soft and durable, excellent for garden work. In sizes 6, 7, 8, 9, and 10. \$2 per pair, postpaid.

Carbon Disulphide

Recommended for killing ants, moles, woodchucks, and ground squirrels. For ants in hills, punch holes at intervals of 10 inches and pour a tablespoonful in each hole, then cover with burlap or similar covering. 1-lb. tin 50 cts., 5-lb. tin \$1.75, 10-lb. tin \$2.50. (Not available.)

Exterminate Moles with Mole-Nots

Kills moles quickly. Safe and easy to use. Simply shake a few of the pills in runways at intervals of 2 to 3 feet. Mole-Nots safeguard bulbs when placed in ground at time of planting. Pkg. (8 "Nots") 35 cts., pkg. (50 "Nots") \$1.

Molgen

A safe and effective method of eliminating Moles in lawns and flower-beds. Comes in powder form. 1/2-lb. can 50 cts.

Cyanogas A Dust

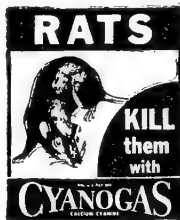

Acknowledged throughout the world to be the most effective pest destroyer. It is Calcium Cyanide which liberates hydrocyanic acid gas when exposed to the natural moisture in the air and kills the pests wherever they are. They breathe the gas and die instantly. Exterminates moles, groundhogs, rats, mice, ants, fleas, wasps, and various other pests.

1-lb. tin... \$0 75 | 100-lb. drum. \$25 00
5-lb. tin... 3 00 | Not available.
25-lb. pail... 10 00

Cyanogas Foot Pump Duster. \$7.

K-R-O

KILLS RATS ONLY

K-R-O is made of red squill, an ingredient recommended by the U. S. Government for rat eradication. Red Squill may be safely used around humans, pets, and livestock. K-R-O. Powder, 2-oz. size, 75 cts., postpaid.

K-R-O Ready Mixed Bis-Kit Form. Small size 35 cts., large size \$1, postpaid.

Pastoxine

Exterminator of rats and mice. Non-poisonous as well as repulsive to man, domestic animals, and poultry. Appetizing to rodents. Causes asphyxia (they run out for air and water to die). Highly concentrated—about 6 grains will kill a rat, a few grains a mouse. 1-oz. jar (about 400 grains) 60 cts., 1-lb. jar \$5, postpaid.

Mouse Seed

Safer and more convenient than traps or any paste or powder preparations. Ready to use. 25 cts., postpaid.

Weed Killers



A new liquid chemical that kills both the plant and seeds of crab-grass and checks reinfestation. Does not destroy lawn grasses and is non-injurious to soil. Proved by 5 years of tests. This new easy method does away with laborious raking and weeding. Simply mix ZOTOX with water and spray it on. A 16-oz. bottle treats 2,000 sq. ft. For "spot" treatment of small patches it goes much farther.

Zotox is also recommended in eradicating dandelion, plantain, chickweed and other perennial weeds. Full directions on bottle.

8-oz. bottle \$1, 16 ozs. \$1.50, 32 ozs. \$2.50, 5 lbs. \$4.50.

Du Pont Ammate Weed Killer Ammonium Sulfamate

Effective for the control of poison ivy, ragweed, Canada thistle, dandelion, plantain and many other weeds. Use 1/2 to 1 pound to a gallon of water, depending on the density of growth and kind of weed. Apply with sprayer or sprinkling-can at rate of 1 gallon of solution to 100 square feet of infested area.

2-lb. bottle. \$0 75 | 50-lb. drum. \$12 00
6-lb. bottle. 1 80 | 350-lb. drum. 63 00

Hammond's Weed Killer

Will kill weeds, poison ivy, and all vegetation without distinction, so it must be used cautiously where grass is desired. Dilute 1 gallon to 30 to 40 gallons of water. Apply with a sprinkling-can. Qt. 50 cts., gal. \$1.50, 5-gal. drum \$7.25. 5-gal. drum returnable at \$1.

Dandelions Can Be Destroyed

Wonderfully quick, easy method to rid your lawn of dandelions—merely touch the dandelion with No-Stoop Applicator and the entire plant dies, dries up, and blows away.

No digging—no pulling—no stooping. Dan-D-Lion Killer Kemical in the special No-Stoop Applicator does all the work.

Combination Outfit (No-Stoop Applicator and 1 qt. Kemical), enough to kill 1,500 weeds... \$2 25



KILLER KEMICAL.

1-qt. can... \$1 25
1/2-gal. can... 1 65
1-gal. can... 2 75
5-gal. can... 10 85
30-gal. drum... 52 80
55-gal. drum... 90 75
No-Stoop Applicator \$1.50.

Seed and Soil Disinfectants and Seed Inoculation

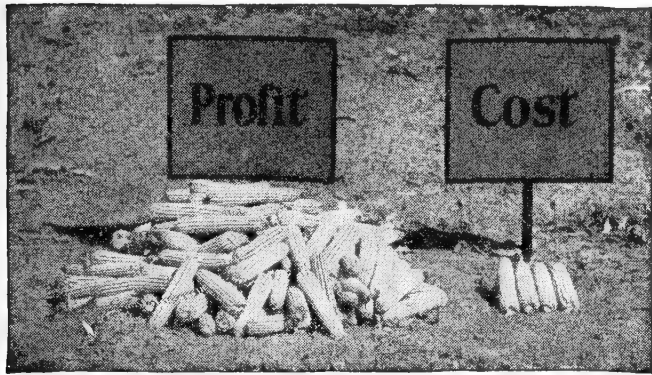

"Semesan Jr." corn treatment increased the yield of this field corn 21.3 bushels per acre over untreated seed

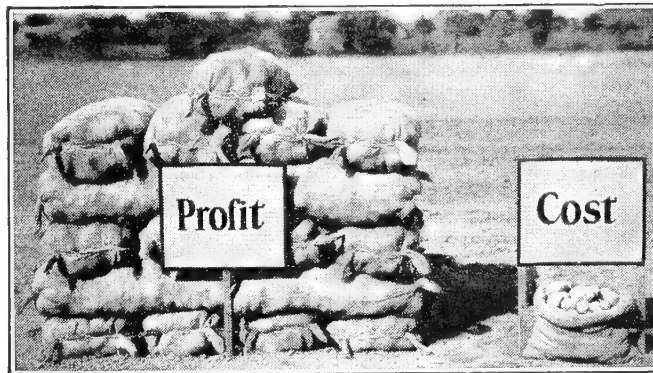

Only 0.4 bushel of the 35.4 bushels increase was needed to pay for the "Semesan Bel" that gave this better potato crop

New Improved "Ceresan"

A dry disinfectant for seed wheat, barley, rye, and oats. Effectively kills certain seed-borne diseases by both contact and vapor; generally controls covered smuts, and frequently increases yields. One pound treats 32 bushels of seed grain. 4-ozs. 30 cts., 1-lb. 80 cts., 4 lbs. \$2.70, 25 lbs. \$15, 100 lbs. \$55.

"Semesan Jr."

A double-acting seed disinfectant for certain seed-borne diseases of corn. Usually reduces seed rotting, checks seedling blight and certain seed-borne rots of root and stalk. Has increased yields an average of 3 bushels per acre. Costs only about 9/10 cents an acre. 1 1/2 ounces treats a bushel of seed. 1 1/2 ozs. 15 cts., 12 ozs. 56 cts., 6 1/4 lbs. \$3.75.

DU PONT SEMESAN SEED DISINFECTANTS Du Pont Semesan Fungicides

"Special Semesan"

The efficiency of "Special Semesan" in the control of brown patch and dollar spot is recognized by many state experiment stations and hundreds of greenskeepers and home owners. Usually provides a wide margin of safety with little danger of yellowing or thinning turf when applied as directed. One pound treats up to 6,000 square feet. 8 ozs. \$1, 6 lbs. \$9.35, 25 lbs. \$36, 100 lbs. \$135.

Nu-Green. 3 ozs. 40 cts., 1-lb. \$1.60.

"Semesan Bel"

Easy, quick-dip treatment for seed potatoes. Costs only about 21 cents an acre. Generally reduces seed-piece decay, seed-borne scab, and rhizoctonia. No mussy soaking—just dip, drain, dry, and plant. One pound treats 60 to 80 bushels of seed. 2-oz. pkg. 30 cts., 1-lb. can \$1.65, 5-lb. can \$7.15, 25-lb. drum \$33.25, 100-lb. drum \$125.

"Semesan"

Aids in reducing rot of flowers and vegetables, gives them a healthy start. Treat seeds, corms, bulbs, and seedlings. "Semesan" generally reduces seed rotting and damping-off. One ounce treats 15 to 60 pounds of seed. 1/3 oz. 10 cts., 2 ozs. 40 cts., 12 ozs. \$1.88, 4 lbs. \$9.10, 25 lbs. \$52.50.

Hammond's Formacide Stabilized Formaldehyde Dust

Used as a control of certain fungous diseases known as damping-off of seedlings and cuttings. For treating soil to be used in pots and flats mix 8 ounces of Formacide thoroughly with each bushel of soil. Also an effective control for smuts of oats and barley. Complete directions on package. 1/2 lb. 50 cts., 1-lb. 85 cts., 5 lbs. \$2.50, 50 lbs. \$17.50.

Suspension Calo-Clor

An intimate mixture of calomel and corrosive sublimate, recommended for the prevention and control of large and small brown patch. Contains 81 per cent mercury metal. Can be used satisfactorily in power sprayers.

25-lb. drum. \$75.75. (Not available.)

Corrosive Sublimate

Mercuric Chloric, Bichloride of Mercury

Used for the prevention and control of brown patch on turf; for the control of thrips on gladiolus bulbs, root maggots in seed-beds, and seed-borne diseases of seed potatoes. Contains 74 per cent mercury metal.

1/4-lb. bottle..\$1 10 | 5-lb. bottle \$13 60
1-lb. bottle.. 3 00 | 25-lb. drum. 58 50
Not available

Always Inoculate with



For Alfalfa, Soy Beans, Clovers and all other Legumes

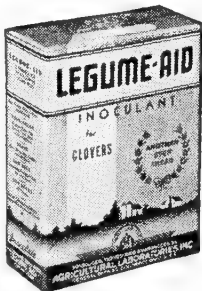

All legumes are heavy nitrogen users and if not inoculated, they rob the soil like any other plant. Inoculating legumes with Legume-Aid Bacteria enables legume plants to draw free nitrogen from the air and make it available as food.

For Alfalfa and All Clovers. 1-bus. size 50 cts., 2 1/2-bus. size \$1.

For Soy Beans, all varieties. 2-bus. size 30 cts., 5-bus. size 55 cts., 25-bus. size (5 5-bus. sizes) \$2.50.

For Vetch, Field and Garden Peas. 100-lb. size 50 cts.

For Lespedeza, Cowpeas, Lima Beans, and Peanuts. 100-lb. size 50 cts.

For Garden Beans, Lima Beans, Garden Peas and Sweet Peas. Home Garden size (for 5 lbs. of seed) 10 cts., 1-bus. size 50 cts.

When ordering don't fail to state the kind of seed to be inoculated

Insure your crops with

Du Pont P. A. C. Formaldehyde

Invaluable as a disinfectant, fungicide, germicide and deodorant on the farm and in the home.

For Grain-Smut Control. An efficient control for smuts of wheat, barley, oats, and rye. Can be applied by the sprinkle, dip, or spray method. A one-pound can will treat 50 to 55 bushels of seed grain.

For Seed-Potato Treatment. Controls scab, rhizoctonia, and some forms of black-leg and dry rot which cut down the stand, cripple the potatoes, and reduce the yields. Potatoes are usually treated just before planting but this work may be done at any time in the winter or spring.

For Soils and Vegetables. Prevents damping-off of seedlings in seed-beds and greenhouse benches; controls onion smut, root-knot, and other diseases.

Mushroom Disease Control. Fumigation with Formaldehyde has been found to be the most satisfactory means of control of the "bubbles" disease.

Lb. bottle 35 cts., 10 1-lb. bottles \$3, case (25 1-lb. bottles) \$6.70, 60-lb. keg \$9.80.

Ask for booklet and full directions.

Tree Tanglefoot

A sticky material for banding trunks of trees, vineyards, etc., to protect them against the ravages of climbing insect pests.

No mixing is required. It comes ready for use and is easily and quickly applied with a wooden paddle. One pound makes 15 to 20 lineal feet of band.

6 ozs. 45 cts., lb. 80 cts., 5 lbs. \$3.75, 10 lbs. \$7, 25 lbs. \$15.

Balsam Wool Tree Bands



Used with Tree Tanglefoot where indirect banding is desired. May be removed after insect season is over. Also makes an impenetrable barrier band for rough-barked trees. Width, 3 inches. Comes in rolls containing 16 $\frac{2}{3}$ lineal feet. Per roll 50 cts., 12 rolls \$5.40.

Hammond's Tree Wound Paint

Contains ingredients necessary to protect trees after pruning; also healing of tree wounds. Used by orchardists, tree surgeons, and state foresters. Applied with a brush.

$\frac{1}{2}$ pt. 50 cts., pt. 90 cts., qt. \$1.75, gal. \$4.50.

Trowbridge's Grafting Wax

Used by softening in warm water, or by the warmth of the hand. It can then be drawn out as thin as paper and spread on the cut and around the graft.

$\frac{1}{2}$ -lb. pkg. 35 cts., 1-lb. pkg. 60 cts., dozen 1-lb. pkgs. \$6.50.

Stanley's Crow Repellent

Protects seed corn during the period when it is most easily damaged by crows, pheasants, blackbirds, and all other corn-pulling birds, and animal pests that pull sprouting corn.

Apply to the seed before planting, and after mixing thoroughly it can be planted immediately. It will not kill birds or animals but will keep them away. One pint treats 2 bushels of seed.

$\frac{1}{2}$ -pt. bottle 60 cts., 1-pt. bottle \$1, 1-qt. bottle \$1.75.

Dogzoff

An efficient repellent against dogs, cats or rabbits. Not poisonous to plants and will not injure animals. Not offensive to humans. Applied with any small sprayer. Bottle 60 cts., postpaid.

Waterproof Tree Wrap

Protects the trunks of newly planted trees against frost, sun scald, borer attack and rodents. Easily applied. 4 in. wide. Roll, 150 lineal feet, 75 cts., pkg., 11 rolls, \$7.15.

Tobacco Dust

A specially ground Tobacco Dust, guaranteed to contain not less than 1 per cent nicotine. It is particularly useful wherever a dusting powder is desired to destroy plant-lice. Owing to its extreme fineness it readily floats in the air, enveloping the entire shrub or tree in a dense cloud.

2-lb. carton 25 cts., 10-lb. pkg. 75 cts., 100-lb. sack \$3.60, 500 lbs. \$16.65.

Whale-Oil Soap

Effective in destroying many sucking insects and lice on plants, trees, ferns, etc. It is an excellent wash to use on rose bushes, porch flowers, vines, rubber plants and palms. Also used as a spreader and adhesive where required.

$\frac{1}{2}$ -pt. can 35 cts., 1-pt. can 65 cts., 1-qt. can \$1.25, 1-gal. can \$4, 5-gal. can \$16.

Linso Soap

A high-quality soap spreader of linseed oil base. Very economical and highly effective. Use 1 $\frac{1}{2}$ pints to 100 gallons of water.

$\frac{1}{2}$ -pt. can. . . \$0 35	1-gal. can. . . . \$2 10
1-qt. can. . . . 80	5-gal. can. . . . 7 45

Hormodin Powders

Contains the hormone-like plant-growth substance that stimulates rapid root-growth on all types of cuttings, enabling growers to propagate from cuttings in higher percentages than ever before possible.

No. 1. For soft wood cuttings. $\frac{1}{4}$ -oz. pkg. 25 cts., $1\frac{3}{4}$ -oz. pkg. 50 cts., 1-lb. pkg. \$3.

No. 2. For less sensitive species and semi-woody types. $1\frac{3}{4}$ -oz. pkg. 75 cts., 1-lb. pkg. \$4.50.

No. 3. For the more resistant species. 1-oz. pkg. \$1, $\frac{1}{2}$ -lb. pkg. \$4.50.

Rootone

The plant hormone powder. Use it for better rooting of cuttings, seeds, bulbs, corms, and tubers. Just dip the base of the moistened cutting in Rootone and set in sand or soil.

To treat seeds and bulbs just dust with Rootone before planting.

$\frac{1}{4}$ -oz. pkt. 25 cts., 2-oz. jar \$1, 1-lb. can \$5.

Rootone No. 10. For woody cuttings such as azalea and evergreens. 2-oz. jar \$2, 1-lb. can \$10.

Fruitone

A spray for stopping pre-harvest drop of apples and pears. Spray tomato and bean blossoms for better fruit set.

$\frac{2}{5}$ -oz. pkt. (makes 5 gals.) 25 cts., 2-oz. can \$1, 12-oz. can \$5.

ELLISCO

Japanese Beetle Traps

The most efficient means of destroying full-grown Japanese beetles. The bait in the Trap attracts the beetles to the trap; the beetles pass through the Trap into the jar, where they can be destroyed easily.

No. 4 Trap. \$1.20 each, \$6.90 for 6, \$13.20 per doz.

No. 1 Trap. Smaller than No. 4. 60 cts. each, \$3.30 for 6, \$6 per doz.

Traps fitted with standard thread to fit any Mason jar. Price of Traps does not include jars, cages, stands, or bait.

Ellisco Granular Bait.

1-oz. can 15 cts., 4-oz. can 40 cts., 1-lb. can \$1.20, 5-lb. can \$4.75.

Perforated Cages. 2-qt. capacity, used in place of Mason jars. 50 cts. each, \$2.70 for 6, \$4.80 per doz.

Stands. Galvanized steel rod to support trap. 35 cts. each.



No. 4 Trap with Perforated Cage

Smith's Lightning Sprayer

Well-built and suitable for all spraying purposes. Open-top tank provides for quick, easy filling and cleaning. Has simple positive device for locking pump to tank. Tank has a capacity of 3 $\frac{1}{2}$ gallons and is well riveted to stand hard usage. Has 1 $\frac{3}{4}$ -in. seamless brass pump. Furnished with 23 inches of $\frac{3}{8}$ -in. hose, 24-in. angle extension rod, trigger control shut-off and non-clog nozzle. No. 24GO. \$6.



Harco Sprayer

An efficient, easy-to-use Sprayer for indoor or outdoor plants. Splendid for house-plants and seedlings in flats. Uses any water-soluble liquid insecticide. Furnished with 1-quart Mason jar, hose, and extension rod. \$2.35.

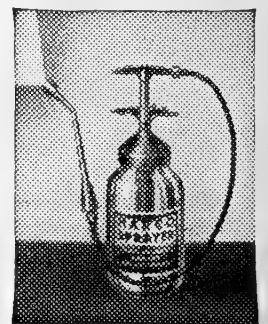

DELIVERY: At prices given in this Catalogue, Insecticides and Fungicides are delivered prepaid on orders amounting to \$2 or more. On orders less than \$2, include postage at rates given on page 1 under Parcel Post Shipments.

McCORMICK Standardized INSECTICIDES



Red Arrow Garden Spray

Kills many varieties of both chewing and sucking insects. One ounce makes several gallons of spray. Safe, leaves no poison residue when sprayed.

Oz.	\$0 35
4 ozs.	1 00
Pt.	2 85
Qt.	5 00
Gal.	16 50

Special Red Arrow

An extra high-powered pyrethrum spray especially effective for control of leaf-tyers, and leaf-rollers, Japanese beetles and other insects which are known to be susceptible to a pyrethrum spray. Leaves no poisonous residue.

1-gal. bottle	\$12 00
5-gal. can	58 25



McCormick's "Red Arrow" Dust

Made with Rotenone and Sulphur

Kills bean beetles and most other leaf-eating and sucking insects. Safe and effective when used on beans, asparagus, cabbage, cauliflower, and other vegetable plants. Use as a dust or spray. Leaves no poisonous residue. Used by commercial growers and home-gardeners.

2-lb. bag 45 cts., 50-lb. bag \$7.75, 100 lbs. (2 50-lb. bags) \$14.50

DELIVERY: REFER TO BOTTOM OF PAGE 70



A Complete 3-Way Spray

Nicotine Pyrox

TRADE MARK REGISTERED

Nicotine Pyrox protects plants against insect pests, blight, and other fungous diseases. Because it contains all the necessary ingredients properly and scientifically blended, Nicotine Pyrox is a complete garden spray. It contains nicotine to combat sucking insects, arsenic poison to control leaf-eating insects, as well as a copper ingredient which provides protection against fungous diseases.

Nicotine Pyrox comes in a mixed paste form, ready to use. Just dilute with water, and spray. It sticks to the

foliage and does not easily wash off. The paste form of spray material is recognized by authorities as the most efficient form of spray material because it permits the finest mist-like spray which settles like fog over the plant, completely covering the surface of the foliage. Such a fine mist-like spray as Nicotine Pyrox provides is possible only because Nicotine Pyrox is a chemical precipitate which makes the minute particles many times finer than many dry, powdered materials can be ground.

20-oz. jar (makes about 4 gals. spray) 60 cts., 5-lb. can \$2, 25-lb. pail \$6.50

DELIVERY: REFER TO BOTTOM OF PAGE 70

To Control Borers, Cutworms, Grubs, Sowbugs, Etc.

Paradow

Paradichlorobenzene

Paradow is recommended for the control of peach-tree borers. When placed around the base of a peach tree, it will generate a gas that will kill the borers in that tree. Should be used in spring or fall when trees are not growing vigorously. Use about 1 ounce per tree. Directions on container.

12-oz. pkg. 40 cts., 5-lb. pkg. \$1.75, 25 lbs. \$6, 50 lbs. \$10.

Para-Scalecide

Controls Peach Tree Borer

Eliminates much of the danger and saves labor in the control of borers in peach and other trees. Comes in liquid form. Dilute one gallon in 7 gallons of water and it is ready to apply directly to the tree. Ask for special leaflet.

1-qt. can	\$0 85	5-gal. can	\$7 03
1-gal. can	2 20	15-gal. drum	16 82

Snarol

With Metaldehyde as an Attractant

Cutworms, sowbugs, grasshoppers, slugs, snails, earwigs, etc., are quickly exterminated.

Snarol is a ready-prepared meal that you simply broadcast on the ground, under the vegetation. Pests eat it at night and are quickly destroyed. It will not deteriorate from rain or sprinkling, and is non-injurious to vegetation.

1-lb. pkg. 25 cts., 2½-lb. pkg. 50 cts.

SCALECID

THE COMPLETE DORMANT SPRAY

Makes a Tree Outgrow Its Troubles

The Guaranteed Oil Spray

Scalecide is a miscible oil that is known as the complete dormant Spray because it controls more insects and diseases than any other Spray or combination of sprays at one time. It is the safest Oil Spray that you can use.

Scalecide is noted for its effectiveness against scale, aphids, red mite and other pests. Scalecide is more than a scale Spray as it controls other insects that winter on the tree, and has a great beneficial effect on the vigor and vitality of your trees.

Spray fruit trees with Scalecide, 1 to 15, as a delayed dormant Spray. On peach and pear trees fall spraying is preferable to control peach curl and pear psylla.

Spray conifers, spruces, pines, shade trees, etc., with Scalecide 1 to 20 just before the new growth starts.

Spray evergreens, euonymus, etc., with Scalecide 1 to 25, in the spring.

EFFECTIVE PROTECTION
for FRUIT TREES,
SHADE TREES and
ORNAMENTALS

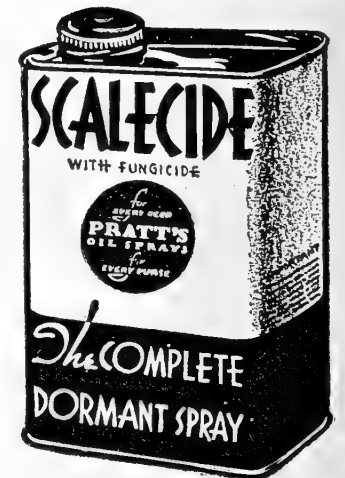

Scalecide is guaranteed to make a better orchard than lime-sulphur or oil emulsion. Ask for copy of full guarantee.

PRICES

1-qt. can.....	\$0 75
1-gal. can.....	1 75
5-gal. can.....	6 35
15-gal. drum \$12.95. Returnable drum extra \$2.00	14 95
30-gal. drum \$21.25. Returnable drum extra \$2.50	23 75
55-gal. drum \$32.89. Returnable drum extra \$3.00	35 89

Deposit on drum refunded when returned to B. G. Pratt Co., Hackensack, N. J., prepaid. Prices on 5 drums and upwards quoted on request.



SPRAYS PROTECT YOUR GARDEN FROM INSECTS

A powerful and active nicotine or rotenone spray in a penetrating spray base for greater kill of sucking and chewing insects on fruit trees, shade trees, vegetables, and flowers.

D-X NICOTINE

An active spray of unusual qualities for sucking insects, aphids, leafhoppers, etc. Combines with bordeaux, lime, and sulphur fungicides and with arsenate of lead for chewing insects. Use wherever nicotine is indicated.

1½-oz. bottle 40 cts., ½-pt. can \$1.40, 1-qt. can \$3.95, 1-gal. can \$10.75, 5-gal. can \$44.75.



D-X ROTENONE

A most effective garden and small fruits spray, non-poisonous to man or warm-blooded animals. Controls the Mexican bean-beetle and other chewing and sucking insects—combines with standard fungicides and arsenate of lead.

1½-oz. bottle 35 cts., ½-pt. can \$1.25, 1-qt. can \$3.50, 1-gal. can \$9.50, 5-gal. can \$39.75.

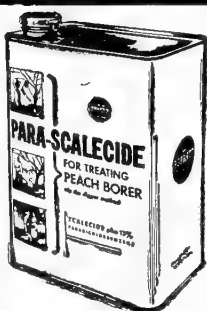

PARA-SCALECID

A combination of paradichlorobenzene and Scalecide in proportions best suited for peach-borer control. Used on both young and old trees. Dilute 1 part to 7 parts of water. Apply by spray or dipper in the fall or late spring. Can be used against borers in shade trees, etc.

1-qt. can 85 cts., 1-gal. can \$2.20, 5-gal. can \$7.03, 15-gal. drum \$16.82, 30-gal. drum \$27.50, 50-gal. drum \$39.15.

SULFOCID

A Better Summer Spray

A powerful fungicide for fruits, vegetables, and flowers. Especially effective for mildew, rust, anthracnose, brown rot, and other fungous diseases. Combine with any D-X formula for an all-purpose spray for insects and fungous diseases.

Pt. 60 cts., qt. \$1, gal. \$2.50, 5 gals. \$8.25, 30 gals. \$36.30, 50 gals. \$55.

SPRAY CATALIZER

A spreader, sticker and safener for arsenate of lead, lime-sulphur or sulfocide, arsenate of lead combinations. Reduces lime-sulphur injury. Takes the place of casine and lime spreaders.

2-lb. bag 60 cts., case (24 2-lb. bags) \$11.52, 50-lb. bags \$11.

Stakes



Wooden, Round, Tapering, painted green.
Light Stakes are made from western white pine and the heavy from cypress.

	Doz.	100
1½ ft. long, light weight....	\$0 35	\$1 85
2 ft. long, light weight.....	55	3 50
3 ft. long, light weight.....	1 00	6 60
4 ft. long, light weight.....	1 30	9 40
3 ft. long, heavy weight....	1 40	10 00
4 ft. long, heavy weight....	1 85	13 00
5 ft. long, heavy weight....	2 35	17 00
6 ft. long, heavy weight....	2 75	21 00

Bamboo Canes. Dyed green. Uniform pencil thickness throughout. Just the thing for pot-plants and plants that need just a light support.

	Doz.	50	100	1,000
24 in. long....	\$0 25	\$0 65	\$1 10	\$9 00
48 in. long....	35	1 10	2 00	18 00

Heavy Bamboo Tonkin Stakes. Make excellent supports for dahlias and plants of this type. Natural finish.

	Diam.	Doz.	50	100
4 ft. 5/8 to 3/4 in....		\$1 40	\$4 50	\$7 50
6 ft. 1/2 to 5/8 in....		1 60	5 50	10 00

Adjusto Plant Supports

A sturdy, hardwood stake seven-eighths inch square, with a strong wire support instantly adjustable to any height. A suitable support for tomatoes, dahlias, peonies, and all similar plants.

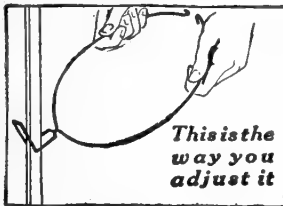

	Each	Doz.	Each	Doz.
3 ft....	\$0 27	\$2 50	5 ft....	\$0 37
4 ft....	32	2 85	6 ft....	40

Garden or Pot Labels (Painted)

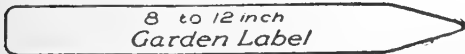
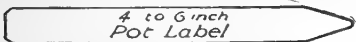

	100	500	1,000
4 in. x 5/8 in. wide....	\$0 45	\$1 75	\$3 00
5 in. x 5/8 in. wide....	50	1 90	3 25
6 in. x 5/8 in. wide....	55	2 15	3 75
8 in. x 7/8 in. wide....	95	4 15	7 75
10 in. x 7/8 in. wide....	1 05	4 75	9 00
12 in. x 1 1/8 in. wide....	1 35	6 25	12 00
3 1/2 in., iron-wired...	55	2 10	3 65

Evermark Label Pencil. Makes a permanent record on garden labels. 20 cts. each.

Bemis Erosionet

For New Lawns and Stubborn Terraces



Bemis Erosionet is a strong, economical, open-mesh fabric made of tightly twisted paper twine.

When placed over any seeded surface, its 1/4-inch square mesh forms millions of tiny dams which catch and hold the seed and soil firmly in place. Thus, damaging "washouts" from heavy rains are effectively checked without cutting off the sunlight.

It is rot-resisting during the period of its need or if allowed to remain it will eventually disintegrate. 45 inches wide. Sample on request. 13 cts. per lineal yd., 250-yd. roll \$30.30.

The BARKER Weeder, Mulcher, Cultivator

One man with a Barker can do more work, do better work than ten men with hoes. It cultivates and pulverizes the soil, forming a soil-mulch which holds moisture. The underground knife cuts all weed roots, and the reel blades clear the dirt from the knife, making a perfect job of weeding.

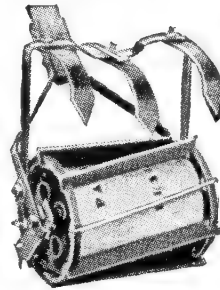

Barker Weeder

The Barker has 7 1/4-inch rugged disc wheels; new patented filler drum, and oscillating leaf-guards. Cutting parts of best-grade steel for its purpose.

No. 8 1/2. An excellent size for general garden work. It cuts an 8 1/2-inch strip. \$8.95.

No. 10. Knife cuts a 10-inch strip. A very popular size. \$9.65.

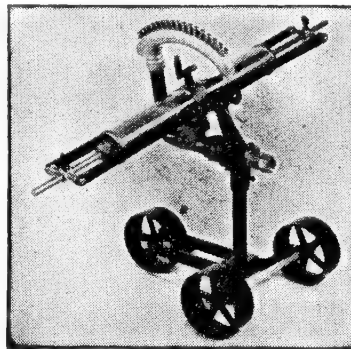

White Showers Rainbow Sprinkler

So designed that it sprinkles in a square instead of circle. The Rainbow has 17 nozzles, mounted on an oscillator and waters an area as large as 50 feet square, but it can quickly be adjusted for smaller areas and also for narrow strips and borders. Discharges 6 gallons per minute. Weight 25 lbs. \$45.

Soil-Soaker Soaks Soil Thoroughly



Made of porous canvas; screws to the water hose, replacing nozzle and sprinkler. The water seeps through the Soil-Soaker surface in drops and gently rolls to the ground without the slightest washing. Enables you to put the water exactly where you want it. Easily moved.

No. 0. 12 ft..	\$1 40	No. 2. 30 ft..	\$2 90
No. 1. 18 ft..	1 90	No. 3. 50 ft..	4 75

Raffia

For tying, bunching, basket-making, etc.

Natural. In plaits. Lb. 50 cts., postpaid 60 cts.; 10 lbs. \$4.50, postpaid \$4.75.

Green. Bundle (about 1 lb.) \$1.10.

The Root Hand Gun

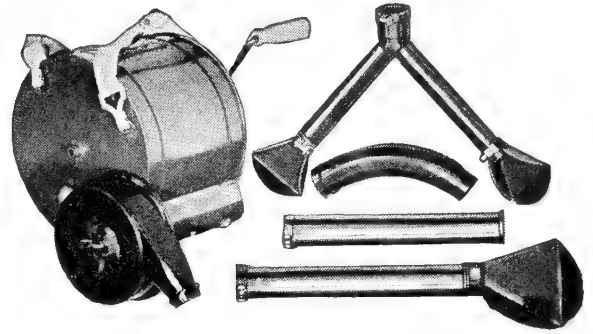

The ideal Dust Gun for dusting all kinds of agricultural dusts where the acreage is not large enough to justify the use of traction or power dusters. It has a powerful fan-blast which thoroughly breaks up the dust and distributes it evenly and uniformly. Can be operated with discharge tube in front or to the rear of the operator. The hopper has a capacity of 7 to 10 pounds of material. Built to stand hard knocks and rough usage.

No. C3. \$21.

American Beauty Duster

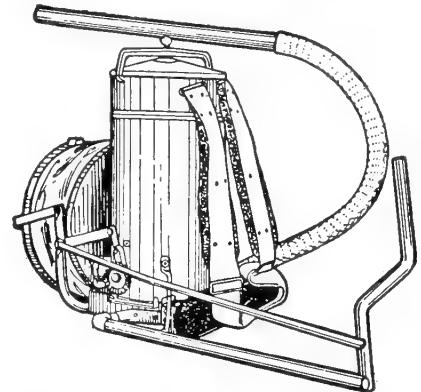

Most powerful one-man Duster built. Drives dust 25 feet in air. Compound handle makes operating of bellows easy. Equipped with instant feed-control, flexible hose, 40-inch tubes and deflector to blow up under lower leaves. Capacity 15 to 20 pounds of dust. Internal moving parts constructed of brass or rustproof plating. Weight, 17 1/2 pounds. \$25.

Dobbins Wheelbarrow Sprayer

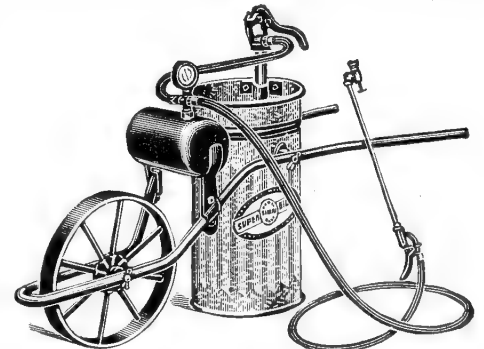

This outfit is adapted for spraying small orchards, vineyards, truck gardens, in the greenhouse, and a very convenient and efficient rig for whitewashing and disinfecting poultry-houses and dairy-barns. It can be used on hillsides and uneven ground without danger of tipping. Heavy galvanized tank, capacity 12 1/2 gallons. Equipped with 6 feet of 3/8-inch 5-ply hose, 2-foot pipe extension, spray nozzle and pressure gauge.

No. 3171. With air-pressure tank. \$22.35.

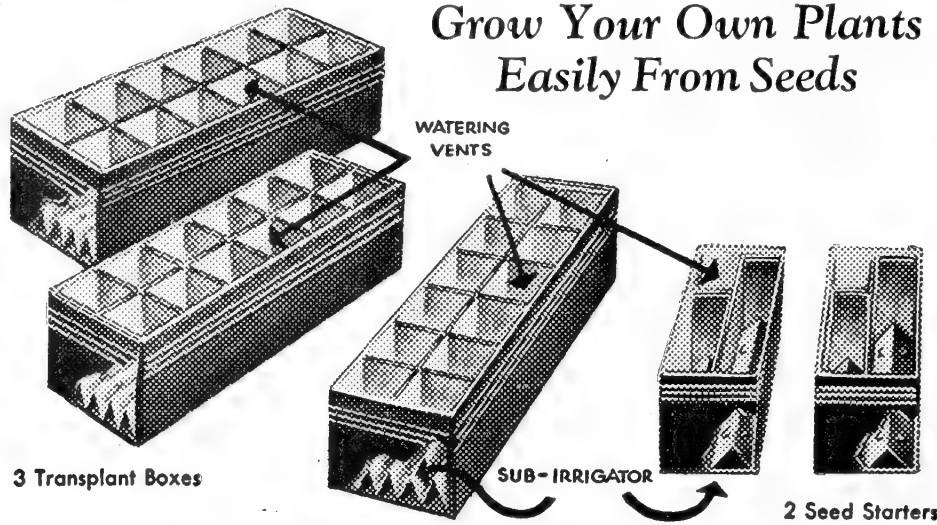

GREEN THUMB WINDOW GARDEN

A practical and inexpensive outfit for starting seed indoors. Grow your own Tomato, Cabbage, Pepper, Eggplant, flower, and other plants. Requires very little attention and is easy to do. Outfit consists of 2 seed starters and 3 fitted transplant boxes; capacity 5 to 10 dozen seedlings and 33 potted plants. Sub-irrigation feature makes success more certain. Made of waterproof, mildew-resistant, fibre resin. Furnished knocked down, but easy to assemble. No. RG 33. 80 cts., postpaid 90 cts.

B-B Garden Flats

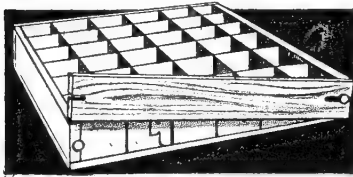

Made of choice lumber. Has patent detachable front which permits plants to be removed without disturbing the roots. Suitable for starting any kind of seeds indoors. Can be used either with or without pots. Size 12 $\frac{3}{8}$ x 18 $\frac{3}{8}$ x 3 in. Holds 54 2-in. pots or 24 3-in. pots. Price (without pots) 70 cts. each; 25 or more, 63 cts. each.

Neponset Red Flower Pots



Universally used by every grower of plants. When used for transplanting they can be handled quickly and the construction permits removing easily if desired. They are ideal for rooting or shipping vegetable and flowering plants of any description. Made from a tough, waterproof paper.

	25	Postpaid	100	Postpaid	1,000
2 $\frac{1}{4}$ -in.	\$0 25	\$0 35	\$0 60	\$0 75	\$4 50
3-in.	30	40	75	90	5 60
4-in.	40	50	1 10	1 35	8 50
6-in.	55	70	1 75	2 00	14 00

Green Thumb Plant Bands

Square, open-bottom pots for use in a seed flat. Made of waterproof material. Package (No. RA 150) 50 1 $\frac{3}{4}$ -in., or (No. RA 236) 36 2 $\frac{1}{2}$ -in., 20 cts. each.

Green Thumb Cutworm Protectors

Waterproof bands, 3 inches high and 3 inches in diameter. Easy to place around plants. No. RA 50. Package of 50 protectors, 20 cts., 10 packages \$1.75.

Germaco Hotkaps



Germaco Hotkaps can make many extra dollars for you this season. They are patented wax-paper cones — "individual hot-houses for each plant" that completely cover them, and fully protect them from frost, wind, rain, ground-crusting, and insects. This is

your assurance of earlier, bigger crops, and higher, early-to-market prices. Hotkaps are inexpensive and easy to use.

	Postpaid
25 Hotkaps	\$0 50
100 Hotkaps*	1 95
250 Hotkaps*	3 50
500 Hotkaps	6 00
1,000 Hotkaps	11 00
5,000 Hotkaps	53 75
10,000 Hotkaps	105 00

*Fiberboard Garden Setter included at price quoted.

Fiberboard Garden Setter alone, 15 cts. each.

Steel Setter and Tamper, \$1.60 each.

Steel Tamper alone, 25 cts. each.

Earthen Flower Pots

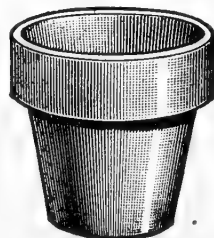

Standard Pots		
Inside diam.	Each	Doz.
2 $\frac{1}{2}$ in.	\$0 04	\$0 30
4 in.	07	60
5 in.	10	1 00
6 in.	15	1 50
7 in.	25	2 50
8 in.	35	3 25
9 in.	50	5 00
10 in.	70	7 00
12 in.	1 30	14 00

Flower-Pot Saucers

Inside diam.	Each	Doz.	Inside diam.	Each	Doz.
4 in.	\$0 05	\$0 45	8 in.	\$0 20	\$1 85
5 in.	07	65	9 in.	25	2 25
6 in.	10	90	10 in.	35	3 25
7 in.	15	1 35	12 in.	50	5 00

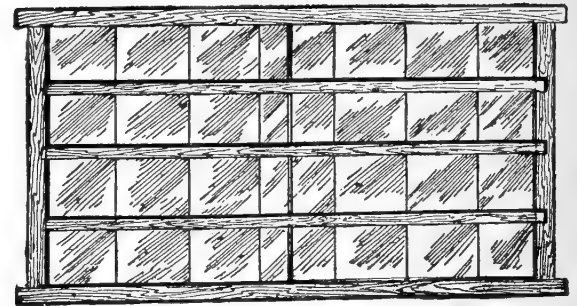

Metropolitan Hotbed Sash

Metropolitan Hotbed Sash are made from select quality air-dried Tidewater Gulf cypress, fabricated and finished on specially designed sash-making machines. All parts are mortised and tenoned to insure accurate, smooth, and tight-fitting joints. The sides are planed perfectly straight to prevent any open space between sash when laid on the frame. They are strictly a quality product.

No. 9. 3 ft. 1 $\frac{1}{2}$ in. x 6 ft. for 4 rows of 8-in. glass \$5.50

Above sash 1 $\frac{3}{4}$ inches thick with wood cross-bar in center and with horns.

Sash are painted two coats white, without glass. 5-sash lots, 15 cts. per sash less; 10-sash lots, 30 cts. per sash less. Special prices on larger quantities or other sizes of sash quoted on request.

Glass for Hotbed Sash

	Per box
6x 8, 150 lights, B, Single Strength	\$4 85
8x10, 90 lights, B, Single Strength	8 85
10x12, 60 lights, B, Single Strength	4 85

10 boxes and upward, 25 cts. per box less than above prices

Densoplastic (Glazing Putty)

A scientifically formulated permanent, elastic, non-bleeding adhesive glazing Putty for glazing, reglazing, and repairing of hotbed sash and greenhouses. Can readily be removed with a putty knife, thus permitting the easy replacement of broken panes. COVERAGE: 300 lineal feet of bar per gal., with $\frac{3}{8}$ -in. nozzle.

1-gal. can	\$2 65
5-gal. kit	10 25
55-gal. drum*	96 75

Glazing Gun free with 55-gal. drums.

*55-gal. drums returnable at \$6 each.

Greenhouse Glazing Points

Made from pure zinc. In three sizes, $\frac{5}{8}$ in., $\frac{3}{4}$ in., and $\frac{7}{8}$ in. 1-lb. pkg. 50 cts., 5 packages \$2.25.



Hotbed Thermometer

No. 5981. Registers from 30° to 230° F. Has brass points. Length over all, 14 $\frac{1}{2}$ inches. \$4, postpaid.

Sieves or Riddles

Constructed from the best steel wire cloth, has wood sides and is well braced; 16 inches in diameter, 3 $\frac{1}{2}$ inches inside depth. Suitable for screening soil and also for cleaning grain.

No. 4. $\frac{1}{4}$ -in. mesh; No. 6. $\frac{3}{8}$ -in. mesh; No. 8. $\frac{1}{2}$ -in. mesh. \$1 each.

Tilley Ladders

They are the most convenient orchard ladders ever produced for trimming trees and picking fruit. Made very light and strong. The best that can be produced.

Single Ladders

OPEN TOP

12-foot.....\$5 25	22-foot.....\$10 15
16-foot.....7 00	24-foot.....12 65
18-foot.....8 25	28-foot.....16 90
20-foot.....9 25	

POINTED TOP

15-foot.....\$7 75	21-foot.....\$10 75
17-foot.....8 75	25-foot.....14 25
19-foot.....9 75	27-foot.....15 50

Point included in above measurement.

Omega Tripod Step-Ladder

Particularly adapted for fruit-picking and for use on uneven ground. Light, strong, rigid, broad-based. Easy to stand on; easy to move; folds up snugly.

6-step.....\$4 10	10-step.....\$6 90
8-step.....5 50	12-step.....9 00

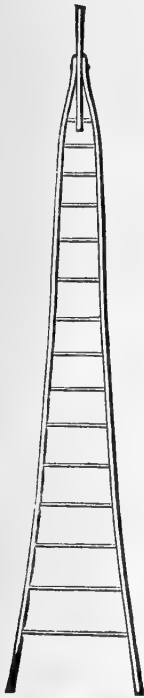

Wenatchee Fruit-Picking Bag

Saves Fruit and Labor

Endless steel frame shaped to fit body comfortably and keeps bag open. Adjusts to 1/2-bushel capacity for picking tender fruits; open to full bushel size when needed. Empties from bottom with "E-Z Off" snap. Has wide adjustable web suspenders; leather reinforced where the wear comes. No. 7. \$2.75.

Pennsylvania Fruit Picker

Made of heavy galvanized wire, and is easily attached to a pole. Used for picking apples, pears, peaches, and all similar fruits. 60 cts. each, postage 10 cts. extra.

Owosso Folding Fruit and Vegetable Crate

Made strong and durable. Used extensively for handling apples, potatoes, onions, and tomatoes from the fields; also for storage purposes. They stack up as high as desired and provide the right amount of ventilation.

Size, 15 1/2 inches wide, 17 3/4 inches long, 13 1/2 inches deep. Holds one heaping bushel. 75 cts. each, prepaid 90 cts.; \$6 for 10, \$27 for 50, \$52 per 100, prepaid.

Aeroil Weed Burner

A proved method of destroying weeds and weed seeds quickly and economically; for disinfecting animal quarters and many other uses. Uses kerosene for fuel. Produces a powerful reddish blue flame, 3 inches in diameter, 30 inches long, of intense heat (2000° F.). Size of flame easily controlled by a regulating valve. Anyone can operate it—absolutely safe. Average oil-consumption 1 gallon per hour. Well constructed, light, compact, portable.

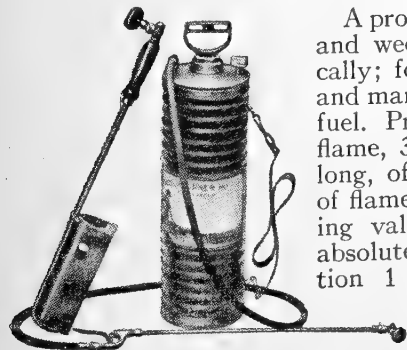

No. 99. 4-gal. corrugated, extra-heavy Galvanized Steel Tank, 2-inch Brass Pump; Pressure Gauge; 7-ft. High-test Hose. \$20.

No. 99BS. Outfit No. 99 with spray attachment, as illustrated. \$22.50.

Prime Electric Fence Controllers

Prime Grand Champion Model No. 480A

For use with 110-120-volt alternating current

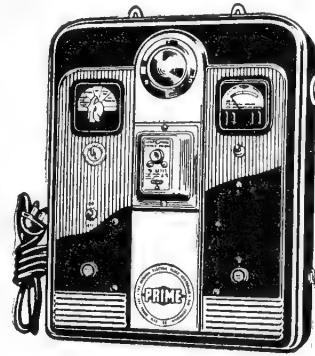

Approved for Safety by Underwriters' Laboratories

The hi-line controller that delivers alternating current (the most effective type for electric fencing) to the fence line. Economical to operate (uses less than 2 kilowatt hours per month). No radio tubes

to burn out. Current on fence interrupted by precision-built timing mechanism. \$42.50.

Equipped with:

- | | |
|------------------------|--------------------------------|
| Short Signal Light | Specially Designed Transformer |
| Soil Selection Switch | Precision-Built Moto-Chopper |
| Safety Circuit Breaker | Short Meter |
| On-Off Switch | Short Meter Switch |
| Double Fuse Plugs | Radio Interference Eliminator |

Prime Model No. 48. Identical with Model No. 480A, but not equipped with on-off switch, short meter, or short meter switch. \$34.50.

Prime Model No. 333

For use with 6-volt direct current (batteries)

A rugged, portable model designed for outdoor use. Mechanism housed in weather-proof cabinet with room for "hot-shot" battery. Suitable for permanent installations or just the outfit for distant pastures and quickly erected, easily moved, temporary fences. Comes ready to install. \$17.50.

Prime Model No. 33. Same as Model No. 333, except that on-off switch and battery compartment have been omitted. \$15.50.

ACCESSORIES

- P1. Standard Post Insulators, 2 cts. each.
- P23. End and Corner Post Insulators, 5 cts. each.
- P36. Heavy Duty End and Corner Post Insulators, 9 cts. each.
- P19. Spring Tie Clips, to fasten fence wire to insulator, bundle of 100, 45 cts.
- P15. Looped wire for unpunched steel posts, bundle of 100, 70 cts.
- P500. Gate Handle, 30 cts. each. P501. Gate Spring, 8 cts. each.
- Test-Rite Electric Fence Tester, \$2.95 each.

Steel Wheels to Fit Old Wagons

Ready-Made Steel Wheels

Furnished only in heights and tire size indicated and to fit any of the skeins listed below. All wheels have deep groove tires. In ordering, give skein measurements and height of wheels wanted.

4 x 3/8 in. tire	
28-in. height.....	\$4 98
32-in. height.....	5 75

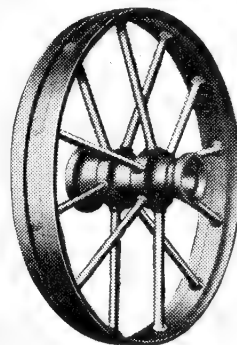

Skein Sizes

Length	Diameter		Collar	Nut
	Large end	Small end		
9 in.	3 1/4 in.	2 1/4 in.	Up to 5 1/4 in.	Up to 3 1/4 in.
10 in.	3 1/4 in.	2 1/4 in.	Up to 5 1/4 in.	Up to 3 1/4 in.
10 in.	3 3/8 in.	2 1/4 in.	Up to 4 7/8 in.	Up to 3 1/4 in.

Made-to-Measure Steel Wheels

The following prices apply to other skein sizes than given above.

24-in. height.....	\$5 41	32-in. height.....	\$6 89
28-in. height.....	5 99	36-in. height.....	7 79

Prices are f.o.b. factory.



START BEEKEEPING—IT PAYS WELL

Root Quality Bee Supplies are well known and need no introduction to beekeepers. Every article is guaranteed to give you absolute satisfaction. If you do not find what you want listed on these two pages, write for Complete Catalogue.

Standard Hives

Standard Hive

KD. 10 Frames
(no comb-
foundation).
5 for \$17.80

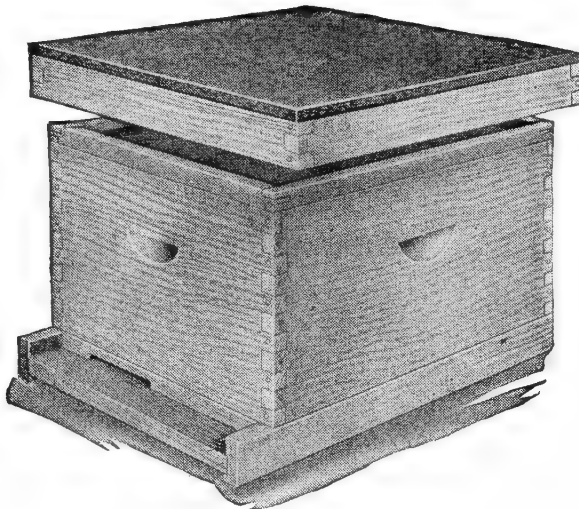

The Standard Hive is made of the best selected pine lumber, perfectly milled and fitted together. It is the one most generally used by the largest honey-producers on account of its light weight and the ease with which it may be moved from one location to another.

It is 16 $\frac{1}{4}$ x20 inches, and 9 $\frac{9}{16}$ inches deep, outside measurements.

Hives in the flat are furnished with nails, tin rabbets, reversible bottom-board, metal cover with inner cover, and Standard frames.

Cat. No.	DESCRIPTION	Quan.	Wt. lbs.	Price
A1	Hive complete, no foundation	1 KD	31	\$4 60
A2	Hive complete, no foundation	5 KD	156	17 80*
A3	Hive complete, full sheets foundation	1 NP	33	8 50

*Packed in four packages.

Hive-Bodies or Full-Depth Supers

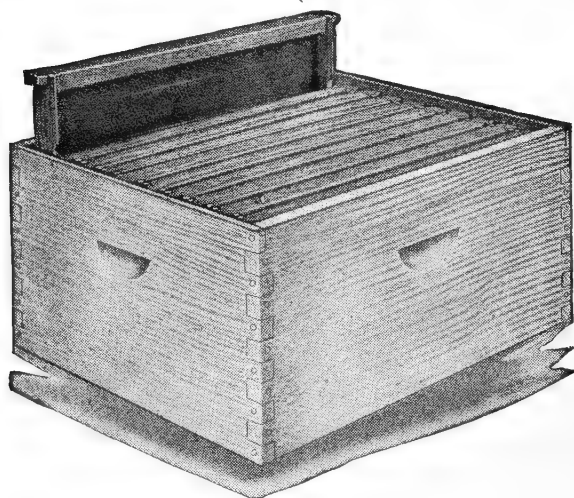

Five
Hive-Bodies
10-Frame Size
No Frames
\$4.40

It pays
to have extra
Hive-Bodies

Made of the same high-quality materials as the Root Standard Hive. They may be used either as a brood-chamber, i. e., the lower story of the Hive, or as a full-depth upper story or super for extracted honey, thus forming a two-story Hive. Nails and tin rabbets included with bodies. No division-board.

Cat. No.	DESCRIPTION	Quan.	Wt. lbs.	Price
C1	Body without frames	1 KD	12	\$1 05
C2	Body without frames	5 KD	45	4 40

Shallow Extracting Supers (5 $\frac{11}{16}$ inches deep)

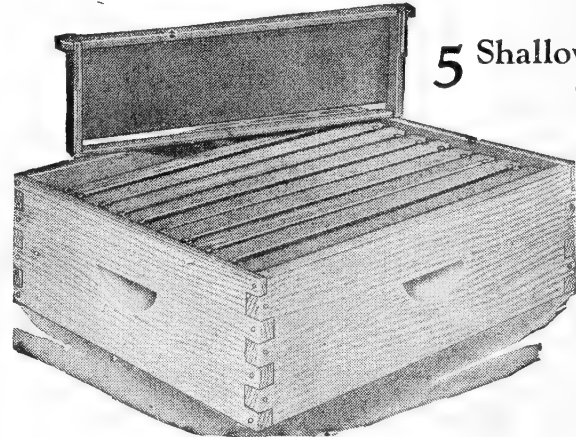

5 Shallow Extracting
Supers
KD, with
frames,
no foundation
\$5.25

This Super is largely used in the production of chunk honey, also for producing extracted honey in shallow frames. Furnished with shallow Hoffman frames, 5 $\frac{3}{8}$ inches deep, without foundation. No tin rabbets or division-boards furnished.

Cat. No.	DESCRIPTION	Quan.	Wt. lbs.	Price
C17	Super with frames, no foundation	1 KD	9	\$1 20
C18	Super with frames, no foundation	5 KD	39	5 25
C12	Super without frames	1 KD	5	65
C13	Super without frames	5 KD	28	3 00

Beeway Section Super (4 $\frac{1}{4}$ x 4 $\frac{1}{4}$ x 1 $\frac{7}{8}$)

This is the most commonly used Super. It is furnished with or without sections, and with or without inch foundation starters. It may be used on any hive, tiered up one or more high. Each Super holds 28 Beeway Sections.

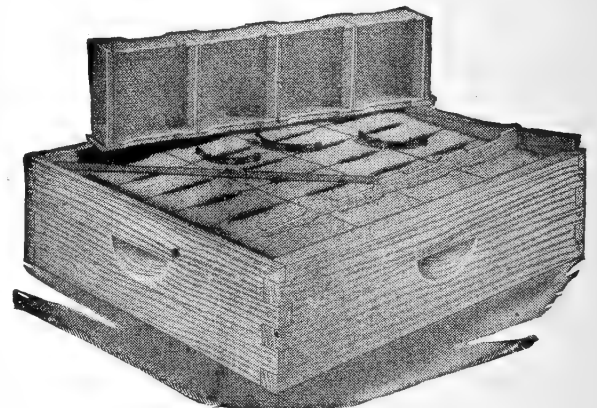

4 $\frac{1}{4}$ x 4 $\frac{1}{4}$ x 1 $\frac{7}{8}$ Beeway Section Super

Super complete without sections includes nails, flat tins, end-stops, Super springs, slotted section-holders, slotted separators, and follower.

Cat. No.	DESCRIPTION	Quan.	Wt. lbs.	Price
D5	Super, no sections or foundation	1 KD	7	\$1 15
D6	Super, no sections or foundation	5 KD	36	5 40

Plain Section Super (4 x 5 x 1 $\frac{3}{8}$)

It is a deeper Super (5 $\frac{1}{16}$ inches), and is fitted with section-holders and M fences with end-stops and springs. It will admit eight section-holders and eight fences with Super springs. Holds 32 4x5x1 $\frac{3}{8}$ Sections. Super complete without sections includes end-stops, section-holders, fences, Super springs, flat tins, and nails.

Cat. No.	DESCRIPTION	Quan.	Wt. lbs.	Price
D8	Super comp., no sections or foundation	1 KD	12	\$1 90
D9	Super comp., no sections or foundation	5 KD	50	8 70

Root Honey Extractors

L35 3-frame Honey Extractor. Hand power.....\$16 95

WRITE OR ASK FOR CATALOGUE OF ROOT'S QUALITY BEE SUPPLIES

BUY ROOT BEE SUPPLIES—SAVE MONEY

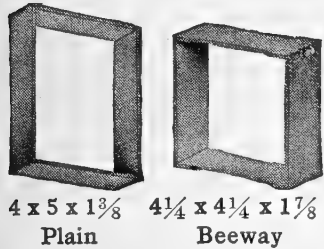

Root Quality Sections

Made of finest basswood lumber, sorted with great care, dried exactly right, planed and cut exactly, expertly polished, dove-tailed perfectly. Rounded bottom, V-grooved, so wood bends without breaking.

4 x 5 x 1 3/8 Plain
4 1/4 x 4 1/4 x 1 1/8 Beeway

MILL RUN GRADE

4 1/4 x 4 1/4 x 1 1/8 Beeway Sections			4 x 5 x 1 3/8 Plain Sections		
Cat. No.	Wt. lbs.	Price	Cat. No.	Wt. lbs.	Price
F1. 100 Sections.....	7	\$1 45	F20. 100 Sections....	6	\$1 35
F3. 500 Sections.....	32	6 60	F22. 500 Sections....	27	6 10

Sections split three sides, \$1 per 1,000 extra

Three-Ply Airco Comb Foundation

This wonderful foundation for brood and extracting combs is the best because there is no sagging, no warping, one-third more worker cells, least amount of gnawing, and 7 sheets to the pound. Sheets are 8x16 3/4 inches.

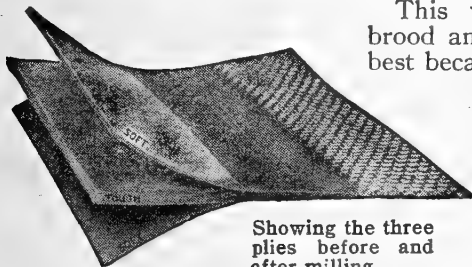

Showing the three plies before and after milling.

Leads all others in volume of sales.

	Wt. lbs.	Per pkg.
H1. 10 sheets. For Standard Frames.....	3	\$1 40
H3. 50 sheets. For Standard Frames.....	9	6 45

Single-Ply Airco Foundation

Genuine Airco Process Foundation, made into clear, tough sheets from finest quality pure beeswax.

MEDIUM BROOD FOUNDATION

For Standard Frames			For Shallow Frames		
Cat. No.	Wt. lbs.	Per pkg.	Cat. No.	Wt. lbs.	Per pkg.
H20. 10 sheets.....	2	\$1 20	H26. 10 sheets.....	2	\$0 75
H22. 50 sheets.....	8	5 65	H28. 50 sheets.....	5	3 35

THIN SUPER FOUNDATION FOR COMB HONEY

For 4 1/4 x 4 1/4 Sections			For 4x5 Sections		
Cat. No.	Wt. lbs.	Per pkg.	Cat. No.	Wt. lbs.	Per pkg.
J1. 1-lb. carton.....	2	\$1 05	J12. 1-lb. carton.....	2	\$1 05
J3. 5-lb. carton.....	7	4 95	J14. 5-lb. carton.....	7	4 95

For 4 1/4 x 4 1/4 Split Sections			For Shallow Frames		
Cat. No.	Wt. lbs.	Per pkg.	Cat. No.	Wt. lbs.	Per pkg.
J6. 1-lb. carton.....	2	\$1 05	J22. 1-lb. carton.....	2	\$1 05
J8. 5-lb. carton.....	7	4 95	J24. 5-lb. carton.....	7	4 95

Frames

Made of clear soft pine lumber, and milled on special machinery designed and built by A. I. Root Co.

Cat. No.	Wt. lbs.	per 100	10	50	100
G1. Standard Frame, 9 1/8 x 17 5/8.....	45	\$0 85	\$3 10	\$6 05	
G20. Shallow Extracting Frame, depth 5 3/8.....	25	60	2 30	4 30	
G24. Shallow Extracting Frame, regular Hoffman top-bar.....	38	75	2 90	5 60	
G40. Regular Half-depth Frame, depth 4 1/2.....	24	2 30	4 30		
211. Root Frame-nailing Device. Wt. 10 lbs.					\$1.85 each.

Wire for Frames

Made especially for the purpose. A 1/2-lb. spool will wire 100 regular frames.

Cat. No.	Wt. ozs.	Price	Cat. No.	Wt. ozs.	Price
G60. 1-oz. spool.....	2	\$0 11	G62. 1/2-lb. spool....	10	\$0 25
G61. 1/4-lb. spool.....	6	17	G63. 1-lb. spool.....	18	45

Root Smokers

Made of quality material throughout. Designed to give satisfactory service.

Cat. No.	Size of Fire Box	Wt. lbs.	Each
N2. Junior (tin).....	3 1/4 x 5 in.	2	\$0 85
N3. Standard (tin).....	3 1/4 x 7 in.	2	1 05
N5. Jumbo (tin).....	4 x 7 in.	3	1 25
N7. Big Jumbo (tin).....	4 x 10 in.	3	1 80

Bee Veils, Gloves and Hat

Cat. No.	Mailing Wt.	Price
N10. Indestructible Veil.....	1 lb.	\$0 85
N11. Alexander Veil.....	1 lb.	80
N12. Delphos steel Veil.....	1 lb.	1 10
N15. Veil (Cotton tulle).....	3 oz.	1 00
N18. Collapsible Hat.....	4 oz.	1 50
Drill Bee Gloves, Small, Medium, Large.....	1 lb.	1 05

Honey Section Cartons

Cat. No.	Wt. lbs. Per 100	100	500
T10. Window Cartons for 4 1/4 x 1 1/8 Sections.....	6	\$1 25	\$5 50
T30. Window Cartons for 4x5 Sections.....	6		5 50
T40. Regular Cartons for 4 1/4 x 1 1/8 Sections.....	6	95	4 00

Super Fixtures

Cat. No.	Wt. lbs. Per 50	10	50
E1. Section Holders for 4 1/4 x 4 1/4 x 1 1/8 Sections.....	15	\$0 50	\$2 30
E8. Section Holders for 4 1/4 x 4 1/4 x 1 1/2 Sections.....	11		2 20
E5. Section Holders for 4x5 Sections.....	19	65	2 95
E15. Beeway Wood Separators, 1/10 in. thick.....	7	30	1 30
2548. Beeway Wood Separators, thin.....	4 1/2	20	92
E25. P Fences, used with 4 1/4 x 4 1/4 x 1 1/2 Sections.....	5	73	3 50
E27. M Fences, used with 4x5 Sections.....	6	78	3 70
E12. End Stops.....	2 1/2	17	70
E35. Super Springs.....	12 ozs.	10	40

Miscellaneous Supplies

Cat. No.	Wt. lbs.	Price
B12. Pine Bottom Board, 1KD.....	7	\$0 80
B13. Pine Bottom Board, 5KD.....	37	3 75
B25. Hive Stand for 10-fr. Standard Hive, 1 KD.....		Not available
B26. Hive Stand for 10-fr. Standard Hive, 5 KD.....		Not available
B1. Mastic Cover with Inner Cover, 1 KD.....	11	1 40
B2. Mastic Cover with Inner Cover, 5 KD.....	51	6 60
B4. All-Wood Cover, 5 KD.....	31	3 65
22671. Inner Cover, without bee escape, nailed.....	4	45
B9. Inner Cover, without bee escape, 5 KD.....	12	1 85
O5. Double Bee-Escape.....	1 oz.	17
B30. Queen Excluder. Standard 3-Wire and Wood.....	4	68
B35. Queen Excluder, Special 7-Wire and Wood.....	4	75
O8. Wire Queen and Drone Trap.....	2	50
O9. Wire Entrance Guard.....	1/2	15
416. Root Foundation Fastener, without lamp.....	2 ozs.	30
N63. Root Wax-tube Fastener.....	5 ozs.	30
N75. Hand Section Press.....	1 1/4	45
N68. Inexpensive Frame-Wiring Outfit.....	1	50
N70. Combined Frame-Wirer and Wire Imbedder. With resistance coil.....	10	5 10
N65. Spur Wire Imbedder.....	1/2	20
N80. Hive Tool, 8 in.....	1/4	57
N81. Hive Tool, 10 in.....	6 ozs.	65
N85. Bristle Bee Brush.....	4 ozs.	55
N35. Plain Uncapping Knife, 8 1/2 in.....	1	1 60
N36. Plain Uncapping Knife, 10 in.....	1	1 80
O2. Boardman Feeder with cap only.....	12 ozs.	25
X5. ABC and XYZ of Bee Culture. 815 pages. 732 illus. Postpaid.....		2 75
X8. Starting Right with Bees. 98 pages. 184 illus. Ppd.....		50

Bees and Queens

V 3. 2-lb. pkg. with queen (April 15 to June 1).....	\$4 55*
V 6. 3-lb. pkg. with queen (April 15 to June 1).....	5 85*
V15. 2-lb. pkg. with queen (After June 1).....	4 30*
V18. 3-lb. pkg. with queen (after June 1).....	5 60*
V 9. Queen (Before May 15) Postpaid.....	1 30
V12. Queen (After May 15) Postpaid.....	1 20

*PRICES ARE F. O. B. APIARY, EXPRESS CHARGES ADDITIONAL

Morton's Sugar-Cure

For Hams and Bacon

A high-grade meat salt, accurately proportioned and scientifically blended with marvelously balanced Sugar-Cure, select spice flavors and the curative and flavoring properties of refined condensed wood smoke. Every ingredient necessary to cure meat and impart to it delightful flavor is combined with the salt. This improved Sugar-Cure does the entire job. 7½-lb. can 75 cts.

Morton's Tender-Quick

A special meat cure for pumping hams and shoulders and curing beef, veal, mutton, lamb, etc. It is so perfectly blended that it cures faster, improves the flavor, and makes more tender cured meats. 2½-lb. can 50 cts., 10-lb. can \$2.

Morton's Meat Pump. Should be used to get a uniform cure from the rind to the bone. \$1.50.

Morton's Sausage Seasoning

Ready for use and makes delicious sausage. 10-oz. can 30 cts., 7½-lb. can \$2.50.

Legg's Old Plantation Pork Sausage Seasoning

8¼-oz. pkg. sufficient for 25 pounds of meat, 25 cts.

Meat Curing Made Easy

Cure in brine made from Wright's Ham Pickle and salt. After curing, let dry ten days, then apply two coats Wright's Condensed Smoke. Wright's Ham Pickle cures meat thoroughly. Wright's Smoke, made from choice hardwoods, adds wonderful old-time flavor. Ask for free booklet, "Meat Production on the Farm."

Wright's Ham Pickle. For sugar curing. 1-qt. bottle 65 cts., ½-gal. bottle \$1.

Wright's Condensed Smoke. For smoking. 1-pt. bottle 65 cts., 1-qt. bottle \$1.

Blackman's Medicated Lick-A-Brik

Conditioner and tonic for horses, mules, cows and sheep. Easy to use—just keep one in the feed-box all the time. 25 cts. per brick, \$2.75 per doz., \$5.25 for 2 doz.

Keystone Pure Salt Bricks

Practical dairymen and live-stock feeders know that live-stock like and want salt. Cattle and horses will be more thrifty and more healthy if given the proper amount of salt in their rations.

Place the Salt Bricks in the feeders built especially for them where the stock can have access to them at all times. They are of pure, unadulterated salt.

25 cts. per brick, doz. bricks \$2.75, 2 doz. bricks \$5.25. Feeder, 60 cts. each.

Sal-Vet

Mineral Supplement for all Live-stock

Contains the necessary minerals required by live-stock; aids digestion, helps to keep them in healthy condition. Used and recommended by live-stock feeders and breeders for over 40 years.

5-lb. pkg. \$0 75 | 50-lb. bag.....\$4 50
10-lb. pkg. 1 20 | 100-lb. bag..... 7 50
25-lb. pkg. 2 50

Salt Blocks

In 50-lb. block; pure salt 60 cts. each, sulphur 85 cts. each.

Perfection Dairy Salt

10-lb. sack 25 cts., 25-lb. sack 50 cts., 100-lb. sack \$1.60.

Crushed Rock Salt

10-lb. sack 25 cts., 100-lb. sack \$1.50.

Wyandotte Cleaner and Cleanser

An efficient but harmless cleaner made purposely for washing milk utensils and containers. It contains no soapy grease, makes no soapy suds, nor resembles soap agents in any way. Used by thousands of farmers and dairymen everywhere.

5-lb. sack 45 cts., postage 15 cts. extra; 100-lb. bag \$5.83, 280-lb. bbl. \$13.80, f.o.b. Pittsburgh.

Conkeys Fly Knocker

A Spray for All Live-stock

A splendid protective measure against stable and horn-flies. Will not injure hair or animal; has good lasting qualities. Qt. 60 cts., gal. \$1.50.

B-K Dairy Bactericide

A fast-acting chlorine bactericide used for treating dairy utensils and milk-plant equipment to kill bacteria. It aids in producing milk of low bacteria count, thus increasing quality, which brings better prices. It works faster, more cheaply, and more thoroughly than dry heat, hot water, or steam as ordinarily used. It does the job in hot or cold water.

B-K POWDER

9½-oz. bottle ... \$0 75 | 1½-lb. bottle.... \$1 50

B-K LIQUID

4-oz. bottle.... \$0 30 | 1-gal. bottle.... \$2 00
10-oz. bottle.... 50 | 5-gal. jug..... 8 50
1-qt. bottle.... 90

HTH-15 Farm Sterilizer

Here's a Sterilizer that makes it easy to keep bacteria counts down and protect your milk-quality. HTH-15 is a dry, free-flowing powder packed in handy, key-opening cans. One standard tablespoonful of the dry powder makes 3 gallons of effective dairy-rinse that is safe to use on milk equipment.

You can also check the spread of respiratory and other diseases of poultry by using HTH-15 in the drinking-water, to disinfect brooders, incubators, pens and other poultry equipment. 1-lb. bottle 50 cts., 3-lb. bottle \$1, case of 6 3-lb. bottles \$5.

Kow-Kare

This great tonic and conditioner supplies invigorating elements needed by freshening cows, promotes digestion and assimilation. Give KOW-KARE with the feed to promote vigor for low-cost production and cow health.

1½-lb. package 65 cts., 2½-lb. package \$1.25, postpaid.

Bag Balm

For Udder and Teats

Never be without this antiseptic ointment for quick healing of tender tissues. A potent aid in treating caked bag, inflammation, exterior teat and udder troubles, and all farm healing.

10-oz. package 60 cts., postpaid.

Bag Balm Teat Dilators

For spider, scabs, bruises, internal injuries, hard milkers. Smooth, ivory-like, cannot irritate or absorb pus infection.

Package of 25, 60 cts., postpaid.

Dr. Hess' Stock Tonic

Used with success for more than 40 years, and now improved in keeping with latest tested and proved feeding practices. Minerals needed by heavy-producing dairy cows have been increased; whets appetite; sustains milk-flow well through lactation period. Valuable at calving-time; increases profits from steer-feeding, and puts horses and mules in condition.

1½-lb. pkg. \$0 30 | 30-lb. pail.... \$3 75
5 -lb. pkg. 85 | 100-lb. drum.... 10 50
10 -lb. pkg. 1 50

Pratt's Animal Regulator

Aids appetite and digestion. Helps livestock produce better on the same feed. Completes mineral diet and guards health. Pkgs. 25 cts., 50 cts., and \$1, postpaid.

Pratt's Cow Tonic

Add to dairy feed. Aids appetite and digestion. Helps cows produce more milk from the same feed. Valuable conditioner. Pkgs. 60 cts. and \$1.20, postpaid.

Dr. Hess' Hog Special

A tonic and mineral supplement for milch cows, feeder cattle, horses and sheep. 1½-lb. pkg. 30 cts., 5-lb. pkg. 85 cts., 10-lb. pkg. \$1.50, 30-lb. pail, \$3.75, 100-lb. drum \$10.50.

Pratt's Hog Powder

Completes the mineral diet for hogs. Rich in Vitamin D. Pkgs. 50 cts. and \$1, postpaid.

Dr. Hess' Dip and Disinfectant

Kills foul odors. For sheep-, horse-stables, dairy-barns, hog-pens, poultry-houses, dog-kennels, and general disinfecting. 1-qt. can 65 cts., 1-gal. can \$1.75, not prepaid.

Calves' Cordial

An effective intestinal astringent for Cows and Calves. 1-lb. pkg. 50 cts.

Dr. A. C. Daniels' Horse

Medicines

Postpaid

Colic Drops. For colic..... \$1 30
C. C. & F. Drops. Coughs, colds, and fevers... 65 cts. and 1 30

Horse Conditioner. A condition powder..... 65

Worm Powder. An aid in expelling worms.... 65

Wonder Lotion. Scratches, wounds, and cuts..... 35 cts. and 65

Gall Salve. A relief for saddle and harness sores..... 35 cts. and 65

Antiseptic Healing Powder. For sores, cuts, and wounds..... 50

Hoof Ointment and Softener..... 65

Oster Cocus Liniment. Cord and muscle liniment..... 35 cts. and 65

Carbo Negus Disinfectant..... 35 cts. and 65

Absorbent Spavin Salve..... 65

Horse Physic Balls..... 65

Hoof Dressing and Polish..... 65

Fiebing's Saddle Soap

The best preparation for cleaning saddles and all articles of brown leather. 12-oz. tin 35 cts.

Fiebing's Harness Soap Dressing. Oils, softens, and preserves all articles of black leather. 1-lb. tin 40 cts.

Since 1908 Corona Since 1908

Antiseptic Ointment for Cows and Horses

Every farm, dairy, and high-class stable will find CORONA indispensable for minor skin injuries and irritations. IDEAL udder and teat massage; wound dressing. Use for galled bruised shoulders, scratches, chapped cracked teats, brittle hoofs. Soothing, softening healing aid.

8-oz. can 75 cts., 1½-lb. can \$1.50.

PTZ

Worm Treatment for Farm Animals

Made with phenothiazine, the new non-toxic worm treatment for sheep, horses, swine, cattle and poultry. Highly effective against the six common species of worms infesting sheep.

PTZ Pellets. 13.5-gram, 7 cts. each; 8-gram 4 cts.

PTZ Powder. 4-oz. pkg. 50 cts., 1-lb. pkg. \$1.25,

5-lb. pkg. \$6, postpaid.

Special Forceps. For individual dosing. 50 cts.

Kan't-Kik Kow Hobble

Stops kicking, side-stepping and saves many a pail of milk. Easily and quickly attached. Clamps over tendons on cow's hind legs. Will not injure or torture the animal in any way. 35 cts.

Improved Keystone Dehorner

The Improved Keystone Dehorner is the most efficient dehorning knife on the market today. It has been improved in several important points of construction, until its strength, cutting service and durability have been greatly increased.

Complete with extra set of blades and screws, \$18, postpaid. Special circular sent on request.

Sealright "Liftright" Milk Bottle Cap

Has strong tab that lifts at the touch of the finger. Ideal Cap for general use.

No. 2 size. Packed in tubes, 500 Caps each.

Stock printing. Postpaid

500 caps..... \$0 45 \$0 55

1,000 caps..... 85 95

5,000 caps..... 3 50 3 75

Prepaid

25,000 caps..... \$16 00

50,000 caps..... 30 00

Printed to order.

10,000 caps..... 9 80

25,000 caps..... 17 50

50,000 caps..... 32 00

Electro charge of \$1.25 for one color and \$2 for two colors will be made on orders for caps with new designs.

Caps printed to order are shipped direct from factory and transportation charges prepaid at prices quoted.

Banco Milk Filter Discs

Made of thinly rolled, non-absorbent cotton especially for the purpose. Filters quick, clean, and uniform.

Plain Discs. 6-in. diam., pkg. of 100, 45 cts.; pkg. of 300, \$1.25. 6½-in. diam., pkg. of 100, 50 cts.;

pkg. of 300, \$1.45.

Thread-faced Discs. 6-in. diam., pkg. of 100, 70

cts.; pkg. of 300, \$2.05. 6½-in. diam., pkg. of 100,

80 cts.; pkg. of 300, \$2.30.

Postage 10 cts. extra on package of 300

Poultry Equipment and Supplies

Chik-Saver Electric Brooder

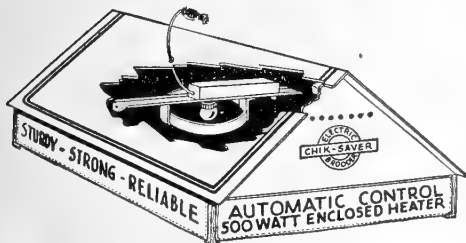

Broods up to 200 Chicks
A real buy
\$6.95

Dependable, low-cost Electric Brooder built especially for the small flock owner. Canopy 40 in. by 40 in. and made from heavy corrugated

kraft stock, supported by sturdy wood frame and assembled with curtains. Has 500-watt heater, bi-metal type automatic thermostat, both completely enclosed and 6 feet of cord and plug. No. UB40, \$6.95.

Premier Thriftie Electric Brooder

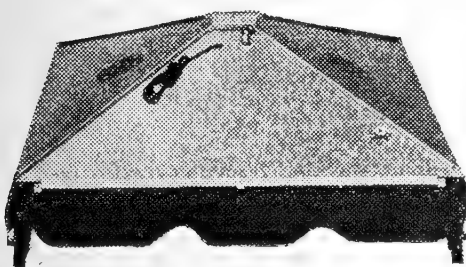

Strongly Built
Has Metal Canopy
\$16.75

Fills the need of the small flock owner who wants a sturdy thoroughly efficient Electric Brooder. Has 36 in. by 36 in. metal canopy with

masonite insulation, built strong to stand hard usage; 500-watt, heavy duty, steel-encased ring type heater and automatic wafer-type thermostat. Capacity up to 200 chicks. No. 236A, \$16.75.

Oakes "Fantype" Electric Brooders

Furnished in 2 sizes.

Will give years of service

Millions of baby chicks, and turkey poults are brooded annually with Oakes Electrics—they brood chicks *Nature's Way*—develop into big, husky, healthy fowls. Fan insures positive heat circulation, warm chicks, and warm, dry floor. Masonite canopy is well braced and rigid. Equipped with snap switch, wafer operated, temperature regulator; adjustable legs; heavy denim curtains. Heating element guaranteed for 2 years. For 110 volt A.C. operation. Shipped K.D. but easy to assemble.



	Canopy	Capacity	Heater
No. 750.	52 x 52 in.	Up to 385 chicks	600 watts... \$27 10
No. 751.	48 x 72 in.	Up to 500 chicks	650 watts... 36 80

Oakes "Gro-Ezy" Electric Brooder

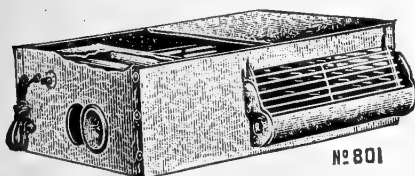

No. 801

Made entirely of metal. For use in basement, garage or spare room. Has 2 compartments divided by curtain. Automatic heat control. Outside dimensions 31 by 39 by 11 inches. Capacity 100 day-old chicks,

about 20 chicks 4 weeks old. No. 801, \$10.98.

5 Deck Gro-Ezy Battery

Consists of 5 No. 801 Units and angle iron frame Rack to hold the 5 Units. Requires 31½ by 37 inches floor space. No. 805, \$68.40.

Oakes "Life Saver" Electric Battery Brooder

A very practical and substantial unit for starting chicks and brooding first 3 to 5 weeks. Metal construction throughout—strong and sturdy; portable—can be rolled any place easily. Automatic temperature control in each compartment. Droppings-pans and ½-inch mesh wire floor, removable from front and rear. Each compartment has 2 feed-troughs and 1 water-trough. Total floor-space in 5 compartments, 6,960 square inches. Capacity, 750 day-old chicks. No. 709E, \$109.

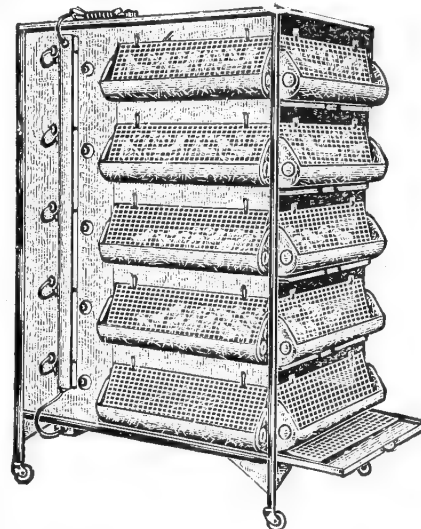

Oakes "Backwarmer Twin" Electric Starter

Sanitary
Convenient
Portable

Furnished with 4 decks, each deck divided into 2 compartments. Suspended hover for each compartment. Hovers can be removed so as to convert to growing battery. Ample head room for chicks to 4 or 5 weeks old. Each deck has a capacity of 310 to 350 chicks and has 16½ feet of feeding and watering space. Well built throughout and mounted on swivel casters. Shipped K.D. No. 1240, \$142.

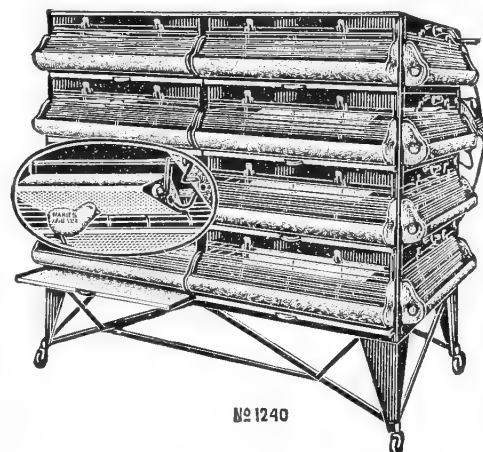

No. 1240

Oakes "DeLuxe" Oil Brooder

Designed to give ideal performance under widest range of operating conditions. Has big, heavy, blue-steel heater drum; air-fed, wickless-type burner; automatic heat regulator; 60-inch heavy gauge steel canopy; 7 gallon fuel tank; draft equalizer; and all necessary fittings. Burns Kerosene or

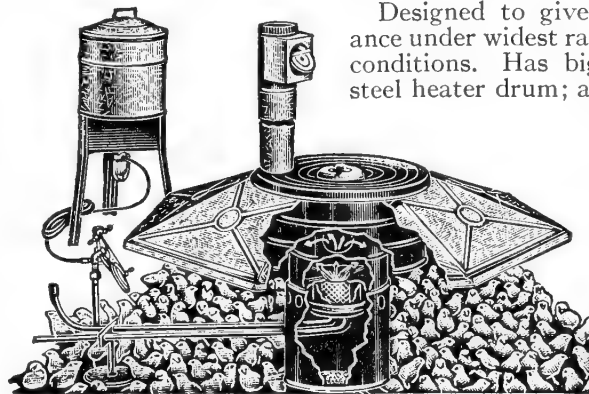

38/40 distillate. Broods up to 500 chicks. No. 560, \$19.95.

SUNNY SOUTH OIL BROODER. For economy this Brooder has no superior. Automatic fuel and temperature control insures even heat. Has wickless cast-iron burner; 48-inch hexagonal canopy; 4½-gallon fuel tank and steel heater drum. Burns kerosene or 38/40 distillate. Broods up to 300 chicks. (Not illustrated.) No. 3648, \$12.80.

Leland Wilson Electric Incubator

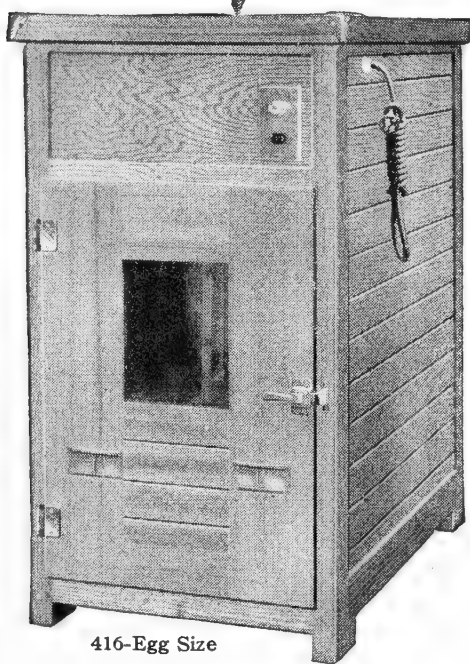

416-Egg Size

A Wilson Incubator will save you more money because it will pay for itself in two or three hatches. Cabinet made of full thickness California redwood. It has many exclusive features: circulating air, automatic temperature control, moisture indicator and control, and Underwriters approval. The machine can be used for continuous hatching; all or any part of the capacity can be used. The operating cost is low—about 60 kw hours of electricity will complete the hatch in the 624-egg size. Equipped for 110-volt A. C. Shipped complete ready to plug in socket.

416-egg size \$61; 624-egg size \$80.

Oakes Electric Incubator

All metal construction. Temperature controlled by wafer-operated switch. Case is heavily insulated to prevent heat waste.

Inspection window in lid permits checking thermometer without raising lid. Has 80-watt heating element. Equipped for 110 volt A.C. Overall measurements: 23½ inches diameter, 8 inches high. Complete with thermometer and moisture pan ready for use. Hatches domestic or game bird eggs. Capacity 100 hen eggs. No. 887, \$12.80.

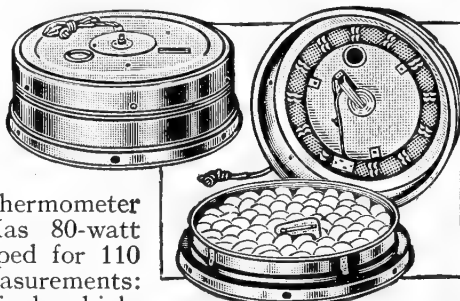

Oakes Coalburning Brooder

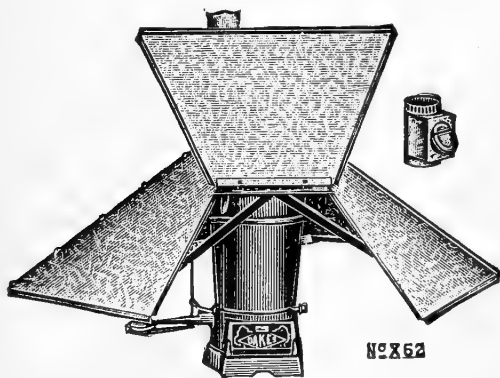

No. X62

Burns Hard or Soft Coal

Recommended for all difficult brooding situations. Has oversize, heavy stove body; dual draft control; 62-inch hexagonal canopy of heavy gauge steel. Canopy revolves, has hinged section for easy filling of fuel magazine. Coal capacity, 52

pounds. Brooding capacity, 425 chicks. No. X62, \$24.25.

Oakes "Dixie" Woodburning Brooder

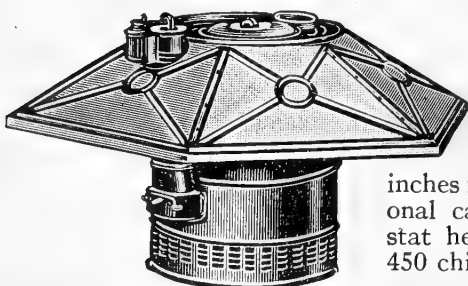

Burns Dry or Green Wood

Well constructed throughout; simple and practical in operation. Round stove body, 22½ inches in diameter; 60-inch hexagonal canopy; automatic thermostat heat control. Broods up to 450 chicks. No. 210, \$15.

Oakes Brood-N-Gro Battery Unit

A Home Broiler Plant

Produces 30 to 35 finished broilers every 4 or 5 weeks. Top unit is Gro-Ezy No. 801 described on page 79. Bottom unit is 2-deck finishing battery. Head room 14 inches. Floor space required 30 by 40 inches. Height 53 inches. Angle iron frame mounted on swivel casters. Shipped K.D. No. 310, \$30.70.



No. 310

Oakes Finishing Battery

Capacity, 120 Broilers

All metal construction—sturdy, strong, sanitary. Has 4 decks, 8 compartments; 14-inch head room, total floor space 5,777 square inches. Capacity, 120 broilers up to 2½ pounds or 48 to 56 hens. Overall height 72 inches. Patented self-locking doors; woven wire floors; removable droppings-pans; ample feeding and watering space; troughs adjustable to 3 positions. Shipped K.D. No. 324, \$57.

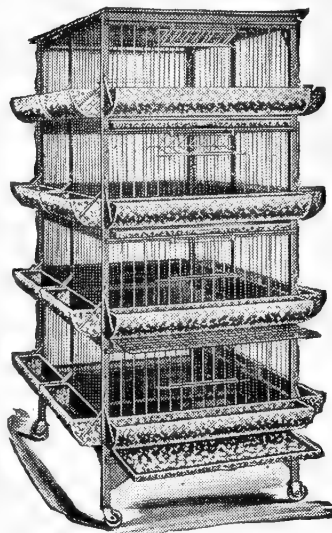

Oakes 25 Per Week Broiler Plant

Consists of 2 starting units, 1 grower unit and 2 finishing units. Circular on request. No. 340, \$65.

Revolving Head Ventilator

Fits any pitch roof up to 25°. Counter-balanced head revolves on ball-bearing axle. 12-inch diameter flue. Entire assembly is 30 inches high. Easy to install. No. 1530, \$7.20.

Roof Saddle. Does away with the necessity of a chimney on a brooder house. Fits any pitch roof. For 5-inch pipe. Complete with cap. No. 143, \$1.60.

Aluminized Metal Egg-Crate

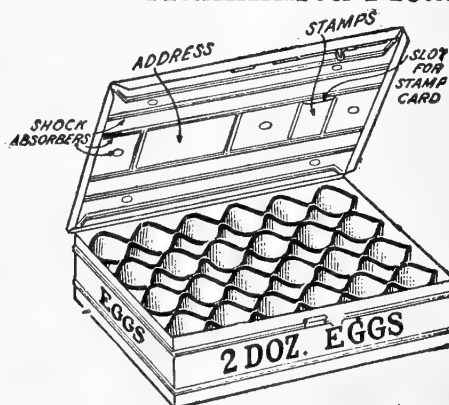

Solves every problem for shipping eggs by parcel post. Built for continued use; practically indestructible; lasts for years. No wrapping is required. A permanent lock pin attached to the Crate holds the lid rigidly closed. Fillers have metal edge. Reversible address cards visible through opening in lid. Names of shipper and receiver are placed on each side of this card.

Weight without eggs	Each Postpaid	Weight without eggs	Each Postpaid
1-doz. size. 2 lbs...	\$1 25 \$1 35	4-doz. size. 5 lbs...	\$2 00 \$2 13
2-doz. size. 3 lbs...	1 50 1 61	6-doz. size. 6 lbs...	2 50 2 64
3-doz. size. 4 lbs...	1 75 1 87		

Square Deal Poultry and Garden Fence

This fencing will turn all poultry, including the smallest chicks; also keep out the small "varmints" that ravage the chicken-pens. The first five line wires at the bottom are only 1 inch apart. The stiff picket-like stay wires are attached to the line wires with the famous Square Deal non-slip knot. Requires no top and bottom board. The top and bottom wires are No. 11 gauge with No. 14½ filler wires. Stay wires 6 inches apart.

Prices per 165-foot roll	
No. 2048-6-14½. 48 in. high, 20 bars	\$6 30
No. 2350-6-14½. 60 in. high, 23 bars	7 25

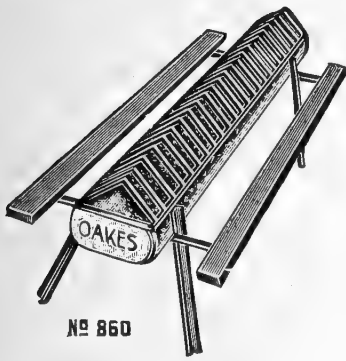

Oakes Flock Feeders

Trough made of heavy galvanized steel, extreme width $9\frac{3}{4}$ inches, depth $4\frac{1}{2}$ inches, length 60 inches, capacity $4\frac{1}{2}$ pecks. Perch 16 inches from floor. Has hinged wire grill with feeding spaces $2\frac{1}{8}$ inches wide. No. 860, \$3.90.

No. 860T. Has steel legs 9 inches long, no perch. Same trough as No. 860. Dandy feeder for pullets or small flock of hens. (Not illustrated.) \$2.95.

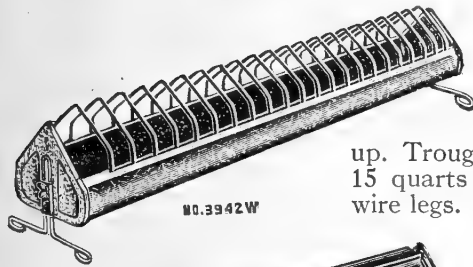

Oakes Broiler Trough

Ideal feeder for chicks 3 weeks old and up. Trough 42 inches long, capacity 15 quarts of feed. Has adjustable wire legs. No. 3942W, \$1.40.



Oakes "Gro-Fast" All-Purpose Feeder

For chicks day-old to 12 weeks. Both stand and reel are adjustable. Trough 48 inches long, capacity 9 quarts of feed. No. 234N, \$1.20.

Oakes Streamline Chick Feeders

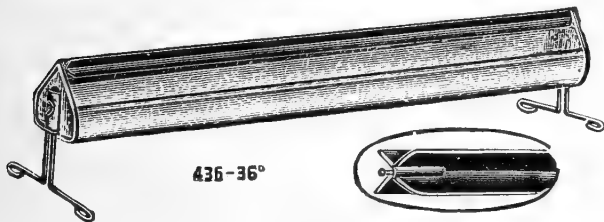

Suitable for day-olds to 8 weeks. Galvanized steel trough, 4 inches by 2 inches. Furnished with adjustable legs and 4-blade reel. No. 436, 36-in. trough 75 cts. No. 448, 48-in. trough 95 cts.

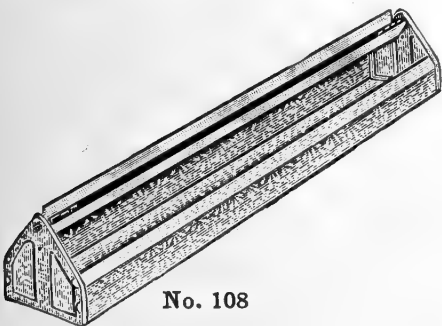

Oakes "Enfold" Chick Feeders

Die-stamped square-bottom feeder. For day-olds to 5 weeks. Adjustable "Z" type metal reel. Trough made of galvanized steel, $3\frac{1}{2}$ inches by $1\frac{3}{4}$ inches. No. 108, 24 inches long 35 cts.; No. 109, 36 inches long 45 cts.

Oakes Mason Jar and Glass Founts

Convenient, cheap, and sanitary chick waterers. Fits pint, quart or half-gallon Mason jars. Jars not furnished. Each Doz.
 No. 69G. Galvanized. \$0 10 \$1 00
 No. 64. Glass. 12 1 30

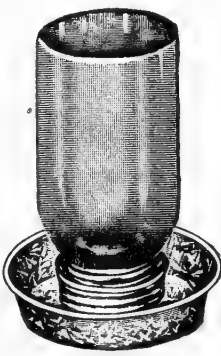

No. 69G

ALL-GLASS WATERERS

No. 1164. Consists of No. 64 glass pan and glass jug. Capacity about 1 gallon. 40 cts.
 No. 710. Glass jug and glass pan. Suitable for broilers and pullets. Capacity about 7 quarts. \$1.00.

Oakes "Never-Dry" Watering Trough

This Trough will serve 100 to 150 hens at lowest possible cost. Trough has V-shaped bottom with drain plug in end and is 48 inches long. Roost-proof wire guard is hinged for easy cleaning of Trough. No. 948X, without heater \$4.65.

No. 9480X, lamp heated \$7.20.
 No. 948EX, electric heated \$7.20.

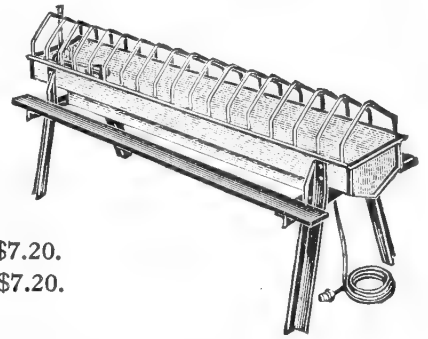

Oakes 8-Gallon Heated Fountain

Heated Waterers Pay

An ideal heated waterer for the laying house when used with fountain heater and stand. Fountain is made of heavy gauge galvanized steel; double wall construction; operates on vacuum principle. Water is necessary for egg production, 100 hens drink 8 gallons per day at the right temperature. It pays for itself in the extra eggs.

No. 32B8. Fountain only. . . \$3 55
 No. 43. Lamp heater. 2 50
 No. 197S. Stand. 1 90
 Complete, as illustrated. . . 7 95

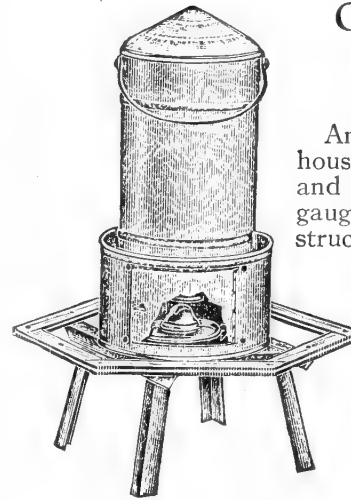

Oakes "Thrifty" Double Wall Fountains

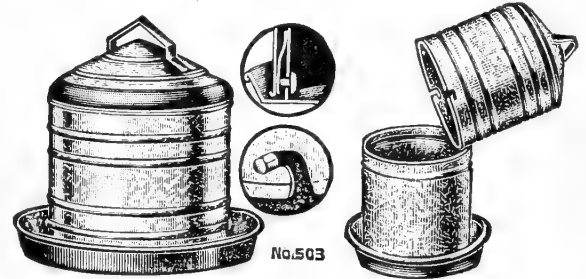

For birds of all ages. Operates on vacuum principle. Outer can locks over rivet in inner can for easy carrying. Made of quality galvanized steel. Beaded for strength. Easy to clean. Can be used with heater. See page 82.

No. 503, 3-gal. \$1.85. No. 505, 5-gal. \$2.50.

Oakes "Two-Piece" Fountains

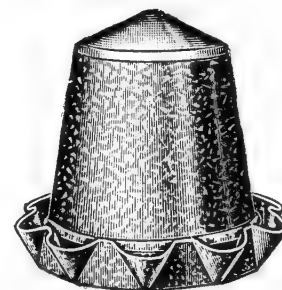

No. 77

Most popular chick Fountain. Operates on vacuum principle. Can fit snugly into pan and held in place by friction. Made of galvanized steel. Easy to keep clean and sanitary. Has 6 drinking cups.



No. 100C

No. 77. Capacity 1 gallon. \$0 55
 No. 100C. Capacity 2 gallons. 85

Feed troughs of all Oakes Feeders are especially designed to prevent unnecessary waste of feed. Reel guards are adjustable, revolve to prevent roosting. Wire grills are hinged for early filling of the troughs. Enough feeders should be provided so that birds do not have to fight or crowd to get feed.

Oakes "All-Metal" Lice Proof Nest

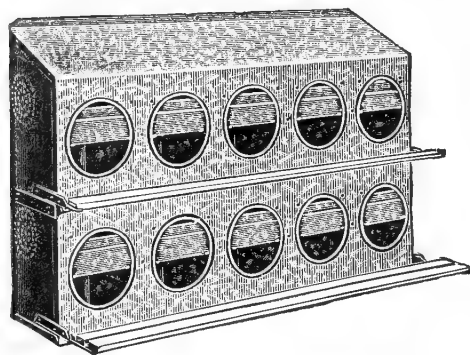

Made of heavy gauge galvanized steel. Each nest 11½ inches wide by 13 inches deep, 9-inch entrance hole. Easy to clean. Sloping roof prevents roosting. Overall length 57¾ inches. Punched so that trap doors may be added. Trap doors are optional and priced extra. No. 580, 10-nest unit \$8.60. No. 590. Set of 5 traps. \$1.60.

Oakes Electric Fountain Heater

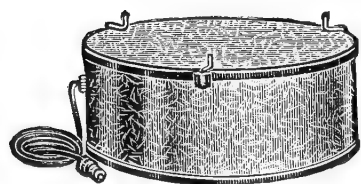

Automatic heat control set to turn on at 50° and off at 55°. Made of galvanized steel, diam. 15 in.; height 6 in. 100-watt heating element. For 110-volt A.C. No. 24, \$4.45.

Oakes Oil Fountain Heaters

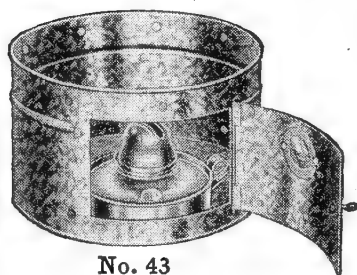

No. 43

Can be used with almost any type water fountain and effectively prevents water from freezing. Made of galvanized steel. Furnished with lamp bowl and burner.

No. 42, Fits No. 503 Fountain, \$2.30.
No. 43, Fits 505 and No. 32B8 Fountain, \$2.50.

Trumbull Automatic Electric Poultry Water Warmer

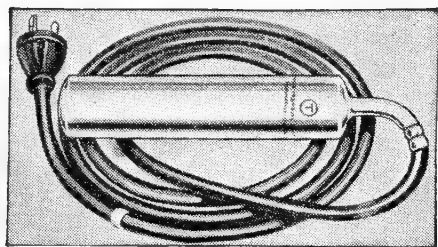

For use in any fountain, pail or trough. Will hold water at 50° automatically. Case made of non-corrosive alloy. Lead cord made of Neoprene to overcome the short life of Pure Rubber. Operating cost is very low. For 110-volt A.C. No. 10040, \$3.50.

Oakes Egg-Cooling Basket



For gathering and quick cooling of eggs. Galvanized wires and bottom. Top diameter 12 inches, bottom 10 inches, depth 8½ inches. New shape prevents egg breakage. Capacity 15 dozen 26-oz. eggs. No. 15A, 95 cts. each, 6 for \$5.40.

Electric Poultry Time Switch HELPS INCREASE EGG PRODUCTION

Simple and dependable in operation. All-steel cabinet 7½ in. by 4½ in. by 3¼ in. For morning lighting turns lights on dim, then bright, then off. For evening, turn lights on, then dim, then off. Completely automatic. Easily installed. For 110-volt A.C.

No. 162P, \$13.50.

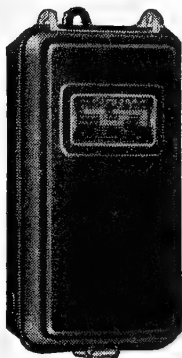

Ask for circular and prices on Hog Fountains and Hog Feeders

Oakes Aluminum Leg-Bands



Made of aluminum. Double lock adjustable. Fits any fowl. Numbered 1 to 100.

12 Bands.....	\$0 15	100 Bands.....	\$0 65
25 Bands.....	25	500 Bands.....	3 00
50 Bands.....	40	1000 Bands.....	5 50

Perfecto Spiral Leg-Bands

KNOW YOUR HENS ON SIGHT



In ten colors—Red, Green, Purple, Black, White, Pink, Yellow, Ruby, Light Blue, and Dark Blue.

Mark each bird for its pen. Give each pen a different color. Mark old birds and pullets

differently and know what you are doing.

- No. 0. For Turkeys.
- No. 1. For Asiatic Breeds.
- No. 2. For American Breeds.
- No. 3. For Leghorns.
- No. 4. For Bantams.
- No. 5. For Pigeons.
- No. 6. For Baby Chicks.

Prices, postpaid	No. 0	No. 1	No. 2	No. 3	No. 4	No. 5	No. 6
25 Bands	\$0 30	\$0 25	\$0 25	\$0 20	\$0 15	\$0 15	\$0 15
50 Bands	45	40	35	35	25	20	20
100 Bands	80	70	60	55	45	35	35
500 Bands	3 50	3 00	2 50	2 25	1 65	1 40	1 25
1,000 Bands	6 50	5 50	4 50	4 00	2 75	2 25	2 00

Reliable Reflecto Egg Candler

This Candler is quick in action and shows every defect in the egg instantly. It is equipped with a reflector that adds to the illumination of the entire egg. Complete, including cord and socket for 110 voltage. No. 700, \$1.40, postpaid.

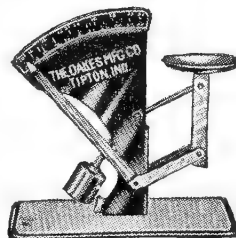
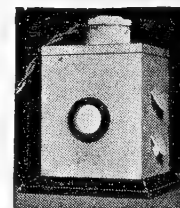

Oakes Egg Scale and Grader

Accurate, dependable, fast, easy to read. Individual egg weight and weight per dozen are indicated on the double dial. Dial is black with white figures. Egg cup, lever parts and counterweight are rust-proof chromium plated. No. 20S, \$1.50.

Genuine Glass Cloth

A strong fabric treated by a patented process to make it translucent, weather-proof, and water-proof. It readily transmits the life-giving vitalizing ultra-violet rays of the sun. Needed by poultry in winter months. Easily put up. In rolls 36 inches wide.

100-yd. roll, 900 sq. ft....	\$31 50	15-yd. roll, 135 sq. ft.....	\$4 75
50-yd. roll, 450 sq. ft....	15 75	10-yd. roll, 90 sq. ft.....	3 25
Less than 10 yds., per yd.....		40	

R-V-Lite Vitapane

The new transparent glass substitute for installation in poultry- and brooder-house windows, cold and hotbed frames, storm-doors, etc. It is made from transparent cellulose acetate, reinforced with a tough netting fabric. High transmission of ultra-violet rays, durable, lightweight, waterproof, easy to install. 36 in. wide. 50-ft. roll, \$9.25; cut lengths, 22 cts. per lineal ft.

Incubator and Brooder Extras

- No. 416W, Wafer. Universal type. Fits most all makes of Coal and Oil Brooders. 35 cts.
- No. 6W, Wafer. Fits most all makes of Electric Brooders. 35 cts.
- No. 264, Incubator Thermometer. With metal stand. \$1.10.
- No. 1265, Brooder Thermometer. Length 4½ inches. 40 cts.
- No. 266, Brooder Thermometer. For most Electric Brooders. 8 inches long. 50 cts.
- No. HE99, Thermostat Switch. Complete with wafer. \$2.30.
- No. 85C, Revolving Chimney Cap. 62 cts.
- No. 155, Draft Equalizer. Helps to prevent back drafts. 72 cts.
- No. 121, Brooder Stove Pipe. 5 in. diam. Per length 32 cts.

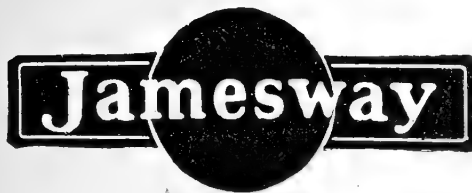

Jamesway Poultry Equipment

EQUIPMENT THAT MAKES BIG EGG-YIELDS

Jamesway Poultry Equipment is built for the discriminating buyer who buys equipment not because of the price, but because of the service it will render in increasing egg-yields, in keeping hens healthy and contented, and in making it easier to care for them.

Jamesway Electric Hover

Capacity
350 to 500
Chicks



The choice of better poultrymen everywhere. Their air-conditioned chicks are hardier and feathered better when brooded this modern, easy, economical way. New air and heat distribution principle prevents hot and cold spots. Chicks make use of entire brooding area—no crowding or piling up. Strongly built. Has ma-

sonite canopy, 48 inches by 72 inches. For 110-volt A.C. No. 1242; \$34.15.

Jamesway Coal-Burning Brooder Stove

Every feature which has made Jamesway coal burners outstanding in the past has been incorporated in the design of this stove. Heavy cast iron body with fins which nearly double the radiating surface provide steadier heat and cut fuel costs. Has 60-inch galvanized canopy. Burns hard or soft coal. Coal capacity 80 pounds. Chick capacity 350 to 500 chicks. Circular on request. No. 1960, \$27.80.

Jamesway Poultry Waterer

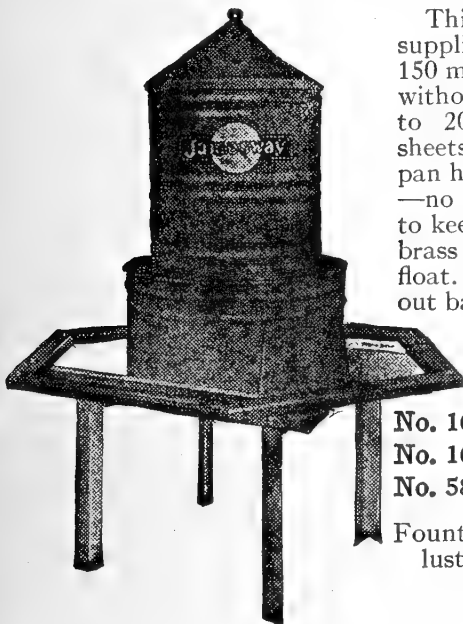

This big flock-size Waterer supplies water for flocks of about 150 mature birds for a whole day without refilling. Room for 15 to 20 hens. Built of heavy sheets. New heavy one-piece pan has rolled edges. Can't leak—no seams to break out—easy to keep clean and sanitary. Has brass valve operated by copper float. Capacity 8 gallons. Without base it may be used for baby chicks. With lamp-heated base it makes an excellent Waterer for winter use.

No. 1616. Without base.. \$4 65
No. 1612. Lamp Heated.. 6 65
No. 585. Stand..... 1 80

Fountain and stand as illustrated..... 8 45

Jamesway Chick Waterer

Accommodates 50 to 150 Chicks. Only two parts, a pail and a heavy one-piece pan. Vacuum type. Can't leak or flood. Capacity 7 quarts. No. 1407, \$1.10.

Jamesway 3-Gallon Waterer

Popular for large broods of chicks or for growing flocks. Water level controlled by copper float operating brass valve. Capacity 3 gallons. No. 1655, \$2.05.



Jamesway 3-Gallon Waterer

Jamesway Open-Trough Mash Feeder

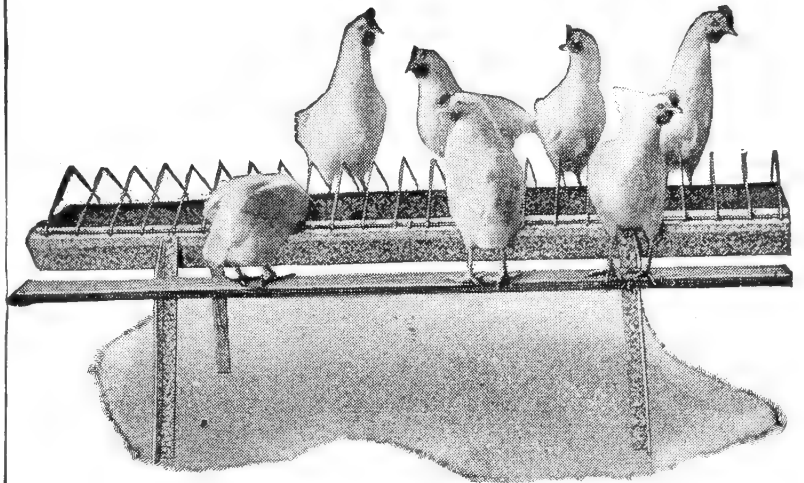

Big, roomy trough for feeding dry or wet mash and green feeds. Wire guard prevents hens from getting into trough. Wide lip on trough keeps hens from pulling mash out on floor. For feed-saving, cleanliness, and real satisfaction, buy this Feeder. Trough is 10 inches wide and 5½ inches deep. Perches 20 inches from floor to prevent vent-picking by birds on floor. Holds 50 pounds of mash. No. 525, \$4.35.

Jamesway Self-Cleaning Nest

Lice- and Mite-Proof
Has Folding Perches

Put Jamesway Nests in your poultry-house and watch your hens side-step the old mite-infested wood boxes. The hard, smooth, sanitary, galvanized surface offers no place for parasites to hide and thrive. Jamesway Nests are clean, sanitary, and lice- and mite-proof. They are easily cleaned, simply swing forward and upward. Nesting material falls out the open back and the nest is cleaned. Unit of 10 Nests as illustrated. No. 1230, \$9.55.

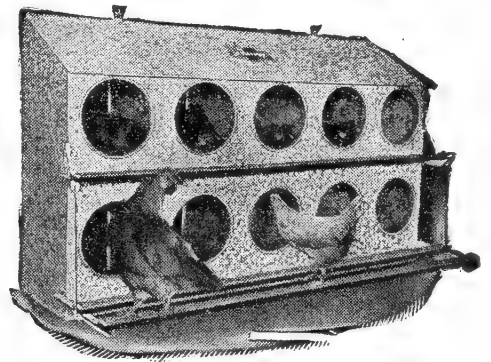

Jamesway Universal Battery Brooder

Space does not permit of a description of this Battery in our catalog. Developed by Jamesway, it is a new, modern Battery in every respect and has many outstanding features. Circular mailed on request. No. 2555, \$185.

Jamesway Poultry-House Heater

A substantial, fire-safe, all-metal cabinet for use in the poultry house. Inside the cabinet may be placed any brooder (coal or oil), that will fit into it. No. 1190 (Without stove), \$11.25.

Day-Old Chicks, Ducklings, Turkey Poults

We make a specialty of furnishing all popular breeds of Day-old Chicks, Baby Ducklings and Turkey Poults during the season. All are selected with extreme care of blood-tested flocks from reliable hatcheries. Prices on request.

Conkeys Aids to Poultry Health and Profits

The secret of poultry profits lies in good birds, careful handling, good feed, and prevention of disease. For almost forty years Conkeys have contributed to poultry raisers' profits by supplying effective aids to health and productivity. You will do well to keep these products on your poultry shelf—for regular use and emergencies:



Conkeys Dia-Tabs in the drinking water helps to keep chicks and poults healthy. As a mild intestinal astringent, these pheno-sulphonate tablets are good for all classes and ages of poultry.

25 tablets 25 cts., 55 tablets 50 cts., 125 tablets \$1, 500 tablets \$3, 1000 tablets \$5.50, all postpaid.

Conkeys Pic-End Bitters. A blood-colored distasteful formula to smear on picked parts of birds which have been attacked by others, to repel further picking.

2¾ oz. 25 cts., 7¾ oz. 65 cts., 1¼ lb. \$1.

Conkeys Y-O. Helps solve the vitamin problem for it is a patented powder-like vitamin food which prolongs the potency of the A and D vitamins of Cod Liver Oil. Y-O also provides a good supply of B vitamin and Riboflavin in the brewers' yeast and Riboflavin Supplement which it contains. It is easy to mix in any mash. Vi-tal-ize your feeds with Y-O—use only 2 to 4% in the mash.

Lb. 55 cts., 2-lbs. \$1, 5-lbs. \$1.70.

Conkeys Lice Powder. Adheres to flesh and feathers and destroys lice and mites that suck the energy from your birds. For individual treatment or use in dust-bath.

12 ozs. 25 cts., 6-lb. pail \$1.50, postage prepaid.

Conkeys 100-to-1 Powder. For large roundworms. Worms are one of the major causes for depleted vitality and productivity of poultry. Mix 100-to-1 Powder in your mash for chicks and grown birds alike at regular intervals.

4 ozs. 30 cts., lb. \$1, 2 lbs. \$1.75, 5 lbs. \$4, 10 lbs. \$7.50.

Conkeys Nox-I-Cide. Serves many purposes.

Use it in solution as a disinfectant spray for control of diseases; to help keep down mites, ticks, blue bugs, etc.; for washing incubators, brooders, fountains, etc.; for dipping cattle and sheep to control lice, mange and sheep ticks. It's unusually economical because it can be diluted up to 1 to 100 parts.

Pt. 40 cts., qt. 60 cts., gal. \$1.50.

Conkeys Old Reliable Powder. Has been used successfully for over 30 years. It's a fine "first aid" for treating some common poultry ailments and acts as a tonic too.

Oz. 25 cts., 2½ ozs. 50 cts., 7 ozs. \$1, 1½ lbs. \$2.35, 5 lbs. \$5.50, postpaid.

Conkeys Nikala Tablets. For large roundworms. When birds are not laying properly, look for evidence of worms and give them this effective treatment.

Pullet size: 200 tablets \$1, 2000 tablets \$9.

Adult size: 100 tablets \$1, 1000 tablets \$9.



Burrell-Dugger Poultry Remedies



An aid in protecting drinking-water of chicks from harmful effects of bacterial contaminated water from spreading disease from one bird to another in the flock. Try Avicol with your next batch and note results.

Price, 50 cts.; large size (holds three times 50-ct. size) \$1; economy size (6 times \$1 size) \$5, postpaid.



Group-Over

Nasal and throat infections often attack poultry with costly results. The symptoms are running nose, wheezing, rattling and choking. These infections, whatever their

origin—so-called "colds" or other purulent catarrhal conditions—tend to clog the air passages with excessive stringy mucous secretions.

Group-Over as an individual treatment and as a vapor will be found a valuable aid in expelling the accumulations of such mucous in the upper nasal passages. Poultry raisers everywhere say they never saw anything like Group-Over for quick results.

Prices, 50 cts.; \$1 (2½ times 50-ct. size); \$3 (4 times \$1 size), postpaid.

Nopco XX Cod-Liver Oil

A uniform, dependable vitamin A and D supplement for daily use in all poultry and live-stock feeds. **Nopco XX** is not only for poultry. Hogs, calves, dairy cows and other animals need vitamins A and D, too. **Nopco XX** is not ordinary cod-liver oil. Each gram of **Nopco XX** is guaranteed to contain 400 A. O. A. C. units of vitamin D and 3,000 U. S. P. units of vitamin A. It's economical!

5-lb. can \$3.75. Postage extra.

Animal-Poultry Yeast Foam

A live yeast product. The benefit in yeast-feeding comes from fermentation of the mash brought about by the enzymes which are found in live yeast. Fermentation of a poultry mash increases its palatability. It can also be fed to all kinds of animals and livestock. Mix it in the feed for cattle, hogs, dogs, rabbits, turkeys, chickens, pigeons, ducks and foxes. Mix one pound of A.-P. Yeast Foam to 100 pounds of mash and allow to stand 24 hours.

4-lb. box \$1.

DON SUNG

Tonic and Conditioner for Laying Hens

Don Sung is easily and economically given in the mash feed of laying hens. It does not force or hurt the hen in any way. It has been successfully used and recommended for years by large and small poultry raisers from coast to coast. Complete directions for proper feeding and housing to promote better egg-production are enclosed with every package. Get a package of Don Sung and see what it will do for your flock—you'll be more than pleased with results.

Don Sung Tablets: Small size (45 tablets) 50 cts.; large size (3 times 50-ct. size) \$1; special size (6 times \$1 size) \$5, postpaid.

T. S. F. (Talcimized Sodium Fluoride)

Kills All Poultry Lice

An effective preparation to get rid of poultry lice. It kills all lice, including the lice that hatch from eggs present on the fowl at the time of treatment.

½lb. 35 cts., lb. 60 cts.

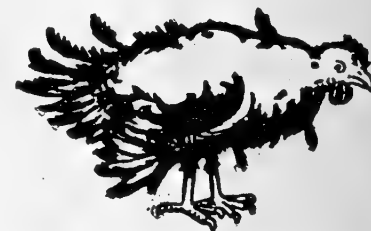

"I Need T. S. F."

Carbola The Disinfecting White Paint

A white paint and powerful disinfectant combined in powder form. Stir the powder in a pail of water and it is ready for brush or sprayer. *Won't peel or flake.*

It gives walls and ceilings a smooth, white finish, and helps keep buildings free from contagious disease germs. For poultry houses, etc. One pound covers about 100 square feet. 5 lbs. 60 cts., 10 lbs. \$1, 25 lbs. \$1.90, 50 lbs. \$3.50.

Dr. Salsbury's Poultry Medicines

As a member of Dr. Salsbury's Nation-Wide Poultry Health Service, we have, at all times, the latest bulletins, booklets, and literature of the scientific poultry world. Ask or write us for free educational literature.

Avi-Ton. For chickens and turkeys. Avi-Ton is a flock treatment for the removal of roundworms, and cecal worms, also contains ingredients that are recognized as having a beneficial effect on digestion. In powder form. Avi-Ton mixes easily in wet or dry mash. 10-oz. pkg. 30 cts., 3-lb. pkg. \$1.35, 6-lb. pkg. \$2.30, 15-lb. pkg. \$5.50, 25-lb. drum \$8.60, 50-lb. drum \$16.20, 100-lb. drum \$31.

Can-Pho-Sal. A medicinal inhalant spray to be diluted with water for spraying chicks and older birds. Tends to loosen accumulations of mucus in nostrils and throats of poultry when used as a nasal wash or spray. 2-oz. bottle 50 cts., 4-oz. bottle 85 cts., 1/2-pt. bottle \$1.25, 1-pt. bottle \$2.10, 1-qt. bottle \$4, 1/2-gal. \$7.50, 1-gal. \$14.

Ren-O-Sal. Dr. Salsbury's new drinking-water medicine for baby chicks and birds of all ages. Use it regularly in small doses for its tonic benefits. Simply increase the dosage to 8 tablets to the gallon of drinking-water for an effective control for cecal cocciidiosis. 25 tablets 30 cts., 100 tablets \$1, 250 tablets \$2, 500 tablets \$3.45, 1000 tablets \$6.25.

Par-O-San. A general, pleasant smelling disinfectant for poultry houses, incubators and brooding equipment. It may be either sprayed or applied with a scrub-brush or broom. Kills by contact, lice, mites and bacteria commonly found present. One quart makes 25 gallons of a general disinfectant. 1/2-pt. bottle 60 cts., 1-qt. bottle \$2, 1-gal. bottle \$6.50

Nic-Sal. Kills lice and mites on poultry by application on the roosts. Applied by brush or oil-can. One pint treats 350 feet of roosts. 4-oz. bottle 50 cts., 1/2-pt. bottle 90 cts., 1-pt. bottle \$1.45.

Rota-Caps. Recommended for the removal of large roundworms and capillary worms in chickens and turkeys. No toxic after-shock; no loss in egg-production or set-back in growth. **Adult Size:** 50 capsules 75 cts., 100 capsules \$1.35, 200 capsules \$2.50, 500 capsules \$5.

Pullet Size: 50 capsules 50 cts., 100 capsules 90 cts.

Walko Tablets

A valuable drinking-water antiseptic for baby chicks, turkeys, ducks, geese, or older fowls. Aids in preventing spread of disease through contaminated water. Give to little chicks in their drinking-water as soon as they are out of the shell. Pkg. (100 tablets) 50 cts., pkg. (235 tablets) \$1, pkg. (1,000 tablets) \$2.50, pkg. (2,000 tablets) \$4.

K-R-O (Kills Rats Only)

Small size 35 cts., large size \$1.

Pratts Poultry Remedies

Pratts Poultry Regulator. Contains "Trace Elements." Sold on money-back guarantee of "More Eggs in 15 days or your money back." Added to the mash it helps hens lay. Pkgs. 50 cts. and \$1, 12 1/2-lb. pkg. \$1.75, 25-lb. carton \$3.25, 100-lb. bag \$10.65.

Pratts Dip and Disinfectant. Should be used liberally by all live-stock and poultry owners to help control worms, lice, and all diseases. Qt. 60 cts., gal. \$1.60.

Pratts R-P Tablets. Helps keep drinking-water safe and thereby prevents spread of colds and "roupy" condition through the flock. Pkgs. 30 cts. and 60 cts.

Pratts Chick Tablets. New—they're floated. Far superior to other chick drinking-water preparations. They keep the water safe 24 hours a day. Pkgs. 30 cts. and 60 cts., postpaid.

C-Ka-Gene. Stops heavy losses from bloody cocciidiosis. Works by the "immunity" (permanent protection) method. Given in the feed, no handling of birds. Pkg. (50 chicks) 75 cts., pkg. (100 chicks) \$1.25.

"Split Action" Worm Capsules. Pennies for worming bring back dollars. Wormy birds cannot lay or grow profitably. Each capsule does the work of two ordinary treatments. It treats for several types of worms. Contains Pheno-Thi-Azine, the new miracle wormer that is nearly 100% effective in killing or expelling cecum worms; also Nicotine and Kamala for large round worms. Satisfactory for both chickens and turkeys. **Adult Size:** 50 capsules 85 cts., 100 capsules \$1.50, 500 capsules \$5.50, 1,000 capsules \$10, postpaid.

Chick Size: 50 capsules 55 cts., 100 capsules \$1, 500 capsules \$3.75, 1,000 capsules \$6.50, postpaid.

Pratts Poultry Worm Powder. A flock treatment for large round and cecum worms. Just add it to the mash. Contains Pheno-Thi-Azine; also an astringent commonly recommended for healing irritated intestines, and a tonic to hasten recovery of birds. 60-ct. pkg. (50 hens), \$1 pkg. (100 hens), \$4.25 pkg. (500 hens).

Pratts Roost Paint. Kill lice and mites this easy way. Just apply to the top of the roost and cross arms. No handling of birds. Lice and mites are killed both by fumes and contact. 1/2-pt. \$1, pt. \$1.75, qt. \$2.50, gal. \$7.50.

Pik-No-Mor. Valuable in preventing and stopping outbreaks of feather picking, toe picking and other forms of cannibalism. Easy to apply—inexpensive—effective. 5-oz. pkg. 60 cts., 1-lb. pkg. \$1.35.

Pratts Powdered Lice Killer. An old stand-by for delousing poultry, stock, and pets. Pkgs. 30 cts. and 60 cts.

Rutland Water Glass

Prepared especially to keep eggs fresh over a period of time. One quart will preserve from 15 to 20 dozens of eggs.

Pt. 20 cts., qt. 30 cts., gal. 90 cts.

Dr. Hess Products

Dr. Hess Poultry Pan-A-Min. Its tonics promote appetite; keep hens healthy; start pullets and moulted hens to lay. Formerly known as Dr. Hess Panacea. 1 1/2-lb. pkg. 30 cts., 5-lb. pkg. 85 cts., 10-lb. pkg. \$1.50, 30-lb. pkg. \$3.75, 100-lb. drum \$10.50.

Dr. Hess Nicozine. A combination of phenothiazine with nicotine. Effective for the removal of large roundworms and cecal worms. Given in mash, the expulsion of worms starts in a few hours and is usually completed within 3 days. No fasting or laxatives required. 2.2-oz. pkg. (50-bird size) 50 cts., 4.4-oz. pkg. 90 cts., 11-oz. pkg. \$1.90, 1 3/8-lb. pkg. \$3.

Dr. Hess Poultry Tablets. Valuable in treatment of roup; slightly astringent, non-irritating, and healing. Used as a local antiseptic and to medicate drinking-water. Aids in preventing disease. 25 cts., 50 cts., and \$1, post paid.

Dr. Hess Powdered Louse-Killer. Effective in ridding poultry of lice and mites. Lb. pkg. 30 cts., 2 1/2-lb. pkg. 65 cts.

Lee's Germozone

Germozone helps prevent the spread of germs through the drinking-water, and medicates the digestive tract. Give to baby chicks and birds of all ages. 4-oz. bottle 40 cts., 12-oz. bottle 75 cts., 32-oz. bottle \$1.50, 1-gal. bottle \$4.50.

Lee's Acidox

Aids in the care of flocks showing visible symptoms of cocciidiosis. For chickens and turkeys. Administer in the drinking-water. 4-oz. bottle 50 cts., 12-oz. bottle \$1, 32-oz. bottle \$2, 1-gal. bottle \$6.50.

Chic-Tone

Chic-Tone in the drinking-water increases the appetite and builds up vitality. It is both an intestinal antiseptic and general tonic. Protects against many intestinal disorders—helps to keep your birds healthy, aiding them to get maximum value from the feed consumed. Chic-Tone in the drinking-water is a safeguard and insurance against low vitality. Qt. \$1, gal. \$3.50, 5 gals. \$13.75.

Chic-Tone Inhalant

When poultry raisers pour Chic-Tone in the drinking-water and spray Chic-Tone Inhalant in the air, their death-losses from colds and respiratory ills are kept way down, and that applies to birds of all ages from baby chicks to old hens. Powerful, germ-killing gases and healing oils in Chic-Tone Inhalant are inhaled by birds, opening up the nostrils, causing discharge of mucus, healing irritated membranes. Do not dilute. Spray right into faces of birds. Qt. \$1, gal. \$3.50, 5 gals. \$13.75.

Morton's Rabbit Salt Spools

Keep your stock healthy and in good condition by keeping Salt Spools always before them. Prevents common disorders and disease. Two kinds: pure salt and salt with sulphur added. Either kind, 6 cts. each, 10 for 50 cts., postage 10 cts. extra; 100 for \$4.50.

B-K Poultry Disinfectant

A powerful quick-acting hypochlorite disinfectant used as an aid in preventing the spread of diseases by contaminated equipment and drinking-water. It is not only a powerful disinfectant, but also a deodorant.

B-K Powder is used as a dry expectorant dust and is applied by means of a dust gun over the heads of baby chicks and adult birds infected with colds, simple bronchitis and infectious bronchitis.

Powder			Postpaid
9½-oz. bottle.....	\$0 75		\$0 85
1¼-lb. bottle.....	1 50		1 60
Liquid			
4-oz. bottle	\$0 30		\$0 40
10-oz. bottle	50		60
1-qt. bottle	90		1 05
		Not Postpaid	
1-gal. bottle.....	\$2 00		
5-gal. jug.....	8 50		

HTH-15

Don't let colds and other respiratory troubles sap the strength of your breeding flocks. Dust with HTH-15 to prevent and combat these ailments. Use it regularly in the drinking-water to prevent spread of infection. Invaluable disinfectant for brooders and incubators. 1-lb. bottle 50 cts., 3-lb. bottle \$1, case of six 3-lb. bottles \$5.

Toxite Disinfectant Spray

Recommended especially for disinfecting brooders, poultry-houses, stables, and other contaminated places. KILLS Red Mites, Bedbugs, Fowl-Ticks, Cattle-Lice, Termites, Fleas, Ants, Blue Bugs, Hog-Lice, Roaches, and similar pests by contact. Very effective inhalant for colds in poultry. Apply with an ordinary garden sprayer.

Qt. 50 cts., gal. \$1.50, 5-gal. drum \$6.50.

Zenoleum Disinfectant-Dip

An efficient insecticide, disinfectant, deodorizer, germicide, and cleanser. It is essentially a solution of coal-tar creosote oil soap and gives a most perfect emulsion when mixed with water. Use it as a spray in poultry-houses and kennels, dip for sheep and lice on horses and cattle. Makes an excellent wash for dogs. One quart makes about 25 gallons of solution. 8-oz. can 35 cts., 1-qt. can 75 cts., 1-gal. can \$2.

Morti-Cocci

Used and recommended by many leading poultrymen for the control of coccidiosis. It should always be kept on hand for immediate use at the first symptoms of the disease. Add it to the drinking-water. A gallon is sufficient for 500 chicks. Complete directions on package.

Qt. \$1.50, ½gal. \$2.50, gal. \$4.

Toxite Veterinary Ointment

Antiseptic and healing and is made for treating cuts and sores of animals. Unusually effective for stopping tail-picking and cannibalism in poultry.

4-oz. jar 50 cts., postpaid.

Carbolineum

Standard Insecticide and Wood Preserver Since 1876

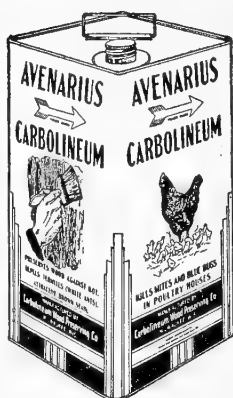

One thorough application of Avenarius Carbolineum, either by brush or sprayer, to the walls, droppings-boards, roosts, etc., of buildings, will kill all mites by direct contact and effectually stop their propagation. Only necessary to apply once a year.

Avenarius Carbolineum is composed of non-volatile anthracene oils and other ingredients, and represents the very cream of wood-preserving oils. It will not evaporate or leach from wood in a short time, but will remain there almost indefinitely.

Termites (white ants) will not attack Avenarius Carbolineum treated wood. Even after they have been found, future infestations may be prevented if Avenarius Carbolineum is applied.

1-gal. can \$1.80, 5-gal. drum \$8.35, 10-gal. drum \$16, 35-gal. drum \$46.65, 55-gal. drum \$64.40.

5-gal. drum returnable at \$1, 10-gal. drum at \$2, 35-gal. and 55-gal. drums at \$5 each.

Pik-Rem Stops Cannibalism

Pik-Rem is not a medicine but a help in breaking the vicious habit of chicks picking each other and will quickly break up the condition known as cannibalism. It is blood-colored and blood-soluble, making it adhere to raw bloody surfaces. Very effective and harmless.

5-oz. jar 50 cts., 12-oz. jar \$1, 26-oz. jar \$2, postpaid.

"Black-Leaf 40"

Controls Poultry Lice and Mites

A sure method for controlling body-lice. With the "Cap-Brush" Applicator, the 1-ounce bottle will treat about 90 birds, other sizes in proportion. (Applicator included in the 1-oz., 5-oz., and 1-lb. bottles.)

When used as a spray, dilute at the rate of 2 to 3 tablespoonfuls to 1 gallon of water and add about ¼ bar of laundry soap. 1-oz. bottle 35 cts., 5-oz. bottle \$1.05, 1-lb. bottle \$2.42, 2-lb. tin \$3.57.

3 x 4 Folding Egg Carton

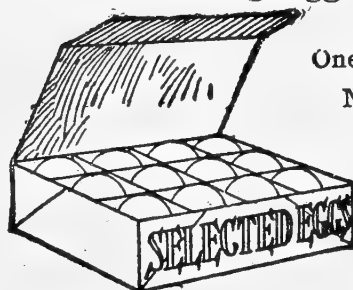

One-dozen size.

No printing

			Postpaid
12 Boxes.....	\$0 15		\$0 25
50 Boxes.....	60		80
125 Boxes.....	1 20		1 45
250 Boxes.....	2 15		2 60
500 Boxes.....	4 00		4 85
1,000 Boxes.....	7 65		Notppd.

"Black Leaf" Worm Powder

CONTROLS POULTRY ROUNDWORM

An odorless, tasteless, dry compound containing nicotine that remains insoluble until it reaches the intestines where large round-worm infestation occurs. This product furnishes "one-shot" control of round-worm without handling the birds and without the disturbance caused by individual handling.

"Black Leaf" Worm Powder is easily fed in mash. The dose for 100 birds is 4 ounces, mixed in a gallon of mash, fed the first thing in the morning. 4-oz. pkg. 75 cts., 1½-lb. pkg. \$3, 3-lb. pkg. \$5.60, ppd.

"Black Leaf" Worm Pellets. Produced from "Black Leaf" Worm Powder. Highly efficient. 85 cts. per 100, \$3.25 per 500, \$6 per 1,000, postpaid.

Gold-Leaf Tobacco-Leaf Dust

Manufactured especially to control roundworms in poultry. So certain is its action that it may well be considered a specific for the control of this trouble. The treatment is exceedingly inexpensive.

Mix two pounds of Gold-Leaf Tobacco-Leaf Dust with 100 pounds of dry mash. 2-lb. carton 25 cts., 10-lb. pkg. 75 cts., carton (6 10-lb. pkgs.) \$4.

PTZ Powder

Worm Treatment for Poultry

Effective in the removal of cecal worms in poultry. Recommended dosage one-tenth gram per bird—added to the ground feed. Made with phenothiazine. 4-oz. pkg. 50 cts., 1-lb. pkg. \$1.25, 5-lb. pkg. \$6, postpaid.

Mash-Nic

A prepared Nicotine Compound for controlling roundworms in poultry. Contains 2.50% Nicotine. Given in the feed. 2-lb. pkg. 80 cts., 5-lb. pkg. \$1.50, 100-lb. bag \$15.60.

BOOKS

American Standard of Perfection. Published by the American Poultry Association and is the American authority on the recognized characters of all breeds of chickens, turkeys, ducks, and geese. Contains nearly 500 pages, 218 illustrations. Cloth, \$2.50.

Best Plans of Poultry-Houses. Following the plans in this book is assurance that you will have a satisfactory poultry-house at the least expense. Illustrated. 50 cts.

Modern Poultry Farming. By Louis M. Hurd. A practical guide for both large and small poultry-keepers, and those interested in starting a poultry enterprise. Full of money-making ideas and modern in every respect. Cloth, \$4.00.

The Home Veterinarian's Handbook. By E. T. Baker. Tells how to handle emergency situations regarding farm animals and poultry. Contains information on: horses, cattle, hogs, sheep, goats, rabbits, dogs, cats, poultry, wild animals, medicine, poisons and parasites. Cloth, \$2.50.

Turkey Production. By L. E. Cline, B.S., M.S. A complete text on breeding, feeding, handling, marketing, and disease control, prepared for the use of turkey producers and agricultural students. 450 pages; illustrated. Cloth, \$3.50.

How to Raise Poultry. By Paul Ives. With the aid of this practical guide anyone can raise poultry successfully. Has chapters on turkeys, ducks, geese and bantams. 96 pages 9 x 12; many illustrations. Paper \$1.00.

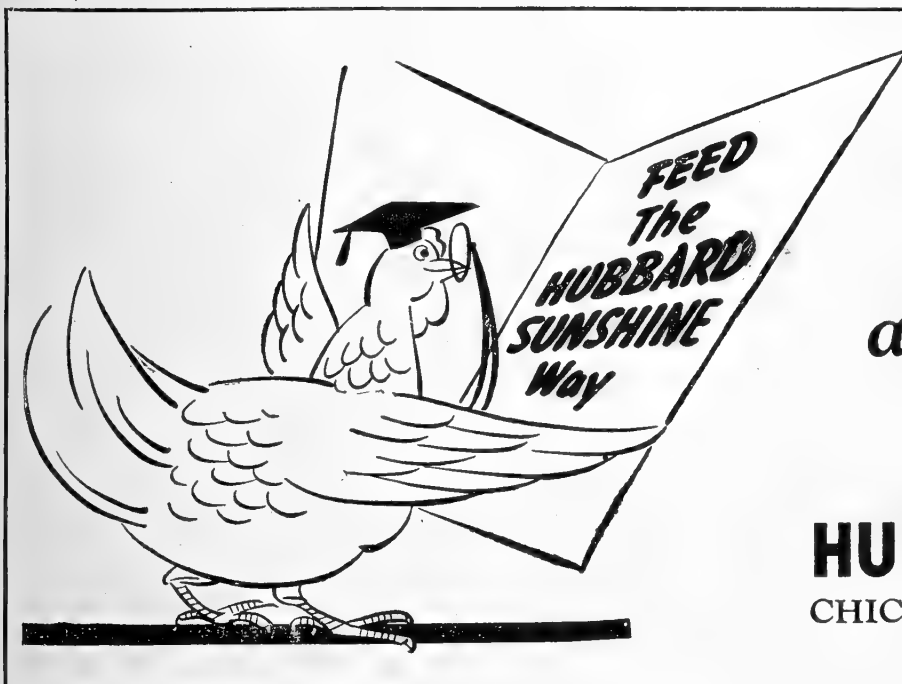
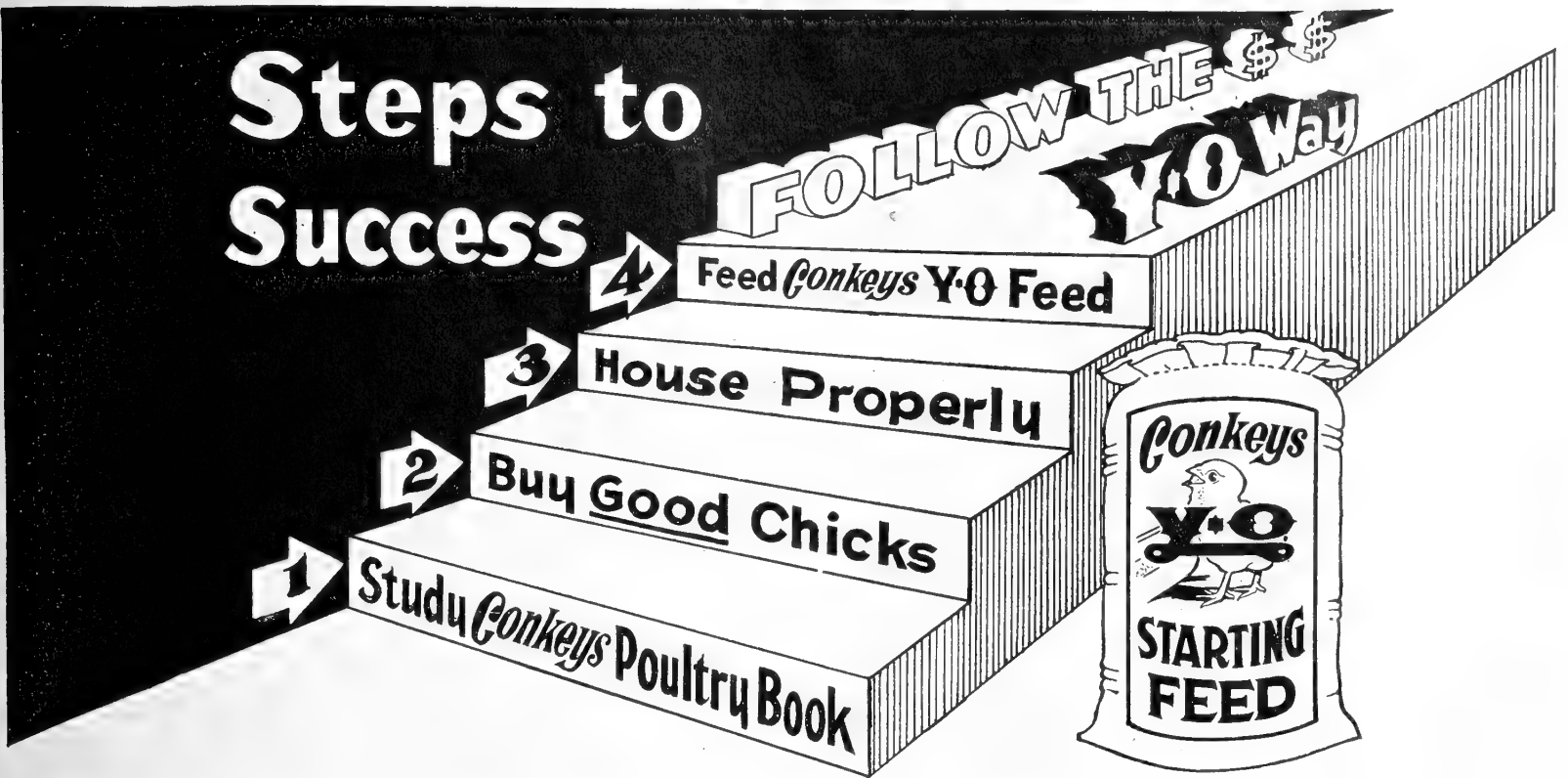

Good Advice For All Poultry and Turkey Feeders!

SEE US FOR

HUBBARD'S SUNSHINE CHICK, POULTRY, AND TURKEY FEEDS

Oyster Shells

They supply sufficient lime for the shell of the egg. Should be kept within easy access to fowls all the year round.

Grit

Essential to all fowls from day-old chicks to full-grown birds. Aids in grinding the food.

Health Grit for Pigeons

Helps keep birds' digestive organs in prime order and wards off many troublesome diseases. Keep before birds at all times. We have two brands: **Broschowsky's** and **Red Cross**.

Meat and Bone Scrap

Supplies the necessary protein and bone phosphate for egg-making. Obtained from freshly rendered meat-trimmings and is thoroughly dried.

Poultry Charcoal

Aids digestion and helps prevent disease. Fowls young and old should have free access to it at all times.

Dried Buttermilk

Supplies the vitamins, protein, and mineral matter which are essential in the diet of all young animals for rapid growth. Fed mixed with ground feeds.

Dickinson's Rabbit Pellets

A complete, balanced and nourishing food for rabbits. Being in pelleted form it eliminates waste.

Miscellaneous Seeds and Grains

- | | |
|-----------------|-------------------|
| Cracked Corn | Pigeon Peas |
| Whole Corn | Whole Flaxseed |
| Pinhead Oatmeal | Flaxseed Meal |
| Hulled Oats | Wheat |
| Sunflower Seed | Buckwheat |
| Hemp Seed | Millet |
| Canary Seed | Alfalfa Leaf Meal |
| Rape Seed | Cotton Seed Meal |
| Kaffir Corn | |

Our stocks of the above are carefully selected and will be found equal to any on the market.

PRICES ON THE ABOVE FEEDS AND MATERIALS WILL BE QUOTED ON REQUEST

Dog and Pet Foods and Supplies



Bannock Body Builder

"Dog Food at Its Best"

For ALL DOGS • ALL BREEDS • ALL AGES

Healthful, economical, and convenient to feed, Bannock Body Builder is a balanced ration, containing all of the food elements necessary for the proper nutrition of dogs. Proteins, vegetables, fats, minerals, vitamins, and "THYMAVITE"*—all especially selected and in correct proportion. Breeders, trainers, and veterinarians alike recommend Bannock Body Builder.



"Thymavite"* provides more essential vitamins, more minerals and more food value—just what dogs need.

*"Thymavite" is the new food discovery, the remarkable vitamin concentrate combined with other health-giving elements.

5-lb. bag.....\$0 55	50-lb. bag.....\$4 00
10-lb. bag.....1 00	100-lb. bag.....7 50
25-lb. bag.....2 25	500 lbs.....35 00

Always in Fine Condition

"I have been using Bannock Dog Food for several years, and my dogs are always in perfect condition, even after weaning large litters. They are not only in excellent condition all the time, but are full of pep and carry magnificent coats. I also get large litters of sturdy puppies, and have never had a bitch miss since I started using Bannock. I am more than glad to recommend such a satisfactory food." (Signed) ELIZABETH D. WHALEN, Pocono Kennels, Pa. Three Champion Shetland Sheepdogs, the pride of Pocono Kennels, Pa.

Spratt's Dog and Puppy Foods

For over eighty years, Spratt's "Meat Fibrine" Biscuit Foods have been termed "Foods of Quality." They lead in nourishing properties, suitability to the constitution of present-day dogs, and in economical value. Their reputation is world-wide.

SPRATT'S FIBO. An appetizing granulated food for shy and dainty feeders. Suitable for change of diet for any dog at any time. Feed dry or soaked with broth. Lb. 20 cts., 2 lbs. 35 cts., 5 lbs. 85 cts., 25 lbs. \$3.65, 50-lb. bag \$6.80.

SPRATT'S OVALS. Handy pocket biscuits suitable for all breeds. Carry a few when on a ramble with your dog. Lb. 18 cts., 2 lbs. 35 cts., 5 lbs. 80 cts., 25 lbs. \$3.50, 50 lbs. \$6.40.

SPRATT'S SPIX. Meat fibrine biscuit, bone size. All dogs like this biscuit. Lb. 18 cts., 2 lbs. 35 cts., 5 lbs. 80 cts., 25 lbs. \$3.50, 50-lb. box \$6.40.

SPRATT'S CHARCOAL OVALS. Aid in the elimination of fetid breath and stomach impurities. Lb. 18 cts., 2 lbs. 35 cts., 5 lbs. 80 cts., 25 lbs. \$3.55, 50-lb. bag \$6.55.

SPRATT'S COD-LIVER OIL OVALS. Aids in the conditioning of dogs; invaluable during the winter months. Lb. 18 cts., 2 lbs. 35 cts., 5 lbs. 80 cts., 25 lbs. \$3.55, 50-lb. bag \$6.55.

SPRATT'S MEAT FIBRINE DOG CAKES. Standard dog cake for large dogs, used by all leading dog breeders. Lb. 18 cts., 2 lbs. 35 cts., 5 lbs. 80 cts., 25 lbs. \$3.50, 50-lb. bag \$6.40.

SPRATT'S ASSORTED BISCUITS. Gives your dog just the variety of crunchy foods needed for the maintenance of stamina and good health. The combination is made up of Spix, Ovals, Charcoal Ovals, and Cod-Liver Oil Ovals. Lb. 18 cts., 2 lbs. 35 cts., 5 lbs. 80 cts., 25 lbs. \$3.55, 50-lb. box \$6.55.

SPRATT'S PEPSINATED MEAL. For puppies or kittens with weak digestion; is extremely assimilative and will make most unpromising youngsters thrive. 12-oz. can 45 cts.

SPRATT'S PUPPILAC. A perfect substitute for the milk of the bitch, for rearing orphan puppies, at weaning-time and for ailing dogs in sickness or convalescence. This is also valuable as a food for cats and kittens. 10-oz. can 75 cts.

SPRATT'S BONE MEAL FOR PUPPIES. A great preventive of early weakness in puppies containing all the elements needed to insure vigorous frame. Prepared for easy mixing with the staple food. 20-oz. tin 30 cts., 3-lb. tin 55 cts.

SPRATT'S CALCIUM PHOSPHATE. For Rickets and Osteoporosis. An admirable adjunct in the feeding of puppies of the large breeds. It may also be given to bitches before whelping. Easily assimilated and has no irritating effect on the stomach. 8-oz. can 40 cts.

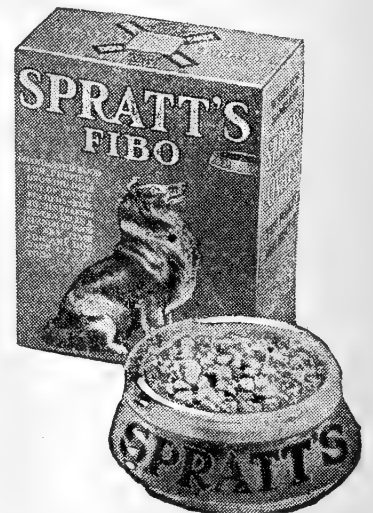

"Old Trusty" All Terrier Food

A granulated food of even balance and carefully mixed. An ideal food for all breeds, particularly terriers and active dogs. May be fed dry or moistened with milk or soup. 5 lbs. 65 cts., 10 lbs. \$1.10, 25-lb. bag \$2.50, 50-lb. bag \$4.65, 100-lb. bag \$9.

Dog Furnishings

We offer an extensive selection in Collars, Harness, Leashes, Baskets, Brushes, Nail Clippers, Dressing Tools, Name Plates, Toys, Novelties, Blankets, and Sweaters for dogs. Since this merchandise is too diversified to be included in the Catalogue, we invite you to call at the store and inspect it personally.

KEN-L-MEAL

A quality meat-cereal product containing Government-inspected meat and wholesome selected cereals with essential vitamins added. For dogs of all breeds and ages. 5 lbs. 55 cts., 10 lbs. \$1.00, 25-lb. bag \$2.15, 50-lb. bag \$4.00, 100-lb. bag \$7.50.

Mail and Telephone Orders

We are organized to give mail and telephone orders the same personal attention as orders placed in our store. If it is not convenient to come to the store, we will appreciate your order either by mail or telephone. Orders amounting to \$2 or more (except where priced otherwise) are delivered free. See page 1.

MILLER'S DOG FOODS

Battle Creek Health Foods for Dogs

Miller's Dog Foods will furnish you with proper food for your dog under wartime meat restrictions. Miller's Foods contain dehydrated meat meal, cereals, vitamins, and minerals. Several types to choose from, and they all help you keep your dog healthy at small expense.

KIBBLES		PUPPY MEAL	
5 lbs.....	\$0 70	5 lbs.....	\$0 70
10 lbs.....	1 25	10 lbs.....	1 25
25-lb. sack.....	2 75	25-lb. sack.....	2 75
50-lb. sack.....	5 10	50-lb. sack.....	5 10
100-lb. sack.....	9 85	100-lb. sack.....	9 85
RATION		BISCUIT	
5 lbs.....	\$0 55	5 lbs.....	\$0 70
10 lbs.....	1 00	10 lbs.....	1 25
25-lb. sack.....	2 25	25-lb. sack.....	2 75
50-lb. sack.....	4 00	50-lb. sack.....	5 10
100-lb. sack.....	7 50	100-lb. sack.....	9 85

MILLER'S KIBBLES DOG FOOD



HEALTH PLUS ECONOMY

Highest quality for 26 years

Gaines Dog Meal

An excellent daily diet for dogs and puppies of all sizes and breeds. Just add water—nothing else—and Gaines offers dogs all the Vitamins A, B₁, B₂ (G), B₆, D, E, Niacin, Pantothenate and other food factors they're known to need. And dogs love it. In fact, actual surveys show that nine out of ten dogs like Gaines right from the very first feeding! Chosen by the U. S. Antarctic Expedition and now fed by the U. S. Army.



5 lbs.....	\$0 55	50 lbs.....	\$4 25
10 lbs.....	1 00	100 lbs.....	8 10
25 lbs.....	2 25	500 lbs.....	38 00

Gaines Krunchon

Made of the same ingredients as Gaines Meal, but in pelleted form.

5 lbs.....	\$0 65	50 lbs.....	\$4 65
10 lbs.....	1 15	100 lbs.....	8 85
25 lbs.....	2 50		

PERFECTION DOG FOODS

TIME-TESTED...

For More Than 30 YEARS



Very little more need be said of these well-known foods—favored by dog and kennel owners everywhere. Certainly a trial will convince you.

MEAT MEAL CEREAL. Ready to feed—For All Dogs—All Ages.

By far the most popular—

5-lb. bag.....	\$0 50
10-lb. bag.....	95
25-lb. bag.....	2 10
50-lb. bag.....	3 85
100-lb. bag.....	7 25
500 lbs.....	33 75

FREE 32-PAGE DOG BOOK

WHOLE BISCUIT.

5-lb. bag.....	\$0 65
10-lb. bag.....	1 10
25-lb. bag.....	2 45
50-lb. bag.....	4 65
100-lb. bag.....	8 85

KIBBLED BISCUIT.

5-lb. bag.....	\$0 65
10-lb. bag.....	1 10
25-lb. bag.....	2 50
50-lb. bag.....	4 75
100-lb. bag.....	9 00

BRESKO DOG FOOD

With Fresh Raw Liver

By a special process fresh raw liver is cooked into Bresko making it a palatable and nourishing food for dogs. Bresko-fed dogs have a sleek silky coat, more pep, better health. Liver is invaluable for body and blood building.

Dogs get the meat they need in Bresko—and plenty of it. Bresko is made of meat-scrap and balanced with other ingredients.

BRESKO MEATBONE CRISP. (Kibbled.)

5 lbs. 65 cts., 10 lbs. \$1.10, 25-lb. bag \$2.50, 100-lb. bag \$9.

BRESKO RATION. 5 lbs. 55 cts., 10 lbs. \$1, 25-lb. bag \$2.25, 100-lb. bag \$8.

Pard Dehydrated Dog Food

A nutritionally balanced diet

Rich in meat food products and other wholesome ingredients. Fed mixed with water. 8-oz. pkg. 11 cts., case (48-pkgs.) \$5, f.o.b. store.

For Economy Feed Chappel's Fresh Meat Biskits

KEN-L-BISKIT

INGREDIENTS

Fresh Meat, Wheat Germ, Yeast, Egg Yolk, Wheat Flour, Fresh Whole Milk and Bone

Vitamin Fortified

Chappel's Ken-L-Biskit is scientifically prepared from fresh raw meat and carefully selected ingredients. Its nutritional value has been proved in laboratory-controlled feeding tests. Can be fed dry or moistened with water or broth and is suitable for dogs of all breeds and ages.

Small cakes, small kibbles, or medium kibbles, 5 lbs. 65 cts., 10 lbs. \$1.10, 25-lb. bag \$2.50, 50-lb. bag \$4.90, 100-lb. bag \$9.75.

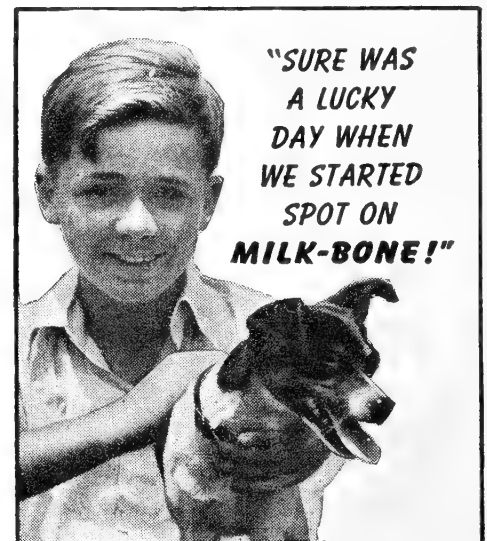

Make it a lucky day for your dog, too. For breakfast give him Milk-Bone Biscuit. It's nourishing... also *crunchy* to provide plenty of tooth and gum firming exercise. Follow up with a hearty supper of Milk-Bone Tiny-Bits... just add warm water, soup, broth or vegetables, plus bits of meat if you wish.

Time-tested Milk-Bone dog food is a skillful blend of high protein meat meal, yeast, milk, whole wheat flour, fish liver oil, important minerals and vitamins A, B₁, D, E, and G.



PRICES:

Dog Biscuit. For large breeds. 29-oz. carton 35 cts. each, 3 for \$1.
Puppy Biscuit. For full-grown dogs in the medium-size class, also puppies. 26-oz. carton 35 cts. each, 3 for \$1.
Tiny-Bits. An all-purpose food. 10 1/4-oz. carton 15 cts. each, 3 for 40 cts.

Spratt's Dog Remedies

Spratt's Medicines are made from the purest ingredients obtainable and are always kept up to the highest level of modern veterinary science. Dosage and directions appear on all packages.

	Pkg.
Tablets for Constipation.....	\$0 60
Sulfur Tablets. For heated blood, etc.....	60
Cough Tablets. Generally effect a quick cure.....	60
Special Tablets. A diuretic and stimulant.....	1 00
Ear Canker Ointment. For both internal and external forms of this disease.....	75
Mange Liquid. 12-oz. bottle.....	75
Tonic Tablets. To build up after sickness.....	60
Cod Liver Oil Capsules. 20 capsules.....	60
Worm Capsules for Puppies.....	60
Worm Capsules for Dogs.....	60
Dry Cleaning Powder.....	35
Dog Soap (White). For fleas, lice, etc.....	Cake 25 cts...
Liquid Shampoo. Also recommended for use by humans.....	35
Chalk Block. For dry-cleaning dogs and cats.....	25

Sergeant's DOG MEDICINES

Special Medicine. For reduction of fever in pups and dogs.....	Pkg. \$1 20
Mange Medicine. For treating sarcoptic mange.....	65
Condition Pills. A tonic and alterative for pups and dogs.....	60
Expectorant Medicine. For coughs due to colds in pups and dogs....	60
Puppy Capsules. For round- and hookworms in pups and dogs weighing less than 10 pounds....	60
Eye-Wash. For treating eye trouble in pups and dogs.....	60
Sure-Shot Capsules. For large roundworms, and hookworms in pups and dogs weighing over 10 pounds.	60
Tapeworm Medicine. For tapeworms in pups and dogs.....	60
Arsenic and Iron Pills. A tonic used alternately with Sergeant's Condition Pills.....	60
Canker Wash. For treating internal and external ear canker.....	60
Pepsin and Aromatic Tablets. Relieves colic in pups and dogs due to improper food.....	60
Intestinal Astringent. Checks too-frequent bowel action in cases of diarrhea.....	60
Diuretic Pills. Stimulates urinary action. Useful in old dogs.....	60
Vitapets. A food supplement for dogs and puppies. Supplies Vitamins A, B, D, and G. Pkg. (23 capsules)	60
Laxative Tablets. For treating constipation in pups and dogs.....	60
Nerve Sedative Medicine. For relief of excitement and nervous irritability.....	60
Skip-Flea Soap. A wonderful bath soap. Will kill fleas, lice, and certain other vermin..	Cake 25 cts...

SERGEANT'S DOG MEDICINES, cont.

Skip-Flea Powder. For fleas and lice on dogs and cats. 2-oz. pkg. \$0 35
 Pine Oil Disinfectant. For general use. 4 ozs. 30 cts., 12 ozs. 65 cts.
 Sergeant's Dog Book Free. Ask for it.

Q-W Dog Remedies

Condition Powder. A general conditioner.....	Pkg. \$1 00
Cough Mixture. Often gives immediate relief.....	65
Sedative Tablets. For treatment of fits and nervous twitching.....	95
Antiseptic Salve. Helps promote healing of cuts and wounds. 1-oz. jar.	65
Worm Capsules. For large roundworms.....	65
Worm Mixture. Safe and sure. 2 ozs. 65 cts., 4 ozs. \$1.	
Flea Powder. Kills fleas.....	50
Flea Oil and Coat Dressing. 1/2-pt....	65
Sarcoptic Mange Lotion. Dressing for mange and itch.....	75
Dog Soap. Has a pure, clean, pleasant odor.....	Cake 25 cts...
Dog Shampoo. A liquid soap that will actually kill fleas.....	35
Constipation Pills. A quick, safe laxative.....	65
Cod-Liver Oil with Calcium Phosphate. Rich in vitamins A and D. 6-oz. bottle.....	60
10-oz. bottle.....	95
Pine Bar. Removes any unpleasant dog odor.....	35
Ear Canker Lotion. For parasitic cankers of the ear.....	1 25
Salicylate Compound Tablets. Give relief in cases of muscular soreness.	65
Tapeworm Mixture. Gives a thorough, healthy, quick cleaning out. 2-oz. bottle.....	1 00
Verminol. Disinfectant, germicide and deodorizer....	1/2-pt. 75 cts..

Dr. Daniel's Medicines for Dogs and Cats

H. B. O. Liquid for hair-balls in cats	Pkg. \$0 65
V. M. Capsules. Vitamins for dogs and cats.....	50
Worm Specials	
Liquid Worm Drops. For cats and toy dogs.....	50
Vermi Kaps. For cats and toy dogs	65
Vermi Kaps. For puppies.....	65
Vermi Kaps. For dogs.....	65
Tape Worm Treatment.....	1 00
Loose Catnip. All leaves and blossoms.....	20
Acobel Wafers. For distemper—colds in cats and puppies.....	50
Condition Tablets. Restorative for dogs.....	65
Dervide Tablets. For fits and convulsions.....	50
Dog and Flea Soap... Cake 25 cts...	
Katonic. A great tonic for cat or kitten.....	25 cts. and. 50
Laxative Tablets. For dogs or cats.	50
Dermite. For itching skin, eczema and sarcoptic mange.....	1 00

Glover's Imperial Dog Medicines

Imperial Capsules. For round and hookworms. Puppy size, pkg. (8 capsules) 25 cts.; pkg. (24 capsules) 60 cts. Dog size, pkg. (6 capsules) 25 cts.; pkg. (18 capsules) 60 cts.	
Vermifuge for Roundworms. For puppies, dogs, foxes, and cats.....	Pkg. \$0 60
Tapeworm Capsules. For puppies, dogs, foxes, and cats.....	60
Laxative Pills. For sluggish bowels and acute constipation.....	60
Compound Tablets. Act upon the kidneys and intestines.....	60
Nerve Sedative. For fits and convulsions.....	60
Mange Medicine. For sarcoptic mange of dogs.....	75
Expectorant Mixture. For coughs due to colds.....	60
Canker Medicine. For canker of the ear in dogs and cats.....	60
Intestinal Astringent. For non-infectious diarrhea.....	60
Tonic Pills. Tonic and appetizer....	60
Eye Lotion and Powder. For minor injuries and irritations in the eyes..	60
Ointment. For sarcoptic mange and minor skin irritations.....	60
Flea Killer Powder. For dogs and cats.	25
Kennel and Flea Soap. Kills fleas and lice.....	Cake 25 cts...
Medicated Soap. A cleansing bath soap for house dogs. Cake 30 cts...	
<hr/>	
Graslets for Dogs. Produced largely from tender unjointed cereal grasses combined with fish-meal and dried buttermilk supplemented with added vitamins to make a balanced blend. Should be included in the dog's food ration every day. Helps to keep dogs in good general health. Not a medicine. 28-oz. pkg. \$1, 5-lb. pkg. \$2.	
Fleischmann's Irradiated Dry Yeast for Dogs. Supplies vitamin D and the B complex vitamins. Vitamin D is essential to the absorption and efficient utilization of the minerals calcium and phosphorus. It is especially needed by pregnant and nursing mothers and puppies. The B complex vitamins are essential to a normal appetite, good growth and soundness of the muscular and nervous systems. 4-oz. bag 25 cts., 8-oz. bag 50 cts., 1-lb. bag 85 cts., 5-lb. can \$3.50.	
Rex Hunter's Tasteless Dog Powders. Provide blood-tonic elements and a reconstructive for dogs of all breeds, any age. Pkg. of 8 tablets 25 cts., 40 for \$1.	
Karswood Dog Tablets. Suitable for all breeds of dogs at all ages. Keeps dogs in splendid condition. Give a dose once every week. Pkg. of 12 tablets, 35 cts.	
Karswood Worm Powders. For puppies and medium- and large-sized dogs. Pkg. of 6 powders, 50 cts.	
Trix Repellent. Keeps male dogs away while females are in season. 1-oz. bottle 75 cts.	



Pulvex. The non-poisonous Flea Powder—it kills lice, fleas and mites. It will also prevent reinfestation of fleas for several days. Pulvex is safe to use on dogs, cats, or birds, and is guaranteed to satisfy.

1½-oz. pkg. 25 cts.,
3⅓-oz. pkg. 50 cts.,

12-oz. pkg. \$1.25, postpaid.

Pulvex Flea Soap. Cleans thoroughly, deodorizes and kills fleas. Cake 25 cts.

Pulvex Dry Cleaner. An odorless, harmless powder that cleans your dog or cat without water. Kills fleas and lice; removes doggy odors. 5-oz. tin 50 cts.

Pulvex Sponge-Away. Kills fleas and lice; controls summer eczema; promotes healing of open sores when caused by scratching. Oz. 25 cts., 3 ozs. 50 cts., 8 ozs. \$1.

Pulvex Combination Treatment Worm Capsules. The Pulvex package contains capsules to give your dog a complete treatment for round, hook, and tapeworms. For puppies and dogs weighing less than 10 pounds, pkg. (16 capsules) 50 cts., pkg. (32 capsules) 75 cts.; for dogs weighing 10 pounds or over, pkg. (12 capsules) 50 cts., pkg. (24 capsules) 75 cts.

Quadine. Used by thousands of kennels and fanciers as an aid in treatment and grooming of the dog's skin and coat. Controls dandruff, fleas, mange. 2-oz. bottle 75 cts., 4-oz. \$1.25, 12-oz. \$2.50, ½gal. \$5.90, gal. \$9.50.

Quadine Crete. Quadine in ointment form. Kills fleas, chiggers and ticks. \$1.50.

Quadine Jr. Atomizer for easy application and 2-oz. bottle of **Quadine** \$2.25.

Allen's Liquid Extract of Garlic. Peps up your dog's appetite. No after odor. Dogs love it. 4-oz. bottle \$1, 12-oz. \$2.25, gal. \$15.

Pulvex Pine Oil Disinfectant. For use in the home and kennel. Has a pleasant odor. 8-oz. tin 50 cts., 1-gal. can \$3.

Delcreo. An internal medication for use in the treatment of infectious diseases. A tonic and conditioner. 4-oz. pkg. \$1.50, 16-oz. pkg. \$5.

Bee Brand Shampoo. Kills fleas on dogs and cats. 4-oz. pkg. 50 cts.

Show Coat. Cleansing pads treated with a soothing lotion that is refreshing and deodorizing. Jar (14 pads 8 by 9 in.) \$1.20.

Vita-Vura. A palatable vitamin and mineral supplement for puppies and older dogs. Give it mixed with their regular food. 5-oz. can 75 cts.

Handy Dog Booklets

Feeding the Dog
Laws about Dogs
Whelping of Puppies
House Breaking the Dog
Dog Shows and Rules
How to Ship Dogs
How to Sell Dogs

The Dog in the Show Ring
Handling the Mating Stud's Care and Management
Puppies and Their Care
Anatomy of the Dog

Each a 16-page booklet. 25 cts. each, 3 for 50 cts.

Hilo Dip. Kills fleas and lice. Removes the cause of Summer Eczema. 1-oz. bottle 25 cts., 3-oz. bottle 50 cts., 6-oz. bottle 85 cts.

Hilo Ointment. Gives quick relief and hastens the healing of sores. 1-oz. jar 25 cts., 3-oz. jar 50 cts.

Cupid Chaser. Keeps dogs from females during mating season. Bottle 75 cts.

Dog-Tex. Removes liquid dog and cat stains from carpets. Ends odor instantly. 8-oz. bottle 85 cts.

Chaperone. Keeps dogs off rugs and furniture. Harmless and odorless. Package \$1.

Magitex Bubble Shampoo. Clean pets easily—rub bubbles on—wipe off—that's all! No tub, rinsing, splashing. Removes fleas, lice on contact. Deodorizes, beautifies coat. 4-oz. bottle 60 cts., 8-oz. bottle \$1.

"Super Foamy" Bubble Bath. Can be used as a regular "old-fashioned" shampoo (with rinsing) or "modern bubble bath" style (wipe off with towel). 2-oz. bottle 25 cts., 6-oz. bottle 50 cts., 16-oz. bottle \$1.

Wash-A-Pooch Oil Shampoo. Soothing, non-irritant cleanser for dogs. Leaves the hair soft, silky and lustrous. 3-oz. bottle 35 cts., 8-oz. bottle 60 cts., 16-oz. bottle \$1.

B'have (Indoors). Keeps dogs and cats off furniture, rugs, drapes. Will not spot or stain. 3-oz. bottle 50 cts., 8-oz. bottle \$1.

B'have (Outdoors). Keeps dogs and cats away from trees and shrubs. 6-oz. bottle 50 cts., 16-oz. bottle \$1.

Retreat. Removes cat and dog stains and odors from carpets and rugs. 2-oz. bottle 25 cts., 6-oz. bottle 50 cts., 16-oz. bottle \$1.

Kazoo Sani-Dip. Pine oil coat groomer, flea killer; allays itching, and aids relief of summer eczema. 2-oz. bottle 25 cts., 8-oz. bottle 50 cts., 16-oz. bottle \$1.

Dr. Merrick's Sulfadene. Stops itching, clears up scales and sores, promotes quick healing. Applied externally. 4-oz. bottles \$1.

Pervinal

A Modern Multiple Vitamin-Mineral Syrup

Not a food—nor a substitute for food. Pervinal is a scientifically prepared syrup concentrate of vitamins A, B₁, B₂(G), B₆, Niacin, D, E and B Complex Factors from both yeast and liver extract . . . fortified with 10 nutritionally important minerals, including calcium, phosphorus and iron.

Easily fed by mixing in teaspoonful doses with dog's regular food. 10-oz. bottle \$1.35; 19-oz. bottle \$2.25; qt. \$4; gal. \$15.

Fish Foods and Supplies

Burnett's Natural Fish Food. Pkg. 10 cts.

Burnett's Dried Daphnien. Pkg. 10 cts.

Burnett's Shrimp Fish Food. Pkg. 10 cts.

Burnett's Tropical Fish Food. Pkg. 25 cts.

Burnett's Turtle Food. Pkg. 25 cts.

Spratt's Wafer Fish Food. Carton 10 cts.

Spratt's Tropical Fish Food. 10 cts. each.

Spratt's Natural Fish Food. Tin 10 cts.

PBF Aquarium Cement. ¼-lb. pkg. 25 cts.

Pabs Fish Food. 1 oz. 10 cts., ½lb. 50 cts.

Cat Foods and Medicines

Spratt's Special Tablets. A diuretic and stimulant. Pkg. \$1.

Spratt's Tonic Tablets. Pkg. 60 cts.

Spratt's Food with Fish and Milk. A complete food for cats. 6½-oz. pkg. 15 cts., 24-oz. pkg. 35 cts.

Milk-Bone Tiny Bits. A food for cats. 10¼-oz. carton 15 cts., 3 for 40 cts.

Catnip Mouse. Makes kittens playful. Pkg. 15 cts.

Bird Foods and Remedies



Spratt's Canary Mixture with Egg-Flake and Fruit. 15-oz. pkg. 25 cts.

Spratt's Cod-Liver Oil Cage-Bird and Nestling Food. For feeding young birds and old birds in the moulting season. A tonic and flesh- and bone-maker. Unequaled as an aid to

feather-growth. 4-oz. pkg. 15 cts.

Spratt's Song Food. Strengthens the voice. 3-oz. pkg. 25 cts.

PBF Bird Manna. For health and song. Pkg. 15 cts.

Spratt's Tonic for Birds. 1-oz. bottle 15c.

Justrite Parrot Mixture. Combination of selected seeds, etc. 16-oz. pkg. 45 cts.

PBF Parrot Biscuit. Specially prepared biscuits for parrots. 1-lb. pkg. 45 cts.

Burnett's Pep. Keeps cage-birds in constant song, improves their plumage, and prevents disease. Pkg. 10 cts.

Silver Brand Bird Gravel. 30-oz. pkg. 15c.

Chamberlain's Perfect Bird Food. Canary seed mixture with vegetable and egg flakes. 11-oz. can 25 cts., 55-oz. can \$1.

Burnett's Bird Nesting. Pkg. 10 cts.

Burnett's Canary Louse Powder. 2-oz. pkg. 25 cts.

Burnett's Unexcelled Bird Food. A song restorer. 3½-oz. pkg. 25 cts.

Burnett's Bird-Wash. For use on canary birds and parrots. 3-oz. pkg. 25 cts.

Burnett's Bird Tonic. For loss of song, weakness, or moulting, asthma or hard breathing and colds. 3-oz. pkg. 25 cts.

Recleaned Canary Seed, in bulk. Keeps canaries in full song. Lb. 20 cts., 3 lbs. 55 cts., 10 lbs. \$1.75.

Bird Rape Seed, in bulk. Lb. 35 cts., 2 lbs. 65 cts., 10 lbs. \$3.

Scott's Canary Seed Mixture, in bulk. Best re-cleaned Canary and Japanese Rape Seed. Lb. 30 cts., 2 lbs. for 55 cts.

Scott's Wild Bird Seed Mixture

A well-balanced, all-year-round ration prepared especially for wild birds. Contains peanut hearts, sunflower and many other kinds of seed. Birds love it. 5-lbs. 75 cts., 10 lbs. \$1.35, 25 lbs. \$3, 50 lbs. \$5.85, 100 lbs. \$11.25.

BIRDS OF PENNSYLVANIA

By George M. Sutton

Written for the beginner who is anxious to know the birds we all see daily. 169 pages, 175 drawings. \$1.

INDEX

Page		Page	
54	Abelia.....	33	Carnations.....
30	Acroclinium.....	9	Carrots.....
47	Adams' Needle.....	34	Castor-Oil Bean.....
65	Adco.....	91	Cat Foods and Remedies.....
36	African Daisy.....	9	Cauliflower.....
30	Ageratum.....	53	Celastrus.....
62, 63	Agrico.....	9	Celeriac.....
58	Alfalfa Seed.....	9	Celery.....
54	Almond, Flowering.....	34	Celoxia.....
54	Althea.....	9	Celutze.....
60	Aluminum Sulphate.....	34	Centaurea.....
31	Alyssum.....	34	Cerastium.....
59	Amaranthus.....	69	Ceresan.....
46	Amber Cane.....	14	Chervil, Curled.....
14	Anemone.....	5	Chicory.....
68	Anise.....	9	Chinese Cabbage.....
31	Ant Killers.....	35	Chinese Forget-me-not.....
31	Antirrhinum.....	40	Chinese Lantern Plant.....
31	Aquilegia.....	34	Chinese Woolflower.....
31	Arabis.....	14	Chives.....
54	Arbutus.....	54	Chokeberry.....
31	Arctotis.....	34	Chrysanthemums.....
31	Armeria.....	53	Cinnamon Vine.....
54	Aronia.....	18	Citron.....
66	Arsenate of Lead.....	34	Clarkia.....
2	Artichoke.....	78	Cleaner and Cleanser.....
32, 3d Cov.	Asparagus.....	53	Clematis.....
54	Asters.....	45, 58	Clover Seed.....
37	Azaleas.....	34	Cobaea.....
34	Baby's Breath.....	34	Cockscomb.....
78	Bachelor's Button.....	84	Cod-Liver Oil.....
40	Bag Balm.....	34	Coleus.....
32	Balloon Flower.....	12	Collards.....
14	Balloon Vine.....	31	Columbine.....
32	Balm.....	67	Copper Sulphate.....
32	Balsam.....	33, 34	Coreopsis.....
39	Balsam Apple.....	14	Coriander.....
39	Balsam Pear.....	34	Cornflower.....
53	Barberry.....	60	Corn, Ensilage.....
61	Barley.....	60	Corn, Field.....
14	Basil, Sweet.....	34	Corn, Ornamental.....
3-5	Beans.....	12	Corn, Pop.....
54	Beauty Bush.....	12	Corn Salad.....
76, 77	Bee Supplies.....	11	Corn, Sweet.....
6	Beet.....	69	Corn, White.....
s32, b46	Begonia.....	35	Corrosive Sublimate.....
32	Bellis.....	54	Cosmos.....
45	Bent Grass.....	54	Cotoneaster.....
69	Bichloride of Mercury.....	78	Cow Hobble.....
53	Bignonia.....	65	Cow Manure.....
91	Bird Supplies.....	78	Cow Medicines.....
53	Bittersweet.....	59	Cowpeas.....
78, 86	B-K Disinfectant.....	75	Crates, Fruit and Vegetable.....
57	Blackberries.....	12	Cress.....
42	Black-eyed Susan.....	70	Crow Repellent.....
66, 86	Black-Leaf 40.....	66	Cryolite.....
36	Blanket Flower.....	12	Cucumber.....
47	Bleeding-Heart.....	73	Cultivators, Garden.....
45, 59	Blue Grass.....	33	Cup-and-Saucer.....
35	Blue Lace Flower.....	34	Cup-and-Saucer Vine.....
67	Blue Vitriol.....	67	Cupro-K.....
64	Bone Meal.....	57	Currants.....
43, 86, 91	Books.....	37	Cut-and-Come-Again.....
14	Borage.....	67, 68	Cyanogas.....
67	Bordeaux Mixture.....	54	Cydonia.....
16	Borecole.....	35	Cynoglossum.....
53	Boston Ivy.....	34	Cypress Vine.....
57	Boysenberry.....	46	Daffodil, Peruvian.....
55	Bridal Wreath.....	s35, b49	Dahlia.....
2	Broccoli.....	36	Daisy, African.....
79, 80, 83	Brooders.....	32	Daisy, English.....
2	Brussels Sprouts.....	40	Daisy, Painted.....
55	Buckthorn.....	34	Daisy, Shasta.....
61	Buckwheat.....	14	Dandelion.....
54	Buddleia.....	68	Dandelion Killer.....
54	Burning Bush.....	47	Daphne.....
41	Butterfly Flower.....	78	Dehorner.....
6	Cabbage.....	35	Delphinium.....
46	Caladium.....	54	Deutzia.....
66	Calcium Arsenate.....	35, 42	Dianthus.....
68	Calcium Cyanide.....	47	Dicentra.....
33	Calendula.....	35	Didiscus.....
36	California Poppy.....	35	Digitalis.....
53	California Privet.....	14	Dill.....
33	Calliopsis.....	36	Dimorphotheca.....
54	Calycanthus.....	67	Dinitro.....
33	Campanula.....	69, 78, 86, 91	Disinfectants.....
59	Canada Field Peas.....	88-91	Dog Foods and Remedies.....
33	Canary Bird Vine.....	54	Dogwood.....
91	Canary Seed.....	73	Dusters.....
33	Candytuft.....	34	Dusty Miller.....
s33, b47	Cannas.....	53	Dutchman's Pipe Vine.....
18	Cantaloupe.....	72	D.X. Spray.....
33	Canterbury Bells.....	80, 86	Egg Carriers.....
14	Caraway.....	85	Egg Preserver.....
68	Carbon Disulphide.....	82	Egg Scales.....
34	Cardinal Climber.....	14	Eggplant.....
12	Cardoon.....	54	Elaeagnus.....
75	Electric Fence Con-troller.....	46	Ismene calathina.....
46	Japan Quince.....	54	Japan Quince.....
70	Japanese Beetle Traps.....	37	Job's Tears.....
31	Joseph's Coat.....	16	Kale.....
55	Kerria.....	38	Kochia.....
16	Kohlrabi.....	59	Korean Clover.....
78	Kow Kare.....	78	Kow Kare.....
53	Kudzu Vine.....	73	Labels.....
75	Ladders.....	32	Lady's Slipper.....
38	Lantana.....	38	Larkspur.....
35, 38	Larkspur.....	38	Lathyrus.....
14	Lavender.....	73	Lawn Covering.....
73	Lawn Seeding.....	44, 45	Lawn Seeds.....
18	Leek.....	82	Leg Bands.....
69	Legume-Aid.....	59	Lespedeza.....
16	Lettuce.....	55	Lilac.....
38, b47	Lily.....	47	Lily-of-the-Valley.....
64, 67	Lime.....	67	Lime-Sulphur.....
38	Linaria.....	38	Linum.....
78	Liquid Smoke.....	38	Lobelia.....
38	Lonicera.....	53, 54	Loniceria.....
39	Love-in-a-Mist.....	32	Love-in-a-Puff.....
37	Lunaria.....	38	Lupins.....
53	Madeira Vine.....	66	Magnesium Arsenate.....
6	Mangel-Wurzel.....	39, 3d Cov.	Marigold.....
14	Marjoram, Sweet.....	37	Marsh-Mallow.....
47	Marsh Plants.....	36	Marvel of Peru.....
36	Matricaria.....	38	Mesembryanthemum.....
38	Mexican Firebush.....	38	Mexican Sunflower.....
42	Michaelmas Daisy.....	38	Mignonette.....
38	Milk Bottle Caps.....	78	Milk Filter Discs.....
78	Milk.....	59	Millet.....
64	Milorganite.....	38	Mimulus.....
36	Mirabilis.....	55	Mock Orange.....
68	Mole Exterminators.....	39	Momordica.....
37	Moonflower.....	37	Morning-Glory.....
41	Mourning Bride.....	68	Mouse Killers.....
68	Mushroom Spawn.....	38	Musk Plant.....
38	Muskmelon.....	18	Mustard.....
18	Myosotis.....	38	Myrtle.....
47	Nasturtiums.....	39	Nests.....
82, 83	Nico-Fume.....	67	Nicotiana.....
39	Nicotine Pyrox.....	71	Nicotine Sulphate.....
66	Nigella.....	39	Nitrate of Soda.....
64	Oats.....	61	Okra.....
18	Onion Plants.....	20	Onion Seed.....
20	Onion Sets.....	20	Orchard Grass.....
59	Ornamental Grass.....	37	Oxalis.....
46	Oyster Plant.....	24	Pain.....
70	Painted Tongue.....	41	Pansies.....
40	Paradichlorobenzene.....	41	Papaver.....
66	Paris Green.....	20	Parsley.....
20	Parsnip.....	20	Pasture Mixture.....
58	Peas.....	22, 23	Peat Moss.....
65	Peonies.....	49	Peppers.....
21	Peppermint.....	14	Perennial Plants.....
47	Periwinkle, Madagascar.....	40, 3d Cov.	Petunias.....
55	Philadelphia.....	41	Physalis.....
40	Pin-Cushion Flower.....	35	Pinks.....
74	Plant Boxes.....	73	Plant Supports.....
65	Plan Tabbs.....	40	Platycodon.....
53	Polygonum.....	47	Pond Plants.....
41	Poppy.....	40	Portulaca.....
73	Pot Labels.....	61	Potatoes.....
81, 83	Poultry Feeders.....	87	Poultry Feeds.....
84-86	Poultry Remedies.....	81, 83	Poultry Waterers.....
40	Primrose.....	40	Primula.....
53	Privet.....	23	Pumpkin.....
55	Pussy Willow.....	40	Pyrethrum.....
66, 71	Pyrox.....	24	Radish.....
73	Raffia.....	34	Ragged Sailor.....
46	Ranunculus.....	59	Rape, Dwarf Essex.....
57	Raspberries.....	68	Red Exterminators.....
45, 59	Ret-Top Seed.....	38	Reseda.....
55	Rhodanth.....	41	Rhodotypos.....
55	Rhubarb.....	24	Rhubarb.....
34	Ricinus.....	68	Roach Killer.....
31	Rock-Cress.....	43	Rock-Garden Seed Mix-ture.....
37	Rocket.....	70	Roosters.....
54	Rose of Sharon.....	50-52	Roses.....
66, 71	Rotoneone Dust.....	14	Rue.....
27	Rutabaga.....	61	Rye.....
45, 59	Rye grass.....	78	Saddle Soap.....
14	Saffron.....	14, 14	Sage.....
41	Salpiglossis.....	24	Salsify.....
78, 85	Salvia.....	41	Satin Flower.....
36	Sausage Seasoning.....	78	Savory, Summer.....
14	Scabiosa.....	41, 3d Cov.	Scalcide.....
72	Scarlet Trumpet Vine.....	53	Schizanthus.....
41	Sea-Pink.....	31	Seed Disinfectants.....
69	Seed Flats.....	74	Seed Sower.....
58	Shasta Daisy.....	65	Sheep Manure.....
78	Shrub Medicines.....	54, 55	Shrubs, Flowering.....
74	Sieves.....	53	Silver Lace Vine.....
53	Silverberry.....	54	Slug Shot.....
66	Smoked Salt.....	78	Snapdragon.....
31	Snow-in-Summer.....	34	Snow-on-the-Mountain.....
47	Snowball.....	39	Soil Disinfectants.....
73	Soil-Soakers.....	64	Soil-Testers.....
59	Sorghum.....	5, 61	Soy Beans.....
42	Speedwell.....	24, 25	Spinach.....
55	Spiraea.....	70, 73	Sprayers.....
73	Spreads, Spray.....	73	Sprinklers, Lawn.....
27	Squash.....	73	Stakes.....
55	Stephanandra.....	41	Stocks.....
78	Stock Remedies.....	37	Straw Flower.....
57	Strawberry Plants.....	54	Strawberry Shrub.....
59	Sudan Grass.....	67, 72	Sulphur.....
38	Summer Cypress.....	46	Summer Hyacinth.....
37	Sunflower.....	37	Superphosphate.....
63	Swan River Everlasting.....	27	Swede Turnip.....
14	Sweet Marjoram.....	38, 42	Sweet Pea.....
54	Sweet Shrub.....	34	Sweet Sultan.....
42	Sweet William.....	6	Swiss Chard.....
54, 55	Symphoricarpos.....	39	Tagetes.....
55	Syringa.....	55	Tamarix.....
27	Tampala.....	14	Tansy.....
14	Tarragon.....	66	Tartar Emetic.....
74, 82	Thermometers.....	42	Thunbergia.....
14	Thyme.....	33	Tickseed.....
45, 59	Timothy Seed.....	42	Tithonia.....
38	To		

From

.....

.....

THE I. W. SCOTT CO.

500 LIBERTY AVE. & 113 DIAMOND ST.

PITTSBURGH 22, PA.

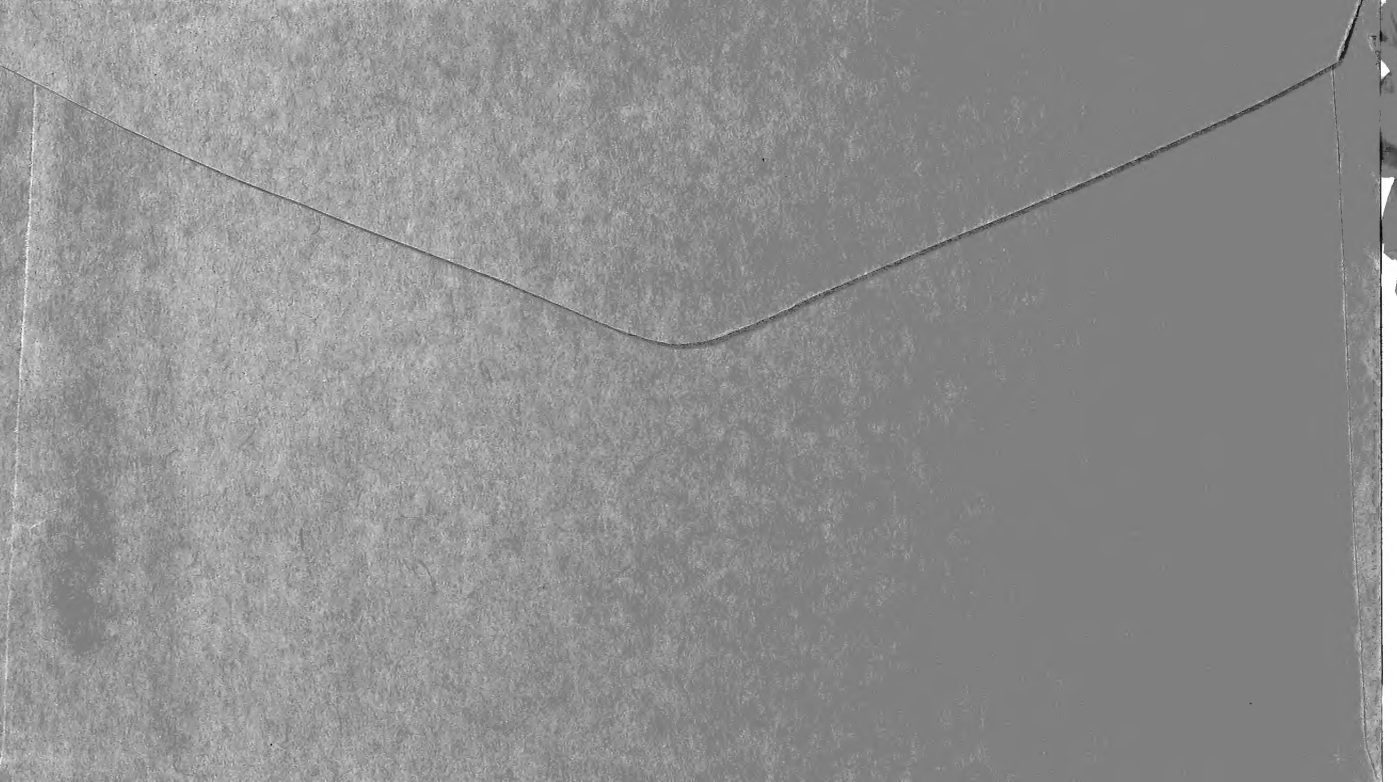

5 Beautiful ANNUALS

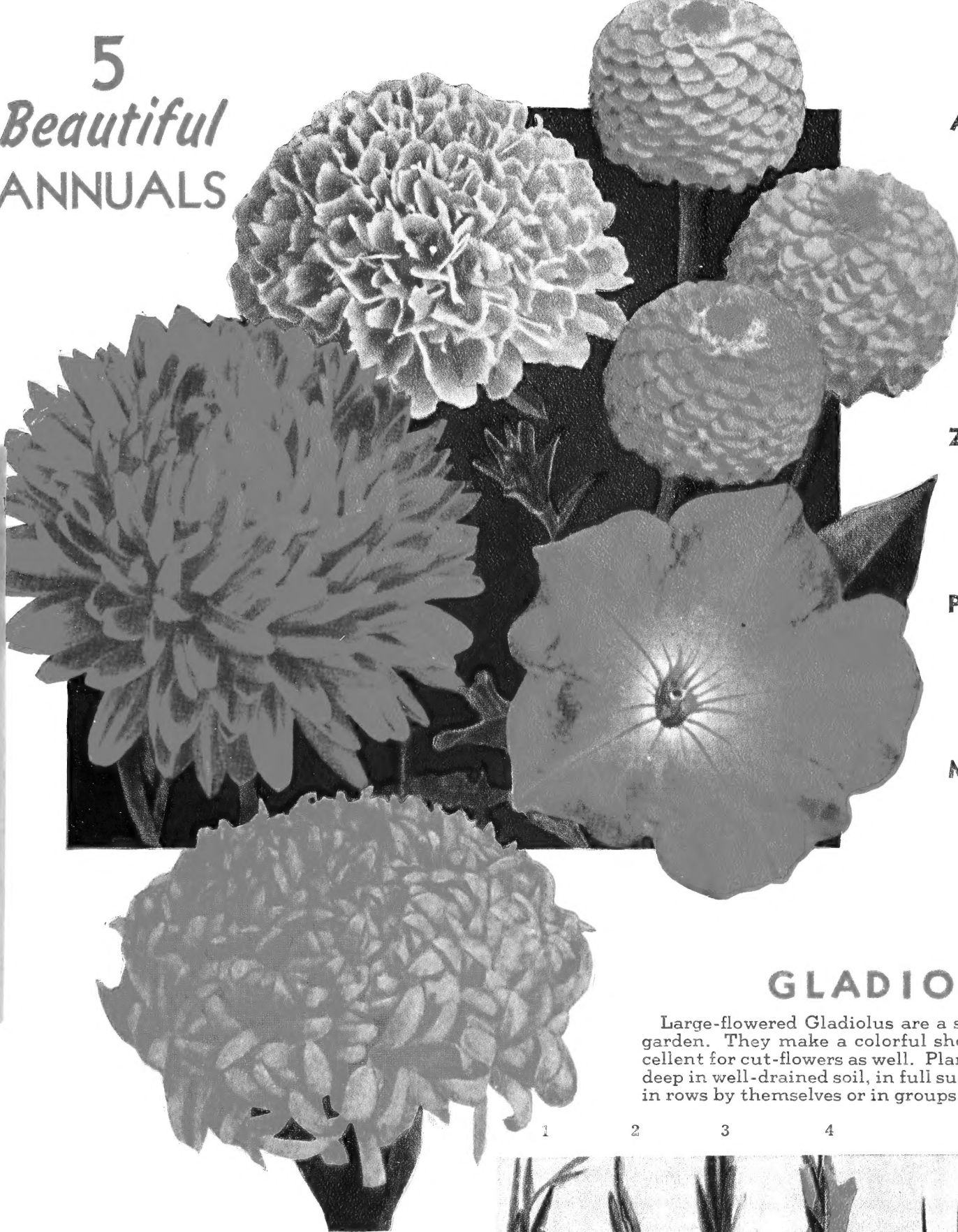

ASTER

Heart of France. Large, double, ruby-red. See page 32. Pkt. 25 cts.

SCABIOSA

Blue Moon. Wavy petals of lavender-blue. See page 41. Pkt. 25 cts.

ZINNIA

Pompon, Mixed Colors. Dwarf plants with attractive small blooms. See page 43. Pkt. 10 cts.

PETUNIA

Rose of Heaven. Lovely rose-color, with light throat. See page 40. Pkt. 10 cts.

MARIGOLD

Yellow Supreme. Lemon-yellow flowers 4 inches across. See page 39. Pkt. 15 cts.

GLADIOLUS

Large-flowered Gladiolus are a standby for the summer garden. They make a colorful show outdoors and are excellent for cut-flowers as well. Plant the bulbs 4 to 5 inches deep in well-drained soil, in full sun. They may be planted in rows by themselves or in groups in the perennial border.

1 2 3 4 5 6 7

Gladiolus Collection

- | | |
|----------------------|------------------|
| 1. Dr. F. E. Bennett | 5. Yellow Wonder |
| 2. Paradise | 6. Pelegrina |
| 3. Marmora | 7. Picardy |
| 4. Dream of Beauty | |

21 bulbs, 3 each of 7 varieties, \$1.70
 42 bulbs, 6 each of 7 varieties, \$3.00
 84 bulbs, 12 each of 7 varieties, \$5.70





SCOTT'S *Purity* LAWN GRASS SEED

FOR A RICH, GREEN LAWN

THIS mixture is the result of over a quarter of a century of testing and improving. We don't claim it is perfect—nothing is—but we do honestly believe that it is the best Lawn Grass Mixture that can be sold at the moderate price we ask for Scott's Purity.

The seeds in this mixture are the highest grade of re-cleaned seeds procurable. They are tested for quick germination and freedom from weeds and unwanted grasses.

Scott's Purity makes a lustrous, springy turf of an even tone of rich green, with long roots that will keep the lawn in place during winter.

Sow at the rate of 1 pound to each 250 square feet or 150 pounds per acre. A measured bushel will weigh about 27 pounds.

1/2-lb. carton.....	\$0 35	10-lb. bag.....	\$5 00
1-lb. carton.....	60	25-lb. bag.....	12 00
2-lb. carton.....	1 10	50-lb. bag.....	23 50
5-lb. carton.....	2 65	100 lbs.....	45 00

Fertilize Lawns with AGRICO for Greater Health and Beauty

Most run-down lawns and lawn failures are due to lack of plant-food. Grass, like every living, growing thing, must be fed to maintain health and vigor. AGRICO FOR LAWNS, TREES and SHRUBS is the complete plant-food, specially made to provide all needed plant-foods in just the right proportions to stimulate a thick, lush growth of deep-rooted lawn grass. If you have a good lawn, keep it that way by feeding it with Agrico every every spring and fall. If your lawn is run down and you plan to repair or rebuild it, Agrico can insure your investment in lawn seed and labor. And don't forget your trees and shrubs. Feed them with Agrico and see them respond with new growth and more luxuriant foliage. Use this Agrico for flower gardens, too. Economical, easy to use—full directions in every bag.

5-lb. bag.....	\$0 45	50-lb. bag.....	\$2 50
10-lb. bag.....	80	100-lb. bag.....	4 00
25-lb. bag.....	1 50	500 lbs.....	18 00



"LAWNS—HOW TO MAKE AND MAINTAIN THEM"—A carefully prepared leaflet FREE to those who ask for it

ESTABLISHED
1876

The I. W. SCOTT COMPANY

500 LIBERTY AVE. • 113 DIAMOND ST. • PITTSBURGH 22, PA.

1945