

Historic, Archive Document

Do not assume content reflects current scientific knowledge, policies, or practices.



62.31

Bunton's Seeds

LIBRARY *and* RECEIVED
Equipment
 U. S. Department of Agriculture
For Garden

Farm and Lawn

1947



B. B. COMET

TENDERGREEN

RUTGERS

BUNTON SEED COMPANY

INCORPORATED

Floyd and Jefferson Streets • LOUISVILLE 2, KENTUCKY

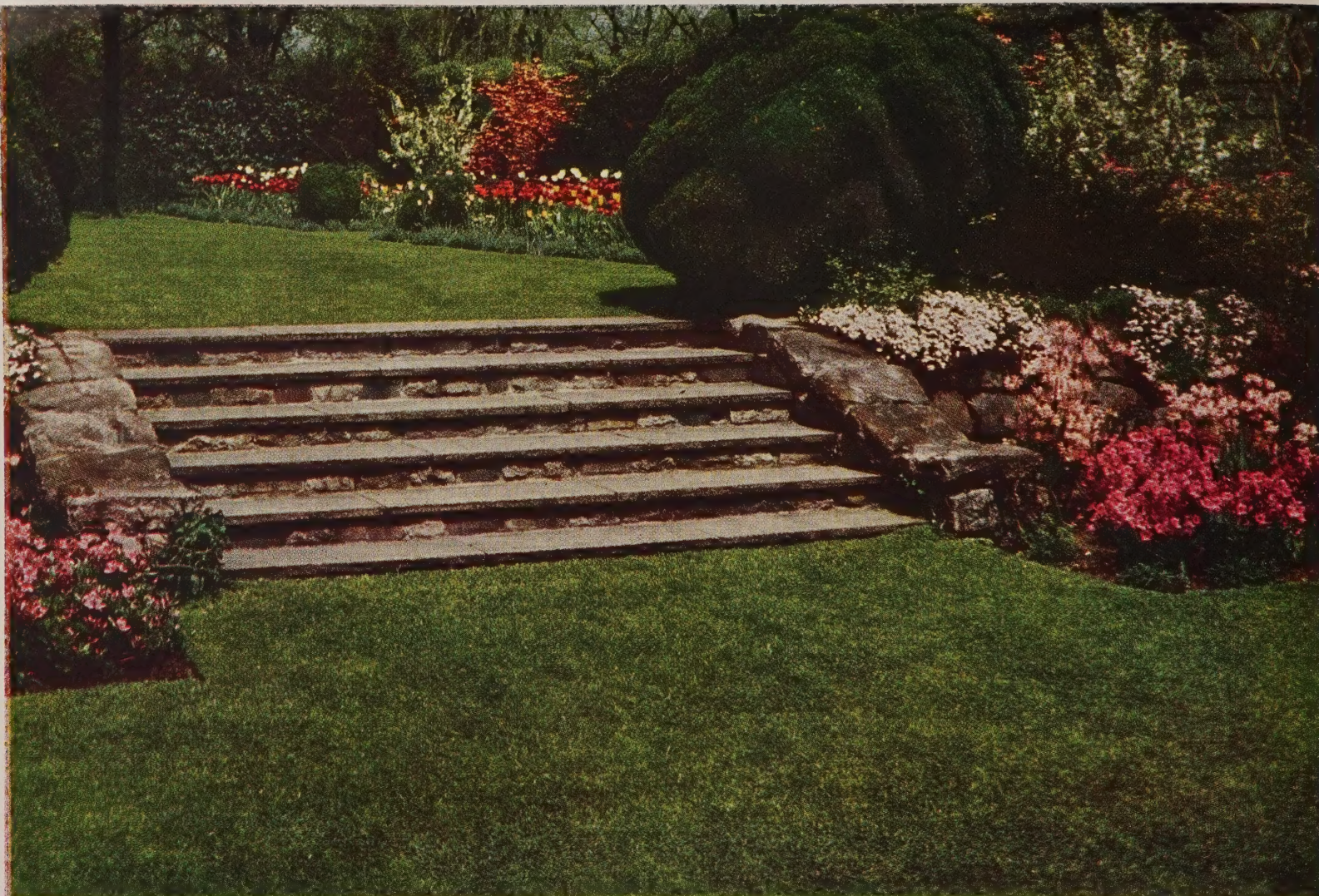

BUNTON'S LAWN SEEDS

Have a Growing Reputation

B. B. LAWN SEED

Super Quality

A combination of the grasses best adapted for making a permanent lawn in this section. The proper blend of B. B. Ky. Blue-grass, B. B. Red Top and White Dutch Clover. 1 lb. sows 300 sq. ft., 100 lbs. per acre. Not available.

EVERGREEN LAWN SEED

A combination of Blue-grass, Red Top and White Dutch Clover for open lawns. Price, 1 lb. \$1.05; 3 lbs. \$3.00; 5 lbs. \$4.90; 10 lbs. \$9.75; 20 lbs. \$19.25; 50 lbs. \$47.50; 100 lbs. \$95.00.

KENTUCKY BLUE-GRASS

No other grass is its equal for permanent lawns when conditions are favorable. 1 lb. sows 300 sq. ft., 100 lbs. per acre. Price, 1 lb. \$1.30; 3 lbs. \$3.75; 5 lbs. \$6.20; 10 lbs. \$12.25.

BUNTON'S MAPLE-SHADE LAWN SEED

(Grows Under Maple Trees)

The low-feeding characteristics of the grasses in this mixture make it better adapted where there are shallow fibrous rooted trees in the lawn, especially water or solar Maples. Plant food should be used regularly. Sow 1 lb. of Maple-Shade to 300 sq. ft. Price, 1 lb. \$1.20; 3 lbs. \$3.45; 5 lbs. \$5.75; 10 lbs. \$11.45; 20 lbs. \$22.60; 50 lbs. \$52.50.

B. B. SHADY GREEN LAWN SEED

Super Quality

Solves the problem of growing fine grass in shady locations. 1 lb. sows 300 sq. ft. Price, 1 lb. \$1.20; 3 lbs. \$3.45; 5 lbs. \$5.75; 10 lbs. \$11.45; 20 lbs. \$22.60; 50 lbs. \$52.50.

B. B. TERRACE TURF SEED

A grass that will give satisfactory results on terraces and steep embankments. Price, 1 lb. 75c.; 3 lbs. \$2.15; 5 lbs. \$3.50; 10 lbs. \$6.75; 20 lbs. \$13.25.

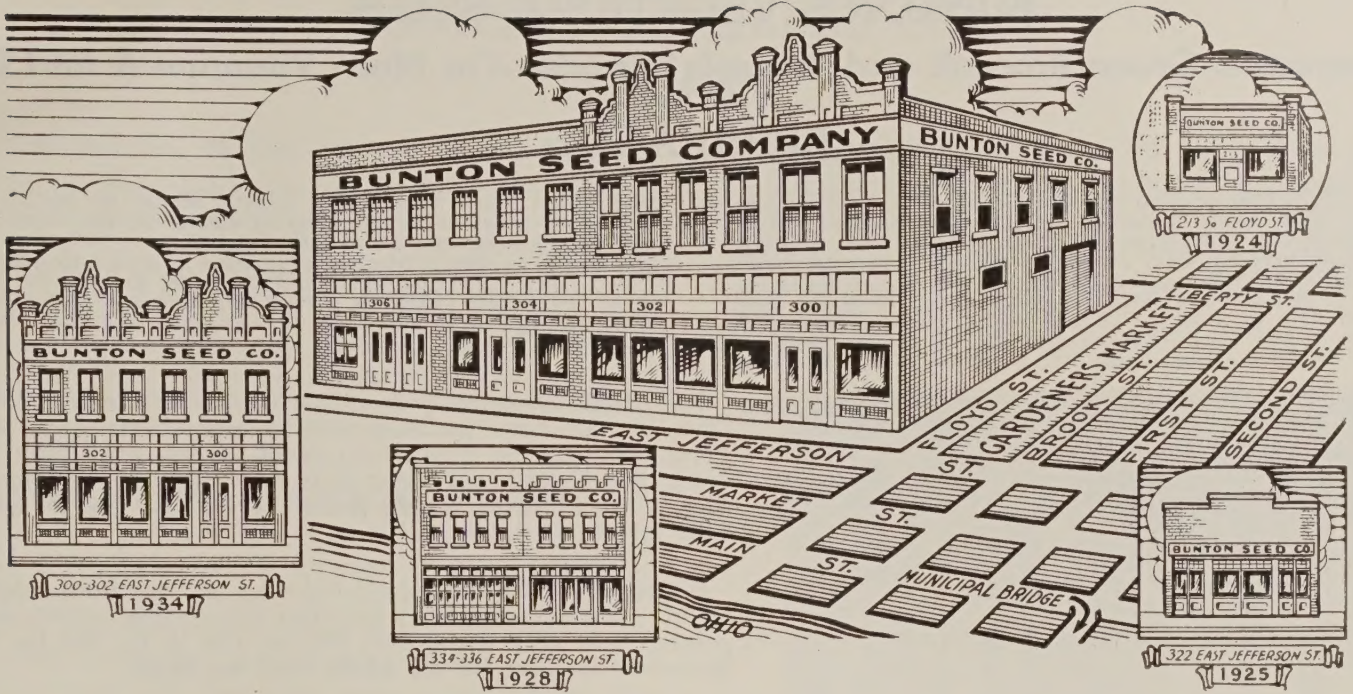

Your preference for the best seeds and equipment for lawns and gardens makes it a pleasure for us to serve you. Gardening will even be more fun and made easier this year with the new equipment and garden accessories now available. Improved strains of seed and better equipment now make it possible to raise more food in less space. You will always find the tastiest and most nutritious vegetables in your own garden.

More equipment is becoming available. However, we still have many unfilled orders for certain models of power mowers, garden tractors, etc. We will continue to hold your order until delivery is made, or the order is cancelled at your request. If an order has not been placed for your needed equipment, please let us know now what your requirements are, so delivery can be made to you soon as possible.

To serve you better, we have enlarged our Service Department and added the latest shop equipment. This Service Department is dedicated to give you longer and better service from your lawn and garden equipment.

INFORMATION TO CUSTOMERS

All prices in this Catalog are those in effect January 1, 1947, and are f. o. b. Louisville, except where otherwise noted, and subject to change without notice.

★Leading varieties are prefixed with number of stars according to comparative popularity of those listed. If you are not familiar with variety names follow the stars in making your selection.

POSTAGE. We pay postage on all packets, ounces and quarter pounds only of Garden and Flower Seed at prices named in Catalog.

BUNTON SEED COMPANY gives no warranty, express or implied, as to the productiveness, of any Seeds or Bulbs, it sells, and will not be in any way responsible for the crop. Our liability, in all instances, is limited to the purchase price of the seeds.

POSTAGE AND PACKING—ZONES FROM LOUISVILLE, KY.

Zone	Miles	For first pound, allow	For each additional pound, add	Zone	Miles	For first pound, allow	For each additional pound, add
First	50.....	.09	.01	Fifth	600 to 1000.....	.12	.06
Second	50 to 150.....	.09	.01	Sixth	1000 to 1400.....	.13	.07
Third	150 to 300.....	.10	.02	Seventh	1400 to 1800.....	.15	.09
Fourth	300 to 600.....	.11	.04	Eighth	1800.....	.16	.11

BUNTON'S VEGETABLE SEEDS

Asparagus, Green Broccoli and Brussels Sprouts—For More Vitamins A and B 1

ASPARAGUS

CULTURE—After soaking seed in warm water 1 to 2 hours, sow in drills about 18 inches apart during Spring or Fall. Thin plants out to 3 inches apart and give frequent thorough cultivation, keeping them free from weeds. The roots should be transplanted when 1 or 2 years old into a permanent bed of the richest soil you have. Open a trench 15 inches deep and put in 8 or 9 inches of well rotted manure; cover with 2 inches of soil; then place the roots 12 inches apart, with the crowns facing one way; cover with 4 inches of soil. The rows

should be 5 feet apart. The growth should be cut in the Fall after which a top dressing of stable manure should be applied, this to be worked into the soil very early the next Spring. It is also advisable to sprinkle a little salt over the bed. Only light cuttings should be made the second year. After the cutting season is over, spray with a combination of Bordeaux and Arsenate of Lead to prevent rust and kill the Asparagus Beetle.

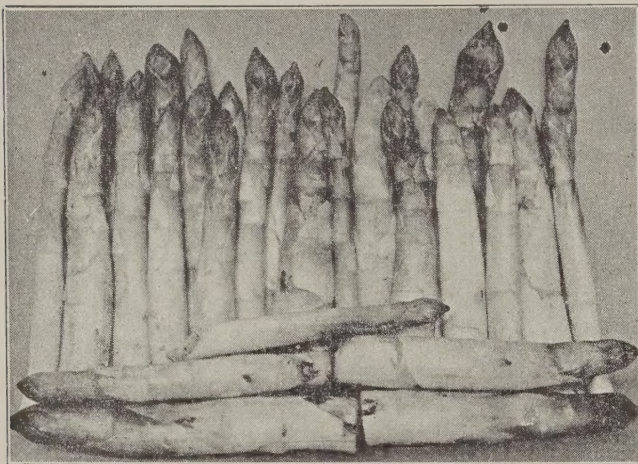

Washington Asparagus

PARADISE—Especially desirable for its outstanding flavor. One of the best varieties for freezing. This new type Asparagus can be grown from seeds in one year, plant the seeds this Spring, cut Asparagus next Spring. Pkt. 20c; oz. 50c; ¼ lb. \$1.50; lb. \$5.00. Roots—25 for 45c; 100 for \$1.50; 1,000 for \$14.00.

PALMETTO (An Old Stand-By)—An old standard variety for all purposes. Vigorous growing dark green variety with pointed tips; very early. Pkt. 10c; oz. 15c; ¼ lb. 30c; lb. 75c; Roots—25 for 35c; 100 for \$1.00; 1,000 for \$9.00.

★**WASHINGTON** (The Large White Asparagus)—This variety is especially adapted for market gardeners, as well as the home garden. Has large, straight shoots, tight pointed buds and does not branch out until well beyond the time for cutting. Practically free from rust and other diseases. Pkt. 10c; oz. 15c; ¼ lb. 40c; lb. \$1.25. Roots—25 for 50c; 100 for \$1.25; 1,000 for \$11.00.

BROCCOLI

CULTURE—Same as Cauliflower or Cabbage.

EARLY GREEN CALABRESE—Have broccoli in your garden, it is a splendid green vegetable that continues to bear for several weeks. For two crops plant early in spring and July. This variety produces a bluish green head at center of plant in about 90 days. After this center head is cut, the plant produces many branches, each bearing small heads that are as desirable as the first. Usually continues to bear until freezing weather. The heads with 3 to 4 inches of stem are used and served like asparagus or cauliflower. Pkt. 10c; oz. 30c; ¼ lb. 85c; lb. \$3.00.



Calabrese Broccoli

BRUSSELS SPROUTS

CULTURE—Sow seeds in cold frames or open ground. Transplant the same as cabbage in the early Spring and up to July. Make rows 3 feet apart having the plants standing 15 inches apart in the row. Cultivate the same as cabbage. An ounce will produce about 2,500 plants. Matures in about 125 days.

LONG ISLAND IMPROVED—Stems grow about two feet in height and are thickly set with the sprouts forming small cabbage-like heads. Pkt. 10c; oz. 35c; ¼ lb. \$1.00.



Brussels Sprouts
Long Island Improved

MOON SIGN BOOK



A GREAT MANY PEOPLE
Believe in Planting by Moon Signs.

If you want to try planting by the Signs, you need the "Moon Sign Book" for complete and correct information to profit by age-old knowledge brought up-to-date for the use of progressive people. Written by Llewellyn George, well known author and lecturer, its 256 pages are crammed with practical, usable information for use in daily activities by everyone.

Tables for planting, hatching, fishing, destroying weeds—and other important every-day jobs—make this book easy to use by anyone. Try it once, and you'll never again miss the opportunity to increase the quantity and improve the quality of produce and live-stock.

In addition to the complete instructions and auspicious dates for planetary planting, the "Moon Sign Book" also gives helpful information, dates, etc., concerning personal, business, domestic and social affairs. 41st annual edition.

Price \$1.00

BUNTON'S GREEN-POD BEANS

(DWARF)

1 Pt. Will Plant 200 Feet of Drill. 1 Bu. to the Acre.

CULTURE—Sow seeds in row 24 to 36 inches apart, dropping the beans 3 inches apart in the row, cover 2 inches deep. Hoe as soon as seedlings appear. When the second or third pair of leaves begin to form, hill the rows slightly toward the plant. Repeat the hilling process as the plants grow larger. Never cultivate while the bushes are wet with dew or rain. For succession of young tender pods, sow every two weeks up to August 15th. A frequent picking of pods will keep the plants bearing. If the soil is not fertile, drill B-B Grower in the rows before seeds are dropped.

★★★★**IMP'D BURPEE STRINGLESS GREEN POD**—(50 days). A splendid improved selection of Burpee Stringless Green Pod. One of the best for truck gardening, shipping, home garden or canning. The foliage is darker than Old Burpee, more hardy and heavily productive. Dark pods 6 inches long are straighter, more slender and hold the snap bean stage longer. Fine quality, entirely stringless and fiberless. Pkt. 10c; pt. 35c; qt. 60c; 1/2 gal. \$1.00; gal. \$1.90; peck \$3.50; 1/2 bu. \$6.65; bu. \$13.00.

KEYSTONIAN—(52 days). A new round, stringless, fiberless, solid bean with fine grained flesh and straight, dark green pods 6 to 6 1/2 inches long. The prolific vines are strong and sturdy making an upright plant about 18 inches tall. Excellent for canning, freezing or shipping. Pkt. 10c; pt. 50c; qt. 85c; 1/2 gal. \$1.40; gal. \$2.60; peck \$4.75; 1/2 bu. \$9.15; bu. \$18.00.

PLENTIFUL—(50 days). An outstanding flat pod variety. The pods are 7 to 7 1/2 inches long, thick, medium green, slightly curved, firm and have a very good flavor. Very productive. Seed black. Pkt. 10c; pt. 35c; qt. 60c; 1/2 gal. \$1.00; gal. \$1.90; peck \$3.50; 1/2 bu. \$6.65; bu. \$13.00.

★★**BOUNTIFUL**—(48 days). The plants are very vigorous and disease resistant. Pods average 6 inches long, are thick through and of a light green color. They are very brittle and absolutely stringless at all stages. Pkt. 10c; pt. 35c; qt. 60c; 1/2 gal. \$1.00; gal. \$1.90; peck \$3.50; 1/2 bu. \$6.65; bu. \$13.00.

★★★★**FULL MEASURE**—(54 days). A very fine, early, stringless variety. The pods are medium green, round, straight, about six inches long and of very good quality. The foliage is strong and vigorous. Pkt. 10c; pt. 35c; qt. 65c; 1/2 gal. \$1.10; gal. \$2.00; peck \$3.75; 1/2 bu. \$7.15; bu. \$14.00.

★★**GIANT STRINGLESS**—(53 days). A splendid stringless green pod bean for home gardens, market or canning. It is very early, producing handsome, meaty, round pods about six inches long, perfectly stringless, brittle and of fine, tender quality. Pkt. 10c; pt. 35c; qt. 60c; 1/2 gal. \$1.00; gal. \$1.90; peck \$3.50; 1/2 bu. \$6.65; bu. \$13.00.

STREAMLINER—(55 days). A new white seeded green pod variety, a heavy yielder with exceptional vigor and resistance to cold. The pods are about 7 inches long, stringless, and fiberless. Pkt. 10c; pt. 35c; qt. 60c; 1/2 gal. \$1.10; gal. \$2.00; peck \$3.75; 1/2 bu. \$7.15; bu. \$14.00.

★★★**TENDERGREEN**—(53 days). An outstanding green podded bean of highest quality, splendid for home use, as well as canning. Plants are large, erect and prolific, with large dark green leaves. Pods are 5 1/2 to 6 1/2 inches long, nearly straight, round, absolutely stringless and fiberless, fleshy, smooth and very attractive. Pkt. 10c; pt. 35c; qt. 60c; 1/2 gal. \$1.10; gal. \$2.00; peck \$3.75; 1/2 bu. \$7.15; bu. \$14.00.

LONGREEN—(56 days). Similar to Tendergreen with the exception that the pod is considerably longer. The stringless pods are round, straight, dark green and 7 inches long. Pkt. 10c; pt. 35c; qt. 60c; 1/2 gal. \$1.10; gal. \$2.10; peck \$4.00; 1/2 bu. \$7.65; bu. \$15.00.

★**TENNESSEE GREEN POD**—(49 days). One of the very earliest and most productive of green pods. Pods 6 to 7 inches long, broad and flat, nearly stringless and of an exceptionally fine flavor. Pkt. 10c; pt. 35c; qt. 60c; 1/2 gal. \$1.00; gal. \$1.90; peck \$3.50; 1/2 bu. \$6.65; bu. \$13.00.



Keystonian

WAX-POD, SHELL-OUT and POLE BEANS

POLE OR CORNFIELD BEANS

1 Pint Will Plant 250 Hills

CULTURE—Pole beans should be planted in hills 4 feet each way and about the same time as the dwarf varieties. If not convenient to secure poles, a trellis can be made by placing a good strong wire 6 feet high between two rows. As runners begin tie small twine to the wire and run down to the bean stalks and tie loosely just above the ground. If planted in corn, wait until the corn is 4 to 5 inches high before planting the beans as the bean is the fastest grower of the two. Plant 2 beans to each hill of corn; thin out to one.

★★★★**IMPROVED KENTUCKY WONDER**—(65 days). Kentucky Wonder combines size, quality, and productiveness. The long pods are generally borne in clusters of two or four individual pods averaging 8 to 9 inches long, deeply saddle-back and very fleshy. Pkt. 10c; pt. 35c; qt. 60c; ½ gal. \$1.10; gal. \$2.00; peck \$3.65; ½ bu. \$7.15; bu. \$14.00.

★**McCASLAN POLE**—(66 days). A very prolific white-seeded pole bean. The pods are about 8 inches long, deep green, mealy, somewhat stringless when young and of excellent eating quality. Pkt. 10c; pt. 35c; qt. 60c; ½ gal. \$1.10; gal. \$2.00; peck \$3.65; ½ bu. \$7.15; bu. \$14.00.

GENUINE CORNFIELD—(71 days). The nearly round pods, straight, medium green at picking time become mottled later. Tender and of good quality but somewhat stringy. Pkt. 10c; pt. 35c; qt. 60c; ½ gal. \$1.15; gal. \$2.10; peck \$3.05; ½ bu. \$7.65; bu. \$15.00.

KENTUCKY WONDER WAX—(67 days). Pods 7 to 7½ inches long, light golden yellow, almost stringless, brittle, tender and fleshy. Pkt. 10c; pt. 40c; qt. 65c; ½ gal. \$1.20; gal. \$2.25; peck \$4.25; ½ bu. \$8.15; bu. \$16.00.

★★**WHITE KENTUCKY WONDER**—(62 days). Pods 6 to 7 inches long, round, nearly straight, tender, fleshy and stringless, and of excellent quality. Pkt. 10c; pt. 35c; qt. 60c; ½ gal. \$1.10; gal. \$2.00; peck \$3.65; ½ bu. \$7.15; bu. \$14.00.

NANCY DAVIS OR STRIPED CREASEBACK—(70 days). A vigorous and productive bean that bears quantities of fleshy pods nearly 8 inches long and so round and fat as to be distinctly crease backed. Pkt. 10c; pt. 35c; qt. 60c; ½ gal. \$1.00; gal. \$1.90; peck \$3.50; ½ bu. \$6.15; bu. \$12.00.

HORTICULTURAL OR SPECKLED CRANBERRY—(70 days). Pods straight, flat and about 5 inches long, pale green becoming streaked with red when matured. The beans may be used either green or dried. Pkt. 10c; pt. 35c; qt. 60c; ½ gal. \$1.00; gal. \$1.85; peck \$3.45; ½ bu. \$6.65; bu. \$13.00.

YARD LONG—(70 days). Pods 18 to 28 inches long, ¼ inch in diameter, light green, nearly round, fleshy. Pkt. 10c; pt. 45c; qt. 80c.

LAZY WIFE—(73 days). Medium green pods 6 inches long, broad flat, stringless, fleshy, brittle and of excellent quality. Pkt. 10c; pt. 35c; qt. 60c; ½ gal. \$1.10; gal. \$2.00; peck \$3.65; ½ bu. \$7.15; bu. \$14.00.

RED SPECKLED CUT SHORT—(74 days). Straight, almost stringless, round dull green pods 3½ to 4 inches long. The pods being produced in clusters makes it a very easy bean to pick. Pkt. 10c; pt. 35c; qt. 60c; ½ gal. \$1.00; gal. \$1.85; peck \$3.45; ½ bu. \$6.65; bu. \$13.00.

★★**MISSOURI WONDER**—(70 days). The pods are 5 inches long, flat, medium green in color, very uniform in size with a tendency to be somewhat tough and stringy. Pkt. 10c; pt. 35c; qt. 60c; ½ gal. \$1.10; gal. \$2.00; peck \$3.65; ½ bu. \$7.15; bu. \$14.00.

★**WHITE CREASEBACK**—(63 days). Pods 5 to 6 inches long, light green, uniform, round and slender, slightly stringy; beans small, oblong and white. Pkt. 10c; pt. 35c; qt. 60c; ½ gal. \$1.10; gal. \$2.00; peck \$3.65; ½ bu. \$7.15; bu. \$14.00.

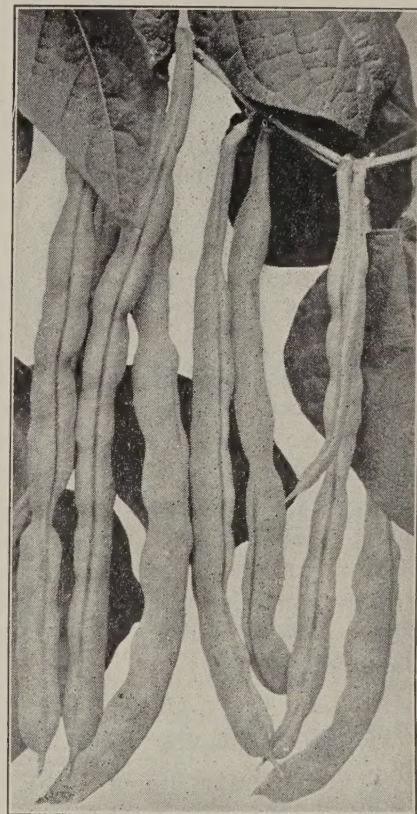

Ky. Wonder Pole

DWARF WAX POD

PENCIL POD BLACK WAX—(54 days). Beautiful yellow straight pods 6 to 7 inches long, well rounded, meaty and deeply saddlebacked. Pkt. 10c; pt. 40c; qt. 65c; ½ gal. \$1.20; gal. \$2.25; peck \$4.25; ½ bu. \$8.15; bu. \$16.00.

TOP NOTCH GOLDEN WAX—(51 days). The pods average five inches long and are quite fleshy, straight, broad, flat and of a rich golden yellow color. Absolutely stringless at all stages. Pkt. 10c; pt. 40c; qt. 65c; ½ gal. \$1.20; gal. \$2.25; peck \$4.25; ½ bu. \$8.15; bu. \$16.00.

SHELL-OUT BUSH

GREAT NORTHERN—(90 days). A large white variety used for dried beans. Pkt. 10c; pt. 25c; qt. 40c; ½ gal. 70c; gal. \$1.25; peck \$2.35; ½ bu. \$4.40; bu. \$8.50.

DWARF HORTICULTURAL—(52 days). Pods are 5 inches long. In the young stages it can be used as a snap bean, as pods begin to mature, they color up a greenish yellow splashed bright crimson. Pkt. 10c; pt. 35c; qt. 75c.

DWARF RED KIDNEY BEANS—(95 days). Very large Kidney shaped red bean. Pkt. 10c; pt. 35c; qt. 60c; ½ gal. \$1.00; gal. \$1.75; peck \$3.35; ½ bu. \$6.40; bu. \$12.50.

DWARF WHITE KIDNEY BEANS—(100 days). Very similar to Red Kidney, differing mostly in color and flavor. Pkt. 10c; pt. 35c; qt. 60c; ½ gal. \$1.00; gal. \$1.90; peck \$3.50; ½ bu. \$6.65; bu. \$13.00.

DWARF WHITE NAVY BEANS—(95 days). The most popular of all varieties used as a shelled bean. Pkt. 10c; pt. 25c; qt. 40c; ½ gal. 70c; gal. \$1.25; peck \$2.35; ½ bu. \$4.40; bu. \$8.50.

BUSH LIMA BEANS

1 Pint Will Plant 70 to 100 Foot Row; 30 to 50 Lbs. Per Acre.

CULTURE—These should not be planted until the ground is thoroughly warm, then sown in well enriched soil, with the rows 36 to 42 inches apart, dropping the beans 10 inches apart in the row, eyes down. The beans should be well hilled to hold the pods off the ground. B-B Lawn and Garden Grower applied at the rate of 10 lbs. to every 100 feet of row will materially increase the yield. This can be done before or after planting.

★★★★**BUNTON'S BUSH LIMA**—(70 days). One of the earliest. The pods will average about five inches long and are filled with large beans of excellent flavor. The plant is a strong grower, holding the pods well off the ground. It is very prolific and continues to bear for a long season. Pkt. 10c; pt. 40c; qt. 75c; ½ gal. \$1.35; gal. \$2.50; peck \$4.65; ½ bu. \$9.15; bu. \$18.00.

★★★**FORDHOOK BUSH LIMA**—(75 days). Generally considered the best of the large seeded bush lima varieties. Bushes of strictly erect habit, branching freely, with all branches held upright. Pods about 5 to 6 inches long, found in clusters of 4 to 8 and well filled with 4 or 5 delicious large beans that are rather thick and of a greenish color. Pkt. 10c; pt. 45c; qt. 85c; ½ gal. \$1.45; gal. \$2.60; peck \$4.95; ½ bu. \$9.65; bu. \$19.00.

★★★**BURPEE'S IMPROVED BUSH LIMA**—(75 days). The plants are vigorous and productive with very large pods, 5 inches long and usually contain 4 large thick beans of excellent quality. Seeds show a greenish white tint, making it a very desirable bean for market purposes also for the home garden. Pkt. 10c; pt. 40c; qt. 75c; ½ gal. \$1.35; gal. \$2.50; peck \$4.65; ½ bu. \$9.15; bu. \$18.00.

★**WOOD'S PROLIFIC BUSH LIMA**—(65 days). This is a very early productive small seeded variety. Plants grow about 20 inches high and bear continually throughout season. Pkt. 10c; pt. 40c; qt. 75c; ½ gal. \$1.35; gal. \$2.50; peck \$4.65; ½ bu. \$9.15; bu. \$18.00.

JACKSON WONDER BUSH LIMA—(65 days). A calico or speckled seeded variety. It is very prolific, beginning to bear early in the season and continuing until killed by frost. Pkt. 10c; pt. 40c; qt. 70c; ½ gal. \$1.30; gal. \$2.40; peck \$4.50; ½ bu. \$8.65; bu. \$17.00.

★★**HENDERSON'S BUSH LIMA**—(65 days). Possibly the earliest of the bush lima beans. Seeds are a little smaller than the Wood's Prolific. Pkt. 10c; pt. 40c; qt. 70c; ½ gal. \$1.30; gal. \$2.40; peck \$4.50; ½ bu. \$8.65; bu. \$17.00.

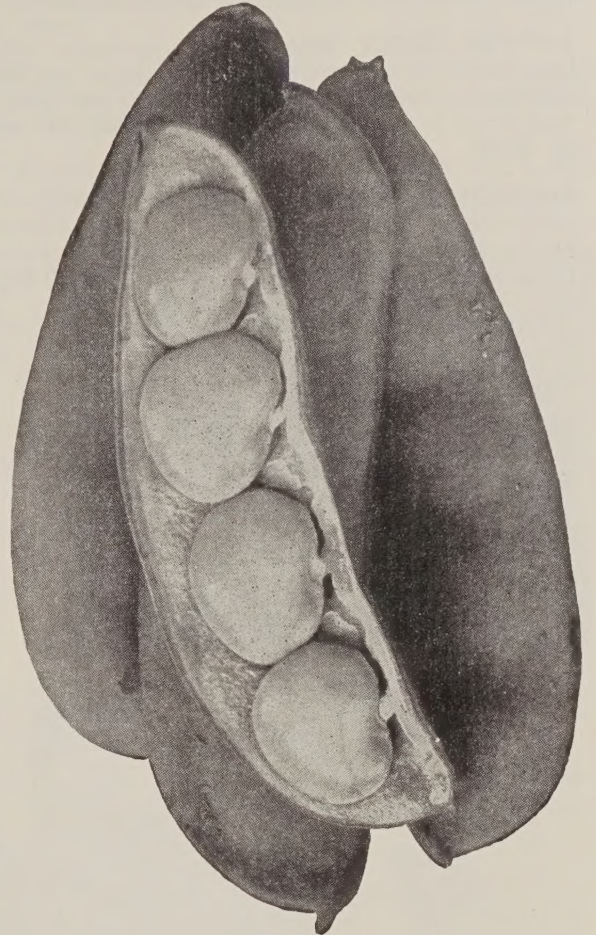

Bunton's Bush Lima

POLE LIMA BEANS

One Pint Will Plant 100 to 150 Hills.

CULTURE—Sow when the soil becomes warm and dry. They are more tender than the snap beans. They should be planted with the eyes down, about 3 to a hill, the hills about 3½ by 3½ feet each way. These should be trellised the same as the Snap Pole Beans. Unless the ground is very fertile, each hill should be supplied with at least a half gallon of well-rotted manure.

★★★★**KING OF THE GARDEN**—(88 days). Vines of strong, vigorous growth, setting many pods, which are closely filled with large, flat beans, much thicker than those of the ordinary pole lima. Pods contain 4 to 5 beans, which retain the green tint in the dry stage. Pkt. 10c; pt. 35c; qt. 60c; ½ gal. \$1.10; gal. \$2.10; peck \$4.00; ½ bu. \$7.65; bu. \$15.00.

★**FLORIDA SPECKLED BUTTER**—(90 days). A small speckled seeded variety that is a sure cropper and bears throughout season. Pkt. 10c; pt. 35c; qt. 60c; ½ gal. \$1.10; gal. \$2.00; peck \$3.75; ½ bu. \$7.15; bu. \$14.00.

SMALL LIMA, OR SIEVA—(75 days). Early, small, but fine flavor. Makes an excellent dried lima bean for winter use. Pkt. 10c; pt. 35c; qt. 60c; ½ gal. \$1.10; gal. \$2.00; peck \$3.75; ½ bu. \$7.15; bu. \$14.00.

★★**LARGE SPECKLED**—(90 days). A large, flat seeded, colored pole Lima (Butter Bean). The seeds are attractively variegated with white and deep purplish blue streaks and blotches, it is very prolific and distinctly flavored. Pkt. 10c; pt. 40c; qt. 65c; ½ gal. \$1.20; gal. \$2.25; peck \$4.25; ½ bu. \$8.15; bu. \$16.00.

GIANT PODDED POLE LIMA—(90 days). The largest pole lima grown. Pkt. 10c; pt. 40c; qt. 65c; ½ gal. \$1.20; gal. \$2.25; peck \$4.25; ½ bu. \$8.15; bu. \$16.00.

BEETS—SWISS CHARD

Garden Beets

1 Oz. to 50 Feet of Drill; 8 to 10 Lbs. to the Acre.

CULTURE—One of the earliest vegetables the garden yields and one of the first to be sown. The soil should be loamy and fertile and well pulverized before seeding. Beets should be drilled in rows and covered about 1 inch deep. The soil should be packed firmly after seed is covered. The rows should be 15 to 18 inches apart. After plants are up 3 inches, thin out to 3 inches apart. For an extra early supply, sow seeds in hotbeds or cold frames from February 15th to March 1st. To have a supply of fresh, tender young beets, sow every two weeks to July 15th.

★★★★**BB EARLY BEAUTY**—A perfectly round, fast growing, dark red beet, with small tap root and medium top, just right for bunching. It is the quickest of the round Beets to reach marketable size. Very uniform in shape and a ready seller on the market. Pkt. 10c; oz. 15c; ¼ lb. 45c; lb. \$1.50; 5 lbs. @ \$1.40.

★**IMPROVED CROSBY'S EGYPTIAN**—Almost a true globe shape, being a little deeper from top to base. Color is a dark red. It is extremely early and has a medium size top. The skin is very smooth; flesh dark, very sweet and tender. Pkt. 10c; oz. 15c; ¼ lb. 40c; lb. \$1.25; 5 lbs. @ \$1.20.

EARLY BLOOD TURNIP—(60 days). An old standard variety, still popular, top-shaped root with deep red flesh, smooth skin, sweet and crisp. Pkt. 10c; oz. 15c; ¼ lb. 40c; lb. \$1.25; 5 lbs. @ \$1.20.

★**EARLY WONDER**—A selection from the Crosby's Egyptian. Very early, uniform and nearly globe-shaped with small top and tap root. Skin dark red, flesh deep blood red with little zoning. Pkt. 10c; oz. 15c; ¼ lb. 40c; lb. \$1.25; 5 lbs. @ \$1.20.

★**DETROIT DARK RED**—One of the most popular red turnip beets for market gardeners or home use. Being a second early, it is used extensively as the main crop variety. The tops are of medium size, fruits very uniform in shape, flesh deep red, very crisp, tender and sweet. Pkt. 10c; oz. 15c; ¼ lb. 40c; lb. \$1.25; 5 lbs. @ \$1.20.

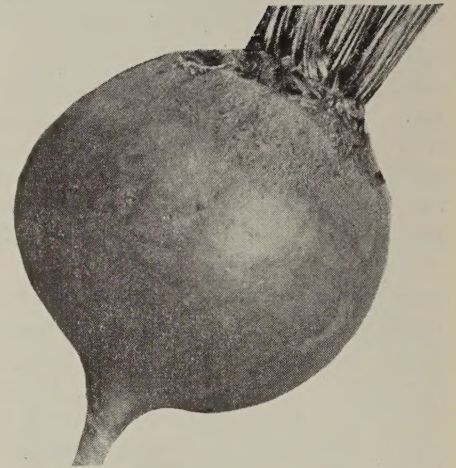

B-B Early Beauty

Stock Beets

CULTURE—Sow in April and May in rows 2 to 3 feet apart, thin out so plant will stand 6 inches apart in the row.

MAMMOTH PRIZE LONG RED—Grows to an enormous size and yields 30 to 50 tons to the acre. Roots nearly cylindrical in shape, light red, growing well above ground; flesh white and rose colored. Pkt. 10c; oz. 15c; ¼ lb. 35c; lb. \$1.00; 5 lbs. @ 90c.

SLUDSTRUP—Of very high feeding value. Roots are long, with reddish yellow skin and white flesh. Extends well out of ground, easy to harvest. Pkt. 10c; oz. 15c; ¼ lb. 35c; lb. \$1.00; 5 lbs. @ 90c.

Swiss Chard

(SPINACH BEET OR SEA KALE)

CULTURE—Sow thinly in rows 14 inches apart and 1 inch deep as early as ground can be worked. When large enough thin out to 10 or 15 inches apart. To assure prompt and even germination, the soil should be pressed firmly on top of seed.

LUCULLUS—Plants grow about 2 to 2½ feet tall and consist, when fully developed, of about a dozen creamy white beautifully curled leaves. The stalks are almost white and after trimming can be cooked and served like asparagus. The leaf part can be cooked like Spinach or Kale Greens, however, if desired the stalks and leaves may be boiled and served in the same manner. Pkt. 10c; oz. 20c; ¼ lb. 45c; lb. \$1.40.

RHUBARB CHARD—A Swiss Chard that looks like Rhubarb. The delicate crimson color of the leaf-stalks extends out through the veins into the dark green, heavily crumpled leaves. This delightful novelty has a flavor of its own. The ornamental plants may be used in flower beds. Pkt. 15c; oz. 50c.



Rhubarb Chard

CABBAGE

CONTAINS VITAMINS A AND B-1

1 Oz. of Seed Will Produce from 1,500 to 2,000 Plants.

CULTURE—For early crop the seed should be sown in hotbeds or boxes in the house during December or January. Summer crops can be sown outside and then transplanted where they are to remain. Plants should be transplanted in good rich, clean, light soil in rows 2 to 3 feet apart, plants 15 to 20 inches apart in the row, according to the variety of cabbage. Early cabbage should be planted close together; the later ones farther apart.

ALLHEAD EARLY—(80 days). A very early medium size cabbage. It makes a deep flat head, solid and uniform in shape, size, and color. Pkt. 10c; oz. 30c; 1/4 lb. 90c; lb. \$3.00.

MAMMOTH RED ROCK—A very large head of intense dark red color, weighing about 10 pounds. Pkt. 10c; oz. 40c; 1/4 lb. \$1.25.



All Head Early

★★★**ALL SEASON** (Yellows Resistant)—(90 days). This strain of ALL SEASON is now the most popular cabbage in this section for summer planting. It is resistant to Yellows and has remarkable ability to withstand hot sun and dry weather. Is good for either early or late planting. The heads are very large, round, solid and of excellent keeping qualities. Pkt. 10c; oz. 30c; 1/4 lb. 90c; lb. \$3.00.

CHARLESTON WAKEFIELD—(65 days). This variety is about one week later than Jersey Wakefield, but the conical heads are fully one-half larger. Pkt. 10c; oz. 30c; 1/4 lb. 90c; lb. \$3.00.

★**COPENHAGEN MARKET**—(65 days). A splendid extra early round-headed sort which matures right after B-B Golden Acre. The heads are medium size, round, unusually firm, averaging 5 to 8 pounds in weight. Upright growth, short stemmed with few leaves. Pkt. 10c; oz. 35; 1/4 lb. \$1.00; lb. \$3.50.

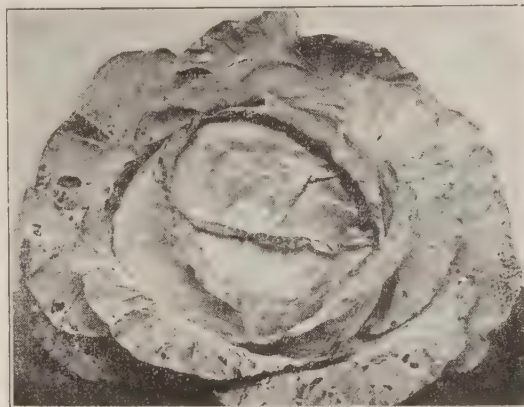

All Season



Golden Acre

★★**EARLY FLAT DUTCH**—(90 days). This is an old standard variety that needs little introduction. It is a medium early variety, growing a large flat head on a short stem. Pkt. 10c; oz. 30c; 1/4 lb. 90c; lb. \$3.00.

EXTRA EARLY JERSEY WAKEFIELD—(60 days). Heads are cone shaped, very solid and extremely uniform in both green color and size. It is usually the first cabbage on the early market, Pkt. 10c; oz. 30c; 1/4 lb. 90c; lb. \$3.00.

★★★★**GOLDEN ACRE**—(63 days). An extra early round head type. Plants are dwarf and have but few outer leaves. Used extensively for early market, heads are about 6 inches in diameter and weight approximately 3 lbs. Pkt. 10c; oz. 40c; 1/4 lb. \$1.25; lb. \$4.00.

★★★**GOLDEN ACRE RESISTANT**—(64 days). Somewhat larger plant growth than standard strain of Golden Acre. Not as early or as uniform although desirable for planting on yellows infested soil. Pkt. 15c; oz. 70c; 1/4 lb. \$2.00; lb. \$6.00.

★★**LATE FLAT DUTCH**—(105 days). A justly popular and esteemed variety; heads are large, round, flat, very firm and on medium stem. Very hardy. Pkt. 10c; oz. 30c; 1/4 lb. 90c; lb. \$3.00.

★**MARION MARKET** (75 days) (**Yellows Resistant Copenhagen**)—It takes about ten days longer to mature than the early strain of Copenhagen and produces a much larger plant. The heads are practically round, very hardy and stand shipment well. It is very highly resistant to the Yellows. Pkt. 10c; oz. 40c; 1/4 lb. \$1.25; lb. \$4.00.

CHINESE CABBAGE

CHIHLI—(75 days). This produces long, slender, very solid head, often measuring 20 inches in height. The outer leaves are light green, inside is of a beautiful creamy yellow, tender and of a delicious flavor. Pkt. 10c; oz. 25c; 1/4 lb. 60c; lb. \$1.75.

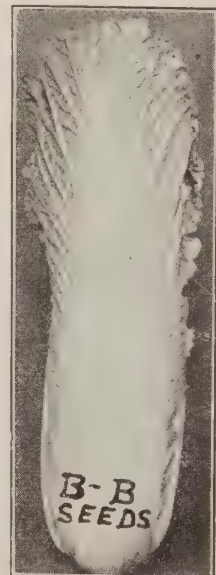

Chihli

BUNTON'S CAULIFLOWER, CELERY, CARROTS

CAULIFLOWER

1 Oz. of Seed Produces About 2,000 Plants.

CULTURE—To raise plants, sow seed in hotbed or greenhouse during January or February. Transplant in cold frame 2 or 3 inches apart each way; set in open ground as soon in Spring as ground can be put in good order. Set plants 18 inches apart in rows 2 feet apart. When the heads are formed they should be bleached by drawing the leaves together and tying with soft string or rubber band.

★**BB SNOWBALL**—One of the earliest and most uniform in size and maturity of any Cauliflower grown. The heads are snow white, large and extra early, matures in about 55 days. Pkt. 20c; ¼ oz. 75c; oz. \$2.50; ¼ lb. \$9.00.

SNOWDRIFT—One of the surest headers known. Self-protecting leaves cover curd during early heading stage. Heads are slightly larger than Snowball types. Snow white, solid and compact. Pkt. 20c; ¼ oz. 75c; oz. \$2.50; ¼ lb. \$9.00.

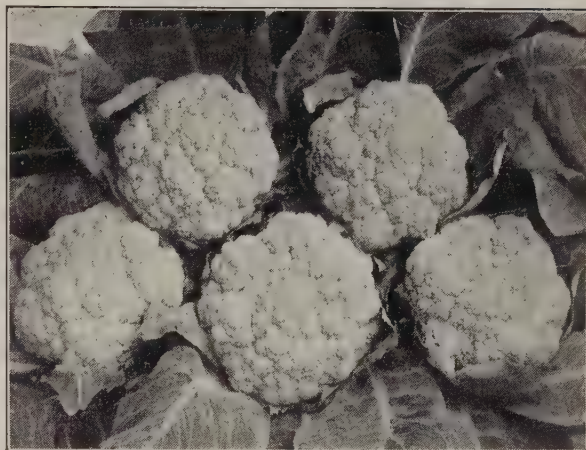

B-B Snowball

CELERY

CULTURE—In early Spring, drill the seed in rows about 12 inches apart. As the seed is rather hard to germinate the soil should be firmly packed after a very light covering and watered frequently. The plants should be transplanted in rows 2½ to 3 feet apart and set 6 inches apart in the rows, from June 1st to August 1st. Care should be taken that the roots are firm in the ground. In hilling, care should be taken not to cover the crown of the plants.

CELERIAC—GIANT PRAGUE—Very large and smooth, solid and crisp. Grown for root only. Pkt. 10c; oz. 70c; ¼ lb. \$2.00; lb. \$6.00.

GIANT PASCAL—Leaves upright and dark green. Stalks short, thick and very broad, blanching a beautiful yellowish white. Pkt. 10c; oz. 70c; ¼ lb. \$2.00; lb. \$6.00.

★★**GOLDEN PLUME, OR WONDERFUL**—The plants are semi-dwarf and resist blight and other celery diseases better than other varieties. It is unequalled in quality, appearance and commands ready sale. Pkt. 10c; oz. 75c; ¼ lb. \$2.35; lb. \$7.00.

★**GOLDEN SELF-BLANCHING**—Plants mature very early, are compact, stocky, very thick and fine flavored. When blanched is of an excellent golden yellow color. Pkt. 10c; oz. 75c; ¼ lb. \$2.35; lb. \$7.00.

UTAH GOLDEN CRISP—Its superb flavor and quality make it the most popular of the green types. Excellent for home use, too tender for shipping. Pkt. 10c; oz. 70c; ¼ lb. \$2.00; lb. \$6.00.

WHITE PLUME—A very early maturing variety; easily blanched and of a beautiful silvery white color. Pkt. 10c; oz. 70c; ¼ lb. \$2.00; lb. \$6.00.



Golden Plume

CARROTS

1 Ounce Will Sow 100 Feet of Drill.

CULTURE—For early crop sow in rows 12 to 15 inches apart and ½ inch deep, as soon as the ground can be worked. For later crop sow from the beginning of March until the later part of July. Thin out young plants to 3 inches. Carrots will do well in almost any soil, however, the better the soil, the better the carrot crop.

★★★**CHANTENAY**—(70 days). An excellent medium early half-long stump-rooted variety. Root about 6 inches long tapering toward base and running suddenly to a point; very smooth, of deep orange-red color. Pkt. 10c; oz. 20c; ¼ lb. 50c; lb. \$1.50.

★★**IMPERATOR**—(77 days). A long smooth handsome carrot, tops medium but strong enough for good bunching. Root shave rounded shoulders, smooth deep rich orange, uniformly tapered to a semi-blunt end, flesh rich orange color, extending to center of root, fine grained, tender and of excellent quality. Pkt. 10c; oz. 20c; ¼ lb. 55c; lb. \$1.60.

★**IMPROVED DANVER HALF LONG**—(75 days). Roots deep orange, medium length, tapering uniformly to a blunt point. Flesh sweet, crisp and tender. Pkt. 10c; oz. 20c; ¼ lb. 50c; lb. \$1.50.

IMPROVED LONG ORANGE—(88 days). Roots 12 inches long, 3 inches broad at the crown tapering rapidly to a point and of deep orange color. Pkt. 10c; oz. 20c; ¼ lb. 50c; lb. \$1.50.

★★★**NANTES (Coreless)**—(70 days). A great favorite of those who know their carrots. The roots are 5 to 7 inches long, 1¼ inches thick, cylindrical and blunt ended. Tops small. The rich orange flesh extends to the center of the root and through the small core. It is fine grained sweet and tender. Very early. Pkt. 10c; oz. 20c; ¼ lb. 55c; lb. \$1.60.



Emperor

BUNTON'S CUCUMBERS, EGG PLANT, COLLARDS

CUCUMBERS

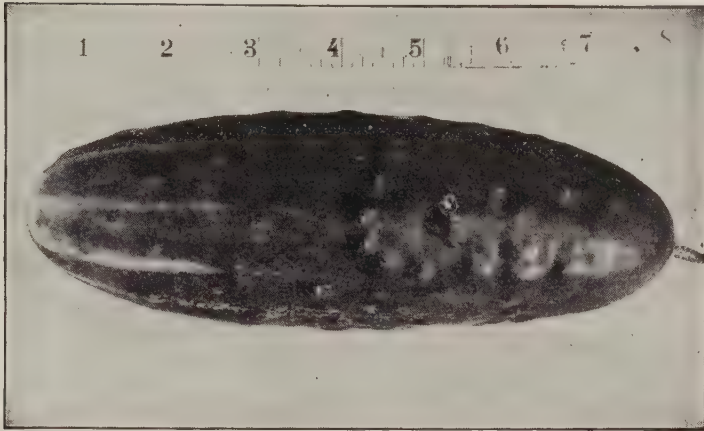

Imp'd Early White Spine

CULTURE—For very early cucumbers, sow seed March 15th in a hotbed. When weather has become settled and warm, sow seed in hills 4 to 6 feet apart each way. Thin out, leaving 4 of the strongest plants in each hill. Can be sown 6 to 12 inches apart in rows 6 feet apart. They do best in rich loamy soil. For succession of this crop, make plantings at intervals until August 10.

★★★★**A and C**—(68 days). For market as well as home use, this new Cucumber is rapidly becoming a true favorite. The long, slender, dark green fruits, are ready sellers at top market prices, it is a vigorous grower, disease resistant, averaging in length 9 to 10 inches, straight and even in diameter and very prolific. **Pkt. 10c; oz. 25c; ¼ lb. 75c; lb. \$2.25.**

★**LONGFELLOW**—(74 days). Those desiring an extremely long, dark green cucumber should plant our Longfellow. It grows 12 to 14 inches long, 2 to 2½ inches in diameter, is handsomely shaped and a beautiful dark green color. A splendid variety for slicing. **Pkt. 10c; oz. 25c; ¼ lb. 75c; lb. \$2.25.**

BB LONG WHITE SPINE—(64 days). About ¼ longer than the improved White Spine and holds its dark bluish green color well, remaining edible for a long period after picked. Very prolific. **Pkt. 10c; oz. 20c; ¼ lb. 60c; lb. \$1.75.**

★**CHICAGO PICKLE**—(58 days). A very popular variety for pickling, when ripe the fruit is medium size, blunt at both ends, black spine. **Pkt. 10c; oz. 20c; ¼ lb. 60c; lb. \$1.75.**

GHERKIN (Small)—(60 days). Very small, somewhat oval in shape, light green and covered with spines. **Pkt. 10c; oz. 30c; ¼ lb. 80c; lb. \$2.50.**

★★**IMPROVED EARLY WHITE SPINE**—(64 days). The very best Cucumber for early market. Will hold its intense dark green color better and remain edible longer than any other strain of White Spine. The skin is smooth, fruits are uniform and symmetrical, 8 to 9 inches long and with tapering ends. Flesh very firm and crisp. **Pkt. 10c; oz. 20c; ¼ lb. 60c; lb. \$1.75.**

IMPROVED LONG GREEN—(68 days). An excellent cucumber for slicing or pickling. Fruit rich dark green, black spined; tapering at ends and slightly warty. 10 to 12 inches long when matured. **Pkt. 10c; oz. 25c; ¼ lb. 65c; lb. \$2.00.**

SNOW'S PERFECTION PICKLE—(56 days). Somewhat like the Chicago Pickle except that it is smaller. It is one of the smoothest, symmetrical pickle kind we know of and is highly recommended for its uniform early pickles. It is enormously productive. **Pkt. 10c; oz. 20c; ¼ lb. 60c; lb. \$1.75.**

STRAIGHT EIGHT—(All American Selection). Excellent for home or market. 8 inches long, 2 inches in diameter, blunt ended. Color is a deep rich green. **Pkt. 10c; oz. 25c; ¼ lb. 65c; lb. \$2.00.**

★**WHITE WONDER**—(55 days). A distinct variety of a beautiful snow-white color which it maintains even when fully matured. It is very uniform in size and shape and usually grows 8 to 10 inches long. **Pkt. 10c; oz. 25c; ¼ lb. 65c; lb. \$2.00.**

EGG PLANT

1 Ounce Will Produce About 1,000 Plants

CULTURES—Thrives well in any good garden soil. Seeds should be sown in hotbeds about March 15th. Transplant to cold frames when plants are sufficiently large. If paper pots are used, they can be transplanted to open ground when soil becomes warm, without disturbing root system. They should be set about 2 feet apart in 3 to 3½ feet rows.

★**BLACK BEAUTY**—(80 days). A rich lustrous purplish black color. It is a distinct sort and a favorite where known. The plants are remarkably healthy in their growth and yield an abundance of large fruit. The fruits are entirely spineless and very attractive in appearance. **Pkt. 10c; oz. 50c; ¼ lb. \$1.40; lb. \$5.00.**

NEW YORK IMPROVED PURPLE—(83 days). The large dark purplish fruit is heavy at the base, narrowing at the top. **Pkt. 10c; oz. 50c; ¼ lb. \$1.50; lb. \$5.00.**



Black Beauty

COLLARDS

Rich in Vitamins A and B-1

GEORGIA—A very popular Southern vegetable, largely used in place of cabbage. It stands cold weather and will make a good crop on land too poor to make a crop of cabbage. Usually planted in June, July or August. Plant and cultivate same as cabbage. **Pkt. 10c; oz. 20c; ¼ lb. 30c; lb. 75c.**



Georgia Collards

GARDEN CORN

CULTURE—Sweet corn should not be planted until the ground is warm. Corn is usually planted in drills, dropping one kernel every 6 inches. Thin out plants to 12 inches after the corn gets a good start. The rows should be from 3 to 3½ feet apart. Corn will succeed well on most any soil, however, will make more rapid growth by using a small quantity of a good commercial fertilizer. For succession of fresh roasting ears, a planting should be made every 10 days or 2 weeks until July 15th.

HYBRID SWEET CORN

Hybrid corns are wilt and disease resistant, mature uniformly. Due to a stronger root system withstand wind and drought better than the open pollinated.

COUNTRY GENTLEMAN HYBRID—(99 days). More sure of making heavy yield than Country Gentleman, otherwise about the same. Pkt. 10c; pt. 50c; qt. 90c; ½ gal. \$1.60; gal. \$3.00; 10 lbs. @ 48c.

★★★★**GOLDEN CROSS BANTAM (Hybrid)**—(85 days). The ears are about 8 inches long with 10 to 14 rows of kernels. Will yield about twice as much as regular strains of Golden Bantam. Pkt. 10c; pt. 40c; qt. 70c; ½ gal. \$1.20; gal. \$2.25; 10 lbs. @ 35c.

★★★★**IOANA (Hybrid)**—(86 days). An attractive and productive variety, ears 7½ to 8 inches long. 12-14 rowed, well filled with medium-narrow light yellow kernels. Pkt. 10c; pt. 40c; qt. 70c; ½ gal. \$1.20; gal. \$2.25; 10 lbs. @ 36c.

★**MARCROSS (Hybrid)**—(72 days). Ears long, plump, abruptly tapered at tips; 10-14 rowed with light creamy yellow kernels of good quality. Pkt. 10c; pt. 40c; qt. 75c; ½ gal. \$1.20; gal. \$2.35; 10 lbs. @ 38c.

★**STOWELL'S EVERGREEN HYBRID**—(93 days). Ears slightly tapered uniform, with 16-18 rows of deep, medium wide, white kernels. Pkt. 10c; pt. 40c; qt. 70c; ½ gal. \$1.20; gal. \$2.25.

★**GOLD RUSH**—(69 days). An extra early, tender, sweet corn of fine quality. The 8½ inch ears are well filled to the tip with 12 or 14 rows of delicious kernels. The 6 foot tall stalks frequently produce 2 ears, covered to the tip with a tight husk. Pkt. 10c; pt. 40c; qt. 70c; ½ gal. \$1.20; gal. \$2.25; 10 lbs. @ 38c.

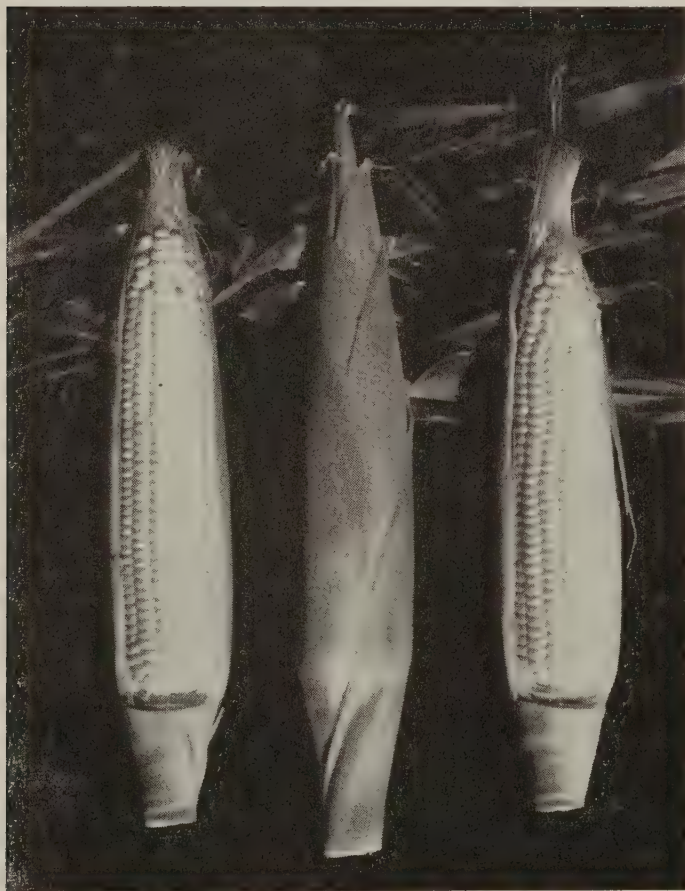

Golden Cross Bantam

SWEET CORN

★★**BANTAM EVERGREEN**—(95 days). As delicious as Bantam and as large and about a week earlier than Evergreen. The ears are about 8 inches long with 12 to 14 rows of rather broad, deep rich golden yellow grains. Pkt. 10c; pt. 30c; qt. 50c; ½ gal. 85c; gal. \$1.50; 10 lbs. @ 20c.

★★**COUNTRY GENTLEMAN**—(95 days). Ears about 7 to 8 inches long, cobs small, white and densely covered with long slender white grains without row information. Pkt. 10c; pt. 30c; qt. 50c; ½ gal. 85c; gal. \$1.50; 10 lbs. @ 20c.

★★**GOLDEN BANTAM**—(79 days). Ears 6 to 7 inches long, filled from butt to tip with 8 rows of deep broad grains of attractive color and most delightful flavor. Pkt. 10c; pt. 30c; qt. 50c; ½ gal. 85c; gal. \$1.50; 10 lbs. @ 20c.

★★★**STOWELL'S EVERGREEN**—(95 days). Ears 8 to 9 inches long, 16 to 18 rows, with a very deep, sweet grain. Pkt. 10c; pt. 30c; qt. 50c; ½ gal. 85c; gal. \$1.50; 10 lbs. @ 20c.

EARLY TABLE CORN

★**BUNTON'S EARLY**—6 to 8 inch ears containing 10 or 12 rows of sweet, tender, pearly white grains. 6 to 7 foot stalks permitting close planting. Pkt. 10c; pt. 25c; qt. 40c; ½ gal. 65c; gal. \$1.10; peck \$2.00; ½ bu. \$3.65; bu. \$7.00.

★★**EARLY ADAMS**—(72 days). Ears are 8 to 9 inches long, with 12 to 14 rows of white grains. Grows about 6 feet high. Pkt. 10c; pt. 20c; qt. 35c; ½ gal. 55c; gal. \$1.00; peck \$1.85; ½ bu. \$3.40; bu. \$6.50.

★**EXTRA EARLY ADAMS**—(69 days). The ear is 6 to 7 inches long, containing 12 to 14 rows of white, sweet grains. It is very hardy, standing early planting exceedingly well. Pkt. 10c; pt. 25c; qt. 40c; ½ gal. 65c; gal. \$1.10; peck \$2.00; ½ bu. \$3.65; bu. \$7.00.

★**EARLY NORTHERN WHITE FIELD**—(85 days). Often has two ears from 9 to 10 inches. This is not only a very valuable variety for market purposes, but is now being grown by a number of farmers as an early feed variety. Pkt. 10c; pt. 20c; qt. 30c; ½ gal. 45c; gal. 85c; peck \$1.50; ½ bu. \$2.65; bu. \$5.00.

★★**BB TRUCKERS FAVORITE**—(77 days). The ears are 9 to 10 inches long, 10 to 12 rows of pure white grains. Grows about 6 feet high. Pkt. 10c; pt. 20c; qt. 30c; ½ gal. 50c; gal. 90c; peck \$1.75; ½ bu. \$3.15; bu. \$6.00.

POP CORN

★ **GIANT YELLOW (T. N. T.)**—(100 days). A large-eared and handsome yellow pop corn. Pops perfectly white and exceedingly large and tender. Pkt 10c; pt. 25c; qt. 40c.

★ **JAPANESE HULLESS**—(85 days). A small stubby-eared variety with pointed grains. Pkt. 10c; pt. 25c; qt. 40c.

★ **WHITE RICE**—(90 days). An old favorite variety that pops pure white. Pkt. 10c; pt. 25c; qt. 40c.

★ **YELLOW HYBRID**—Pkt. 15c; pt. 40c; qt. 75c; 10 lbs. @ 40c.

BUNTON'S GARDEN GREENS

ENDIVE

1 Oz. of Seed Will Drill 200 Foot Row.

CULTURE—For early use sow about the 1st of April; for late or Fall use, sow in June or July. This should be drilled in rows 14 inches apart and covered very shallow. When 2 or 3 inches high, thin out to 1 foot apart. To bleach draw the leaves together and tie with soft twine or use rubber bands. This should be done when plants are dry. It requires about 3 weeks for the plants to be properly blanched.

★**LARGE GREEN CURLED**—(95 days). Hardy and vigorous sort, leaves bright deep green, readily blanches creamy white. Favorite variety with the market gardener. Pkt. 10c; oz. 20c; ¼ lb. 40c; lb. \$1.50.

GREEN CURLED—ROSE RIBBED—(95 days). The lower part of outer leaf stems are tinged with rose pink, the center blanches readily to a rich cream color. Pkt. 10c; oz. 20c; ¼ lb. 40c; lb. \$1.50.



Green Curled Endive



Dwarf Blue Curled Scotch

★★**DWARF BLUE CURLED SCOTCH**—(55 days). Carefully selected strain of Scotch Kale. It is very dwarf, spreading close to the ground, of a very deep bluish green color and the leaves more finely curled after a light freeze. It is very hardy and will stand more winter weather than the ordinary Dwarf Curled Scotch. Its seeds are sown in June or July, a strong growth will be made, enabling it to better stand freezing weather. Pkt. 10c; oz. 20c; ¼ lb. 50c; lb. \$1.50.

MUSTARD

CULTURE—Sow in early Spring, June, July, or August, in rows 15 inches apart or broadcast. After plants are up thin out to 4 inches apart.

FORDHOOK FANCY—A comparatively new variety that has long, slender, upright finely curled leaves of a deep green color with edges deeply cut. The plant makes a vigorous growth and stands a long time before going to seed. Pkt. 10c; oz. 15c; ¼ lb. 30c; lb. 75c; 5 lbs. @ 70c.



Fordhook Fancy Mustard

KALE

CULTURE—The large majority of Kale seed is sown during July and August for winter greens. The Siberian, while not nearly as curly as the Scotch, is hardier and is seldom winter killed. The seed is usually sown broadcast 3 lbs. to the acre. Some are very successfully growing Scotch Kale in 18-inch drills.

★**BB DWARF CURLED SIBERIAN**—(65 days). A most vigorous and spreading variety. Leaves large and rather plain in the center, with cuts and frills at the edges; color bluish green; very hardy. Usually stands through winter in this latitude. Pkt. 10c; oz. 15c; ¼ lb. 25c; lb. 75c.

PLAIN, OR SMOOTH—(45 days). Used extensively for early spring sowing. It has smooth leaves, is a very rapid grower and usually the first on the spring market. Pkt. 5c; oz. 10c; ¼ lb. 25c; lb. 40c; 5 lbs. \$1.50.



B-B Dwarf Curled Siberian Kale

★**B-B SOUTHERN GIANT CURLED**—A new type and much improved southern giant curled mustard. It stands longer before shooting seed stalks; is a deeper green and more densely curled. Pkt. 10c; oz. 15c; ¼ lb. 30c; lb. 75c; 5 lbs. @ 70c.

MUSTARD SPINACH (Tendergreen)—This new vegetable is all its name implies, a very mild mustard with a creamy spinach flavor. The seeds germinate quickly and the plants make rapid growth, being ready for cutting three or four weeks after planting. It thrives well during hot, dry weather, therefore planting may be made every two weeks throughout the entire summer, as well as early spring and fall. Pkt. 10c; oz. 15c; ¼ lb. 30c; lb. 75c.

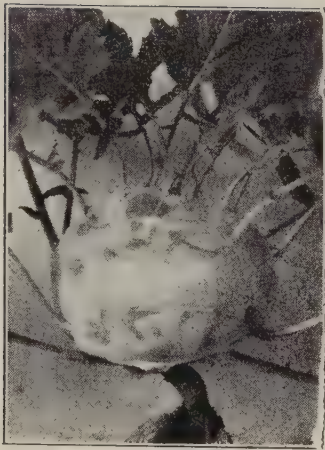

Early White Vienna

KOHL RABI

One Ounce of Seed Will Sow a Drill of About 100 Feet.

CULTURE—Drill in rows like Radishes or Beets. Thin out so they will stand about 5 or 6 inches apart in the row, having the rows about 18 inches apart. They are ready when bulbs average from $2\frac{1}{2}$ to 3 inches in diameter.

EARLY WHITE VIENNA—(55 days). Extremely early, with few leaves and small top. Bulbs are medium size, very light green, nearly white, and the best quality. Pkt. 10c; oz. 40c; $\frac{1}{4}$ lb. \$1.00; lb. \$3.50.

LEEK

Plant 1 Oz. to 100 Feet of Drill

CULTURE—Sow about 1st of April in drills 1 foot apart, $\frac{1}{2}$ inch deep. When 6 or 8 inches high, transplant into deep rich soil in rows 12 inches apart and 5 to 6 inches apart in the row.

AMERICAN FLAG—Produces large thick stem of mild flavor; leaves are short and plant is very hardy. Plant either in spring or fall. Pkt. 20c; oz. 60c; $\frac{1}{4}$ lb. \$1.75; lb. \$5.50.

LETTUCE

Oz. Will Sow 200 to 300 Feet of Row

CULTURE—For very early crop, seed should be sown in hotbeds. Transplant plants to open ground fairly well in season. The plants being hardy, will stand quite a bit of cold weather. The loose heading varieties often do well when sown broadcast, or they may be sown in 1 foot rows and thinned out to 3 inches when the plants begin to spread. Heading varieties should be sown very early in the Spring, in drills 15 to 18 inches apart. After well up, thin out to 8 to 10 inches apart in the row. Cultivate often.

★★★★**KENTUCKY BIBB** (70 days). A waxy head variety with very deep green outer leaves, bleaching to a rich yellowish green inside; heads medium size, unusually crisp and tender, highly recommended and of distinct flavor. Pkt. 10c; oz. 35c; $\frac{1}{4}$ lb. \$1.00; lb. \$3.00.

OAK LEAF—(40 days). A leaf lettuce that does not become bitter during hot weather. Leaves are small, tender and deep green. Pkt. 10c; $\frac{1}{2}$ oz. 30c; oz. 50c.

★★**GRAND RAPIDS**—(43 days). Favorite loose leaf for forcing under glass. Leaves exceptionally crumpled, border frilled, color very light green with no trace of brown. Pkt. 10c; oz. 20c; $\frac{1}{4}$ lb. 60c; lb. \$1.75.

★★**NEW YORK HEAD**—(80 days). Very large, late, globular heading variety; leaves broad, of thick texture; fairly blistered and crumpled; border frilled, color clear dark green. Pkt. 10c; oz. 35c; $\frac{1}{4}$ lb. \$1.00; lb. \$3.00.

ICEBERG—(84 days). A large, late crisp, cabbage-heading variety heads very firm, hard and well balanced. Pkt. 10c; oz. 25c; $\frac{1}{4}$ lb. 60c; lb. \$2.00.

★★★★**BLACK SEEDED SIMPSON**—(46 days). One of the most reliable and popular loose leaf varieties. Leaves broad, crumpled, frilled at border and of yellowish green color. Pkt. 10c; oz. 20c; $\frac{1}{4}$ lb. 60c; lb. \$1.75.

TRIANON COS—(66 days). A medium large, strictly self-closing lettuce, making a well formed and firm, cone-shaped head; quality excellent. Pkt. 10c; oz. 20c; $\frac{1}{4}$ lb. 60c; lb. \$2.00.

BIG BOSTON—(75 days). Heads large and compact, leaves broad, almost smooth with waves at the edge; color a light green slightly tinged reddish brown; heart greenish white tinged yellow. Pkt. 10c; oz. 20c; $\frac{1}{4}$ lb. 60c; lb. \$2.00.

GREAT LAKES—(82 days). A new summer head lettuce very similar in appearance to Iceberg, however it stands heat and sun extremely well. Very slow to bolt to seed, resistant to tip burn. Pkt. 10c; oz. 55c; $\frac{1}{4}$ lb. \$1.60; lb. \$5.00.

CHICKEN LETTUCE—Affords an enormous amount of tender green food for poultry. The plant grows three to four feet high, loaded with leaves that may be pulled. Pkt. 10c; oz. 20c; $\frac{1}{4}$ lb. 60c; lb. \$1.75.

★**EARLY CURLED SIMPSON**—(45 days). Leaf or loose heading sort. Leaves broad and crumpled with edges nicely frilled. Color yellowish green. Pkt. 10c; oz. 20c; $\frac{1}{4}$ lb. 60c; lb. \$1.75.

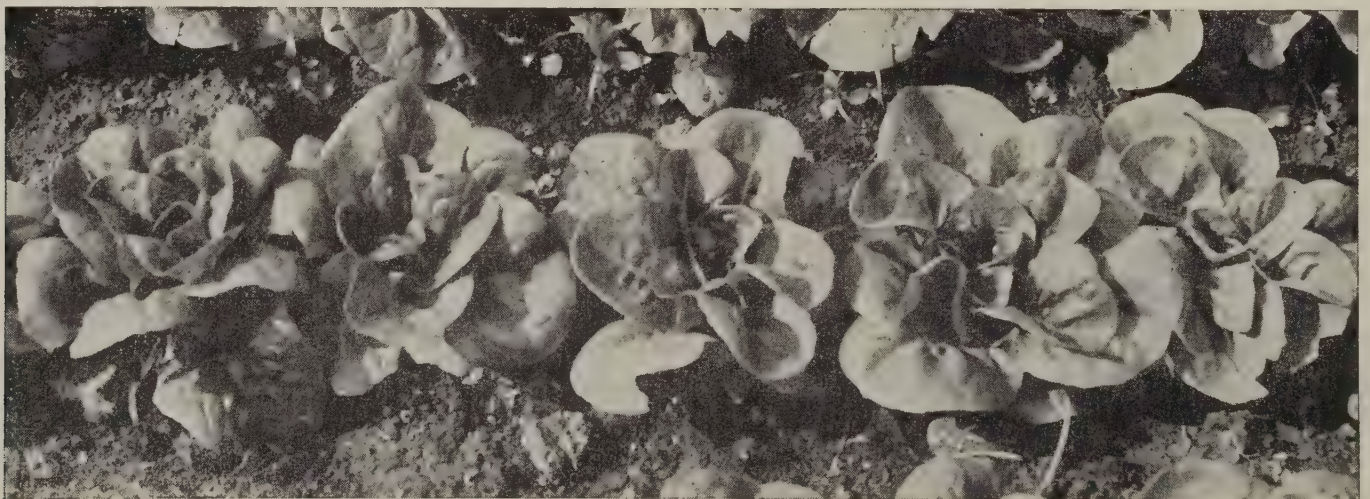

Kentucky Bibb Lettuce in the Garden

CANTALOUPE OR MUSKMELON

CULTURE—For early melons, seeds can be planted in paper pots and set in cold frames. After the danger of frost, transplant to the open ground in hills 4 to 6 feet apart each way. If possible, use well rotted manure in each hill. If seeds are planted in open ground, plant about 10 seeds in different parts of the hill, just under the surface of the soil. When plants are well up, thin out to 3 or 4 to the hill. Rotenone is a very effective remedy against enemies of the Cantaloupe crop.

★★**PRIDE OF WISCONSIN**—(85 days). A very delicious, sweet variety of fine flavor. Flesh is orange colored, solid and thick; seed cavity is small. The oval fruits average about 3³/₄ pounds; pearly gray rind, faintly ribbed, with sparse, coarse netting. Pkt. 10c; oz. 20c; 1/4 lb. 60c; lb. \$1.75.

★**SCHOON'S HARD SHELL**—(95 days). New and Excellent flavored melon, valuable for its extra hard shell, which makes it fine for shipping. Pkt. 10c; oz. 20c; 1/4 lb. 60c; lb. \$1.75.

★**GOLD-LINED ROCKY FORD**—(95 days). Size 5¹/₄ x 5¹/₄". Small, almost round, smooth, showing no rib and densely covered with a hard gray netting. Flesh thick, deep green, showing a faint lining of pink or gold at the center. Pkt. 10c; oz. 20c; 1/4 lb. 60c; lb. \$1.75.

★★★**HEARTS OF GOLD**—(88 days). Size 6¹/₂ x 5³/₄". Fruit small, round, with tendency to heart shape; slightly ribbed and covered with fine netting; flesh thick, deep salmon color, high quality. Pkt. 10c; oz. 20c; 1/4 lb. 60c; lb. \$1.75.

HONEY DEW—(110 days). Size 7¹/₂ x 7". The outer skin is smooth, hard and nearly white. The melons are large, round to oval in shape, flesh is light green and of honeylike flavor. Pkt. 10c; oz. 20c; 1/4 lb. 60c; lb. \$1.75.

BANANA—(94 days). Size 20¹/₂ x 4". A long, yellow fleshed melon. Skin smooth and slightly ribbed. Flesh thick; sweet and tender. Pkt. 10c; oz. 20c; 1/4 lb. 60c; lb. \$1.75.

★**NETTED TIP-TOP**—(96 days). Size 7 x 6¹/₂". Large gray-green in color, round, flattened at the ends, distinct rib, and well netted. Flesh very thick, deep salmon in color. Pkt. 10c; oz. 20c; 1/4 lb. 60c; lb. \$1.75.

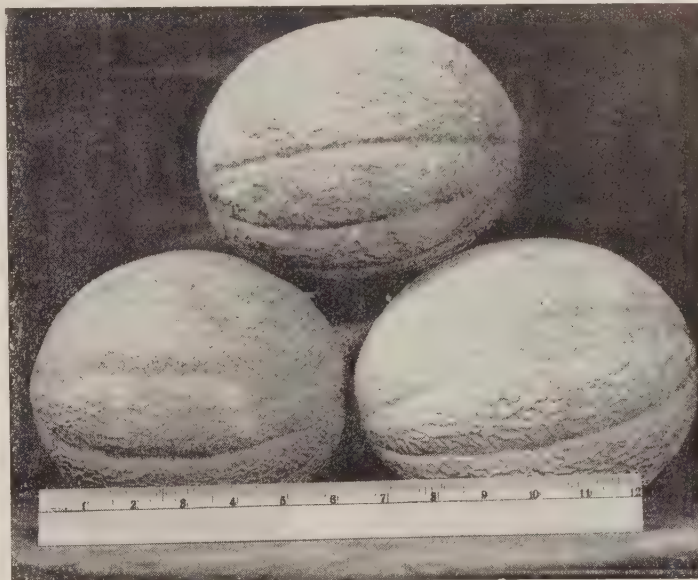

Pride of Wisconsin

BENDER'S SURPRISE—(94 days). Size 8 x 7¹/₂". It is early for a melon of this size and the flesh is of exceptionally high quality. It has coarse netting, distinct ribs and the rind is very hard. Pkt. 10c; oz. 20c; 1/4 lb. 60c; lb. \$1.75.

★★★**HALE'S BEST No. 36**—(85 days). Very uniform, about 5¹/₂ x 5¹/₂", the netting is heavy with just a faint stripe, the shape slightly oval and the flesh pink and very thick. Pkt. 10c; oz. 20c; 1/4 lb. 60c; lb. \$1.75.

★★★**HONEY ROCK (or Sugar Rock)**—(85 days). Size 5¹/₄ x 5¹/₄". It is one of the best pink fleshed sorts. The rind is tough and hard, covered with a distinctive rope-like netting. The flesh is of deep salmon color, fairly thick and very sweet. Pkt. 10c; oz. 20c; 1/4 lb. 60c; lb. \$1.75.

ONIONS

WHITE PORTUGAL OR SILVER SKIN—The bulbs are flat and are very largely used for growing sets on account of their fine shape when small and good keeping quality. Pkt. 10c; oz. 35c; 1/4 lb. \$1.00; lb. \$3.00.

RIVERSIDE SWEET SPANISH—A very large globe-shaped, light yellow onion with small top. Flesh sweet and mild. Pkt. 15c; oz. 50c; 1/4 lb. \$1.50; lb. \$5.00.

SOUTHPORT WHITE GLOBE—A uniformly globe-shaped variety, pure white and very mild flavor; equally as good as the Yellow Globe. Sow in early spring for green bunch onions. Pkt. 15c; oz. 50c; 1/4 lb. \$1.50; lb. \$4.50.

JAPANESE, OR EBENEZER—The onions are very large, somewhat flat, have attractive yellow skin and firm white flesh of delicate flavor. It is noted for having so few seed stalks when grown from sets. Pkt. 10c; oz. 30c; 1/4 lb. 90c; lb. \$2.75.

BERMUDA ONION PLANTS

Large, flat, mild and sweet, they are delicious and easily grown plants. Set them three inches apart in the rows and pull every other one for a green onion, this allows double use of the same space and gives the remaining onions plenty of room to reach their enormous size. Lift mature onions only when dry, cut off tops to onion and place upside down for two or three weeks before storing for winter.

Our plants are field grown in the south and we generally can supply Yellow Bermuda and Crystal Wax plants during March and first part of April. They are tied in bundles of approximately 100 each.

Prices, postpaid: 100 for 30c; 200 for 55c; 500 for \$1.25; 1,000 for \$2.15 Not postpaid: 100 for 20c; 200 for 35c; 500 for 85c; 1,000 for \$1.50. Standard crate, 6,000, \$7.75.

YELLOW ONION SETS—Quart 20c; gal. 70c. Postpaid: Quart 30c; gal. 85c.

WHITE ONION SETS—Quart 25c; gal. 80c. Postpaid: Quart 35c; gal. 95c.

ON LARGER QUANTITIES ASK FOR PRICE.

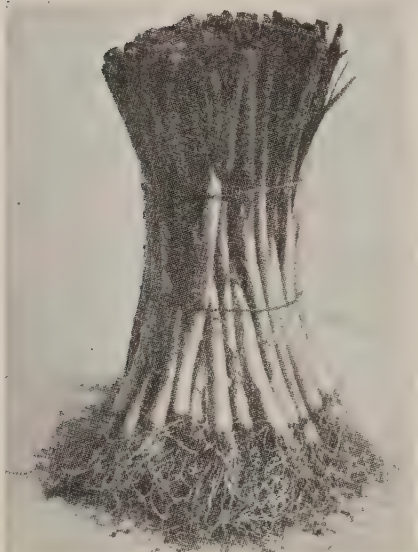

Bermuda Onion Plants

OKRA, PARSLEY, PUMPKIN, TAMPALA

OKRA

CULTURE—Okra is very easy to grow in any garden. It is a very tender plant and seeds should not be sown until ground is warm. Sow in rows 3 feet apart, 3 to 4 seeds per foot. Thin out to 10 inches apart.

WHITE LIGHTNING—(50 days). A great improvement over the White Velvet type and the best home garden okra. It grows 4 to 6 feet tall, bearing an earlier and very heavy crop of long, white, smooth, absolutely spineless pods. **Pkt. 10c; oz. 15c; 1/4 lb. 35c; lb. 75c.**

★★**CLEMSON SPINELESS**—(55 days). A green pod type that grows 3 1/2 to 4 feet tall, practically spineless, rich green in color, ridged pods of good quality, uniform and a distinct improvement. **Pkt. 10c; oz. 15c; 1/4 lb. 35c; lb. 75c.**

WHITE VELVET—(60 days). Plants grow 3 1/2 feet high; pods white, long, smooth and tender. **Pkt. 10c; oz. 15c; 1/4 lb. 35c; lb. 75c.**

★**DWARF PROLIFIC**—(50 days). One of the earliest and most dwarf varieties; pods short, deep green, slightly corrugated. **Pkt. 10c; oz. 15c; 1/4 lb. 35c; lb. 75c.**

PERKINS MAMMOTH POD—(56 days). Early and productive, the pods are deep green, very long, slender, slightly corrugated. **Pkt. 10c; oz. 15c; 1/4 lb. 35c; lb. 75c.**

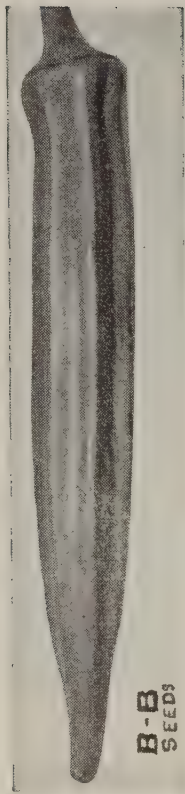

B-B
SEEDS

Clemson
Spineless

PARSLEY

CULTURE—Sow in early spring in rows 15 to 18 inches apart, covering seeds about 1/2 inch, pressing down the soil after covering. The seed is very slow to germinate, often requiring 4 to 5 weeks. It is advisable to soak the seeds two days before sowing, which will hasten germination.

CHAMPION MOSS CURLED—(70 days). Closely curled and one of the best for decorative and flavoring purposes. **Pkt. 10c; oz. 20c; 1/4 lb. 45c; lb. \$1.25.**

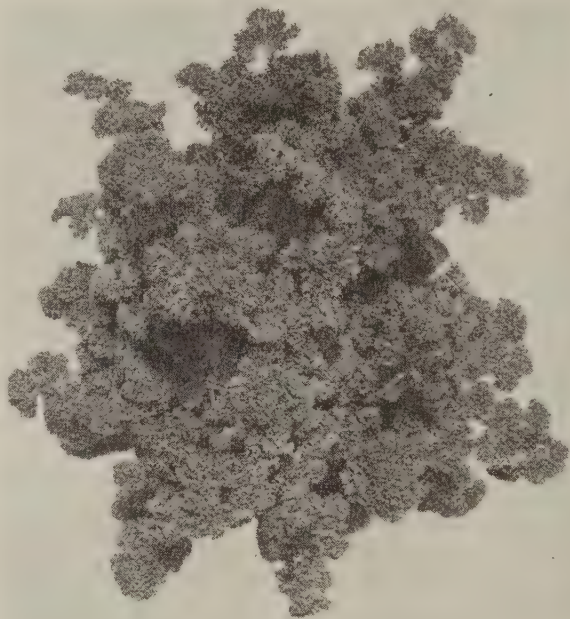

Moss Curled Parsley

PUMPKIN

One Ounce for 20 Hills; About One Pound to Acre.

CULTURE—Sow in good soil in May when the ground becomes warm, in hills 10 feet apart each way or in fields of corn every third or fourth hill. Very often planted at the same time with the corn.

★★★**LARGE CHEESE**—(110 days). Popular for stock feeding or canning. Flat, growing to a large size, is cream or buff color and has thick meat. **Pkt. 10c; 1/4 lb. 35c; lb. \$1.00.**

KING OF THE MAMMOTH—(120 days). A very fine flavored pumpkin, being well adapted to this climate; very large, meat thick, outside deeply ribbed. **Pkt. 10c; oz. 20c; 1/4 lb. 50c; lb. \$1.50.**

TENNESSEE SWEET POTATO—(110 days). Medium size, nearly bell shaped with neck slightly crooked. Flesh creamy white, thick, fine grained and excellent quality. **Pkt. 10c; oz. 20c; 1/4 lb. 50c; lb. \$1.50.**

★**WHITE CUSHAW**—(110 days). A popular crook-necked variety with hard, creamy-white shell; fruits two feet in length, with long, solid, mealy neck of fine quality. **Pkt. 10c; oz. 15c; 1/4 lb. 40c; lb. \$1.25.**

★★**STRIPED CUSHAW**—(112 days). Very large with solid crooked neck. Very delicious for table when cooked and served like sweet potatoes. Flesh light yellow, very thick and sweet. **Pkt. 10c; oz. 15c; 1/4 lb. 40c; lb. \$1.25.**



Tampala

TAMPALA

A new vegetable; the leaves are cooked and served like spinach or as a salad. The stems may be cooked like asparagus. One sowing usually produces enough greens for the season, however, for a continuous supply of tender leaves make successive sowings about 2 weeks apart. Sow seed outdoors after ground has become warm. Entire plants may be used when 5 or 6 inches high. Plants grown singly 2 feet apart will be about 1 1/2 feet across and 2 feet high, from these repeated cuttings can be made of the 4 or 5-inch tips of each branch. **Pkt. 15c; 1/8 oz. 60c.**

BUNTON'S FAMOUS GARDEN PEAS

1 Pint Will Plant 200 Feet of Drill; 50 to 60 Lbs. to the Acre

CULTURE—If weather conditions are favorable, smooth varieties are often sown in February. Any of the varieties can be successfully grown if planted during any of the early spring months, March and April being preferred. By planting early, medium early and late varieties at the same time, a succession of fresh peas may be had over several weeks. For Fall use plant from July 1st to August 15th. Plant in drills 2 inches deep, 20 peas to the foot, in rows, from 24 to 48 inches apart, depending on the variety.

★★★★**SUPREME**—(62 days). One of our specials, introduced here by us in 1926 and since that time has steadily grown in favor with all that have planted it.

It is a great pea and fully merits the unusual popularity it has gained since its introduction. It is the earliest of the large pod, dwarf wrinkled class and the most productive. The dwarf vine and foliage are of an intensely deep green color, being only 15 to 18 inches high and may be planted successfully in rows as close as 2 feet apart.

The pods are 4 inches long, broad, handsome, dark green and well filled with 8 deep green peas of exceptionally high quality and good flavor. Pkt. 10c; pt. 25c; qt. 45c; 1/2 gal. 85c; gal. \$1.60; peck \$3.00; 1/2 bu. \$5.65; bu. \$11.00.

★★**BUNTON'S IDEAL**—(65 days). A new, early, giant podded variety, only 2 or 3 days later than our B-B Supreme, pods at least one-fourth larger; has strong, dark green vine about 22 inches high, does not require sticks. The pods 4 1/2 to 5 inches, dark green, round with pointed ends.

It has outstanding merits, which are of special value to the market grower. Unusually early for such a large pea and commands highest market prices. Pkt. 10c; pt. 25c; qt. 45c; 1/2 gal. 85c; gal. \$1.60; peck \$3.00; 1/2 bu. \$5.65; bu. \$11.00.

EARLY BIRD—(61 days). The earliest large podded, semi-wrinkled pea, bearing medium dark green pods 4 to 4 1/2 inches long that usually contain 8 to 9 large peas of good quality; height 18 to 22 inches; matures to picking stage in about 55 days.

It is a heavy producer for a dwarf pea and is recommended for truckers and market growers. Pkt. 10c; pt. 25c; qt. 45c; 1/2 gal. 85c; gal. \$1.60; peck \$3.00; 1/2 bu. \$5.65; bu. \$11.00.

★★**EXTRA EARLY ALASKA**—(57 days). The very earliest, smooth, green pea. Grows to 2 1/2 feet high. Pods are 2 1/2 inches long, round, straight, square ended and contain six light green peas; very uniform in maturing. Pkt. 10c; pt. 25c; qt. 40c; 1/2 gal. 75c; gal. \$1.40; peck \$2.50; 1/2 bu. \$4.65; bu. \$9.00.

LITTLE MARVEL—(64 days). A splendid, first early dwarf wrinkled pea. 16 to 18 inches high, producing dark green pods about 3 inches long, blunt ended and crowded with 6 to 8 peas of extra fine flavor, tender and sweet. Pkt. 10c; pt. 25c; qt. 45c; 1/2 gal. 85c; gal. \$1.60; peck \$3.00; 1/2 bu. \$5.65; bu. \$11.00.

★**IMPROVED DARK POD TELEPHONE**—(74 days). The pods are 4 3/4 inches long, very broad, dark green, straight but slightly curved at the point and containing 9 large, medium green peas of the finest quality. The vines are very strong and grow 4 feet high. It is classed as a late variety, although one of the heaviest yielders. A very profitable pea to plant as a second or third early. Pkt. 10c; pt. 25c; qt. 45c; 1/2 gal. 85c; gal. \$1.60; peck \$3.00; 1/2 bu. \$5.65; bu. \$11.00.

MAMMOTH MELTING SUGAR—(74 days). The best of the edible podded sorts for home and market. Vines 4 to 5 feet high, light green. Pods 3 1/2 inches long, light green, brittle, fleshy, stringless, and of good quality, containing 7 light green peas. Pkt. 10c; pt. 30c; qt. 50c; 1/2 gal. 95c; gal. \$1.85; peck \$3.50.

THOMAS LAXTON—The 3 1/2-inch, medium green pods contain 7 to 9 good quality peas. Vines grow about 2 1/2 feet high. Pkt. 10c; pt. 25c; qt. 45c; 1/2 gal. 85c; gal. \$1.60; peck \$3.00; 1/2 bu. \$5.65; bu. \$11.00.

★**PERFECTO**—(69 days). Its large, handsome, dark green pods sell for a premium over other peas. A strong, healthy grower, attaining a height of 2 to 2 1/2 feet, considered a semi-dwarf and resistant to fusarium wilt. The unusual large pods, 4 1/2 to 5 inches long, are dark green, slightly curved and pointed, containing on an average of 10 large, delicious peas. Pkt. 10c; pt. 30c; qt. 50c; 1/2 gal. 90c; gal. \$1.75; peck \$3.25; 1/2 bu. \$6.15; bu. \$12.00.

★**BUNTONIAN**—(60 days). Buntonian is the earliest large podded pea you can plant. A rapid and vigorous grower and very productive. The vine and foliage are heavy and a deep green color. Height about 2 1/2 feet; pods 3 1/2 to 3 3/4 inches long, dark green, saddled back and blunt ended, usually containing eight large light green peas. Pkt. 10c; pt. 25c; qt. 45c; 1/2 gal. 85c; gal. \$1.60; peck \$3.00; 1/2 bu. \$5.65; bu. \$11.00.

IMPROVED GRADUS—(59 days). An improved type of Gradus, slightly earlier, more dwarf and very productive. The vines are moderately stout, medium green color and 2 feet high. Pods medium green, 4 inches long, fairly broad, pointed and filled with 7 to 9 very large, dark green peas of exceptional quality. Pkt. 10c; pt. 25c; qt. 45c; 1/2 gal. 85c; gal. \$1.60; peck \$3.00; 1/2 bu. \$5.65; bu. \$11.00.



Bunton's Ideal

PARSNIP

1 Oz. Will Sow a 100 Ft. Row

CULTURE—Plant seed in early spring as soon as the soil is warm, in rows 18 to 20 inches apart, 5 inches apart in the row. Cover seeds about $\frac{3}{4}$ inch. A rich loamy soil is best and should be loosened 10 inches deep. Being hardy they may be left in the ground during winter and dug as needed, as frost improves the flavor.

★**SUGAR, OR HOLLOW CROWN**—(95 days). This is a long, smooth variety growing from 10 to 12 inches long. It is very tender, sweet and of an excellent flavor; color, creamy white. We recommend this for home garden. Pkt. 10c; oz. 15c; $\frac{1}{4}$ lb. 40c; lb. \$1.25.

ALL AMERICAN—(95 days). A new and very good variety; the roots are large and broad shouldered, of medium length, fine texture, white color, and with small core; very free from side rootlets. Pkt. 10c; oz. 15c; $\frac{1}{4}$ lb. 40c; lb. \$1.25.



Hollow Crown Parsnip

PEPPER

Green Peppers Contain Vitamin A and B1

1 Oz. Will Produce About 2,000 Plants

CULTURE—Sow in hotbeds during February or March. In May transplant plants to outside, placing them 18 inches apart in 3 foot rows. When the ground becomes warm, the seed can be sown outside and transplanted as above. A good garden fertilizer worked into the soil when plants are 6 inches high, will materially increase the yield.

★★★**WORLD BEATER**—(75 days). A splendid variety for market gardening. The fruits are very large, with unusually thick sweet flesh of a mild flavor; the color, deep green when young; bright scarlet when ripe. Pkt. 10c; oz. 65c; $\frac{1}{4}$ lb. \$1.85; lb. \$5.50.

★★★**CALIFORNIA WONDER**—(75 days). Is very large, usually about 4 inches across and $4\frac{1}{2}$ inches in length. Its being smooth, dark green and nicely shaped, gives it a very pleasing outward appearance. The flesh is very thick, of fine quality, sweet, tender and entirely free from pungency. It is a very desirable variety for home gardens and a profitable one for the market grower. Pkt. 10c; oz. 70c; $\frac{1}{4}$ lb. \$2.00; lb. \$6.00.

CALWONDER—(63 days). An early strain of California Wonder, maturing a week to ten days earlier. Plant stocky and sturdy, vigorous, prolific. Fruits 3 and 4 lobbed, very attractive, smooth, uniform, deep green, changing to bright crimson at maturity. Flesh thick, sweet and mild. Pkt. 10c; oz. 75c; $\frac{1}{4}$ lb. \$2.25; lb. \$7.00.

BELL OR BULLNOSE, (Sweet)—(70 days). Vigorous and productive, bearing large attractive fruits early in season. Fruits deep green when young; flesh sweet, very thick, mild and fine flavored. Pkt. 10c; oz. 70c; $\frac{1}{4}$ lb. \$1.70; lb. \$5.00.

★★**FLORIDA GIANT**—(75 days). A heavy producer of large size, smooth, very uniform, sweet and mild flavored, dark glossy green peppers. It is somewhat similar to California Wonder, while the flesh is not hardly as thick, it is more productive of smooth, salable fruits, most of which have four lobes that are well filled out. Pkt. 10c; oz. 70c; $\frac{1}{4}$ lb. \$2.00; lb. \$6.00.

SUNNYBROOK—(73 days). A tomato shaped sweet pimento pepper. Fruits smooth, 3 inches in diameter by $2\frac{1}{2}$ inches in depth; thick fleshed. Red when ripe. Pkt. 10c; oz. 40c; $\frac{1}{4}$ lb. \$1.25.

PIMENTO—(73 days). A very thick flesh, heart shaped, smooth, mild variety. Pkt. 10c; oz. 70c; $\frac{1}{4}$ lb. \$1.75; lb. \$6.00.

LONG RED CAYENNE—(70 days). Fruits often curved and twisted; bright red, hot and pungent. Pkt. 10c; oz. 50c; $\frac{1}{4}$ lb. \$1.50; lb. \$5.00.

RED CHILI—(82 days). A rather small, bright red variety. Pods about 2 inches long, cone shaped, very hot and exceedingly prolific. Pkt. 10c; oz. 70c; $\frac{1}{4}$ lb. \$1.75; lb. \$6.00.

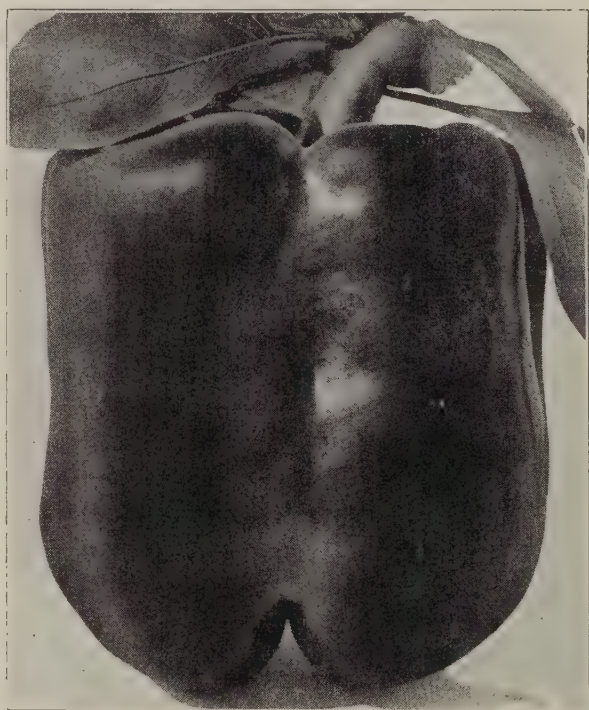

California Wonder

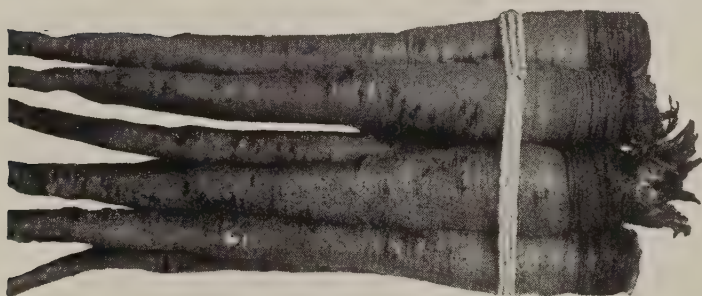

Mammoth Sandwich Island Salsify

SALSIFY

1 Oz. to 75 Feet; 6 Lbs. to the Acre

CULTURE—The same as Carrots except that Salsify is hardier and may be left in the ground all winter. Sow seeds in the early spring after ground has become warm, in drills 14 inches apart. Cover seed about 1 inch. Thin out plants to 4 inches in the row.

MAMMOTH SANDWICH ISLAND—This variety is large and strong growing with smooth, almost white, tapering roots. It has a mild and delicate flavor. The best sort for market gardener. Pkt. 10c; oz. 40c; $\frac{1}{4}$ lb. \$1.25; lb. \$3.50.

BUNTON'S RADISHES

1 Oz. of Seed Sows 100 Feet of Drill

CULTURE—Sow seeds in drills as soon as the frost is out of the ground. The plants should be thinned out to 2 inches apart in the row; rows about 12 inches apart. They may be sown successfully until the last of August.

★★**SPARKLER WHITE TIP**—(26 days). Quite similar to Scarlet Turnip White Tip as to size and time of maturity. However, the root is more round or ball shaped. The white extends further upon the radish and on this account is more popular in many markets. Pkt. 10c; oz. 15c; ¼ lb. 30c; lb. 75c; 5 lbs. @ 70c.

WHITE STRASBURG—(39 days). Roots are about 5 inches long, thick at the shoulder and tapers abruptly; skin and flesh are pure white. Remains firm and brittle longer than most varieties. Pkt. 10c; oz. 15c; ¼ lb. 30c; lb. 75c; 5 lbs. @ 70c.

★★**WHITE ICICLE**—(27 days). The leading long white radish and one of the earliest. The roots are about 6 inches long, white, slender and smooth. Pkt. 10c; oz. 15c; ¼ lb. 30c; lb. 75c; 5 lbs. @ 70c.

FRENCH BREAKFAST—(25 days). Roots oblong, thicken toward the bottom, dull scarlet with white tip, flesh white and crisp. Pkt. 10c; oz. 15c; ¼ lb. 30c; lb. 90c.



Sparkler White Tip

★★★**EXTRA EARLY SCARLET GLOBE**—(23 days). Very early and of attractive shape and color. The flesh is firm, crisp, tender, juicy and mild. It is a little longer than round, very uniform in shape and size; bright scarlet in color, with a very small root. Our forcing strain has a small top, grown from carefully selected transplanted roots. Pkt. 10c; oz. 15c; ¼ lb. 30c; lb. 75c; 5 lbs. @ 70c.

★**EARLY SCARLET GLOBE (Short Top)**—(23 days). Pkt. 10c; oz. 15c; ¼ lb. 30c; lb. 75c; 5 lbs. @ 70c.

LONG BLACK SPANISH—(58 days). Is especially adapted for winter use; is late maturing and very hardy. The roots are almost black, long and thick. Flesh white and very firm. Pkt. 10c; oz. 15c; ¼ lb. 35c; lb. \$1.00.

ROUND BLACK SPANISH—(55 days). An excellent keeping variety with large, black, round root. Fine for serving sliced as the flesh is white, solid, crisp and flavored. Roots will average 3½ to 4 inches in diameter. Pkt. 10c; oz. 15c; ¼ lb. 35c; lb. \$1.00.

★★★★**COMET**—(23 days). This new radish is becoming more popular each year, its bright scarlet color and perfect globe shape appeals to the eye and makes it a ready seller, it is quick growing, has medium top and small tap root. If left in the ground will grow to a large size without getting pithy. Is crisp, tender and nicely flavored. Pkt. 10c; oz. 15c; ¼ lb. 30c; lb. 90c; 5 lbs. @ 85c.



Icicle

CRIMSON GIANT—(28 days). Very large, but never pithy. Globe shaped and one of the best red radishes for outdoor culture. Pkt. 10c; oz. 15c; ¼ lb. 30c; lb. 75c; 5 lbs. @ 70c.



B-B Comet



Scarlet Globe

RHUBARB

CULTURE—Plants can be easily grown in any good garden soil. Sow seeds thinly in drills 18 inches apart, thin out plants to 4 or 5 inches. Two-year-old roots are generally preferred for the home garden. A dozen good plants is usually sufficient for the average family. The roots should be set 4 feet each way in deep, warm and very rich soil. The more manure the better stalk.

MYATT'S VICTORIA—Regarded as the best variety for market and home garden. Stalks are red and of immense size. Seed: Pkt. 10c; oz. 15c; ¼ lb. 60c; lb. \$2.00. Roots: Each 15c; doz. \$1.25.

CRIMSON WINTER—Produces small crimson stems of the finest color and quality in winter and spring, continues bearing over a long period. Pkt. 10c; oz. 40c; ¼ lb. \$1.25; lb. \$3.50.



Blight Resistant Bloomsdale

SPINACH FOR SUMMER AND WINTER USE

CULTURE—For Spring and Summer use, sow seeds in drills 1 foot apart and 1 inch deep as early as the ground can be worked and every two weeks to the middle of May.

★**BLIGHT RESISTANT BLOOMSDALE**—A very rapid growing strain of Bloomsdale Savoy, bred for disease resistance.

The plant is compact, leaves rounded, well crinkled and deep green in color. Its popularity with market growers is increasing each year and is now by far in greater demand than any other Spinach we list. Pkt. 10c; oz. 15c; ¼ lb. 25c; lb. 50c; 5 lbs. \$2.10; 10 lbs. \$4.00.

★**SELECTED BLOOMSDALE**—Very early and hardy. Color glossy deep green, favorite variety for home and market. Pkt. 10c; oz. 15c; ¼ lb. 25c; lb. 50c; 5 lbs. \$2.10; 10 lbs. \$4.00.

NEW ZEALAND—A distinct type of spinach, the plants grow in branching form, with thick, succulent leaves. The leaves and stems can be gathered at any time after they are well grown and plant will start out into new growth. Pkt. 10c; oz. 20c; ¼ lb. 50c; lb. \$1.50.

SQUASH

CULTURE—For SUMMER or bush varieties, sow seed after danger of frost and when ground has become warm. Plant 5 or 6 seeds in hills 4 feet each way. For WINTER or vine varieties, hills should be 8 by 6 feet each way. When well up they should be thinned out to two plants.

★★★**EARLY WHITE BUSH SCALLOP (Patty Pan Cym-ling)**—(52 days). The plant is bushy, with creamy white fruits, rather flat and scalloped edges; very prolific. Pkt. 10c; oz. 15c; ¼ lb. 40c; lb. \$1.25.

★★**GOLDEN SUMMER CROOKNECK**—(52 days). A standard and early productive summer sort; fruits moderately warted and of a bright yellow color. Pkt. 10c; oz. 15c; ¼ lb. 40c; lb. \$1.25.

★**TABLE QUEEN**—(58 days). A small winter squash of excellent quality, about the size of a cocoanut and dark green in color, changing to a bright golden after picking and storing. The meat is dry and meaty and requires only 20 minutes to bake. Pkt. 10c; oz. 20c; ¼ lb. 50c; lb. \$1.50.

★**WARTED HUBBARD**—(110 days). Fruits are large size, rough, skin dark green in color, flesh is bright orange. A splendid keeping variety. Pkt. 10c; oz. 20c; ¼ lb. 60c; lb. \$2.00.

EARLY PROLIFIC STRAIGHTNECK—(50 days). A week to ten days earlier than similar strains. The fruit grows to a length of about ten inches in a week after blossoming; the neck is thick, while the blossom end is decidedly blunt with a large blossom scar. The blunt blossom end makes the squash more symmetrical than when pointed. The color is a lemon yellow, which gives the fruits a distinct fresh appearance when on vegetable stands. One of its favorite characteristics is the small vine growth which permits much closer plantings than standard commercial varieties. Pkt. 10c; oz. 15c; ¼ lb. 40c; lb. \$1.25.

★**SUMMER STRAIGHTNECK**—(60 days). A carefully bred selection from the Golden Summer Crookneck, having all the good qualities of its parent, plus a straight and more meaty neck that does not break so easily when packed for shipment or market. Pkt. 10c; oz. 15c; ¼ lb. 40c; lb. \$1.25.



Straight Neck Squash



Warted Hubbard



Early Whitebush

TOBACCO

KY. 16 BURLEY (Root Rot Resistant)—A strain developed by the Ky. Agricultural Station that has become extremely popular for the Cigarette market. Strong grower, leaves bright, long and broad. Pkt. 20c; ½ oz. 40c; oz. 75c.

FOLLOWING VARIETIES—Pkt. 20c; ½ oz. 40c; oz. 75c.
JUDY'S PRIDE WHITE BURLEY—IMPROVED ONE
SUCKER (Dark)—**BIG ORONOKO (Dark)**—**SWEET ORONOKO (Dark)**—**YELLOW PRYOR**—**CHOICE HAVANA (Dark)**.

BUNTON'S TOMATO SEEDS

1 Oz. Will Produce About 1500 Plants. 4000 Plants to the Acre.

CULTURE—For early tomatoes, sow seeds in hotbeds during the latter part of February or the first of March. When plants are 3 inches high, transplant into cold frames, setting about 4 inches each way. Paper pots can be used to advantage for this as the root system would not be disturbed when transplanted to the open ground, after danger of frost. If the tap root is not broken, will continue to bear much longer. For main or fall crop, seed can be sown in the open ground from May 10th to June 1st. Plants should be transplanted where they are to remain 3 to 4 feet apart each way. More perfect and better fruits can be had if plants are well staked.



Pritchard

★★**PRITCHARD** (Wilt Resistant)—(76 days). A favorite medium early and main crop variety. The uniformly smooth, globe shaped fruits are large, solid and heavy, have thick walls; skin and flesh are intense scarlet; no core and small seed pockets. Pkt. 10c; 1/2 oz. 35c; oz. 65c; 1/4 lb. \$1.75; lb. \$6.00.

EARLIANA—(66 days). Fruit of fair size, bright scarlet color, round, very smooth, solid and produced in clusters in center of plant. Pkt. 10c; 1/2 oz. 40c; oz. 75c; 1/4 lb. \$2.00; lb. \$7.00.

★★★★**RUTGERS**—(80 days). An exceptionally heavy producing main crop variety having a strong vine growth, the fruits are globe shaped except somewhat flattened at the stem end, intense red in color and when it is red on the outside, you can be assured it is ripe all over. The outer and inner walls are solid meat, has small seed cavity and very few seeds. Pkt. 10c; 1/2 oz. 35c; oz. 65c; 1/4 lb. \$1.75; lb. \$6.00.

★★★**BREAK-O-DAY** (Wilt Resistant)—(70 days). An early type of Marglobe of lighter scarlet color. Fruits globe shaped with thick walls; meat firm and almost solid, having few seeds. Vine is vigorous and spreading with little foliage. Pkt. 10c; 1/2 oz. 40c; oz. 75c; 1/4 lb. \$2.00; lb. \$7.00.

★**BONNY BEST**—(70 days). A very popular extra early variety of medium size and bright red color. Fruits ripen uniformly and are produced in clusters in center of plant. Pkt. 10c; 1/2 oz. 35c; oz. 65c; 1/4 lb. \$1.75; lb. \$6.00.

STOKESDALE—(73 days). Medium large fruit, globe shaped, bright scarlet with solid flesh. Vines are medium heavy and unusually productive for this type. Pkt. 10c; 1/2 oz. 35c; oz. 65c; 1/4 lb. \$1.75; lb. \$6.00.

JUBILEE—ALL AMERICA BRONZE MEDAL WINNER—(72 days). A new large bright orange-yellow globular shaped, thick walled variety having few seeds and a very pleasant flavor. Excellent for table use, juice and canning. Plants sturdy and compact. A good producer. Pkt. 15c; 1/4 oz. 60c.

★★**MARGLOBE** (Wilt Resistant)—(75 days). A second early, scarlet fruited variety. Fruits are large, smooth, globular, meaty and almost coreless; plants are medium large and erect. Pkt. 10c; 1/2 oz. 30c; oz. 50c; 1/4 lb. \$1.50; lb. \$5.00.

★**GREATER BALTIMORE**—(78 days). Main crop, bright red fruited variety. Deep from stem to blossom ends, firm, solid and free from cracks and ridges. Pkt. 10c; 1/2 oz. 25c; oz. 40c; 1/4 lb. \$1.25; lb. \$4.00.

★**NEW STONE**—(83 days). Very vigorous and productive. Fruits round, large, solid, smooth and deep red in color. Pkt. 10c; 1/2 oz. 25c; oz. 40c; 1/4 lb. \$1.25; lb. \$4.00.

OXHEART—(90 days). An extra large, smooth, very solid, heart shaped tomato. Has few seed cells and quite free from acid. Color, purplish-pink. Pkt. 10c; 1/2 oz. 60c; oz. \$1.00.

★**PONDEROSA**—(88 days). An exceptionally large purplish pink tomato. Fruits very solid with few seeds; ripens early and bears well until very late. One of the best for home use. Pkt. 10c; 1/2 oz. 50c; oz. 90c; 1/4 lb. \$3.00; lb. \$10.00.

GOLDEN PONDEROSA—(86 days). Equal in size to purple ponderosa. Pkt. 10c; 1/2 oz. 50c; oz. 90c.

YELLOW PEAR—(75 days). About size of Yellow Plum. Pkt. 10c; 1/2 oz. 35c; oz. 65c; 1/4 lb. \$2.00.

YELLOW PLUM—(75 days). A small fruited variety. Splendid for preserving. Pkt. 10c; 1/2 oz. 40c; oz. 75c; 1/4 lb. \$2.00.



Rutgers

BUNTON'S DELICIOUS WATERMELONS

1 Oz. Will Plant 40 Hills; 2 Lbs. to the Acre

CULTURE—When the ground becomes warm, plant in hills 10 by 8 feet apart each way. If possible, use a shovelful of well rotted manure in each hill, putting it 4 or 5 inches under the top soil. Plant 5 seeds to the hill; when plants are well up thin out to three. Cultivate until vines cover ground. Pinch ends of the growing shoots to induce early fruiting.

DIXIE QUEEN—(85 days). A small seeded, round melon, handsomely striped and equal in size to the Stone Mountain.

It has proven to be a good seller and is increasing in demand. It is firm and solid, almost all heart, scarlet flesh is luscious sweetness. **Pkt. 10c; oz. 35c; 1/4 lb. 80c; lb. \$2.50.**

IRISH GRAY—(90 days). The rind is yellowish gray, mottled, quite thin but very tough, the flesh is bright sparkling red and exceedingly sweet, weighs 25 to 30 pounds. **Pkt. 10c; oz. 20c; 1/4 lb. 50c; lb. \$1.50.**

EARLY KANSAS—(75 days). One of the largest of early melons, nearly round in shape, with light green rind and darker green zigzag stripes. The rind is medium thick, and the bright red flesh, which goes down nearly to the rind, is of fine texture and very sweet, weighs 35 to 60 pounds. **Pkt. 10c; oz. 20c; 1/4 lb. 50c; lb. \$1.50.**

FLORIDA GIANT—(95 days). Enormous new variety sometimes weighing 100 pounds, solid dark green rind, flesh bright red and firm, nearly round shape. **Pkt. 10c; oz. 25c; 1/4 lb. 70c; lb. \$2.00.**

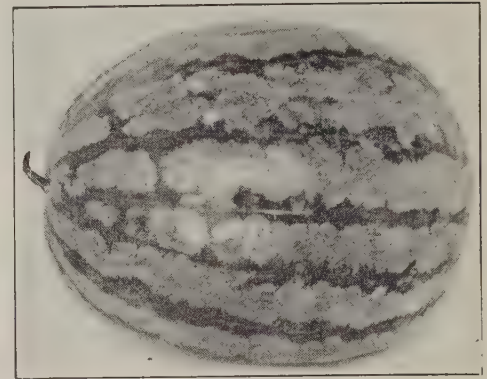

Dixie Queen

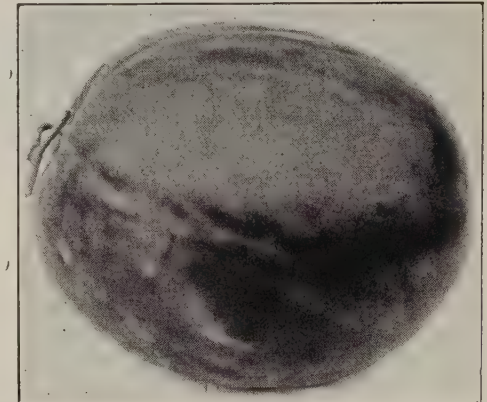

Florida Giant

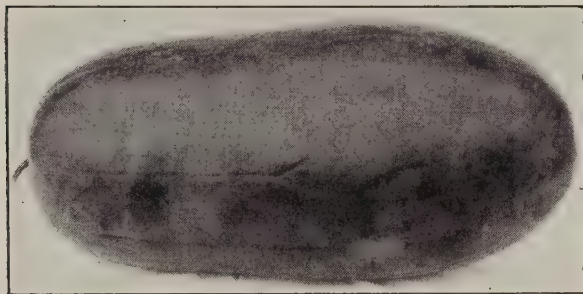

Kleckley's Sweet

STONE MOUNTAIN—(85 days). The largest and sweetest of the round melons. Under favorable conditions, fruits weigh from 50 to 60 pounds and ripen in about 85 days.

Its delicious, crisp, tender flesh is unsurpassed. The outside color is a dark green, medium thick rind, flesh deep red, firm and solid. It is the favorite melon for the home garden and market. **Pkt. 10c; oz. 25c; 1/4 lb. 65c; lb. \$1.75.**

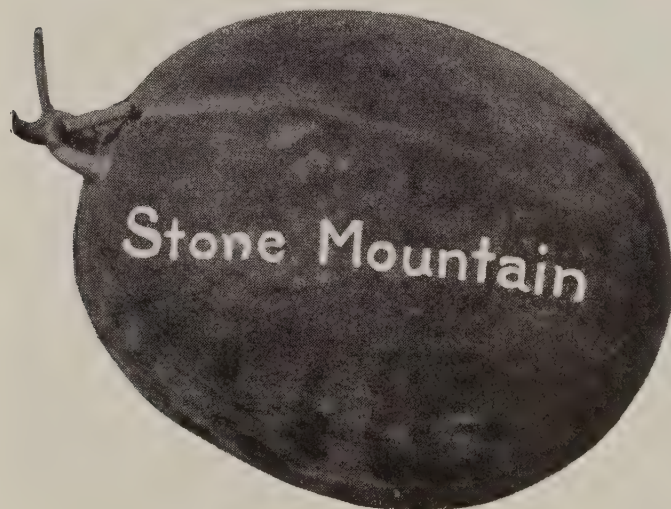

Stone Mountain

GOLDEN HONEY—(85 days). A rich golden yellow flesh oblong melon. Is deliciously flavored, sweet and tender. **Pkt. 10c; oz. 20c; 1/4 lb. 50c; lb. \$1.50.**

HALBERT'S HONEY—(75 days). It is very early and one of the sweetest melons grown. Its delicious crimson red flesh extends nearly to the skin; the rind is very thin and brittle. Is long and its dark green skin gives it a handsome appearance. **Pkt. 10c; oz. 20c; 1/4 lb. 50c; lb. \$1.50.**

IMPROVED KLECKLEY'S SWEET—(85 days). An oblong melon with attractive rich glossy, bluish green rind. Large size, often weighing 50 pounds and about 20 inches long.

The flesh is sparkling red and unusually delicious right up to the rind. Ripens in 85 to 90 days. Regular stock. **Pkt. 10c; oz. 20c; 1/4 lb. 50c; lb. \$1.50.**

TOM WATSON—(80 days). One of the favorite market melons. Its handsome appearance makes it a good seller on most any market. They are oblong and average 40 to 50 pounds. **Pkt. 10c; oz. 20c; 1/4 lb. 50c; lb. \$1.50.**



Tom Watson

TURNIPS, POTATOES, RUTABAGA

Oz. Will Drill About 250 Feet; 1 lb. to the Acre

CULTURE—For Spring crop, sow seed in drills, in rows 15 to 18 inches apart. Cover seed 1/2 inch. When plants are up thin out to 4 inches. For Fall and Winter crop, sow during July or August, in drills or broadcast.

BB PURPLE TOP GLOBE—Our highly selected strain of this well known variety is the best looking turnip grown, almost a perfect globe in shape, flesh and lower skin clear white. The purple skin runs well down on the sides, where it very uniformly joints the white, quick grower, sweet and tender. Pkt. 5c; oz. 15c; 1/4 lb. 30c; lb. 75c.

EXTRA EARLY PURPLE TOP MILAN—Extremely early and of splendid quality; bulbs of medium size, flat and white with a bright purple top. Pkt. 5c; oz. 15c; 1/4 lb. 30c; lb. \$1.00.

PURPLE TOP STRAP LEAVED—A very early, productive sort; roots flat, large size; purple or dark red above ground, white below; flesh white, tender and fine grained. Pkt. 5c; oz. 15c; 1/4 lb. 30c; lb. 75c.

SHOGOIN (Japanese Foliage)—The best dual purpose Turnip, the upright growing bright green leaves are mild and tender, roots semi-globular, white throughout, excellent quality, a rapid grower and resistant to aphids. Pkt. 5c; oz. 15c; 1/4 lb. 30c; lb. 75c.

SEVEN TOP (For Greens)—The tops are very popular for salads. Being a quick grower it is extensively planted in early Spring and Fall for real healthful greens. Pkt. 5c; oz. 10c; 1/4 lb. 20c; lb. 50c.



Purple Top Globe Turnip

IMPROVED PURPLE TOP RUTABAGA—The most desirable sort for table use or stock feeding. Roots are somewhat of a globe shape and grow to large size. Pkt. 5c; oz. 10c; 1/4 lb. 25c; lb. 60c.

BUNTON'S SEED POTATOES

PRICES SUBJECT TO CHANGE—(B SIZE 1 1/2 TO 1 7/8 INCHES IN DIAMETER.)

IRISH COBBLER—An early round white potato with deep eyes. A good yielder for both spring and fall crop; cooking and eating qualities unsurpassed. Cobbler is one of the most popular varieties.

	Per	100 Lb.
	Bu.	Bag
B Size Select.....	\$2.10	\$3.25
A Size Certified.....		3.90

KATAHDIN—A new white potato that has made record yields for this locality.

Katahdin is a fine looking, excellent cooking white potato, shape almost round, slightly oblong with shallow eyes. It is one to two weeks later than Irish Cobbler and without question the very best variety for the fall crop.

	Per	100 Lb.
	Bu.	Bag
B Size Select.....	\$2.10	\$3.25

EARLY RED TRIUMPH—The earliest variety of all. Potatoes are round with pink skin and shallow eyes, good quality and a fair yielder.

	100 Lb.
	Bag
A Size—Certified	\$3.90
B Size—Certified	3.75



Irish Cobbler

SEED TREATMENT GENERALLY PAYS

Semesan Bel is generally profitable to use because it usually increases yields and improves quality. In widely scattered tests, Semesan Bel has shown increases in Irish potato yields up to 25% and an average yield increase of 13.6% or 35.4 bushels per acre. If you price the 35.4 bushels at 50c each, they are worth \$17.70. Deduct 45c as the cost of the Semesan Bel for treating 20 bushels of seed per acre and the gross return is \$17.25—a well worthwhile return on the small cost for disinfectant (excluding labor). Repeated tests indicate that over a period of years you may expect Semesan Bel will usually increase the yield and improve the quality of the crop.—See page 24.



VEGETABLE PLANTING TABLE

FOR LATITUDE OF LOUISVILLE, KY.

Variety	When to Plant	Seeds or Plants for 100 Ft. Row	Seeds or Plants Required for Acre	Rows Apart	Apart in Row	Depth to Plant	Ready for Use
Asparagus Seeds	Early spring and fall	1 1/2 ounces	2 to 3 pounds	18 inches	2 to 3 inches	1 inch	1 year
Asparagus Roots	Spring and fall	80 to 100 roots	6000 to 9000	4 1/2 to 5 1/2 feet	12 inches	4 inch	2nd spring
Beans, Dwarf Snap	April to August 15th	1/2 pint	60 pounds	24 to 36 inches	3 inches	1 1/2 to 2 ins.	8 to 10 weeks
Beans, Pole Snap	May to August 1st	1/4 pint	15 to 20 pounds	30 to 40 inches	12 to 20 inches	1 1/2 to 2 ins.	10 to 12 weeks
Beans, Dwarf Lima	May to July 15th	3/4 to 1 pint	30 to 50 pounds	36 to 42 inches	10 inches	1 1/2 to 2 1/2 ins.	10 to 12 weeks
Beans, Pole Lima	May to July 1st	1/2 pint	25 to 30 pounds	40 to 48 inches	6 to 12 inches	1 1/2 to 2 1/2 ins.	12 to 14 weeks
Broccoli, Seeds	Feb. to Mar. and June	1/2 ounce	1/2 pound	12 inches	Drill	1/4 inch	
Broccoli, Plants	March to July	50 to 60 plants	8000	36 inches	18 to 24 inches		90 days
Brussels Sprout	May to July	1 packet	1/2 pound	30 to 36 inches	15 inches	1/2 inch	125 days
Beets, Garden	March to August 15	1 ounce	6 to 8 pounds	15 to 18 inches	3 inches	1 inch	40 to 50 days
Cabbage Seeds	January to May	1 packet	1/2 pound	12 inches	Drill	1/4 inch	Plants in 12 weeks
Cabbage Plants	Mar., April-June, July	50 to 65 plants	9000 to 16000	24 to 36 inches	15 to 20 inches		14 to 18 weeks
Carrots	March to July 15th	1 ounce	3 pounds	12 to 15 inches	2 to 3 inches	1/2 inch	10 to 12 weeks
Cauliflower Seed	January to March	1/4 ounce	1/2 pound	3-inch seed bed	3-inch seed bed	1/4 inch	18 to 20 weeks
Cauliflower Plants	March and April	65 plants	1500 plants	30 inches	18 inches		14 to 16 weeks
Celery Seed	February to April	1/4 ounce	1/4 pound	8-inch seed bed	Drill	1/2 inch	24 to 26 weeks
Celery Plants	June to August 1st	200	30,000	30 to 36 inches	6 inches		16 to 18 weeks
Corn, Garden	March to July 20th	1/4 pint	7 to 8 pounds	36 to 42 inches	10 to 15 inches	2 inches	10 to 12 weeks
Cucumber	April to July 10th	1/2 ounce	2 pounds	6 feet	6 to 12 inches	1 inch	8 to 10 weeks
Egg Plant Seed	February to April	1 packet	1/4 pound	Seed bed	Transplant 4 ins.	1/2 inch	18 to 20 weeks
Egg Plant Plants	May to July 1st	50 to 60 plants	7000 to 9000	36 to 42 inches	24 inches		10 to 12 weeks
Endive	March to August 1st	1/2 ounce	1 pound	14 to 16 inches	12 inches	1/4 inch	14 to 18 weeks
Kale	February to October	1 ounce	2 to 4 pounds	15 to 24 inches	Drill	1/2 inch	6 to 10 weeks
Kohl Rabi	Mar., May-Aug., Sept.	1 ounce	2 pounds	18 inches	5 to 6 inches	1/2 inch	10 to 12 weeks
Leek	March and April	1 ounce	4 pounds	12 to 18 inches	5 to 6 inches	1/2 inch	14 to 18 weeks
Lettuce, Leaf	March to September	1/2 ounce	2 pounds	12 to 15 inches	3 to 4 inches	1/2 inch	8 to 10 weeks
Lettuce, Head	February to August	1/4 ounce	1 pound	15 to 18 inches	8 to 10 inches	1/2 inch	12 to 16 weeks
Melons, Musk	May to July	ounce—50 hills	2 pounds	6 feet	4 feet	1 inch	13 to 15 weeks
Melons, Water	May to June	ounce—40 hills	2 pounds	10 feet	8 feet	1 inch	13 to 15 weeks
Mustard	March to September	1 ounce	4 to 5 pounds	15 inches	Drill	1/2 inch	6 to 8 weeks
Okra	May to June	2 ounces	6 pounds	36 to 42 inches	8 to 10 inches	1 inch	10 to 12 weeks
Onion Seed for Sets	March to April	1 1/2 ounces	40 pounds	12 inches	Drill 14 to inch	1/2 inch	16 to 22 weeks
Onion Seed for Onions	March to April	1/2 ounce	3 pounds	12 inches	Drill 1 to inch	1/2 inch	16 to 22 weeks
Onion Sets	February to May	2 quarts	10 to 15 bushels	12 inches	4 inches	1/2 inch	16 to 22 weeks
Onion Plants	February to May	300 plants	13200	12 inches	4 inches	1 inch	16 to 22 weeks
Parsley	Feb., Mar.-Sept., Oct.	1 ounce	4 to 5 pounds	15 to 18 inches	Drill	1/2 inch	12 to 14 weeks
Parsnips	March to June 1st	1 ounce	4 pounds	18 to 20 inches	4 to 5 inches	3/4 inch	After frost
Peas	February to April	1/2 pint	50 to 60 pounds	24 to 48 inches	1 to 2 inches	1 1/2 to 2 inches	14 to 20 weeks
Pepper Seed	February, March, April	1 packet	1 pound	Plant bed	1/2 to 1 inch	1/4 inch	
Pepper Plants	May and June	65 plants	9800 plants	36 inches	18 inches		10 to 12 weeks
Potatoes, Irish	March, April and July	1/2 peck	10 to 12 bushels	28 to 36 inches	11 to 15 inches	3 to 4 inches	12 to 15 weeks
Potatoes, Sweet	May and June	100	12000	4 feet	10 to 12 inches	Ridge	13 to 15 weeks
Pumpkin	May and June	ounce—20 hills	1 pound	10 feet	10 feet	1 inch	18 to 22 weeks
Radish	February to September	1 ounce	8 to 10 pounds	10 to 12 inches	1 to 2 inches	1/2 inch	18 to 24 days
Rhubarb Seed	March and April	1 ounce	8 to 10 pounds	24 to 30 inches	4 to 5 inches	1/2 inch	1 year
Rhubarb Roots	February to May	40 to 50	5500	4 feet	2 feet	4 inches	2nd year
Salsify	March to June	1 1/2 ounces	6 pounds	14 to 18 inches	3 to 5 inches	1 inch	14 to 18 weeks
Spinach	April, May-Aug., Sept.	2 ounces	12 to 15 pounds	12 inches	2 to 3 inches	1 inch	8 to 12 weeks
Squash, Summer	April to June	1 ounce	2 pounds	4 feet	3 feet	1 inch	10 to 12 weeks
Squash, Winter	April and May	1/2 ounce	1 pound	8 feet	6 feet	1 inch	14 to 18 weeks
Swiss Chard	Early spring	1 ounce	4 to 5 pounds	14 to 16 inches	10 to 15 inches	1 inch	
Tomato Seed	February to June	1 packet	10 pounds	18 inches	1 inch	1/2 inch	Plants in 6 to 8 wks.
Tomato Plants	April to July 1st	40 to 50	3000 to 5000	3 to 4 feet	2 to 3 feet		12 to 14 weeks
Turnip	Mar., April-June to Sept.	1 packet	1 pound	15 to 18 inches	4 inches	1/2 inch	10 to 12 weeks

Special Uses of Flower Seed—Page 40

NOTE: Sometimes seed with a high germination test fails to grow in the open ground when conditions are seemingly favorable. Sometimes certain plantings produce a healthy vigorous growth, yet do not bear fruit. You can work with nature better than against it. If you have had crop failures or poor yields without an explainable reason try the MOON SIGN BOOK for 1947. Order your copy today. Price \$1.00 postpaid.

CALENDAR FOR FORAGE AND FIELD CROPS

Variety	Seeds Required per Acre	When to Sow or Plant	How to Plant	Average Yield	Lbs. of Seed per Bu.
Barley	1 1/2-2 bushels	Aug., Sept., Oct.	Drill or broadcast	30 to 50 bushels	48
Beets—Stock	6 to 8 pounds	April and May	Drill 6 inches by 2 feet	20 to 25 tons	
Blue Grass	2 to 4 bushels	Spring and fall	Broadcast	Pasture	14
Buckwheat	1 bushel	July 10-20th	Drill or broadcast	25 to 35 bushels	48
Cane or Sorghum, Forage	Peck to bushel	May and June	Drill peck—broadcast bushel	15 to 20 tons	50
Cane or Sorghum, Syrup	5 to 8 pounds	May	Drill 36-inch rows		50
Carrots, Stock	4 pounds	May and June	Drill in rows, 18 inches apart	15 to 20 tons	
Clover—Alfalfa	15 pounds	Mar., April, Aug.	Broadcast	6 to 8 tons	60
Clover—Alsike	5 pounds	Mar., April, Aug.	Broadcast	2 to 4 tons	60
Clover—Crimson	20 pounds	July, Aug., Sept.	Broadcast	2 to 4 tons	60
Clover—Medium Red	8 to 10 pounds	Mar., April, Aug.	Broadcast	3 to 6 tons	60
Clover—Mammoth Red	8 to 10 pounds	Mar., April, Aug.	Broadcast	3 1/2 to 7 tons	60
Clover—Korean Lespedeza	5 to 20 pounds	April, May	Broadcast	Pasture	
Clover—Ladino	4 pounds	Feb., April, May, Aug., Sept.	Broadcast	Pasture	60
Clover—Sweet	12 to 15 pounds	Feb., Mar., April, July, Aug.	Broadcast	2 to 4 tons	60
Corn—Broom	5 pounds	May	Drill in row 3 1/2 feet apart	1/2 ton broom straw	46
Corn—Ensilage	8 to 10 pounds	April, May	Drill 1 foot by 3 1/2 feet	20 to 40 tons	56
Corn—Indian	7 to 8 pounds	April, May, June	Drill or check	40 to 50 bushels	56
Corn—Kaffir	3 pounds	May, June	Drill in rows 3 feet apart	1 1/2 to 2 tons	50
Corn—Pop	6 pounds	May, June	Drill 1 foot by 3 feet	1500 to 2000 pounds	56
Cow Peas	1 1/4 to 1 1/2 bushels	May, June, July	Drill or broadcast	2 to 4 tons	60
Millet	1 bushel	May, June, July	Broadcast	2 to 3 tons	50
Oats—Spring	13 1/4 to 2 1/2 bushels	Feb., Mar., April	Drill or broadcast	2 tons hay, 40, bushels gra	32
Oats—Winter Turf	2 to 3 bushels	August to October	Drill or broadcast	Grazing	32
Orchard Grass	1 to 2 bushels	Feb., Mar., April	Broadcast	Pasture	14
Rape	6 to 8 pounds	Feb. to April 15th	Drill or broadcast	Grazing	
Rye	1 1/2 to 2 bushels	Aug. to Nov.	Drill or broadcast	Grazing	56
Rye Grass	30 to 50 pounds	Spring or fall	Broadcast	Pasture	24
Red Top Grass	6 to 8 pounds	Spring and fall	Broadcast	Hay and pasture	14
Sudan Grass	5 to 20 pounds	May and July	Drill or broadcast	8 to 10 tons	50
Sunflower	5 pounds	April, May, June	Drill in rows 3 1/2 feet apart		24
Timothy	1/4 bushels	Spring and fall	Broadcast		45
Vetch, Winter	30 to 40 pounds	Aug., Sept., Oct.	Drill or broadcast	Pasture or cover crop	
Wheat, Winter	1 to 1 1/4 bushels	Sept. to Nov.	Drill or broadcast	15 to 20 bushels	60

BUNTON'S FIELD CORN

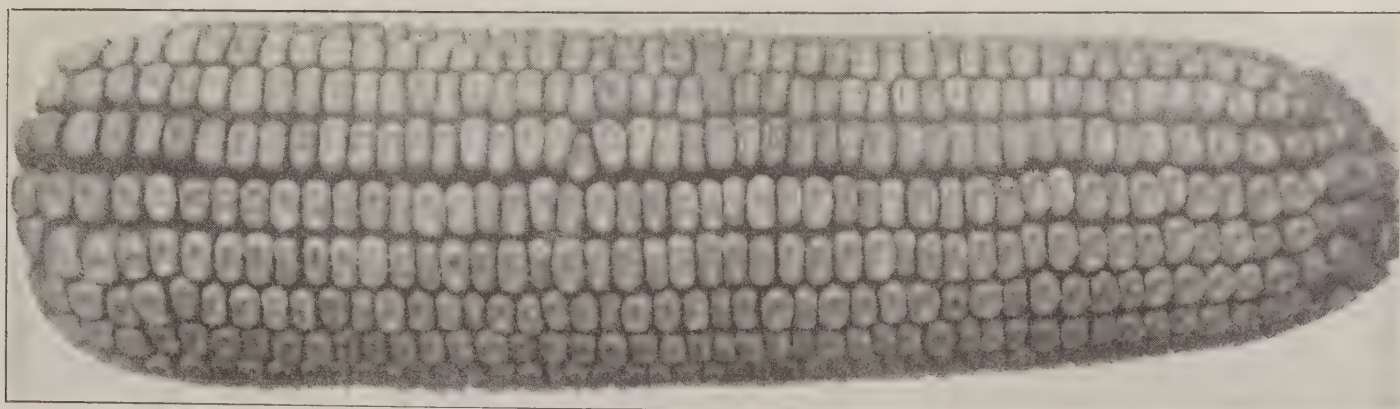

HYBRID CORN

U. S. 13 YELLOW HYBRID. From inbreds of Reids, Krugs and Lancaster; has proven to be well adapted for Kentucky. Has large single ears with an average of 18 rows of deep grains, stalks about 9 feet high, ear about 4 feet from ground. It is resistant to southern corn root worms, frost and Stewart disease. Maturity 122 to 125 days. **Pt. 25c; qt. 40c; 1/2 gal. 70c; gal. \$1.25; pk. \$2.25; 1/2 bu. \$4.25; bu. \$8.00.**

IND. 844 YELLOW HYBRID—This variety won for an Indiana farmer the title of Corn King of the U. S. and Canada. The ears are large with some resemblance of Reid's Yellow Dent. Ears are uniform on stalks. **Pt. 25c; qt. 40c; 1/2 gal. 70c; gal. \$1.25; pk. \$2.25; 1/2 bu. \$4.15; bu. \$8.00.**

KY. 203 WHITE HYBRID—Rated the highest yielding Kentucky White Hybrid. A good medium early variety with large well filled ears. The vigorous stalks are tall and show good habits of growth. Matures very uniformly. A real white hybrid corn bred in Kentucky for Kentucky farmers. **Pt. 25c; qt. 40c; 1/2 gal. 70c; gal. \$1.30; pk. \$2.50; 1/2 bu. \$4.65; bu. \$9.00.**

OPEN POLINATED

BOONE COUNTY WHITE—One of the most popular white corns. The ears are large and well filled with 18 to 20 rows of deep grain. The grains are soft and pure white, the cob large and white and is usually filled over the tip end. **Qt. 20c; 1/2 gal. 35c; gal. 60c; pk. \$1.10; 1/2 bu. \$2.05; bu. \$3.75.**

JOHNSON COUNTY WHITE DENT—Somewhat similar to Boone County though slightly larger, grains very deep, soft and pure white. **Qt. 20c; 1/2 gal. 35c; gal. 60c; pk. \$1.10; 1/2 bu. \$2.05; bu. \$3.75.**

HICKORY KING—Matures in about 120 days. Roasting ears in 95 days, and usually has 2 to 3 fair sized ears to the stalk. The cobs are very small, the grain white and are so broad it takes only 8 rows to fill the cob. **Qt. 25c; 1/2 gal. 45c; gal. 80c; pk. \$1.40; 1/2 bu. \$2.65; bu. \$5.00.**

IOWA SILVER MINE—The ears are large, the grains fairly broad and deep, it matures in about 100 days and nearly always two ears to the stalk. **Qt. 20c; 1/2 gal. 35c; gal. 60c; pk. \$1.10; 1/2 bu. \$2.05; bu. \$3.75.**

REID'S YELLOW DENT—This is probably one of the most used yellow corns in this part of the country. The ears average about 10 inches long and well filled with 18 to 20 rows of deep kernels. Matures in about 120 days. **Ask for price.**

SILAGE CORNS

EUREKA ENSILAGE—A tall, leafy variety growing 12 to 15 feet high with an enormous growth of fodder. It bears 1 to 2 ears to the stalk, the ears frequently over 12 inches. **Bu. \$5.00.**

SOUTHERN PROLIFIC—Takes about 125 days to develop into hard corn. Stalks are large, 8 to 12 feet tall; leaves are large and plentiful, the ears medium sized and often 4 to 6 on a stalk. **Bu. \$5.00.**

HAND CORN PLANTERS

No. 306—Two-hand, slide type, steel slide adjustable to vary drop. Steel hopper 3x3 1/2 inches. Overall length 36 inches. **Each \$2.10.**

No. 308—Two-hand planter complete with fertilizer attachment. Drops corn and fertilizer accurately. **Each \$3.85.**

CORN KNIVES

No. WB3—Straight, crucible steel blade 18 inches long, 1 1/2 inches wide. Hardwood handle with 3 rivets. **Each 85c.**

No. W55—15-inch steel blade, extreme width 3 1/4 inches. Wood handle fastened with rivets. **Each 50c.**

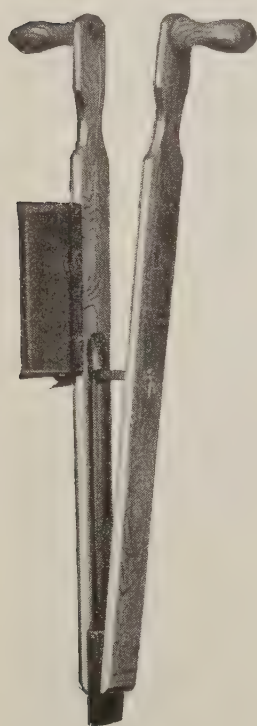

No. 306

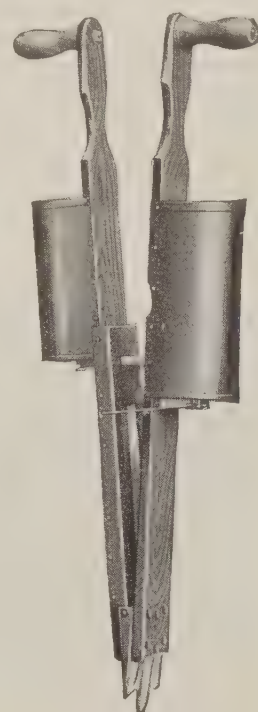

No. 308

SEED TREATMENT INCREASES YOUR CROP YIELDS AND PROFITS!

SEMESAN

On Vegetables and Flowers

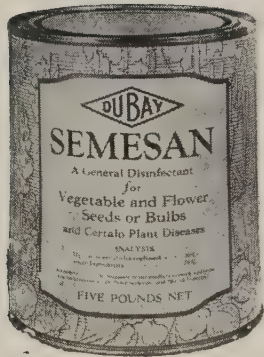

Prevent the many damaging diseases of flowers and vegetables that are carried on the seed, by disinfection of the seed with Semesan. It destroys the destructive diseases on the seed and protects them from the rots in the soil, which results in increased stands of more vigorous, healthy plants that yield larger, quality crops. Sprinkling of the seedling beds with Semesan solution effectively prevents damping-off. Recommended especially

for seeds bulbs, gladiolus corms, dahlia tubers, and rose bushes. Easily applied as a liquid or dust. One ounce treats 15 to 30 pounds of seed. Costs 1/4 to 1c per pound of seed. Directions in every can. Prices—1/2 oz. env. 12c; 2 oz. can 45c; 12 oz. can \$1.88; 4 lb. can \$10.10; 25 lb. drum \$58.28; 100 lb. drum \$219.80.

NEW IMPROVED SEMESAN, JR.

For Field and Sweet Corn

Illinois Experiment Station tests show field or sweet corn dusted with **New Improved Semesan Jr.** is protected from destructive **Diplodia** and **Gibberella** root rot carried by the seed, and from rotting in the cold, wet soil. **New Improved Semesan Jr.** insures better stands and yields of corn. In 26 out of 28 tests, it increased the yield as high as 22%, and gave an average increase of nearly 10%. The cost of treating Field Corn is approximately 2 1/2 to 3 cents per acre. Prices—1 1/2 oz. pkg. 17c; 12 oz. can 62c; 1 lb. can 75c; 6 1/4 lb. can \$4.16; 25 lb. pail \$13.85; 100 lb. drum \$49.95.

IMPROVED SEMESAN BEL

For Seed Potatoes

Seed potato treatment will bring you more profit than ever before. **New Improved Semesan Bel**—the quick dip treatment—has cut treating cost to 1 1/2c to 3c per bushel of seed and gives equal or better control of seed-borne Rhizoctonia and scab than the old soak treatments. It protects seed pieces against rotting, insuring maximum stands; gives more consistent increases in yield and consequently larger profits. It costs less in time and labor than the old treatments.

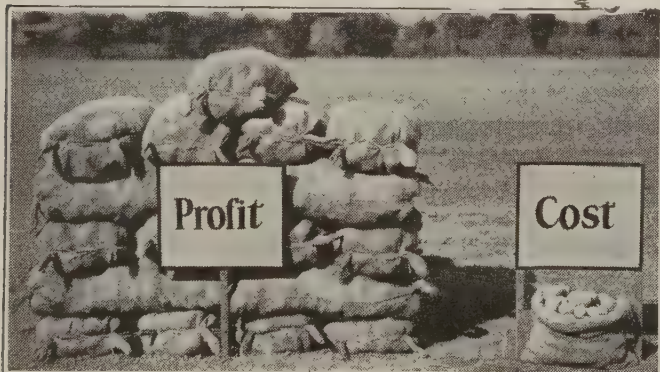

It is easily and quickly applied. Just mix 1 pound of **Improved Semesan Bel** with 7 1/2 gallons of water, dip your seed potatoes, drain and plant. One lb. treats 60 to 80 bushels of seed potatoes. Prices

2 oz. pkg. 35c; 1 lb. can \$1.83; 4 lb. can \$6.33; 25 lb. drum \$36.90; 100 lb. drum \$138.75.

ARASAN—A seed disinfectant and protectant, combating seed rotting and decay. Helps seed germinate normally and produce healthy plants and usually higher yields. 1 oz. 16c; 8 oz. 80c; 5 lbs. \$6.45; 25 lbs. \$30.00; 100 lbs. \$115.00.

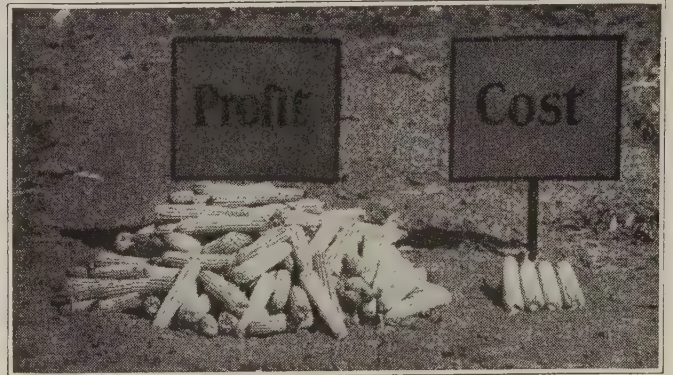

NEW IMPROVED CERESAN

For Wheat, Oats, Barley

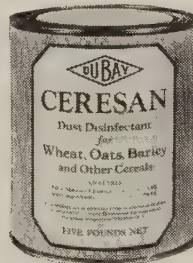

Lower your grain production cost per acre—enlarge your profit—by increasing yields with **New Improved Ceresan**. It is unusually effective in controlling bunt or stinking smut of wheat, covered smut and stripe of barley, and oats smuts. Frequently improves the stand and increases the yield of grain 1 to 5 or more bushels per acre.

New Improved Ceresan is easily and quickly applied by 20 to 25 revolutions of the seed treater, or, by 3 turnings with a shovel. Seed should be treated 24 hours before planting. No disagreeable, nauseating dust to be breathed—no swollen or injured seed—no drill damage for the use of **New Improved Ceresan**.

COST—Just 1 7/8 to 2 1/3 cents per bushel of seed. One pound treats 32 bushels of wheat, oats and barley. Price—4 oz. can 35c; 1 lb. can 90c; 4 lb. can \$3.00; 8 lb. can \$6.00; 25 lb. pail \$16.65; 100 lb. drum \$61.05.

Inoculate all Legume Seeds with

NITRAGIN

1898—Nearly A Half Century of Service—1947

When ordering, Always state name of seed

ALFALFA		SOYBEANS	
Swt., Bur, Hubam Clovers	Retail	Size	Retail
1 bu. each....	\$.50	Small, (Inoculates up to 120 lbs. seed)	\$.30
2 1/2 bu. each....	1.00	5 bu. each.....	.55
		25 bu. each.....	2.50
		(One can)	
CLOVERS		30 bu. each.....	3.25
Red, Alsike, Crimson, White and Ladino.		(6-5 bu. cans)	
1 bu. each....	\$.50	BEANS—Navy, Pinto, Wax, String, Kidney and Great Northern	
2 1/2 bu. each....	1.00	1 bu. each.....	\$.35
LESPEDEZA		PEANUTS, LIMA BEANS, COW PEAS	
100 lb. size (Inoculates up to 100 lbs.) ..	\$.50	Small, (Inoculates up to 120 lbs. seed)	\$.30
PEAS (All Varieties)		5 bu. each.....	.55
VETCHES (All Varieties)		25 bu. each.....	2.50
100 lb. size (Inoculates up to 100 lbs.) ea.	\$.50	(One can)	
1200 lb. size ea...	5.70	30 bu. each.....	3.25
(12-100 lb. cans)		(6-5 bu. cans)	
LUPINES (All Varieties)		GARDEN SIZE—Peas, Beans, Sweet Peas, Lupines, Lima Beans and Edible Soybeans	
100 lb. Size (Inoculates up to 100 lbs. seed) ea.	\$.50	Enough for 8 lbs. seed — Retail Price 10c each	

BUNTON'S FIELD SEED



ALFALFA

The feed and soil improving value of Alfalfa is so valuable for the average farm that the acreage is gradually increasing each year. The yield is ordinarily more than twice the amount of hay that Red Clover will afford and the feed is valued at least twice as high. It can be cut from three to five times per year, and will average four to five tons to the acre. It is a great nitrogen-gathering plant and will increase the value of the farm because it enriches the soil.

It makes a wonderful pasture for hogs and assists keeping them in a healthy and growing condition. All kinds of stock are very fond of it and it comes nearer taking the place of grain as a fatter than any other hay.

KANSAS—Bu. \$28.50.

OKLAHOMA (APPROVED)—Bu. \$28.00.

SWEET CLOVER

One of the greatest plants for enriching the soil. The plant seems to be able to live from the air and deposit great quantities of nitrogen in nodule form on the roots. If given a chance, it will restore fertility within a few years on badly worn and neglected land. Also an excellent hay and pasture; feed value next to Alfalfa; it is a very rapid grower and usually affords the first green feed in the spring and the last in the fall. Also Sweet Clover will inoculate your ground for Alfalfa. The seeds should be sown during the early spring or early fall months.

WHITE BLOSSOM (SCARIFIED)—

YELLOW BLOSSOM (SCARIFIED)—Bu. \$10.50.

RED CLOVER

A standard variety and used extensively in crop rotation. It is one of the best nitrogen-gathering plants and enriches the soil as well as being a very heavy producer of excellent hay. B-B Grade—**Bu. \$35.00.**

MAMMOTH, or SAPLING CLOVER

—The plant of this clover is at least one-third larger than the ordinary Red Clover.



LADINO CLOVER

Ladino is a giant variety of White Dutch Clover and is increasing in popularity each year. It is well suited to this state and makes about twice the growth of ordinary White Clover. It grows well with grasses, especially orchard grass. **Lb. \$2.00; 10 lbs. @ \$1.75.**

ALSIKE CLOVER

One of the hardiest of all clovers and succeeds well on a wide variety of soils. Specially adapted to moist or low land. Makes a very fine quality hay, and is one of the best clovers for grazing. If you have failed with the other clovers, try Alsike. **Bu. \$34.00.**

CRIMSON CLOVER — An unusual clover usually sown in this latitude during months of July, August or September.

KOREAN LESPEDEZA

Korean Lespedeza will usually make. As far as known never fails because of drought and comes to a thick stand each year until plowed. All stock relish Korean. It is one of the highest protein yielding plants, and puts on the weight. If cut for hay while in the blooming stage the remaining stubble will mature abundance of seed to assure a volunteer crop the next season. In this state (Kentucky) Korean sod land yields more corn than before Korean was used. The cost per acre is small. Sow 5 to 10 lbs. to the acre when sown with other seeds. 20 to 30 lbs. when by itself. Sow in the early spring.

B-B GRADE (Dodder Free)—\$9.00 per 100 lbs.

No. 1 GRADE (Trace of Dodder)—\$8.50 per 100 lbs.

CHOICE GRADE (Dodder present)—\$8.00 per 100 lbs.

PRIME GRADE—A large per cent hulled seed, (Dodder present) suitable for pasture land. **\$6.00 per 100 lbs.**

SUDAN GRASS

Sudan grass is considered a very important, quick growing hay and pasture grass. It is usually ready to cut in 45 days from time of seeding, thus if sown in spring as soon as the soil is warm, it will afford 2 to 3 cuttings during the season. Its slender leafy stems are easily handled with ordinary haying machinery. Being drought and heat resistant, it makes its greatest growth in July, August and September. It is a valuable green food crop for dairy men to use when pastures are dried up by summer heat.

SORGHUM, OR CANE SEED

For Forage Crop

ORANGE—A splendid variety that grows well and produces a light colored and fine flavored syrup.

Ask for Current Field Seed Price List

BUNTON'S FIELD SEED

KENTUCKY BLUE GRASS—Kentucky is famous for this native grass which is fine for lawns and pastures. It is one grass that does well in many climates and affords a beautiful green turf the year round. The seed is slow to germinate, but when once started, it will spread and eventually completely cover the ground. It is unequalled for lawns and permanent pastures.

SEASIDE BENT—A true creeping bent, spreading rapidly by means of stolens or runners. It stands close cutting, but requires frequent watering. **Lb. \$1.75; 10 lbs. @ \$1.60.**

CHEWING FESCUE—Forms a close and lasting turf, especially adapted for dry sandy soil. It resists extreme drought and thrives well on poor soils. Sow 2 lbs. to 300 square feet. **1 lb. \$1.25.**

RYE GRASS—A splendid grass where quick growth is desired or for winter coverage; is deep rooting and holds well on terraces and embankments. Sow 2 pounds to 300 square feet. **1 lb. 25c; 5 lbs. \$1.00; 10 lbs. \$1.50.**

BERMUDA GRASS—A persistent growing grass, especially adapted to climatic conditions of the southern states. Stands long hot summers without injury. Turns brown after frost. Not recommended for lawns. **Lb. 85c.**

RED TOP—A quick growing grass suitable for lawns and pastures; is particularly adapted to moist soil. One pound for 400 square feet. Fancy Grade—**1 lb. 35c; 5 lbs. \$1.50; 100 lbs. \$23.00.**

MEADOW FESCUE—A splendid deep rooting grass. Well adapted to poor soils for pasture or meadow. Stands close grazing and stays green throughout the year.

ORCHARD GRASS—Orchard grass is a very valuable grass for pasture or hay; grows very rapidly and will furnish an excellent pasture of green grass very early in spring and late in the fall. **Bu. \$3.50.**

TIMOTHY—Timothy is recognized most everywhere as valuable hay crop; thrives well on most any soil; does much better than other grasses on low land. It can be sown either in the fall or spring months. **Bu. \$4.50.**

WHITE DUTCH CLOVER—Makes a small, close, compact growth, covering the ground like a carpet. It is very hardy and well adapted to most any soil. **B-B Grade.**

DWARF ESSEX RAPE—Rape is unequalled as a green forage or grazing for sheep, hogs or poultry. It has been known to produce 10 tons of green forage per acre. For hogs, an acre of rape will easily pasture 20 hogs for two months. Sow in drills 18 inches to 2 feet apart and cultivate occasionally. It will obtain a minimum growth in 8 to 10 weeks. Sow as early as possible, in drills 3 to 4 pounds, broadcast 8 lbs. Sowing 7 to 8 pounds of rape in corn at the last working will prove a very profitable practice. **1 lb. 35c; 10 lbs. \$2.00.**

MILLET TENNESSEE GOLDEN (GERMAN)—A very rapid-growing plant and on good soil grows 4 to 5 feet high, producing a very sweet and palatable hay. Prices fluctuate and are subject to change. **Bu. \$4.00.**

HAIRY VETCH—Great Hay and Fertilizing Plant. A very hardy nitrogen gathering plant that is used extensively as a winter cover crop. Also for hay and grazing. It has been known to have 20 long vines from a single root and each one 6 to 7 feet long. It yields well on all kinds of soils.

COW PEAS

BRAHAM—A particularly valuable variety for hay. Holds its foliage well, seeds smallest of all cow peas, requiring less seed than most varieties.

MIXED COW PEAS—Grow thicker, producing a better crop of vines and forage than sowing single varieties. For soil-improving it is really an advantage to sow mixed peas. Ask for prices.

WHIPORWILL—A well known favorite, both for hay and soil improving, vines usually about 6 feet long.

NEW ERA—In habit of growth is similar to Whiporwill. However earlier and with smaller seeds.

EDIBLE PEAS

LARGE BLACK EYE—Dwarf or bushy growth being well filled with long pods. Matures in about 110 days. Generally grown to produce dried peas for winter use. **1 lb. 20c; 5 lbs. 75c; 10 lbs. \$1.40.**

SOY BEANS

MAMMOTH YELLOW—Largest and heaviest hay producer of all the soy beans and matures in about 145 days.

EARLY YELLOW—An early variety, maturing in about 115 days. Highly recommended for hay.

BLACK—A heavy yielder of both hay and beans of high quality.

VIRGINIA BROWN—A splendid variety for hay.



Hairy Vetch

Ask for Current Field Seed Price List

BUNTON'S ANNUAL FLOWER SEEDS

ANNUALS from seed bloom and die the first year; some reseed themselves, blooming again the next year. Ornamental plants for most any use in the garden can be found in our large assortment of annuals from seed. Select carefully and have all the flowers your heart may desire the entire summer and early fall. There are many types of annuals for general garden decoration, borders, beds, backgrounds, edgings, rock gardens, rock walls, cut flowers, etc. Refer to "Special uses of flowers from seed" in this catalog.

AFRICAN DAISIES

Artistic Daisy-like flowers freely produced on 1 foot plants during summer and fall. Fine for rockeries, edgings and cutting. Very easy to grow and quick to bloom. Shades of orange, salmon, yellow and white. **MIXED Pkt. 10c.**

AGERATUM

The dense heads of fluffy flowers bloom throughout the summer and fall. Suitable for edgings, borders, beds and pot culture. Easy culture.

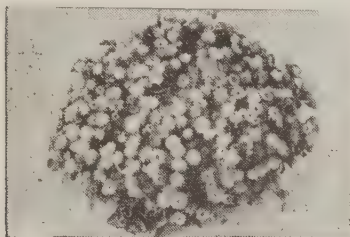

Ageratum Dwarf Blue

DWARF BLUE — Lavender-blue flowers on dwarf plants, excellent for beds and borders. **Pkt. 10c.**

TALL BLUE — Grows about 2 feet tall. Bright azure-like flowers borne in clusters, good for cutting. **Pkt. 10c.**

TALL MIXED—A good assortment of white, lavender and shades of blue. Plants grow about 2 feet high. **Pkt. 10c.**

ALYSSUM

An easily grown annual that is fine for beds and edging. Very quick growing, blooms from early summer until frost.

SWEET SCENTED—A spreading type, growing about 8 inches high. Honey-scented flowers, pure white in color, blooms until late fall. **Pkt. 10c.**

LITTLE GEM—Very dwarf and completely covered with snow-white blossoms. Fine for borders. **Pkt. 10c.**

LILAC QUEEN — Deep lilac, compact, grows about 6 inches high. **Pkt. 10c.**

VIOLET QUEEN—Large heads of clear violet flowers, very fragrant. This continuous bloomer grows about 5 inches high. **Pkt. 15c.**

MIXED—A good mixture of several varieties providing an unusual border plant. **Pkt. 10c.**

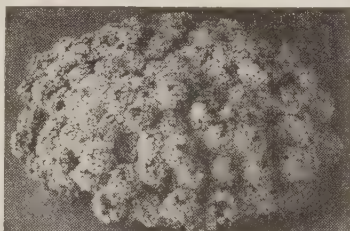

Alyssum Little Gem

AMARANTHUS

Tall vigorous ornamental foliage plants. Produce their best colors in sunny locations.

LOVE LIES BLEEDING—(Caudatus). Plants grow about 3 feet high producing an abundance of drooping red spikes. **Pkt. 10c.**

JOSEPH'S COAT—(Tricolor). Beautiful foliage of dark bronze, green, scarlet and gold. Plants grow about 3 feet high. **Pkt. 10c.**

ANCHUSA (Summer Forget-Me-Not)



Anchusa

BLUE BIRD — Clusters of intense blue flowers with distinct white eyes, borne well above the compact, bushy plants. Grow about 18 inches high. One of the finest blue annuals for borders and bedding. **Pkt. 10c.**

ARCTOTIS (Blue Eyed African Daisy)



Arctotis

A hardy annual growing about 2 or 3 feet high. Flowers 2½ to 3 inches across, silvery white with gold band surrounding a delicate mauve center. Plants branch freely. Delightful for cutting, beds or borders. **Pkt. 10c.**

ARCTOTIS MIXED

The extra large flowers come in many shades of bronze, red, rose, pink, yellow, mauve, white and scarlet. Plants grow about 1 foot high. **Pkt. 15c.**

ASTERS

Asters are easy to grow though in some cases the soil has become infested and only the wilt resistant strains should be used. Wilt infected plants should be removed and burned.

AMERICAN BRANCHING MIXED—(Wilt Resistant). Plants are 2½ to 3 feet tall, free branching, vigorous; flowers bloom profusely from late summer until frost and are of good form and size. **Pkt. 10c.**

CALIFORNIA GIANTS MIXED—Extra large blooms, curled and interlaced, measuring 5 to 6 inches in diameter. Plants reach a height of 3 feet, blooming from late summer until frost. A well balanced blend of colors; this is the variety to grow for specimen blooms. As this variety is not wilt resistant we recommend growing it where you have not had asters before if you have had trouble with wilt. **Pkt. 15c.**



Aster
American Branching

QUEEN OF THE MARKET MIXED—(Wilt Resistant). Popular because of its earliness. The plants grow about 20 inches high, branching freely and sending up many long stemmed blooms about 3 inches across. Predominating colors in this mixture are crimson, purple, light blue, scarlet and white. **Pkt. 15c.**

IMBRICATED POMPON MIXED—The small round pompon flowers are very unusual in their petal formation. The quilled center petals are surrounded by a few rows of short but broad outer petals. A fine mixture. **Pkt. 15c.**



Aster
California Giant

ASTERS — ALL COLORS AND SORTS — A surprisingly delightful assortment of various double types and colors. A bed of these will supply you with cut flowers over a long period. **Pkt. 10c.**

BUNTON'S ANNUAL FLOWER SEED

ASTERS—Continued

COMET MIXED—(Wilt Resistant) Large double, well formed, feathery flowers on upright plants about 2 feet tall. Blooms in late August. A fine mixture of blue, crimson, purple, lavender, rose, pink, salmon pink and white. **Pkt. 15c.**

CREGO—(Wilt Resistant) Beautiful blooms with petals twisted, curled and interlaced, usually measure 4 to 5 inches across. Plants grow about 2 feet high, strong, well branched and produce long stemmed blooms from middle of August until frost.

CREGO DEEP ROSE—Delightful intense rose. **Pkt. 15c.**

CREGO PINK—Soft glowing deep pink. **Pkt. 15c.**

CREGO PURPLE—Charming royal purple. **Pkt. 15c.**

CREGO SHELL PINK—Beautiful delicate blush pink. **Pkt. 15c.**

CREGO WHITE—Very popular pure white. **Pkt. 15c.**

CREGO MIXED—A marvelous blend of all the crego colors. **Pkt. 15c.**

SUPER GIANTS—These are the largest and most fully double asters known. The flowers are 6 to 8 inches across, with graceful, interlacing petals. Plants are about 2½ feet tall, with six to eight long non-lateral stems per plant.

SUPER GIANT EL MONTE—Deep glowing crimson. **Pkt. 15c.**

SUPER GIANT LOS ANGELES—Pure shell pink. **Pkt. 15c.**

CALIFORNIA SUNSHINE—Large flowers from 4 to 5 inches across in shades of pink, deep rose, blue and lavender contrasted with light yellow or blue centers. The outer petals are somewhat loosely placed giving an airy, lace-like effect which is altogether charming. **Pkt. 15c.**

BACHELOR BUTTON (Centaurea Cyanus)

An easy-to-grow hardy annual. Keep cutting the flowers and they will bloom all summer. Try these improved strains for beds, borders or cutting. Plants grow about 2½ feet high.

DOUBLE BLUE—A true cornflower-blue. Excellent for cutting. **Pkt. 10c.**

PINKIE—Very attractive light pink. **Pkt. 15c.**

MIXED—All colors mixed. **Pkt. 10c.**

JUBILEE GEM—Dwarf plants of compact growth, covered with double blooms of dark blue. The foliage is a bright green. Plants grow 12 inches high. **Pkt. 15c.**

BALSAM (Lady Slipper)

CAMELIA FLOWERED MIXED—One of the quickest growing annuals. Produces large, brilliantly colored flowers, borne along the stems. Plants grow 2 to 3 feet high. **Pkt. 10c.**

BUSH FLOWERED MIXED—The double rose-like flowers are borne on top of the stems instead of alongside as in the camelia flowered type. Plants grow from 2 to 2½ feet tall. **Pkt. 10c.**

BLUE LACE FLOWER (Didiscus)

Easily grown annual producing large heads of small lavender blue flowers. Fine for cutting or borders, height 3 feet. **Pkt. 10c.**

BRACHYCOME (Swan River Daisy)

The small Cineraria-like blooms come in shades of blue, rose violet and white. Plants grow about 12 inches and bloom all summer. **Pkt. 10c.**

CACALIA (Tassel Flower)

A graceful and profuse flowering plant with scarlet and gold tassel shaped flowers borne in clusters on long stalks. Plants grow about 2 feet high. **Pkt. 10c.**

CANTERBURY BELLS ANNUAL MIXED

You can have blooms in six months from seed with the annual type of this popular flower. Brings spring color to your fall garden. Plants grow to 2½ feet with six or seven blooming spikes. **Pkt. 10c.**

CLARKIA

DOUBLE MIXED—Large spikes of double flowers in brilliant shades of purple, salmon, white and carmine. 2 feet high. **Pkt. 10c.**



Crego Aster



Aster
California Sunshine



Centaurea
Jubilee Gem



Balsam
Camelia Flowered



Blue Lace Flower



Brachycome



Canterbury Bells



Clarkia

BUNTON'S ANNUAL FLOWER SEED

CALENDULAS (Pot Marigolds)

One of the best annuals, easy to grow, free flowering, long lasting and colorful. Fine for cutting, beds, borders. Plants grow 12 to 24 inches tall.

ART OR PASTEL SHADES—A good assortment of light shades. Pkt. 10c.

CHRYSANTHA—Large double flowers of butter cup yellow. Petals give the appearance of a Chrysanthemum. Stems are long and stiff making them ideal for cutting. Pkt. 10c.

LEMON QUEEN—Deep lemon yellow with dark brown eye. Pkt. 10c.

ORANGE FANTASY—Beautiful crested blooms of coppery orange, petals edged mahogany, dark center. Very unusual. Pkt. 10c.

ORANGE KING—Large blooms of deep glowing orange, center petals are incurved giving the flower a very artistic arrangement. Pkt. 10c.

ORANGE SHAGGY—The odd formation of the petals gives the appearance of chrysanthemums. Color is a deep orange with lighter shading at center. Long stems for cutting. Pkt. 15c.

ORANGE SUNSHINE—Long, gracefully curled petals, loosely formed, makes this chrysanthemum type very attractive. Color is clear light orange. Excellent for cutting. Pkt. 10c.

RADIO—The bright orange petals are slightly quilled and tinted yellow at the ends. A fine variety for gay cut flowers. Pkt. 10c.

YELLOW COLOSSIAL—Extra large double flowers 4 to 5 inches across. Petals are long, loose and gracefully curved. Stems are long and heavy. The clear brilliant yellow flowers are borne freely. Superb for cutting. Pkt. 10c.

MIXED COLORS—An excellent mixture from named varieties. Pkt. 10c.



Calendula Orange Shaggy

CALLIOPSIS

A hardy and easily grown annual that blooms throughout the summer, excellent for beds or cutting.

GOLDEN CROWN—Large rich orange-yellow with maroon center. The 12 inch stems make it ideal for cutting. Pkt. 10c.

DWARF VARIETIES MIXED—Many shades of yellow and orange with contrasting tones. Use this mixture for lively colors in beds and borders. Pkt. 10c.

CANDYTUFT

An easy-to-grow dwarf bedding plant not only used for borders, beds and rockeries but can be used for cutting. Very quick to bloom. Plants grow about 1 foot high.

MINIATURE GEM—A very dwarf plant producing an abundance of pure white blooms. Try this for massing in beds or edging. Pkt. 10c.

WHITE HYACINTH FLOWERED—Large snow-white spikes borne upright on compact plants about 1 foot high. Pkt. 10c.

MIXED COLORS—A delightful mixture of the umbrella-shaped blossoms, borne profusely on bushy plants about 1 foot high. A fine plant with many uses. Pkt. 10c.

CARNATION

Start the seed early, transplant and enjoy this delightful cut flower. In the fall plants may be cut back and potted for indoor blooming. Plants grow 15 to 20 inches high.

MARGUERITE MIXED—Large, fragrant, fringed flowers in a good color assortment. Pkt. 10c.



Calendula Orange Fantasy



Calliopsis

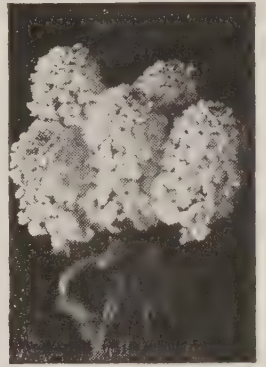

Candytuft

COLEUS

Possibly the most handsome foliage plant obtained from seed. Large heart-shaped leaves in a beautiful variation of color combinations. Pkt. 10c.



Carnation



Chinese Wool Flower

CHINESE WOOL FLOWER (Celosia Childsi)

For a splash of color until frost use this quick growing annual. Plants from 2 to 3 feet high, producing many ball shaped blooms resembling balls of wool.

CRIMSON—Holds its scarlet-crimson color until frost. Pkt. 10c.

MIXED—A gay array of scarlet, crimson, rose and yellow. Pkt. 10c.



Calendula Chrysantha

ANNUAL FLOWER SEEDS

CHRYSANTHEMUMS

Exquisitely colored blooms, easy to grow and excellent for cut flowers. Bloom in late summer and fall.

DOUBLE ANNUAL MIXED—Fine mixture of the double varieties. Pkt. 10c.

SINGLE ANNUAL MIXED—A good blend of many delightful fall colors. Pkt. 10c.

CLEOME (Spider Plant)

PINK QUEEN—Large trusses of brilliant salmon-pink. Flowers turning white as they age. Blooms from early summer until frost. Easily grown, fine for beds, borders and backgrounds. Plants grow about 4 feet high. Pkt. 15c.

COCKSCOMBE (Celosia Cristata)

Brighten up your garden with this dependable annual. The flowers resemble a rooster's comb and bloom until frost. Grows from 8 to 12 inches.

GLASGOW PRIZE—Velvety crimson blooms. Pkt. 10c.

DWARF MIXED—Many shades of crimson, rose, deep orange and golden yellow. Pkt. 10c.

COCKSCOMBE (Celosia Plumosa)

FEATHERED MIXED—Very decorative plants having an abundance of graceful blooms throughout a long season. Pkt. 10c.

COSMOS

An outstanding plant for the annual border or background. Bright colored flowers bloom on graceful stems from midsummer until frost. Plants grow up to 4 feet high.

SINGLE MIXED—A good blend of crimson, pink and white. Pkt. 10c.

DOUBLE CRESTED MIXED—Bushy plants growing about 3 feet high and covered with blooms of several colors. Most of the flowers are double and crested. Pkt. 10c.

YELLOW FLARE—Bright clear yellow; the new yellow flare cosmos brings a brand new shade to this family. The single flowers are 2½ inches across and produced in great masses on the attractive three foot plants. Colorful in the garden and delightful in cut flower arrangements. Pkt. 10c.

KLONDYKE ORANGE FLARE—An early flowering strain; blooming in about 3 months from seed and flowering freely until frost. Mari-gold-like foliage, 2 to 3 feet tall and very bushy. You will be pleased with the brilliant orange flowers. Pkt. 10c.

SENSATION MIXED COLORS—Extra large flowers often measuring 4 to 6 inches across. The broad, heavily-fluted petals slightly overlap. Plants reach a height of 4 or 5 feet. The long, strong stems hold up the blooms well and make them ideal for cutting and exhibition. Pkt. 15c.

DAHLIAS (from Seeds)

For some of the most delightful surprises the garden offers; grow dahlias from seed.

UNWINS DWARF HYBRIDS—Semi-double, early flowering miniature hybrids. Fine for cut flowers and bedding, growing to a height of about 2 feet. Pkt. 15c.

BB MIXED—A special mixture of the finest double cactus and other large flowered varieties. Pkt. 10c.

DIANTHUS (Pinks)

The many uses of annual pinks make them desirable in most every garden. Very dependable for borders, beds, rock gardens and cutting, as they bloom freely from July until frost. Very fragrant.

HEDDEWIGI DOUBLE MIXED—A good variation of color, ranging from crimson to pink. Plants grow about 12 inches high. Pkt. 10c.

HEDDEWIGI DOUBLE LACINIATED—Plants are dwarf and compact. The double flowers have lacinated and fringed petals giving a very odd and dainty appearance. Free blooming plants grow about 12 inches. Pkt. 10c.

DOUBLE CHINA—The double flowers of many colors are pleasingly arranged in clusters on strong plants about 20 inches high. Colors range in shades of white, crimson, pink and rose. Pkt. 10c.

HEDDEWIGI SINGLE LACINIATED MIXED—Dainty blooms of unusual form in shades of salmon, orange-scarlet and crimson. The ragged petal formation is very attractive. Plants grow 12 inches. Pkt. 10c.

LARGE CHINA SINGLE MIXED—The plants grow about 20 inches high producing the flowers in clusters. Single petalled; the blooms range in color from light pink to crimson. Pkt. 10c.



Double Chrysanthemum



Cleome



Double Cosmos



Sensation Cosmos



Dianthus
Heddeewigi Double



Cockscombe Glasgow Prize



Single Chrysanthemum



Feathered Cockscombe



Klondyke Cosmos



Unwin Dahlia



Dianthus
Single Lacinated

ANNUAL FLOWER SEEDS



Stock
Evening Scented



Double Gaillardia



Gypsophila



Hollyhock
Indian Spring



Hunnemannia

DUSTY MILLER (CENTAUREA GYMNOCARPA)

Finely cut, silvery white foliage of soft texture. Plants grow about 20 inches high. Lavender flowers appear in late summer. Pkt. 10c.

EUPHORBIA (SNOW ON THE MOUNTAIN)

Grows about 2 feet high, with beautiful green foliage broadly edged silvery white. Fine for borders and mixing with cut flowers. Pkt. 10c.

EVENING SCENTED STOCK (MATTHIOLA)

Small purplish lilac blooms that are delightfully fragrant after a shower or in the evening and morning. Blooms from July to frost. Plants 15 inches high. Pkt. 10c.

FOUR O'CLOCK (MIRABILIS)

This well known old fashioned favorite blooms in the afternoon or most of the day when the skies are cloudy. The colors are red, yellow, lilac, white and pink. Pkt. 10c.

FORGET-ME-NOT (MYOSOTIS)

This biennial thrives well in the shade or open borders, but flourishes best in a moist, shady location. Seed should be sown under glass in February or March to have blooms the first year. Plants grow about 12 inches high.

ALPESTRIS BLUE — Very attractive, dainty blooms of indigo blue. Pkt. 10c.

MIXED—Pkt. 10c.

GAILLARDIA-ANNUAL

Gay colored, dependable, free flowering and easy-to-grow; Gaillardias will brighten up your borders and beds from early summer until fall. The long stems make them ideal for cutting. 12 to 18 inches high.

SINGLE MIXED—A well balanced mixture of many colors. Pkt. 10c.

DOUBLE MIXED—Large double blooms on long stems. Pkt. 10c.

INDIAN CHIEF—One of the best annual types. Flowers are deep coppery red with dark brown center. Blooms measure 2½ inches across, plants grow about 15 inches high. Pkt. 10c.

GILIA (QUEEN ANNE'S THIMBLE).

Lovely lavender-blue flowers about 1 inch across, borne profusely on bushy plants with feathery foliage. Blooms last well and can be used as a dried cut flower as they hold their color. Plants grow about 2 feet high. Pkt. 10c.

GODETIA (SATIN FLOWER)

A very attractive hardy annual; profusely bearing showy flowers of satiny texture in many rich and varied colors. Blooms during the summer and fall. Excellent for borders, beds and cutting. Tall varieties grow about 20 inches, dwarf varieties from 12 to 15 inches.

TALL SINGLE MIXED—Pkt. 10c.

TALL DOUBLE MIXED—Pkt. 10c.

DWARF SINGLE MIXED—Pkt. 10c.

DWARF DOUBLE MIXED—Pkt. 10c.

GOMPHRENA (GLOBE AMARANTH)

A very showy clover-like bloom that may be used as an everlasting flower. Plants grow about 18 inches high. Pkt. 10c.

GYPSOPHILA (ANNUAL BABY'S BREATH)

A graceful, free flowering plant covered with bell shaped blossoms. Excellent for mixing with cut flowers. Make several plantings for continuous bloom.

COVENT GARDEN STRAIN—Lovely white. Pkt. 10c.

ROSE PINK—Pure bright rose. Pkt. 10c.

HELICHRYSUM (STRAWFLOWER)

The most popular everlasting flower for winter bouquets. For large flowers allow only one bloom per stem. For dried blooms; cut before fully open strip leaves from stem and hang upside down in a cool, dark place. Many colors. **MIXED**—Pkt. 10c.

HOLLYHOCK-ANNUAL

Bring spring to your garden in the late summer with annual type of Hollyhock. Blooms may be had in July by sowing seed indoors and transplanting. With a little protection the plants will live over winter and bloom again the next year.

INDIAN SPRING—The six foot main stem and the flowering branches produce many semi-double blooms of rosy-carmine and bright rose. Very satisfactory for backgrounds. Pkt. 15c.

HUNNEMANNIA (SANTA BARBARA POPPY)

Semi-double flowers of canary-yellow, blooming from July until frost. Extra rows of short petals on the outside of the tulip shaped blooms makes them very attractive. Especially good as a cut flower, lasting several days after cutting. Plants grow 2 feet high. Pkt. 15c.

JOB'S TEARS (COIX LACHRYMAE)

A hardy annual growing 2 to 3 feet high. Produces curious pearly gray seeds which are sometimes used as beads. Used with everlasting flowers for winter bouquets. Pkt. 10c.

KOCHIA (MEXICAN FIRE BUSH)

Sometimes called Burning Bush; this plant may be used individually or as a hedge. The light green foliage turns to a blood red in the early fall. Plants grow about 3 feet tall. Pkt. 10c.

LANTANA

BRUANT'S HYBRIDS MIXED—Attractive clusters of Verbena-like flowers in charming shades of red, pink, yellow and orange. Blooms from mid-summer until frost. Plants grow about 18 inches high. Start seeds under glass and transplant into pots or open ground after danger of Frost. Pkt. 10c.



Single Gaillardia



Tall Double Godetia



Helichrysum



Lantana

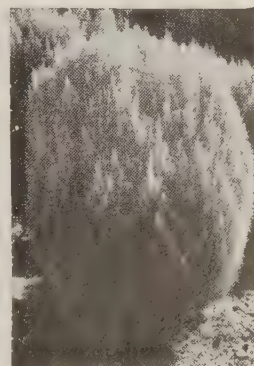

Kochia

SPECIAL QUANTITY DISCOUNT

For cash with order on all 10c packets

FLOWER SEEDS

Your choice of any

3 for 25c; 7 for 50c; 11 for 75c; 15 for \$1.00

LARKSPUR

A favorite, well deserving its place as one of the best annuals. Easy-to-grow; Larkspur may be used for cut flowers, beds and borders. The flowers are well placed on long Delphinium-like spikes, borne well above the deep green, fine foliage.



Larkspur
Stock Flowered

TALL DOUBLE STOCK FLOWERED MIXED

Plants grow 3 to 4 feet tall, are well branched and have many spikes of well placed double blooms. Dark and light blue, lilac, rose carmine, pink and white. Pkt. 10c.



Larkspur
Giant Imperial

LARKSPUR —GIANT IMPERIAL

The attractive flower-spikes of this type are held upright as the branches start at the base of the plant. Ideal for long stemmed cut flowers. The plants do not need as much room as the stock flowered type.

BLUE BELL—Clear azure blue. Pkt. 15c.

BLUE SPIRE—Deep violet blue. Pkt. 15c.

CARMINE KING—Deep carmine rose. Pkt. 15c.

DAINTINESS—Delicate lavender. Pkt. 15c.

EXQUISITE PINK—Soft pink. Pkt. 15c.

MISS CALIFORNIA—Deep rose on salmon. Pkt. 15c.

WHITE SPIRE—Pure white. Pkt. 15c.

MIXED—A well balanced mixture of sky blue, lilac blue, deep blue, carmine rose, lavender, light and deep pinks, lilac and white. Pkt. 15c.

LEPTOSYNE (Sea Dahlia)

The yellow, Daisy-like flowers are 3 inches across and make a delightful cut flower. Plants grow to a height of 2 feet. Very quick to bloom. Pkt. 10c.



Leptosyne

LINUM (Scarlet Flax)

Bright red flowers appear daily on plants about 18 inches tall. A gay color for beds and borders. The blooms are about 1 inch across and are borne in clusters. Pkt. 10c.

LINARIA

(Miniature Snapdragon)

The dainty blooms resemble tiny Snapdragon, are very free flowering and quick to bloom. Plants grow about 1 foot high.

FAIRY BOUQUET—Many lovely colors. Pkt. 10c.



Linaria



Linum
Scarlet Flax

LOBELIA

CRYSTAL PALACE—Dwarf, compact plants covered with deep blue flowers accentuated by the dark foliage. Fine for beds, rockeries, edgings or pots. Plants grow about 5 inches high. Pkt. 15c.

LUNARIA (Honesty or Money Plant)

Sweet scented, purplish magenta flowers are produced in abundance, followed by the thin seed pods which are used for dry bouquets. Plants grow about 4 feet high. Pkt. 10c.

LUPINUS

Very attractive graceful spikes of fragrant, pea-shaped blossoms. The colors are rich shades of blue, rose and white. Plants grow 3 to 4 feet tall. Excellent for beds, borders and cut flowers.

GIANT KING MIXED—Pkt. 10c.

BLUE LUPINS—Charming flowers of easy culture. Pkt. 10c.

RUSSELL LUPINS—Colossal spikes of well formed flowers in an unusual range of color. Pkt. 25c.

MIGNONETTE

An annual to be grown for its fragrance rather than beauty of bloom. Plant seed in the open ground in spring, do not try to transplant. Excellent for beds and borders.



Mignonette

SWEET GRANDIFLORA—Large, light yellowish white blooms, borne on 16 inch plants. Pkt. 10c.

MATCHET—Dwarf vigorous plants of pyramidal growth. Extra large spikes of red flowers. Plants grow about 15 inches high. Pkt. 10c.

BUNTON'S MARIGOLDS

MARIGOLDS

No other annual has had so many improvements in size, color and substance. Now there are types of Marigolds for most any application in the garden. You can depend on them to brighten up your beds and borders or to supply you with an abundance of long-lasting cut flowers over a long season.

MARIGOLD—LARGE DOUBLE AFRICAN

LEMON QUEEN—Large blooms of lemon-yellow on plants 2 to 3 feet tall. Pkt. 10c.

ORANGE QUEEN—Large deep golden-orange, plants 2 to 3 feet tall. Pkt. 10c.

DOUBLE MIXED—A good mixture of yellow and orange shades, plants grow 2 to 3 feet tall. Pkt. 10c.



Double African



Crown of Gold

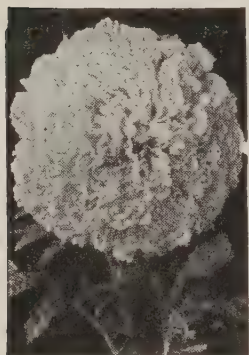

Sunset Giants



Ferdinand

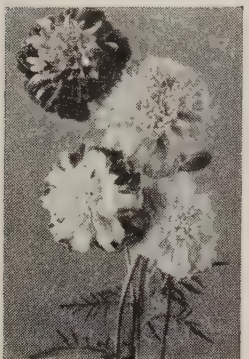

Harmony Hybrids

MARIGOLD—LARGE FLOWERED ODORLESS

CHRYSANTHEMUM FLOWERED HYBRIDS—Orange and yellow shades of the delightful new Chrysanthemum types. Excellent for cut flowers. Plants grow 2 to 3 feet tall. Pkt. 15c.

CROWN OF GOLD—2½ inch flowers of golden orange with crested centers, odorless foliage. Plants grow 2 feet tall. Pkt. 10c.

DIXIE SUNSHINE—Brilliant golden yellow, fully double and slightly scented with the characteristic Marigold odor. The large bell shaped flowers are ingeniously composed of dozens of tiny, five petaled florets gracefully interlocking. Pkt. 15c.

GOLDSMITH (Mission Giant)—Large ball shaped, chrysanthemum-type blooms of a delightful golden orange color. Petals are incurved. Plants grow about 2 feet tall. Pkt. 15c.

YELLOWSTONE (Mission Giant)—Large ball shaped, chrysanthemum-like blooms, with incurved petals. Color is a clear golden yellow. Blooms will measure up to 4 inches across and are borne on extra long stems. The late flowering plants grow from 3 to 4 feet tall. Pkt. 15c.

GUINEA GOLD—Carnation-type blooms about 2½ inches across with petals loosely arranged. The golden orange flowers are freely borne on 2½ ft. plants. Pkt. 10c.

ORANGE SUNSET—Extremely large blooms measuring from 5 to 7 inches across. Sweet scented deep orange blooms are freely borne on the robust plants growing from 2½ to 3 feet tall. Ideal for show purposes, florist use and garden decoration. Pkt. 15c.

SUNSET GIANTS—Definitely sweet scented instead of having the usual Marigold odor; these giant blooms will average 5 inches across, some flowers attaining a size of 7½ inches. The loosely formed and full centered flowers are even larger than the Dahlia flowered Zinnias. Colors range from deep orange to lemon yellow. Plants 2½ to 3 ft. high. The specimen blooms are well supported on extra heavy stems. Pkt. 15c.

YELLOW CROWN—Bright canary-yellow flowers 2½ inches across with crested center and broad guard petals. The odorless foliage plants grow about 2 feet tall. Pkt. 15c.

YELLOW SUPREME—A large, fluffy, well rounded bloom of delicately mild honey fragrance. Broad, loose, frilled petals of a rich, creamy lemon-yellow color form beautiful flowers 4 inches across. Plants grow about 2½ ft. high. Pkt. 15c.



Dixie Sunshine



Yellow Crown



Pot O'Gold

MARIGOLD—LARGE FLOWERED DWARF

POT O'GOLD—Deep golden orange, sweet scented. 4 inch flowers on 12 to 15 inch plants. Early, free flowering and compact. Pkt. 25c.

MARIGOLD—DWARF BEDDING

GOLDEN ORANGE—The single golden orange flowers are borne on dwarf, bushy and compact plants with fern-like foliage. Plants grow about 10 inches high. Ideal for bedding and edging. Pkt. 10c.

MARIGOLD—DWARF DOUBLE FRENCH

The small, double blooms are very desirable for short-stem cut flowers and the plants are just right for bedding, edging or even pot culture. Blooms average about 1½ inches, plants 12 inches.

ROYAL SCOT—True mahogany and gold striped, double blooms, carried well above the dwarf compact plants. Pkt. 15c.

BUTTERBALL—Dwarf compact plants about 8 inches tall. The small blooms are a beautiful shade of canary-yellow. Pkt. 15c.

HARMONY—The flowers are scabiosa-like in formation with tubular, deep orange center petals, flanked by broad velvety dark maroon-brown guard petals. Very popular for cut flowers. Plants are compact and early. Pkt. 10c.

HARMONY HYBRIDS—A wide and varied range of striking color combinations from lemon-yellow to golden orange with maroon. The flowers have crested centers and flanking guard petals. Plants are early and compact. Pkt. 10c.

DWARF FRENCH MIXED—A pleasing mixture of many varieties. Pkt. 10c.

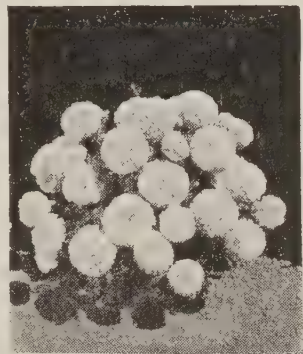

Chrysanthemum Flowered



Yellow Supreme

MARIGOLD—FRENCH TALL

FERDINAND—The flowers have a crested center of dainty, golden yellow, tubular florets, surrounded by a single row of broad mahogany-red guard petals. Long stems make them excellent for cutting. Pkt. 15c.

JOSEPHINE—Dark maroon with an edging of gold. This single French type is free blooming on long stems. Plants grow about 2 feet high. Pkt. 10c.

TALL FRENCH MIXED—A good mixture of single and double varieties with long stems, good for cutting. Plants grow about 2 feet tall. Pkt. 10c.

ANNUAL FLOWER SEEDS

NASTURTIUM



Nemesia

DWARF SINGLE MIXED—Still a favorite with many; the five petaled or single Nasturtiums are loved for their color and markings which have not yet been duplicated in the double varieties. Plants are compact and free blooming. Fine for beds, borders, edging and cut flowers. Pkt. 10c; oz. 30c; 1/4 lb. \$1.00; 1/2 lb. \$1.75.

TALL SINGLE MIXED—A good range of color for trellises or beds where they have room to spread. Pkt. 10c; oz. 30c; 1/4 lb. \$1.00; 1/2 lb. \$1.75.

DOUBLE GLEAM HYBRIDS—The double, fragrant blooms are large and include salmon, golden yellow, orange, crimson and gold flushed scarlet. Plants are semi-dwarf. Pkt. 15c; oz. 45c; 1/4 lb. \$1.25.

DWARF DOUBLE GEM MIXTURE—The plants are truly dwarf and compact. Sweet scented, double flowers, gaily cover the little plant in an excellent color range which includes shades of yellow, orange, scarlet, crimson, salmon, cerise, cream maroon and spotted varieties. Pkt. 15c; oz. 45c; 1/4 lb. \$1.25.

DOUBLE SCARLET GLEAM—The flowers are a fiery orange scarlet, a color comparable to the brilliance of scarlet sage. Plants are semi-dwarf. Pkt. 15c; oz. 45c; 1/4 lb. \$1.25.



Nicotiana

DOUBLE GOLDEN GLOBE—Double and semi-double flowers on uniformly dwarf and compact plants. The sweet scented blooms are golden yellow. Pkt. 15c; oz. 45c; 1/4 lb. \$1.25.

GOLDEN GLEAM—Large, double and semi-double, fragrant blooms on nice stems for cutting. This variety should be trained on a support or used where it has plenty of room. Flowers are golden yellow. Plants semi-tall. Pkt. 15c. oz. 45c; 1/4 lb. \$1.25.

NEMOPHILA (Baby Blue Eyes)

The flowers are cup shaped, sky-blue with white center and about one inch in diameter. Plants grow less than 1 foot high, bloom freely. Pkt. 10c.

NEMESIA

A half hardy annual growing about 1 foot high and used for both outdoor and pot culture. Very good for low borders and beds. The dainty, white, orange, pink, yellow, crimson, rose and blue colored flowers are in bloom until frost. Pkt. 10c.

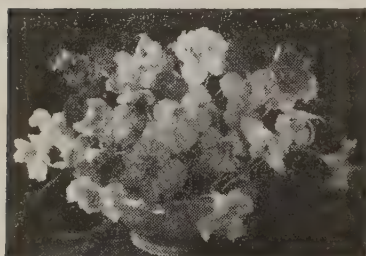

Nasturtium
Double Gleam Hybrids

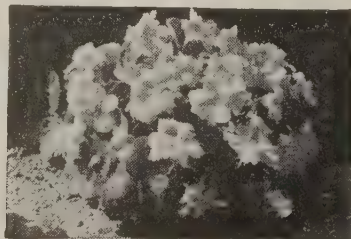

Nasturtium
Double Golden Globe

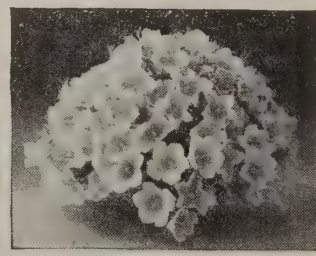

Nierembergia

NICOTIANA

Resembling Petunias in shape, but with longer tubes; the flowers become fully expanded only in the morning and evening or on cloudy days. The five petaled, star-like blooms are very fragrant and come in delightful shades of blue, red, rose, crimson and creamy white. Plants 2 to 3 feet high. **MIXED**—Pkt. 10c.

WHITE—Tuberose scented pure white flowers profusely borne in clusters on bushy plants 2 1/2 feet high. Pkt. 10c.

NIEREMBERGIA (Blue Cup Flower)

Plants are very dwarf and spread from 10 to 12 inches. Covered with hundreds of exquisite cup shaped blooms in summer and fall. A sensation for beds, borders, rock gardens and pot culture.

PURPLE ROBE—A very lovely purplish-blue which holds its depth of color even in hot weather. Pkt. 35c.

HIPPOMANICA—Lavender-blue, dwarf and compact. Pkt. 25c.



Annual Phlox

NIGELLA (Love In A Mist)

Dainty, double, dark blue flowers blooming abundantly over a long season on graceful feathery foliage. Plants grow about 18 inches high. For borders or cutting. Pkt. 10c.

ANNUAL PHLOX

With gay colors or soft pastel shades you will find many uses for this easy-to-grow annual in your garden. Keep the faded flowers removed and be rewarded with continuous bloom until frost. Fine for cutting, beds, borders, edging etc. Plants grow about 15 inches tall and are well branched. The large blooms are composed of many florets.

PINK—Pkt. 15c; **PURPLE**—Pkt. 15c; **RED WITH WHITE EYE**—pkt. 15c; **WHITE**—Pkt. 15c.

ANNUAL MIXED—A very attractive assortment of red, lilac, violet, blue, rose, pink, flesh, scarlet and white. Pkt. 15c.

DWARF ANNUAL PHLOX

The plants grow about 8 inches high, blooming profusely all summer and fall. An excellent range of colors for beds and edging, also a very lovely short-stemmed cut flower. **MIXED COLORS**—Pkt. 15c.

PHLOX GIGANTEA ART SHADES—Annual

Immense blooms composed of florets 1 1/2 inches across. A delightful variety of soft colors. Pkt. 15c.

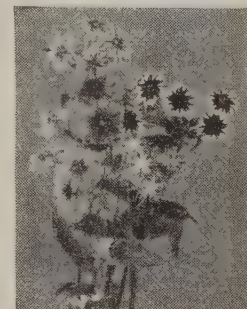

Phlox Star Flowered

STAR FLOWERED PHLOX—Annual

An unusual Phlox with fringed and pointed petals. The blooms come in many different colors and combinations. Plants grow about 1 foot high. **MIXED COLORS**—Pkt. 15c.

BUNTON'S PETUNIAS

PETUNIAS

For cut flowers, beds, borders, edging or pot culture; you will find your desire in the many types and colors of this universal flower. Easy-to-grow; Petunias reward you well with gay colors for a long season.

PETUNIAS—RUFFLED OR FRINGED

GIANTS OF CALIFORNIA—A very wonderful strain with edges of the blooms beautifully frilled. Flowers often measure 5-7 inches across and come in many colors, blotched and variegated. Pkt. 15c.

DWARF GIANTS OF CALIFORNIA—Dwarf compact plants, extra large flowers with ruffled edges. This mixture is a blend of unusual and pleasing colors with pronounced veining in the large open throats. The outstanding petunia for pot culture, borders and beds. Pkt. 40c.

FLUFFY RUFFLES—A mixture of delicate light shades, containing numerous soft tints, veined and bicolor combinations not found in the separate color varieties. Flowers are finely fringed and so heavily ruffled that they appear double. One of the finest petunias for home gardens. A favorite with florists. Pkt. 25c.

GLAMOUR—Luscious salmon rose; delicately veined brown in a creamy, open, shallow throat; huge ruffled blooms. Pkt. 25c.

MARTHA WASHINGTON—A beautiful blush pink; strongly veined a rich wine red, deepening in the throat to dark violet. Plants dwarf and compact. Fine for borders, bedding pots and window boxes. Pkt. 25c.



Dwarf Giants of California

DOUBLE MIXED—An exquisite blend of beautifully formed, large, gracefully fringed, double blooms. Don't discard the weaker seedlings. The strongest plants are usually single, but lovely. Pkt. 75c.

BEDDING PETUNIAS (1½ to 2 ft.)

BURGUNDY—A rich wine-red with velvety sheen. The white throat is veined purplish red making a beautiful contrasting color combination. Pkt. 25c.

ELK'S PRIDE—An extra large, dark velvety purple. One of the best and most beautiful of the dark colors. Pkt. 25c.

FLAMING VELVET—A sensation because of the uniform excellence of its velvety rich, blood-red flowers. Semi-compact in habit the plant is about 15 inches high; flowers are large and borne in great profusion. Pkt. 25c.

HOWARD'S STAR IMPD.—A large crimson maroon with a definite white star. Pkt. 15c.

HOLLYWOOD STAR—The five points of the star-like blooms are drawn out to a very fine tip. The rich rose flowers with golden throats seem to cover the entire plant. Pkt. 25c.

RADIANCE—Rich cerise rose underlaid with salmon. The lovely golden yellow throats are brown veined. Pkt. 25c.



Dainty Lady

SETTING SUN—A profuse blooming, brilliant deep rose with dark throats. Plants are very compact. Pkt. 25c.

THEODOSIA—A large bright rose-pink with a clear golden yellow throat; deeply ruffled. Plants grow about 18 inches. Pkt. 25c.

DAINTY LADY—The flowers are medium size and daintily fringed. A delicate light yellow deepening to golden yellow at the throat. An unusual variety. Pkt. 25c.

BEDDING MIXED (Fine Single)—A well balanced mixture of many gay and delightful colors. You can depend on this spreading type for a mass of blooms all summer. Pkt. 10c.

Dwarf Bedding Petunias (10 to 15 in.)

ALDERMAN—A velvety, deep violet-blue with darker throat. Plants grow about 10 inches high. Pkt. 15c.

BLUE BEDDER—An outstanding true blue, one of the best for beds and borders. Pkt. 15c.

CELESTIAL ROSE—A lovely rich satiny rose. More compact in growth and deeper in color than Rose Of Heaven. Pkt. 15c.

GLOW—Bright rose-red with light throat, very charming for beds and borders. Pkt. 15c.

ROSE OF HEAVEN—A very desirable bright rose with inconspicuous white throat. One of the favorite bedding Petunias. Pkt. 10c.

ROSY MORN—Medium sized flowers of clear rose-pink. A very free bloomer. Pkt. 10c.

DWARF ROSY MORN—An improved strain of the popular Rosy Morn. Plants are more dwarf and compact, flowers a deeper pink. Pkt. 15c.

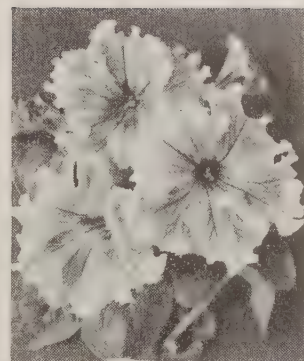

Glamour



Theodosia

SALMON SUPREME—An exquisite soft pastel salmon; gradually changing to a distinct light salmon. A compact plant exceptionally good for borders, beds and edgings. Pkt. 25c.

SNOWBALL—Pure white flowers, borne in abundance on compact plants. Pkt. 10c.

TWINKLES—Very free flowering brilliant rose, starred white. Plants are dwarf and compact. Pkt. 15c.

DWARF BEDDING MIXED—

Ideal for edgings, borders, beds, and pot culture. This dwarf compact type does not wander out of the beds like the trailing varieties. Many delightful colors in bloom until frost. Pkt. 15c.

BALCONY PETUNIAS (Trailing—1½ to 2 ft.)

This large flowered type is very popular for trailing over porch boxes, pots and hanging baskets as well as planting in beds. The long branched plants are covered with 2½ to 3 inch blooms.

BALCONY BLUE—Very attractive, velvety violet blue. One of the most popular blue petunias. Pkt. 15c.

BALCONY RED—A very dark crimson-red. Pkt. 15c.

BALCONY ROSE—Fiery rose, a truly pleasing shade. Pkt. 15c.

BALCONY WHITE—One of the finest white Petunias, a very pure and bright white. Pkt. 15c.

BALCONY MIXED—A really fine assortment of red, crimson, dark and light blue, rose and white. Extra large blooms until frost. Pkt. 15c.

MINIATURE PETUNIAS (6 in.)

A new strain, ideal for borders, edgings and pots. The plants are ball shaped and covered with a mass of 2 inch blooms; in continuous bloom from early summer until frost.

ROSE GEM—An intense rich rose, holding its depth of color through the hot summer. The bright green, thick foliage brings out the vivid color in the mass of blooms. Pkt. 25c.

MINIATURE GEM MIXED—A very attractive assortment of rose, pink, violet shades and white. Plants very compact. Pkt. 15c.



Giants of California



Bedding Mixed

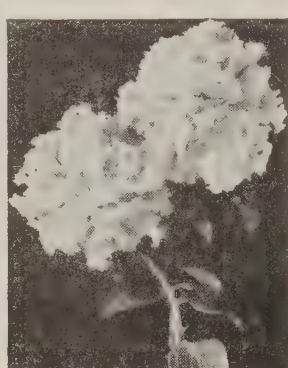

Double Mixed

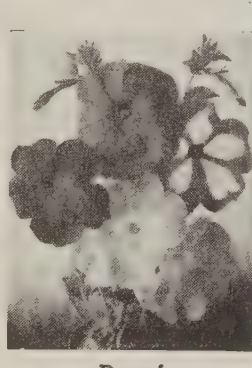

Dwarf Bedding Mixed



Balcony Mixed

BUNTON'S ANNUAL FLOWER SEEDS

PORTULACA (Rose Moss)

A bright, gay covering for sunny spots, rock gardens, beds, or borders. The charming little rose-like blooms require plenty of sunlight, will bloom all summer until frost. Plants grow about 6 inches high. Foliage very fine.

SINGLE MIXED—A well balanced mixture of white, pink, orange, scarlet and yellow shades. Pkt. 15c.

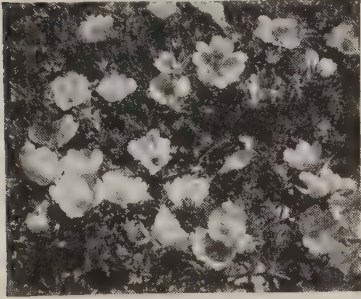

Single Portulaca

scarlet of enormous size. Pkt. 10c.

CALIFORNIA (ESCHSCHOLTZIA)—A dainty, free flowering type, growing about 1 foot high with finely cut foliage. Colors are yellow, red, buff, carmine and orange. Pkt. 10c.

TULIP POPPY—Large Tulip shaped blooms of dazzling scarlet. Plants grow about 20 inches high. Pkt. 10c.

SHIRLEY POPPIES—ANNUAL

A magnificent type producing throughout a long season, large flowers of charmingly delicate colors, mostly with white centers.

SINGLE MIXED—Large single flowers with satiny soft colors. Pkt. 10c.



Double Portulaca

DOUBLE MIXED—A large flowering type with most of the blooms coming double. A good combination of pink, scarlet, salmon, white and yellow colors. Pkt. 15c.

ANNUAL POPPIES

AMERICAN LEGION

A very brilliant orange-

scarlet of enormous size. Pkt. 10c.

CALIFORNIA (ESCHSCHOLTZIA)—A dainty, free flowering type, growing about 1 foot high with finely cut foliage. Colors are yellow, red, buff, carmine and orange. Pkt. 10c.

TULIP POPPY—Large Tulip shaped blooms of dazzling scarlet. Plants grow about 20 inches high. Pkt. 10c.

SHIRLEY POPPIES—ANNUAL

A magnificent type producing throughout a long season, large flowers of charmingly delicate colors, mostly with white centers.

SINGLE MIXED—Large single flowers with satiny soft colors. Pkt. 10c.

DOUBLE MIXED—Double and semi-double; the fascinating blooms come in a wide range of beautiful shades. Pkt. 10c.

QUEEN ANNE'S LACE FLOWER

White lacy-like blooms on plants 2 to 2½ foot high. Fine for using with cut flowers. Pkt. 10c.

RICINUS (Castor Beans)

Large leaved, tall, ornamental plants growing from 8 to 10 feet high. Very useful for background. **ZANZIBARIENSIS MIXED**—Pkt. 10c; oz. 25c.

ROCK GARDEN ANNUALS MIXED

A delightful surprise for those desiring rock garden plants in variety that bloom the first year from seed. Pkt. 10c.

SCHIZANTHUS (Butterfly Flower)

Good bushy plants with finely lacinated foliage and numerous Butterfly-like blooms. The flowers are dainty and have many exquisite markings and colors. Plants grow about 18 inches high. Pkt. 15c.

SALVIA (Scarlet Sage)

The brilliant scarlet of the salvias brings a cheerful splash of color to your beds and borders. There are tall varieties for cutting, medium for beds, dwarf for edging or pot culture and window boxes.

AMERICA—One of the earliest and most profuse bloomers of all Scarlet Sages. Very uniform in growth; plants do not grow over 15 inches high. The long spikes of brilliant scarlet flowers are thrown well above the plants. Pkt. 25c.

SPLENDENS—Long spikes of brilliant scarlet, well supported on plants from 2½ to 3 ft. tall. One of the most popular. Pkt. 15c.

ZURICH—Dwarf plants 12 to 15 in. high, large blooms of intense scarlet. Pkt. 25c.

SCABIOSA

(Mourning Bride—Pin Cushion Flower)

One of the best cut flowers, very easy to grow and will continue to bloom profusely if old flowers are removed from plants. The flowers of many lovely colors are borne on long, slender stems and are very long lasting in vases, etc. Sometimes called Pin Cushion flower because of stamens which stick out of petals, resembling pins stuck in a cushion. Plants grow about 3 feet high.

BLUE COCKADE—Dark azure blue. Pkt. 10c.

FIRE KING—Rich rosy crimson. Pkt. 10c.

KING OF THE BLACKS—Reddish black. Pkt. 10c.

ROSETTE—Delightful deep salmon-rose. Pkt. 10c.

SHASTA—Pure white. Pkt. 10c.

MIXED—All colors. Pkt. 10c.

SCABIOSA—IMPERIAL GIANTS

This new type has flowers composed entirely of broad, heavy, wavy petals, eliminating the Pin-Cushion center. Because of their complete doubleness the blooms are very large and attractive.

BLUE MOON—A rich deep lavender blue, usually hard to find in annual flowers, an ideal cutting type with long stems. Plants grow from 3 to 3½ feet high. Pkt. 15c.



Queen Anne's Lace



Salvia



Calif. Poppy



Poppy
Single Shirley

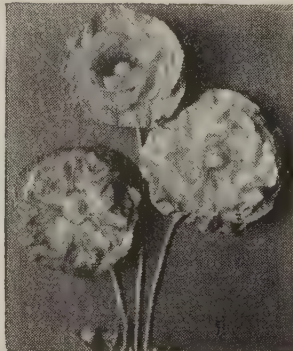

Poppy
Double Shirley



Scabiosa
Mixed



Scabiosa
Blue Moon

ANNUAL FLOWER SEEDS



Salpiglossis

SALPIGLOSSIS

(Painted Tongue—Velvet Flower)

A very easy-to-grow and attractive annual, with richly colored, funnel or Petunia-shaped blossoms. Each flower regardless of color is beautifully veined or penciled. Will bloom until frost. Very good for cutting. Plants grow 2½ to 3 ft. high. Colors range in shades of blue and gold, brown and gold, crimson and gold, purple and gold, purple, violet, red, white, yellow and black. Pkt. 10c.

STATICE

One of the easily grown everlasting flowers. Used as fresh cut flowers or dried for winter bouquets. Plants grow 2 to 2½ ft. tall.

SINUATA MIXED—A mixture of blue, lavender, rose and white shades. Pkt. 10c.

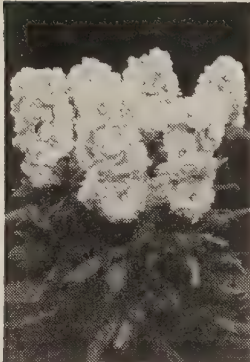

Dwarf Stocks

STOCKS

Strong spikes of rosette-like, fragrant blooms in beautiful, soft colors appealing to all flower lovers. Sow seeds early. Best results are had if transplanted.

DOUBLE PERFECTION MIXED—A wonderful, large flowered type containing many good colors. Excellent for borders and cutting. Plants 2½ ft. Pkt. 10c.

DWARF TEN WEEKS MIXED—Dwarf, compact, very fine for bedding. The 12 inch plants bloom in about ten weeks after sowing seed. Colors are red, yellow, blue, pink, rose and white. Pkt. 10c.

STRAW FLOWERS MIXED

All kinds and colors of everlasting flowers. Pkt. 10c.

SUNFLOWER (Helianthus)

The size and brilliancy of their flowers make good effect among shrubbery; also valuable for screening unsightly view and fences.

DOUBLE CALIFORNIA—Rich golden yellow flowers with green centers. Plants grow about 5 feet tall. Pkt. 10c.

DWARF SINGLE RED—Attractive single blooms in shades of red. Plants grow about 5 feet tall. Pkt. 10c.

RUSSIAN GIANT—Huge golden yellow pads on plants 8 to 10 feet tall. Pkt. 10c.

STELLA—Well formed, single flowers of golden yellow color with black centers. Plants are 5 feet tall. Pkt. 10c.

SWEET SULTAN

(Centaurea Imperialis)

Large, fragrant, fringed flowers on long stems, blooming for a long period during the summer. A very useful plant for garden ornamentation and cutting. Charming shades of red, purple, lilac, rose and white. Plants grow about 3 feet high. **MIXED**—Pkt. 10c.

TEXAS BLUE BONNET

One of the dwarf Lupinus; grows about 15 inches high, flowers in late spring and early summer. The graceful spikes are made up of pretty blue flowers with deep rose, heart shaped blotches. Pkt. 10c.



Venidium

SNAPDRAGON

(Antirrhinum)

An old favorite for garden and greenhouse. Many delightful colors are found in the mixtures. The large flower spikes are borne well above the foliage. One of the very best cut flowers. We offer the rust-resistant varieties.

SNAPDRAGON—

Tall Giant

(2 to 3 ft.)

PINK—Very lovely silver pink. Pkt. 15c.

RED—Attractive copper-red. Pkt. 15c.

ROSE—Brilliant soft rose. Pkt. 15c.

WHITE—Beautiful pure white. Pkt. 15c.

YELLOW—Canary-yellow with white tube. Pkt. 15c.

TALL GIANT MIXED—Extra large spikes on tall, base branching plants. This rust-resistant strain has clean luxuriant foliage. Superb for long stem cut flowers. Colors are pink, bronze, crimson, yellow, white, rose and copper. Pkt. 15c.



Sunflower
Double California



Sweet Sultan

SNAPDRAGON MEDIUM TALL

These rust-resistant, semi-tall plants grow 20 to 24 inches. Are bushy and compact, holding the spikes well above the foliage. Plants do not need staking. Ideal for beds, borders and cut flowers. Colors are white, cerise, scarlet, rose-pink, gold, salmon and purple. Pkt. 15c.

TITHONIA

(Golden Flower of the Incas—Mexican Sunflower)

Large, single Dahlia-like flowers, excellent for cutting. Plants grow 6 to 8 feet tall making a very fine background or screening plant with heavy dark green foliage.

ORANGE—Orange vermillion, early flowering. Pkt. 10c.

FIREBALL—Dazzling scarlet orange. Pkt. 15c.

VENIDIUM

MONARCH OF THE VELDT—Deep orange Daisy-like flowers, 4-5 inches across, with a double row of petals, the upper row marked at the center with a reddish brown zone. Plants grow 2 to 3 feet with the blooms well above the fine foliage and flowering over a long season. Pkt. 15c.

FASTUOSUM MIXED COLORS—

A very unusual range of colors, white, ivory, yellow and buff contrasted by black centers with maroon markings at base of petals. Pkt. 15c.



Snapdragon

BUNTON'S FLOWER SEED

VERBENA



Vinca

Easy-to-grow plants that do well in most any type soil, blooming from midsummer until frost. The flowers come in a wide range of colors and are borne on large trusses. Suitable for beds, borders, rock garden, porch boxes and cutting.

BLUE SENTINEL—10-inch plants bearing large trusses of royal violet-blue. Pkt. 15c.

CARMINE BALL—Symmetrical plants about 10 inches high, 12 inches across, completely covered with bright carmine flowers. Excellent for bedding, pots and borders. Pkt. 15c.

GOLDEN QUEEN—Tall plants with the best yellow blooms. Pkt. 10c

LAVENDER GLORY—Giant flowered, pure lavender with cream eye. Pkt. 15c.

LUMINOSA—Giant flowered, glowing flame pink, shading to salmon. Pkt. 15c.

PURPLE—Tall plants with delightful purple blooms. Pkt. 10c.

ROSEGLOW—Lovely, Softrose. Pkt. 10c.

WHITE—Giant flowered, pure white. Pkt. 10c.

DWARF MIXED—Compact plants about 6 inches high, covered with dainty blooms of many colors. Pkt. 15c.

MAMMOTH MIXED—Giant flowered blooms on tall plants, ideal for cutting, beds, borders. This mixture has many pleasing colors. Pkt. 10c.

VIRGINIAN STOCK (FRENCH FORGET-ME-NOT)

Plants grow from 6 to 10 inches high, excellent for low borders, rock gardens and mass bedding. Charming, fragrant flowers in gay crimson, rose and white. **MIXED**—Pkt. 10c.

VINCA (PERIWINKLE)

A very ornamental, free blooming plant with bright green shiny foliage, bushy and erect. Blooms freely throughout the season. The rose and white, single flowers measure 1½ inches across. Often used as a pot plant as well as for beds, borders and cutting. Plants grow about 1½ feet high.

ROSE—A very desirable shade of rose-pink. Pkt. 10c.

MIXED—An attractive mixture of rose shades and white. Pkt. 10c.

VISCARIA (RAINBOW DROPS)

Large, single flowers of pink, blue, white, red, and rose profusely borne on plants about 12 inches high. May be used for pot culture, edgings or borders. Blooms over a long season. Pkt. 10c.

WILD FLOWER GARDEN

For a variety of cut flowers all summer; plant this mixture of many annual varieties and colors in rows or as a scatter garden. It provides a surprising variety all season without robbing the regular display beds. Pkt. 10c.

BUNTON'S SPECIAL ZINNIAS



Crown O' Gold

DOUBLE GIANT ZINNIA

Well shaped flowers not as large as the Dahlia Flowered or California Giants, but deeper, therefore giving the double appearance. A well balanced color assortment. Mixed. Pkt. 10c.

ZINNIA-SUPER CROWN O'GOLD PASTEL TINTS

Flowers are 5 to 5½ inches in diameter, each petal of the flower is overlaid at the base with a golden yellow, while carrying out the individual flower color at the tip. Colorful for gardens and unexcelled for cutting. Pkt. 15c.

SCABIOSA FLOWERED ZINNIA

A remarkable resemblance to the annual Scabiosa, from which they get their name. The plants are extremely free flowering and grow about 2½ feet high. Particularly rich in shades of crimson, scarlet, orange, yellow and pink. Pkt. 15c.

TOM THUMB ZINNIA

The plants are round and compact, 4 to 6 inches high, literally covered with well formed flowers of the Lilliput type. The ideal border plant, also adapted for window boxes and pot culture. A well balanced mixture. Pkt. 15c.

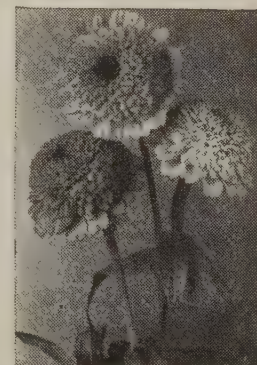

Zinnia
Scabiosa Flowered

FANTASY ZINNIAS

The medium size, double, rounded blooms are a mass of shaggy petals, charmingly guilled and interlaced. The flowers are just large enough to lend themselves gracefully to good flower arrangements. Blooms are about 3½ inches across, plants about 2 feet high, with good stems for cutting.

FANTASY STAR DUST—Intense deep golden yellow. Pkt. 15c.

FANTASY WILDFIRE—Bright dazzling scarlet. Pkt. 15c.

FANTASY MIXED—A good mixture of rose, scarlet, white, lavender, yellow, golden-yellow and orange. Pkt. 10c.



Howard's Giant Crested

HOWARD'S GIANT CRESTED ZINNIA

Unusual blooms, about 4 inches across with cushion-like center surrounded by large guard petals. Plants grow about 2½ feet high. A very wide range of colors. Mixed. Pkt. 15c.

MEXICANA MINIATURE ZINNIA

The small flowered Mexican Zinnias have a charm all their own. The smaller flowers lend themselves to bedding and make a brilliant display and yet have stems long enough to make fine bouquets for small vases and bowls. The mixture contains many attractive colors and color combinations. Plants grow from 1 to 1½ feet tall, flowers average about 1½ inches across. Pkt. 10c.

GAILLARDIA FLOWERED ZINNIA

Medium sized flowers about 2 inches in diameter, carried on stems of medium length. Plants are about 2 feet tall and very free flowering. Colors range through rose, pink, bronze, yellow, orange, lavender, and combinations of these colors. Most of the flowers are two-toned and somewhat resemble the double Gaillardia. Pkt. 10c.



Zinnia Linearis

LINEARIS ZINNIA

Dwarf, compact and very early flowering; the plants grow about 12 inches high and are covered with single blooms about 1½ inches across. The petals of the flower are an intense orange with a light yellow stripe down the center. The dark centers of the bloom give a very effective contrast to the bright petals. Pkt. 10c.

PICOTEE ZINNIA

A novelty type with medium size blooms. The curled petals are tipped with darker shades or picotee markings. Plants grow about 2½ feet high. Colors range in shades of orange, pink, cerise, lemon and flesh. Mixed. Pkt. 10c.

BUNTON'S PRIZE WINNING ZINNIAS

One of the easiest of all flowers to grow, unquestionably deserving their popularity. The wide range of types and colors makes them one of the essentials in all complete gardens. There is a type of Zinnia for most every need; large flowers on long stems, medium size on medium stems, small on medium stems and the very dwarf for porch boxes, beds and borders.

DAHLIA FLOWERED ZINNIAS

One the largest Zinnia types; the fully double blooms, 5 inches across are borne on long stems. Excellent as a garden variety and superb for cutting. The flowers last a very long time. Plants grow from 2½ to 3 feet tall and are very free flowering.

CANARY BIRD—A very colorful, rich shade of canary-yellow. Pkt. 15c.

CRIMSON MONARCH—Extra large, deep crimson; one of the most magnificent of all the Zinnias. Pkt. 15c.

DREAM—A fine deep rosy lavender turning to purple. Pkt. 15c.

EXQUISITE—A very popular light rose with deep rose center. Pkt. 15c.

GOLDEN STATE—A very rich yellow-orange turning to orange. Pkt. 15c.

ILLUMINATION—Large, deep tyrian rose, excellent for cutting. Pkt. 15c.

METEOR—Velvety, deep red, darkest of all the reds. Pkt. 15c.

OLD ROSE—A real old rose shade, very lovely. Pkt. 15c.

ORIOLE—Exquisite golden orange with copper-orange centers. Pkt. 15c.

POLAR BEAR—Large, double, creamy white with long stems. Pkt. 15c.

PURPLE PRINCE—A very attractive deep purple. Pkt. 15c.

SCARLET FLAME—Intense bright scarlet, very colorful. Pkt. 15c.

BUNTON DAHLIA FLOWERED ZINNIA COLLECTION—One regular packet of each of the above varieties (12 pkts. \$1.80 value) for only \$1.00.

DAHLIA FLOWERED MIXED—A well balanced mixture of the named varieties; blended to bring out the best in their gay color combinations. Pkt. 10c; ¼ oz. 40c; ¼ oz. 70c.



Lilliput Zinnia



Dahlia Flowered Zinnia

CALIFORNIA GIANT ZINNIAS

Extra large double flowers, 5 to 6 inches across with overlapping petals gracefully placed to form a very beautiful flower for cutting. The plants are taller than the dahlia flower, growing 3 to 4 feet high with the large flat blooms well supported on long, stiff stems.

CERISE QUEEN—A very beautiful orange-rose. Pkt. 15c.

DAFFODIL—Very desirable, true canary-yellow. Pkt. 15c.

ENCHANTRESS—Delightful light rose with deep rose center. Pkt. 15c.

GRENADIER—Very bright, dark red, large blooms. Pkt. 15c.

LAVENDER QUEEN—Deep rosy lavender, an unusual shade. Pkt. 15c.

MISS WILLMOTT—Soft rich pink, long stemmed, free blooming. Pkt. 15c.

ORANGE KING—Large orange-scarlet of good substance. Pkt. 15c.

ORANGE QUEEN—Brilliant golden-orange. Pkt. 15c.

PURITY—One of the best white in all Zinnias. Pkt. 15c.

ROSE QUEEN—A very striking deep rose. Popular for cutting. Pkt. 15c.

SCARLET QUEEN—Glowing deep scarlet, good stems. Pkt. 15c.

VIOLET QUEEN—Large graceful flower of deep purple. Pkt. 15c.

BUNTON CALIFORNIA GIANT ZINNIA COLLECTION—One regular packet of each of the above varieties (12 Pkts. \$1.80 Value) for only \$1.00.

BUNTON CALIFORNIA GIANTS MIXED—A carefully blended mixture of the named varieties, balanced according to their many delightful colors for the best effect. A superb variety for cutting. Pkt. 10c. ¼ oz. 40c; ¼ oz. 70c.

LILLIPUT—BABY OR POMPON ZINNIAS

The Lilliputs are among the most popular Zinnias for cut flower use. The dainty, double, compact flowers are about 1½ inches across and are freely borne on long, stiff stems all summer long. Plants grow about 18 inches tall, are ideal for edging or bordering the tall types.

CANARY GEM—Clear canary-yellow. Pkt. 10c.

CRIMSON GEM—Intense, deep crimson. Pkt. 10c.

GOLDEN GEM—Charming golden orange. Pkt. 10c.

LILAC GEM—An unusual lavender-lilac. Pkt. 10c.

ROSEBUD—Popular, true rose-pink. Pkt. 10c.

SCARLET GEM—Bright, well formed scarlet. Pkt. 10c.

SALMON GEM—Attractive salmon rose. Pkt. 10c.

VALENCIA—Deep burnt orange, long stems. Pkt. 10c.

WHITE GEM—Lovely pure white. Pkt. 10c.

BUNTON LILLIPUT ZINNIA COLLECTION—One regular packet of each of the above varieties (9 Pkts. 90c Value) for only 50c.

LILLIPUT MIXED—There are many delightful colors in this mixture. Pkt. 10c; ¼ oz. 30c; ½ oz. 50c.

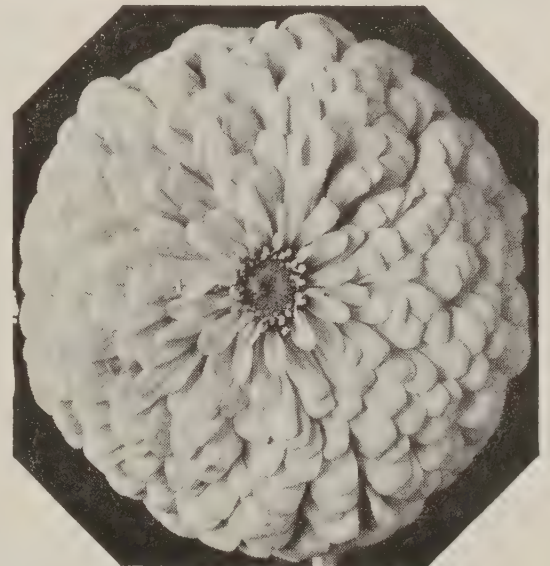

California Giant Zinnia

BUNTON'S SWEET PEAS

Noted for their brilliant colors, long stems, size and free blooming; Bunton's Spencer varieties are as fine as can be grown. Plant Sweet Peas early.

SPENCER MIXED—The very best varieties of the Giant Flowering Spencer types are blended according to their color in this mixture to give it the widest range possible. Pkt. 10c; 1/2 oz. 20c; 1 oz. 35c; 1/4 lb. \$1.20; 1/2 lb. \$2.25.

RUFFLED SPENCER MIXED—The extra frilliness of the blooms gives them a double appearance lending an unusual attractiveness. The large flowers come in many beautiful colors. Pkt. 10c; 1/2 oz. 30c; 1 oz. 50c; 1/4 lb. \$1.75; 1/2 lb. \$3.25.

EARLY FLOWERING SPENCER SWEET PEAS

The blooms of the early flowering types are just as large as the Giant Flowering and the stems just as long. They will come into bloom 3 or 4 weeks earlier than regular Giant Spencer. This is the type used for winter flowering under glass. Sweet Peas like cool weather; sow the seed in early spring just as soon as the ground can be prepared.

AVIATOR—Large, dazzling deep crimson scarlet. Pkt. 15c; oz. 60c.

BALL ORANGE—Clear deep glowing orange. Pkt. 15c; oz. 60c.

CASCADE—Excellent pure white with long stems. Pkt. 15c; oz. 60c.

DAPHNE—Soft salmon pink on cream; good stems. Pkt. 15c; oz. 60c.

FLORIST BLUE—The best clear blue. Pkt. 15c; oz. 60c.

MEMORY—Clear rosy lavender, large wavy flowers. Pkt. 15c; oz. 60c.

SHIRLEY TEMPLE—Large soft rose pink, long stems. Pkt. 15c; oz. 60c.

BUNTON SWEET PEA COLLECTION — One regular packet of each of the above separate colors (7 pkts. \$1.05 value) for only 75c.

BB EARLY FLOWERING SPENCER MIXED—An extra fine assortment of the best named varieties; carefully blended according to their color value. Pkt. 15c; 1/2 oz. 30c; oz. 50c; 1/4 lb. \$1.75; 1/2 lb. \$3.25.



Sweet Pea—Early Flowering—Spencer

SPECIAL USES OF FLOWERS FROM SEED

FOR CUT FLOWERS

Anchusa	Candytuft	Gerbera	Mignonette	Poppy	Snapdragon
Arctotis	Carnation	Gaillardia	Nasturtium	Pyrethrum	Stocks
Aster	Centaurea	Gypsophila	Nigella	Salpiglossis	Sweet Peas
Brachycome	Chrysanthemum	Helichrysum	Pentstemon	Scabiosa	Tithonia
Cacalia	Clarkia	Hunneemannia	Petunia	Schizanthus	Verbena
Calendula	Coreopsis	Larkspur	Phlox	Shasta Daisy	Zinnia
Calliopsis	Cosmos	Marigold	Pinks		

ANNUALS WHICH WITHSTAND DROUGHT

Ageratum	Calliopsis	Euphorbia	Marigold	Scabiosa	Sweet William
Alyssum	Candytuft	Four O'clock	Petunia	Statice	Valeriana
Arctotis	Centaurea	Gaillardia	Pinks	Sunflower	Wall Flower
Brachycome	Cosmos	Hollyhock	Portulaca	Tithonia	

ANNUALS FOR FRAGRANCE

Alyssum	Evening Scented Stock	Nasturtium	Scabiosa	Sweet Sultan	Valeriana
Candytuft	Heliotrope	Nicotiana	Stocks	Sweet William	Wall Flower
Carnation	Mignonette	Petunia	Sweet Peas		

DWARF EDGING PLANTS

Ageratum	Cockscombe Dwarf	Nasturtium Dwarf	Nierembergia	Verbena Dwarf	Virginian Stock
Alyssum	Double Daisy	Memesia	Pansy	Viola	Zinnia Tom Thumb
Arabis	Forget-me-not	Nemophila	Portulaca		

ANNUALS FOR ROCK GARDENS

Alyssum	Linaria	Nemophila	Saponaria	Zinnia Tom Thumb
Brachycome	Marigold Dwarf	Phlox Dwarf	Thunbergia	Zinnia Mexicana
Candytuft	Nasturtium Dwarf	Pinks	Verbena	Rock Garden
Leptosyne	Nemesia	Portulaca	Virginian Stock	Annuals mixed

PERENNIALS FOR ROCK GARDENS

Alyssum Gold Dust	Arabis	Columbine	Double Daisy	Geum
Rock Garden Perennials	Linum	Dianthus	Forget-me-not	Viola

FOR SEMI-SHADE

Anchusa	Clarkia	Double Daisy	Godetia	Pansy
Canterbury Bells	Coleus	Forget-me-not	Linaria	Sweet William
Centaurea	Columbine	Geum	Lupin	

DRIED FLOWERS FOR WINTER BOUQUETS

Chinese Lantern	Lunaria	Cockscombe	Statice	Gomphrena	Gypsophila Per.	Helichrysum
-----------------	---------	------------	---------	-----------	-----------------	-------------

BUNTON'S PERENNIAL FLOWER SEEDS

Perennials continue to bloom year after year; the growth above the ground dies yearly but the roots remain dormant and send up new growth the following season. Perennials may be selected to have a continuous array of blooms throughout the season. Usually it takes two seasons for Perennials to flower from seed; however some will bloom the first year if planted early. You will find certain Perennials for most any of your garden needs, such as borders, backgrounds, edgings, rockeries, general garden decoration or cut flowers.

ALYSSUM

GOLD DUST—A very valuable plant for rock garden and borders. The golden yellow blooms cover the 12 inch plants. Blooms in early spring. **Pkt. 15c.**

ARABIS (Rock Cross)

One of the finest rock garden or spreading border plants. Very free blooming plants about 10 inches tall. Blooms early in the spring. The pure white flowers may be used for cutting. **Pkt. 10c.**

ANEMONE (Windflower)

The large, double and semi-double flowers appear in May and June. A very showy garden subject, plants grow about 1 foot high. **Pkt. 15c.**



Canterbury Bells

HARDY ASTER

One of the most satisfactory late flowering Perennials. Usually blooms the first year if sown early in the spring. **MIXED—Pkt. 15c.**

CANTERBURY BELLS (Campanula)

A beautiful pyramidal plant about 2½ feet tall with large trusses of gay colored, bell-like blooms. Colors are shades of blue, rose, pink and white. **SINGLE MIXED—Pkt. 10c.**



Cup and Saucer

CUP AND SAUCER Campanula Calycanthema

Plants and blooms are very similar to the single Canterbury Bells except the extra large calyx gives the appearance of a cup with saucer. Lovely shades of blue, rose, pink and white. **Pkt. 10c.**

CACTUS

It is very fascinating to grow Cactus from seed. **MIXED—Pkt. 25c.**

CANNA SEED

Many colors, plants grow from 4 to 6 feet high. **Pkt. 10c.**

HARDY CARNATION

Immense, double clove-scented, fringed blooms over 2 inches across. Plants grow about 2 feet tall. Will bloom in 5 or 6 months after seed is sown. Many delightful shades of crimson, pink, rose, white and yellow. **GIANT MIXED—Pkt. 15c.**

COLUMBINE (Aquilegia)

One of the most beautiful of the hardy Perennials, blooms in the spring and is highly prized for cut flowers as well as an outstanding border plant. The graceful flowers are carried well above the lovely foliage.

ROCKY MOUNTAIN BLUE—Exquisite violet-blue sepals with white corolla. Blooms in April and May. **Pkt. 10c.**

LONG SPURRED MIXED—The most charming of the Columbines; broad petals and extra long spurs adding much to their gracefulness and beauty. Very desirable shade of pink, white, blue, red and yellow will be found in mixture. **Pkt. 10c.**

DOUBLE MIXED—Large double blooms of many attractive colors. Their long stems make them very nice for cutting. A very colorful plant for the border. **Pkt. 10c.**



Columbine Long Spurred

COREOPSIS

A very popular, easy-to-grow, hardy plant about 2½ feet high. Blooms freely all summer if the dead blooms are removed. Fine for cutting or borders. Usually blooms the first year if sown early.

DOUBLE GIANTS—Well formed double and semi-double flowers on long stems. Blooms are a bright golden yellow. **Pkt. 15c.**



Double Coreopsis

MAYFIELD GIANT—The flowers are larger than the ordinary grandiflora type and have an intense golden yellow color that is very effectively contrasted against the green foliage. **Pkt. 15c.**

DELPHINIUM (Hardy Larkspur)

Large, majestic spike borne freely over their decorative foliage are a source of pride to all flower growers. No other flower can take their place as cut flower ornamental plant in the garden. Plant early in rich, well drained soil. Blooms in June.



Coreopsis Mayfield Giant

BELLADONNA—Loosely arranged, single flowers of a lovely light blue on long spikes. Fine for cutting. **Pkt. 10c.**

BELLAMOSA—Deep blue, single flowers gracefully arranged on the tall spikes which are well above the foliage. **Pkt. 10c.**

PERENNIAL MIXED—A very showy mixture of several shades. **Pkt. 10c.**

WREXHAM HOLLYHOCK FLOWERED—Vigorous plants with magnificent spikes of single, semi-double and double flowers closely arranged. This strain is a glorious array of light blue, dark blue, pink and lavender shades. **Pkt. 15c.**

DIANTHUS (Rock Garden Pinks)

Brilliant rosy-pink flowers produced abundantly on hardy plants about 8 inches high. Fine for rock garden, massing and edgings. **Pkt. 15c.**

DOUBLE DAISY (Bellis)

Very nicely worked in with Pansies; these colorful little plants grow from 6 to 8 inches high. The white and rose colored blooms are fully double and measure about 2 inches across. Sometimes known as English Daisies.

MIXED—Pkt. 10c.

FORGET-ME-NOT (Myosotis)

A Biennial; growing the first year from seed, blooming and dying the next; however if sown under glass in February or March will bloom the first year. Thrives well in shade or open borders but flourishes best in a moist, shady location.

BLUE—Dainty flowers of indigo blue, plants grow about 12 inches high. **Pkt. 10c.**

MIXED—Colors are white and shades of blue. **Pkt. 10c.**



Wrexham Delphinium

BUNTON'S PERENNIAL FLOWER SEEDS

FOXGLOVE (DIGITALIS)

Large bell-shaped flowers on extra large spikes. The spotted blooms are in shades of purple, white and pink. As this is a Biennial it should be sown each year for continuous bloom.

GLOXINIAFLORA MIXED—Pkt. 10c.

GAILLARDIAS

One of the most effective and showiest Perennials. Free blooming and easy to grow. The large single flowers with long stems are ideal for cutting. Plants grow about 18 inches high.

PERENNIAL MIXED—Many fine shades of yellow, orange and maroon. Pkt. 10c.
THE DAZZLER—Large golden yellow with maroon center. Pkt. 10c.

GEUM

Plants grow about 2 feet high and will produce dainty double flowers from June until fall by continued cutting. Excellent for cutting or borders. Will bloom the first year if sown early. Should have protection in severe cold weather.

LADY STRATHEDEN—Flower loosely double, a very lovely golden yellow. Pkt. 15c.

MRS. BRADSHAW—Large, double, orange scarlet, fine for cutting. Pkt. 15c.

GERBERA (TRANSVAAL DAISY)

Large, exquisite, daisy-like blooms in a range of soft yellow, orange, white, scarlet, pink and crimson. Plants grow about 20 inches high, holding flowers erect on long stems. One of the finest cut flowers. Sow early and transplant when leaves are one inch long. **MIXED** Pkt. 25c.

GYPSOPHILA (BABY'S BREATH)

This Perennial Baby's Breath may be used fresh or as dried winter flowers. Excellent for filling in cut flower bouquets. Plants are 2 to 3 feet high.

PERENNIAL SINGLE—Masses of tiny white, single flowers. Pkt. 15c.

PERENNIAL DOUBLE—Large sprays of long lasting, double, white blooms. Pkt. 15c.

HIBISCUS

Large, shrub-like plants growing from 4 to 5 feet high, bearing profusely the large single flowers in red, white and pink. Blooms during August and September. **MIXED** Pkt. 10c.

IBERIS (PERENNIAL CANDYTUFT)

Dwarf plants 6 to 8 inches tall, ideal for rock gardens, edgings, etc. The plants are covered with rosy lilac blooms during spring and early summer.

QUEEN OF ITALY—Pkt. 10c.

LINUM (PERENNIAL FLAX)

A dainty flower for the border or cutting. Buds open up a delightful steel blue. Will bloom from seed the first year. Pkt. 10c.



Gerbera

HOLLYHOCKS

Popular and dependable the Hollyhocks provide a wealth of color as a screen or border plant; blooming from late spring to midsummer. Thrive best in a rich and well drained soil.

CHATER'S DOUBLE MIXED—A delightful mixture of pink, red, crimson, scarlet, white and rose. Pkt. 10c.

SINGLE MIXED—Vigorous plants, freely producing large single blooms of many colors. Pkt. 10c.

PANSIES

Bunton Pansies are noted for their size, marvelous color range and free blooming qualities. For earlier blooms start seed indoors about 4 or 5 weeks before outside planting time. They do best in a rich well drained soil. Keep the dead blooms removed.

ENGELMANN'S GIANT — The outstanding Pansy for immense size and wonderful coloring both in the light and dark shades. Plants are compact and free blooming. Flowers will measure up to 4 inches across. Pkt. 25c.

GIANT TRIMARDEAU—A very good bedding strain with an unusually wide color range. Very dependable for borders and edgings. Pkt. 10c.

MAMMOTH EXHIBITION MIXED—A wonderful mixture of every desirable color. Excellent for beds or cutting. Pkt. 15c.

MAPLE LEAF GIANT—A superb giant of good substance and form. Many charming colors will be found in this mixture. The leaves are extra large and the blooms can be grown up to 4 inches in diameter. Pkt. 25c.

ROGLI GIANT MIXED — A gorgeous mixture of giant bloom of fine form and color combinations. An early variety, ideal for beds, borders and cutting. Pkt. 20c.

PENTSTEMON (BEARDED TONGUE)

Bell shaped flowers about 2 inches long, borne on long graceful spikes. A beautiful range of gay, brilliant colors. Plants grow about 2½ feet high. Will bloom the first year if sown early and transplanted. **MIXED** Pkt. 10c.



Foxglove



Hibiscus



Engelmann Giant Pansy

BUNTON'S PERENNIAL FLOWER SEEDS

PHYSALIS (Chinese Lantern)

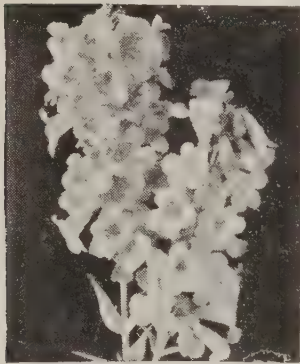

Pentstemon

Produces balloon-like husks that resemble Chinese lanterns. Plants grow about 2 feet high. The orange-scarlet fruits make a very lovely autumn and winter decoration. Pkt. 10c.

PHLOX

A splendid assortment of large flowering varieties. Plants grow from 2 to 3 feet high. **PERENNIAL MIXED**—Pkt. 15c.

POPPIES

ICELAND EMPEROR—Large brilliant orange blooms with broad overlapping fluted petals giving a semi-double effect. Plants grow 20 inches high. Will bloom the first year from seed. Pkt. 10c

ICELAND SUNBEAM HYBRIDS—Exquisite shades of orange, salmon, rose and pink. The charming blooms are issued on slender stalks about 12 inches high from the fern-like foliage. Very free blooming. Pkt. 10c.

ORIENTAL ORANGE—Large blooms measuring 6 inches across. Color is a vivid orange. Plants grow 3 feet high and may be left undisturbed for years. Pkt. 15c.

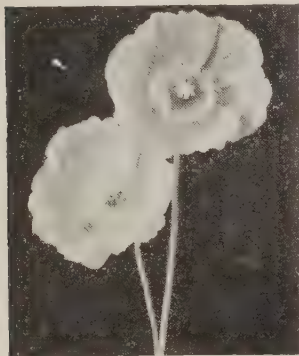

Poppy
Iceland Emperor

ORIENTAL SCARLET—A very brilliant orange-scarlet with massive blooms. The hardy plants grow about 3 feet high. Pkt. 15c.

ORIENTAL MIXED—A marvelous blend of the several shades in this giant hardy Poppy. Ideal for borders and perennial beds. Pkt. 15c.

PYRETHRUM (Painted Daisy)

SINGLE MIXED—This quick growing half hardy perennial is often treated as an annual. The Daisy-like blooms are in lovely shades of pink and rose. The fern-like foliage is very pretty in itself. Plants grow about 2 feet high. Pkt. 15c.

ROCK GARDEN PERENNIALS MIXED

A well balanced mixture of perennials suitable for rockeries, etc. Pkt. 15c.

SAPONARIA

A very showy plant of trailing habit, growing about 6 inches high. The bright rose colored blooms are in profusion from June until the last of August. Pkt. 10c.

PERENNIAL SCABIOSA

ISAAC HOUSE STRAIN—A delightful color range from light lavender to the dark blues. The large

flowers are borne on long stems making them extra nice for cutting. Plants grow about 2 feet high. Pkt. 15c.

SHASTA DAISY

ALASKA—A very dependable flower for cutting or beds, requires very little attention. The large white, single flowers are over 4 inches across with yellow centers. Bloom freely in June and July on plants from 2 to 2½ feet high. Pkt. 10c.



Pyrethrum

SWEET ROCKET (Dames Violet)

Very hardy, grow about 2 feet high producing fragrant spikes of snowy white, lilac and purple blooms. Pkt. 10c.

SWEET WILLIAM

Treated as a biennial, blooms in May and June. The large flower heads are made up of many individual blooms in beautiful shades of red, crimson, pink, scarlet and white. Plants grow from 1 to 1½ feet high.

DOUBLE MIXED—A very colorful mixture. Pkt. 10c.

SINGLE MIXED—Many beautiful shades, well blended. Pkt. 10c.

VALERIANA (Garden Heliotrope)

Giant heads of brilliant rosy red blooms with a delightful Heliotrope-like fragrance. Free blooming from June until October. Plants grow 2 feet tall. Pkt. 10c.



Viola

TRITOMA (Red Hot Poker)

The flowers are borne in compact form on 3 to 4 foot stems and have the appearance of orange and red spear heads. An excellent border plant; the tall spikes make very desirable cut flowers. Bloom freely from August to October. Pkt. 15c.

VIOLA

The easy-to-grow plants are about 6 inches high and very free blooming. Keep the dead blooms removed. Can be treated as an annual, will bloom the first year from seed. A charming range of colors. Pkt. 10c.

VIOLETS

JERSEY GEM—Grows about 4 inches high, blooms throughout the summer having flowers of rich pure violet, large and fragrant. Nice long stems for cutting. Pkt. 25c.

SWEET VIOLET—Large, single dark blue blooms, very fragrant. Blooms spring and fall. Pkt. 15c.

WALL FLOWER

An old favorite garden perennial, delightfully fragrant, blooming in bright gorgeous oriental red and yellow shades in May. The graceful spikes are borne against dark green foliage on bushy plants 2 feet high. Pkt. 10c.



Perennial Scabiosa



Shasta Daisy

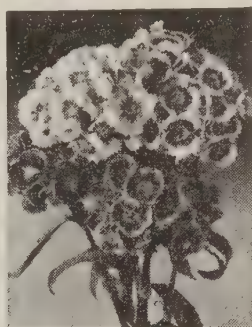

Sweet William—Single



Tritoma



Wallflower

BUNTON'S FLOWERING VINES—FROM SEED

More in demand each year; these flowering climbers are useful for screening undesirable views as well as their general ornamentation. Some are surprisingly quick to give complete coverage and provide a suitable background on fences, walls, etc., for other plantings.



Ornamental Gourds

CANARY BIRD VINE

An excellent climber for shady location, producing hundreds of canary-yellow delicate flowers. Somewhat resembling a bird in flight, whence its name. The dainty leaves are beautifully cut. Grow from 15 to 20 feet. Pkt. 10c.

CARDINAL CLIMBER

A very rapid grower with lacy-like foliage; likes plenty of sunlight. The bright red, trumpet shaped flowers about one inch in diameter are attractive to Humming Birds. Under favorable conditions will grow 25 feet. Pkt. 10c.

COBAEA SCANDENS (Cathedral Bells)

A fast and vigorous grower with handsome foliage. Produces bell-shaped flowers that gradually turn to a lilac-purple. Blooms freely and grows from 20 to 30 feet. Pkt. 10c.

CYPRESS VINE

Beautiful and dainty this rapid grower has fern-like foliage and freely produces star shaped scarlet and white flowers. Grows about 10 feet. Not dense enough for a good screening plant. Pkt. 10c.

ORNAMENTAL GOURDS

Well balanced mixture of both the large and small sorts providing a heavy vine for screening and many odd shaped and colored fruits. Shellac the fruits and use them for novel winter decorations in the house. A novelty with a wealth of entertainment. Pkt. 10c.

PENGUIN GOURDS

Their shape makes it easy to decorate them to resemble penguins. A fast grower providing a good coverage for fences, etc. Pkt. 10c.

HYACINTH BEAN (Dolichos)

A fast growing climber that stands the summer heat well. The purple and white flowers are borne in clusters somewhat like the Hyacinth. Attractive seed pods are formed as the flowers die. Fine for covering fences, etc. Grows about 10 feet. Pkt. 10c.

KUDZU VINE (Jack-and-the-Bean-Stalk)

A hardy climber with extra heavy foliage similar to the lima bean leaf but 3 to 4 times as large, soft and dark green. Probably gives a more dense covering than any other vine from seed. Will grow 25 to 30 feet. A very fast grower after once established. The purple blossoms are in clusters and are very appealing. Pkt. 10c.



Cypress Vine



Morning Glory
Clarke's H. Blue



Thunbergia



Moonflower Double Rose Marie

MOONFLOWER

One of the quick blooming climbers with luxuriant foliage and brilliant colored blooms. The blossoms usually open up in late afternoon and close again late the next morning; staying open on cloudy days.

BLUE EVENING GLORY—Large violet flowers. Vines grow about 20 feet high. Pkt. 10c.

DOUBLE ROSE MARIE—An early, free flowering, clear deep rose. As the flowers are double, they give the appearance of being open even after the other Ipomeas in the garden have closed for the day. Plants grow about 15 feet high. Pkt. 15c.

WHITE—A fast grower with dense foliage and covered with large white flowers. Grow about 20 feet high. Pkt. 10c.

MORNING GLORIES

CLARKE'S HEAVENLY BLUE

—Large bright sky-blue flowers measuring from 4 to 5 inches across. The white and yellow throats accentuate the blue color of the bloom making it very striking even from a great distance. Its good habits of growth and free blooming keep it one of the most popular of all vines. Pkt. 15c.

PEARLY GATES—A lovely lustrous white with creamy shading deep down in the summer until frost; wonderful companion to Clarke's Heavenly Blue. Pkt. 15c.

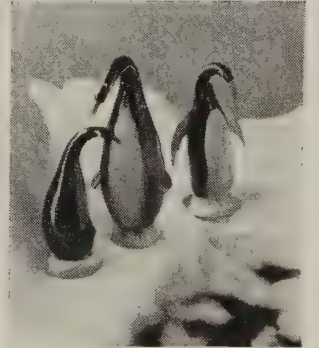

Penguin Gourds

SCARLET O'HARA—Flowers are deep velvety scarlet and measure about 3½ inches across. Free blooming from July until frost. Vines grow about 15 feet high. Pkt. 15c.

MIXED—Large flowers with many colors and markings. Pkt. 10c.

PASSION VINE

A half hardy perennial; shedding its leaves in winter. Grows and blooms luxuriantly from early summer until fall. The fruits mature in late summer attaining the size of the average peach. Flowers are bluish white, fruit is green turning to purple. Pkt. 10c.

SCARLET RUNNER BEANS

An annual climber, growing rapidly and bearing sprays of brilliant scarlet pea-shaped blossoms. Pkt. 10c.

HARDY SWEET PEAS

A perennial climber that produces clusters of flowers on stiff stems, not fragrant. Colors are red, pink and white. **MIXED**—Pkt. 15c.

THUNBERGIA (Black Eyed Susan)

A very popular climbing or trailing annual, used extensively as a plant for hanging basket, tall urn, window box or fence. Flowers are all shades of yellow, orange, buff to pure white, mostly with black centers. Grows about 5 feet. Pkt. 10c.

WILD CUCUMBER VINE

A hardy annual climber having abundant foliage and thickly covered with sprays of small white, fragrant flowers followed by numerous prickly seed pods. Pkt. 10c.

BUNTON'S FLOWER BULBS and ROOTS

DAHLIAS

30c each; 10 for \$2.50
Postpaid—35c each; 10 for \$2.75

CULTURE

For exhibition type blooms, put plenty of humus into the soil. A well drained soil is best. B-B GROWER will supply the necessary nitrogen, phosphate, and potash, mix it into the soil when planting.

Plant the roots about 4 inches deep in heavy soil, 6 inches deep in sandy soil. Daily watering is not nearly as beneficial as a good soaking when the ground becomes fairly dry. Keep the plants well cultivated.

DECORATIVE TYPE DAHLIAS

FRANCIS De La ROCCA—Clear canary yellow. Long erect stems.

HARRY MAYER—Rich growing lavender, large and beautiful.

JANE COWL—Large blooms of glistening buff and salmon shades.

JERSEY BEACON—Beautiful scarlet with buff tips on petals.

JERSEY BEAUTY—Fine eosine pink. Good bloomer. Long stems.

KENTUCKY—Creamy pink, long stems, excellent cut flower.

MRS. GEO. BOUTELIER—Extra large, bright red, shading to rich cardinal red.

MRS. IDA VER WARNER—Large lavender, free bloomer on long stems.

MRS. MARGARET WOODROW WILSON—Creamy white and Phlox pink, large.

PORTHOS—Sparkling deep red. Free bloomer of magnificent size.

PRIDE OF CALIFORNIA—Excellent deep scarlet red, one of the best.

ROYAL PENNANT—Large deep royal purple. Very good grower.

ROSE GLORY—Rose pink of large size, long stems. Very popular.

SANHICAN'S BLUE BIRD—Near blue, very popular, long stems.

SAGAMORE—Beautiful Autumn colored bronze, free bloomer.

SNOWDRIFT—A good white, large flower, excellent grower.

THE COMMODORE—Extra large, lemon yellow, often 14 inches across.

WHITE KING—A large pure white of excellent form.

CALADIUM

Plant grows to good height; the large leaves are shaped much like an elephant's ear. **Small size, each 10c; 3 for 25c. Medium size, each 20c; 3 for 50c. Extra large size, 30c; 3 for 75c.**

CANNA BULBS

HUNGARIA—Deep pink. Leaves bluish green. 3½ feet. Each 10c; doz. \$1.00; 100, \$8.00.

KING HUMBERT—Large orange scarlet flowers surmount beautiful vigorous deep bronze foliage. 4½ feet. Each 10c; doz. \$1.00; 100, \$8.00.

THE PRESIDENT—The greatest red Canna, very large and a free bloomer. Green foliage. 4 feet. Each 10c; doz. \$1.00; 100, \$8.00.

YELLOW KING HUMBERT—Flowers are yellow dotted orange scarlet. Green foliage. 4½ feet high. Each 10c; doz. \$1.00; 100, \$8.00.

TUBEROSES

DOUBLE EXCELSIOR PEARL—Suitable for culture anywhere, in pots or open ground, and is the most fragrant of the summer flowering bulbs. Each 10c; dozen \$1.00.



Dahlia

CACTUS TYPE DAHLIAS

BRIDES BOUQUET—White.

COUNTESS OF LONSDALE—Salmon.

CELIA—Lavender pink.

LIBELLE—Royal purple.

BALL TYPE DAHLIAS

RED BALL—Red.

A. D. LIVONI—Pink.

STORM KING—White.

BONNIE BLUE—Lavender.

LUCY FAWCETT—Yellow.

POMPON TYPE DAHLIAS

EDITH MUELLER—Orange.

DR. JIM—Purple.

AMBER QUEEN—Bronze.

YELLOW GEM—Yellow.

LITTLE HERMAN—Red.

MORNING MIST—Lavender.

HYACINTHUS CANDICANS

(Summer Hyacinths)

Stately plants bearing tall spikes of large pure white pendant blooms. Bulbs 2 for 15c; 12 for 60c.

ISMENE (BASKET LILY)

Showy, sweet scented white flowers of unusual but attractive form. Blooms in just a few weeks. Bulbs 25c each; 6 for \$1.35; 12 for \$2.50.

LILY OF THE VALLEY

Delightfully fragrant white flowers, grows about 8 inches. Clump 30c.

MADEIRA VINE

Small white flowers, blooming in summer and fall. Leaves bright green, grows about 15 feet. Roots 5c each; 12 for 50c.

BUNTON'S BETTER ROSES

BUNTON'S HYBRID TEA ROSES

(Everblooming or Monthly)

B-B GRADE

Two-year-old, healthy field grown No. 1 plants with roots packed in special Moss and wrapped in moisture proof Nursery Kraft paper. True to name, will bloom the first year.

\$1.00 each—10 or more @ 90c

AUTUMN—Double blooms of orange, yellow and red.

BETTY UPRICHARD—Delicate salmon-pink, pointed buds, very fragrant.

CALEDONIA—One of the best whites, long buds, large double flowers.

CONDESA DE SASTAGO—Deep coppery pink inside, golden yellow reverse.

DUQUESA DE PENARANDA—Apricot orange and pink. Vigorous.

E. G. HILL—Dazzling brilliant red, which shades to dark crimson.

EDITH NELLIE PERKINS—Light cerise pink, inside suffused gold.

EDITOR McFARLAND—Shapely buds and double brilliant pink blooms.

ETOILE DE HOLLANDE—Dark velvety red, large, fragrant, profuse.

HEINRICH GAEDE—Long pointed buds of brilliant red. Flowers are a rich vermillion shaded with golden-yellow.

JOANNA HILL—Deep creamy yellow shaded bronzy pink in center.

K. A. VIKTORIA—Ivory white, pale lemon center; high centered.

McGREDY'S SCARLET—Brilliant scarlet shaded rose pink. Excellent.

MME. JOS. PERRAUD—Shades from shell pink at the edges to orange.

MRS. E. P. THOM—Double blooms of pure yellow. Strong plants.

MRS. P. S. DuPONT—Free flowering, rich golden-yellow, plant is bushy and somewhat compact in habit.

PICTURE—Beautiful pink of excellent form.

PRES. HERBERT HOOVER—Multicolor of flame, scarlet, yellow and cerise.

RED RADIANCE—Glowing crimson, profuse and hardy. Vigorous.

SOEUR THERESE—Double rich yellow, profuse, upright, vigorous.

SOUV. CLAUDIUS PERNET—Beautiful long buds, rich yellow blooms.

TALISMAN—Bright yellow, gold and pink shading to gold and rose pink.

CLIMBERS

BLAZE—(Pat. No. 10)—The "Everblooming Paul's Scarlet Climber." The dazzling red blooms are borne in clusters several times a season. **\$1.50 each.**

DOUBLOONS—(Pat. No. 52)—Large golden yellow, excellent for cutting. **\$1.50 each.**

JACOTTE—Large semi-double coppery yellow, tinted red. **75c each.**

MARY WALLACE—Large bright pink with luminous sheen. **75c each.**

PAUL'S SCARLET CLIMBER—Intense red blooms borne in loose clusters. **75c each.**

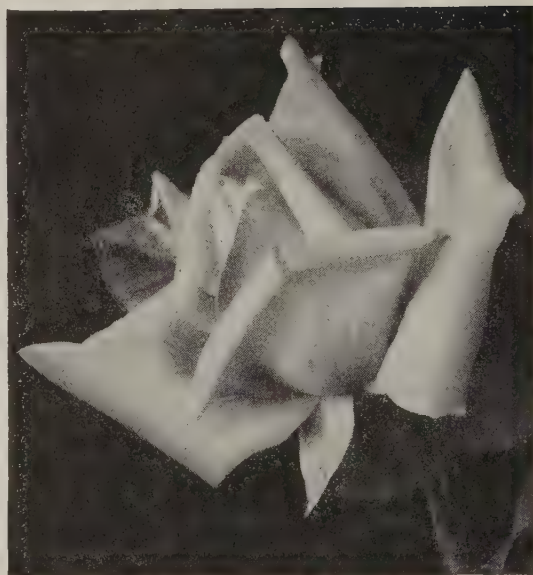

PATENTED HYBRID TEA ROSES

COUNTESS VANDAL—(Pat. No. 38)—Long pointed and high centered buds; fragrant blooms of coppery bronze suffused with soft gold. **\$1.50 each.**

HEARTS DESIRE—(Pat. No. 501)—Long deep red buds opening into large crimson blooms. Fragrant. **\$1.50 each.**

PEACE (Pat. No. 591)—Buds open yellow with cerise edges. The five-inch blooms open slowly, each petal edged with pink. **\$2.50 each.**

MME. HENRY GUILLOT (Pat. No. 337)—Deep watermelon pink with reddish orange. **\$1.50 each.**

MME. CHANG KAI-SHEK—Beautiful canary yellow. **\$2.00 each.**

RUBAIYAT (Pat. No.)—Beautiful new crimson-red. An All-America Selection. **\$2.00 each.**

TEXAS CENTENNIAL—(Pat. No. 162)—A red sport of Pres. Herbert Hoover. Vermillion red when first opening, aging to deep rich pink. Really a beautiful rose with good habits of growth. **\$1.00 each.**

CHOICE GRADE HYBRID TEA ROSES

75c each—10 or more @ 70c

These 2 year, field grown plants are true to name and delivered to you in good condition. Roots packed and wrapped. Will bloom the first year.

CALEDONIA—Pure white.

CONDESA DE SASTAGO—Multicolor.

EDITH NELLIE PERKINS—Salmon pink.

EDITOR McFARLAND—Brilliant pink.

E. G. HILL—Dark crimson.

ETOILE DE HOLLANDE—Crimson red.

MRS. P. S. DU PONT—Yellow.

PINK RADIANCE—Rose pink.

PRES. HERBERT HOOVER—Multicolor.

SOEUR THERESE—Yellow.

TALISMAN—Multicolor.

BUNTON'S GLADIOLUS BULBS



Gladiolus

ALBATROSS—One of the best and largest white Gladiolus, the immense flowers are absolutely without blotches or throat markings of any sort. A very strong grower of good substance. Each 11c; 6 for 60c; \$1.10 per dozen; \$8.00 per 100.

BEACON—Clear bright rose scarlet with cream blotch. Medium large ruffled blooms. Each 11c; 6 for 60c; \$1.10 per doz.; \$8.00 per 100.

BAGDAD—Very attractive smoky old rose, a little darker toward the edge and lighter in the throat. The enormous blooms have a faint creamy blotch marked with pink. Each 11c; 6 for 60c; \$1.10 per dozen; \$8.00 per 100.

BERTY SNOW—Lovely large light rosy lavender flowers with lighter throat. The large flowers are well placed. One of the finest for general garden and cutting. Each 11c; 6 for 60c; \$1.10 per dozen; \$8.00 per 100.

BETTY NUTHALL—Giant flower of glowing orange-pink with light yellow throat markings. Very popular with both the commercial grower of cut flowers and the gardener because of its large, straight and well formed spikes. Several spikes often come from one bulb. One of the finest. Each 9c; 6 for 50c; 95c per dozen; \$7.00 per 100.

FOR PRIZE-WINNING GLADIOLUS, GIVE THEM PLENTY WATER AND FEED REGULARLY WITH BB GROWER

CULTURE—For best results Gladiolus should be planted in a sunny location in rows 12 inches apart and about 3 inches in the row.

Plant the Bulbs about 2 inches deep. Cultivate regularly, keeping them free from weeds. When the plants are about 10 inches high, use a contact insecticide for the control of Thrip. Protect your Bulbs against Thrip and Rot by soaking them in a Semesan solution, before planting.

CHARLES DICKENS—Bright radiant purplish violet, a very unusual color. A long lasting cut flower. Each 11c; 6 for 60c; \$1.10 per dozen; \$8.00 per 100.

DEBONAIR—La France-pink shading to shrimp-pink with creamy blotch in throat lightly peppered crimson. Spikes are very tall and will have 6 or more blooms open at one time. Each 11c; 6 for 60c; \$1.10 per dozen; \$8.00 per 100.

EXCELLENCE—New light red of good substance. The large spikes are well formed and have a good number of blooms open at the same time. Each 11c; 6 for 60c; \$1.10 per dozen; \$8.00 per 100.

GATE OF HEAVEN—Beautiful ruffled deep yellow with greenish yellow buds. Spikes are of medium height and good form. Each 11c; 6 for 60c; \$1.10 per dozen; \$8.00 per 100.

GIANT NYMPH—Popular, dependable light rose pink with creamy yellow throat. Large flowers on tall spikes. Each 9c; 6 for 50c; 95c per dozen; \$7.00 per 100.

GOLDEN DREAM—Large flowering yellow of excellent substance. An old favorite. Each 9c; 6 for 50c; 95c per dozen; \$7.00 per 100.

MAID OF ORLEANS—Beautiful milky white with cream throat. Tall vigorous grower with 8 or more well placed blooms open at a time. Each 11c; 6 for 60c; \$1.10 per dozen; \$8.00 per 100.

MARGARET FULTON—Clear rich soft dark salmon of a beautiful distinct shade. Each 11c; 6 for 60c; \$1.10 per dozen; \$8.00 per 100.

MINUET—Beautiful clear light lavender. Four to six large, heavily textured blooms open at same time on a good strong stem. The most desirable of the lovely lavender shades. Each 11c; 6 for 60c; \$1.10 per dozen; \$8.00 per 100.

PARADISE—Extra large slightly ruffled pure apricot. A beautiful variety. Each 9c; 6 for 50c; 95c per dozen; \$7.00 per 100.

PEARL HARBOR—New large white. The beautiful flowers are well placed on tall straight spikes. Each 11c; 6 for 60c; \$1.10 per dozen; \$8.00 per 100.

PHYLIS McQUISTON—Glowing rosy shrimp pink, shading lighter toward the center. Each 11c; 6 for 60c; \$1.10 per doz.; \$8.00 per 100.

PRIDE OF WANAKA—Delightful two toned pink. Immense flowers on straight spikes. Each 11c; 6 for 60c; \$1.10 per dozen; \$8.00 per 100.

POLAR ICE—Clear white, large, early bloomer. A very popular variety for cutting. Each 11c; 6 for 60c; \$1.10 per dozen; \$8.00 per 100.

PICARDY—A sensational flower of delicate apricot pink, ruffled and a heavy wax-like substance. A favorite for cutting. Each 9c; 6 for 50c; 95c per dozen; \$7.00 per 100.

PURPLE HEART—A new introduction. Flowers are beautiful purple-lavender. Each 11c; 6 for 60c; \$1.10 per doz.; \$8.00 per 100.

ROSA de LIMA—Beautiful pink with white midrib and throat. Deep in the throat there is a delightful touch of dusty lavender. Each 11c; 6 for 60c; \$1.10 per doz.; \$8.00 per 100.

VAGABOND PRINCE—Iridescent mahogany brown, shading lighter in the throat with small vivid flame scarlet blotch. Each 11c; 6 for 60c; \$1.10 per doz.; \$8.00 per 100.

SONATINE—Light pink often flaked with darker pink. Small red diffused blotches. Large blooms. Each 11c; 6 for 60c; \$1.10 per dozen; \$8.00 per 100.

WASAGA—A beautiful clear glowing buff with wide open ruffled blooms. Each 11c; 6 for 60c; \$1.10 per dozen; \$8.00 per 100.

BB GLADIOLUS MIXED—The finest blend of the best varieties, balanced according to their color value. This mixture contains many delightful surprises for cut flowers or garden display. 6 for 45c; 85c per dozen; 25 for \$1.60; \$6.00 per 100.

CHOICE MIXED GLADIOLUS—A good mixture of standard varieties. 6 for 35c; 65c per dozen; \$4.50 per 100.

MEAT CURING PRODUCTS

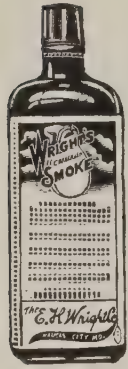

Cure your home killed meat the easy, quick, scientific way.

WRIGHT'S CONDENSED SMOKE—16 oz. (smokes 150 pounds meat) 65c; 32 oz. \$1.00; gallon \$3.00.

WRIGHT'S HAM PICKLE—For sugar curing meat. Quart 65c—with 14 pounds of salt cures 150 pounds meat; 1/2 Gallon \$1.00—with 28 pounds of salt cures a barrel of meat.

FIGARO SUGAR CURE SMOKE SALT—10 lb. can \$1.00 (cures 150 pounds of meat).

FIGARO RUBBED SAGE—1 oz. can 25c.

FIGARO SAUSAGE SEASONING—10 oz. can 30c.

FIGARO LIQUID SMOKE—16 oz. bottle 65c (for 150 pounds of meat).

FIGARO LIQUID SMOKE—32 oz. bottle \$1.00 (for 300 pounds of meat).

MORTON'S SMOKE SALT—10 lb. can 90c (for 150 pounds of meat).

MORTON'S TENDER QUICK—2 1/2 lb. can 50c.



SOIL-SOAKER



VICTORY GARDENS



FLOWER GARDENS and HEDGES

The new "Seepage-Irrigation" method soaks soil thoroughly, no run-off, no soil-washing. The perfect way to water lawns, victory gardens, flowers, shrubs and trees. Under normal pressure the water seeps through the pores in the special canvas directly into the soil. Saves water by putting it only where you want it, prevents loss by wind and evaporation. Equipped with coupling to fit regular garden hose. Available in four lengths. No. 0—12 feet \$1.65; No. 1—18 feet \$2.15; No. 2—30 feet \$3.35; No. 3—50 feet \$5.45.

SUDBURY SOIL TESTERS

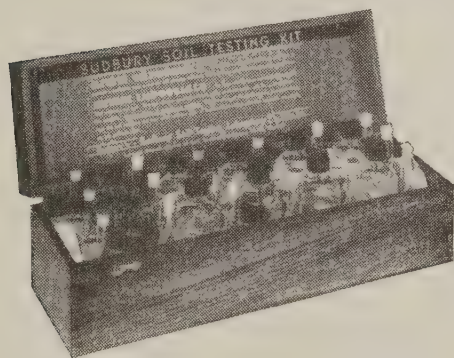

The Sudbury Soil Test Kits make instantly available the essential information you require for gardening success. With them you can make quick practical tests which will show the acidity of your soil and

any possible deficiency in nitrogen, phosphorus and potash. As a result, you can avoid failure by prompt adjustment of your soil to the requirements of your plants and grasses. Sudbury Soil Test Kits are used by leading amateur and professional growers throughout the country.

Test Your Soil and Be Sure

HOME GARDENER MODEL	\$ 2.00
JR. PROFESSIONAL MODEL	\$ 4.75
JR. DeLUXE MODEL	\$ 6.00
HORTICULTURAL MODEL	\$ 9.75
NEW DeLUXE MODEL	\$22.50



Have Every Feature You Want in a Garden Glove

**All-Leather—DIRT PROOF—Durable
SOFT—Comfortable—WASHABLE**

Easy on the hands and easy to wear!

Economical, too—outwear 6 pairs of ordinary fabric gloves, are washable and can be used the year round for garden, housework, yard, painting, furnace, garage, etc. You'll like them.

Sizes for Women (small, medium, large) for Men (small, medium, large). Price, \$1.15 cents a pair.

PIGSKIN GARDEN GLOVES

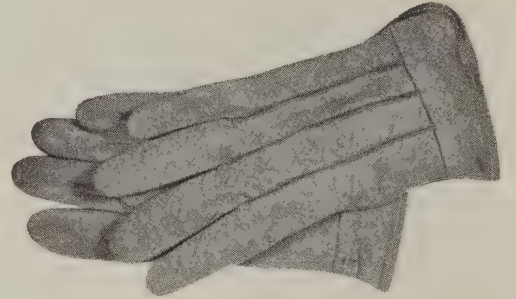

Protect your hands from scratches, bruises, dirt and stain with these soft, comfortable and long wearing gloves made from special pigskin. They are washable and remain soft. Tough enough for hard work, nice enough for driving. The ideal glove for garden, yard, housework, painting, etc. Ladies' size 7, \$1.75 per pair.

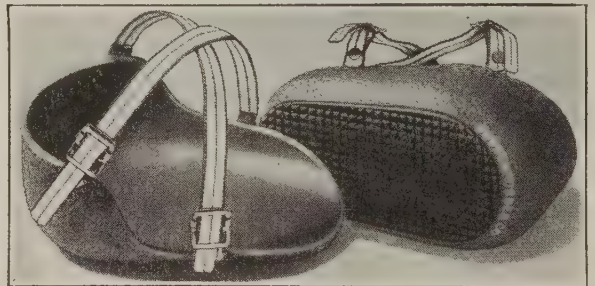

KNEE PADS

A comfort and protection for your knees when your work requires kneeling. The soft, thick, spongy and flexible rubber not only affords protection against hard, rough surfaces but is moisture proof as well. Quick and easy to put on and may be left on when walking upright. Very durable. Price per paid, \$1.50.

Erosionet is a strong, open mesh fabric made of tightly twisted paper twine. When placed on seeded areas of slopes and terraces that are apt to wash, its 1/4 inch square mesh forms millions of tiny dams which catch and hold the seed firmly in place. Erosionet also catches and holds moisture. It helps overcome seed losses and lawn disappointments from poor germination.

Erosionet comes in rolls 45 inches wide. Price per lineal yard. 1 to 25 yards @ 17c; 25 to 99 yards @ 16c; 100 yards or over @ 15c.

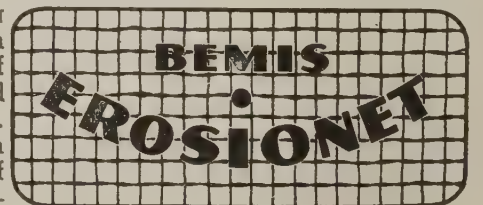

PLANT FOODS and AIDS

B-B GROWER

THE COMPLETE PLANT FOOD FOR VEGETABLES, SHRUBS, LAWNS, AND FLOWERS

Your vegetables will grow better, flowers bloom more profusely, lawns be more thrifty with a healthier green color, if you feed them B-B GROWER. It is packed in sizes for most every need and requirement. A TRIAL IS CONVINCING—TRY IT. Economically priced as follows: 5 lb. pkgs., 40c; 10 lb. pkgs., 70c; 25 lb. bag, \$1.25; 50 lb. bag, \$2.00; 100 lb. bag, \$3.50; 10 bags at \$3.25 each.



VIGORO is a complete, odorless plant food for lawns, flowers, vegetables, trees, shrubs and potted plants. It is sanitary and pleasant to use. 1 lb. bag 10c; 5 lb. bag 45c; 10 lb. bag 85c; 25 lb. bag \$1.50; 50 lb. bag \$2.50; 100 lb. bag \$4.00.

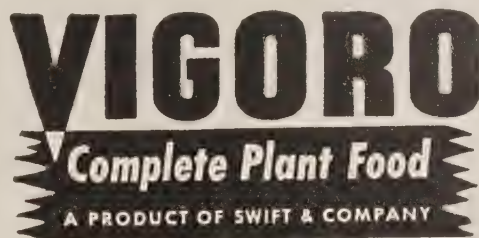

PLANT DINNER

Odorless, easy to use and economical. Contains Vitamin B-1 and Hormones as well as the Nitrogen, Phosphorus, Potash, etc. Dissolve 2 teaspoons to gallon of water. 1/2 oz. 10c; 1 1/4 oz. 25c; 6 oz. 75c; 1 lb. \$1.75; 5 lbs. \$7.50.

PULVERIZED SHEEP MANURE

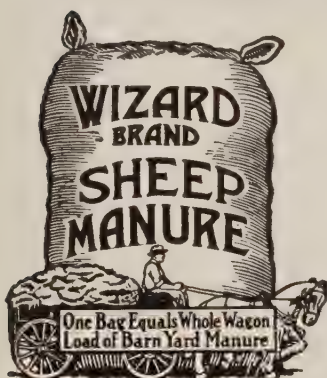

Makes All Plants
Grow to Perfection

Wizard is a natural weed-less fertilizer that puts new life and beauty into lawns and gardens. Everybody can get wonderful results with Wizard because it is easy to use and does not burn plants. Use Wizard this year and make your lawn and garden the envy of the neighborhood. 5 lbs. 35c; 10 lbs. 60c; 25 lbs. \$1.00; 50 lbs. \$1.80; 100 lbs. \$3.00.

HYPONEX

A complete and balanced plant food, clean and odorless. Contains NITROGEN, PHOSPHATE and POTASH with Vitamin B1 added. For growing plants in soil, sand or water. 1 oz 10c; 3 oz. 25c; 1 lb. \$1.00.

ROOTONE

Is the new root-inducing chemical that stimulates rapid growth on leafy cuttings, being especially valuable for propagating all plants by cuttings, whether rooted with ease or normally rooted with difficulty.

Rootone hastens the rooting of cuttings, to much less than normal time, assuring quicker and better rootings in higher percentages than ever before possible. No special equipment is needed. Rootone comes in powder form and is easily applied. The cost is only a fraction of a cent per cutting. Full directions for using on each package. 1/4 oz. pkt. 25c; 2 oz. jar \$1.00; 1 lb. \$5.00.

TRANSPLANTONE

(The Hormone)—Vitamin B-1 treatment for transplanting. 1/2 oz. 25c; 3 oz. \$1.00; 1 lb. \$4.00.

VITAMIN B-1

Gives most plants an unusual growth. Remarkable results on certain flowers, vegetables, trees, etc.

THOMPSONS

10 Pellet pkg. makes 200 gallons.....\$0.25
100 Pellet pkg. makes 2,000 gallons..... 1.00

NUVIM

250 tablet bottle makes 250 gallons..... .50
1 oz. bottle makes 140 gallons..... .25
40 Tablets makes 40 gallons..... .10

COW MANURE

An ideal material for mulching and feeding roses and other flowering plants, shrubs, evergreens, etc. It also adds a liberal amount of humus when worked into the soil, thus preventing the soil from getting hard and lumpy. 25 lbs. \$1.00; 50 lbs. \$1.80; 100 lbs. \$3.00.

PEAT MOSS

FINELY GRANULATED

Every Grower Should Use It for Mulching Flower and Vegetable Beds, Evergreens, Roses, Shrubs, Etc.

It retains moisture and furnishes the needed organic matter which all soils require. Lawns will not dry out so quickly if covered with a light layer of Peat Moss in the spring. For the flower garden spread a layer about 3 inches deep and work into the soil. For porch and window boxes mix a good proportion of Peat Moss with rich compost or soil. Peat Moss is dry and compressed into bales. Small Bale \$1.75; Large Bale \$4.75.

PLANTABBS

ODORLESS PLANT
FOOD TABLETS

Plant one of the Plantabbs in each pot about every two weeks and you'll have the finest flowers you ever grew.

Everyone who tries Fulton's Plantabbs praises them. 30 tablets 25c; 75 tablets 50c; 200 tablets \$1.00; 1000 tablets \$3.50.



LAWN LIME

50-lb. bag 50c; 5 bags \$2.25; 10 bags \$4.25; 20 bags \$8.25.

PALCO PETE'S MULCH



Brings "dead" soil to life by improving the soil structure, retaining moisture, aerating the soil and giving protection against sun and wind. When used as a surface cover reduces weeding and cultivation. Increases germination in seed flats, greatly assists potted plants. A splendid top dressing for lawns. Palco Pete's Mulch consists of tiny cork cells and fine wiry bark fibres. It easily mixes with all types of soils and does not readily decompose. Hence it lasts longer and keeps soil particles from becoming compacted and lumpy over extended periods of time. Available in

convenient sack containing 3 1/2 cubic feet of material ready for immediate use. Approximate weight per bag 45 lbs. Price \$2.35 per bag; 5 bags at \$2.25; 10 bags at \$2.15.

Small bags @ \$1.15 per bag.

PLANT INSECTICIDES—FUNGICIDES



APHIS SPRAY (Acme)—An improved nicotine spray combining a soft fish oil soap with Black Leaf "40" controls all kinds of aphids, (plant lice) thrip, leaf hopper and many more hardy insects infesting rose bushes, flowers, shrubs, vines, bushes and trees. **3 oz. Collapsible Tube, 40c.**

ARSENATE OF LEAD (Acme)—The most favored arsenical insecticide found on the American market. Recommended for fruit trees, vegetables, bushes and tobacco. Can be used as dust or spray. **Prices: 1 lb. Carton 40c; 1 lb. bag 35c; 4 lbs. 90c.**

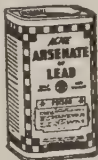

BAIT-EM—Kills slugs, snails, sow bugs and other soil insects. **1 lb. 35c; 2½ lbs. 75c.**

BEAN BEETLE DUST ("75" Rotenone Dust)—A non-poisonous insecticide, very effective in the control of Mexican Bean Beetle, European Corn Borer, Caterpillar or Aphid on Broccoli, Brussels Sprouts, Cauliflower, Kohl-Rabi, Mustard, Kale, Turnips and Collards. Apply as a dust as it comes from the package, be sure to dust plants thoroughly, covering the upper and lower surfaces of the foliage. **1 lb. bag 35c; 2 lb. bag 60c; 5 lb. bag \$1.00.**

"75" ROTENONE DUST WITH D. D. T.—1 lb. bag 40c; 2 lb. bag 65c; 5 lb. bag \$1.25; 50 lb. bag \$9.00.

BLACK LEAF "40" has many uses. Sprayed on shrubs, flowers, vines and vegetables, controls sucking insects. In the **POULTRY** house, when thinly spread on tops of perches, it kills body lice and feather mites with no handling of the birds. **Prices: 1 oz. 36c; 5 oz. \$1.05; 1 lb. \$2.42; 2 lbs. \$3.92; 5 lbs. \$7.40; 10 lbs. \$12.85.**



BLUESTONE—Used in making Bordeaux Mixtures and Copper Solutions. **Lb. 20c; 5 lbs. 65c; 10 lbs. \$1.20; 25 lbs. \$2.75; 50 lbs. \$5.00; 100 lbs. \$9.00.**



BORDEAUX MIXTURE (Acme)—Prevents large losses caused by blight, rot, mildew, scab, anthracnose and certain other fungous diseases. **1 lb. Carton 40c; 4 lb. Bag 90c.**

CALCIUM ARSENATE—The cheapest arsenical insecticide on the market but of great economy and efficiency for certain purposes. Recommended to combat chewing insects. **Prices: 1 lb. 25c; 4 lbs. 50c; 24 lbs. \$2.85.**



CYANOOGAS G-FUMIGANT for greenhouses. **Prices: 5 lbs. \$3.00; 25 lbs. \$10.00; 100 lbs. \$30.00.**

D. D. T.—2% Powder. **1 lb. bag 20c; 5 lbs. 75c.**

DEENATE 50-W—(DuPont 50% DDT). A wettable powder for use on agricultural crops, farm buildings and animals. Mix 1 or 2 pounds with 100 gallons of water for agricultural use. **1 lb. 90c; 4 lbs. \$2.75.**

DuPONT GARDEN DUST—An insecticide and fungicide containing Rotenone, DDT and Fermate. Use as a dust or spray on vegetables, flowers, fruit trees and some ornamentals. **8 oz. dust gun 70c; 1 lb. can \$1.00; 4 lbs. \$3.00.**



EMO (Acme)—A summer oil spray of fine quality, safe to use. Recommended as a contact spray in the control of White Flies, Rust Mites, Blister Mites, Mealy Bugs, Red Spiders, certain scale, and other insects. **8 oz. 30c; pint 50c; quart 70c; gallon \$1.95; 5 gals. \$5.00.**

FERMATE (DuPont)—An effective control for Blue Mold on Tobacco and fungus diseases on fruits and certain plants. **3 lb. bag \$2.45.**

NICO-FUME PRESSURE FUMIGANT—For greenhouses to destroy Aphid and Thrip. **1 lb. can 75c; 12 1-lb. cans \$7.95.**



PARIS GREEN—For use on: Potatoes, cotton, tobacco; also to mix with arsenate of lead for fruit tree spraying where quick results are necessary. **Prices: ¼ lb. 20c; 1 lb. 55c; 5 lbs. \$2.45; 25 lbs. \$10.00.**

ROTENONE GARDEN GUARD (Acme)—Protect your garden with a safe insecticide dust. The killing ingredient is Rotenone. Non-injurious to humans and warm-blooded animals yet effective both by contact and as a stomach poison against insects. **1 lb. sifter carton 40c.**



LIME SULPHUR (DRY)—For use in dormant spraying against scale, peach blight, leaf curl and twig borer. Summer spraying against scab, soot, blotch, red spider and mite. **1 lb. 35c; 5 lbs. \$1.50; 12½ lb. paper bag \$2.00; 100 lbs. \$14.00.**

LIME SULPHUR LIQUID—4 qts. 50c; 5 gal. \$1.75; 10 gal. \$3.00; 30 gal. bbl. \$6.90; 50 gal. bbl. \$9.00.

NNOR GARDEN SPRAY (Rotenone)—A non-poisonous spray for sucking and chewing insects. Economical to use. **1 oz. 35c; 6 oz. \$1.00; Pint \$2.15.**

PARADICHLOROBENZENE—Kills the Peach Tree Borer. One ounce required for each tree. Full directions for use on each package. **1 lb. 50c; 4 lbs. \$1.25.**

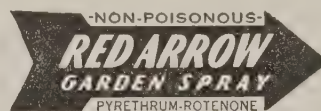

RED ARROW—A non-poisonous flower and vegetable garden spray. Kills red spider, mealy bug, Mexican bean beetle, aphid (plant lice), cabbage worm and other chewing and sucking insects. Harmless to humans, animals and plants. Scientifically blends the toxic principles of Pyrethrum and Rotenone with soap. Simply mix with water and spray. **1 oz. makes 8 gallons of spray against aphids. 1 oz. 35c; 4 oz. \$1.00; 1 pt. \$2.85; qt. \$5.50; gal. \$16.00.**



SCALECIDE—The Complete Dormant Spray—The quality miscible oil. Oldest and best known dormant spray for trees, shrubs, and vines—makes them more beautiful, healthful and fruitful. Used by leading fruit growers. Pleasant to use—non-caustic, non-corrosive, non-poisonous. Kills scale, insects, eggs, larvae and disease cankers. Mixes instantly—dilute 1 to 15. **Qt. 75c; gal. \$1.75; 5 gal. \$6.35; 10 gal \$10.90; 15 gal. \$14.95; 30 gal. \$23.75; 50 gal. \$32.90.** One gallon equals 3½ gallons lime-sulphur.

SCALE MULSION (MISCIBLE)—An economical self-emulsifying spray oil for dormant spraying of fruits and shade trees and shrubs. **1 gal. to 50 gal. water. 1 gal. 75c; 52 gal. drum \$25.80.**

SLUGSHOT (Powder)—A very popular insecticide for destroying cabbage worms, tomato worms and other leaf-eating insects that prey on vegetables. It can be applied freely as it will not burn and is non-poisonous to human life. **Prices: 1 lb. (canister) 30c; 5 lb. pkg. \$1.00.**



TOBACCO DUST—Very effective for destroying plant lice or aphid, striped bugs on melons, cucumbers and squashes and other insects; also remedy for poultry lice. **Lb. 10c; 10 lbs. 50c; 25 lbs. \$1.25; 100 lbs. \$3.00.**



TREE TANGLEFOOT—For protecting trees against climbing insect pest in a simple, economical and effective way. Put a band of Tree Tanglefoot from 3 to 5 inches wide completely around the tree. **6 oz. can 35c; 1 lb. 70c; 5 lbs. \$3.25; 10 lbs. \$6.25.**

ROSE SPRAYS



TRI-OGEN
Reg. U. S. Pat. Off.
The all-purpose spray

Gives complete protection against all plant insects and diseases, including black spot, mildew, aphid (plant-lice), slug-worms, caterpillars, etc. The stimulating value of TRI-OGEN promotes vigor and growth, healthy green foliage, with resulting luxuriant blooms.

TRI-OGEN is offered in five sizes:

- A. Small Kit (makes 16 quarts).....\$ 1.50
Protects 12 to 20 roses for season.
- B. Medium Kit (makes 64 quarts)..... 4.00
Protects 50 to 80 roses for season.
- C. Large Kit (makes 32 gallons)..... 6.00
Protects 100 to 160 roses for season.
- D. Estate Kit (makes 128 gallons)..... 20.00
Protects 400 to 600 roses for season.
- E. TRIAL KIT (makes 8 quarts)..... .90
Protects 6 to 10 roses for season.

Du PONT ROSE DUST—Contains sulphur and "Fermate" the new fungicide. Controls black spot, powdery mildew, rust and other diseases of roses. Fine for carnations and snapdragons. 1 lb. sifter top can \$1.00; 4 lb. canister \$3.00.



ACME KOPPER QUEEN (Mildew Spray)—A stainless liquid copper spray for the control of mildew, leaf spot, and black spot on rose bushes, flowers and many other kinds of foliage. Leaves no unsightly residue. A liquid spray replacing Bordeaux Mixture and Sulphur. 1/2 pt. 35c; pt. 60c; qt. 90c; gal. \$2.25.

ACME WETTABLE DUSTING SULPHUR (An Excellent Chigger Chaser)—An improved dusting sulphur for home use which can also be used as a liquid spray. Recommended to control mildew, leaf spot, black spot and rust on rose bushes, chrysanthemums, snapdragons, carnations, and certain other foliage; also red spiders on evergreens. 98% passes through 325 mesh screen. 2 lb. carton 30c.



ACME SCIENTIFIC ROSE SPRAY

A "system" of spray treatment for roses and flowers of all kinds. Eliminates guess work. Each set contains three separate items—A, B, and C—each scientifically made to combat one of the three major classifications of blight and insect pest. Mix all three together with water. Use regularly. Result: Complete all-round protection. Surprisingly economical.



Sizes	Amount of Spray	No. of Roses Protected all season	Prices
No. 3.....	12 qts.....	7 to 12 bushes.....	\$0.95
No. 6.....	24 qts.....	15 to 25 bushes.....	1.50
No. 24.....	96 qts.....	60 to 100 bushes.....	4.00
No. 48.....	48 gals.....	120 to 200 bushes.....	6.00
No. 96.....	96 gals.....	240 to 400 bushes.....	9.75

ACME DAWG-GONE

Protects that evergreen—keeps dogs away. Remove cap and hang tube of Dawg-Gone (opening down) in the lower branches of trees at the points of approach. The odor slowly emanating from the open tube will keep dogs at a distance. Tube 25c each.



ANTI-KILL (Acme)—A sure method to destroy ants, killing the entire colony. Junior Set 35c; Cottage Set 60c.

ADCO—Turns leaves into manure. 7 1/2 lb. carton \$1.00; 25 lbs. \$2.50.

ACTIVO—Turns leaves into manure. No. 2 (makes 450 lbs. compost) \$1.00; No. 7 (makes 1,500 lbs. compost) \$2.00; No. 25 (makes 3 tons compost) \$5.75.

CATTLE SPRAY (T-N-T.)—Is economical to use and dynamite to flies. An absolute killer and repellent. It will not deteriorate or lose strength with age. Prices: Gal. \$1.10; 5 gals. \$4.80.

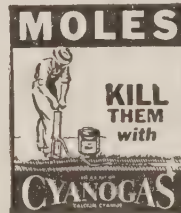

CYANOGEN A-DUST—While rats can keep clear of baits and traps they cannot escape from CYANOGEN A-DUST.

Nothing is surer, quicker or more economical for mole control than CYANOGEN A-DUST. Every 10 feet along the runways make a hole and pump in the powerful CYANOGEN A-DUST. Prices 1/2 lb. 45c; 1 lb. 75c; 5 lbs. \$3.00; 25 lbs. \$10.00; 100 lbs. \$30.00.

MOLOGEN—An efficient powder. Non-poisonous to pets, soil or grass. Rids your lawn of moles in 2 to 3 days. Odorless, easy to use. Prices 1/2 lb. can 50c; 1 1/2 lb. can \$1.25; 5 lb. can \$4.00.

SMITH RODENT DESTROYER—Kills rats, moles and ground squirrels in their holes, tunnels and burrows. Light fuse and insert in hole and the rodents can't escape the gases that are given off. 10c each; 3 for 25c; \$1.00 per dozen.

JIM DANDY RAT KILLER—Non-poisonous baits already prepared. Pkg. (10 baits) 15c; 2 for 25c.

DuPONT 5% DDT INSECT DUST—For floors, cracks and shelves. Controls flies, ants, bedbugs, cockroaches, fleas, ticks, etc. 1 oz. puffer can 25c; 2 oz. sifter top can 25c; 8 oz. shaker top can 70c; 1 lb. sifter top can \$1.15.

Du PONT 5% DDT INSECT SPRAY—A residual spray containing pyrethrins for quick action. Leaves an invisible coating that kills by contact. Gets rid of flies, mosquitoes, bedbugs and 7 other household pests. Pint 45c; quart 75c; 1 gallon \$2.50.

Du PONT 50% DDT—For use on animals, agricultural crops and in farm buildings. A wettable powder to mix with water. 1 lb. 90c; 4 lb. bag \$2.75.

ACME KOPPER SHIELD (A Pruning and Tree Wound Paint)—An antiseptic treatment to prevent such diseases as European canker fungus, hard rot, and certain other fungi from penetrating the wounds while the tree is naturally overcoming the shock. 1/2 pt. 30c; pt. 45c; qt. 75c; gal. \$2.35.



LIME (Hydrated)—Is used as a reducer and in combination of many insecticides; for whitewash, deodorizing, and as a top dressing for lawns. 50 lb. bag 60c; 5 bags at 50c.

FRUITONE—Stops the premature drop in apples. A safe Hormone Powder to be mixed with water and sprayed on the fruit. 1/2 lb. Fruitone to 100 gallons water. 2 oz. \$1.00; 1/2 lb. \$3.75; 12 oz. \$5.00.

FUMEOGEN—Dogs, cats, ants and other insect pests do not like it. It repels them—it keeps them away. Price 50c.

SULPHUR FLOUR—Now being used and recommended for treating seed potatoes for scab; is usually dusted on while cutting potatoes for planting. Prices: Lb. 10c; 10 lbs. 75c; 50 lbs. \$1.75; 100 lbs. \$3.25.

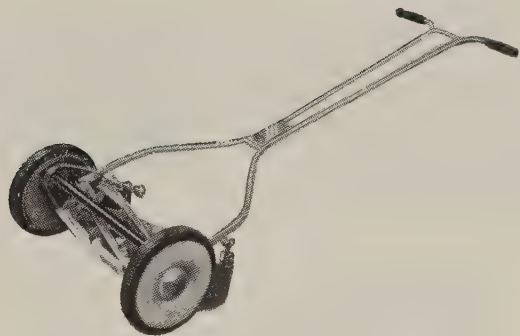

Michigan Noiseless

LAWN MOWERS

NEW POST-WAR MODELS

MICHIGAN NOISELESS—5 blade, 17 inch cut, steel construction, rubber tires, annular ball bearings, hard wood roller. **\$26.52.**

TORO SPORTSMAN—5 blade, 17 inch cut, steel construction, tubular handles, precision bearings, rubber roller, large rubber tires. **\$27.45.**

CLEMSON SUPER D-17—5 blade, 17 inch cut, new type handle suspension eliminates bobbing, 3 section plastic roller for easier turning. No wrenches needed to adjust blades or change cutting height. Large rubber tires, strong tubular handles. **\$32.47.**

DAYTON LAWN SPRINKLERS

3-WAY—A combination sprinkler for large, small or irregular shaped areas. Change is made quickly by hand. **\$6.75.**

RAINSTORM—Coverage 25 to 48 feet diameter. 2 short nozzles and two longer arms. **\$3.85.**

No. 12—Even coverage at any pressure. Covers circle 45 ft. in diameter when revolving or 12 feet width when set for square sprinkling. **\$6.15.**

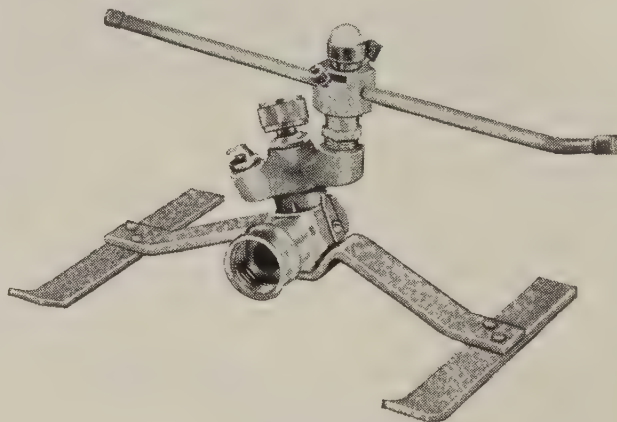

Dayton 3-Way



Yardgroom Sweeper

PARKER LAWN SWEEPERS

EASE OF OPERATION and unusual quietness is obtained by special, new design and Parker precision construction. Brush reel is mounted on separable type ball bearings, fully enclosed. Semi-pneumatic tires.

COLLAPSIBLE FOR STORAGE . . . The heavy duty canvas hopper of both models, with metal bottom, is collapsible for easy storage in garage or basement.

HOPPER EASY TO UNLOAD . . . Both models have large hopper capacity that makes emptying easy in any desired spot. No basket or heavy container to lift or drag around.

SAVES MANY HOURS OF MANUAL RAKING. It takes just one-sixth the time to free your lawn of debris if you use a Parker Lawn Sweeper. Ends the drudgery of back-breaking manual raking.

The **YARDGROOM**. Specifications: Sweeping brush, 9-inch diameter, 20-inch sweeping width. Wheels, gears and side plate of high tensile strength aluminum alloy. 3½ bushel hopper capacity. **\$34.00**

The **SPRINGFIELD**. Specifications: Sweeping brush, 9-inch diameter, 27-inch sweeping width. Wheels, gears and side plate of high tensile strength aluminum alloy. 5 bushel hopper capacity. **\$44.00**

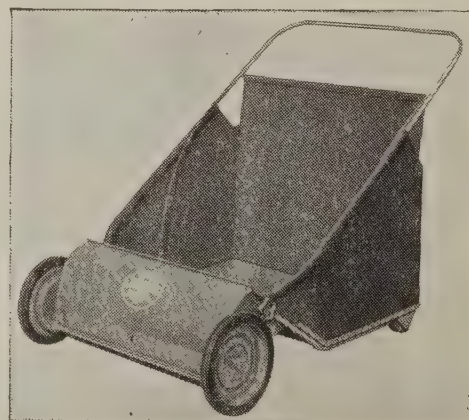

Springfield Sweeper

WEED KILLERS

Spray away lawn weeds without killing the lawn grasses. 2,4-D (Dichlorophenoxyacetic Acid), the selective weed killer, kills the plant underground as well as above the ground.

Easy to use—just mix with water and spray.

Doesn't corrode spray equipment, stain the skin, leave a residue on plants, that is hazardous to livestock or plants, or sterilize the soil.

The many weeds that it kills include poison ivy, poison oak, morning-glories, honeysuckle, chickweed, wild mustard, rag-weed, dandelions, plantain, and wild garlic.

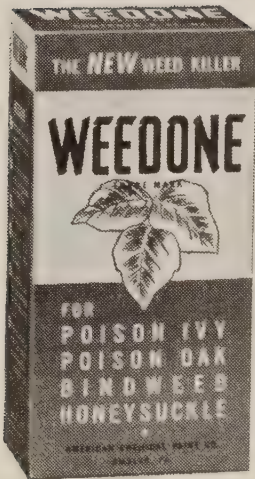

WEEDONE:

(The original 2,4-D selective weed killer) 6 oz. can (makes 5 gal. spray) **\$0.75**; 1 qt. can (makes 25 gal. spray) **\$2.50**; 1 gal. (makes 100 gal. spray) **\$7.50**; 5 gal. can (makes 500 gal. spray) **\$30.00**; 54 gal. drum (makes 27,000 gal. spray) **\$270.00**.

Du PONT "KARMEX"

(2,4-D in Tablet Form). 25 tablet bottle (treats 1,250 sq. ft.) **\$1.00**; 100 tablet bottle (treats 5,000 sq. ft.) **\$3.40**.

Du PONT 2,4-D WEED KILLER

(Ammonium 2,4 Dichlorophenoxyacetate 83.5%) for weed control in field, pastures, lawns and golf courses. 1 lb. (makes 100 gal. spray) **\$4.00**; 5 lbs. (makes 500 gal. spray) **\$16.00**; 5 gallons of solution will cover 1,000 sq. ft. or 200 gallons per acre.

Du PONT AMMATE WEED KILLER

Kills annuals and perennials, weeds, trees, grasses and woody perennials. Ammate is not considered poisonous and may be used safely on weed-infested areas without danger to livestock and humans. It is entirely free from fire or explosion hazards. Ammate usually exerts only temporary soil sterilizing effects, varying with the soil. Ammate can be used for the control for many types of noxious weeds. Ammate generally effects a permanent kill on many noxious weeds. 2 lbs. jar **\$0.75**; 6 lbs. **\$1.80**.

ACME WEED KILLER

For killing all vegetation. A concentrated or arsenical poison with a double action in the control of weeds. Makes the soil sterile to many seeds for a long time after application.

For use on cinder driveways, paths, ditches, clay courts, fence rows, and waste places where all vegetation is to be eliminated, it should be diluted 1 to 50 with water and sprayed thoroughly over the section desired.

Caution:

Acme Weed Killer is very poisonous. Do not allow live stock or chickens to feed among poisoned weeds. Pint **\$0.45**; qt. **\$0.65**; 1 gal. **\$1.84**; 5 gal. **\$8.45**.

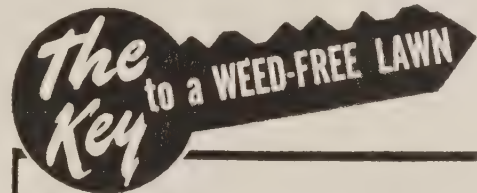

... is EndoWeed, new, improved selective weed killer! Applied to the leaves, EndoWeed penetrates entire plant, killing roots and all in a week or so. Kills dandelions, chickweed, plantain and over 50 other weeds, yet will not harm ordinary grass nor affect the soil. 8 ounces treats 2000 sq. ft. of lawn. Stop in for EndoWeed!

PRESENTED
BY SWIFT



MAKERS OF VIGORO

ENDOWEED

1/2 pint (treats 2,000 sq. ft.) **\$1.00**; Pint (treats 4,000 sq. ft.) **\$1.65**; Quart (treats 8,000) **\$2.75**; Gallon **\$8.50**.

ZOTOX

CRAB GRASS KILLER

Zotox kills Crab Grass **without destroying permanent lawn grasses**. This selective action is possible because Crab Grass has broader leaves than most turf grasses and many times the quantity of leaf surface, which causes it to absorb an excess quantity of the Zotox poison. Being a shallow rooted annual also makes Crab Grass less resistant to Zotox than the deep rooted perennial grasses.

Minimum Solution

For killing Crab Grass in partially infested lawns **without destroying permanent lawn grasses**. Add 8 oz. Zotox to 5 gallons water for each 1,000 sq. ft. (20 x 50), or 3 tablespoonfuls to 1 gallon for each 200 sq. ft.

Maximum Solution

For lawns totally covered with Crab Grass where it is advisable to kill off all growth and start a new lawn. Add 16 oz. Zotox to 5 gallons water for each 1,000 sq. ft. (20 x 50), or 6 tablespoonfuls to 1 gallon for each 200 sq. ft.

Does Not Sterilize Soil

Diluted Zotox does not sterilize the soil and the lawn may be reseeded or fertilized 3 or 4 days after Zotox is applied. 8 oz. **\$1.00**; 16 oz. **\$1.50**; 32 oz. **\$2.50**; 5 lb. **\$4.50**.

SPRAYERS

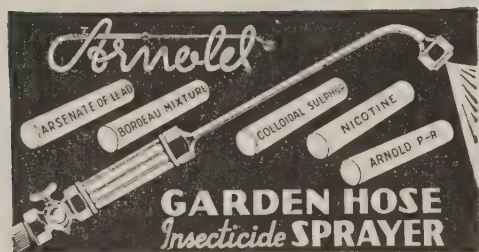

ARNOLD GARDEN HOSE PRODUCTS

Just insert a cartridge into the chamber, attach to your garden hose, turn on the water and you are ready to spray.

Arnold Standard Sprayer; shut-off transparent cartridge chamber, 12-inch angle nozzle, all exposed metal chromium plated.....**\$4.50**

Arnold sprayer with adjustable nozzle.....\$5.50

ARNOLD CARTRIDGES

Pyrethrum-Roteneone; Weed-O-Spray; Arsen-O-Spray; Cryolitespray; Pyr-O-Spray; Rot-O-Spray; Funguspray; Sulph-O-Spray. **35c each; 3 for \$1.00.**

CONTINUOUS HAND SPRAYERS

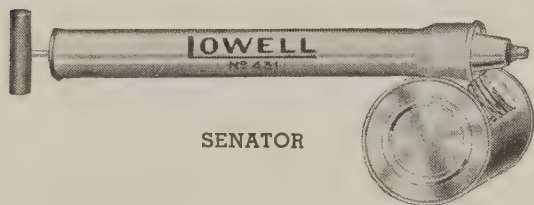

SENATOR

MASTER No. 208—1-quart heavy tin container with adjustable nozzle. **Each \$1.45.**

SENATOR No. 431—1-quart tin container with set nozzle. **Each 85c.**

CHALLENGER No. 215G—3-quart galvanized container with combination hand grip and support. Adjustable nozzle. **Each \$1.50.**



Brown
No. 26AG

BROWN No. 26AG—Quart glass jar container, easy to fill and clean. **Each \$1.45.**

HAND SPRAYERS—NON-CONTINUOUS

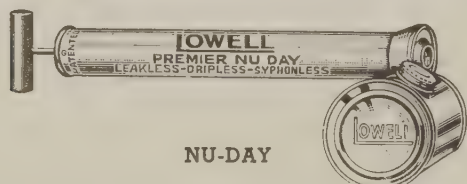

NU-DAY

DOME TOP No. 14—Quart size, tin, large opening. **Each 55c.**

PREMIER No. 270—Quart size, tin, with drop cup. **Each 55c.**

NU-DAY No. 265—Pint capacity with drop cup. **Each 45c.**

COMPRESSED-AIR SPRAYERS

OPEN-HED No. 4D—4-gallon galvanized compressed air sprayer with large opening for easy filling and cleaning. Complete with carrying strap, hose, extension and cut off. **Each \$8.50.**

PENNANT No. 46G—4-gallon, compressed air sprayer of best design and quality. The galvanized tank is 7½ inches in diameter, 21 inches high with larger opening in top for easy cleaning and filling. Pressure is automatically exhausted before top can be removed. Seamless brass pump 1¾ inches in diameter, 15½ inches long. High pressure spray hose 27 inches long, all-brass shut-off valve can be locked open for continuous spraying. 2-foot extension pipe, all brass, angle nozzle sprays fog or solid stream. Adjustable web carrying strap with snaps. **Each \$9.25.**

STREAMER No. 94G—3¾-gallon sprayer with galvanized tank 21 inches high, diameter 7¼ inches with 4½-inch opening in top. Seamless brass pump 1¾" diameter, 14 inches long. Pump locks securely to top of tank, pressure is exhausted before pump unlocks. 24 inches of high pressure hose, all-brass angle nozzle, adjustable carrying straps, automatic cut-off control, 2-foot extension pipe. **Each \$7.60.**

JUNIOR No. 24G—2½-gallon, galvanized tank sprayer 6½-inch diameter, 18 inches high. Seamless brass pump is 1¾ inches in diameter, 14 inches long. 4½-inch opening for easy filling and cleaning, 24 inches of high pressure hose, 24-inch pipe extension, brass shut-off and angle nozzle, adjustable web carrying strap. Women and children like its light weight, its high pressure and sturdy, safe construction. **Each \$7.35.**

RELIABLE No. 93G—3¾-gallon sprayer with galvanized tank 7⅞ inches in diameter, 21 inches high. Funnel top for easy filling. Pump screws into top, seamless brass, 1¾-inch diameter, 14 inches long. Complete with 24-inch high pressure hose, 24-inch extension pipe, brass angle-nozzle, automatic shut-off and carrying strap. **Each \$6.00.**

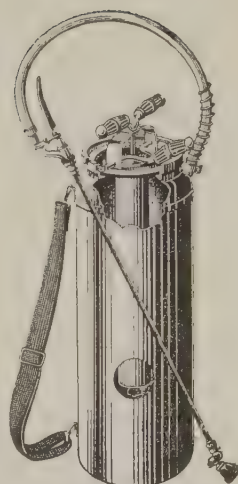

Open-Hed No. 4D

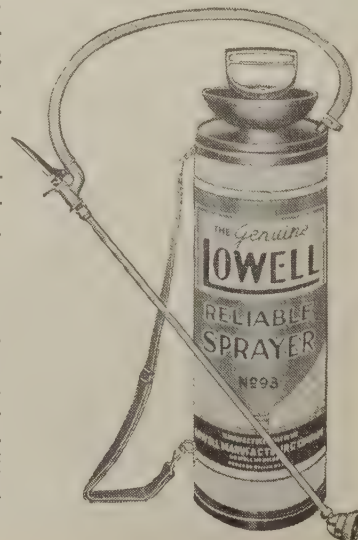
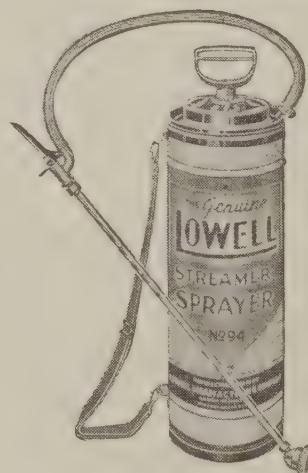
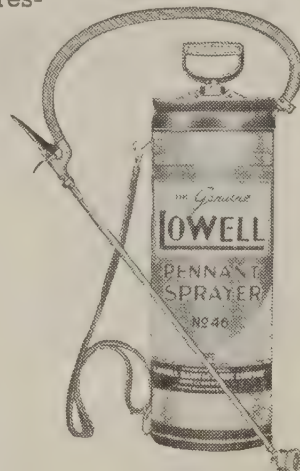

PARAGON SPRAYERS

No. 3
Paragon



An improved type of pump for white washing and spraying. Very rugged in construction and designed for ease of operation. The air chambers are of sufficient size to insure a constant spray at high pressure. Strainer is made of brass and automatically cleaned at each stroke of the pump by the all-metal agitator. All working parts are easily removed for cleaning or repairing.

PARAGON SPRAYER No. 00. Capacity, 5 Gallons—Is equipped with 4 feet special spray hose, 3 ft. spray pipe, 1 Mist Spray Nozzle, 1 Steel Cap for white washing, 1 Straight Spray. **Price, \$17.85.**

PARAGON SPRAYER No. 1. Capacity, 6 Gallons—Equipped with 5 ft. Special Spray Hose, 5 ft. pipe, 1 Mist Nozzle, 1 Steel Cap for whitewashing. 1 Straight Spray Nozzle. **Price \$20.60.**

PARAGON SPRAYER No. 3. Capacity, 12 Gallons—Equipped with 10 ft. Special Spray Hose, 7½ ft. of Extension Pipe, 1 Mist Nozzle, 1 Steel Cap, 1 Straight Spray. **Price, \$27.20.**

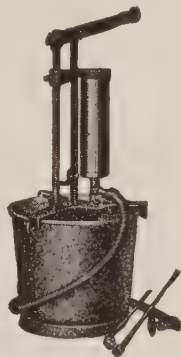

No. 0
Paragon

CYCLONE POWER SPRAYER No. 644—18 gallon galvanized, reinforced tank. Splasher type agitator with self cleaning intake screen. Pump powered by 1½ H.P. gasoline engine with automatic governor. Two rubber tired wheels make it very portable. Overall width 18½ inches, length 58 inches. Complete with 10 ft. of high pressure spray hose, 2 ft. extension pipe, shut off and adjustable nozzle. **Each \$142.75.**

WEED BURNERS

Weed control, the burning of rubbish, thawing of pipes, burning garbage, stumps or disinfecting poultry houses, kennels, barns, etc., are all possible with Flame Sprayers.

LOWELL FLAME SPRAYER No. 21W—¾-gallon, galvanized fuel tank with 4½" top opening. 1¾"x14" seamless brass pump. Burner develops a 2,000 degrees, 12-inch flat flame. Uses kerosene, distillate or stove oil. Complete with carrying strap, pressure gauge and needle valve. **Each \$18.35.**

INSECTICIDE DUSTERS

GENERAL No. 367—Powder compartment one full pint. Pump 1½"x10". 12-inch extension with straight and upshoot nozzles. Made of heavy tin. **Each 55c.**

WARRIOR No. 465—One-quart capacity. Pump 1¾"x13". 2 12-inch extensions with straight and upshoot nozzles. Made of heavy tin. **Each \$1.05.**

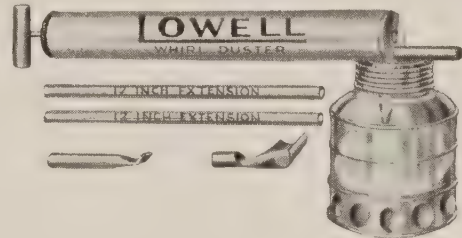

WHIRL No. 415—24-ounce glass jar container with standard Mason thread. Pump 1¾"x13". 2 12-inch extensions with straight and upshoot nozzles. **Each \$1.25.**

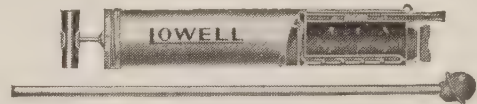

Roto-Blast

ADMIRAL No. 765—Powder compartment 2¾" diameter, 4½" long. Pump 2¾" diameter, 9½" long. 24" extension with nozzle adjustable for straight or angle dusting. A powerful self-agitating duster. **Each \$1.40.**



Feeney Model BX Duster

FEENEY MODEL BX DUSTER—Reservoir holds about 1 pint. Is equipped with long tube and spreader nozzle, adapting it for dusting underneath the leaves of low plants. **Price, each, \$1.25.**

FEENEY MODEL "F" DUSTER—Hopper holds one quart, equipped with two 12-inch extension tubes. One straight nozzle and one curved nozzle for dusting the under side of plants. **Each \$1.95.**

MODEL "D" FEENEY DUSTER



This is a very satisfactory duster for the truck grower, for applying any kind of dry insecticides on row or hill crops, the reservoir holds two quarts and the nozzle can be set to direct the dust on under side of the foliage. **Each, \$3.20.**

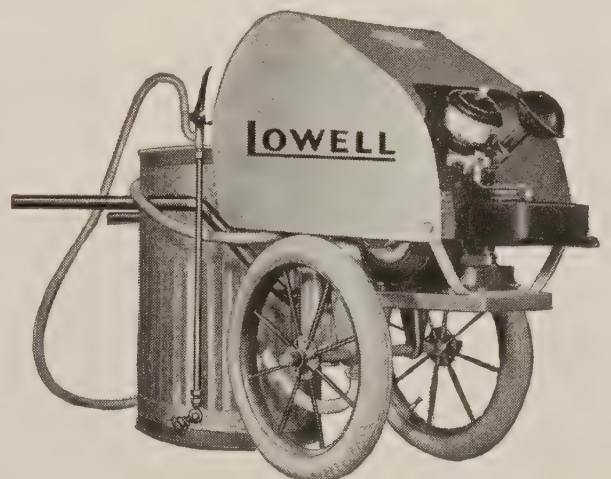

Cyclone Power Sprayer

GARDENING HELPERS

PLANT MARKERS AND STAKES

COPPER WIRED TREE LABELS

3 1/2 x 5/8 inch • 45c per 100 \$2.75 per 1,000

POT LABELS

	Per 100		Per 1,000	
	Plain	Painted	Plain	Painted
4 inch	30c	35c	\$2.25	\$2.75
5 inch	40c	45c	2.50	2.95
6 inch	45c	50c	3.00	3.40
8 inch	50c	55c	3.50	4.25

GARDEN STAKES

For Marking Rows or Individual Plants

10 x 1 inch	\$1.00 per 100	\$ 9.00 per 1,000
12 x 1 inch	1.35 per 100	10.50 per 1,000

DAHLIA, TOMATO AND PEONY STAKES

Made of seasoned oak, 15-16 inch square. Nicely pointed and painted with Green Creosote paint. This stake is strong and durable, will last several seasons.

3 ft.	\$1.00 per doz.	\$ 7.50 per 100
4 ft.	1.30 per doz.	10.00 per 100
5 ft.	1.50 per doz.	11.50 per 100
6 ft.	1.65 per doz.	13.50 per 100

NEPONSET RED PAPER POTS

For storage, transplanting and shipping. Made of tough, waterproof paper. Light, clean, and unbreakable.

	Doz.	100	1,000
2 1/4 in.	\$0.10	\$0.65	\$ 6.00
2 1/2 in.	.13	.65	6.10
3 in.	.15	.75	6.85
3 1/2 in.	.20	1.00	9.15
4 in.	.22	1.10	10.40
5 in.	.25	1.40	13.30



GERMACO HOTKAPS can make you extra dollars this season. They protect plants from frost, wind, rain, insects and ground crusting. Thus they produce harder, quicker crops. You get higher prices!

Prices: 1,000 for \$12.00; 5,000 lots at \$11.75; 10,000 lots at \$11.50; Germaco steel HOT-CAP Setter, \$1.75.

HOTKAPS for your backyard garden.

25 HOTKAPS and Paper Setter	60c.
100 HOTKAPS and Setter	\$2.20.
250 HOTKAPS and Setter	\$4.15.

PLANT BANDS

	1 3/4 x 2 1/2	2 x 2 1/2	2 x 3	2 1/2 x 3	3 x 3	3 x 4
Vita-Band A per M	\$4.25	\$4.70	\$5.05	\$5.20	\$6.30	\$7.35
Growtex per M	2.90	3.25	3.75	4.15	4.55	6.95

TIE YOUR PLANTS WITH "TWIST-EMS"

"Twist-ems" are dark green strong tapes with wire reinforcing that make perfect plant ties with a twist of the wrist. For plants and vines. 8 in.—Pkg. of 125 35c.

GREEN THUMB GARDEN HELPERS

Made of a new waterproof, mold-resistant fibre resin; these items have been proven by extensive research to be highly compatible to plant growth. They not only provide fascinating entertainment but actually make it possible to have earlier vegetables and flowers. Fun for young and old.

GREEN THUMB

WINDOW SILL GREENHOUSE No. RB-22
The sub-irrigated trays are waterproof and mildew resistant. Has a capacity of 30 to 60 seedlings, 22 potted plants. Complete with instructions. 29c per set.

GREEN THUMB BANDS

2 1/2 inch square open bottom pots to be used in flats or wooden boxes for potting seedlings. RA-236 (package of 36) 20c.

GREEN THUMB CUTWORM PROTECTORS

Cutworms are no menace to your plants when protected with these waterproof bands that do not disintegrate. RA-12 (package of 12) 10c; RA-50 (package of 50) 20c.

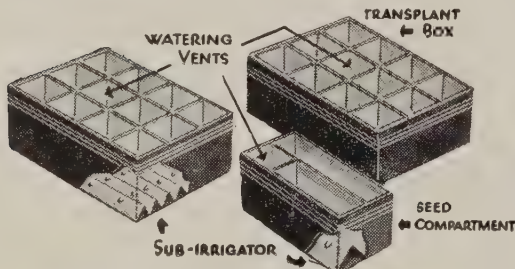

Green Thumb Window Sill Greenhouse RB-22



The modern easy way to irrigate, \$2.95 each.

BETTER GARDENING BOOKS

These books written by authorities, are recommended to help you garden efficiently. For amateur or expert.

Vegetable Gardening in Color—Foley.....	\$2.50
The Gardeners Handbook—L. H. Bailey.....	1.98
Designs in Flower Arrangement—D. N. Arms.....	2.75
Gardening With Experts.....	2.50
How to Grow Roses—J. H. McFarland.....	2.00
Pest Control in Home Garden—L. Pyenson.....	2.50
Magic Gardens—Rosetta E. Clarkson.....	3.50
Principles of Vegetable Gardening—L. H. Bailey.....	3.75
Hortus Second—L. H. Bailey.....	5.00
Plants in Home—Frank K. Balthis.....	3.50
Weeds, Revised Edition—W. C. Muenscher.....	4.50
The Garden of Gourds—L. H. Bailey.....	2.50
Farm Management—Robert R. Hudelson.....	2.50
Adventures with Hardy Bulbs—L. B. Wilder.....	2.50
Daylilies—A. B. Stout.....	3.50
Landscaping in Home Grounds—L. W. Ramsey.....	2.00
Book of Trees—A. F. Hottes.....	3.50
Garden Guides.....	2.00
Plant Propagation—A. F. Hottes.....	2.00
Perennials—A. F. Hottes.....	2.00
Shrubs—A. F. Hottes.....	3.00
Annuals—A. F. Hottes.....	1.50
Gardening in the South—George R. Briggs.....	2.00



Green Thumb Plant Bands

TOOLS, SEEDERS, EQUIPMENT

FOUR TINE HEAVY SPADING FORKS
 Heavy Angular Back Tines 11-inches long
 Approximate Weight 4½ lbs.
 With 30-inch Bent Handle—Steel D Top



No. HSP Geyer as illustrated above.....\$2.20
 LBS Same as above, except lighter..... 1.75

CULTIVATOR AND WEEDER



Has four sharp tines which penetrate soil easily. Small and light. Excellent for cultivating flowers or shrubs. Width of head about 5-inches Digging depth of tines about 4-inches. Has 4½-foot handle. No. 4, \$1.40.

LEVEL HEAD STEEL GARDEN RAKE

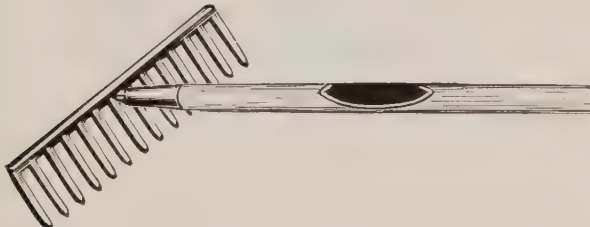

The regular standard pattern, straight tooth level head rake. Forged from one piece of high carbon steel. Depth of head 3¼ inches. Thickness of head, 5/16 inch.

No. HL-14 14-tooth as illustrated.....\$1.20
 ALS-14 14-tooth, same as above, except lighter weight..... .85

FIELD AND GARDEN HOES

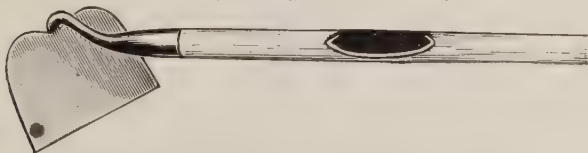

The standard, general purpose farm and garden hoe used in practically all sections of the country. Polished blades, specially formed and hand sharpened. Socket pattern with 7/16-inch shank. Blade and shank one piece forged steel.

Socket Type—4½-Foot Handle

No. FGS-6½—As illustrated\$1.25
 AF-6½—Socket hoe, light weight85



THE HORN SEED SOWER

THE "HORN" SEED SOWER—
 The Sectional Tube Style Has Brass Seed Gauge—It is used for sowing clover, timothy, alfalfa and all other small, smooth seeds. Is adjustable to sow any amount. Each \$1.25.



THE CYCLONE SEED SOWER—Its well known double feed insures a uniform flow of seed The slope feed board keeps hopper properly filled. Feed adjustment is automatic and starts or stops flow of seed instantly. Price each, \$3.50. Heavy Duty, \$4.50.

TREE TRIMMERS



WATERS STYLE, TREE PRUNER

This is a very efficient type of pruner for small jobs of light work. The pole is high grade basswood 1¼ x 1⅞ inch and both the head and pull lever are securely fastened to it by bolts instead of rivets. Price with 8 ft. pole \$4.00; 10 ft. \$4.50; 12 ft. \$4.95.



No. 1-W Pulley Type Trimmer

No. 1-W PULLEY TYPE TRIMMER

Is the most powerful cutting Trimmer made. The compound leverage is increased due to the pulley being attached to the curved lever. It is made for heavy work and will cut any limb up to 1¼ inch in diameter with the slightest effort, the pole is 1⅞ x 1¼ inch. We stock 10 and 12 foot lengths, can supply other lengths from factory. No. 1-W 10 foot, \$11.15; No. 1-W, 12 foot, \$12.35.

POLE SAWS

No. 43—For those who require a low priced pole saw of lightweight. It is mounted in a 1⅞ x 1 inch basswood pole, 12 feet long, saw blade 12 inches, each \$3.90.

No. 44—This is a companion to the No. 1-W pulley type trimmer, for use on limbs too large for the trimmer. Has 16 inch saw blade mounted on pole 1¼ x 1⅞ inch. 12 feet long. Each \$6.55.

No. 44 Pole Saw

NASH MOLE TRAP

THE ONLY TRAP THAT ALWAYS CATCHES THE MOLE IN ALL KINDS OF GROUND

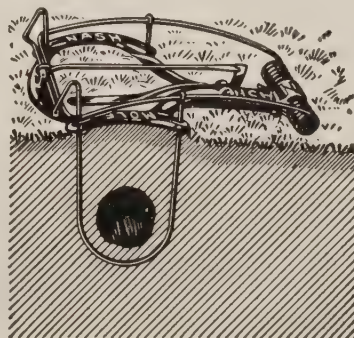

It gets him going in either direction, as the Trigger pan is located between the two choker loops.

When set and properly placed, it is impossible for Mr. or Mrs. Mole to pass thru the loops without releasing the trigger catch. We sell them on a money-back guarantee, price \$1.75.

EQUIPMENT

PLANET JR. No. 12 Double and Single Wheel Hoe

A very popular and complete garden tool. Equipment as illustrated. As a double wheel hoe it cultivates both sides of the row by straddling until plants are 20 inches high. It is then useful as a single wheel hoe between rows. Cultivating equipment all oil tempered. Will last for many years. **Price \$15.70.**

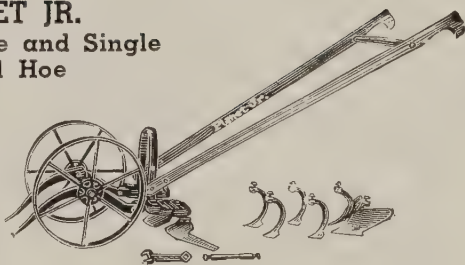

No. 13 Double and Single Wheel Hoe

Equipment: one pair of 6-inch hoes only. **Price \$12.00.**

No. 17 Single Wheel Hoe

The No. 17 is very popular with both the home gardener and the market gardener. It includes just the equipment that is most generally used and with which you can plow, cultivate, weed, hoe, open furrows for

large seed, fertilizer, etc., and cover them, and hill up plants. Handles adjustable to suit height of operator. **Price \$10.85.**

No. 17½—Same as No 17, less the plow. **Price \$9.65.**

No. 18—Equipment: one pair of 6-inch hoes only, most useful cultivating attachment. **Price \$8.40.**

The No. 19 is a very complete and at the same time moderate priced garden plow and cultivator. The equipment includes a 2-inch cultivator tooth, a 10-inch sweep, large garden plow.

With the No. 19 you can plow, cultivate, hoe, rake, weed, open and close furrows and hill up plants. **Price \$7.00.**

No. 19 Garden Plow and Cultivator



A plate or disc seeder for all seeds from the smallest up to and including peas, beans and corn. Growers of peas and beans will appreciate this seeder as it does not break the seed and sows with great regularity. Only three plates, each with thirteen holes, making ample adjustment for various seed. Hopper holds four quarts and is removable which makes easy filling and emptying. Net weight 36 pounds **\$27.50**

No. 300 A Drill Seeder



No. 4D Plain

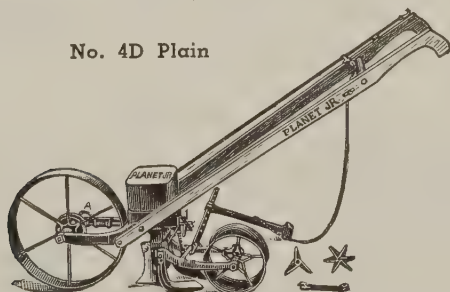

The No. 4D Plain is especially designed for the home gardener and for the small market gardener. More of them in use than any other tool of this kind. Sows in straight drills or drops in hills 4, 6, 8, 12 or 24 inches apart. Capacity of hopper 2½ quarts. A complete seeding machine. **\$20.30.**

CULTIVATOR ATTACHMENT No. 7563X.

A 5-prong cultivator attachment for both the high and low wheel cultivators. The forged spring steel teeth are removable making it possible to use it as a 3 or 5-tooth attachment. **Price, each, \$1.50.**

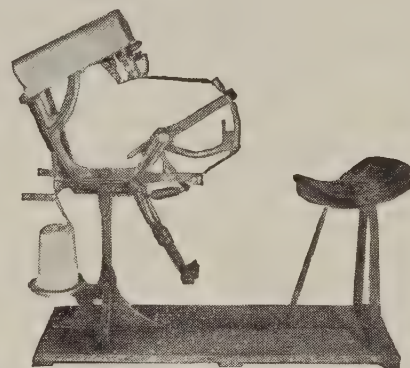
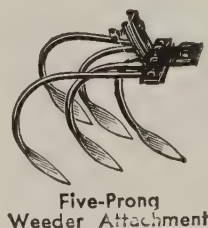

FELINS TYING MACHINE FOR BUNCHING VEGETABLES \$84.50

Ask for circular on vegetable washer.

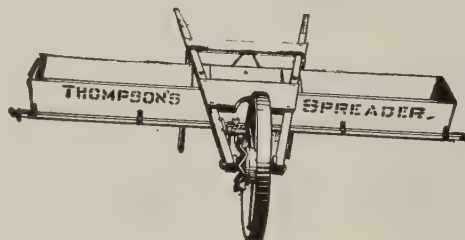

THOMPSON'S WHEELBARROW GRASS SEEDERS

No. 5—DOUBLE HOPPER SEEDER sows all small seeds like clover, timothy and alfalfa, also chaffy seeds like red top, orchard grass and blue grass. Hopper 14 feet long. **\$16.50.**

No. 6—SINGLE HOPPER SEEDER for sowing clovers and timothy. **\$10.00.**

VIGORO SPREADERS

Lawn seed and fertilizer should be applied evenly for the best results and no waste.

Model	Special	Standard	Junior	Model "B"
Spreading width....	36 in.	24 in.	16 in.	14 in.
Fertilizer capacity..	100 lbs.	65 lbs.	35 lbs.	15 lbs.
Price	\$22.80	\$15.35	\$7.45	\$3.25



AIR-COOLED ENGINES

THE FAMOUS 4 CYCLE. BRIGGS & STRATTON

DEPENDABLE, PORTABLE POWER

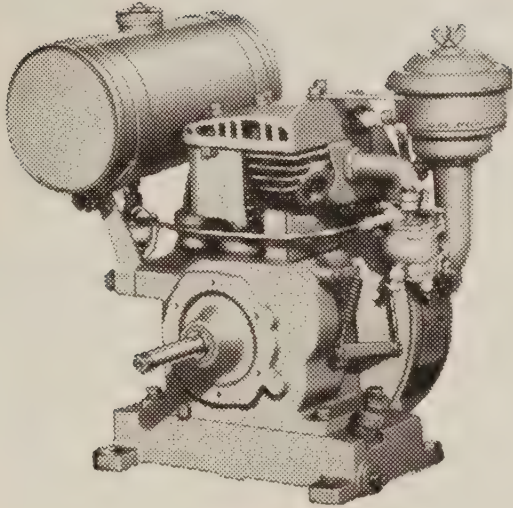

Model A Briggs & Stratton

Model WMB— $\frac{2}{3}$ H. P.....	\$ 39.45
Model WI— $\frac{2}{3}$ H. P.....	43.15
Model WIPR6— $\frac{2}{3}$ H. P.....	52.95
Model N— $1\frac{1}{2}$ H. P.....	50.75
Model NPR6— $1\frac{1}{2}$ H. P.....	64.90
Model A—2 H. P.....	85.52
Model AR6—2 H. P.....	104.95
Model B—3 H. P.....	103.75
Model BR6—3 H. P.....	122.45
Model Z—6 H. P.....	132.05
Model ZZR6—6 H. P.....	154.05

All models complete with gasoline tank and air cleaner. Ready to run. R6—6 to 1 gear reduction.

SPECIALIZED SERVICE
on
AIR-COOLED ENGINES
POWER LAWN MOWERS
GARDEN TRACTORS
HAND LAWN MOWERS
GOLF COURSE TRACTORS
FAIRWAY MOWERS
POWER SPRAYERS

TO SERVE YOU BETTER—Our service department has been enlarged and new equipment added.

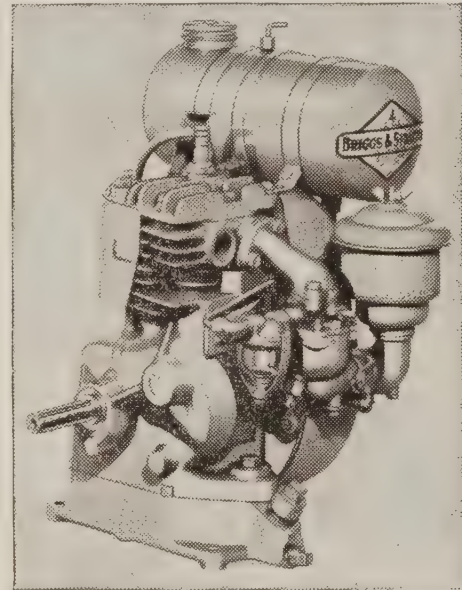

Model N Briggs & Stratton

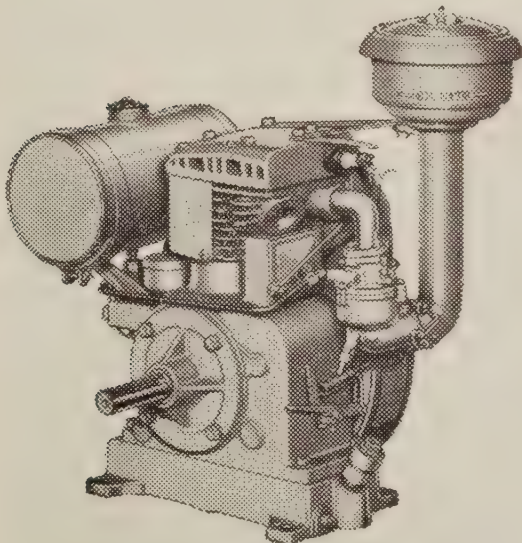

Model B Briggs & Stratton

- GOODYEAR TIRES
- CHAMPION SPARK PLUGS
- MACMILLIAN RING FREE OIL
- GATES RUBBER BELTS
- WHEELING GASOLINE CANS
- TOOL BOXES
- TIMKEN AND HYATT BEARINGS
- MAYTAG MOTOR OIL
- TILLOTSON & ZENITH CARBURETORS
- LAUSON ENGINES & PARTS

GOODALL ROTARY CUTTERS

POWER LAWN MOWERS THAT CUT WEEDS TOO!



Mowing The Lawn

GOODALL Sixteen

The Sixteen-inch model is designed for close trimming and for mowing lawns up to one acre. In order to permit closer trimming and because of the shorter knife length, this model does not have the guard wheels in front. A guard plate is attached to the rear of the frame to prevent sticks, stones or other loose objects on the lawn from being thrown back toward the operator. Power is furnished by a 4 cycle $\frac{3}{4}$ H. P. Lauson engine—\$112.50.

GOODALL Eighteen

The Eighteen-inch model will cut about $1\frac{1}{2}$ acres per day. Guard wheels prevent the blade from cutting into the ground when used on uneven lawns and rough areas. An adjustable guard on rear of frame protects operator from loose sticks, stones or bones on the lawn. This model is just right for rough cutting because of its perfect and reserve power from the Lauson 4 cycle 1 H. P. engine—\$135.00.

GOODALL Twenty

The Twenty-inch model will cut about 2 acres per day, making quick work of the average large lawn. Lightweight and simplicity of design makes even this largest model easy to handle. Guard wheels prevent the blade from scalping. An adjustable guard on rear of frame protects operator from loose sticks, stones or bones on the lawn. This model weighs only 66 pounds. Powered by a Lauson 4 cycle 1 H. P. engine—\$155.00.



No Weed Too Tall for a Goodall

GOODALL is the sensational, new rotary type mower that proud owners are so enthusiastic about. Unusually simple in construction and weighing only about 30 pounds more than the average hand lawn mower, the Goodall is making fun out of the job of grass cutting.

The patented vertical crankshaft drives the cutter arm direct, thus eliminating belts, chains, pulleys, sprockets and gears. The blade will slip in case of contact with an object it cannot cut. A direct drive makes it possible to have the engine balanced on only two wheels, which accounts for the ease of handling.

No controls are necessary on the Goodall, just start the engine and roll it along, the automatic governor regulates the cutter speed for light or heavy cutting. Powered by an easy starting, dependable, Lauson 4 cycle engine, grass or weeds cannot get too high or heavy for the Goodall, it will cut a year's growth of any grass or weed. Buckhorn-Plantain, Dandelion, Crabb Grass and other seed stalks are kept under control with the Goodall. Height of grass or weeds make no difference to the one-piece cutter knife which rotates horizontally at 2500 revolutions per minute.



Trimming Close to Shrub and Fence

GOODALL SPECIFICATIONS

MOTOR: Lauson 4 cycle, L head, vertical crankshaft, designed and built for Goodall Rotary Cutters; fly ball type governor on crankshaft.

LUBRICATION: Simple force-feed type. Oil in base, lubricates entire engine and cutting unit bearings. Oil base holds one quart.

CARBURETOR: Float feed with simple adjustment. Oil bath air cleaner on 18-inch and 20-inch models. 16-inch has moss type air cleaner.

FRAME: Polished aluminum, ribbed for strength. Will not rust. Light in weight. Model Twenty has lightweight steel frame.

WHEELS: Main wheels have 10 x 2.75 pneumatic tires with 2 ball bearings in each wheel. Guard wheels on 18-inch and 20-inch models prevent scalping, yet gives 2-wheel flexibility.

CUTTING UNIT: One piece blade is made of oil-tempered steel, replaced or sharpened in a few minutes. Safety clutch drive. Can be adjusted to cut from $2\frac{1}{4}$ to $3\frac{1}{2}$ inches high.

FUEL CAPACITY: Tank holds $\frac{1}{2}$ gallon of gasoline, will run 8 hours on one gallon. Straight gasoline is used—no mixing of oil and gas.

HANDLES: Metal with rubber hand grips. Adjustable for comfort. All specifications are subject to change.

TORO ZIPPER

36-INCH WEED CUTTER

\$ 189⁰⁰

The Zipper is a 36-inch Power Sickle Bar which has a wide range of usefulness for cutting weeds and other rank growth. Being a self-propelled traction drive, all the operator has to do is to guide it—and due to its light tubular steel construction, the Zipper is easy to handle on rough ground, side slopes, and around trees, fences, shrubbery and walls.

From a simplicity standpoint, the Zipper is genuinely outstanding. The powerful $1\frac{1}{2}$ H. P. four cycle engine securely mounted on the end of the drive shaft, equipped with a gear reduction and single V belt, not only reciprocates the knife but provides traction through a simple spring-mounted friction drive engaging the wheels. The Scotch Yoke principle of the center drive on the sickle bar leaves both ends free to work around shrubs—under fences—and with a greatly reduced amount of vibration common to all sickle bar mowers where the drive is at the end of the bar.

The wide baffle plate attached to the bar in the center, being constantly in motion when the machine is in operation, has a tendency to spread the cut vegetation as it falls, and leaves it in windrows on both sides of the pointed shield.

In thickly matted June grass, it is a simple matter to exert a slight upward pressure on the handle bars, so that the sickle holds the ground and "submarines" the growth instead of sliding over it. The proper spread between the drive wheels creates a finely balanced machine for



Toro Zipper

use on slopes. This feature, combined with the light but extremely durable tubular steel construction, makes it a great performer on levees, banks, highway ditches—and on other ground uncuttable except by hand.

The Zipper is the correct answer to the otherwise difficult problem of cutting scattered patches of weeds. It is so light you can put it in the back of your car and haul it from place to place—you can lift it over fences—roll it up on a trailer—and find considerable use for it around farms, country homes, week-end cabins—summer resorts—railroad yards—oil tanks—and hundreds of other places.

SPECIFICATIONS

MOTOR: Lauson 4 to 1 Gear Reduction, four cycle, 1.50 H.P. @ 3600 R.P.M., bore 2", Stroke $1\frac{7}{8}$ "; oil bath air cleaner; $\frac{1}{2}$ gallon gas tank, float feed carburetor, rope starter, magneto ignition, completely dust-proof.

SICKLE BAR: Standard 2" sections and guards; two special guards on ends of bar to protect end knives. Two knives furnished with machine—one smooth and one with under-serrated sections.

GRASS DIVIDER: A simple and unique divider that really divides the cut of grass and prevents bunching on the cutter bar.

POWER TRANSMISSION: SICKLE DRIVE—Direct, ball bearing mounted shaft drive to sickle head through automatic safety overload slip coupling, which pre-

vents breakage of knives and guards in case operator runs the cutter into scraps of metal or stone.

TRACTION DRIVE—Through a very easily adjusted "V" belt from motor to friction rollers which drive main traction wheels. Friction drive rollers are deeply serrated for long continuous operation.

WHEELS: Steel disc wheels, running on adjustable ball bearings with semi-solid tires 20x1.75".

HEIGHT OF CUT: $1\frac{1}{2}$ " to 13"

WIDTH OF CUT: 36"

WEIGHT: 140 Pounds.

TORO HOMELAWN POWER MOWERS

18-INCH CUT \$100⁶⁰

21-INCH CUT \$125⁰⁰

The Homelawn is built from the ground up as a power mower and will provide the type of service that you expect from a mower specifically built for power. It is not to be confused with some of the lightweight hand mowers on which power has been added.

Strongly built of pressed steel—that marvelous construction which has meant so much to the automobile—you get everything in the way of strength and lack of brittleness, but in addition you get ease of handling and a lighter mower, which is so important.

The Homelawn is a self-propelled mower and the steady dependable Briggs & Stratton engine pulls the mower and drives the cutting reel. Because you don't have to push it, your son, daughter or your wife can handle it without undue physical strain.

Ample power and wide-diameter rubber-tired wheels take the Homelawn up sharp grades and terraces. The 6-inch five blade alloy steel revolving reel is securely welded to steel discs, making it relatively free from springing when hitting small foreign objects like acorns and twigs.

It can be sharpened under its own power by means of a simple round Figure 8 belt.

Freedom from annoying minor mechanical difficulties is assured by the simple and easily understood V belt transmission, with the complete elimination of complicated clutches and mechanisms.

The Toro Homelawn is built in two sizes—18 and 21-inch—for lawns up to 1½ acres. If your lawn is one acre, then specify the 21-inch because it will save you both time and energy



on hot days. The price of both models is so low every home-owner can have one.

The Homelawn will give you excellent dependable service—and for those who like to cut high in July and August, it is built to cut up to 2½ inches to preserve the strength and fertility of your lawn.

Grass catchers are available for those who want them.

Homelawn power mowers are used in practically all parts of the world, and will do a beautiful job of cutting, and amaze you with their sterling performance.

SPECIFICATIONS

MOTOR: Briggs & Stratton 4 cycle ⅔ H.P. @ 2200 RPM, bore 2", stroke 1½"; oil bath air cleaner—1 quart gas tank—suction feed carburetor—rope starter, magneto ignition.

CHASSIS: All steel construction.

REEL: 6" diameter stamped steel spiders—five blade reel made of heat-treated alloy steel. ¾" solid steel reel shaft running on adjustable Timken bearings with grease seals and protection cups.

BED KNIFE: Lipped blade of heat-treated alloy steel, easily accessible screw adjustment from above. Bed knife and bar can be removed without disturbing side plates.

WHEELS: Alloy grey iron running on oilless bronze bearings. Toro rubber tires 1.75"x11.00" easily replaced.

REAR ROLLER: Large diameter hard maple—multiple section for easy turning.

DRIVE: V belt and chain drive, manually controlled from handle bars.

HANDLE: Tubular steel, adjustable for height.

HEIGHT OF CUT: 13/16" to 2½"—easily adjusted.

WIDTH OF CUT: 18" and 21".

WEIGHT: 18-inch—110 pounds. 21-inch—120 pounds.

GRASS CATCHER: Canvas and metal grass catcher available at extra cost.

TORO STARLAWN POWER MOWERS

24-inch Cut \$241⁶⁵

27-inch Cut \$255⁰⁰

30-inch Cut \$297⁵⁰

EASY STARTING
FAST MOWING
DEPENDABLE
LOW MAINTENANCE
EASY HANDLING
RUGGED
LOTS OF POWER

The new Starlawns are built in three sizes—24, 27 and 30-inches. Pneumatic wheels are standard equipment. They are amply powered with quick-starting Briggs & Stratton engines. In the 24 and 27-inch sizes they have 7-inch diameter reels—and in the 30-inch size 8 $\frac{1}{4}$ inch diameter reels, both with five blades. Each blade is built of tough, wear-resisting alloy steel.

There are independent controls for both reel and traction. That means the Starlawn pulls itself with the reel stopped, over sidewalks and pavements. Simple, dependable mechanism makes it an economical mower for you to buy—and also an economical mower for you to run year in and year out.

Several thousand Starlawn mowers went through the war period and gave their owners excellent satisfaction with a very minimum of upkeep and overhaul expense. Use it and we think you will agree it is an outstanding advancement in building a fine mower at a popular price level.

SPECIFICATIONS

24 AND 27 INCH

MOTOR:	1 $\frac{1}{2}$ H.P. air-cooled quick-starting with automatic governor.
CUTTING UNIT:	All steel construction with 7-inch revolving reel.
BED KNIFE:	Double-edge reversible type, cadmium plated.
DUAL CONTROLS:	Independent drive to both reel and traction. Controls on handle bars.
DIFFERENTIAL:	Bevel gear enclosed drive differential.
HEIGHT OF CUT:	7 $\frac{1}{16}$ inches to 2 $\frac{1}{4}$ inches.
WHEELS:	Pneumatic size 3.00x7 traction tread.
REAR ROLLER:	Three section hard maple roller.
FLOATING AXLE:	With rigid locking device.
HANDLE:	Tubular steel $\frac{7}{8}$ inch diameter. Rubber handle grips.
GRASS CATCHER:	Canvas grass catcher with metal bottom available at extra cost.
SHIPPING WEIGHT:	24 in. weight: 175 pounds. Shipping weight: 240 pounds. 27 in. weight: 185 pounds. Shipping weight: 255 pounds.
CAPACITY:	24 in.: 3 $\frac{3}{4}$ acres per day. 27 in.: 4 $\frac{1}{4}$ acres per day.



30-inch Toro Starlawn with Riding Sulky

RIDING SULKY \$51.50

30-INCH STARLAWN SPECIFICATIONS

MOTOR: 2 H.P. air-cooled four cycle quick starting with automatic governor.
CUTTING UNIT: All steel construction with 8-inch diameter five blade revolving reel.
BED KNIFE: Double-edge reversible type—cadmium plated.
DIFFERENTIAL: Bevel gear enclosed drive.
DUAL CONTROLS: Independent drive to both reel and traction. Controls on handle bars.
HEIGHT OF CUT: 7 $\frac{1}{16}$ inches to 2 $\frac{1}{4}$ inches.
WHEELS: Pneumatic rubber-tired wheels 4.00x7 traction tread.

ROLLER: 3 section hard maple roller.
FLOATING AXLE: With rigid locking device.
HANDLE: Tubular steel $\frac{7}{8}$ -inch diameter. Rubber handle grips.
GRASS CATCHER: Canvas grass catcher with metal bottom available at extra cost.
RIDING SULKY: Lightweight riding sulky available at extra cost.
WEIGHT: 240 pounds—Shipping weight: 305 pounds.
CAPACITY: 5 $\frac{1}{2}$ acres per day.

TORO POWER MOWERS

FOR ESTATES, CEMETERIES, INSTITUTIONS, PARKS

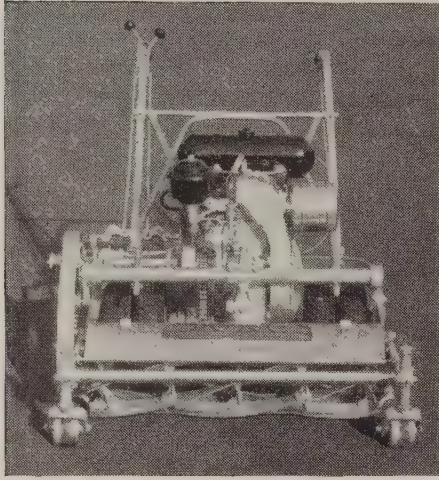

Park Special

30-INCH PARK SPECIAL
America's No. 1 Power Mower
For Over 25 Years
Rugged and Dependable
\$480⁰⁰

30-INCH PARKLAWN
The Modern Mower.
Built-On Seat
Floating Unit
Reverse Gear
\$683⁵⁰



Parklawn

PARK SPECIAL SPECIFICATIONS

MOTOR: Toro own make single-cylinder air-cooled 3 H.P. motor with counter balance crankshaft mounted on ball bearings; automatic built in governor; quick starting magneto. Tillotson needle valve carburetor, oil bath air cleaner, extra large muffler.

CLUTCHES: Both reel and traction are mounted on a single clutch shaft. They are simple, yet strong and accessible. Separate controls are provided for both reel and traction clutches so that the reel can be disengaged when the mower is being transported, or the reel operated alone.

CUTTING UNIT: Cutting swath, 30". Revolving reel is 8 $\frac{1}{4}$ inches in diameter and built with five blades. Each blade is 1 $\frac{1}{2}$ inches in width and built of chrome-vanadium steel. Reel shaft, 1 $\frac{1}{8}$ inches in diameter and carried on precision ball bearings, double edged reversible bed knife.

DUAL HANDLE BARS: Rubber mounted dual handle bars are a distinctive feature and provide an easy

firm grip. They are spring mounted to eliminate excess vibration.

SHARPENING: Can be sharpened under own power.

DRIVE CHAIN: Heavy-duty motorcycle chain with tighteners.

GAS TANK: Six quart capacity-steel, bullet shaped.

TOOL BOX: Ample for crank and small tools.

DRIVE WHEELS: Late type with inner tubes. 3.00 x 7 studded pneumatic duals.

DIFFERENTIAL: Fully enclosed and running in oil.

CAPACITY: At 4 $\frac{1}{2}$ miles per hour will cut about 7 acres per day.

RIDING ATTACHMENT: Rubber tired sulky is available for cutting large open areas.

NET WEIGHT: 364 pounds, shipping weight 460 pounds.

PARKLAWN SPECIFICATIONS

MOTOR: Toro own make single-cylinder air-cooled 4 $\frac{1}{2}$ H.P. motor with counterbalanced crankshaft mounted on ball bearings; automatic built-in governor; quick-starting magneto. Tillotson needle valve carburetor, oil bath air cleaner, extra large muffler.

CLUTCHES: Heavy Double Twin Disc Traction Clutch—Single Twin Disc Reel Clutch.

REVERSE GEAR: Strong planetary type, operated by traction clutch control. Can be used as brake on steep grades. Fully enclosed in oil tight housing.

CHASSIS: Steel electrically welded throughout.

DRIVE CHAIN. Heavy duty motorcycle chain with tighteners.

GAS TANK: 10 quart capacity—steel, bullet-shaped.

TOOL BOX: Ample for crank and small tools.

DRIVE WHEELS: Late type with inner tubes. Size 3.00 x7 studded duals.

DIFFERENTIAL: Fully enclosed and running in oil.

REVOLVING REEL: 30-inch width—7-inch diameter, equipped with 5-blade reel. Shaft built of cold-rolled steel mounted on pre-sealed and lubricated bearings. No lubrication necessary. Steel knife bar.

REAR ROLLERS: Sectional roller made of steel tubing running on long wearing hard oil soaked wooden bushings.

GRASS SHIELDS: Heavy sheet metal.

RUBBER BUMPERS: To absorb shock and prevent injury to trees, monuments, etc.

SNOW PLOW: V type or moldboard type snowplow attachment available at extra cost.

MEASUREMENTS: Cutting swath, 30 inches—Speed, 4 $\frac{1}{2}$ miles per hour. Capacity, 7 acres per day. Overall width—37". Height, 32". Weight, 510 pounds.

TORO PROFESSIONAL POWER MOWER

FOR LARGE LAWNS

76-INCH CUT—REVERSE GEAR

FLOATING UNITS THAT FOLD UP

BUILT-ON SEAT—\$871⁰⁰



First introduced in 1939, the Professional has built a world-wide reputation, particularly with institutional users and owners of lawns over ten acres. The leading Municipal Park Systems—the great Universities—and the finest cemeteries and private estate owners, have found it to be the finest mower of its type.

Cutting a swath 76-inches wide at a speed of 4½ miles per hour, the Professional will normally mow from 15 to 20 acres of grass per day. Because of its ingenious design, it is highly flexible and will work in extremely close places and cut within a few inches of trees, shrubs, walks and walls, and monuments.

Powered with Toro 4½ horsepower air-cooled four cycle engine, it is equipped with a forward

and reverse transmission giving the operator instant and adequate control at all times. Traction to climb twenty per cent grades is secured through dual pneumatic 3.00x7 studded wheels, and the chassis is formed of steel.

The individual mowers are all power driven from the engine. The front mower is 30-inches in width and the two wing mowers 25½ inches. It is possible to cut heavy turf with the Professional and do it easily and smoothly.

The Professional is built to take the place of heavy, expensive tractors and gang mowers, and enjoys an excellent reputation for fine performance.

SPECIFICATIONS

ENGINE: Toro own make, single-cylinder air-cooled 4½ H.P. with counterbalanced crankshaft mounted on ball bearings, automatic built-in governor, quick starting magneto. Tillotson needle valve carburetor, oil bath air cleaner. Extra large muffler.

CLUTCHES: Heavy Double Twin Disc Traction Clutch. Single Twin Disc Reel Clutch.

REVERSE GEAR: Strong planetary type, operated by traction clutch control. Can be used as a brake on steep grades. Fully enclosed in oil-tight housing.

CHASSIS: Steel electrically welded throughout.

DRIVE CHAIN: Heavy duty motorcycle chain with tighteners.

GAS TANK: 10-quart capacity. Steel, bullet-shaped.

TOOL BOX: Ample for crank and small tools.

DRIVE WHEELS: Late type with inner tubes. Size 3.00x7 studded duals.

DIFFERENTIAL: Fully enclosed and running in oil.

MOWERS: 3 cutting units, each power driven from engine. Front mower 30 inches—wing mowers 25½ inches.

REVOLVING REEL: 7-inches in diameter, equipped with five blade reel. Shaft built of cold rolled steel, mounted on presealed and lubricated bearings. No lubrication necessary. Steel knife bar.

REAR ROLLER: Sectional roller made of steel tubing, running on long wearing, hard, oil soaked wooden bushings.

GRASS SHIELDS: Of heavy sheet metal on all three mowers.

RUBBER BUMPERS: To absorb shock and prevent injury.

SNOW PLOW: V type or Moldboard type snowplow attachment available at extra cost.

MEASUREMENTS: Cutting swath 76 inches. Speed 4½ miles per hour. Capacity 20-25 acres per day. Overall width—Mowers down 80 inches. Mowers up—37 inches. Height—32 inches. Weight 655 pounds.

TORO TRACTORS & MOWERS

FOR PARKS, AIRPORTS, ESTATES, HIGHWAYS, CEMETERIES, GOLF COURSES

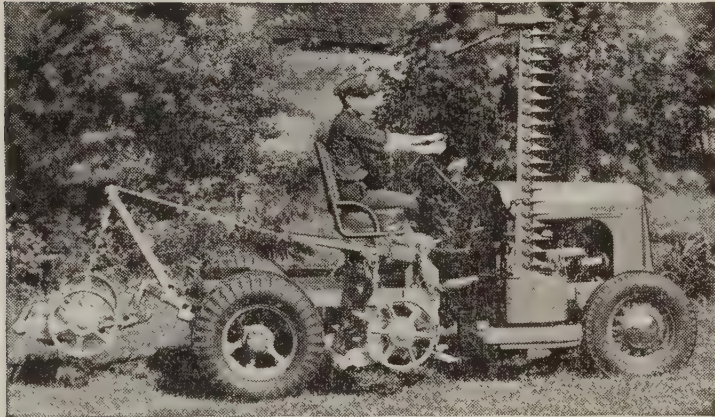

THE PARKMASTER

Lifting type tractor mower which raises and lowers the mowers for transporting

The first successful Tractor Mower that solved the problem of cutting scattered areas cheaply and quickly. It comes equipped with either three or five 30-inch mowers, and with or without a sickle bar, and is built with a manually operated hydraulic lifting device for raising and lowering the mowers. This machine does its own cutting and its own transporting without the need of supplementary equipment. It will cut up to 38 acres per day and do the work of five or six hand guided power mowers.

When transporting from place to place, all that is necessary is to raise the mowers free and clear of the ground, and drive the tractor under its own power to the next location.

When the mowing season is over, the lifting device and the mowers can be dropped off quickly and easily and in thirty minutes' time you have a twelve months' general utility tractor.

The five-foot Sickle Bar is optional equipment, making the machine a combination for cutting both fine lawns and rough weeds. The sickle bar drives from the power takeoff on the transmission, and is built with all modern improvements.

Descriptive catalog mailed free on request.

BULLET TRACTOR

Built for turf operation, the Bullet is far superior to heavy cumbersome farm tractors which were designed for miscellaneous jobs.

Bullet tractors were designed for a specific job—and that is to handle gang mowers, sickle bars, and do general utility work on turfed areas. They are built close to the ground—have a low center of gravity—are easy to look at—easy to handle—highly efficient—and will climb steep grades.

Powered with a Ford 4-cylinder Model 40 Tractor Engine and with a four speed transmission, they have an ample range of power for varying conditions, and are very economical to operate—with owners reporting gasoline consumption of between 5 and 6 gallons per working day.

The Bullet has a speed range of approximately 24 miles per hour in high or fourth speed—14 MPH in third—5 MPH in second—and 2½ MPH in low. It will haul seven gang mowers over steep hills easily.

ENGINE: Ford four cylinder Model 40, bore 3.187 inches, stroke 3.75 inches, piston displacement 119.2 cubic inches, brake horsepower 30 at 2100 R.P.M., forced feed lubrication, air cleaner, oil filter.

SELF-STARTER: Generator and battery.

TRANSMISSION: Heavy-duty with reduction gear on drive shaft. Four speeds forward, one reverse. Range 2½, 5, 14—24 miles per hour for transporting in fourth.

CHASSIS: Four inch structural electrically welded steel channels.

FRONT AXLE: Spring mounted center pivot.

REAR AXLE: Heavy-duty enclosed bevel gear differential, full floating type.

TIRES: 6.00x16 front, 7.50x16 rear, tractor type.

RADATOR: Large tubular radiator, tractor type, four gallon capacity, all steel radiator shell.

GASOLINE TANK: Seven gallon capacity, built of eighteen gauge terne plate.

BRAKES: Transmission type on drive shaft.

SEAT: Leather upholstered bus type, upholstered back, seat mounted on coil spring.

WIDTH: Front wheel tread 57 inches; rear wheel tread 59 inches; with dual tires 61 inches.

WEIGHT: 2010 pounds.

TORO GANG MOWERS HAVE CUTTING SWATHS UP TO 20 FEET



Seven Gang Toro Fairway Mower

BOLENS HUSKI GARDENER

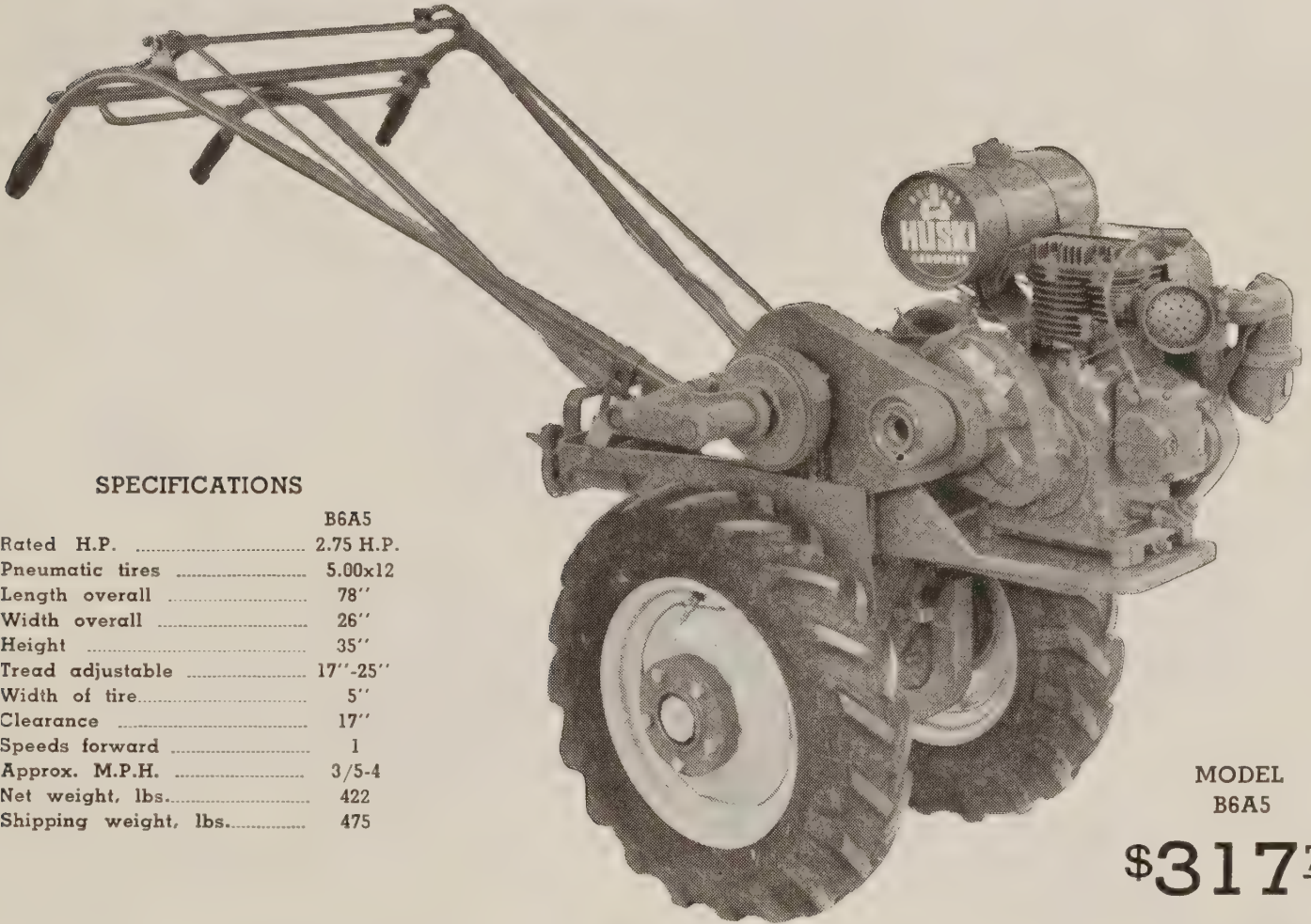

SPECIFICATIONS

	B6A5
Rated H.P.	2.75 H.P.
Pneumatic tires	5.00x12
Length overall	78"
Width overall	26"
Height	35"
Tread adjustable	17"-25"
Width of tire.....	5"
Clearance	17"
Speeds forward	1
Approx. M.P.H.	3/5-4
Net weight, lbs.....	422
Shipping weight, lbs.....	475

MODEL
B6A5

\$317⁷⁴

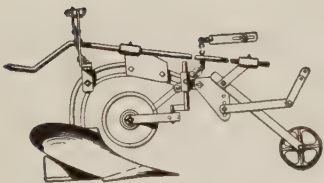

No. BR244 Plow

PLOWING . . . An easy job for the HUSKI-GARDENER Plow Attachment. The BR244-8" plow attachment has a gauge wheel which is regulated by a crank lever to raise or lower the depth of the furrow instantly and while in motion. Attachment consists of frame with quick attaching brackets, plow and beam, and adjustable rolling coulter. **\$31.14.**

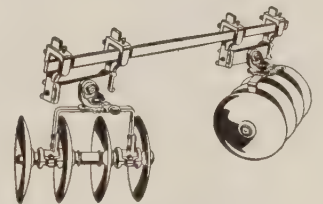

No. BR296 Disc

DISC HARROWING . . . Model BR296A 8/11 Disc shown. A highly versatile tool, the HUSKI Disc Harrow can be used both for preparing the ground before seeding, for straddle or between-row cultivating of either flat or bedded land, also for tillage operation in orchards, vineyards, chicken runs and other uses. It is quickly and easily adjustable for pulverizing, hilling, barring off, and adjustable for varying row widths. **\$37.32.**

CULTIVATING . . . DJ101E One or Two-row Cultivator for Garden Type Tools, can be used to stride one narrow row and cultivate two complete middles. By alternating the rows straddled, very accurate work can be done on all rows every second time over. Can also be used for cultivating between wide rows. Fits Instant Hitch clamps. **\$18.83.**

MOWING . . . No. BR300 Sickle Bar front attachment—42-inch bar. Easy to attach or remove. Fine for jobs supplementary to expensive big equipment. **\$94.91.**

CULTIVATING . . . Field Type . . . for wide row crops. DJ102A with six tool holder bars and standards for straddle or between-row cultivation Tool holder bars may be set as desired on cross bar for variety of work. **\$23.79.**

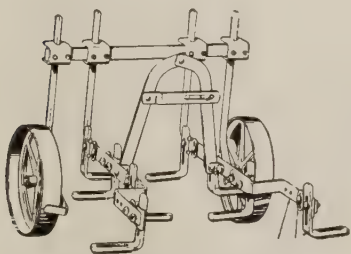

No. DJ101E Cultivator

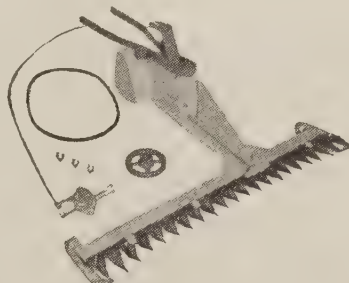

No. BR300 Mower

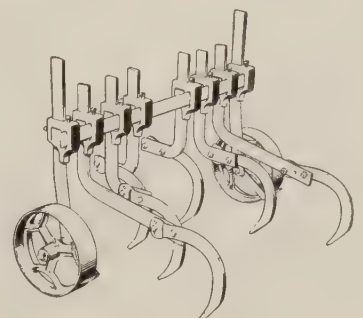

No. DJ102A Cultivator

BOLENS SUPER-HUSKI POWER-HO

MODEL 12A4
WITH CULTIVATOR

\$178⁷³



A Real High Class Garden Tractor at a Popular Price

That will make gardening a pleasure—for the back yard gardener, the suburban or "City Farmer"—Estate—the farmer's wife. No more back-breaking toil when hoeing, cultivating, seeding, light furrowing, hilling, etc.—also snow plowing and lawn mowing, and—

A Newly Designed Sickle Bar or Power Scythe for Field and Rough Mowing

The FIRST Successful Power Hoe

The Super-HUSKI Power-Ho was the first successful Low Cost Motorized Wheel Hoe built. Today it belongs in every garden, on every farm. In use, it will straddle rows as narrow as 11 inches. The clearance is 13 inches and the wheel with pneumatic tires (4.00 x 12) has a tread of 16" to 21½". Motor is 4-cycle, air-cooled, with flywheel magneto—all moving parts enclosed. It brings modern mechanized Power Gardening within the reach of thousands of gardeners.

SPECIFICATIONS

Model	12A4
Tread center to center of tires	16" and 21½"
Clearance overall	13"
Vision ahead of tools (avg.)	36"
Length overall	67"
Height overall	29½"
Speed—Approx. M.P.H.	1¾ to 3
Motor—4-cycle air cooled. Rated 1½ H.P.	
Net weight, approx.....	230 lbs.
Shipping weight, approx.	270 lbs.

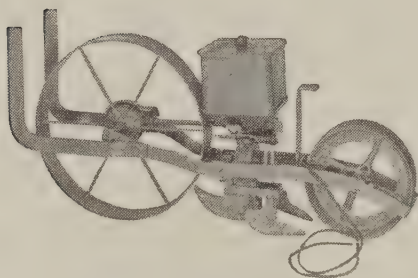

No. 10B Seeder

ONE-ROW SEEDER

With Marker and Hitch. Saves time and labor. Permits accurate row cultivation. Will handle all the planting of any vegetable seeds up to bush lima beans. \$33.25.

SICKLE BAR

Easy to attach or remove from front of tractor; 30-inch cutting bar. Also does a supplementary job for big, expensive equipment. \$88.81.

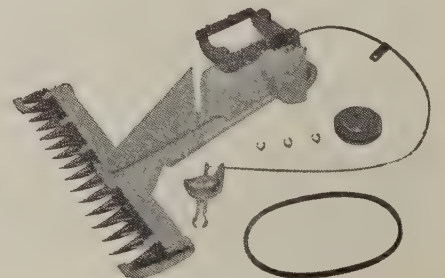

No. 12A250 Sickle Bar

PLANET JR. GARDEN TRACTOR

FOR PLOWING, DISCING, SEEDING, CULTIVATING, MOWING WEEDS OR LAWN

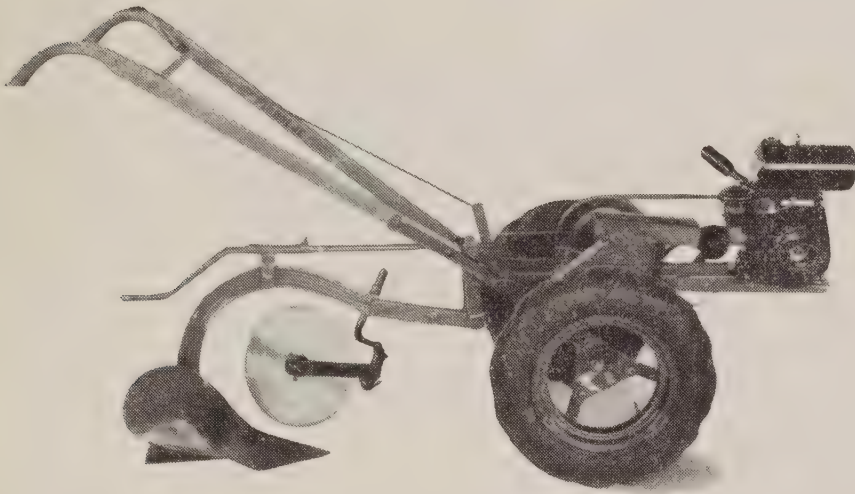

Model BP-1 With 6-Inch Plow

A really low cost all-purpose tractor. Light in weight—simple to operate—anyone can easily handle it.

An efficient 1½ H.P. engine furnishes an astonishing amount of power. It comes equipped with a cultivator, but quite an assortment of additional equipment is available for use with it. The wheels on the BP-1 have two settings—14 or 24 inches center to center. Clearance under the tractor is sufficient for early cultivation of any crop and for all season cultivation of most narrow row vegetable crops.

The plow, disc, seeder, and cultivator attachments can be quickly changed by removing one king pin, no wrenches are necessary. The mower attachment is quickly and easily mounted to the front of the tractor.

ATTACHMENTS

B-21 Plow Attachment—A grower with acreage too limited to justify use of the large tractor must still have some means of plowing his ground. The B-21 is a 6-inch plow and does a beautiful job plowing from 5 to 6-inches deep under normal conditions. A rolling coulter is included as standard equipment. **\$30.93**

9541X Balance Weight—Attaches to front of the tractor frame and adds more than 40 pounds weight for the increased traction. It also balances the weight of the plow making the tractor easier to handle. **\$8.46**

B-61 Disc Harrow Attachment—This disc harrow is almost a "must" for anyone using the tractor for soil fitting. The discs are 12 inches in diameter, large enough for thorough work. The disc is also used for cultivating either straddle or between rows. They can be set to draw dirt away from or up to the rows. **\$19.93**

AB-56 Field Mower Attachment—An efficient mower for cutting hay, grass and weeds. Cuts 34 inches—four or five acres a day. Easy and quickly attached to the front of the tractor. The height of cutting is from 1½ to 4 inches. The oscillator keeps the mower clean and prevents grass or weeds from piling up and clogging the knife. **\$58.00.**

B-11 Heavy Duty Cultivating Equipment—An assembly of parts to change the regular cultivator to a horse or field type for heavy duty cultivating of corn, potatoes, etc. In addition to the cultivator steels, other equipment such as sweeps, turning shovels, or furrowers, can be used to handle a variety of other jobs. **\$10.69**

9905X Lawn Mower Hitch—This hitch makes it possible to convert your hand lawn mower into a power mower. It is easily and quickly attached to the tractor. **\$6.75**

Ask for the Planet Jr. Tractor catalog which gives specifications on other available equipment.

MODEL BP-1
WITH CULTIVATOR
\$192⁵⁰

MODEL BP-1
COMPLETE WITH
PLOW AND BALANCE WEIGHT
DISC HARROW
CULTIVATOR
FIELD MOWER
\$309⁸²



With No. AB-56 Field Mower

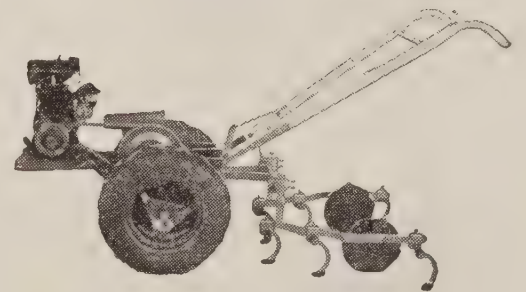

With Cultivator Attachment

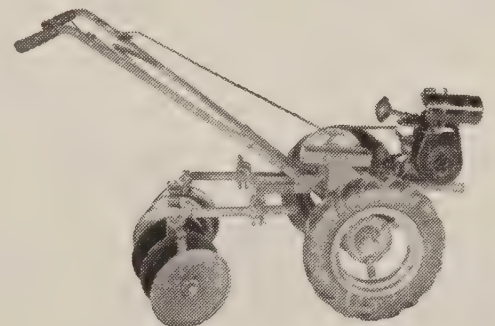

With No. B-61 Disc Harrow

PLANET JR. GARDEN TRACTOR

HEAVY DUTY MODELS HB AND HT

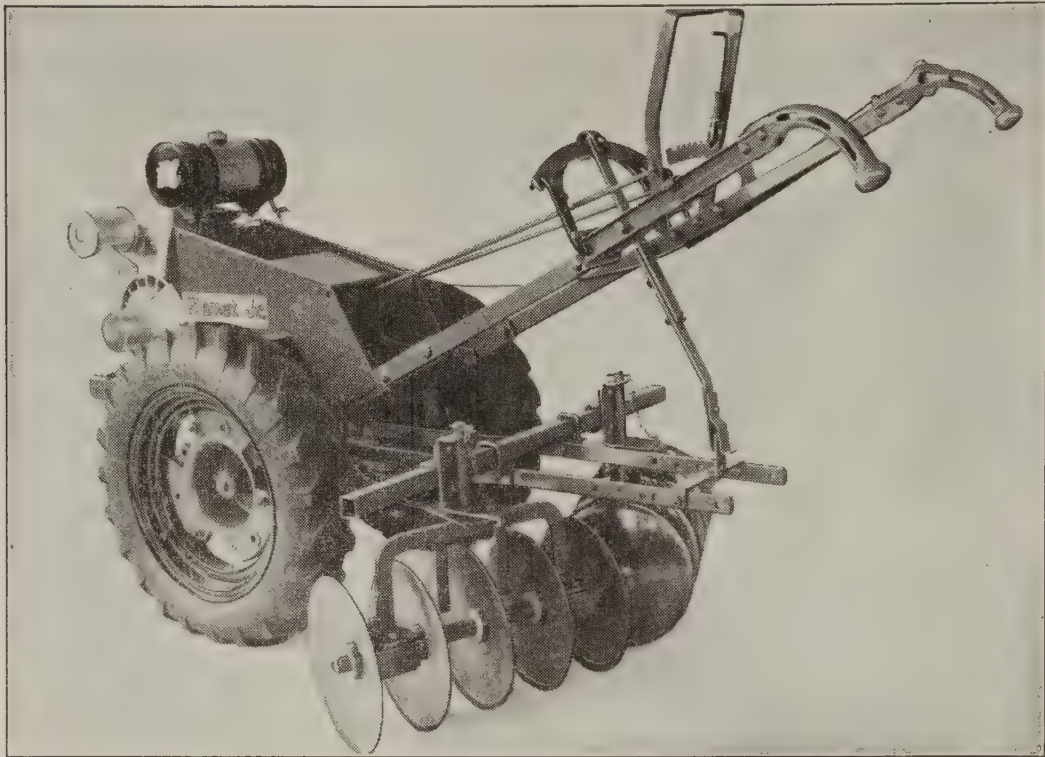

4½ H. P. Tractor with HT-68 Disc Harrow

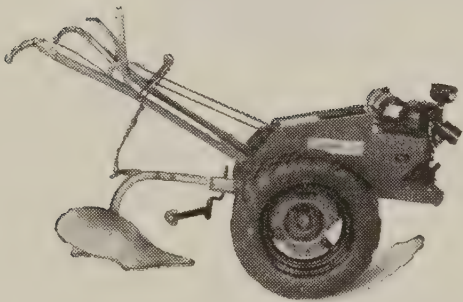

3 H.P. with 9-inch Plow

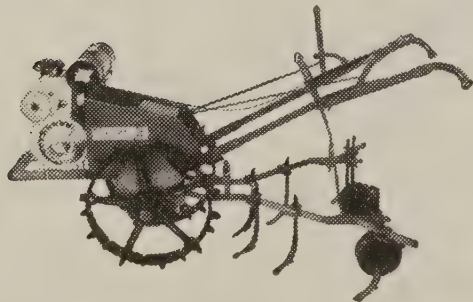

With Cultivator

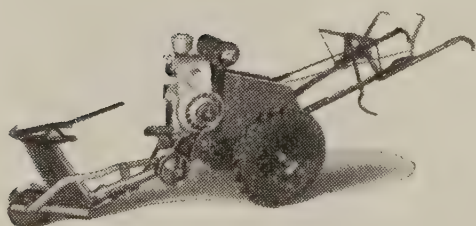

With Mowing Attachment

The Heavy Duty Planet Jr. tractor is available with a 3 or 4½ H.P. motor. Both motors provide ample power for all ordinary operations, but for heavy work the 4½ H.P. motor is recommended. It will handle a 10-inch plow.

The motor is set well ahead of the wheels, balancing the weight, making it easier to turn the tractor at the ends of the rows, providing maximum traction and power.

Perfect steering is the secret of the ease of handling of the Planet Jr. Tractor.

	Model H.B 3 H.P.	Model H.T. 4½ H.P.
Tractor with metal wheels.....	\$381.71	\$411.71
Tractor with 5.00 x 16 tires.....	412.44	442.44
Tractor with 5.50 x 16 tires.....	419.50	449.50

ATTACHMENTS

HT-26	9-inch plow with hitch and coulter..... (recommended for 3 or 4½ H.P. tractor)	\$ 43.20
HT-27	10-inch plow with hitch and coulter..... (recommended for 4½ H.P. tractor only)	43.20
HT-N	Cultivator with GT-2 Standards and shovels.....	34.60
HT-68	10 x 12" Disc Harrow.....	50.12
HT-57	Field mower, 46" cutter bar.....	141.38

Descriptive catalog mailed free on request

ARIENS-Tiller



\$580²⁵ DELIVERED
LOUISVILLE, KY.

PREPARES A COMPLETELY PULVERIZED LEVEL SEED BED IN ONE OPERATION

Once over the ground with an Ariens Tiller and the seed bed is properly prepared—thoroughly aerated with fertilizer and the soil shredded and evenly mixed from top to any depth down to 12 inches. The soil is literally torn into shreds. There are no large chunks of ground left to retard seed growth—no plow sole—but a seed bed in which weeds and insect life are destroyed. In the one operation you obtain a better seed bed than can be obtained by plowing, discing, harrowing and even rolling the ground. Fine seed beds will hold more moisture, so necessary to plant growth, than seed beds not so well prepared. The wide use of Ariens Tillers attest to their efficiency and general acceptance by growers.

The tines, made of specially treated high-quality spring steel, revolving through the ground take small "bites" at each revolution, completely pulverizing and mixing the soil.

**IT HARROWS
AS IT DISCS
AS IT PLOWS**

SPECIFICATIONS

MOTOR: 9 H.P. Wisconsin 4-cycle cylinder, 3 $\frac{5}{8}$ " x 4" stroke, air cooled, equipped with oil bath air cleaner high tension magneto with impulse starter, mechanical governor.

CLUTCH: Twin Disc running in oil bath.

TRANSMISSION: Two speed forward and reverse, all bearings Timken tapered roller, heat-treated gears and Ampco bronze worm, entirely enclosed bath lubrication, oil and dust tight.

MILLER DRIVE: Hardened worm and Ampco bronze gear, Timken and ball bearings equipped with safety throw-out clutch. Entirely enclosed and running in oil bath.

WHEELS: Standard equipment 5" x 12" tractor tires or steel wheels. Wheels are free wheeling or can be locked if desired.

HANDLEBARS: Adjustable up or down to suit any operator and to either side of machine so operator does not have to walk in newly tilled soil. All control within easy reach of operator's position.

SPEEDS: Low $\frac{1}{2}$ to 1 M.P.H., high 1 to 2 $\frac{1}{4}$ M.P.H., reverse $\frac{3}{4}$ to 1 $\frac{1}{2}$ M.P.H.

FUEL CONSUMPTION: $\frac{5}{8}$ gallon per hour full load.

CAPACITY: 20 inch cut, $\frac{1}{2}$ acre per day deep tillage, cultivating up to $\frac{1}{2}$ acre per hour.

DEPTH: Easily regulated from 2 to 10 inches.

WIDTH OF TILLAGE: Standard Model B cuts 20 inch width, may be easily reduced to 14 inches or increased to 26 inches for cultivating by using larger hood.

DIMENSIONS: Length 78 inches, overall width 23 in., height 28 inches, weight 625 pounds.

Ariens Tillers meet all requirements of gardener, market grower, landscaper, nurseryman, etc.





POULTRY AND STOCK—FEEDS AND REMEDIES

BUNTON'S QUALITY FEEDS

The ingredients of Bunton's feeds are blended to give the best results and at the same time be a palatable feed that prevents waste. We offer Bunton's Feed in one quality—The Best.



BUNTON'S SCRATCH GRAIN—Your hens won't leave any of Bunton's Scratch Grain, it contains plenty cracked corn. A fine combination. Protein 10%, Fat 3%, Fibre 4%. 100 lb. bag.

BUNTON'S INTERMEDIATE SCRATCH GRAIN—The right combination of cracked grains for the growing chicken. Protein 10%, Fat 3%, Fibre 4%. 100 lb. bag.

BUNTON'S CHICK GRAIN—Give chicks a good start with this finely cracked blend of grains. Protein 10%, Fat 3%, Fibre 3%. 100 lb. bag.

BUNTON'S LAYING MASH—Your hens will respond with more eggs if Bunton's Laying Mash is kept before them. Protein 19%, Fat 4%, Fibre 7%. 100 lb. bag.

BUNTON'S GROWING MASH—It is important to feed the growing chicken the right food for developing them into good layers. Start feeding Bunton's Growing Mash at six weeks. Protein 18%, Fat 4%, Fibre 6%. 100 lb. bag.

BUNTON'S STARTING MASH—Be sure that your chicks first feed is the best. Get them off to a good start with Bunton's Starting Mash. Protein 19%, Fat 4%, Fibre 6%. 100 lb. bag.

BUNTON'S BROILER RATION—To produce good, heavy broilers in the shortest possible time. No other food necessary when raising broilers as it is a complete battery ration. Protein 16%, Fat 4½%, Fibre 6%. 100 lb. bag.

BUNTON'S 24% DAIRY FEED—A real producer of more rich milk. Cows love it and respond to its wholesome goodness. Protein 24%, Fat 4½%, Fibre 8%. 100 lb. bag.

We deliver feed to all sections of Louisville. 15c per 100 lb. bag deducted for cash and carry.

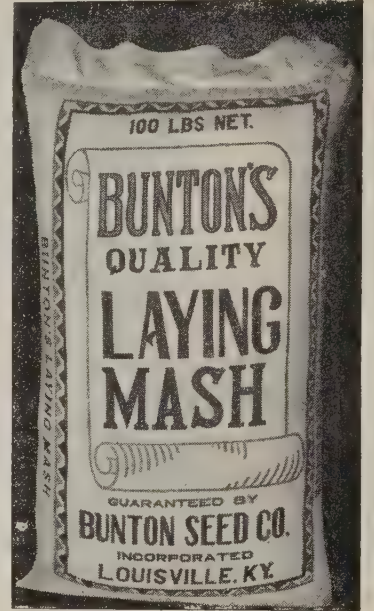

AIDS AND REMEDIES FOR POULTRY AND STOCK

PRATTS POULTRY REGULATOR—Helps hens lay, tones up run-down birds. 2¾ lb. 50c; 6 lb. \$1.00; 12½ lb. \$1.75; 25 lb. \$3.25.

PRATTS WORM POWDER—An easy flock treatment for large round worms. No handling or set backs to the birds. 4 oz. 60c; 8 oz. \$1.00; 2½ lb. \$4.25.

PRATTS R-P TABLETS—Individual dosage or drinking water treatment for roup. 1½ oz. Pkg. 30c; 3 oz. Pkg. 60c.

PRATTS CHICK TABLETS—A 24 hour a day protection against disease germs in the drinking water. 1 oz. Pkg. 30c; 2 oz. Pkg. 60c.

PRATTS SPLIT-ACTION CAPSULES—A double action wormer that kills both the cecum and round worms. Does the work of two ordinary treatments. For adult birds—50 capsules 85c; 100 cap. \$1.50; 500 cap. \$5.50; 1000 cap. \$10.00. For pullets—50 capsules 55c; 100 cap. \$1.00; 500 cap. \$3.75; 1000 cap. \$6.50.

PRATTS PIK-NO-MOR—Stops cannibalism, toe, feather and vent picking in chicks and adult fowls. Stops bleeding and starts the healing process. 5 oz. jar 60c; large jar \$1.35.

PRATTS POULTRY INHALANT—A new flock treatment for relieving colds and bronchial conditions. Pint 70c; Quart \$1.25; Gal. \$3.25.

PRATTS ROOST PAINT—A quick, economical killer for mites and lice regardless of size of flock. ½ Pint \$1.00; Pint \$1.75; Quart \$2.50.

PRATTS LICE KILLER—An old standby for delousing poultry and stock. 14 oz. 30c; 2 lb. 60c.

PRATTS C-KA-GENE—A new, highly effective flock treatment that prevents large losses from bloody coccidiosis thru the new immunity method. 1¾ lb. 75c; 3½ lb. \$1.25; 8¾ lb. \$2.75; Large size (500 chicks) \$5.00.

PRATTS DISINFECTANT—Helps to control worms, lice and all diseases. Six times as strong as crude carbolic acid, but safe and non-poisonous. An excellent dip for livestock. Quart 60c; Gal. \$1.60; 5 Gal. \$7.25.

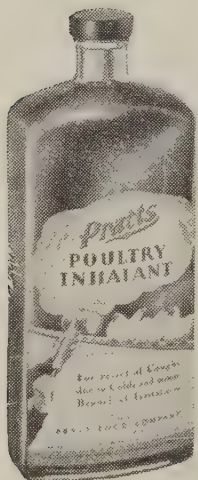

PRATTS ANIMAL REGULATOR—A general stock tonic for all livestock. To be used with feed. Improves appetite and digestion. 2½ lb. 50c; 6 lb. \$1.00; 25 lb. \$3.50.

PRATTS HOG POWDER—A tonic and mineral supplement with Vitamin D. 3 lbs. 50c; 7 lbs. \$1.00; 25 lbs. \$3.25.

PRATTS ZENE-A-TROL—A Phenothiazine treatment for worming hogs, sheep, horses and turkeys. ½ lb. 90c; 1 lb. \$1.50; 5 lbs. \$6.00.

PRATTS MEDICATED POWDER—An antiseptic, astringent powder for galls, burns, wounds and surface injuries of livestock. 3 oz. can 25c.

PRATTS COW TONIC—Keep the milk factory fit. Insures vigorous health that means more milk and healthy calves. A real aid at calving time. 1½ lb. 60c; 3½ lb. \$1.20; 25 lb. \$5.00.

PRATTS BAG OINTMENT—A penetrating benzonated ointment for udders. 10 oz. 50c.

RUSSELL'S KORUM—A liquid drinking water medication which mixes easily with water, is not distasteful and can be given to any age birds. It is easier to keep your birds healthy than to make them well again. Make a comparative test with Korum, if you are not entirely satisfied your money will be refunded. ½ Pint 65c; Pint \$1.00; Quart \$1.75; ½ Gal. \$3.00; Gallon \$5.00.

RUSSELL'S WORM POWDER—An effective round worm treatment for the entire flock by mixing 7 ounces of the powder with 100 pounds of mash. Regular treatment will aid in preventing reinfestation. 3½ oz. 65c; 7 oz. (for 150 hens) \$1.00; 14 oz. \$1.75; 5 lb. \$9.00.

RUSSELL'S REVENGE LICE DESTROYER—A guaranteed lice powder for individual, nest or dust box treatment. Sticks to feathers, not easily shaken off. 1½ lb. 65c; 3 lb. \$1.00; 6 lb. \$1.75.

RUSSELL'S SPRAYER INHALANT—Makes breathing easier for cold infested flocks and helps them to get rid of mucous discharges. ¼ Pt. 65c; ½ Pt. \$1.00; Pint \$1.75.

RUSSELL'S PICKER—Blood-red and bitter it discourages cannibalism. 1¾ oz. jar 25c.

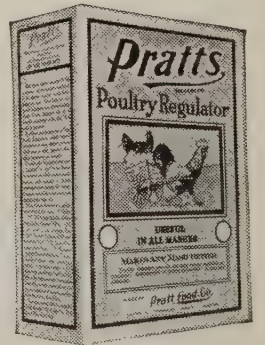

POULTRY AND HOG FEEDERS



CHICK FEEDER

No. 224—Die formed from heavy galvanized steel. Trough $1\frac{3}{4}$ " deep; $2\frac{5}{8}$ " bottom width; $4\frac{1}{4}$ " top width; feed saving lip. Reel floats in either of two positions on shouldered reel pins. Prevents injured chick toes. Length 24 inches. **Each 40c.**

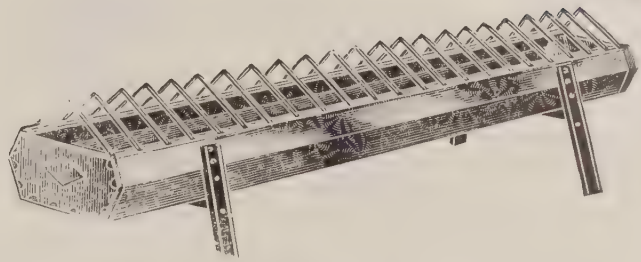

FLOCK FEEDER

No. 350—A popular feeder for growing and grown stock. Capacity 40 lbs. Trough is 9" wide, $4\frac{5}{8}$ " deep, with 1" feed saving lip. All edges folded or curled to make smooth sturdy feeder. Fitted with sturdy tinned wire grill hinged for convenient filling and cleaning. Mounted on 9-inch channel steel legs, braced and supported. Length 5 feet. **Each \$3.10.**

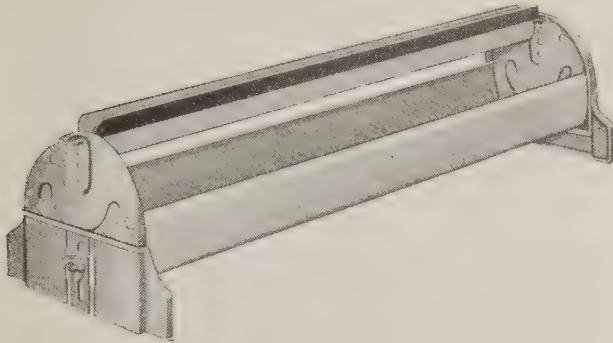

CHICK FEEDER

No. 6360—Stands permit quick adjustment of feeder as chicks grow. 4-blade red enameled reel floats on shouldered reel pins. Adjusts to three convenient positions according to chick size. Welded ends. 2" deep 4" top width; 3" bottom width; length 36 inches. **Each 80c.**

FLOCK FEEDER

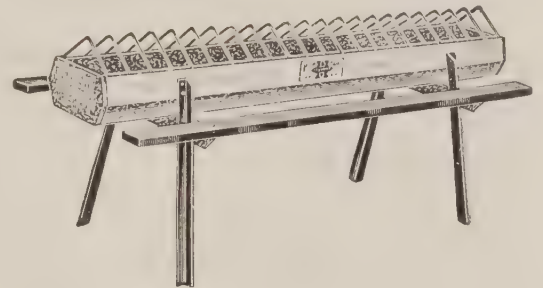

No. 25S—A substantial, inexpensive feeder suitable for growing birds and full grown stock. Handles dry mash, grain, shells, grit and other feeds. Easy to keep clean. Easy for hens to clean up feed. No sharp or rough edges. Convenient hinged grill. Stiff angle legs are cross-braced to give unusually rigid construction. The $2\frac{1}{2}$ " redwood perches are round edge, mite and water proof, 16 inches off the floor. Plenty of range space for hens below. Trough 9 inches wide, $4\frac{5}{8}$ inches deep, holds 40 lbs. mash, serves 60 hens. Length 5 feet. **Each \$4.35.**

No. 28S—Same specifications as No. 25S except is 8 feet long and holds 64 pounds of dry mash. **Each \$6.80.**

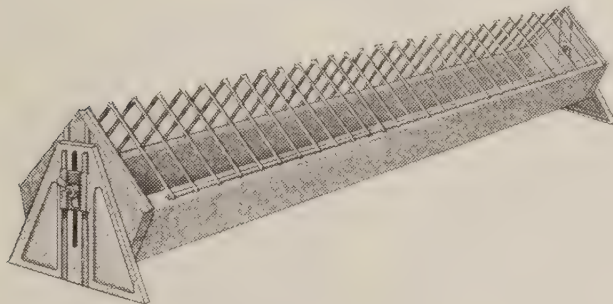

BROILER FEEDER

No. 748—Extra large feeder with fully adjustable metal stands and adjustable 4-blade reel. Day old chicks to well past broiler age. Feeder trough $2\frac{5}{8}$ " deep; $4\frac{1}{2}$ " wide at top $\frac{5}{8}$ " feed saving lip. Welded ends. Length 48 inches. **Each \$1.80.**

SELF FEEDERS FOR HOGS

Protects grain and ground feeds from rain and rodents, controlled feed flow, gives every hog an equal chance. Heavy gauge galvanized steel, thoroughly braced.

No. 2X5 FEEDER—For 15 head. 2-foot, 2 doors, 1 compartment, 5 bushel capacity. **Each \$16.50.**

No. 315 FEEDER—For 45 head. 3-foot, 6 doors, 2 compartments, separate feed regulators. 15-bushel capacity. **Each \$32.45.**

No. 525 FEEDER—For 75 head. 5-foot, 10 doors, 3 compartments, separate feed regulators. 25-bushel capacity. **Each \$45.65.**

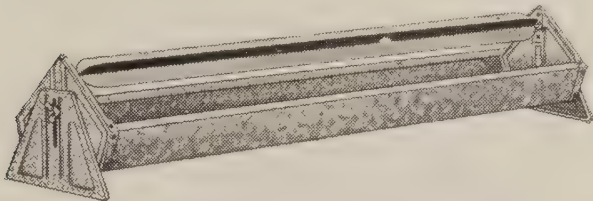

BROILER FEEDER

No. 548—For chicks two weeks of age until finished broilers. Raise stands as chicks grow. Extra large capacity steel trough. $6\frac{1}{2}$ " top width; 3" depth; 1" feed saving lip, no rough edges. Hinged grill, welded ends. Length 48 inches. **Each \$1.40.**

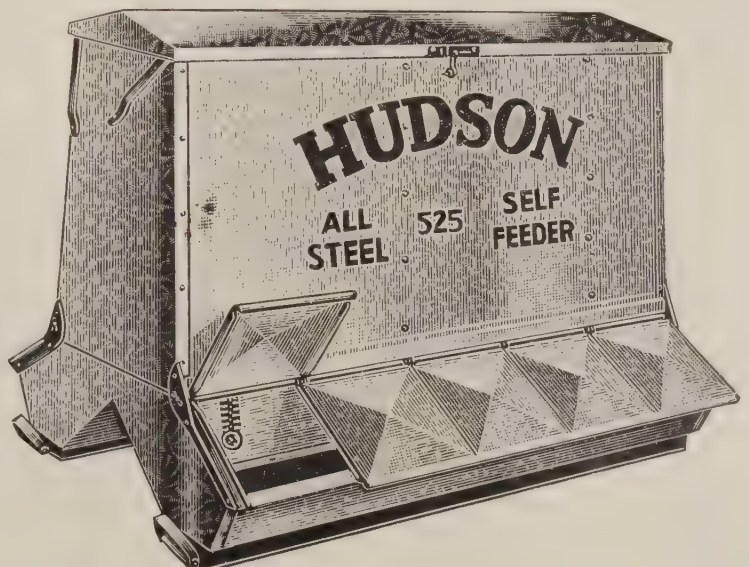

POULTRY EQUIPMENT



FOUNTAINS

No. A8 — A single wall handy-fill chick fountain with a snap-on cupped pan. Designed to prevent chicks from getting into water. Inverted for filling, can be carried without spilling. Capacity 2 gallons. **\$1.05.**



BROODERS

No. 70 — Hudson Battery Brooder with thermostat controlled removable heating unit in center. 2 feed troughs, 2 water troughs, 1/2 inch mesh heavy wire floor, removable dropping pan. Inside dimensions 24"x36", head room 9 1/2" without heater. Adjustable grills over troughs. Easily serviced. Designed for use in tiers up to 5 high or in combination with finishing units. **Each \$18.60.**

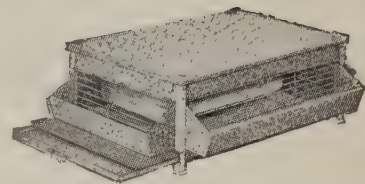

FINISHING BROODER

No. 310A — A 2-deck growing and finishing brooder in a popular size. Inside dimensions 24"x36", head room 15 inches. Two troughs per deck, 3 inches deep, 5 inches wide. (The No. 70 Starting Brooder will fit on top of this unit). Heavy wire mesh floor and removable dropping pan. Price complete with truck. **\$28.15.**



No. K5 — Double wall substantial fountain with roost-proof high dome top. All brass self-closing valve holds water in tank when jacket is removed for filling. Fitted with inside carrying handle. Saucer-shaped wade-proof pan. Provides 48 inches of drinking space. **Each \$3.25.**

KEROSENE FOUNTAIN HEATER

No. 5H — A 60-hour capacity heater for 5-gallon fountains. Diameter 15 1/2 inches, height 8 inches. **Each \$2.50.**

ELECTRIC FOUNTAIN HEATER

No. 569 — A water-proof, shock-proof heater for 5-gallon fountains that requires no attention. The 135 watt heating element is completely shielded from outside moisture. Diameter 15 1/4 inches, height 8 3/4 inches. Drinking water of the correct temperature helps produce more eggs—don't make your hens drink ice-cold water. Complete with 6-foot approved cord and unbreakable plug. **Each \$4.80.**

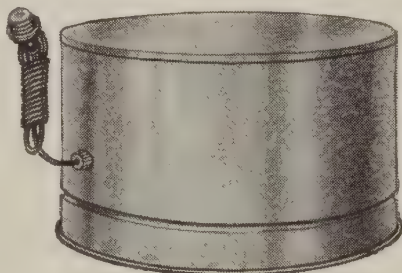

Fountain Heater No. 568

HEATER-FOUNTAIN STAND

No. 5B — A combination stand and perch for 5-gallon fountains with heaters. Sturdy iron legs, hexagon shaped wood perch, well up off floor keeping litter out of water yet easily accessible. **\$3.30.**



Heated Fountain No. K5-5H-5B

ELECTRIC HEATED FOUNTAIN WITH STAND

No. K5-568-5B — A combination of the 5-gallon double walled fountain, No. 568 electric heater and No. 5B stand and perch. **\$10.65.**

KEROSENE HEATED FOUNTAIN WITH STAND

No. K5-5H-5B — A combination of the 5-gallon double walled fountain, No. 5H kerosene heater and No. 5B stand and perch. **\$9.25.**



No. 310A

COMBINATION STARTER AND FINISHING BROODERS

No. 70310A — A combination of one starting brooder No. 70 and the No. 310A Finishing Brooder complete with truck. Handles 60 broilers from start to finish. **\$44.90.**

No. 70310B — A combination of one starting brooder No. 70 and a three section finishing brooder complete with truck. Handles 100 broilers from start to finish. **\$54.90.**

HUDSON "LECTRIC-HEN" BROODERS

An easy to use, convenient floor type brooder with two fully enclosed heating elements providing plenty of heat throughout the length of the brooder. The desired temperature is maintained by a positive, automatic thermostat control. Handy inspection door, plenty of room inside for feeders and fountains, detachable heavy duck curtain. The adjustable legs allow extra head room as chicks grow.

No. 4872 — 500 day-old chicks, 1,100 watts. 48x72". **Price \$39.50.**

No. 4262 — 300 day-old chicks. 700 watts. 48x48". **Price \$32.00.**

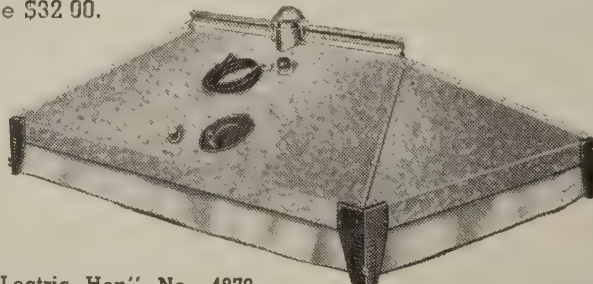

"Lectric Hen" No. 4872

POULTRY EQUIPMENT



HUDSON SAFETY-OIL BROODER

No. 149B—Hexagon shaped "Heat-Saver" top, new safety base and Hudson hushed flame burner. Heavy blued steel drum—20-inch diameter, 7½ inches deep. Recommended for houses up to 12x12 feet. Complete with 6-gallon fuel tank. (Fuel tank stand \$1.20 extra), pipe cap and draft regulator. **Price \$19.80.**

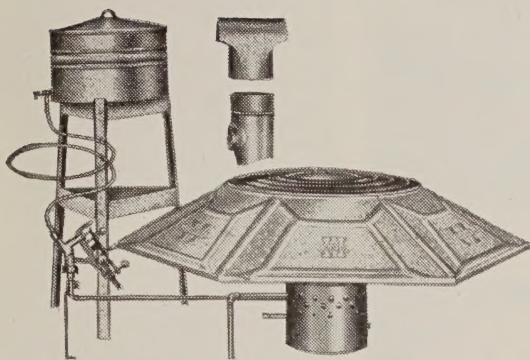

Safety-Oil Brooder No. 149B

HUDSON "LIFE-TIME" METAL NESTS

Easy to clean and keep free from mites and lice, all-metal nest compartments with wood perches. 9¼-inch hole, nest compartment 13¼ inches wide, 13½ inches deep. Fastened to wall by movable hinges which make it possible to swing out from wall at bottom for easy cleaning. May be fitted with removable traps. You should provide at least one nest for each four hens.

No. H6—6-section, two tiers high, 36½ inches long, 35 inches high. **\$9.90.**

No. H10—10-section, two tiers high, 61 inches long, 35 inches high. **\$14.30.**

No. H15—15-section, three tiers high, 61 inches long, 50 inches high. **\$20.35.**

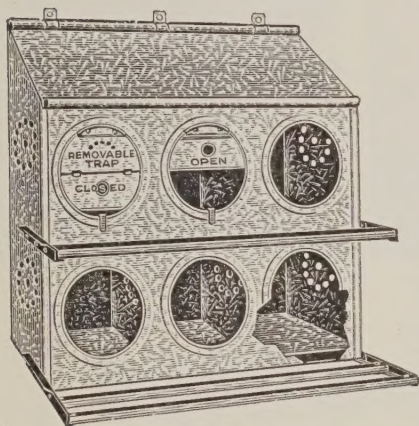

"Life-Time" Nests No. H6

HUDSON ROOF SADDLE

No. RS5—Made of galvanized steel. Adjustable to any required angle from a flat to 30 degree pitch roof. Any standard 5-inch pipe will slip into tapered extension. **Each \$1.60.**

No. PC5—5-inch pipe cap. **Each 50c.**

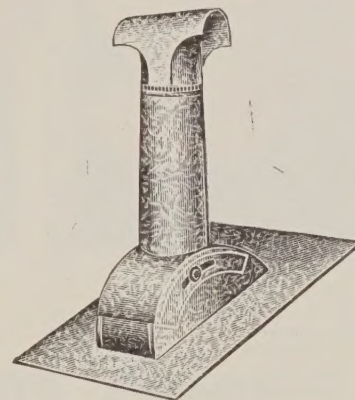

Roof Saddle No. RS5

MAY DAY HUMIDIFIER

No. 5—Designed to maintain the proper humidity in the brooder house; a great aid in developing healthy birds. **Each \$2.00.**

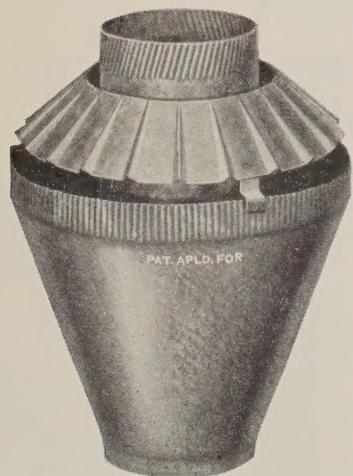

May-Day Humidifier No. 5

THERMOSTAT WAFERS

Dependable wafers guard the lives of your chicks. Prevent trouble by replacing them each year.

No. 31WG—Hudson Universal—Has a removable sleeve which makes it a three type wafer. **Each 40c.**



Float Valve No. 168



Hudson Wafer

HUDSON FLOAT VALVE

No. 168—An automatically operated float valve to maintain the proper level in most any type drinking pan or trough. As the level of the water is lowered the float opens the valve for more fresh water and cuts it off at the proper level again. Can be attached to water pipe or tank. Will operate on pressure up to 50 pounds. **Each \$1.10.**

THERMOMETERS

No. 303 —Incubator	\$1.00
No. 20 —Battery Brooder45
No. 202-1 —Battery Brooder60
No. 400 —Electric Floor Brooder.....	.65
No. 212 —Outdoor	1.35
No. 60 —Milk Testing85
No. 211-1 —Brooder House	1.00
No. 328 —Greenhouse	8.50

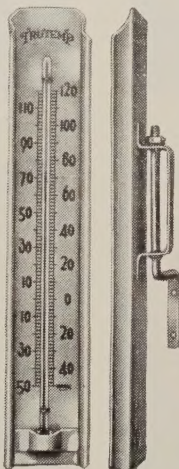

HUDSON BROODER VENTILATOR

No. A9—Has flat adjustable base for any roof-pitch up to 20°, flue diameter 9 inches, height 24 inches. **Price \$4.35.**

HUDSON REVOLVING HEAD VENTILATOR

No. 512—The head is perfectly balanced on ball bearing pivot. Bearings are moisture and frost proof, ⅜ inch mesh galvanized screen makes cupola bird-proof. Satin aluminum finish. Diameter 12 inches, base size 16x16 inches. **Price \$9.90.**

GENERAL INDEX

Activo	51	Deenate	50	Melons, Water	20	Rotary Cutters	60
Adco	51	Distributors	58	Mole Traps	57	Rotenone Dust	50
Ammate	53	Dry Lime Sulphur	50	Mologen	51	Rotenone Garden Guard	50
Antkill	51	Dusters	55	Moon Sign Book	2, 22	Rutabaga	21
Aphis Spray	50	Egg Plant	9	Mulching Materials	49	Rye Grass	26
Arasan	24	Emo	50	Muskmelon	13	Salsify	16
Arsenate of Lead	50	Endive	11	Mustard	11	Scalecide	50
Asparagus Seed	2	Engines	59	Mustard Spinach	11	Scale Mulsion	50
Asparagus Root	2	Ensilage Corn	23	Neponset Pots	56	Seeders	57, 58
Bait-Em	50	Erosionet	48	Nitragin	24	Selocide	61
Bean Beetle Dust	50	Feeds	72	Okra	14	Semesan	24
Beans	3, 4, 5	Feeders	73, 74	Onion Plants	13	Semesan Bel	24
B-B Grower	49	Fermate	50	Onion Seed	13	Semesan Jr.	24
Beets, Stock Feeding	6	Fertilizer	49	Palco Pete	49	Sheep Manure	49
Beets, Garden	6	Fescue	59	Paradichlorobenzene	50	Slug Shot	50
Bent Grass	26	Field Seeds	23, 25, 26	Paris Green	50	Soil Soakers	48
Bermuda Grass	26	Fly Killer	51	Parsley	14	Soil Testers	48
Bibb Lettuce	12	Fruitone	51	Parsnips	16	Spinach	18
Black Leaf "40"	50	Fumeogen	51	Peas, Garden	15	Sprayers	54, 55
Blue Grass	26, Cover	Fungicides	60, 61	Peat Moss	49	Squash	18
Blue Stone	50	Garden Books	56	Peppers	16	Stakes, Plant	56
Bordeaux Mixture	50	Gloves	48	Plantabbs	49	Stock Beets	6
Broccoli	2	Grass Seed	26, Cover	Plant Dinner	49	Sulphur, Dusting	51
Brussels Sprouts	2	Greens	11, 14, 18, 21	Plant Foods	49	Sulphur Flour	51
Cabbage	7	Hotkaps	56	Plant Stakes	56	Swiss Chard	6
Cabbage, Chinese	7	Hoes	57	Planting Table	22	Tampala	14
Calcium Arsenate	50	Humus	49	Pomo-Green	60	Tanglefoot	50
Cantaloupe	13	Hyponex	49	Pop Corn	10	Terogen	61
Carrots	8	Insecticides	50, 51	Postage Rates	1	Tobacco	18
Cattle Spray	51	Insecticide Dusters	55	Potatoes	21	Tobacco Dust	50
Cauliflower	8	Kale	11	Pots, Paper	56	Tomatoes	19
Celeraic	8	Knee Pads	48	Poultry Equip	73, 74, 75	Tools	49
Celery	8	Kohl-Rabi	12	Poultry Remedies	72	Tractors	66, 67, 68, 69, 70, 71
Ceresan	24	Kopper Queen	51	Power Lawn Mowers	60-66	Transplantone	49
Clovers	25	Kopper Shield	51	Pressure Fumigant	50	Tree Dressing	51
Collards	9	Labels, Wood	56	Pruning Paint	51	Tree Trimmer	57
Corn, Ensilage	23	Lawn Mowers	56	Pumpkin	14	Tri-ogen	51
Corn, Field	23	52, 60, 61, 62, 63, 64, 65, 66		Radish	17	Turnips	21
Corn, Garden	10	Lawn Sprinklers	52	Rakes	57	Twist-em	56
Corn, Hybrid	23	Lawn Seed	Cover	Rape	26	Tying Machine	58
Corn Planters	23	Lawn Sweepers	52	Rat Killers	51	Vitamin B1	49
Corn Knives	23	Leek	12	Red Arrow	50	Vigoro	49
Cow Manure	49	Lettuce	12	Red Top	26	Vigoro Spreaders	58
Cucumbers	9	Lime, Lawn	49	Rhubarb	17	Watermelon	20
Cultivators	58	Lime Hydrated	51	Rhubarb Chard	6	Weed Cutters	61
Cushaw	14	Lime Sulphur, Dry	50	Rodent Destroyer	51	Weed Killer	53
Cutworm Protectors	56	Lime Sulphur, Liquid	50	Rootone	49	Weedone	53
Cyanogas	50, 51	Maple Shade	Cover	Rose Dust	51	Window Garden	56
D. D. T.	50, 51	Meat Curing Products	48	Roses	42	Wood Labels	56
Dawg-Gone	51			Rose Spray	51	Zotox	53

Flower Seeds, Bulbs and Plants

SPECIAL USES OF FLOWERS FROM SEEDS—PAGE 40

African Daisy	27	Cornflower	28	Larkspur	32	Rock Garden Annuals	36
Ageratum	27	Cosmos	30	Leptosyne	32	Rock Garden Perennials	43
Alyssum	27, 41	Cup and Saucer	41	Lily of the Valley	45	Rose Moss	36
Amaranthus	27	Cypress Vine	44	Linnaria	32	Roses	46
Anchusa	27	Dahlia (seed)	30	Linum	32, 42	Salpiglossis	37
Anemone	41	Dahlias, Roots	45	Lobelia	32	Salvia	36
Antirrhinum	37	Delphinium	41	Love In-A-Mist	34	Saponaria	43
Aquilegia	41	Dianthus	30, 41	Love Lies Bleeding	27	Scabiosa	36, 43
Arabis	41	Digitalis	42	Lunaria	32	Scarlet Runner Beans	44
Arctotis	27	Dolichos	44	Lupines	32	Scarlet Sage	36
Asters	27, 28, 41	Dusty Miller	31	Madeira Vine	45	Schizanthus	36
Baby Blue Eyes	34	Elephant Ear	45	Marigold	33	Shasta Daisy	43
Baby's Breath	31, 42	English Daisy	41	Matthiola	31	Sea Dahlia	32
Bachelor's Button	28	Euphorbia	31	Mexican Fire Bush	31	Snapdragon	37
Balsam	28	Flax	32, 42	Mignonette	32	Snow-on-the-Mountain	31
Bellis	41	Forget-Me-Not	31, 41	Mirabilis	31	Spider Plant	30
Black Eyed Susan	44	Four O'Clock	31	Moon Flower	44	Statice	37
Blue Cup Flower	34	Foxglove	42	Morning Glory	44	Stocks	37
Blue Lace Flower	28	Gaillardia	31, 42	Mourning Bride	35	Strawflower	31, 37
Brachycome	28	Gerbera	42	Nasturtium	34	Summer Cypress	31
Cacalia	28	Geum	42	Nemesia	34	Sunflower	37
Cactus	41	Gilia	31	Nemophila	34	Swan River Daisy	28
Caladium	45	Gladiolus	47	Nicotiana	34	Sweet Peas	40, 44
Calendula	29	Globe Amaranth	27	Nierembergia	34	Sweet Rocket	43
Calliopsis	29	Godetia	31	Nigella	34	Sweet Sultan	37
Campanula	28, 41	Gomphrena	31	Old Maid	38	Sweet William	43
Canary Bird Vine	44	Gourds	44	Painted Daisy	43	Tassel Flower	28
Candytuft	29	Gypsophila	31, 42	Pansies	42	Texas Blue Bonnet	37
Canna Bulbs	45	Helichrysum	31	Passion Vine	44	Thunbergia	44
Canna, Seeds	41	Helianthus	37	Pentstemon	42	Thionia	37
Canterbury Bells	28	Heliotrope	43	Perennial Plants	34	Tritoma	43
Cardinal Climber	44	Hibiscus	42	Periwinkle	38	Tuberose	45
Carnation	29, 41	Hollyhock	31, 42	Petunias	35	Tulip Poppy	31
Cathedral Bells	44	Hunnemannia	31	Physalis	43	Valeriana	43
Celosia	25, 26	Hyacinth Bean	44	Phlox	34, 43	Venidium	37
Centaurea	28	Hyacinth Candicans	45	Pin Cushion Flower	36	Verbena	38
Chinese Lantern	43	Iberis	42	Pinks	30	Vinca	38
Chinese Woolflower	29	Ismene Calathene	45	Poppies	36, 43	Viola	43
Chrysanthemum	30	Job's Tears	31	Portulaca	36	Violets	43
Clarkia	28	Joseph's Coat	27	Pyrethrum	43	Virginian Stock	38
Cleome	30	Kochia	31	Queen Anne's Lace	36	Viscaria	38
Cobaea Scandens	44	Kudzu Vine	44	Queen Anne's Thimble	27	Wall Flower	43
Cockscomb	30	Lantana	31	Red Hot Poker	43	Wild Cucumber Vine	44
Coleus	29			Ricinus	36	Wild Flower Garden	38
Columbine	41					Zinnias	38, 39
Coreopsis	41						



Autumn



K. A. Viktoria



Edith Nellie Perkins



Hinrich Gaede



E. G. Hill



Mrs. P. S. du Pont



Talisman



Soeur Therese

BUNTON'S Best Everblooming Roses

**Two-Year-Old
Field-Grown Plants**

READY TO BLOOM THIS SPRING

Guaranteed True to Name

B. B. GRADE. . \$1.00 each

10 or More at 90c. each

For Complete List See Page 46



Mrs. E. P. Thom



Picture



Caledonia



Condesa de Sastago



Editor McFarland



Joanna Hill



Pres. Herbert Hoover



Etoile de Hollande



BUNTON'S GLADIOLUS COLLECTION

- 1. EXCELLENCE
- 2. PHYLLIS McQUISTON
- 3. MINUET
- 4. PRIDE OF WANAKA
- 5. GOLDEN DREAM
- 6. BEACON
- 7. CHAS. DICKENS
- 8. ROSA DE LIMA
- 9. PARADISE
- 10. ALBATROSS
- 11. BAGDAD
- 12. VAGABOND PRINCE

60 BULBS, 5 EACH
VARIETY \$5.00

120 BULBS, 10 EACH
VARIETY \$9.50

Kept Separate and Labeled

For Complete List See Page 47

BUNTON SEED COMPANY, Inc.

Cor. Floyd and Jefferson Sts. • LOUISVILLE 2, KY.