

Historic, Archive Document

Do not assume content reflects current scientific knowledge, policies, or practices.



Scott's SEEDS 1947

U.S. DEPARTMENT OF AGRICULTURE
MAR 17 1947
U.S. Dept. of Agriculture



**PITTSBURGH'S
COMPLETE
GARDEN
STORE**

MAIL AND TELEPHONE ORDERS • Telephone ATLantic 2022

ESTABLISHED
1876

The I. W. SCOTT COMPANY

500 LIBERTY AVE. • 113 DIAMOND ST. • PITTSBURGH 22, PA.

**71st
YEAR**

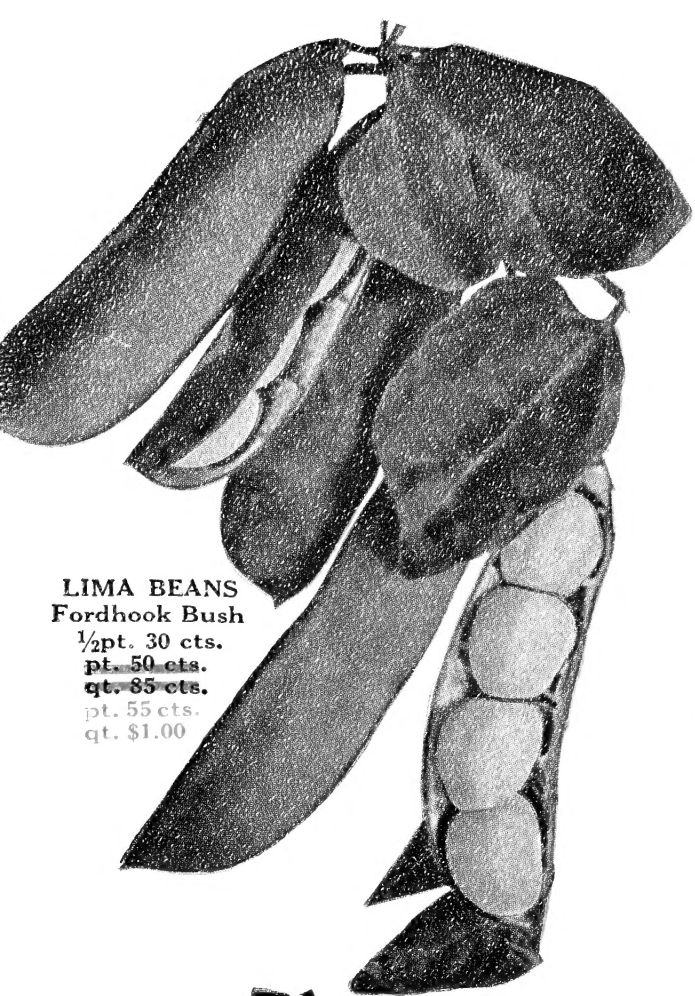

LIMA BEANS
Fordhook Bush
 1/2pt. 30 cts.
 pt. 50 cts.
 qt. 85 cts.
 pt. 55 cts.
 qt. \$1.00

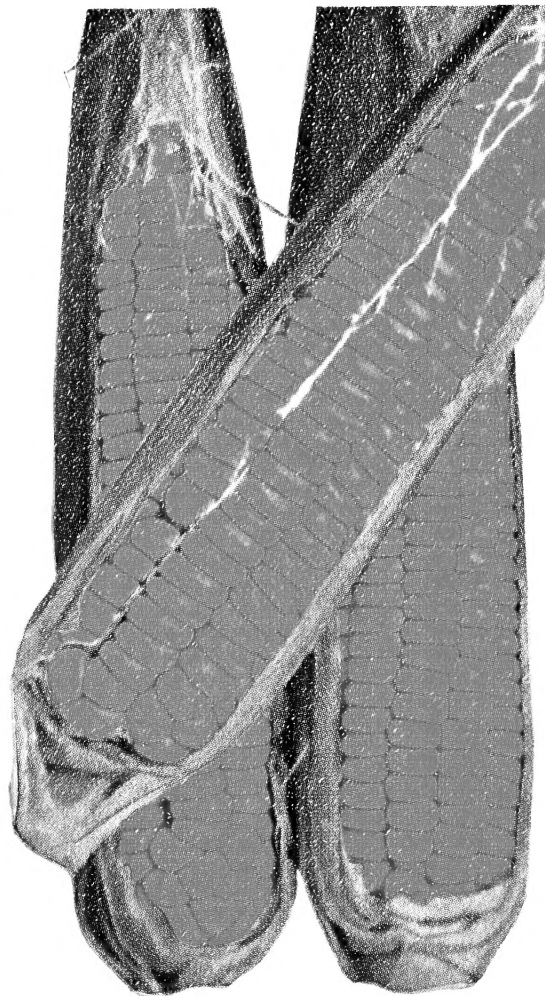

CORN, Golden Cross Bantam
 1/2pt. 30 cts., pt. 50 cts., qt. 85 cts.,
 pk. \$5.50, bus. \$20.00

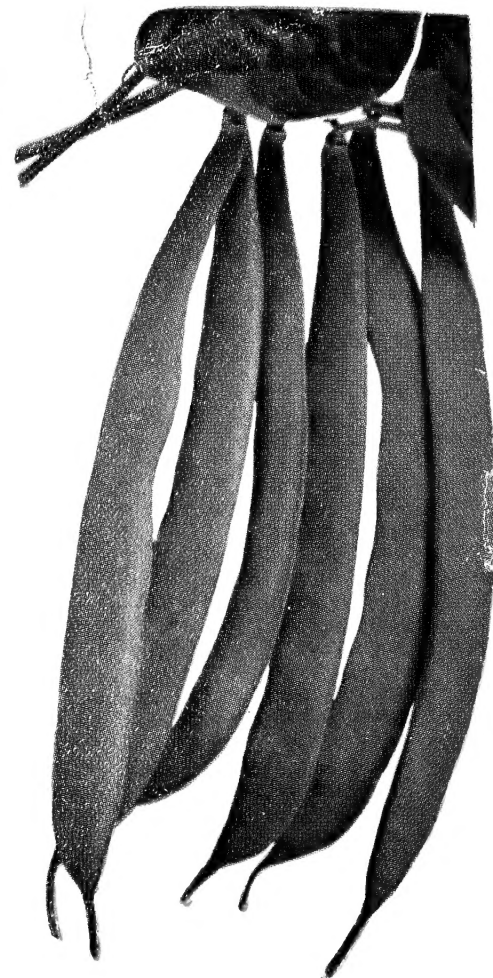

BEANS, Tendergreen
 1/2pt. 25 cts., pt. 45 cts., qt. 75 cts.,
 pk. \$4.65, bus. \$16.80

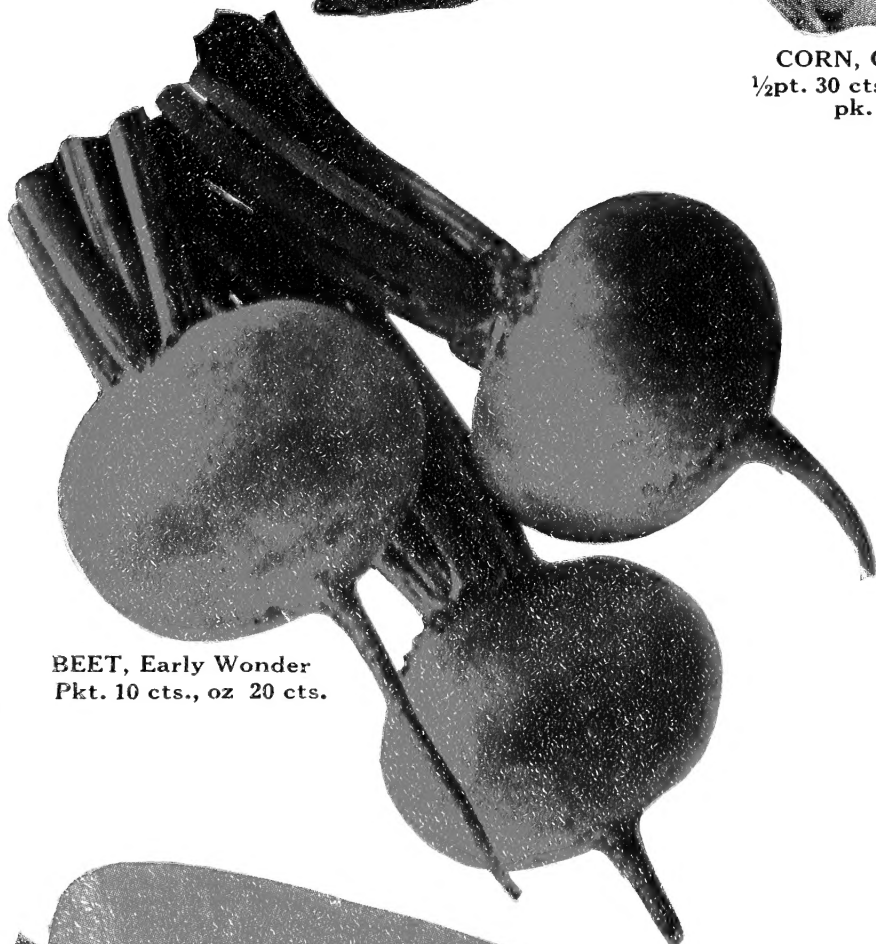

BEET, Early Wonder
 Pkt. 10 cts., oz 20 cts.



CABBAGE, Copenhagen Market. Pkt. 10 cts.,
 oz 45 cts., 1/4lb. \$1.25, lb. \$4.00



CARROT, Danvers Half Long. Pkt. 10 cts., oz. 25 cts.

THE I. W. SCOTT COMPANY

LAWN GARDEN **SEEDS** FIELD FLOWER

Farm, Garden and Poultry Equipment and Supplies

PITTSBURGH, PENNA.

1876 KEEPING FAITH FOR 71 YEARS 1947

TO OUR FRIENDS AND CUSTOMERS:

Have you had occasion to purchase from us over the past year? If you have, you know that our desire to serve you honestly has NOT been changed! Because of the many items in short supply, it would have been possible for us to substitute merchandise of a questionable grade, but here's the "hitch": if we had done that we would have lost, for all time, the confidence we so earnestly seek. No, even in these critical times, with production still lagging, we are going to stand firm on our policy of QUALITY first, last, and always.

And, to those of you who are about to make your first purchase from us: let me, as President, not only welcome you personally but at the same time assure you that it will be our duty to serve your needs capably and honestly.

Our Store is a combination of many talents and many skills. Our Seed Department, for instance, is staffed with experts -- men who have devoted their lives to Seeds. The same holds true with our Poultry Department, our Nursery Department, and in every Department in our Store. These men stand ready to give you the benefit of their wide experience. Get to know them personally. Bring to them your questions and your problems. Their knowledge can play a great part in your success.

Finally, let me say a word about this Catalog: not all of the goods shown are in stock for immediate delivery but are expected reasonably soon. Orders received for goods not in stock will be shipped as soon as available. Again, we expect to have other items that are not listed. So if the article you may want is not shown, please come to the Store or check with us. We may have it, or be able to give you some idea of when it will be available.

We want to thank all of our friends and customers for their confidence in us these many years and for 1947 we pledge all of you our very best efforts.

Sincerely yours,

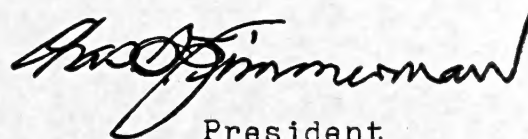

President

January 20, 1947.

Your 1947 Food Bill

can be cut considerably if you raise your own vegetables. Peacetime gardens are just as much needed as were the wartime Victory gardens, for the mounting cost of living is making inroads on every family budget. A home-garden is a real economy measure and the fresh, health-giving vegetables that you get from it are much superior to any you can buy.

★ **WHEN IN DOUBT, ORDER
THE STAR VARIETIES**



Artichoke,
Large Green Globe.
Pkt. 15 cts.

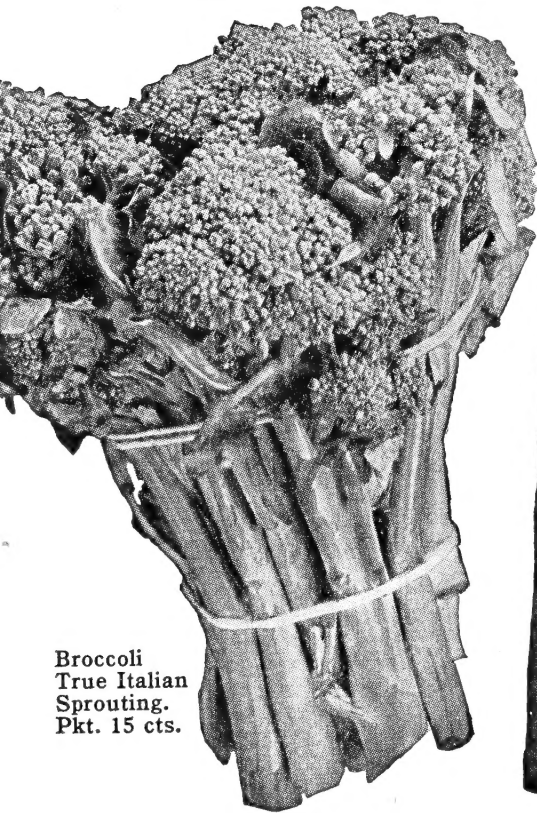

Broccoli
True Italian
Sprouting.
Pkt. 15 cts.



Asparagus, Mary Washington
2-yr. roots, 75 cts. per doz.

Brussels Sprouts, Half-Dwarf
Improved. Pkt. 15 cts.



ASPARAGUS

Equally good results may be secured by planting seed or roots; seed is cheaper but from one to two years' time is saved by starting with roots.

Sow seed early in the spring, in shallow drills 12 to 15 inches apart, and when the plants are 4 inches high, thin out to 3 inches apart; transplant to the permanent bed the following spring.

An Asparagus bed should be deeply dug and plenty of manure worked in. Set the plants so that the crown is about 3 inches below the bed-level, in rows at least 3 feet apart and 1½ to 2 feet apart in the row. Barely cover at first, filling in as the plants grow. Do not cut the first year.

*One ounce of seed will sow a 100-foot row;
5 pounds will sow an acre*

Mary Washington. ★ Plants vigorous, very productive and nearly rust-free. Shoots dark green with heavy purple overtone and of excellent quality. By far the most extensively grown variety. Seed, pkt. 10 cts., oz. 25 cts., ¼lb. 60 cts., lb. \$2.00.

Two-year-old roots, 75 cts. per doz., \$2.00 for 50, \$3.50 per 100, \$12.00 for 500, \$22.00 per 1,000.

BROCCOLI

Resembles cauliflower except in color. Suitable for home-garden, market, or freezing. For an early crop, sow the seed in a hot-bed in March and transplant seedlings in the open ground after frost. For late crop, sow the seed in the open ground in April and transplant in May or June. Days to maturity are figured from the time the plants are set in the garden.

An ounce of seed will produce about 3,000 plants

True Italian Sprouting. 70 days. A distinct variety with large, solid heads that stay green. Many sprouts develop from the leaf-axils after the heads are cut, and each terminates in a small head which is also edible. Pkt. 15 cts., oz. 50 cts., ¼lb. \$1.50.

FRENCH ARTICHOKE

This highly prized salad can be grown in our climate, provided the plants are given light protection over winter. Start the seed indoors and give the same treatment as you would tomatoes, transplanting to the garden in May. The plants are perennial.

An ounce of seed will produce 500 plants

Large Green Globe. The best variety. Pkt. 15 cts., oz. 75 cts., ¼lb. \$2.50, lb. \$8.00.

BRUSSELS SPROUTS

The "sprouts" are like miniature cabbages growing along the main stem. Takes the same culture as cabbage.

An ounce of seed will produce 2,000 plants

Half-Dwarf Improved. Compact plants about 2 feet tall. Pkt. 15 cts., ¼oz. 35 cts., oz. \$1.00, ¼lb. \$3.00.

BEANS

Everyone Can Grow Beans

DWARF GREEN-PODDED AND WAX BEANS

Although the pods of Wax Beans are considered more attractive than those of the green-podded sorts, there is no difference in quality, and personal choice, or market demand, must decide which to grow; both are delicious and both yield bountiful returns from limited space. Home gardeners will want some of both types. As soon as the ground warms up, plant the Beans $1\frac{1}{2}$ to 2 inches deep and 2 to 3 inches apart in rows 2 to $2\frac{1}{2}$ feet apart. Later plantings should be covered $2\frac{1}{2}$ to 3 inches deep. For a constant supply, plant every two weeks from May to August.

**For Increased Yield
Inoculate This Seed
with LEGUME-AID.**

A pint of seed will sow 150 feet of furrow; 1 to $1\frac{1}{2}$ bushels, depending on variety, will be required for an acre when the seed is planted in drills.

Dwarf Green-podded Beans

Bountiful. ★ 48 days. A splendid variety, well named, for it is extremely productive and always reliable. The pods are flat, of good size, and handsome appearance, always stringless, tender until full grown and of excellent flavor. Pkt. 10 cts., $\frac{1}{2}$ pt. 25 cts., pt. 45 cts., qt. 75 cts., pk. \$4.65, bus. \$16.80.

Burpee's Stringless Green-Pod. 50 days. Very productive, with pods round, thick, very meaty and perfectly stringless. An old favorite with many people. $\frac{1}{2}$ pt. 25 cts., pt. 45 cts., qt. 75 cts., pk. \$4.65, bus. \$16.80.

Giant Stringless Green-Pod. ★ 53 days. A very dependable producer. The pods are long, dark green, round, always stringless and very tender. Extensively used for canning. Pkt. 10 cts., $\frac{1}{2}$ pt. 25 cts., pt. 45 cts., qt. 75 cts., pk. \$4.65, bus. \$16.80.

Italian Black-Eye. 70 days. A very prolific yielder with long, round, slender pods, dark green in color and stringless. $\frac{1}{2}$ pt. 30 cts., pt. 50 cts., qt. 85 cts., pk. \$5.40, bus. \$19.80.

Plentiful. 50 days. Very productive and of excellent quality. Pods long, flat, straight, medium deep green, brittle, stringless, and of a distinctive flavor. Notably resistant to common rusts. A splendid variety for home-garden or market. $\frac{1}{2}$ pt. 25 cts., pt. 45 cts., qt. 75 cts., pk. \$4.65, bus. \$16.80.

Streamliner. 50 days. Ideal where a flat, heavy-yielding Bean is desired. Pods are long, straight, flat and perfectly stringless at all stages of growth. $\frac{1}{2}$ pt. 25 cts., pt. 45 cts., qt. 75 cts., pk. \$4.95, bus. \$18.00.

Stringless Black Valentine. ★ 52 days. A heavy yielder, round, stringless, with fine quality and delicate flavor. Popular with market-gardeners but equally good for home-gardens. $\frac{1}{2}$ pt. 25 cts., pt. 45 cts., qt. 75 cts., pk. \$4.65, bus. \$16.80.

Stringless Red Valentine. 52 days. Pods round, stringless, meaty, tender and of rich flavor. Unusually hardy. $\frac{1}{2}$ pt. 25 cts., pt. 45 cts., qt. 75 cts., pk. \$4.65, bus. \$16.80.

Tendergreen. ★ 53 days. Has perfectly round pods $6\frac{1}{2}$ to 7 inches long, quite slender, straight, light green, tender, absolutely stringless, meaty, and of high quality. A very popular variety with home-gardeners. Ideal for canning and freezing. $\frac{1}{2}$ pt. 25 cts., pt. 45 cts., qt. 75 cts., pk. \$4.65, bus. \$16.80.

Dwarf Wax-podded Beans

Improved Golden Wax. 51 days. Pods are thick and flat, creamy yellow in color and stringless. Hardy and prolific. $\frac{1}{2}$ pt. 25 cts., pt. 45 cts., qt. 75 cts., pk. \$4.95, bus. \$18.00.

Pencil-Pod Black Wax. 54 days. Pods round, long, slender, golden yellow, and of fine quality. Bears profusely over a long period. Desirable for home, market-garden, and canning. $\frac{1}{2}$ pt. 25 cts., pt. 45 cts., qt. 75 cts., pk. \$4.95, bus. \$18.00.

Round-Pod Brittle Wax. ★ 58 days. This Bean is superior in flavor, remarkably brittle and tender, and absolutely stringless. The pods are long, round and bright yellow. $\frac{1}{2}$ pt. 25 cts., pt. 45 cts., qt. 75 cts., pk. \$4.95, bus. \$18.00.

Dwarf Wax-podded Beans continued on page 5

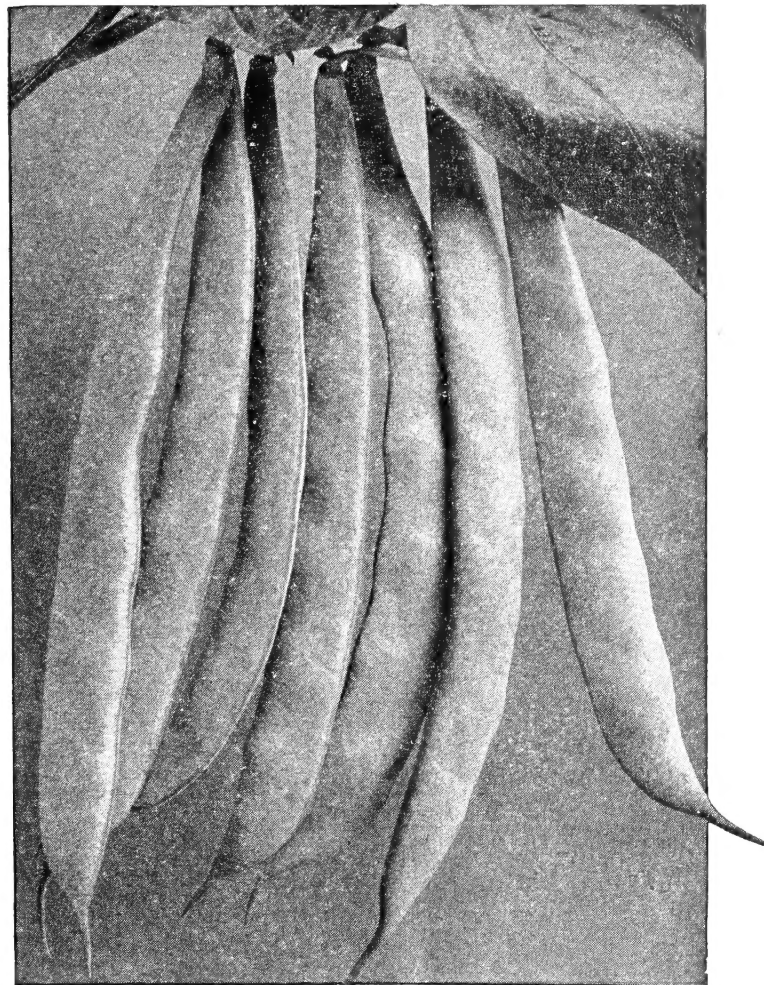

Beans, Bountiful. Pkt. 10 cts., $\frac{1}{2}$ pt. 25 cts., pt. 45 cts., qt. 75 cts.

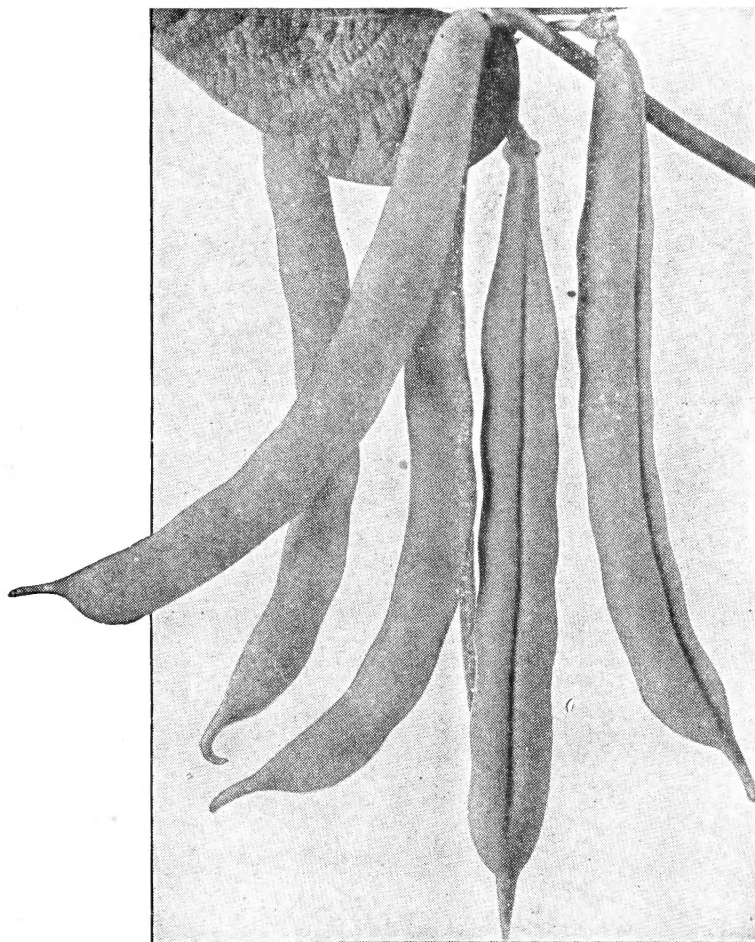

Beans, Tendergreen. $\frac{1}{2}$ pt. 25 cts., pt. 45 cts., qt. 75 cts.

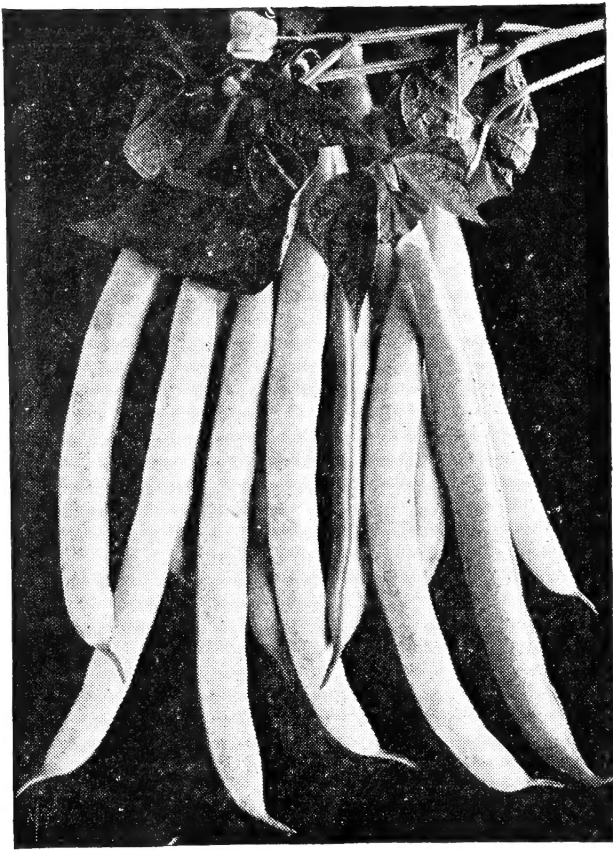

Beans, Sure-Crop Stringless Wax
Pkt. 10 cts., 1/2pt. 25 cts., pt. 45 cts., qt. 75 cts.

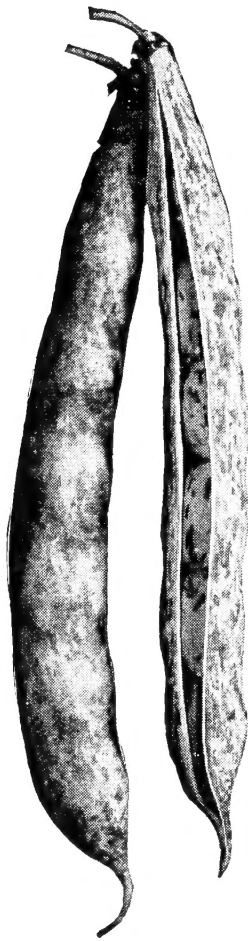

Beans, Dwarf Horticultural
1/2pt. 25 cts., pt. 45 cts.



Beans, Kentucky Wonder
Pkt. 10 cts., 1/2pt. 25 cts., pt. 45 cts., qt. 75 cts.

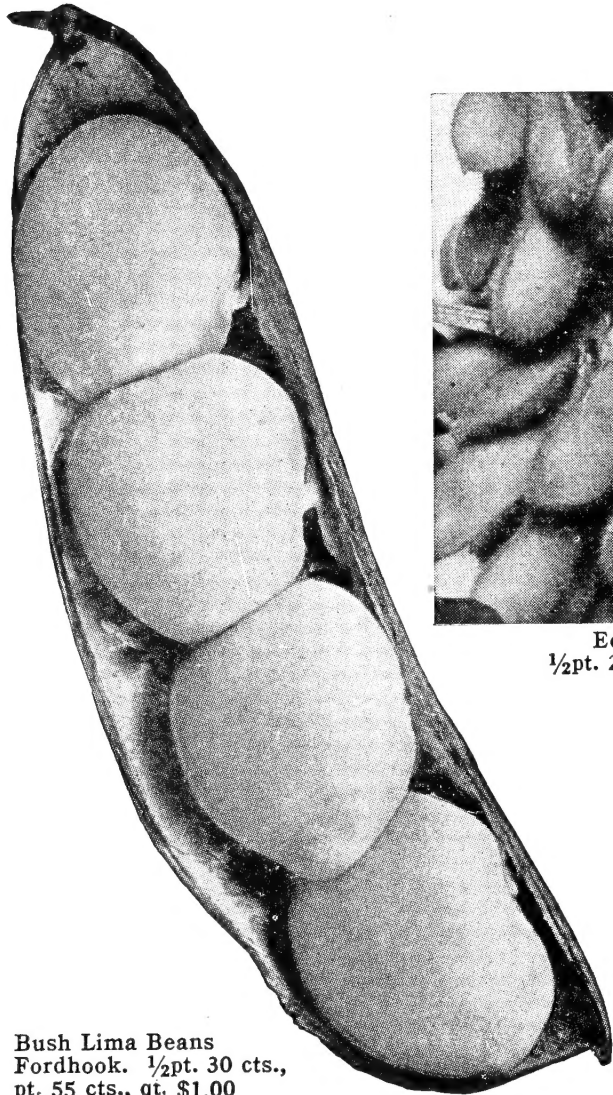

Bush Lima Beans
Fordhook. 1/2pt. 30 cts.,
pt. 55 cts., qt. \$1.00

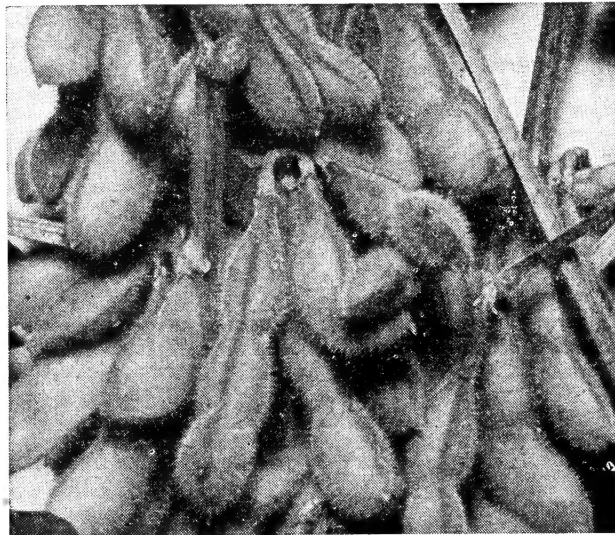

Edible Soy Beans, Bansei
1/2pt. 25 cts., pt. 40 cts., qt. 65 cts.

Beans are a stand-by in every home-garden. There are so many different types, all of high food value, that they may be enjoyed in a variety of ways. Plant succession crops in order always to have Beans at their best.

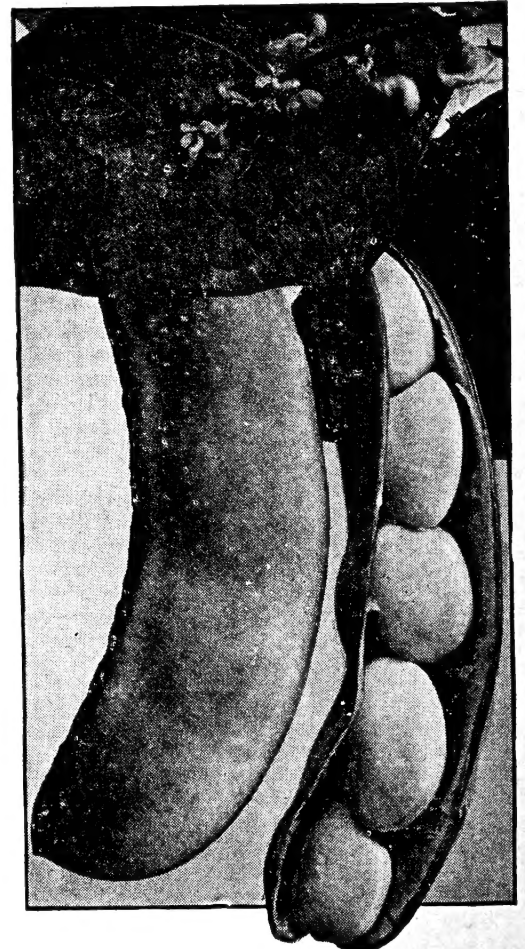

Pole Lima Beans, King of the Garden
1/2pt. 25 cts., pt. 45 cts., qt. 75 cts.

DWARF WAX-PODDED BEANS, continued

Sure-Crop Stringless Wax. ★ 53 days. Also known as Yellow Bountiful. The pods are of good size, broad, thick-flat, and bright yellow in color, entirely stringless and of fine quality. Very productive and excellent for both home and market-garden. The most popular yellow variety. Pkt. 10 cts., ½pt. 25 cts., pt. 45 cts., qt. 75 cts., pk. \$4.65, bus. \$16.80.

Top Notch Wax. 50 days. Small, compact plant with creamy yellow pods. Pods flat-oval, straight, stringless, and brittle. Valued because of its freedom from rust and other diseases. ½pt. 25 cts., pt. 45 cts., qt. 75 cts., pk. \$4.95, bus. \$18.00.

Wax- and Green-podded Pole Beans

Do not plant until the weather is really warm, then cover 6 to 10 Beans 2 inches deep in hills 3 to 4 feet apart, thinning out to 3 or 4 plants to each pole.

A quart of seed will plant 100 to 150 hills; from 12 to 16 quarts will plant an acre, depending upon the size of the Beans

Asparagus, or Yard-Long. 72 days. Pods round, slender and 2 feet or more in length. Generally grown as a novelty. ½pt. 45 cts., pt. 75 cts., qt. \$1.25.

Burger's Green-Pod Stringless. 64 days. Also known as White-Seeded Kentucky Wonder. Very prolific, bearing round, brittle pods of fine quality. ½pt. 25 cts., pt. 45 cts., qt. 75 cts., pk. \$4.65, bus. \$16.80.

Kentucky Wonder. ★ 65 days. Reliable under all conditions, and immensely productive, bearing long, round, dark green pods of fine quality. An old variety that continues to be the most popular of the Pole Beans. Pkt. 10 cts., ½pt. 25 cts., pt. 45 cts., qt. 75 cts., pk. \$4.65, bus. \$16.80.

Kentucky Wonder Wax. ★ 67 days. A Wax Bean similar in productiveness to the green-podded variety. Pkt. 10 cts., ½pt. 25 cts., pt. 45 cts., qt. 75 cts., pk. \$4.80, bus. \$17.40.

Lazy Wife. 75 days. Late sort with great clusters of richly flavored green pods which are 5 to 6 inches long. Useful also as a Shell Bean. Seeds are white. ½pt. 25 cts., pt. 45 cts., qt. 75 cts., pk. \$4.65, bus. \$16.80.

Pole Horticultural. 70 days. Also known as Pole Roman Bean or Speckled Cranberry. Very productive. Generally used as a Shell Bean, either green or dried. ½pt. 25 cts., pt. 45 cts., qt. 75 cts., pk. \$4.65, bus. \$16.80.

Scarlet Runner. 90 days. An ornamental climber whose bright scarlet blossoms are most attractive. The dried Beans are used like Limas. ½pt. 25 cts., pt. 45 cts., qt. 75 cts., pk. \$4.65.

Dwarf Shell Beans

Dwarf Horticultural. Also known as Roman Bean. Snap 54 days, green shelled 65 days. A fine producer of String and Shell Beans. Pods are about 4 inches long, wide, flat, stringless; light green with stripe of red at maturity. The ripe Beans are oval; brown, speckled with purplish red. ½pt. 25 cts., pt. 45 cts., qt. 75 cts., pk. \$4.65, bus. \$16.80.

French Horticultural. Snap 62 days, green shelled 72 days. Pods about 6 inches long, flat, stringy when mature and deep green in snap stage turning to light buff with heavy splashing of deep carmine. Plant very prolific with short runners. ½pt. 25 cts., pt. 45 cts., qt. 75 cts., pk. \$4.80, bus. \$17.40.

Red Kidney. 95 days. Resembles the White Kidney except that the ripe Beans are red in color. ½pt. 25 cts., pt. 45 cts., qt. 75 cts., pk. \$4.65, bus. \$16.80.

White Kidney. 100 days. Largely grown for dry Shell Beans. The ripe Beans are large, kidney-shaped, pure white and do not discolor when cooked. ½pt. 25 cts., pt. 45 cts., qt. 75 cts., pk. \$4.65, bus. \$16.80.

White Marrowfat. 100 days. The favorite Bean for baking. A good producer of large, white Beans of fine quality. ½pt. 30 cts., pt. 50 cts., qt. 85 cts., pk. \$5.25, bus. \$19.20.

White Navy, or Pea Bean. 95 days. Used mostly for field planting; a sure cropper and extremely prolific. The dried Beans are small, round, and white. ½pt. 25 cts., pt. 40 cts., qt. 70 cts., pk. \$4.20, bus. \$15.00.

NOTE: One pint of Beans weighs about 1 lb., 1 quart about 2 lbs., and 1 bushel, 60 lbs.

Bush Lima Beans

Never plant Bush Lima Beans until the weather is really warm. Plant on edge, with the eye down, 4 to 5 inches apart and 1 inch deep, in rows 2½ to 3 feet apart; thin the plants to 8 to 10 inches apart.

A pint of seed will sow 100 feet of furrow; a bushel will sow an acre

Baby Fordhook. 70 days. A thick-seeded, small Lima Bean of excellent quality which remains green a long time. Extra-heavy cropper; especially suitable for canning. ½pt. 30 cts., pt. 50 cts., qt. 85 cts., pk. \$5.25, bus. \$19.20.

Burpee Improved. ★ 75 days. The large bushes bear loads of big, broad pods, each containing 4 or 5 Beans of the largest size and finest quality. ½pt. 30 cts., pt. 55 cts., qt. \$1.00, pk. \$5.55, bus. \$20.40.

Fordhook. ★ 75 days. Extremely prolific, bearing good-sized pods which contain 3 to 5 large, thick, meaty Beans of delicious flavor. Its fine quality, attractive appearance, and large pods rate it as the best dwarf Lima Bean for either home-garden or commercial use. ½pt. 30 cts., pt. 55 cts., qt. \$1.00, pk. \$5.55, bus. \$20.40.

Fordhook 242. 72 days. A new variety with thick, plump seeds, 3 or 4 to the pod and of fine flavor. Good yielder. ½pt. 30 cts., pt. 55 cts., qt. \$1.00, pk. \$5.55, bus. \$20.40.

Pole Lima Beans

These take longer to bear than the Bush Limas, but yield larger crops and continue to bear for a longer period. The seed is usually planted in hills, at least 3 feet apart each way, dropping 4 to 6 Beans to the hill. Set poles 8 to 10 feet long in each hill to support the vines.

A quart of seed will plant 100 hills; 20 quarts will plant one acre

Carpinteria. 90 days. Large pods, containing 3 to 5 Beans which are very thick and mealy and retain their green color even when ripe. ½pt. 25 cts., pt. 45 cts., qt. 75 cts., pk. \$4.65, bus. \$16.80.

Challenger. ★ 92 days. A vigorous grower, hardy, and very productive. Pods are 5 to 6 inches long and filled with 4 or 5 thick, plump Beans of delicious flavor. ½pt. 25 cts., pt. 45 cts., qt. 75 cts., pk. \$4.65, bus. \$16.80.

King of the Garden. ★ 88 days. Broad pods 5 to 6 inches long, containing 4 or 5 large, flat Beans. Probably the leading Pole Lima Bean for both home and market-gardeners. Allow only two vines to each pole. ½pt. 25 cts., pt. 45 cts., qt. 75 cts., pk. \$4.65, bus. \$16.80.

Leviathan. ★ 85 days. A general favorite, being early and productive, bearing loads of giant pods, well filled with large tender Beans. ½pt. 25 cts., pt. 45 cts., qt. 75 cts., pk. \$4.65, bus. \$16.80.

Edible Soy Beans

Bansei. 90 days. A very popular variety of vegetable-type Soy Beans. Early and extremely productive. They are delicious when eaten green or dry. Seeds are bright green while young and yellow when mature. ½pt. 25 cts., pt. 40 cts., qt. 65 cts., pk. \$3.30, bus. \$11.40.

CHICORY

The Large-rooted variety is grown for its roots, which may be cooked and served like turnips.

The Witloof variety is highly esteemed as a winter salad, for which purpose the plants are taken up in the fall, cut back nearly to the top of the root, and then covered with soil in a box or trench in a warm cellar. The new leaves which grow from the old roots in about a month's time are nearly white, crisp and of a fine, piquant flavor.

Sow Chicory seed in April or May, in shallow drills in rows about 18 inches apart and thin the plants to stand 4 to 6 inches apart.

An ounce will sow about 400 feet of drill

Large-rooted. Roots 12 to 14 inches long, 2 inches in diameter at top, and tapered. Pkt. 10 cts., oz. 50 cts., ¼lb. \$1.50, lb. \$5.00.

Witloof. Sometimes called French Endive. Pkt. 10 cts., oz. 65 cts., ¼lb. \$2.00, lb. \$6.00.

BEETS

Sow seed as early in the spring as possible, in drills 15 to 18 inches apart, covering about 1 inch deep, and thin the plants to 2 to 3 inches apart. Plantings every three weeks until mid-July will furnish a supply of fresh Beets until late fall. Late in June make a large planting to produce Beets for winter use. Harvest before frost and store in pits outdoors, or in a dry cellar. For an extra-early crop start the seed under glass.

An ounce of seed will sow about 100 feet of drill; 6 pounds an acre

Crosby's Extra-Early. ★ 55 days. Dark red skin and deep red flesh; very uniform in shape and size. Pkt. 10 cts., oz. 20 cts., $\frac{1}{4}$ lb. 65 cts., lb. \$2.00.

Detroit Dark Red. ★ 60 days. Smooth, and uniformly globe-shaped, with dark red skin and flesh, fine-grained, tender and sweet. The standard variety for home-gardeners. Pkt. 10 cts., oz. 20 cts., $\frac{1}{4}$ lb. 65 cts., lb. \$2.00.

Early Blood Turnip. 55 days. Dark red skin and bright red flesh of good quality. Pkt. 10 cts., oz. 20 cts., $\frac{1}{4}$ lb. 65 cts., lb. \$2.00.

Early Wonder. ★ 50 days. The most desirable variety for market-gardeners. Roots round, deep red, smooth, tender and of excellent quality. Unsurpassed in uniformity and depth of interior color. Pkt. 10 cts., oz. 20 cts., $\frac{1}{4}$ lb. 65 cts., lb. \$2.00.

Extra-Early Egyptian. 53 days. One of the earliest. Medium-sized, flat, smooth roots with dark crimson skin and flesh. Pkt. 10 cts., oz. 20 cts., $\frac{1}{4}$ lb. 65 cts., lb. \$2.00.

Green Top Early Wonder. ★ 50 days. An outstanding new selection of Early Wonder. Foliage clean bright green, which does not have the tendency to turn red when grown in cool weather. Pkt. 10 cts., oz. 20 cts., $\frac{1}{4}$ lb. 65 cts., lb. \$2.00.

Perfected Detroit. 60 days. Roots globular, medium smooth, deep red; flesh dark red and practically free from zoning. Good quality. Pkt. 10 cts., oz. 20 cts., $\frac{1}{4}$ lb. 65 cts., lb. \$2.00.

MANGEL-WURZEL or CATTLE BEETS

Generally used for winter feeding of poultry and livestock.

Sow the seed in April or early May in rows 2 to 3 feet apart and when the plants are 2 to 3 inches high, thin them out to stand 8 to 10 inches apart. Harvest before frost and store in pits outdoors or in a dry, frost-proof cellar.

Four to 5 pounds of seed will sow an acre in drills

Golden Tankard. ★ Large, long roots unusually high in feeding value. Oz. 20 cts., $\frac{1}{4}$ lb. 50 cts., lb. \$1.50, 5 lbs. \$7.00.

Long Red Mammoth. ★ Enormous roots which grow largely above ground and are easy to harvest. Oz. 20 cts., $\frac{1}{4}$ lb. 50 cts., lb. \$1.50, 5 lbs. \$7.00.

White Sugar. Very productive, rich in sugar and especially good for stock-feeding. Oz. 20 cts., $\frac{1}{4}$ lb. 50 cts., lb. \$1.50, 5 lbs. \$7.00.

SWISS CHARD

One of the best of the vegetables grown for "greens." It takes the same culture as Beets except that the plants should be thinned to stand 8 inches apart. Pull the leaves off as they become ready and new ones will grow in their place.

An ounce of seed will sow about 150 feet of drill

Fordhook Giant. ★ 58 days. An outstanding variety with curly, rich dark green leaves and broad white ribs, of a quality better than spinach. Pkt. 10 cts., oz. 20 cts., $\frac{1}{4}$ lb. 65 cts., lb. \$2.00.

Lucullus Giant. 58 days. A tall variety with light green, deeply wrinkled and crumpled leaves. Pkt. 10 cts., oz. 20 cts., $\frac{1}{4}$ lb. 65 cts., lb. \$2.00.

Rhubarb Chard. ★ 58 days. Stalks glowing but delicate crimson; the rich red color extends through the veins into the dark green, heavily crumpled leaves. Has a delicious flavor. Pkt. 15 cts., oz. 50 cts.

CABBAGE

Early Cabbage should be started under glass in February or early March, and transplanted to the open ground as soon as the weather is suitable. For late Cabbage sow the seed outdoors about May 1. Plants should stand $1\frac{1}{2}$ to 2 feet apart, according to variety. Number of days shown indicate days to maturity from the time the plants are set in the garden. Allow about 40 days to produce plants from seed.

An ounce of seed will produce about 2,000 plants

Copenhagen Market. ★ 68 days. The heads are round, extremely solid, with small core and of excellent quality. The most popular early sort for both home and market-gardens. Pkt. 10 cts., oz. 45 cts., $\frac{1}{4}$ lb. \$1.25, lb. \$4.00.

Early Jersey Wakefield. 63 days. Heads rather small, pointed, solid, crisp and tender. The best early, pointed-head variety. Pkt. 10 cts., oz. 45 cts., $\frac{1}{4}$ lb. \$1.25, lb. \$4.00.

Glory of Enkhuizen. ★ 80 days. A very attractive second-early variety. Heads large, round, solid and of excellent quality. A good keeper. Pkt. 10 cts., oz. 45 cts., $\frac{1}{4}$ lb. \$1.25, lb. \$4.00.

Golden Acre. 64 days. An early strain of the Copenhagen type. Heads small, uniformly round, firm and solid; crisp, tender and of fine quality. Especially valuable for early market. Pkt. 10 cts., oz. 45 cts., $\frac{1}{4}$ lb. \$1.25, lb. \$4.00.

Hollander, or Danish Ballhead. ★ 95 days. Most widely used and best all-purpose variety for market, kraut or storage. Heads are medium size, deep round, very hard, crisp, tender and of fine quality. Pkt. 10 cts., oz. 45 cts., $\frac{1}{4}$ lb. \$1.25, lb. \$4.00.

Penn State Ballhead. ★ 100 days. The hard, tight heads weigh one-third more than ordinary heads of same size and are good keepers. Pkt. 15 cts., oz. 45 cts., $\frac{1}{4}$ lb. \$1.25, lb. \$4.00.

Premium Flat Dutch. 105 days. A heavy yielder, producing large, heavy, flat heads which keep well until late in winter. Pkt. 10 cts., oz. 45 cts., $\frac{1}{4}$ lb. \$1.25, lb. \$4.00.

Yellows-Resistant Varieties

Specially selected strains of Cabbage developed for use on yellow-infested soil.

Detroit. 64 days. Yellows-resistant strain of Golden Acre. Heads medium sized, round, solid, crisp and of excellent quality. Pkt. 15 cts., oz. 60 cts., $\frac{1}{4}$ lb. \$1.75, lb. \$6.00.

Globe. 85 days. A yellows-resistant strain of Glory of Enkhuizen. Pkt. 15 cts., oz. 60 cts., $\frac{1}{4}$ lb. \$1.75, lb. \$6.00.

Jersey Queen. 65 days. A pointed-head type selected from Early Jersey Wakefield for disease resistance. Pkt. 15 cts., oz. 60 cts., $\frac{1}{4}$ lb. \$1.75, lb. \$6.00.

Marion Market. ★ 78 days. A development from Copenhagen Market but later maturing and slightly larger head. Pkt. 15 cts., oz. 60 cts., $\frac{1}{4}$ lb. \$1.75, lb. \$6.00.

Wisconsin All Season. 92 days. A hardy drumhead variety which stands hot weather unusually well and is highly resistant to "yellows." Heads are semi-flat, solid and compact, and of fine quality. Pkt. 15 cts., oz. 60 cts., $\frac{1}{4}$ lb. \$1.75, lb. \$6.00.

Wisconsin Hollander No. 8. ★ 105 days. Of the Danish Ballhead type. Popular late variety for yellows-infested soil. Pkt. 15 cts., oz. 60 cts., $\frac{1}{4}$ lb. \$1.75, lb. \$6.00.

Red Cabbage

Mammoth Rock Red. 100 days. Heads flattened and very large. Pkt. 10 cts., oz. 60 cts., $\frac{1}{4}$ lb. \$1.75, lb. \$6.00.

Red Hollander. (Yellows-resistant.) 100 days. Head round, hard and of medium size. Pkt. 15 cts., oz. \$1.00, $\frac{1}{4}$ lb. \$3.00.

Savoy Cabbage

The leaves are curled and crinkled and the heads are firm and solid. They are best late in the season after a heavy frost.

Chieftain. 90 days. Solid heads with nicely savoyed leaves. Pkt. 15 cts., oz. 50 cts., $\frac{1}{4}$ lb. \$1.50, lb. \$5.00.

Drumhead Savoy. 95 days. Large, solid heads and few outer leaves. Pkt. 10 cts., oz. 50 cts., $\frac{1}{4}$ lb. \$1.50, lb. \$5.00.

★ WHEN IN DOUBT, ORDER THE STAR VARIETIES

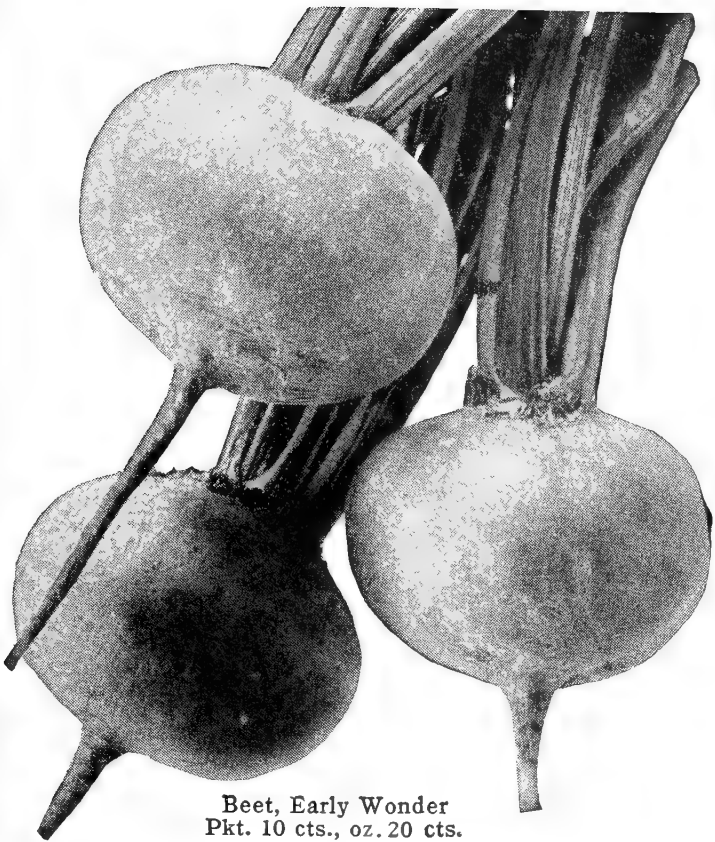

Beet, Early Wonder
Pkt. 10 cts., oz. 20 cts.

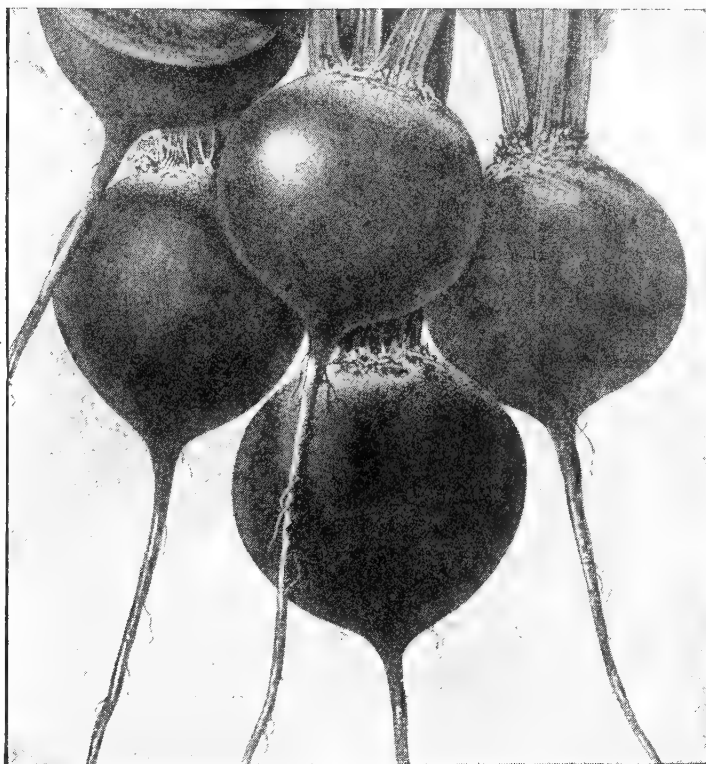

Beet, Detroit Dark Red. Pkt. 10 cts., oz. 20 cts.

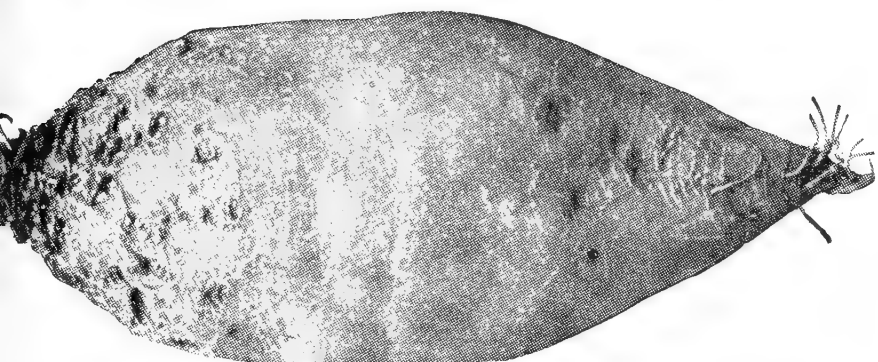

Mangel-Wurzel, Long Red Mammoth. Oz. 20 cts., 1/4lb. 50 cts.

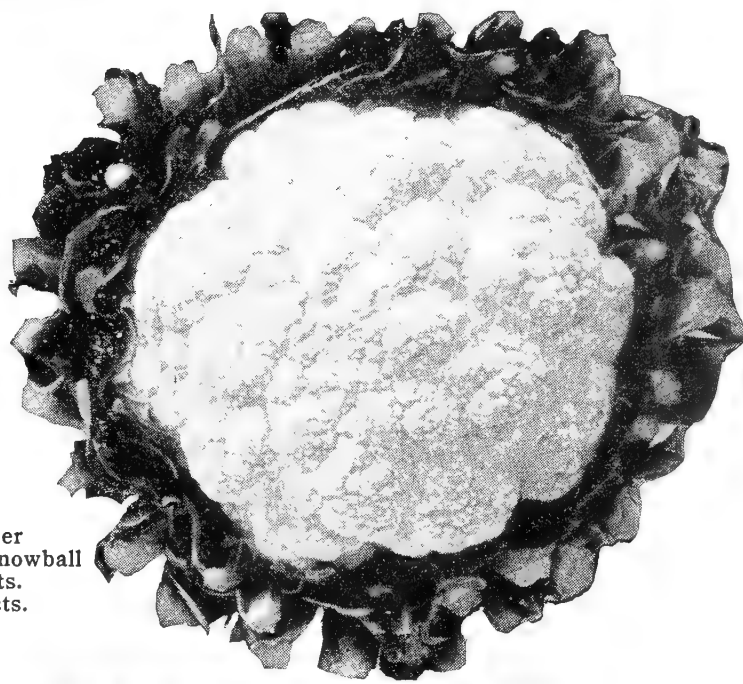

Cauliflower
Select Early Snowball
Pkt. 25 cts.
1/4oz. 90 cts.

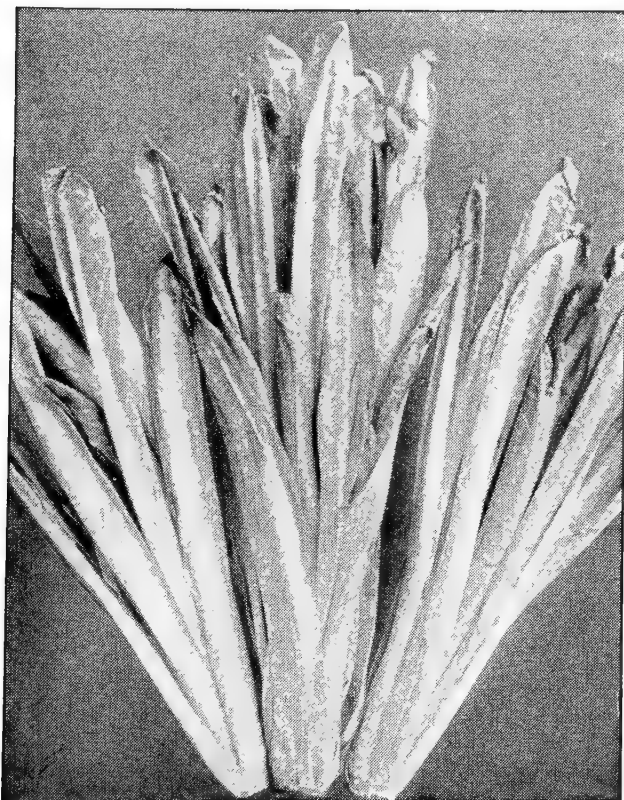

Chicory, Witloof. Pkt. 10 cts., oz. 65 cts.



Swiss Chard, Fordhook Giant. Pkt. 10 cts., oz. 20 cts.

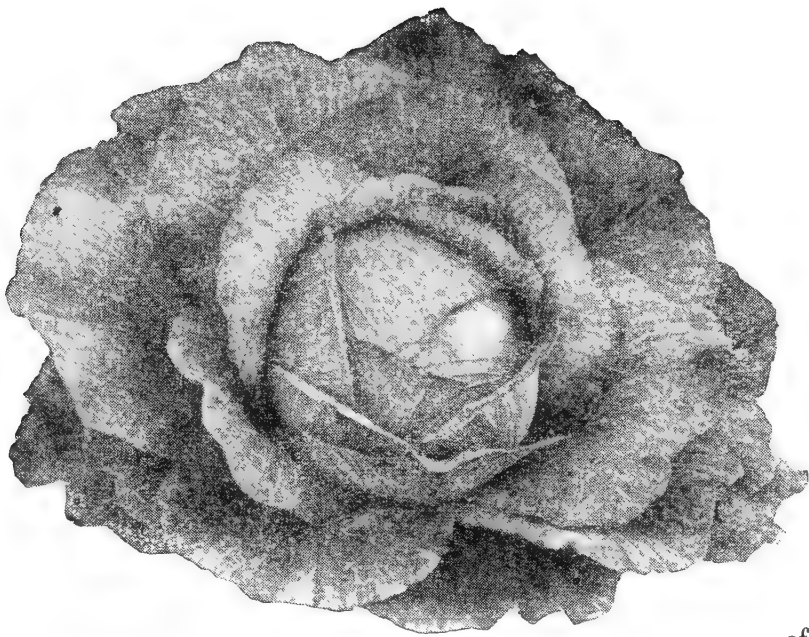

Cabbage, Hollander. Pkt. 10 cts., oz. 45 cts.



**Chinese or
Celery Cabbage
Chihli
Pkt. 10 cts.
oz. 40 cts.**

Cabbage is an important source of vitamin C. It is an especially valuable food when served raw or cooked only a short time. Chinese and Savoy Cabbage are delicious novelties for the table.

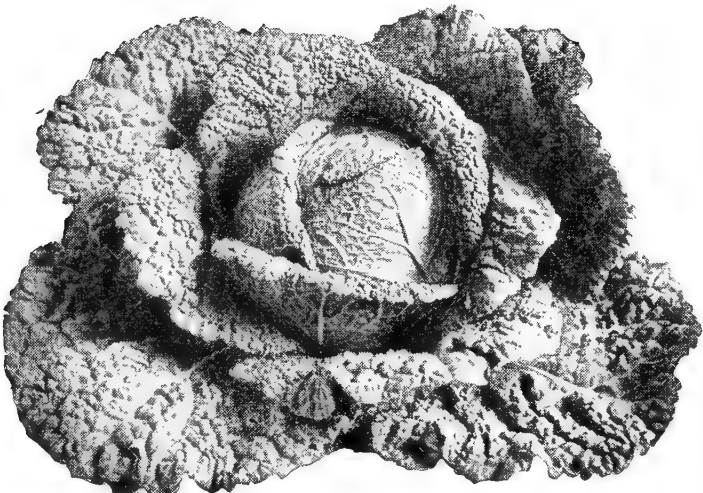

Savoy Cabbage, Chieftain. Pkt. 15 cts., oz. 50 cts.



Cabbage, Copenhagen Market. Pkt. 10 cts., oz. 45 cts.



**Carrot
Chantenay
Pkt. 10 cts.
oz. 25 cts.**

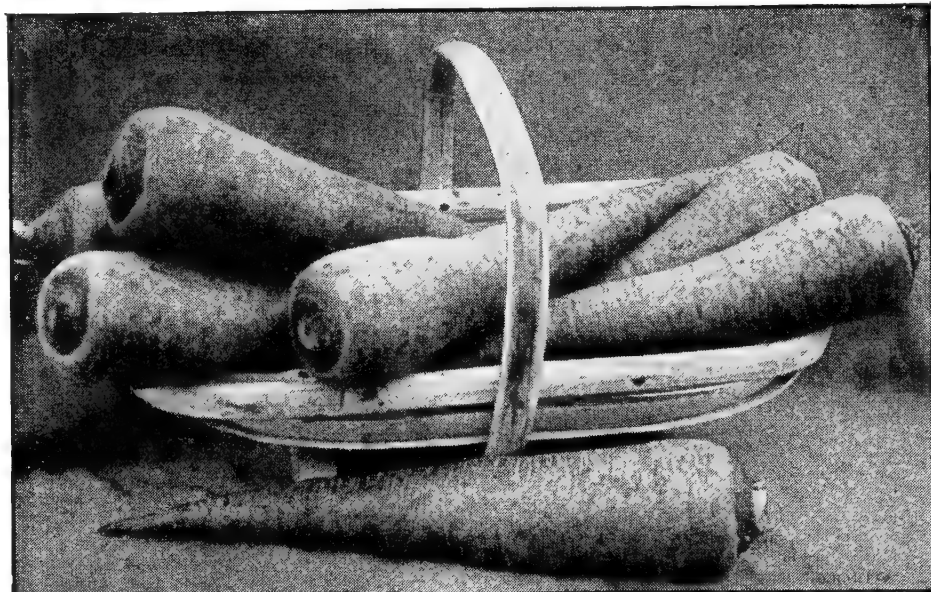

Carrot, Improved Long Orange. Pkt. 10 cts., oz. 25 cts.



**Carrot, Danvers Half-Long
Pkt. 10 cts., oz. 25 cts.**

CARROTS

Carrots succeed in any good garden soil. Sow the seed any time after the frost is out of the ground in rows about 15 inches apart, covering it about $\frac{1}{2}$ inch deep and pressing down firmly. Thin the seedlings to 2 inches apart in the row. Make sowings every 3 to 4 weeks from late March to the end of June. Carrots for winter storage should be sown in early June.

*An ounce of seed will sow about 200 feet of drill;
3 to 4 pounds are required to sow an acre*

- Chantenay.** ★ 70 days. The roots are broad at the top, tapering to an abrupt point. It produces heavy yields on comparatively shallow soils. Pkt. 10 cts., oz. 25 cts., $\frac{1}{4}$ lb. 75 cts., lb. \$2.00.
- Danvers Half-Long.** ★ 75 days. The roots are smooth, nearly cylindrical, bluntly pointed, and in good soil will attain a length of 6 to 8 inches. The skin and flesh are bright orange-red, fine-grained and tender. Pkt. 10 cts., oz. 25 cts., $\frac{1}{4}$ lb. 75 cts., lb. \$2.00.
- Imperator.** 77 days. Roots deep rich orange, smooth, about 8 inches long and uniformly tapered to a semi-blunt end. Flesh rich orange, fine grained, tender and of excellent quality. Meets the most exacting demand for a long, smooth, handsome Carrot. Pkt. 10 cts., oz. 25 cts., $\frac{1}{4}$ lb. 75 cts., lb. \$2.00.
- Improved Long Orange.** 85 days. Large, tapering roots, 12 to 14 inches long, smooth, bright orange in color and of good quality. Pkt. 10 cts., oz. 25 cts., $\frac{1}{4}$ lb. 75 cts., lb. \$2.00.
- Morse's Bunching.** 77 days. Roots rich even reddish orange, small core; 8 inches long, sweet, tender; short, strong tops. Pkt. 10 cts., oz. 25 cts., $\frac{1}{4}$ lb. 75 cts., lb. \$2.00.
- Nantes Half Long.** ★ 68 days. One of the best for home-garden and early market. Roots bright orange, 6 to 7 inches long, stump-rooted; flesh bright orange and of highest quality. Core inconspicuous. Pkt. 10 cts., oz. 25 cts., $\frac{1}{4}$ lb. 75 cts., lb. \$2.00.
- Oxheart.** 75 days. Thick, blunt, bright orange roots. Grown largely for stock feed. Prolific and a good keeper. Pkt. 10 cts., oz. 25 cts., $\frac{1}{4}$ lb. 75 cts., lb. \$2.00.
- Red-Cored Chantenay.** 70 days. A rich orange color, decidedly deeper than the ordinary Chantenay. Roots are uniform in size and appearance, and a little earlier in maturity than ordinary Chantenay. Pkt. 10 cts., oz. 25 cts., $\frac{1}{4}$ lb. 75 cts., lb. \$2.00.

CAULIFLOWER

Sow the seed and treat the young plants exactly as you would cabbage, starting the spring crop in flats indoors or in the hotbed early in February and transplanting to the garden in May after danger from frost is past. Sow for fall crop in coldframe or seed-bed in May and transplant in June. Set the plants $1\frac{1}{2}$ feet apart, digging in plenty of manure if it is available. When the plants show signs of heading, water them freely. Finally, when the heads are about 2 inches in diameter, tie the outer leaves loosely together over the top with soft twine, to protect them from the sun and blanch them white. Days to maturity are from the time the plants are set in the garden. Allow about 30 days to produce the plants from seed.

An ounce of seed will produce about 4,000 plants

- Danish Giant, or Dry Weather.** 70 days. A little later than Snowball and the plants are larger. Preferred in some sections because it will grow and head during dry weather. Pkt. 25 cts., $\frac{1}{4}$ oz. 90 cts., oz. \$2.50, $\frac{1}{4}$ lb. \$8.00.
- Select Early Snowball.** ★ 60 days. Extra-early and one of the surest headers. It produces deep, solid heads of medium size, pure white, and of fine quality. Being compact in growth, the plants can be set close together. Pkt. 25 cts., $\frac{1}{4}$ oz. 90 cts., oz. \$2.50, $\frac{1}{4}$ lb. \$8.00.
- Snowdrift.** ★ 60 days. Somewhat more vigorous than Snowball and selected to produce a larger head without losing materially in earliness. The pure white heads are remarkable for their great depth and unexcelled white color, and the curd is of fine texture and free from small protruding leaves. Very productive and one of the surest headers known. Pkt. 25 cts., $\frac{1}{4}$ oz. 90 cts., oz. \$2.50, $\frac{1}{4}$ lb. \$8.00.

CELERY

Celery wants plenty of fertilizer—enrich the spot where you are going to grow it with manure, humus, or rich compost, or if you lack these, with a commercial fertilizer high in nitrogen. For early crops sow indoors or in a hotbed about April 1, barely covering the seed with soil. When the seedlings are 2 to 3 inches high, thin out or transplant $1\frac{1}{2}$ to 2 inches apart. Set out by the end of May. For winter Celery, sow seed in a coldframe or sheltered spot in the garden about mid-April and reset in the trenches about July 1. It is a good plan to cut off the tops of the plants when they are 4 to 5 inches high to make them more stocky.

An ounce of seed will produce about 7,500 plants

- Easy Blanching.** ★ The stalks are of medium height, thick through, and brittle; the heart is heavy, blanching quickly to a clear light yellow. Good for both early and late crop. Pkt. 10 cts., oz. 60 cts., $\frac{1}{4}$ lb. \$1.75, lb. \$6.00.
- Fordhook.** Stalks smooth, entirely free from stringy fibers, and $1\frac{1}{2}$ inches through when cut. Blanches pure white but heart has a tinge of light, buttery yellow. Crisp, nutty flavor. Pkt. 10 cts., oz. 60 cts., $\frac{1}{4}$ lb. \$1.75, lb. \$6.00.
- Giant Pascal.** ★ A fine, late Celery with broad, thick, heavy stalks of superb nutty flavor; blanches yellowish white. A good winter keeper, retaining its flavor and crispness in storage. Pkt. 10 cts., oz. 60 cts., $\frac{1}{4}$ lb. \$1.75, lb. \$6.00.
- Golden Plume, or Wonderful.** ★ Resembles Golden Self-blanching in crispness and flavor, but much larger, blanches quicker and matures earlier. Desirable for market-gardeners. Pkt. 15 cts., oz. 80 cts., $\frac{1}{4}$ lb. \$2.25, lb. \$8.00.
- Golden Self-Blanching.** It is rather low and compact in growth, with thick, round stalks and heavy heart, blanching easily to a rich golden yellow. In flavor and quality it is unsurpassed. Pkt. 10 cts., oz. 80 cts., $\frac{1}{4}$ lb. \$2.25, lb. \$8.00.
- Summer Pascal.** ★ An early variety of excellent quality. Plant not tall but sturdy and robust. Stems are thick, tender, stringless and of rich flavor. Pkt. 25 cts., oz. \$1.50, $\frac{1}{4}$ lb. \$5.00.
- Utah Jumbo.** Plants are large, erect, compact, full hearted and usually grow 26 to 28 inches high. Edible stems are numerous, thick, and quite smooth; are crisp and of fine quality. Pkt. 15 cts., oz. 70 cts., $\frac{1}{4}$ lb. \$2.00, lb. \$7.00.
- White Plume.** A very early, easily grown variety with tall, handsome stalks which blanch quickly to a silvery white. A favorite. Pkt. 10 cts., oz. 60 cts., $\frac{1}{4}$ lb. \$1.75, lb. \$6.00.

CELERIAC or TURNIP-ROOTED CELERY

The roots—not the stalks—are the edible portion of this plant. They are used for flavoring soups and in stews, in place of Celery or Celery seed, and are also cooked or used as a salad. Grown like Celery but does not require blanching. Roots may be stored as you would beets and carrots, and used throughout the winter.

- Large Prague.** A productive variety with large, round roots. Pkt. 10 cts., oz. 70 cts., $\frac{1}{4}$ lb. \$2.00.

Chinese or Celery Cabbage

A most palatable and wholesome vegetable which may be served raw as salad or cole slaw, or it may be cooked like cabbage. Sow the seed the last of June or early in July, in shallow drills about 2 feet apart, and thin or transplant the seedlings to stand about 15 inches apart.

- Chihli.** 75 days. Produces heads about 18 inches high and 4 inches or more in diameter. Very firm, crisp, sweet and tender. Pkt. 10 cts., oz. 40 cts., $\frac{1}{4}$ lb. \$1.15, lb. \$3.50.

CELTUCE

An appetizing vegetable novelty from China. Seed is sown outdoors and the young plants thinned to 6 inches apart. Grows about a foot high. Young leaves are used as salad; the stalk eaten raw or cooked. Pkt. 15 cts., oz. \$1.00, $\frac{1}{4}$ lb. \$3.00.

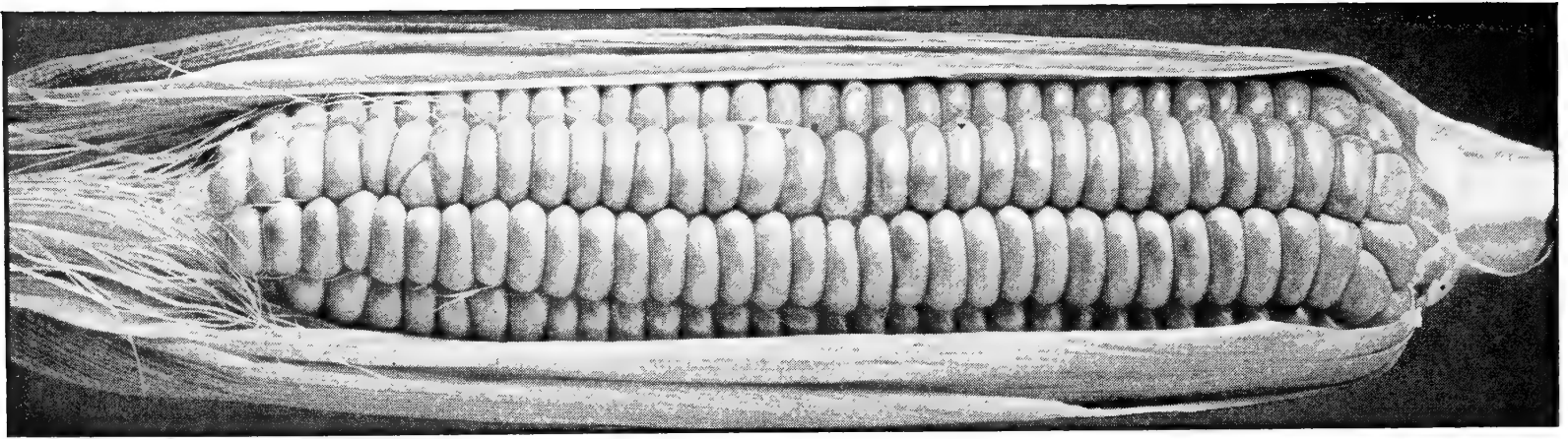

Corn, Golden Bantam. $\frac{1}{2}$ pt. 20 cts., pt. 35 cts., qt. 60 cts.

We have an excellent line of Sweet Corn, and recommend that you try some of the hybrid varieties developed in recent years for disease resistance and high yields.

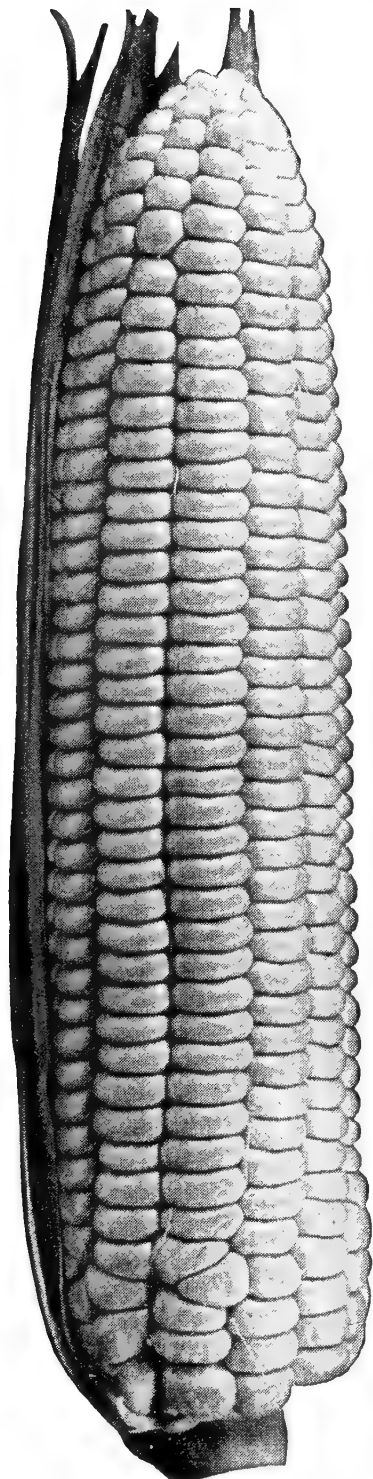

Corn, Golden Evergreen
 $\frac{1}{2}$ pt. 20 cts., pt. 35 cts., qt. 60 cts.

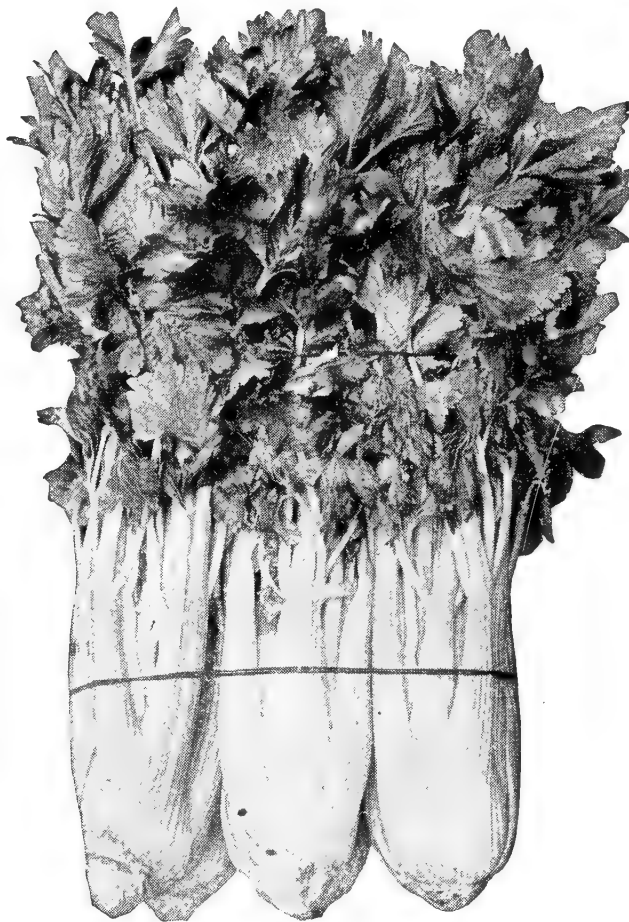

Celery, Golden Plume or Wonderful
Pkt. 15 cts., oz. 80 cts.



Celeriac or Turnip-rooted Celery
Large Prague. Pkt. 10 cts., oz. 70 cts.

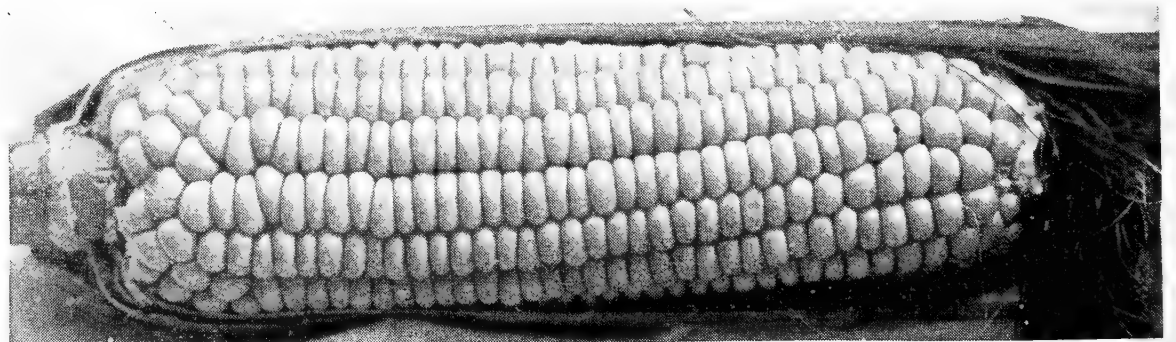

Corn, Marcross C13.6. $\frac{1}{2}$ pt. 30 cts., pt. 50 cts., qt. 85 cts.

SWEET CORN

Do not make the first sowing until the soil is warm and comparatively dry—the middle of May is usually the earliest it is safe to sow Corn in this section. Plant every 2 weeks until early July. It can be grown in hills or in rows. Hills are placed 2 to 3 feet apart each way, dropping about six seeds in each hill and, when the plants are about 8 inches high, pulling out all but the three or four strongest. Rows are spaced $2\frac{1}{2}$ to $3\frac{1}{2}$ feet apart and the plants thinned to stand 12 to 15 inches apart in the rows. In planting, cover the seed about 2 inches deep. In order that the ears may develop perfectly they must receive plenty of pollen from near-by stalks; consequently, it is always best to plant Sweet Corn in several short rows, side by side, rather than in one or two long rows. If you want to enjoy Sweet Corn far sweeter and richer than any you have ever been able to buy, grow it yourself and pick it just before it is to be cooked.

*One pint of seed will plant about 150 hills or 300 feet of row;
6 to 8 quarts will plant an acre*

Early Varieties

- Burbank's Bantam.** ★ 70 days. The ear is 7 to 8 inches long, with 12 to 16 rows of delicious yellow kernels. The earliest of the yellow varieties. $\frac{1}{2}$ pt. 20 cts., pt. 35 cts., qt. 60 cts., pk. \$3.25, bus. \$12.00.
- Early Mayflower.** 70 days. Ears 7 inches long with 8 or 10 rows of broad, tender, pure white kernels. Fine for first early. $\frac{1}{2}$ pt. 20 cts., pt. 35 cts., qt. 60 cts., pk. \$3.25, bus. \$12.00.
- Extra-Early Adams.** 70 days. Not a true Sweet Corn but extremely hardy and early. $\frac{1}{2}$ pt. 20 cts., pt. 35 cts., qt. 60 cts., pk. \$2.75, bus. \$10.00.
- Golden Bantam.** ★ 80 days. For many years the most popular variety in the country—a distinction which it still retains and deservedly so, for no other variety can surpass it for quality and sweetness. The ears are slender, about 6 inches long, and well filled with golden kernels of the most delicious flavor. Everyone likes Golden Bantam. Pkt. 10 cts., $\frac{1}{2}$ pt. 20 cts., pt. 35 cts., qt. 60 cts., pk. \$3.25, bus. \$12.00.
- Golden Sunshine.** ★ 75 days. An improvement on Golden Bantam in that the ears are an inch longer and 12-rowed instead of 8-rowed. A very popular variety because of its sweetness and flavor combined with its extreme earliness. $\frac{1}{2}$ pt. 20 cts., pt. 35 cts., qt. 60 cts., pk. \$3.25, bus. \$12.00.

Medium-Early Varieties

- Barden's Wonder Bantam.** 85 days. A strain of Golden Bantam. Ears 8-rowed, about 8 inches long; kernels rich golden yellow, deliciously sweet and tender. $\frac{1}{2}$ pt. 20 cts., pt. 35 cts., qt. 60 cts., pk. \$3.25, bus. \$12.00.
- Black Mexican.** 88 days. The ears are of good size with broad kernels which are bluish white when they reach the edible stage and turn violet when cooked. Very sweet and tender. $\frac{1}{2}$ pt. 20 cts., pt. 35 cts., qt. 60 cts., pk. \$3.25, bus. \$12.00.
- Early Evergreen.** 95 days. Not quite so tall but several days earlier than Stowell's, bearing large ears of typical Evergreen type and quality. $\frac{1}{2}$ pt. 20 cts., pt. 35 cts., qt. 60 cts., pk. \$3.25, bus. \$12.00.
- Golden Giant.** ★ 85 days. As sweet, tender, and rich in flavor as the famous Golden Bantam, practically as early, more productive, and much larger. $\frac{1}{2}$ pt. 20 cts., pt. 35 cts., qt. 60 cts., pk. \$3.25, bus. \$12.00.
- Howling Mob.** ★ 85 days. Unusually large ear for so early a sort and not surpassed in quality by any other white Sweet Corn. $\frac{1}{2}$ pt. 20 cts., pt. 35 cts., qt. 60 cts., pk. \$3.25, bus. \$12.00.
- Whipple's Early White.** 85 days. Matures about a week later than the small extra-early sorts. Ears 8 to 9 inches long with 16 or 18 rows of pearly white and sweet grains. $\frac{1}{2}$ pt. 20 cts., pt. 35 cts., qt. 60 cts., pk. \$3.25, bus. \$12.00.
- Whipple's Early Yellow.** ★ 85 days. Ears about 7 inches long with 12 or 14 rows of golden yellow kernels, fairly deep, sweet and of delicious flavor. Popular home and market-garden variety. $\frac{1}{2}$ pt. 20 cts., pt. 35 cts., qt. 60 cts., pk. \$3.25, bus. \$12.00.

Late Varieties

- Country Gentleman.** 95 days. Fine rich flavor. The ears are 7 to 8 inches long with long, narrow kernels set densely and irregularly on a very small cob. Often called "Shoe-Peg." Pkt. 10 cts., $\frac{1}{2}$ pt. 20 cts., pt. 35 cts., qt. 60 cts., pk. \$3.25, bus. \$12.00.
- Golden Colonel.** 95 days. Given award of merit in All-America Seed Selections for 1936. Like Country Gentleman except color, which is brilliant yellow. The only yellow Sweet Corn ripening with main-crop sorts. $\frac{1}{2}$ pt. 20 cts., pt. 35 cts., qt. 60 cts., pk. \$3.25, bus. \$12.00.
- Golden Evergreen.** ★ 95 days. Also known as Bantam Evergreen. One of the best of the medium-late varieties. Ears 8 to 9 inches long, 12 to 14-rowed; kernels rich golden yellow, deep, tender, sweet and of excellent quality. Remains tender and sweet for a long time after it reaches full size. $\frac{1}{2}$ pt. 20 cts., pt. 35 cts., qt. 60 cts., pk. \$3.25, bus. \$12.00.
- Late Mammoth.** ★ 100 days. Noted for its exceptionally large ears, which are often 12 inches long. Ears are well filled with 14 or more rows of deep, white narrow kernels. $\frac{1}{2}$ pt. 20 cts., pt. 35 cts., qt. 60 cts., pk. \$3.25, bus. \$12.00.
- Stowell's Evergreen.** ★ 100 days. The ears are 8 to 10 inches long with 16 or 18 rows of very deep, white sweet kernels. It remains tender and sweet for a long time. Pkt. 10 cts., $\frac{1}{2}$ pt. 20 cts., pt. 35 cts., qt. 60 cts., pk. \$3.25, bus. \$12.00.

Hybrid Sweet Corn

Hybrid varieties can be depended on to produce crops of better quality and larger yields. They are extremely uniform in ear characteristics and in maturity and are resistant to disease.

- Carmelcross.** 80 days. Fine 8-inch ears with 10 to 14 rows of deep yellow kernels of super quality. Wonderfully sweet. $\frac{1}{2}$ pt. 30 cts., pt. 50 cts., qt. 85 cts., pk. \$5.50, bus. \$20.00.
- Golden Cross Bantam.** ★ 88 days. Ears 10 to 14-rowed, $7\frac{1}{2}$ to 8 inches long, and of excellent quality. Kernels light yellow, medium in width and depth. $\frac{1}{2}$ pt. 30 cts., pt. 50 cts., qt. 85 cts., pk. \$5.50, bus. \$20.00.
- Golden Evergreen Hybrid.** ★ 95 days. Kernels golden yellow, medium wide and deep, sweet and of fine quality. Ears average about 10 inches long, 14 or 16-rowed. $\frac{1}{2}$ pt. 30 cts., pt. 50 cts., qt. 85 cts., pk. \$5.50, bus. \$20.00.
- Ioana.** 87 days. Very productive and highly resistant to wilt. Ears 7 to 8 inches, 12 to 14-rowed, well filled with light yellow kernels. Excellent for home-gardens. $\frac{1}{2}$ pt. 30 cts., pt. 50 cts., qt. 85 cts., pk. \$5.50, bus. \$20.00.
- Lincoln.** ★ 85 days. Ears large, 12 to 16-rowed and of good quality. Kernels bright golden and narrow. Desirable for both home and market use. $\frac{1}{2}$ pt. 30 cts., pt. 50 cts., qt. 85 cts., pk. \$5.50, bus. \$20.00.
- Marcross C 13.6.** ★ 74 days. An outstanding early variety. Large, thick ears and very uniform. Kernels golden yellow and of good quality. $\frac{1}{2}$ pt. 30 cts., pt. 50 cts., qt. 85 cts., pk. \$5.50, bus. \$20.00.
- Marcross P 39.** 85 days. A very productive main-crop variety. Kernels a golden yellow. Characters about the same as Golden Cross Bantam but slightly shorter ear. $\frac{1}{2}$ pt. 30 cts., pt. 50 cts., qt. 85 cts., pk. \$5.50, bus. \$20.00.
- Spancross C 13.4.** 72 days. An early golden yellow variety of good quality and yield. Ears slender, 10 to 14-rowed and well filled, uniform and attractive. $\frac{1}{2}$ pt. 30 cts., pt. 50 cts., qt. 85 cts., pk. \$5.50, bus. \$20.00.
- Stowell's Evergreen Hybrid.** 95 days. The leading white hybrid variety. Ears extra-large, often 9 inches long, with 14 to 18 rows of deep, narrow, white kernels of fine texture and flavor. $\frac{1}{2}$ pt. 30 cts., pt. 50 cts., qt. 85 cts., pk. \$5.50, bus. \$20.00.
- Whipcross.** 90 days. Ears 7 to 8 inches long with 14 to 16 rows well filled with dark yellow kernels. $\frac{1}{2}$ pt. 30 cts., pt. 50 cts., qt. 85 cts., pk. \$5.50, bus. \$20.00.

NOTE: One pint of Corn weighs about $\frac{3}{4}$ pound, one quart about $1\frac{1}{2}$ pounds, and one bushel about 48 pounds.

CUCUMBERS

For an extra-early crop, start indoors or in a frame about April 1, sowing the seed in paper pots or dirt-bands and transplant to the garden the latter part of May, disturbing the roots as little as possible. Sow the main crop directly in the garden late in May, and, for a continuous supply, make additional sowings every two weeks up to the middle or latter part of July. Prepare hills 4 to 6 feet apart, digging up the soil to a depth of a foot or more and mixing in plenty of manure or compost. Leave the soil in the hills loose and a little higher than the general level of the garden. Sow eight to ten seeds in each hill and thin out all but the strongest three or four plants. Do not disturb the vines after they have started to spread. If the striped beetles interfere with the development of the young plants, spray them with Nicotine Pyrox or dust with Rotenone Dust. See insecticide pages.

An ounce of seed will plant about fifty hills; 2 pounds of seed will be required for an acre

A and C. ★ 68 days. Fruits deep green color, slightly tapered at neck and moderately pointed, 8 to 9 inches long; white spined. Especially recommended for market-gardeners. Pkt. 10 cts., oz. 30 cts., $\frac{1}{4}$ lb. 85 cts., lb. \$2.50.

Black Diamond. 60 days. The earliest White Spine Cucumber. Fruits dark green, 7 to 8 inches long, perfectly smooth, of handsome appearance. Pkt. 10 cts., oz. 30 cts., $\frac{1}{4}$ lb. 85 cts., lb. \$2.50.

Cubit. 70 days. Fruits about 8 inches long, dark green, white spined, and smooth. They hold their attractive color to larger size than most other varieties. Pkt. 10 cts., oz. 35 cts., $\frac{1}{4}$ lb. \$1.00, lb. \$3.00.

Davis Perfect. ★ 62 days. A dependable producer of very long, slender fruits which are rich dark green in color and of finest quality. It holds its deep green color for a long time. Very popular with home-gardeners. Pkt. 10 cts., oz. 30 cts., $\frac{1}{4}$ lb. 85 cts., lb. \$2.50.

Early Fortune. 62 days. Long, slender fruits, deep green in color and exceedingly uniform in size and shape, with crisp, firm flesh and few seeds. Early. Pkt. 10 cts., oz. 30 cts., $\frac{1}{4}$ lb. 85 cts., lb. \$2.50.

Evergreen White Spine. 66 days. Fruits 10 to 12 inches long, dark green in color, smooth, and of splendid quality. Good for late crop. Pkt. 10 cts., oz. 30 cts., $\frac{1}{4}$ lb. 85 cts., lb. \$2.50.

Improved Early White Spine. ★ 60 days. Extra early and prolific. Produces medium-sized, light green fruits of fine quality for slicing or pickles. A popular variety because of its quality and productiveness. Pkt. 10 cts., oz. 30 cts., $\frac{1}{4}$ lb. 85 cts., lb. \$2.50.

Klondike. 65 days. Unusual dark green color which it holds for a long time even under the hottest sun. Fruits of good size and shape. Pkt. 10 cts., oz. 25 cts., $\frac{1}{4}$ lb. 65 cts., lb. \$2.00.

Japanese Climbing. 65 days. A good Cucumber for the small garden as the vines can be trained on fence or trellis; in fact, it requires some sort of support. Fruits long and thick, crisp, tender and of fine quality. Pkt. 10 cts., oz. 35 cts., $\frac{1}{4}$ lb. \$1.00, lb. \$3.00.

Long Green Turkey. ★ 70 days. Very productive. Fruits 12 to 14 inches long, straight and slender, slightly warted, dark green with crisp white flesh. Desirable for home-gardens because of its slicing qualities. Pkt. 10 cts., oz. 30 cts., $\frac{1}{4}$ lb. 85 cts., lb. \$2.50.

Longfellow. ★ 70 days. Fruits 12 to 15 inches long, dark green, uniform, straight, and attractive, holds color and crispness well after being picked. Not as heavy a bearer as some varieties but this is overcome by the quality, attractiveness and size of the fruit. Pkt. 10 cts., oz. 30 cts., $\frac{1}{4}$ lb. 85 cts., lb. \$2.50.

Marketer. 70 days. An excellent market variety. Fruits dark green, about 8 inches long, tapered slightly at ends. Vines vigorous and prolific. Pkt. 10 cts., oz. 35 cts., $\frac{1}{4}$ lb. \$1.00, lb. \$3.00.

Straight-8. ★ 65 days. The Cucumbers are straight, 8 to 10 inches long, smooth, and deep green in color. The flesh is crisp, white, and of fine quality. A heavy yielder and one of the leading varieties for market-gardeners. Pkt. 10 cts., oz. 35 cts., $\frac{1}{4}$ lb. \$1.00, lb. \$3.00.

Pickling Varieties

Jersey Pickling. ★ 62 days. The fruits are slender and tapering, growing 6 inches long, medium green in color. Extremely prolific. A standard pickling variety for many years. Pkt. 10 cts., oz. 25 cts., $\frac{1}{4}$ lb. 65 cts., lb. \$2.00.

Green Prolific. 58 days. Also known as Boston Pickling. For small pickles. Produces short, thick, bright green fruits, smooth and symmetrical. Pkt. 10 cts., oz. 25 cts., $\frac{1}{4}$ lb. 65 cts., lb. \$2.00.

Heinz Pickle. 60 days. A dependable plant that bears excellent crops of well-formed fruits when other varieties fail. The Cucumbers are blunt at both ends, dark green, and get large when mature. Pkt. 10 cts., oz. 25 cts., $\frac{1}{4}$ lb. 65 cts., lb. \$2.00.

National Pickling. ★ 55 days. A high-yielding variety especially bred for pickling in the small sizes. Fruits deep green, straight, symmetrical, blunt-ended, but not chunky. Pack without waste space. Makes firm, crisp pickles. The leading variety with market-gardeners. Pkt. 10 cts., oz. 30 cts., $\frac{1}{4}$ lb. 85 cts., lb. \$2.50.

West India Gherkin, or Bur. 60 days. Not a true pickle but used for pickling. The vines are luxuriant, bearing quantities of small, nearly round fruits, light green and covered with spines. Pkt. 10 cts., oz. 30 cts., $\frac{1}{4}$ lb. 85 cts., lb. \$2.50.

CORN SALAD

A hardy, quick-growing plant, popular as a substitute for lettuce in late fall and early winter. Sow the seed early in the fall in shallow drills, and give plenty of water. Late plants, covered with a light mulch of straw or leaves, will be suitable for use in early spring.

An ounce of seed sows about 100 feet of drill

Large-seeded. Pkt. 10 cts., $\frac{1}{2}$ oz. 25 cts., oz. 45 cts., $\frac{1}{4}$ lb. \$1.25, lb. \$4.00.

CRESS

(For peppery salads and garnishes)

Fine-Curled Pepper Grass. Sow the seed any time from early spring on. It need not be grown in rows and requires no thinning. The leaves can be cut several times before the plants begin to form seed. Make sowings every week or ten days, a small patch at a time, for a continuous supply. Pkt. 10 cts., oz. 60 cts., $\frac{1}{4}$ lb. \$1.75, lb. \$6.00.

Water Cress. (True.) Grows in damp places. Sow the seed in shallow water along the bank of a stream. No further care is required after sowing. Pkt. 15 cts.

CARDOON

Grown somewhat like celery and served like asparagus. Large, fleshy plants used as a winter vegetable. The blanched stalks and ribs of the inner leaves are tender and of a fine flavor when cooked. Pkt. 10 cts., $\frac{1}{2}$ oz. 60 cts., oz. \$1.00, $\frac{1}{4}$ lb. \$3.00, lb. \$10.00.

COLLARDS

Georgia, or Southern. Non-heading form of the cabbage family. Largely grown for "greens" in the southern states. Sow outdoors in the spring and give the plants plenty of room to develop. Pkt. 10 cts., oz. 15 cts., $\frac{1}{4}$ lb. 30 cts., lb. 90 cts.

POP-CORN

Golden Queen. Large golden yellow kernels. Pops pure white. Lb. 30 cts., 2 lbs. 55 cts.

White Rice. The most popular sort for general use. Productive; popping quality excellent. Lb. 30 cts., 2 lbs. 55 cts.

★ WHEN IN DOUBT, ORDER THE STAR VARIETIES

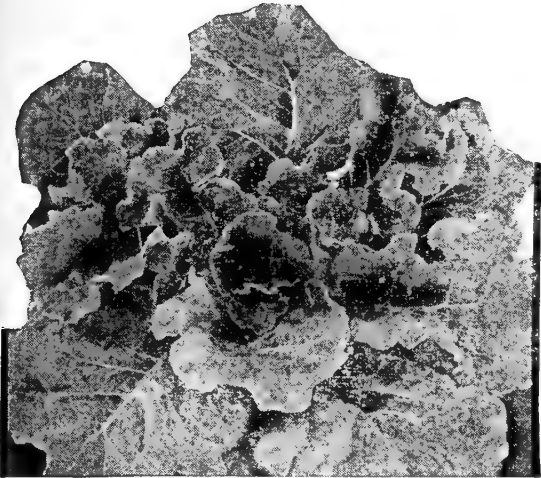

Collards, Georgia or Southern
Pkt. 10 cts., oz. 15 cts.



Corn Salad, Large-seeded. Pkt. 10 cts., 1/2oz. 25 cts.

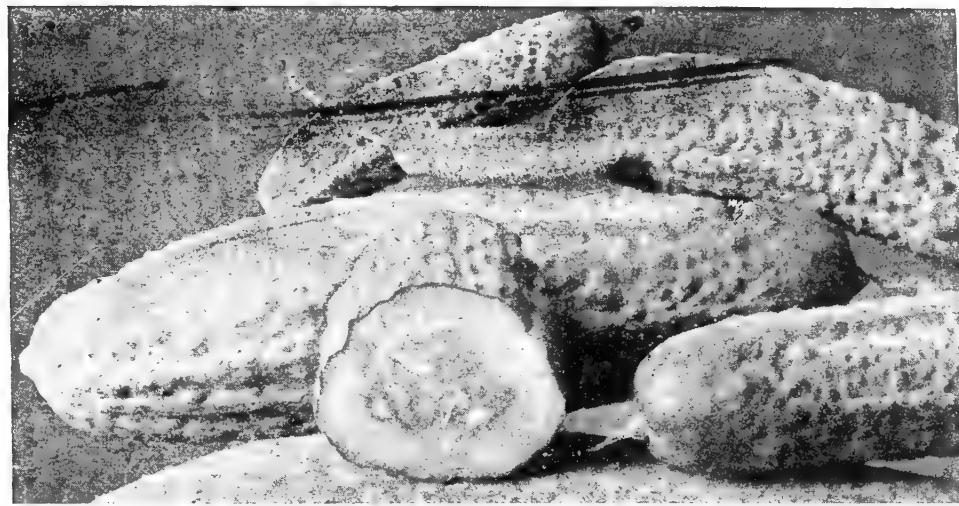

Cucumber, National Pickling. Pkt. 10 cts., oz. 30 cts.

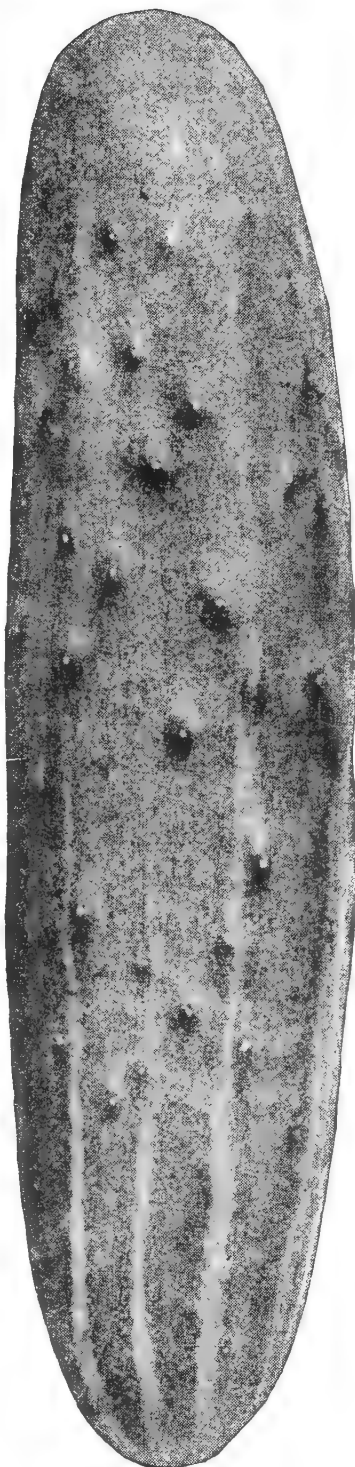

Cucumber, Davis Perfect
Pkt. 10 cts., oz. 30 cts.

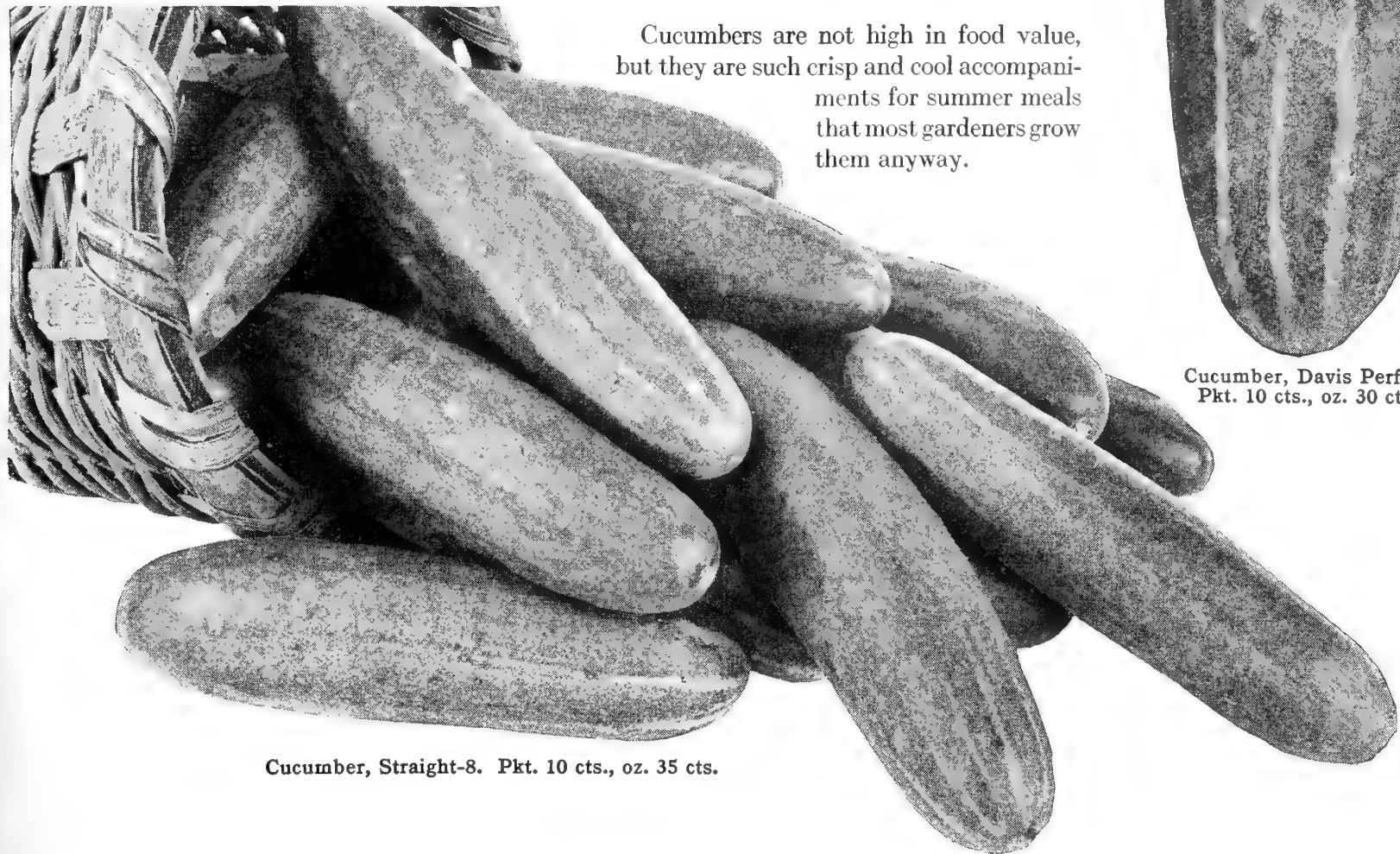

Cucumber, Straight-8. Pkt. 10 cts., oz. 35 cts.

Cucumbers are not high in food value, but they are such crisp and cool accompaniments for summer meals that most gardeners grow them anyway.

EGGPLANT

Start the seed in March, in hotbeds or boxes indoors. Push the seedlings along with plenty of light, heat, and moisture, and when they are about 3 inches high, transplant them to 3 to 4-inch paper pots or dirt-bands. Set out in the garden about June 1, spacing 2 to 2½ feet apart each way. Disturb the roots as little as possible in transplanting, and water freely. Days to maturity are from the time the plants are set in the garden. Allow about 50 days to produce the plants from seed.

An ounce of seed will produce about 2,000 plants

Black Beauty. ★ 80 days. Fruits are of enormous size, smooth, purplish black, and of fine quality. Very prolific and the leading variety for both home and market-gardeners. Pkt. 10 cts., oz. 60 cts., ¼lb. \$1.75, lb. \$6.00.

New Hampshire Hybrid. 75 days. Pear-shaped fruit of dark purple. Very early and a heavy producer. For home and market. Pkt. 10 cts., oz. 60 cts., ¼lb. \$1.75, lb. \$6.00.

New York Improved Spineless. 85 days. Large, smooth, dark purple fruits of good quality, six to eight fruits to the plant. Free from spines and of excellent quality. Pkt. 10 cts., oz. 60 cts., ¼lb. \$1.75, lb. \$6.00.

ENDIVE

Sow the seed any time from early April to the end of July. Plant in shallow drills, about 15 inches apart, and thin the plants to stand 10 to 12 inches apart in the rows. When full grown, tie the tips of the outer leaves together over the center of the plant to blanch the heart, which will take about a week's time.

An ounce of seed will sow 300 feet of row; 3 pounds will sow an acre

Full Heart. ★ 90 days. An improved strain of Broad-leaved with larger leaf and broader, more compact head. Partially self-blanching. Very good quality. Pkt. 10 cts., oz. 25 cts., ¼lb. 65 cts., lb. \$2.00.

Broad-leaved (Escarolle). 90 days. The leaves are broad and quite thick and heavy, slightly twisted and scalloped. Medium green in color. Pkt. 10 cts., oz. 25 cts., ¼lb. 65 cts., lb. \$2.00.

Florida Deep Heart. 90 days. An improved strain with large, broad, thick leaf of upright growth. Blanching easily and of good quality. Pkt. 10 cts., oz. 25 cts., ¼lb. 65 cts., lb. \$2.00.

Green Curled. ★ 90 days. The plants are large and handsome, with finely cut and fringed, dark green leaves. Blanching easily to clear white. Good fall variety. Pkt. 10 cts., oz. 25 cts., ¼lb. 65 cts., lb. \$2.00.

Large Curled Pancalier. 90 days. A vigorous grower with thick curled leaves and midribs tinged with rose. Pkt. 10 cts., oz. 25 cts., ¼lb. 65 cts., lb. \$2.00.

White Curled. 90 days. Foliage is a little finer than the Green Curled and the inner leaves become creamy white without blanching. Pkt. 10 cts., oz. 25 cts., ¼lb. 65 cts., lb. \$2.00.

DANDELION

If the leaves are tied together, the center of the plant will blanch as white and clear as endive. Sow the seed early in shallow drills, in rich soil, and thin the plants to stand about 1 foot apart. If desired for early spring use, the seed may be sown later and the plants covered lightly over winter.

An ounce of seed will sow about 300 feet of drill

Improved French. Pkt. 20 cts., oz. \$1.00, ¼lb. \$3.00, lb. \$10.00

HORSE RADISH ROOTS

Maliner Kren. The largest and most vigorous variety. Plant in early spring in rich, moist soil. Will produce a good crop in one season. Roots, 50 cts. per doz., \$2.25 per 100, \$15.00 per 1,000.

HERBS

Grandmother's garden always had a little patch of herbs and, doubtless, much of the savoriness of grandmother's cooking as well as the effectiveness of her home remedies was derived from her store of "yarbs." Most of the commoner herbs are perennials, although they last but a few seasons in ordinary situations. Any odd corner will do, provided it is sunny and the soil not too hard or poor. Sow seed in early spring, thinning out as needed.

Anise. The seeds are used for flavoring candy and pastries, and the leaves for garnishing and adding to salads. Pkt. 10 cts., ½oz. 30 cts., oz. 50 cts., ¼lb. \$1.50.

Balm. The lemon-scented leaves are used for making a medicinal tea, as well as for salads and flavoring vinegar and wines. Pkt. 15 cts., ½oz. 50 cts., oz. 90 cts., ¼lb. \$2.50.

Basil, Sweet. A highly aromatic herb whose leaves and tops are used for seasonings and, in a limited way, in salads. Pkt. 10 cts., ½oz. 30 cts., oz. 50 cts.

Basil, Sweet, Small-Leaf. An annual whose small leaves are valued for flavoring soups, etc. Pkt. 10 cts., ½oz. 30 cts., oz. 50 cts.

Borage. An annual plant that is used freely by bee-keepers. Pkt. 10 cts., ½oz. 40 cts., oz. 75 cts., ¼lb. \$2.00.

Caraway. The seeds of this plant are used for culinary purposes, in confectionery and also in medicines. Pkt. 10 cts., ½oz. 30 cts., oz. 50 cts., ¼lb. \$1.50.

Chives. Used as a substitute for onions in soups and salads. Pkt. 25 cts., ½oz. 85 cts., oz. \$1.25.

Chervil, Curled. Leaves of Chervil very much resemble those of parsley and are used in a similar way. Pkt. 10 cts., ½oz. 30 cts., oz. 50 cts., ¼lb. \$1.50.

Coriander. An annual whose seeds are strongly aromatic. Used in cooking and candy making. Pkt. 10 cts., ½oz. 40 cts., oz. 75 cts., ¼lb. \$2.00.

Dill. An annual plant, seeds of which are used as a seasoning and also in the preparation of Dill pickles. The leaves are used for garnishing and in making vinegar. Pkt. 10 cts., oz. 25 cts., ¼lb. 75 cts., lb. \$2.00.

Fennel, Florence. A very delicious salad vegetable. It can be served like celery or boiled. Pkt. 10 cts., ½oz. 30 cts., oz. 50 cts., ¼lb. \$1.50.

Fennel, Sweet. The leaves are finely cut and are used for garnishing. Pkt. 10 cts., ½oz. 30 cts., oz. 50 cts.

Horehound. Chiefly used for medicinal purposes, as it has strong tonic properties. Pkt. 10 cts., ½oz. 40 cts., oz. 75 cts.

Lavender. Dried flowers impart a pleasing odor to the contents of linen-chests. Pkt. 15 cts., ½oz. \$1.25, oz. \$2.00.

Marjoram, Sweet. Pleasingly fragrant leaves of particular value as a seasoning and in salads. Pkt. 15 cts., ½oz. 60 cts., oz. \$1.00, ¼lb. \$3.00.

Peppermint. A perennial used for flavoring and for its pungent oil. Sold out.

Rue. A medicinal plant of extremely pungent taste. Pkt. 10 cts., ½oz. 60 cts., oz. \$1.00.

Saffron. Cultivated for medicinal purposes. Pkt. 10 cts., ½oz. 75 cts., oz. \$1.25, ¼lb. \$4.00.

Sage. An old familiar herb with a pungent odor. The dried leaves are commonly used to flavor stuffings and sauces. Pkt. 25 cts., ½oz. 60 cts., oz. \$1.00.

Savory, Summer. Dried foliage used for flavoring during the winter months. Pkt. 10 cts., ½oz. 45 cts., oz. 75 cts., ¼lb. \$2.50.

Tansy. A 3-foot perennial with strongly scented yellow flowers. Used for seasoning and as a meat preservative. Pkt. 15 cts., ½oz. 85 cts., oz. \$1.50.

Tarragon. A perennial used for flavoring vinegar and salads. 2 ft. Sold out.

Thyme. The leaves and young branches are used for seasoning. Pkt. 10 cts., ½oz. 50 cts., oz. 90 cts., ¼lb. \$2.50.

Wormwood. Has medicinal qualities. Pkt. 25 cts., ½oz. \$1.25, oz. \$2.00.

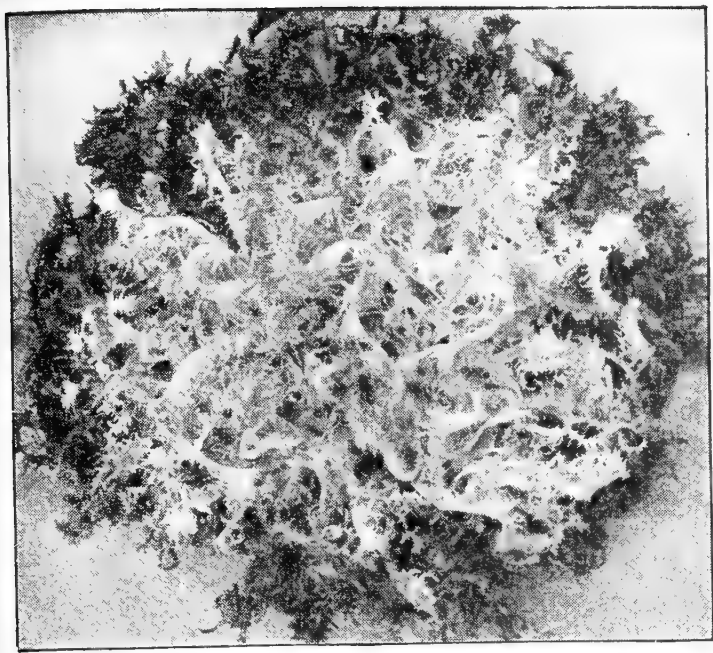

Endive, Green Curled. Pkt. 10 cts., oz. 25 cts.



Dill. Pkt. 10 cts.



Lettuce, New York or Wonderful. Pkt. 10 cts., oz. 50 cts.

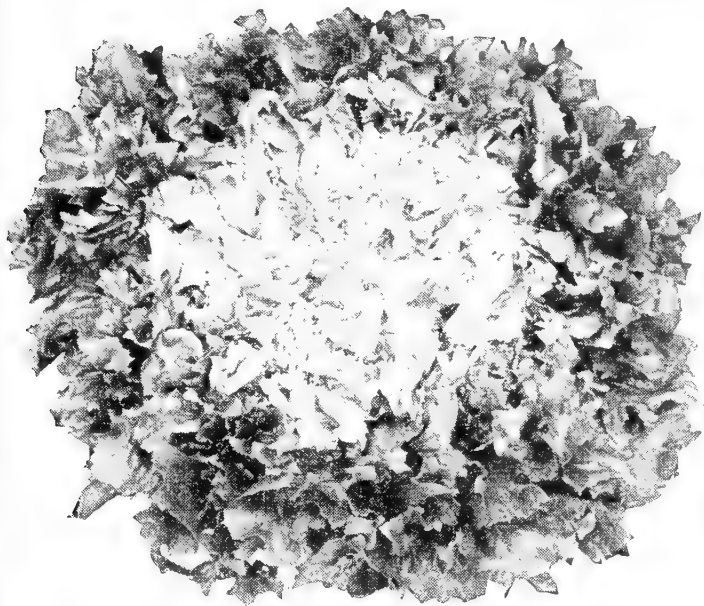

Endive, Broad-leaved (Escarolle). Pkt. 10 cts., oz. 25 cts.

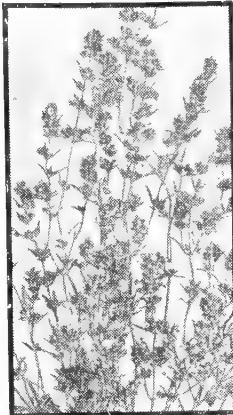

Sweet Marjoram
Pkt. 15 cts.



Eggplant, Black Beauty. Pkt. 10 cts., oz. 60 cts.



Sage. Pkt. 25 cts.

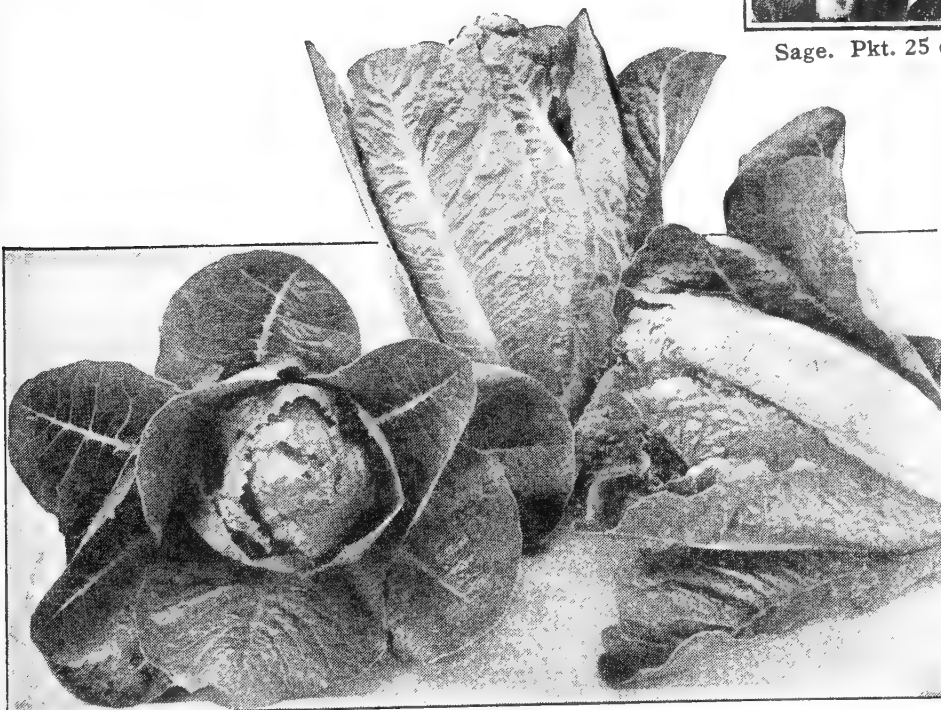

Lettuce, Dark Green Cos. Pkt. 10 cts., oz. 30 cts.

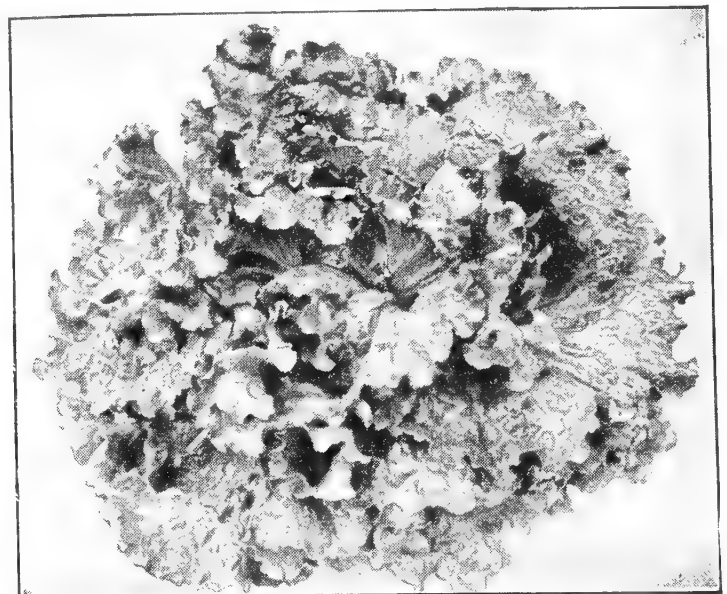

Lettuce, Black-seeded Simpson. Pkt. 10 cts., oz. 25 cts.

LETTUCE

By starting seed for the first crop in the hotbed or in flats in the house in February or early March, and by carefully choosing varieties which will furnish a succession of crops in the garden, one may have fresh Lettuce for the table from May to November. Make the first sowing outdoors as soon as the ground can be put in shape, making the seed-bed as fine and mellow as possible. Scatter the seed in shallow furrows at least 15 inches apart, and cover lightly. As soon as the plants are big enough, thin them out to stand 3 to 4 inches apart. Then, when they begin to touch each other in the row, use alternate plants, leaving them 8 to 12 inches apart. Cultivate constantly.

An ounce of seed will sow about 300 feet of row

Loose-leaved Varieties

All varieties of loose-leaved Lettuce are edible in about 45 days.

Black-Seeded Simpson. ★ The plants are large, with broad, beautifully crumpled and frilled leaves, light green in color and of good quality. Stands more heat than others of its class. The most popular variety of loose-leaved Lettuce. Pkt. 10 cts., oz. 25 cts., $\frac{1}{4}$ lb. 75 cts., lb. \$2.10.

Chicken. A hardy, tall-growing, non-heading, dark green variety, producing the largest amount of leaves of any Lettuce. Grown exclusively for feeding to poultry and rabbits. Pkt. 10 cts., oz. 25 cts., $\frac{1}{4}$ lb. 75 cts., lb. \$2.10.

Deer Tongue. A distinctly different Lettuce, crisp and tender. May be planted early and stands hot weather well. Pkt. 15 cts., $\frac{1}{2}$ oz. 30 cts., oz. 50 cts., $\frac{1}{4}$ lb. \$1.25, lb. \$4.00.

Early Curled Simpson. Early, medium large, with yellowish green, crumpled and frilled leaves of excellent quality. Pkt. 10 cts., oz. 25 cts., $\frac{1}{4}$ lb. 75 cts., lb. \$2.10.

Grand Rapids. ★ An extremely early variety good for first spring crop in the garden; also grown in greenhouses for winter market. The plants are large, with bright green, intensely curled and crinkled leaves. Stands the heat well in summer. Pkt. 10 cts., oz. 25 cts., $\frac{1}{4}$ lb. 75 cts., lb. \$2.10.

Prizehead. A quick-growing sort with broad, crumpled, frilled, green leaves, tinged red on outside; crisp and sweet. Pkt. 10 cts., oz. 25 cts., $\frac{1}{4}$ lb. 75 cts., lb. \$2.10.

Heading Varieties

All heading varieties of Lettuce mature in 65 to 75 days.

Big Boston. ★ Large, compact heads of rich buttery quality, but will not ordinarily "head up" for the home-gardener unless it is started indoors or sown very early so as to mature before warm weather. Pkt. 10 cts., oz. 25 cts., $\frac{1}{4}$ lb. 75 cts., lb. \$2.10.

HEADING VARIETIES, continued

Crisp-As-Ice. Makes a solid head of medium size. Unusually hardy, it is desirable for fall sowing. The outer leaves are dark bronzy green, crumpled and heavy in texture; inner leaves creamy yellow, crisp and sweet. Pkt. 10 cts., oz. 50 cts., $\frac{1}{4}$ lb. \$1.25, lb. \$4.00.

Great Lakes. ★ An excellent new variety becoming popular. The crisp cream-white head of the Iceberg type develops easily. Slow in bolting to seed. Pkt. 15 cts., oz. 50 cts., $\frac{1}{4}$ lb. \$1.50, lb. \$5.00.

Iceberg. Outer leaves light green, tinged with brown at the edges; inner leaves white, crisp, firm and sweet. Choice home-garden variety. Pkt. 10 cts., oz. 30 cts., $\frac{1}{4}$ lb. 90 cts., lb. \$2.60.

Imperial 44. ★ An Iceberg type particularly adapted to eastern conditions. The heads are solid, uniform, very crisp and of the finest quality. Recommended for early and late planting. Pkt. 10 cts., oz. 50 cts., $\frac{1}{4}$ lb. \$1.25, lb. \$4.00.

Improved Hanson. ★ The plants are of good size; outer leaves medium green, somewhat crinkled; inner leaves blanched white. Because of its quality, a favorite for home-gardens. Pkt. 10 cts., oz. 25 cts., $\frac{1}{4}$ lb. 75 cts., lb. \$2.10.

May King. An early Butterhead Lettuce of superb quality, and an ideal sort for early spring planting. Solid heads of medium size, with light green outer leaves and rich golden yellow hearts. Pkt. 10 cts., oz. 25 cts., $\frac{1}{4}$ lb. 75 cts., lb. \$2.10.

New York, or Wonderful. ★ It grows slowly but makes a fine heavy head. The outer leaves are dark green; the inner blanch to creamy white. The most popular variety of Iceberg-type Lettuce. Pkt. 10 cts., oz. 50 cts., $\frac{1}{4}$ lb. \$1.25, lb. \$4.00.

Oak Leaf. A distinct type of Lettuce. It forms a close center with rather loose outer leaves. The leaves are deeply lobed. It is the one variety that is excellent late in the summer when other varieties are bitter. Pkt. 10 cts., oz. 40 cts., $\frac{1}{4}$ lb. \$1.10, lb. \$3.40.

White Boston. ★ The best variety of the Butterhead type. Our strain is very uniform in size and a high percentage of the plants will form solid heads. Head of medium size and compact, with creamy yellow heart. Excellent quality. Pkt. 10 cts., oz. 25 cts., $\frac{1}{4}$ lb. 75 cts., lb. \$2.10.

Dark Green Cos, or Romaine. Leaves green and when fully blanched are white with only the faintest tinge of green. Pkt. 10 cts., oz. 30 cts., $\frac{1}{4}$ lb. 90 cts., lb. \$2.60.

White Paris Cos, or Romaine. The best and most widely grown Romaine Lettuce. Heads medium large, medium green, upright, firm, exceptionally crisp, tender and of excellent flavor. Pkt. 10 cts., oz. 30 cts., $\frac{1}{4}$ lb. 90 cts., lb. \$2.60.

KALE (Borecole)

Makes delicious "greens" for fall and early spring use. Sow seed in the open from early spring until the middle of August. The early sowings give fully grown plants, whereas the later sowings will furnish delicious small tender leaves. Sow seed in shallow drills and thin or transplant to stand about 2 feet apart each way. Late plantings can be sown broadcast like spinach. Light frost will not injure Kale but will improve its flavor.

*An ounce will sow about 300 feet of drill;
4 pounds will sow an acre*

Dwarf Blue Scotch. ★ 55 days. Dwarf, compact plants with finely curled bluish green leaves, retaining their color after cutting. One of the handsomest varieties. Pkt. 10 cts., oz. 35 cts., $\frac{1}{4}$ lb. \$1.00, lb. \$3.00.

Dwarf Curled Scotch. ★ 55 days. Extremely hardy and fine for early winter use. Grows 15 to 18 inches high and produces a heavy crop of beautifully curled, bright green leaves, tender and of fine flavor. Pkt. 10 cts., oz. 35 cts., $\frac{1}{4}$ lb. \$1.00, lb. \$3.00.

Dwarf German. 60 days. Low and compact in growth, with finely curled, yellowish green leaves. Nice for garnishing. Pkt. 10 cts., oz. 20 cts., $\frac{1}{4}$ lb. 65 cts., lb. \$2.00.

KALE, continued

Tall Curled Scotch. 80 days. Like the dwarf form but grows about 2 $\frac{1}{2}$ feet high. Hardy and particularly good for late planting. Pkt. 10 cts., oz. 35 cts., $\frac{1}{4}$ lb. \$1.00, lb. \$3.00.

KOHLRABI

Sometimes called Turnip-rooted Cabbage. Sow the seed in shallow drills in April, or for extra-early crop start in the hotbed in March. Thin or transplant the plants about 6 inches apart. Kohlrabi grows rapidly and should be used when about half grown, 2 to 2 $\frac{1}{2}$ inches in diameter. Can be sown up to the middle of July.

An ounce of seed will sow about 250 feet of drill

Purple Vienna. 60 days. A little later and larger than the White Vienna, and a reliable sort. Skin purple; flesh white. Pkt. 10 cts., oz. 50 cts., $\frac{1}{4}$ lb. \$1.50, lb. \$5.00.

White Vienna. ★ 55 days. The quickest growing and most popular kind for table use. Leaves few and small; bulbs of medium size with white skin and flesh, tender and of delicate flavor. Pkt. 10 cts., oz. 50 cts., $\frac{1}{4}$ lb. \$1.25, lb. \$4.00.

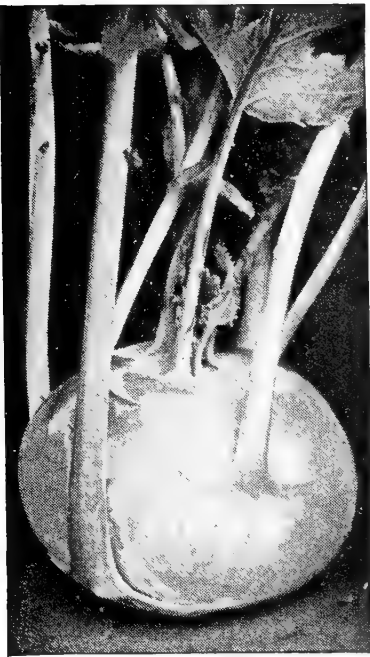

Kohlrabi, White Vienna
Pkt. 10 cts., oz. 50 cts.

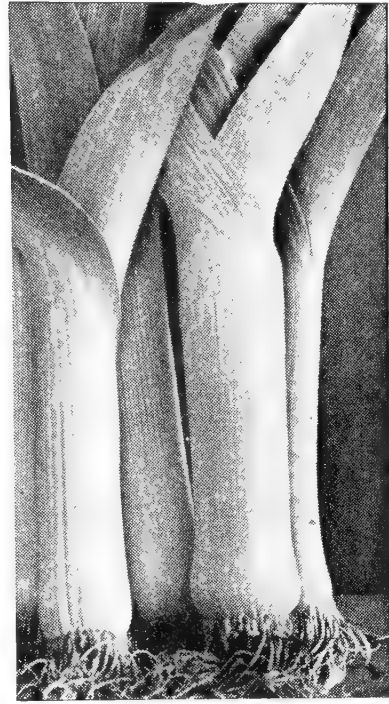

Leek, Large London Flag
Pkt. 10 cts., oz. \$1.00

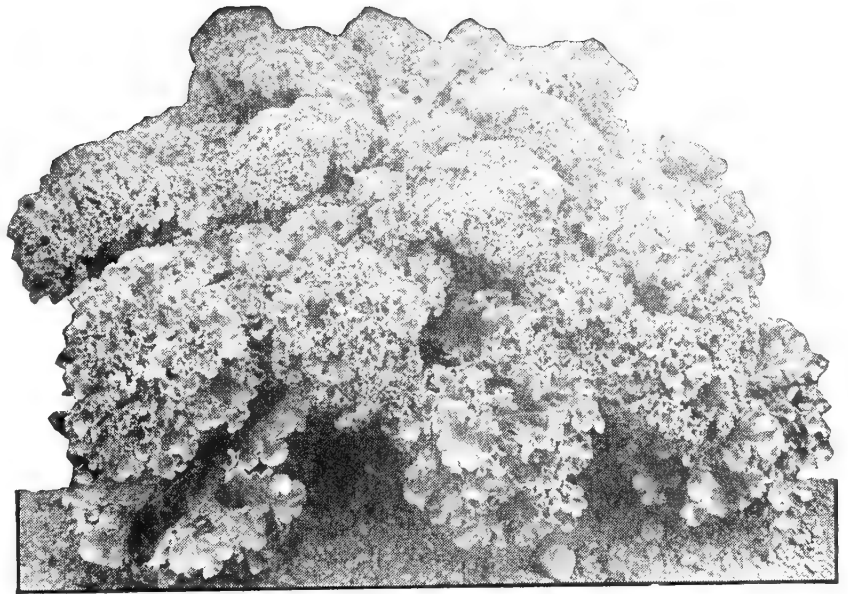

Kale, Dwarf Curled Scotch. Pkt. 10 cts., oz. 35 cts.

On this page are pictured some of the less-common vegetables such as Kale, Kohlrabi, and Mustard. Try some of them this year, and you will probably be delighted with the new flavors that will find their way to your table.

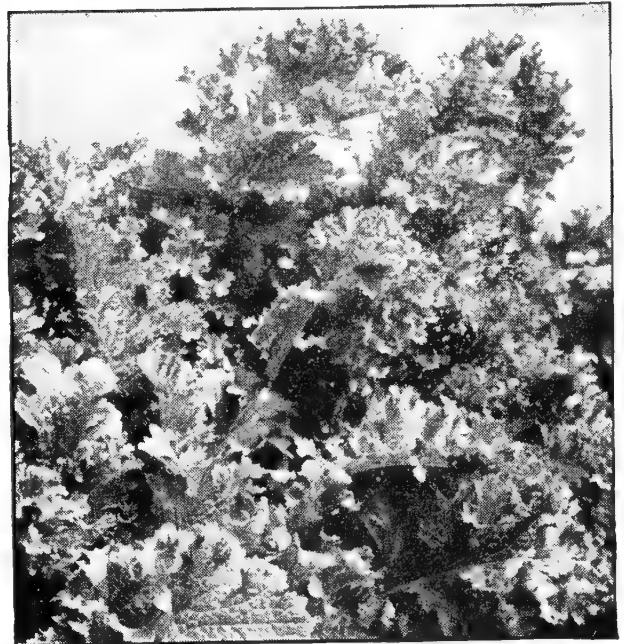

Mustard, Southern Giant. Pkt. 10 cts., oz. 20 cts.

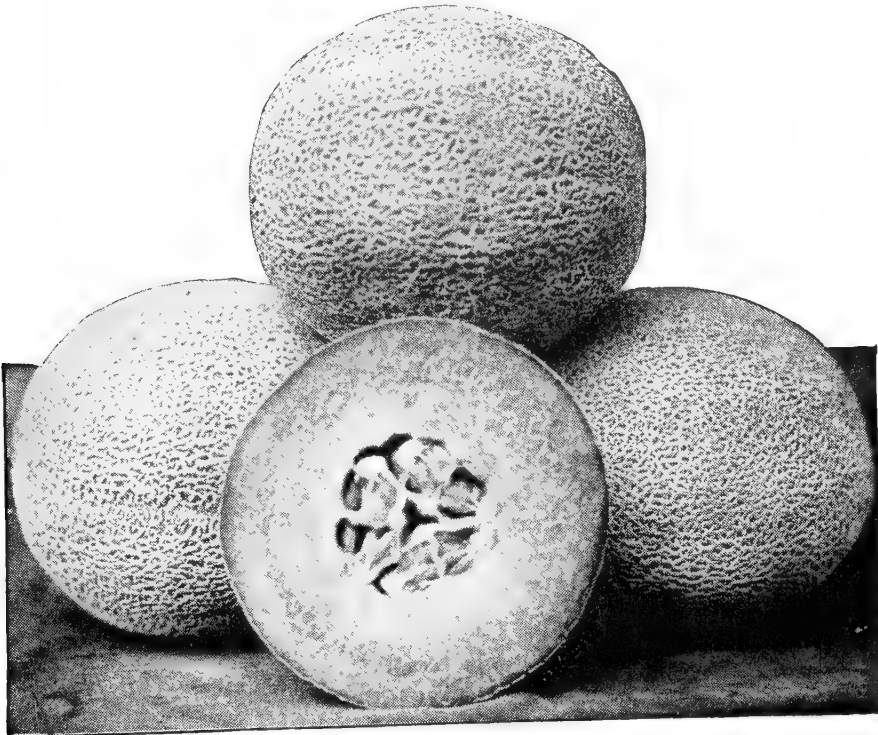

Muskmelon, Tip-Top. Pkt. 10 cts., oz. 30 cts.



Watermelon, Cole's Early. Pkt. 10 cts., oz. 30 cts.

Melons need rich soil, with plenty of warmth and moisture. Watch the vines for the first evidence of beetles and borers, and get rid of them promptly.

MUSKMELON or Cantaloupe

Sow the seed after the soil has warmed up in hills 5 to 6 feet apart, digging the soil to a depth of a foot and mixing in plenty of manure or fertilizer with the bottom soil. No more than 3 or 4 strong plants should be left in each hill. Since Muskmelons require a long growing season, it is a good plan to start the seed in a hotbed or box indoors, using dirt bands or pots, and setting them in the garden after the soil has become warm.

*An ounce of seed will plant about 50 hills;
2 to 3 pounds will plant an acre*

- Emerald Gem.** ★ 85 days. An early, prolific melon. The fruits are small, decidedly flattened and deeply ribbed; the skin is dark green and the flesh is unusually deep and solid, bright orange in color clear to the rind, and of remarkably fine quality. Pkt. 10 cts., oz. 30 cts., $\frac{1}{4}$ lb. 90 cts., lb. \$2.50.
- Extra-Early Hackensack.** 80 days. A large, round melon, slightly flattened at the ends. The skin is ribbed and netted; the flesh is thick, light green in color, and of good quality. Pkt. 10 cts., oz. 30 cts., $\frac{1}{4}$ lb. 90 cts., lb. \$2.50.
- Honey Dew.** 110 days. The fruits are very large, with thin, hard, smooth, pale green rind and thick green flesh which remains firm and crisp for a long time. Juicy and tender. Pkt. 10 cts., oz. 30 cts., $\frac{1}{4}$ lb. 90 cts., lb. \$2.50.
- Honey Rock.** 85 days. Skin gray-green, covered with coarse, sparse netting. Flesh orange-salmon, thick and juicy, with very fine flavor. Good for home use and local early markets. Pkt. 10 cts., oz. 30 cts., $\frac{1}{4}$ lb. 90 cts., lb. \$2.50.
- Imperial.** ★ 90 days. Netted yellow fruit with orange flesh. A fine cropper, even in hot, dry seasons. Pkt. 10 cts., oz. 30 cts., $\frac{1}{4}$ lb. 90 cts., lb. \$2.50.
- Osage, or Miller's Cream.** 95 days. The fruits are large, slightly elongated, with lightly netted dark green skin and thick, firm, orange flesh. Pkt. 10 cts., oz. 30 cts., $\frac{1}{4}$ lb. 90 cts., lb. \$2.50.
- Rocky Ford.** 90 days. The fruits are medium small, oval in shape, slightly ribbed and covered with a coarse, gray netting. Flesh green and remarkably sweet. Pkt. 10 cts., oz. 30 cts., $\frac{1}{4}$ lb. 90 cts., lb. \$2.50.
- Tip-Top.** ★ 90 days. Probably the most dependable melon for this region. Medium early and productive, bearing large, round, ribbed and netted fruits with thick, sweet, orange flesh. Pkt. 10 cts., oz. 30 cts., $\frac{1}{4}$ lb. 90 cts., lb. \$2.50.

MUSHROOMS

Anyone who has a cellar or dark room where the temperature can be kept at from 50 to 60 degrees, can grow Mushrooms of surpassing tenderness and flavor. We furnish special printed directions free with each order, or for 25 cents we will send, post-paid, an illustrated booklet on Mushroom culture which gives the latest improved methods of growing as well as full instructions for preparing for market and recipes for cooking.

Spore-Culture Mushroom Spawn, Northern-Grown. Pure and vigorous. In the form of compressed bricks, each of which will plant about 16 square feet of bed. Brick 40 cts., 10 bricks \$3.50, 50 bricks \$15.00, 100 bricks \$28.00.

LEEK

Sow the seed in shallow drills early in the spring and when the plants are about 5 inches high, transplant them 6 to 8 inches apart in rows, and cultivate frequently. At the time of transplanting it is a good plan to cut back the plants a third. The stalks are best when blanched by drawing earth up around them.

An ounce of seed will sow 300 feet of row; 2 pounds will produce sufficient plants for an acre

Large London Flag. 140 days. The hardest and most generally cultivated variety. Broad stalks of strong flavor. Pkt. 10 cts., oz. \$1.00, $\frac{1}{4}$ lb. \$3.00.

Musselburg. 140 days. Grows larger and is milder in flavor than the preceding. Pkt. 10 cts., oz. \$1.00, $\frac{1}{4}$ lb. \$3.00.

WATERMELON

In general, Watermelons require the same treatment as muskmelons. It is not safe to sow seed outdoors until the last of May. Prepare the hills carefully, spacing them 6 to 8 feet apart and digging them deep, mixing in each a couple of shovelfuls of manure or a little commercial fertilizer. Thin to 2 or 3 plants in each hill. Water freely in dry spells.

An ounce will plant about 20 hills; 4 pounds will plant an acre

- Cole's Early.** ★ 80 days. The best variety for home-gardens. Fruits medium size, almost round, with alternate dark and light green stripes. Flesh rich red, firm, fine grained and of good sweet flavor. Seeds black. Pkt. 10 cts., oz. 30 cts., $\frac{1}{4}$ lb. 90 cts., lb. \$2.50.
- Kleckley Sweets.** 85 days. The fruits grow about 20 inches long and 10 inches in diameter, with thin green rind and bright scarlet flesh. White seeds. Pkt. 10 cts., oz. 30 cts., $\frac{1}{4}$ lb. 90 cts., lb. \$2.50.
- Sweetheart.** ★ 85 days. Large, heavy fruits, nearly round, with a thick, mottled light and dark green rind and firm red flesh. Black seeds. Pkt. 10 cts., oz. 30 cts., $\frac{1}{4}$ lb. 90 cts., lb. \$2.50.
- Tom Watson.** 95 days. Fruits 24 inches long and about 12 inches in diameter, with a thin, tough, mottled green rind and rich red flesh of good quality. Brown seeds. Pkt. 10 cts., oz. 30 cts., $\frac{1}{4}$ lb. 90 cts., lb. \$2.50.

CITRON

A form of melon used only for preserving, as the flesh is not edible when raw, Citrons are grown in the same way as watermelons; they are prolific and not so particular as to soil. Home-preserved Citron is much superior to that handled in the stores in a dried or candied form.

- Green-Seeded.** 90 days. Also called "Colorado Preserving." Fruits large and oblong. Pkt. 10 cts., oz. 30 cts., $\frac{1}{4}$ lb. 90 cts., lb. \$2.50.
- Red-Seeded.** 90 days. Flesh firm, with comparatively few seeds. Fruits round. Pkt. 10 cts., oz. 30 cts., $\frac{1}{4}$ lb. 90 cts., lb. \$2.50.

MUSTARD

The young, tender leaves make piquant salads and are delicious as well as healthful as boiled "greens." Seed can be sown any time from April 1 to the middle of August. Sow thinly in shallow drills 12 to 15 inches apart. Mustard can also be forced in frames or in the greenhouse during winter.

An ounce of seed will sow about 200 feet of drill

- Fordhook Fancy.** 40 days. A dark green variety of robust growth, more curled on the edges than any other sort. Pkt. 10 cts., oz. 20 cts., $\frac{1}{4}$ lb. 40 cts., lb. \$1.25.
- Southern Giant Long Standing.** ★ 35 days. The plants grow 2 to 3 feet high, producing quantities of broad, succulent leaves which are handsomely curled and fringed. Pkt. 10 cts., oz. 20 cts., $\frac{1}{4}$ lb. 40 cts., lb. \$1.25.
- Spinach Mustard, Tendergreen.** 30 days. A rapid-growing Mustard with narrow, thick, dark green leaves. Has a delicious spinach flavor. Pkt. 10 cts., oz. 25 cts., $\frac{1}{4}$ lb. 75 cts., lb. \$2.00.

OKRA or GUMBO

Grown for its seed-pods, which are pickled when young, before they get tough, and used for flavoring and thickening soups. Sow late in May, in drills about an inch deep and 2½ feet apart and thin out to about 1 foot apart in the row. For an early crop, start seed in the hotbed late in March.

*One ounce will sow about 100 feet of row;
8 pounds will sow an acre*

- White Velvet.** 65 days. An early, low-growing variety. Pods of medium size; light green. Very productive. Pkt. 10 cts., oz. 20 cts., $\frac{1}{4}$ lb. 50 cts., lb. \$1.50.
- Long Green.** ★ 60 days. A tall-growing variety which bears quantities of deep green pods that average 6 to 7 inches in length at the edible stage. Slow to ripen. Pkt. 10 cts., oz. 20 cts., $\frac{1}{4}$ lb. 50 cts., lb. \$1.50.

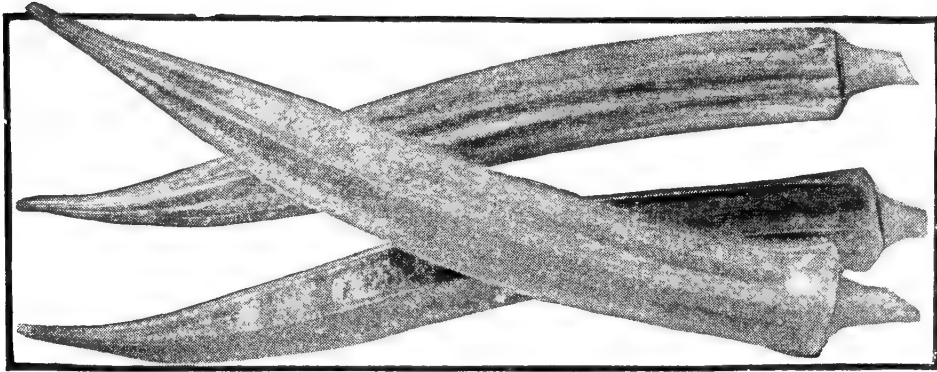

Okra, Long Green. Pkt. 10 cts., oz. 20 cts.

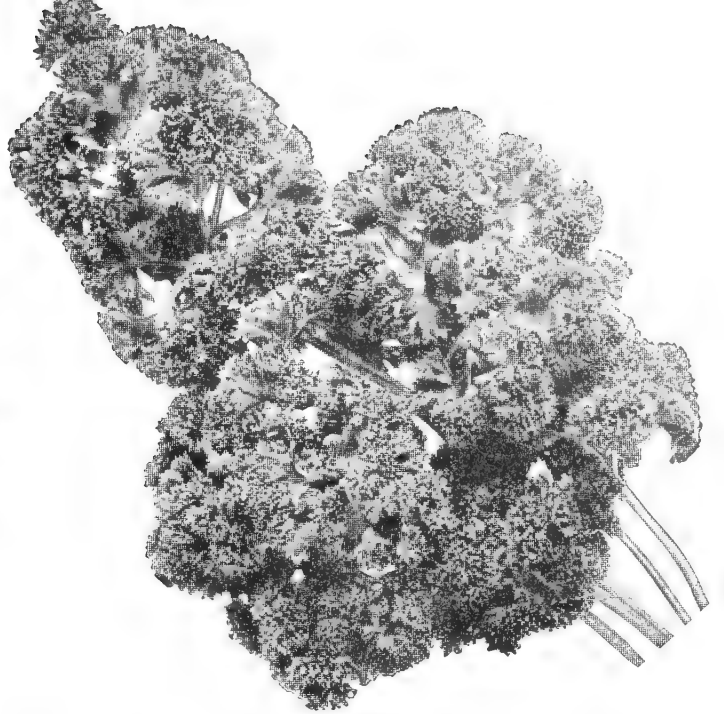

Parsley, Double-Curled. Pkt. 10 cts., oz. 20 cts.

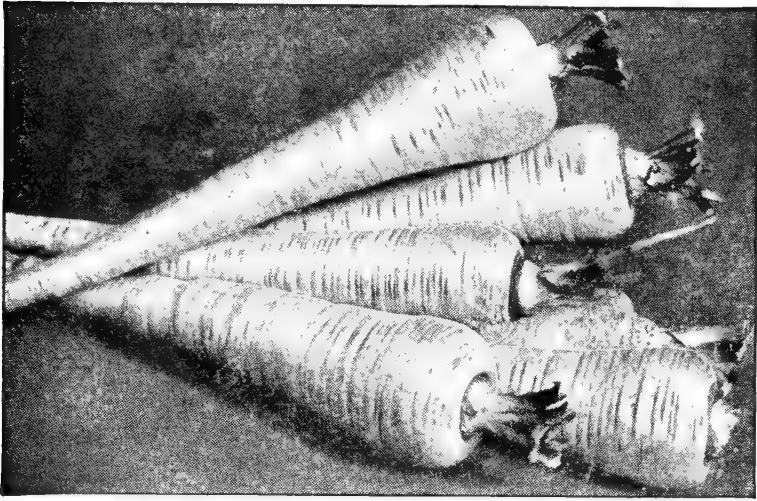

Parsnip, Hollow Crown. Pkt. 10 cts., oz. 25 cts.

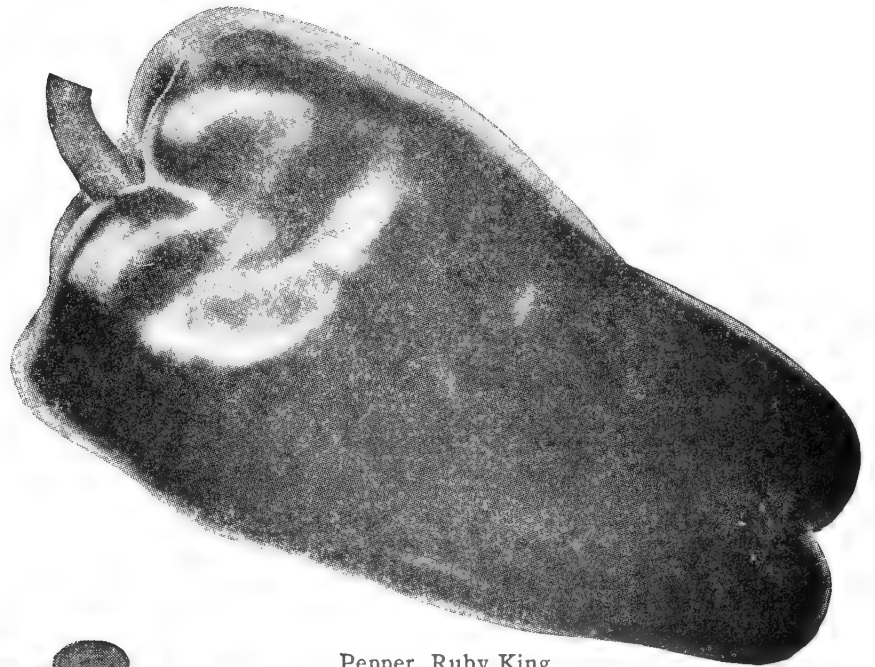

Pepper, Ruby King
Pkt. 10 cts., oz. 65 cts.



Hot Pepper, Hungarian Wax.
Pkt. 10 cts., oz. 75 cts.

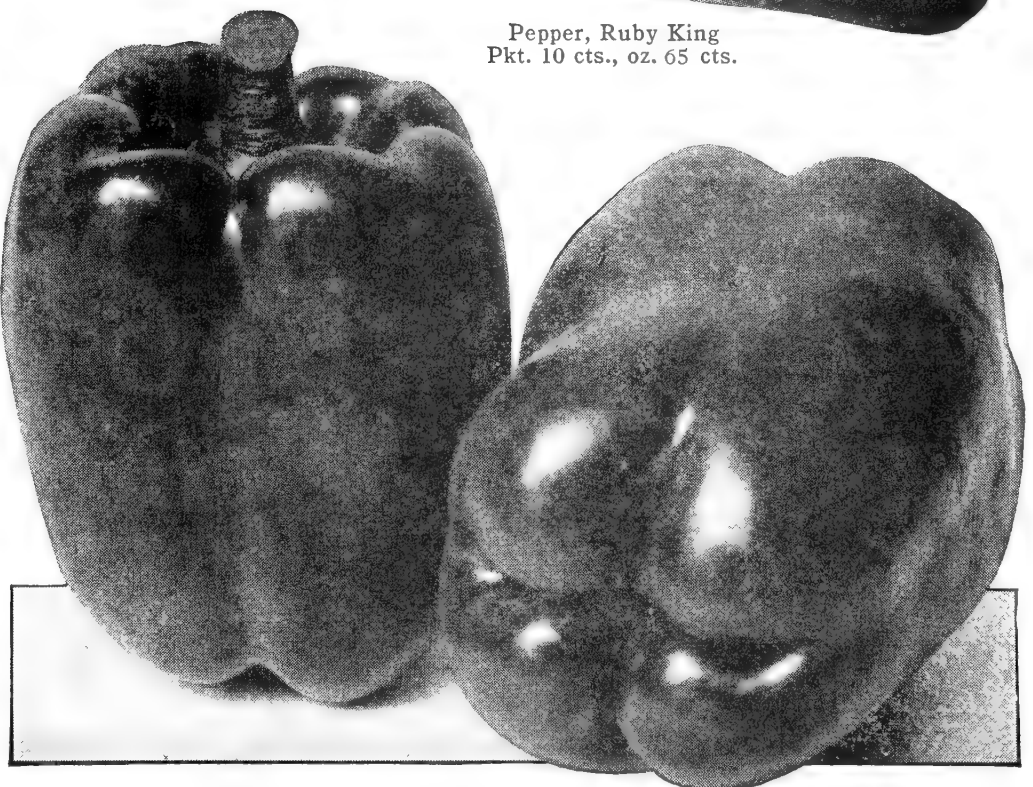

Pepper, California Wonder. Pkt. 10 cts., oz. 75 cts.

ONION

Green Onions from Seed. Easily grown from seed sown in fine, well-prepared soil early in the spring. Sow thinly in rows 12 to 15 inches apart, covering the seed with about $\frac{1}{2}$ inch of soil. Onions are ready in about 50 days. An ounce of seed will sow about 100 feet of row; 5 to 6 pounds will sow an acre.

Dry Onions from Seed. If possible sow seed in hotbeds in March, thinning the seedlings enough to prevent crowding. Transplant to the open ground in April or May, spacing them 3 to 4 inches apart, depending on variety. If hotbeds are not available sow the seed in the garden as early as the soil can be put in shape. Thin promptly. An ounce of seed will sow about 300 feet of row; 2 to 3 pounds will sow an acre.

Days given are from sowing of seed to dry Onion stage

Ailsa Craig. 105 days. One of the largest Onions grown. Globular in form, with pale straw-colored skin and crisp white flesh very mild in flavor. A heavy cropper and an excellent keeper. Pkt. 10 cts., oz. 50 cts., $\frac{1}{4}$ lb. \$1.50, lb. \$5.00.

Crystal White Wax. 95 days. A mild and sweet Onion of the Bermuda type. Excellent for slicing. Bulbs medium sized and flat; flesh white, sweet and of delicious flavor. Not suitable for long storage. Pkt. 10 cts., oz. 60 cts., $\frac{1}{4}$ lb. \$1.75, lb. \$6.00.

Large Red Wethersfield. 110 days. Standard late variety of splendid keeping quality. Bulbs large, flat but rather deep; skin deep purplish red; strong white flesh with faint pink flush. Excellent for sets and for mature bulbs. Pkt. 10 cts., oz. 50 cts., $\frac{1}{4}$ lb. \$1.50, lb. \$5.00.

Prizetaker. ★ 105 days. A fine selection of the giant Spanish Onion, which will, if planted early, produce bulbs 4 inches or more in diameter. It makes handsome, uniform, globe-shaped bulbs with thin, pale yellow skin and mild, sweet, white flesh. Pkt. 10 cts., oz. 60 cts., $\frac{1}{4}$ lb. \$1.75, lb. \$6.00.

Southport White Globe. ★ 115 days. The largest and handsomest of the white Onions, also the best keeper. The bulbs are uniformly globe-shaped with pure white skin and fine-grained, solid flesh of sweet, mild flavor. One of the best varieties for green Onions. Pkt. 10 cts., oz. 65 cts., $\frac{1}{4}$ lb. \$2.00, lb. \$7.00.

White Bunching. ★ A very quick-growing Onion of mild flavor. Grown almost exclusively for an early bunching or "green" Onion. Skin and flesh pure white. Pkt. 10 cts., oz. 60 cts., $\frac{1}{4}$ lb. \$1.75, lb. \$6.00.

White Portugal, or Silverskin. 100 days. Most widely used white Onion for sets, pickling Onions, mature bulbs and for green Onions from seed. Bulbs of medium size, flat but fairly deep, pure white; flesh fine grained, firm and hard. A splendid keeper. Pkt. 10 cts., oz. 60 cts., $\frac{1}{4}$ lb. \$1.75, lb. \$6.00.

White Sweet Spanish. 110 days. Similar to Yellow Sweet Spanish in type, but having clear white skin and white flesh. Pkt. 10 cts., oz. 65 cts., $\frac{1}{4}$ lb. \$2.00, lb. \$7.00.

Yellow Globe Danvers. ★ 110 days. Productive and medium early; bulbs large, solid, nearly globe-shaped, with yellowish brown skin and pure white flesh, crisp, sweet, and mild in flavor. Pkt. 10 cts., oz. 50 cts., $\frac{1}{4}$ lb. \$1.50, lb. \$5.00.

Yellow Sweet Spanish. 110 days. A popular large yellow variety of Spanish origin. Globular in shape with golden yellow skin and clear white flesh. Very sweet and of pleasing flavor, firm and mild. Good winter keeper. Pkt. 10 cts., oz. 65 cts., $\frac{1}{4}$ lb. \$2.00, lb. \$7.00.

ONION SETS

By starting with sets, small green Onions can be produced very early and large dry Onions can be harvested sometime during August. Plant sets as soon as the ground is ready in rows about 15 inches apart and 1 inch deep. For green Onions, space them 1 inch apart in the row, and for dry Onions about 3 inches apart.

Our sets are grown especially for us in the best Onion-set-growing section of the country. They are well cured, dried and carefully machine cleaned, graded and sized on the most modern equipment.

Yellow. Qt. 25 cts. **White.** Qt. 30 cts., postpaid.

Garlic Sets or Bulbs. Qt. 75 cts.

Prices on larger quantities quoted on request

BERMUDA ONION PLANTS

These are field-grown plants, grown out-of-doors in the South during the winter, and are perfectly hardy and ready to plant early. Mature Onions are flat and of medium size; flesh mild, sweet and of delicious flavor, making an excellent slicing Onion.

Available April 1 to June 1

1 bunch (75 to 100 plants) 35 cts., 10 bunches \$3.00, postpaid.

PARSLEY

Used mostly for seasoning and garnishing. Seed should be sown as early in the spring as possible, as it is very slow to germinate. Sow thinly in rows about 15 inches apart and cover about $\frac{1}{2}$ inch. Use the outer branches and it will continue to produce all season.

An ounce of seed will sow 200 feet of row; 8 pounds will sow an acre

Champion Moss Curled. Leaves attractively crimped and curled. Pkt. 10 cts., oz. 20 cts., $\frac{1}{4}$ lb. 50 cts., lb. \$1.50.

Double-Curled. ★ Unusually rich dark green foliage, tightly curled. Ideally suited for home and market-gardens. Pkt. 10 cts., oz. 20 cts., $\frac{1}{4}$ lb. 50 cts., lb. \$1.50.

Hamburg Parsnip-rooted. ★ Grown for its roots, which resemble parsnips and are highly flavored; useful in soups and stews. Can be stored for winter use. Sow in rows 15 inches apart and thin to stand 3 to 4 inches apart in the row. Pkt. 10 cts., oz. 20 cts., $\frac{1}{4}$ lb. 50 cts., lb. \$1.50.

Paramount. An improved strain of curled Parsley with unusually dark green, densely curled foliage. Pkt. 10 cts., oz. 20 cts., $\frac{1}{4}$ lb. 50 cts., lb. \$1.50.

Plain or Single. ★ The leaves are deeply cut but not curled. Stronger flavor than the curled, and preferred for soups, etc. Pkt. 10 cts., oz. 20 cts., $\frac{1}{4}$ lb. 50 cts., lb. \$1.50.

PARSNIP

Parsnips must be sown in the early spring as soon as the ground can be prepared. Sow the seed $\frac{1}{2}$ inch deep in rows about 15 inches apart, and when the plants are well up thin to 3 to 4 inches apart. The roots mature in the fall and, being perfectly hardy, may be left in the ground all winter, to be dug as needed. Their flavor is improved by freezing.

An ounce of seed will sow 200 feet of drill; 5 pounds will sow an acre

All-American. The white roots are large and broad-shouldered, of medium length and fine texture, with small core. Very free from side rootlets. An excellent variety. Pkt. 10 cts., oz. 25 cts., $\frac{1}{4}$ lb. 75 cts., lb. \$2.00.

Hollow Crown. ★ Long, smooth roots with white skin and fine-grained flesh. Most commonly used of all varieties. Pkt. 10 cts., oz. 25 cts., $\frac{1}{4}$ lb. 75 cts., lb. \$2.00.

The cost of the vegetable seed is such a small part of the total investment made in your garden that it pays to plant the very best. Make your time and labor count by planting Scott seeds.

PEPPER

Peppers require a moderately rich and light soil, a long growing season, and plenty of warmth at all stages. Grow them like egg-plants, starting the seed indoors or in the hotbed in March, transplanting to pots or dirt-bands when the second or third leaf has developed. Set the plants in the garden early in June in rows 2½ to 3 feet apart and spaced 2 feet apart in the row. Days to maturity are figured from the time the plants are set in the garden.

An ounce of seed will produce about 1,500 plants

Sweet Peppers

- California Wonder.** ★ 75 days. Peppers are of good size, with heavy thick walls, sweet, tender and of excellent flavor. The skin is very smooth, glossy green, turning to bright crimson when ripe. The best all-round sweet Pepper. Pkt. 10 cts., oz. 75 cts., ¼lb. \$2.50, lb. \$8.00.
- Calwonder, Early.** 67 days. An early strain of California Wonder but fruits slightly smaller. Pkt. 10 cts., oz. 75 cts., ¼lb. \$2.50, lb. \$8.00.
- Chinese Giant.** 80 days. The largest of all Peppers, often measuring 5 inches in length and diameter. Flesh thick and very mild and sweet; deep red when ripe. Pkt. 10 cts., oz. 75 cts., ¼lb. \$2.50, lb. \$8.00.
- Early Giant.** 65 days. Large, early variety about 4 inches long by 3 inches through. It is deep green, turning to red, and of sweet flavor. Pkt. 10 cts., oz. 75 cts., ¼lb. \$2.50, lb. \$8.00.
- Golden Queen.** 80 days. The largest and finest yellow-fruited Pepper. Very heavy, meaty, and strictly mild. Glossy golden yellow skin. Pkt. 10 cts., oz. 65 cts., ¼lb. \$2.00, lb. \$6.00.
- King of the North.** 65 days. Very early, productive, mild and sweet. Fruits enormous, 5 inches long and 3 inches through; dark green coloring to a bright red earlier than any other large variety. Pkt. 10 cts., oz. 75 cts., ¼lb. \$2.50, lb. \$8.00.
- Pimiento.** 75 days. Fruits are heart-shaped, smooth, dark green changing to crimson; flesh thick, sweet and mild. Grown for canning whole. Pkt. 10 cts., oz. 65 cts., ¼lb. \$2.00, lb. \$6.00.
- Ruby Giant.** ★ 75 days. Thick-fleshed and one of the largest of the early sweet Peppers. Deep green, changing to rich red when ripe. Pkt. 10 cts., oz. 65 cts., ¼lb. \$2.00, lb. \$6.00.
- Ruby King.** 68 days. Early and productive. Dark green turning to bright red at maturity, averaging 4 inches in length and 3 inches in diameter, tapering to a blunt point. The flesh is thick and sweet. Pkt. 10 cts., oz. 65 cts., ¼lb. \$2.00, lb. \$6.00.
- Squash or Tomato.** 75 days. Flesh thick and mild; shaped like a tomato; 2 to 3 inches in diameter. Glossy green changing to deep red at maturity. Generally used for canning and pickling. Pkt. 10 cts., oz. 65 cts., ¼lb. \$2.00, lb. \$6.00.
- World Beater.** ★ 75 days. Fruits large, oblong, deep green becoming bright deep red; thick flesh, mild and sweet. Plants very productive. Pkt. 10 cts., oz. 65 cts., ¼lb. \$2.00, lb. \$6.00.

Hot Peppers

- Anaheim Chili.** 80 days. Late, hot variety for canning and drying. Fruits 6 to 8 inches long, 1 inch diameter. Pkt. 10 cts., oz. 50 cts., ¼lb. \$1.50, lb. \$5.00.
- Bull Nose.** ★ 70 days. Scarlet when mature; medium size, square and blunt-pointed. Generally considered sweet but is sometimes quite hot. Pkt. 10 cts., oz. 65 cts., ¼lb. \$2.00, lb. \$6.00.
- Hungarian Wax.** ★ 60 days. Fruits about 5 inches long and 1½ inches in diameter at stem end, tapered; waxy yellow and red when ripe. Hot. Desirable for both home-and market-gardeners. Pkt. 10 cts., oz. 75 cts., ¼lb. \$2.50, lb. \$8.00.
- Large Red Cherry.** 82 days. Fruits erect, round or cherry-shape; very hot. Pkt. 10 cts., oz. 75 cts., ¼lb. \$2.50, lb. \$8.00.
- Long Red Cayenne.** ★ 70 days. Pods about 6 inches long, slender and pointed, dark green turning to bright scarlet; flesh very hot in taste and pungent in odor. Pkt. 10 cts., oz. 65 cts., ¼lb. \$2.00, lb. \$6.00.
- Red Chili.** 82 days. Fruits about 2½ inches long, ¾ inch in diameter at shoulder, and tapering to point. Light green turning to deep red; thin fleshed. A really hot variety. Used extensively for Pepper sauces, pickling and drying. Pkt. 10 cts., oz. 65 cts., ¼lb. \$2.00, lb. \$6.00.

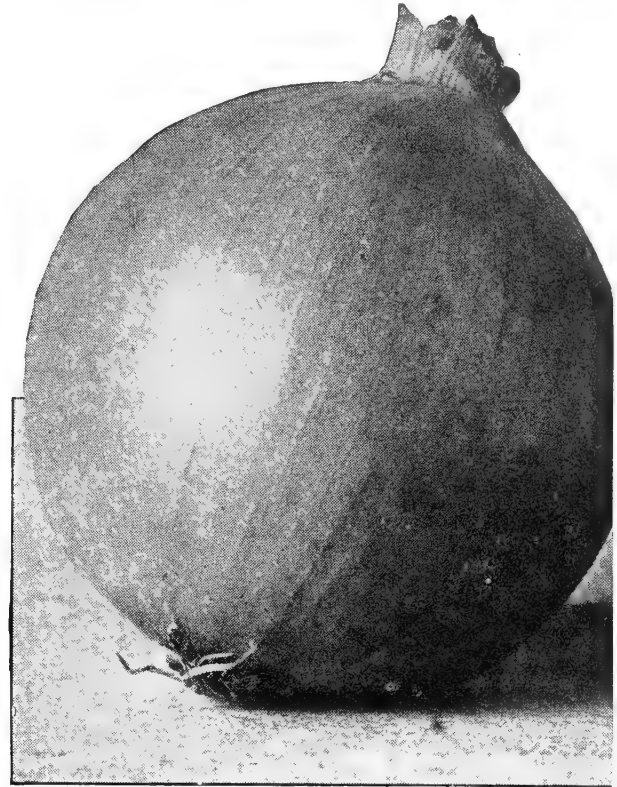

Onion, Yellow Globe Danvers
Pkt. 10 cts., oz. 50 cts.

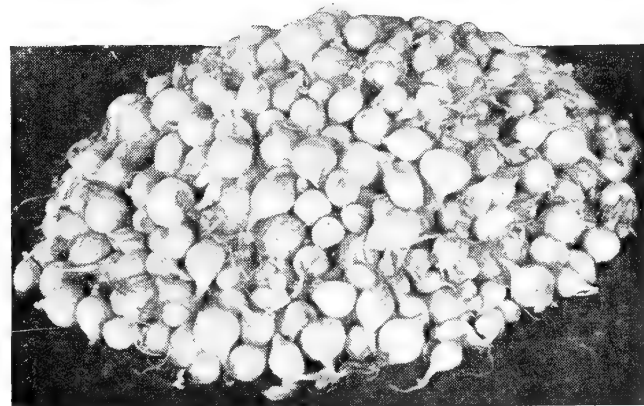

Onion Sets. Yellow, qt. 25 cts., White, qt. 30 cts., postpaid

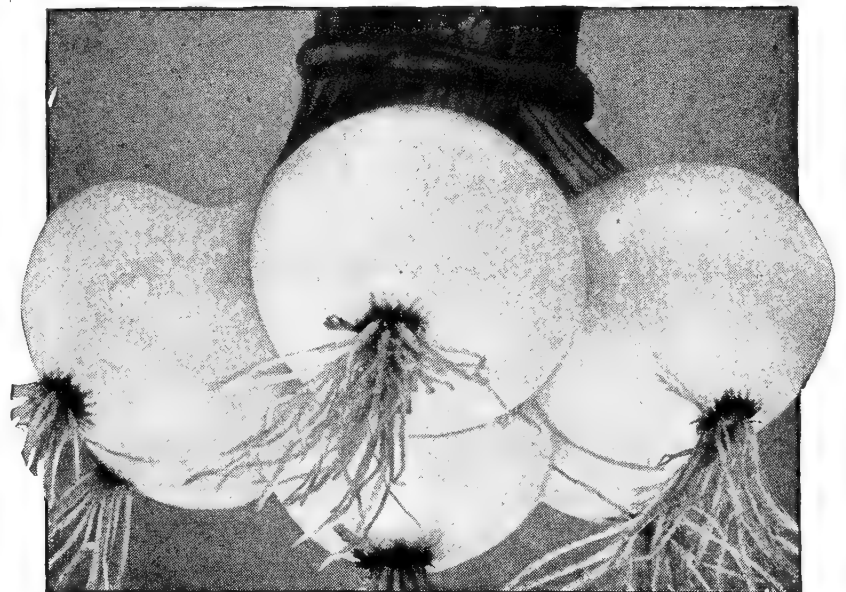

Onion, Southport White Globe in Bunching Stage
Pkt. 10 cts., oz. 65 cts.

GARDEN PEAS

Peas can be sown very early in the spring, the early smooth-seeded varieties even as early as March 1. For the first sowings use the smooth or round-seeded sorts, but after the first of April change to the wrinkled kinds which, although not so hardy, are much superior in quality. Make additional sowings every two weeks up to June 1 for a continuous supply, but arrange to put the later plantings on deep, rich soil where you can conveniently water them during dry weather. Plant dwarf varieties in rows 2 to 2½ feet apart, tall varieties about 3 feet apart. Cover both kinds about 2 inches and thin to stand 3 inches apart in the row. The tall varieties do best for late planting, and while some people prefer to provide supports for them they are really not necessary.

**For Increased Yield
Inoculate This Seed
with LEGUME-AID.**

*A pint of seed will sow 100 feet of row;
1 to 1½ bushels will sow an acre*

Early Smooth-Seeded Peas

Alaska. 54 days. A very productive smooth Pea, long in favor with canners and home-gardeners for a first-early variety. About 2 feet tall; pods rather small, ripening all at once; Peas small and of medium quality. ½pt. 25 cts., pt. 40 cts., qt. 75 cts., pk. \$3.40, bus. \$12.00.

Mammoth-Podded Extra Early. 58 days. A very prolific early, smooth-seeded variety valuable for its large pods. Vines medium dark green, 30 inches tall; pods 3 inches long, medium green, with 6 to 7 Peas in each pod. Popular in many home and market-gardens. ½pt. 25 cts., pt. 40 cts., qt. 75 cts., pk. \$3.40, bus. \$12.00.

Market Surprise. 54 days. An extra-early sort, growing about 2½ feet tall. It is about the same season as Alaska, but the pods are larger and Peas of better quality. ½pt. 25 cts., pt. 40 cts., qt. 75 cts., pk. \$3.40, bus. \$12.00.

Early Wrinkled-Seeded Peas

Gradus, or Extra-Early Telephone. 62 days. A grand old standby and a most dependable producer. Vines 3 feet high; pods about 4 inches long, broad and slightly curved, containing 7 to 9 Peas of excellent quality. ½pt. 25 cts., pt. 40 cts., qt. 75 cts., pk. \$3.40, bus. \$12.00.

Laxtonian. ★ 64 days. Also known as Blue Bantam. A dwarf, heavy-yielding variety that bears over a long season. Pods are dark green and contain 7 to 8 large succulent Peas. Unequaled for its combination of extreme earliness, superb quality, and unusual productiveness, and the best all-round variety for both home and market-gardens. Pkt. 10 cts., ½pt. 25 cts., pt. 40 cts., qt. 75 cts., pk. \$3.40, bus. \$12.00.

Laxton's Progress. ★ 62 days. Slightly larger podded than Laxtonian. The Peas are deep green, of excellent flavor, fully wrinkled, and average 9 or 10 to the pod. Grows 18 inches high. Desirable for both home and market-gardens. ½pt. 25 cts., pt. 40 cts., qt. 75 cts., pk. \$3.40, bus. \$12.00.

Little Marvel. ★ 62 days. The vines grow about 18 inches high and bear big crops of 3¼-inch pods, containing large Peas of excellent flavor. It is unsurpassed by any other variety in its class and is the variety we recommend for home-gardens. Pkt. 10 cts., ½pt. 25 cts., pt. 40 cts., qt. 75 cts., pk. \$3.40, bus. \$12.00.

Nott's Excelsior. 60 days. Also known as American Wonder. A dwarf variety, growing about 14 inches tall. Pods are about 3 inches long and well filled with 6 or 7 large, sweet Peas in every pod. A vigorous grower and very prolific. ½pt. 25 cts., pt. 40 cts., qt. 75 cts., pk. \$3.40, bus. \$12.00.

Thomas Laxton. 62 days. Vines grow 3 feet tall and are very prolific. Pods are rich deep green and contain 7 or 8 large, tender Peas of splendid quality. Unsurpassed as an early, all-purpose variety. ½pt. 25 cts., pt. 40 cts., qt. 75 cts., pk. \$3.40, bus. \$12.00.

World's Record. 60 days. Vines about 2½ feet tall and moderately productive. Pods 3¼ inches long, light green and contain 7 to 8 large tender Peas of good quality. ½pt. 25 cts., pt. 40 cts., qt. 75 cts., pk. \$3.40, bus. \$12.00.

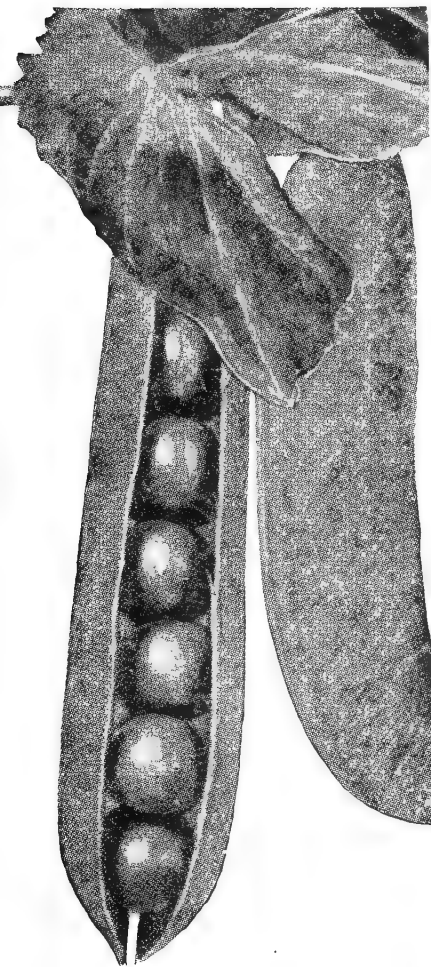

Peas, Laxtonian.
Pkt. 10 cts., ½pt. 25 cts.
pt. 40 cts., qt. 75 cts.

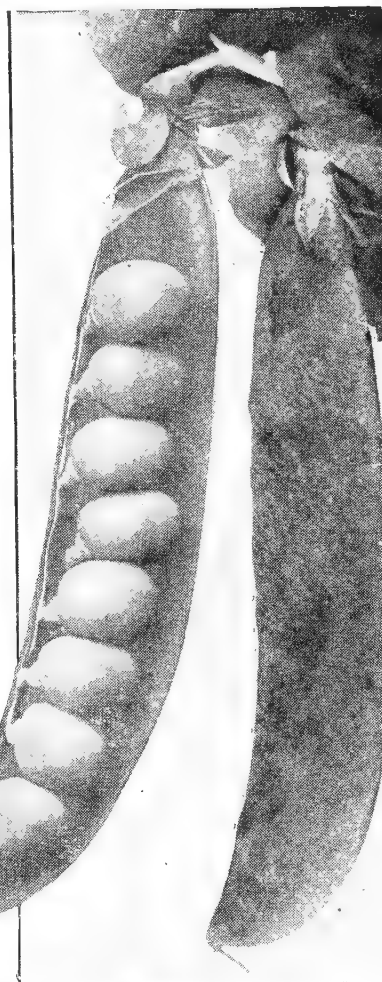

Peas, Potlatch
½pt. 25 cts., pt. 40 cts., qt. 75 cts.

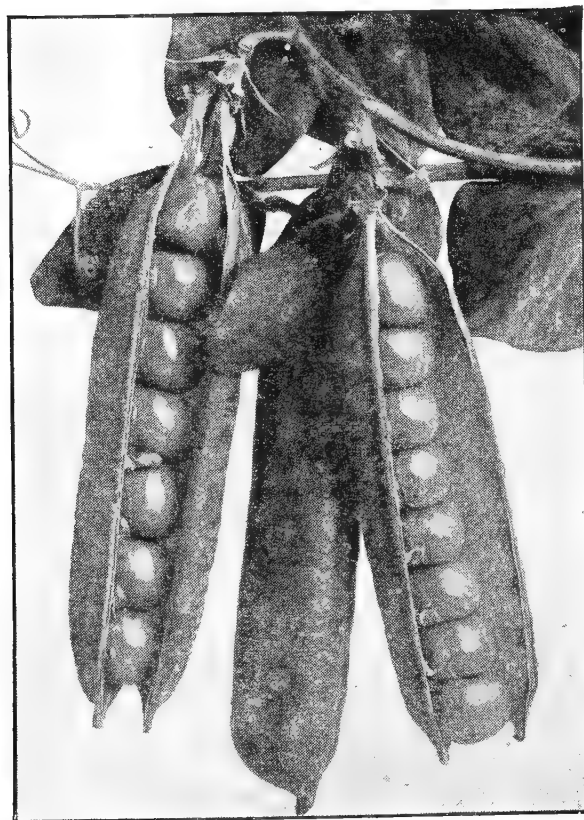

Peas, Little Marvel
Pkt. 10 cts., ½pt. 25 cts., pt. 40 cts., qt. 75 cts.

Main-Crop Varieties

Alderman. ★ 75 days. Vines about 4 feet high, strong and vigorous; leaves and pods rich dark green; productive; quality the finest. Pods are 4½ to 5½ inches long, handsome and well filled with 8 to 10 extra-large Peas. ½pt. 25 cts., pt. 40 cts., qt. 75 cts., pk. \$3.40, bus. \$12.00.

Dwarf Telephone. 77 days. Also known as "Daisy." Grows 2½ feet tall, with 4½-inch pods, containing 7 or 8 Peas of the very best quality. ½pt. 25 cts., pt. 40 cts., qt. 75 cts., pk. \$3.40, bus. \$12.00.

Improved Telephone. 75 days. Grows 4 feet high; pods 4½ inches long, with 8 to 10 extra-large Peas. Bears several pickings. ½pt. 25 cts., pt. 40 cts., qt. 75 cts., pk. \$3.40, bus. \$12.00.

Mammoth-Podded Sugar. 75 days. A tall, late, prolific variety which produces big, broad pods, so tender and sweet that the whole pod can be cooked and served like snap beans. If you have not grown sugar-pod Peas, be sure to try them this year. ½pt. 30 cts., pt. 45 cts., qt. 90 cts., pk. \$3.90, bus. \$14.00.

Potlatch. ★ 80 days. Dwarf growth and extra-fine quality. Vines luxuriant, 2 feet high; pods deep green, 5 inches long and quite broad; Peas large and tender, often 10 to a pod. A superior variety for home- and market-gardens. ½pt. 25 cts., pt. 40 cts., qt. 75 cts., pk. \$3.40, bus. \$12.00.

Wyoming Wonder. 73 days. Vine is dark green and about 28 inches tall. Pods are dark green, 5 to 6 inches long, each one containing 8 to 10 large Peas of unusually fine flavor. Remains sweet and tender a week to 10 days after reaching the picking stage. An excellent market-gardener's variety. ½pt. 25 cts., pt. 45 cts., qt. 75 cts., pk. \$3.40, bus. \$12.00.

NOTE: One pint of Peas weighs about 1 lb. and 1 quart about 2 lbs. One bushel of round-seeded varieties weighs 60 lbs. and 1 bus. wrinkled varieties weighs 56 lbs.

PUMPKIN

The seed should be sown as soon as the ground gets warm, in hills 6 to 8 feet apart, dropping from four to eight seeds in each hill, and thin out to 3 or 4 plants to each hill. Since Pumpkins require a lot of space they are generally grown with corn. Sow after the corn is up.

*One ounce of seed will plant about 25 hills;
4 to 5 pounds will plant an acre*

Connecticut Field. ★ 120 days. Very productive; fruits oblong with bright yellow skin and rather coarse flesh. Usually grown for stock. An old and popular variety. Pkt. 10 cts., oz. 20 cts., ¼lb. 50 cts., lb. \$1.50, 5 lbs. \$7.00.

Kentucky Field. 120 days. A heavy-yielding variety used principally for stock feed. Fruits large, variable in shape, deep orange; flesh deep yellow, coarse, and of good flavor. Pkt. 10 cts., oz. 20 cts., ¼lb. 50 cts., lb. \$1.50, 5 lbs. \$7.00.

King of Mammoths. ★ 120 days. Round, flattened at the ends; skin yellow mottled with orange and deep yellow flesh of fair quality. Grows to an enormous size. Very attractive and a good keeper. Pkt. 10 cts., oz. 25 cts., ¼lb. 75 cts., lb. \$2.00.

Large Cheese. 110 days. Big, flat, uniform Pumpkins with light buff skin and thick yellow flesh, deep rib, hard shell and fair quality. Pkt. 10 cts., oz. 20 cts., ¼lb. 50 cts., lb. \$1.50.

Mammoth Golden Cushaw. 110 days. A large crookneck with golden orange skin and deep, rich yellow flesh of the very finest quality. Pkt. 10 cts., oz. 20 cts., ¼lb. 50 cts., lb. \$1.50.

Small Sugar. ★ 105 days. Small but productive and of splendid quality. Fruits round with bright orange skin and thick, sweet flesh. Never coarse or stringy; a good keeper and the best for pies. Pkt. 10 cts., oz. 20 cts., ¼lb. 50 cts., lb. \$1.50.

Striped Cushaw. 110 days. Crookneck shape; smooth white skin with mottled green stripes; flesh yellow, fine-grained and sweet. Pkt. 10 cts., oz. 20 cts., ¼lb. 50 cts., lb. \$1.50.

Tennessee Sweet Potato. 110 days. Sweet, tender, yellow flesh. One of the extra-good pie Pumpkins. Bell-shaped in form. Pkt. 10 cts., oz. 20 cts., ¼lb. 50 cts., lb. \$1.50.

Winter Luxury. ★ 100 days. Flesh golden russet color, of extra-fine flavor. Pumpkins medium size, with netted skin. Recommended for home-gardens, being good for canning and pie-making. Pkt. 10 cts., oz. 20 cts., ¼lb. 50 cts., lb. \$1.50.

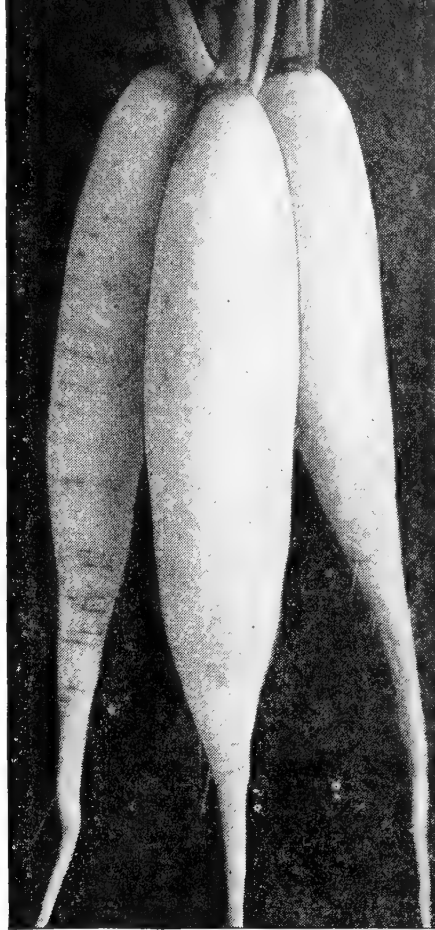

Such quick-growing crops as Radishes and leaf Lettuce may be grown between rows of vegetables requiring a longer season. By the time the main crop needs the full space allotted to it, the quicker one has already been gathered. Everyone with limited garden space should follow this method.



Radish, Early
Scarlet Globe
Pkt. 10 cts.
oz. 20 cts.

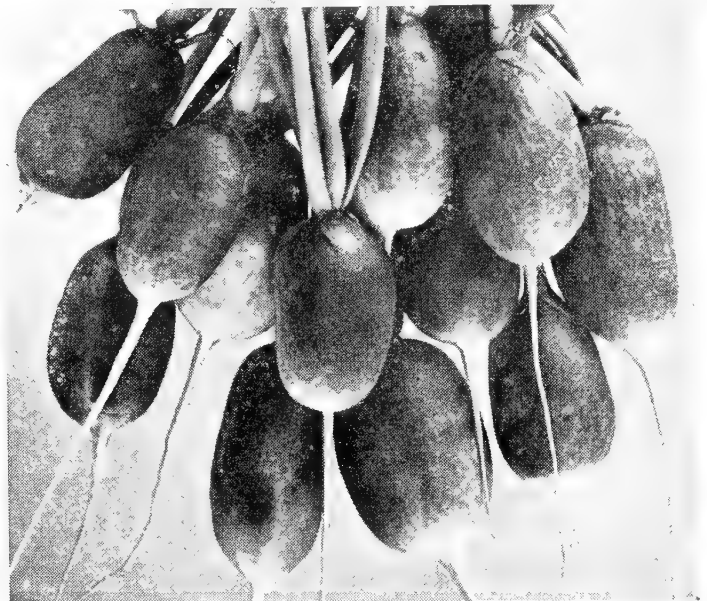

Radish, French Breakfast. Pkt. 10 cts. oz. 20 cts.

RADISHES

Start outdoors as soon as the ground can be put in shape and sow seed of any of the quick-growing round or olive-shaped sorts, not too thick, in drills $\frac{1}{2}$ inch deep and 1 to $1\frac{1}{2}$ feet apart. Thin out the seedlings promptly to stand about an inch apart in the rows. If not thinned out they will only produce tops and not develop a bulb. After putting in seed for the first crop, make additional sowings every ten days to two weeks, but for the later crops, which will ripen in warm weather, use the long varieties.

For late summer and fall use, sow the Summer and Winter Radishes which are larger and slower growing but will, unlike the early round Radishes, thrive in hot weather. The Summer Radishes may be sown any time up to August 1. The big Winter Radishes should be sown late in June to attain full size before frost. *One ounce of seed will sow about 100 feet of drill; 8 to 10 pounds will sow an acre*

Early Radishes

Cincinnati Market. ★ 35 days. A popular home and market-garden variety. Roots long; skin deep red; flesh clear white, very brittle and mild. Popular for forcing. The best long red early Radish. Pkt. 10 cts., oz. 20 cts., $\frac{1}{4}$ lb. 50 cts., lb. \$1.50.

Crimson Giant. ★ 30 days. The largest of the early, round Radishes. Handsome, deep red, globe-shaped roots. Will retain its crispness longer than any other Radish of its type. Pkt. 10 cts., oz. 20 cts., $\frac{1}{4}$ lb. 50 cts., lb. \$1.50.

Early Scarlet Globe. ★ 25 days. Medium-sized, very uniform, globe-shaped, bright scarlet roots. Flesh white, mild and crisp. The best variety of its kind for home and market-gardens. Pkt. 10 cts., oz. 20 cts., $\frac{1}{4}$ lb. 50 cts., lb. \$1.50.

Early Scarlet Turnip. 25 days. Roots of medium size, round, smooth, bright red; tops small. Pkt. 10 cts., oz. 20 cts., $\frac{1}{4}$ lb. 50 cts., lb. \$1.50.

French Breakfast. 27 days. An oblong or olive-shaped Radish of very fine quality. Bright scarlet skin with clear white tip. The flesh is white, firm, crisp and tender. Pkt. 10 cts., oz. 20 cts., $\frac{1}{4}$ lb. 50 cts., lb. \$1.50.

Icicle. ★ 35 days. It grows quickly, making handsome, smooth roots 5 to 6 inches long with pure white skin and crisp, mild flesh. Reliable for either spring or summer use. Retains its crispness longer than most other varieties. The best long white Radish. Pkt. 10 cts., oz. 20 cts., $\frac{1}{4}$ lb. 50 cts., lb. \$1.50.

Sparkler (White Tip). 25 days. Tops small; roots globe shape, bright scarlet with pronounced white tip. Crisp and of splendid quality until fairly large. Pkt. 10 cts., oz. 20 cts., $\frac{1}{4}$ lb. 50 cts., lb. \$1.50.

Summer Radishes

Chartier, Improved. 38 days. Intermediate in season between the early and the summer Radishes. Roots 7 to 8 inches long. 1 inch thick, bright rose with white tip. Pkt. 10 cts., oz. 20 cts., $\frac{1}{4}$ lb. 50 cts., lb. \$1.50.

White Strasburg. ★ 40 days. Roots about 5 inches long, $1\frac{1}{2}$ inches thick at the shoulder, tapering and smooth. Skin and flesh pure white; remains firm and brittle longer than most sorts. Pkt. 10 cts., oz. 20 cts., $\frac{1}{4}$ lb. 50 cts., lb. \$1.50.

White Stuttgart. ★ 55 days. A large, late, pure white kind, with almost round or turnip-shaped roots 3 inches in diameter. Of good quality and a good keeper. Pkt. 10 cts., oz. 20 cts., $\frac{1}{4}$ lb. 50 cts., lb. \$1.50.

Winter Radishes

Celestial, or White Chinese. ★ 60 days. Cylindrical in shape, often 8 inches long and 3 inches in diameter; skin and flesh pure white. Of fine quality and a good keeper. Pkt. 10 cts., oz. 20 cts., $\frac{1}{4}$ lb. 50 cts., lb. \$1.50.

Chinese Rose. 55 days. Roots 4 to 5 inches long, 2 inches in diameter, cylindrical but thicker near the bottom; skin smooth, bright rose in color; flesh white, crisp and tender. Pkt. 10 cts., oz. 20 cts., $\frac{1}{4}$ lb. 50 cts., lb. \$1.50.

Long Black Spanish. 60 days. Roots 7 to 9 inches long and 2 to 3 inches in diameter at the top, tapering to an abrupt point. Skin black, flesh clear white and of fine quality. Pkt. 10 cts., oz. 20 cts., $\frac{1}{4}$ lb. 50 cts., lb. \$1.50.

Long White Spanish. 60 days. Exactly like the preceding except in color of skin. Pkt. 10 cts., oz. 20 cts., $\frac{1}{4}$ lb. 50 cts., lb. \$1.50.

Round Black Spanish. ★ 60 days. Roots nearly round, 3 to 4 inches in diameter; skin black; flesh white and crisp. Pkt. 10 cts., oz. 20 cts., $\frac{1}{4}$ lb. 50 cts., lb. \$1.50.

RHUBARB

It is cheapest to start with seed but only a percentage of the plants grown from seed will be worth saving. Sow early in the spring, in drills an inch deep and a foot apart, and thin the plants to stand about 5 inches apart. The following spring, reset the best plants 3 to 4 feet apart each way. If you start with roots, plant them with the crown about 1 inch below the surface. Give water, if needed, while the plants are producing and dress with manure every year after the cutting season is over.

Victoria. Broad, thick, tender stalks shaded red. Very productive. Seed, pkt. 10 cts., oz. 20 cts., $\frac{1}{4}$ lb. 60 cts. Roots, 20 cts. each, \$2.10 per doz.

Mac Donald. Stalks brilliant red, tender and of excellent flavor and quality. A new variety well adapted to the northern section of the country. Roots, 50 cts. each, \$5.50 per doz.

SALSIFY

Often called "Vegetable Oyster" or "Oyster Plant" on account of its flavor. Sow the seed early, as the plants require a long season to attain full size; cover about an inch deep and thin to 3 inches apart. The roots mature in the fall, and being perfectly hardy, may be left in the ground all winter and dug as needed.

*One ounce of seed will sow about 100 feet of drill;
10 pounds will sow an acre*

Mammoth Sandwich Island. The best variety. Roots often 10 to 12 inches long, tender, and of delicious flavor. Pkt. 10 cts., oz. 50 cts., $\frac{1}{4}$ lb. \$1.50, lb. \$5.00.

SPINACH

Spinach is a cool-weather crop and may be sown as soon as the ground can be made ready in the spring and followed with successive sowings every ten days up to the middle of May. Make additional sowings in August and September for fall use. Sow in drills $\frac{1}{2}$ inch deep, in rows about 12 inches apart, and thin the plants to stand about 2 inches apart.

To provide Spinach during hot weather, when ordinary varieties do not thrive, make a sowing of the heat-resistant New Zealand Spinach in April. Sow in rows 3 feet apart and let the plants stand about 1 foot apart in the row.

NOTE—The time from sowing of seed to cutting of plants varies considerably with the season of the year in which sowings are made. Days given apply to spring sowings.

*One ounce of seed will sow about 100 feet of drill;
14 to 15 pounds will sow an acre*

Bloomsdale Savoy-Leaved. ★ 40 days. (Reselected.) Very hardy and consequently most desirable for autumn and early spring use. The plants are upright and vigorous, with heavily crumpled, dark green leaves. Oz. 15 cts., $\frac{1}{4}$ lb. 30 cts., lb. 85 cts., 5 lbs. \$3.75, 10 lbs. \$7.00, 25 lbs. \$16.25.

Bloomsdale Long-Standing. ★ 43 days. A quick-growing, blight-resistant hardy sort that is much planted for market and canning. Leaves curled and wrinkled. Remains edible longer than other varieties. Oz. 15 cts., $\frac{1}{4}$ lb. 30 cts., lb. 85 cts., 5 lbs. \$3.75, 10 lbs. \$7.00, 25 lbs. \$16.25.

Spinach continued on next page

SPINACH, continued

Improved Thick-Leaved. 45 days. A hardy, vigorous sort, particularly valuable for spring sowing. Leaves deeply crumpled and dark green. Oz. 15 cts., $\frac{1}{4}$ lb. 30 cts., lb. 85 cts., 5 lbs. \$3.75, 10 lbs. \$7.00, 25 lbs. \$16.25.

Juliana. ★ 50 days. Grows close to the ground and has dark green, crumpled leaves that keep fresh-looking and retain their crispness a long time. Oz. 15 cts., $\frac{1}{4}$ lb. 30 cts., lb. 85 cts., 5 lbs. \$3.75, 10 lbs. \$7.00, 25 lbs. \$16.25.

King of Denmark. 48 days. Leaves are thick, crumpled, and dark green. Does not go to seed as quickly as most varieties. Oz. 15 cts., $\frac{1}{4}$ lb. 30 cts., lb. 85 cts., 5 lbs. \$3.75, 10 lbs. \$7.00, 25 lbs. \$16.25.

Virginia Blight-Resistant. 45 days. This is a cool-weather variety that is resistant to "yellows" and mosaic disease, and has moderately savoyed leaves. Being resistant to cold weather, it is a desirable variety for fall planting. Oz. 15 cts., $\frac{1}{4}$ lb. 30 cts., lb. 85 cts., 5 lbs. \$3.75, 10 lbs. \$7.00, 25 lbs. \$16.25.

New Zealand. 70 days. Often called "Summer Spinach." A distinct type of Spinach which makes large, bushy plants, often 3 feet in diameter. Only the young leaves and tips of the branches are used and the more they are picked, the faster the plant seems to grow. Thrives in hot, dry weather. Pkt. 10 cts., oz. 30 cts., $\frac{1}{4}$ lb. 90 cts., lb. \$2.50.



Spinach, New Zealand
Pkt. 10 cts., oz. 30 cts.

**★WHEN IN DOUBT ORDER THE
STAR VARIETIES**

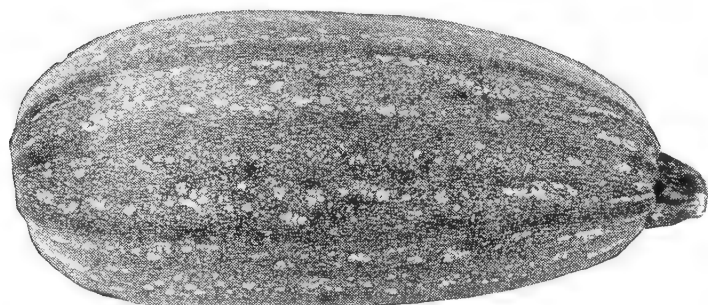

Squash, Cocozelle. Pkt. 10 cts., oz. 25 cts.



Pumpkin, Small Sugar. Pkt. 10 cts., oz. 20 cts.

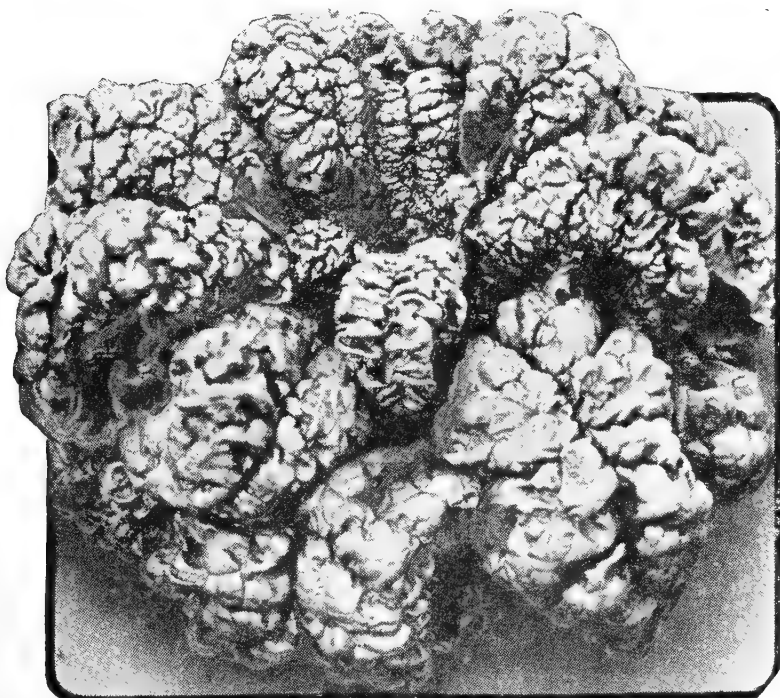

Spinach, Bloomsdale Long-standing. Oz. 15 cts., $\frac{1}{4}$ lb. 30 cts.



Squash, Mammoth White Bush. Pkt. 10 cts., oz. 25 cts.



Squash
Acorn
Pkt. 10 cts.
oz. 25 cts.

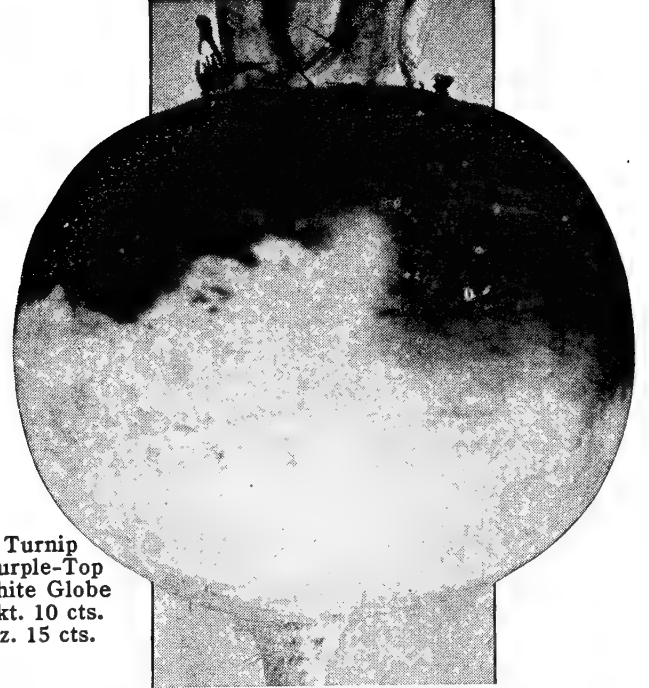

Turnip
Purple-Top
White Globe
Pkt. 10 cts.
oz. 15 cts.

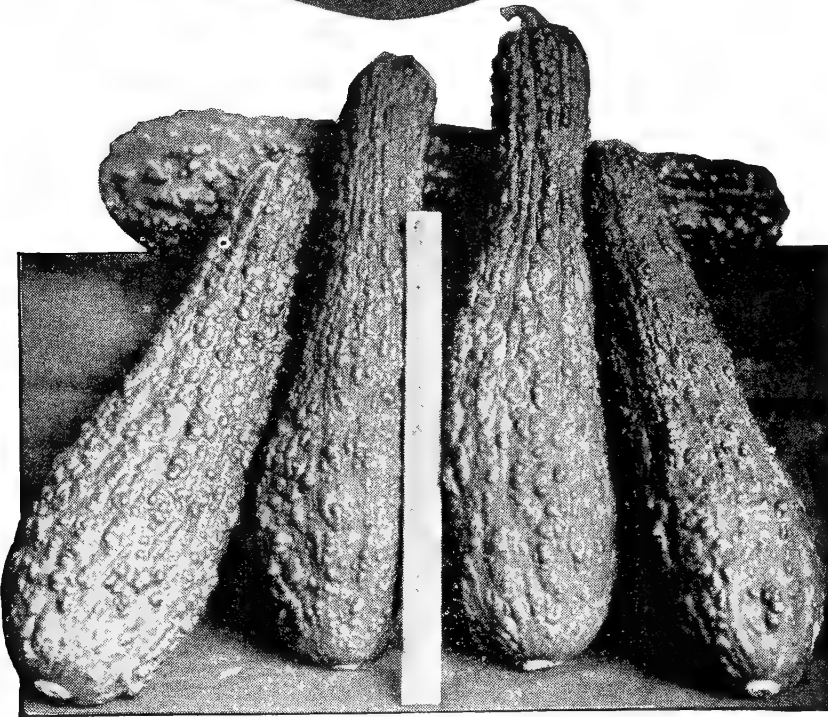

Squash, Yellow Summer Straightneck. Pkt. 10 cts., oz. 25 cts.

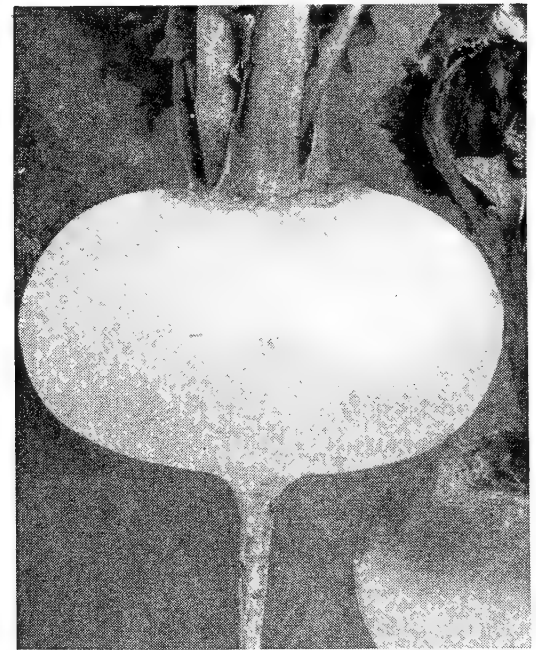

Turnip, Extra-Early White Milan
Pkt. 10 cts., oz. 20 cts.



Squash, Golden Hubbard. Pkt. 10 cts., oz. 30 cts.



Rutabaga or Swede Turnip
Improved Purple-Top
Pkt. 10 cts., oz. 15 cts.

SQUASH

SUMMER SQUASH. Sow the seed in fertile, deep soil when the ground is warm and dry and after all danger of frost has passed, in hills about 4 feet apart each way. Allow about 4 plants to remain in each hill.

WINTER SQUASH. Plant in hills 8 to 10 feet apart each way and when the plants are about 5 inches tall, thin to 3 plants to the hill. Allow the Squash to remain on the vine until fully matured. Keep in a moderately warm, dry place during the winter.

*One ounce of Squash seed will plant 15 to 20 hills;
3 to 5 pounds will plant an acre, according to variety*

Summer or Bush Squash

Black Zucchini. ★ 65 days. Cylindrical and of uniform thickness; rind dark green; flesh firm and of delicate flavor. Easy to grow, and very prolific. Pkt. 10 cts., oz. 25 cts., $\frac{1}{4}$ lb. 75 cts., lb. \$2.00.

Cocozelle (Italian Vegetable Marrow.) 65 days. Bushy plants, requiring little space, produce many oblong fruits averaging a foot long and 4 inches in diameter; green skin, mottled and striped with yellow and darker green. Quality extra-fine. Becoming better known every year. Pkt. 10 cts., oz. 25 cts., $\frac{1}{4}$ lb. 75 cts., lb. \$2.00.

Mammoth White Bush. ★ 55 days. One of the earliest. Compact in growth and prolific, with round, ivory-white fruits, with scalloped edges. Bears throughout the season if kept gathered. A very popular sort because of its fine flavor. Pkt. 10 cts., oz. 25 cts., $\frac{1}{4}$ lb. 75 cts., lb. \$2.00.

Yellow Summer Crookneck. 62 days. Long, curved fruits with thin, golden yellow, warted skin; sweet, tender flesh. Pkt. 10 cts., oz. 25 cts., $\frac{1}{4}$ lb. 75 cts., lb. \$2.00.

Yellow Summer Straightneck. ★ 62 days. Similar to Yellow Summer Crookneck except that it is straight and smoother. Fruits are golden yellow, about 10 inches long and 3 inches in diameter at the blossom end, thickly warted; flesh golden yellow, thick and fine flavored. Pkt. 10 cts., oz. 25 cts., $\frac{1}{4}$ lb. 75 cts., lb. \$2.00.

Winter or Vining Squash

Acorn (Table Queen). ★ 85 days. An early-maturing variety which can also be planted for summer use. Fruits pointed acorn shape, 5 inches long and 4 inches through. Skin smooth, dark green; shell thin; flesh light yellow, mealy and of wonderful flavor. Pkt. 10 cts., oz. 25 cts., $\frac{1}{4}$ lb. 75 cts., lb. \$2.00.

Boston Marrow. 95 days. A productive late variety, shaped like the well-known Hubbard, with orange skin and thick, yellow flesh. A good keeper. Pkt. 10 cts., oz. 25 cts., $\frac{1}{4}$ lb. 75 cts., lb. \$2.00.

Fordhook. 85 days. An excellent variety that is suitable for both summer and winter use. The fruits are oblong averaging 8 to 10 inches long, with thin, light yellow skin and thick, straw-colored flesh. Pkt. 10 cts., oz. 25 cts., $\frac{1}{4}$ lb. 75 cts., lb. \$2.00.

Golden Hubbard. ★ 100 days. True Hubbard shape but earlier, a trifle smaller, and the skin is a rich orange-red in color. Flesh deep orange, dry and sweet; an excellent keeper. May be used either as a vegetable or for pie. Pkt. 10 cts., oz. 30 cts., $\frac{1}{4}$ lb. 90 cts., lb. \$2.50.

Improved Hubbard. 110 days. A selection from the old Hubbard, with more vigorous vine and slightly larger fruits. Skin smooth, dark green; flesh deep yellow and of superb quality. Pkt. 10 cts., oz. 30 cts., $\frac{1}{4}$ lb. 90 cts., lb. \$2.50.

Warted Hubbard. ★ 115 days. Fruits weigh around 15 pounds, are globular in shape and pointed at both ends; shell thick and hard; skin is heavily warted and very dark green in color. Flesh is orange-yellow, very thick, dry, fine grained and of excellent flavor. If properly stored will keep until spring. Makes excellent "pumpkin" pies. Pkt. 10 cts., oz. 30 cts., $\frac{1}{4}$ lb. 90 cts., lb. \$2.50.

TURNIP

The main crop is usually sown in July or August, to mature during the fall, but early-season crops can be obtained by sowing the quick-maturing varieties as soon as the ground can be prepared in the spring. Sow the seed thinly in rows 15 inches apart, and cover with $\frac{1}{2}$ inch of soil. Thin the early sorts to stand 3 to 4 inches apart in the rows and the large main-crop Turnips about 6 inches. If not thinned out they will produce only tops and will not develop roots.

*An ounce of seed will sow about 300 feet of drill;
a pound will sow an acre*

Cow Horn. 75 days. Roots shaped rather like a carrot, often over a foot long and 3 inches in diameter. Skin and flesh white. Pkt. 10 cts., oz. 15 cts., $\frac{1}{4}$ lb. 35 cts., lb. 85 cts., 5 lbs. \$3.75.

Extra-Early White Milan. 45 days. The quickest growing of the Turnips. The roots are small and flat with pure white skin and flesh; mild and sweet. Most desirable variety for early sowing. Pkt. 10 cts., oz. 20 cts., $\frac{1}{4}$ lb. 50 cts., lb. \$1.50.

Purple-Top Strap-Leaf. ★ 50 days. The roots are flat and quite large; skin white except for a ring of purple around the top; flesh white, fine-grained and of excellent table quality. Pkt. 10 cts., oz. 15 cts., $\frac{1}{4}$ lb. 35 cts., lb. 85 cts., 5 lbs. \$3.75.

Purple-Top White Globe. ★ 60 days. The roots are large, nearly round, white with upper third purple. The flesh is firm and of good quality. Productive and a splendid keeper. Pkt. 10 cts., oz. 15 cts., $\frac{1}{4}$ lb. 35 cts., lb. 85 cts., 5 lbs. \$3.75.

Seventop. Grown principally for greens. The young shoots are very tender. Roots tough and not edible. Pkt. 10 cts., oz. 15 cts., $\frac{1}{4}$ lb. 35 cts., lb. 85 cts.

Yellow Globe. 80 days. Round, smooth roots of medium size, with light yellow skin and flesh. Used chiefly for stock feed, but suitable for table use when young. Pkt. 10 cts., oz. 15 cts., $\frac{1}{4}$ lb. 35 cts., lb. 85 cts.

RUTABAGA or Swede Turnip

The flavor of Rutabagas is preferred by many to that of Turnips. They are grown much like Turnips but they require a longer season and attain a larger size. Sow during June or early July in rows 18 inches apart. Cover the seed with $\frac{1}{2}$ inch of fine soil and thin out the seedlings to 8 to 10 inches. They may be stored in a cool cellar or pit for winter use.

*An ounce of seed will sow about 400 feet of drill;
a pound will sow an acre*

Improved Purple-Top. ★ 90 days. Large, globular roots. Skin smooth, light yellow with purple top; flesh yellow, firm, and of fine quality. Good winter keeper. Pkt. 10 cts., oz. 15 cts., $\frac{1}{4}$ lb. 35 cts., lb. 85 cts.

Sweet German. 90 days. A large, globe-shaped variety with white skin and flesh. Fine-grained, solid and sweet. Pkt. 10 cts., oz. 15 cts., $\frac{1}{4}$ lb. 35 cts., lb. 85 cts.

TAMPALA

A new leafy green vegetable prepared and served like spinach, but with a distinctive flavor. The tender leaves need to be cooked only five minutes. Stands hot weather well. Sow the seed outdoors when the soil has become warm in the spring; the young leaves will be ready for picking in six to eight weeks. Pkt. 15 cts.

TOBACCO

For best results, Tobacco requires a rich, mellow soil and careful cultivation. Sow the seed in frames or a fine seed-bed early in April and reset the plants in the open ground late in May or early in June, spacing them 2 feet apart in rows 4 feet apart. Cultivate frequently.

Connecticut Seed-Leaf. One of the hardiest and most popular sorts. Pkt. 10 cts., $\frac{1}{4}$ oz. 25 cts., $\frac{1}{2}$ oz. 40 cts., oz. 75 cts.
Havana. True type; productive and of finest quality. Pkt. 10 cts., $\frac{1}{4}$ oz. 25 cts., $\frac{1}{2}$ oz. 40 cts., oz. 75 cts.

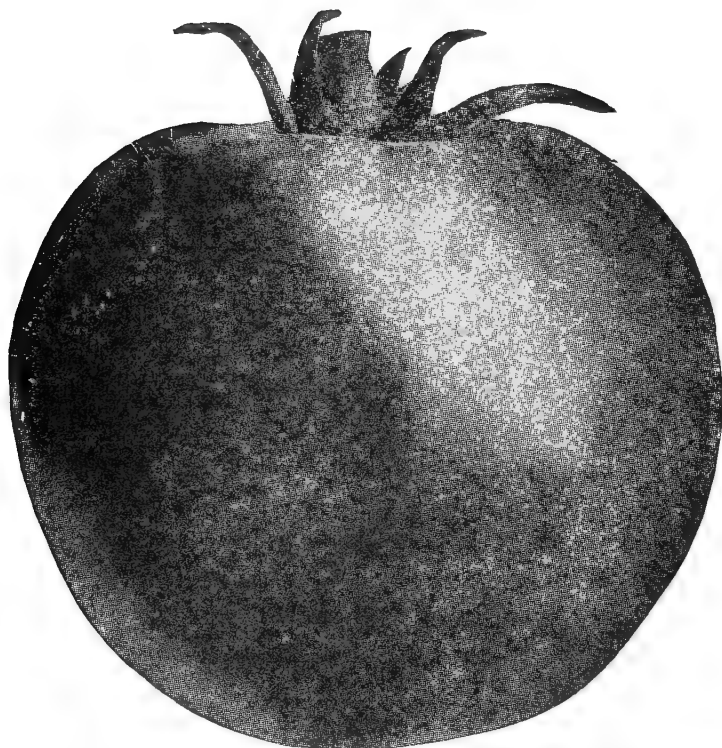

Tomato, Rutgers. Pkt. 10 cts., $\frac{1}{2}$ oz. 40 cts.

Undoubtedly Tomatoes are the most valuable vegetable in the garden. They give greater returns for the space they occupy than anything else that can be grown. With most families they are a favorite all during their season, and the surplus is easily canned or made into juice. Tomatoes are not only good; they are also good for you, since they are high in vitamin C.

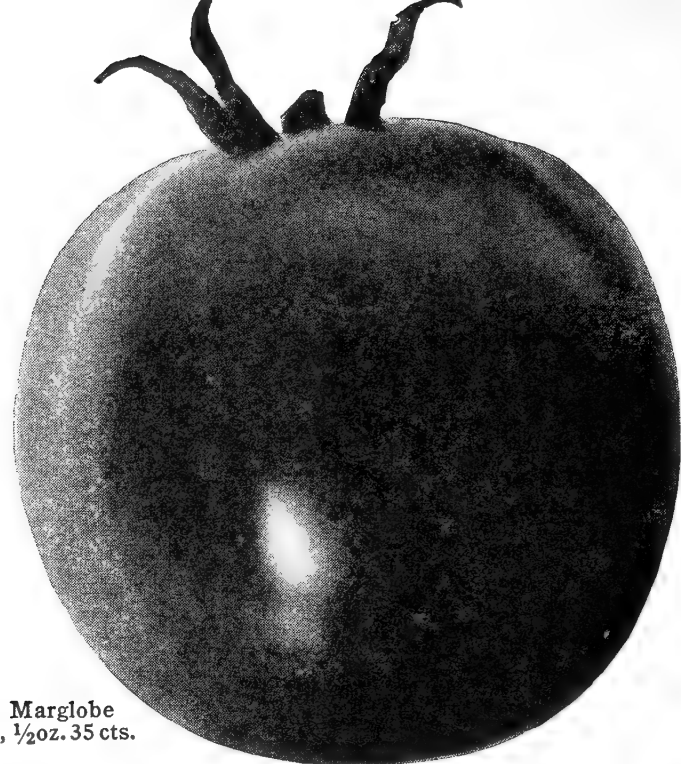

Tomato, Marglobe
Pkt. 10 cts., $\frac{1}{2}$ oz. 35 cts.



Tomato, Bonny Best. Pkt. 10 cts., $\frac{1}{2}$ oz. 35 cts.

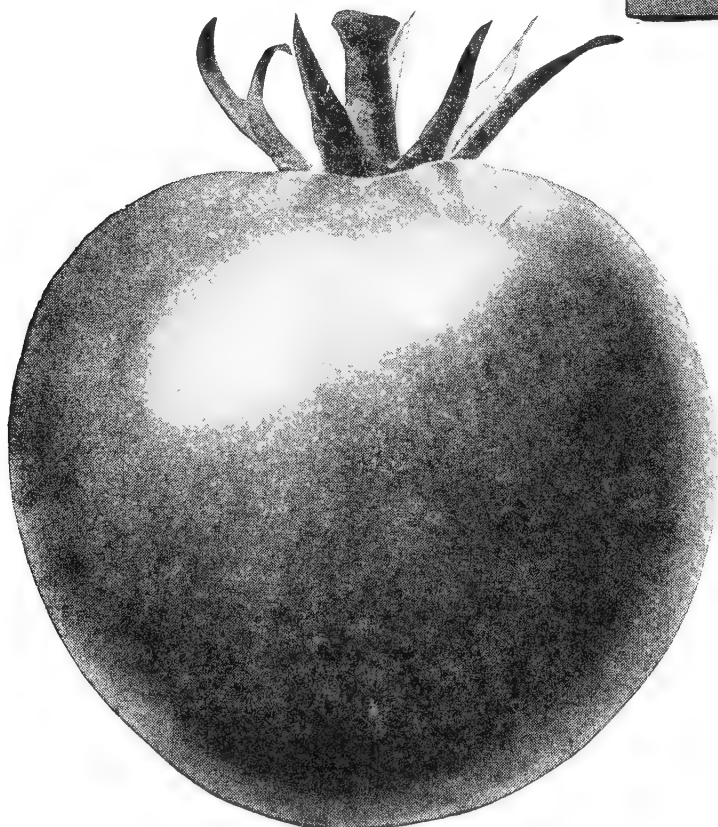

Tomato, Pritchard. Pkt. 10 cts., $\frac{1}{2}$ oz. 35 cts.

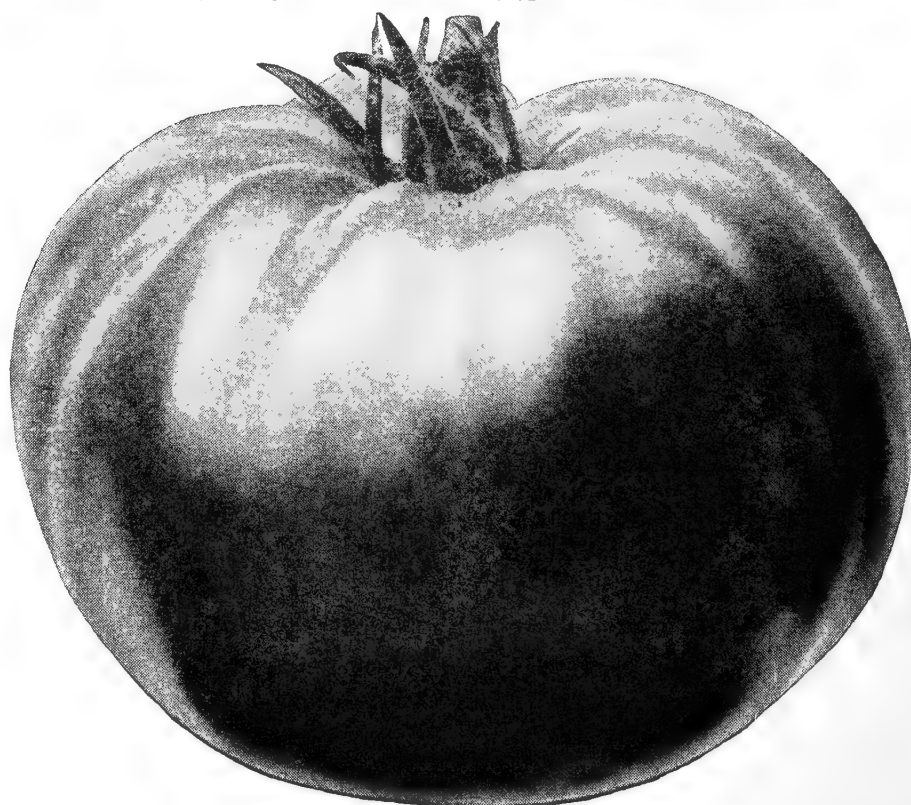

Tomato, Ponderosa. Pkt. 10 cts., $\frac{1}{2}$ oz. 65 cts.

TOMATOES

The seed should be sown indoors in late February or March, in shallow boxes or pots placed in a warm, sunny window. As soon as the little plants are strong enough, thin or transplant them to stand 3 to 4 inches apart; then when they are about 3 inches high transfer them to small paper pots or dirt-bands. To secure extra-strong, stocky plants, transfer them again, when 6 to 8 inches tall, to larger pots. When all danger from frost is past, set them out in the garden, spacing them about 4 feet apart each way.

Treat the seed with Semesan to prevent damping-off of seedlings. Use Transplantone when transplanting the plants to the garden. (See fertilizer pages.) To guard against blight, spray the plants with Bordeaux Mixture or Sulfocide two or three times during the season; arsenate of lead will kill the Tomato worms. Nicotine Pyrox will control both blight and insects.

Days to maturity are figured from the time the plants are set in the garden.

An ounce of seed will produce about 2,000 plants

Early Varieties

Benny Best. ★ 70 days. It is remarkably productive with large, round, smooth fruits in handsome clusters. Uniform in size and shape, solid, free from cracks, bright scarlet in color. Pkt. 10 cts., $\frac{1}{2}$ oz. 35 cts., oz. 65 cts., $\frac{1}{4}$ lb. \$2.00, lb. \$7.00.

Break O'Day. ★ 68 days. Fruits orange-red, smooth and of good size. Very productive and a good early market-gardeners' variety. Pkt. 10 cts., $\frac{1}{2}$ oz. 40 cts., oz. 75 cts., $\frac{1}{4}$ lb. \$2.25, lb. \$8.00.

Earliana. 66 days. The plants are compact, with light foliage; the fruits are of good size, bright red, and quite solid. Pkt. 10 cts., $\frac{1}{2}$ oz. 40 cts., oz. 75 cts., $\frac{1}{4}$ lb. \$2.25, lb. \$8.00.

John Baer. ★ 70 days. The fruits are of good size, perfectly smooth, and nearly globe-shaped, with brilliant scarlet skin and firm flesh, entirely free from core and with few seeds. The flavor is mild and deliciously sweet. Pkt. 10 cts., $\frac{1}{2}$ oz. 35 cts., oz. 65 cts., $\frac{1}{4}$ lb. \$2.00, lb. \$7.00.

June Pink. 70 days. The earliest of the pink-fruited varieties. Fruits of medium size, somewhat flattened, smooth, solid and meaty. Pkt. 10 cts., $\frac{1}{2}$ oz. 40 cts., oz. 75 cts., $\frac{1}{4}$ lb. \$2.25, lb. \$8.00.

Marhio. 75 days. Fruit of a very attractive deep pink. A vigorous grower, heavy cropper, and wilt-resistant. Fruits globe shaped, medium sized, smooth, firm and free from cracks. A good forcing variety. Pkt. 15 cts., $\frac{1}{2}$ oz. 35 cts., oz. 60 cts., $\frac{1}{4}$ lb. \$1.75, lb. \$6.00.

Pritchard. ★ 75 days. Fruits scarlet, medium size, globe shaped, smooth, solid and of the finest quality. Vines compact and very productive. A good home-garden variety. Pkt. 10 cts., $\frac{1}{2}$ oz. 35 cts., oz. 60 cts., $\frac{1}{4}$ lb. \$1.75, lb. \$6.00.

Victor. 65 days. Fruits bright scarlet, globular, medium size, smooth and of fair quality. Plants are very productive and bear all their fruit in the first few weeks of the picking season. Because of their compact growth plants can be set 2 feet apart in the row. An extra-early market-gardeners' variety. Pkt. 15 cts., $\frac{1}{2}$ oz. 40 cts., oz. 75 cts., $\frac{1}{4}$ lb. \$2.25, lb. \$8.00.

Second-Early and Main-Crop Varieties

Beefsteak. ★ 90 days. Late; purplish pink; vines strong and vigorous; very little seed; large, solid fruit. An old favorite with home-gardeners. Pkt. 10 cts., $\frac{1}{2}$ oz. 40 cts., oz. 75 cts., $\frac{1}{4}$ lb. \$2.25, lb. \$8.00.

Dwarf Stone. 85 days. Bushy, compact plants, bearing solid bright red fruits. Medium early. Pkt. 10 cts., $\frac{1}{2}$ oz. 40 cts., oz. 75 cts., $\frac{1}{4}$ lb. \$2.25, lb. \$8.00.

SECOND-EARLY and MAIN-CROP VARIETIES, con.

Greater Baltimore. Noted for its deep red color throughout. Fruits are large, flattened globe in shape, solid and of good quality. Vines vigorous and very productive. Pkt. 10 cts., $\frac{1}{2}$ oz. 35 cts., oz. 60 cts., $\frac{1}{4}$ lb. \$1.75, lb. \$6.00.

Greater Marglobe. ★ 78 days. As a result of extensive breeding work, this strain shows vast improvement over the original Marglobe in size and uniformity of fruits. We recommend it as the finest stock of this variety of Tomato. Pkt. 15 cts., $\frac{1}{2}$ oz. 40 cts., oz. 75 cts., $\frac{1}{4}$ lb. \$2.25, lb. \$8.00.

Livingston's Globe. ★ 82 days. Heavy crops of good-sized, uniform, distinctly globe-shaped fruits with smooth, glossy, deep pink skin. Pkt. 10 cts., $\frac{1}{2}$ oz. 40 cts., oz. 75 cts., $\frac{1}{4}$ lb. \$2.25, lb. \$8.00.

Marglobe. ★ 78 days. The most popular variety with both home and market-gardeners. Fruits large, deep scarlet, very uniform, globe shaped, smooth, with thick walls and small seed cells. Delicious and mild flavor. Plants vigorous, productive, disease-resistant and of long bearing period. Pkt. 10 cts., $\frac{1}{2}$ oz. 35 cts., oz. 60 cts., $\frac{1}{4}$ lb. \$1.75, lb. \$6.00.

Matchless. 85 days. A main-crop Tomato with bright red, solid fruits of excellent quality. Pkt. 10 cts., $\frac{1}{2}$ oz. 35 cts., oz. 60 cts., $\frac{1}{4}$ lb. \$1.75, lb. \$6.00.

Oxheart. 90 days. A main-crop, pink-fruited variety. Fruits are extra large, heart-shaped, heavy and solid. Choice variety for salads and slicing. Pkt. 15 cts., $\frac{1}{2}$ oz. 65 cts., oz. \$1.20, $\frac{1}{4}$ lb. \$3.50, lb. \$12.00.

Ponderosa. ★ 88 days. One of the largest pink-fruited Tomatoes. Somewhat irregular in shape but extremely solid and with very few seeds. Has a delightful mild flavor. Plants are large and very productive. Pkt. 10 cts., $\frac{1}{2}$ oz. 65 cts., oz. \$1.20, $\frac{1}{4}$ lb. \$3.50, lb. \$12.00.

Rutgers. ★ 85 days. The best all-purpose Tomato. Fruits uniform, large, globular, bright red, very smooth, meaty, and of mild flavor. Vines large, dense, and resistant to disease. Yields an abundance of handsome and delicious fruit; ideal for canning and slicing. Pkt. 10 cts., $\frac{1}{2}$ oz. 40 cts., oz. 75 cts., $\frac{1}{4}$ lb. \$2.25, lb. \$8.00.

Stokesdale. 78 days. The fruits are smooth, brilliant red, with a very solid interior. A heavy yielder; excellent for canning and for making juice. Pkt. 10 cts., $\frac{1}{2}$ oz. 35 cts., oz. 60 cts., $\frac{1}{4}$ lb. \$1.75, lb. \$6.00.

Stone. 85 days. An unusually productive, smooth, bright red Tomato. It is a favorite for canning and a most dependable sort for main crop in both market and home-gardens. Pkt. 10 cts., $\frac{1}{2}$ oz. 40 cts., oz. 75 cts., $\frac{1}{4}$ lb. \$2.25, lb. \$8.00.

Yellow Varieties

Golden Queen. 83 days. Good-sized, round, smooth fruits, bright yellow in color, solid and of splendid quality. Pkt. 10 cts., $\frac{1}{2}$ oz. 40 cts., oz. 75 cts., $\frac{1}{4}$ lb. \$2.25, lb. \$8.00.

Golden Jubilee. 75 days. A smooth, bright golden orange Tomato. Fruits are medium size, firm, deep globe shaped, with solid interior and small seed pockets. A really fine-flavored and delicious Tomato. Plants bear over a long season. Pkt. 15 cts., $\frac{1}{2}$ oz. 65 cts., oz. \$1.20, $\frac{1}{4}$ lb. \$3.50.

Yellow Plum. 75 days. The fruits resemble a plum in size and shape but are bright yellow in color. Enormously prolific; in great demand for preserving. Pkt. 10 cts., $\frac{1}{2}$ oz. 60 cts., oz. \$1.00, $\frac{1}{4}$ lb. \$3.00, lb. \$10.00.

Yellow Ponderosa. 88 days. A very large, mild-flavored sort, desirable for the home-garden. Skin clear golden yellow; flesh pale yellow, solid and meaty, mild and sweet. Pkt. 10 cts., $\frac{1}{2}$ oz. 40 cts., oz. 75 cts., $\frac{1}{4}$ lb. \$2.25, lb. \$8.00.

Growing Flowers FROM SEED

To start seeds indoors, use a shallow box filled with light, rich soil not likely to bake or form a crust when the surface dries, and which has been treated with Formaldehyde or Semesan. Tamp firmly, so that the level is about half an inch below the top of the box. Make shallow furrows crossways, about an inch apart. Very fine seeds, like Petunias and Portulacas, need merely marks; large seeds, like Scabiosas, Lupines, and Four o'Clocks, should have furrows a half-inch deep. Sow the seed thinly in the rows, and label each row. Sift fine soil, mixed with sand, over the seeds, covering them to the soil level. Then press the surface with a board or a brick and water with a very fine nozzle or sprinkle the surface with a whisk-broom dipped in water. Cover the box with a sheet of glass and newspaper, and set it in a warm position, watching from day to day to see that the surface does not get dry or become soggy.

As soon as the seedlings break through the ground, the newspaper must be removed and the box set where it will receive the largest amount of sunlight. When the first leaves are fully formed, remove the glass or tilt it to admit air; when the seedlings are all up and gathering strength, take off the glass.

Special care will be needed in watering. If too much water is used, the seedlings are likely to damp off; if not enough, they will not grow rapidly.

Transplant once before moving to garden.

Perennials require exactly the same treatment, except that sowing may be delayed until the annuals are out of the way.

Good results can also be obtained by sowing most annuals outdoors any time from early April to June.

Alyssum saxatile

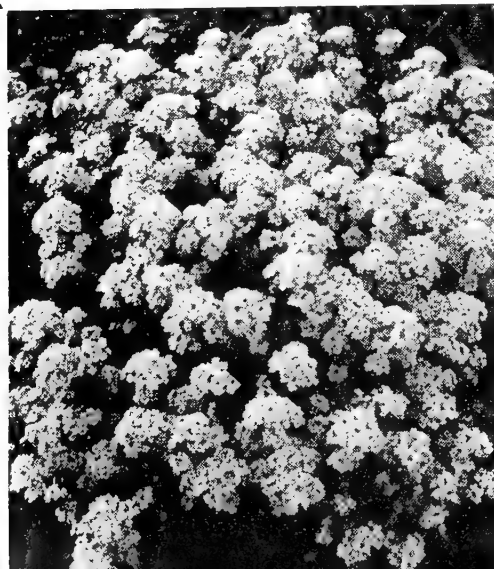

Scott's Flower Seeds



Acroclinium

Annual

Double Large-flowering Hybrids. Beautiful Everlasting Flowers in salmon, apricot, pink, rose and cerise, white and creamy tones with golden centers. For drying, cut as soon as they open. Pkt. 10 cts., $\frac{1}{4}$ oz. 25 cts.

Ageratum • Floss Flower

Annual

Excellent for low borders and edging, and is often used for porch-boxes. Can be sown outdoors in May, but to have blooms earlier start indoors in March.

Blue Perfection. Pretty, deep lavender-blue flowers. Plants grow about 15 inches high. Pkt. 10 cts., $\frac{1}{4}$ oz. 40 cts.

Dwarf Blue Boy. A new variety only about 4 inches high. Very uniform growth, completely covered with bloom in rich shades of blue. Pkt. 10 cts., $\frac{1}{4}$ oz. 75 cts.

Imperial Dwarf Blue. Perfectly formed little plants about 8 inches tall, with flowers of clear blue. Pkt. 10 cts., $\frac{1}{4}$ oz. 75 cts.

Little Blue Star. Tiny plants, not over 5 inches high, covered with masses of bright blue flowers. Pkt. 25 cts., $\frac{1}{4}$ oz. \$1.50.

Alyssum

Annuals and Perennials

The ever-popular and always satisfactory flower for edging beds or planting in porch-boxes or rockeries. Sow the seed in the open ground any time from early April to June. Blooms all summer.

Violet Queen. Annual. Dwarf, compact plants rarely 6 inches high. Flowers deep lavender-lilac. A very pretty variety. Pkt. 10 cts., $\frac{1}{4}$ oz. 50 cts., oz. \$1.50.

Little Gem. Annual. A dwarf form which makes dense, round, little bushes about 6 inches high, covered with very white flowers. Pkt. 10 cts., $\frac{1}{4}$ oz. 25 cts., oz. 75 cts.

Saxatile compactum, Blanket of Gold. Perennial. Bushy plants a foot high. Tiny bright yellow flowers in clusters. A good rock-plant. Pkt. 10 cts., $\frac{1}{4}$ oz. 40 cts., oz. \$1.25.

White Carpet. Annual. The name describes it—a carpet of white only 2 to 3 inches high. Pkt. 10 cts., $\frac{1}{4}$ oz. 25 cts., oz. 75 cts.

White Sweet. Annual. The old-fashioned variety. Low-growing and spreading. Sweet-scented, pure white flowers. Pkt. 10 cts., $\frac{1}{4}$ oz. 15 cts., oz. 50 cts.

Antirrhinums · Snapdragons

Annual

A free-blooming garden flower of the easiest culture, producing its spikes of lovely flowers all summer and fall.

Sow the seed in April, transplanting when 2 to 3 inches high, to the garden.

TALL GIANT-FLOWERED. A fine strain for bedding or cutting as the spikes are heavy and long.

Apple Blossom. Soft apple-blossom-pink.

Canary Bird. Brilliant canary-yellow with deeper yellow lip.

Cattleya. Fine spikes of orchid-lavender—a lovely shade.

Copper King. Velvety bronzy copper.

Old-Gold. Rich old-gold, flushed rose.

Orchid. That peculiar shade known by this name.

Ruby. Rich velvety ruby-red.

Snowflake. Pure white, with yellow lip.

The Rose. Deep rose-pink.

Finest Mixed. A mixture of all the colors.

All Tall Giant-flowered Antirrhinums, pkt. 25 cts., ¼oz. \$1, oz. \$3

HALF-DWARF LARGE-FLOWERING, MIXED. A nice strain for bedding, with heavy spikes of good length for cutting. Good mixture of colors. Pkt. 10 cts., ¼oz. 50 cts., oz. \$1.50.

GIANT-FLOWERED, MAJESTIC TYPE (RUSTPROOF), MIXED. Our new rustproof strain of the Tall Large-flowered type. Try these where rust has been troublesome. A fine mixture of all colors in this type. Pkt. 25 cts., ¼oz. 75 cts., oz. \$2.50.



Arctotis

Amaranthus

Annual

Start seed in house or hotbed early in spring, or in a special seed-bed outdoors later on and transplant to place where they are to bloom.

Molten Fire. One of the most beautiful foliage plants. Grows 4 feet high and each lateral produces a poinsettia-like tuft of flaming fire. Pkt. 15 cts., ¼oz. 75 cts.

Sunrise. Crimson foliage with a strong tinge of bronze. A cluster of bright scarlet leaves grows at the end of each branch. Extremely showy. Pkt. 25 cts., ¼oz. \$1.

Tricolor. Joseph's Coat. Tall, erect plants with luxuriant foliage gorgeously marked with scarlet, yellow, and green. Pkt. 10 cts., ¼oz. 25 cts., oz. 75 cts.

Aquilegia · Columbine

Perennial

Favorite border perennials, blooming in May and June and thriving best in moist, partially shaded spots. Sow seed from May to August. Plants require no protection over winter.

Long-spurred Hybrids, Mixed. These are the finest of the Columbines, producing large flowers in a great variety of delightful colors. Pkt. 10 cts., ¼oz. 75 cts., oz. \$2.50.

Long-spurred Hybrids, Mrs. Scott Elliott's Strain, Mixed. From May to midsummer these will give a wonderful show of color. Plants grow about 3 feet high and flower profusely. Mixed colors, pkt. 25 cts., ¼oz. \$1, oz. \$3.50.

Arabis · Rock Cress

Perennial

Alpina. Mountain Rock-Cress. Excellent rock-garden or edging plant. Foliage gray-green. Flowers white, in early spring. Pkt. 10 cts., ¼oz. 50 cts.

Ageratum. See page 30.



Molten Fire Amaranthus

Arctotis

Annual

Its rich and abundant blooming makes it a very desirable plant for cutting.

Giant Hybrids. A brilliant assortment of orange and bronzy red shades, rose, cream, yellow and salmon. Should be started indoors early. Pkt. 25 cts.

Grandis. Blue-eyed African Daisy. Plants 2 feet high, with silvery white foliage and 2½-inch, daisy-like, silvery white flowers with sky-blue eyes. Pkt. 10 cts., ¼oz. 25 cts.

Armeria · Sea-Pink

Perennial

Rock-garden or edging plant making handsome, evergreen, mossy tufts from which rise clustered flowers like clover blossoms.

Cephalotes. Giant Thrift. Rose and White. Pkt. 15 cts., ¼oz. \$1.

Lauchiana. Dwarf Thrift. Bright rose. Pkt. 25 cts., ¼oz. \$5.



Antirrhinum (Snapdragon)

Why not use annuals to add new interest to your shrub planting and your perennial border? For the background—Cosmos, African Marigolds and Nicotianas. For the middleground—Zinnias, French Marigolds, Gaillardias and Petunias in variety. For borders—Sweet Alyssum, Phlox Drummondii or the dwarf Marigold, Little Giant.

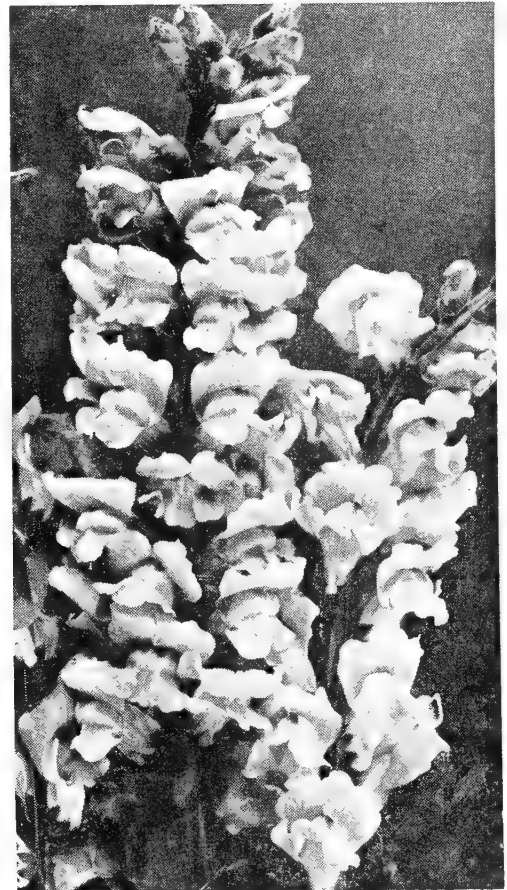

There are many summer-flowering bulbs that will lend new interest to your summer garden. Why not plant several groups of Summer Hyacinths or Peruvian Daffodils or Gladiolus? Dahlias are always spectacular and Tuberoses are delightfully fragrant.

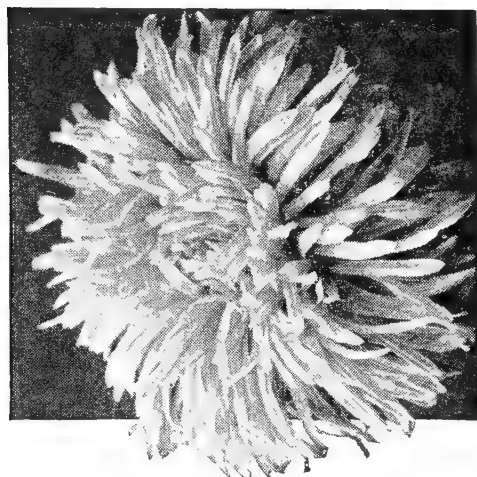

Aster, California Giant

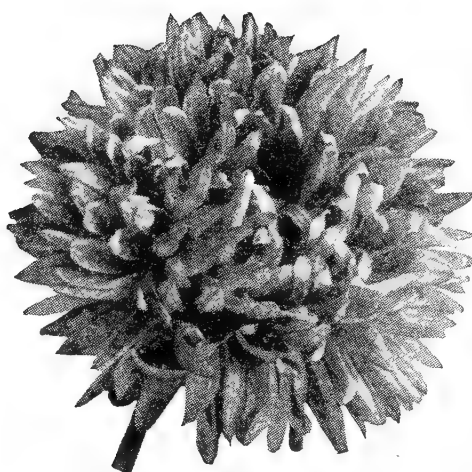

Aster, Heart of France



Giant California Sunshine Asters

Asters *Annual*

Asters prefer an open, sunny situation and they respond amazingly to fertilizers and good cultivation. It is advisable to change the location of the Aster-bed each year if you want large flowers and lots of them. For early bloom, start the seed in a window-box or hotbed, in March, giving the little plants plenty of light and water as required, and thinning 3 to 4 inches apart, or transplanting them when a few inches high to small pots. Set them out after danger from frost is past. For solid beds of color, set the plants 8 to 10 inches apart, but if large flowers and long stems are wanted for cutting, plant at least 1 foot apart in rows 1½ to 2 feet apart. The seed may be sown outdoors in early May with good results except that the plants will bloom later.

EARLY-BLOOMING

Queen of the Market. (Wilt-resistant Strain.) Low, bushy plants bearing quantities of large flowers from July on.

- | | |
|---------|--------------|
| White | Lavender |
| Pink | Purple |
| Crimson | Mixed Colors |

All Queen of the Market Asters, pkt. 10 cts., ¼oz. 50 cts., oz. \$1.50

MIDSEASON BLOOMING

Improved Crego. (Wilt-resistant Strain.) Large flowers, often 5 inches across, with twisted and curled petals, are freely produced on long stems. They bloom just after the early varieties.

- | | |
|-------------------|---------------|
| Blue Flame | Light Blue |
| Cattleya (orchid) | Peach Blossom |
| Crimson | Shell-Pink |
| Dark Violet | White |
| Deep Rose | Mixed |

All Improved Crego Asters, pkt. 10 cts., ¼oz. 50 cts., oz. \$1.50

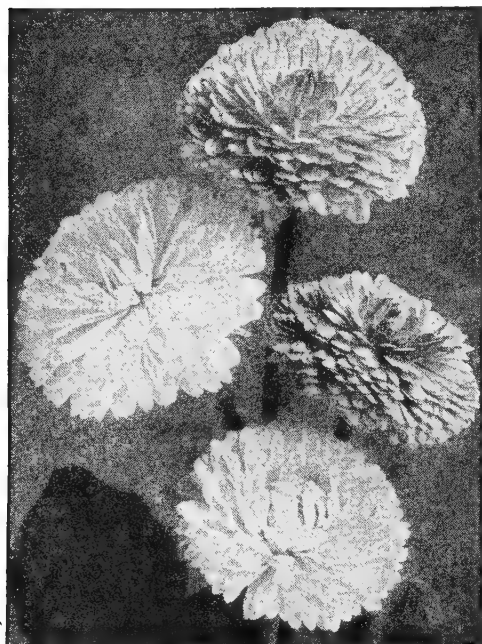

Bellis

GIANTS OF CALIFORNIA IMPROVED.

Large, full flowers of the Crego type, with curled and interlaced petals, on long, heavy stems. Strong, upright plants that bloom from late summer until frost.

- | | |
|--------------|---------------|
| Carmine-Rose | Light Blue |
| Dark Purple | Peach Blossom |
| Light Purple | White |
| Mixed | |

All Giants of California Improved Asters, pkt. 25 cts., ¼oz. 75 cts., oz. \$2.50

CALIFORNIA SUNSHINE, MIXED.

Immense, single flowers, 4 to 5 inches across, with a single row of petals surrounding large yellow quill-like center discs. Branching plants 2 to 3 feet tall. Excellent for cutting. Mixed colors, pkt. 25 cts., ¼oz. \$1, oz. \$3.

GIANT BRANCHING LATE-BLOOMING.

(Wilt-resistant Strain.) A wilt-resistant strain of late-blooming Asters. Valuable to finish the season. Long, strong stems carrying large flowers with broad, incurved petals. A great cutting Aster.

- | | |
|-----------|-----------|
| Crimson | Deep Rose |
| Dark Blue | White |
| Mixed | |

All Giant Branching Late-blooming Asters, pkt. 10 cts., ¼oz. 50 cts., oz. \$1.50

MISCELLANEOUS TYPES

AURORA. A free-flowering Aster with large, full flowers, quilled centers and outer band of broad petals. Quite distinct from all other Asters. Plants are of medium height and should be in bloom by Labor Day.

Blue. Light blue, yellow center. Pkt. 25 cts.

Golden Sheaf. (Wilt-resistant.) Double; yellow. Pkt. 25 cts.

Heart of France. (Wilt-resistant.) Medium-sized flowers of rich dark red. Branching plants 1½ to 2 feet high. Blooms in late August. Pkt. 25 cts., ¼oz. 75 cts., oz. \$2.50.

Super Giant, El Monte. This fine Aster received special mention in the 1936 All-America Selections. Large crimson flowers, with interlaced, plume-like petals. Each plant produces 6 to 8 of these huge flowers. Pkt. 25 cts., ¼oz. \$1, oz. \$3.

Asters

Perennial

Michaelmas Daisies. Tall, autumn-flowering Daisies in various shades. **Mixed Colors.** Pkt. 15 cts., ¼oz. \$1.50, oz. \$5.

Balloon Vine • Love-in-a-Puff

Annual

A rapid-growing annual climber with dark green leaves and small white flowers, followed by curious balloon-like seed-pods. Pkt. 10 cts., ½oz. 25 cts.

Balsam • Lady's Slipper

Annual

Tall Double, Mixed. Large flowers, resembling camellias, in self colors, as well as spotted and blotched varieties. The seed should either be started inside or sown outdoors late in May when the soil and weather are warm. Pkt. 10 cts., ¼oz. 25 cts., oz. 75 cts.

Begonia

Tender Perennial

The Begonias are great favorites, both as pot-plants in the home in winter and for outdoor bedding during the summer. Seed is fine and must be sown on well-prepared, rich soil in the greenhouse or in shallow boxes placed in a warm, sunny window.

Gracilis, Luminosa. Large bright scarlet flowers. Pkt. 25 cts.

Prima Donna. Light rose-pink flowers. Extra fine. Pkt. 25 cts.

Tuberous-rooted Begonia Bulbs. See page 46.

Bellis • English Daisy

Biennial

Double Giant-flowered, Mixed. Useful for beds and edging, thriving in partial shade or full sun. Will bloom the first year if seed is planted very early under glass but best results are obtained by sowing seed in late summer and carrying over winter in a cold-frame. Fine mixture of colors. Pkt. 10 cts., ¼oz. \$3.



Annual Calliopsis

Calliopsis (Coreopsis) Tickseed

Annual

Easy to grow, free-blooming, and a favorite for cutting. Especially nice for edging beds or for planting in pots. Sow in April or May and thin to stand 6 to 8 inches apart.

Crimson King. Deep crimson, yellow backs.

Drummondii. Golden Wave. Medium tall, covered with bright golden yellow flowers with brown centers.

Golden Ray. Golden yellow.

Tiger Star. Yellow and brown.

Mixed. A variety of colors.

All Calliopsis, pkt. 10 cts., 1/4oz. 25 cts., oz. 75 cts.

Cannas

Annual

Large-flowered, Dwarf, Mixed. Saved from brilliantly colored varieties, including red, yellow, and various striking combinations. Pkt. 10 cts., 1/4oz. 25 cts., oz. 75 cts.

For **Canna Roots**, see page 47.

Campanula Medium Canterbury Bells

Biennial

Lovely, bell-shaped flowers. One of the finest border plants. Sow the seed any time from early June to August, and protect the plants with straw or leaves over winter.

Single Varieties, Mixed. The true "Canterbury Bells." Good mixture of colors. Pkt. 10 cts., 1/4oz. 25 cts., oz. 75 cts.

Calycanthemum, Mixed. Cup-and-Saucer. A very pretty double form in a good mixture of colors. Pkt. 15 cts., 1/4oz. 75 cts., oz. \$2.50.



Calendula, Campfire

Calendula • Pot Marigold

Annual

Among the brightest and easiest to grow of all garden annuals. They prefer a sunny location but will thrive on any soil. Sow the seed during April or May and thin the plants to 8 to 10 inches.

Campfire. A vigorous grower with large, brilliant orange flowers having a scarlet sheen and a full yellow center. Pkt. 10 cts., 1/4oz. 25 cts., oz. 75 cts.

Chrysantha (Sunshine). Superb new variety with rich, gleaming yellow flowers like quilled Chrysanthemums. The rays are long and slender, curving inward. Pkt. 10 cts., 1/4oz. 25 cts., oz. 75 cts.

Lemon Queen. Like Orange King but the flowers are clear lemon-yellow. Pkt. 10 cts., 1/4oz. 20 cts., oz. 60 cts.

Orange King. Large, double flowers of deep glowing orange. Pkt. 10 cts., 1/4oz. 20 cts., oz. 60 cts.

Orange Shaggy. Deep orange color, shading lighter at the center of flower. Long, fringed, overlapping petals make the blooms graceful and attractive. Pkt. 10 cts., 1/4oz. 35 cts., oz. \$1.

Radio. A new type. Full flowers with quilled petals; rich glowing orange. Pkt. 10 cts., 1/4oz. 25 cts., oz. 75 cts.

Double Mixed. Pkt. 10 cts., 1/4oz. 20 cts., oz. 60 cts.

Canary-Bird Vine

Tropaeolum peregrinum

Annual

A quick-growing, slender annual vine with light green, fern-like leaves and brilliant yellow flowers. Pkt. 10 cts., 1/2oz. 40 cts., oz. 75 cts.

Carnations

Early Dwarf Double, Mixed. Biennial. Dwarf, erect, free-flowering strain. Extremely hardy. Grows 15 to 18 inches tall. Comes in a wide range of colors. Pkt. 25 cts., 1/4oz. \$1.50, oz. \$5.

Enfant de Nice, Mixed. Annual. The plants are robust and upright, with long, strong stems and flowers 2 1/2 to 3 inches in diameter. It is the last word in this popular flower. Good mixture of colors. Pkt. 25 cts., 1/8oz. 75 cts.

Grenadin, Cardinal-Red. Perennial. An early-flowering type with large brilliant scarlet blooms. Pkt. 25 cts., 1/4oz. \$1.50, oz. \$5.

Marguerite, Mixed. Annual. An improved, large-flowering strain. The flowers are very fragrant, and last for a long time when cut. Sow early in May. Pkt. 10 cts., 1/4oz. 60 cts., oz. \$2.

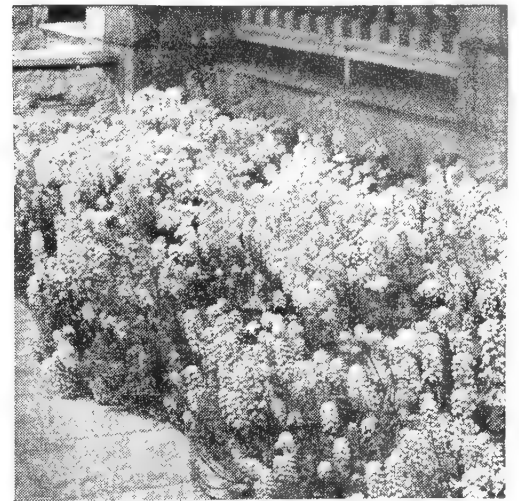

Giant Hyacinth-flowered Candytuft

Candytuft • Iberis

One of the best of all low-growing plants for beds and edging. Sow the seed early in the spring, and when the seedlings are strong enough, thin them to stand 6 to 8 inches apart.

ANNUAL VARIETIES

Giant Empress. Extra-large, pure white flowers. Nice for cutting as well as bedding. Pkt. 10 cts., 1/4oz. 25 cts., oz. 65 cts.

Giant White Hyacinth-flowered. Immense, pure white spikes with large individual bracts. Strong plants. An improved florists' variety for cutting or pot-culture. Pkt. 10 cts., 1/4oz. 25 cts., oz. 65 cts.

Umbellata. Blooms quickly from seed. The flowers are in flat clusters and are produced for many weeks.

Lilac Rose **Crimson Mixed**

Each, pkt. 10 cts., 1/4oz. 25 cts., oz. 65 cts.

PERENNIAL VARIETIES

Gibraltarica Hybrids. A compact form with lilac flowers. Pkt. 10 cts., 1/4oz. 50 cts., oz. \$1.50.

Sempervirens. Perennial or Evergreen Candytuft. Bears pure white flowers in the spring and the leaves are dark glossy green the year round. Fine for edging. Pkt. 25 cts., 1/4oz. \$1.50, oz. \$5.

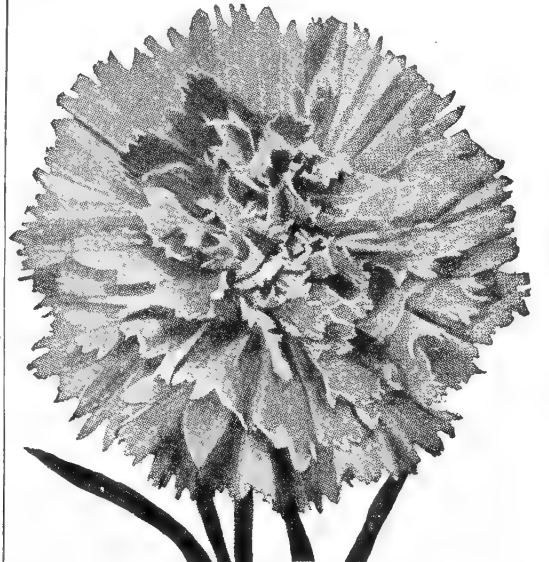

Carnation

Cardinal Climber

Annual

A slender, quick-growing vine with exceedingly ornamental, deeply cut leaves, and small, star-shaped flowers of a brilliant cardinal-red, borne in the greatest profusion. Sow after the weather and soil are warm. Pkt. 15 cts., $\frac{1}{4}$ oz. 75 cts., oz. \$2.50.

Castor-Oil Bean • Ricinus

Annual

Extremely large plants that may be used for ornamental hedges, for the center of beds of cannas, and as individual specimens wherever a tropical effect is wanted. Sow in May.

Zanzibarensis. A giant strain, that sometimes grows 12 feet high. Dark green, bronze, or reddish foliage. Pkt. 10 cts., oz. 25 cts., $\frac{1}{4}$ lb. 75 cts., lb. \$2.50.

Finest Mixed. Many different types, varying in color of leaf, stalks, fruit, etc. All large. Pkt. 10 cts., oz. 25 cts., $\frac{1}{4}$ lb. 75 cts., lb. \$2.50.

Celosia Annual

These make gorgeous beds and are useful also for borders where bright colors and mass effect are desired. The seed should be started indoors in April or sown in well-prepared soil outdoors late in May.

Childsi, Mixed. Chinese Woolflower. A profusion of massive, wool-like flowers in shades of red and pink. Height 3 feet. Sow seed outdoors after danger of frost is past. Pkt. 10 cts., $\frac{1}{4}$ oz. 50 cts., oz. \$1.50.

Cristata, Finest Mixed. Cockscomb. Showy, comb-like heads in a variety of rich colors. Pkt. 10 cts., $\frac{1}{4}$ oz. 50 cts., oz. \$1.50.

CRISTATA PLUMOSA. IMPROVED FEATHER TYPE.

Pride of Castle Gould. Pyramidal growth with large, painted plumes of brilliant red. Fine for either bedding or pot-culture. Pkt. 15 cts., $\frac{1}{4}$ oz. \$1.50.

Scarlet. A brilliant scarlet selection of the lovely feather type. Pkt. 15 cts., $\frac{1}{4}$ oz. \$1.

Cerastium

Perennial

Tomentosum. Snow-in-Summer. A perennial rock-plant with white foliage and starry white flowers. Pkt. 10 cts., $\frac{1}{4}$ oz. 50 cts., oz. \$1.50.



Celosia Childsi (Woolflower)

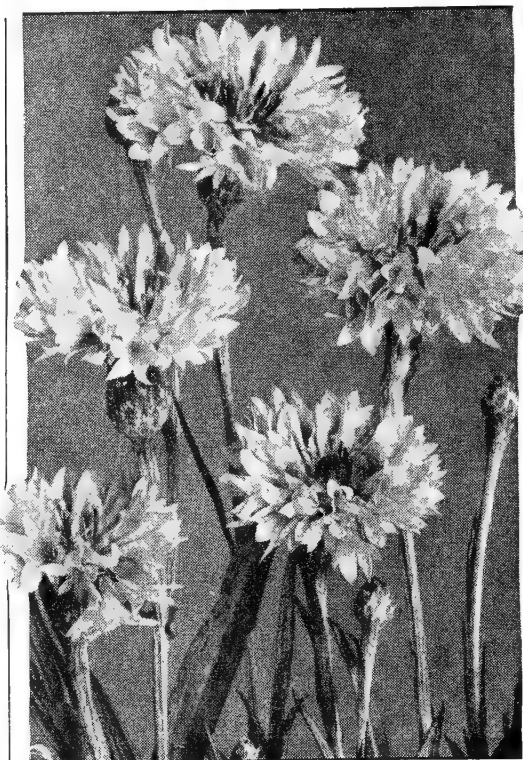

Centaurea cyanus

Centaurea Annual

A family of very popular and easy-to-grow flowers.

CYANUS. Familiarly known as "Cornflower," "Ragged Sailor," or "Bachelor's Button." About 1 $\frac{1}{2}$ feet tall, thriving in almost any situation and blooming freely for a long season.

Double Blue. Deep blue Cornflower.

Double Maroon. Fine for a mixed bouquet.

Double Rose-Pink. A lovely shade for cutting.

Double White. A pure white Cornflower.

Double, Mixed. A select mixture of many colors.

All above, pkt. 10 cts., $\frac{1}{4}$ oz. 25 cts., oz. 75 cts.

Jubilee Gem. Silver Medal. Plants 12 to 15 inches with double flowers of cornflower-blue. Pkt. 15 cts., $\frac{1}{4}$ oz. 50 cts., oz. \$1.75.

IMPERIALIS. The Giant Sweet Sultan, one of the largest of the Centaurea family and the finest for cut-flowers. The large blooms are borne on long stems and are very fragrant.

Lavender Purple White
Lilac Rose Mixed

All above, pkt. 10 cts., $\frac{1}{4}$ oz. 35 cts., oz. \$1

GYMNOCARPA. Dusty Miller. Grows but a foot high. Excellent for edging beds and borders. Foliage is fern-like and of silvery gray color. Pkt. 10 cts., $\frac{1}{4}$ oz. 35 cts., oz. \$1.

Chrysanthemums

Chrysanthemums thrive in rich soil in any sunny situation and bloom very freely. They require plenty of water.

Coronarium, Double Annual, Mixed. Full-centered flowers in shades of cream, lemon, and gold. Pkt. 10 cts., $\frac{1}{4}$ oz. 35 cts., oz. \$1.

Leucanthemum. Shasta Daisy. Perennial. Hardy plants with lovely white flowers for cutting.

Alaska. Magnificent single flowers of pure white, 5 inches or more in diameter. Pkt. 10 cts., $\frac{1}{4}$ oz. 75 cts., oz. \$2.50.

Alaska, Double. A double form of the above, with beautiful shaggy white flowers. Pkt. 25 cts.

Clarkia

Annual

Elegans. An attractive variety that makes loose, shrubby plants 2 to 3 feet high, covered with dainty flowers. Nice for cutting.

Double and Single, Mixed. Pkt. 10 cts., $\frac{1}{4}$ oz. 30 cts., oz. 75 cts.

Cobaea

Annual

Scandens. Cup-and-Saucer Vine. An annual climber that grows quickly and makes a good screen of foliage. The flowers are large and bell-shaped, blue in color. Pkt. 10 cts., $\frac{1}{4}$ oz. 30 cts., oz. 75 cts.

Coleus

Annual

Choice Mixed. Popular bedding plants grown for their ornamental variegated foliage. Sow seed in boxes indoors and transplant to the open late in May. Pkt. 25 cts.

Coreopsis

Perennial

Double Sunburst. Large, golden yellow, fully double flowers 3 to 3 $\frac{1}{2}$ inches in diameter. A superb cut-flower, or a mass of garden color. Pkt. 15 cts., $\frac{1}{4}$ oz. 35 cts., oz. \$1.

Grandiflora. Easily grown from seed sown any time during late spring or summer and, being perfectly hardy, the plants require no protection in winter and will live for years. Pkt. 10 cts., $\frac{1}{4}$ oz. 25 cts., oz. 75 cts.

Corn, Ornamental Indian

Annual

The kernels are of various bright colors and are used in making Charm or Patio Strings. Pkt. 10 cts., oz. 25 cts., $\frac{1}{4}$ lb. 50 cts.

Cypress Vine

Annual

Finest Mixed. A graceful, slender climber with very finely cut foliage and bright little flowers which are produced in the greatest profusion. Pkt. 10 cts., $\frac{1}{4}$ oz. 60 cts., oz. \$2.



Cerastium tomentosum



Cosmos

Cosmos

Annual

Their free-blooming habit and graceful flowers make the Cosmos one of the most popular flowers for late summer and fall use. Sow seed outdoors about May 1, or, if possible, start the seed indoors in early March.

Early Klondyke, Orange Flare. Gold Medal, 1935 All-America Selections. Deep brilliant orange flowers, borne on long stems. Nice for cutting. Plants 2 to 3 feet high. Pkt. 15 cts., $\frac{1}{4}$ oz. 50 cts., oz. \$1.50.

Extra-Early, Double-crested. An improved strain of the double-flowering form of Cosmos, and while the flowers vary in degree of doubleness, all are beautiful.

Pink Beauty. Soft rosy pink.

Crimson King. Deep rose-crimson.

White Queen. Pure white.

Finest Mixed. All colors.

All Double-crested Cosmos, pkt. 15 cts., $\frac{1}{4}$ oz. 85 cts., oz. \$2.75

Lady Lenox. Blooms enormous, of a most attractive shade of shell-pink. Pkt. 10 cts., $\frac{1}{4}$ oz. 25 cts., oz. 75 cts.

Mammoth Early-flowering, Mixed. Large-flowered strain which blooms early. Best to use for late sowings outdoors. Pkt. 10 cts., $\frac{1}{4}$ oz. 25 cts., oz. 75 cts.

Mammoth Late-flowering, Mixed. Plants 6 to 8 feet, blooming in September. Large flowers 4 to 5 inches across. Pkt. 10 cts., $\frac{1}{4}$ oz. 25 cts., oz. 75 cts.

Sensation. Award of Merit, 1936 All-America Selections. Flowers 4 to 5 inches across, on long stems, from 4-foot plants. Blooms for 10 weeks from sowing. Flowers Pink and White. Pkt. 10 cts., $\frac{1}{4}$ oz. 35 cts., oz. \$1.

Cynoglossum

Chinese Forget-Me-Not

Amabile, Blue Bird. Splendid plants growing $1\frac{1}{2}$ to 2 feet tall and bearing a profusion of bloom from May until frost. The Forget-me-not-like flowers are a fine shade of bright blue and are in nice sprays suitable for cutting. Pkt. 10 cts., $\frac{1}{4}$ oz. 60 cts., oz. \$2.

Dahlias

Annual

It is easy to raise Dahlias from seed, if started early in spring in hotbed or in a warm window. Set plants out late in May in sunny location, a foot or more apart.

Cactus-flowered, Mixed. Seed saved from the best Cactus type. Pkt. 25 cts.

Double, Finest Mixed. Seed saved from some of the best named sorts. Pkt. 10 cts., $\frac{1}{4}$ oz. 75 cts., oz. \$2.50.

Single, Fine Mixed. Seed saved from select flowers of single varieties. Pkt. 10 cts., $\frac{1}{4}$ oz. 75 cts., oz. \$2.50.

UNWIN'S DWARF HYBRIDS. Blooms in sixty days from seed sown in the garden. Unsurpassed as cut-flowers. Flowers are semi-double, 3 inches in diameter, and come in a range of colors. Pkt. 10 cts., $\frac{1}{4}$ oz. 75 cts., oz. \$2.50.

Delphinium Perennial Larkspur

The finest of blue flowers for the hardy border are the Perennial Larkspurs. Sow the seed in May or June and transplant about 1 foot apart in early September.

Belladonna. Long, loose spikes of delicate light blue flowers, of supreme value for cutting. Pkt. 25 cts., $\frac{1}{8}$ oz. 75 cts., $\frac{1}{4}$ oz. \$1.25.

Bellamosa. This is a taller, straighter plant than Belladonna, and the flowers are rich clear blue, several shades darker. Pkt. 25 cts., $\frac{1}{8}$ oz. 75 cts., $\frac{1}{4}$ oz. \$1.25.

Blackmore & Langdon Strain, Mixed. Lovely flowers in a wide range of colors. Strong plants with excellent spikes. Pkt. 50 cts.

Cardinale. A native Delphinium with long-spurred brilliant scarlet flowers on 3-foot plants. Pkt. 25 cts., $\frac{1}{8}$ oz. 75 cts., $\frac{1}{4}$ oz. \$1.25.

Kelway's Gold Medal Hybrids. A famous English strain of great size and vigor, producing flowers in all shades of blue. Pkt. 25 cts., $\frac{1}{8}$ oz. 50 cts., $\frac{1}{4}$ oz. 75 cts., oz. \$2.25.

Pacific Giants. Flowers are of immense size, tightly set on straight, strong stems. White. Pkt. 50 cts.

Mixed Colors. Shades of blue, lavender, pink, and clear white. Pkt. 50 cts., $\frac{1}{8}$ oz. \$1.50, $\frac{1}{4}$ oz. \$2.50, $\frac{1}{2}$ oz. \$4.25, oz. \$8.

Wrexham (Hollyhock Strain). Sturdy plants producing conical spikes of flowers 2 inches or more across, and $2\frac{1}{2}$ to 3 feet long. Colors range from clear light blues and lavenders to shades of deep blue, purple, and mauve. Pkt. 25 cts., $\frac{1}{8}$ oz. \$1.25, $\frac{1}{4}$ oz. \$2.

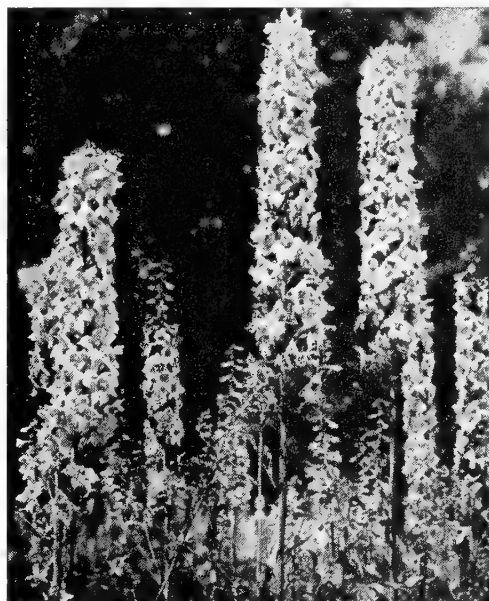

Delphiniums

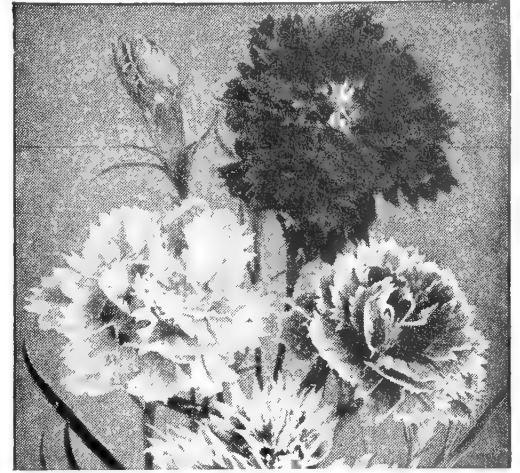

Dianthus Heddegi

Didiscus

Annual

Cerulea. Blue Lace Flower. Exquisite, lacelike flower-heads of dainty azure-blue, gracefully borne on long stems. Sow seed in March in hotbed and outdoors in May and June. Pkt. 10 cts., $\frac{1}{4}$ oz. 35 cts., oz. \$1.

Dianthus

A large family of easily grown flowers loved for their fragrance and all-round usefulness.

Chinensis, Double. China Pink. Annual. All plants 20 inches high, with flowers in clusters, in many bright colors. Free-blooming type. Pkt. 10 cts., $\frac{1}{4}$ oz. 35 cts., oz. \$1.

Deltoides. Maiden Pink. Perennial. A creeping rock-garden plant with deep rose-colored flowers on 8-inch stems in midsummer. Pkt. 15 cts., $\frac{1}{4}$ oz. 75 cts., oz. \$2.50.

Heddegi. Japanese Pinks. Annual. Dwarf, compact plants 10 to 12 inches tall, with large, spectacular flowers, fine for cutting as well as making a grand garden display.

Double, Fireball. Crimson.

Double, Mourning Cloak. Blackish maroon, margined white.

Double, Violet Queen. Violet.

Double, Mixed. All colors.

All Heddegi, pkt. 10 cts., $\frac{1}{4}$ oz. 40 cts., oz. \$1.25

Single, Mixed. Pkt. 10 cts., $\frac{1}{4}$ oz. 25 cts., oz. 75 cts.

Plumarius. Garden Grass Pinks. Perennial. The Pheasant-Eye, or Clove Pink should be in every garden. Plants 8 to 10 inches, with grass-like foliage and fragrant, fringed flowers. Sow from April to August.

Single, Mixed. Many beautiful colors. Pkt. 10 cts., $\frac{1}{4}$ oz. 35 cts., oz. \$1.

Digitalis • Foxglove

Biennial

A plant for the back of the border. Spikes of thimble-shaped flowers on plants 3 to 4 feet tall, during June and July. Sow in early summer and transplant in the fall.

Hybrida Lutzi. Magnificent, 4-foot plants with lovely salmon flowers. Pkt. 15 cts., $\frac{1}{4}$ oz. 75 cts.

Isabelina. Fine spikes of yellow blossoms that deepen to chamois. Sold out.

The Shirley, Giant Hybrids. An excellent strain with large flowers ranging in color from white to dark rose, each with throats spotted with crimson, maroon or chocolate. Plants 5 to 7 feet tall, with 4-foot spikes of bloom. Pkt. 15 cts., $\frac{1}{4}$ oz. 75 cts.

Finest Mixed. All types and colors. Pkt. 10 cts., $\frac{1}{4}$ oz. 50 cts., oz. \$1.50.



Dimorphotheca

Dimorphotheca African Daisy

Annual

Dwarf plants, 12 to 15 inches high, with foliage close to the ground. Daisy-like flowers 2 to 3 inches across, with narrow petals. Flowers close toward evening.

Aurantiaca, Mixed. Shades of yellow, orange, and white. Pkt. 10 cts., $\frac{1}{4}$ oz. 35 cts., oz. \$1.

Aurantiaca, Orange, Improved. An improved strain of the original orange variety. Pkt. 10 cts., $\frac{1}{4}$ oz. 35 cts., oz. \$1.

Dolichos • Hyacinth Bean

Annual

Lablab, Mixed. Very pretty annual climber quickly growing 8 to 10 feet and bearing quantities of clustered flowers like pea blossoms, followed by lustrous purple pods. Good mixture of colors. Sow the seed in late May. Pkt. 10 cts., oz. 30 cts.

Eschscholtzia California Poppy

Annual

These hardy little annuals make very bright beds and bloom from June until frost. Flowers resemble single Poppies. Sow in early spring, where they are to bloom.

SPREADING VARIETIES

Aurantiaca. Orange.

Carmine King. Deep carmine.

Chrome Queen. Amber-yellow.

Mikado. Orange-crimson.

The Geisha. Brilliant gold inside, orange-crimson outside, fluted.

All Eschscholtzias, pkt. 10 cts., $\frac{1}{4}$ oz. 35 cts., oz. \$1

Mixed. All colors. Pkt. 10 cts., $\frac{1}{4}$ oz. 20 cts., oz. 60 cts.

ERECT VARIETY

Ramona. Golden bronze, coppery rose outside, frilled and incurved. Pkt. 10 cts., $\frac{1}{4}$ oz. 35 cts., oz. \$1.

Euphorbia

Annual

Variiegata. "Snow-on-the-Mountain." Showy plants growing about 2 feet high, with ornamental deep green foliage, bordered and marked with white. Seed should be sown during May. Pkt. 10 cts., $\frac{1}{4}$ oz. 20 cts., oz. 60 cts.



Eschscholtzia, Ramona

Four o'Clock • Mirabilis

Annual

Jalapa, Mixed. "Marvel of Peru." Makes most effective beds and annual hedges. The plants grow about 2 feet tall, bearing quantities of fragrant flowers which open late in the afternoon. Pkt. 10 cts., oz. 40 cts., $\frac{1}{4}$ lb. \$1.25, lb. \$4.

Gaillardia • Blanket Flower

Extra-good bedding plants, and especially desirable cut-flowers.

Burgundy. Perennial. A new variety with large, wine-colored flowers. Very choice. Pkt. 25 cts., $\frac{1}{4}$ oz. 90 cts., oz. \$3.

Maxima aurea. Perennial. Rich golden yellow flowers with a large red eye. Pkt. 25 cts., $\frac{1}{4}$ oz. 75 cts., oz. \$2.50.

Picta, Mixed. Annual varieties in various colors. Pkt. 10 cts., $\frac{1}{4}$ oz. 25 cts., oz. 75 cts.

The Dazzler. Perennial. Very large flowers of blazing orange-scarlet, illumined by a brilliant yellow edge at the tip of each ray or petal. Pkt. 25 cts., $\frac{1}{4}$ oz. 75 cts., oz. \$2.50.

Geranium

Annual

Fine Mixed. Great favorites for bedding and window-boxes. Seed saved from the choicest varieties. Pkt. 25 cts., $\frac{1}{4}$ oz. \$1.50, oz. \$5.



Geum, Mrs. Bradshaw



Gaillardia, The Dazzler

Geum • Avens

Perennial

Lady Stratheden. Practically the same plant as Mrs. Bradshaw, except that the flowers are shining golden yellow. Pkt. 10 cts., $\frac{1}{4}$ oz. 75 cts., oz. \$3.

Mrs. Bradshaw. Handsome, fairly dwarf border plant with attractive foliage, and double scarlet flowers with crimped and ruffled petals. Pkt. 10 cts., $\frac{1}{4}$ oz. 75 cts., oz. \$3.

Globe Amaranth

Gomphrena

Annual

Mixed Colors. The plants grow 2 to 3 feet tall, with globe-shaped flowers which may be cut and dried in their natural color for winter bouquets. Pkt. 10 cts., $\frac{1}{4}$ oz. 25 cts., oz. 75 cts.

Godetia • Satin Flower

Annual

The plants are bushy, with attractive foliage, and the flowers are quite large, somewhat resembling single hollyhocks. Godetias make fine pot-plants.

Dwarf Double Azalea-flowered, Mixed. Lovely azalea-like flowers in various brilliant colors. Pkt. 10 cts., $\frac{1}{4}$ oz. 25 cts., oz. 75 cts.

Sybil Sherwood. An upright plant with single flowers of bright salmon-pink. Pkt. 10 cts., $\frac{1}{4}$ oz. 50 cts., oz. \$1.50.

Gourds

Annual

In addition to their interesting fruit, many of which are useful as well as ornamental, the vines have large foliage excellent for covering fences, stumps, trellises, etc. Sow the latter part of May.

Calabash Pipe or Powder-Horn. An intriguing pipe-shaped variety. Pkt. 10 cts., oz. 40 cts., $\frac{1}{4}$ lb. \$1.

Cave-Man's Club. Dark green; knobby; club-shaped. Pkt. 10 cts., oz. 40 cts., $\frac{1}{4}$ lb. \$1.

Dipper. The ripe fruits, cut away and cleaned out, make very serviceable dippers. Pkt. 10 cts., oz. 40 cts., $\frac{1}{4}$ lb. \$1.

Dish-Cloth. Sometimes called Sponge Gourd. Pkt. 10 cts., oz. 40 cts., $\frac{1}{4}$ lb. \$1.

Ornamental, Mixed. Includes a great number of interesting and diverse forms. Pkt. 10 cts., oz. 40 cts., $\frac{1}{4}$ lb. \$1.

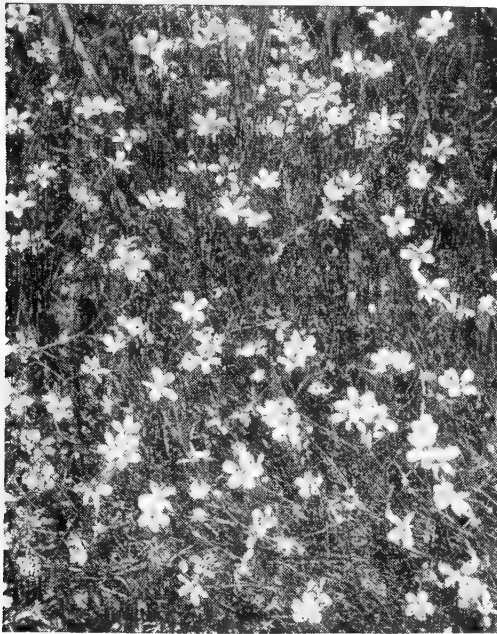

Gypsophila elegans alba grandiflora

Gypsophila • Baby's Breath

These are largely used in making up bouquets and are also most attractive garden plants.

Elegans alba grandiflora. Annual Baby's Breath. An improved strain with pure white flowers. Pkt. 10 cts., $\frac{1}{4}$ oz. 20 cts., oz. 60 cts.

Paniculata alba, Single. Perennial. Tiny white flowers in airy sprays. Excellent for cutting. Pkt. 10 cts., $\frac{1}{4}$ oz. 25 cts., oz. 75 cts.

Paniculata alba, Double. Fine sprays of little, double, pure white flowers. Dries nicely for winter bouquets. Pkt. 25 cts., $\frac{1}{8}$ oz. \$1.

Repens alba. Perennial. A trailing variety, not over 6 inches high, with white flowers in July and August. Pkt. 25 cts., $\frac{1}{4}$ oz. \$1., oz. \$3.50.

Repens rosea. Perennial. Rose-colored variety of the above. Pkt. 25 cts., $\frac{1}{4}$ oz. \$1, oz. \$3.50.

Helianthemum • Sun Rose

Perennial

Mutabile, Mixed. Rock-plant of shrubby habit, growing 8 to 12 inches high. Foliage evergreen. Flowers of pastel shades. Pkt. 10 cts., $\frac{1}{4}$ oz. 60 cts., oz. \$2.

Helianthus • Sunflower

Annual

Sow the seed in April or May and give the plants plenty of room. Fine for massive borders and backgrounds.

Dwarf Double Chrysanthemum-flowered. Strong plants, growing 4 to 5 feet high, with many branches bearing big, double flowers like golden chrysanthemums. Pkt. 10 cts., $\frac{1}{4}$ oz. 25 cts., oz. 75 cts.

Mammoth Russian. The common variety and the largest and most productive, growing to a height of 6 to 8 feet. Oz. 10 cts., $\frac{1}{4}$ lb. 20 cts., lb. 50 cts.

Maroon Prince. Single red flowers on 4-foot plants. The best red Sunflower. Pkt. 10 cts., $\frac{1}{4}$ oz. 35 cts., oz. \$1.

Miniature (*H. cucumerifolius*). Single bright yellow flowers, with dark brown centers. Fine for cutting as well as display. Pkt. 10 cts., $\frac{1}{4}$ oz. 25 cts., oz. 75 cts.

Helichrysum • Everlasting

Annual

The best of the "Straw Flowers." To preserve the flowers for permanent bouquets, pick them when half opened and hang them by the stems, head down, to dry in a shady place. Double, bright-colored flowers.

Fireball or Scarlet **Salmon Queen**
Goldenball **Silverball**
Rose Queen **Violet Queen**
Finest Mixed

All Helichrysums, pkt. 10 cts., $\frac{1}{4}$ oz. 35 cts., oz. \$1

Heliotrope

Annual

Choice Mixed Colors. Prized for its delightful fragrance. Can be grown in pots or in the garden. Start the seed indoors in March, or sow outdoors after the soil and weather are warm. Pkt. 15 cts., $\frac{1}{4}$ oz. \$1.50.

Hesperis • Rocket

Perennial

Matronalis. Sweet Rocket. The plants make large clumps 2 to 3 feet high, with showy spikes of red flowers. Pkt. 10 cts., $\frac{1}{4}$ oz. 60 cts., oz. \$2.

Hibiscus • Marsh-Mallow

Perennial

Finest Mixed. Shrubby perennials 4 to 6 feet tall with large foliage and immense, funnel-shaped flowers 6 to 12 inches across. Fine mixture of colors. Pkt. 10 cts., $\frac{1}{4}$ oz. 35 cts., oz. \$1.

Hollyhock

Wherever tall-growing plants can be used these are wonderfully effective, with a charm all their own. A favorite for the old-fashioned garden.

Chater's Double, Mixed. Perennial. An extra-fine strain in many bright colors. Pkt. 10 cts., $\frac{1}{4}$ oz. 60 cts., oz. \$2.

Indian Spring. Annual. Silver Medal, 1939 All-America Selections. Semi-double, frilled pink flowers in 5 months from seed. Plants 4 to 5 feet tall. A splendid novelty. Pkt. 15 cts.

Single, Finest Mixed. Perennial. Lovely single flowers in a wide range of colors. Pkt. 10 cts., $\frac{1}{4}$ oz. 25 cts., oz. 75 cts.

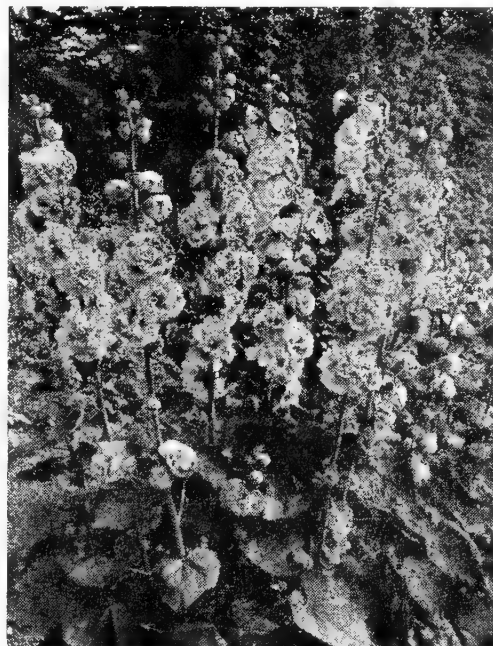

Double Hollyhocks

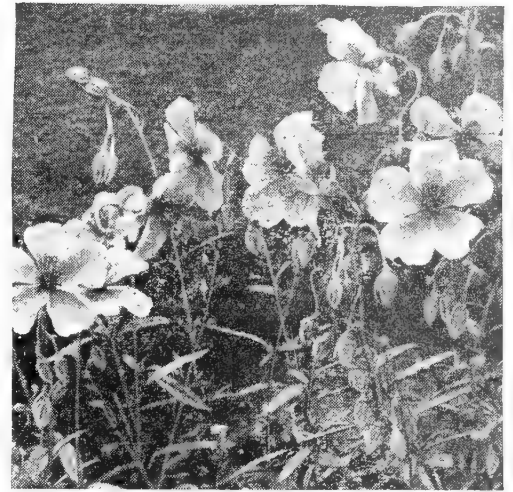

Helianthemum mutabile

Honesty • Lunaria

Biennial

An easily grown plant, about 1 $\frac{1}{2}$ feet high. The blooms may be dried for winter bouquets. Violet or White, pkt. 15 cts., $\frac{1}{4}$ oz. 60 cts., oz. \$2.

Humulus • Hop Vine

Annual

A very rapid-growing annual vine which, on account of its dense, attractive foliage, is valuable for porch-screens and arbors.

Green-leaved or **Variegated-leaved.** Pkt. 10 cts., $\frac{1}{4}$ oz. 25 cts., oz. 60 cts.

Hunnemannia • Tulip Poppy

Annual

Sunlite. Semi-double flowers of clear canary-yellow. Very desirable. Grows 1 $\frac{1}{2}$ to 2 feet tall, with many blooms all summer. Pkt. 10 cts., $\frac{1}{4}$ oz. 35 cts., oz. \$1.

Ipomoea • Morning-Glory

Annual

Fine for covering fences and trellises on account of their rapid, luxuriant growth. They bloom freely all summer. The seed may be soaked in warm water over night to hasten germination.

Heavenly Blue. Blue Moonflower. An early strain of this lovely flower. Deep sky-blue flowers of large size from midsummer until frost. Start seeds under glass, early. Pkt. 15 cts., $\frac{1}{4}$ oz. 35 cts., $\frac{1}{2}$ oz. 60 cts., oz. \$1.

Imperial Mixed. Large flowers of various pleasing colors. Sow as soon as ground gets warm. Pkt. 10 cts., oz. 50 cts., $\frac{1}{4}$ lb. \$1.50, lb. \$5.

Noctiflora. White Moonflower. Large white flowers. Pkt. 10 cts., $\frac{1}{4}$ oz. 20 cts., oz. 50 cts.

Pearly Gates. A satiny white sport of Heavenly Blue. The 3-inch trumpets are perfect companions for the blue parent. Blooms early. Pkt. 25 cts., $\frac{1}{4}$ oz. 75 cts.

Scarlett O'Hara. Large flowers 3 $\frac{1}{2}$ inches across, of bright carmine, are freely produced on vigorous twining vines from early summer until late fall. Pkt. 15 cts., $\frac{1}{4}$ oz. 75 cts., $\frac{1}{2}$ oz. \$1.25, oz. \$2.25.

Job's Tears • Coix

Annual

Lacryma. An ornamental grass which grows 2 to 3 feet high and bears large, ivory-white seeds from which it gets its name. The children make necklaces from the hard seeds. Pkt. 10 cts., $\frac{1}{4}$ oz. 20 cts., oz. 50 cts.

Kochia*Annual*

Scoparia trichophylla. Summer Cypress; Mexican Firebush. Grows about 2 feet high making beautifully rounded bushes like clipped evergreens. In summer, foliage is bright, light green but in fall the whole plant is a ball of crimson. Sow seed in late May. Pkt. 10 cts., $\frac{1}{4}$ oz. 25 cts., oz. 75 cts.

Lantana*Annual*

Dwarf Hybrids, Mixed. Desirable bedding plants, giving a mass of color; also useful in porch-boxes and pots. Flowers are in clusters. Blooms constantly. Pkt. 15 cts., $\frac{1}{4}$ oz. 60 cts., oz. \$1.75.

Larkspur*Annual*

Favorite, easy-to-grow annuals, producing their tall spikes very freely for several weeks during summer. They are most effective planted in the border in groups among lower-growing flowers. Sow the seed in April and thin or transplant to stand 8 to 10 inches apart.

GIANT IMPERIAL. A new strain of annual Larkspurs that grows 3 to 4 feet high. Fine well-filled spikes.

Blue Bell. Deep sky-blue.

Blue Spire. Clear violet-blue.

Carmine King. Deep, glowing pink with a fiery sheen, almost scarlet.

Daintiness. Delicate lavender.

Miss California. Brilliant rose-pink.

White Spire. Pure white.

Mixed. All colors.

All above Larkspurs, pkt. 25 cts., $\frac{1}{4}$ oz. 50 cts.

Pink Perfection. Lovely, long-lasting flowers of clear pink. Pkt. 25 cts.

TALL DOUBLE STOCK-FLOWERED. Plants 3 feet tall, with candelabra-like branches and long spikes closely set with large, double flowers.

Rosamond. A lovely shade of pure bright rose. Pkt. 25 cts., $\frac{1}{4}$ oz. \$1.

Fine, Mixed. All the colors of this type. Pkt. 10 cts., $\frac{1}{4}$ oz. 25 cts., oz. 75 cts.

DWARF EMPEROR, MIXED. A dwarf, compact strain not over 2 feet tall in an unusual range of colors. Pkt. 10 cts., $\frac{1}{4}$ oz. 25 cts., oz. 75 cts.

For Hardy Larkspur, see Delphiniums, page 35.



Lupinus

Lathyrus**Everlasting or Hardy Sweet Pea***Perennial*

Finest Mixed. Hardy climbers, attaining a height of 5 to 6 feet each season and living from year to year. Flowers resemble the old-fashioned Sweet Peas except that they have no fragrance. Pkt. 10 cts., $\frac{1}{4}$ oz. 45 cts., oz. 75 cts.

Lily • Lilium*Perennial*

Regale. Most popular and easiest to grow of all Lilies, flowering abundantly within 18 months from seed. Perfectly hardy. Pkt. 25 cts.

For Lily Bulbs, see page 47.

Linum • Flax*Perennial*

Showy plant with gray-green foliage and flowers of great delicacy and beauty.

Perenne, Blue. Perennial. Very graceful, bright blue flowers.

Grandiflorum rubrum. Annual. Very showy crimson-scarlet flowers. Blooms all summer.

Either of above, pkt. 10 cts., $\frac{1}{4}$ oz. 25 cts., oz. 75 cts.

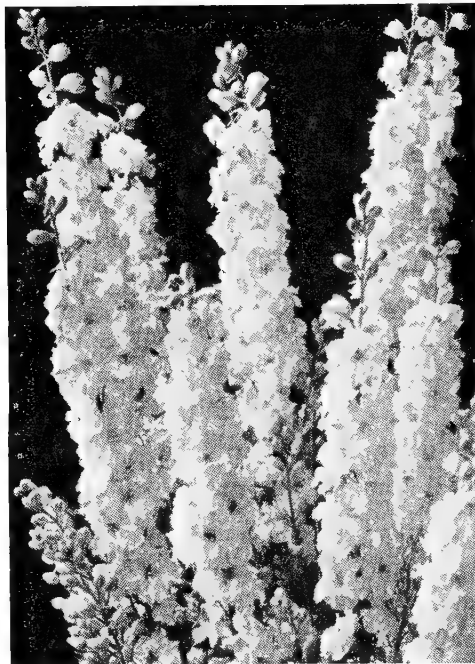

Larkspur, Giant Imperial

Linaria • Toadflax*Annual*

Slender little plants a foot high, bearing dainty, miniature Snapdragons of pink and purple. Excellent for edging.

Maroccana, Fairy Bouquet, Mixed. Compact, 8-inch plants with flowers of various pastel shades. Pkt. 25 cts.

Maroccana, Hybrid Excelsior, Mixed. Plants 1 foot high, with flowers of bright shades. Pkt. 10 cts., $\frac{1}{4}$ oz. 25 cts.

Lobelia*Annual*

Crystal Palace Compacta. Rich dark blue flowers. Dark green foliage. Dainty little plants, popular for porch-boxes, vases, and low beds. Seed should be started indoors in February or March and the plants set out in May. Pkt. 15 cts., $\frac{1}{4}$ oz. \$1.50.

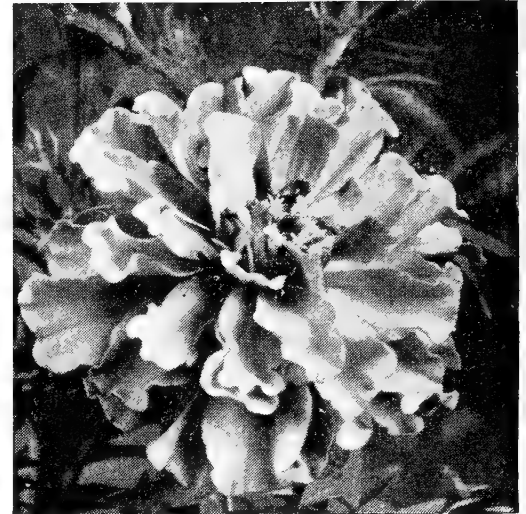

Marigold, Guinea Gold. See page 39

Lupinus • Lupin

The Lupins do well in any good garden soil, preferably with a little shade. They make bushy plants with very attractive leaves and long spikes, closely set with blossoms. Give them plenty of lime, wood-ashes, bonemeal, or other soil-sweetening fertilizers.

Hartwegi, Mixed Colors. Annual. Quick-growing annuals with woolly foliage and stems. Erect spikes with pea-shaped flowers. Pkt. 10 cts., $\frac{1}{4}$ oz. 25 cts., oz. 75 cts.

Polyphyllum, Mixed Colors. Perennial. Grows 2 $\frac{1}{2}$ to 3 feet tall. Sow in May or June and thin to 1 $\frac{1}{2}$ feet apart. Pkt. 10 cts., $\frac{1}{4}$ oz. 25 cts., oz. 75 cts.

Russell. A new English strain with large flowers in colors of rich yellows, oranges, red, and bicolors. Pkt. 25 cts., $\frac{1}{4}$ oz. 60 cts., oz. \$2.

Mesembryanthemum*Annual*

Crystallinum. Ice Plant. Dwarf annual with tender stems and leaves, portions of which are transparent and resemble little icicles. Pkt. 10 cts., $\frac{1}{4}$ oz. 25 cts., oz. 75 cts.

Tricolor. Brilliant red and white, with black centers. Pkt. 10 cts., $\frac{1}{4}$ oz. 50 cts., oz. \$1.50.

Mignonette • Reseda*Annual*

Highly valued for its distinct fragrance.

Giant Machet. An improved strain with giant spikes of reddish green florets. Pkt. 10 cts., $\frac{1}{4}$ oz. 25 cts., oz. 75 cts.

Machet, Special Mixed. Contains all the Machet varieties. Pkt. 10 cts., $\frac{1}{4}$ oz. 20 cts., oz. 60 cts.

Matricaria • Feverfew*Annual*

Double, white, button-shaped flowers on aromatic plants. Pkt. 10 cts., $\frac{1}{4}$ oz. 35 cts., oz. \$1.

Mimulus*Annual*

Moschatus. Musk Plant. Musk-scented foliage and small yellow flowers. Nice for baskets and vases. Pkt. 25 cts., $\frac{1}{8}$ oz. \$2.

Myosotis • Forget-me-not*Biennial*

Alpestris. A biennial but it will bloom the first summer from seed sown in early spring. If early spring flowers are wanted, sow in July and transplant the young plants to their permanent bed about the middle of September. Pkt. 10 cts., $\frac{1}{8}$ oz. 75 cts.

MARIGOLD • Tagetes (Annual)

Vigorous, free-blooming annuals, thriving on any soil but preferring plenty of sunlight. The African Marigolds grow about 3 feet tall with immense, globular blooms, while the dwarf French kinds are only about 10 inches high with smaller flowers but more of them.



Marigold, Crown of Gold

Double Tall African Marigold

Dixie Sunshine. All-America Winner. A tall, late-blooming variety with ball-shaped flowers of golden yellow. Pkt. 25 cts., $\frac{1}{4}$ oz. 75 cts., oz. \$2.

Guinea Gold. All-America Winner. Double, ruffled flowers of pure deep golden yellow, fragrant. Pkt. 10 cts., $\frac{1}{4}$ oz. 35 cts., oz. \$1.

Lemon Queen. A companion to Prince of Orange, but clear lemon-yellow. Pkt. 10 cts., $\frac{1}{4}$ oz. 75 cts., oz. \$2.

Prince of Orange. Very large and double; deep glowing orange. Pkt. 10 cts., $\frac{1}{4}$ oz. 50 cts., oz. \$1.50.

Yellow Supreme. All-America Winner. Extra-large flowers, 3 inches or more across, brilliant lemon-yellow. Pkt. 15 cts., $\frac{1}{4}$ oz. 50 cts., oz. \$1.50.

Mixed. Shades of orange and yellow. Pkt. 10 cts., $\frac{1}{4}$ oz. 35 cts., oz. \$1.

French Marigolds

Ferdinand. A tall French Marigold with brown rays and golden tufts. Pkt. 15 cts., $\frac{1}{4}$ oz. 50 cts., oz. \$1.50.

Harmony, Dwarf Double. An extra-early variety, making 12-inch mounds of bloom. The flowers are a large-crested cushion of golden yellow petals surrounded by mahogany ray petals. Pkt. 10 cts., $\frac{1}{4}$ oz. 50 cts., oz. \$1.50.

Legion of Honor, Dwarf Single. Bushy. Flowers gold and brown. Pkt. 10 cts., $\frac{1}{4}$ oz. 35 cts., oz. \$1.

Royal Scot, Tall Double. Large flowers of mahogany and gold in symmetrical stripes on 30-inch plants. Pkt. 15 cts., $\frac{1}{4}$ oz. 50 cts., oz. \$1.50.

Royal Scot, Dwarf Double. Plants 12 to 15 inches tall with flat flowers irregularly striped brown and gold. Pkt. 15 cts., $\frac{1}{4}$ oz. 50 cts., oz. \$1.50.

Finest Mixed, Dwarf Double. Double flowers of orange and yellow, variously striped and marked with reddish brown. Pkt. 10 cts., $\frac{1}{4}$ oz. 35 cts., oz. \$1.

Other Marigolds

Collarette, Crown of Gold. Gold Medal, 1937 All-America Selections. Chrysanthemum-type flowers of deep orange surrounded by a collar of flat guard petals. Scentless foliage. Pkt. 10 cts., $\frac{1}{4}$ oz. 50 cts., oz. \$1.50.

MARIGOLD, continued

Early Sunrise. Chrysanthemum-flowered golden yellow. Pkt. 25 cts., $\frac{1}{4}$ oz. 75 cts., oz. \$2.

Orange Sunset. Immense, rich orange flowers of the Gigantea type. A glorious Marigold. Pkt. 15 cts., $\frac{1}{4}$ oz. 75 cts., oz. \$2.50.

Pot O'Gold. Dwarf plants 15 inches tall, bearing 4-inch blooms of deep golden orange. The little plants will carry a dozen blooms at a time. Pkt. 25 cts.

Signata Pumila, Little Giant. Spreading plants 6 inches high, covered with lovely little single flowers of golden yellow. Pkt. 15 cts., $\frac{1}{4}$ oz. 75 cts., oz. \$2.

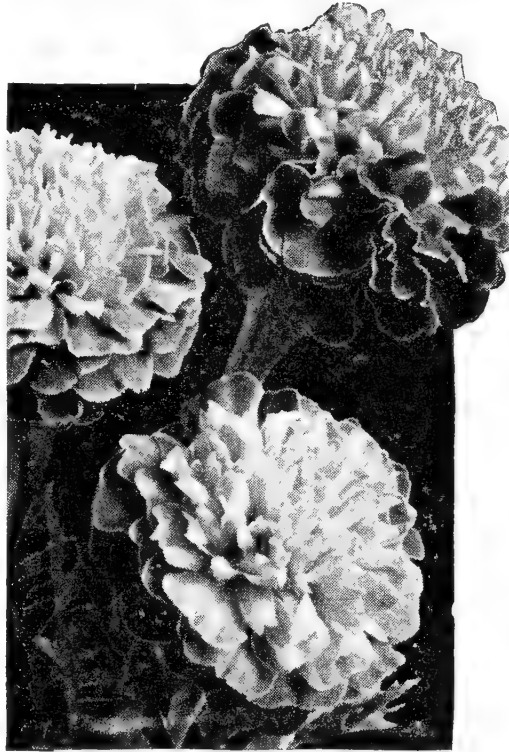

Marigold, Harmony

Momordica

Annual

Vigorous climbing vines with ornamental fruits, and foliage that is dense enough to make a pleasant shade.

Balsamina. Balsam Apple. Flowers yellow, with dark centers. Fruits orange. Pkt. 10 cts., $\frac{1}{4}$ oz. 25 cts., oz. 75 cts.

Charantia. Balsam Pear. Pear-shaped fruits. Dense foliage. Pkt. 10 cts., $\frac{1}{4}$ oz. 25 cts., oz. 75 cts.

Nicotiana

Sweet-scented Tobacco

Annual

Fine annuals for the tall border, thriving best on a deep, rich soil. They grow about 2½ feet high, with large, attractive foliage at the base and clusters of delicately fragrant trumpet-shaped flowers on long stems.

Affinis Hybrids. Pink and red shades in addition to white. A fine sweet-scented strain. Pkt. 10 cts., $\frac{1}{4}$ oz. 35 cts., oz. \$1.

Sanderæ Hybrids. The flowers are larger than the preceding and come in white and shades of pink and red. Pkt. 10 cts., $\frac{1}{4}$ oz. 35 cts., oz. \$1.

Nasturtiums

Annual

We know of no flowers that are easier to grow or give more general satisfaction than Nasturtiums. They do best in poor soil and they flower all summer long in all kinds of weather.

SEMI-DOUBLE VARIETIES

Dwarf Golden Globe. All-America Winner. Flowers deep golden yellow, sweet scented. Plants produce a great number of blooms which resemble the famous Golden Gleam.

Glorious Gleam Hybrids. All-America Winner. From Golden Gleam and Scarlet Gleam has been derived this remarkable new strain with glorious, semi-double flowers in a beautiful array of brilliant colors, all very sweetly scented. Every plant is a profuse bloomer.

Golden Gleam. All-America Winner. Compact plants 1 to 1½ feet high, with clear, golden yellow, semi-double flowers. In addition to the remarkable doubling of the bloom, the flowers possess a delicate scent which lacks the usual coarseness of the Nasturtium odor.

Scarlet Gleam. All-America Winner. A worthy companion to the famous Golden Gleam. The large, semi-double, fragrant flowers are dazzling scarlet. The dwarf, vigorous plants are profuse bloomers all season long.

All Semi-Double Nasturtiums, pkt. 10 cts., oz. 30 cts., $\frac{1}{4}$ lb. \$1, lb. \$3.50

SINGLE VARIETIES

Dwarf Fine Mixed Colors. Fine for beds and edging, any place where masses of color are desired. The plants are covered with flowers in a wide range of colors from June until frost.

Tall Fine Mixed Colors. The tall or climbing Nasturtiums are useful for covering fences, or may be allowed to trail over stumps and rockwork.

All Single Nasturtiums, pkt. 10 cts., oz. 25 cts., $\frac{1}{4}$ lb. 90 cts., lb. \$3

Nigella • Love-in-a-Mist

Annual

Pretty annual 1½ feet high, for bedding and cutting, easily and quickly grown from seed in any sunny spot.

Miss Jekyll, Blue. Fine double azure-blue. Pkt. 10 cts., $\frac{1}{4}$ oz. 25 cts., oz. 75 cts.

Miss Jekyll, White. Flowers pure white. Double. Pkt. 10 cts., $\frac{1}{4}$ oz. 25 cts., oz. 75 cts.

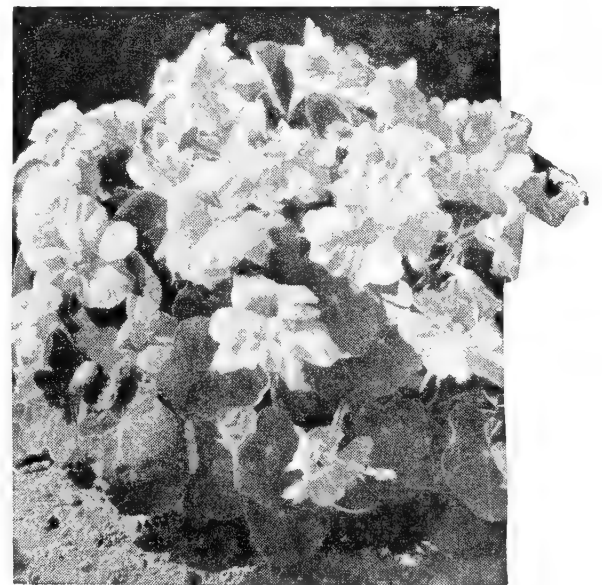

Nasturtium, Glorious Gleam Hybrids

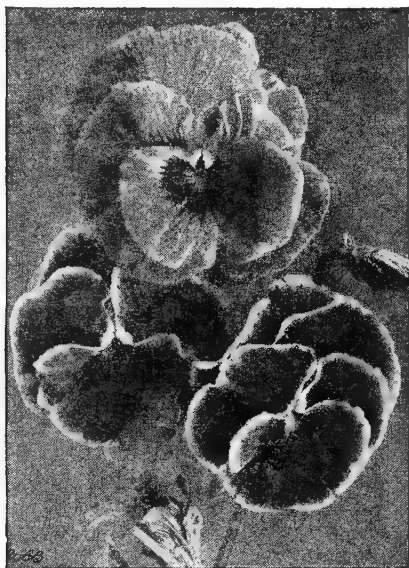

Pansies

Pansies

The best results are secured by sowing late July or August and protecting the young plants over winter with a covering of straw manure or a deep blanket of leaves. They will then be ready to begin blooming as soon as the weather opens up in the spring and will continue to flower until hot weather. The next best time to sow is very early in the spring, in February or March, starting the seed in a box indoors or in a coldframe and setting the plants outdoors the latter part of April. If set out in a spot that is shaded part of the day, where the soil is deep and moist, and the flowers picked daily, the plants may be kept blooming all summer.

Engelmann's Giant Mixed. Dark and light shades; huge flowers. Compact and early flowering. Choice bedding and cut-flower strain. Pkt. 25 cts., $\frac{1}{8}$ oz. \$1.75, $\frac{1}{4}$ oz. \$3, oz. \$10.

Giants of California, Mixed. A special mixture of giant types. Pkt. 20 cts., $\frac{1}{4}$ oz. \$2.50, oz. \$9.

Mastodon, Finest Mixed. An American strain with flowers often $2\frac{1}{2}$ inches in diameter. Strong in red and purple shades. Pkt. 20 cts., $\frac{1}{4}$ oz. \$2.50, oz. \$9.

Roggli Giant Blotched, Mixed. A Swiss strain with especially fine coloring. Pkt. 20 cts., $\frac{1}{4}$ oz. \$2.50, oz. \$9.

Fine Mixed Colors. A fine assortment of select varieties for bedding, including many bright and beautiful colors. Pkt. 10 cts., $\frac{1}{4}$ oz. \$2, oz. \$7.

Physalis

Perennial

Francheti. Chinese Lantern Plant. Flowers yellow with dark centers, and fruits with blood-red inflated calyx which turn bright red when ripe and resemble Chinese lanterns. Attractive when dried for winter use. Pkt. 15 cts., $\frac{1}{4}$ oz. 60 cts., oz. \$2.

Platycodon • Balloon Flower

Perennial

Erect, leafy plants bearing a profusion of inflated, balloon-like buds, opening to wide, saucer-shaped flowers. Good border perennial for late summer blooming.

Grandiflorum. Steel-blue. Pkt. 10 cts., $\frac{1}{4}$ oz. \$1, oz. \$3.

Grandiflorum album. White. Pkt. 10 cts., $\frac{1}{4}$ oz. \$1, oz. \$3.

Petunias *Annual*

For solid beds of color, borders and edging, vases and porch-boxes, in fact, for every purpose, the Petunias are surpassed by few if any of the easily grown garden annuals. They come into bloom early and continue to flower profusely all summer long, thriving on poor soil and in the hottest weather. Sow the seed in April or May, scattering it thinly on fine sifted soil and, instead of covering it, press it firmly into contact with the earth with a smooth board. When the seedlings are about 2 inches high, transplant them to the place where you want them to bloom. For extra-early flowers, start seed indoors in March or April.

LARGE-FLOWERING SINGLE FRINGED VARIETIES

Dainty Lady. An entirely new variety, with light golden yellow flowers—a shade previously unknown in Petunias. Pkt. 50 cts.

Dwarf Giants of California, Mixed. (Ramona Strain.) An improved new dwarf strain of the well-known California Giants. Flowers are large and beautifully colored, with open throats, well marked and veined. Pkt. 50 cts.

Elk's Pride. Large and very dark purple, plain edged. Pkt. 25 cts.

Pink Beauty. Clear light pink. Pkt. 25 cts.

Pride of Portland. Deep glowing rose. Pkt. 25 cts.

Scarlet Beauty. Crimson-scarlet. Pkt. 25 cts.

White Beauty. Snowy white. Pkt. 25 cts.

Ruffled Giants, Mixed Colors. Immense single flowers with ruffled and fringed petals, in all colors. Pkt. 25 cts.

SINGLE BEDDING VARIETIES

Blue Bedder. Dwarf, compact, erect plants with fine flowers of mid-blue. Pkt. 15 cts., $\frac{1}{8}$ oz. \$1, oz. \$5.

Flaming Velvet. All-America Winner. The large, showy flowers are brilliant velvety blood-red or scarlet. Pkt. 25 cts.

Hollywood Star. Silver Medal. 1939 All-America Selections. A distinct Petunia with lobes coming to needle points, making a lovely five-pointed star. The color is rich rose and the throat is amber. Compact, dwarf plants. Pkt. 25 cts.

Martha Washington. Blooms are about 3 inches across, with ruffled edges, blush-pink, shading to dark violet in the throat; veins wine-red. Pkt. 25 cts.

Pink Gem. Grows 5 to 6 inches high, forming a compact ball completely covered with deep pink blooms 2 inches across. Pkt. 25 cts.

Rose of Heaven. Brilliant fiery rose, similar to Rosy Morn, but more brilliant. The best dwarf pink variety. Pkt. 10 cts., $\frac{1}{8}$ oz. 75 cts., oz. \$4.

Rosy Morn. Vigorous plants, 10 inches tall, compact and free-flowering. Flowers soft carmine-pink with white throat. Pkt. 10 cts., $\frac{1}{8}$ oz. 75 cts., oz. \$4.

Snow Queen. Plants of the Nana Compacta type. Cover themselves with snow-white flowers all summer and fall. A lovely variety. Pkt. 15 cts., $\frac{1}{8}$ oz. \$1, oz. \$5.

Violacea, Blue Bird. Violet-blue. Extra fine. Pkt. 10 cts., $\frac{1}{8}$ oz. 75 cts., oz. \$4.

Striped and Blotched, Mixed. Compact plants with flowers striped and blotched. Very striking. Pkt. 10 cts., $\frac{1}{8}$ oz. 75 cts., oz. \$4.

Single, Fine Mixed. An excellent assortment for bedding, including many fine colors. Pkt. 10 cts., $\frac{1}{8}$ oz. 75 cts., oz. \$4.

LARGE-FLOWERING DOUBLE FRINGED VARIETIES

Alldouble Giant Fringed, Mixed. A magnificent strain produced by careful hand hybridizing. The flowers are large and have beautifully frilled and crinkled petals. These Petunias make splendid pot-plants. Pkt. \$1.

Large, Double-flowering Fringed, Mixed. A fancy mixture which produces a large percentage of doubles. Pkt. 50 cts.

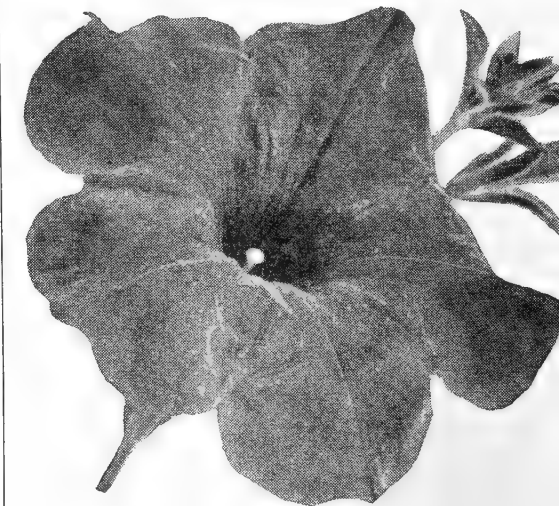

Petunia, Flaming Velvet

Portulaca *Annual*

The Portulacas will grow on soil too poor and in places too hot and sunny for any other flower. The plants are low and spreading, commencing to bloom in July and blooming profusely all summer. Sow the seed when the ground gets warm. Flowers like little roses.

Double, Mixed. Pkt. 10 cts., $\frac{1}{8}$ oz. 60 cts., $\frac{1}{4}$ oz. \$1, oz. \$3.

Single, Mixed. Very bright and attractive. Good mixture of colors. Pkt. 10 cts., $\frac{1}{4}$ oz. 35 cts., $\frac{1}{2}$ oz. 60 cts., oz. \$1.

Primula • Primrose

Perennial

Auricula, Large-flowering, Mixed. Fine free-blooming flower for the rocky and perennial border. Blooms in early spring. The plants are tender and should be given light protection over winter. Seed germinates slowly; may be in the ground a year before it sprouts. Pkt. 50 cts.

Pyrethrum

Perennial

Very easy to grow from seed sown any time from early spring to late summer. Seed started under glass in February will give blooming plants the first summer. Set them in full sun in fertile soil. The 2-foot flower stems make them excellent for cutting and they last very well. By cutting off the first crop of flowers a second crop will be produced in the fall.

Aureum. Golden Feather. Grown mostly for its showy golden yellow lacinated foliage. Nice for borders. Pkt. 10 cts., $\frac{1}{4}$ oz. \$1, oz. \$3.

Roseum, James Kelway. Large, daisy-like flowers of deep scarlet. An excellent cut-flower variety. Pkt. 25 cts., $\frac{1}{4}$ oz. 75 cts., oz. \$2.75.

Roseum, Mixed. Large, daisy-like flowers of many colors. An excellent cut-flower. Pkt. 15 cts., $\frac{1}{8}$ oz. \$1.25, $\frac{1}{4}$ oz. \$2.

Phlox Drummondii

Annual

Blooming in midsummer, these easily grown flowers make the most brilliant of beds. They prefer an open, sunny situation, but are not particular as to soil and will give good results under almost any conditions. Sow the seed in April or early May and thin the plants to stand about 4 inches apart.

TALL VARIETIES (about 15 in. high)
Crimson Violet, white eye
Lilac White
Rose, dark eye Yellow
Finest Mixed

All Tall Phlox, pkt. 10 cts., ¼oz. \$1, oz. \$3

Gigantea, Art Shades. All-America Winner. A lovely strain with flowers over an inch in diameter of soft pastel shades, each with a distinctive eye. Bushy plants about 10 inches high. Pkt. 25 cts., ¼oz. \$2,

DWARF VARIETIES Annual

Nana compacta, Mixed. These grow about 8 inches high and quite bushy, making fine borders and ribbon beds. Mixed colors. Pkt. 10 cts., ¼oz. \$1, oz. \$3.

HARDY VARIETIES Perennial

Finest Mixed. Produces large heads of brilliantly colored flowers of many shades. Plants grow 2 to 4 feet high. Pkt. 10 cts., ¼oz. \$1, oz. \$3.

Poppy • Papaver

Although the Poppies last for only a short time, while they are in bloom no flowers can rival them in brilliant colors. The seed is fine and should be scattered thinly in the place where the plants are wanted to bloom, as they do not transplant well. Height, 2 feet. Sow the annual sorts in April and the perennial kinds June to September.

ANNUAL VARIETIES

Double Shirley, Dazzler. Double flowers of vivid orange-scarlet. Pkt. 10 cts., ¼oz. 25 cts.

Double Shirley, Sweet Briar. Double flowers of the same color as the Single Wild-Rose-Pink. Pkt. 10 cts., ¼oz. 25 cts.

Shirley, American Legion. Brilliant scarlet, single blooms. An improved Flanders Poppy. Pkt. 10 cts., ¼oz. 25 cts.

Shirley, Wild-Rose-Pink. Single flowers of soft wild-rose-pink. A beautiful flower. Pkt. 10 cts., ¼oz. 25 cts.



Papaver nudicaule

POPPIES, continued

Shirley, Mixed Colors. Probably the finest strain of annual, single-flowered Poppies. White and pale pink to bright scarlet and deep crimson, including rose with white edge, red with white edge, etc. Very showy. Pkt. 10 cts., ¼oz. 25 cts.

Tall Peony-flowered, Mixed. Large, double flowers with plain edges in a wide range of colors. Pkt. 10 cts., ¼oz. 25 cts.

Tulip Poppy (P. glaucum). Dazzling scarlet with a black maltese cross at center. Pkt. 10 cts., ¼oz. 25 cts.

PERENNIAL VARIETIES

Nudicaule, El Monte. Large flowers of deep tangerine-orange. Pkt. 25 cts., ¼oz. 75 cts.

Nudicaule, Sunbeam Hybrids, Mixed. A fine strain of Iceland Poppies in shades of yellow and orange. Pkt. 10 cts., ¼oz. 75 cts.

Oriente, Scarlet. The big, bright scarlet Decoration Day Poppy. A hardy perennial form bearing immense single flowers. Pkt. 10 cts., ¼oz. \$1.

Oriente, Mixed. A fine mixture of the various Oriental Poppy colors. Pkt. 10 cts., ¼oz. \$2.

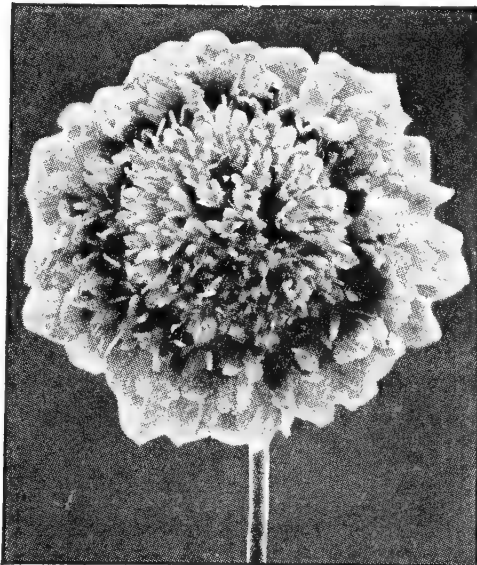

Scabiosa, Peach Blossom

Rhodanthe

Swan River Everlasting

Annual

Mixed Colors. Can be dried in its natural colors for winter bouquets. It is an easily grown annual, about 1 ½ feet tall, with silvery gray leaves and very pretty, little, double flowers. Pkt. 10 cts., ¼oz. 25 cts., oz. 75 cts.

Salpiglossis • Painted Tongue

Annual

A popular, easily grown garden annual, richly colored and fine for cutting. The flowers are borne in clusters at the top of long stems and are produced very freely from midsummer to fall. Sow the seed in late April or May and thin the plants to stand about 10 inches apart.

Brown and Gold **Scarlet and Gold**
Golden Yellow **Velvety Red**
Light Blue and Gold **Finest Mixed**

All Salpiglossis, pkt. 15 cts., ¼oz. 35 cts., oz. \$1

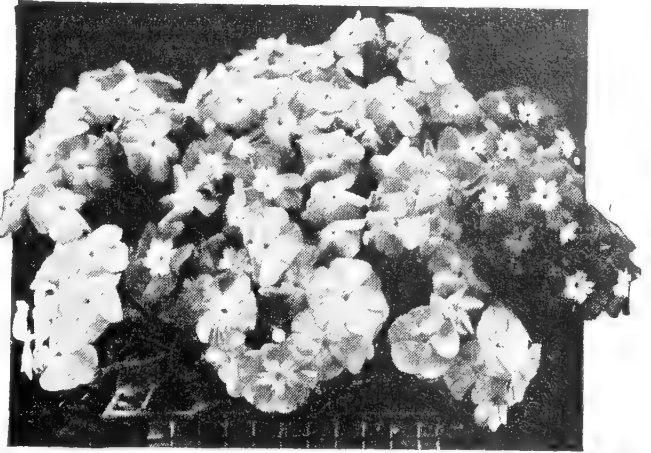

Phlox Drummondii, Art Shades

Salvia • Sage

Start the seed indoors or in hotbeds very early, during January or February if possible. When 2 to 3 inches high transplant into small pots or space to 6 inches apart. Transplant to the garden in late May, in a sunny location and rich, deeply dug soil, setting the plants at least 1 ½ feet apart.

America. Annual. Grows about 1 ½ feet tall. Plants a mass of light blazing scarlet. Profuse bloomer. Pkt. 10 cts., ¼oz. \$1.50, oz. \$5.

Bonfire. Annual. A select strain, fine for mass planting, as it is very compact in growth and has exceedingly brilliant scarlet flowers. Pkt. 10 cts., ¼oz. \$1.50, oz. \$5.

Farinacea, Blue Bedder. A fine perennial with light blue flowers on spikes about 2 feet long. Seed sown in early May should give plants that bloom from July to frost. Pkt. 15 cts., ½oz. \$1.10, ¼oz. \$1.75, oz. \$6.

Splendens. Annual. The original Scarlet Sage. It grows about 2 feet tall and is covered with large, bright red blossoms all summer long. Pkt. 10 cts., ¼oz. \$1.50, oz. \$5.

Zurich. Annual. An early variety only 1 foot high. Pkt. 10 cts., ¼oz. \$1.50, oz. \$5.

Scabiosa • Mourning Bride

Annual

One of the finest annuals for cutting. Grows in almost any situation; 2 ½ to 3 feet high; blooms for a long season.

Azure Fairy. Azure-blue.

Black Prince. A very dark purple.

Cherry-Red. A nice shade of red.

Loveliness. Soft salmon-rose.

Peach Blossom. Peach-blossom-pink.

Shasta. Pure white.

Above Scabiosa, pkt. 15 cts., ¼oz. 25 cts., oz. 75 cts.

Blue Moon. Honorable Mention, 1939 All-America Selections. Erect, free-blooming plants with thick heads of deep lavender-blue. Pkt. 15 cts., ¼oz. 50 cts., ½oz. 75 cts.

Giant-flowered, Mixed. Pkt. 10 cts., ¼oz. 25 cts., oz. 75 cts.

Schizanthus • Butterfly-Flower

Annual

Wisetonensis Excelsior compactus. A dainty little plant 6 inches high, adapted to bedding and borders. Blooms freely during the entire summer. An excellent pot-plant. Finest mixed, pkt. 15 cts., ¼oz. \$1.25.

Stock • Gilliflower Annual

Large-flowering, Mixed. The old-fashioned Ten-Weeks Stocks are beautiful, free-flowering, sweet-scented annuals, requiring a mellow soil. Sow the seed in April or May and give the plants 12 to 15 inches of space. Pkt. 10 cts., ¼oz. \$1.25, oz. \$2.50.

Sweet Peas
Scott's Spencers

Sweet Peas

Annual

Sweet Peas bloom best in an open, sunny situation. Keeping the flowers picked as fast as they open prolongs the period of bloom. The old-fashioned or Grandiflora type of Sweet Peas are hardy and very floriferous and the flowers are heavily scented, although of only medium size and rather stiff in form. The new Spencer or Waved Sweet Peas are much larger and finer in form as well as colors, but not quite so free-blooming. Modern gardeners and florists as a rule grow only the Spencer varieties. Plant as early as the ground can be worked, in deeply prepared rich soil. Never allow the soil to dry out after the plants appear.

Scott's Summer-flowering Spencers

Distinguished by giant size, often measuring 2 inches in diameter, and by beautifully waved petals. Hundreds of varieties are known to specialists and new sorts are being constantly produced by English and American breeders, but we believe that the varieties we offer comprise the best and most satisfactory of the new as well as old, in all of the favorite colors.

One ounce of seed will plant a row about 15 feet long

- Ambition.** Rosy lavender.
- Avalanche.** Glistening white.
- Black Diamond.** Dark maroon.
- Crimson King.** Rich deep crimson.
- Damask Rose.** Deep rose.
- Derby Day.** Sparkling crimson.
- Fluffy Ruffles.** Light cream-pink.
- Gigantic.** Best white.
- Gleneagles.** Large; pale lavender.
- Grand Slam.** Cerise-scarlet.
- Jubilee.** Scarlet.
- Mastercream.** Cream.
- Mrs. A. Searles.** Bright salmon.
- Olympia.** Rich purple.
- Prince of Orange.** Deep orange.
- Pinkie.** Large; rose-pink.
- Red Rover.** Fine dark crimson.
- Reflection.** Clear blue.
- Ruffled Mauve.** Pure mauve.
- The Admiral.** Violet-blue.
- Welcome.** Dazzling scarlet.

All above Spencer Sweet Peas, pkt. 10 cts., oz. 30 cts., ¼lb. \$1, lb. \$3

Sweet Pea Mixture

Scott's Finest Mixed Spencers. A wonderful mixture of finest varieties in many beautiful colors. Pkt. 10 cts., oz. 25 cts., ¼lb. 60 cts., lb. \$2.

Scott's Finest Mixed Grandiflora. The old-fashioned, deliciously fragrant kind. Oz. 10 cts., ¼lb. 30 cts., lb. \$1.

Sweet William *Dianthus barbatus*

Biennial

A great favorite in all gardens. Easily grown from seed. The flowers are borne in large trusses and are delightfully fragrant. Sow any time from early spring to July. The plants should stand at least 8 inches apart.

Double Varieties, Mixed Colors. The double flowers are very attractive in form as well as colors. Pkt. 10 cts., ¼oz. 60 cts., oz. \$2.

Newport Pink, Single. A single variety of a salmon-rose shade. Fine cut-flower. Pkt. 10 cts., ¼oz. \$1, oz. \$3.

Single Varieties, Mixed Colors. A wide range of colors, many with distinct "eyes" or margins of a different shade. Pkt. 10 cts., ¼oz. 25 cts., oz. 75 cts.

Thunbergia • Black-eyed Susan

Annual

A slender climbing or trailing annual with many little flowers, varying from palest primrose to deep buff-yellow, all with dark centers, from which it derives its common name. Start indoors in February or March. Pkt. 10 cts., ¼oz. 35 cts., oz. \$1.

Tithonia • Mexican Sunflower

Annual

Speciosa. A tall, branching, half-hardy annual with very striking rich orange-scarlet flowers. Fine for clumps in the tall border. Grows 6 feet or more high. Pkt. 15 cts., ¼oz. 50 cts., oz. \$1.75.

Verbena

Annual

Low, spreading plants with handsome dark green foliage and great clusters of sweet-scented flowers all summer long. Old favorites for low beds and edging, also for boxes and vases. Sow indoors in February or March.

GRANDIFLORA GIGANTEA HYBRIDS. A showy type with giant flowers in fine heads. The colors are brilliant and stand out against the lovely green foliage. A continuous bloomer from midsummer on.

Beauty of Oxford. Spectacular heads of nice form. The color-range is from rose-pink to rose-red.

Lavender Glory. Large flowers of pure lavender with a creamy white eye.

Royale. Royal blue, creamy yellow eye.

Scarlet Queen. Rosy scarlet, large white eye.

Spectrum Red. Intense bright red.

All Grandiflora Gigantea Hybrids, pkt. 15 cts., ¼oz. 75 cts., oz. \$2.50

MAMMOTH HYBRIDS. These varieties produce extra-large flower-heads with individual florets often measuring an inch across.

Auricula-Eyed, Mixed.

Blue Shades.

Defiance. Scarlet.

Italian, Striped, Mixed.

Lucifer. Brilliant scarlet.

Pink and Rose Shades.

White.

Mammoth, Mixed.

All Mammoth Hybrid Verbenas, pkt. 10 cts., ¼oz. 35 cts., oz. \$1

Choice Mixed. Pkt. 10 cts., ¼oz. 25 cts., oz. 75 cts.

Veronica • Speedwell

Perennial

Spicata. Sturdy plants bearing erect spikes of dark blue flowers in midsummer. A good low perennial about 18 inches tall, useful for garden decoration and cutting. Pkt. 10 cts., ¼oz. \$1.50, oz. \$5.

Vinca rosea

Madagascar Periwinkle

Annual

Forms handsome, bushy bedding plants that bloom profusely all summer from seed sown indoors in February or March, and is fine for pot-culture. Height, 1 to 1½ feet.

Finest Mixed. An excellent assortment of Red, White with Rose center, Pure White, and Pink. Pkt. 10 cts., ¼oz. 75 cts., oz. \$2.50.

Viola

Perennial

Finest Mixed. The most attractive colors of this desirable spring flower. Pkt. 25 cts., ¼oz. 75 cts., oz. \$2.50.

Wallflower Perennial

The Wallflowers are perennials but in our rigorous climate they require protection over winter and are best carried over in a cold-frame. Sow the seed indoors in March or outdoors late in May and space the plants about 8 inches apart. The flowers are clustered on spikes 1½ feet tall, and are very fragrant.

Double Varieties, Extra-Fine Mixed. Artistic shades of coppery red, bright brown, bronzy yellow, etc. Pkt. 50 cts.

Wild Cucumber Vine

Annual

Lobata. A very rapid-growing, vigorous climber, often running 30 to 40 feet in a season. It bears small, white, slightly fragrant flowers, followed by spiny seed-pods. Pkt. 10 cts., ¼oz. 20 cts., oz. 60 cts.

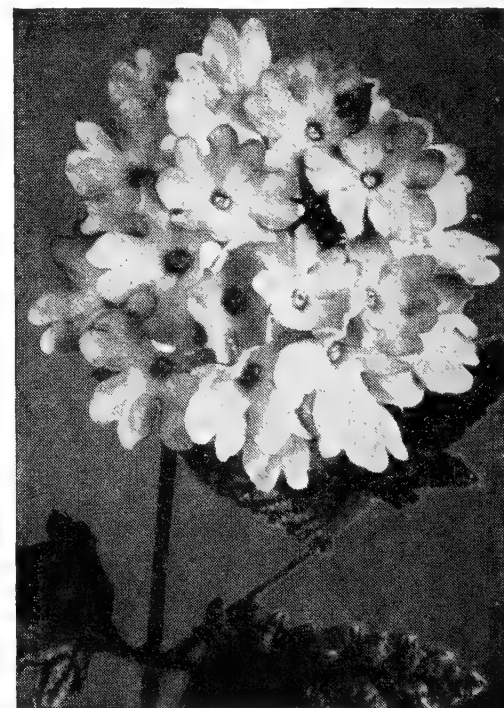

Verbena, Beauty of Oxford

ZINNIAS • Youth and Old Age

Few flowers provide a more gorgeous display with less care or attention; all they require is a sunny spot to cause them to grow and bloom vigorously from early summer until frost. The seed may be sown in the garden any time during April or May and the plants

thinned or transplanted to stand 8 to 18 inches apart, according to variety. The largest specimen blooms are produced on plants that are grown on a mellow, moderately rich soil and given ample room to develop.

GIANT DOUBLE DAHLIA-FLOWERED VARIETIES. Plants 2½ to 3 feet high, bearing huge, double flowers resembling the Show type of Dahlia.

Crimson Monarch. Deep crimson.
Dream. Deep rosy lavender.
Exquisite. Light rose, deep rose center.
Giant Attraction. Brick-red.
Golden Dawn. Golden yellow.
Illumination. Deep rose.
Oriole. Orange and gold bicolor.
Polar Bear. Pure white.
Scarlet Flame. Bright scarlet.
Will Rogers. Brilliant scarlet-red.
Finest Mixed. All colors.

All above, pkt. 15 cts., ¼oz. 50 cts., oz. \$1.50

ELEGANS, CURLED AND CRESTED. Tall, double flowers with the petals artistically twisted and curled. Pkt. 10 cts., ¼oz. 35 cts., oz. \$1.



Zinnia, Fantasy

FANTASY

Rosalie. Fantasy type flowers in various shades of rose and pink. Free-blooming plants. Pkt. 15 cts., ¼oz. 90 cts., oz. \$3.

Star Dust. Clear golden yellow flowers. Blooms early and generously. Pkt. 15 cts., ¼oz. 60 cts., oz. \$2.

Fantasy Mixed. Striking rich colors; medium-sized flowers. Splendid cutting material. Pkt. 10 cts., ¼oz. 50 cts.

CALIFORNIA GIANTS. Plants 3 to 4 feet high; flowers large and flat, with long stems. Excellent for cut-flowers.

Crimson Queen, Daffodil (Canary-yellow), **Lavender Queen, Purity** (White), **Scarlet Queen, Violet Queen, Finest Mixed.** Pkt. 10 cts., ¼oz. 50 cts., oz. \$1.50.

DOUBLE MEXICAN HYBRIDS

Haageana, Finest Mixed. Small flowers on low, bushy plants, making a fine display over a long season. Stems are long enough for cutting. Pkt. 15 cts., ¼oz. 40 cts., oz. \$1.25.

DWARF DOUBLE VARIETY. Cut-and-Come-Again. An excellent bedding type not over 2 feet tall. Distinct colors. Finest Mixed. Pkt. 10 cts., ¼oz. 35 cts., oz. \$1.

POMPON or BABY DWARF VARIETIES. A popular type for cutting. Small compact flowers. Plants 1½ to 2 feet tall.

Canary Gem, Salmon Gem, Crimson Gem, Lilac Gem, Purple Gem, Rosebud, Scarlet Gem, Valencia (Orange) or **Mixed.** Pkt. 10 cts., ¼oz. 35 cts., oz. \$1.

SCABIOSA-FLOWERED. Resembles the annual Scabiosa, with ray petals surrounding a large cushion.

Giant Crested. A new large-flowered crested variety with shades of orange, yellow, scarlet, maize, rose, and crimson predominating. Lovely for cutting and garden decoration. Pkt. 25 cts.

Finest Mixed. Pkt. 15 cts., ¼oz. 75 cts.



Double Dahlia-flowered Zinnia

Flower Seed Mixtures Scott's Annual Cut-Flower

Here is a mixture of annuals that we do not hesitate to recommend. Anyone is sure to have success with it, and it provides continuous bloom all summer. Pkt. 10 cts., ½oz. 25 cts., oz. 45 cts., ¼lb. \$1.50.

Scott's Annual Rock-Garden

A carefully selected assortment suitable for the rockery. Especially useful to fill vacancies. Pkt. 10 cts., ¼oz. 35 cts., oz. \$1.

Scott's Perennial Rock-Garden

A fine collection for permanent plants for the rock-garden. Recommended to the beginner. Pkt. 25 cts., ¼oz. 75 cts., oz. \$2.50.

GARDEN BOOKS

Five Popular Garden Books

GARDEN GUIDE. A most complete book for the amateur. Written by 28 authors. Covers the entire place from landscaping through the finished garden, both fruit, vegetable, and flower. Chapters on soils, fertilizers, diseases, insects, propagation, transplanting, pruning, winter protection, etc. 576 pages; over 300 illustrations. Cloth, \$2.

WHAT EVERY ROSE-GROWER SHOULD KNOW. Prepared for the American Rose Society as a primer for beginners. Tells all the steps in rose-growing from preparing the ground, through planting, protection against insects and diseases, summer care, pruning, and winter protection. 80 pages; 4 illustrations in color, 5 in black and white, and numerous sketches. \$1.

GARDEN FLOWERS IN COLOR. By Daniel J. Foley. Here is the only book to show the important garden flowers in accurately colored photographs—350 of them. It identifies each plant, and gives brief and adequate cultural directions. A guide book for the beginner and a reference book for the advanced gardener. \$2.49.

GARDEN BULBS IN COLOR. By McFarland, Hatton and Foley. Has 275 color-plates and 100 beautiful half-tones. Complete cultural notes are included. 296 pages. \$2.49.

THE COMPLETE BOOK OF GARDEN MAGIC. By Roy E. Biles. Tells exactly how to plan your garden. Gives suggestions, instructions, diagrams, illustrations, step by step, month by month, to make your garden more beautiful. 27 chapters of practical advice; Lawns and Grading, Planting and Transplanting, How to Plant Bulbs, How to Prune Roses, Soilless Gardening, Soil Fertility, Rock Gardens, Window Boxes, Vegetable Garden, Flower Arrangement, Garden Calendar—the kind of information you have always wanted. Over 300 pages. \$3.

HOW TO GROW ROSES. By McFarland and Pyle. A completely rewritten edition of America's most popular rose book. 192 pages, profusely illustrated, many in color. \$2.

If the book you are wanting is not listed, give us the subject and we will be glad to tell you what is available, and the price

VEGETABLE GARDENING IN COLOR. By Daniel J. Foley. Expert and practical directions for growing all the common vegetables, herbs, and berries. Has chapters on insects and diseases and winter storage. A valuable guide for home-gardeners. 256 pages; 150 pictures in full color. \$2.50.

THE MODERN FAMILY GARDEN BOOK. By Roy E. Biles. Shows you what to plant—where, when, and how. A thoroughly reliable book packed full of useful, easy-to-apply information, with detailed illustrations. 160 pages, 400 diagrams, charts, and tables. (A condensation of THE COMPLETE BOOK OF GARDEN MAGIC.) \$1.

CLIMBING ROSES. By G. A. Stevens. A companion volume to "How to Grow Roses." 31 color-plates and 32 half-tone illustrations. Cloth, \$2.

THE BOOK OF BULBS. By F. F. Rockwell. Here is the "last word" on bulbs and how to grow them, both outdoors and inside the home. 264 pages; 187 illustrations. \$3.50.

GLADIOLUS. By F. F. Rockwell. 79 pages; 45 illustrations. \$1.25.

PEONIES. By F. F. Rockwell. Tells all about peonies, where and how to grow them, their planting, care, cultivation, propagation, and protection. Illustrated with photographs and drawings. \$1.25.

ANNUALS FOR YOUR GARDEN. By Daniel J. Foley. Contains full cultural directions for 90 annual flowers. 97 pages, 32 full color-plates. \$1.

PLANT PROPAGATION. By Alfred C. Hottes. Easily understood by the amateur but covers propagation by all the approved commercial methods. Revised edition. 238 pages; 136 illustrations. Cloth, \$2.

PEST CONTROL IN THE HOME GARDEN. By Louis Pyenson. An invaluable book for those who are striving to grow healthy plants and take pride in good crops. Has chapters on fruit trees, small fruit, and vegetables. 190 pages; 111 illustrations. \$2.

SUCCESS ON THE SMALL FARM. By Haydn S. Pearson. Tells what every successful farmer must know, from starting out to getting the most profit out of his farm. Contains valuable information for both the beginner and the established farmer. 285 pages; illustrated. \$2.50.



The Finest Lawns
in
Western Pennsylvania
are made with
SCOTT'S LAWN SEED



SCOTT'S "PURITY" LAWN GRASS SEED

This is the mixture we recommend for general lawn sowing. It has proved satisfactory to our customers for many years. Produces a lustrous, well-established turf of an even tone of rich green that, with proper care, will last for many years. Composed of the highest grades of re-cleaned seeds procurable. Thousands of beautiful lawns attest the quality of this mixture.

For new lawns, sow at the rate of 1 pound to each 250 square feet, or 150 pounds per acre. For lawn maintenance, sow about 1 pound to each 400 square feet or about 100 pounds per acre.

1/2 lb. 60 cts., lb. \$1, 2 lbs. \$1.90, 5 lbs. \$4.60, 10 lbs. \$8.90, 25 lbs. \$21.50, 50 lbs. \$41.50, 100 lbs. \$82.

SCOTT'S "SUPERFINE" LAWN SEED

For those who prefer a lawn with Bent Grass we offer our Superfine Lawn Seed Mixture. The mixture consists of extra-heavy weight Kentucky Blue Grass, Fancy re-cleaned Red-Top and Colonial Bent Grass and mixed in the correct proportions to produce a luxuriant, velvety and permanent turf. It is 98% pure.

One pound sows 400 square feet, 100 pounds an acre. A measured bushel weighs about 32 pounds.

1/2 lb. 70 cts., lb. \$1.25, 2 lbs. \$2.40, 5 lbs. \$5.75, 10 lbs. \$11.25, 25 lbs. \$27, 50 lbs. \$53.

SCOTT'S "EVERGREEN" LAWN GRASS MIXTURE

This mixture has been prepared for those requiring a moderate-priced lawn grass seed. We believe it is unequalled at the price.

1/2 lb. 45 cts., lb. 75 cts., 2 lbs. \$1.45, 5 lbs. \$3.50, 10 lbs. \$6.60, 25 lbs. \$16, 50 lbs. \$30.50, 100 lbs. \$60.

SCOTT'S "SHADY" LAWN MIXTURE

There are only a few good grasses thriving in shade so we have put them all together here. We believe you will get surprisingly good results from this mixture. Use same quantities as Scott's Purity.

1/2 lb. 60 cts., lb. \$1.10, 2 lbs. \$2.10, 5 lbs. \$5, 10 lbs. \$9.50, 25 lbs. \$22.50, 50 lbs. \$43, 100 lbs. \$85.

SCOTT'S "FAIRWAY" MIXTURE

Down the fairway the turf must be pleasing to the eye and tough enough to stand close clipping and considerable wear and tear. Our mixture answers those requirements.

Fairways do best when seeded liberally.

5 lbs. \$5.50, 10 lbs. \$10.50, 25 lbs. \$25, 50 lbs. \$48, 100 lbs. \$95.

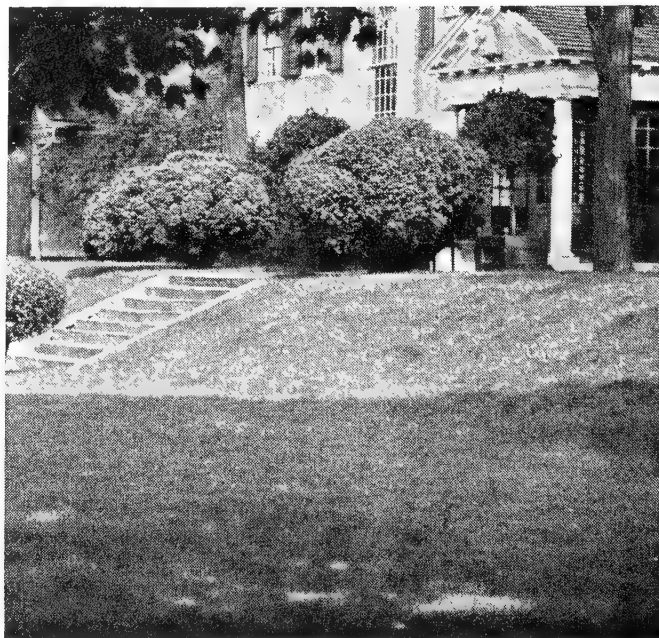

SCOTT'S "TERRACE" LAWN MIXTURE

Grasses with strong, well-developed root-systems quickly established, have been selected for difficult terraces where this mixture has given unqualified satisfaction for several years.

1/2 lb. 60 cts., lb. \$1, 2 lbs. \$1.90, 5 lbs. \$4.60, 10 lbs. \$8.90, 25 lbs. \$21.50, 50 lbs. \$41.50, 100 lbs. \$82.

SCOTT'S "ATHLETIC FIELD" MIXTURE

This calls for good appearance and the toughness of an elephant's hide. Our mixture produces a turf that is just that, standing the gouging of cleated shoes and the pounding of running feet. Seed liberally.

5 lbs. \$5.50, 10 lbs. \$10.50, 25 lbs. \$25, 50 lbs. \$48, 100 lbs. \$95.

SEPARATE VARIETIES OF GRASS SEEDS

All Recleaned and of Highest Quality

MIXED CREEPING BENT. A superior Grass for putting-greens on account of its dwarf growth and its narrow leaves. It will grow and make good turf in good or bad soils, and dry weather or heavy rains seem to have no serious effects. About forty pounds of seed are required for an acre. Lb. \$2, 5 lbs. \$9.50, 10 lbs. \$18, 25 lbs. \$41.25.

COOS COUNTY BENT or SEASIDE BENT (*Agrostis alba maritima*). A fine-leaved bright green Grass used principally on golf-courses for putting-greens. Its texture is fine and uniform, and under good cultural conditions, on soils of reasonable fertility, it will form a sod very quickly. It makes a very good growth in rather dense shade and spreads with great rapidity. Lb. \$2, 5 lbs. \$9.50, 10 lbs. \$18, 25 lbs. \$42.50.

COLONIAL BENT (*Agrostis tenuis*). A tight, thick turf, permanent under close mowing. For putting-greens and fairway mixtures. Lb. \$2, 5 lbs. \$9.50, 10 lbs. \$18, 25 lbs. \$40.

ASTORIA BENT (*Agrostis tenuis; Astoriana*). An underground creeper making a deep, heavy sod of fine texture and color. Lb. \$2, 5 lbs. \$9.50, 10 lbs. \$18, 25 lbs. \$40.

RED-TOP (*Agrostis alba*). A valuable Grass for hay, pasture or lawn. About fifteen to twenty pounds of seed will be required for an acre. Lb. 50 cts., 10 lbs. \$4.50, 25 lbs. \$10.

KENTUCKY BLUE GRASS (*Poa pratensis*). Kentucky Blue Grass is most valuable for pastures and lawn planting. For lawns it is indispensable and, when well established, the lawn will last for years, as the Grass makes an extra-close fine-textured turf. The seed should be mixed with other Grasses that mature earlier, for Blue Grass is very slow in both germinating and maturing. Lb. \$1.50, 10 lbs. \$14.50, 25 lbs. \$35.

PERENNIAL RYE GRASS (*Lolium perenne*). A fine-leaved Grass, not as coarse as the ordinary variety and more resistant to cold. An excellent grass on fairways or anywhere that a quick-growing sod is needed. An excellent nurse Grass for slow-germinating Grasses. Lb. 50 cts., 10 lbs. \$4.50, 25 lbs. \$10.

DOMESTIC RYE GRASS. A mixture of Italian and English Rye Grass grown in the United States. Quick-growing; often used for a temporary turf. Lb. 35 cts., 10 lbs. \$3, 25 lbs. \$5.

POA TRIVIALIS. A thick-matting, stoloniferous species which makes a heavy turf and is well adapted to shady situations when sown with other Grasses. Prefers light moisture and does not do well in dry, exposed places. Lb. \$1.40, 5 lbs. \$6.75, 10 lbs. \$13, 25 lbs. \$30.

CREEPING RED FESCUE (*Festuca rubra*). A creeping, turf-forming Grass especially valuable for lawns. Color is deep green, with fine, needle-like leaves and a strong creeping root system. Thrives on all types of soil and is well adapted to shady situations. Lb. \$1.30, 5 lbs. \$6.25, 10 lbs. \$12, 25 lbs. \$26.25.

CHEWING'S FESCUE (*Festuca rubra fallax*). A fine, needle-like sod excellent for putting-greens and lawns. Resistant to heat, drought, and hard wear. Lb. \$1.30, 5 lbs. \$6.25, 10 lbs. \$12, 25 lbs. \$26.25.

TIMOTHY (*Phleum pratense*). One of the most important hay Grasses, sometimes used to nurse lawns made on rough soil. Lb. 25 cts., 5 lbs. \$1, 10 lbs. \$1.75.

WHITE DUTCH CLOVER (*Trifolium repens*). Valuable for quick lawns and permanent pastures. $\frac{1}{4}$ lb. 50 cts., $\frac{1}{2}$ lb. 85 cts., lb. \$1.50, 5 lbs. \$7, 10 lbs. \$13.

Prices on larger quantities quoted on request. Above prices subject to market changes.

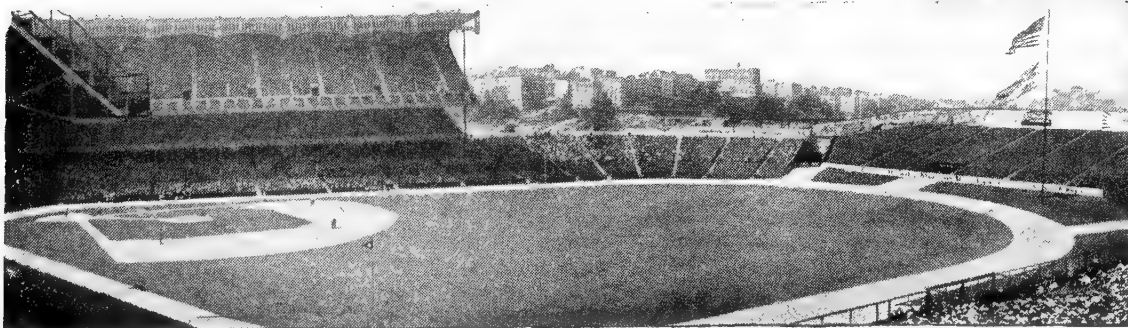
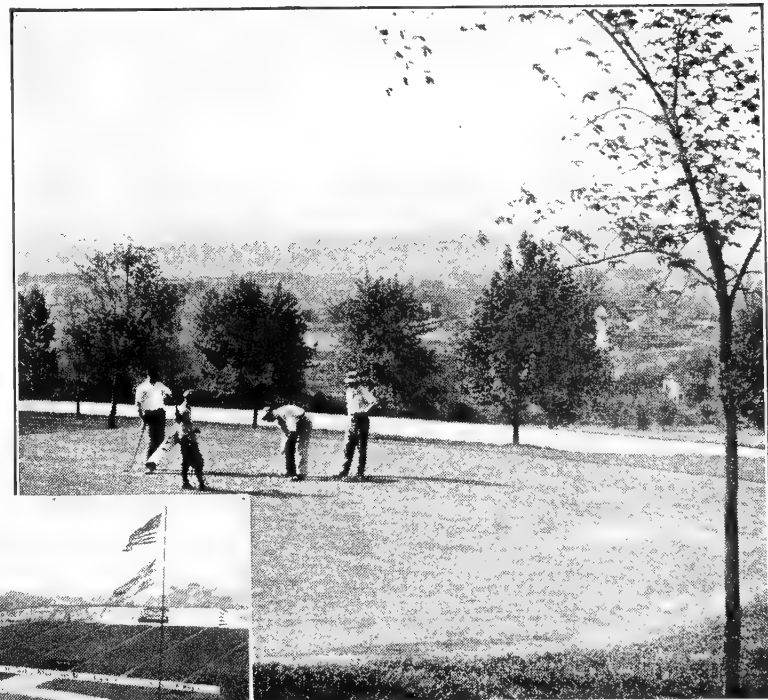
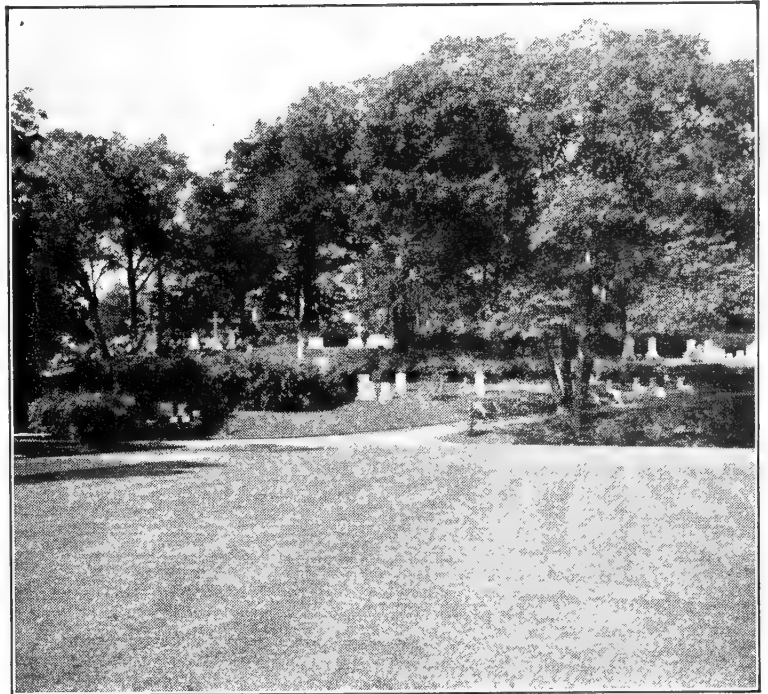
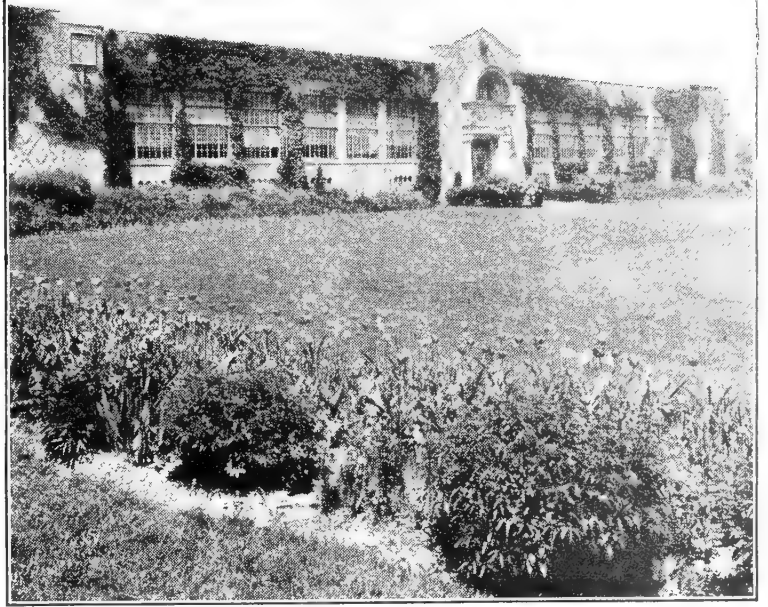

SUMMER-FLOWERING BULBS

TUBEROUS-ROOTED BEGONIAS

Graceful, free-flowering plants suitable for bedding or pot culture. They make strong, fleshy stems a foot or more high with big, very beautiful leaves, crowned by flowers of enormous size and almost unbelievable brilliance. Blooms 4½ to 5 inches across are not unusual. Bulbs are hollowed on one side, and in planting, the hollowed side must be up. They do best in shady or semi-shady places. Bulbs should be started in pots or pans indoors in February or March and transplanted to the garden about the time that corn is growing well. They may also be started outdoors at the same time.

Single Frilled. Flowers beautifully frilled and fringed. In separate colors, white, scarlet, pink, or yellow.

Camellia-flowered, Double. Double flowers resembling a fine camellia. In separate colors, red, rose, white, or orange.

Any of the above, 35 cts. each, 3 for 95 cts., \$3.65 per doz., 25 for \$7.

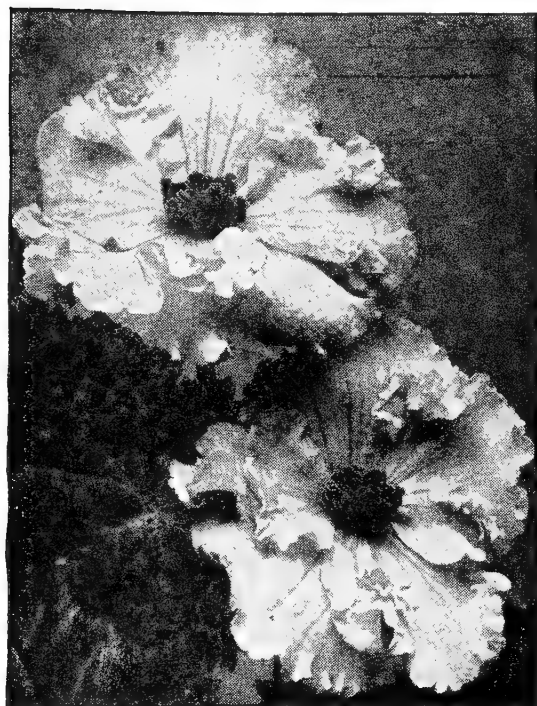

Tuberous-rooted Begonias

Anemone • Windflower

Suitable for pot or border culture and for massing. Flowers very charming and colorful.

Blue Poppy. A newer variety of a sky-blue color.

De Caen. A very large-flowered, single strain of unique beauty. All colors.

His Excellency. Rich crimson flowers from June until frost.

St. Brigid. Very large, vivid flowers of scarlet, pink, purple etc.

All Anemones, 10 cts. each, \$1 per doz.
\$7 per 100



Anemone, St. Brigid

Hyacinthus candicans

Summer Hyacinth. Tall spikes with scores of drooping, bell-shaped white flowers in midsummer. Very attractive and unusual. Handle like gladiolus.

15 cts. each, 3 for 40 cts., \$1.50 per doz.

Caladium esculentum

Elephant's Ear. Plants produce large, broad green leaves and grow from 3 to 5 feet high. Plant the bulbs late in May, after all danger from frost is past, spacing them 2 to 4 feet apart and covering them a few inches deep. Give plenty of water throughout the season; liquid manure is very beneficial. Large bulbs, 25 cts. each, 3 for 65 cts., \$2.50 per doz. Extra large bulbs, 35 cts. each, 3 for 95 cts., \$3.50 per doz.

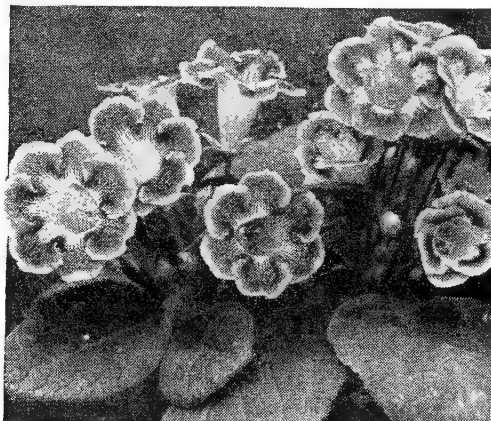

Gloxinia

Gloxinia

Beautiful velvety flowers of trumpet shape, easily grown indoors or in shaded garden spots. The large foliage is covered with plush-like hairs, and should not be wet. Keep them warm at all times.

Crimson Rose White
Mottled Violet Rose Bordered
50 cts. each, 3 for \$1.35, \$5 per doz.

Oxalis

Summer-blooming. Charming low, bushy plants for growing in pots, borders or rock-gardens, with clover-like leaves and round, cheerful flowers of various shades of pink and crimson which close at night. Continue in bloom for many weeks.
20 cts. for 15 bulbs, \$1.25 per 100.

Ranunculus

Fine, brilliantly colored, double and semi-double flowers in a range of finest colors. Excellent for cutting.

3 for 35 cts., \$1.25 per doz., \$8 per 100.

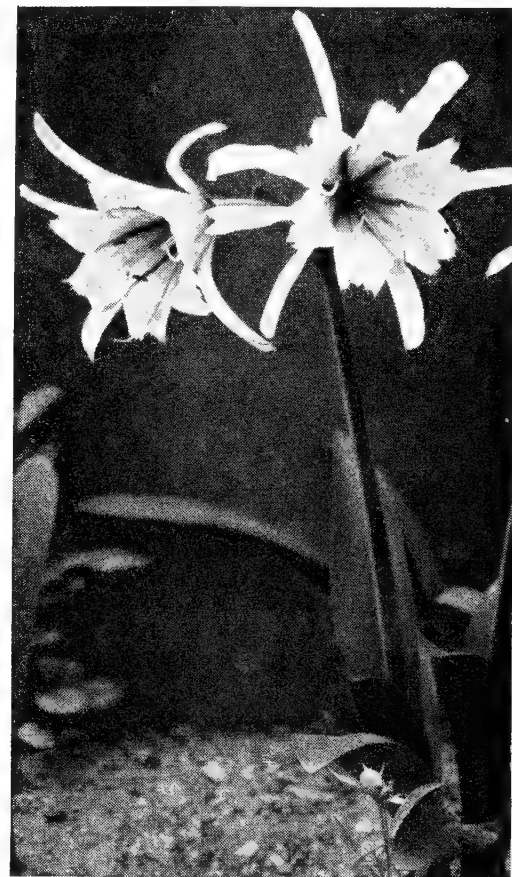

Ismene calathina

Ismene calathina

Peruvian Daffodil. Enormous, richly fragrant white flowers of the amaryllis type, curiously cupped and most attractive. Easy to grow. Plant in a warm, sunny soil.

40 cts. each, 3 for \$1.10, \$4.25 per doz.

Tuberose

Old-fashioned flowers valued for their fragrance. Start the bulbs indoors in March and transplant to the open in early May. Flowers creamy white, large, and double.

	Each	3 for	Doz.
First-Size Bulbs...	\$0 20	\$0 55	\$2 00
Mammoth Bulbs...	25	65	2 50

AGRICO Makes Gardens Grow!

Especially made for flowers and vegetables. Produces flowers of greater beauty and more and better vegetables. See page 59.

All Bulbs Sent Postpaid at Prices Quoted

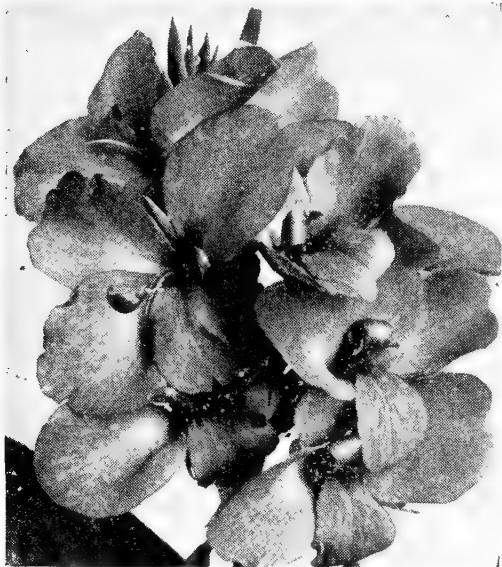

Canna

Cannas

Roots may be started indoors in pots or shallow boxes in March or April and planted out late in May. Dormant roots should not be planted outdoors until the ground warms up.

For best results beds should be dug at least 18 inches deep and generous quantities of manure well mixed with the soil.

20 cts. each, \$2 per doz., \$15 per 100

City of Portland. Clear glowing rosy pink flowers of unusually large size. Broad, rich green leaves. Wonderfully effective and the best Canna of its color. Height 3½ feet.

Eureka. The best white-flowering Canna for bedding. Height 4½ feet.

King Humbert. On account of its rich purplish bronze foliage, one of the most handsome. Flowers orange-scarlet, freely produced for a long season. Height 4½ feet.

The President. Enormous glowing scarlet flowers of wonderful substance borne erect on strong stems; luxuriant deep green foliage. Blooms continuously from midsummer until frost. Height 4 feet.

Yellow King Humbert. A large-flowered yellow variety, popular for tall beds. Flowers deep yellow, blotched with red; leaves dark green. Height 5 feet.



Lilium regale

Hardy Lilies

Showy garden flowers of the utmost beauty and stateliness, which are enormously popular just now. Plant them 6 to 8 inches deep and as early as possible in well-drained unfertilized soil, and let them alone. Spread an inch of sharp sand under each bulb to provide drainage. Cover with litter when hard frosts come.

Speciosum rubrum. Flowers white, shaded with deep rose and spotted red. Grows 3 to 4 feet tall, blooming in August and September. One of our most beautiful Lilies. \$1 each, 3 for \$2.85.

Regale (The Royal Lily). Enormous, trumpet-shaped flowers with waxen white petals suffused with gold inside and stained with purple outside; fragrant. Does well in almost any situation, growing 2 to 4 feet high and bearing its blooms in a whorl at the top. 75 cts. each, \$8 per doz.

Philippinense formosanum. A lovely easy-to-grow Lily which blooms during September and October. The slender trumpets are 5 to 6 inches long, pure white inside, greenish white with rosy stripes outside. Delicious fragrance. 60 cts. each, 3 for \$1.65, \$6.25 per doz.

Tenuifolium (Coral Lily). Small flowers of bright coral-scarlet, produced in generous quantities on 1½-foot plants in June. 35 cts. each, \$3.75 per doz.

Tigrinum splendens (Tiger Lily). Grows 4 to 6 feet tall; flowers orange-red and brown. 35 cts. each, \$3.75 per doz.

Umbellatum. Sturdy, 2-foot plants bearing umbellate heads of erect, spreading flowers of rich orange. Easy to grow. June bloom. 35 cts. each, \$3.75 per doz.

Dahlias

30 cts. each, 3 for 85 cts., \$3.25 per doz.

- Aida.** (D.) Maroon.
- Angela Mia.** (D.) White.
- Bonnie Blue.** (B.) Bluish-lilac.
- Canary Cup.** (D.) Deep yellow.
- City of Cleveland.** (D.) Large; orange, suffused red.
- Ellinor Vanderveer.** (D.) Rose-pink.
- Gertrude Brinton.** (D.) Red.
- Hillcrest Mandarin.** (D.) Red and yellow. Flashy and very large.
- Jersey's Mammoth.** (D.) Giant mahogany and gold.
- Le Toreador.** (D.) Brilliant red.
- Margaret Woodrow Wilson.** (D.) Opalescent pink. Very attractive.
- Melody.** (C.) Yellow.
- Minamoto.** (C.) Scarlet.
- Mrs. C. D. Anderson.** (B.) Crimson.
- Mrs. Carl Salbach.** (D.) Lavender-pink.
- Mrs. J. G. Cassatt.** (D.) Dark pink.
- Penn Charter.** (D.) Buff tinted apricot. A fine cut-flower.
- Pres. Franklin D. Roosevelt.** (D.) Bright red.
- Pride of Springhill.** (D.) Beautiful rose-red.
- Purity.** (D.) White.
- Red Cross.** (C.) Salmon-orange.
- Rose Glory.** (D.) Rose-lavender.
- Sanhican's Bluebird.** (D.) Bright violet-blue. A splendid variety.
- Snowdrift.** (D.) Large white.
- Starlight.** (D.) Large; golden yellow.
- The Commodore.** (D.) Canary-yellow.
- Yellow Duke.** (B.) Yellow.

In the above list, B indicates Ball or Show; C, Cactus; D, Decorative.

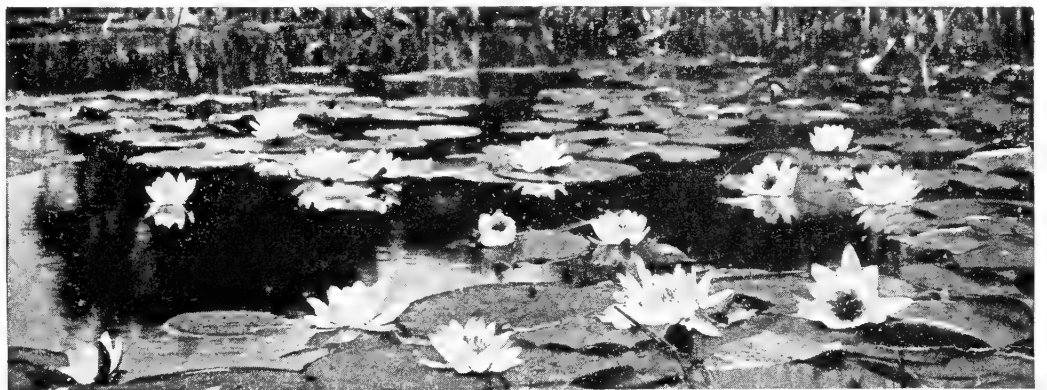

Pond and Marsh Plants

Hardy Water-Lilies require little care and may be left without disturbing for several years. A few ornamental fish in the pool add to interest and keep mosquitoes under control and a few snails will keep the water clean.

Hardy Water-Lilies

	Each ppd.
Blue Beauty. (Tropical.) Day blooming. Glorious rich blue.	\$2 75
Chromatella. Rich canary-yellow.	2 25
Comanche. Sunset shade.	3 00
Firecrest. Pink.	2 00
General Pershing. (Tropical.) Light pink.	3 00
Gladstone. Pure white; large.	2 25
Gloriosa. Red. Very free bloomer.	3 25
Mrs. George Pring. (Tropical.) White.	2 50
Panama-Pacific. (Tropical.) Day blooming. Purple.	2 50

Marsh or Bog-Plants

Anacharis. Oxygenating plant.	15 cts. each
Blue Flag.	3 for \$1
Giant Arrowhead.	3 for 75 cts.
Graceful Cattail.	3 for 75 cts.
Parrot Feather.	20 cts. each
Pickrel Rush.	35 cts. each, 3 for \$1
Primrose Creeper.	25 cts. each
Umbrella Palm.	35 cts. each, 3 for \$1
Variegated Sweet Flag.	3 for \$1
Water Hyacinth.	15 cts. each
Water Poppy.	20 cts. each
Yellow Flag.	3 for \$1

GLADIOLUS

*Few flowers are lovelier
or easier to grow*

There are few flowers to compare with the Gladiolus for all-round usefulness in the home-garden. Their graceful form, attractive colors, and characteristic markings have given them the popular name of "Garden Orchids." Plant the bulbs any time after mid-April up to the end of June, setting them about 4 inches deep and 6 inches apart. For a constant supply of flowers for cutting from August to frost, make plantings every week or ten days. Our bulbs average 1½ inches and over in diameter, which is considered the very best flowering size. Thrips are, possibly, the greatest enemy of Gladiolus and we recommend that the bulbs be treated with Semesan before planting. When the growth is about 6 inches high, begin spraying with D-X Spray and continue spraying at 10-day intervals to protect new growth.

9 cts. each, \$1 per doz., \$7 per 100, except as noted

Red Shades

Algonquin. Brilliant glowing scarlet. Tall, straight spike. Very large. 15 cts. each, \$1.65 per doz., \$12.50 per 100.

American Commander. Blood-red. Its unusual vigor and uniformity make it one of the outstanding reds. Very large. 15 cts. each, \$1.65 per doz., \$12.50 per 100.

Beacon. A beautiful light red with a large, clear blotch. Very striking. 12 cts. each, \$1.25 per doz., \$9 per 100.

Dr. F. E. Bennett. Peach-red, overlaid with flame-scarlet; throat speckled ruby and creamy white. Sturdy grower.

Dream O'Beauty. Giant American-Beauty-rose-red, with slightly deeper throat. Grows 5 feet tall. Because of its vivid coloring this variety is an especial favorite.

Excellence. Deep orange-vermilion, self color in effect with faint throat markings of slightly deeper shade. Everyone that sees this variety in bloom marvels at its gorgeous color. 12 cts. each, \$1.25 per doz., \$9 per 100.

Flaming Sword. The standard extra-early bright red. Nice tall spike and very attractive.

Kassel. Pure scarlet. Tall, strong spike. Very graceful and a favorite among all Gladiolus lovers.

Red Lory. Long, straight spike with flowers of rich orange-crimson.

Red Phipps. A glowing bright red of translucent texture. Straight spike.

Scarlet Wonder. Pure deep scarlet. Mammoth flowers, many open at a time on tall, stiff stems.

Salmon and Pink Shades

Betty Nuthall. Flower-spikes long and graceful. Warm coral-pink, with pale orange throat.

Corona. Creamy white with distinct pink edges. Large, very distinctive and beautiful. 15 cts. each, \$1.65 per doz., \$12.50 per 100.

Debonair. La-France-pink with a creamy throat touched with crimson. Fine straight spike.

Giant Nymph. Large; light salmon-rose. Considered one of the very best commercial and exhibition pinks.

SALMON AND PINK SHADES, continued

Margaret Fulton. Beautiful rich dark salmon of distinctive form. A wonderful cut-flower as well as decorative type. Early and has ability to withstand heat.

Peach Rose. Lovely rose-colored variety. Blended just enough to be classified as peach-color. Large flower.

Peggy Lou. Soft pink flowers with tall spikes and florets well placed.

Picardy. One of the best of the new Glads. The blooms are large, slightly ruffled, and a charming apricot-pink color.

Pride of Wanakah. One of the most beautiful rose-colored varieties. It is very dark rose almost light red. One of the best all-round Gladiolus.

Rose of Lima. Very tall and early show variety. Flower is lovely light rose. 12 cts. each, \$1.25 per doz., \$9 per 100.

Santa Barbara. Slightly ruffled, saffron-pink flowers turning to apricot in center; narrow line of scarlet in throat. Large spike. 12 cts. each, \$1.25 per doz., \$9 per 100.

Smiling Maestro. Large flowers of salmon-rose. Many florets open at once. 12 cts. each, \$1.25 per doz., \$9 per 100.

Sonatine. Bright clear pure pink with inconspicuous throat-marking. Very tall grower and a fine cut-flower.

Orange Shades

Bit O'Heaven. Medium-sized florets of orange with a yellow throat. Tall, straight plant opening 9 to 12 flowers. 12 cts. each, \$1.25 per doz., \$9 per 100.

Paradise. Large apricot flower. Many open at one time. Florets are well placed. Makes a splendid cut-flower variety. Tall strong spike, rich and refined. Early.

Token. One of the newer orange varieties. Tall spike. Fine for cutting.

Wasaga. Somewhat ruffled blooms of the softest apricot with a buff throat.

Yellow Shades

Gate of Heaven. Beautiful ruffled deep yellow blooms. Medium height.

Gold Dust. New deep yellow variety. Makes a long good spike. Very popular with all growers who have tried it.

Golden Dream. A very large golden yellow flower. By many growers still considered the best yellow. Straight tall spike of high quality for cut-flower as well as decorative purpose.

YELLOW SHADES, continued

Miss Bloomington. A fine variety with 6 to 8 light yellow florets open on tall plants. Very late.

Yellow Wonder. Buttercup-yellow, slightly deeper in the throat.

Blue, Lilac, and Purple Shades

Bagdad. Immense, smoky old-rose bloom somewhat darker toward the edges and lighter toward the throat.

Blue Admiral. A good rich dark blue with long spikes. One of the best varieties in its color. 15 cts. each, \$1.65 per doz., \$12.50 per 100.

Charles Dickens. Purple-violet. A very good grower and choice variety. 12 cts. each, \$1.25 per doz., \$9 per 100.

King Arthur. Lovely lavender-pink. Ruffled and fluted edges give it a distinct and beautiful appearance. 15 cts. each, \$1.65 per doz., \$12.50 per 100.

Marmora. Lavender-gray, with petunia-colored blotch. Ten to twelve very large flowers open at once.

Minuet. Beautiful clear, light lavender. The leading standard lavender for many years.

Pelegrina. Deep violet-blue with a deeper violet throat. There is a dark blue velvety sheen over all.

Purple Heart. Large, light purple with a deep purple heart. Many florets open at a time.

Vagabond Prince. The loveliest of the "smokies." Garnet-brown with a glowing scarlet spot on lower petals. Appreciated by everyone. 12 cts. each, \$1.25 per doz., \$9 per 100.

White Shades

Margaret Beaton. White with scarlet blotch. One of the most beautiful varieties in its class. Very large. 15 cts. each, \$1.65 per doz., \$12.50 per 100.

Pearl Harbor. Larger white flower. Claimed to be the best white on the market. 12 cts. each, \$1.25 per doz., \$9 per 100.

Snow Princess. Beautiful white, creamy in the throat. 15 cts. each, \$1.65 per doz., \$12.50 per 100.

SCOTT'S GARDEN MIXTURE.

This mixture of standard varieties in many beautiful colors will make an excellent showing in the garden or for cut-flowers. Large, healthy bulbs, 8 cts. each, 85 cts. per doz., \$6 per 100.

See Gladiolus Collection Offer on 3d cover.

25 Bulbs of a variety at 100 rates. Prices are postpaid.



Peonies

Peonies are among the most gorgeous plants that can be grown in a garden. Given a deep, rich soil and a sunny situation they will thrive anywhere. A mulch of manure each fall will help to maintain them. Plant the roots so that the eyes will be about

½ inch below the surface of the ground. We offer strong divisions with 3 to 5 eyes, and plenty of roots, and are larger than usually offered.

Price, 85 cts. each, \$2.35 for 3, \$9 per doz., postpaid.



Peonies

Asa Gray. Pale pink, lilac dotted. Fine cut-flower variety.

Edulis Superba. Bright old-rose to pink. Very fragrant. Blooms extra early.

E. G. Hill. Large; light red. A really lovely variety.

Felix Crousse. Flame-red. Large, bomb-shaped. Late midseason.

Festiva Maxima. White; very large, globular. Still one of the best. Early.

Fragrans. Small, dark rose-pink flowers. Very beautiful cut-flower variety. Late.

Grover Cleveland. One of the finest dark crimson sorts. Late midseason.

Gypsy. Very attractive single pink.

Karl Rosenfield. Dark crimson, very brilliant and striking in color. Blooms are of semi-rose type. Midseason.

Madame de Verneville. White with blush-white center. Strong grower and reliable bloomer. Early.

Marie Crousse. Globe-shaped blooms rather loose in form. Color pale lilac-rose. Plants tall and free blooming. Midseason.

Liberty. Beautiful dark rose-red, edged and tipped pale buff-yellow. Considered one of the best single red varieties.

Mme. Ducl. Light mauve-rose with a silvery reflex. Globe-shaped blooms, slightly fragrant. An extra-fine variety.

Mons. Jules Elie. A large flower with a high crown. Color pale lilac-rose, with an amber-yellow collar; fragrant. Early.

Princess Beatrice. Guard and crown petals violet-rose; collar creamy white with crimson flecks. An extra-good variety blooming in midseason.

Reine Hortense. Large; rose-pink. Deliciously fragrant. Midseason.

Souvenir de Louis Bigot. Vivid rose-pink, brightening to shell-pink in center. A gorgeous variety. Midseason.

Victory. Attractive single pink.

PEONIES BY COLOR. Strong-growing roots of selected varieties. Named to color, red, white, or pink. 75 cts. each, \$2.10 for 3, \$8 per doz.

VINES

BITTERSWEET (*Celastrus scandens*). Large foliage hung in autumn with clusters of orange and yellow berries which are very decorative all winter. 85 cts. each, \$2.35 for 3.

BOSTON IVY (*Ampelopsis Veitchii*). High-climbing, clinging, deciduous vine with lustrous, three-pointed leaves 2 to 4 inches across. 85 cts. each, \$2.35 for 3.

CINNAMON VINE. Vigorous climber with broad heart-shaped leaves and clusters of white, cinnamon-scented flowers. Dies to the ground each winter but comes up again very quickly in the spring. Large roots, 12 cts. each, \$1.25 per doz., \$9 per 100.

CLEMATIS Jackmani. Large, flat, 3 to 4-inch, velvety purple flowers, freely produced. \$1.35 each.

paniculata. Sweet Autumn Clematis. In August or September the plants are densely covered with fragrant white flowers, followed by seeds, each of which has a grayish, fuzzy plume which gives the plant the appearance of being in bloom until winter comes. 85 cts. each, \$2.35 for 3.

Mme. Edouard Andre. Large bright carmine-violet flowers. Unusual and distinct. \$1.50 each.

DUTCHMAN'S PIPE (*Aristolochia Siphon*). Fast-growing; 6 to 15-inch broadly reniform leaves and pipe-like flowers. \$1.50 each.

SCARLET TRUMPET VINE. Vigorous climber. Handsome, trumpet-shaped, reddish orange flowers in midsummer. 85 cts. each, \$2.35 for 3.

HONEYSUCKLE (Lonicera), Halliana. Sweetly scented flowers from July to frost. Desirable for trailing over fences, arbors, and as a ground-cover for banks. 50 cts. each, \$1.35 for 3.

KUDZU VINE. Fast-growing hardy vine. Foliage large. Rosy purple, pea-shaped flowers in August. Fine for permanently covering verandas, dead trees, etc. 85 cts. each, \$2.35 for 3.

MADEIRA VINE. Rapid-growing climber that quickly covers porch, trellis, etc. Foliage light green; flowers white, small and feathery, delightfully fragrant. Plant roots in May. Large roots, 10 cts., each, 25 cts. for 3, 75 cts. per doz.

SILVER LACE VINE (*Polygonum Auberti*). Rapid climber. Light green, waxen foliage. Stringy clusters of crystal-white flowers of irregular shape. 90 cts. each, \$2.40 for 3.

Vines, continued

TRUMPET CREEPER (*Bignonia radicans*). The Bignonias are very useful for covering unsightly places, stumps, rockwork, or for planting in crevices in ledges. Large, attractive, scarlet flowers are borne in profusion. 85 cts. each, \$2.35 for 3.

VIRGINIA CREEPER (*Ampelopsis quinquefolia*). One of the best and quickest-growing vines for covering trees, trellises, arbors, etc. The large deep green foliage turns yellow, crimson and scarlet in fall. 85 cts. each, \$2.35 for 3.

WISTERIA sinensis. Handsome, showy, pea-like pale blue flowers in large grape-like clusters. Well adapted for training on porches, arbors, trellises, or trees. They require a deep rich soil. Strong. 2-yr. grafted plants, \$1.50 each.

HEDGE PLANTS

CALIFORNIA PRIVET (*Ligustrum ovalifolium*). A rapid grower with dark green foliage that persists until early winter. May be pruned to any shape. Unpruned, it assumes an upright, spreading habit, about 10 feet tall. 12 to 18-in. plants, \$3.50 for 25, \$12 per 100, \$55 for 500.

IBOLIUM PRIVET. A hybrid of California and Iboeta Privet and is hardier than either. Fast upright grower. Dark green foliage. May be trimmed to any shape. 12 to 18-in. plants, \$4.25 for 25, \$15 per 100.

BARBERRY (*Berberis Thunbergii*). Compact-growing, much-branched low shrub with many spines. Its red berries persist until spring. 12 to 18-in. transplanted plants, \$3.75 for 10, \$17 for 50, \$32 per 100.

RED-LEAVED BARBERRY (*Berberis Thunbergii atropurpurea*). Foliage is rich crimson, becoming scarlet when the sun falls on it. 18 to 24-in. plants. 75 cts. each, \$7 for 10.

We have not listed Rose bushes because of the extreme shortage of northern-grown stock. Will issue price-list of varieties available about March 15. Mailed on request.

Prices given on vines and hedge plants are prepaid where the order amounts to \$2 or more. See page 92

HARDY FLOWERING SHRUBS

Flowering Shrubs bring the greatest return on investment that one can put into the home-grounds. They thrive with but little care, are attractive even in winter when the branches are without foliage, and when they do burst into bloom transform the grounds into bowers of scented beauty. In addition to their lovely flowers many shrubs develop attractive fruit which lasts well into the winter.

We offer a fine list for planting this spring.

ABELIA grandiflora. The Bush Arbutus is a medium-sized shrub with lovely glossy foliage and tubular flowers of pinkish white. Graceful when grown naturally and can be sheared to any height. Makes a grand hedge. \$3 each.

ALTHÆA. Rose of Sharon. A very useful shrub with large, single or double flowers in great profusion in late summer, a time when flowering shrubs are scarce.

Pink, Purple, Red, White, or Variegated. 2 to 3 ft., 75 cts. each, \$2 for 3.

ALMOND, Flowering (*Amygdalus*). Double fragrant flowers in May. **Pink or White.** 2 to 3 ft., \$1.25 each, \$3.35 for 3.

ARONIA arbutifolia brilliantissima. The Crimson Chokeberry has bright red berries and crimson leaves in fall. Grows 10 to 12 feet. 1½ to 2 ft., \$1 each.

melanocarpa. The Black Chokeberry grows slightly lower and bears glossy black berries. 2 to 3 ft., \$1 each.

AZALEAS. These hardy Azaleas bloom with the utmost freedom, becoming solid masses of flowers at their season, and continuing in splendor for several weeks. Plant in slight shade and shelter from severe winter.

Amœna. Brilliant reddish purple flowers completely cover every twig. Very showy. Evergreen. B&B. \$5 each.

Hinodegiri. A sparkling red variation of Amœna, with no trace of the purple. Evergreen. B&B. \$5 each.

mollis. A dwarf, very bushy, deciduous variety. Flowers light yellow to apricot and deep orange. B&B. \$4 each.



Beauty Bush

BEAUTY BUSH. An exceedingly handsome ornamental shrub. The foliage and habit are attractive when the bush is out of flower and it is perfectly hardy. It grows 6 to 9 feet high when mature, with long, arching branches. Covered in spring with clusters of small, tubular flowers of the honeysuckle type, borne in such profusion that the bush is one cloud of delicate pink. 2 to 3 ft., \$1.25 each.

BUDDLEIA, Ile de France. A new variety with fragrant, rosy purple flowers suffused with violet, borne in spikes 6 to 9 inches long. The symmetrical bushes are 3 to 4 feet high. 85 cts. each, \$2.35 for 3.

CALYCANTHUS floridus. Sweet Shrub. This is the popular old-fashioned "Strawberry Shrub," with brown, slightly scented, starry flowers, followed by pods of smooth brown seeds. 2 to 3 ft., 90 cts. each.

COTONEASTER divaricata. The Spreading Cotoneaster will grow to 6 feet and as wide. Pink flowers are followed by red fruit and foliage turns red in fall. 15 to 18 in., B&B. \$2.50 each.

DEUTZIA, Pride of Rochester. A very popular blush-white form, growing taller and bushier than *D. gracilis*. 2 to 3 ft., 90 cts. each, \$2.40 for 3.

gracilis. A small shrub covered with pure white flowers in graceful nodding racemes. Good for edging borders. 15 to 18 in., 75 cts. each, \$2 for 3.

DOGWOOD (*Cornus sanguinea*). Blood-twigged Dogwood. An upright shrub having bright coral-red branches with dark green leaves, pale beneath, and creamy white flowers in numerous flat-topped clusters, followed by bluish fruits. 2 to 3 ft., 85 cts. each, \$2.35 for 3.

florida. The well-known White-flowering Dogwood. Big, spreading shrub or small tree with large white flowers in spring. Foliage scarlet in autumn. Rich red berries. B&B. \$3 each.

florida rubra. One of the loveliest flowering trees. Blooms glowing peach-blossom-pink, tinged darker. A specimen in full bloom is a magnificent spectacle. 3 to 4 ft., B&B. \$4 each.

EUONYMUS alatus. Winged Burning Bush. Bushy shrub with corky winged branches. A fine shrub for specimen planting. Leaves turn to rich red and crimson in autumn. 2 to 3 ft., \$1.50 each.

europæus. A strong-growing shrub or small tree with finely toothed foliage and pink fruit. 2 to 3 ft., 90 cts. each.

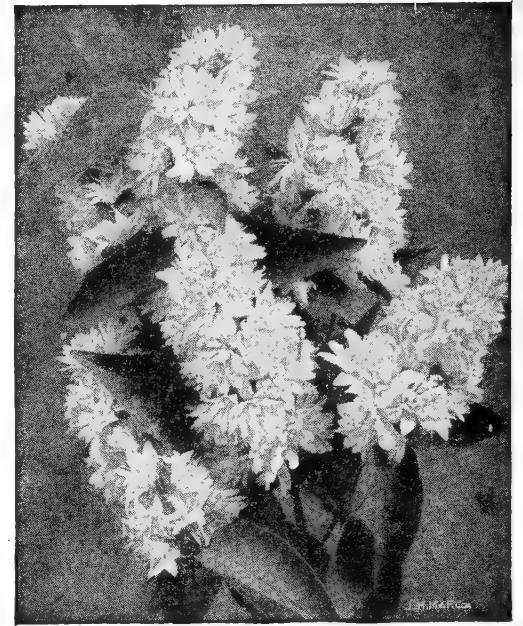

Deutzia gracilis

ELÆAGNUS argentea. Silverberry. Fragrant flowers and attractive foliage, silvery on both sides, on a 10-foot shrub. 2 to 3 ft., \$1.25 each.

FORSYTHIA. One of the very earliest shrubs to bloom and unsurpassed in splendor and brilliancy by other spring-flowering varieties.

spectabilis. Sturdy, erect bush with an unbelievable abundance of golden yellow flowers a shade or two darker yellow than any other variety. 2 to 3 ft., 85 cts. each, \$2.35 for 3.

suspensa Fortunei. A tall, willowy shrub literally covered with golden bells in early spring. 85 cts. each, \$2.35 for 3.

HONEYSUCKLE, Red Tatarian (*Lonicera tatarica sibirica*). A bushy shrub, reaching 10 feet, with crimson flowers in June, followed by red fruits. 2 to 3 ft., 85 cts. each, \$2.35 for 3.

White Tatarian (*L. tatarica alba*). About the same as the above except that the flowers are white. 2 to 3 ft., 85 cts. each, \$2.35 for 3.

HYDRANGEA, Nikko. Blue Hydrangea. One of the most showy of all plants. When planted in moist soil, flowers may assume a pinkish hue, but blue flowers may be assured by mixing alum with the soil. 1½ to 2 ft., B&B. \$2 each.

paniculata grandiflora. Big conical trusses of white flowers that soon assume rose and bronze tones, are borne in late summer and last till frost. Severe pruning in early spring brings big trusses of bloom. 18 to 24 in., 85 cts. each, \$2.35 for 3. 2 to 3 ft., \$1 each, \$2.75 for 3.

INDIAN CURRANT (*Symphoricarpos vulgaris*). Tall, slender shrub, with coral-red fruits. 2 to 3 ft., 75 cts. each, \$2 for 3.

JAPAN QUINCE (*Cydonia japonica*). Often called "Fire Bush." Scarlet and vivid pink flowers. Very early. 1½ to 2 ft., 85 cts. each, \$2.35 for 3.

Prices on Shrubs and Trees are prepaid where the order amounts to \$2 or more. See page 92

KERRIA japonica. From June to October this shrub is a golden yellow bouquet, 3 to 4 feet high. Smooth green bark. 1½ to 2 ft., \$1 each.

LILAC (*Syringa*).

Persica. Persian Lilac. Lavender-blue flowers in loose panicles. Delightfully different. 2 to 3 ft., \$1.25 each.

Vulgaris. The fragrant old Lilac found blooming in May in old gardens.

Purple. 2 to 3 ft., 90 cts. each.

White. 2 to 3 ft., \$1.25 each.

Lilac, Named French Varieties:

Belle de Nancy. Double flowers of satiny rose in long clusters.

Ludwig Spaeth. Deep reddish purple flowers in long clusters. Very unusual.

Mme. Lemoine. Narrow clusters of double flowers of purest white.

President Grevy. Double, rosy blue flowers in pyramidal clusters.

Above 4 Lilacs, Bush Form, \$1.50 each

MOCK ORANGE, Virginal (*Philadelphus virginialis*). A vigorous, tall grower, with very large, double-crested, pure white, sweetly scented flowers. A decided improvement over the old-fashioned Mock Orange. 2 to 3 ft., \$1 each; 3 to 4 ft., \$1.25 each.

PUSSY WILLOW. Furry catkins so popular in early spring for table decoration. 3 to 4 ft., \$1 each.

RHAMNUS Frangula. Glossy Buckthorn. Large shrub with glossy leaves and red fruit eventually turning black. 2 to 3 ft., 90 cts. each.

RHODOTYPOS kerrioides. White Kerria. Very ornamental, medium-sized shrub with pretty foliage and large, single white flowers in late May. Black berries. 2 to 3 ft., 90 cts. each.

SNOWBALL (*Viburnum opulus sterile*). The old-fashioned Snowball. White flowers in May and June. Very decorative. 1½ to 2 ft., 90 cts. each.

Oriental (*V. tomentosum plicatum*). Large, globular, pure white flowers in May and June. The fall foliage is especially fine. 2 to 3 ft., \$1.25 each.

SNOWBERRY (*Symphoricarpos racemosus*). Small, rose-colored flowers in June and July followed by large clusters of pearly white fruit which endure into the winter. 2 to 3 ft., 85 cts. each, \$2.35 for 3.



Mock Orange, Virginal

SPIRÆA, Anthony Waterer. Bright rosy crimson flowers in dense corymbs produced abundantly from July till frost. Fine for facing plantings of larger shrubs or edging walks. 1 to 1½ ft., 75 cts. each, \$2 for 3.

Van Houttei. The arching branches bend to the ground under many corymbs of small white flowers. 2 to 3 ft., 75 cts. each, \$2 for 3.

STEPHANANDRA flexuosa. A graceful shrub seldom more than a few feet high. An excellent plant for growing in the shade of other shrubs or trees. 2 to 3 ft., 85 cts. each, \$2.35 for 3.

TAMARIX africana. A very distinct variety covered with sprays of delicate soft pink flowers during July and August, when few other shrubs are blooming. 2 to 3 ft., 90 cts. each.

VIBURNUM acerifolium. Shrub, attaining 5 feet, with slender, upright branches. Flowers yellowish white; fruit almost black. Grows well under trees. Foliage dark purple in autumn. 2 to 3 ft., \$1.25 each.

americanum. Cymes of white flowers in May and June followed by brilliant scarlet fruit. Grows to 10 feet. \$1 each.

Carlesi. Fragrant Viburnum. Clusters of fragrant pink flowers appear in May. Plant grows to about 6 feet high. 1½ to 2 ft., B&B. \$3 each.

Opulus. High-Bush Cranberry. Maple-like foliage and large heads of white flowers in May or June followed by scarlet berries. 2 to 3 ft., 90 cts. each.

WEIGELA, Abel Carriere. Brilliant deep pink. Blooms in May and June and again in the fall. Dark green foliage. 2 to 3 ft., \$1.25 each.

Eva Rathke. An upright shrub 5 to 6 feet high, covered in late May with an abundance of rich reddish purple, trumpet-shaped flowers. 2 to 3 ft., \$1.25 each.

floribunda. A tall, graceful shrub bearing lovely dark crimson flowers. 2 to 3 ft., 90 cts. each.

Hendersoni. Very large flowers of pink and white. A vigorous, tall-growing, nicely shaped bush. 2 to 3 ft., 90 cts. each, \$2.45 for 3.

WINTERBERRY (*Ilex verticillata*). Brilliant berries in great profusion. Especially attractive after the foliage drops. 1½ to 2 ft., \$1.25 each.

Ornamental and Shade Trees

CATALPA Bungei. Umbrella-shaped trees on straight trunks. Heart-shaped leaves. Good for formal effects. 5 to 6 ft., \$3 each.

CHERRY, Flowering. Spring-flowering, bearing a profusion of blossoms of exquisite effect. Very popular.

James H. Veitch. Double; pink.

Kwanzan. Double; dark pink.

Mt. Fuji. Double; pure white.

All Flowering Cherries, 3 to 4 ft., \$2.50 each



Flowering Cherry Blossoms

CHERRY, Weeping. Round-headed tree with drooping branches; resembles an open umbrella. 2-yr. heads, 5 to 6-ft. stem, \$4.50 each.

CRAB, Bechtel's Double-flowering (*Malus*). Delicate pink blossoms in the spring and handsome fruits in the fall, which are attractive to the birds. 3 to 4 ft., \$2 each.

ELM, Chinese. A quick-growing Elm of pleasing form and apparent freedom from blight. 8 to 10 ft., \$3.50 each.

Vase. A type developed from the American Elm. Largely used for street planting and the home-grounds. 8 to 10 ft., \$3.50 each.

JUDAS TREE (*Cercis canadensis*). The American Redbud is a fine small tree with masses of rosy pink flowers before the foliage. 3 to 4 ft., \$1.50 each.

MAGNOLIA Soulangeana. Immense saucer-shaped flowers, purplish pink on the outside and white inside. 2 to 3 ft., B&B. \$5 each.

MAPLE, Norway. 8 to 10 ft. \$4 each.

Silver. Noble 80-foot shade tree with dense branches and beautiful pointed foliage silvery on the under side. 8 to 10 ft., \$2.75 each.

MOUNTAIN-ASH. 8 to 10 ft., \$3.50 each.

PLUM, Red-Leaf (*Prunus, Newport*). This little tree has deep purple leaves which retain their color until fall. In the spring it is covered with fine deep pink flowers. 4 to 5 ft., \$1.50 each.

POPLAR, Bolleana. A columnar tree with foliage silvery gray underneath. 6 to 8 ft., \$2 each.

Lombardy. Slender, erect trees, planted for landscape effect and screens. 8 to 10 ft., \$1.50 each.

SYCAMORE or PLANE, European (*Platanus orientalis*). Useful for street and specimen planting. Bright green foliage. 8 to 10 ft., \$3.50 each.

WILLOW (*Salix babylonica*). The Weeping Willow is our most graceful tree for moist ground, especially fine near a pool or brook. 8 to 10 ft., \$3 each.

FRUIT TREES . . .

Even the smallest garden can find room for one Fruit Tree to furnish shade as well as delicious fruit. We offer a selected list of Fruits which will not disappoint you. All Fruit Trees offered are No. 1 grade, two-year-old budded trees. Prices given are prepaid when the order amounts to \$2 or more. See page 92.

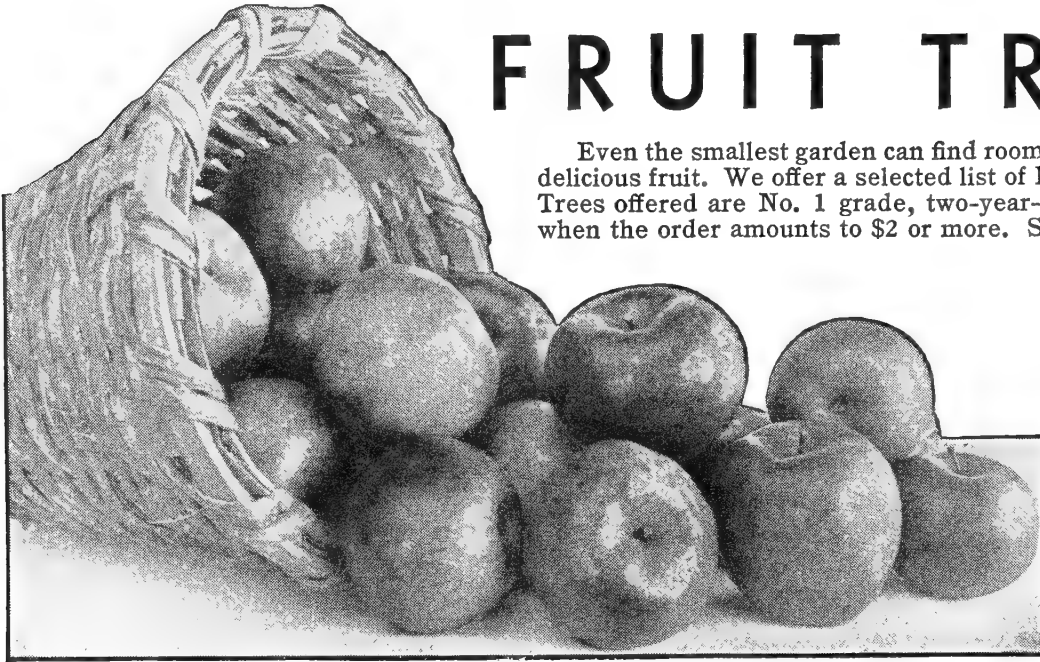

Baldwin Apples

Apples

\$1.75 each, \$16.50 for 10

- Baldwin.** Best all-round winter Apple.
Jonathan. Bright solid red; firm and crisp. Good keeper.
McIntosh. Beautiful red; flesh crisp and spicy. Ripens in September.
Northern Spy. Large, red winter Apple; crisp and juicy.
Red Astrachan. Best summer eating and cooking Apple.
Red Delicious. A splendid winter eating Apple.
Rome Beauty. Large round winter sort. Good late keeper.
Stayman Winesap. Large, dark red; desirable cooking and eating winter variety.
Wealthy. Red streaked with white. Heavy yielder and of good quality. Early fall.
Yellow Transparent. Earliest ripening Apple. Excellent for cooking and eating.
Hyslop Crab. Fruit dark red. The best Crabapple variety.

Plums

\$2.25 each, \$21.50 for 10

- Bradshaw.** Very large; skin dark violet-red; yellowish green, juicy flesh. Early August.
German Prune. Medium dark blue; rich flavor. September.
Italian Prune (Fellenberg). Medium size, dark purple, juicy and delicious. Fine for canning.
Lombard. Skin reddish; flesh yellow, juicy and delicious.
Shropshire Damson. Dark purple and very productive. Fine for butter. Late September.
Stanley Prune. Dark blue skin; flesh golden yellow and of mild sweet flavor. Excellent for eating or canning.

Pears

\$2.25 each, \$21.50 for 10

- Bartlett.** Large, yellow with red cheek, tender, juicy and delicious. Very popular.
Clapp's Favorite. Large, yellow with dull red skin; delicate flavor. August.
Kieffer. Rich golden yellow. Good keeper. Late fall.
Seckel. Juicy and of rich flavor. September.

Sweet Cherries

\$2.50 each, \$24 for 10

- Black Tartarian.** Very large; purplish black. Very popular. Late June.
Governor Wood. Large; russet-yellow, juicy and delicious. June.
Napoleon. Yellow with bright red cheeks; flesh firm, juicy and sweet. Late June.
Windsor. Large, liver-colored; flesh firm and juicy; very prolific. Early July.

Sour Cherries

\$2.25 each, \$21.50 for 10

- Early Richmond.** Fruit medium size, round, bright red; good for pies. Early June.
Montmorency. Best and largest Sour Cherry. Fruit dark red, firm and of fine flavor. Late June.

Peaches

\$1.35 each, \$12.50 for 10

- Champion.** Good white variety. August. Freestone.
Crawford Late. Fruits large, yellow and of fine flavor. Late September.
Elberta. The standard yellow. Fruits yellow with red cheek; flesh yellow, firm, juicy and of high quality. Early September.
Golden Jubilee. An excellent variety for the home orchard. Fruit large, yellow; flesh golden yellow, juicy, tender and sweet. Early August.
Hale-Haven. Fruits large, beautiful yellow, and of good flavor. Very hardy and a heavy bearer. Late August.
South Haven. Fruits large, yellow with red blush, juicy and deliciously sweet. Late August.

- APRICOT, Hungaria.** Fruit large, good quality, with yellow flesh of very fine flavor. \$2.50 each.

Quince

\$2.50 each

- Orange.** A mighty fine-quality variety and extremely popular.



Elberta Peaches

STRAWBERRY PLANTS

Everybody loves Strawberries and they are never as good as when freshly picked in your own garden. By all means have a Strawberry-patch if you have room.

Strawberries are easy to grow in any good well-drained soil.

Set the plants as early in the spring as the ground can be prepared. If the ground has not been recently manured, mix a little bone-meal in the soil under each plant when planting or top dress around the plants with a fertilizer high in phosphorus and potash just as soon as the plants start to grow. Keep the plants cultivated and free of grass.

Our plants are "New-ground plants" from a famous plant-growing district and being strong and well-developed will go right to work. The varieties we offer were selected as the best in their class and we know they are dependable and profitable.

In general, plants are set in rows 3½ to 4 feet apart and 1½ feet apart in the row. In home-gardens or where space is limited, the rows can be 2½ feet apart. Set the plants with the bud just at the surface of the ground. Strawberry plants should be set early in the spring so they can become established while the soil is still cool and moist. Frequent cultivation will produce a better crop of berries.

Extra-Early

Premier. It is the earliest of all Strawberries, has a long fruiting season, and bears unusually large crops of bright, glossy, firm, red berries above the average in size. Excellent shipper.

Fairfax. Large, sweet, richly flavored dark red berries. Vigorous grower and disease-resistant. Not quite so productive as Dorsett but berries are larger and of better quality.

Dorsett. A vigorous plant-maker with bright red berries of wonderfully high flavor. Excellent for table and home use. A very dependable all-round variety.

Robinson. Berries of fine flavor, glossy red, firm and large. For home use its quality and flavor are unsurpassed. A strong vigorous grower and heavy yielder.

Second-Early

Senator Dunlap. For many years has been grown as the main-crop berry. A very heavy bearer of good-sized, uniformly shaped berries of a dark red color. Splendid for canning as it holds its shape, rich color and flavor long after canning.

Medium Late

Catskill. By far the best new midseason berry that has been introduced recently. Fruit is extra large and the plant is a heavy bearer and vigorous grower. Can be depended on for good crops and the quality is excellent.

Everbearing

Mastodon. Very productive; unusually large size; brilliant, attractive color; and excellent shipping qualities. Produces fruit ninety days from planting. Pick the first crop from July to killing frosts; the second crop the following June; and the third crop from August to killing frosts in late autumn.

Minnesota 1166. The large berries are rich solid dark red, with a rich, sweet flavor. Ripens from July to November. A few plants in the garden will keep you supplied.

PRICES

	Per 25	Per 50	Per 100	Per 250	Per 500
Premier	\$1 40	\$2 35	\$3 50	\$6 50	\$11 50
Fairfax	1 40	2 35	3 50	6 50	11 50
Dorsett	1 40	2 35	3 50	6 50	11 50
Robinson	1 40	2 35	3 65	7 00	12 00
Senator Dunlap	1 10	1 80	2 80	5 50	9 00
Catskill	1 40	2 35	3 65	7 00	12 00
Mastodon	2 35	4 00	6 50	12 00	23 00
Minnesota 1166	2 50	4 25	6 90	12 00	24 00

All orders shipped direct from nursery to customer at proper time for planting. Prices given are postpaid.

Mastodon Strawberries

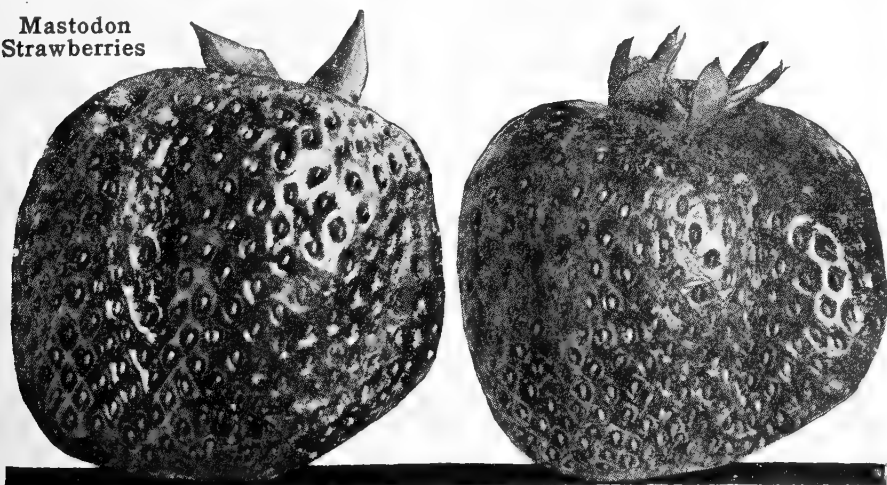

CURRENTS

2-yr. plants, 75 cts. each, \$7 for 10

Fay's Prolific. Medium to long clusters of dark red, juicy fruits.

Perfection. Large, bright red fruits; big clusters.

Wilder. Medium-sized, mildly acid red berries in large clusters.

GRAPES

2-yr. plants, 60 cts. each, \$5.75 for 10, unless noted

Brighton. Big red berries of excellent flavor; productive and vigorous.

Catawba. Luscious dark red berries; late ripening and keeps well.

Concord. The standard Grape. Rich, sweet juicy fruits. 50 cts. each, \$4.75 for 10.

Delaware. Red, sweet and delicious.

Moore's Early. Like Concord, but two weeks earlier.

Niagara. An extra fine, sweet, white Grape.

Worden. Large bunches of big, black berries of high quality. Earlier than Concord.

GOOSEBERRIES

2-yr. plants, 85 cts. each, \$8 for 10

Downing. Whitish green. The most widely planted and highly prized sort.

Red Jacket. Large reddish green fruits.

BOYSENBERRY

Delicious berries 1½ to 2 inches long and 1 inch in diameter of dark reddish purple. Exceptionally good for home-gardens, being unbeaten for jellies, jams and pies. Thornless. 2-yr., Bearing age, 3 for \$1.75, doz. \$5, postpaid.

RED RASPBERRIES

Chief. The best early red. Heavy yielder.

Latham. Best late sort. Very productive.

BLACK RASPBERRY

Cumberland. Berries large, with delicious flavor.

BLACKBERRY

Eldorado. Of best quality and always dependable.

Raspberries	Per 12	Per 25	Per 50	Per 100
Chief	\$2 10	\$3 40	\$5 80	\$9 00
Latham	2 10	3 40	5 80	9 00
Cumberland	1 75	2 75	4 50	6 50

Blackberry
Eldorado 1 75 2 75 4 50 6 50

One-year No. 1 plants. Prices given are postpaid.

All orders shipped direct from nursery to customer.



Concord Grapes

SCOTT'S

Farm Seeds

*For increased yields inoculate
Clover and Alfalfa with Legume Aid.
See page 66.*

Good pasturage increases milk production and produces more beef

For over 70 years it has been our policy to supply the very best of everything we sell, and farm seeds are no exception. Not only is every lot of seed offered selected for purity, freedom from weed seed, and high germination but the origin is also considered. This is very important with many kinds of seed, particularly the Clovers and Alfalfa. When estimating your seed requirements, consider your crops and decide that you want the very best—and with this in mind you will order Scott's Seeds. Remember we promise to furnish plump, clean, healthy seeds that you can depend upon for hardiness, vitality, and stamina—seeds that have made money for successful farmers for more than 70 years.

CLOVERS

MEDIUM RED. Most popular Clover for short rotations. When grown with timothy it usually makes two good hay crops. Plants grow 2 feet or more in height. Sow seed in late winter on winter grains or on a firm seed-bed with spring grain. Sow 8 to 10 pounds with timothy, or 15 to 18 pounds alone.

MAMMOTH RED. Also called Sapling Clover. This Clover cuts a heavier first crop of hay, does better on poorer, drier soils, and is more persistent than Medium Red. Valuable for the grower who needs maximum organic matter to plow down.

ALSIKE. A favorite with timothy on acid soils, thin soils, and for wet sites. It may be sown in spring or late summer and is perfectly hardy. Flowers are sweet-scented and attractive to bees, are larger and more pink than White Clover. Adapted only to short rotations. Sow 8 to 10 pounds to the acre alone, or 3 to 6 pounds in mixtures.

SWEET CLOVER. The biennial form is most popular for soil improvements, pasture, or hay. It does best on sweet (neutral) soils and will grow luxuriantly on land too poor for Red Clover or alfalfa. It reseeds itself the year after sowing if not cut. Annual forms of this legume do not do well this far north. Seed should be inoculated. Sow 10 to 20 pounds to the acre, the heavier rate if seeded alone.

CRIMSON. Popular in southern part of region for green-manure crop and soil improvement. Often sown in corn at last cultivation for winter cover-crop. For hay, plants should be cut in pre-bloom stage. Seed 20 pounds to the acre any time after April 1. Plants are annual, requiring reseeding each year.

LADINO. A giant form of White Clover with heavy stems which hug the ground and take root at the nodes (joints). Very popular, nutritious, and high-yielding when properly used as pasture for poultry, dairy cattle, beef, sheep, and hogs. A favorite as a cover-crop in sod orchards. Requires fertile soil and good management. Generally sown with other pasture grasses at the rate of 2 pounds per acre.

WHITE DUTCH. A small, low-growing White Clover used principally in lawn and pasture mixtures. Less productive than Ladino for hay and pasture. Succeeds in nearly all types of soil and is quite persistent. Use 3 to 5 pounds to the acre in mixtures.

WILD WHITE. A dwarf variety of White Clover, hardy and excellent for permanent pasture. Handle like White Clover.

ALFALFA

Alfalfa is of importance as a forage crop because of its high nutritive value, its palatability, productiveness, drought resistance, and long liveability. There is no other forage crop that will produce such an abundance of high-class protein feed. For all classes of livestock it is considered the best hay obtainable. It requires a well-drained neutral or alkaline soil and high fertility. If lime is needed, it should be applied before the seed is sown. Alfalfa is used alone and in mixtures with other grasses. It is usually seeded in the spring with fall- or spring-sown grains, but in some sections late summer seedings are popular. It will provide two or three cuttings of hay in a season, and also makes excellent pasture for all kind of livestock. Seed should be inoculated. From 12 to 15 pounds of seed are usually sown to the acre when grown alone; half this quantity in mixtures. We can furnish Northwestern Common and Grimm.

Northwestern Common. Grown successfully and entirely satisfactorily in this area.

Grimm. Generally considered longer-lived and better adapted to severe winter weather.

PERMANENT PASTURE MIXTURE

A well-balanced pasture-producing mixture made up of the very highest grades of re-cleaned grass and clover seeds, which will produce an abundant and nutritious food-supply for all kinds of stock. The land should be plowed in the fall, left rough over winter, and prepared in the spring, making the seed-beds as fine as possible by repeated harrowing. Sow 40 pounds to the acre. 5 lbs. \$3.75, 10 lbs. \$6.75, 25 lbs. \$16.25, 50 lbs. \$31, 100 lbs. \$60.

Cyclone Seed Sower

This Seed Sower can be used for sowing clover, timothy, lawn grass seed, and all other seeds that can be sown broadcast. Has positive force-feed and is quickly adjusted for different seeds. The touch of a lever will start or stop the flow of seed. Seed cannot clog or rush. Container is made of heavy canvas ducking and holds about ½ bushel. Price, \$3.40, post-paid.



LATEST PRICE-LIST OF FARM SEEDS GLADLY SENT ON REQUEST

TIMOTHY

Description of this old familiar hay-making grass is unnecessary here. Its feeding value is not quite equal to red clover or alfalfa, but it fits in well with almost any crop-rotation program and for this reason is probably the most extensively grown of all the grasses. It can be sown in the spring or fall and may be sown alone or with alfalfa, red clover, alsike clover, or with other grasses. If sown alone, 12 to 15 pounds are usually sown to the acre; with other grasses 3 to 6 pounds to the acre.

KENTUCKY BLUEGRASS. One of the best-known perennial grasses for permanent pasture. Requires rich soil and stands heavy close grazing. It starts early and furnishes grazing well into the fall but tends to be "dormant" during dry hot summer weather. Add 6 to 8 pounds to the acre to mixture of clovers and other grasses.

RED TOP. This grass is well adapted to soils that are inclined to be wet or acid. It is not so palatable as Kentucky Bluegrass nor is it so permanent. Alsike or Ladino clover do well with Red Top. Under fertile soil conditions Red Top will be replaced by heavier grasses. Use 2 to 4 pounds to the acre in mixtures.

PERENNIAL RYE GRASS. This grass is a very rapid grower. It will produce pasture in six to eight weeks, and will last several years. It is well adapted to fertile moist soils and stands close grazing but should be seeded only in mixtures. Use 4 to 6 pounds to the acre in mixtures.

DOMESTIC RYE GRASS. A quick-growing grass that is valuable for pasture and relished by all livestock. For a winter cover-crop seed can be sown at the last cultivation of corn or after the harvest of an early crop. Makes good late fall pasture when used as cover-crop in corn. Broadcast seed at the rate of 20 to 25 pounds per acre.

ORCHARD GRASS. This is a long-lived bunch-type grass which produces maximum summer grazing. Does best in combination with long-lived legumes like Ladino clover and alfalfa. It makes good hay if cut in pre-bloom stage and makes heavy yields of silage. Use 4 to 6 pounds to the acre in mixtures; 12 to 14 pounds when seeded alone.

SUDAN GRASS. A high-yielding, quick-growing annual grass most valuable for summer pasture, but will make good hay when sown with soy beans and cut when soy beans are well formed. It can be pastured when 15 to 18 inches tall and it is very drought-tolerant. Grows to a height of 5 to 9 feet. Sow 35 pounds to the acre broadcast; 25 pounds drilled.

MILLET. A quick-growing annual generally used for an emergency hay crop or pasture. For hay it should be cut while the plants are in bloom. Sow in May or early June at the rate of 30 to 40 pounds of seed to the acre.

DWARF ESSEX RAPE. Furnishes quick and inexpensive pasture for hogs and sheep. Sow 10 pounds of seed to the acre if sown broadcast; 5 pounds if drilled.

LESPEDEZA. Popular in southern states for hay, pasture, and seed. Annual types persist only through natural reseeding.

SORGHUM or AMBER CANE. Used principally as a summer fodder for cattle. Growth is rapid. If carefully cured it will make an excellent dry fodder. May be sown in drills about 30 inches apart, at the rate of 5 to 6 pounds of seed for an acre. If sown broadcast, about 75 pounds of seed are generally used.

COWPEAS. Grown mainly for green manure but makes good pasture or hay. Sow in May or June. Use 1 to 1½ bushels of seed to the acre when sown broadcast.

CANADA FIELD PEAS. Used for hay and pasture as well as soil improvement. Sow as early as possible in the spring, either alone or with oats. When sown broadcast alone, sow 2 bushels to the acre, or with oats 1½ bushels of Peas and 1 bushel of oats.

WINTER or HAIRY VETCH. One of the best legumes and largely used in this section for soil-improvement. Because of the great length of Vetch plants, it is best to furnish a support for the plants by sowing rye, barley, or oats with it. When drilled use 1 bushel of grain and 20 to 30 pounds of Vetch to the acre.

FARM SEEDS



Vicland Oats



Sudan Grass

Harvesting Alfalfa



FIELD CORN

10 to 14 pounds of Seed Corn required to seed an acre

HYBRID KINDS

The acreage planted to Hybrid Corn in recent years proves conclusively that the hybrids are far more satisfactory than the open-pollinated varieties. They have more vigor, produce larger yields, and are more drought and storm-resistant than open-pollinated varieties.

The hybrids we offer have been selected from a large group for their outstanding performances and superiority over other varieties, and in our opinion are the best adapted to this section.

If you have not been growing any of the hybrids, we recommend that you try at least one of them this year.

OHIO W17. Well adapted to this section, and a heavy yielder. Stalks are leafy and of medium height, ear about 8 inches in length, and kernel light yellow in color. Maturity 100 to 105 days. A very popular hybrid with many farmers.

IOWA 939. Adapted to a wide range of conditions and probably the best-known hybrid. Has stiff stalk, medium in height; ears have 16 rows with somewhat rough, soft, rich yellow kernels. Maturity 100 to 105 days.

OHIO K23. An early hybrid adaptable for use in the better soils. Stalks are short, deep green, and leafy; ears are medium in size, with 16 to 18 rows. Maturity 90 to 95 days.

OHIO K24. A high-yielding hybrid. Stalks of medium height, leafy and dark green; ears of medium length with 14 to 16 rows. Maturity 95 to 100 days.



Iowa 939 Hybrid
Field Corn

OPEN-POLLINATED VARIETIES

For the farmer who prefers the open-pollinated varieties, we offer the following. All are selected with the utmost care. They are carefully cleaned and graded, of high germination, and of the best possible quality.

SCOTT'S SURE-CROP. The tremendous quantity of shelled Corn this variety produces to the acre surprises everyone who grows it. Ears are medium long, cob thin, kernels long and of a rich, deep yellow.

GOLDEN SURPRISE. Ears are good size, with 14 to 18 rows of long, light orange kernels. Matures in 90 to 95 days. An excellent Corn for the crib.

PRIDE OF THE NORTH. Ears 8 to 10 inches long, with 16 rows on the ear. Cob small, grain above medium size and closely set. One of the hardiest. Matures in 90 days.

IMPROVED LEAMING. Produces a good-sized ear with deep, broad grains. Matures in 105 days.

WHITE-CAP YELLOW DENT. Particularly suited for light soil. Ears about 10 inches long, well filled, with 16 or 18 rows; grain is yellow with white tip. Ripens in about 115 days.

All of our Seed Corn is selected with the utmost care. The ears are carefully hand-selected before they are shelled and the grain is carefully graded on the most modern grading equipment. It is thoroughly dried, of high germination, and of the best possible quality.

ENSILAGE CORN

LANCASTER COUNTY SURE-CROP. The leading ensilage variety. Ears are long, with yellow grains, and not proportionately thick. Stalks are quite tall and very leafy. An extremely heavy yielder and a most desirable ensilage variety.

EUREKA. Produces unusually heavy foliage and often grows 16 to 18 feet tall. Ears are very long; grain is large, broad, and ivory-white.

U.S. 13 HYBRID. One of the highest yielding of all hybrid varieties for both grain and silage. The stalks are medium tall and lodge-resistant; ears medium long, with 20 to 22 rows of deep grains. Matures in 110 to 115 days.

Treat Seed Corn with Semesan Jr.

See page 66.

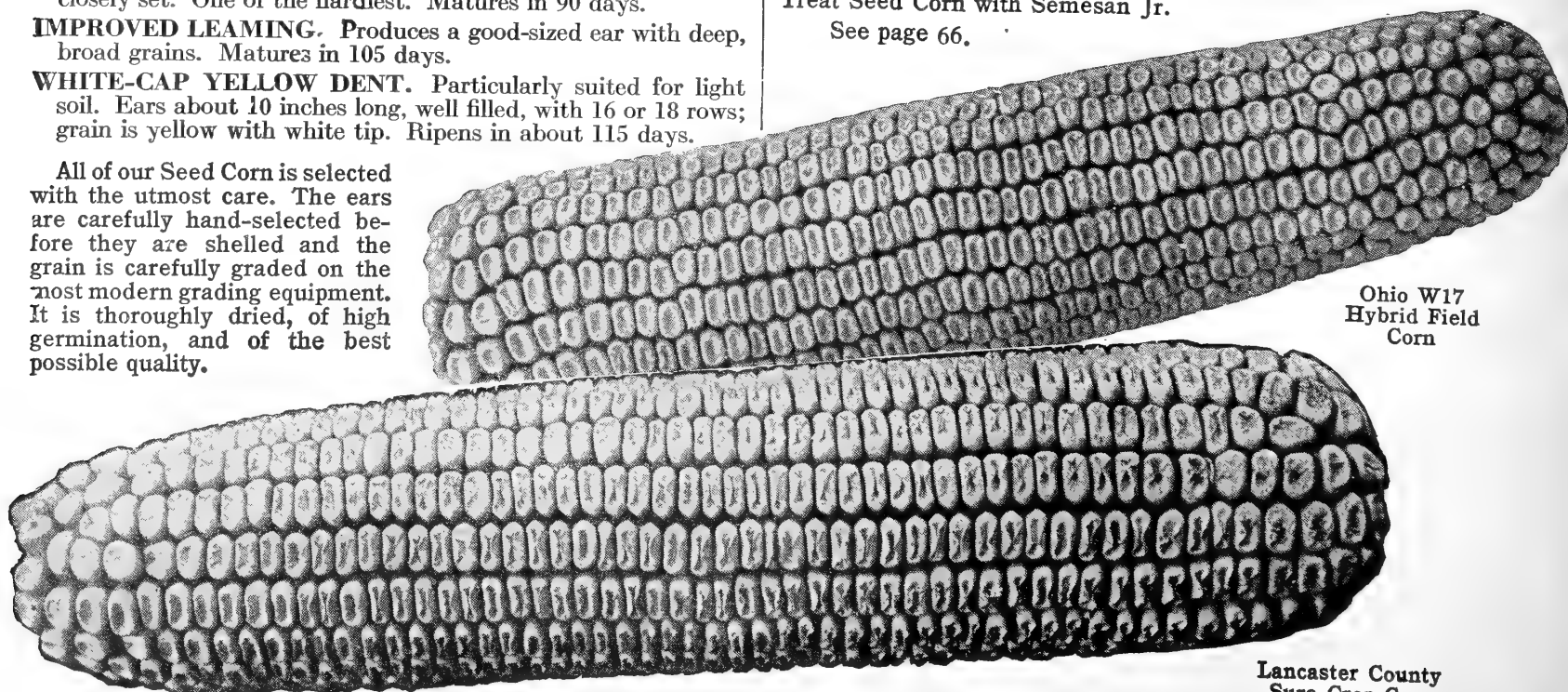

Ohio W17
Hybrid Field
Corn

Lancaster County
Sure-Crop Corn

SOY BEANS

A good soil-builder when plowed under for green manure. Makes excellent hay or silage but is little used for pasture except for hogs. Sow when ground is thoroughly warm, in May or June. If used for hay, cut after the pods form. Use 2 bushels to the acre broadcast; $1\frac{1}{2}$ bushels when drilled. Seed should be inoculated.

We offer two varieties—**Wilson Black** and **Manchu**. Both are suitable for hay, silage, or soil improvement. **Manchu**. Stalk is large and bushy and a heavy producer of both foliage and beans. Seed is yellow. **Wilson**. Not quite so rank a grower as Manchu. Does well on most any type of soil. The most popular variety in this section.

OATS

Alfalfa, red clover, permanent grass and clover mixtures can all be satisfactorily sown with Oats. Sow during April or early May at the rate of 2 to 3 bushels by weight to the acre.

VICLAND. By all odds the best grain Oats for this section. In comparison with other varieties it has out-performed them all. Kernels plump and heavy; straw stiff and strong. Early maturing and resistant to rusts and smuts. A good yielder and because of its short straw is not likely to lodge. Does best in good soil. The seed we offer is Wisconsin-grown, thoroughly cleaned and graded, and of high germination.

SWEDISH SELECT. A well-known variety preferred by many farmers. Kernels very thick, with thin shuck; straw stiff and of medium height. Late maturing.

STORM KING. A side Oats that has been grown successfully for many years. Has long, strong straw that will stand the most severe winds without lodging; heads long, containing an unusually large number of grains.

SPRING BARLEY. Valuable either as a grain crop or as a nurse crop for clover or alfalfa. We have the Oderbrucker variety, a six-rowed, bearded Barley, and a good producer of both grain and straw. Requires 2 bushels of seed for an acre.

BUCKWHEAT. A dependable crop for poor land. Matures in about two months and makes an excellent feed for poultry. Sow during June or early July, using 1 bushel of seed to the acre.

WINTER WHEAT. We can supply the leading sorts of Winter Wheat. Write us for samples and prices before seeding time.

SPRING WHEAT. Grain is smaller and harder than Winter Wheat. Not so popular as Winter Wheat but gives a satisfactory yield and makes excellent flour. Sow in early spring, about 2 bushels to the acre.

WINTER RYE. Grown principally for a winter cover-crop, sometimes for winter pasture or cut for hay. Can be sown up to the middle of November. Requires about 2 bushels of seed for an acre; for small garden plots, about 5 or 6 quarts for 2,500 square feet.

SPRING RYE. Makes an excellent green food when cut, or will supply pasture for several weeks. Sow early.

SEED POTATOES

The stock we offer is raised by experienced growers in the cold North and Northwest. It is grown especially for seed purposes, and is certified stock, U. S. Standard No. 1, high quality, true to type and free from disease. Experience has shown that northern-grown stock moved only a few hundred miles south often produces double the crop of home-grown seed.

Early Varieties

EARLY OHIO. An early sort that is well known by market-gardeners who want a first-early Potato for home trade. The tubers are almost round, with pink skin, and of excellent quality.

IRISH COBBLER. An extra-early, round, white Potato with rather deep eyes. Vines yield heavily and the tubers are of extremely fine quality. A most dependable variety, either for the home-garden or for growing commercially.

CHIPPEWA. About ten days later than Irish Cobbler but superior in smoothness and whiteness, and eyes are not quite so deep. Has desirable cooking qualities.

Late Varieties

KATAHDIN. A handsome, shallow-eyed, glossy, white-skinned variety of fine table quality. It is roundish-oval in shape and very uniform in both shape and size. Gaining in popularity every year. Good yielder.

RUSSET. Tubers round to oblong, of good size, with pure white flesh, russet skin, and few shallow eyes. Excellent table quality, good keeper, and very productive. Vines are strong and disease-resistant.

SEBAGO. A high-yielding, smooth, white, shallow-eyed variety of excellent table quality. A strong grower highly resistant to blight. Very late.

Latest Price-List of Farm Seeds gladly sent on request



SOY BEANS





AGRICO—THE NATION'S LEADING FERTILIZER

FOR BIGGER, BETTER FARM CROPS

YOU will be money ahead next harvest by using Agrico under your crops when you plant. Crop records clearly demonstrate Agrico's extra plant-feeding efficiency. Extra increases in yield and quality produced by Agrico often pay the entire

cost of the Agrico application. Agrico is a great crop-producer and money-maker for the farmer, and you'll say so yourself when you use it. This year get Agrico for all your crops. Be on the safe side—order early and take delivery as soon as you can.

AGRICO FOR TRUCK (5-10-5)

Specially made for market produce and canning crops. Noted for high yields of better quality truck and earlier maturity for the higher-priced markets.



In 100-lb. paper bags,
\$45.25 per ton

AGRICO FOR CORN (3-12-6)



Carefully formulated to promote vigorous root-growth, sturdier stalks, and ears filled with good, hard corn. Extra yields per acre for lower-cost feed.

In 100-lb. paper bags,
\$42.85 per ton

AGRICO FOR POTATOES (4-12-12)

Used by the nation's leading growers of seed and table stock, because side-by-side tests have proved Agrico produces more No.1's of uniform size and quality.

In 100-lb. paper bags,
\$50.45 per ton



AGRICO FOR FRUIT (10-6-4)

Orchards thrive on this complete, well-balanced fertilizer. Use Agrico and profit by heavier yields of premium-quality fruit.

In 100-lb. paper bags,
\$51.45 per ton



WHEN YOU NEED SUPER-PHOSPHATE, USE 18% NORMAL

18% NORMAL is Superphosphate produced the "normal" way, without reduction in valuable calcium and sulphur content . . . and 18% NORMAL is more economical per unit of available phosphorus. In addition to its many uses in the field, add 18% NORMAL Superphosphate to manure to reduce nitrogen loss, increase the phosphorus content, and improve manure's crop-producing power.

In 100-lb. paper bags, \$28.55 per ton

All prices on this page are f.o.b. our warehouse or cars Pittsburgh and are subject to 10 per cent discount for cash with order. Transportation charges are additional on orders for local delivery or rail shipment.



AGRICO FOR TOMATOES (4-12-8)

Try this Agrico specially formulated for tomato production and see how it increases tonnage, boosts the grading, and increases acre returns.

In 100-lb. paper bags,
\$46.85 per ton



AGRICO FOR GRAIN (3-12-6)

Specially formulated for wheat, oats, and other small grains. Noted for extra yields of quality grain that weighs heavy and grades high in quality.

In 100-lb. paper bags,
\$42.85 per ton



AGRICO FOR TOP DRESSING (7-7-7)

Apply this complete, well-balanced Agrico on your permanent pastures and haylands. Pays for itself over and over in increased growth of roughage, higher in protein and minerals.

In 100-lb. paper bags,
\$48.75 per ton



AGRICO FERTILIZERS AND 18% NORMAL SUPERPHOSPHATE ARE MANUFACTURED ONLY BY



3 SPECIAL-PURPOSE AGRICO FERTILIZERS

FOR BETTER LAWNS AND HOME GARDENS

TO MEET the different plant-food needs of lawns, trees and shrubs . . . of flowers and vegetables . . . and of broadleaf evergreens, Agrico comes in three grades. Each of these three special-purpose Agrico Fertilizers is made to do its own job and do it better than any all-purpose fertilizer could possibly do.

Yet, Agrico costs no more . . . is more economical to use . . . gives you more value per pound and per dollar. Agrico is made by one of the world's oldest and largest manufacturers of fertilizers for farm and home. On the basis of results, Agrico is the Nation's Leading Fertilizer.

AGRICO FOR LAWNS, TREES AND SHRUBS

If you have a good lawn, keep it that way by feeding it with Agrico every spring and fall. In repairing or rebuilding a lawn, use Agrico to insure your investment in seed and labor. And don't forget to feed your trees and shrubs.



5-lb. bag . . . \$0 45	50-lb. bag . . . \$2 50
10-lb. bag . . . 80	100-lb. bag . . . 4 00
25-lb. bag . . . 1 50	500 lbs. 18 00
2000 lbs. \$68 00	

AGRICO FOR GARDENS

Use this special-purpose Agrico for flowers of greater health and beauty, also for larger yield of vegetables richer in minerals and vitamins. Safe, odorless, easy to use. Complete directions on every bag.

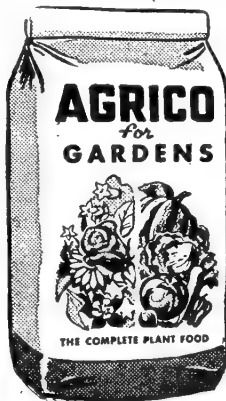

5-lb. bag . . . \$0 45	50-lb. bag . . . \$2 50
10-lb. bag . . . 80	100-lb. bag . . . 4 00
25-lb. bag . . . 1 50	500 lbs. 18 00
2000 lbs. \$68 00	

AGRICO FOR BROADLEAF EVERGREENS

Prepared especially for Rhododendrons, Azaleas, Laurel, Viburnum, Hemlock, Yews, Gardenias, Magnolia, Dogwood and other acid-loving plants. Provides all the needed plant-foods and at the same time builds up the soil's acidity.



10 lbs. \$1 00	100 lbs. \$5 00
25 lbs. 2 00	500 lbs. 22 50
50 lbs. 3 25	2000 lbs. 85 00

SPECIALLY MADE FOR GOLF COURSES

Used by the nation's leading golf courses, AGRICO COUNTRY CLUB FERTILIZER is the standard of quality for feeding greens and fairways. This complete, carefully balanced plant-food is specially formulated for golf-course use and is backed by two generations of success in this specialized field.



500 lbs. \$17 00	1000 lbs. \$30 60
2000 lbs. \$57 40	
Larger quantities quoted on request	

AGRICO FOR COMMERCIAL GROWERS

This Agrico is used by many of the nation's largest and most outstanding greenhouses. See for yourself how it gets plantings off to a better start. Specially made for this purpose, with organic and inorganic nitrogen in exactly the right proportions for best greenhouse results.



100 lbs. \$3 50	1000 lbs. \$32 00
500 lbs. 17 00	2000 lbs. 60 00

ALL PRICES ON THIS PAGE INCLUDE LOCAL DELIVERY IN QUANTITIES OF 50 POUNDS OR MORE

THE AMERICAN AGRICULTURAL CHEMICAL CO., 129 LEWIS STREET, BUFFALO 6, N. Y.

**For Greener Lawns—Better Vegetables
Use VIGORO**



Any home can have the extra beauty that a lovely lawn provides . . . thanks to Vigoro. Vegetable yields will be bigger, too, for Vigoro supplies all the food elements growing things need from the soil. Use Vigoro on everything you grow for finest results.

5-lb. carton . . . \$0 45	50-lb. bag . . . \$2 50
10-lb. bag 85	100-lb. bag . . . 4 00
25-lb. bag 1 50	500 lbs. 18 00

**H Y P O N E X
COMPLETE AND BALANCED
P L A N T F O O D**

A complete, balanced, scientific plant-food for either indoor or outdoor use. It can be used on vegetable crops, flowers, lawns, trees or plants in pots. Hyponex is also invaluable for rooting cuttings and in transplanting. It speeds up growth and produces strong, lusty plants. Contains chemical nitrogen. One pound makes 100 gallons of liquid plant-food. 3-oz. can 25 cts., 7-oz. can 50 cts., 1-lb. can \$1, 10-lb. drum \$8, 25-lb. drum \$15, 50-lb. drum \$25, 100-lb. drum \$40.



Use Transplantone when transplanting tomato, cabbage, pepper, eggplant, and all vegetable and flower seedlings. Soak hardy plants, roses, and shrubs overnight in Transplantone solution before planting. It starts them sooner into active growth and prevents wilting and delay in development. Widely used by nurserymen and growers. 1/2-oz. pkt. 25 cts., 3-oz. can \$1, 1-lb. can \$4.

Lawn and Garden Bone-Meal

Especially adapted for lawns, gardens, and greenhouses.

Nitrogen, 1.75 per cent; total Phosphoric Acid, 20 per cent.

5 lbs. \$0 60	50 lbs. \$3 50
10 lbs. 1 10	100-lb. bag . . . 5 90
25 lbs. 2 25	500 lbs. 27 00

Nitrate of Soda

16% Nitrogen

1 lb. \$0 15	25 lbs. \$1 65
5 lbs. 50	50 lbs. 2 65
10 lbs. 85	100 lbs. 4 25

Sulphate of Ammonia

20.56% Nitrogen

1 lb. \$0 15	25 lbs. \$1 50
5 lbs. 45	50 lbs. 2 50
10 lbs. 80	100 lbs. 4 00

Larger quantities of above 3 materials quoted on request.

PlanTabbs

A complete balanced plant-food in convenient tablet form, plus Vitamin B₁. Can be used both in the garden and on house-plants. 30 tablets 25 cts., 75 tablets 50 cts., 200 tablets \$1, 1000 tablets \$3.50.

MILORGANITE

All-Organic Natural Fertilizer

This dependable, safe and easy-to-use fertilizer will carpet your lawn with dense weed-free turf. Grass will stay green longer. You can grow more delicious vegetables, finer flowers, and better trees and shrubs by using Milorganite.

A Natural Organic Food.

Besides containing all the basic fertilizer elements, Milorganite is rich in the trace elements, too.

Effects Longer Lasting.

Milorganite promotes continuous healthy growth over long periods. Its water-insoluble, organic nitrogen is released slowly as needed. That's why Milorganite-fed lawns stay green longer. Soluble mineral fertilizer acts quicker, but effects are short-lived.

25-lb. bag \$1 25
50-lb. bag 2 10
100-lb. bag 3 60

Easy and Safe to Use.

Clean and free flowing because every particle is a distinct granule—therefore easy to apply. No burning, so immediate watering is unnecessary to avoid scorching of foliage—hence safe to use.

Keeps Indefinitely.

Never cakes or hardens during storage—does not rot the bag. So any unused portion can be stored indefinitely for future use.

500 lbs. \$16 50
1000 lbs. 30 25
2000 lbs. 55 00

Bald Eagle Hydrated Lime

Minimum Calcium Oxide, 70.00
Minimum Magnesium Oxide, .70

Prepared especially for vegetable gardens, lawns, greenhouses, whitewash, and kindred uses, besides all the various other purposes for which Lime is essential. It corrects the sour condition which exists in many soils, especially those shaded by houses or trees. For the treatment of lawns and gardens, apply in the late fall or early spring at the rate of 5 pounds per 100 square feet of space. Broadcast the Lime over the surface as evenly as possible and thoroughly rake into the prepared top-soil a few days before planting.

10-lb. bag . . . \$0 25	500 lbs. . . . \$7 75
25-lb. bag . . . 45	1,000 lbs. . . . 13 50
50-lb. bag . . . 1 00	2,000 lbs. . . . 23 00
100 lbs. 1 75	

Alfalfa Brand Agricultural Limestone

Minimum Calcium Carbonate, 96.00
Minimum Magnesium Carbonate, 1.00

100 per cent passing 20 mesh; 70 per cent passing 100 mesh

Pure ground Limestone, artificially dried and very finely pulverized. Use 15 to 20 pounds per 100 square feet.

80-lb. bag . . \$1 20	960 lbs. . . . \$8 64
480 lbs. 5 28	2,000 lbs. . . . 14 00

Humus

An organic material used principally as a soil-conditioner and for mixing with potting soil. Recommended for lawns, flower-beds and gardens.

Large bag (about 100 lbs.) \$2 00
5 bags 9 00
10 bags 17 00

Electra Fertilizer (4-9-3)

Used very extensively by commercial and private growers, Electra contains Vitamins A and B complex and D, and is designed to exercise a corrective influence on every phase of plant development, soil, roots, structure, breaks, buds, flowers, fruit, and seeds. Highly organic. Use it for feeding, forcing, or finishing. Electra guarantees complete and uniform plant-development and color without softness.

100-lb. bag . . \$7 50	1,000 lbs. . . . \$69 50
500 lbs. 35 25	2,000 lbs. . . . 138 00

Aluminum Sulphate

Experiments have shown that soil acidity is required for rhododendrons, azaleas and all other evergreens. Apply at the rate of about one-half pound per square yard.

1 lb. \$0 15	25 lbs. \$1 50
5 lbs. 50	50 lbs. 2 40
10 lbs. 75	100 lbs. 4 25

Sudbury Junior Professional Model Soil-Test Kit

This new model makes 50 individual tests for nitrogen, phosphorus, potash and acidity, showing how to lime and fertilize for best results. Easy to use. Comes in handsome, sturdy, leatherette case. Complete with instructions and helpful chart. \$4.75.

Sudbury Home Model Soil-Test Kit. Makes 20 tests for each element. \$2.50.

Sudbury Deluxe Model Soil-Test Kit. Makes 200 tests for each element. In mahogany case. \$22.50.

Testing Fluid for Refill. (Specify whether for nitrogen, phosphorus, potash, or acidity.) 2 ozs. \$1, 6 ozs. \$2.

All prices on this page include local delivery in quantities of 50 pounds or more



Triple Action Plant Food

For Lawns and Flowers

Shrubs, Trees and Vegetables

You get added value and greater effectiveness from Wizard Natural Plant Food because of these three distinctive and important features:

- 1. All Plant Food Elements.**
Wizard supplies in a safe natural form all the elements needed to make plants thrive.
- 2. Soil Building Humus.**
Humus is a vital need of all soils and is supplied in abundance by Wizard. Humus is only supplied by Natural Organic Plant Foods.
- 3. Beneficial Bacterial Action.**
The vast store of plant food locked-up in all soils is liberated and made available to plants by the bacterial action that Wizard promotes.

Wizard improves the physical condition and puts new life into worn-out soils. It is safe, absolutely weedless and lasting in effect.

Lawns.

Six to ten pounds to 100 sq. ft. in Spring and Fall will produce a thick green turf.

Flowers.

A handful mixed with soil under each new plant or 10 lbs. to 100 sq. ft. of bed area will insure luxuriant green foliage and an abundance of bloom.

Vegetables.

Wizard promotes quick, tender growth of high quality vegetables. Apply in hill or row or broadcast at rate of 6 lbs. to 100 sq. ft.

Shrubs and Trees.

The lasting qualities of Wizard make it the ideal food for trees and shrubs. It releases plant food continuously over a long period.

5 lbs.....	\$0 35
10 lbs.....	60
25 lbs.....	1 10
50 lbs.....	2 00
100 lbs.....	3 50
500 lbs.....	15 00
1000 lbs.....	28 00
2000 lbs.....	53 00

Prices include local delivery in quantities of 50 pounds or more. Call orders and rail shipments in quantities of 500 pounds or more quoted on request.

Nature's Perfect Soil Builder



MASTERS FERTILIZER DISTRIBUTORS

Simple, sturdy, and efficient machines for the even distribution of dry commercial fertilizer, grass seed, top-dressing and similar material. Revolving agitator insures free-flowing material. Shut-off control on handle. Masters distributors are built to give years of hard service.

Saves Time, Labor, Material

Model	Spreading width	Hopper capacity	Price
No. 25	18-in.	20 lbs.	\$5 75
No. 30	18-in.	30 lbs.	9 00
*M180	18-in.	50 lbs.	12 65
*M240	24-in.	75 lbs.	15 90
*M361D	36-in.	120 lbs.	34 00

*These are heavy-duty models suitable for large estates, cemeteries, golf courses, landscape gardeners, etc.



No. 25 Home Lawn Model \$5.75

SALEM FERTILIZER SPREADERS

Designed for the even distribution of fertilizers, grass seed, and other granular materials. Salem Spreaders are of steel construction with reinforced hopper and feature both manual and automatic shut-off. All models equipped with selective feed control.

Hopper width	Hopper capacity	Price
16 in.	22 lbs.....	\$5 95
20 in.	40 lbs.....	9 95
30 in.	80 lbs.....	16 75
36 in.	125 lbs.....	29 75

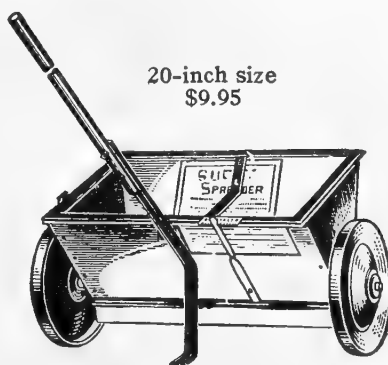

20-inch size \$9.95

FERTILIZER DISTRIBUTORS PAY FOR THEMSELVES IN MATERIALS SAVED

Pioneer Garden Peat Moss

This true sphagnum Peat Moss is all-organic and makes a most economical source of humus for loosening heavy clay soils, gives body to sandy soils, stores up valuable moisture, promotes the development of vigorous root-growth. It aerates the soil and prevents baking and crusting.

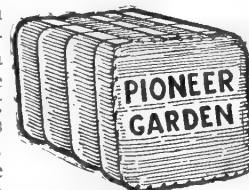

As a Protective Mulch against extreme heat of summer and freezing blasts of winter, spread it around base of plants to a depth of 3 to 4 inches.

1/2-bus. bag 35 cts., 1-bus. bag 60 cts., 1/2 bale \$3.50, bale \$5.50, 5-bale lots, \$5.30 per bale.

Turn Garden Rubbish Into "Rich Fertilizer" Use Adco

Field and garden wastes—grass cuttings, leaves, etc.—contain everything needed by growing things, but they cannot be used in their "raw" state. Mixed with a small proportion of Adco, they are speedily converted into rich plant-food. It's easy to do—and inexpensive.

7 1/2-lb. carton (enough to treat about 100 lbs. dry material).....\$1 00
 25-lb. bag (enough for 12 wheelbarrow loads of garden waste, making about 1/2 ton of manure)..... 2 25
 150-lb. bag (enough for a heap 10 x 10 x 6 ft., making about 3 tons of manure).....10 50

Insecticides and Fungicides



SPRAY ROTENONE PYRETHRUM D.D.T.

Kills Chewing and Sucking Insects on Fruit Trees, Shade Trees, Vegetables, and Flowers

One of the most complete garden and orchard contact sprays. 1½ pints D-X Spray in 100 gallons of water will control most insects on fruit and shade trees and in gardens and greenhouses. Contains rotenone, pyrethrum and 5% D.D.T.

A simple spray plan for vegetables and flowers is to spray the home-garden every ten days or two weeks throughout the insect season with two teaspoonfuls of D-X Spray in one gallon of water.

1½-oz. bottle.....	\$0 40	1-gal. can.....	\$12 75
½pt. bottle..	1 50	5-gal. can.....	50 50
1-qt. can..	4 75		



Used by Leading Rosarians

Tri-ogen Spray gives protection against certain insects and diseases, including black-spot, mildew, aphids, etc. It is especially recommended for roses, asters, snapdragons, hollyhocks, phlox, delphiniums, dahlias, and many other plants. The stimulating value of Tri-ogen promotes vigor and growth, healthy green foliage, with resultant luxuriant blooms.

Protects for season

E. Kit.	6 to 10 roses.....	\$0 90
A. Small Kit.	12 to 20 roses.....	1 50
B. Medium Kit.	50 to 80 roses.....	4 00
C. Large Kit.	100 to 160 roses.....	6 00
D. Estate Kit.	400 to 600 roses.....	20 00

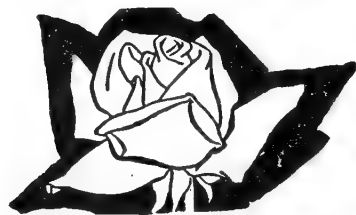

TRI-OGEN

Patents Pending

Rose Garden Spray Treatment

To Control Fungus, Mildew, Black-Spot, and Rust

Bowker's Powdered Bordeaux Mixture

A powerful fungicide for the control of blights, rusts, and rots on any crops where Bordeaux is the recommended control.

1-lb. pkg. 35 cts., 4-lb. bag \$1, 48 lbs. (12 4-lb. pkgs.) \$10.56.

Cupro-K

Recommended as a spray for control of leaf-spot (shot-hole) on sour cherry trees. Is more effective than lime-sulphur and easier to use. Also used as a spray or dust for control of foliage diseases of certain vegetables, such as wilt and leaf-spot on cucumbers, and blight and leaf-spot on tomatoes.

3-lb. bag 85 cts., case (16 3-lb. bags) \$11.76.

Chipman Copper Hydro

An effective copper fungicide. May be used as a spray or dust. Compatible with most insecticides. Contains 26% metallic copper.

4-lb. bag \$1.10, case (12 4-lb. bags) \$11.76.

"Bell-Mine" Rotary Kiln Lime

For making Bordeaux Mixture solution. 80-lb. paper bag \$1.25. Larger quantities quoted on request.

Niagara Copodust

An excellent fungicide for early and late blights on tomatoes, potatoes, and other fungous diseases on vegetables and ornamentals. Contains no lime. For use as a dust only. Do not use on Beans.

5-lb. bag, 85 cts., case (10 5-lb. bags) \$7.50.

Sulfocide

A Better Summer Spray

A highly concentrated sulfur fungicide, which, when sprayed on the fruit or foliage, precipitates an extremely fine colloidal sulfur, that is successful in the control of fungous diseases of fruits, vegetables and flowers.

Combine with any D-X formula for an all-purpose spray for insects and fungous diseases.

Pt. 75 cts., qt. \$1.25, gal. \$2.75, 5 gals. \$9.25, 30 gals. \$40.30, 50 gals. \$60.

Superfine Dusting Sulphur

Controls mildew, black-spot, leaf-spot, and other fungous diseases on roses, chrysanthemums, phlox, delphiniums, snapdragons, and many other plants. 2-lb. sifter carton 40 cts., 10 lbs. \$1, 25 lbs. \$1.75, 50 lbs. \$3, 100 lbs. \$5.60.

Dow "Mike" Wettable Sulphur

Goes into suspension instantly and used as a spray. 10-lb. bag \$1.35, case (6 10-lb. bags) \$7.25.

Bowker's Nicotine Pyrox

A complete garden spray. It contains nicotine to combat sucking insects, arsenic poison to control leaf-eating insects, as well as a copper ingredient which provides protection against fungous diseases. Comes in a paste form, ready to use.

20-oz. jar (makes about 4 gals. spray) 60 cts., 5-lb. can \$2, 25-lb. pail \$6.50.

Bowker's Pyrox. Same as above except that it does not contain nicotine.

25-lb. drum \$5.75, 50-lb. drum \$8.35, 100-lb. drum \$14, 300-lb. barrel \$34.50.

Du Pont Garden Dust

Effective control for many plant insects and diseases. Contains rotenone, D.D.T., Fermate and Zerlate. Can be used as a dust or spray. 1-lb. can \$1, 4-lb. can \$3.

Du Pont Rose Dust

A proved fungicide for the control of black-spot, powdery mildew, rust and other foliage diseases of roses. Can also be used on carnations and snapdragons. Use as a dust or spray.

1-lb. can \$1, 4-lb. can \$3.

Red Arrow Garden Spray

Kills many varieties of both chewing and sucking insects. One ounce makes several gallons of spray.

Oz. 35 cts., 4 ozs. \$1, pt. \$2.85, qt. \$5.50, gal. \$18.50.

Copper Sulphate (Blue Vitriol)

For making Bordeaux Mixture solution. Lb. 25 cts., 5 lbs. 85 cts., 10 lbs. \$1.50, 50 lbs. \$5.75, 100 lbs. \$11.00.

Pomo-Green With and Without Nicotine

Pomo-Green prevents and controls black-spot, mildew, chewing and sucking insects on plants, shrubs, and roses quickly and effectively.

Protect new growth by dusting or spraying with Pomo-Green once each week throughout the growing season.

Pomo-Green with Nicotine. The all-in-one material. 1-lb. can 80 cts., 5 lbs. \$3.30.

Pomo-Green without Nicotine. Used to control diseases and leaf-eating insects only. 1-lb. can 55 cts., 5-lb. carton \$1.85.

Du Pont Zerlate

An effective fungicide for the control of certain plant diseases. Compatible with common insecticides. 25-lb. drum \$16.75.

Du Pont Fermate

A safe, non-caustic fungicide. Effective on a wide range of plants and compatible with most insecticides. 3-lb. bag \$2.25, case (12 3-lb. bags) \$24.12.

TO CONTROL CHEWING AND SUCKING INSECTS

Rotenone Dust

Kills the Mexican Bean Beetle

A general-purpose Dust that controls the Mexican bean beetle and most species of aphids, thrips, leaf-worms, beetles, larvæ, and other sucking and leaf-eating insects on vegetables, flowers, small fruit, etc. Requires 15 to 25 pounds to the acre.

To control the Mexican bean beetle the dust must be applied to the under side of the leaves. $\frac{3}{4}$ % Rotenone Dust.

1-lb. can... \$0 50 | 50-lb. bag. \$12 50
5-lb. bag... 1 65 | 100 lbs.... 24 00

1% Rotenone Dust

50-lb. bag.. \$15 00 | 100 lbs....\$29 00

Hammond's Slug-Shot

A light, composite, fine powder that is easily distributed either by duster or in water and sprayed. It is thoroughly reliable in killing the Mexican bean beetle and other leaf-chewing insects.

Lb. 40 cts., 5 lbs. \$1.70, 25-lb. bag \$5.50.

Kryocide D-50

A ready-mixed dust containing natural cryolite and sulphur. It effectively controls most chewing insects and plant diseases. Particularly recommended for the home vegetable and flower garden.

1-lb. shaker canister 50 cts.; 3-lb. bag 85 cts.

Kryocide C. An insecticide and fungicide containing natural cryolite and copper. May be used either as a dust or as a spray in water.

1-lb. shaker canister 55 cts.; 3-lb. bag 90 cts.

Alorco Cryolite

Very effective in controlling the Mexican bean beetle, cabbage worm and many other chewing insects. Can be used as a spray or dust. Safe and easy to apply. A proved insecticide for both commercial growers and home gardeners. 1-lb. can 35 cts., 6-lb. bag \$1.25, case (8 6-lb. bags) \$7.84.

Bowker's Powdered Arsenate of Lead

Can be used either as a spray or as a dust for external chewing insects. It will not burn or injure your crop. It is the fineness of Bowker's Arsenate of Lead that causes it not only to spread and to stick better, but to kill better. Mixes easily, stays well in suspension, with no trouble from clogged nozzles.

Also used extensively for soil-treatment of golf greens and lawns to control white grubs and beetles that infest the sod and eat the roots of grass. Use 4 to 8 pounds for each 1,000 square feet of surface, mixed with top-soil, loam, or fine sand. Use 4 pounds of Arsenate to about 1 bushel of soil.

1-lb. pkg. 45 cts., 4-lb. pkg. \$1.25, 48 lbs. (12 4-lb. pkgs.) \$13.44.

"AA" Quality Calcium Arsenate

Excellent for potatoes and truck crops; it is cheaper than lead arsenate. Use it to kill such pests as potato bugs, bean beetles, and other leaf-chewing insects. May be applied either wet or dry.

1-lb. pkg. 25 cts., 4-lb. pkg. 60 cts., 48 lbs. (12 4-lb. pkgs.) \$6.24.

Dow's Magnesium Arsenate

Dow's Magnesium Arsenate is an effective insecticide for the control of the Mexican bean beetle and other chewing insects. It proves fully effective without damage to tender bean foliage. As a spray, use 6 teaspoonfuls to 1 gallon of water. For dusting, use 1 part Magnesium Arsenate to 3 parts hydrated lime. 12-oz. can 40 cts., 2-lb. bag 65 cts.

Paris Green

$\frac{1}{4}$ -lb. carton 30 cts., 1-lb. carton 80 cts., 5-lb. carton \$3.50.

Tartar Emetic

Used in a spray mixture to control gladiolus thrip. Use $\frac{1}{2}$ pound Tartar Emetic and 1 pound brown sugar to 25 gallons of water. $\frac{1}{4}$ lb. 50 cts., lb. \$1.50, 5 lbs. \$4.90, 25 lbs. \$19.

Black-Leaf 40

Nicotine Sulphate

Recommended by experiment stations and by spraying experts throughout the United States and the Dominion of Canada.

The standard contact insecticide for spraying vegetables, fruits, flowers, and plants to destroy aphids, most thrips, leaf-hoppers, and similar sucking insects. Also effective for dipping purposes. One ounce makes 6 gallons of spray.

1-oz. bottle..\$0 35 | 2-lb. can...\$3 92
5-oz. bottle.. 1 05 | 5-lb. can... 7 40
1-lb. bottle... 2 42 | 10-lb. can...12 85

Volck Oil Spray

A Summer Oil Spray and Spray Carrier

A contact insecticide for the control of scale insects, red spider, white flies and mealy bugs on trees, plants, shrubs and evergreens. Can be combined with nicotine, rotenone, pyrethrum, or arsenate of lead to control aphids, thrips, and certain leaf-eating insects.

4-oz. bottle..\$0 25 | 5-gal. drum.\$8 50
16-oz. bottle. 50 | 54-gal. drum.48 50
1-gal. bottle. 2 25

Ogen's Corn Ear Worm Drops

Simple and effective media for the control of the corn ear worm. Apply several drops to each ear after the silks have been pollinated.

2-oz. bottle with applicator 35 cts.

Kolo Fruit Tree Dust or Spray

Formulated for complete insect and disease control after the dormant stage. Can be used with safety on fruit trees and certain ornamentals. Contains basic lead arsenate, sulphur and D.D.T. It has good adhesive qualities and stays in suspension. Three pounds makes 25 gallons of spray.

3-lb. bag \$1.25.

D.D.T. PRODUCTS

Pratt's 25% D.D.T. Spray

Use 1 to 2 quarts to 100 gallons of water to control certain insects on fruit and shade trees and in gardens and greenhouses. Also used at the rate of 1 part to 4 parts of water (5% solution) for treatment of barns, dairies, kennels, etc., for flies, mosquitoes, gnats, and fleas.

1 $\frac{1}{2}$ -oz. bottle 35 cts., $\frac{1}{2}$ -pt. bottle \$1, 1-qt. can \$2.85, 1-gal. can \$8.50, 5 gals. \$30

Chipman Dual Dust

A ready mixed dust containing 3% D.D.T. and 25% of a 26% metallic copper fungicide. Controls certain insects and prevents diseases. An effective dust for control of insects and late blight on potatoes.

4-lb. bag 85 cts., 50-lb. bag \$7.60.

Pratt's Surfispray

Pratt's Surfispray is 5% D.D.T. fortified with pyrethrum and piperonyl cyclohexanone, a spray for flies, mosquitoes, moths, fleas, gnats, bedbugs, roaches, and silverfish. For use in homes, kennels, dairy barns, and all livestock quarters. 100% active ingredients. Gives quick kill, and when applied to surface of walls and ceilings, residue is effective for three or four months. Ready to use; does not stain.

1-pt. bottle 65 cts., 1-qt. can \$1, 1-gal. can \$2.85, 5-gal. can \$10.50.

Chipman D.D.T. 5% Dust

A ready mixed dust used whenever a 5% D.D.T. dust is recommended. Controls corn ear worm, cabbage caterpillars, and certain other insects on vegetables. Also chinch bugs in lawns.

4-lb. bag 75 cts., 50-lb. bag \$6.25.

Du Pont "Deenate" 50-W D.D.T. Powder

A micronized dry wettable 50% D.D.T. powder that mixes readily and shows no tendency to agglomerate in the spray tank. Two pounds in 100 gallons of water is generally used for codling moth, Japanese beetle, potato beetle, flea beetle, leafhoppers, leaf rollers, corn borers and thrips.

Also suitable for spraying animals, farm buildings and greenhouse crops.

1-lb. pkg. \$1, 4-lb. bag \$2.70, 48 lbs. (12 4-lb. bags) \$28.80.

Du Pont 10% D.D.T. Insect Dust

Controls cockroaches, flies, bedbugs, moths, carpet beetles and silverfish. Easy to apply into cracks and corners where bugs hide out. 1-oz. puffer can 20 cts., 8-oz. dust gun 85 cts., 1-lb. sifter can \$1.15.

Dormant Sprays for Control of Scale



for FRUIT TREES,
SHADE TREES and
ORNAMENTALS

SCALECIDIDE—the complete dormant spray—is the safest and most effective means of getting rid of overwintering insects. It invigorates your trees and gives them a good healthy start for spring growth.

Scalecide kills scale, red mite, aphid (delayed dormant), bud moth, case bearer, pear psylla, overwintering codling moth and many other pests. Scalecide also has an invigorating effect on tree growth that is unequalled by any other spray. Apply just before the foliage starts in the spring.

Spray fruit trees, shade trees, small fruit, and shrubs with Scalecide 1 to 15 in the spring before the buds show green, provided the temperature is not colder than 40°. On peach and pear trees fall spraying is preferable to control peach curl and pear psylla.

Spray evergreens, euonymus, etc. with Scalecide 1 to 20 in the spring just before the new growth starts.

1-qt. can.....	\$0 80
1-gal. can.....	2 00
5-gal. can.....	7 35
15-gal. drum.....	17 25
30-gal. drum.....	27 50
55-gal. drum.....	42 50



Scalecide gives your trees a healthy start

Du Pont's Liquid Lime-Sulphur

Prepared from the highest grade of lime and the purest sulphur, combined in especially designed apparatus and in quantities so large as to allow plenty of time for storage and settling. Thus, the solution which reaches you is cherry-red in color, clear and sparkling. It will not crystallize, thicken up in the barrel, or clog the finest nozzles. If used according to directions, will kill every scale that it touches. For dormant spraying use 1 gallon to 8 or 9 gallons of water.

1-qt. can 65 cts., 1-gal. can \$1.10, 5-gal. can \$3.75, 50-gal. bbl. \$15.50.

F.O.B. our warehouse, 50-gal. bbl. \$13.50, 3 50-gal. bbls. \$39. Containers not returnable.

Dow's Dry Lime-Sulphur

Dow's Dry Lime-Sulphur is made by a special patented process which keeps the product in good physical condition, thus insuring its going into suspension quickly. It is used either as a dormant spray to kill scale or as a summer spray to control fungous diseases such as scab, rot, etc. For dormant spraying use 24 to 30 pounds in 100 gallons of water. For summer spraying use 5 to 8 pounds in 100 gallons of water.

1-lb. pkg. 35 cts., 5-lb. pkg. \$1.50, 12½-lb. bag \$1.75, 100 lbs. (8 12½-lb. bags) \$11.

Sunoco Self Emulsifying Spray Oil

Scale insects include some of the most dangerous enemies of horticulture. They are small, but propagate so rapidly that neglected trees quickly become incrustated with them. Sunoco applied as a dormant spray will control most all kinds of scale.

1-gal. can... \$1 50 | 55-gal. drum \$24 20
5-gal. drum... 6 00

DN-Dry Mix (Wettable) Dinitro-O-Cresol

A spring dormant spray recommended for use alone in water or in combination with oil sprays. When added to oil it increases the toxicity of the spray to certain scale insects.

1-lb. bag 80 cts., case (24 1-lb. bags) \$15.60.

To Control Borers, Cutworms, Grubs, Sowbugs, Etc.

Para-Scalecide

Controls Peach Tree Borer

Eliminates much of the danger and saves labor in the control of borers in peach and other trees. Comes in liquid form. Dilute one gallon in 7 gallons of water and it is ready to apply directly to the tree. Ask for special leaflet.

1-qt. can... \$1 00 | 15-gal. drum \$19 82
1-gal. can... 2 50 | 30-gal. drum 32 50
5-gal. can... 8 25 | 55-gal. drum 50 00

Paradow

Paradichlorobenzene

Paradow is recommended for the control of peach-tree borers. When placed around the base of a peach tree, it will generate a gas that will kill the borers in that tree. Should be used in spring or fall when trees are not growing vigorously. Use about 1 ounce per tree. Directions on container.

12-oz. pkg. 40 cts., 5-lb. pkg. \$1.75, 25-lb. drum \$7, 50-lb. drum \$12.

Snarol

With Metaldehyde as an Attractant

Cutworms, sowbugs, grasshoppers, slugs, snails, earwigs, etc., are quickly exterminated.

Snarol is a ready-prepared meal that you simply broadcast on the ground, under the vegetation. Pests eat it at night and are quickly destroyed. It will not deteriorate from rain or sprinkling, and is non-injurious to vegetation.

Lb. 35 cts., 2½ lbs. 75 cts., 6 lbs. \$1.50.

Greenhouse Insecticides and Fungicides

Nico-Fume Pressure Fumigator

Nico-Fume Powder packed in hermetically sealed cans. An effective greenhouse fumigant to destroy aphid, thrips, midge, etc.

½-lb. tin, 50 cts. each, \$2.60 for 6, \$4.60 per doz.

1-lb. tin, 75 cts. each, \$3.90 for 6, \$7.35 per doz.

Nico-Fume Liquid

A highly refined solution of free nicotine, guaranteed to contain fully 40 per cent of nicotine. Extensively used for spraying or vaporizing in greenhouses to destroy aphid, thrips, etc.

1-lb. tin \$2.60, 2-lb. tin \$3.45, 8-lb. tin \$11.95.

Special Red Arrow

An extra high-powered pyrethrum spray. Very effective. Circular on request.

1-gal. bottle \$14.50, 5-gal. can \$67.50.

Du Pont Loro

A thiocyanate contact insecticide for the control of mealy bugs, red spider, chrysanthemum midge, thrips, cyclamen mite and aphid. 1-pt. bottle \$2.10, 1-gal. bottle \$11.25, 5-gal. can \$46.25.

Du Pont Spreader-Sticker

Increases the effectiveness of contact sprays by making possible more thorough wetting of foliage and insects. 1-pt. bottle \$1, 1-gal. bottle \$6.

Atlas NNOR

A double-action contact insecticide for the control of red spider, aphids, soft scales, leafhoppers, thrips, mealy bugs, midge on mums, and white fly. Mixes readily with water, gives high kill and is pleasant to apply. 1-gal. can \$13.50, 5-gal. can \$60.

CYANOGAS G. Fumigant. Fine for greenhouse and mushroom-house fumigation. In the greenhouse, ¼ ounce per 1,000 cubic feet will control aphids, white fly, soft scale, thrips, and other greenhouse pests. (Booklet on request.)

5-lb. tin... \$3 00 | 100-lb. drum \$25 00
25-lb. pail... 10 00 | Not mailable.



Now you can spray your lawn with WEEDONE, the famous 2,4D Weed Killer, and the weeds will die within two or three weeks. Will not kill the grass. In addition to the lawn weeds, such as dandelion and plantain, WEEDONE kills poison ivy, honeysuckle and the ragweeds that cause hay fever.

WEEDONE is mixed with the recommended amount of water and the resulting emulsion is applied as a spray to the weeds.

Du Pont "Karmex"

Kills Lawn Weeds

A selective weed killer that kills the weeds without harming the lawn. Comes in convenient tablet form—easy to use and economical. One tablet in 2 quarts of water makes enough spray solution to treat approximately 100 square feet of lawn. Bottle of 25 tablets \$1; bottle of 100 tablets \$3.40.

Weed Killers

**KILLS DANDELION,
PLANTAIN, WITHOUT
INJURY TO LAWNS**

WEEDONE does not corrode metal spray equipment.

It does not leave a residue on the plants that is hazardous to man or animal. It is non-explosive and does not stain the skin.

Six ounces make sufficient solution for 500 sq. ft., 1 quart for 2,500 sq. ft.

6-oz. can.	\$0 75
1-qt. can.	2 50
1-gal. can.	7 50
5-gal. can.	30 00

Hammond's Weed Killer

Kills All Vegetation

Will kill weeds, poison ivy, and all vegetation without distinction, so it must be used cautiously where grass is desired. Used principally on tennis courts, driveways, walks, etc. Dilute 1 gallon to 30 to 40 gallons of water. Apply with a sprinkling-can.

Qt. 70 cts., gal. \$2, 5-gal. drum \$8.

ZOTOX

Crab Grass Killer

A liquid chemical that kills both the plant and seeds of crab-grass and checks reinfestation. Does not destroy lawn grasses and is non-injurious to soil. This new easy method does away with laborious raking and weeding. Simply mix ZOTOX with water and spray it on. A 16-oz. bottle treats 2,000 sq. ft. For "spot" treatment of small patches it goes much farther.

Zotox is also recommended in eradicating dandelion, plantain, chickweed and other perennial weeds. Full directions on bottle.

8-oz. bottle \$1, 16 ozs. \$1.50, 32 ozs. \$2.50, 5 lbs. \$4.50.

Du Pont Ammate Weed Killer

Ammonium Sulfamate

Effective for the control of poison ivy, ragweed, Canada thistle, dandelion, plantain and many other weeds. Use 1/2 to 1 pound to a gallon of water, depending on the density of growth and kind of weed. Apply with sprayer or sprinkling-can at rate of 1 gallon of solution to 100 square feet of infested area.

2-lb. bottle. \$0 75	50-lb. drum. \$12 00
6-lb. bottle. 2 00	350-lb. drum. 63 00

To Control Ants, Moles, Rats, Mice, Groundhogs, Etc.

Terro Ant Killer

Will drive ants in 24 hours from pantries, refrigerators, plants, flowers or any other place infested with them. A clean preparation in syrup form that cannot be blown into food or about the house and can be used without soiling or discoloring floors or receptacles. Terro is guaranteed to do the work or money back. Small size 25 cts., large size 50 cts. Postage 10 cts. extra.

Antrol Ant Killer

Antrol is easy to use, economical, and safe around children and pets. It consists of small glass containers from which the worker ants carry Antrol Syrup to their nests for food. The whole ant family is quickly killed at the source—the only way to get permanent freedom from these pests.

The containers may be refilled and used year after year. Adapted to any size home or garden. Guaranteed.

Antrol Ready-Filled Set consists of 4 special glass "feeders" containing regular Antrol Syrup. 40 cts. per set. Postage 10 cts. extra.

Antrol Syrup. 4-oz. bottle 20 cts.

Magikil Jelly

(Ant Bait)

A jelly bait that needs no feeders or traps. Simply place small doses in infested areas. Does not melt at ordinary temperatures. Endorsed by many state experiment stations. Garden tube 40 cts., estate tube \$1.



Cyanogas Ant-Killer

Ants die instantly when you drop a little Cyanogas Ant-Killer into the entrance to the nest. It is simple and sure. The gas does the work—penetrates all through the nest. 4-oz. tin 30 cts. (Not mailable.)

Carbon Disulphide

Recommended for killing ants, moles, woodchucks, and ground squirrels. For ants in hills, punch holes at intervals of 10 inches and pour a tablespoonful in each hole, then cover with burlap or similar covering. 1-lb. tin 50 cts., 5-lb. tin \$1.75, 10-lb. tin \$2.50. (Not mailable.)

Exterminate Moles with

Mole-Nots

Kills moles quickly. Safe and easy to use. Simply shake a few of the pills in runways at intervals of 2 to 3 feet. Mole-Nots safeguard bulbs when placed in ground at time of planting. Pkg. (8 "Nots") 35 cts., pkg. (50 "Nots") \$1.

Mologen

A safe and effective method of eliminating Moles in lawns and flower-beds. Comes in powder form. 1/2-lb. can 50 cts.

Cyanogas A Dust

Exterminates moles, ground-hogs, rats, mice, ants, fleas, wasps, and various other pests. It is Calcium Cyanide which liberates hydrocyanic acid gas when exposed to the natural moisture in the air and kills the pests wherever they are. They breathe the gas and die instantly.

1-lb. tin.	\$0 75
5-lb. tin.	3 00
25-lb. pail.	10 00
100-lb. drum.	25 00

Not mailable.

Cyanogas Foot Pump Duster. \$7.

Tat-Antu (Formula 83)

Ready to use—no mixing. Contains ANTU, remarkably effective new rodenticide, tested and used by U. S. Public Health Service. Kills two ways—as feeding bait and as drinking bait.

Trial-size pkg. 35 cts., 4-oz. pkg. \$1.

Pastoxine

Exterminator of rats and mice. Non-poisonous as well as repulsive to man, domestic animals, and poultry. Appetizing to rodents. Causes asphyxia (they run out for air and water to die). Highly concentrated. 1-oz. jar 60 cts., 1-lb. jar \$5, postpaid.

Mouse Seed

Safer and more convenient than traps or any paste or powder preparations. Ready to use. 25 cts., postpaid.

Seed and Soil Disinfectants and Seed Inoculation



"Semesan Jr." corn treatment increased the yield of this field corn 21.3 bushels per acre over untreated seed

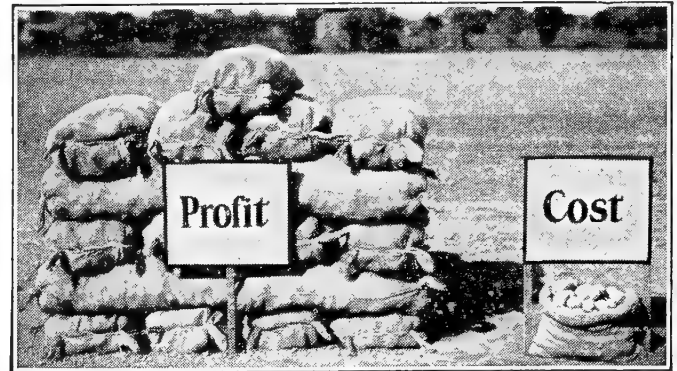

Only 0.4 bushel of the 35.4 bushels increase was needed to pay for the "Semesan Bel" that gave this better potato crop

New Improved "Ceresan"

A dry disinfectant for seed wheat, barley, rye, and oats. Effectively kills certain seed-borne diseases by both contact and vapor; generally controls covered smuts, and frequently increases yields. One pound treats 32 bushels of seed grain. 4-ozs. 35 cts., 1-lb. 90 cts., 4 lbs. \$3, 25 lbs. \$16.65, 100 lbs. \$61.05.

"Semesan Jr."

A double-acting seed disinfectant for certain seed-borne diseases of corn. Usually reduces seed rotting, checks seedling blight and certain seed-borne rots of root and stalk. Has increased yields an average of 3 bushels per acre. Costs only about 9/10 cents an acre. 1½ ounces treats a bushel of seed. 1½ ozs. 17 cts., 12 ozs. 62 cts., 6¼ lbs. \$4.16.

DU PONT SEMESAN SEED DISINFECTANTS

Du Pont Semesan Fungicides

"Special" Semesan

The efficiency of "Special" Semesan in the control of brown patch and dollar spot is recognized by many state experiment stations and hundreds of greenskeepers and home owners. Usually provides a wide margin of safety with little danger of yellowing or thinning turf when applied as directed. One pound treats up to 6,000 square feet. 8 ozs. \$1.10, 6 lbs. \$10.35, 25 lbs. \$39.96, 100 lbs. \$149.85.

Nu-Green. 3 ozs. 40 cts., 1-lb. \$1.60.

"Semesan Bel"

Easy, quick-dip treatment for seed potatoes. Costs only about 21 cents an acre. Generally reduces seed-piece decay, seed-borne scab, and rhizoctonia. No mussy soaking—just dip, drain, dry, and plant. One pound treats 60 to 80 bushels of seed. 2-oz. pkg. 35 cts., 1-lb. can \$1.83, 4-lb. can \$6.33, 25-lb. drum \$36.90, 100-lb. drum \$138.75.

"Semesan"

Aids in reducing rot of flowers and vegetables, gives them a healthy start. Treat seeds, corms, bulbs, and seedlings. "Semesan" generally reduces seed rotting and damping-off. One ounce treats 15 to 60 pounds of seed. ½ oz. 12 cts., 2 ozs. 45 cts., 12 ozs. \$2.10, 4 lbs. \$10.10, 25 lbs. \$58.28.

Hammond's Formacide Stabilized Formaldehyde Dust

Used as a control of certain fungous diseases known as damping-off of seedlings and cuttings. For treating soil to be used in pots and flats mix 8 ounces of Formacide thoroughly with each bushel of soil. Also an effective control for smuts of oats and barley. Complete directions on package. ½ lb. 50 cts., 1-lb. 85 cts., 5 lbs. \$2.50, 50 lbs. \$17.50.

Suspension Calo-Clor

An intimate mixture of calomel and corrosive sublimate, recommended for the prevention and control of large and small brown patch. Contains 81 per cent mercury metal. Can be used satisfactorily in power sprayers.

25-lb. drum \$75.75. (Not available.)

Corrosive Sublimate

Mercuric Chloric, Bichloride of Mercury

Used for the prevention and control of brown patch on turf; for the control of thrips on gladiolus bulbs, root maggots in seed-beds, and seed-borne diseases of seed potatoes. Contains 74 per cent mercury metal.

¼-lb. bottle..\$1 10 | 5-lb. bottle \$13 60
1-lb. bottle.. 3 00 | 25-lb. drum. 58 50
Not available

Always Inoculate with



For Alfalfa, Soy Beans, Clovers and all other Legumes

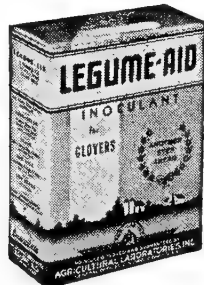

All legumes are heavy nitrogen users and if not inoculated, they rob the soil like any other plant. Inoculating legumes with Legume-Aid Bacteria enables legume plants to draw free nitrogen from the air and make it available as food.

For Alfalfa and All Clovers. 1-bus. size 50 cts., 2½-bus. size \$1.

For Soy Beans, all varieties. 2-bus. size 30 cts., 5-bus. size 55 cts., 25-bus. size (5 5-bus. sizes) \$2.50.

For Vetch, Field and Garden Peas. 100-lb. size 50 cts.

For Lespedeza, Cowpeas, Lima Beans, and Peanuts. 100-lb. size 30 cts.

For Garden Beans, Lima Beans, Garden Peas and Sweet Peas. Home Garden size (for 5 lbs. of seed) 10 cts., 1-bus. size 50 cts.

When ordering don't fail to state the kind of seed to be inoculated

Insure your crops with

Du Pont P. A. C. Formaldehyde

Invaluable as a disinfectant, fungicide, germicide and deodorant on the farm and in the home.

For Grain-Smut Control. An efficient control for smuts of wheat, barley, oats, and rye. Can be applied by the sprinkle, dip, or spray method, as you wish. A one-pound bottle will treat 50 to 55 bushels of seed grain.

For Seed-Potato Treatment. Controls scab, rhizoctonia, and some forms of black-leg and dry rot which cut down the stand, cripple the potatoes, and reduce the yields. Potatoes are usually treated just before planting but this work may be done at any time in the winter or spring.

For Soils and Vegetables. Prevents damping-off of seedlings in seed-beds and greenhouse benches; controls onion smut, root-knot, and other diseases.

Mushroom Disease Control. Fumigation with Formaldehyde has been found to be the most satisfactory means of control of the "bubbles" disease.

Lb. bottle 35 cts., 10 1-lb. bottles \$3, case (25 1-lb. bottles) \$6.70, 60-lb. keg. \$9.

Ask for booklet and full directions.

Tree Tanglefoot

A sticky material for banding trunks of trees, to protect them against the ravages of climbing insect pests.

No mixing is required. It comes ready for use and is easily and quickly applied with a wooden paddle. One pound makes 15 to 20 lineal feet of band.

6 ozs. 45 cts., lb. 80 cts., 5 lbs. \$3.75, 10 lbs. \$7, 25 lbs. \$15.

Balsam Wool Tree Bands



Used with Tree Tanglefoot where indirect banding is desired. May be removed after insect season is over. Also makes an impenetrable barrier band for rough-barked trees. Width, 3 inches. Comes in rolls containing 16½ lineal feet. Per roll 50 cts., 12 rolls \$5.40.

Trowbridge's Grafting Wax

Used by softening in warm water, or by the warmth of the hand. It can then be drawn out as thin as paper and spread on the cut and around the graft.

½-lb. pkg. 45 cts., 1-lb. pkg. 70 cts., dozen 1-lb. pkgs. \$6.50.

Bartlett Tree Paint

Contains ingredients necessary to protect trees after pruning and to heal tree wounds. Used by orchardists, tree surgeons, and state foresters.

Liquid. ½-pt. 55 cts., pt. 85 cts., qt. \$1.50, gal. \$3, 5 gals. \$9.50.

Plastic. Used for cavities and crevices. Pt. \$1, qt. \$1.85, gal. \$3.60.

Stanley's Crow Repellent

Protects seed corn during the period when it is most easily damaged by crows, pheasants, blackbirds, and all other corn-pulling birds.

Apply to the seed before planting. It will not kill birds or animals. One pint treats 2 bushels of seed.

½-pt. bottle 60 cts., 1-pt. bottle \$1, 1-qt. bottle \$1.75.

Peter Rabbit Repellent

Applied on trees, will prevent rabbits from girdling them. Apply in the fall. One quart will treat about 50 trees.

1-pt. bottle 85 cts., 1-qt. bottle \$1.50, 1-gal. bottle \$4.50.

Dogzoff

An efficient repellent against dogs, cats or rabbits. Not poisonous to plants and will not injure animals. Not offensive to humans. Applied with any small sprayer. Bottle 60 cts., postpaid.

Waterproof Tree Wrap

Protects the trunks of newly planted trees against frost, sun scald, borer attack and rodents. Easily applied. 4 in. wide. Roll, 150 feet, 75 cts., pkg., 11 rolls, \$7.15.

Tobacco Dust

A specially ground Tobacco Dust, guaranteed to contain not less than 1 per cent nicotine. It is particularly useful wherever a dusting powder is desired to destroy plant-lice. Owing to its extreme fineness it readily floats in the air, enveloping the entire shrub or tree in a dense cloud.

2-lb. carton 25 cts., 10-lb. pkg. 75 cts., 100-lb. sack \$3.90, 500 lbs. \$18.25.

Whale-Oil Soap

Effective in destroying many sucking insects and lice on plants, trees, ferns, etc. It is an excellent wash to use on rose bushes, porch flowers, vines, rubber plants and palms. Also used as a spreader and adhesive where required.

½-pt. can 35 cts., 1-pt. can 65 cts., 1-qt. can \$1.25, 1-gal. can \$4, 5-gal. can \$16.

CPO Insecticide Soap Spreader

A dependable Soap Spreader or wetting agent for use with nicotine, pyrethrum, rotenone and other contact insecticides in common use. Non-poisonous, odorless; used on evergreens, shrubs, trees, flowering plants and in the greenhouse.

Solid. 25-lb. drum \$7.50, 50-lb. drum \$12.75, 100-lb. drum \$21.

Liquid. 1-pt. can 75 cts., 1-qt. can \$1.25, 1-gal. can \$2.75, 5-gal. drum \$9, 10-gal. drum \$16.50, 30-gal. drum \$42.

Spray Catalizer

A spreader, sticker and peacemaker of sulphur composition. It acts as a safener in lime sulphur-arsenate of lead mixtures or sulfocides—arsenate of lead mixtures and reduces the danger of burning, especially in damp, slow drying weather. Takes the place of casine and lime spreaders.

2-lb. bag 75 cts., case (24 2-lb. bags) \$14.75, 50-lb. bag \$13.50.

Rootone

The plant hormone powder. Use it for better rooting of cuttings, seeds, bulbs, corms, and tubers. Just dip the base of the moistened cutting in Rootone and set in sand or soil. To treat seeds and bulbs just dust with Rootone before planting.

¼-oz. pkt. 25 cts., 2-oz. jar \$1, 1-lb. can \$5.

Rootone No. 10. For woody cuttings such as azalea and evergreens. 2-oz. jar \$2, 1-lb. can \$10.

Grow Seedless Tomatoes with FRUITONE

This plant hormone spray will help to develop a better set and a bigger crop of tomatoes. If the spray hits the blossoms after blooming and before pollination, the tomatoes will be seedless. Simple and easy to use. Also a spray for stopping pre-harvest drop on fruit trees.

¾-oz. pkt. (makes 5 gals.) 25 cts., 2-oz. can (makes 25 gals.) \$1, 12-oz. can \$5.

JAPONEX

Milky Disease Spore Powder for Control of the Japanese Beetle

Japonex kills the Japanese beetle grubs, which live principally in turf where they feed on the grass roots, frequently destroying entire areas of lawns. Japonex lasts indefinitely and is not harmful to humans, animals, or plants.

½-lb. pkg. (treats 2,000 sq. ft. of lawn area) \$3.25, 5-lb. drum \$27, 25-lb. drum \$118.75.

ELLISCO

Japanese Beetle Traps

The most efficient means of destroying full-grown Japanese beetles. The bait in the Trap attracts the beetles to the Trap; the beetles pass through the Trap into the cage where they can be destroyed easily.

No. 4 Trap. \$1.20 each, \$6.90 for 6, \$13.20 per doz.

Price of Traps does not include cage, stand, or bait.

Ellisco Granular Bait. 4-oz. can 40 cts., 1-lb. can \$1.20, 5-lb. can \$4.75.

Perforated Cages. 2-qt. capacity. 50 cts. each, \$2.70 for 6, \$4.80 per doz.

Stands. 35 cts. each.

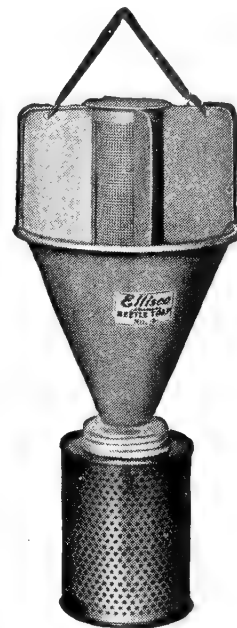

No. 4 Trap with Perforated Cage

Aeroil Weed Burner

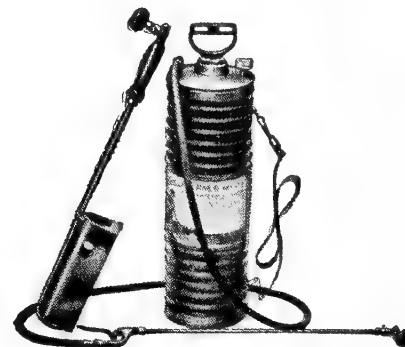

A proved method of destroying weeds and weed seeds quickly and economically; for disinfecting animal quarters and many other uses. Uses kerosene for fuel. Produces a powerful reddish blue flame, 3 inches in diameter, 30 inches long, of intense heat (2000°F.). Size of flame easily controlled by a regulating valve. Anyone can operate it—absolutely safe. Average oil-consumption 1 gallon per hour. Well constructed, light, compact, portable.

No. 99. 4-gal. extra-heavy Galvanized Steel Tank, 2-inch Brass Pump; Pressure Gauge; 7-ft. High-test Hose. \$22.

No. 99BS. Outfit No. 99 with spray attachment, as illustrated. \$25.50.

DELIVERY: At prices given in this Catalog, Insecticides and Fungicides are delivered prepaid on orders amounting to \$2 or more. On orders less than \$2, include postage at rates given on page 92 under Parcel Post Shipments.



Garden and Field Hoes

No. G. 4 1/3-ft. handle, steel socket, best quality. 6 1/4-in. blade, \$1.50 each; 7-in. blade, \$1.55 each.



One-Piece Steel Mattock

Just the tool for heavy soil. Has two oil-tempered blades. Strong and light. 4 1/2-ft. ash handle. No. DE3H. \$2.75.

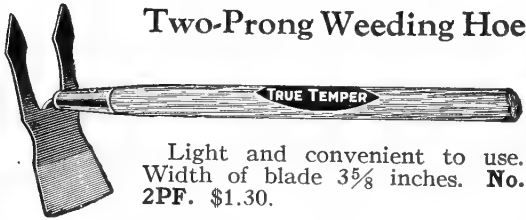

Two-Prong Weeding Hoe

Light and convenient to use. Width of blade 3 5/8 inches. No. 2PF. \$1.30.



Italian Grape Hoe

Blade and eye forged from one solid piece of steel. Blade, 7 in. wide x 9 in. deep, 3 1/2-ft. ash handle. A heavy tool for heavy work. No. 1GH7. \$2.90.

Potato Hook

Five round tines; goose neck pattern. 4 1/3-ft. handle. No. 5GNR. \$1.90.



Rakes

No. T14. 14-tooth Level Head Steel Garden... \$1 50

No. B15. 15-tooth Bow

Pattern Steel Garden... 1 90

McGuire's Bamboo Rake. 18-in. 1 75
24-in. 2 25
30-in. 2 75

"All-Purpose" Lawn Rake. Width adjustable from 8 in. to 18 in. Metal handle, rustproof tines. 1 95

No. LC24 Lawncomb. Steel frame and well-braced, flat steel teeth, 24 inches wide. 2 40

No. 25X Lawn Groomer. Flat spring steel teeth, 17 inches wide. 75

No. CG. Crabgrass Rake. 26 teeth. 1 55

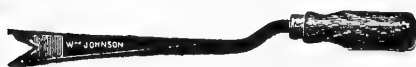

Norcross V-Point Weeder

No. 25N. Used also as an asparagus cutter. Length overall, 14 inches. 35 cts.

Dibbles

No. 218. Wood handle, usual size. \$1 25

No. 219. Wood handle, small size. 1 10

No. 220. All iron. 1 00

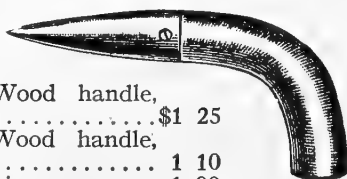

Featherlite Garden Tools

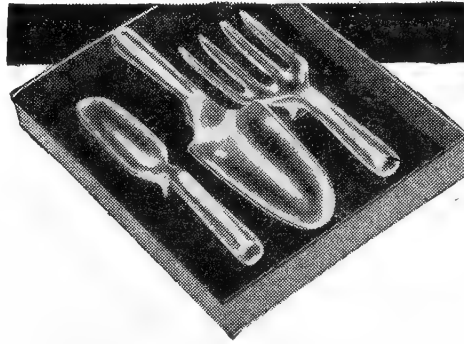

Made in one piece of an aluminum alloy and polished. Strong, light weight, non-rusting, will not bend; patented finger rest.

- No. 101. Garden Trowel. \$2 00
- No. 102. Transplanting Trowel. 1 50
- No. 103. Cultivating Fork. 2 00
- No. 104. Matched set of 3 tools. 4 95

Johnson Garden Trowels

- No. 211. Blade and shank forged from one piece of steel; heavy steel ferrule. 6-in. \$1 25
- No. 215. Riveted shank. 6-in. 40
- No. 217. Transplanting. 6-in. 35
7-in. 45

FORKS



Spading Forks
No. MS. Diamond back tines 12 in. long, steel D-handle. \$2 00

Hay Forks. Oval tines, tubular ferrule.
No. 034B. 4-ft. handle. \$1 85
No. 034 1/2 B. 4 1/2-ft. handle. 1 95

Manure Forks. Oval tines, tubular ferrule.
No. 044. 4-tine, 4-ft. bent handle. \$2 10
No. 04D. 4-tine, iron D-handle. 2 20
No. 064. 6-tine, 4-ft. handle. 2 60
No. 06D. 6-tine, iron D-handle. 2 70

Ensilage or Barn Forks. Steel D-handle.
No. 508. 8 16-in. tines. \$3 85

Spades

Garden. D-handle, blade 7 1/4 x 12 in. \$2 10
Garden. Long handle, blade 7 1/4 x 12 in. 2 10

Norcross Hand Garden Cultivator

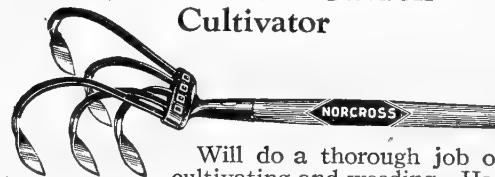

Will do a thorough job of cultivating and weeding. Has forged prongs and 4-foot ash handle.

- No. 59N. 1-prong. \$0 70
- No. 33N. 3-prong. 1 50
- No. 55N. 5-prong. 1 75



Speedy Cultivator

A very useful tool for work around flowerbeds, shrubs, and roses.

- No. SC4. With 4 tines. \$1 70
- No. FW3. With 3 tines. 1 45

No. 300A Planet Jr. Drill Seeder



Price \$29.00
Weight, 34 lbs.
Capacity, 4 quarts

15-in. driving wheel.
9-in. concave rear wheel

The No. 300A Seeder is a very efficient plate Seeder intended primarily for the market-gardener and farmer. Quick, easy, and accurate adjustment for all sizes of seed can be made in an instant. Plates provide 39 different holes through which a patented feed-wheel drops seeds in a steady, even row without crushing or jamming. It has removable hopper for emptying excess seeds.

No. 17 Planet Jr. Single-Wheel Hoe



Price \$11.50
Steel Frame
15-in. Steel Wheel

Used by home gardeners and commercial growers. Inexpensive yet a complete gardening cultivator. Easy to handle—strong and sturdy. It is the most popular of all Wheel Hoes. Complete with tools as illustrated, \$11.50.

Planet Jr. No. 12 Double and Single-Wheel Hoe. A Single and Double-Wheel Hoe in one. Straddles crops till 20 inches high, then works between. Complete with 2 pairs scuffle hoes, 5 cultivator teeth and 1 pair hilling plows. \$16.50.

The BARKER Weeder, Mulcher Cultivator

It cultivates and pulverizes the soil, forming a soil-mulch which holds moisture. The under-groundknife cuts all weed roots, and the reel blades clear the dirt from the knife, making a perfect job of weeding.

The Barker has 7 1/4-inch rugged disc wheels; new patented filler drum, and oscillating leaf-guards. Cutting parts of best-grade steel for its purpose.

No. 8 1/2. An excellent size for general garden work. It cuts an 8 1/2-inch strip. \$8.95.

No. 10. Knife cuts a 10-inch strip. A very popular size. \$9.65.

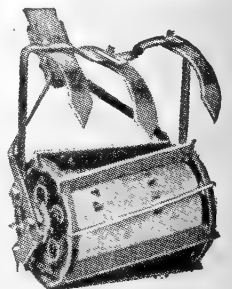

Barker Weeder

Ideal Weeder



Forged steel; all edges beveled.
No. 200. 60 cts.

HEDGE SHEARS

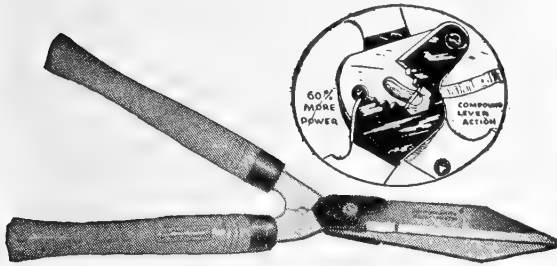

Seymour Smith Multi-Power. Blades of hardened tempered cutlery steel, with thin, keen edges. Patented compound lever provides "soft," smooth, non-jolting action. **No. 26.** 6-in. blades \$2; 8-in. blades \$3; 9½-in. blades \$3.25.

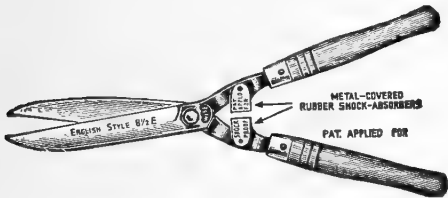

Wiss English Pattern. Blades are full forged, hollow ground, polished, hardened and tempered. Handles are of hardwood, riveted through nickel-plated steel ferrule, handle and tang. Rubber shock absorber reduces arm fatigue. **No. 8½E.** 8½-in. blade \$4.50.

Cyclone Hedge Trimmer

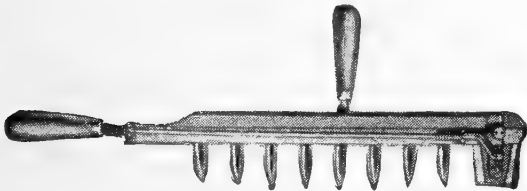

Eliminates slow, tiresome trimming of hedges, shrubs, and bushes, and assures even and uniform results. Cuts through the thickest and toughest growth many times faster than with shears. Each full stroke of the knife cuts a 32-square-inch swath straight and level on either top or sides. Knife made of the highest quality tool steel, hardened and ground. Weighs 3½ lbs. \$9.75.



A powerful and dependable electric hedge trimmer. Does a much better job faster and much more easily than hand shears. Has ¼ H.P. motor. Cutter blade 12 in. long. Weighs 6 lbs. Price, with 6 ft. of rubber-covered cord and toggle switch, \$34.50.



Eezy-Wear Garden Gloves

Soft and durable, excellent for garden work. In sizes 6, 7, 8, 9, and 10. \$1.25 per pair, postpaid.

Neegards

An absolute necessity for those who do any work that requires kneeling on the ground or floor. Knee cupped, adjustable straps, made of finest grade sponge rubber and designed for comfort and durability. \$2 per pair.

GRASS SHEARS

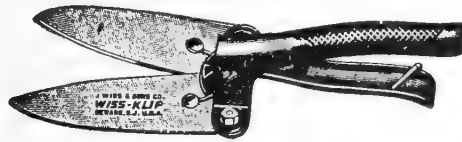

Doo Klip Grass Shears. Operates with an easy up-and-down movement. \$1.75.

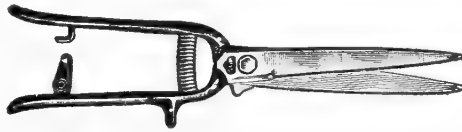

No. 5600 Wiss. Dropped forged from cutlery steel, hardened and tempered, hollow ground, polished blades. Offset handles eliminate bruised knuckles. Length 12 in. \$2.25.



Turf Edger

No. 040F. For trimming edges of walks and driveways. Flat top blade. 4-ft. handle, \$1.65.

GARDEN HOSE



Vigilant Garden Hose. The most popular two-ply Garden Hose made. Heavy moulded construction throughout. Will stand lots of use and give years of service. ½-in. diam., 25-ft. length, \$4.80; 50-ft. length, \$9. Coupled.

Vixen Garden Hose. An ideal Hose for the average home-garden or lawn. Heavy single-ply construction. From the standpoint of service it is fully equal to many of the lighter grades of two-ply Hose. ½-in. diam., 25-ft. length, \$3.90; 50-ft. length \$7.20. Coupled.

Boston Nozzle. Made of brass, quickly adjustable. \$1 each.

The Salem Real-Reel Hose Reel

Permits use of whatever length of hose is desired without unreeling all of the hose to make connection to faucet. Increases life of hose, eliminates kinks and twists, convenient to use. All-metal construction. Holds 150 feet of ½-in. hose. \$12.50

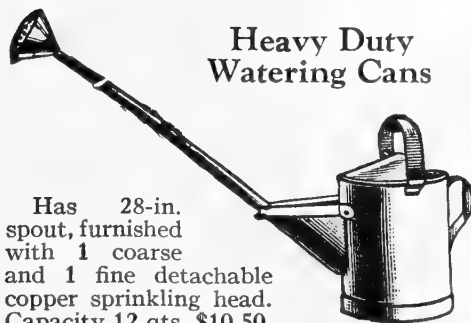
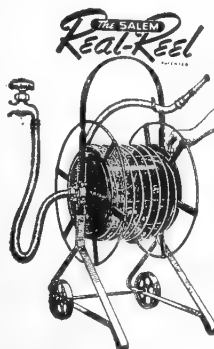

Heavy Duty Watering Cans

Has 28-in. spout, furnished with 1 coarse and 1 fine detachable copper sprinkling head. Capacity 12 qts. \$10.50.

LAWN SPRINKLERS

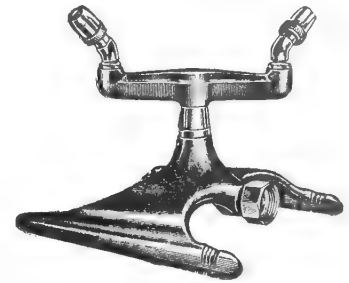

Parkside Lawn Sprinkler

Nozzles can be adjusted for a fine mist or coarse stream, and to cover a large circle or small area. Will operate on high or low pressure. **No. 7003.** \$4.50.

Rain King Lawn Sprinkler

A new automatic Lawn Sprinkler. Set control button for any desired area 5 to 50 feet in diameter and it then automatically sprinkles that area without further attention. All exposed brass parts are chromium plated. Height 10 in. **Model K.** \$6.75.

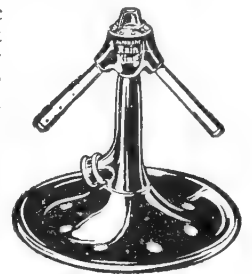

The Waterfan Lawn Sprinkler

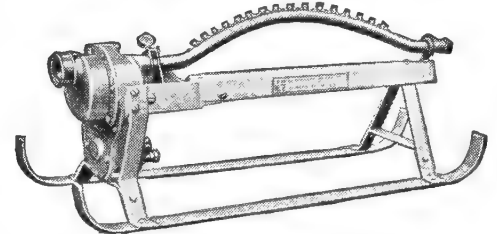

A portable, oscillating lawn and garden Sprinkler. Operated by a turbine motor. Motor built of brass and phosphor bronze. Covers an area 40 by 50 feet. Works best on 30 to 35 pounds water pressure. Discharges 6 gallons per minute. **No. 7.** \$18.

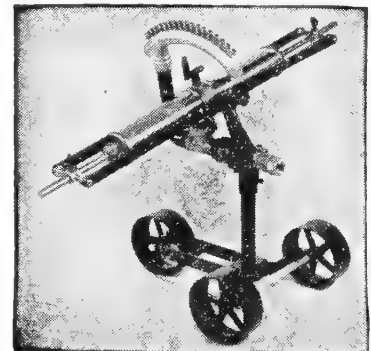

White Showers Rainbow Sprinkler

So designed that it sprinkles in a square instead of circle. The Rainbow has 17 nozzles, mounted on an oscillator and waters an area as large as 50 feet square, but it can quickly be adjusted for smaller areas and also for narrow strips and borders. Discharges 6 gallons per minute. Weight 25 lbs. \$45.

Wheelbarrows

Dowcraft DeLuxe Lawnbarrow



A light, easy-to-handle Wheelbarrow designed especially for home-garden and lawn use. Its sturdy construction, modern lines and finish make it the latest and smartest thing in garden equipment. Made of magnesium; has pneumatic rubber tire. Weighs only 16 lbs. \$34.50.

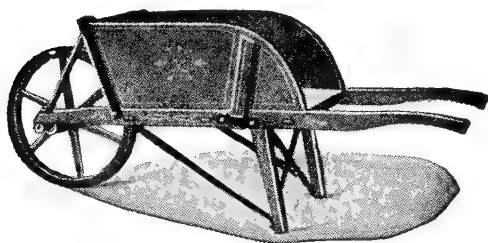

Pittsburgh Garden Barrows

These Barrows are made of thoroughly seasoned wood and are firmly bolted together and iron braced. They are substantially built and neatly finished.

No. 2. Body 28 in. long, 20 in. wide in front, 24 in. wide at back; sideboards 12 in. high; wood wheel 20-in. diam., 1 3/4-in. tire. Weight 50 lbs. \$13.

No. 3. Body 26 in. long, 19 in. wide in front, 22 in. wide at back; sideboards 12 in. high; wood wheel 20-in. diam., 1 3/4-in. tire. Weight 50 lbs. \$12.50.

16 x 4 in. Pneumatic rubber tire wheel on No. 2 or No. 3 in place of wood wheel, extra \$13.50.

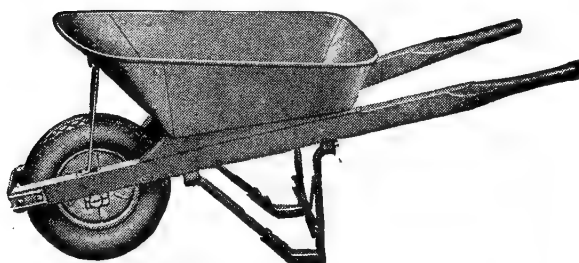

Steel Tray Barrows

General-purpose Barrows adapted to cement or construction work, hauling coal, manure, etc. Has one-piece solid pressed steel tray and heavy channel steel legs with wearing shoes and plank rest.

No. 154. Round front tray. Capacity 4 cu. ft. Weight 70 lbs. \$12.60.

No. 174. Square front tray. Capacity 4 cu. ft. Weight 70 lbs. \$11.90.

16 x 4 in. Pneumatic Rubber Tire Wheel on No. 154 or No. 174 in place of steel wheel, extra \$12.25.

Masters "Handi-Cart"

The "Handi-Cart" really takes the hard work out of every job of moving dirt, sand, gravel, leaves, grass cuttings, trash, etc. Simply tip it down and rake into it to load. Easily emptied by tipping forward. Built extra strong, yet light in weight.

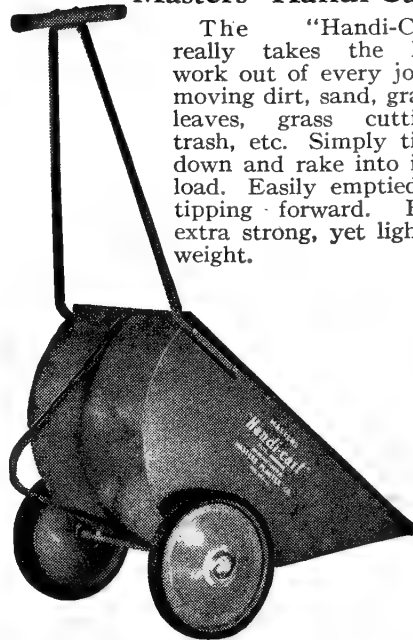

No. 18S. Capacity 3 cu. ft. \$7 25
No. 20D. Capacity 3 1/2 cu. ft. 9 50

Dunham Water-Weight Lawn Roller

Built for long service; easy to operate; has hollow, watertight steel drum with rounded edges, bayonet type drum plug and adjustable scraper. Not furnished with arched brace as shown in cut.

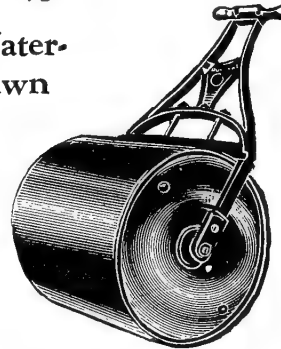

	Diam.	Width	Weight empty	Weight filled with water	Price
No. 2.	14 in.	24 in.	55 lbs.	165 lbs.	\$14 70
No. 4.	18 in.	24 in.	70 lbs.	230 lbs.	16 40
No. 7.	24 in.	24 in.	100 lbs.	400 lbs.	25 00
No. 9.	24 in.	32 in.	120 lbs.	530 lbs.	28 40

For better Lawns, use AGRICO FOR LAWN FERTILIZER. See page 59.

Parker Lawn Sweepers

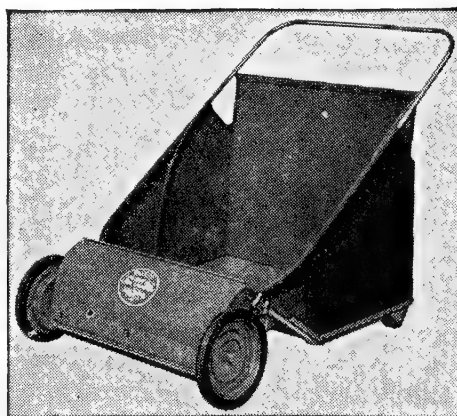

Collects leaves, grass clippings and other debris without harm to the growing grass.
Yardroom Model. Sweeping width 20 in.; collecting hopper 3 1/2-bus. capacity. \$36.
Springfield Model. (Illustrated.) Sweeping width 27 in.; collecting hopper 5-bus. capacity. \$46.

Pennsylvania Junior Lawn Mower

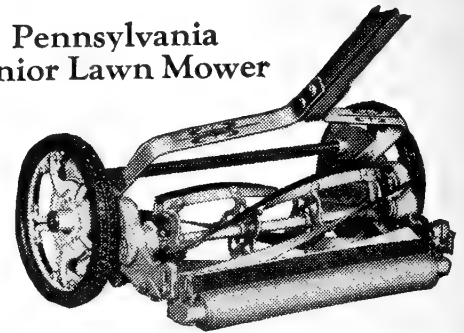

Precision built—strong and durable—will cut the thickest and toughest grass. The cylinder has 5 extra-wide, crucible analysis steel blades, driven by a train of 3 cut gears on both sides; dustproof gear case; steel axles; ball bearings on cutting reel. Height of cut adjustable from 1/4 inch to 1 1/2 inches. Has 10-inch wheels with rubber tires. 17-inch cut (weight 43 lbs.) \$34.95.

Pennsylvania Meteor Lawn Mower

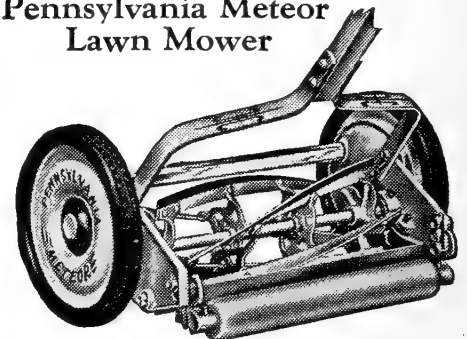

A lightweight, quiet, easy-running Lawn Mower. Aluminum construction; has ball bearings; fitted with oil cups for lubricating all bearings; adjustable for height of cut from 1/2 inch to 1 3/4 inches.

5-blade model 16-in. cut (weight 36 lbs.) \$30; 19-in. cut (weight 39 lbs.) \$31.90.

7-blade model. 16-in. cut (weight 38 lbs.) \$33.50.

Pennsylvania Lawn Trimmer and Edger

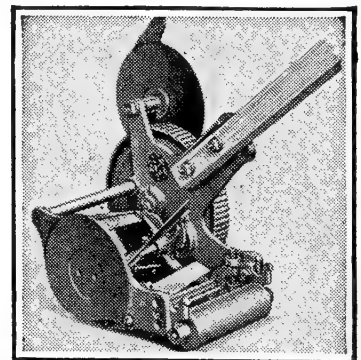

Designed for trimming the overhanging grass along the edges of walks, paths, flowerbeds, etc. Has steel disc and small plow for edging. Width of cut 6 inches. Weight 22 lbs. \$15.90.

Decorative Watering Pots



Designed for watering indoor plants. Made of metal. 1-qt. \$1.35, 2-qt. \$1.65, 4-qt. \$2.

MOTO-MOWER Power Lawn-Mowers

The Moto-Mower has been recognized as the leader in the field of Power Lawn Mowers for many years. They are designed and built to give satisfactory service and are used and recommended by careful buyers everywhere.

Moto-Mowers are "streamlined" for performance as well as appearance but not to the detriment of efficient operation. With 27 years' experience selling Moto-Mowers we enthusiastically recommend them.

Moto-Boy Model Moto-Mower

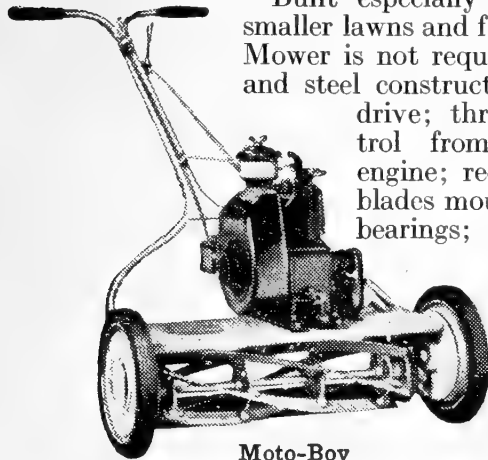

Moto-Boy
Model Moto-Mower

Built especially for home-owners with smaller lawns and for places where a larger Mower is not required. Sturdy malleable and steel construction; V-belt and chain drive; throttle and clutch control from handle-bar; $\frac{3}{4}$ H.P. engine; reel has 5 crucible steel blades mounted on Timken roller bearings; spring-mounted channel steel handles; wheels on roller-bearings with semi-pneumatic tires. Like all Moto-Mowers, many years' experience stand back of this model. 19-in. cut. Weight 115 lbs. Price, \$120.00.

Scout "Deluxe" Model Moto-Mower

Lawn-mowing becomes a pleasure with the smooth, easy-operating Scout Model. Built to give many years of efficient service. Powered with $1\frac{1}{2}$ H.P. engine. Sturdy malleable and steel construction; double V-belt and chain drive; throttle and clutch control from handle-bar; reel has 5 crucible steel blades mounted on Timken roller bearings; tubular steel handles; wheels fitted with roller-bearings and heavy semi-pneumatic tires. An outstanding model. 21-in. cut. Weight 140 lbs. Price, \$180.00.

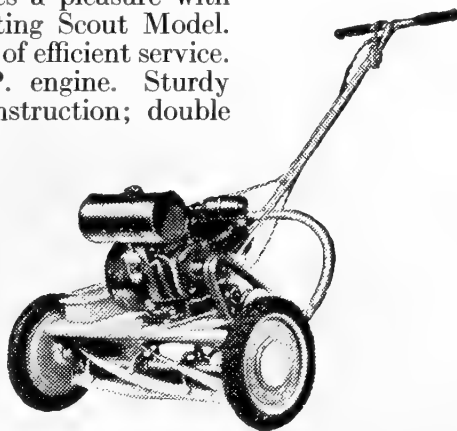

Scout "DeLuxe"
Model Moto-Mower

Super-Detroit Model
With Sickle-Bar



Possessing such sturdy construction and perfect balance, the Super-Detroit cuts every kind of grass efficiently and with least exertion to the operator. Strong and powerful though it is, "twist-of-the-wrist" guiding makes the Super-Detroit as responsive to the touch as a light Hand Mower. Consequently, the operator can now mow 6 to 7 acres per day with it every day of the season without experiencing fatigue. Recommended for country estates, parks, cemeteries and large lawns. The Super-Detroit outsells any other Power Mower in the same price class. Equipped with a 3 H.P. 4-cycle engine. Width of cut, 30 inches. Weight 360 lbs. Has cast-steel wheels with slip-on rubber tires. Price, \$465.00. Sickle bar additional.

City Model Moto-Mower

A great Mower with an enviable reputation which it has enjoyed for many years. It is a heavy-duty type of Power Mower for lawns of 2 to 3 acres. Possesses "twist-of-the-wrist" guiding. Powered with $1\frac{1}{2}$ H.P. engine. Automatic speed-control, which the City Model possesses in common with all the other Moto-Mowers enables the operator to set the engine at any speed he desires, and, by means of an automatic governor, the machine will run at that speed through all grades and thicknesses of grass. 22-in. cut. Weight 200 lbs. Price, \$265.00.

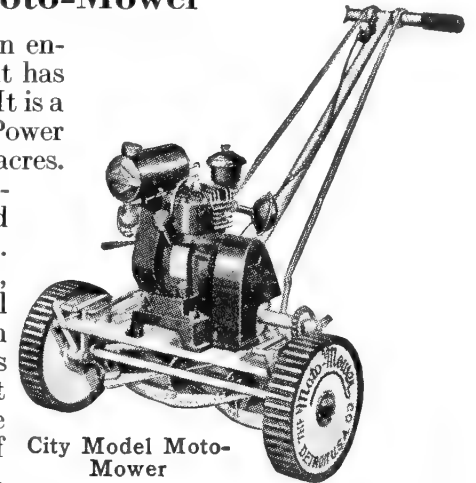

City Model Moto-
Mower

Standard Model Moto-Mower

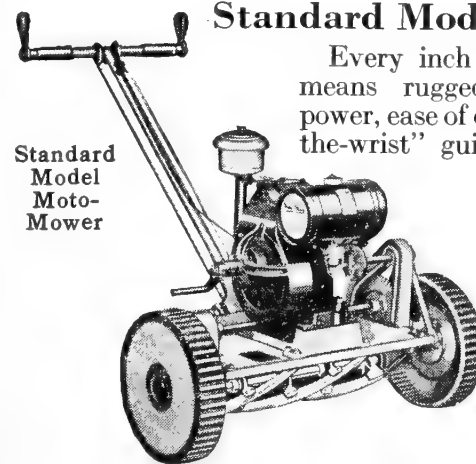

Standard
Model
Moto-
Mower

Every inch a Moto-Mower, which means rugged construction, ample power, ease of operation, and "twist-of-the-wrist" guiding. Particularly well adapted for cemetery use and will give a good account of itself on any lawn. Cutting capacity, 4 to 5 acres per day.

Is the same construction as the Super-Detroit and is powered with a $2\frac{1}{4}$ H.P. engine. Width of cut 24 inches. Weight 260

lbs. - Furnished with pressed steel wheels and slip-on rubber tires. Price, \$365.00.

The Super-Detroit Moto-Mower

The supply of Moto-Mowers is still not sufficient to meet the demand. Orders will be accepted for shipment when available and at prices in effect at time of shipment.

Dobbins Hand Sprayers

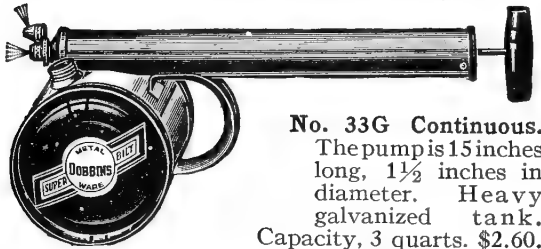

No. 33G Continuous.
The pump is 15 inches long, 1½ inches in diameter. Heavy galvanized tank. Capacity, 3 quarts. \$2.60. Postage 15 cts. extra.



No. 703 Continuous. Has 1-quart glass jar which is easily detachable and has a large filler opening. Two-way nozzle permits spraying up or straight ahead. \$1.65. Postage 15 cts. extra.

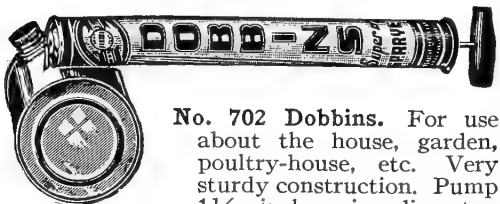

No. 702 Dobbins. For use about the house, garden, poultry-house, etc. Very sturdy construction. Pump 1½ inches in diameter.

Capacity 1 quart. 50 cts.
No. 710 Dobbins. Household Sprayer. Capacity 10 ounces. 35 cts.



The Arnold Garden Hose Insecticide Sprayer is a special mixing and spraying device which is attached to the garden hose in place of the regular nozzle. Arnold Soluble Insecticide Cartridges are placed in the cartridge chamber and as the water passes through the chamber under pressure the Cartridge is dissolved in the correct solution and forced out of the nozzle in the form of a fine, cloud-like spray. It is ruggedly constructed, light in weight, and undoubtedly the most practical labor-saving tool ever developed for gardeners.

Arnold Sprayer. (Chrome plated.)
Without Cartridges..... \$4 50
36-inch Straight Extension. For spraying tall shrubbery, etc..... Each.. 1 75
P-R (Pyrethrum-Rotenone), DDT, Arsen-O-Spray, Fungus-spray, and Sulph-O-Spray Cartridges, 35 cts. each; 1 doz. (any selection) \$4.

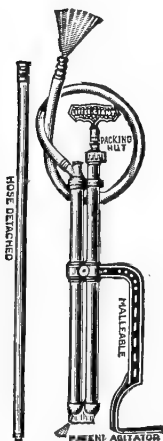

Myers Little Giant Bucket Spray Pump

A sturdy Sprayer for spraying fruit trees, shrubs, etc. Can be used for whitewashing. Made entirely of brass. Will throw a solid stream 50 feet. Has jet agitator to keep the solution thoroughly mixed and agitated. Furnished with hose and fine spray nozzle. **No. 327½.** \$6.05. Whitewash nozzle extra, \$1.45.

The Myers Compressed-Air Sprayer

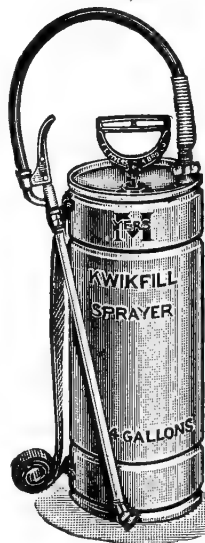

The Myers Compressed-Air Sprayer meets all demands for this style of Sprayer. The tank is made of heavy galvanized iron. The sidewall is closeriveted and soldered. The top and bottom are made of extra-heavy material. Has 1¼-inch brass tube air pump. Equipped with 24-inch length of hose, 18-inch pipe extension and angle brass nozzle.

The concave top forms an 8-inch funnel which permits easy filling. The removable discharge tube and hose connection permit thorough drainage and cleaning of the tank.

No. 2240. 2½-gal. Galvanized Tank..... \$7 85
No. 2242. 4-gal. Galvanized Tank.... 8 80

Dobbins "Super" Big Head Sprayer

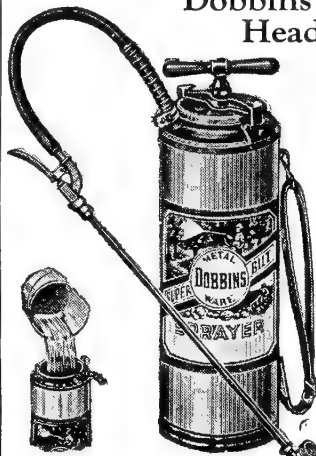

All of the latest improvements in Sprayer construction and design are built into this "Super" Sprayer. The tank opening is 5½ inches in diameter, which permits easy filling and cleaning. The pump is made of seamless brass tubing, 1¼ inches in diameter, 16 inches long, with patented air-valve. Has double grip handle so

that both hands can be used for pumping. Furnished with 22-inch length of hose, 24-inch brass extension, and brass adjustable nozzle.

No. 44G. 4-gal. Galvanized Tank... \$10 10
No. 44B. 4-gal. Copper Tank..... 18 40

Dobbins Fun-L-Fill Sprayer



A good quality Sprayer throughout and designed to meet the demand for a Sprayer at a favorable price. Equipped with Fun-L-Fill for convenience in filling. Tank is made of heavy galvanized steel and all seams are electrically welded. Seamless brass tubing pump. Has 20-inch length of spray hose, 20-inch brass curved extension rod, and brass nozzle.

No. 21G. 2-gal. Galvanized Tank..... \$6 35

Dragon Garden Sprayer



An efficient Sprayer that will handle all types of liquid spray material. Nozzle instantly adjustable from finest fog spray to powerful full stream which will carry 35 feet. Has 4½-gallon galvanized tank, 4 feet of hose, adjustable nozzle, and brass shut-off. Develops 150-lb. pressure. \$23.

Armstrong Sprayer

An Efficient and Inexpensive Sprayer for Tall Trees



A very simple and powerful Sprayer. Ideal for spraying liquid insecticides of all kinds. Will produce sprays of varying fineness—from a mist to a straight

stream that will reach the top of the tallest orchard tree from the ground.

The Spray Pump is made entirely of brass. Equipped with standard brass nozzle and 5 discs for producing various types of spray. Used with any pail or bucket. \$5.50.

Cornelius Sprayer

A powerful, compact, precision built, hydraulic - aerosol Sprayer designed for applying household insecticide deodorants, and D.D.T. sprays. Very easy to operate, works perfectly at any angle, produces a fog spray and will give years of good service. 8-oz. capacity \$2.50.



Dupor Respirator

Made of soft, high-grade rubber. Does not hinder vision or conversation. Provides protection against dusting and spraying hazards. \$2.

Wheelbarrow Sprayers

These outfits are adapted for spraying small orchards, truck gardens, vineyards, greenhouses, and for whitewashing and disinfecting poultry-houses, dairy barns, hog pens, kennels, and other farm buildings. They will handle all agricultural insecticides, disinfectants, whitewash and cold-water paints without clogging.

The Myers Portable Sprayer



Has 12½-gallon tank made of heavy galvanized iron, reinforced at top and bottom by steel bands and hung in the frame on trunnions. The wheel and handles are made of wrought steel thoroughly braced. The pump is fitted with cog gear handle, dasher and jet agitators and is securely attached to the tank. Outfit is strong and substantially built throughout and will give many years of satisfactory service. Equipped with 15 feet of ⅜-inch hose, 8-foot iron pipe extension, and Vermorel nozzle. Nozzle can be graduated from a fine mist up to a solid spray. No. 336½B. \$33.90.

Dobbins Wheelbarrow Sprayers

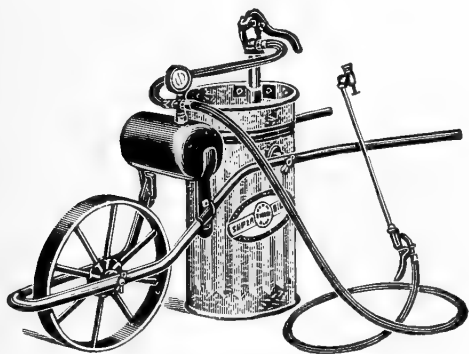

No. 3171R. 12-gal. heavy galvanized tank, fitted with 6 feet of ⅜-in. spray hose, shut-off and 2-foot brass extension rod with vermored nozzle and pressure tank with gauge as shown in illustration. Equipped with 16-in. by 1¼-in. semi-pneumatic-tired wheel. \$31.

No. 3170. 12-gal. heavy galvanized tank, fitted with 6 feet of ⅜-in. spray hose, shut-off and 2-foot brass extension rod with vermored nozzle. Has 16-in. by 2-in. steel wheel. \$17.85.

No. 3191. 18-gal. heavy galvanized tank, fitted with 8 feet of ⅜-in. spray hose, shut-off and 6-foot ¼-in. iron pipe extension with brass spray head with extra discs for fine and coarse sprays or solid stream. Heavy seamless brass tubing pump, 1-¾ in. diameter by 6 in. long, designed to maintain a continuous pressure of 200 pounds. Equipped with large 12-in. in diameter by 18 in.-long pressure tank made of boiler steel with welded joints. Has 16-in. by 4-in. pneumatic tire. \$60.

All of above outfits equipped with mechanical agitator

John Bean Power Sprayers

The Bean Farm Protector

No. 4-E

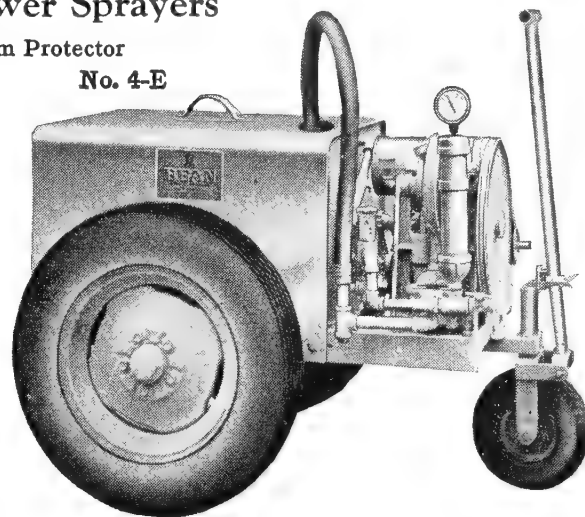

A ruggedly built, easy-to-handle outfit, designed expressly for the many spraying jobs around estates, small orchards, gardens and farms. Practical for spraying livestock quarters, poultry and dairy buildings and suited to do dozens of jobs that will save time, labor and expense. The portability of the Farm Protector makes it particularly useful for applying any of the 2, 4 D lawn weed killers. Simple and economical to operate. Powered with 1¾-h.p. Briggs & Stratton engine, has 50-gallon all-steel, leakproof, corrosion-resistant tank and pneumatic tires. Fitted with 50 feet of ½-in. high-pressure spray hose and Bean Spraymaster gun. Capacity 4 gallons per minute at 400 pounds pressure. Weight 475 lbs. No. 4-E. \$440.

No. 4-A. Same outfit mounted on wood skids instead of pneumatic-tired chassis. Can be transported in a small truck. Weight 350 lbs. \$365.

COMPLETE CATALOG OF JOHN BEAN POWER SPRAYERS SENT ON REQUEST.

Dobbins Estate Sprayers

A new, up-to-date, lightweight Sprayer designed for country estates, small orchards, landscape gardeners and golf-courses. It has ample capacity and pressure for the economical application of all spray solutions. The tank is made of steel, is rust-proofed on inside and has a capacity of 50 gallons. The outfit is modern in every respect and is well made throughout of the best materials.

No. 4250R. 1½ G.P.M. (single cylinder) pump at 250 lbs. pressure, 1½-h.p. engine, 12½ ft. ⅜-in. hose and spray gun. Weight 270 pounds. \$219.50.

No. 3260R. 3 G.P.M. (double cylinder) pump at 300 lbs. pressure. 1¾-h.p. engine, 25 ft. ½-in. hose and spray gun. Weight 350 pounds. \$311.58. Above outfits furnished with 5.50 x 16 pneumatic-tired wheels at prices shown. Special circular on request.

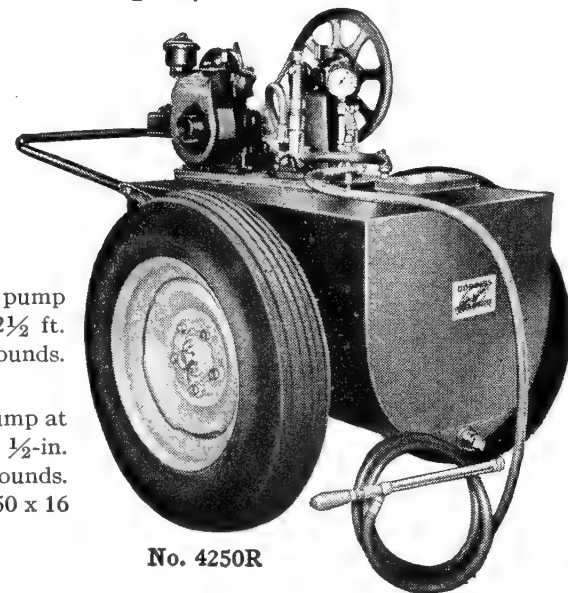

No. 4250R

Dobbins Eveready Power Sprayer

A portable lightweight spray outfit capable of handling all spray jobs for the individual owner, landscape gardener or small grower. Outside width 18½ inches; permitting easy access to narrow aisles and passageways. Has brass pump with hardened stainless steel valves with capacity of 1½ gallons per minute at 250 pounds pressure. 25-gallon steel tank. Furnished with 1-½-h.p. Briggs & Stratton engine, 12½ ft. of ⅜-in. hose and adjustable spray gun.

No. 4240. With Steel Wheels \$158.50.

No. 4240R. With 26 x 2½-in. pneumatic tires. \$165.

Dobbins Power Sprayer on Skids

A practical light-weight outfit designed, for use with truck, wagon or trailer. Has 100-gallon steel tank, double cylinder pump, 2¾-h.p. Briggs & Stratton engine. Discharges 4 gallons per minute at 350 lbs. pressure. Weight 385 pounds. No. 3266. \$325. Circular on request.

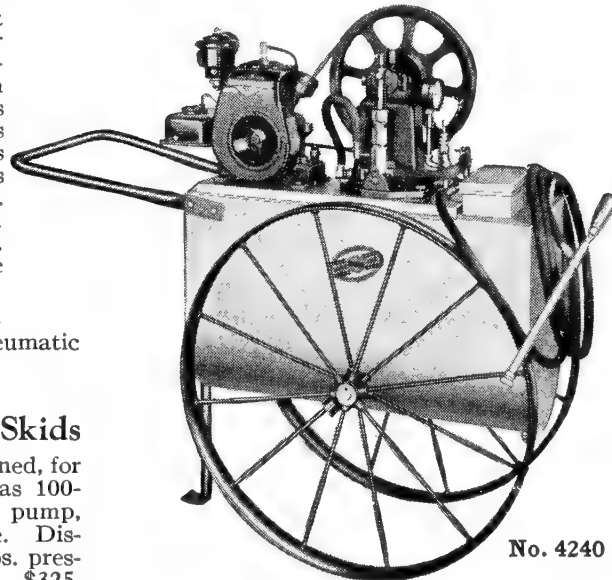

No. 4240

Hand Dusters



No. P1 Root. A very efficient and durable Duster for the flower and vegetable garden. Has large powder chamber and adjustable nozzle which permits dusting underside of foliage. Length, 20 inches. \$1.75.

No. P2 Root. Similar to No. P1 shown above except has much greater capacity. Both Dusters are made of steel which insures long life. Length, 32½ inches. \$3.25.

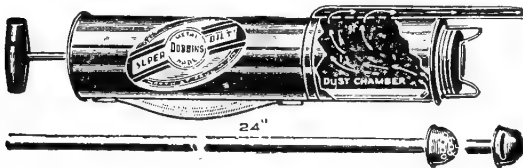

No. 132. Dobbins. Handles all kinds of dry dust very efficiently. It is used in the home-garden, on truck-plots, around poultry-houses, etc. Furnished with 24-inch extension tube and two-way dust cap for dusting over and under leaves. Capacity, 1 pound. \$1.45.

American Beauty Duster

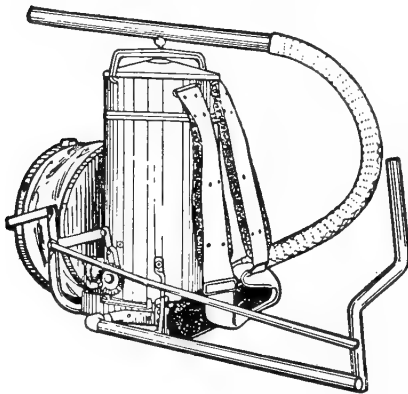

Most powerful one-man Duster built. Drives dust 25 feet in air. Compound handle makes operating of bellows easy. Equipped with instant feed-control, flexible hose, 40-inch tubes and deflector to blow up under lower leaves. Capacity 15 to 20 pounds of dust. Internal moving parts constructed of brass or rustproof plating. Weight, 17½ pounds. \$27.50

The Root Hand Gun

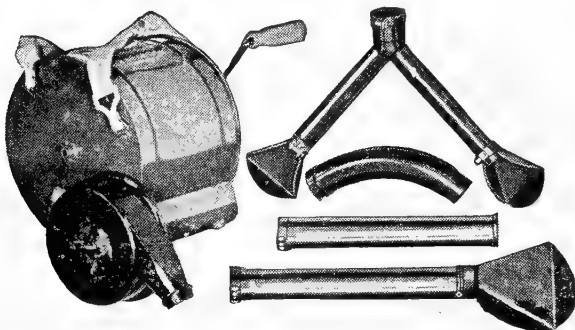

The ideal Dust Gun for dusting all kinds of agricultural dusts where the acreage is not large enough to justify the use of traction or power dusters. It has a powerful fan-blast which thoroughly breaks up the dust and distributes it evenly and uniformly. Can be operated with discharge tube in front or to the rear of the operator. The hopper has a capacity of 7 to 10 pounds of material. Built to stand hard knocks and rough usage. **No. C3. \$23.**

Root Wheelbarrow Traction Duster

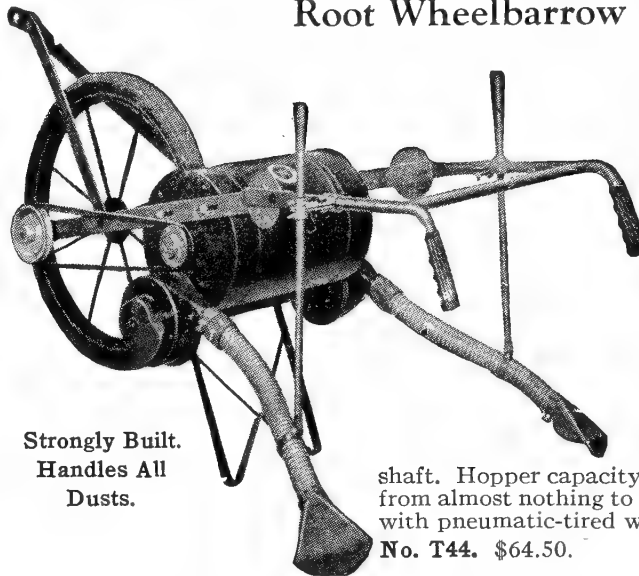

Strongly Built. Handles All Dusts.

Designed especially for small-acreage truck-crop operations. Commercial growers particularly will appreciate this Duster because of its high speed performance, adaptability to all row crops, and top efficiency with expensive dusting materials. Built of high-quality materials throughout and will give many years of trouble-free operation. Has two fan cases, each independently driven by belt. The two-nozzle-to-row coverage can be quickly changed to single-nozzle application to each row. Can be thrown out of gear by removing cotter pin in the wheel hub and the main shaft. Hopper capacity, 15 to 25 pounds. Feed adjustment from almost nothing to 25 to 30 pounds per acre. Furnished with pneumatic-tired wheel. Weight, 58 pounds. **No. T44. \$64.50.**

Prime Electric Fence Controllers

All Highline Models Approved for safety by Underwriters Laboratories



Model No. 486

For use with 110-120-volt 60 cycle AC

Multiple Signal Light System gives a constant, accurate reading of fence condition and tells the user whether or not controller is being properly used. Shock Control Switch enables user to select proper shock output for all conditions. Delivers true alternating current (most effective type) to the fence. \$44.50.



486

Model No. 2C1

For use with 110-120-volt 60 cycle AC

New! Revolutionary! A "Double Circuit" controller designed especially for two wire fences. Particularly effective for small, hard-to-hold animals such as hogs, sheep, goats and calves and for extremely dry or rocky soil. Each circuit is completely independent—a short on one does not affect the other. Doubly strong shock between the two wires regardless of ground conditions. \$47.50.



2C1

Model No. 333

For use with 6-volt battery

Portable, Weatherproof, Convenient, Economical

Can be installed anywhere, indoors or out. Ideal for temporary fences, hogging down corn, strip and contour fencing, etc. Weatherproof cabinet has plenty of space for hot-shot battery. Cover hinged for easy access to battery. High shocking power with low battery drain. Most popular of all battery controllers. \$22.50.

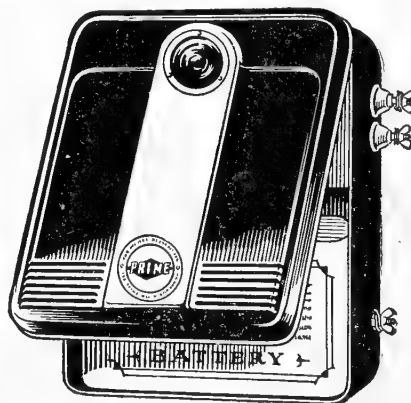

333

Model No. 48

A safe, effective, low-priced highline controller. Built to the same rigid standards as Model 486. \$34.50.

Accessories

- P 1. Standard Post Insulators, 2 cts. each.
 - P 23. End and Corner Post Insulators, 5 cts. each.
 - P 36. Heavy Duty End and Corner Post Insulators, 9 cts. each.
 - P 19. Spring Tie Clips, to fasten fence wire to insulator, bundle of 100, 45 cts.
 - P 15. Looped wire for unpunched steel posts, bundle of 100, 70 cts.
 - P500. Gate Handle, 30 cts. each.
 - P501. Gate Spring, 8 cts. each.
- Ask for circular and price of posts for electric fence.

Stakes



Wooden, Round, Tapering, painted green.
Light Stakes are made from western white pine and the heavy from cypress.

	Doz.	100
1½ ft. long, light weight....	\$0 35	\$1 85
2 ft. long, light weight.....	55	3 50
3 ft. long, light weight.....	1 00	6 60
4 ft. long, light weight.....	1 30	9 40
3 ft. long, heavy weight....	1 40	10 00
4 ft. long, heavy weight....	1 85	13 00
5 ft. long, heavy weight....	2 35	17 00
6 ft. long, heavy weight....	2 75	21 00

Bamboo Canes. Dyed green. Uniform pencil thickness throughout. Just the thing for pot-plants and plants that need just a light support.

	Doz.	50	100	1,000
24 in. long....	\$0 25	\$0 65	\$1 10	\$9 00
36 in. long....	30	90	1 60	14 00
48 in. long....	35	1 10	2 00	18 00

Heavy Bamboo Tonkin Stakes. Make excellent supports for dahlias and plants of this type. Natural finish.

	Diam.	Doz.	50	100
4 ft. 5/8 to 3/4 in....		\$1 40	\$4 50	\$7 50
6 ft. 1/2 to 5/8 in....		1 60	5 50	10 00

Adjusto Plant Supports

A sturdy, hardwood stake seven-eighths inch square, with a strong wire support instantly adjustable to any height. A suitable support for tomatoes, dahlias, peonies, and all similar plants.

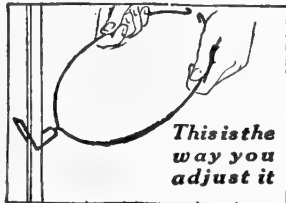

	Each	Doz.	Each	Doz.	
3 ft....	\$0 27	\$2 50	5 ft....	\$0 37	\$3 25
4 ft....	32	2 85	6 ft....	40	3 50

Garden or Pot Labels (Painted)

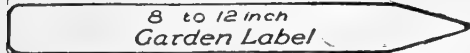
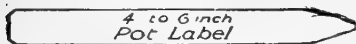
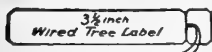

	100	500	1,000
4 in. x 5/8 in. wide....	\$0 50	\$2 00	\$3 50
5 in. x 5/8 in. wide....	55	2 20	3 90
6 in. x 5/8 in. wide....	60	2 45	4 40
8 in. x 7/8 in. wide....	1 10	5 00	9 50
10 in. x 7/8 in. wide....	1 25	5 65	10 80
12 in. x 1 1/8 in. wide....	1 60	7 55	14 60
3 1/2 in., iron-wired ...	55	2 25	4 00

Evermark Label Pencil. Makes a permanent record on garden labels. 20 cts. each.

TWIST-EMS' The New Handy Plant-Tie

Strong tapes with wire reinforcing that make perfect plant-ties. For perennials, annuals, shrubs, vines, etc. Dark green color, 8 in. long. Box of 125, 35 cts.



Raffia

For tying, bunching, basket-making, etc.

Natural. In plaits. Lb. 50 cts., postpaid 60 cts.; 10 lbs. \$4.50, postpaid \$4.75.

Green. Bundle about (1 lb.) \$1.10.

Pruning Tools

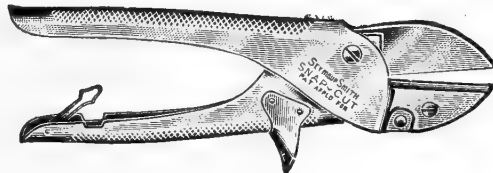

Snap-Cut Pruner

All-steel construction.

No. 118. 6-inch.....	\$1 40
No. 119. 8-inch.....	2 25

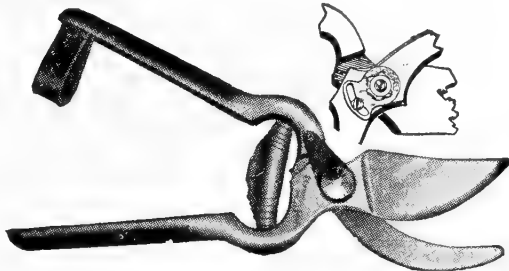

Seymour Smith Professional Pruner

Finest one-piece drop-forged steel. Keen, powerful, positive slicing action. Honed edges.

No. 124. 8-inch.....	\$3 50
No. 125. 9-inch.....	4 00



Seymour Smith California Pattern

Polished, ground and tempered cutlery steel blades riveted to malleable iron handles.

No. 130. 9-inch.....	\$1 50
----------------------	--------

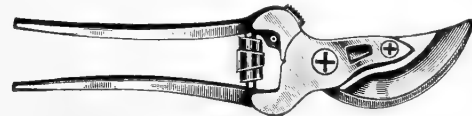

Porter Twin-Cut No. 9

Blades drop-forged steel, heat-treated and polished. Cuts close and clean. Thumb-operated locking device. Designed for the professional. Weight 12 ounces. 8 3/4-inch, \$6.75.



Porter HKP. Forester

Patented slide shift gives amazing multiplication of cutting pressure. No strain on tool or operator. Has two sharp cutting blades.

No. 2FO. Cuts 1 1/2-in. green wood. 27-in. .	\$8 50
No. 3FO. Cuts 2-in. green wood. 34-in. .	9 75

Porter HKP. Pointcut Pruner

The blades are so designed that suckers are cut on the point with minimum handle opening and limbs up to 1 1/4 inches in diameter with full handle opening.

No. 120P. 20-in. handle.....	\$7 50
No. 124P. 24-in. handle.....	7 75

Clyde Tree Trimmer

Blade and hook are made from the best tool steel, firmly riveted to selected basswood handle. The blade is held open by means of a coil spring from the lever handle to the pole. A well-made Trimmer at a low price. No. 5407.

10-ft. Trimmer.....	\$3 25
12-ft. Trimmer.....	3 50
14-ft. Trimmer.....	4 00
16-ft. Trimmer.....	4 50

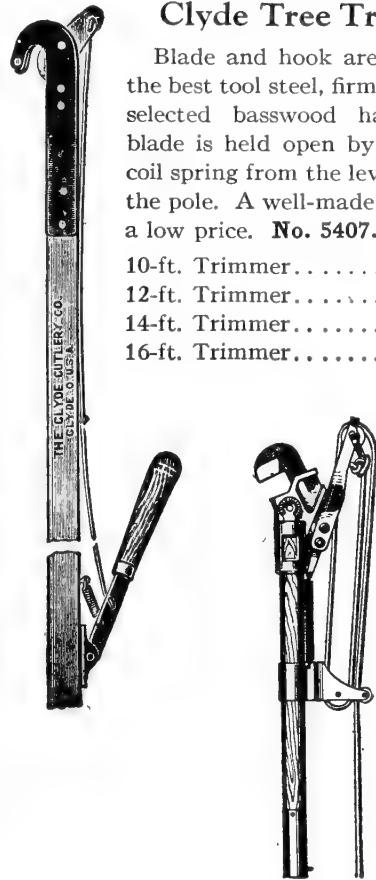

Newman Tree Trimmers

A powerful Trimmer designed for hard usage. The No. 800 and No. 900 Trimmers have compound leverage as shown in cut; the No. 700 has single action pulley. Unit consists of 5-foot head section and 5-foot end section.

No. 700. Cuts 1 in.....	\$8 60
No. 800. Cuts 1 in.....	12 65
No. 900. Cuts 1 1/2 in.....	13 75

Tiffany "Hammer-Forged" Pruner



Forged from special steel and tempered to stand the strain and hold a keen edge. Put together with a heavy rivet under tremendous pressure, no nuts to work loose. Cuts 1 1/2-inch limbs with ease. Has steel handles.

24-in. Pruner.....	\$3 75
28-in. Pruner.....	4 00

General Electric Soil Heating Kit

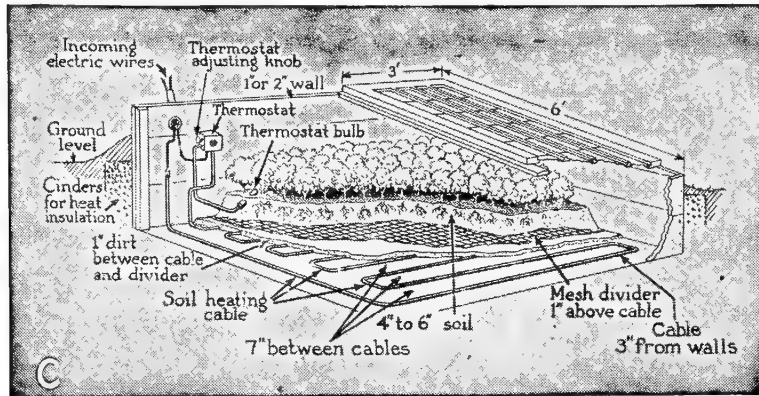

Illustrates how simply it is installed

Designed for home gardeners and small growers and provides a convenient and economical method for heating hotbeds. Any minimum temperature from just above freezing to 120° F. can be selected and maintained automatically. Gives positive control of plant growth and more uniform and more vigorous plants in a shorter time. Uses 1/2 to 1 1/2 KW hours per day per sash. This is only 2 to 6 cents per day per sash, based on a rate of 4 cents per KW hour.

The 60-foot cable will heat a 36-square-foot or smaller bed. Kit comes complete ready to plug into any 115-volt AC outlet.

No. 69X787. Kit with Thermostat and 60-foot Cable Assembly, \$16. Extra 60-foot Cable Assemblies, \$4.50 each. One thermostat will control from 1 to 6 lengths of cable. Ask for publication GEA3349A.

Neponset Red Flower Pots



Universally used by every grower of plants. When used for transplanting they can be handled quickly and the construction permits removing easily if desired. They are ideal for rooting or shipping vegetable and flowering plants of any description. Made from a tough, waterproof paper.

	25 Postpaid	100 Postpaid	1000
2 1/4-in.	\$0 30	\$0 40	\$0 85
3-in.	35	45	95
4-in.	50	60	1 35
6-in.	70	85	2 10

Bird's Vita-Band 40

Nutrient-treated Plant Bands made of fibre-resin material. Tested and approved under all growing conditions by successful greenhouse operators. Simple to set up.

	Per 1000
1 3/4 x 1 3/4 x 2 1/2 in.	\$4 25
2 x 2 x 2 1/2 in.	4 70
2 x 2 x 3 in.	5 05
2 1/2 x 2 1/2 x 3 in.	5 20
3 x 3 x 3 in.	6 30
3 x 3 x 4 in.	7 35

F.O.B. Pittsburgh or F.O.B. factory if not in stock

Green Thumb Plant Bands

Square, open-bottom pots for use in a seed flat. Made of waterproof material.

No. RA230. Package of 30 2x2x2 1/2-in. Bands, 25 cts. each.

Green Thumb Cutworm Protectors

Waterproof bands, 3 inches high and 3 inches in diameter. Easy to set.

No. RA50. Package of 50 Protectors, 25 cts.

Sieves or Riddles

Constructed from the best steel wire cloth, has wood sides and is well braced; 16 inches in diameter, 3 1/2 inches inside depth. Suitable for screening soil and also for cleaning grain.

No. 4. 1/4-in. mesh; No. 6. 3/8-in. mesh; No. 8. 1/2-in. mesh. \$1.25 each.

Grow Earlier, Hardier Vegetables and Flowers



Protect tender seedlings from frost, hot sun, wind, etc.—reduce shock of transplanting with Hotkaps. These patented wax-paper cones form miniature hothouses over each plant. Enjoy all your favorite flowers and vegetables—*first*. Quick and easy to set.

	Postpaid
25 Hotkaps with setter	\$0 60
100 Hotkaps with setter	2 20
250 Hotkaps with setter	4 15

Weeks Earlier to Market

Thousands of market gardeners are getting premium prices every year by using Hotkaps. They eliminate weather and insect damage, help produce earlier and bigger crops. Hotkaps are inexpensive and easy to use.

1,000 Hotkaps. \$12 00
5,000 Hotkaps, prepaid. 58 75
10,000 Hotkaps, prepaid. 115 00
Fiberboard Garden Setter, each 20 cts.
Steel Setter and Tamper, each \$2.

Earthen Flower Pots

In. diam.	Each	Doz.	In. diam.	Each	Doz.
2 1/2 in.	\$0 04	\$0 35	7 in.	\$0 25	\$2 65
3 in.	05	45	8 in.	35	3 50
4 in.	07	65	9 in.	50	5 25
5 in.	12	1 15	10 in.	75	7 25
6 in.	17	1 65	12 in.	1 40	14 50

Flower-Pot Saucers

Inside diam.	Each	Doz.	Inside diam.	Each	Doz.
4 in.	\$0 06	\$0 65	8 in.	\$0 24	\$2 65
5 in.	08	85	9 in.	30	3 45
6 in.	12	1 30	10 in.	45	5 00
7 in.	18	1 90	12 in.	65	7 35

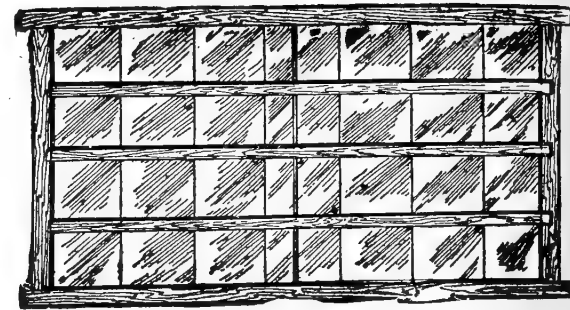

Metropolitan Hotbed Sash

Metropolitan Hotbed Sash are made from good quality Tidewater Gulf cypress, fabricated and finished on specially designed sash-making machines. All parts are mortised and tenoned to insure accurate, smooth, and tight-fitting joints. The sides are planed perfectly straight to prevent any open space between sash when laid on the frame. They are strictly a quality product.

No. 9. 3 ft. 1 1/2 x 6 ft. for 4 rows of 8-in. glass. \$10 75

Above sash 1 3/4 inches thick with 1/8-in. round iron cross-bar in center and with horns.

Sash are painted two coats paint, without glass. 5-sash lots, 15 cts. per sash less; 10-sash lots, 20 cts. per sash less. Special prices on larger quantities or other sizes of sash quoted on request.

Glass for Hotbed Sash

	Per box
6x 8, 150 lights, B, Single Strength. . .	\$6 50
8x10, 90 lights, B, Single Strength. . .	6 50
10x12, 60 lights, B, Single Strength. . .	6 50

10 boxes and upward, 25 cts. per box less than above prices

Densoplastic (Glazing Putty)

A scientifically formulated permanent, elastic, non-bleeding adhesive glazing Putty for glazing, reglazing, and repairing of hotbed sash and greenhouses. Can readily be removed with a putty knife, thus permitting the easy replacement of broken panes. COVERAGE: 300 lineal feet of bar per gal., with 3/8-in. nozzle.

1-gal. can.	\$3 40
5-gal. kit.	14 90
55-gal. drum.	140 25

Glazing Gun with 3/8-in. nozzle, \$6.50.

Peerless Glazing Points

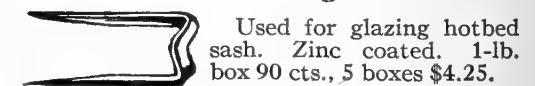

Used for glazing hotbed sash. Zinc coated. 1-lb. box 90 cts., 5 boxes \$4.25.

B-B Garden Flats

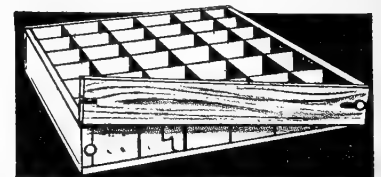

Made of choice lumber. Has patent detachable front which permits plants to be removed without disturbing the roots. Suitable for starting any kind of seeds indoors. Can be used either with or without pots. Size 12 3/8 x 18 3/8 x 3 in. Holds 54 2-in. pots or 24 3-in. pots. Price (without pots) 70 cts. each; 25 or more, 63 cts. each.

Morton's Sugar-Cure
For Hams and Bacon

A high-grade meat salt, accurately proportioned and scientifically blended with marvelously balanced Sugar-Cure, select spice flavors and the curative and flavoring properties of refined condensed wood smoke. Every ingredient necessary to cure meat and impart to it delightful flavor is combined with the salt. This improved Sugar-Cure does the entire job. 7 1/2-lb. can 75 cts.

Morton's Tender-Quick

A special meat cure for pumping hams and shoulders and curing beef, veal, mutton, lamb, etc. It is so perfectly blended that it cures faster, improves the flavor, and makes more tender cured meats. 2 1/2-lb. can 50 cts., 10-lb. can \$2.

Morton's Meat Pump. Should be used to get a uniform cure from the rind to the bone. \$1.50.

Morton's Sausage Seasoning

Ready for use and makes delicious sausage. 10-oz. can 30 cts., 7 1/2-lb. can \$2.50.

Legg's Old Plantation Pork Sausage Seasoning

8 1/4-oz. pkg. sufficient for 25 pounds of meat, 25 cts.

Meat Curing Made Easy

Cure in brine made from Wright's Ham Pickle and salt. After curing, let dry ten days, then apply two coats Wright's Condensed Smoke. Wright's Ham Pickle cures meat thoroughly. Wright's Smoke, made from choice hardwoods, adds wonderful old-time flavor. Ask for free booklet, "Meat Production on the Farm."

Wright's Ham Pickle. For sugar curing. 1-qt. bottle 65 cts., 1/2-gal. bottle \$1.

Wright's Condensed Smoke. For smoking. 1-pt. bottle 65 cts., 1-qt. bottle \$1.

Blackman's Medicated Lick-A-Brik

Conditioner and tonic for horses, mules, cows and sheep. Easy to use—just keep one in the feed-box all the time. 25 cts. per brick, \$2.75 per doz., \$5.25 for 2 doz.

Keystone Pure Salt Bricks

Practical dairymen and livestock feeders know that livestock like and want Salt. Cattle and horses will be more thrifty and more healthy if given the proper amount of salt in their rations.

Place the Salt Bricks in the feeders built especially for them where the stock can have access to them at all times. They are of pure, unadulterated salt.

25 cts. per brick, doz. bricks \$2.75, 2 doz. bricks \$5.25. Feeder, 75 cts. each.

Sal-Vet

Mineral Supplement for all Livestock

Contains the necessary minerals required by livestock; aids digestion, helps to keep them in healthy condition. Used and recommended by livestock feeders and breeders for over 40 years.

5-lb. pkg.\$0 75 | 50-lb. bag.....\$4 50
10-lb. pkg. 1 20 | 100-lb. bag..... 7 50
25-lb. pkg. 2 50

Salt

Salt Blocks. 50-lb. block; pure Salt 60 cts. each, sulphur 85 cts. each.

Morton's Dairy Salt. 10-lb. sack 25 cts., 25-lb. sack 50 cts., 100-lb. sack \$1.25.

Crushed Rock Salt. 10-lb. sack 25 cts., 100-lb. sack \$1.25.

Conkeys Fly Knocker

A Spray for All Livestock

A splendid protective measure against stable and horn-flies. Will not injure hair or animal; has good tasting qualities. Qt. 45 cts., gal. \$1.25.

Standard Glass Churns

An improved, streamlined, Glass Churn designed for home butter making. Has extra-heavy clear glass jar, efficient dasher, built-in strainer, covered gears and holding handle. Complete butter-making directions supplied with each Churn. Churning capacity about one-half the total capacity of the Churn. 4-qt. size \$2.90, 8-qt. size \$3.80.

B-K Dairy Bactericide

A fast-acting chlorine Bactericide used for treating dairy utensils and milk-plant equipment to kill bacteria. It aids in producing milk of low bacteria count, thus increasing quality, which brings better prices. It works faster, more cheaply, and more thoroughly than dry heat, hot water, or steam as ordinarily used. It does the job in hot or cold water.

B-K POWDER

9 1/2-oz. bottle ...\$0 75 | 1 1/2-lb. bottle....\$1 50

B-K LIQUID

4-oz. bottle....\$0 30 | 1-gal. bottle....\$2 00
10-oz. bottle.... 50 | 5-gal. jug..... 8 50
1-qt. bottle.... 90

HTH-15 Farm Sterilizer

Here's a Sterilizer that makes it easy to keep bacteria counts down and protect your milk-quality. HTH-15 is a dry, free-flowing powder packed in handy, key-opening cans. One standard tablespoonful of the dry powder makes 3 gallons of effective dairy-rinse that is safe to use on milk equipment.

You can also check the spread of respiratory and other diseases of poultry by using HTH-15 in the drinking-water, to disinfect brooders, incubators, pens and other poultry equipment. 1-lb. bottle 50 cts., 3-lb. bottle \$1, case of 6 3-lb. bottles \$5.

Kow-Kare

This great tonic and conditioner supplies invigorating elements needed by freshening cows, promotes digestion and assimilation. Give KOW-KARE with the feed to promote vigor for low-cost production and cow health.

1 1/4-lb. package 65 cts., 2 3/4-lb. package \$1.25, postpaid.

Bag Balm

For Udder and Teats

Never be without this antiseptic ointment for quick healing of tender tissues. A potent aid in treating caked bag, inflammation, exterior teat and udder troubles, and all farm healing.

10-oz. package 60 cts., postpaid.

Bag Balm Teat Dilators

For spider, scabs, bruises, internal injuries. Smooth, ivory-like, cannot irritate or absorb pus infection.

Package of 25, 60 cts., postpaid.

Dr. Hess' Stock Tonic

Used with success for more than 50 years. Whets appetite; sustains milk-flow well through lactation period. Contains minerals needed by heavy-producing dairy cows. Valuable at calving-time; increases profits from steer-feeding, and puts horses and mules in condition.

1 1/2-lb. pkg.\$0 30 | 30-lb. pail.....\$3 75
5 -lb. pkg. 85 | 100-lb. drum.....10 50
10 -lb. pkg. 1 50

Dr. Hess' Hog Special

Has tonics and minerals to keep hogs' internal organs in full function. In research tests, hogs fed Dr. Hess' Hog Special reached market weight in six to ten days' less time and consumed 20% less feed. 1 1/2-lb. pkg. 30 cts., 5-lb. pkg. 85 cts., 10-lb. pkg. \$1.50, 30-lb. pail, \$3.75, 100-lb. drum \$10.50.

Dr. Hess' Dip and Disinfectant

Kills foul odors. For sheep-, horse-stables, dairy-barns, hog-pens, poultry-houses, dog-kennels, and general disinfecting. 1-qt. can 65 cts., 1-gal. can \$1.75, not prepaid.

Calves' Cordial

An effective intestinal astringent for Cows and Calves. 1-lb. pkg. 65 cts.

STEWART ANIMAL CLIPPERS and SHEARING MACHINES

Quiet, powerful, smooth-running



No. 51-1. Clipmaster.

No. 51-1. Clipmaster. Clips cows, horses, mules, and dogs. \$29.50.

No. 31B-1. Shearmaster. Shears sheep and goats. \$37.50.

Both machines are furnished with long, rubber-covered cord and operate on any 110-120 volt current, AC or DC.



No. 31B-1. Shearmaster.

Dr. A. C. Daniels' Horse Medicines

Colic Drops. For colic.....\$1 30
C. C. & F. Drops. Coughs, colds, and fevers... 65 cts. and 1 30

Horse Conditioner. A condition powder.... 65

Worm Powder. An aid in expelling worms. ... 65

Wonder Lotion. Scratches, wounds, and cuts 35 cts. and 65

Gall Salve. A relief for saddle and harness sores..... 35 cts. and 65

Antiseptic Healing Powder. For sores, cuts, and wounds..... 50

Hoof Ointment and Softener..... 65

Oster Cocus Liniment. Cord and muscle liniment..... 35 cts. and 65

Carbo Negus Disinfectant..... 35 cts. and 65

Absorbent Spavin Salve..... 65

Horse Physic Balls..... 65

Hoof Dressing and Polish..... 65

Since 1908 Corona Since 1908

Antiseptic Ointment for Cows and Horses

Every farm, dairy, and high-class stable will find CORONA indispensable for minor skin injuries and irritations. Ideal udder and teat massage; wound dressing. Use for galled bruised shoulders, scratches, chapped cracked teats, brittle hoofs. Soothing, softening, healing aid.

8-oz. can 75 cts., 1 1/4-lb. can \$1.50.

PTZ

Worm Treatment for Farm Animals

Made with phenothiazine, the new non-toxic worm treatment for sheep, horses, swine, cattle and poultry. Highly effective against the six common species of worms infesting sheep.

PTZ Pellets. 13.5-gram, 7 cts. each; 8-gram 4 cts.

PTZ Powder. 4-oz. pkg. 50 cts., 1-lb. pkg. \$1.25, 5-lb. pkg. \$6 postpaid.

Special Forceps. For individual dosing. 50 cts.

Improved Keystone Dehorner

The Improved Keystone Dehorner is the most efficient dehorning knife on the market today. It has been improved in several important points of construction, until its strength, cutting service and durability have been greatly increased.

Complete with extra set of blades and screws, \$20, postpaid. Special circular sent on request.

Sealright "Liftright" Milk Bottle Cap

Has strong tab that lifts at the touch of the finger. Ideal Cap for general use.

No. 2 size. Packed in tubes, 500 Caps each.

Stock printing. Postpaid

500 caps.\$0 50 \$0 60
1,000 caps. 95 1 05
5,000 caps. 4 25 4 50

Prepaid

25,000 caps.\$19 25
50,000 caps. 36 50

Printed to order.

10,000 caps. 10 90
25,000 caps. 21 75
50,000 caps. 40 00

Electro charge of \$1.75 for one color and \$2.50 for two colors will be made on orders for Caps with new designs.

Caps printed to order are shipped direct from factory and transportation charges prepaid at prices quoted.

Banco Milk Filter Discs

Made of thinly rolled, non-absorbent cotton especially for the purpose. Filters quick, clean, and uniform.

Plain Discs. 6-in. diam., pkg. of 100, 65 cts.; pkg. of 300, \$1.85. 6 1/2-in. diam., pkg. of 100, 75 cts.; pkg. of 300, \$2.10.

Thread-faced Discs. 6-in. diam., pkg. of 100, \$1, pkg. of 300, \$3.10. 6 1/2-in. diam., pkg. of 100, \$1.10; pkg. of 300, \$3.10.

Postage 10 cts. extra on package of 300



START BEEKEEPING—IT PAYS WELL

Root Quality Bee Supplies are well known and need no introduction to beekeepers. Every article is guaranteed to give you absolute satisfaction. If you do not find what you want listed on these two pages, write for Complete Catalogue.

Standard Hives

Standard Hive

KD. 10 Frames
(no comb-
foundation).

5 for \$25.05

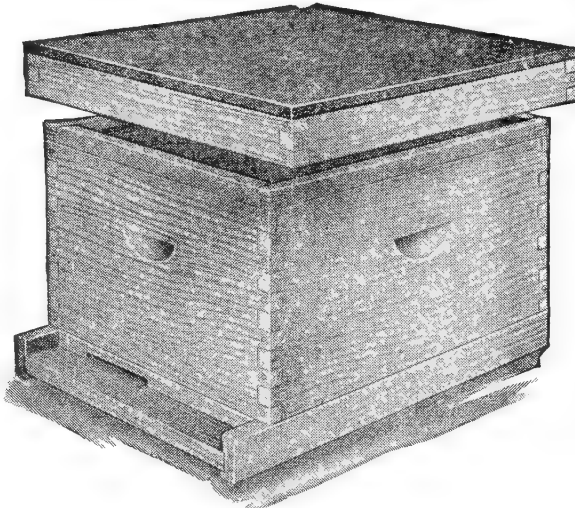

The Standard Hive is made of the best selected pine lumber, perfectly milled and fitted together. It is the one most generally used by the largest honey-producers on account of its light weight and the ease with which it may be moved from one location to another.

It is 16 1/4 x 20 inches, and 9 9/16 inches deep, outside measurements.

Hives in the flat are furnished with nails, tin rabbets, reversible bottom-board, metal cover with inner cover, and Standard frames.

Cat. No.	DESCRIPTION	Quan.	Wt. lbs.	Price
A1	Hive complete, no foundation	1 KD	31	\$5 65
A2	Hive complete, no foundation	5 KD	156	25 05*
A3	Hive complete, full sheets foundation	1 NP	33	12 00

*Packed in four packages.

Hive-Bodies or Full-Depth Supers

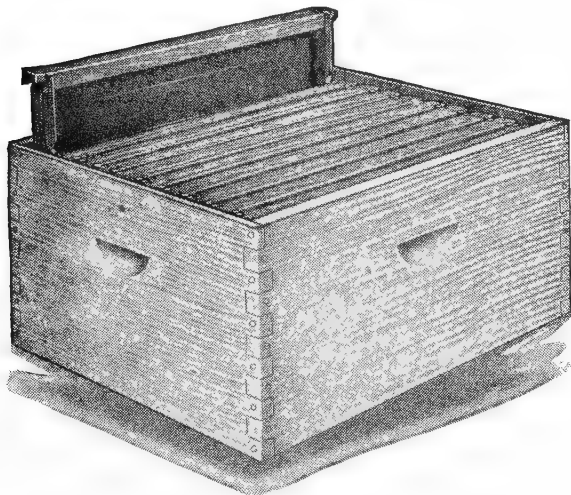

Five
Hive-Bodies
10-Frame Size
No Frames
\$6.50

It pays
to have extra
Hive-Bodies

Made of the same high-quality materials as the Root Standard Hive. They may be used either as a brood-chamber, i. e., the lower story of the Hive, or as a full-depth upper story or super for extracted honey, thus forming a two-story Hive. Nails and tin rabbets included with bodies. No division-board.

Cat. No.	DESCRIPTION	Quan.	Wt. lbs.	Price
C1	Body without frames	1 KD	12	\$1 55
C2	Body without frames	5 KD	45	6 50

Shallow Extracting Supers (5 11/16 inches deep)

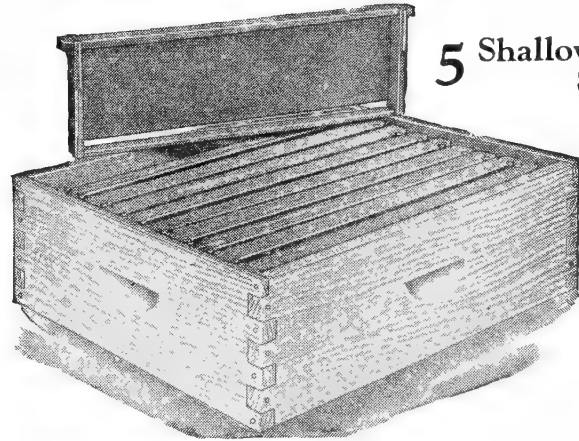

5 Shallow Extracting
Supers
KD, with
frames,
no foundation
\$7.50

This Super is largely used in the production of chunk honey, also for producing extracted honey in shallow frames. Furnished with shallow Hoffman frames, 5 3/8 inches deep, without foundation. No tin rabbets or division-boards furnished.

Cat. No.	DESCRIPTION	Quan.	Wt. lbs.	Price
C17	Super with frames, no foundation	1 KD	9	\$1 70
C18	Super with frames, no foundation	5 KD	39	7 50
C12	Super without frames	1 KD	5	92
C13	Super without frames	5 KD	28	4 20

Beeway Section Super (4 1/4 x 4 1/4 x 1 7/8)

This is the most commonly used Super. It is furnished with or without sections, and with or without inch foundation starters. It may be used on any hive, tiered up one or more high. Each Super holds 28 Beeway Sections.

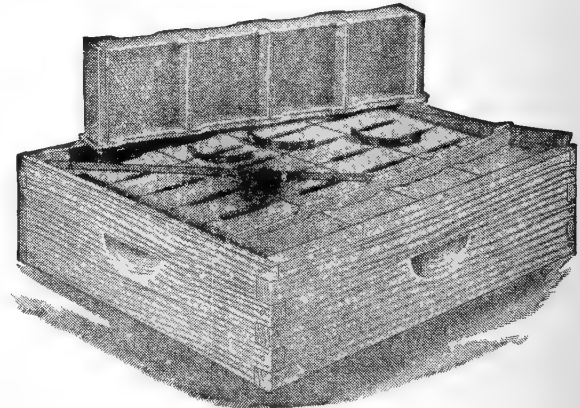

4 1/4 x 4 1/4 x 1 7/8 Beeway Section Super

Super complete without sections includes nails, flat tins, end-stops, Super springs, slotted section-holders, slotted separators, and follower.

Cat. No.	DESCRIPTION	Quan.	Wt. lbs.	Price
D5	Super, no sections or foundation	1 KD	7	\$1 65
D6	Super, no sections or foundation	5 KD	36	7 20

Plain Section Super (4 x 5 x 1 3/8)

It is a deeper Super (5 1/8 inches), and is fitted with section-holders and M fences with end-stops and springs. It will admit eight section-holders and eight fences with Super springs. Holds 32 4x5x1 3/8 Sections. Super complete without sections includes end-stops, section-holders, fences, Super springs, flat tins, and nails.

Cat. No.	DESCRIPTION	Quan.	Wt. lbs.	Price
D8	Super comp., no sections or foundation	1 KD	12	\$2 65
D9	Super comp., no sections or foundation	5 KD	50	11 75

Root Honey Extractors

L35 3-frame Honey Extractor. Hand power.....\$22 00

WRITE OR ASK FOR CATALOGUE OF ROOT'S QUALITY BEE SUPPLIES

BUY ROOT BEE SUPPLIES—SAVE MONEY

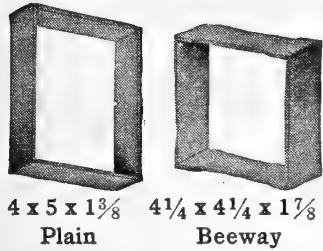

Root Quality Sections

Made of finest basswood lumber, sorted with great care, dried exactly right, planed and cut exactly, expertly polished, dove-tailed perfectly. Rounded bottom, V-grooved, so wood bends without breaking.

4 x 5 x 1 3/8 Plain
4 1/4 x 4 1/4 x 1 7/8 Beeway

MILL RUN GRADE

4 1/4 x 4 1/4 x 1 7/8 Beeway Sections			4 x 5 x 1 3/8 Plain Sections		
Cat. No.	Wt. lbs.	Price	Cat. No.	Wt. lbs.	Price
F1. 100 Plain	7	\$2 25	F20. 100 Plain	6	\$2 15
F3. 500 Plain	32	10 05	F22. 500 Plain	27	9 80
F4. 100 Split	7	2 40	F23. 100 Split	6	2 35
F6. 500 Split	32	10 75	F25. 500 Split	27	10 55

Three-Ply Airco Comb Foundation

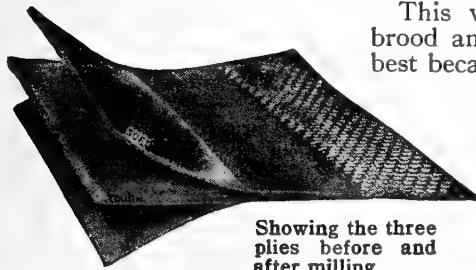

This wonderful Foundation for brood and extracting combs is the best because there is no sagging, no warping, one-third more worker cells, least amount of gnawing, and 7 sheets to the pound. Sheets are 8x16 3/4 inches.

Showing the three plies before and after milling.

Leads all others in volume of sales.

Cat. No.	Wt. lbs.	Per pkg.	Price
H1. 10 sheets. For Standard Frames	3		\$1 75
H3. 50 sheets. For Standard Frames	9		8 10

Single-Ply Airco Foundation

Genuine Airco Process Foundation, made into clear, tough sheets from finest quality pure beeswax.

MEDIUM BROOD FOUNDATION

For Standard Frames			For Shallow Frames		
Cat. No.	Wt. lbs.	Per pkg.	Cat. No.	Wt. lbs.	Per pkg.
H20. 10 sheets	2	\$1 45	H26. 10 sheets	2	\$0 92
H22. 50 sheets	8	6 85	H28. 50 sheets	5	4 00

THIN SUPER FOUNDATION FOR COMB HONEY

For 4 1/4 x 4 1/4 Sections			For 4x5 Sections		
Cat. No.	Wt. lbs.	Per pkg.	Cat. No.	Wt. lbs.	Per pkg.
J1. 1-lb. carton	2	\$1 27	J12. 1-lb. carton	2	\$1 27
J3. 5-lb. carton	7	6 00	J14. 5-lb. carton	7	6 00

For 4 1/4 x 4 1/4 Split Sections			For Shallow Frames		
Cat. No.	Wt. lbs.	Per pkg.	Cat. No.	Wt. lbs.	Per pkg.
J6. 1-lb. carton	2	\$1 27	J22. 1-lb. carton	2	\$1 27
J8. 5-lb. carton	7	6 00	J24. 5-lb. carton	7	6 00

Frames

Made of clear soft pine lumber, and milled on special machinery designed and built by A. I. Root Co.

Cat. No.	Wt. lbs.	per 100	10	50	100
G1. Standard Frame, 9 1/2 x 17 5/8	45	\$1 20	\$4 50	\$8 75	
G20. Shallow Extracting Frame, depth 5 3/8	25	90	3 45	6 55	
G24. Shallow Extracting Frame, regular Hoffman top-bar	38	1 10	4 25	8 15	
G40. Regular Half-depth Frame, depth 4 1/2	24	3 45	6 55		
211. Root Frame-nailing Device. Wt. 10 lbs.					\$1.85 each.

Wire for Frames

Made especially for the purpose. Standard frames take 6 1/2 feet of wire for each frame, shallow frames 3 1/2 feet.

Cat. No.	Wt. ozs.	Price	Cat. No.	Wt. ozs.	Price
G61. 350 feet	6	\$0 25	G63. 1400 feet	18	\$0 55
G62. 700 feet	10	35			

Root Smokers

Made of quality material throughout. Designed to give satisfactory service.

Cat. No.	Size of Fire Box	Wt. lbs.	Each
N2. Junior (tin)	3 1/4 x 5 in.	2	\$1 25
N3. Standard (tin)	3 1/4 x 7 in.	2	1 50
N5. Jumbo (tin)	4 x 7 in.	3	1 75
N7. Big Jumbo (tin)	4 x 10 in.	3	2 35

Bee Veils, Gloves and Hat

Cat. No.	Mailing Wt.	Price
N10. Indestructible Veil	1 lb.	\$1 15
N11. Alexander Veil	1 lb.	1 20
N12. Delphos steel Veil	1 lb.	1 50
N15. Veil (Cotton tulle)	3 oz.	1 65
N18. Collapsible Hat	4 oz.	1 80
Drill Bee Gloves, Small, Medium, Large	1 lb.	1 75

Honey Section Cartons

Cat. No.	Wt. lbs.	Per 100	100	500
T10. Window Cartons for 4 1/4 x 1 7/8 Sections	6	\$1 55	\$6 65	
T30. Window Cartons for 4x5 Sections	6	1 55	6 65	

Super Fixtures

Cat. No.	Wt. lbs.	Per 50	10	50
E1. Section Holders for 4 1/4 x 4 1/4 x 1 7/8 Sections	15	\$0 70	\$2 95	
E8. Section Holders for 4 1/4 x 4 1/4 x 1 1/2 Sections	11		2 85	
E5. Section Holders for 4x5x1 3/8 Sections	19		3 95	
E15. Beeway Wood Separators, 1/10 in. thick	7	42	1 80	
E25. P Fences, used with 1 1/4 x 4 1/4 x 1 1/2 Sections	5		4 70	
E27. M Fences, used with 4x5x1 3/8 Sections	6		4 95	
E12. End Stops	2 1/2	22	90	
E35. Super Springs	12 ozs.	13	50	

Miscellaneous Supplies

Cat. No.	Wt. lbs.	Price
B1. Metal Cover with Inner Cover, 1 KD	11	\$1 95
B2. Metal Cover with Inner Cover, 5 KD	51	8 90
B8. Inner Cover, without bee escape, 1 KD	3	60
B9. Inner Cover, without bee escape, 5 KD	12	2 50
B12. Pine Bottom Board, 1KD	7	1 15
B13. Pine Bottom Board, 5KD	37	5 15
B25. Hive Stand for 10-fr. Standard Hive, 1 KD		Not available
B26. Hive Stand for 10-fr. Standard Hive, 5 KD		Not available
B30. Queen Excluder, Standard 3-Wire and Wood	4	85
B35. Queen Excluder, Special 7-Wire and Wood	4	90
N35. Plain Uncapping Knife, 8 1/2 in.	1	1 85
N36. Plain Uncapping Knife, 10 in.	1	2 10
N63. Root Wax-tube Fastener	5 ozs.	40
N65. Spur Wire Imbedder	1/2	25
N68. Inexpensive Frame-Wiring Outfit	1	75
N70. Combined Frame-Wirer and Wire Imbedder.		
With resistance coil	10	6 50
N75. Hand Section Press	1 1/4	65
N80. Hive Tool, 8 in.	1/4	65
N81. Hive Tool, 10 in.	6 ozs.	75
N85. Bristle Bee Brush	4 ozs.	60
O2. Boardman Feeder with cap only	12 ozs.	30
O5. Double Bee-Escape	1 oz.	20
O8. Wire Queen and Drone Trap	2	65
O9. Wire Entrance Guard	1/2	25
X5. ABC and XYZ of Bee Culture. 815 pages. 732 illus. Postpaid		2 75
X8. Starting Right with Bees. 98 pages. 184 illus. Ppd.		75

Bees and Queens

V 3. 2-lb. pkg. with queen (April 15 to June 1)	\$5 45*
V 6. 3-lb. pkg. with queen (April 15 to June 1)	6 75*
V15. 2-lb. pkg. with queen (After June 1)	Price on request
V18. 3-lb. pkg. with queen (After June 1)	Price on request
V12. Queen (After June 1)	Price on request

*PRICES ARE F. O. B. APIARY, EXPRESS CHARGES ADDITIONAL

Poultry Equipment and Supplies

E-Con-O Jr. Electric Brooder

The perfect solution for brooding small lots of chicks at a low initial cost. Has 32-inch by 32-inch strong fiberboard canopy, heat deflector, and 4 feet of rubber covered electric cord with porcelain socket. Operates on ordinary light bulb (not furnished). For use in room of 60 degrees temperature or more. Capacity 150 day-old chicks. No. EC-1, \$3.40.



Premier Thriftie Electric Brooder

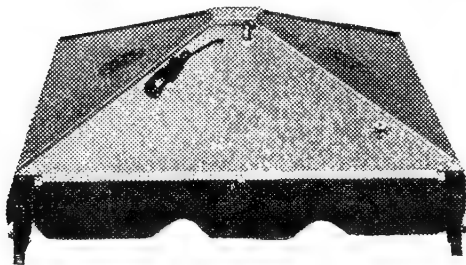

**Strongly Built
Has Metal Canopy**

Fills the need of the poultryman who wants a sturdy, thoroughly efficient Electric Brooder. Has metal canopy with masonite insulation, built strong to stand hard usage; heavy duty, steel-encased ring type heater and automatic wafer-type thermostat.

	Canopy	Capacity	Heater
No. 236.	36 x 36 in.	200 chicks	500-watt. . . . \$18 40
No. 448.	48 x 48 in.	400 chicks	800-watt. . . . 23 65

Oakes "Fantype" Electric Brooders

Millions of baby chicks, and turkey poults are brooded annually with Oakes Electrics—they brood chicks *Nature's Way*—develop into big, husky, healthy fowls. Fans insure positive heat circulation, warm chicks, and warm, dry floor. Galvanized iron canopy is well braced and rigid. Equipped with snap switch, wafer operated, temperature regulator; adjustable legs; heavy denim curtains. Heating element guaranteed for 2 years. For 110 volt A.C. operation. Shipped K.D. but easy to assemble.



	Canopy	Capacity	Heater
No. 750.	52 x 52 in.	Up to 385 chicks	600 watts. . . \$31 30
No. 751.	48 x 72 in.	Up to 500 chicks	650 watts. . . 42 50

Oakes "Gro-Ezy" Electric Brooder

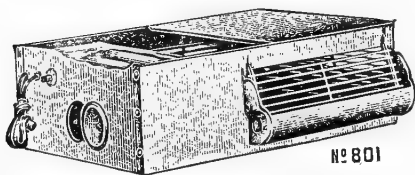

Made entirely of metal. For use in basement, garage or spare room. Has 2 compartments divided by curtain. Automatic heat control. Outside dimensions 31 by 39 by 11 inches. Capacity 100 day-old chicks,

about 20 chicks 4 weeks old. No. 801A, \$13.60.

5 Deck Gro-Ezy Battery

Consists of 5 No. 801 Units and angle iron frame Rack to hold the 5 Units. No. 805, \$83.60.

Chik-Saver Electric Brooder

The Chik-Saver broods chicks successfully. Canopy is 36 inches by 42 inches, has galvanized top and is lined throughout with insulating board. Furnished with 500-watt enclosed type heater with bi-metal, automatic thermostat, cord, plug, and socket. Capacity up to 200 chicks. No. UB42, \$15.35.

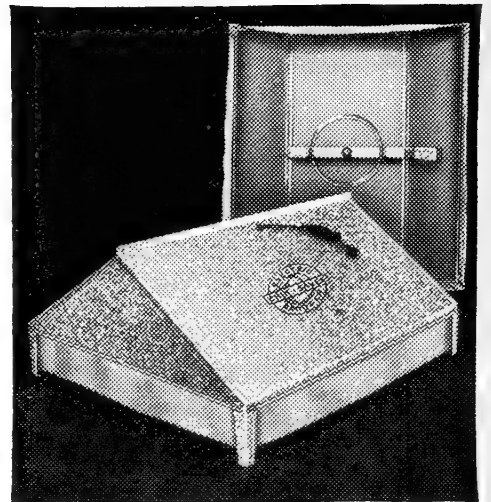

Oakes "DeLuxe" Oil Brooder

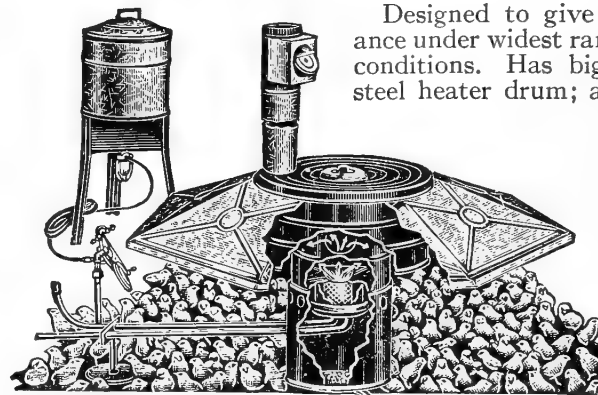

Designed to give ideal performance under widest range of operating conditions. Has big, heavy, blue-steel heater drum; air-fed, wickless type burner; automatic heat regulator; 60-inch heavy gauge steel canopy; 7 gallon fuel tank; draft equalizer; and all necessary fittings. Burns Kerosene or

38/40 distillate. Broods up to 500 chicks. No. 560, \$23.

SUNNY SOUTH OIL BROODER. For economy this Brooder has no superior. Automatic fuel and temperature control insures even heat. Has wickless cast-iron burner; 48-inch hexagonal canopy; 4½-gallon fuel tank and steel heater drum. Burns kerosene or 38/40 distillate. Broods up to 300 chicks. (Not illustrated.) No. 3648, \$14.80.

Oakes Coalburning Brooder

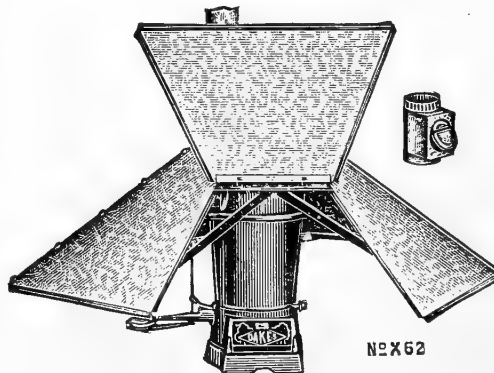

Burns Hard or Soft Coal

Recommended for all difficult brooding situations. Has oversize, heavy stove body; dual draft control; 62 inch hexagonal canopy of heavy gauge steel. Canopy revolves, has hinged section for easy filling of fuel magazine. Economical to operate.

No. X62.	Brooding capacity, 425 chicks.	\$30 80
No. X162.	Brooding capacity, 500 chicks.	36 20

Oakes "Dixie" Woodburning Brooder

Well constructed throughout; simple and practical in operation. Round stove body, 22½ inches in diameter; 60-inch hexagonal canopy; automatic thermostat heat control. Burns dry or green wood. Broods up to 450 chicks. No. 210, \$17.30.

Oakes Electric Incubator

All metal construction. Temperature controlled by wafer-operated switch. Case is heavily insulated to prevent heat waste.

Inspection window in lid permits checking thermometer without raising lid. Has 80-watt heating element. Equipped for 110 volt A.C. Overall measurements: 23½ inches diameter, 8 inches high. Hatches domestic or game bird eggs. Capacity 100 hen eggs. No. 887, \$14.80.

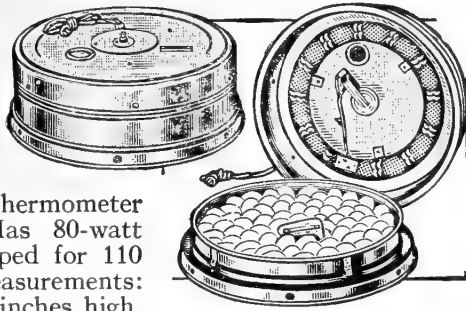

Oakes "Backwarmer Twin" Electric Starter

Sanitary
Convenient
Portable

Furnished with 4 decks, each deck divided into 2 compartments. Suspended hover for each compartment. Hovers can be removed so as to convert to growing battery. Ample head room for chicks to 4 or 5 weeks old. Each deck has a capacity of 310 to 350 chicks and has 16½ feet of feeding and watering space. Well built throughout and mounted on swivel casters. Shipped K.D. No. 1240, \$165.

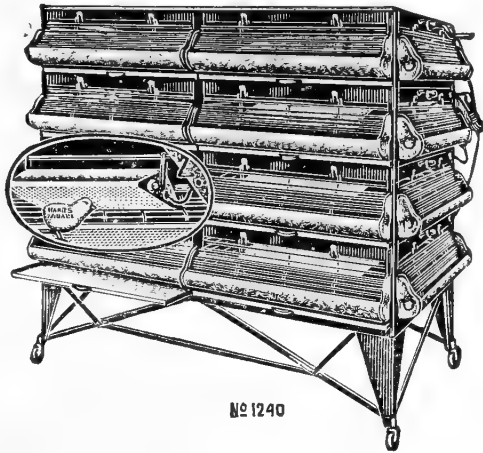

No. 1240

Oakes Brood-N-Gro Battery Unit

A Home Broiler Plant

Produces 30 to 35 finished broilers every 4 or 5 weeks. Top unit is Gro-Ezy No. 801 described on page 80. Bottom unit is 2-deck finishing battery. Head room 14 inches. Floor space required 30 by 40 inches. Height 53 inches. Angle iron frame mounted on swivel casters. Shipped K.D. No. 310, \$36.40.



No. 310

Oakes Finishing Battery

Capacity, 120 Broilers

All metal construction—sturdy, strong, sanitary. Has 4 decks, 8 compartments; 14-inch head room, total floor space 5,777 square inches. Capacity, 120 broilers up to 2½ pounds or 48 to 56 hens. Overall height 72 inches. Patented self-locking doors; woven wire floors; removable droppings-pans; ample feeding and watering space; troughs adjustable to 3 positions. Shipped K.D. No. 324, \$66.

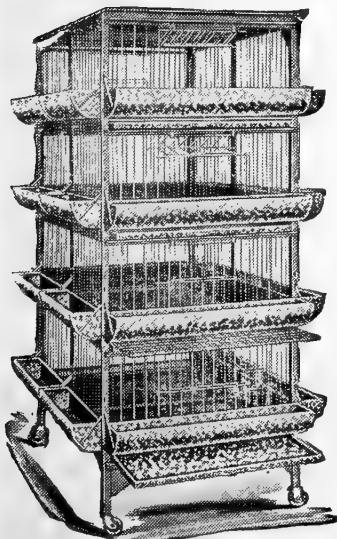

Oakes 25 Per Week Broiler Plant

Consists of 2 starting units, 1 grower unit and 2 finishing units. Circular on request. No. 340, \$75.10.

Selectomatic Poultryman's Egg Grader

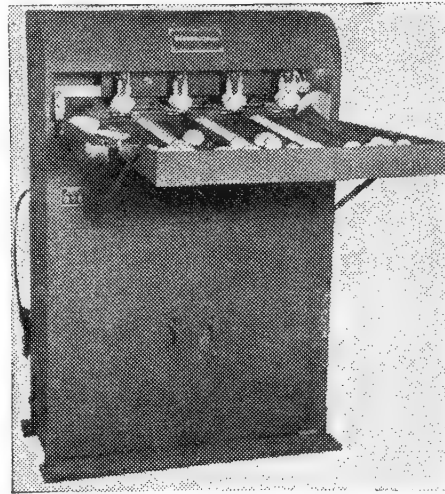

Graded Eggs
Bring Extra Profits

The Poultryman's Model has been developed for flocks of 1,500 birds up. It will candle, grade and sort 2,400 eggs per hour—several times as fast, more gentle, and more economical than old-fashioned hand methods. It is correctly designed, substantially built and streamlined in appearance. Circular on request. \$275.

L & W Egg Grader

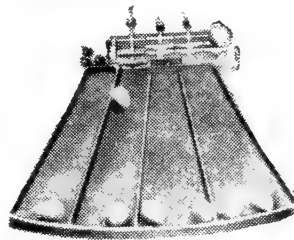

Precision built, mechanical in operation, automatically separating eggs into any four grades desired. Grades 3 to 5 cases per hour. Has molded sponge rubber tray, 20 by 24 inches. Weighs less than 6 pounds. \$16.50.

Oakes "All-Metal" Lice-Proof Nest

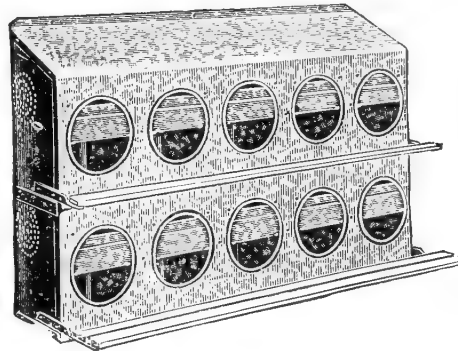

Made of heavy gauge galvanized steel. Each nest 11½ inches wide by 13 inches deep, 9-inch entrance hole. Easy to clean. Sloping roof prevents roosting. Overall length 57¾ inches. Punched so that trap doors may be added. Unit of 10 Nests as illustrated. No. 580. \$10.40. Traps if wanted, \$3.90 additional.

Aluminized Metal Egg-Crate

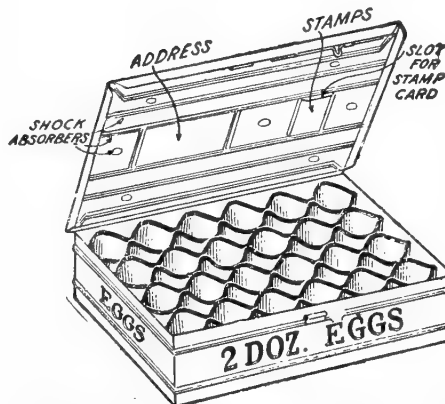

Solves every problem for shipping eggs by parcel post. Built for continued use; practically indestructible; lasts for years. No wrapping is required. A permanent lock pin attached to the Crate holds the lid rigidly closed. Fillers have metal edge. Reversible address cards visible through opening in lid. Names of shipper and receiver are placed on each side of this card.

Weight without eggs	Each	Postpaid	Weight without eggs	Each	Postpaid
1-do. size. 2 lbs...	\$1 50	\$1 60	4-do. size. 5 lbs...	\$2 25	\$2 38
2-do. size. 3 lbs...	1 75	1 86	6-do. size. 6 lbs...	2 75	2 89
3-do. size. 4 lbs...	2 00	2 12			

Oakes Revolving Head Ventilator

Fits any pitch roof up to 25°. Counterbalanced head revolves on ball-bearing axle. 12-inch diameter flue. Entire assembly is 30 inches high. Easy to install. No. 1530, \$8.75.

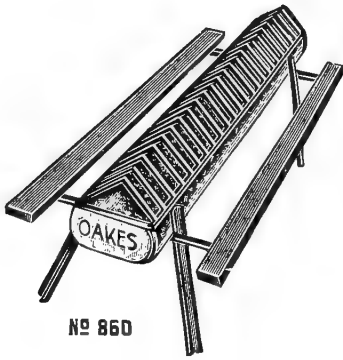

Oakes Flock Feeders

Trough made of heavy galvanized steel, extreme width $9\frac{3}{4}$ inches, depth $4\frac{1}{2}$ inches, length 60 inches, capacity $4\frac{1}{2}$ pecks. Perch 16 inches from floor. Has hinged wire grill with feeding spaces $2\frac{7}{8}$ inches wide. No. 860, \$4.70.

No. 860T. Has steel legs 9 inches long, no perch. Same trough as No. 860. Dandy feeder for pullets or small flock of hens. (Not illustrated.) \$3.60.

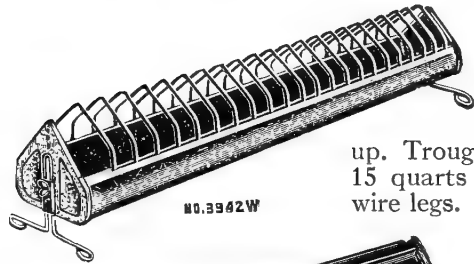

Oakes Broiler Trough

Ideal feeder for chicks 3 weeks old and up. Trough 42 inches long, capacity 15 quarts of feed. Has adjustable wire legs. No. 3942W, \$1.70.

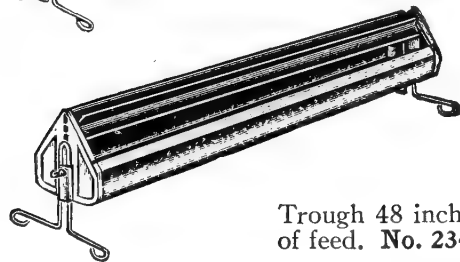

Oakes "Gro-Fast" All-Purpose Feeder

For chicks day-old to 12 weeks. Both stand and reel are adjustable. Trough 48 inches long, capacity 9 quarts of feed. No. 234N, \$1.45.

Oakes Streamline Chick Feeders

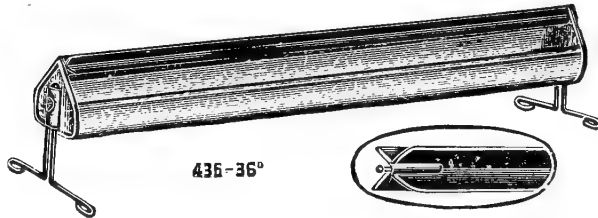

Suitable for day-olds to 8 weeks. Galvanized steel trough, 4 inches by 2 inches. Furnished with adjustable legs and 4-blade reel. No. 436, 36-in. trough 90 cts. No. 448, 48-in. trough \$1.10.

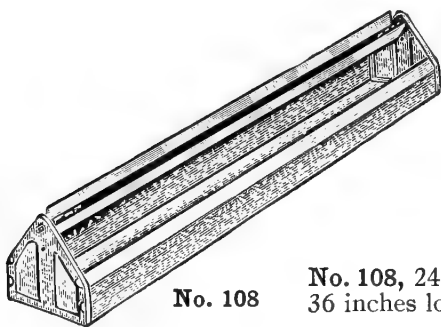

Oakes "Enfold" Chick Feeders

Die-stamped square-bottom feeder. For day-olds to 5 weeks. Adjustable "Z" type metal reel. Trough made of galvanized steel, $3\frac{1}{2}$ inches by $1\frac{3}{4}$ inches. No. 108, 24 inches long 40 cts.; No. 109, 36 inches long 55 cts.

Oakes Mason Jar and Glass Founts

Convenient, cheap, and sanitary chick waterers. Fits pint, quart or half-gallon Mason jars. Jars not furnished. Each Doz.
 No. 69G. Galvanized. \$0 12 \$1 20
 No. 64. Glass. 13 1 30
 No. 1164. Consists of No. 64 glass pan and glass jug of about 1 gallon capacity. 40 cts.

Premier Chick Fountain

Has 1-gallon glass jar with $4\frac{3}{4}$ -inch mouth and galvanized pan $8\frac{1}{4}$ inches in diameter and $1\frac{1}{2}$ inches deep. Easily cleaned—can't tip. No. B132., 65 cts. each, 3 for \$1.80.

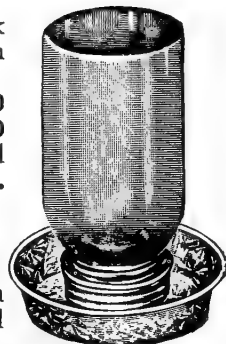

No. 69G

Oakes "Never-Dry" Watering Trough

This Trough will serve 100 to 150 hens at lowest possible cost. Trough has V-shaped bottom with drain plug in end and is 48 inches long. Roost-proof wire guard is hinged for easy cleaning of Trough.

No. 948X, without heater \$5.70.
 No. 9480X, lamp heated \$8.70.
 No. 948EX, electric heated \$8.70.
 No. 948F. Automatic Float Valve, \$1.

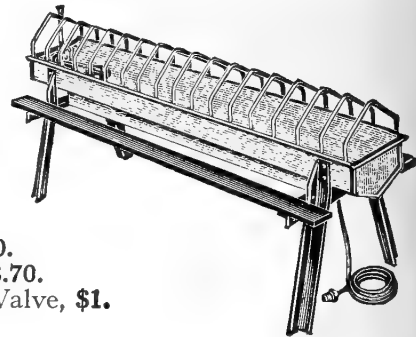

Oakes 8-Gallon Heated Fountain

Heated Waterers Pay

An ideal heated waterer for the laying house when used with fountain heater and stand. Fountain is made of heavy gauge galvanized steel; double wall construction; operates on vacuum principle. Water is necessary for egg production, 100 hens drink 8 gallons per day at the right temperature. It pays for itself in the extra eggs. No. 508. Fountain only. . . . \$4 30
 No. 43. Lamp heater. 3 05
 No. 197S. Stand. 2 20
 Complete, as illustrated. . . . 9 55

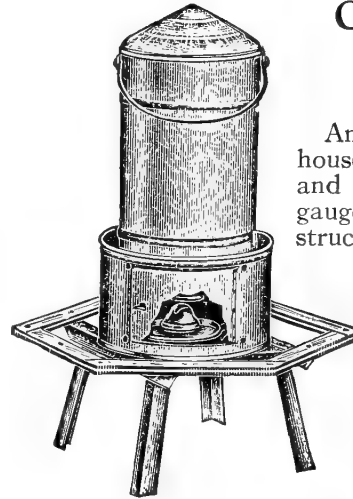

Oakes "Thrifty" Double Wall Fountains

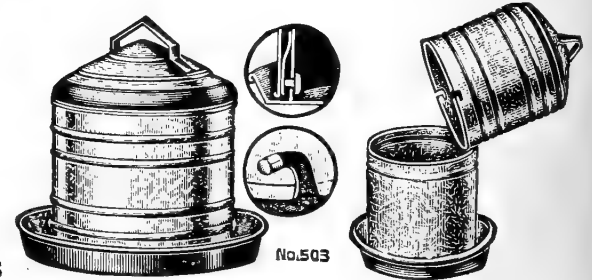

For birds of all ages. Operates on vacuum principle. Outer can locks over rivet in inner can for easy carrying. Made of quality galvanized steel. Beaded for strength. Easy to clean. Can be used with heater. See page 83.
 No. 503, 3-gal. \$2.25. No. 505, 5-gal. \$3.15.

Oakes "Two-Piece" Fountains

Most popular chick Fountain. Operates on vacuum principle. Can fit snugly into pan and held in place by friction. Made of galvanized steel. Easy to keep clean and sanitary. Has 6 drinking cups.
 No. 77. Capacity 1 gallon. \$0 65
 No. 100C. Capacity 2 gallons. 1 00

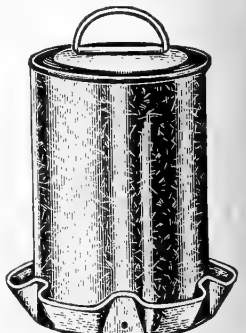

No. 100C

Premier Waterer and Feeder

Ideal for water, medicine, milk or mash. Has dozens of uses on any poultry or general farm. Pan is heavy porcelain enamel, grill corrosion-resisting wire. Pan $17\frac{3}{4}$ inches diameter, $4\frac{1}{2}$ inches deep. No. 45E, \$1.75 each, 3 for \$4.95.



Oakes Electric Fountain Heater

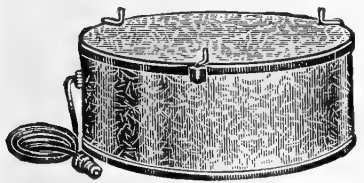

Automatic heat control set to turn on at 50° and off at 55°. Made of galvanized steel, diam. 15 in.; height 6 in. 100-watt heating element. For 110-volt A.C. No. 24, \$5.40.

Oakes Oil Fountain Heaters

Can be used with almost any type water fountain and effectively prevents water from freezing. Made of galvanized steel. Furnished with lamp bowl and burner.

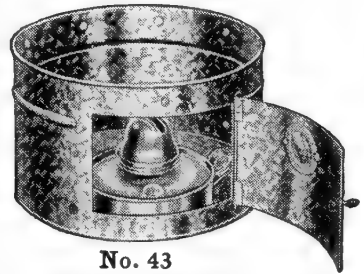

No. 43

No. 42, Fits No. 503 Fountain, \$2.80.
No. 43, Fits 505 and No. 32B8 Fountain, \$3.05.

Trumbull Automatic Electric Poultry Water Warmer

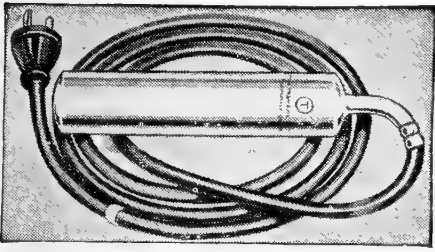

For use in any fountain, pail or trough. Will hold water at 50° automatically. Case made of non-corrosive alloy. Lead cord made of Neoprene to overcome the short life of Pure Rubber. Operating cost is very low. For 110-volt A.C. No. 10040, \$4.

Premier Electric Water Heater

HOT WATER BY THE PAIL

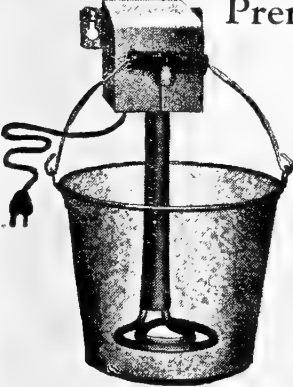

You will find dozens of uses for this portable electric water heater. Anywhere, any time you need hot water, the Premier Electric Water Heater is your answer. Unit does not heat until bucket with water is hung on the switch lever. Shuts off automatically when bucket is removed. Has 1500-watt heating unit. Rugged, heavy metal construction. No. P20, \$16.25.

Oakes Egg-Cooling Basket

For gathering and quick cooling of eggs. Galvanized wires and bottom. Top diameter 12 inches, bottom 10 inches, depth 8½ inches. New shape prevents egg breakage. Capacity 15 dozen 26-oz. eggs. No. 15A, \$1.15 each, 6 for \$6.55.



Electric Poultry Time Switch

HELPS INCREASE EGG PRODUCTION

Simple and dependable in operation. All-steel cabinet 7½ in. by 4½ in. by 3¼ in. For morning lighting turns lights on dim, then bright, then off. For evening, turns lights on, then dim, then off. Completely automatic. Easily installed. For 110-volt A.C. No. 162P, \$13.50.

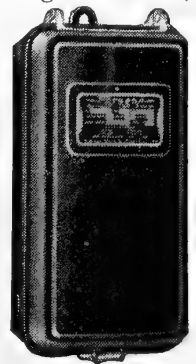

Day-Old Chicks, Ducklings, Turkey Poults

We make a specialty of furnishing all popular breeds of Day-old Chicks, Baby Ducklings and Turkey Poults during the season. All are selected with extreme care of blood-tested flocks from reliable hatcheries. Prices on request.

Oakes Aluminum Leg-Bands



Made of aluminum. Double lock adjustable. Fits any fowl. Numbered 1 to 100.

12 Bands....\$0 15	50 Bands....\$0 40	500 Bands...\$3 00
25 Bands..... 25	100 Bands.... 65	1000 Bands... 5 75

Oakes Celluloid Leg-Bands

KNOW YOUR HENS ON SIGHT



In ten colors—Red, Green, Purple, Black, White, Pink, Yellow, Ruby, Light Blue, and Dark Blue.

Mark each bird for its pen. Give each pen a different color. Mark old birds and pullets differently and know what you are doing.

- | | |
|----------------------------|------------------------------|
| No. 4. For Baby Chicks. | No. 11. For American Breeds. |
| No. 5. For Pigeons. | No. 12. For Asiatic Breeds. |
| No. 6. For Growing Chicks. | No. 13. For Turkeys. |
| No. 9. For Leghorns. | |

Prices, postpaid	No. 4	No. 5	No. 6	No. 9	No. 11	No. 12	No. 13
25 Bands	\$0 15	\$0 15	\$0 20	\$0 20	\$0 25	\$0 25	\$0 30
50 Bands	25	25	30	35	40	40	55
100 Bands	40	40	50	60	70	75	95
500 Bands	1 50	1 55	1 90	2 50	2 90	3 25	4 15
1000 Bands	2 50	2 60	3 25	4 55	5 30	6 00	7 80

Oakes Egg Candler

This Candler is quick in action and shows every defect in the egg instantly. Can be used in vertical or horizontal position. Complete, including drop cord and plug-in connection. No. 195, \$1.80, postpaid.

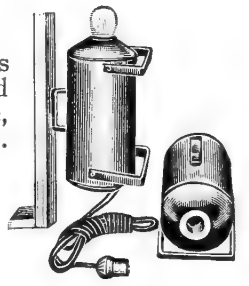

Oakes Egg Scale and Grader

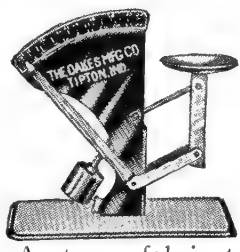

Accurate, dependable, fast, easy to read. Individual egg weight and weight per dozen are indicated on the double dial. Dial is black with white figures. Egg cup, lever parts and counterweight are rust-proof chromium plated. No. 20S, \$1.80.

Genuine Glass Cloth

A strong fabric treated by a patented process to make it translucent, weather-proof, and water-proof. It readily transmits the life-giving vitalizing ultra-violet rays of the sun. Needed by poultry in winter months. Easily put up. In rolls 36 inches wide.

100-yd. roll, 900 sq. ft....\$35 00	15-yd. roll, 135 sq. ft.....\$5 25
50-yd. roll, 450 sq. ft.... 17 50	10-yd. roll, 90 sq. ft..... 3 75

Less than 10 yds., per yd..... 43

R-V-Lite Vitapane

The new transparent glass substitute for installation in poultry- and brooder-house windows, cold and hotbed frames, storm-doors, etc. It is made from transparent cellulose acetate, reinforced with a tough netting fabric. High transmission of ultra-violet rays, durable, lightweight, waterproof, easy to install. 36 in. wide. 50-ft. roll, \$10.25; cut lengths, 24 cts. per lineal ft.

Incubator and Brooder Extras

- No. 416W, Wafer. Universal type. Fits most all makes of Coal and Oil Brooders. 40 cts.
- No. 6W, Wafer. Fits most all makes of Electric Brooders. 40 cts.
- No. 263A, Incubator Thermometer. With metal stand. \$1.05.
- No. 1265, Brooder Thermometer. Length 4½ inches. 45 cts.
- No. 266, Brooder Thermometer. For most Electric Brooders. 8 inches long. 60 cts.
- No. HE99, Thermostat Switch. Complete with wafer. \$2.65.
- No. 85C, Revolving Chimney Cap. 75 cts.
- No. 155, Draft Equalizer. Helps to prevent back drafts. 87 cts.,
- No. 121, Brooder Stove Pipe. 5 in. diam. Per length 38 cts.
- No. 143, Roof Saddle. For 5-in. pipe. \$1.95.



Jamesway Poultry Equipment

EQUIPMENT THAT MAKES BIG EGG YIELDS

Jamesway Poultry Equipment is built for the discriminating buyer who buys equipment not because of the price, but because of the service it will render in increasing egg yields, in keeping hens healthy and contented, and in making it easier to care for them.

Jamesway Electric Hover

No. 1242.
Capacity
500 Chicks

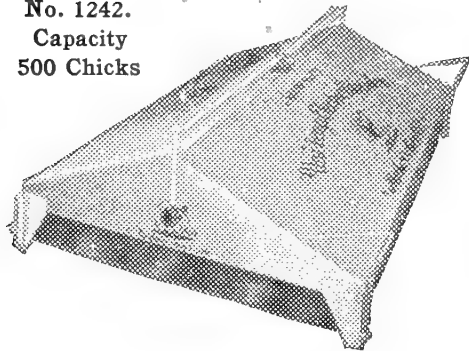

The choice of better poultrymen everywhere. Their air-conditioned chicks are hardier and feathered better when brooded this modern, easy, economical way. New air and heat distribution principle prevents hot and cold spots. Chicks make use of entire brooding area—no crowding or piling up. Strongly built. Has gal-

vanized canopy. For 110-volt A.C.

No. 1240. Canopy 48 inches square, 350-chick capacity. \$38.00.

No. 1242. Canopy 48 inches by 72 inches, 500-chick capacity. \$42.75.

Jamesway Coal-Burning Brooder Stove

Every feature which has made Jamesway coal burners outstanding in the past has been incorporated in the design of this stove. Heavy cast iron body with fins which nearly double the radiating surface provide steadier heat and cut fuel costs. Has 60-inch galvanized canopy. Burns hard or soft coal. Coal capacity 80 pounds. Chick capacity 350 to 500 chicks. Circular on request. No. 1960, \$33.75.

Jamesway Poultry Waterer

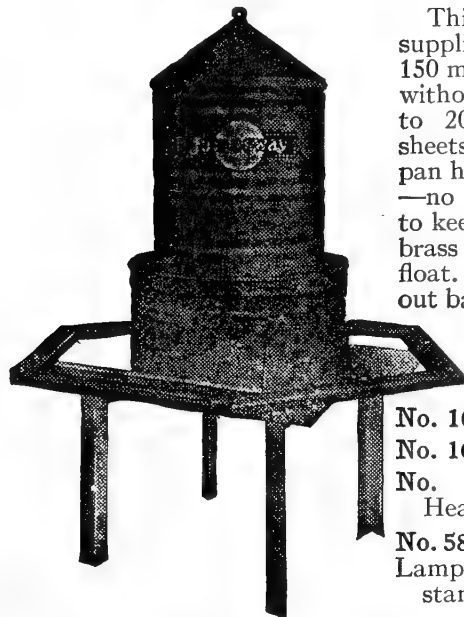

This big flock-size Waterer supplies water for flocks of about 150 mature birds for a whole day without refilling. Room for 15 to 20 hens. Built of heavy sheets. New heavy one-piece pan has rolled edges. Can't leak—no seams to break out—easy to keep clean and sanitary. Has brass valve operated by copper float. Capacity 8 gallons. Without base it may be used for baby chicks. With lamp-heated base it makes an excellent Waterer for winter use.

No. 1616. Without base..\$5 90

No. 1612. Lamp Heated.. 8 45

No. 1614. Electrically Heated.....11 00

No. 585. Stand..... 2 25
Lamp-heated fountain and stand as illustrated.....10 70

Jamesway Chick Waterer

Accommodates 50 to 150 Chicks. Only two parts, a pail and a heavy one-piece pan. Vacuum type. Can't leak or flood. Capacity 7 quarts. No. 1407, \$1.55.

Jamesway 3-Gallon Waterer

Popular for large broods of chicks or for growing flocks. Water level controlled by copper float operating brass valve. Capacity 3 gallons. No. 1655, \$2.90.



Jamesway 3-Gallon Waterer

Jamesway Open-Trough Mash Feeder

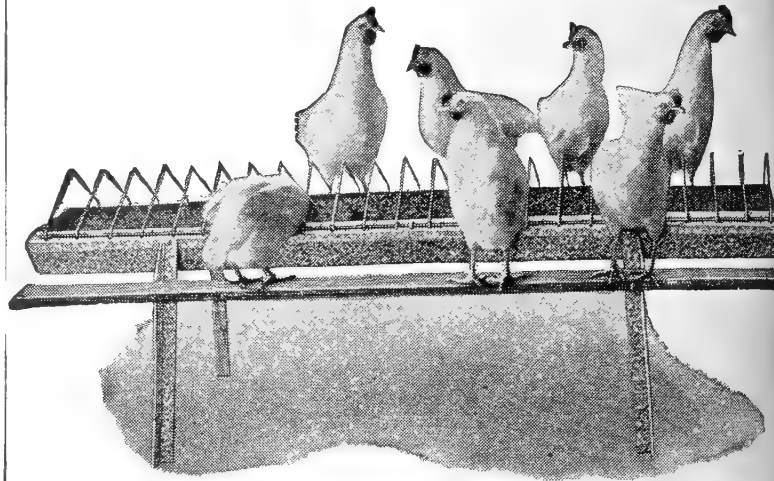

Big, roomy trough for feeding dry or wet mash and green feeds. Wire guard prevents hens from getting into trough. Wide lip on trough keeps hens from pulling mash out on floor. For feed-saving, cleanliness, and real satisfaction, buy this Feeder. Trough is 10 inches wide and 5½ inches deep. Perches 20 inches from floor to prevent vent-picking by birds on floor. Length 5 feet. Holds 50 pounds of mash. No. 525, \$5.35.

Jamesway Self-Cleaning Nests

Lice- and Mite-Proof
Has Folding Perches

Jamesway Nests are clean, sanitary, and lice- and mite-proof. The hard, smooth, sanitary, galvanized surface offers no place for parasites to hide and thrive. They are easily cleaned, simply swing forward and upward. Nesting material falls out the open back and the nest is cleaned.

No. 1230, 10-Nest Unit (illustrated). \$11.65.

No. 1235, 15-Nest Unit. \$15.85.

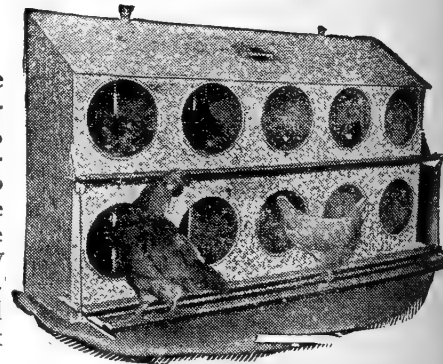

Jamesway Universal Battery Brooder

Space does not permit of a description of this Battery in our catalog. Developed by Jamesway, it is a new, modern Battery in every respect and has many outstanding features. Circular mailed on request. No. 2371, \$225.

Jamesway Chick Feeders

These Feeders are carefully designed and built of quality galvanized sheets. Have "Z" type, easy-turning reel with two adjustments.

No. 290. Trough 24 in. long; 2½-qt. capacity. 40 cts. each.

No. 296. Trough 36 in. long; 3¾-qt. capacity. 50 cts. each.

Jamesway Growing Flock Feeders

Practical Feeders for baby chicks and growing flocks. Built of high-quality galvanized sheets. Equipped with easy rolling 4-blade adjustable reel and adjustable legs.

No. 292. Trough 4 in. wide, 2 in. deep, 48 in. long; 6½-qt. capacity. \$1.20 each.

No. 332. Trough 5½ in. wide, 3 in. deep, 48 in. long; 13½-qt. capacity. \$1.75 each.

Dr. Salsbury's Poultry Medicines

As a member of Dr. Salsbury's Nation-Wide Poultry Health Service, we have, at all times, the latest bulletins, booklets, and literature of the scientific poultry world. Ask or write us for free educational literature.

Avi-Ton. For chickens and turkeys. Avi-Ton is a flock treatment for the removal of roundworms, and cecal worms, also contains ingredients that are recognized as having a beneficial effect on digestion. In powder form. Avi-Ton mixes easily in wet or dry mash. 10-oz. pkg. 30 cts., 3-lb. pkg. \$1.35, 6-lb. pkg. \$2.30, 15-lb. pkg. \$5.50, 25-lb. drum \$8.60, 50-lb. drum \$16.20, 100-lb. drum \$31.

Can-Pho-Sal. A medicinal inhalant spray to be diluted with water for spraying chicks and older birds. Tends to loosen accumulations of mucus in nostrils and throats of poultry when used as a nasal wash or spray. 2-oz. bottle 50 cts., 4-oz. bottle 85 cts., ½-pt. bottle \$1.25, 1-pt. bottle \$2.10, 1-qt. bottle \$4, ½-gal. \$7.50, 1-gal. \$14.

Ren-O-Sal. Dr. Salsbury's new drinking-water medicine for baby chicks and birds of all ages. Use it regularly in small doses for its tonic benefits. Simply increase the dosage to 8 tablets to the gallon of drinking-water for an effective control for cecal coccidiosis. 25 tablets 30 cts., 100 tablets \$1, 250 tablets \$2, 500 tablets \$3.45, 1000 tablets \$6.25.

Par-O-San. A general, pleasant smelling disinfectant for poultry houses, incubators and brooding equipment. It may be either sprayed or applied with a scrub-brush or broom. Kills by contact, lice, mites and bacteria commonly found present. One quart makes 25 gallons of a general disinfectant. ½-pt. bottle 60 cts., 1-qt. bottle \$2, 1-gal. bottle \$6.50.

Nic-Sal. Kills lice and mites on poultry by application on the roosts. Applied by brush or oil-can. One pint treats 350 feet of roosts. 4-oz. bottle 50 cts., ½-pt. bottle 90 cts., 1-pt. bottle \$1.45.

Rota-Caps. Recommended for the removal of large roundworms and capillaria worms in chickens and turkeys. No toxic after-shock; no loss in egg-production or set-back in growth. **Adult Size:** 50 capsules 75 cts., 100 capsules \$1.35, 200 capsules \$2.50, 500 capsules \$5.

Pullet Size: 50 capsules 50 cts., 100 capsules 90 cts.

Walko Tablets

A valuable drinking-water antiseptic for baby chicks, turkeys, ducks, geese, or older fowls. Aids in preventing spread of disease through contaminated water. Give to little chicks in their drinking-water as soon as they are out of the shell. Pkg. (100 tablets) 50 cts., pkg. (235 tablets) \$1, pkg. (1,000 tablets) \$2.50, pkg. (2,000 tablets) \$4.

Mouse Seed

The modern way to kill mice. Pkg. 25 cts.

Pratts Poultry Remedies

Pratts Poultry Regulator. Its trace elements make **more eggs** when otherwise balanced feeds lack them. Also a valuable tonic for birds recovering from molt, disease, or the after effects of worm infestation. Pkgs. 25 cts., 50 cts. and \$1. 12½-lb. pkg. \$1.85, 25-lb. carton \$3.50, 100-lb. drum \$11.25.

Pratts Dip and Disinfectant. Should be used liberally by all livestock and poultry owners to help control worms, lice, and all diseases. Pt. 50 cts., qt. 75 cts., gal. \$1.85.

Pratts R-P Tablets. Helps keep drinking-water safe and thereby prevents spread of colds and "roupy" condition through the flock. Pkgs. 30 cts. and 60 cts.

Pratts Chick Tablets. New—they're floated. Far superior to other chick drinking-water preparations. They keep the water safe 24 hours a day. Pkgs. 35 cts. and 70 cts., postpaid.

C-Ka-Gene. Stops heavy losses from bloody coccidiosis. Works by the "immunity" (permanent protection) method. Given in the feed, no handling of birds. Pkg. (50 chicks) 75 cts., pkg. (100 chicks) \$1.25.

"Split Action" Worm Capsules. Pennies spent for worming bring back dollars. Wormy birds cannot lay or grow profitably. Each "Split Action" Capsule does the work of two ordinary treatments. They contain phenothiazine, the new miracle wormer that is nearly 100 per cent effective against cecum worms, and nicotine, which is the most effective drug known for large roundworms. Suitable for both chickens and turkeys.

Adult Size: 50 capsules 85 cts., 100 capsules \$1.50, 500 capsules \$5.50, 1,000 capsules \$10, postpaid.

Chick Size: 50 capsules 55 cts., 100 capsules \$1, 500 capsules \$3.75, 1,000 capsules \$6.50, postpaid.

Pratts Poultry Worm Powder. A flock treatment for large round and cecum worms. Just add it to the mash. Contains phenothiazine and a special shockless nicotine. 60-ct. pkg. (50 hens) \$1 pkg. (100 hens), \$4.25 pkg. (500 hens).

Pratts Roost Paint. Now contains DDT and nicotine. Kills lice and mites when just applied to roosts and cross arms. Has double action—works by both fumes and contact. Eliminates the necessity of handling birds. 3¼ ozs. 50 cts., ½pt. \$1, pt. \$1.75, qt. \$2.50, gal. \$7.50.

Pik-No-Mor. Valuable in preventing and stopping outbreaks of feather picking, toe picking and other forms of cannibalism. Easy to apply—inexpensive—effective. 2-oz. pkg. 30 cts., 5-oz. pkg. 60 cts., 1-lb. pkg. \$1.35.

Pratts Powdered Lice Killer. Valuable for delousing poultry, stock and pets. Contains DDT. Pkgs. 35 cts. and 75 cts.

Farmrite Egg Preservative. One quart will make sufficient solution to preserve 20 dozen fresh eggs. Easy to do, and the results are very satisfactory. Pt. 25 cts., qt. 40 cts., gal. \$1.20.

Conkeys First Aid Products

Dia-Tabs. One diseased chick may pollute the drinking-water! Prevent the spread of pullorum and other bacterial diseases such as typhoid and paratyphoid through contaminated water by adding DIA-TABS. Fine to disinfect fountains and feeders, too. Harmless to chicks but death to germs!

½pt. 65 cts., pt. \$1, qt. \$1.75, gal. \$5.50.

Old Reliable Powder. A mild external astringent for poultry. Apply direct to canker in mouth and put in drinking-water too, especially on raw, damp days.

Oz. 25 cts., 2½ ozs. 50 cts., 7 ozs. \$1, 1½ lbs. \$2.35, 5 lbs. \$5.50, postpaid.

Phe-Nikala Tablets. You can't beat these tablets for individual treatment of chickens or turkeys to rid them of both cecal and large roundworms. One tablet per bird does the trick.

Pkg. of 100 tablets \$1, pkg. of 500 tablets \$4.25.

Phe-Nikala Powder. Rids birds of both cecal and large roundworms. Won't shock birds. Just mix it with a little mash, feed it to chickens or turkeys, then back to regular feed. Simple as A, B, C, but very effective. Economical, too!

Pkg. (100-bird size) 90 cts., pkg. (300-bird size) \$2.25.

100-to-1 Powder. For large roundworms. Mix in mash for chicks or grown birds at regular intervals.

4 ozs. 30 cts., lb. \$1, 2 lbs. \$1.75, 5 lbs. \$4, 10 lbs. \$7.50.

Lice Powder. Adheres to body and feathers and destroys lice and mites. Gets most of nits, too. For individual treatment or use in dust-bath.

12 ozs. 25 cts., 6-lb. pail \$1.50.

Poultry Tonic. Acts as an appetizer and tonic. Use 3 pounds to each 100 pounds of mash periodically.

1½ lbs. 30 cts., 3¼ lbs. 55 cts., 6½ lbs. \$1.

Nox-I-Cide Disinfectant. A good disinfectant to help keep down disease and control mites (mix half and half with car oil).

Pt. 40 cts., qt. 70 cts., gal. \$1.75.

Red Pic-End Paint. Use this Paint to help guard against cannibalism. Light filtered through a coating of PIC-END PAINT on windows or light bulbs makes red objects, *i.e.* blood, less attractive; hence chicks do not pick each other so much. Affects hens the same way. It pays to use it.

¼pt. 50 cts., ½pt. 90 cts., pt. \$1.50.

Pic-End Bitters. A distasteful paste. Smear it on injuries to help prevent further picking. Use with Pic-End Paint. 2¾ ozs. 25 cts., 7¾ ozs. 65 cts., 1¼ lbs. \$1.

Y-O. A patented powder-like vitamin supplement, which prolongs the potency of A and D vitamins of cod-liver oil. Also provides plenty of vitamin B-complex, riboflavin and E. Use only 2 to 4 per cent in the mash for poultry. Good for dogs, cats and all fur-bearing animals, too.

Lb. 60 cts., 2-lbs. \$1.10, 5-lbs. \$1.75.

Dr. Hess Products

Dr. Hess Poultry Pan-A-Min. Its tonics promote appetite; keep hens healthy; start pullets and moulted hens to laying. Formerly known as Dr. Hess Panacea. 1½-lb. pkg. 30 cts., 5-lb. pkg. 85 cts., 10-lb. pkg. \$1.50, 30-lb. pkg. \$3.75, 100-lb. drum \$10.50.

Dr. Hess Nicozine. A combination of phenothiazine with nicotine. Effective for the removal of large roundworms and cecal worms. Given in mash, the expulsion of worms starts in a few hours and is usually completed within 3 days. No fasting or laxatives required. 2.2-oz. pkg. (50-bird size) 50 cts., 4.4-oz. pkg. 90 cts., 11-oz. pkg. \$1.90, 1¾-lb. pkg. \$3.

Dr. Hess Poultry Tablets. Valuable in treatment of roup; non-irritating and healing. Used as a local antiseptic and to medicate drinking-water. Aids in preventing disease. 25 cts., 50 cts., and \$1, postpaid.

Dr. Hess Coxitrol. A new aid in the control and treatment of bloody or cecal coccidiosis. The ingredients of Coxitrol are a special mycronized sulfur and urea. Coccidiosis is worse during rainy, damp weather. As a prevention, be sure to use Coxitrol when the weather is bad. When used as a preventive, give 1% of Coxitrol in an all-mash feed. 1-lb. pkg. 80 cts., 5-lb. pkg. \$3.50, 10-lb. pkg. \$6.50.

Dr. Hess Powdered Louse-Killer. Effective in ridding poultry of lice and mites. 1-lb. pkg. 30 cts., 2½-lb. pkg. 65 cts.

Lee's Germozone

Germozone helps prevent the spread of germs through the drinking-water, and medicates the digestive tract. Give to baby chicks and birds of all ages. 4-oz. bottle 40 cts., 12-oz. bottle 75 cts., 32-oz. bottle \$1.50, 1-gal. bottle \$4.50.

Lee's Acidox

Aids in the care of flocks showing visible symptoms of coccidiosis. For chickens and turkeys. Administer in the drinking-water. 4-oz. bottle 50 cts., 12-oz. bottle \$1, 32-oz. bottle \$2, 1-gal. bottle \$6.50.

Burrell-Dugger Poultry Remedies

Don Sung. A mineral supplement for laying hens given in the mash feed. Successfully used and recommended for years by large and small poultry raisers from coast to coast. 2½-oz. pkg. (sufficient for 15 hens for 30 days) 50 cts., 7½-oz. pkg. \$1, 3-lb. pkg. \$5.

Avicol. An aid in protecting drinking-water of chicks from harmful effects of bacterial contamination. For all poultry, and for turkeys, ducks, and geese. Pkg. of 60 tablets 50 cts., pkg. of 180 tablets \$1, economy pkg. (six times the \$1 pkg.) \$5.

Group-Over. A soothing, antiseptic application for the mucous membranes of the mouth and nostrils of poultry. Group-Over as an individual treatment and as a vapor will be found a valuable aid in expelling the accumulations of such mucus in the upper nasal passage. 3-oz. bottle 50 cts., 8-oz. bottle \$1, 1-qt. bottle \$3.

Carbolineum

Standard Insecticide and Wood Preserver
Since 1876

Has many uses around poultry houses and general farms. In poultry and brooder houses it kills and keeps out mites, blue bugs and fowl ticks; preserves wood everywhere against rot and decay; stops tunneling termites; prevents gnawing of wood by horses, rats, or gophers. It is a heavy, non-volatile, brown oil to which other ingredients have been added. It will not evaporate readily and its effectiveness is long-lasting. Comes ready to use and is applied with an ordinary paint brush or sprayer.

1-gal. can \$1.85, 5-gal. drum \$7.50,
30-gal. drum \$36, 55-gal. drum \$60.50.

Pik-Rem Stops Cannibalism

Pik-Rem is not a medicine but a help in breaking the vicious habit of chicks picking each other and will quickly break up the condition known as cannibalism. It is blood-colored and blood-soluble, making it adhere to raw bloody surfaces. Very effective and harmless.

5-oz. jar 50 cts., 12-oz. jar \$1, 26-oz. jar \$2, postpaid.

"Black-Leaf 40"

Controls Poultry Lice and Mites

A sure method for controlling body-lice. With the "Cap-Brush" Applicator, the 1-ounce bottle will treat about 90 birds, other sizes in proportion. (Applicator included in the 1-oz., 5-oz., and 1-lb. bottles.)

When used as a spray, dilute at the rate of 2 to 3 tablespoonfuls to 1 gallon of water and add about ¼ bar of laundry soap. 1-oz. bottle 35 cts., 5-oz. bottle \$1.05, 1-lb. bottle \$2.42, 2-lb. tin \$3.92.

Gold-Leaf Tobacco-Leaf Dust

Manufactured especially to control roundworms in poultry. So certain is its action that it may well be considered a specific for the control of this trouble. The treatment is exceedingly inexpensive.

Mix two pounds of Gold-Leaf Tobacco-Leaf Dust with 100 pounds of dry mash. 2-lb. carton 25 cts., 10-lb. pkg. 75 cts., carton (6 10-lb. pkgs.) \$4.

PTZ Powder

Worm Treatment for Poultry

Effective in the removal of cecal worms in poultry. Recommended dosage one-half gram per bird—added to the ground feed. Made with phenothiazine. 4-oz. pkg. 50 cts., 1-lb. pkg. \$1.25, 5-lb. pkg. \$6, postpaid.

K-R-O (Kills Rats Only)

K-R-O is made of red squill, an ingredient recommended by the U. S. Government for rat eradication. Red Squill may be safely used around humans, pets, and livestock. K-R-O. Powder, 2-oz. size, 75 cts., postpaid.

K-R-O Ready Mixed Bis-Kit Form. Small size 35 cts., large size \$1, postpaid.

Toxite Disinfectant Spray

A dependable, all-year-round germ killer and insecticide that will neither freeze nor evaporate; also used widely as an inhalant for colds in poultry. Especially adapted for keeping poultry houses, stables, etc., free from disease germs and insect pests such as red mites. Kills by contact household pests such as bedbugs, ants, roaches, fleas, termites. Particularly recommended for controlling coccidiosis and in the treatment of mange. Apply with ordinary sprayer.

10 ozs. 35 cts., qt. 60 cts., gal. \$1.75,
5-gal. drum \$6.50.

B-K Poultry Disinfectant

A powerful quick-acting hypochlorite disinfectant used as an aid in preventing the spread of diseases by contaminated equipment and drinking-water. It is not only a powerful disinfectant, but also a deodorant.

B-K Powder is used as a dry expectorant dust and is applied by means of a dust gun over the heads of baby chicks and adult birds infected with colds, simple bronchitis and infectious bronchitis.

B-K Powder. 9½-oz. bottle 75 cts.,
1¾-lb. bottle \$1.50.

B-K Liquid. 4-oz. bottle 30 cts., 10-oz. bottle 50 cts., 1-qt. bottle 90 cts., 1-gal. bottle \$2, 5-gal. jug \$8.50.

HTH-15

Don't let colds and other respiratory troubles sap the strength of your breeding flocks. Dust with HTH-15 to prevent and combat these ailments. Use it regularly in the drinking-water to prevent spread of infection. Invaluable disinfectant for brooders and incubators. 1-lb. bottle 50 cts., 3-lb. bottle \$1, case of six 3-lb. bottles \$5.

DDT Carbola

The insect-killing and disinfecting white paint in powder form. Simply mix the DDT Carbola powder with water and it is ready for brush or sprayer. *Won't peel or flake.* It gives walls and ceilings a smooth white finish. Kills flies, mosquitoes, roaches, spiders, ants and other insects. Carbola DDT includes a disinfectant which destroys disease germs in barns, poultry houses, cellars, etc. Harmless to skin. Two and one-half pounds makes 1 gallon of paint covering 250 square feet.

5 lbs. 80 cts., 10 lbs. \$1.35, 25 lbs. \$3,
50 lbs. \$5.50.

CCC Powder

Contains 10% D.D.T.

Kills roaches, bedbugs, fleas, ants, silverfish, dog ticks, and lice on cattle, poultry, and hogs. Ready to use. 1-lb. can 50 cts.

Humane Poultry Killer



Easy to operate and makes a sure kill. Place the blade in the bird's mouth, close the handle, and the bird is brained and bled in one operation. Will work equally well on turkeys, ducks, or geese. \$1.75, postpaid \$1.85.

Toxite Veterinary Ointment

A healing salve for the treatment of cuts and sores of animals and for massaging chapped udders of cows; effective in stopping tail-picking and cannibalism in poultry. Safe and economical.

4-oz. jar 50 cts., postpaid.

Morti-Cocci

Used and recommended by many leading poultrymen for the control of coccidiosis. It should always be kept on hand for immediate use at the first symptoms of the disease. Add it to the drinking-water. A gallon is sufficient for 500 chicks. Complete directions on package.

Qt. \$1.50, 1/2gal. \$2.50, gal. \$4.

Nopco XX Fortified Cod-Liver Oil

A uniform, dependable vitamin A and D supplement for daily use in all poultry and live-stock feeds. **Nopco XX** is not only for poultry. Hogs, calves, dairy cows and other animals need vitamins A and D, too. **Nopco XX** is not ordinary cod-liver oil. Each pound of **Nopco XX** is guaranteed to contain 400 A. O. A. C. units of vitamin D and 3,000 U. S. P. units of vitamin A. It's economical.

5-lb. can \$5.25. Postage extra.

Nest Eggs

Glass Nest Eggs. 6 cts. each, 3 for 15 cts., 50 cts. per doz.

Lime Nest Eggs. Made from pure sterilized sulphate of lime. 3 for 10 cts., 30 cts. per doz.

BOOKS

American Standard of Perfection. Published by the American Poultry Association and is the American authority on the recognized characters of all breeds of chickens, turkeys, ducks, and geese. Contains nearly 500 pages, 218 illustrations. Cloth, \$2.50.

Best Plans of Poultry-Houses. Following the plans in this book is assurance that you will have a satisfactory poultry-house at the least expense. Illustrated. 50 cts.

The Home Veterinarian's Handbook. By E. T. Baker. Tells how to handle emergency situations regarding farm animals and poultry. Contains information on: horses, cattle, hogs, sheep, goats, rabbits, dogs, cats, poultry, wild animals, medicine, poisons and parasites. Cloth, \$2.50.

Turkey Management, by S. J. Marsden and J. Holmes Martin. Covers every phase of the turkey business from the origin and history of the turkey to artificial breeding, sexing, and caponizing. 700 pages; 200 illustrations and charts. \$3.50.

How to Raise Poultry. By Paul Ives. With the aid of this practical guide anyone can raise poultry successfully. Has chapters on turkeys, ducks, geese and bantams. 96 pages 9 x 12; many illustrations. Paper \$1.00.

CONKEYS Y-O POULTRY AND CHICK FEEDS

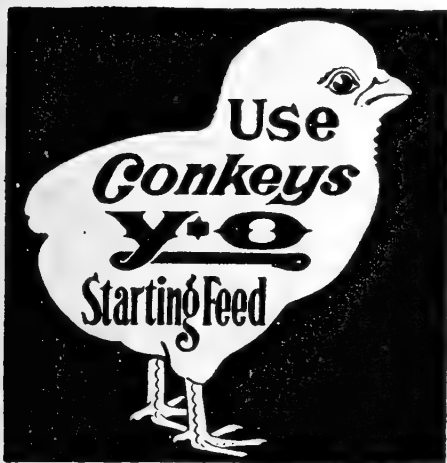

Fed by thousands of chick raisers who demand a high-quality, easily digested, vitamin-rich, well-balanced starter at a reasonable price. Remember, Conkeys is Vi-tal-ized with Y-O, the patented product rich in A, B, D, E and G vitamins.

LOOK FOR THE 2 BIG RED Y-O LETTERS ON THE BAG



For fast, uniform growth and feather development feed Conkeys. It has what it takes to get your birds over the growing period in minimum time. Proteins, fats, minerals and vitamins—all are found in adequate quantities for satisfactory results in this mash. Remember, it is vi-tal-ized with Y-O—rich in vitamins A, B, D, E and G.



Appetizing because the ingredients it contains are palatable; wholesome because the formula consists of a good variety of highly digestible nutrients; productive of results because of the well-balanced combination of proteins, fats and minerals, plus the addition of

CONKEYS Y-O

Conkeys Y-O is a patented product rich in vitamins.

For an economical egg mash—one which gives results that satisfy—use Conkeys Y-O Egg Mash.

Oyster Shells

They supply sufficient lime for the shell of the egg. Should be kept within easy access to fowls all the year round.

Grit

Essential to all fowls from day-old chicks to full-grown birds. Aids in grinding the food.

Health Grit for Pigeons

Helps keep birds' digestive organs in prime order; provides the proper shell material; assists the birds in the moult and wards off many troublesome diseases. Keep before birds at all times.

Meat and Bone Scrap

Supplies the necessary protein and bone phosphate for egg-making. Obtained from freshly rendered meat-trimmings and is thoroughly dried.

Poultry Charcoal

Aids digestion and helps prevent disease. Fowls young and old should have free access to it at all times.

Dried Buttermilk

Supplies the vitamins, protein, and mineral matter which are essential in the diet of all young animals for rapid growth. Fed mixed with ground feeds.

Conkeys Rabbit Pellets

A complete, balanced and nourishing food for rabbits. Being in pelleted form it eliminates waste.

Miscellaneous Seeds and Grains

- | | |
|-----------------|-------------------|
| Cracked Corn | Pigeon Peas |
| Whole Corn | Whole Flaxseed |
| Pinhead Oatmeal | Flaxseed Meal |
| Hulled Oats | Wheat |
| Sunflower Seed | Buckwheat |
| Hemp Seed | Millet |
| Canary Seed | Alfalfa Leaf Meal |
| Rape Seed | Cotton Seed Meal |
| Kaffir Corn | |

Our stocks of the above are carefully selected and will be found equal to any on the market.

Dog and Pet Foods and Supplies



Bannock Body Builder

"Dog Food at Its Best"

For ALL DOGS • ALL BREEDS • ALL AGES

Healthful, economical, and convenient to feed, Bannock Body Builder is a balanced ration, containing all of the food elements necessary for the proper nutrition of dogs. Proteins, vegetables, fats, minerals, vitamins, and "THYMAVITE"*—all especially selected and in correct proportion. Breeders, trainers, and veterinarians alike recommend Bannock Body Builder.



"Thymavite"* provides more essential vitamins, more minerals and more food value—just what dogs need.

*"Thymavite" is the new food discovery, the remarkable vitamin concentrate combined with other health-giving elements.

5-lb. bag	\$0 65	50-lb. bag	\$5 25
10-lb. bag	1 25	100-lb. bag	10 00
25-lb. bag	2 90	500 lbs.	47 50

Always in Fine Condition

"I have been using Bannock Dog Food for several years, and my dogs are always in perfect condition, even after weaning large litters. They are not only in excellent condition all the time, but are full of pep and carry magnificent coats. I also get large litters of sturdy puppies, and have never had a bitch miss since I started using Bannock. I am more than glad to recommend such a satisfactory food." (Signed) ELIZABETH D. WHALEN, Pocono Kennels, Pa. Three Champion Shetland Sheepdogs, the pride of Pocono Kennels, Pa.

Spratt's Dog and Puppy Foods

For over eighty years, Spratt's "Meat Fibrine" Biscuit Foods have been termed "Foods of Quality." They lead in nourishing properties, suitability to the constitution of present-day dogs, and in economical value. Their reputation is world-wide.

SPRATT'S FIBO. An appetizing granulated food for shy and dainty feeders. Suitable for change of diet for any dog at any time. Feed dry or soaked with broth. Lb. 20 cts., 2 lbs. 35 cts., 5 lbs. 85 cts., 25 lbs. \$3.90, 50-lb. bag \$7.50.

SPRATT'S OVALS. Handy pocket biscuits suitable for all breeds. Carry a few when on a ramble with your dog. Lb. 20 cts., 2 lbs. 35 cts., 5 lbs. 80 cts., 25 lbs. \$3.65, 50 lbs. \$7.

SPRATT'S SPIX. Meat fibrine biscuit, bone size. All dogs like this biscuit. Lb. 20 cts., 2 lbs. 35 cts., 5 lbs. 80 cts., 25 lbs. \$3.65, 50-lb. box \$7.

SPRATT'S CHARCOAL OVALS. Aid in the elimination of fetid breath and stomach impurities. Lb. 18 cts., 2 lbs. 35 cts., 5 lbs. 85 cts., 25 lbs. \$3.75, 50-lb. bag \$7.25.

SPRATT'S COD-LIVER OIL OVALS. Aids in the conditioning of dogs; invaluable during the winter months. Lb. 20 cts., 2 lbs. 35 cts., 5 lbs. 85 cts., 25 lbs. \$3.75, 50-lb. bag \$7.25.

SPRATT'S MEAT FIBRINE DOG CAKES. Standard dog cake for large dogs, used by all leading dog breeders. Lb. 20 cts., 2 lbs. 35 cts., 5 lbs. 80 cts., 25 lbs. \$3.65, 50-lb. bag \$7.

SPRATT'S ASSORTED BISCUITS. Gives your dog just the variety of crunchy foods needed for the maintenance of stamina and good health. The combination is made up of Spix, Ovals, Charcoal Ovals, and Cod-Liver Oil Ovals. Lb. 20 cts., 2 lbs. 35 cts., 5 lbs. 85 cts., 25 lbs. \$3.75, 50-lb. box \$7.25.

SPRATT'S PEPSINATED MEAL. For puppies or kittens with weak digestion; is extremely assimilative and will make most unpromising youngsters thrive. 12-oz. can 45 cts.

SPRATT'S PUPPILAC. A perfect substitute for the milk of the bitch, for rearing orphan puppies, at weaning-time and for ailing dogs in sickness or convalescence. This is also valuable as a food for cats and kittens. 10-oz. can 85 cts.

SPRATT'S BONE MEAL FOR PUPPIES. A great preventive of early weakness in puppies containing all the elements needed to insure vigorous frame. Prepared for easy mixing with the staple food. 18-oz. tin 30 cts.

SPRATT'S CALCIUM PHOSPHATE. For Rickets and Osteoporosis. An admirable adjunct in the feeding of puppies of the large breeds. It may also be given to bitches before whelping. Easily assimilated and has no irritating effect on the stomach. 8-oz. can 40 cts.

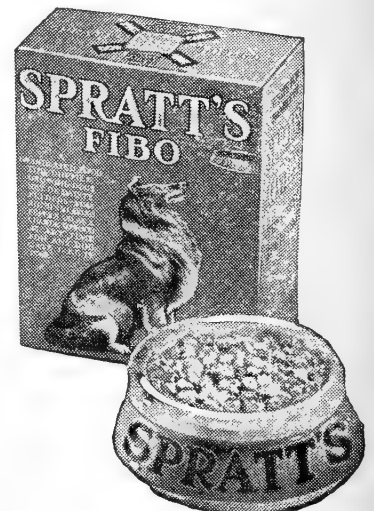

"Old Trusty" All Terrier Food

A granulated food of even balance and carefully mixed. An ideal food for all breeds, particularly terriers and active dogs. May be fed dry or moistened with milk or soup. 5 lbs. 75 cts., 10 lbs. \$1.35, 25-lb. bag \$3.25, 50-lb. bag \$6.25, 100-lb. bag \$11.75.

Dog Furnishings

We offer an extensive selection in Collars, Harness, Leashes, Baskets, Brushes, Nail Clippers, Dressing Tools, Name Plates, Toys, Novelties, Blankets, and Sweaters for dogs. Since this merchandise is too diversified to be included in the Catalogue, we invite you to call at the store and inspect it personally.

Armstrong Dog Meal

A complete, balanced food for dogs of all breeds and ages. High in nutritional value, appetizing—dogs go for it, helps keep your dog lively and strong. 5-lb. bag 65 cts., 10-lb. bag \$1.25, 25-lb. bag \$3, 50-lb. bag \$5.75, 100 lbs. \$10.50, 500 lbs. \$50.

Mail and Telephone Orders

We are organized to give mail and telephone orders the same personal attention as orders placed in our store. If it is not convenient to come to the store, we will appreciate your order either by mail or telephone. Orders amounting to \$2 or more (except where priced otherwise) are delivered free. See page 92.

MILLER'S DOG FOODS

Battle Creek Health Foods for Dogs

Miller's Dog Foods will furnish you with all the essentials needed to keep your dog at his best. Miller's Foods contain dehydrated meat meal, cereals, vitamins, and minerals. Several types to choose from, and they all help you keep your dog healthy at small expense.

KIBBLES		PUPPY MEAL	
5 lbs.....	\$0 80	5 lbs.....	\$0 80
10 lbs.....	1 50	10 lbs.....	1 50
25-lb. sack.....	3 50	25-lb. sack.....	3 50
50-lb. sack.....	6 75	50-lb. sack.....	6 75
100-lb. sack.....	13 00	100-lb. sack.....	13 00
RATION		BISCUIT	
5 lbs.....	\$0 65	5 lbs.....	\$0 80
10 lbs.....	1 25	10 lbs.....	1 50
25-lb. sack.....	3 00	25-lb. sack.....	3 50
50-lb. sack.....	5 75	50-lb. sack.....	6 75
100-lb. sack.....	10 50	100-lb. sack.....	13 00

MILLER'S KIBBLES DOG FOOD

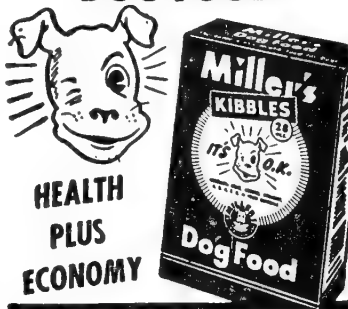

HEALTH PLUS ECONOMY

Highest quality for 26 years

Gaines Dog Meal

An excellent daily diet for dogs and puppies of all sizes and breeds. Just add water—nothing else—and Gaines offers dogs all the Vitamins A, B₁, B₂ (G), B₆, D, E, Niacin, Pantothenate and other food factors they're known to need. And dogs love it. In fact, actual surveys show that nine out of ten dogs like Gaines right from the very first feeding! Chosen by the U. S. Antarctic Expedition and now fed by the U. S. Army.



5 lbs.....	\$0 65	50 lbs.....	\$5 50
10 lbs.....	1 25	100 lbs.....	10 50
25 lbs.....	3 00	500 lbs.....	50 00

Gaines Krunchon

Made of the same ingredients as Gaines Meal, but in pelleted form.

5 lbs.....	\$0 65	50 lbs.....	\$5 50
10 lbs.....	1 25	100 lbs.....	10 50
25 lbs.....	3 00		

Sturdy Dog Foods

Made from tested and proven formulas and contain a wide variety of ingredients. Suitable for dogs of every age, every size and every breed. They can be fed dry or moistened.

Terrier Blend. 5 lbs. 65 cts., 10 lbs. \$1.25, 25-lb. bag \$2.75, 50-lb. bag \$5.50, 100 lbs. \$10.
Whole Biscuit. 5 lbs. 65 cts., 10 lbs. \$1.25, 25 lbs. \$3, 50-lb. bag \$5.75, 100 lbs. \$11.
Meal. 5 lbs. 55 cts., 10 lbs. \$1, 25-lb. bag \$2.40, 50-lb. bag \$4.75, 100 lbs. \$8.50.

MILK-BONE

-- your dog's favorite food

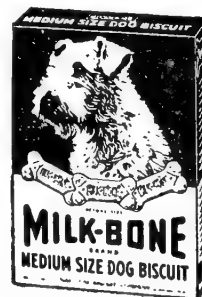

Large Milk-Bone for big dogs—medium size for medium size dogs—little ones for small dogs and puppies—and the all-purpose food, Milk-Bone. Tiny-Bits (broken up Milk-Bone biscuits) for all dogs. That's the wonderful variety Milk-Bone offers.

Whatever the size, hearty, wholesome Milk-Bone is packed with the food elements dogs need—with high-protein meat meal, yeast, milk, whole-wheat flour, fish, liver oil, vitamins A, B₁, B₂, D, and E as well as important minerals.

Dog Biscuit. For large breeds. 29-oz. carton 37 cts. each, 3 for \$1.10.

Puppy Biscuit. For full-grown dogs in the medium-size class, also puppies. 26-oz. carton 37 cts. each, 3 for \$1.10.

Tiny-Bits. An all-purpose food. 10¼-oz. carton 20 cts., each, 3 for 55 cts.

PERFECTION DOG FOODS

TIME-TESTED...

For More Than 30 YEARS



Very little more need be said of these well-known foods—favored by dog and kennel owners everywhere. Certainly a trial will convince you.

MEAT MEAL CEREAL. Ready to feed—For All Dogs—All Ages.

By far the most popular—

5-lb. bag.....	\$0 55
10-lb. bag.....	1 00
25-lb. bag.....	2 40
50-lb. bag.....	4 50
100-lb. bag.....	8 50
500 lbs.....	40 00

FREE 32-PAGE DOG BOOK

WHOLE BISCUIT.

5-lb. bag.....	\$0 65
10-lb. bag.....	1 25
25-lb. bag.....	3 00
50-lb. bag.....	5 75
100-lb. bag.....	11 00

KIBBLED BISCUIT.

5-lb. bag.....	\$0 65
10-lb. bag.....	1 25
25-lb. bag.....	3 00
50-lb. bag.....	5 75
100-lb. bag.....	11 00

BRESKO DOG FOOD

With Fresh Raw Liver

By a special process fresh raw liver is cooked into Bresko making it a palatable and nourishing food for dogs. Bresko-fed dogs have a sleek silky coat, more pep, better health. Liver is invaluable for body and blood building.

Dogs get the meat they need in Bresko—and plenty of it. Bresko is made of meat-scrap and balanced with other ingredients.

BRESKO MEATBONE CRISP. (Kibbled.) 5 lbs. 65 cts., 10 lbs. \$1.25, 25-lb. bag \$3, 50 lbs. \$5.75, 100 lbs. \$11.

BRESKO RATION. 5 lbs. 60 cts., 10 lbs. \$1.10, 25-lb. bag \$2.65, 50 lbs. \$5.

Pard Dehydrated Dog Food

A nutritionally balanced diet

Rich in meat food products and other wholesome ingredients. Fed mixed with water. 8-oz. pkg. 13 cts., case (48 pkgs.) \$5.65, f.o.b. store.

For Economy Feed Chappel's Fresh Meat Biskits

KEN-L-BISKIT

INGREDIENTS

Fresh Meat, Wheat Germ, Yeast,

Egg Yolk, Wheat Flour,

Fresh Whole Milk and Bone

Vitamin Fortified

Chappel's Ken-L-Biskit is scientifically prepared from fresh raw meat and carefully selected ingredients. Its nutritional value has been proved in laboratory-controlled feeding tests. Can be fed dry or moistened with water or broth and is suitable for dogs of all breeds and ages.

Small cakes, small kibbles, or medium kibbles, 5 lbs. 70 cts., 10 lbs. \$1.35, 25-lb. bag \$3.25, 50-lb. bag \$6.25, 100-lb. bag \$12.

Spratt's Dog Remedies

Spratt's Medicines are made from the purest ingredients obtainable and are always kept up to the highest level of modern veterinary science. Dosage and directions appear on all packages.

Tablets for Constipation.....	Pkg. \$0 60
Sulfur Tablets. For heated blood, etc.	60
Cough Tablets. Generally effect a quick cure.....	60
Special Tablets. A diuretic and stimulant.....	1 00
Ear Canker Ointment. For both internal and external forms of this disease.....	75
Mange Liquid. 12-oz. bottle.....	75
Tonic Tablets. To build up after sickness.....	60
Cod Liver Oil Capsules. 20 capsules.	60
Worm Capsules for Puppies.....	60
Worm Capsules for Dogs.....	60
Dry Cleaning Powder.....	35
Dog Soap (White). For fleas, lice, etc.....	Cake 25 cts.
Liquid Shampoo. Also recommended for use by humans.....	35
Chalk Block. For dry-cleaning dogs and cats.....	35

Sergeant's DOG MEDICINES

Special Medicine. For reduction of fever in pups and dogs.....	Pkg. \$1 20
Mange Medicine. For treating sarcoptic mange.....	65
Condition Pills. A tonic and alterative for pups and dogs.....	60
Expectorant Medicine. For coughs due to colds in pups and dogs....	60
Puppy Capsules. For round- and hookworms in pups and dogs weighing less than 10 pounds....	60
Eye-Wash. For treating eye trouble in pups and dogs.....	60
Sure-Shot Capsules. For large roundworms, and hookworms in pups and dogs weighing over 10 pounds.	60
Tapeworm Medicine. For tapeworms in pups and dogs.....	60
Arsenic and Iron Pills. A tonic used alternately with Sergeant's Condition Pills.....	60
Canker Wash. For treating internal and external ear canker.....	60
Pepsin and Aromatic Tablets. Relieves colic in pups and dogs due to improper food.....	60
Intestinal Astringent. Checks too-frequent bowel action in cases of diarrhea.....	60
Diuretic Pills. Stimulates urinary action. Useful in old dogs.....	60
Vitapets. A food supplement for dogs and puppies. Supplies Vitamins A, B, D, and G. Pkg. (23 capsules)	60
Laxative Tablets. For treating constipation in pups and dogs....	60
Nerve Sedative Medicine. For relief of excitement and nervous irritability.....	60
Skip-Flea Soap. A wonderful bath soap. Will kill fleas, lice, and certain other vermin..	Cake 25 cts.

SERGEANT'S DOG MEDICINES, cont.

Skip-Flea Powder. For fleas and lice on dogs and cats. 2-oz. pkg. \$0 35
 Pine Oil Disinfectant. For general use. 4 ozs. 30 cts., 12 ozs. 65 cts.
 Sergeant's Dog Book Free. Ask for it.

Q-W Dog Remedies

Condition Powder. A general conditioner.....	Pkg. \$1 00
Cough Mixture. Often gives immediate relief.....	65
Sedative Tablets. For treatment of fits and nervous twitching.....	95
Antiseptic Salve. Helps promote healing of cuts and wounds. 1-oz. jar.	65
Worm Capsules. For large roundworms.....	65
Worm Mixture. Safe and sure. 2 ozs. 65 cts., 4 ozs. \$1.	
Flea Powder. Kills fleas.....	50
Flea Oil and Coat Dressing. 1/2-pt....	65
Sarcoptic Mange Lotion. Dressing for mange and itch.....	75
Dog Soap. Has a pure, clean, pleasant odor.....	Cake 25 cts.
Dog Shampoo. A liquid soap that will actually kill fleas.....	35
Constipation Pills. A quick, safe laxative.....	65
Cod-Liver Oil with Calcium Phosphate. Rich in vitamins A and D. 6-oz. bottle.....	60
10-oz. bottle.....	95
Pine Bar. Removes any unpleasant dog odor.....	35
Ear Canker Lotion. For parasitic cankers of the ear.....	1 25
Salicylate Compound Tablets. Give relief in cases of muscular soreness.	65
Tapeworm Mixture. Gives a thorough, healthy, quick cleaning out. 2-oz. bottle.....	1 00
Verminol. Disinfectant, germicide and deodorizer....	1/2-pt. 75 cts..

Dr. Daniel's Medicines for Dogs and Cats

H. B. O. Liquid for hair-balls in cats	Pkg. \$0 65
V. M. Capsules. Vitamins for dogs and cats.....	50
Worm Specials	
Liquid Worm Drops. For cats and toy dogs.....	50
Vermi Kaps. For cats and toy dogs	65
Vermi Kaps. For puppies.....	65
Vermi Kaps. For dogs.....	65
Tape Worm Treatment.....	1 00
Loose Catnip. All leaves and blossoms.....	25
Acobel Wafers. For distemper—colds in cats and puppies.....	50
Condition Tablets. Restorative for dogs.....	65
Dervide Tablets. For fits and convulsions.....	50
Dog and Flea Soap...Cake	25 cts.
Katonic. A great tonic for cat or kitten.....	25 cts. and. 50
Laxative Tablets. For dogs or cats.	50
Dermitite. For itching skin, eczema and sarcoptic mange.....	1 00

Glover's Imperial Dog Medicines

Imperial Capsules. For round and hookworms. Puppy size, pkg. (8 capsules) 25 cts.; pkg. (24 capsules) 60 cts. Dog size, pkg. (6 capsules) 25 cts.; pkg. (18 capsules) 60 cts.

Vermifuge for Roundworms. For puppies, dogs, foxes, and cats.....	Pkg. \$0 60
Tapeworm Capsules. For puppies, dogs, foxes, and cats.....	60
Laxative Pills. For sluggish bowels and acute constipation.....	60
Compound Tablets. Act upon the kidneys and intestines.....	60
Nerve Sedative. For fits and convulsions.....	60
Mange Medicine. For sarcoptic mange of dogs.....	75
Expectorant Mixture. For coughs due to colds.....	60
Canker Medicine. For canker of the ear in dogs and cats.....	60
Intestinal Astringent. For non-infectious diarrhea.....	60
Tonic Pills. Tonic and appetizer....	60
Eye Lotion and Powder. For minor injuries and irritations in the eyes..	60
Ointment. For sarcoptic mange and minor skin irritations.....	60
Flea Killer Powder. For dogs and cats.	25
Kennel and Flea Soap. Kills fleas and lice.....	Cake 25 cts.
Medicated Soap. A cleansing bath soap for house dogs. Cake	30 cts.

Rex Wheat Germ Oil. Contributes to the dog's general health, in addition to helping maintain a healthy coat and skin. Valuable aid in breeding dogs and other animals. 4-oz. bottle \$1, 1-pt. bottle \$3.90.

Sheen. Specially prepared powdered eggs for dogs. Fed mixed with dog's regular food. 1/2-lb. bottle 75 cts., 1-lb. bottle \$1.40.

Fleischmann's Irradiated Dry Yeast for Dogs. Supplies vitamin D and the B complex vitamins. Vitamin D is essential to the absorption and efficient utilization of the minerals calcium and phosphorus. It is especially needed by pregnant and nursing mothers and puppies. The B complex vitamins are essential to a normal appetite, good growth and soundness of the muscular and nervous systems. 3 1/2-oz. can 30 cts., 8-oz. can 60 cts., 1-lb. can \$1, 5-lb. can \$4.

Conkey's Y-O for Dogs and Cats. A granular vitamin product made by a patented process. Adding Y-O to the diet will help assure an ample supply of vitamins. 4 1/2-oz. pkg. 25 cts., 1-lb. pkg. \$1, 5-lb. pkg. \$3.25.

Rudhard's Ready-Baked Meat Balls. A safe, sensible treat of well balanced, highly nourishing foods that dogs need. Rich in natural vitamins. 6-oz. pkg. 25 cts., 24-oz. pkg. 70 cts.

Rex Hunter's Tasteless Dog Powders. Provide blood-ionic elements and a reconstructive for dogs of all breeds, any age. Pkg. of 8 tablets 25 cts., 40 for \$1.



Pulvex. Now contains D.D.T. It is safe to use and is most effective in killing lice and fleas on an animal at the time of application, and in addition will protect the treated animal against a reinfestation of fleas for days.

1½-oz. pkg. 25 cts., 3⅜-oz. pkg. 50 cts., 12-oz. pkg. \$1.25, post-paid.

Pulvex Flea Soap. Cleans thoroughly, deodorizes and kills fleas. Cake 25 cts.

Pulvex Dry Cleaner. An odorless, harmless powder that cleans your dog or cat without water. Kills fleas and lice, removes doggy odors. 5-oz. tin 50 cts.

Pulvex Sponge-Away. Kills fleas and lice; controls summer eczema; promotes healing of open sores when caused by scratching. Oz. 25 cts., 3 ozs. 50 cts., 8 ozs. \$1.

Pulvex Combination Treatment Worm Capsules. The Pulvex package contains capsules to give your dog a complete treatment for round, hook, and tapeworms. For puppies and dogs weighing less than 10 pounds, pkg. (16 capsules) 50 cts., pkg. (32 capsules) 75 cts.; for dogs weighing 10 pounds or over, pkg. (12 capsules) 50 cts., pkg. (24 capsules) 75 cts.

Quadine. Used by thousands of kennels and fanciers as an aid in treatment and grooming of the dog's skin and coat. Controls dandruff, fleas, mange. 2-oz. bottle 75 cts., 4-oz. \$1.25, 12-oz. \$2.50, ½gal. \$5.90, gal. \$9.50.

Quadine Cerate. Quadine in ointment form. Kills fleas, chiggers and ticks. \$1.50.

Quadine Jr. Atomizer for easy application and 2-oz. bottle of **Quadine** \$2.25.

Allen's Liquid Extract of Garlic. Peps up your dog's appetite. No after odor. Dogs love it. 4-oz. bottle \$1, 12-oz. \$2.25, gal. \$15.

Pulvex Pine Oil Disinfectant. For use in the home and kennel. Has a pleasant odor. 8-oz. tin 50 cts., 1-gal. can \$2.75.

Delcreo. An internal medication for use in the treatment of infectious diseases. A tonic and conditioner. 4-oz. pkg. \$1.50, 16-oz. pkg. \$5.

Show Coat. A soothing, cleansing lotion that is refreshing and deodorizing. Treated pads, jar (14 pads 8 by 9 in.) \$1.20. Lotion, 16-oz. bottle \$1.20.

Vita-Vurv. A palatable vitamin and mineral supplement for puppies and older dogs. Give it mixed with their regular food. 5-oz. can 75 cts.

Handy Dog Booklets

Feeding the Dog
Laws about Dogs
Whelping of Puppies
House Breaking the Dog
Dog Shows and Rules
How to Ship Dogs
How to Sell Dogs

The Dog in the Show Ring
Handling the Mating Stud's Care and Management
Puppies and Their Care
Anatomy of the Dog

Each a 16-page booklet. 25 cts. each, 5 for \$1.

HOW TO RAISE AND TRAIN YOUR PUPPY, by Bob Becker. An authoritative guide to the selection, care, and discipline of your puppy. 72 pages, 8½ by 11 inches; many photographs. \$1.

Bee Brand Shampoo. Kills fleas on dogs and cats. 4-oz. pkg. 55 cts.

Hilo Dip. Kills fleas, lice and ticks. Removes the cause of Summer Eczema. 1-oz. bottle 25 cts., 3-oz. bottle 50 cts., 6-oz. bottle 85 cts., 1-pt. bottle \$2, 1-qt. bottle \$3.50.

Hilo Ointment. Gives quick relief and hastens the healing of sores. 1-oz. jar 25 cts., 3-oz. jar 50 cts., 15-oz. can \$1.50.

Cupid Chaser. Keeps dogs from females during mating season. Bottle \$1.

Dog-Tex. Removes liquid dog and cat stains from carpets. Ends odor instantly. 8-oz. bottle 85 cts.

Chaperone. Keeps dogs off rugs and furniture. Harmless and odorless. Package \$1.

"Super Foamy" Bubble Bath. Can be used as a regular "old-fashioned" shampoo (with rinsing) or "modern bubble bath" style (wipe off with towel). 2-oz. bottle 25 cts., 6-oz. bottle 50 cts., 16-oz. bottle \$1.

B'have (Indoors). Keeps dogs and cats off furniture, rugs, drapes. Will not spot or stain. 3-oz. bottle 50 cts., 8-oz. bottle \$1.

B'have (Outdoors). Keeps dogs and cats away from trees and shrubs. 6-oz. bottle 50 cts., 16-oz. bottle \$1.

Dr. Merrick's Sulfodene. For summer eczema in dogs and cats. Stops itching, clears up scales and sores, promotes quick healing. Applied externally. 4-oz. bottle \$1, 16-oz. bottle \$3.50.

Kent's Eye-Glo. Medication for irritated, mattery, or watering eyes. 2-oz. bottle with dropper, 75 cts.

O-Ten Ear Drops. Special prescription for prevention and relief of ear canker in dogs. 1-oz. bottle with dropper, \$1.25.

Karswood Dog Tablets. Suitable for all breeds of dogs at all ages. Keeps dogs in splendid condition. Give a dose once every week. Pkg. of 12 tablets, 35 cts.

Karswood Worm Powders. For puppies and medium- and large-sized dogs. Pkg. of 6 powders, 50 cts.

Trix Repellent. Keeps male dogs away while females are in season. 1-oz. bottle 75 cts.

Pervinal

A Modern Multiple Vitamin-Mineral Syrup

Not a food—nor a substitute for food. Pervinal is a scientifically prepared syrup concentrate of vitamins A, B₁, B₂(G), B₆, Niacin, D, E and B Complex Factors from both yeast and liver extract . . . fortified with 10 nutritionally important minerals, including calcium, phosphorus and iron.

Easily fed by mixing in teaspoonful doses with dog's regular food. 10-oz. bottle \$1.35; 19-oz. bottle \$2.25; qt. \$4; gal. \$15.

Sanicedar Kennel Bedding

Makes a clean, dry, fragrant bed for dogs, cats and other pets. Kills doggy odor, keeps coat clean. Bushel bag 75 cts.

Framingham Cedar Bedding

A clean, wholesome and aromatic bedding for dogs or pets. Prepared from dry sound cedar wood. 25-lb. bale \$3, 50-lb. bale \$5, 100-lb. bale \$9.

Fish Foods and Supplies

Burnett's Natural Fish Food. Pkg. 10 cts.
Burnett's Dried Daphnien. Pkg. 10 cts.
Burnett's Shrimp Fish Food. Pkg. 10 cts.
Burnett's Tropical Fish Food. Pkg. 25 cts.
Burnett's Turtle Food. Pkg. 25 cts.
Spratt's Wafer Fish Food. Carton 10 cts.
Spratt's Tropical Fish Food. 10 cts. each.
Spratt's Natural Fish Food. Tin 10 cts.
PBF Aquarium Cement. ¼-lb. pkg. 25 cts.
Pabs Fish Food. 1 oz. 10 cts., ½lb. 50 cts.

Cat Foods and Medicines

Spratt's Food with Fish and Milk. A complete food for cats. 6½-oz. pkg. 15 cts., 24-oz. pkg. 35 cts.
Milk-Bone Tiny Bits. A food for cats. 10¼-oz. carton 20 cts., 3 for 55 cts.
Spratt's Special Tablets. A diuretic and stimulant. Pkg. \$1.
Spratt's Tonic Tablets. Pkg. 60 cts.
Pulvex Flea Powder. Compounded especially for cats. Does not contain D.D.T. 1½-oz. pkg. 25 cts., 3⅜-oz. pkg. 50 cts.
Catnip. Loose, pkg. 25 cts.; Ball, 25 cts. each; Mouse, 20 cts. each.

Bird Foods and Remedies



Spratt's Canary Mixture with Egg-Flake and Fruit. 15-oz. pkg. 25 cts.
Spratt's Cod-Liver Oil Cage-Bird and Nestling Food. For feeding young birds and old birds in the moulting season. A tonic and flesh- and bone-maker. Unequaled as an aid to feather-growth. 4-oz. pkg. 15 cts.

Spratt's Song Food. Strengthens the voice. 3-oz. pkg. 25 cts.

PBF Bird Manna. For health and song. Pkg. 15 cts.

Spratt's Tonic for Birds. 1-oz. bottle 15c.

Justrite Parrot Mixture. Combination of selected seeds, etc. 14-oz. pkg. 35 cts.

Silver Brand Bird Gravel. 30-oz. pkg. 15c.

Chamberlain's Perfect Bird Food. Canary seed mixture with vegetable and egg flakes. 11-oz. can 25 cts.

Recleaned Canary Seed, in bulk. Keeps canaries in full song. Lb. 20 cts., 3 lbs. 55 cts., 10 lbs. \$1.75.

Bird Rape Seed, in bulk. Lb. 35 cts., 2 lbs. 65 cts., 10 lbs. \$2.50.

Scott's Canary Seed Mixture, in bulk. Best recleaned Canary and Japanese Rape Seed. Lb. 30 cts., 2 lbs. for 55 cts.

Scott's Wild Bird Seed Mixture

A well-balanced, all-year-round ration prepared especially for wild birds. Contains peanut hearts, sunflower and many other kinds of seed. Birds love it. 5 lbs. 75 cts., 10 lbs. \$1.35, 25 lbs. \$3.25, 50 lbs. \$6.50, 100-lbs. \$12.25.

BIRDS OF PENNSYLVANIA

By George M. Sutton

Written for the beginner who is anxious to know the birds we all see daily. 169 pages, 175 drawings. \$1.

INDEX

<table border="0" style="width: 100%;"> <tr><td>Adco.....</td><td style="text-align: right;">61</td></tr> <tr><td>Aluminum Sulphate.....</td><td style="text-align: right;">60</td></tr> <tr><td>Ant Killers.....</td><td style="text-align: right;">65</td></tr> <tr><td>Arsenate of Lead.....</td><td style="text-align: right;">62</td></tr> <tr><td>Bag Balm.....</td><td style="text-align: right;">77</td></tr> <tr><td>Bee Supplies.....</td><td style="text-align: right;">78,79</td></tr> <tr><td>Bent Grass.....</td><td style="text-align: right;">45</td></tr> <tr><td>Bichloride of Mercury.....</td><td style="text-align: right;">66</td></tr> <tr><td>Bird Supplies.....</td><td style="text-align: right;">91</td></tr> <tr><td>B-K Disinfectant.....</td><td style="text-align: right;">77,86</td></tr> <tr><td>Black-Leaf 40.....</td><td style="text-align: right;">63,86</td></tr> <tr><td>Blue Vitriol.....</td><td style="text-align: right;">62</td></tr> <tr><td>Bone Meal.....</td><td style="text-align: right;">60</td></tr> <tr><td>Books.....</td><td style="text-align: right;">43,87,91</td></tr> <tr><td>Bordeaux Mixture.....</td><td style="text-align: right;">62</td></tr> <tr><td>Brooders.....</td><td style="text-align: right;">80,81,84</td></tr> <tr><td>Bulbs.....</td><td style="text-align: right;">46-48</td></tr> <tr><td>Calcium Arsenate.....</td><td style="text-align: right;">63</td></tr> <tr><td>Calcium Cyanide.....</td><td style="text-align: right;">65</td></tr> <tr><td>Canary Seed.....</td><td style="text-align: right;">91</td></tr> <tr><td>Carbola.....</td><td style="text-align: right;">86</td></tr> <tr><td>Carbon Disulphide.....</td><td style="text-align: right;">65</td></tr> <tr><td>Cat Foods and Remedies.....</td><td style="text-align: right;">91</td></tr> <tr><td>Clipping Machines.....</td><td style="text-align: right;">77</td></tr> <tr><td>Cod-Liver Oil.....</td><td style="text-align: right;">87</td></tr> <tr><td>Copper Sulphate.....</td><td style="text-align: right;">62</td></tr> <tr><td>Corn, Ensilage.....</td><td style="text-align: right;">56</td></tr> <tr><td>Corn, Field.....</td><td style="text-align: right;">56</td></tr> <tr><td>Corrosive Sublimate.....</td><td style="text-align: right;">66</td></tr> <tr><td>Cow Manure.....</td><td style="text-align: right;">61</td></tr> <tr><td>Cow Medicines.....</td><td style="text-align: right;">77</td></tr> <tr><td>Crow Repellent.....</td><td style="text-align: right;">67</td></tr> <tr><td>Cryolite.....</td><td style="text-align: right;">63</td></tr> <tr><td>Cultivators, Garden.....</td><td style="text-align: right;">68</td></tr> <tr><td>Cupro-K.....</td><td style="text-align: right;">62</td></tr> <tr><td>Cutworm Protectors.....</td><td style="text-align: right;">76</td></tr> <tr><td>Cyanogas.....</td><td style="text-align: right;">64,65</td></tr> <tr><td>Dahlias.....</td><td style="text-align: right;">35</td></tr> <tr><td>DDT.....</td><td style="text-align: right;">63,86</td></tr> <tr><td>Dehorners.....</td><td style="text-align: right;">77</td></tr> <tr><td>Dibbles.....</td><td style="text-align: right;">68</td></tr> </table>	Adco.....	61	Aluminum Sulphate.....	60	Ant Killers.....	65	Arsenate of Lead.....	62	Bag Balm.....	77	Bee Supplies.....	78,79	Bent Grass.....	45	Bichloride of Mercury.....	66	Bird Supplies.....	91	B-K Disinfectant.....	77,86	Black-Leaf 40.....	63,86	Blue Vitriol.....	62	Bone Meal.....	60	Books.....	43,87,91	Bordeaux Mixture.....	62	Brooders.....	80,81,84	Bulbs.....	46-48	Calcium Arsenate.....	63	Calcium Cyanide.....	65	Canary Seed.....	91	Carbola.....	86	Carbon Disulphide.....	65	Cat Foods and Remedies.....	91	Clipping Machines.....	77	Cod-Liver Oil.....	87	Copper Sulphate.....	62	Corn, Ensilage.....	56	Corn, Field.....	56	Corrosive Sublimate.....	66	Cow Manure.....	61	Cow Medicines.....	77	Crow Repellent.....	67	Cryolite.....	63	Cultivators, Garden.....	68	Cupro-K.....	62	Cutworm Protectors.....	76	Cyanogas.....	64,65	Dahlias.....	35	DDT.....	63,86	Dehorners.....	77	Dibbles.....	68	<table border="0" style="width: 100%;"> <tr><td>Dinitro.....</td><td style="text-align: right;">64</td></tr> <tr><td>Dirr Bands.....</td><td style="text-align: right;">76</td></tr> <tr><td>Disinfectants.....</td><td style="text-align: right;">77,86,90</td></tr> <tr><td>Dog Foods and Remedies.....</td><td style="text-align: right;">88-91</td></tr> <tr><td>Dusters.....</td><td style="text-align: right;">74</td></tr> <tr><td>D.X. Spray.....</td><td style="text-align: right;">62</td></tr> <tr><td>Egg Basket.....</td><td style="text-align: right;">83</td></tr> <tr><td>Egg Carriers.....</td><td style="text-align: right;">81</td></tr> <tr><td>Egg Graders.....</td><td style="text-align: right;">81</td></tr> <tr><td>Egg Preserver.....</td><td style="text-align: right;">85</td></tr> <tr><td>Egg Scales.....</td><td style="text-align: right;">83</td></tr> <tr><td>Electric Fence Controller.....</td><td style="text-align: right;">74</td></tr> <tr><td>Farm Seeds.....</td><td style="text-align: right;">54-57</td></tr> <tr><td>Feeds, Poultry.....</td><td style="text-align: right;">87</td></tr> <tr><td>Fertilizers.....</td><td style="text-align: right;">58-61</td></tr> <tr><td>Fertilizer Spreaders.....</td><td style="text-align: right;">61</td></tr> <tr><td>Fish Foods.....</td><td style="text-align: right;">91</td></tr> <tr><td>Flower Pots.....</td><td style="text-align: right;">76</td></tr> <tr><td>Flower Seeds.....</td><td style="text-align: right;">30,31</td></tr> <tr><td>Fly Spray.....</td><td style="text-align: right;">77</td></tr> <tr><td>Forks.....</td><td style="text-align: right;">68</td></tr> <tr><td>Formaldehyde.....</td><td style="text-align: right;">66</td></tr> <tr><td>Fruit Trees.....</td><td style="text-align: right;">52</td></tr> <tr><td>Fruitone.....</td><td style="text-align: right;">66</td></tr> <tr><td>Fungicides.....</td><td style="text-align: right;">62-67</td></tr> <tr><td>Garden Seeds.....</td><td style="text-align: right;">2-29</td></tr> <tr><td>Gladiolus.....</td><td style="text-align: right;">48,3d Cov.</td></tr> <tr><td>Glass.....</td><td style="text-align: right;">76</td></tr> <tr><td>Glass Substitutes.....</td><td style="text-align: right;">83</td></tr> <tr><td>Glazing Putty.....</td><td style="text-align: right;">76</td></tr> <tr><td>Gloves.....</td><td style="text-align: right;">69</td></tr> <tr><td>Grafting Wax.....</td><td style="text-align: right;">67</td></tr> <tr><td>Grass Shears.....</td><td style="text-align: right;">69</td></tr> <tr><td>Heaters.....</td><td style="text-align: right;">83</td></tr> <tr><td>Hedge Plants.....</td><td style="text-align: right;">49</td></tr> <tr><td>Hedge Shears.....</td><td style="text-align: right;">69</td></tr> <tr><td>Herbs.....</td><td style="text-align: right;">14</td></tr> <tr><td>Hoes.....</td><td style="text-align: right;">68</td></tr> <tr><td>Hog Medicines.....</td><td style="text-align: right;">77</td></tr> </table>	Dinitro.....	64	Dirr Bands.....	76	Disinfectants.....	77,86,90	Dog Foods and Remedies.....	88-91	Dusters.....	74	D.X. Spray.....	62	Egg Basket.....	83	Egg Carriers.....	81	Egg Graders.....	81	Egg Preserver.....	85	Egg Scales.....	83	Electric Fence Controller.....	74	Farm Seeds.....	54-57	Feeds, Poultry.....	87	Fertilizers.....	58-61	Fertilizer Spreaders.....	61	Fish Foods.....	91	Flower Pots.....	76	Flower Seeds.....	30,31	Fly Spray.....	77	Forks.....	68	Formaldehyde.....	66	Fruit Trees.....	52	Fruitone.....	66	Fungicides.....	62-67	Garden Seeds.....	2-29	Gladiolus.....	48,3d Cov.	Glass.....	76	Glass Substitutes.....	83	Glazing Putty.....	76	Gloves.....	69	Grafting Wax.....	67	Grass Shears.....	69	Heaters.....	83	Hedge Plants.....	49	Hedge Shears.....	69	Herbs.....	14	Hoes.....	68	Hog Medicines.....	77	<table border="0" style="width: 100%;"> <tr><td>Horse Medicines.....</td><td style="text-align: right;">77</td></tr> <tr><td>Horse-Radish Roots.....</td><td style="text-align: right;">14</td></tr> <tr><td>Hose.....</td><td style="text-align: right;">69</td></tr> <tr><td>Hose Reel.....</td><td style="text-align: right;">69</td></tr> <tr><td>Hotbed Sash.....</td><td style="text-align: right;">76</td></tr> <tr><td>Hotbed Supplies.....</td><td style="text-align: right;">76</td></tr> <tr><td>Hotkaps.....</td><td style="text-align: right;">76</td></tr> <tr><td>Humus.....</td><td style="text-align: right;">60</td></tr> <tr><td>Hyponex.....</td><td style="text-align: right;">60</td></tr> <tr><td>Incubators.....</td><td style="text-align: right;">81</td></tr> <tr><td>Inoculants, Seed.....</td><td style="text-align: right;">66</td></tr> <tr><td>Insecticides.....</td><td style="text-align: right;">62-67</td></tr> <tr><td>Japanese Beetle Traps.....</td><td style="text-align: right;">67</td></tr> <tr><td>Knee Guards.....</td><td style="text-align: right;">69</td></tr> <tr><td>Kow Kare.....</td><td style="text-align: right;">77</td></tr> <tr><td>Labels.....</td><td style="text-align: right;">75</td></tr> <tr><td>Lawn Edger.....</td><td style="text-align: right;">69,70</td></tr> <tr><td>Lawn Mowers.....</td><td style="text-align: right;">70,71</td></tr> <tr><td>Lawn Rollers.....</td><td style="text-align: right;">70</td></tr> <tr><td>Lawn Seeds.....</td><td style="text-align: right;">44,45</td></tr> <tr><td>Lawn Sprinklers.....</td><td style="text-align: right;">69</td></tr> <tr><td>Lawn Sweepers.....</td><td style="text-align: right;">70</td></tr> <tr><td>Leg Bands.....</td><td style="text-align: right;">83</td></tr> <tr><td>Lime.....</td><td style="text-align: right;">60</td></tr> <tr><td>Lime-Sulphur.....</td><td style="text-align: right;">64</td></tr> <tr><td>Magnesium Arsenate.....</td><td style="text-align: right;">63</td></tr> <tr><td>Marsh Plants.....</td><td style="text-align: right;">47</td></tr> <tr><td>Milk Bottle Caps.....</td><td style="text-align: right;">77</td></tr> <tr><td>Milk Filter Discs.....</td><td style="text-align: right;">77</td></tr> <tr><td>Milorganite.....</td><td style="text-align: right;">60</td></tr> <tr><td>Mole Exterminators.....</td><td style="text-align: right;">65</td></tr> <tr><td>Mouse Killers.....</td><td style="text-align: right;">65</td></tr> <tr><td>Mushroom Spawn.....</td><td style="text-align: right;">18</td></tr> <tr><td>Nest Eggs.....</td><td style="text-align: right;">87</td></tr> <tr><td>Nests.....</td><td style="text-align: right;">81,84</td></tr> <tr><td>Nico-Fume.....</td><td style="text-align: right;">64</td></tr> <tr><td>Nicotine Sulphate.....</td><td style="text-align: right;">63</td></tr> <tr><td>Nitrate of Soda.....</td><td style="text-align: right;">60</td></tr> <tr><td>Nozzles.....</td><td style="text-align: right;">69</td></tr> <tr><td>Nursery Stock.....</td><td style="text-align: right;">49-53</td></tr> </table>	Horse Medicines.....	77	Horse-Radish Roots.....	14	Hose.....	69	Hose Reel.....	69	Hotbed Sash.....	76	Hotbed Supplies.....	76	Hotkaps.....	76	Humus.....	60	Hyponex.....	60	Incubators.....	81	Inoculants, Seed.....	66	Insecticides.....	62-67	Japanese Beetle Traps.....	67	Knee Guards.....	69	Kow Kare.....	77	Labels.....	75	Lawn Edger.....	69,70	Lawn Mowers.....	70,71	Lawn Rollers.....	70	Lawn Seeds.....	44,45	Lawn Sprinklers.....	69	Lawn Sweepers.....	70	Leg Bands.....	83	Lime.....	60	Lime-Sulphur.....	64	Magnesium Arsenate.....	63	Marsh Plants.....	47	Milk Bottle Caps.....	77	Milk Filter Discs.....	77	Milorganite.....	60	Mole Exterminators.....	65	Mouse Killers.....	65	Mushroom Spawn.....	18	Nest Eggs.....	87	Nests.....	81,84	Nico-Fume.....	64	Nicotine Sulphate.....	63	Nitrate of Soda.....	60	Nozzles.....	69	Nursery Stock.....	49-53	<table border="0" style="width: 100%;"> <tr><td>Onion Plants.....</td><td style="text-align: right;">20</td></tr> <tr><td>Onion Sets.....</td><td style="text-align: right;">20</td></tr> <tr><td>Paint.....</td><td style="text-align: right;">67</td></tr> <tr><td>Paradichlorobenzene.....</td><td style="text-align: right;">64</td></tr> <tr><td>Paris Green.....</td><td style="text-align: right;">63</td></tr> <tr><td>Pasture Mixture.....</td><td style="text-align: right;">54</td></tr> <tr><td>Peat Moss.....</td><td style="text-align: right;">61</td></tr> <tr><td>Peonies.....</td><td style="text-align: right;">49</td></tr> <tr><td>Plant Boxes.....</td><td style="text-align: right;">76</td></tr> <tr><td>Plant Supports.....</td><td style="text-align: right;">75</td></tr> <tr><td>PlanTabbs.....</td><td style="text-align: right;">60</td></tr> <tr><td>Pond Plants.....</td><td style="text-align: right;">47</td></tr> <tr><td>Pot Labels.....</td><td style="text-align: right;">75</td></tr> <tr><td>Potato Hook.....</td><td style="text-align: right;">68</td></tr> <tr><td>Potatoes.....</td><td style="text-align: right;">57</td></tr> <tr><td>Poultry Feeders.....</td><td style="text-align: right;">82,84</td></tr> <tr><td>Poultry Feeds.....</td><td style="text-align: right;">87</td></tr> <tr><td>Poultry Killers.....</td><td style="text-align: right;">86</td></tr> <tr><td>Poultry Remedies.....</td><td style="text-align: right;">85-87</td></tr> <tr><td>Poultry Waterers.....</td><td style="text-align: right;">82,84</td></tr> <tr><td>Pruning Tools.....</td><td style="text-align: right;">75</td></tr> <tr><td>Rabbit Repellent.....</td><td style="text-align: right;">67</td></tr> <tr><td>Raffia.....</td><td style="text-align: right;">75</td></tr> <tr><td>Rakes.....</td><td style="text-align: right;">68</td></tr> <tr><td>Rat Exterminators.....</td><td style="text-align: right;">65</td></tr> <tr><td>Respirators.....</td><td style="text-align: right;">72</td></tr> <tr><td>Rhubarb.....</td><td style="text-align: right;">24</td></tr> <tr><td>Rootone.....</td><td style="text-align: right;">67</td></tr> <tr><td>Rose Bushes.....</td><td style="text-align: right;">49</td></tr> <tr><td>Rotenone Dust.....</td><td style="text-align: right;">63</td></tr> <tr><td>Salt.....</td><td style="text-align: right;">77</td></tr> <tr><td>Sausage Seasoning.....</td><td style="text-align: right;">77</td></tr> <tr><td>Scalecide.....</td><td style="text-align: right;">64</td></tr> <tr><td>Seed Potatoes.....</td><td style="text-align: right;">57</td></tr> <tr><td>Seeds, Farm.....</td><td style="text-align: right;">54-57</td></tr> <tr><td>Seeds, Flower.....</td><td style="text-align: right;">30-43</td></tr> <tr><td>Seeds, Garden.....</td><td style="text-align: right;">2-29</td></tr> <tr><td>Seeds, Lawn.....</td><td style="text-align: right;">44,45</td></tr> <tr><td>Seed Disinfectants.....</td><td style="text-align: right;">66</td></tr> <tr><td>Seed Drills.....</td><td style="text-align: right;">68</td></tr> <tr><td>Seed Sower.....</td><td style="text-align: right;">54</td></tr> <tr><td>Shearing Machines.....</td><td style="text-align: right;">77</td></tr> <tr><td>Sheep Manure.....</td><td style="text-align: right;">61</td></tr> <tr><td>Sheep Medicines.....</td><td style="text-align: right;">77</td></tr> <tr><td>Shrubs, Flowering.....</td><td style="text-align: right;">50,51</td></tr> <tr><td>Sieves.....</td><td style="text-align: right;">76</td></tr> <tr><td>Slug Shot.....</td><td style="text-align: right;">63</td></tr> <tr><td>Smoked Salt.....</td><td style="text-align: right;">77</td></tr> <tr><td>Soil Disinfectants.....</td><td style="text-align: right;">66</td></tr> <tr><td>Soil Heating Kit.....</td><td style="text-align: right;">76</td></tr> <tr><td>Soil-Testers.....</td><td style="text-align: right;">60</td></tr> <tr><td>Spades.....</td><td style="text-align: right;">68</td></tr> <tr><td>Sprayers.....</td><td style="text-align: right;">72,73</td></tr> <tr><td>Spreaders, Spray.....</td><td style="text-align: right;">64,67</td></tr> <tr><td>Sprinklers, Lawn.....</td><td style="text-align: right;">69</td></tr> <tr><td>Stakes.....</td><td style="text-align: right;">75</td></tr> <tr><td>Stock Remedies.....</td><td style="text-align: right;">77</td></tr> <tr><td>Strawberry Plants.....</td><td style="text-align: right;">53</td></tr> <tr><td>Sulphur.....</td><td style="text-align: right;">62,64</td></tr> <tr><td>Superphosphate.....</td><td style="text-align: right;">58</td></tr> <tr><td>Tartar Emetic.....</td><td style="text-align: right;">63</td></tr> <tr><td>Time Switch.....</td><td style="text-align: right;">83</td></tr> <tr><td>Tobacco Seed.....</td><td style="text-align: right;">27</td></tr> <tr><td>Tobacco Dust.....</td><td style="text-align: right;">67,86</td></tr> <tr><td>Transplantone.....</td><td style="text-align: right;">60</td></tr> <tr><td>Tree Bands.....</td><td style="text-align: right;">67</td></tr> <tr><td>Tree Paint.....</td><td style="text-align: right;">67</td></tr> <tr><td>Tree Tanglefoot.....</td><td style="text-align: right;">67</td></tr> <tr><td>Tree Wrap.....</td><td style="text-align: right;">67</td></tr> <tr><td>Trees, Fruit.....</td><td style="text-align: right;">52</td></tr> <tr><td>Trees, Shade.....</td><td style="text-align: right;">51</td></tr> <tr><td>Tri-Ogen.....</td><td style="text-align: right;">62</td></tr> <tr><td>Trowels.....</td><td style="text-align: right;">68</td></tr> <tr><td>Twist-Ems.....</td><td style="text-align: right;">75</td></tr> <tr><td>Ventilators.....</td><td style="text-align: right;">81</td></tr> <tr><td>Vines.....</td><td style="text-align: right;">49</td></tr> <tr><td>Water Glass.....</td><td style="text-align: right;">85</td></tr> <tr><td>Watering Cans.....</td><td style="text-align: right;">69</td></tr> <tr><td>Water-Lilies.....</td><td style="text-align: right;">47</td></tr> <tr><td>Weed Burners.....</td><td style="text-align: right;">67</td></tr> <tr><td>Weed Killers.....</td><td style="text-align: right;">65</td></tr> <tr><td>Weeders.....</td><td style="text-align: right;">68</td></tr> <tr><td>Whale-Oil Soap.....</td><td style="text-align: right;">67</td></tr> <tr><td>Wheelbarrows.....</td><td style="text-align: right;">70</td></tr> <tr><td>Worm Medicines.....</td><td style="text-align: right;">77,85</td></tr> <tr><td>Yeast.....</td><td style="text-align: right;">90</td></tr> </table>	Onion Plants.....	20	Onion Sets.....	20	Paint.....	67	Paradichlorobenzene.....	64	Paris Green.....	63	Pasture Mixture.....	54	Peat Moss.....	61	Peonies.....	49	Plant Boxes.....	76	Plant Supports.....	75	PlanTabbs.....	60	Pond Plants.....	47	Pot Labels.....	75	Potato Hook.....	68	Potatoes.....	57	Poultry Feeders.....	82,84	Poultry Feeds.....	87	Poultry Killers.....	86	Poultry Remedies.....	85-87	Poultry Waterers.....	82,84	Pruning Tools.....	75	Rabbit Repellent.....	67	Raffia.....	75	Rakes.....	68	Rat Exterminators.....	65	Respirators.....	72	Rhubarb.....	24	Rootone.....	67	Rose Bushes.....	49	Rotenone Dust.....	63	Salt.....	77	Sausage Seasoning.....	77	Scalecide.....	64	Seed Potatoes.....	57	Seeds, Farm.....	54-57	Seeds, Flower.....	30-43	Seeds, Garden.....	2-29	Seeds, Lawn.....	44,45	Seed Disinfectants.....	66	Seed Drills.....	68	Seed Sower.....	54	Shearing Machines.....	77	Sheep Manure.....	61	Sheep Medicines.....	77	Shrubs, Flowering.....	50,51	Sieves.....	76	Slug Shot.....	63	Smoked Salt.....	77	Soil Disinfectants.....	66	Soil Heating Kit.....	76	Soil-Testers.....	60	Spades.....	68	Sprayers.....	72,73	Spreaders, Spray.....	64,67	Sprinklers, Lawn.....	69	Stakes.....	75	Stock Remedies.....	77	Strawberry Plants.....	53	Sulphur.....	62,64	Superphosphate.....	58	Tartar Emetic.....	63	Time Switch.....	83	Tobacco Seed.....	27	Tobacco Dust.....	67,86	Transplantone.....	60	Tree Bands.....	67	Tree Paint.....	67	Tree Tanglefoot.....	67	Tree Wrap.....	67	Trees, Fruit.....	52	Trees, Shade.....	51	Tri-Ogen.....	62	Trowels.....	68	Twist-Ems.....	75	Ventilators.....	81	Vines.....	49	Water Glass.....	85	Watering Cans.....	69	Water-Lilies.....	47	Weed Burners.....	67	Weed Killers.....	65	Weeders.....	68	Whale-Oil Soap.....	67	Wheelbarrows.....	70	Worm Medicines.....	77,85	Yeast.....	90
Adco.....	61																																																																																																																																																																																																																																																																																																																																																																																																																														
Aluminum Sulphate.....	60																																																																																																																																																																																																																																																																																																																																																																																																																														
Ant Killers.....	65																																																																																																																																																																																																																																																																																																																																																																																																																														
Arsenate of Lead.....	62																																																																																																																																																																																																																																																																																																																																																																																																																														
Bag Balm.....	77																																																																																																																																																																																																																																																																																																																																																																																																																														
Bee Supplies.....	78,79																																																																																																																																																																																																																																																																																																																																																																																																																														
Bent Grass.....	45																																																																																																																																																																																																																																																																																																																																																																																																																														
Bichloride of Mercury.....	66																																																																																																																																																																																																																																																																																																																																																																																																																														
Bird Supplies.....	91																																																																																																																																																																																																																																																																																																																																																																																																																														
B-K Disinfectant.....	77,86																																																																																																																																																																																																																																																																																																																																																																																																																														
Black-Leaf 40.....	63,86																																																																																																																																																																																																																																																																																																																																																																																																																														
Blue Vitriol.....	62																																																																																																																																																																																																																																																																																																																																																																																																																														
Bone Meal.....	60																																																																																																																																																																																																																																																																																																																																																																																																																														
Books.....	43,87,91																																																																																																																																																																																																																																																																																																																																																																																																																														
Bordeaux Mixture.....	62																																																																																																																																																																																																																																																																																																																																																																																																																														
Brooders.....	80,81,84																																																																																																																																																																																																																																																																																																																																																																																																																														
Bulbs.....	46-48																																																																																																																																																																																																																																																																																																																																																																																																																														
Calcium Arsenate.....	63																																																																																																																																																																																																																																																																																																																																																																																																																														
Calcium Cyanide.....	65																																																																																																																																																																																																																																																																																																																																																																																																																														
Canary Seed.....	91																																																																																																																																																																																																																																																																																																																																																																																																																														
Carbola.....	86																																																																																																																																																																																																																																																																																																																																																																																																																														
Carbon Disulphide.....	65																																																																																																																																																																																																																																																																																																																																																																																																																														
Cat Foods and Remedies.....	91																																																																																																																																																																																																																																																																																																																																																																																																																														
Clipping Machines.....	77																																																																																																																																																																																																																																																																																																																																																																																																																														
Cod-Liver Oil.....	87																																																																																																																																																																																																																																																																																																																																																																																																																														
Copper Sulphate.....	62																																																																																																																																																																																																																																																																																																																																																																																																																														
Corn, Ensilage.....	56																																																																																																																																																																																																																																																																																																																																																																																																																														
Corn, Field.....	56																																																																																																																																																																																																																																																																																																																																																																																																																														
Corrosive Sublimate.....	66																																																																																																																																																																																																																																																																																																																																																																																																																														
Cow Manure.....	61																																																																																																																																																																																																																																																																																																																																																																																																																														
Cow Medicines.....	77																																																																																																																																																																																																																																																																																																																																																																																																																														
Crow Repellent.....	67																																																																																																																																																																																																																																																																																																																																																																																																																														
Cryolite.....	63																																																																																																																																																																																																																																																																																																																																																																																																																														
Cultivators, Garden.....	68																																																																																																																																																																																																																																																																																																																																																																																																																														
Cupro-K.....	62																																																																																																																																																																																																																																																																																																																																																																																																																														
Cutworm Protectors.....	76																																																																																																																																																																																																																																																																																																																																																																																																																														
Cyanogas.....	64,65																																																																																																																																																																																																																																																																																																																																																																																																																														
Dahlias.....	35																																																																																																																																																																																																																																																																																																																																																																																																																														
DDT.....	63,86																																																																																																																																																																																																																																																																																																																																																																																																																														
Dehorners.....	77																																																																																																																																																																																																																																																																																																																																																																																																																														
Dibbles.....	68																																																																																																																																																																																																																																																																																																																																																																																																																														
Dinitro.....	64																																																																																																																																																																																																																																																																																																																																																																																																																														
Dirr Bands.....	76																																																																																																																																																																																																																																																																																																																																																																																																																														
Disinfectants.....	77,86,90																																																																																																																																																																																																																																																																																																																																																																																																																														
Dog Foods and Remedies.....	88-91																																																																																																																																																																																																																																																																																																																																																																																																																														
Dusters.....	74																																																																																																																																																																																																																																																																																																																																																																																																																														
D.X. Spray.....	62																																																																																																																																																																																																																																																																																																																																																																																																																														
Egg Basket.....	83																																																																																																																																																																																																																																																																																																																																																																																																																														
Egg Carriers.....	81																																																																																																																																																																																																																																																																																																																																																																																																																														
Egg Graders.....	81																																																																																																																																																																																																																																																																																																																																																																																																																														
Egg Preserver.....	85																																																																																																																																																																																																																																																																																																																																																																																																																														
Egg Scales.....	83																																																																																																																																																																																																																																																																																																																																																																																																																														
Electric Fence Controller.....	74																																																																																																																																																																																																																																																																																																																																																																																																																														
Farm Seeds.....	54-57																																																																																																																																																																																																																																																																																																																																																																																																																														
Feeds, Poultry.....	87																																																																																																																																																																																																																																																																																																																																																																																																																														
Fertilizers.....	58-61																																																																																																																																																																																																																																																																																																																																																																																																																														
Fertilizer Spreaders.....	61																																																																																																																																																																																																																																																																																																																																																																																																																														
Fish Foods.....	91																																																																																																																																																																																																																																																																																																																																																																																																																														
Flower Pots.....	76																																																																																																																																																																																																																																																																																																																																																																																																																														
Flower Seeds.....	30,31																																																																																																																																																																																																																																																																																																																																																																																																																														
Fly Spray.....	77																																																																																																																																																																																																																																																																																																																																																																																																																														
Forks.....	68																																																																																																																																																																																																																																																																																																																																																																																																																														
Formaldehyde.....	66																																																																																																																																																																																																																																																																																																																																																																																																																														
Fruit Trees.....	52																																																																																																																																																																																																																																																																																																																																																																																																																														
Fruitone.....	66																																																																																																																																																																																																																																																																																																																																																																																																																														
Fungicides.....	62-67																																																																																																																																																																																																																																																																																																																																																																																																																														
Garden Seeds.....	2-29																																																																																																																																																																																																																																																																																																																																																																																																																														
Gladiolus.....	48,3d Cov.																																																																																																																																																																																																																																																																																																																																																																																																																														
Glass.....	76																																																																																																																																																																																																																																																																																																																																																																																																																														
Glass Substitutes.....	83																																																																																																																																																																																																																																																																																																																																																																																																																														
Glazing Putty.....	76																																																																																																																																																																																																																																																																																																																																																																																																																														
Gloves.....	69																																																																																																																																																																																																																																																																																																																																																																																																																														
Grafting Wax.....	67																																																																																																																																																																																																																																																																																																																																																																																																																														
Grass Shears.....	69																																																																																																																																																																																																																																																																																																																																																																																																																														
Heaters.....	83																																																																																																																																																																																																																																																																																																																																																																																																																														
Hedge Plants.....	49																																																																																																																																																																																																																																																																																																																																																																																																																														
Hedge Shears.....	69																																																																																																																																																																																																																																																																																																																																																																																																																														
Herbs.....	14																																																																																																																																																																																																																																																																																																																																																																																																																														
Hoes.....	68																																																																																																																																																																																																																																																																																																																																																																																																																														
Hog Medicines.....	77																																																																																																																																																																																																																																																																																																																																																																																																																														
Horse Medicines.....	77																																																																																																																																																																																																																																																																																																																																																																																																																														
Horse-Radish Roots.....	14																																																																																																																																																																																																																																																																																																																																																																																																																														
Hose.....	69																																																																																																																																																																																																																																																																																																																																																																																																																														
Hose Reel.....	69																																																																																																																																																																																																																																																																																																																																																																																																																														
Hotbed Sash.....	76																																																																																																																																																																																																																																																																																																																																																																																																																														
Hotbed Supplies.....	76																																																																																																																																																																																																																																																																																																																																																																																																																														
Hotkaps.....	76																																																																																																																																																																																																																																																																																																																																																																																																																														
Humus.....	60																																																																																																																																																																																																																																																																																																																																																																																																																														
Hyponex.....	60																																																																																																																																																																																																																																																																																																																																																																																																																														
Incubators.....	81																																																																																																																																																																																																																																																																																																																																																																																																																														
Inoculants, Seed.....	66																																																																																																																																																																																																																																																																																																																																																																																																																														
Insecticides.....	62-67																																																																																																																																																																																																																																																																																																																																																																																																																														
Japanese Beetle Traps.....	67																																																																																																																																																																																																																																																																																																																																																																																																																														
Knee Guards.....	69																																																																																																																																																																																																																																																																																																																																																																																																																														
Kow Kare.....	77																																																																																																																																																																																																																																																																																																																																																																																																																														
Labels.....	75																																																																																																																																																																																																																																																																																																																																																																																																																														
Lawn Edger.....	69,70																																																																																																																																																																																																																																																																																																																																																																																																																														
Lawn Mowers.....	70,71																																																																																																																																																																																																																																																																																																																																																																																																																														
Lawn Rollers.....	70																																																																																																																																																																																																																																																																																																																																																																																																																														
Lawn Seeds.....	44,45																																																																																																																																																																																																																																																																																																																																																																																																																														
Lawn Sprinklers.....	69																																																																																																																																																																																																																																																																																																																																																																																																																														
Lawn Sweepers.....	70																																																																																																																																																																																																																																																																																																																																																																																																																														
Leg Bands.....	83																																																																																																																																																																																																																																																																																																																																																																																																																														
Lime.....	60																																																																																																																																																																																																																																																																																																																																																																																																																														
Lime-Sulphur.....	64																																																																																																																																																																																																																																																																																																																																																																																																																														
Magnesium Arsenate.....	63																																																																																																																																																																																																																																																																																																																																																																																																																														
Marsh Plants.....	47																																																																																																																																																																																																																																																																																																																																																																																																																														
Milk Bottle Caps.....	77																																																																																																																																																																																																																																																																																																																																																																																																																														
Milk Filter Discs.....	77																																																																																																																																																																																																																																																																																																																																																																																																																														
Milorganite.....	60																																																																																																																																																																																																																																																																																																																																																																																																																														
Mole Exterminators.....	65																																																																																																																																																																																																																																																																																																																																																																																																																														
Mouse Killers.....	65																																																																																																																																																																																																																																																																																																																																																																																																																														
Mushroom Spawn.....	18																																																																																																																																																																																																																																																																																																																																																																																																																														
Nest Eggs.....	87																																																																																																																																																																																																																																																																																																																																																																																																																														
Nests.....	81,84																																																																																																																																																																																																																																																																																																																																																																																																																														
Nico-Fume.....	64																																																																																																																																																																																																																																																																																																																																																																																																																														
Nicotine Sulphate.....	63																																																																																																																																																																																																																																																																																																																																																																																																																														
Nitrate of Soda.....	60																																																																																																																																																																																																																																																																																																																																																																																																																														
Nozzles.....	69																																																																																																																																																																																																																																																																																																																																																																																																																														
Nursery Stock.....	49-53																																																																																																																																																																																																																																																																																																																																																																																																																														
Onion Plants.....	20																																																																																																																																																																																																																																																																																																																																																																																																																														
Onion Sets.....	20																																																																																																																																																																																																																																																																																																																																																																																																																														
Paint.....	67																																																																																																																																																																																																																																																																																																																																																																																																																														
Paradichlorobenzene.....	64																																																																																																																																																																																																																																																																																																																																																																																																																														
Paris Green.....	63																																																																																																																																																																																																																																																																																																																																																																																																																														
Pasture Mixture.....	54																																																																																																																																																																																																																																																																																																																																																																																																																														
Peat Moss.....	61																																																																																																																																																																																																																																																																																																																																																																																																																														
Peonies.....	49																																																																																																																																																																																																																																																																																																																																																																																																																														
Plant Boxes.....	76																																																																																																																																																																																																																																																																																																																																																																																																																														
Plant Supports.....	75																																																																																																																																																																																																																																																																																																																																																																																																																														
PlanTabbs.....	60																																																																																																																																																																																																																																																																																																																																																																																																																														
Pond Plants.....	47																																																																																																																																																																																																																																																																																																																																																																																																																														
Pot Labels.....	75																																																																																																																																																																																																																																																																																																																																																																																																																														
Potato Hook.....	68																																																																																																																																																																																																																																																																																																																																																																																																																														
Potatoes.....	57																																																																																																																																																																																																																																																																																																																																																																																																																														
Poultry Feeders.....	82,84																																																																																																																																																																																																																																																																																																																																																																																																																														
Poultry Feeds.....	87																																																																																																																																																																																																																																																																																																																																																																																																																														
Poultry Killers.....	86																																																																																																																																																																																																																																																																																																																																																																																																																														
Poultry Remedies.....	85-87																																																																																																																																																																																																																																																																																																																																																																																																																														
Poultry Waterers.....	82,84																																																																																																																																																																																																																																																																																																																																																																																																																														
Pruning Tools.....	75																																																																																																																																																																																																																																																																																																																																																																																																																														
Rabbit Repellent.....	67																																																																																																																																																																																																																																																																																																																																																																																																																														
Raffia.....	75																																																																																																																																																																																																																																																																																																																																																																																																																														
Rakes.....	68																																																																																																																																																																																																																																																																																																																																																																																																																														
Rat Exterminators.....	65																																																																																																																																																																																																																																																																																																																																																																																																																														
Respirators.....	72																																																																																																																																																																																																																																																																																																																																																																																																																														
Rhubarb.....	24																																																																																																																																																																																																																																																																																																																																																																																																																														
Rootone.....	67																																																																																																																																																																																																																																																																																																																																																																																																																														
Rose Bushes.....	49																																																																																																																																																																																																																																																																																																																																																																																																																														
Rotenone Dust.....	63																																																																																																																																																																																																																																																																																																																																																																																																																														
Salt.....	77																																																																																																																																																																																																																																																																																																																																																																																																																														
Sausage Seasoning.....	77																																																																																																																																																																																																																																																																																																																																																																																																																														
Scalecide.....	64																																																																																																																																																																																																																																																																																																																																																																																																																														
Seed Potatoes.....	57																																																																																																																																																																																																																																																																																																																																																																																																																														
Seeds, Farm.....	54-57																																																																																																																																																																																																																																																																																																																																																																																																																														
Seeds, Flower.....	30-43																																																																																																																																																																																																																																																																																																																																																																																																																														
Seeds, Garden.....	2-29																																																																																																																																																																																																																																																																																																																																																																																																																														
Seeds, Lawn.....	44,45																																																																																																																																																																																																																																																																																																																																																																																																																														
Seed Disinfectants.....	66																																																																																																																																																																																																																																																																																																																																																																																																																														
Seed Drills.....	68																																																																																																																																																																																																																																																																																																																																																																																																																														
Seed Sower.....	54																																																																																																																																																																																																																																																																																																																																																																																																																														
Shearing Machines.....	77																																																																																																																																																																																																																																																																																																																																																																																																																														
Sheep Manure.....	61																																																																																																																																																																																																																																																																																																																																																																																																																														
Sheep Medicines.....	77																																																																																																																																																																																																																																																																																																																																																																																																																														
Shrubs, Flowering.....	50,51																																																																																																																																																																																																																																																																																																																																																																																																																														
Sieves.....	76																																																																																																																																																																																																																																																																																																																																																																																																																														
Slug Shot.....	63																																																																																																																																																																																																																																																																																																																																																																																																																														
Smoked Salt.....	77																																																																																																																																																																																																																																																																																																																																																																																																																														
Soil Disinfectants.....	66																																																																																																																																																																																																																																																																																																																																																																																																																														
Soil Heating Kit.....	76																																																																																																																																																																																																																																																																																																																																																																																																																														
Soil-Testers.....	60																																																																																																																																																																																																																																																																																																																																																																																																																														
Spades.....	68																																																																																																																																																																																																																																																																																																																																																																																																																														
Sprayers.....	72,73																																																																																																																																																																																																																																																																																																																																																																																																																														
Spreaders, Spray.....	64,67																																																																																																																																																																																																																																																																																																																																																																																																																														
Sprinklers, Lawn.....	69																																																																																																																																																																																																																																																																																																																																																																																																																														
Stakes.....	75																																																																																																																																																																																																																																																																																																																																																																																																																														
Stock Remedies.....	77																																																																																																																																																																																																																																																																																																																																																																																																																														
Strawberry Plants.....	53																																																																																																																																																																																																																																																																																																																																																																																																																														
Sulphur.....	62,64																																																																																																																																																																																																																																																																																																																																																																																																																														
Superphosphate.....	58																																																																																																																																																																																																																																																																																																																																																																																																																														
Tartar Emetic.....	63																																																																																																																																																																																																																																																																																																																																																																																																																														
Time Switch.....	83																																																																																																																																																																																																																																																																																																																																																																																																																														
Tobacco Seed.....	27																																																																																																																																																																																																																																																																																																																																																																																																																														
Tobacco Dust.....	67,86																																																																																																																																																																																																																																																																																																																																																																																																																														
Transplantone.....	60																																																																																																																																																																																																																																																																																																																																																																																																																														
Tree Bands.....	67																																																																																																																																																																																																																																																																																																																																																																																																																														
Tree Paint.....	67																																																																																																																																																																																																																																																																																																																																																																																																																														
Tree Tanglefoot.....	67																																																																																																																																																																																																																																																																																																																																																																																																																														
Tree Wrap.....	67																																																																																																																																																																																																																																																																																																																																																																																																																														
Trees, Fruit.....	52																																																																																																																																																																																																																																																																																																																																																																																																																														
Trees, Shade.....	51																																																																																																																																																																																																																																																																																																																																																																																																																														
Tri-Ogen.....	62																																																																																																																																																																																																																																																																																																																																																																																																																														
Trowels.....	68																																																																																																																																																																																																																																																																																																																																																																																																																														
Twist-Ems.....	75																																																																																																																																																																																																																																																																																																																																																																																																																														
Ventilators.....	81																																																																																																																																																																																																																																																																																																																																																																																																																														
Vines.....	49																																																																																																																																																																																																																																																																																																																																																																																																																														
Water Glass.....	85																																																																																																																																																																																																																																																																																																																																																																																																																														
Watering Cans.....	69																																																																																																																																																																																																																																																																																																																																																																																																																														
Water-Lilies.....	47																																																																																																																																																																																																																																																																																																																																																																																																																														
Weed Burners.....	67																																																																																																																																																																																																																																																																																																																																																																																																																														
Weed Killers.....	65																																																																																																																																																																																																																																																																																																																																																																																																																														
Weeders.....	68																																																																																																																																																																																																																																																																																																																																																																																																																														
Whale-Oil Soap.....	67																																																																																																																																																																																																																																																																																																																																																																																																																														
Wheelbarrows.....	70																																																																																																																																																																																																																																																																																																																																																																																																																														
Worm Medicines.....	77,85																																																																																																																																																																																																																																																																																																																																																																																																																														
Yeast.....	90																																																																																																																																																																																																																																																																																																																																																																																																																														

GENERAL INFORMATION AND SUGGESTIONS

FREE DELIVERY

At prices named in this Catalogue, on Vegetable Seeds, Flower Seeds, Grass Seeds, and Bulbs, *We Deliver Free* anywhere in the United States.

On other goods where the order amounts to \$2 or more (except where priced otherwise), *We Deliver Free* in Pennsylvania, Ohio, and West Virginia. Customer pays transportation charges on orders less than \$2.

Free deliveries are made at our option by truck, or by mail, express, or freight to your nearest post office, express office, or freight station.

PARCEL POST SHIPMENTS

Where the Catalogue provides that postage be added to the remittance, include for postage as follows:

Less than 1-lb. package.....	\$0 08	20-lb. package.....	\$0 30
1-lb. package.....	10	25-lb. package.....	37
2-lb. package.....	11	50-lb. package.....	65
3-lb. package.....	12	Less than 1-pt. package.....	08
4-lb. package.....	13	1-pt. package.....	10
5-lb. package.....	14	1-qt. package.....	15
10-lb. package.....	19	½-gal. package.....	20
15-lb. package.....	25	1-gal. package.....	25

C. O. D.

We will accept orders for shipment C.O.D. except on nursery stock, roses, strawberry plants, or other perishable goods.

ORDER IN ADVANCE

We cannot urge too strongly the necessity of anticipating your requirements as far in advance as possible. The coöperation of our customers in this respect will be appreciated.

PRICE CHANGES

Because of present unsettled conditions, prices in this catalogue are subject to change. Should the price of any commodity be advanced, the customer will be notified before shipping, or in case of a reduction, the difference in price will be refunded. It has always been our policy to keep prices as low as possible and we will not advance prices unless it is absolutely necessary due to increased costs.

QUANTITY RATES ON VEGETABLE SEEDS

Half-bushels will be furnished at bushel rates; half-pecks at the peck rate; and half-pounds at the pound rate.

TERMS

Our terms are cash and prices are net, with no discounts. To persons and firms with established credit we are glad to extend the convenience of a charge account. Usual credit references are required.

MAIL AND TELEPHONE ORDERS

We are organized to give mail and telephone orders the same personal attention as orders placed in our store. If it is not convenient to come to the store we will appreciate your order either by mail or telephone.

REMITTANCES

These should be sent by money order, registered letter, bank draft, or check. Amounts less than \$1 may be sent in postage stamps.

NON-WARRANTY

The I. W. Scott Company gives no warranty, express or implied, as to the productiveness of any seeds, bulbs or plants it sells and will not be in any way responsible for the crop. Our liability, in all instances, is limited to the purchase price of the seeds, bulbs or plants.

The I. W. SCOTT CO.

500 LIBERTY AVENUE

113 DIAMOND STREET

PITTSBURGH, PENNA.

PRICE LIST OF GRASS AND FARM SEEDS SEED POTATOES

FEBRUARY 15, 1947

On account of the frequent changes in market prices, the prices named herein are for immediate orders only, and subject to change without notice. Prices are f. o. b. our store or cars Pittsburgh, Pa., bags free.

The purity and germination tests given in this list are representative of the grades we regularly carry in stock. Orders received from this list will be filled from lots of equal or better purity and germination.

CLOVERS

Varieties	Purity	Germination	Grown	½ Bu.	Per Bu. 60 Lb.
Medium Red	99.25%	90.00%	Central States	\$18.30	\$36.00
Medium Red	99.25%	90.00%	Idaho	18.90	37.20
Mammoth Red	99.25%	90.00%	Central States	18.30	36.00
Alsike	98.50%	90.00%	Central States	17.40	34.20
Sweet	99.25%	90.00%	Central States	6.30	12.00
Crimson	99.25%	90.00%	Tennessee	9.30	18.00
White Dutch	98.50%	90.00%	Idaho	33.00	64.80
Wild White	98.50%	90.00%	Idaho, per lb.	\$2.25	
Ladino	99.25%	90.00%	California, per lb.	2.75	

ALFALFA

Varieties	Purity	Germination	Grown	½ Bu.	Per Bu. 60 Lb.
Common	99.25%	90.00%	Kansas	\$15.90	\$31.20
Northwest. Common	99.25%	90.00%	Utah	18.90	37.20
Grimm	99.25%	90.00%	Michigan	17.40	34.20
Certified Grimm	99.25%	90.00%	Utah	21.30	42.00

TIMOTHY

Varieties	Purity	Germination	Grown	½ Bu.	Per Bu. 45 Lb.
Special	99.60%	90.00%	Iowa	\$ 2.75	\$ 5.00

10 bushel lots and upwards, 10c per bushel less.

PERMANENT PASTURE MIXTURE

	Purity	Germination	5 lb.	10 lb.	25 lb.	100 lb.
Scott's Pasture Mixture	94.00%	85.00%	\$3.75	\$6.75	\$16.25	\$60.00

SEED CORN

Field Corn Varieties

	Purity	Germination	Grown	1/2 Bu.	56 Lb.	Per Bu.
Golden Surprise	99.00%	90.00% or better	Ohio ...	\$ 3.25		\$ 6.00
Scott's Sure Crop	99.00%	90.00% or better	Ohio ...	3.25		6.00
Pride of North	99.00%	90.00% or better	Ohio ...	3.25		6.00
Improved Leaming	99.00%	90.00% or better	Penna. ..	3.25		6.00
White Cap Yellow Dent .	99.00%	90.00% or better	Penna. ..	3.25		6.00
*Hybrid, Ohio W 17	99.00%	90.00% or better	Penna. ..	4.75		9.00
*Hybrid, Iowa 939	99.00%	90.00% or better	Penna. ..	4.75		9.00
*Hybrid, Ohio K 23	99.00%	90.00% or better	Penna. ..	4.75		9.00
*Hybrid, Ohio K 24	99.00%	90.00% or better	Penna. ..	4.75		9.00
*Hybrid, Ohio M 34	99.00%	90.00% or better	Ohio ...	4.75		9.00

Ensilage Corn Varieties

	Purity	Germination	Grown	1/2 Bu.	56 Lb.	Per Bu.
Lancaster Co. Sure Crop	99.00%	90.00% or better	Penna. ..	\$ 3.25		\$ 6.00
Eureka	99.00%	90.00% or better	Ohio ...	3.25		6.00
*Hybrid, U. S. 13	99.00%	90.00% or better	Penna. ..	4.75		9.00
*Flat kernel grade:						

SEED OATS

	Purity	Germination	Grown	32 Lb.	15 Bu.	30 Bu.	Per Bu.
Vicland	99.00%	92.00%	Wisconsin	\$.185	\$26.25	\$51.90	
Certified Vicland ..	99.50%	95.00%	Canada ..	2.10	30.00	59.40	
Storm King					None to Offer		
60 Bu. lots 3c per Bu. less than 30 Bu. price.							

SEED GRAINS

	Purity	Germination	Grown		Per Bu.
Oderbrucker Barley					None to Offer
Wisconsin No. 38, 6 row ..	98.00%	90.00%	Northwest		\$3.25
Spring Rye	98.00%	90.00%	Northwest		4.85
Marquis Spring Wheat ...	99.00%	92.00%	Northwest		4.10
Japanese Buckwheat	99.00%	95.00%	New York		3.10
10 Bu. lots 10c per Bu. less.					

SOY BEANS

	Purity	Germination	Grown		Per Bu.
Wilson	99.50%	90.00%	Delaware		\$4.60
Lincoln	99.50%	90.00%	Penna.		4.60
Manchu					None to Offer
10 Bu. lots 10c per Bu. less.					

COW PEAS

	Purity	Germination	Grown	1/2 Bu.	60 Lb.	Per Bu.
Mixed	98.00%	80.00%	Illinois ...	\$3.75		\$7.00

CANADA FIELD PEAS

	Purity	Germination	Grown	1/2 Bu.	60 Lb.	Per Bu.
No. 1 White	99.00%	90.00%	Michigan ..	\$3.10		\$5.80

CANE OR SORGHUM

	Purity	Germination	Grown	1/2 Bu.	50 Lb.	Per Bu.
Amber	99.00%	85.00%	Cent. States	\$3.10		\$5.65
Orange	99.00%	85.00%	Cent. States	3.20		5.90

MILLET

	Purity	Germination	Grown	Per Bu. 50 Lb.
Tennessee Golden	99.00%	85.00%	Tennessee	\$4.50
German	99.00%	85.00%	Central States	4.25
Hungarian	99.00%	85.00%	Central States	4.25

MISCELLANEOUS

	Purity	Germination	Grown	1 Lb.	10 Lb.	25 Lb.	100 Lb.
Dwarf Essex Rape	99.00%	90.00%	Idaho	\$.35	\$3.00	\$6.25	\$21.00
Hairy Vetch	98.00%	90.00%	Michigan	.35	3.20	7.25	27.00
Sudan Grass	98.00%	85.00%	Texas	.30	2.50	5.25	17.00
Korean Lespedeza	98.00%	90.00%	Missouri	.25	2.00	4.25	15.00

SEED POTATOES—U. S. No. 1—Certified

Early Varieties

Grown	Pk.	Bu.	100 Lb. Sack
Early Ohio-Dakota	\$1.20	\$4.20	\$6.50
Irish Cobbler-Maine	.90	3.00	4.50
Irish Cobbler-New York	1.00	3.60	5.40
Chippewa-New York	1.00	3.60	5.40

Late Varieties

Katahdin-Maine	\$.90	\$3.00	\$4.50
Russett-New York	1.00	3.60	5.40
Sebago-Maine	.90	3.00	4.50

SEED DISINFECTANTS and INOCULATION

Legume-Aid

Described on page 66 of catalog.

For all Clovers and Alfalfa

1-bu. size	\$0.50
2½-bu. size	1.00

For Soy Beans

2-bu. size	\$0.30
5-bu. size	.55

For Vetch

100-lb. size	\$0.50
--------------	--------

When ordering Legume-Aid be sure to state the kind of seed to be inoculated.

Formaldehyde

Described on page 66 of catalog.

For Seed Wheat, Oats, Barley and Potatoes

1-lb. bottle	\$0.35
Ten 1-lb. bottles	3.00
Case 25 1-lb. bottles	6.70

New Improved Ceresan

Described on page 66 of catalog.

For Seed Wheat, Oats and Barley

4-oz. pkg.	\$0.35
1-lb. pkg.	.90
4-lb. pkg.	3.00

Semesan Jr.

Described on page 66 of catalog

For Seed Corn

1½-oz. pkg.	\$0.17
12-oz. pkg.	.62

Semesan Bel

Described on page 66 of catalog.

For Seed Potatoes

2-oz. pkg.	\$0.35
1-lb. can	1.83
4-lb. can	6.33

Stanley's Crow Repellent

Described on page 67 of catalog.

For Seed Corn

½-pt. bottle	\$0.60
1-pt. bottle	1.00
1-qt. bottle	1.75

SCOTT'S LAWN GRASS MIXTURES

Our Lawn Grass Mixtures are made of the best re-cleaned Grass Seeds we can procure. We use no "fillers" such as unhulled Red Top, light weight Blue Grass, etc., in making them up.

They are as free from weed seeds as the most modern and careful methods of harvesting and cleaning can make them.

	1/2 lb.	1 lb.	5 lb.	10 lb.	25 lb.	100 lb.
Scott's "Purity" Lawn Grass Seed	\$.60	\$1.00	\$4.60	\$8.90	\$21.50	\$82.00
Scott's "Shady" Lawn Mixture	.60	1.10	5.00	9.50	22.50	85.00
Scott's "Superfine" Lawn Seed	.70	1.25	5.75	11.25	27.00	105.00
Scott's "Evergreen" Lawn Grass Mixture	.45	.75	3.50	6.60	16.00	60.00
Scott's "Terrace" Lawn Mixture	.60	1.00	4.60	8.90	21.50	82.00
Scott's "Fairway" Mixture	5.50	10.50	25.00	95.00
Scott's "Athletic Field" Mixture	5.50	10.50	25.00	95.00
White Dutch Clover	.85	1.50	7.00	13.00

GRASS SEEDS

Varieties	Purity	Germination	1 lb.	10 lb.	25 lb.	100 lb.
Kentucky Blue Grass	85.00%	80.00%	\$1.50	\$14.50	\$35.00	\$125.00
Kentucky Blue Grass	98.00%	80.00%
Re-cleaned Red Top	98.00%	90.00%	.50	4.50	10.00	35.00
Orchard Grass	85.00%	85.00%	.50	4.50	10.00	35.00
Perennial Rye Grass	99.00%	90.00%	.50	4.50	10.00	35.00
Domestic Rye Grass	99.00%	90.00%	.35	3.00	5.00	16.00
Mixed Creeping Bent	98.00%	90.00%	2.00	18.00	41.25	155.00
Coos County Bent	98.00%	90.00%	2.00	18.00	42.50	160.00
Astoria Bent	98.00%	90.00%	2.00	18.00	40.00	150.00
Colonial Bent	98.00%	90.00%	2.00	18.00	40.00	150.00
Poa Trivialis	90.00%	90.00%	1.40	13.00	30.00	110.00
Chewings Fescue	98.00%	90.00%	1.30	12.00	26.25	95.00
Creeping Red Fescue	98.00%	90.00%	1.30	12.00	26.25	95.00

The purity and germination tests given in this list are representative of the grades we regularly carry in stock. Orders received from this list will be filled from lots of equal or better purity and germination.

If you are not ready to place your order now, write us when you are in the market, specifying the varieties and quantity of each wanted. Samples gladly furnished on request.

Full description of the different varieties of field seeds, grains, grasses and potatoes are found in our 1947 Catalogue.

NON-WARRANTY. The I. W. Scott Company gives no warranty, express or implied, as to the productiveness of any seeds, bulbs or plants it sells and will not be in any way responsible for the crop. Our liability, in all instances, is limited to the purchase price of the seeds, bulbs or plants.

The I. W. Scott Company.

The I. W. SCOTT CO.

500 LIBERTY AVE. Telephone Atlantic 2022 113 DIAMOND ST.
PITTSBURGH, PENNA.

Seed Specialists—Since 1876

"GLADS"

An essential summer cut-flower for every garden, and one of the easiest to grow, is the Gladiolus. If you would have a succession of bloom, plant your bulbs at intervals of two weeks. To eliminate staking, plant the bulbs in groups, setting them 5 to 6 inches deep in well-drained soil in full sun. Gladiolus are easily grown and require little care.

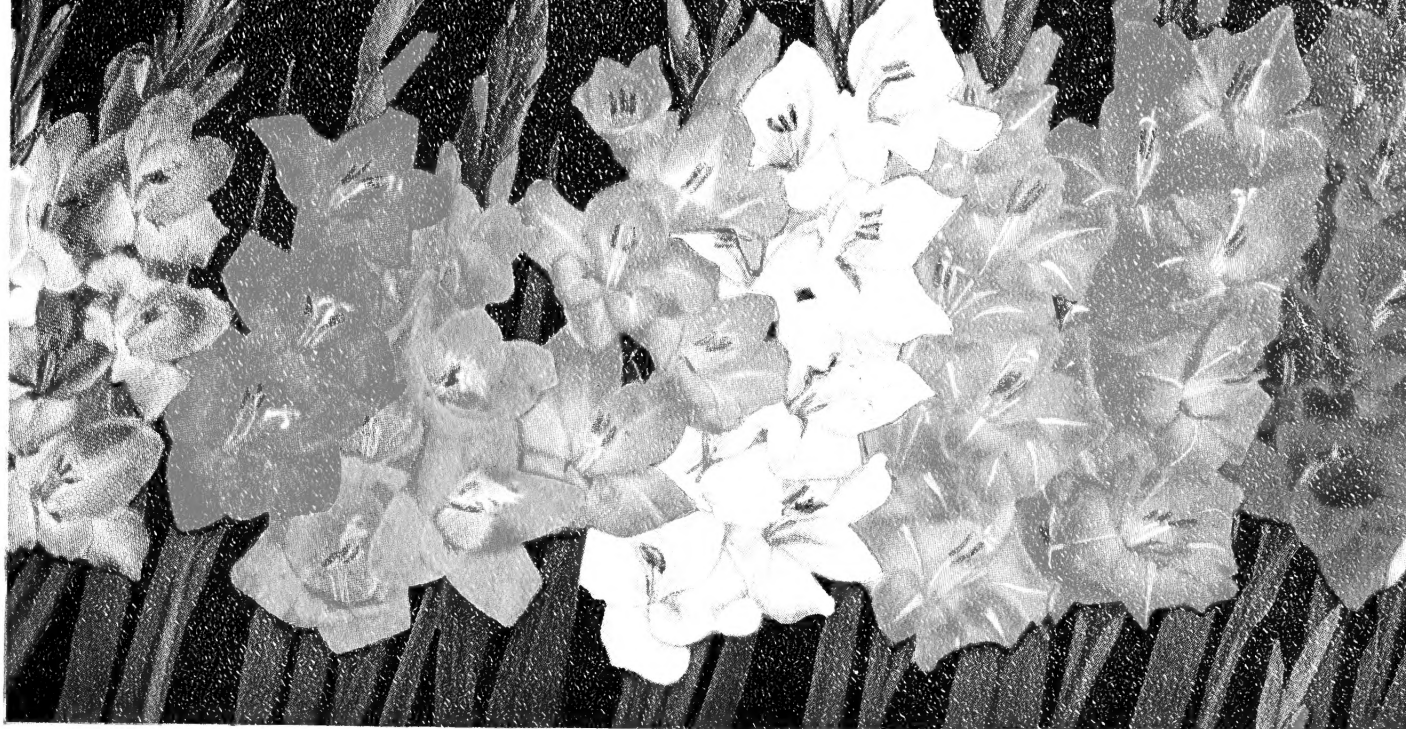

① ② ③ ④ ⑤ ⑥ ⑦ ⑧

COLLECTION OF GLADIOLUS

- | | |
|------------------------------------|------------------------------------|
| 1. Purple Heart. Light purple. | 5. Snow Princess. Creamy white. |
| 2. Margaret Fulton. Dark salmon. | 6. Dream O'Beauty. Rose-red. |
| 3. Miss Bloomington. Light yellow. | 7. Excellence. Flame-red. |
| 4. Picardy. Apricot-pink. | 8. Charles Dickens. Purple-violet. |

24 bulbs, 3 each of 8 varieties, \$2.10. 48 bulbs, 6 each of 8 varieties, \$4.00
96 bulbs, 12 each of 8 varieties, \$7.60

CENTAUREA (Cornflower)
Double Blue. Pkt 10 cts.

ZINNIA
Double
Dahlia-flowered
Golden Dawn
Pkt. 15 cts.

CYNOGLOSSUM
(Chinese
Forget-me-not)
Blue Bird
Pkt. 10 cts.

COSMOS
Early Klondyke, Orange Flare
Pkt. 15 cts.

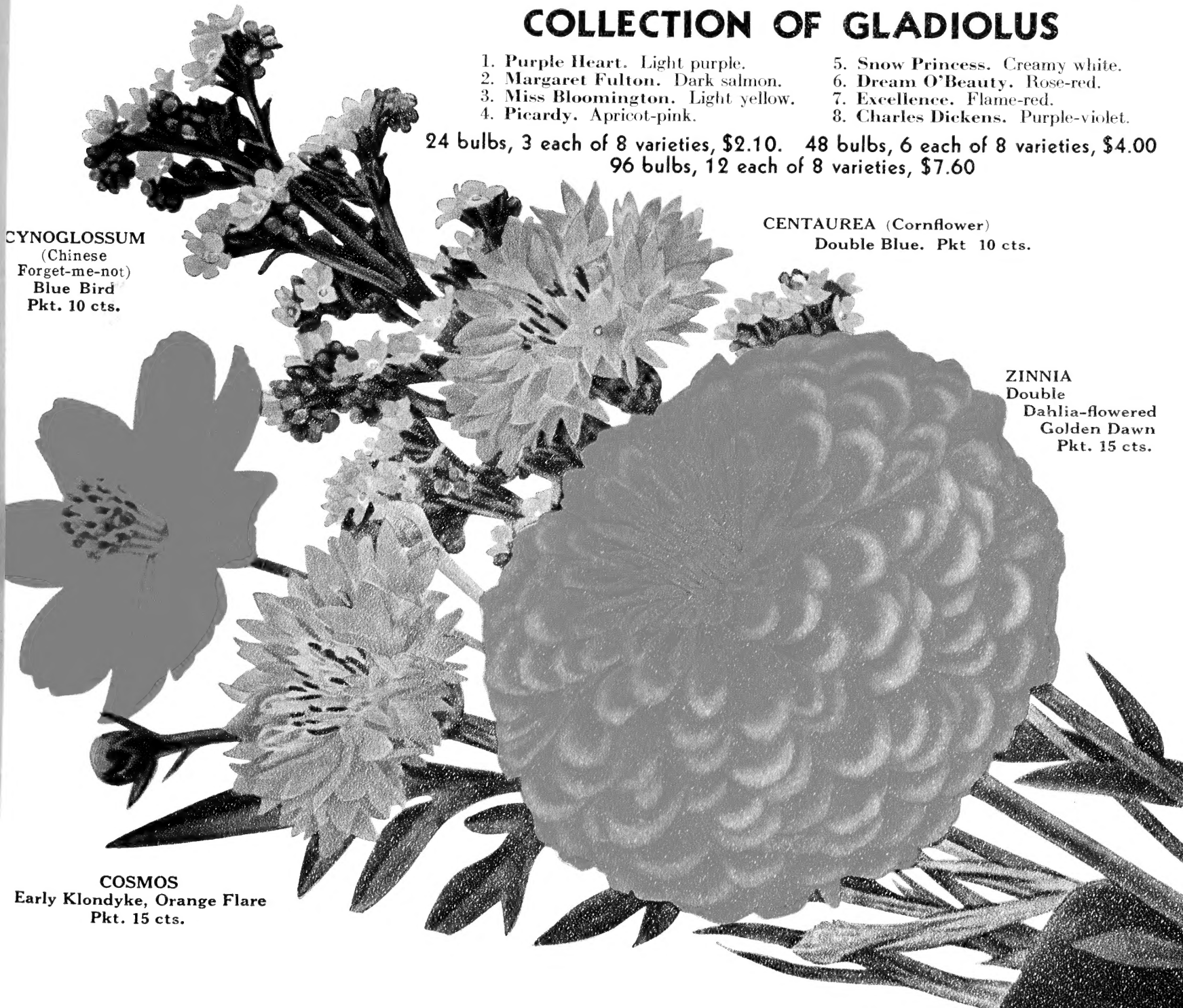

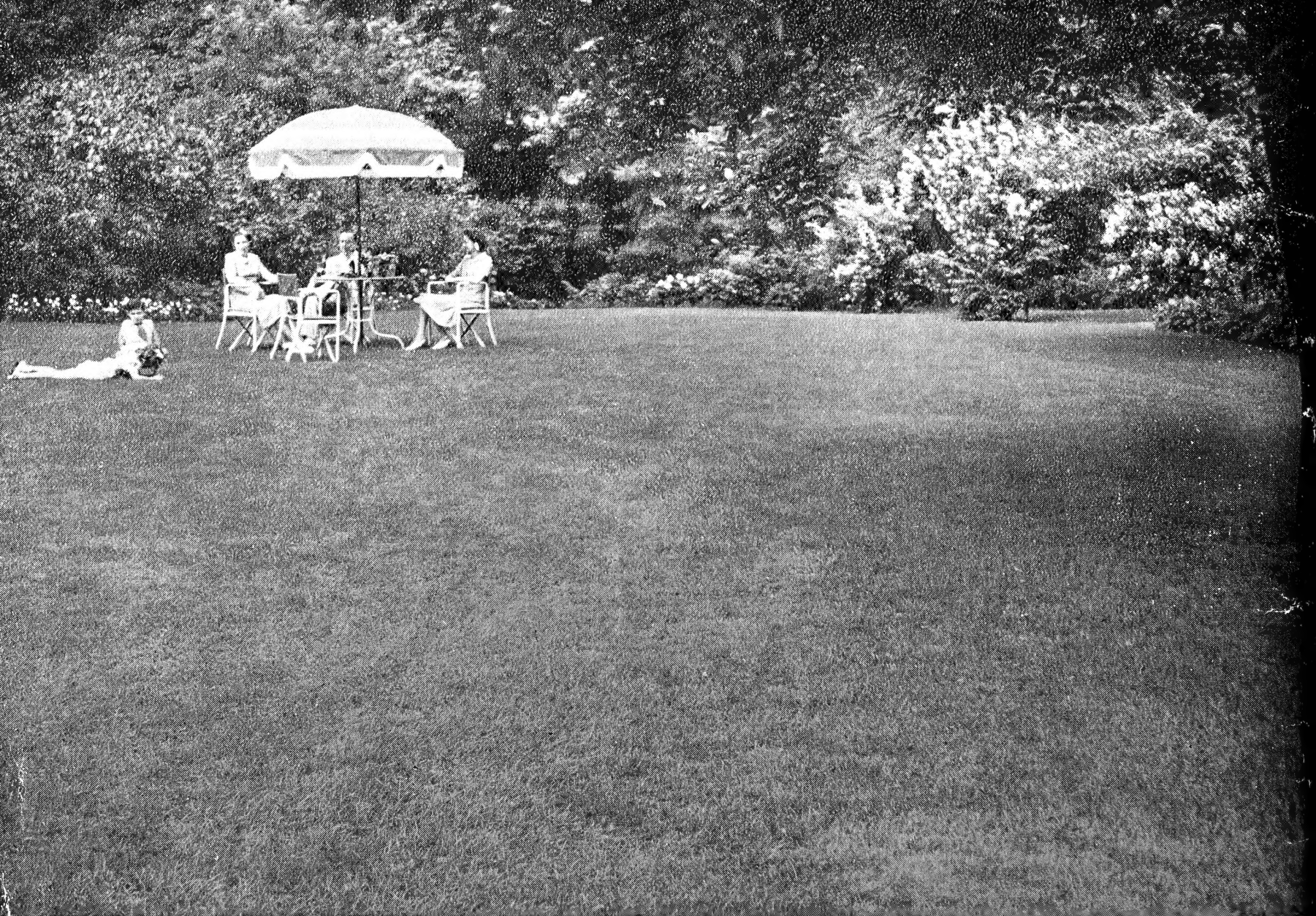

SCOTT'S *Purity* LAWN GRASS SEED

A good lawn is perhaps the greatest single asset that your home grounds can have. Good lawns require persistent care, but first of all you need top-grade seed.

Scott's Purity Lawn Grass Seed is a mixture of several varieties. Together they will produce a velvety green turf of even texture, with long roots to help it survive the winter. This is the highest grade of re-cleaned seeds procurable, tested for quick germination and freedom from weeds and impurities. This blend is meant for all general purposes and will make a good permanent lawn that should not require major repairs for some time.

Sow at the rate of 1 pound to each 250 square feet or 150 pounds per acre. A measured bushel will weigh about 27 pounds.



1/2-lb. carton	\$0 60	10-lb. bag	\$8 90
1-lb. carton	1 00	25-lb. bag	21 50
2-lb. carton	1 90	50-lb. bag	41 50
5-lb. carton	4 60	100 lbs.	32 00

Fertilize Lawns with AGRICO for Greater Health and Beauty

Most run-down lawns and lawn failures are due to lack of plant-food. AGRICO FOR LAWNS, TREES and SHRUBS is the complete plant-food, specially made to provide all that is needed in just the right proportions to stimulate a thick, lush growth of deep-rooted lawn grass. If you have a good lawn, keep it that way by feeding it with Agrico every spring and fall. If your lawn is run down and you plan to repair or rebuild it, Agrico can insure your investment in lawn seed and labor. And don't forget your trees and shrubs. Feed them with Agrico and see them respond with new growth and more luxuriant foliage. Economical, easy to use—full directions on every bag.



5-lb. bag	\$0 45	50-lb. bag	\$2 50
10-lb. bag	80	100-lb. bag	4 00
25-lb. bag	1 50	500 lbs.	18 00

"LAWNS—HOW TO MAKE AND MAINTAIN THEM"—A carefully prepared leaflet FREE to those who ask for it

ESTABLISHED
1876

The I. W. SCOTT COMPANY

500 LIBERTY AVE. • 113 DIAMOND ST. • PITTSBURGH 22, PA.

1947