

Historic, Archive Document

Do not assume content reflects current scientific knowledge, policies, or practices.

62,111

THE ROCKY MOUNTAIN SEED CO.

MAin 6134

1321-27 15th Street, DENVER, COLORADO

LIBRARY
RECEIVED

MAR 23 1950



U.S. Department of Agriculture



GARDEN GUIDE for 1950



BEANS
TOP CROP—The All American
Gold Medal Winner for 1950

For a
Complete List of
**VEGETABLES FOR YOUR
GARDEN**

See
Pages 1-25 (Inc.)



RADISH, COMET
Long Standing Type



CARROTS
Imperator Long Type or
California Shipper



LETTUCE, Premier Strain, Great Lakes

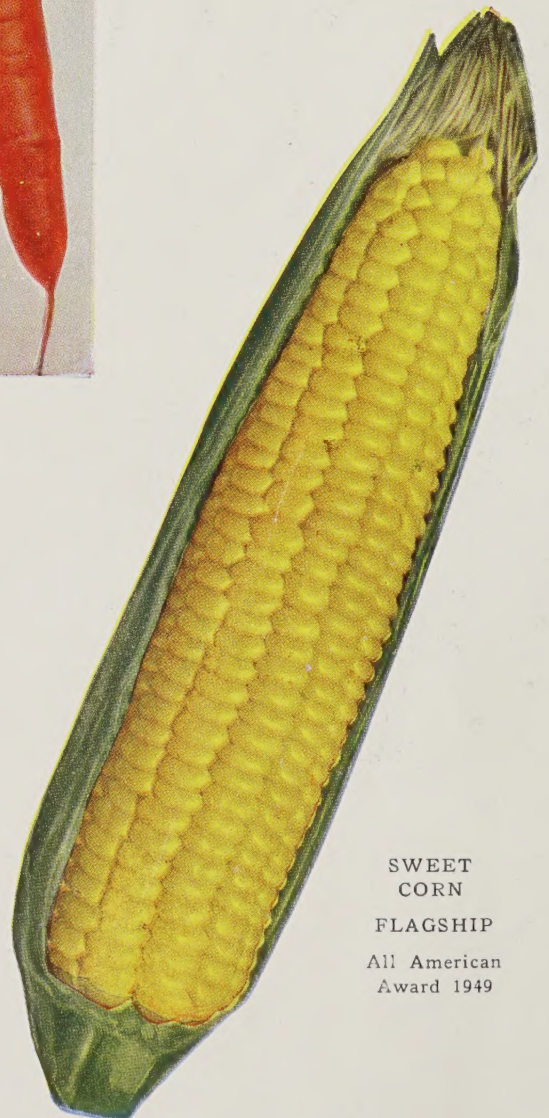

SWEET
CORN
FLAGSHIP
All American
Award 1949

THE ROCKY MOUNTAIN SEED CO.

1321-27 FIFTEENTH STREET

DENVER, COLORADO

Date _____		AMOUNT ENCLOSED
Name _____		P. O. Order _____
Post Office _____	State _____	Draft _____
R.F.D. _____	Box No. _____	Express Order _____
OR		Cash _____
Street Address _____		Stamps _____
Shipping Station _____		Total _____
Express or Railroad Company _____		
How ship? Mail <input type="checkbox"/> Express <input type="checkbox"/> Freight <input type="checkbox"/>		

All members of one family should order under one name. Please print or write plainly.

Where seeds are quoted postpaid these will be sent charges paid by us to the 4th postal zone from Denver. If you live beyond the 4th zone, add extra postage on all articles priced not postpaid. Be sure to add postage at zone rate.

NOTICE—While we take all possible pains to supply only pure and reliable seeds, WE GIVE NO WARRANTY, expressed or implied, as to the productiveness of any seeds or bulbs we sell and we will not be in any way responsible for the crop. Our liability, in all instances, is limited to the purchase price of the seed. When mentioned, purity and germination tests are for information only and without guarantee.

Quantity	NAME OF ARTICLES WANTED	PRICE	AMOUNT
TOTAL			

VEGETABLE SEEDS

FOR CRITICAL PLANTERS

ASPARAGUS

CULTURE—One ounce for 300 roots. Asparagus seed is sown in the spring. The earlier the better after frost is out of the ground and the soil is in good workable condition, not sticky. Scatter the seed an inch apart in drills 2 to 3 feet apart and cover with about $\frac{3}{4}$ -inch of soil. Keep cultivated, well watered and free from weeds.

MARY WASHINGTON—The best rust-resistant variety, heavily productive, producing large deep green shoots of the highest quality.

Postpaid (Pkt. 10c) (Oz. 20c) ($\frac{1}{4}$ lb. 60c) (lb. \$2.00).

ARTICHOKE

The artichoke is grown for its edible blossoms. It is a perennial but requires renewing every two or three years. The Jerusalem Artichoke so called is grown for its tuberous root.

LARGE GREEN GLOBE—The standard variety for home and market gardens. A perennial, but not hardy in the north. Flower heads large, globular, deep green, with fleshy bases on the bud scales.

Postpaid (Pkt. 15c) (Oz. 50c) ($\frac{1}{4}$ lb. \$1.50).

GARDEN BEANS

CULTURE—Beans can be planted with safety any time from May 15th to August 1st. They do better in a light sandy loam soil, but will thrive well in any good garden soil. Sow in rows $2\frac{1}{2}$ to 3 feet apart; 1 lb. will sow a row 100 feet long; 60 to 90 lbs. will plant an acre. For a continuous supply plant every 10 days until August. Never cultivate or handle beans when the vines are wet.

Maturity periods listed means in the wax and green pod varieties the number of days required to produce snap beans. In Lima Beans the time required to produce green shell beans and in the Field class, the number of days required to produce dry shell beans fully matured.

GREEN PODDED BUSH BEANS



TOP CROP BEAN

BOUNTIFUL OR EARLY SIX WEEKS—51 days. Very prolific producer of flat entirely stringless pods of clear light green, $6\frac{1}{2}$ to 7 inches long.

Postpaid (Pkt. 10c) ($\frac{1}{4}$ lb. 20c) (lb. 50c) (2 lbs. 95c) (5 lbs. \$2.25).

Not Postpaid (10 lbs. \$3.50) (25 lbs. \$7.50).

BROAD WINDSOR (Fava or Horse Bean)—75 days. An Italian variety used as a shell bean. Beans are large, broad, flat light green 6 to a pod.

Postpaid (Pkt. 10c) ($\frac{1}{4}$ lb. 20c) (lb. 45c) (2 lbs. 85c) (5 lbs. \$2.00).

Not Postpaid (10 lbs. \$3.50) (25 lbs. \$7.50).

BURPEE'S STRINGLESS—54 days. Gardeners and canners like this stringless and fiberless bean for its excellent quality. It sells readily on the market, and for cut beans for canning, it can't be beat. Pod 6 inches long, medium green, round.

Postpaid (Pkt. 10c) ($\frac{1}{4}$ lb. 20c) (lb. 50c) (2 lbs. 95c) (5 lbs. \$2.25).

Not Postpaid (10 lbs. \$3.50) (25 lbs. \$7.50).

FULL MEASURE—60 days. Very desirable home garden and canning variety. Pods, medium green $6\frac{1}{2}$ inches long, round, very fleshy, brittle and stringless.

Postpaid (Pkt. 10c) ($\frac{1}{4}$ lb. 20c) (lb. 50c) (2 lbs. 95c) (5 lbs. \$2.25).

Not Postpaid (10 lbs. \$3.50) (25 lbs. \$7.50).

GIANT STRINGLESS—56 days. Pods medium green, round, about $6\frac{1}{2}$ inches long, very fleshy with marked indentation between seeds. Brittle and stringless.

Postpaid (Pkt. 10c) ($\frac{1}{4}$ lb. 20c) (lb. 50c) (2 lbs. 95c) (5 lbs. \$2.25).

Not Postpaid (10 lbs. \$3.50) (25 lbs. \$7.50).

IMPROVED LOGAN—54 days. Plants are upright and bushy, of the Tendergreen type, pods are 6 inches long, completely round and straight. Color same as Tendergreen. Logan tends to cluster its blossoms, setting pods at one setting, meaning that the market gardener will get a very high percentage of pick when stripping his field.

Postpaid (Pkt. 10c) ($\frac{1}{4}$ lb. 25c) (lb. 55c) (2 lbs. \$1.05) (5 lbs. \$2.50).

Not Postpaid (10 lbs. \$4.50) (25 lbs. \$10.00)

KEYSTONIAN—52 days. A fine new bean combining the delicious tenderness of "Tendergreen" with the productivity of "Stringless Green Pod." Long, straight, round pods, 6 to $6\frac{1}{2}$ inches long, fine grained, straight and a rich dark green color, perfectly stringless.

Postpaid (Pkt. 10c) ($\frac{1}{4}$ lb. 20c) (lb. 50c) (2 lbs. 95c) (5 lbs. \$2.25).

Not Postpaid (10 lbs. \$3.75) (25 lbs. \$8.00).

LANDRETH'S STRINGLESS—54 days. Pods medium green, nearly round, very fleshy, stringless, fine grained and tender. Retain their green color well, very productive.

Postpaid (Pkt. 10c) ($\frac{1}{4}$ lb. 20c) (lb. 50c) (2 lbs. 95c) (5 lbs. \$2.25).

Not Postpaid (10 lbs. \$3.50) (25 lbs. \$7.50).

NEW STRINGLESS GREEN POD (Tendergreen)—53 days. Pods average 6 inches in length, are an attractive dark green, nearly straight, round fleshy, stringless and of excellent quality.

Postpaid (Pkt. 10c) ($\frac{1}{4}$ lb. 20c) (lb. 50c) (2 lbs. 95c) (5 lbs. \$2.25).

Not Postpaid (10 lbs. \$3.50) (25 lbs. \$7.50).

PLENTIFUL (Black Seeded Bountiful)—53 days. Very desirable for shipping or home and market garden. An improved, very productive variety of the Bountiful type. Noticeably resistant to certain rust diseases. Pods flat, $7\frac{1}{2}$ inches long, straight, medium deep green, brittle, stringless and of distinctive flavor.

Postpaid (Pkt. 10c) ($\frac{1}{4}$ lb. 20c) (lb. 45c) (2 lbs. 85c) (5 lbs. \$2.00).

Not Postpaid (10 lbs. \$3.50) (25 lbs. \$7.50).

ROGER'S STRINGLESS BLACK VALENTINE—Round Pod. 55 days. Excellent shipping variety, pods $6\frac{3}{4}$ inches long, medium green, nearly straight, stringless and of fine quality. Retains its color and texture long after picking, very prolific.

Postpaid (Pkt. 10c) ($\frac{1}{4}$ lb. 20c) (lb. 50c) (2 lbs. 95c) (5 lbs. \$2.25).

Not Postpaid (10 lbs. \$3.50) (25 lbs. \$7.50).

ROGER'S STRINGLESS LONGREEN—56 days. A new market bean originating from the New Stringless variety. The season, vine, pod type and color are similar to regular New Stringless, but has longer pods. Pods are round, straight, dark green in color and 7 inches long.

Postpaid (Pkt. 10c) ($\frac{1}{4}$ lb. 20c) (lb. 50c) (2 lbs. 95c) (5 lbs. \$2.25).

Not Postpaid (10 lbs. \$3.75) (25 lbs. \$8.00).

TOP CROP—The All American Gold Medal winner for 1950. 53 days. Plants grow 15-16 inches high with about 23 inch spread. High yields are borne during a short interval, giving a few large pickings rather than a number of small pickings. The pods are $5\frac{1}{2}$ to 6 inches long, $\frac{7}{16}$ inch wide, and round. The color is slightly lighter green than Tendergreen. They are straight to slightly curved, smooth entirely stringless. Top Crop is an excellent market, canning and freezing type. Seeds are oval, brown mottled and Mosaic resistant.

Postpaid (Pkt. 10c) ($\frac{1}{4}$ lb. 25c) (lb. 55c) (2 lbs. \$1.05) (5 lbs. \$2.50).

Not Postpaid (10 lbs. \$4.50) (25 lbs. \$10.00).

GREEN PODDED BUSH BEANS—Continued

RUBY DWARF HORTICULTURAL—53 days. Excellent for green shell use and snaps. Pods dark green, flat, stringless at snap stage; greenish yellow splashed with carmine and nearly round at green shell stage.
Postpaid (Pkt. 10c) (¼ lb. 20c) (lb. 50c) (2 lbs. 95c) (5 lbs. \$2.25).
Not Postpaid (10 lbs. \$3.50) (25 lbs. \$7.50).

STREAMLINER—51 days. A good home and early market variety. The pods are 7½ to 8 inches long, slender, straight with a slight curved end, flat, medium green in color.
Postpaid (Pkt. 10c) (¼ lb. 20c) (lb. 50c) (2 lbs. 95c) (5 lbs. \$2.25).
Not Postpaid (10 lbs. \$3.50) (25 lbs. \$7.50).

WAX BEANS

CHEROKEE—52 days. Plant large and erect, pods 6 inches long, golden wax, oval, nearly straight, stringless at all stages, tender and of good quality.
Postpaid (Pkt. 10c) (¼ lb. 25c) (lb. 55c) (2 lbs. \$1.05) (5 lbs. \$2.50).
Not Postpaid (10 lbs. \$4.50) (25 lbs. \$10.00).

IMPROVED GOLDEN WAX—51 days. Pods 4½ to 5 inches long, stringless, of rich golden yellow color, nearly flat. Superior in quality and yield.
Postpaid (Pkt. 10c) (¼ lb. 20c) (lb. 50c) (2 lbs. 95c) (5 lbs. \$2.25).
Not Postpaid (10 lbs. \$3.75) (25 lbs. \$8.00).

ROUND POD KIDNEY WAX OR BRITTLE WAX—58 days. Plants of medium size, with tender succulent buttery flavored beans. Ideal for home use and canning. Pods 6 to 6½ inches long, lemon yellow in color and stringless.
Postpaid (Pkt. 10c) (¼ lb. 20c) (lb. 50c) (2 lbs. 95c) (5 lbs. \$2.25).
Not Postpaid (10 lbs. \$3.75) (25 lbs. \$8.00).

PENCIL POD BLACK WAX—55 days. Pods are 6½ inches long, round, fleshy, golden yellow, tender and absolutely stringless, brittle and of finest quality.
Postpaid (Pkt. 10c) (¼ lb. 20c) (lb. 50c) (2 lbs. 95c) (5 lbs. \$2.25).
Not Postpaid (10 lbs. \$3.75) (25 lbs. \$8.00).

PUREGOLD WAX—63 days. Pods are 5½ to 6 inches long, slim, round, golden yellow and stringless. Bush dark green, about 18 inches high. Seed white with light brown coloring around the eye. Resistant to common bean mosaic.
Postpaid (Pkt. 10c) (¼ lb. 25c) (lb. 55c) (2 lbs. \$1.05) (5 lbs. \$2.50).

POLE BEANS

BLUE LAKE—68 days. Vine dull green, climber, white flowers. Pods 6 inches long, curved round, stringless when young.
Postpaid (Pkt. 10c) (¼ lb. 20c) (lb. 50c) (2 lbs. 95c) (5 lbs. \$2.25).
Not Postpaid (10 lbs. \$3.75) (25 lbs. \$8.00).

KENTUCKY WONDER OR OLD HOMESTEAD—65 days. Pods medium green, borne in clusters, are round, 7½ to 8½ inches long, curved. Have delicious flavor and cook tender at all times.
Postpaid (Pkt. 10c) (¼ lb. 20c) (lb. 50c) (2 lbs. 95c) (5 lbs. \$2.25).
Not Postpaid (10 lbs. \$3.75) (25 lbs. \$8.00).

KENTUCKY WONDER WAX—68 days. Considered the best wax podded pole bean. Has beautiful flat, nearly stringless, waxy, yellow pods.
Postpaid (Pkt. 10c) (¼ lb. 20c) (lb. 50c) (2 lbs. 95c) (5 lbs. \$2.25).
Not Postpaid (10 lbs. \$3.75) (25 lbs. \$8.00).

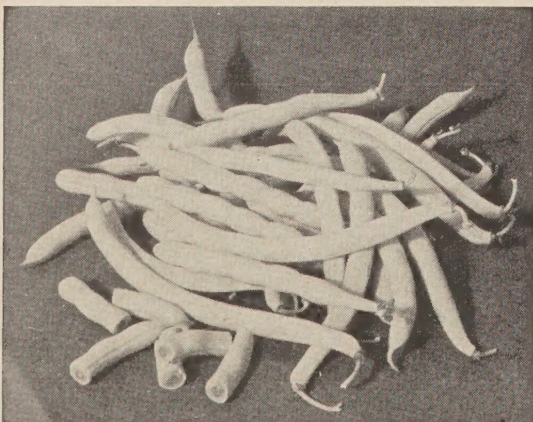

ROUND POD KIDNEY WAX

OREGON GIANT—71 days. A desirable snap bean. Plants sturdy and prolific. Pods long stringless when young, splashed purplish blue.

Postpaid (Pkt. 10c) (¼ lb. 20c) (lb. 50c) (2 lbs. 95c) (5 lbs. \$2.25).

SCARLET RUNNER—90 days. Brilliant scarlet flowers used for ornamental purposes as well as for snap and green shell beans.

Postpaid (Pkt. 10c) (¼ lb. 20c) (lb. 50c) (2 lbs. 95c) (5 lbs. \$2.25).

BUSH LIMA BEANS

BABY POTATO LIMA—72 days. The seeds are small but thick, of bright green color when fresh, and similar in flavor to Fordhook. Adapted not only for produce markets, but also for canning and quick freezing.

Postpaid (Pkt. 10c) (¼ lb. 20c) (lb. 50c) (2 lbs. 95c) (5 lbs. \$2.25).
Not Postpaid (10 lbs. \$3.75) (25 lbs. \$8.00).

BURPEE'S IMPROVED—75 days. Thick seeded or "potato type." Pods 6 inches long and 1¼ inches wide. Usually contains four large thick, flat green beans, fine grained and tasty.

Postpaid (Pkt. 10c) (¼ lb. 20c) (lb. 50c) (2 lbs. 95c) (5 lbs. \$2.25).
Not Postpaid (10 lbs. \$3.75) (25 lbs. \$8.00).

FORDHOOK—75 days. Plants strong, erect, bearing pods in clusters of 4 to 8. Pods measure 4 to 5½ inches long and contain three to five large thick green beans.

Postpaid (Pkt. 10c) (¼ lb. 20c) (lb. 50c) (2 lbs. 95c) (5 lbs. \$2.25).
Not Postpaid (10 lbs. \$3.75) (25 lbs. \$8.00).

HENDERSON'S (Baby Lima)—65 days. Plant medium large, very productive. Small pods 3 inches long contain 3 to 4 green shell beans of very fine quality. Plants bear continuously.

Postpaid (Pkt. 10c) (¼ lb. 20c) (lb. 50c) (2 lbs. 95c) (5 lbs. \$2.25).
Not Postpaid (10 lbs. \$3.25) (25 lbs. \$7.50).

JACKSON WONDER BUSH—66 days. Pods medium size, holding 4 or 5 moderately thick, fairly large beans of good quality. Dry seed mottled and speckled with brownish-red markings.

Postpaid (Pkt. 10c) (¼ lb. 20c) (lb. 50c) (2 lbs. 95c) (5 lbs. \$2.25).

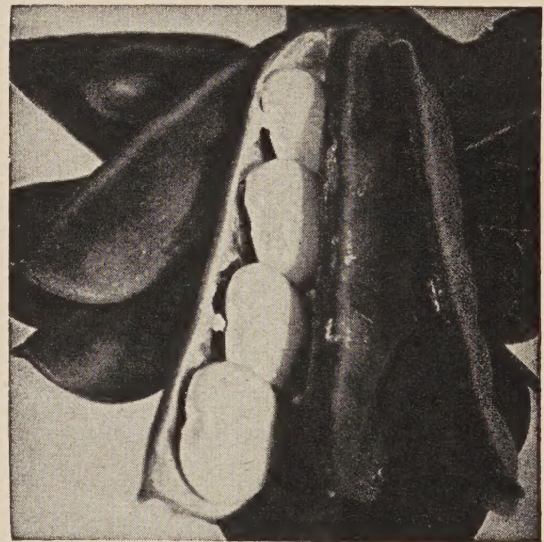

LIMA BEAN, FORDHOOK BUSH

EDIBLE SOYBEANS

In recent years many varieties of edible soybeans have been imported from the Orient by the U. S. Department of Agriculture, and detailed studies on their adaptation to North American growing conditions have been made. As a result we offer the following varieties. They are very prolific, highly resistant to disease and insect pests, of attractive appearance and eating qualities when cooked and served similar to Lima Beans.

The number of days refers to picking for use as green shelled beans; full maturity for dry shelled beans is 30 days later. At green eating stage all have dark green beans, more or less oval in shape though varying in size. Steep pods of Soybeans in boiling water for a few minutes and they will shell out readily.

GIANT GREEN—91 days. A home garden sort and desirable in localities with short growing season, recommended for use in green shell stage. Shatters badly upon ripening. Plant short and erect.

Postpaid (Pkt. 10c) (¼ lb. 20c) (lb. 50c) (2 lbs. 95c) (5 lbs. \$2.25).
Not Postpaid (10 lbs. \$3.25) (25 lbs. \$7.50).

TABLE BEETS

CULTURE—Sow 2 ounces to 100 feet of drill; 5 to 6 pounds per acre.



BEET, DETROIT DARK RED

DETROIT DARK RED—Excellent for home and market garden, shipping and canning. Roots oval, dark red color, remaining tender even when full grown. Small collar and tap root.

Postpaid (Pkt. 10c) (Oz. 20c) (¼ lb. 50c) (lb. \$1.75).

DETROIT DARK RED (Special)—The outstanding variety for gardeners and canners. Top medium green, tinged with red. Roots globular, smooth, uniform, attractive with small tap root. Color deep oxblood red. Flesh dark red with faintly defined rings which disappear entirely when beet is cooked.

Postpaid (Oz. 25c) (¼ lb. 60c) (lb. \$2.00).

PERFECTED DETROIT (Special)—A mid-season variety. Tops tall, green and red. Roots globular, medium, flesh purplish red, sweet and tender. Specially bred for earliness and dark color. Ready for market in 50 to 60 days from time of planting.

Postpaid (Pkt. 10c) (Oz. 25c) (¼ lb. 60c) (lb. \$2.00).

GOOD FOR ALL—An excellent new variety developed from Detroit Dark Red. Especially fine for canning and pickling whole at 1¼ to 1½ inches in diameter. Roots smooth, even in size and shape; collar and tap roots very small; interior deep crimson free from white zones.

Postpaid (Pkt. 10c) (Oz. 25c) (¼ lb. 60c) (lb. \$2.00).

CROSBY'S EGYPTIAN—An early variety for home and market garden use. Roots flattened, globular in shape, with small tap root; dark red. Top medium, flesh purplish red, sweet and tender. Specially bred for earliness and dark color.

Postpaid (Pkt. 10c) (Oz. 20c) (¼ lb. 50c) (lb. \$1.75).

GREEN TOP BUNCHING—60 days. Early, extremely attractive bunching beet. Tops medium sized and erect. Foliage clear, grayish green that does not turn red or brown in the fall. Roots round, smooth and glossy, flesh bright blood-red.

Postpaid (Pkt. 10c) (Oz. 20c) (¼ lb. 50c) (lb. \$1.75).

ASGROW WONDER—Distinctive green tops, erect, uniform in size and color, bunching very attractive for market. Roots round when young, semi-globular later, deep red, smooth with small neck and tap root.

Postpaid (Pkt. 10c) (Oz. 20c) (¼ lb. 40c) (lb. \$1.50).

EARLY WONDER (Regular Strain)—Valuable to truckers and shippers as a first early variety; also used for fall planting. Tops medium small, erect, leaves purple mixed with green. Roots semi-globular, flesh blood red with zones of lighter shades; tender and of good quality.

Postpaid (Pkt. 10c) (Oz. 20c) (¼ lb. 40c) (lb. \$1.50).

EARLY WONDER (Tall Top)—Same as above except leaves are much taller, excellent for bunching and beet greens.

Postpaid (Pkt. 10c) (Oz. 20c) (¼ lb. 50c) (lb. \$1.75).

EARLY WONDER GREEN TOP—Roots same as regular strain, tops all green, tall and erect, used for bunching and beet greens.

Postpaid (Pkt. 10c) (Oz. 20c) (¼ lb. 50c) (lb. \$1.75).

EXTRA EARLY FLAT EGYPTIAN—Very early, used by truckers for forcing to reach the earliest market. Tops small and erect. Roots flattish, medium dark red. Flesh bright blood red with light zones.

Postpaid (Pkt. 10c) (Oz. 20c) (¼ lb. 40c) (lb. \$1.50).

IMPROVED EARLY BLOOD TURNIP—A medium early variety for home and market garden use. Tops medium but somewhat coarse. Roots top-shaped; dark red. Flesh bright red with zones of lighter shade.

Postpaid (Pkt. 10c) (Oz. 20c) (¼ lb. 40c) (lb. \$1.50).

MANGELS AND SUGAR BEETS

CULTURE—Sow 8 to 10 lbs. per acre. Sow in rows 2½ to 3 feet apart as soon as ground can be thoroughly worked. Cover seed about one inch, making ground firm over the seed. When 4 inches high, thin to 8 inches apart in the row. Mangels are a valuable feed for poultry and cattle. Thirty tons per acre is not an uncommon yield. For winter use store in pits the same as other root vegetables.

DANISH SLUDSTRUP—A good cropper and of high feeding value. Roots long, oval, reddish yellow. Grows half above ground, easily harvested. Flesh white, tinged with yellow.

GIANT HALF SUGAR ROSE TOP—A heavy yielding, valuable variety for feeding. Roots long, oval; skin white, with rose-colored shoulder; flesh white with good sugar content.

GOLDEN TANKARD—Roots large, nearly cylindrical, partly above ground; skin deep orange, flesh yellow with white zones. Very productive.

MAMMOTH LONG RED—The most popular and the best cropper of all the mangels. Roots extremely large, slightly tapering; grow half above the ground; color light red, flesh white with rose tinge.

KLEIN WANZLEBEN (Sugar Beet)—The variety most used for making sugar. Roots long with thick shoulder, tapered; skin grey-white; flesh solid white.

WESTERN GIANT SUGAR BEET—A popular variety for sugar manufacturing because of high sugar content, also good for stock feed. Roots are long with white skin and flesh. Prices on all above varieties: Postpaid (Oz. 20c) (¼ lb. 35c) (lb. \$1.00) (5 lbs. \$4.50).

SWISS CHARD

CULTURE—Swiss Chard is a beet grown for its leaves. The midrib when boiled makes delicious greens, or the leaves may be boiled and served as spinach. Sown in the spring, the leaves are soon ready to eat and will continue to grow all through the summer and fall.

DARK GREEN—Leaves broad, upright in growth, very dark green savoyed with broad white midrib. This variety on account of its giant size and pleasing deep green color, will probably supersede other sorts.

FORDHOOK GIANT—Tall and sturdy; leaves broad, heavily crumpled, dark green; stems broad, thick white.

LUCULLUS—A new variety with curled leaves like a Savoy Cabbage. The plant grows nearly two feet high and the stem and leaves are very large and of fine quality.

Above Varieties: Postpaid (Pkt. 10c) (Oz. 20c) (¼ lb. 35c) (lb. \$1.00).

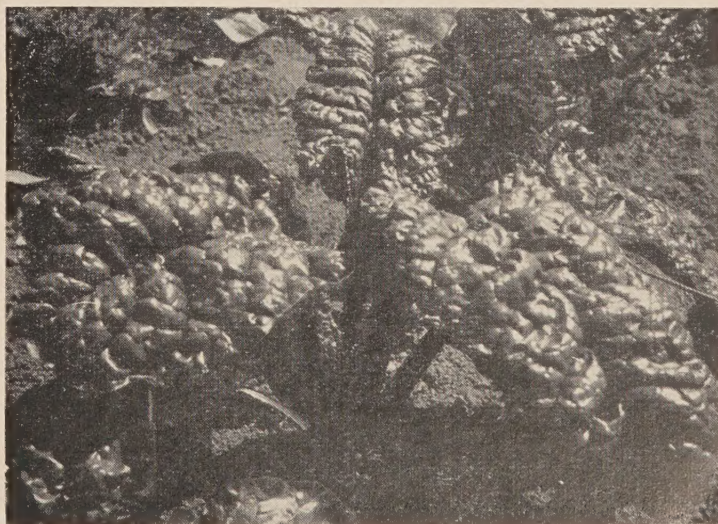

RHUBARB CHARD

RHUBARB CHARD—A recently introduced strain in which the stems and midribs are bright crimson red. Leaves crumpled, dark green with red veins. Attractive home garden variety.

Postpaid (Pkt. 10c) (Oz. 25c) (¼ lb. 75c) (lb. \$2.50).

BROCCOLI

CULTURE—Belongs to the same family as the cauliflower. More hardy and therefore better adapted to a wider range of conditions. Sow the seed in the same manner as for late cabbage, in May, and transplant in June or July, in very rich soil.

DeCICCO—An extremely early strain producing heads ready for market ten days earlier than Italian Green Sprouting. Plants medium tall, light green in color and very productive. Our stock of this strain has been carefully selected for uniformity and can be highly recommended as the earliest maturing strain obtainable.

Postpaid (Pkt. 10c) (Oz. 50c) (¼ lb. \$1.75) (lb. \$6.00).

EARLY ONE—Plants are 3 to 4 ft. high and branched, after the central head is removed a number of small heads are produced on stems 4 to 5 inches in length, color dark bluish green. If kept cut, the plants will continue to produce for 5 to 6 weeks.

Postpaid (Pkt. 10c) (Oz. 50c) (¼ lb. \$1.75) (lb. \$6.00).

CABBAGE

CULTURE—One ounce of seed will produce from 2,000 to 3,000 plants. It requires from 4 to 6 ounces of seed to produce plants for an acre of ground. For early cabbage in the Northern States the seed should be sown in hot-beds in February or March, or about six weeks before the ground outside is ready to receive the plants.



GOLDEN ACRE

EARLY VARIETIES

GOLDEN ACRE—65 days. An extra early selection of the Copenhagen type, and the earliest of the round headed cabbages, maturing with Jersey Wakefield. Plants small, dwarf and compact, with few outer leaves; heads of medium size, round as a ball, hard, solid and very uniform. The best early shipping variety on account of its hard medium sized heads.

Postpaid (Pkt. 10c) (Oz. 50c) (¼ lb. \$1.50) (lb. \$5.00).

GREEN ACRE—66 days. An attractive strain of Golden Acre. The type and general characteristics are the same, but Green Acre holds its green color longer and is thus of added value to market gardeners and shippers.

Postpaid (Pkt. 10c) (Oz. 50c) (¼ lb. \$1.50) (lb. \$5.00).

EUROPEAN MARKET—65 days. This variety resembles the Copenhagen Market in shape, but is smaller in size, more solid and fully ten days earlier. The plant is dwarf and compact, producing medium sized heads, fine for market or home use.

Postpaid (Pkt. 10c) (Oz. 50c) (¼ lb. \$1.50) (lb. \$5.00).

GLORY OF ENKHUIZEN—80 days. A second early sure-heading variety of excellent quality. Heads large, round, solid, with few outer leaves. Used largely for kraut, also by truckers and shippers.

Postpaid (Pkt. 10c) (Oz. 35c) (¼ lb. \$1.25) (lb. \$4.00).

EARLY JERSEY WAKEFIELD—65 days. Pointed head, medium early, very compact.

Postpaid (Pkt. 10c) (Oz. 25c) (¼ lb. \$1.00) (lb. \$3.50).

ITALIAN GREEN SPROUTING—A new and distinct variety of the sprouting type. It forms a large head consisting of a cluster of bluish green flower-heads. When this central head is removed the plant develops numerous lateral sprouts, each of which produces a small head. These are cut, leaving about 6 inches of the stem, and are tied in bunches for market. Both stems and heads are cooked and served like cauliflower.

(Pkt. 10c) (Oz. 50c) (¼ lb. \$1.50) (lb. \$5.00).

BRUSSELS SPROUTS

CULTURE—Used in the fall and early winter. Plant resembles the cabbage, the edible part being the numerous very small heads or sprouts an inch or two in diameter formed on the stalk at each leaf joint. The culture is the same as for the cabbage, except the leaves should be broken down in the fall to give the little heads more room to grow.

LONG ISLAND IMPROVED (Special Stock)—Plant dwarf and compact, 20 inches tall; very uniform; stem well covered with firm round cabbage-like heads of 1¼ to 1½ inches in diameter, which mature in succession.

Postpaid (Pkt. 10c) (Oz. 50c) (¼ lb. \$1.75) (lb. \$6.00).

Seeds of the late varieties may be sown in cold frames or in the open ground in April or May and transplanted in the fields in June and July. Seed of early varieties for late crop may be sown as late as June 10th and mature a good crop. Cabbage requires a well-fertilized soil to grow a successful crop; 12,000 plants will set an acre. Where the soil is infected with Cabbage "yellows," Yellow Resistant varieties should be planted.

COPENHAGEN MARKET—75 days. A very early round head cabbage. Plants compact with short stems and hard round heads. Used largely as an early shipper and for early kraut. Fine quality.

Postpaid (Pkt. 10c) (Oz. 35c) (¼ lb. \$1.25) (lb. \$4.00).

EARLY FLAT DUTCH—80 days. Second early variety with large flat heads.

Postpaid (Pkt. 10c) (Oz. 30c) (¼ lb. \$1.00) (lb. \$3.50).

ALL HEAD EARLY—80 days. A large flat but deep short stemmed, solid headed variety. Few outside leaves and plants may be set closer than with other large cabbages. Heads weigh 6 to 7 lbs.

Postpaid (Pkt. 10c) (Oz. 30c) (¼ lb. \$1.00) (lb. \$3.50).

MIDSEASON AND LATE VARIETIES

PREMIUM LATE FLAT DUTCH—95 days. A justly popular and esteemed variety extensively cultivated for market and family use. Heads large, round, flattened and very firm; has a medium stem and is very hardy, fine for kraut purposes.

Postpaid (Pkt. 10c) (Oz. 30c) (¼ lb. \$1.00) (lb. \$3.50).

VALLEY BALLHEAD—100 days. A large sized, short stemmed, round head, firm and solid; heads weigh 7 to 8 pounds. Color gray-green, with creamy white center, of crisp texture and good quality. Desirable for winter storage and for kraut.

Postpaid (Pkt. 10c) (Oz. 50c) (¼ lb. \$1.50) (lb. \$5.50).

DANISH BALLHEAD SHORT-STEM—105 days. One of the best winter sorts and one of the most hardy; heads round, deep or balloon shaped and very solid. Good for storage and shipping.

Postpaid (Pkt. 10c) (Oz. 35c) (¼ lb. \$1.25) (lb. \$4.00).

EVERGREEN HOLLANDER—110 days. A selection from Short Stem Hollander. Heads are large round, weight 5 to 6 lbs., solid and retains its dark green color late in the season. Good winter keeper.

Postpaid (Pkt. 10c) (Oz. 50c) (¼ lb. \$1.50) (lb. \$5.50).

DANISH ROUND HEAD OR SHORT STEM HOLLANDER—105 days. The most popular variety for fall and winter use. Desirable for shipping, storage and kraut. Plants medium with short stem. Heads solid, deep round and attractive.

Postpaid (Pkt. 10c) (Oz. 35c) (¼ lb. \$1.25) (lb. \$4.00).

PENN STATE BALLHEAD (Originator's Strain)—105 days. Developed by the Penn Agricultural College. An extra heavy-yielding strain of Ballhead, with slightly flattened heads, and resistant to insect attacks.

Postpaid (Pkt. 10c) (Oz. 50c) (¼ lb. \$1.50) (lb. \$5.50).

SHORT STEM HOLLANDER (Special)—120 days. The best late variety. Heads become firm while still rather small, reach good marketable size in 90 to 100 days. Plants medium small, allowing closer planting. Heads remarkably firm and solid and of splendid keeping quality.

Postpaid (Pkt. 10c) (Oz. 50c) (¼ lb. \$1.50) (lb. \$5.50).

YELLOW RESISTANT VARIETIES

GOLDEN ACRE (Yellows Resistant)—60 days. Valuable new addition to the list of early round head varieties. Produces heads ready for market ten days earlier than Marion Market. Postpaid (Pkt. 10c) (Oz. 50c) (¼ lb. \$1.50) (lb. \$5.50).

RACINE MARKET (Yellows Resistant)—60 days. Selected from Copenhagen Market; same head type except that leaf is gray-green. Heads round, solid, of superior quality and 98 to 100 per cent resistant. Postpaid (Pkt. 10c) (Oz. 50c) (¼ lb. \$1.50) (lb. \$5.50).

MARION MARKET (Yellows Resistant)—70 days. Selected from Copenhagen Market, but is later and has more blue-green foliage; heads larger, round and very compact; 95 to 100 per cent resistant. Postpaid (Pkt. 10c) (Oz. 40c) (¼ lb. \$1.25) (lb. \$4.50).

IMPROVED GLOBE (Yellows Resistant)—75 days. Selected from Glory of Enkhuizen. A fine mid-season, round-head type, a few days later than Marion Market. Heads globe shaped, very compact, with small core. Heavy yielder, 95 to 100 per cent resistant. Postpaid (Pkt. 10c) (Oz. 50c) (¼ lb. \$1.50) (lb. \$5.50).

WISCONSIN BALLHEAD (Yellows Resistant)—85 days. Selected from Danish Ballhead, identical in type and season. Round, solid, compact heads; short stem; blue foliage. Suitable for early fall shipping and when planted to mature late, suitable for storage. Heads smaller and more uniform than Wisconsin Hollander; will produce equal tonnage if planted closer. Very uniform in type and maturity, 97 to 100 per cent resistant. Postpaid (Pkt. 10c) (Oz. 50c) (¼ lb. \$1.50) (lb. \$5.50).

WISCONSIN HOLLANDER No. 8 (Yellows Resistant)—90 to 100 days. Selected from Danish Ballhead. Not as uniform as the Wisconsin Ballhead. Heads round, becoming slightly flattened across the top; color blue-green. A heavy yielder and ideal for storage and shipping. Highly resistant to the yellows. Postpaid (Pkt. 10c) (Oz. 50c) (¼ lb. \$1.50) (lb. \$5.50).

RED HOLLANDER (Yellows Resistant)—100 days. A round-head, late red cabbage; very uniform; foliage purple-red, with heads becoming a deeper color with maturity. Heads solid and compact. Ideal late fall shipper and good for storage. Highly resistant to the yellows. Postpaid (Pkt. 10c) (Oz. 50c) (¼ lb. \$1.75) (lb. \$6.50).



WISCONSIN HOLLANDER NO. 8

MISCELLANEOUS VARIETIES

PERFECTION DRUMHEAD SAVOY—90 days. The best of the Savoy type for general use; an excellent keeper. Heads nearly round, full and hard; leaves large, coarsely crimped, dark bluish green, of good quality. Postpaid (Pkt. 10c) (Oz. 40c) (¼ lb. \$1.25) (lb. \$4.50).

CHIEFTAIN SAVOY—88 days. Plants 12 to 15 inches tall, dark olive green and savoy leaved with a short stem. Head 8 inches broad by 6½ inches deep, weight 6 to 7 pounds, drumhead type, very solid, somewhat rounded at top and flat at base. Stands a long time without bursting. Very uniform and recommended for market gardeners. Postpaid (Pkt. 10c) (Oz. 40c) (¼ lb. \$1.25) (lb. \$4.50).

RED ACRE—90 days. Heads round and compact, color deep purplish red. Good for storage; earlier than Red Rock. Postpaid (Pkt. 10c) (Oz. 50c) (¼ lb. \$1.75) (lb. \$6.00).

EARLY RED SUMMER—88 days. A superior strain of Red Rock developed by careful selection for uniformity and quality. Heads round, hard and heavy, deep colored throughout. A good shipper.

Postpaid (Pkt. 10c) (Oz. 50c) (¼ lb. \$1.75) (lb. \$6.00).

MAMMOTH RED ROCK—110 days. The largest and best red cabbage. Heads round, extremely hard; color purplish red; excellent keeper.

Postpaid (Pkt. 10c) (Oz. 50c) (¼ lb. \$1.50) (lb. \$5.50).

CHINESE OR CELERY CABBAGE

CULTURE—Seeds sown out of doors late in July produce firm heads in October. The heads keep well in storage for at least two months.

CHIHILI—Early and sure heading. Heads become 18 to 20 inches tall, 3½ to 4 inches thick, tapering near tip, very firm, well blanched, crisp, tender and very sweet.

Postpaid (Pkt. 10c) (Oz. 30c) (¼ lb. \$1.00) (lb. \$3.00).

IMPORTED CHIHILI—70 days. The imported Chihili is more vigorous, the leaves are dark green without the yellowish cast. The leaf margins are wavy and the individual plants are very uniform, very sure heading and firm.

Postpaid (Pkt. 10c) (Oz. 40c) (¼ lb. \$1.25) (lb. \$4.50).

WONG BOK—Heads 8 to 10 inches tall, broad, firm. Well blanched, tender and excellent quality.

Postpaid (Pkt. 10c) (Oz. 30c) (¼ lb. \$1.00) (lb. \$3.00).

CARROTS

CULTURE—One ounce for 100 feet of drill, 4 pounds for an acre. The carrot, like other root crops, delights in a rich, sandy loam, well tilled. For early crops, sow in spring, as soon as the ground is in good working order, say April or May; for late crops they may be sown at any time from the middle of June to July. Sow ½-in. deep in rows 12 in. apart, thinning out to 3 in. between the plants. As carrot seed is slow to germinate, extra precautions must be taken to firm the seed in the soil.



CARROTS, RED CORED CHANTENAY

CHANTENAY—LONG TYPE—72 days. An excellent all purpose, medium early variety; desirable for home and market garden and for canning. A good cropper. Roots 5 to 6 inches long, deep orange, smooth, tapered, stump-rooted; flesh deep orange. Fine for bunching.

Postpaid (Pkt. 10c) (Oz. 25c) (¼ lb. 60c) (lb. \$2.00).

CHANTENAY RED CORED—72 days. An improved Chantenay with good interior color, valuable for market gardeners and shippers. Roots of same size and shape as standard Chantenay; flesh reddish orange with indistinct core; tender and sweet.

Postpaid (Pkt. 10c) (Oz. 25c) (¼ lb. 60c) (lb. \$2.00).

COLORADO SHIPPER—72 days. A new strain bred particularly for the shipping trade. Top short, dark green, strong enough for good bunching; roots long, deep orange largely blunt ended; flesh bright orange, tender and of good quality. Postpaid (Pkt. 10c) (Oz. 25c) (¼ lb. 75c) (lb. \$2.50).

SUPERB HALF LONG—75 days. A new home and market garden variety. Resembles a small refined Danvers with short tops. Roots 6 to 7 inches long, about 2 inches in diameter at shoulder, tapering to a half stump. Exterior smooth and of excellent color. Core small and the same dark orange as the rest of the flesh.

Postpaid (Pkt. 10c) (Oz. 25c) (¼ lb. 75c) (lb. \$2.50).

STREAMLINER—An ideal new bunching carrot for shippers and market gardeners. Tops short, rather sparse, dark green, and strong. Roots long, slender, nearly cylindrical; at maturity 8 to 10 inches long by 1¼ to 1½ inches at shoulder; grow completely underground. Color very deep orange, cores small and uniformly red.

Postpaid (Pkt. 10c) (Oz. 25c) (¼ lb. 75c) (lb. \$2.50).

CARROTS—Continued



CARROTS. IMPERATOR

IMPERATOR LONG TYPE or CALIFORNIA SHIPPER—77 days. A long carrot with rounded shoulders, tapered to semi-stump end. Roots 7 to 8½ inches long. Top strong enough for bunching, flesh deep orange with indistinct core. Postpaid (Pkt. 10c) (Oz. 25c) (¼ lb. 75c) (lb. \$2.50).

DANVERS HALF LONG—75 days. Very productive and popular for home and market garden; much used for shipping. Roots bright deep orange, 6 to 7 inches long, tapered to a blunt end. Flesh bright orange, crisp and tender. Postpaid (Pkt. 10c) (Oz. 25c) (¼ lb. 60c) (lb. \$2.00).

DANVER'S HALF LONG (Special)—75 days. An improvement on the standard strain with roots 6 to 8 inches long. Roots tapered to a blunt end. Flesh bright orange, tender, and of good quality. Best variety for shipping. Postpaid (Pkt. 10c) (Oz. 25c) (¼ lb. 75c) (lb. \$2.50).

NANTES HALF LONG—70 days. Popular coreless carrot, very stump-rooted and with fine dark orange color throughout. Small top. Postpaid (Pkt. 10c) (Oz. 25c) (¼ lb. 75c) (lb. \$2.50).

NANTES STRONG TOP STRAIN—70 days. This new coreless strain of Nantes has been especially bred for stronger tops so that they do not break off as easily when pulled for bunching. The tops are no larger but they are heavier at the crown, a distinct advantage for both market and home gardens. The roots are of the same fine texture as regular strain of Nantes. Postpaid (Pkt. 10c) (Oz. 25c) (¼ lbs. 75c) (lb. \$2.50).

TOUCHON—70 days. A fine "coreless" carrot desirable for home and market. Roots 6 to 7 inches long, deep orange, cylindrical, stump rooted, fine flavor. Tops small. Postpaid (Pkt. 10c) (Oz. 25c) (¼ lb. 75c) (lb. \$2.50).

OXHEART OR GUERANDE—72 days. Desirable for home use; prolific and a good keeper. Roots bright orange, thick, blunt ended, of heart shape. Flesh deep orange; small tops; easily harvested. Postpaid (Pkt. 10c) (Oz. 25c) (¼ lb. 60c) (lb. \$1.75).

CAULIFLOWER

CULTURE—On ounce will produce 2,000 plants. Four to 6 ounces of seed are required to produce enough plants to set an acre. Cauliflower delights in a rich, moist soil and in dry seasons should be abundantly watered, especially when heading. Early cauliflower is difficult to grow and is not of the best quality as the plants mature when the weather is hot. When the plants are set out about the first of July there should be no difficulty in getting fine large heads of first class quality, as these plants will mature when the weather is cool. For early crops sow the seed in the hot beds in January or February and transplant when weather permits. For late crop sow the seed in cold frames or in the open ground in April or May. Set only young, stocky plants that have not been stunted; 10,000 plants will plant an acre. Cauliflower is a rank grower and requires more room than cabbage. Care must be taken that the plants do not become checked in growth as that will cause them to head prematurely. Cultivation for cauliflower is the same as for cabbage. When heading tie the outside leaves loosely over the head to protect it from the sun.

SUPER-SNOWBALL—A very excellent variety, bred for early headings and uniformity. Heads are compact, medium large, pure white in color. Plants are sturdy. Leaf growth sufficient to make tying easy. A popular variety among market gardeners and shippers. Postpaid (Pkt. 25c) (¼ Oz. 60c) (Oz. \$2.00) (¼ lb. \$7.50) (lb. \$25.00).

EARLY AMERICAN BEAUTY SNOWBALL—This new variety is outstanding for earliness and ability to produce uniform fine large heads. It is the earliest cauliflower we have seen, producing a great proportion of the heads in one cutting. The heads are of the Snowball type, uniformly large and deep, with a beautiful white and tight curd. The plant is rugged with an abundance of long, broad leaves which protect the head until it is quite large. Postpaid (Pkt. 25c) (¼ Oz. 60c) (Oz. \$2.00) (¼ lb. \$7.50) (lb. \$25.00).

EARLY SNOWBALL "A"—Super Snowball type. A most satisfactory early strain of Snowball. Plants of medium height with rather waved and crumpled leaves which bend outward at the tips. Inner leaves cover the head well. Foliage is medium green. Heads of good depth, solid, ivory white, and of fine quality. Early and very even in time of maturity; adapted for summer and early fall harvest. Postpaid (Pkt. 25c) (¼ Oz. 60c) (Oz. \$2.00) (¼ lb. \$7.50) (lb. \$25.00).

SNOWBALL "X"—Snowdrift type. Well adapted for use under a wide range of conditions and generally considered the most satisfactory strain for main crop for fall harvest. Plants are large and erect with ample foliage for head coverage. The heads are large, smooth, very deep, very solid and pure white. Postpaid (Pkt. 25c) (¼ Oz. 60c) (Oz. \$2.00) (¼ lb. \$7.50) (lb. \$25.00).

WHITE MOUNTAIN OR SNOWDRIFT—A vigorous type of the Snowball class and selected to produce a larger head than Snowball without losing its earliness. Matures with great evenness, the pure white heads are remarkable for their

great depth, weight and unexcelled white color. The curd is of fine texture and resistant in a high measure to "richness" and "fuzziness." Adapted for summer and early fall harvest and used in districts having a short growing season. Postpaid (Pkt. 25c) (¼ Oz. 60c) (Oz. \$2.00) (¼ lb. \$7.50) (lb. \$25.00).

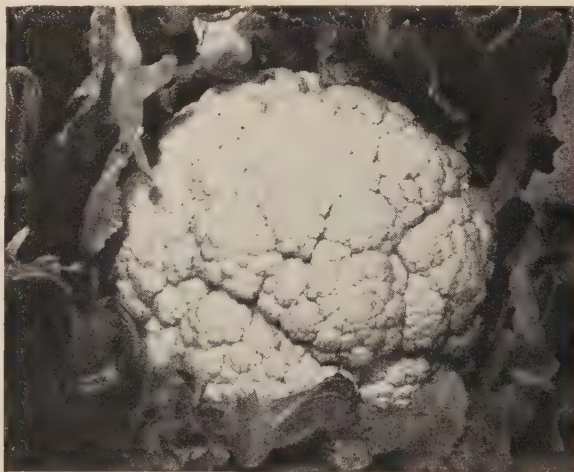

CAULIFLOWER, EARLY SNOWBALL

DANAMERICA SUPER SNOWBALL—A second early variety, it forms a head that is unusually solid, heavy and snow white, it heads uniformly throughout the field and the whole crop is ready to cut inside of two weeks. The stalk of Danamerica is shorter than in any other variety, the leaves are not spaced but grow as closely together as cabbage, forcing the inner leaves to curl over the head providing perfect protection from unfavorable weather. Postpaid (Pkt. 25c) (¼ Oz. 60c) (Oz. \$2.00) (¼ lb. \$7.50) (lb. \$25.00).

SNOWBALL NO. 34—A selection in the super-snowball. Mid-season. Has small frame, foliage deep green twisted and folded and self-protecting. Heads of medium size, very solid and of a perfect texture, ivory-white, long-standing and fairly heat resisting. Postpaid (Pkt. 25c) (¼ Oz. 60c) (Oz. \$2.00) (¼ lb. \$7.50) (lb. \$25.00).

SNOWBALL NO. 116—The best all-around midseason cauliflower. Stands up well under adverse conditions, and is an ideal market grower's variety. Plant of medium height, with upstanding medium green outer leaves. Heads firm, solid and very white. Well protected by inner folding leaves; curd has fine texture and is free from small protruding leaves. Postpaid (Pkt. 25c) (¼ Oz. 60c) (Oz. \$2.00) (¼ lb. \$7.50) (lb. \$25.00).

CELERY

CULTURE—One ounce of seed will produce 15,000 plants. Golden Self-Blanching Seed should be sown in hot-beds about March 1st, covering the seed very lightly. Keep the seed-bed moist, giving it plenty of air. Keep the tops of the plants sheared off, which will cause them to grow stockier with better roots. Keep the soil well stirred between the rows and around the plants. A good rule is to plow or work the ground every time it is watered. Great care should be used in watering, or the ground will sour and cause the celery to blight or rust. Celery requires water often, but not a great deal at a time.



CELERY, UTAH

GIANT PASCAL (Special Dwarf Strain)—Pascal celery is a very important crop with local celery growers and we have developed an excellent strain of this delicious vegetable. The plants are of dwarf stocky growth and do not develop soft stalks, nor seeders, and blanches easily to a rich creamy white. May be used as wrapped celery for early fall use or for trenching for winter use, a dozen stalks trimmed ready for market often weighing 10 to 15 pounds.

Postpaid (Pkt. 25c) (Oz. \$3.00) (¼ lb. \$9.00) (lb. \$30.00).

GIANT PASCAL—135 days. The old standard green variety; tall, large dark green foliage, large full heart which bleaches to creamy white, has rich nutty flavor. A fine keeper for mid-winter use.

Postpaid (Pkt. 10c) (Oz. 75c) (¼ lb. \$2.50) (1 lb. \$8.00).

SUMMER QUEEN—120 days. One of the most popular green varieties. Recommended for home and shipping. Plants of medium height, but with good length to the first joint. Blanches more readily than some of the other varieties of green celery. Stalks nearly round, smooth, brittle and of outstanding quality.

Postpaid (Pkt. 25c) (Oz. \$2.00) (¼ lb. \$7.00) (lb. \$25.00).

CRYSTAL WHITE JUMBO (Utah Strain)—125 days. A very popular celery today and justly so for its superb flavor and quality. The plant is medium large, with exceptionally full heart, that blanches very nicely into a valuable sort for the market.

Postpaid (Pkt. 15c) (Oz. \$1.25) (¼ lb. \$4.25) (lb. \$14.00).

EPICURE—115 days. An early green celery. Height 22 to 28 inches, tops medium light, bright green. Plants medium size, cylindrical. Edible stems 8 to 10 inches to first joint, broad, thick, smoothly rounded, creamy white when blanched. Shows resistance to fusarium yellows.

Postpaid (Pkt. 15c) (Oz. \$1.25) (¼ lb. \$4.25) (lb. \$14.00).

UTAH NO. 15—A strain of Utah of mid-season maturity. Plants are large—height 26 to 28 inches. Leaves are dark green deeply cut, moderately broad. Plants are erect, compact, full hearted. Edible stems usually 8 to 10 inches long,

When about ready to harvest, it may be blanched with either boards or dirt, boards being preferable in warm weather, and dirt in cool weather.

Giant Pascal seed should be sown from the 1st to the 15th of April in the hot-beds, same as the Golden Self-Blanching. Plants should be set in the field from June 10th to July 1st, in single rows, about 8 inches apart in the row, cultivating same as the Golden Self-Blanching. About October 10th or before freezing, it should be trenched and protected from freezing, when it will bleach and be ready for winter use.

are numerous, of medium width, thick rounded and quite smooth, are crisp and of fine quality.

Postpaid (Pkt. 25c) (Oz. \$1.75) (¼ lb. \$6.00) (lb. \$20.00).

CORNELL NO. 19—100 days. An early, easy blanching strain of outstanding quality, described as a cross between the Self-Blanching and the Utah, 10½-11 inches to joint with an overall length of 24 inches. Hearts long and comparatively full. Stems thick, rounded and of smooth texture. Combines the good qualities of the pascal type and is highly resistant to fusarium yellows.

Postpaid (Pkt. 25c) (Oz. \$2.00) (¼ lb. \$7.00) (lb. \$25.00).

MASTERPIECE—90 days. An early self-blanching strain, grows to a height of 24 to 26 inches, stems 8 to 9 inches to first joint, are very thick, comparatively broad, and almost free from strings. Very crisp and fleshy and has that rich, nutty flavor so highly prized.

Postpaid (Pkt. 15c) (Oz. \$1.25) (¼ lb. \$4.25) (lb. \$14.00).

GOLDEN SELF BLANCHING (Tall Type)—110 days. An early and particularly valuable type for home and market garden. Plants are 26 to 28 inches tall, compact with firm thick stalks which blanch readily and are of splendid quality, edible stalks 8 to 8½ inches to first joint.

AMERICAN GROWN SEED—Postpaid (Pkt. 10c) (Oz. \$1.00) (¼ lb. \$3.50) (1 lb. \$12.00).

FRENCH GROWN SEED—Postpaid (Pkt. 10c) (Oz. \$1.00) (¼ lb. \$3.50) (lb. \$12.00).

GOLDEN PLUME NON-BOLTING—A dwarf, compact golden strain. Tops are distinct dark green. Overall height 20 to 24 inches. Length of edible stem 6 to 8 inches. Plants are compact, upright in habit, hearts full, stems are broad and thick. Quality is good and blanches easily to a clear creamy white.

Postpaid (Pkt. 25c) (Oz. \$2.00) (¼ lb. \$7.00) (lb. \$25.00).

UTAH OR GOLDEN CRISP—An excellent variety for fall use, maturing about a week or ten days earlier than Giant Pascal. Plants sturdy, compact and exceptionally solid. Stems are broad, but thick and well rounded, of fine quality and rich, nutty flavor.

Postpaid (Pkt. 10c) (Oz. 75c) (¼ lb. \$2.50) (lb. \$9.00).

SUPREME GOLDEN—90 days. Uniform strong growing early strain. Height overall varies from 22 to 27 inches, the edible stem is long, from 7 to 10 inches to the first point, broad, fairly thick and carries the width well up to the joint. Tops dark green and very erect. Blanches readily to an attractive clear creamy white at maturity.

Postpaid (Pkt. 25c) (Oz. \$2.00) (¼ lb. \$7.00) (lb. \$25.00).

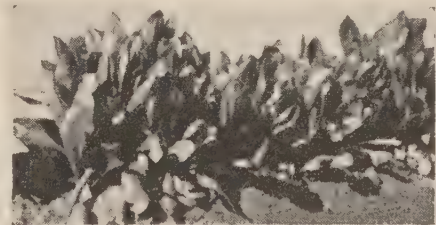

CHICORY

CHICORY

One ounce of seed to 200 foot row.

LARGE ROOTED OR COFFEE—The largest rooted variety. Postpaid (Pkt. 10c) (Oz. 50c).

WITLOFF OR FRENCH ENDIVE—A superior strain with wider leaves, larger tips and stalks, roots thicker at the shoulder, shorter and smoother.

Postpaid (Pkt. 10c) (Oz. 50c).

SWEET CORN

CULTURE—Days indicated means average time required to produce roasting ears. One pound will plant 100 hills; 10 pounds an acre. Sweet corn should not be planted until the ground is warm and danger from frost is past. Corn thrives

best in warm, rich soil, and succeeds only when given frequent but shallow cultivation. For a continuous supply, begin planting as early as the season will permit, and plant every ten days or two weeks until July.

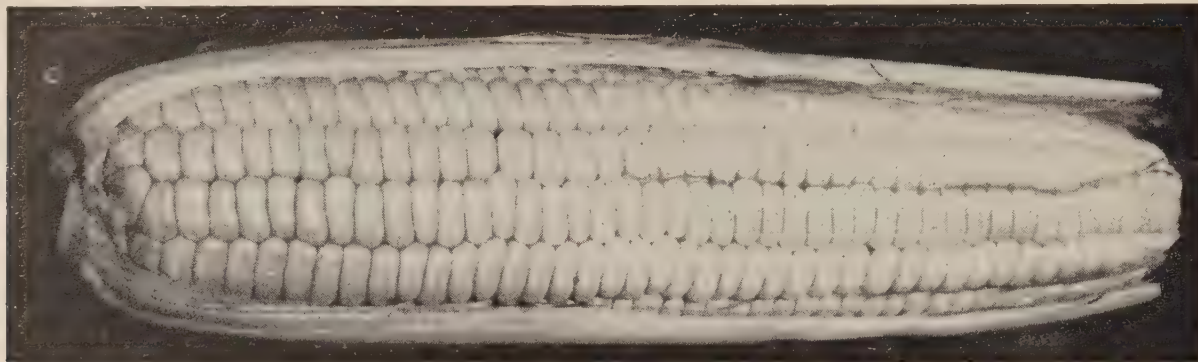

HYBRID SWEET CORN

SENECA "60"—60 days. The earliest of all hybrids. Is outstanding in quality for such an early corn. The stalk is 4 to 4½ feet tall, ears 6 inches long, 8 to 10 rowed, kernels yellow, produces 2 to 3 ears per stalk.

Postpaid (Pkt. 10c) (¼ lb. 25c) (lb. 75c).

SENECA GOLDEN HYBRID—75 days. A new hybrid that might be described as an early Golden Cross Bantam. Stalks 5½ feet tall, bearing two marketable ears on practically every stalk. A very good hybrid for high altitude and extra early growing. Kernels large, golden yellow and of best quality. Seed small; 6 to 8 lbs. will plant an acre.

Postpaid (Pkt. 10c) (¼ lb. 20c) (lb. 70c) (5 lbs. \$3.25) (10 lbs. \$6.00).

EARLY GOLDEN HYBRID 1.13—67 to 72 days. One of the better early hybrids developed from Maine and Connecticut inbreds. Ears 7 inch, deep yellow kernels, sweet and tender. Stalks 5½ to 6 ft. A popular large early sort for market gardeners and commercial growers.

Postpaid (Pkt. 10c) (¼ lb. 20c) (lb. 70c) (5 lbs. \$3.25) (10 lbs. \$6.00).

Not Postpaid (10 lbs. \$5.50) (25 lbs. \$12.50) (100 lbs. \$45.00).

GOLD RUSH—69 days. A first early yellow hybrid for early market with the strong hybrid vigor and productiveness to replace the open pollinated first early yellow sorts. Ears 8½ inches long, 12 to 14 rowed, slightly tapered, well filled to tip, most attractive yellow, tight husk. Tender, sweet, of fine quality and flavor.

Postpaid (Pkt. 10c) (¼ lb. 20c) (lb. 70c) (5 lbs. \$3.25) (10 lbs. \$6.00).

Not Postpaid (10 lbs. \$5.50) (25 lbs. \$12.50) (100 lbs. \$45.00).

GOLDEN ROCKET—70 days. An early Market Garden Sweet Corn producing ears of excellent flavor and quality, ears 7 inches long, 10 to 12 rowed with golden yellow kernels. It is a good clean plant virtually suckerless with stalks 5½ feet tall.

Postpaid (Pkt. 10c) (¼ lb. 20c) (lb. 70c) (5 lbs. \$3.25) (10 lbs. \$6.00).

Not Postpaid (10 lbs. \$5.50) (25 lbs. \$12.50).

MARCROSS NORTHERN—70 days. A popular large eared early sort for market gardeners. Ears 6½ to 7 inches long, 14-16 rows of medium width, yellow deep kernels. Sweet and tender. Stalk, 5½ feet.

Postpaid (Pkt. 10c) (¼ lb. 20c) (lb. 70c) (5 lbs. \$3.25) (10 lbs. \$6.00).

Not Postpaid (10 lbs. \$5.50) (25 lbs. \$12.50) (100 lbs. \$45.00).

MARCROSS C6.13—72 days. An early market and home garden variety. Stalks short but sturdy, highly resistant to bacterial wilt. Ears long, plump, abruptly tapered at tips; 10-14 rowed ears 7 inches long, with light cream-yellow, medium broad kernels of good quality.

Postpaid (Pkt. 10c) (¼ lb. 20c) (lb. 70c) (5 lbs. \$3.25) (10 lbs. \$6.00).

Not Postpaid (10 lbs. \$5.50) (25 lbs. \$12.50) (100 lbs. \$45.00)

CARMELCROSS—79 days. A second early variety for market, canning or home garden use. Vigorous and heavy yielding in comparison to its earliness. Medium sized, gently tapering ears 7 inches long, with 12-14 rows of yellow kernels.

Postpaid (Pkt. 10c) (¼ lb. 20c) (lb. 70c) (5 lbs. \$3.25) (10 lbs. \$6.00).

Not Postpaid (10 lbs. \$5.50) (25 lbs. \$12.50) (100 lbs. \$45.00)

MARCROSS P-39—75 days. A second early market hybrid that fits in well between Gold Rush and Golden Cross Hybrids to give a continuous supply of roasting ears. Stalks 6 feet tall, ears 7 to 7½ inches long, 12 to 14 rows, medium yellow and slightly tapered at tips, fills well.

Postpaid (Pkt. 10c) (¼ lb. 20c) (lb. 70c) (5 lbs. \$3.25) (10 lbs. \$6.00).

Not Postpaid (10 lbs. \$5.50) (100 lbs. \$45.00).

TOP CROSS MAINE BANTAM—81 days. Stalk sturdy with deep green foliage; ear 6 inches, 12-16 rowed, kernels medium-narrow and golden yellow. Tender and of excellent flavor. Highly resistant to Stewart's disease.

Postpaid (Pkt. 10c) (¼ lb. 20c) (lb. 60c) (5 lbs. \$2.75) (10 lbs. \$5.00).

Not Postpaid (10 lbs. \$4.50) (25 lbs. \$10.00) (100 lbs. \$38.00).

FLAGSHIP—85 days. A golden yellow hybrid combining great vigor and high quality. The tender kernels and delicious flavor assure pleasing quality. Ears 8½ inches long, 12 to 16 rows, cylindrical, well filled with heavy husks, ears are carried high on stalk for ease in harvesting. The great vigor enables it to overcome unfavorable growing conditions and adapts it to production under varying climates.

Postpaid (Pkt. 10c) (¼ lb. 20c) (lb. 70c) (5 lbs. \$3.25) (10 lbs. \$6.00).

EVERGREEN HYBRID No. 14-13—86 days. This is a hybrid to take the place of regular Stowell's Evergreen. It is outstanding for its productiveness, drought resistance and uniform strong vigorous growth. Excellent for market, canning home garden and quick freeze pack. Ears 8½ inches long, 14 to 18 rowed, large white kernel of good depth and fine quality, well filled to the tip, stalk 8 feet.

Postpaid (Pkt. 10c) (¼ lb. 20c) (lb. 70c) (5 lbs. \$3.25) (10 lbs. \$6.00).

Not Postpaid (10 lbs. \$5.50) (25 lbs. \$12.50) (100 lbs. \$45.00).



CORN, MARCROSS

HYBRID SWEET CORN

IOANA—87 days. Ears average 8 to 9 inches in length with 12 to 14 rows of medium width, deep yellow kernels of excellent quality and flavor. Height of stalk 6 to 6½ feet. A new high yielding hybrid destined to be popular.

Postpaid (Pkt. 10c) (¼ lb. 20c) (lb. 60c) (5 lbs. \$2.75) (10 lbs. \$5.00).

Not Postpaid (10 lbs. \$4.50) (25 lbs. \$10.00) (100 lbs. \$38.00).

IOCHIEF—88 days. A new hybrid with exceptionally deep yellow kernels, excellent flavor and tender ears 9 to 10 inches long 16-18 rowed, stalk 6½ ft., tall, heavy, wind resistant and very few suckers. Highly desirable for home, market gardener or canner.

Postpaid (Pkt. 10c) (¼ lb. 20c) (lb. 70c) (5 lbs. \$3.25) (10 lbs. \$6.00).

ILLINOIS GOLDEN No. 10—89 days. This hybrid is in season with Golden Cross Bantam and should not be overlooked as a main cropper. It is outstanding for canning, has excellent possibilities in market gardens. Attractive golden color, tender and sweet. Ears 8 inches long, tight shuck, 12 to 16 rowed, very uniform, rows straight, slightly tapered at tip.

Postpaid (Pkt. 10c) (¼ lb. 20c) (lb. 60c) (5 lbs. \$2.75) (10 lbs. \$5.00).

Not Postpaid (10 lbs. \$4.50) (25 lbs. \$10.00) (100 lbs. \$38.00).

GOLDEN CROSS BANTAM—88 days. The most widely adapted hybrid. Noted for great uniformity, heavy yield, resistance to bacterial wilt and for its flavor and quality.

Postpaid (Pkt. 10c) (¼ lb. 20c) (lb. 60c) (5 lbs. \$2.75) (10 lbs. \$5.00).

Not Postpaid (10 lbs. \$4.50) (25 lbs. \$10.00) (100 lbs. \$38.00).



CORN, GOLDEN CROSS BANTAM

OPEN POLINATED VARIETIES

SIXTY DAY GOLDEN—60 days. Earliest of the golden varieties with medium large ears with twelve rows of rather wide yellow kernels of very good quality. A good early market or garden corn. Height of stalks 5 feet.

Postpaid (Pkt. 10c) (¼ lb. 20c) (lb. 45c) (5 lbs. \$1.75) (10 lbs. \$3.00).

Not Postpaid (10 lbs. \$2.75) (25 lbs. \$6.50) (100 lbs. \$24.00).

GOLDEN SUNSHINE—76 days. An early variety with good sized ear, particularly desirable for market garden use. Ears 10 to 12 rowed. Kernels medium broad golden yellow, sweet, tender and of good flavor.

Postpaid (Pkt. 10c) (¼ lb. 20c) (lb. 45c) (5 lbs. \$1.75) (10 lbs. \$3.00).

Not Postpaid (10 lbs. \$2.50) (25 lbs. \$5.50) (100 lbs. \$20.00).

COUNTRY GENTLEMAN—93 days. A late prolific variety of excellent quality, used widely by canners; also desirable for home and market gardens. Stalks often with two ears. Kernels very deep, slender, sweet, with tender hull and set irregularly without row formation.

Postpaid (Pkt. 10c) (¼ lb. 20c) (lb. 45c) (5 lbs. \$1.75) (10 lbs. \$3.00).

Not Postpaid (10 lbs. \$2.50) (25 lbs. \$5.50) (100 lbs. \$20.00).

STOWELL'S EVERGREEN—95 days. The best known late variety. Highly desirable for home and market garden. Stalks sturdy and erect; ears 2½ inches thick, uniform, tender. Holds well in prime condition at eating stage.

Postpaid (Pkt. 10c) (¼ lb. 20c) (lb. 45c) (5 lbs. \$1.75) (10 lbs. \$3.00).

Not Postpaid (10 lbs. \$2.50) (25 lbs. \$5.50) (100 lbs. \$20.00).

EARLY EVERGREEN—90 days. One of the best known and widely used canning varieties, also desirable for market gardeners.

Postpaid (Pkt. 10c) (¼ lb. 20c) (lb. 45c) (5 lbs. \$1.75) (10 lbs. \$3.00).

Not Postpaid (10 lbs. \$2.50) (25 lbs. \$5.50) (100 lbs. \$20.00).

GOLDEN BANTAM—83 days. Early variety of excellent quality for both market and home use. Stalks 4½ to 5 feet tall, very productive, commonly bearing two ears. Ears 6 to 7 inches long, 8 rowed, kernels rich golden yellow, very tender, sweet and of splendid flavor.

Postpaid (Pkt. 10c) (¼ lb. 20c) (lb. 45c) (5 lbs. \$1.75) (10 lbs. \$3.00).

Not Postpaid (10 lbs. \$2.50) (25 lbs. \$5.50) (100 lbs. \$20.00).

IMPROVED GOLDEN BANTAM—84 days. A selection from the original strain of Golden Bantam resulting in a larger ear with more rows and greater productivity. Ears 10 to 14 rowed, uniform and attractive. Kernels golden yellow, medium wide, deep sweet and of fine flavor.

Postpaid (Pkt. 10c) (¼ lb. 20c) (lb. 45c) (5 lbs. \$1.75) (10 lbs. \$3.00).

Not Postpaid (10 lbs. \$2.50) (25 lbs. \$5.50) (100 lbs. \$20.00).

BANTAM OR GOLDEN EVERGREEN—89 days. Developed through crossing Golden Bantam and Stowell's Evergreen. Ears 14 to 18 rowed. Kernels rich golden yellow, deep with tender hull, sweet, and of fine quality. An outstanding medium late variety.

Postpaid (Pkt. 10c) (¼ lb. 20c) (lb. 45c) (5 lbs. \$1.75) (10 lbs. \$3.00).

Not Postpaid (10 lbs. \$2.50) (25 lbs. \$5.50) (100 lbs. \$20.00).

POP CORN

CULTURE—Pop corn is raised the same as field corn. It should be allowed to get thoroughly ripe before cutting. Very easily raised and often proves a profitable crop. 5 to 6 pounds will plant an acre.

OPEN POLINATED VARIETIES

HULLESS OR TOM THUMB—105 days. A heavy yielder, ears closely set with pure white, rice like kernels. Kernels are free from hulls or shells and pop readily. The popped kernels are snow white and so tender they melt in your mouth.

Postpaid (Pkt. 5c) (¼ lb. 15c) (lb. 40c) (5 lbs. \$1.75) (10 lbs. \$3.00).

Not Postpaid (10 lbs. \$2.50) (25 lbs. \$5.50) (100 lbs. \$20.00).

GOLDEN GIANT—Pops the largest kernels of any variety, crisp and tender, fine flavored, of a rich golden butter color.

Postpaid (Pkt. 5c) (¼ lb. 15c) (lb. 40c) (5 lbs. \$1.75) (10 lbs. \$3.00).

Not Postpaid (10 lbs. \$2.50) (25 lbs. \$5.50) (100 lbs. \$20.00).

HYBRID POP CORN

MINHYBRID 250 WHITE HULLESS—It far surpasses the old Jap Hulless—records show a 16 per cent greater yield and a 29 per cent greater popping expansion. Minhybrid is the finest Pop Corn obtainable from the standpoint of quality, flavor and tenderness.

Postpaid (¼ lb. 30c) (lb. 85c) (5 lbs. \$4.00) (10 lbs. \$7.50).

Not Postpaid (10 lbs. \$7.00) (25 lbs. \$16.25).

NEW HI-POP YELLOW HYBRID POP CORN (South American Type)—110 to 120 days. Pops to large flaky, tender kernels of a rich butter color and is unusually high in popping volume. HI-POP is a profitable variety to grow for the market as it produces greater yields than open pollinated corn.

Postpaid (¼ lb. 30c) (lb. 85c) (5 lbs. \$4.00) (10 lbs. \$7.50).

Not Postpaid (10 lbs. \$7.00) (25 lbs. \$16.25).

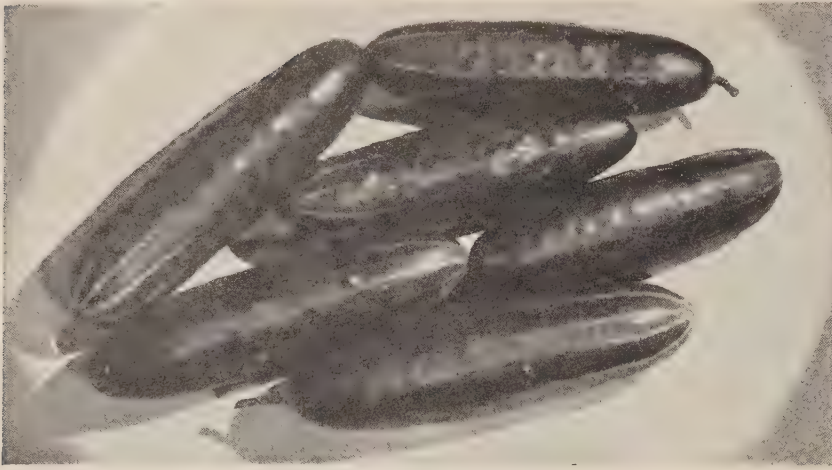

CUCUMBER, MARKETTER

CUCUMBERS

CULTURE—One ounce of seed will plant 50 hills, 2 pounds an acre. Cucumbers succeed best in warm, moist, rich loamy soil. Plant as soon as danger from frost has passed. In hills about 4 feet apart each way.

SLICING VARIETIES

EVERBEARING—55 days. Small, very early variety. By keeping the fruits picked, it will continue to bear throughout the growing season.

Postpaid (Pkt. 10c) (Oz. 25c) (¼ lb. 60c) (lb. \$2.00).

ARLINGTON WHITE SPINE—60 days. Popular among the older early sorts; good for home garden use.

Postpaid (Pkt. 10c) (Oz. 25c) (¼ lb. 60c) (lb. \$2.00).

STAYS GREEN (Black Diamond)—60 days. A handsome, early, medium sized, prolific variety used extensively for shipping. Fruits symmetrical, nearly square ended. Very dark green, holds color and firmness well when shipped long distances.

Postpaid (Pkt. 10c) (Oz. 25c) (¼ lb. 60c) (lb. \$2.00).

EARLY FORTUNE—63 days. Desirable for shipping and good for slicing. Fruits medium-deep green, slightly tapering. Flesh firm and crisp.

Postpaid (Pkt. 10c) (Oz. 25c) (¼ lb. 60c) (lb. \$2.00).

CLARK'S SPECIAL OR WOODRUFF'S HYBRID (Long Strain)—64 days. Valuable for market garden and shipping; a main crop sort, prolific and attractive. Fruits dark green; slightly tapered at both ends; flesh crisp and firm.

Postpaid (Pkt. 10c) (Oz. 25c) (¼ lb. 60c) (lb. \$2.00).

MARKETER—65 days. Medium size, very prolific, trim and of uniform size, tapering slightly to both ends, attractive dark green color.

Postpaid (Pkt. 10c) (Oz. 30c) (¼ lb. 90c) (lb. \$3.00).

DAVIS PERFECT—65 days. A desirable mid-season variety for shipping. Fruits dark green; flesh crisp and of good quality.

Postpaid (Pkt. 10c) (Oz. 25c) (¼ lb. 60c) (lb. \$2.00).

COLORADO—67 days. A very attractive variety, good for market gardens and for shipping. Fruit very dark green, cylindrical, round with small seed pocket. Unusually free from striping at blossom end.

Postpaid (Pkt. 10c) (Oz. 30c) (¼ lb. 90c) (lb. \$3.00).

CUBIT—70 days. Bronze medal winner of 1944. A prolific, white spined variety distinguished by unusually uniform dark green exterior color and long blunt-ended cylindrical shape. The interior has smooth crisp texture with small seed area. Cubit is a main crop long slicing variety.

Postpaid (Pkt. 10c) (Oz. 30c) (¼ lb. 90c) (lb. \$3.00).

STRAIGHT-8—68 days. Desirable for home and market gardens and shipping. Fruit uniformly cylindrical; rounded at ends, medium green; quite free from light stripes. An attractive variety.

Postpaid (Pkt. 10c) (Oz. 30c) (¼ lb. 90c) (lb. \$3.00).

A AND C—68 days. An outstanding variety for shipping on account of its deep green color. Fruits slightly tapered at neck and moderately pointed, but fairly straight and symmetrical; 8-9 inches long, 2½ inches thick; white-spined.

Postpaid (Pkt. 10c) (Oz. 30c) (¼ lb. 90c) (lb. \$3.00).

IMPROVED LONG GREEN—70 days. Standard late variety for home garden; excellent for slicing; hardy and prolific. Fruits deep green, straight, slightly tapered; flesh very white and crisp.

Postpaid (Pkt. 10c) (Oz. 25c) (¼ lb. 60c) (lb. \$2.00).

LONGFELLOW (Vaughan)—70 days. Desirable for home garden, and for shipping; also sometimes used for greenhouse forcing. Fruits dark green, uniform, straight and attractive.

Postpaid (Pkt. 10c) (Oz. 30c) (¼ lb. 90c) (lb. \$3.00).



CUCUMBER, WOODRUFF'S HYBRID

PICKLING VARIETIES

EARLY MINCU—53 days. Bears from 8 to 10 fruits within a foot of the hill. Cucumbers average 4½ inches long and 2 inches in diameter, suitable both for slicing and pickling. The skin is medium green, the flesh white and crisp. Mincu is very early and a heavy cropper.

Postpaid (Pkt. 10c) (Oz. 25c) (¼ lb. 60c) (lb. \$2.00).

EARLY CLUSTER—55 days. Very fine pickling sort. Very popular. Medium dark green, prolific, full at both ends.

Postpaid (Pkt. 10c) (Oz. 25c) (¼ lb. 60c) (lb. \$2.00).

NATIONAL PICKLING—54 days. Especially bred for pickling in the small sizes. Fruit straight, and blunt-ended, but not chunky. Deep green color. Makes firm, crisp pickles.

Postpaid (Pkt. 10c) (Oz. 25c) (¼ lb. 60c) (lb. \$2.00).

SNOW'S PERFECTION PICKLING—56 days. Extremely early and prolific. Fruit 5 inches long; dark green at pickling size, black spined, symmetrical, blunt ended.

Postpaid (Pkt. 10c) (Oz. 25c) (¼ lb. 60c) (lb. \$2.00).

WEST INDIA GHERKIN—60 days. An extremely small fruited variety grown exclusively for pickles. It has no value for slicing. Is very prickly, but tender and crisp if picked when young. Seed germinates slowly.

Postpaid (Pkt. 10c) (Oz. 25c) (¼ lb. 75c) (lb. \$2.50).

EGGPLANT

CULTURE—One ounce will produce 1,000, to 2,000 plants. Seed is of slow germination and requires a moderate amount of heat. Should be started in hotbeds early in March and transplanted to four or six inches apart. Eggplants are very tender and will not stand frost.

BLACK BEAUTY—80 days. A prolific early variety. Medium sized plants, fruit deep purplish black, smooth, large blunt egg-shaped producing 4 to 6 per plant.

Postpaid (Pkt. 10c) (Oz. 50c) (¼ lb. \$1.50) (lb. \$5.00).



EGG PLANT, BLACK BEAUTY

NEW YORK IMPROVED—83 days. The fruits are large, round-oval, of a rich deep purple-black color and splendid quality. Spineless and a heavy producer.

Postpaid (Pkt. 10c) (Oz. 50c) (¼ lb. \$1.50) (lb. \$5.00).

FLORIDA HIGH BUSH—85 days. The plants are large and high, usually bearing the fruit off the the ground. Resistant to drought and blight. Fruit medium size, pear shaped and of purple color.

Postpaid (Pkt. 10c) (Oz. 50c) (¼ lb. \$1.50) (1 lb. \$5.00).

ENDIVE

One ounce of seed sows 150 feet of drill.

BROAD-LEAVED BATAVIAN (Escarolle)—A decided improvement on the old broad-leaved Batavian. Leaves dark green. The plants are of a larger size and make a fuller heart, easily blanched without needing to be tied. This is a money-making crop.

Postpaid (Pkt. 10c) (Oz. 25c) (¼ lb. 75c) (lb. \$2.00).

GREEN CURLED—All Heart Strain—Grows larger than Green Curled and has less serrated leaves. It is later in maturing, but when well grown on good soil it forms a large full heart of fine quality. When blanched, the heads are delicate yellow in the heart and very attractive. Used largely by market growers.

Postpaid (Pkt. 10c) (Oz. 25c) (¼ lb. 75c) (lb. \$2.00).



KOHL RABI



ENDIVE

KOHL RABI

One ounce will see 200 feet of row.

EARLY WHITE VIENNA—The leading variety, a very fancy strain of the short-leaved type. Best for forcing or in the open field.

Postpaid (Pkt. 10c) (Oz. 40c) (¼ lb. \$1.25) (lb. \$4.00).

EARLY PURPLE VIENNA—A few days later in maturing, with leaves and bulbs of purple color. Otherwise similar to White Vienna.

Postpaid (Pkt. 10c) (Oz. 40c) (¼ lb. \$1.25) (lb. \$4.00).

LEEK

Cultivate the same as onions.

LARGE AMERICAN FLAG—The most popular variety; grows to a good size, is straight and uniform, and is of the best quality.

Postpaid (Pkt. 10c) (Oz. 60c) (¼ lb. \$2.00) (lb. \$6.00).

GIANT MUSSELBURG—The rich flavor of this extra large leek has made it popular. It is a very hardy sort with dark green fan-shaped leaves. The edible stems are 6 to 8 inches in length and about 3 inches in diameter.

(Pkt. 10c) (Oz. 60c) (¼ lb. \$2.00) (lb. \$6.00).

HERBS

CULTURE—Herbs delight in a rich, mellow soil. Sow in early spring in shallow drills one foot apart; cover lightly with fine soil, and when up a few inches thin out, or transplant into prepared beds. Care should be taken to harvest properly. Do this on a dry day, just before they come into full bloom; dry quickly in the shade, pack closely in bottles or dry boxes to exclude the air.

ANISE—75 days. Annual. 1½ ft. Used for garnishing and flavoring; the seeds have an aromatic flavor and are used in cakes, soups and other foods.
(Pkt. 10c) (½ Oz. 40c).

BALM—Perennial. Leaves and stems are used for their aromatic odor.
(Pkt. 10c).

BORAGE—80 days. Annual 1½ ft. Leaves are used in salads and also to flavor cooling drinks. Splendid for bees.
(Pkt. 10c) (½ Oz. 40c).

CARAWAY—70 days. Biennial. 1½ ft. tall. Seeds are used for flavoring pastry. Young leaves may be used in salads.
(Pkt. 10c) (½ Oz. 40c).

CATNIP—80 days. Perennial. 1½ ft. Leaves are strongly scented, when dried are given as a special treat to cats.
(Pkt. 10c) (½ Oz. 40c).

CHERVIL—75 days. Annual. Used as flavoring in egg and fish sauces. Leaves used in salads.
(Pkt. 10c) (¼ Oz. 25c).

CHIVES—80 days. Perennial. 6 inch. Tops, finely cut are used for giving a mild onion like flavor to salads, stews and soups.
(Pkt. 10c) (Oz. \$1.25).

CORIANDER—75 days. Annual. 1½ ft. The green leaves are used in soups and sauces; the dried seeds in meats, sausage, and pastry.
(Pkt. 10c) (½ Oz. 30c).

DANDELION—60 days. Used for salads.
(Pkt. 10c).

DILL—70 days. Annual. 2 to 2½ ft. The dry or green branches are used for flavoring dill pickles and beets.
(Pkt. 10c) (Oz. 25c) (¼ lb. 60c) (lb. \$1.50).

FLORENCE FENNEL—60 days. Annual. 2½ ft. The large leaf base has a pleasing anise-like flavor and may be boiled and used in fish sauces and pastry, or the stalks are eaten raw like celery.
(Pkt. 10c) (½ Oz. 35c).

HOREHOUND—75 days. Perennial. 14 inch. The leaves are used for seasoning and in candy or medicine for coughs and colds.
(Pkt. 10c) (½ Oz. 55c).

LAVENDER (True)—60 days. Perennial. 1 ft. Flowers are dried and placed in linen closets to impart their perfume to the contents. Sweet scented lavender blue flowers on stems of silvery gray foliage.
(Pkt. 10c) (½ Oz. 60c).

ROSEMARY—75 days. Perennial. 1 ft. Fragrant leaves used for seasoning and in manufacturing perfume.
(Pkt. 10c) (¼ Oz. 35c).

SAGE—75 days. Perennial, 1 to 2 ft. Used as a seasoning for poultry, sausage, and dressing. May be used fresh or dried.
(Pkt. 10c) (½ Oz. 40c).

SWEET BASIL—85 days. Annual. 1½ to 2 ft. The leaves green or dried are chiefly used as a seasoning for soups, sauces, vinegar, beans and peas.
(Pkt. 10c) (¼ oz. 25c).

SUMMER SAVORY—60 days. Annual. 1 ft. Used chiefly for flavoring salads.
(Pkt. 10c) (¼ Oz. 25c).

THYME—85 days. Perennial. 6 to 10 inches high. Has aromatic foliage which is used in seasoning soups, stews, sauces and dressings.
(Pkt. 10c) (½ Oz. 30c).

LETTUCE

CULTURE—One ounce will sow 150 feet or drill, two pounds an acre. Lettuce is a hardy plant and will stand a low degree of temperature; however, a moderate temperature is desirable during the growing period. Lettuce stands cold much better than heat, making it impossible to produce lettuce of good quality during the hot summer months. Hot weather causes the plants to go to seed instead of heading.

Lettuce required considerable soil moisture; however, an

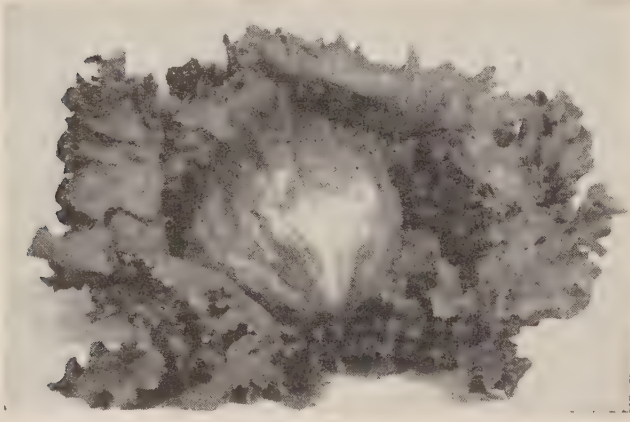

LETTUCE, GREAT LAKES

GREAT LAKES—Bronze Medal award for 1944. This is of the Imperial type which is so largely used by truck gardeners. What chiefly distinguishes Great Lakes from other varieties of the Imperial type is its increased resistance to tip-burn injury and greater ability to produce solid heads under adverse conditions. The leaves are large, relatively thick, folding well over the head so that when unwrapped they give large pieces desirable for salads.

We offer four strains for this season.

Strain No. 428—This strain is about ten days earlier than the Standard, very uniform in maturity; adapted for early spring or late fall. Small rib, excellent strain for shipping. **Postpaid (Pkt. 25c) (Oz. 75c) (¼ lb. \$2.00) (lb. \$7.50).**

Strain No. 407—This strain was developed primarily to stand the heat, it has large protective wrapper leaves, fine cut edge. Matures about a week later than No. 428. **Postpaid (Pkt. 25c) (Oz. 75c) (¼ lb. \$2.00) (lb. \$7.50).**

Premier—This traces back to a single individual plant selected for earliness, smoothness, lack of ribbiness and uniformity of heading. It is 7 to 10 days earlier than regular Great Lakes. **Postpaid (Pkt. 25c) (Oz. 75c) (¼ lb. \$2.00) (lb. \$7.50).**

Regular Strain—This is the same strain we have offered for the past two years. **Postpaid (Pkt. 15c) (Oz. 50c) (¼ lb. \$1.50) (lb. \$5.50).**

PENN LAKE—83 days. Cross between Imperial 847 and Great Lakes. Heads medium size, uniform and dark green in color. Comparatively free from objectional ribbiness; interior crisp and firm. **Postpaid (Pkt. 25c) (Oz. 75c) (¼ lb. \$2.00) (lb. \$7.50).**

ROHCO—A new introduction of the Imperial type, a selection from Imperial 615. It will produce more marketable heads of highest quality and earlier than Imp. 615. Does well in cool weather, withstands frost and cold better than other Imperial varieties. **Postpaid (Pkt. 10c) (Oz. 35c) (¼ lb. \$1.00) (lb. \$3.40).**

NEW YORK No. 12—A widely used strain of New York, well adapted to mid-season maturity, as it stands heat well. Plant and head lighter green than New York, with fewer outer leaves, several days earlier; large, compact and attractive. **Postpaid (Pkt. 10c) (Oz. 35c) (¼ lb. \$1.00) (lb. \$3.40).**

NEW YORK No. 55—All American Selection for 1942, introduced by Pieters-Wheeler. Probably the earliest maturing New York type in existence. Good base, hard heading, crisp, of the highest quality with considerable resistance to tip-burn. Heads well in summer and early fall. **Postpaid (Pkt. 10c) (Oz. 35c) (¼ lb. \$1.00) (lb. \$3.40).**

NEW YORK No. 515—A Pieters-Wheeler introduction, bred as a summer variety to resist tip-burn. A cross between Iceberg and New York, resembling No. 12; has better fold, is more sure heading and more resistant to tip-burn. **Postpaid (Pkt. 10c) (Oz. 35c) (¼ lb. \$1.00) (lb. \$3.40).**

excess of moisture may cause stem rot. A light, loamy soil, enriched with well-rotted manure, is best adapted for the successful growing of lettuce. If planted on poor soil the heads will be small and leaves tough.

As soon as the ground can be successfully worked, sow in drills 15 to 20 inches apart, one-half to one inch deep. Thin the plants 8 to 15 inches apart in the row. Large headed varieties, like New York Wonderful or Iceberg, thin to 15 inches in the row.

TRIPLE XXX—The best of the No. 515 types, highly resistant to tip-burn. **Postpaid (Pkt. 10c) (Oz. 35c) (¼ lb. \$1.00) (lb. \$3.40).**

IMPERIAL No. 847—Resistant to brown blight. Heads hard and fine. Best for early spring and late fall crop. Black seed. **Postpaid (Pkt. 10c) (Oz. 35c) (¼ lb. \$1.00) (lb. \$3.40).**

IMPERIAL No. 456—A new variety developed by the U.S.D.A. and Cornell Experiment Station. Matures hard, large heads in mid-summer and will not burn in the hottest weather. Leaves grass-green color, brittle foliage, prominent mid-ribs. An excellent market garden and shipping variety. Seed white. **Postpaid (Pkt. 25c) (Oz. 50c) (¼ lb. \$1.75) (lb. \$6.50).**

IMPERIAL No. 615—Bred from Imperial No. 152 but somewhat later; resistant to brown blight; does not develop suckers. Heads medium large, solid and firm. Best for fall crops. **Postpaid (Pkt. 10c) (Oz. 35c) (¼ lb. \$1.00) (lb. \$3.40).**

IMPERIAL No. 152—Resistant to brown blight, adapted for fall crop. Dependable in heading, heads medium large, solid and attractive. **Postpaid (Pkt. 10) (Oz. 35c) (¼ lb. \$1.00) (lb. \$3.40).**

IMPERIAL No. 44—Is an Iceberg type and is superior to N. Y. Special. Outstanding in trials this past year. A large head, solid and crisp. Forms a larger percentage of marketable heads than other varieties. Seems to be quite resistant to tip-burn. You will be well pleased with Imperial No. 44, either on muck or upland soils. Stands the hot weather when others fail. **Postpaid (Pkt. 10c) (Oz. 35c) (¼ lb. \$1.00) (lb. \$3.40).**

PROGRESS—80 days. A new variety developed by the U. S. Department of Agriculture. A selection out of Imperial 44. Head is medium size, compact, early, leaves medium green, thick, heavily savoyed with edges more cut and waved than Imperial 44. Tip burn resistant. **Postpaid (Pkt. 25c) (Oz. 50c) (¼ lb. \$1.75) (lb. \$6.50).**

PARIS WHITE COS or ROMAINE—Large size, and medium green, compact head, well blanched. For home and market, and well adapted for greenhouse use. **Postpaid (Pkt. 10c) (Oz. 35c) (¼ lb. \$1.00) (lb. \$3.40).**

LEAF LETTUCE

EARLY CURLED SIMPSON or SILECIA—A fine home garden sort, light green frilled leaves. **Postpaid (Pkt. 10c) (Oz. 20c) (¼ lb. 75c) (lb. \$2.10).**

BLACK SEEDED SIMPSON—An early loose leaved type, with yellowish-green frilled leaves. **Postpaid (Pkt. 10c) (Oz. 20c) (¼ lb. 70c) (lb. \$2.10).**

GRAND RAPIDS—One of the most popular sorts, for forcing or out-of-door use. Plants compact with light green frilled leaves. Tip-burn resistant. **Postpaid (Pkt. 10c) (Oz. 25c) (¼ lb. 75c) (lb. \$2.35).**

PRIZEHEAD—An early, non-heading sort, leaves dark green edged with brown and highly frilled. **Postpaid (Pkt. 10c) (Oz. 25c) (¼ lb. 75c) (lb. \$2.35).**

OAKLEAF—An early dark green leaf lettuce, leaves are thick, smooth, but deeply lobed to resemble the leaf of an oak tree. **Postpaid (Pkt. 10c) (Oz. 25c) (¼ lb. 75c) (lb. \$2.35).**

MUSKMELON OR CANTALOUPE

CULTURE—One ounce of seed is sufficient for 50 hills; 2 pounds per acre. Plant in May and June. Melons do best in sandy soil or sod land; the ground should be made rich. The

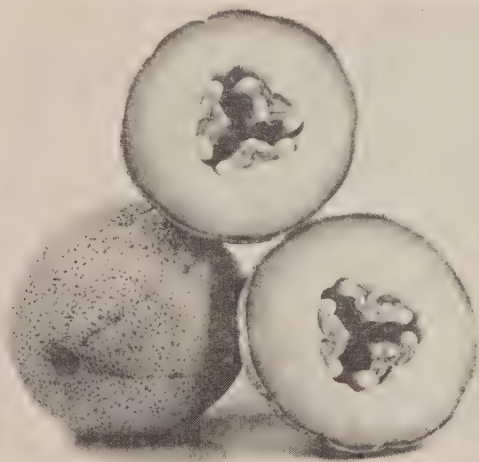

MELON, HALE'S BEST

HALE'S BEST, JUMBO—82 days. A large fruited strain of this well-known variety for local markets. Fruits slightly oval, ribbing prominent, heavily netted. Flesh thick, salmon-orange, sweet and of excellent quality; seed pocket rather large.

Postpaid (Pkt. 10c) (Oz. 25c) (¼ lb. 75c) (lb. \$2.25).

HALE'S BEST 9-36—87 days. An early variety with medium vines, vigorous and healthy. Melons oval in shape, running to jumbo sizes. Well netted; flesh pink, sweet and thick. A heavy yielder.

Postpaid (Pkt. 10c) (Oz. 25c) (¼ lb. 75c) (lb. \$2.25).

HALE'S BEST No. 9-36—All hand-cut, crown set seed in 1-pound sealed bags.

Postpaid (\$2.50).

HALE'S BEST No. 45—86 days. Mildew resistant, An early variety developed particularly for the shipping trade. The No. 45 is a true Hale's Best. Oval shape, medium size, with heavy net and a faint stripe. Flesh is deep salmon, thick, and firm with small seed cavity. Recommended to plant where mildew is prevalent.

Postpaid (Pkt. 10c) (Oz. 25c) (¼ lb. 75c) (lb. \$2.25).

HALE'S BEST No. 45—All hand-cut, crown set seed in 1-pound sealed bags.

Postpaid (\$2.50).

IMPERIAL 4-50—This melon was introduced to be used in place of No. 45 in areas where the No. 45 did not produce a large sized melon. The No. 4-50 retains all the characteristics of the No. 45 except it is 1/5 larger in size.

Postpaid (Pkt. 10c) (Oz. 25c) (¼ lb. 75c) (lb. \$2.25).

IMPROVED PERFECTO—92 days. An excellent late shipping variety. Melons are heavily netted without ribbing. Flesh orange, thick and has a delicious flavor. Small seed cavity. An excellent melon.

Postpaid (Pkt. 10c) (Oz. 25c) (¼ lb. 75c) (lb. \$2.25).

NEW SEED BREEDERS—84 days. All purpose melon, very uniform. Heavily netted with a faint stripe, shape is slightly oval with deep pink flesh. Similar to Hale's Best but will outyield Hale's because of fewer culls.

Postpaid (Pkt. 10c) (Oz. 25c) (¼ lb. 75c) (lb. \$2.25).

U. S. D. A. No. 5—Mildew Resistant (New)—85 days. Totally resistant to all kinds of mildew. Adapted for long distance shipping, for crating and for home garden. When cut the flesh is extraordinarily thick, a brilliant orange and unexcelled for sweetness. Same size and shape as Hale's Best.

Postpaid (Pkt. 10c) (Oz. 25c) (¼ lb. 90c) (lb. \$3.25).

QUEEN OF COLORADO—90 days. A development from Pride of Wisconsin. The melon is rather large with faint ribs and heavy, coarse net. The outside color is pearly grey turning golden when ripe. Flesh thick, deep orange in color. Excellent eating qualities. Good for home and local markets.

Postpaid (Pkt. 10c) (Oz. 25c) (¼ lb. 75c) (lb. \$2.25).

PRIDE OF WISCONSIN—90 days. A most attractive fruit both on outside and when cut. The rind is very hard, pearly grey color with but a faint rib, heavily covered with a distinctive netting. Fruit practically round, pink fleshed, usually thick with good flavor, small triangular seed cavity. Good for both home use and shipping.

Postpaid (Pkt. 10c) (Oz. 25c) (¼ lb. 75c) (lb. \$2.25).

SCHOON'S HARDSHELL—90 days. Noted for its hard rind which makes it better adapted for shipping and market. Exterior color grayish yellow netting rather open. Melons average 7 inches in length, almost round, flesh salmon-pink.

Postpaid (Pkt. 10c) (Oz. 25c) (¼ lb. 75c) (lb. \$2.25).

hills should be 4 to 6 feet apart with 10 to 12 seeds in each hill. Put the seeds an inch deep and when danger of frost is over, thin to four good plants to a hill. Cultivation should be kept up as long as possible.

BENDER'S SURPRISE—87 days. A large size melon weighing 7 to 8 lbs. Round shaped, deeply ribbed with coarse netting. Flesh very thick and sweet. An excellent home garden and shipping variety, growing well in all sections.

Postpaid (Pkt. 10c) (Oz. 25c) (¼ lb. 75c) (lb. \$2.25).

HEARTS OF GOLD—88 days. Grown extensively by market gardeners, likewise a good shipping type. Fruits practically round, slightly ribbed, covered with fine grey netting. Flesh very thick, deep pink salmon; tender, juicy, sweet and aromatic.

Postpaid (Pkt. 10c) (Oz. 25c) (¼ lb. 75c) (lb. \$2.25).

ROCKY FORD—95 days. Also known as Netted Gem. Fruits oval, show no ribbing and are entirely covered with a uniform netting. Flesh green and of excellent flavor.

Postpaid (Pkt. 10c) (Oz. 25c) (¼ lb. 75c) (lb. \$2.25).

EXTRA EARLY HACKENSACK—80 days. A well-known first early sort for home garden and truckers for local markets. Fruits large, globular, flattened; heavily ribbed, with coarse netting. Flesh green, thick of good quality.

Postpaid (Pkt. 10c) (Oz. 25c) (¼ lb. 75c) (lb. \$2.25).

OSAGE OR MILLER'S CREAM—92 days. Dark green skin sparsely netted and ribbed. Thick salmon flesh, fine grained and of rich spicy flavor. A home garden variety or for local markets.

Postpaid (Pkt. 10c) (Oz. 25c) (¼ lb. 75c) (lb. \$2.25).

BANANA—94 days. Resembles a banana in shape. Fruits smooth and slender, flesh pronounced salmon, of banana-like flavor.

Postpaid (Pkt. 10c) (Oz. 25c) (¼ lb. 75c) (lb. \$2.25).

PERSIAN—115 days. While not properly a Casaba the Persian is of tropical origin. It is of dark color and completely covered with a fine netting. Fruits globular, weighing about 7 lbs.; the flesh is extremely thick, of excellent flavor and orange in color.

Postpaid (Pkt. 10c) (Oz. 25c) (¼ lb. 75c) (lb. \$2.25).

HONEY DEW (Green Fleshed)—105 days. A medium sized round melon of a dull creamy white color, flesh green, quite distinct and very delicious flavor. The rind is tough without netting, and ships well to distant markets.

Postpaid (Pkt. 10c) (Oz. 25c) (¼ lb. 75c) (lb. \$2.25).

HONEY DEW (Pink Fleshed)—105 days. In outward appearance like the Honey Dew, but has salmon colored flesh and a delicious flavor.

Postpaid (Pkt. 10c) (Oz. 25c) (¼ lb. 75c) (lb. \$2.25).

HONEY DEW GOLD RIND (Green Fleshed)—100 days. A true green flesh Honey Dew except when about two-thirds grown the outside coloring turns to an attractive golden shade. It withstands heat in that fruits do not show sunburn, because of the color. It has good flavor, a thick flesh and carries well in shipping.

Postpaid (Pkt. 10c) (Oz. 25c) (¼ lb. 75c) (lb. \$2.25).

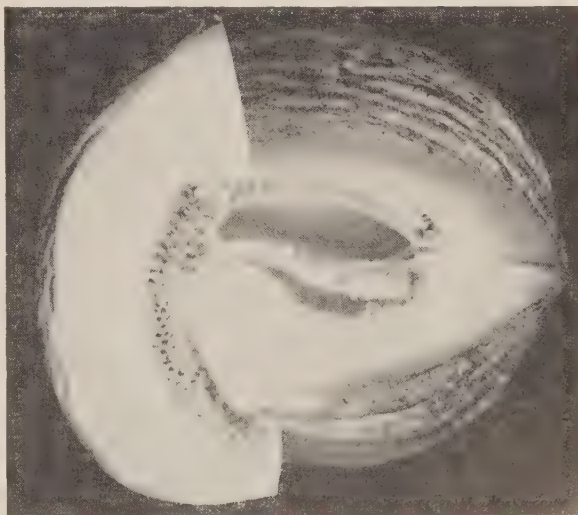

CASABA, GOLDEN BEAUTY

GOLDEN BEAUTY CASABA—115 days. One of the best of the autumn Casabas. Easily grown, very prolific. The fruits are easily handled, being firm and heavy; ripens early in September and fruits can be kept until into December.

Postpaid (Pkt. 10c) (Oz. 25c) (¼ lb. 75c) (lb. \$2.25).

WATERMELONS

CULTURE—The same as for Muskmelons, except that they should be planted from 8 to 10 feet apart. One ounce for 30 hills and 3 to 4 pounds to the acre.

EARLY NORTHERN SWEET—65 days. This new melon is of Russian origin, introduced by the Minnesota Experiment Station. Especially adapted for the northern sections and high altitudes where the seasons are short. It is of an attractive green color striped with lighter green. Flesh is dark red and tender with a rich sugary flavor. Splendid for early market and home garden.

Postpaid (Pkt. 10c) (Oz. 20c) (¼ lb. 50c) (lb. \$1.35).

EARLY ARIZONA—70 days. A new early prolific melon, of the Ice Box Type, producing fruit about the size of a bowling ball. Skin dark green, flesh brilliant red with large seeds, very sweet.

Postpaid (Pkt. 10c) (Oz. 20c) (¼ lb. 50c) (lb. \$1.35).

WICHITA RED or EARLY KANSAS—82 days. One of the finest introductions in recent years; very popular in the Middle West. It is a melon of large size, alternate stripes of light and dark green, oblong in shape, with deep red flesh and brown seeds.

Postpaid (Pkt. 10c) (Oz. 20c) (¼ lb. 50c) (lb. \$1.35).

DIXIE QUEEN—85 days. A very prolific, shipping type of mid-season maturity. Fruits oval-round, light green with dark green stripes; rind thin but tough. Flesh bright red, crisp, of splendid quality, quite free from fibre.

Postpaid (Pkt. 10c) (Oz. 25c) (¼ lb. 60c) (lb. \$1.60).

BLACK SEEDED CHILIAN—85 days. A splendid melon for home and market gardeners. Fruits medium large, averaging about 18 pounds. Nearly round shape with thick dark green, tough rind, making it a good shipper. The bright red flesh is crisp, fine grained and very sweet.

Postpaid (Pkt. 10c) (Oz. 20c) (¼ lb. 50c) (lb. \$1.35).

KLONDIKE—80 days. A melon of good quality. Exceptionally sweet and fine flavor. Flesh is deep red and brittle, fruit oblong. A very good yielder, fairly early, and has given satisfaction for the market and home garden.

Postpaid (Pkt. 10c) (Oz. 25c) (¼ lb. 60c) (lb. \$1.60).

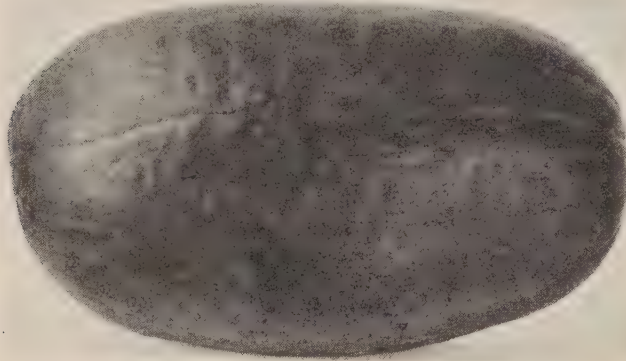

WATERMELON, KLONDIKE

STRIPED KLONDIKE—80 days. An early garden and shipping variety similar to regular Klondike but with irregular dark green stripes. Fruits oblong, of medium size, rind medium hard. Flesh deepest red known to watermelon; sweet and crisp.

Postpaid (Pkt. 10c) (Oz. 25c) (¼ lb. 60c) (lb. \$1.60).

KLONDIKE No. R7 (Wilt Resistant)—85 days. This is the first strain of the Klondike to be released showing a high resistance to wilt. This melon seems fully as desirable as the other Klondikes for both edible quality and shipping.

Postpaid (Pkt. 10c) (Oz. 25c) (¼ lb. 60c) (lb. \$1.60).

IMP. KLECKLEY'S SWEETS or WONDERMELON—88 days. A large oblong melon with a thin dark rind and showing faint tracings or indentations running the length of the melon. Flesh deep scarlet-red; solid heart; is a favorite shipping melon.

Postpaid (Pkt. 10c) (Oz. 20c) (¼ lb. 50c) (lb. \$1.35).

IMP. KLECKLEY'S No. 6 (Wilt Resistant)—88 days. A certified wilt resistant strain of the popular Imp. Kleckley's Sweet, developed in Iowa and grown under supervision of the Iowa State Agricultural College. Quality is superior to the regular strain of Kleckley's.

Postpaid (Pkt. 10c) (Oz. 25c) (¼ lb. 60c) (lb. \$1.60).

OKLAHOMA CHIEF—88 days. A large, round melon with a black-green shiny glossy rind. The rind is very thin and tough so the melons can be hauled long distances without damage. The flesh is blood red, tender and very sweet, melons average about 40 lbs. They are hardy and drought resistant.

Postpaid (Pkt. 10c) (Oz. 25c) (¼ lb. 60c) (lb. \$1.60).

FLORIDA GIANT—90 days. Vines vigorous and very productive. Fruits dark green, nearly round. Flesh firm and red, of excellent quality. Ships well, though rather large for some markets; average weight about 40 lbs. Good all-purpose variety. Seed mottled dark brown.

Postpaid (Pkt. 10c) (Oz. 25c) (¼ lb. 60c) (lb. \$1.60).

BLACK DIAMOND (Improved)—90 days. A selection out of Florida Giant, a large oblong melon, with dark green rind that is thin but tough, making it a desirable melon for shipping. Flesh bright red and of very sweet flavor, average weight about 50 lbs. Makes a vigorous vine growth, does not sunburn as easily as many varieties.

Postpaid (Pkt. 10c) (Oz. 25c) (¼ lb. 60c) (lb. \$1.60).



WATERMELON, ANGELINO

ANGELINO—90 days. It is desirable for shipping. The fruits are medium sized, nearly round or slightly oblong. The skin is very deep green, indistinctly mottled and striped with a lighter shade. The flesh is decidedly mottled bright vermillion-red, remarkably fine grained but firm, and very sweet.

Postpaid (Pkt. 10c) (Oz. 20c) (¼ lb. 50c) (lb. \$1.35).

GEORGIA RATTLESNAKE—92 days. A long, fairly large melon with light green color, irregularly mottled, with dark green stripes. The rind is quite thick, the flesh pink in color.

Postpaid (Pkt. 10c) (Oz. 20c) (¼ lb. 50c) (lb. \$1.35).

IRISH GRAY—95 days. A large, long, main crop variety with a distinctive gray-green skin; shell very tough and hard, making a fine shipper; flesh very firm, crisp and sweet.

Postpaid (Pkt. 10c) (Oz. 20c) (¼ lb. 50c) (lb. \$1.35).

TOM WATSON—95 days. Probably the best shipping melon and one of the best main crop sorts; grows to a very large size. Fruit large and long in shape, colored a medium green with a light tracing of a darker shade; flesh rich red and of good quality, seeds brown.

Postpaid (Pkt. 10c) (Oz. 20c) (¼ lb. 50c) (lb. \$1.35).

GOLDEN HONEY—90 days. Fruits chunky, nearly round, medium sized, light green with mottled darker green stripes; rind brittle. Flesh amber-yellow, crisp and delicious, free from stringy sections.

Postpaid (Pkt. 10c) (Oz. 25c) (¼ lb. 60c) (lb. \$1.60).

KING AND QUEEN (Winter Watermelon)—100 days. A Russian variety of fair size, round in shape; rind light cream with faint, irregular light green striping; early, prolific and excellent in quality; seeds small, black.

Postpaid (Pkt. 10c) (Oz. 25c) (¼ lb. 60c) (lb. \$1.60).

EARLY VARIETIES MIXED COLLECTION—65 days. Includes seeds of the following varieties: Favorite Honey, Sweet Sensation, Honey Cream, Yamato, Early Arizona, Early Canada, Northern Sweet, Dakota Sweet. These are all good melons and very interesting to plant.

Postpaid (Pkt. 10c) (Oz. 20c) (¼ lb. 50c) (lb. \$1.35).

CITRON (Green Seeded)—95 days. Used only for preserving; extremely productive. Flesh white and solid.

Postpaid (Pkt. 10c) (Oz. 20c) (¼ lb. 50c) (lb. \$1.35).

CITRON (Red Seeded)—95 days. Practically identical with Green Seeded Citron, except slightly smaller and with bright red seed.

Postpaid (Pkt. 10c) (Oz. 20c) (¼ lb. 50c) (lb. \$1.35).

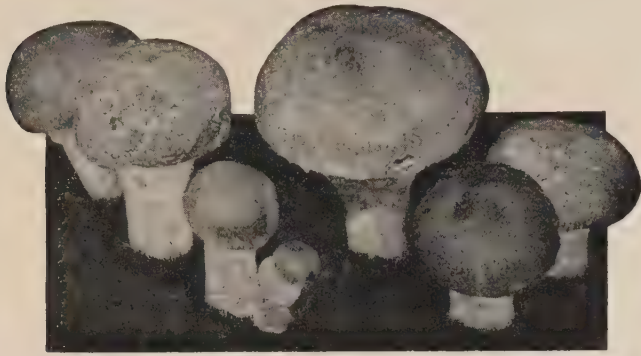

MUSHROOM SPAWN

Cultural instructions for growing mushrooms given free to every purchaser of spawn.

LAMBERT'S PURE CULTURE—This spawn is specially prepared for us and produces results where the average spawn proves a failure. It is a strong strain of spawn thoroughly acclimated and selected with reference to earliness, size, flavor, appearance, prolificacy and quality of the mushrooms that it will produce. We highly recommend this spawn for those who intend to raise mushrooms for the market.

Bricks 40 cents each (5 bricks \$1.75) Postpaid.

MUSTARD

CULTURE—One ounce of seed will sow 100 feet of drill.

FORDHOOK FANCY—A handsome, vigorous growing, mild variety, standing a long time before going to seed; leaves bright green, intensely curled and fringed on the edges; fine for salads and garnishings; seed reddish-brown.

Postpaid (Pkt. 10c) (Oz. 20c) (¼ lb. 35c) (lb. \$1.00).

SOUTHERN GIANT CURLED (Long-Standing)—This strain of Southern Giant Curled Mustard is much superior to the old type, as it will stand a considerable time longer before going to seed.

Postpaid (Pkt. 10c) (Oz. 20c) (¼ lb. 35c) (lb. \$1.00).

FLORIDA BROAD LEAF—33 days. Vigorous, large leaf variety that grows fast but stands longer than most varieties before going to seed. The leaves are large, yellowish-green in color; nearly smooth without fringing. The mid-rib is a lighter shade of green.

Postpaid (Pkt. 10c) (Oz. 20c) (¼ lb. 35c) (lb. \$1.00).

WHITE ENGLISH—Plant of rapid, upright growth, soon going to seed; leaves rather small and smooth, deeply cut or divided; color deep green, seed large, light yellow.

Postpaid (Pkt. 10c) (Oz. 20c) (¼ lb. 35c) (lb. \$1.00).



MUSTARD
GIANT
SOUTHERN
CURLED

MUSTARD SPINACH

TENDERGREEN—28 days. A very pleasingly flavored green. Leaves oblong, thick, fairly smooth dark green with lighter green ribs, resistant to heat and drought; combines the flavor of both Mustard and Spinach.

Postpaid (Pkt. 10c) (Oz. 20c) (¼ lb. 35c) (lb. \$1.25).

ONIONS

CULTURE—One ounce of seed is sufficient for 100 feet of drill, 4 pounds for one acre. Onion seed should be sown as early in the spring as possible to get the ground in shape, even though the weather is cold. Thorough preparation of the soil is one of the most essential points in successful onion growing. They delight in a rich, deep sandy loam, but excellent yields can be obtained from heavier soils properly fertilized. Sow the seed in rows 12 to 14 inches apart and about ½ inch deep. After they are well started, or about 3 to 4 inches high, thin out to stand about 2 inches apart, keeping them well hoed and free from weeds at all times throughout the season.

YELLOW VARIETIES

YELLOW SWEET SPANISH No. 6 (Special Strain)—Developed by Prof. A. M. Binkley of the Colorado Experiment Station. Bulbs large, perfect globe shape, small neck curves down excellently, with heavy protecting deep yellowish-brown skin. Flesh white; fine grained; mild, pleasing flavor.

Postpaid (Pkt. 10c) (Oz. 75c) (¼ lb. \$2.50) (lb. \$7.50).

YELLOW SWEET SPANISH (Utah Strain)—Well-known strain of Sweet Spanish. Very productive. Bulbs large yellow globe shaped, small neck which curves down well. Flesh white; fine grained; of mild flavor and a good keeper.

Postpaid (Pkt. 10c) (Oz. 50c) (¼ lb. \$1.75) (lb. \$6.00).

EARLY BABOSA OR GRANO—An early relatively non-bolting variety, bulbs top-shaped, medium large with straw-colored skin, flesh white, mild and of excellent flavor. Highly desirable for early market.

Postpaid (Pkt. 10c) (Oz. 50c) (¼ lb. \$1.50) (lb. \$5.00).

YELLOW GLOBE DANVERS—One of the best and most extensively grown yellow onions. Bulbs are uniformly globe-shaped, small neck and enormous yielder, and fine keeper.

Postpaid (Pkt. 10c) (Oz. 40c) (¼ lb. \$1.25) (lb. \$4.00).

EBENEZER or JAPANESE—An excellent variety for producing sets of exceptional keeping quality. Bulbs deep-flat, of medium size; dark yellow, very firm, with thick skin.

Postpaid (Pkt. 10c) (Oz. 40c) (¼ lb. \$1.25) (lb. \$4.00).

EXCEL (Bermuda No. 986)—83 days. Excel is a heavy-yielding variety of the Bermuda type developed by the U. S. Department of Agriculture. Earlier than other Bermuda varieties and more resistant to splitting and bolting. Uniformly thick, flat, with small tops and necks.

Postpaid (Pkt. 10c) (Oz. 40c) (¼ lb. \$1.25) (lb. \$4.50).

MOUNTAIN DANVERS—This variety is semi-round. It is one of the very earliest and seems to ripen practically all the crop at once. Color is a beautiful dark yellow, shading to brown. The skin is thick and heavy, which makes it a good keeping and shipping sort.

Postpaid (Pkt. 10c) (Oz. 40c) (¼ lb. \$1.25) (lb. \$4.00).

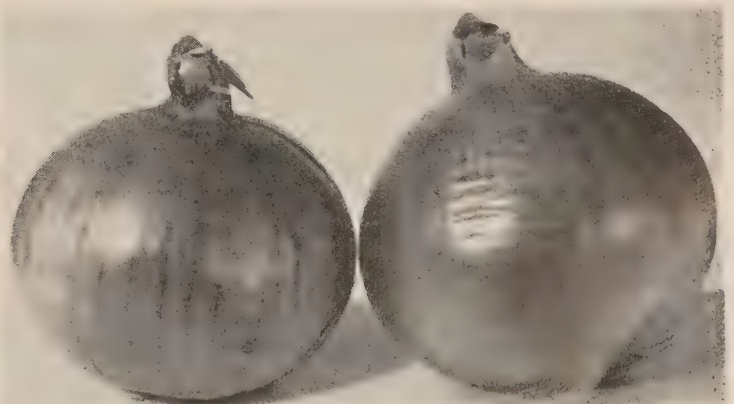

ONION, UTAH SWEET SPANISH

ONIONS—WHITE VARIETIES

CRYSTAL WHITE WAX (Bermuda)—Waxy-white, very flat, medium early Bermuda type, with mild flavor.

Postpaid (Pkt. 10c) (Oz. 40c) (¼ lb. \$1.25) (lb. \$4.00).

WHITE SWEET SPANISH (Special Utah Strain)—Similar to the famous White Sweet Spanish in flavor, uniformity and mildness, but produces a larger onion and greater yield per acre than regular strain.

Postpaid (Pkt. 10c) (Oz. 75c) (¼ lb. \$2.00) (lb. \$7.50).

WHITE SWEET SPANISH—The pure white flesh of this onion is fine-grained and exceptionally sweet. It is a splendid sort to use in salads or other ways without cooking. A very good keeper for so early and large variety, and is excellent for either the home or market garden.

Postpaid (Pkt. 10c) (Oz. 50c) (¼ lb. \$1.75) (lb. \$6.00).

WHITE BABOSA OR GRANO—The White Grano is just becoming known, developed by the New Mexico Experiment Station for an early shipping sort to fulfill the demand for a more productive and better shipping sort to replace Crystal Wax, bulbs are top shaped, white skinned, mild and sweetly flavored firm flesh, bulbs will grow large like Yellow Grano.

Postpaid (Pkt. 10c) (Oz. 60c) (¼ lb. \$2.00) (lb. \$6.50).

WHITE BABOSA OR GRANO (Special Strain)—Bulbs medium large, mild and of excellent flavor. The skin color is a clear Silverskin white, highly desirable for early markets.

Postpaid (Oz. 75c) (¼ lb. \$2.50) (lb. \$7.50).

MAMMOTH SILVER KING—Very large white, flat onion, used principally for bunching while green. Seed sown in the spring will make boiling onions in July and August.

Postpaid (Pkt. 10c) (Oz. 40c) (¼ lb. \$1.25) (lb. \$4.00).

SOUTHPORT WHITE GLOBE—Beautiful silvery white, perfectly globe shaped, uniform in size. Flesh firm, fine-grained, solid and of pleasant flavor. Very small neck.

Postpaid (Pkt. 10c) (Oz. 50c) (¼ lb. \$1.50) (lb. \$5.00).

WHITE PORTUGAL or SILVERSKIN—A fine silvery-white flattened bulb that keeps well; useful for pickling, bunching, and the standard for white sets. Medium sized, with mild flavor, and earlier than Southport White Globe.

Postpaid (Pkt. 10c) (Oz. 40c) (¼ lb. \$1.25) (lb. \$4.50).

WHITE LISBON—Grown exclusively as an early bunching onion, stems white.

Postpaid (Pkt. 10c) (Oz. 40c) (¼ lb. \$1.25) (lb. \$4.00).

WHITE BARLETTA (Pickling)—The best small white onion for pickling. Our seed is the real Barletta onion, producing very small round, white onions that mature early. Sow at the rate of 40 pounds per acre.

Postpaid (Pkt. 10c) (Oz. 40c) (¼ lb. \$1.25) (lb. \$4.00).



BUNCHING ONIONS

NEBUKA WHITE BUNCHING—A bulbless bunching variety grown for its very long, pure white stems; long-standing, tender and of delicate flavor. Resistant to pinkroot, thrips and smut.

Postpaid (Pkt. 10c) (Oz. 40c) (¼ lb. \$1.25) (lb. \$4.00).

ONION SETS

CULTURE—One quart will plant 20 feet of row; 12 to 15 bushels an acre. Soil requirements the same as for onion seed. Place the onion sets 3 to 4 inches apart, according to size, 3 inches deep, in rows 1 foot apart. Furrow out the soil with a hoe, set the onions in this furrow right side up, and cover with a garden rake.

	Qt.	3 Qts.
Yellow Bottom Sets.....	\$0.35	\$1.00
White Bottom Sets.....	.40	1.10
Red Bottom Sets.....	.35	1.00

By Parcel Post, Postpaid



PARSNIPS

OKRA OR GUMBO

CULTURE—One ounce of seed will sow 40 feet of drill. Very wholesome. The pods, when young, make fine soup and are also used in mixed vegetable soups. Plant seed after the ground is warm and dry, in drills 3 feet apart, thinning the young plants to 1 foot apart. Make early and late sowing to secure a supply throughout the season. Easy to grow in any good garden soil. Popular in the South.

DWARF GREEN LONG-POD—An early, dwarf growing, sturdy variety producing an abundance of long, fluted, dark green 8-inch pointed pods. One of the best for canning.

WHITE VELVET—Plants 3½ feet high. Pods creamy white, 7 inches long, slightly curved and pointed, smooth and tender, early and productive.

CLEMSON SPINELESS—All America Silver Medal for 1939. A very uniform spineless strain of the Perkins long-podded type. Plant has less foliage than Perkins; pods rich green, 7 inches long, straight, ridged. A valuable introduction for commercial or garden crops.

Prices on above varieties:

Postpaid (Pkt. 10c) (Oz. 20c) (¼ lb. 35c) (lb. \$1.00).

PARSLEY

One ounce of seed will plant 150 feet of drill; 3 pounds an acre.

EVERGREEN—Dark green very finely curled leaves, of upright growth with stout stems. Good for home garden as well as for market gardeners and forcing.

PARAMOUNT—Very uniform plants with stout stems for bunching, a vigorous grower developing to 12 inches tall and a width of 20 inches; shows resistance to tipburning and is of exceptionally dark rich green color.

PERFECTION — An excellent vigorous parsley with finely curled leaves. The color is deep emerald green and most attractive. Rapid grower with upright plants.

PLAIN OR ITALIAN — The leaves of this variety are flat, deeply cut but not curled. Very desirable for flavoring. Above, Prices Postpaid: (Pkt. 10c) (Oz. 20c) (¼ lb. 50c) (lb. \$1.50).

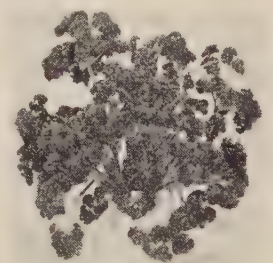

PARSLEY

PARSNIPS

One ounce of seed will plant 200 feet of drill; 3 pounds to the acre.

IDEAL OR MODEL—The roots are of medium length, very smooth, pure white without small roots or prongs. Very attractive for the home garden and more salable in the market. Of excellent quality.

Postpaid (Pkt. 10c) (Oz. 15c) (¼ lb. 40c) (lb. \$1.25).

GUERNSEY HOLLOW CROWN—Roots half long, smooth, thick-shouldered, of sugary flavor. One of the best.

Postpaid (Pkt. 10c) (Oz. 15c) (¼ lb. 40c) (lb. \$1.25).

ALL AMERICAN—A new and very good variety. The roots are large and broad-shouldered, of medium length, fine texture, white color with small core, free from side roots.

Postpaid (Pkt. 10c) (Oz. 20c) (¼ lb. 50c) (lb. \$1.50).

PEAS

CULTURE—One pound will plant 50 feet of drill; 90 to 120 pounds for an acre. Peas do best in a light, rich loamy soil that has been liberally manured the previous season. Plant the smooth varieties as early as the ground can be worked. The wrinkled peas are not so hardy as the smooth kinds, and should be planted later; they are, however, sweeter and better

ALASKA—60 days. The earliest of all smooth blue peas. Pods 3 inches in length. Vines 30 inches tall; very uniform in maturing the crop. Seeds small, round, smooth, bluish-green. Used for canning and early market.

**Postpaid (Pkt. 10c) (¼ lb. 20c) (lb. 40c) (5 lbs. \$1.75) (10 lbs. \$3.00).
Not Postpaid (10 lbs. \$2.50) (25 lbs. \$4.50) (100 lbs. \$16.00).**

THOMAS LAXTON—62 days. Excellent for home and market gardens and for shipping, canning, and freezing. Plants deep green and medium heavy. Pods, single rich deep green, plump, broad, blunt; contains 7-8 large, tender peas of splendid quality.

**Postpaid (Pkt. 10c) (¼ lb. 20c) (lb. 50c) (5 lbs. \$2.25) (10 lbs. \$4.00).
Not Postpaid (10 lbs. \$3.00) (25 lbs. \$6.00) (100 lbs. \$22.00).**

LITTLE MARVEL—62 days. This pea has been rightly named. It is an early wrinkled sort, grows about 12 to 15 inches tall, and bears heavily. There is no earlier wrinkled pea and the quality satisfies everybody. Adapted to home gardens. Pods dark green, 3 inches long, round with square ends, and often contains seven rich, dark green peas.

**Postpaid (Pkt. 10c) (¼ lb. 20c) (lb. 50c) (5 lbs. \$2.25) (10 lbs. \$4.00).
Not Postpaid (10 lbs. \$3.00) (25 lbs. \$6.00) (100 lbs. \$22.00).**

LAXTON'S PROGRESS—62 days. The largest podded and most attractive of the Laxtonian family. Popular for shipping to distant markets, also for home and market garden planting. Vines medium dark green. Pods single, ¾ inch wide, dark green, somewhat curved, pointed, handsome; contains 7 to 9 large peas of good quality. Seeds large, cream and green wrinkled. Our strain of this important variety is noted for its solid deep green color.

**Postpaid (Pkt. 10c) (¼ lb. 20c) (lb. 50c) (5 lbs. \$2.25) (10 lbs. \$4.00).
Not Postpaid (10 lbs. \$3.00) (25 lbs. \$6.50) (100 lbs. \$24.00).**

ROGERS GIANT PODDED HAMPER—65 days. A giant podded early variety, vines 22 inches tall, dark and heavy. Pods are 4½ to 5 inches long, dark green and pointed.

**Postpaid (Pkt. 10c) (¼ lb. 20c) (lb. 50c) (5 lbs. \$2.25) (10 lbs. \$4.00).
Not Postpaid (10 lbs. \$3.00) (25 lbs. \$7.00) (100 lbs. \$25.00).**



PEAS, TALL TELEPHONE

flavored. For a succession, plant every two weeks—until June 1st, then discontinue until August 1st, when the extra early varieties may be planted for a fall crop. When grown for market, peas are rarely staked; in small gardens grow in double rows, 12 inches apart, and stake with brush. They should be kept clean and the earth worked toward them two or three times during growth.



PEAS, LAXTON'S PROGRESS

ROGERS DWARF MARKET—72 days. Vines are about 28 inches high. Pods are dark green, pointed and 4 to 4½ inches long. They contain 7 to 9 peas of finest quality. A popular home and market garden variety.

**Postpaid (Pkt. 10c) (¼ lb. 20c) (lb. 50c) (5 lbs. \$2.25) (10 lbs. \$4.00).
Not Postpaid (10 lbs. \$3.00) (25 lbs. \$6.50) (100 lbs. \$24.00).**

DWARF ALDERMAN—72 days. One of the outstanding varieties for shipping and market gardeners. Vine 20 inches, bearing an abundance of heavy dark green vines. Pod 4½ inches, dark green and pointed.

**Postpaid (Pkt. 10c) (¼ lb. 20c) (lb. 50c) (5 lbs. \$2.25) (10 lbs. \$4.00).
Not Postpaid (10 lbs. \$3.00) (25 lbs. \$7.00) (100 lbs. \$25.00).**

No. 95 or ICER—80 days. Vine 20 inches high, coarse and dark green. Length of pod 4½ to 5 inches, dark green and pointed. Excellent for shipping.

**Postpaid (Pkt. 10c) (¼ lb. 20c) (lb. 50c) (5 lbs. \$2.25) (10 lbs. \$4.00).
Not Postpaid (10 lbs. \$3.00) (25 lbs. \$7.00) (100 lbs. \$25.00).**

No. 40—75 days. Resembles Strategem but 4 to 5 days earlier; unequalled in pod size, and exceptional in quality; resistant to Fusarium wilt. Bred particularly for shippers and market gardeners. Vines dark green, stocky and branching. Pods single and double, round, dark green, plump, pointed, curved at tip; contain 8 to 10 large, succulent peas. Seeds large, wrinkled, green.

**Postpaid (Pkt. 10c) (¼ lb. 20c) (lb. 50c) (5 lbs. \$2.25) (10 lbs. \$4.00).
Not Postpaid (10 lbs. \$3.00) (25 lbs. \$7.00) (100 lbs. \$25.00).**

TALL TELEPHONE (Dark Podded)—74 days. Identical with Alderman; excellent for home and market garden, and for shipping. Vines dark green, coarse. Pods single, broad, plump, dark green, pointed, straight. Seeds large, wrinkled, light green. A standard mid-season variety of high quality.

**Postpaid (Pkt. 10c) (¼ lb. 20c) (lb. 50c) (5 lbs. \$2.25) (10 lbs. \$4.00).
Not Postpaid (10 lbs. \$3.00) (25 lbs. \$6.00) (100 lbs. \$22.00).**

PEAS—Continued

DWARF TELEPHONE—75 days. A late, large podded, highly productive sort, for home garden and truckers, and for shipping. Resistant to Fusarium wilt. Vines light green, stocky and branching. Pods single and double, medium light green, lightly curved, broad, pointed and attractive; contains 8 to 10 peas of excellent quality. Seeds large, wrinkled, green, with bluish cast.

Postpaid (Pkt. 10c) (¼ lb. 20c) (lb. 50c) (5 lbs. \$2.25) (10 lbs. \$4.00).
Not Postpaid (10 lbs. \$3.00) (25 lbs. \$6.00) (100 lbs. \$22.00).

ALDERMAN—74 days. A handsome large podded variety of the Telephone family. Excellent for home garden, for truckers, and for shipping to distant markets; resistant to Fusarium wilt. Vines dark green, coarse. Pods single, very broad, plump, straight, dark green, pointed; contain 8 to 10 peas of highest quality. Seed large, wrinkled, light green. This variety can well be considered the standard of high quality.

Postpaid (Pkt. 10c) (¼ lb. 20c) (lb. 50c) (5 lbs. \$2.25) (10 lbs. \$4.00).
Not Postpaid (10 lbs. \$3.00) (25 lbs. \$6.00) (100 lbs. \$22.00).

EVERBEARING—76 days. A long bearing variety for the home and market garden; resistant to Fusarium wilt. Vines dark green, thick, coarse and branching. Pods double, light green, plump, blunt, straight; contain 4 to 5 large peas of sweet marrowy flavor. Seeds very large, light green, flat, wrinkled.

Postpaid (Pkt. 10c) (¼ lb. 20c) (lb. 50c) (5 lbs. \$2.25) (10 lbs. \$4.00).
Not Postpaid (10 lbs. \$3.00) (25 lbs. \$6.00) (100 lbs. \$22.00).

DWARF GRAY SUGAR (Edible Pod)—68 days. A prolific edible podded variety for home garden; resistant to Fusarium wilt. Vines slender and wiry, with purple blossoms. Pods double, light green, heavily curved, semi-pointed, strongly indented between the peas. Seeds small, mottled, gray, round.

Postpaid (Pkt. 10c) (¼ lb. 20c) (lb. 50c) (5 lbs. \$2.25) (10 lbs. \$4.00).
Not Postpaid (10 lbs. \$3.00) (25 lbs. \$6.00).

GIANT LUSCIOUS SUGAR—74 days. A tall growing edible podded variety for home and market garden. It is used in the same way as snap beans; resistant to Fusarium wilt. Pods 5 inches, broad blunt. Seed large, smooth, gray.

Postpaid (Pkt. 10c) (¼ lb. 20c) (lb. 50c) (5 lbs. \$2.25).

PEANUTS

CULTURE—Peanuts can be successfully grown in the North on warm, sandy soil in a sheltered place with a southern exposure.

Plant the same as corn in rows 2½ feet apart. Drop the shelled nuts 8 to 10 inches apart, cover 1 inch deep. When the plants are nearly grown, throw earth up to them. This will cause the nuts to form.

IMPROVED LARGE VIRGINIA (Jumbo)—It has the largest pods and more kernels, with fewer imperfect pods.

Postpaid (lb. 60c).

TENNESSEE REDS—The earliest variety grown. Pods are small, well filled and of fine quality.

Postpaid (lb. 60c).

WHITE SPANISH—110 days. The dwarf bushes grow close and are easily cultivated and gathered. The kernels are small and very sweet.

Postpaid (lb. 60c).



PEPPER, PIMENTO

PEPPERS

CULTURE—One ounce of seed should produce 1,000 to 1,500 plants. A warm, moist soil is best suited for peppers. For early green peppers sow seed in hotbeds in January, February or March, according to locality and climate. Transplant to the field as soon as weather and soil in your locality will permit, and when danger of frost has passed. Pepper Seeds are slow and hard to germinate, therefore those sown early will require a good hotbed with plenty of heat. Otherwise the seed will rot before they sprout. Pepper plants are very tender and easily killed by frost.

OAKVIEW WONDER—65 days. Developed from California Wonder, but is at least a week earlier. It has slightly smaller but blockier and more symmetrical fruits and lacks the deep depression and curling at the nose which characterize most peppers. Has thick walls and high quality of California Wonder, and its exceptional uniformity, earliness and high yield have already made it a favorite among market growers and truckers.

Postpaid (Pkt. 10c) (Oz. 75c) (¼ lb. \$2.00) (lb. \$8.50).

KING OF THE NORTH—65 days. A late introduction, and a winner, similar in type to Ruby King, but decidedly earlier. The plant is of medium size and prolific. The fruit is long, moderately slender, tapering to three or four points.

Postpaid (Pkt. 10c) (Oz. 60c) (¼ lb. \$2.00) (lb. \$6.00).

CALIFORNIA WONDER—75 days. An outstanding medium late variety for market garden and shipping. Plants vigorous, upright, prolific. Fruits 4-lobed, chunky; very attractive, smooth, uniform and deep green, changing to bright crimson; flesh thicker than any other variety; sweet and mild.

Postpaid (Pkt. 10c) (Oz. 60c) (¼ lb. \$2.00) (lb. \$6.00).

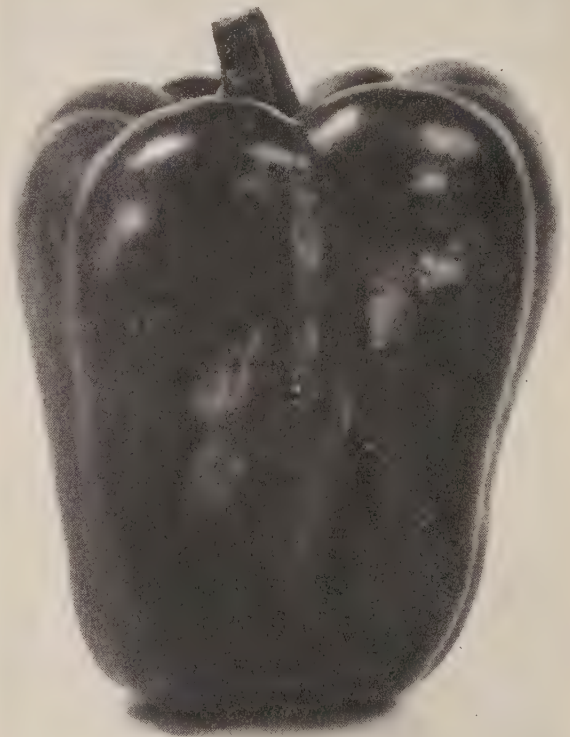

PEPPER, CALIFORNIA WONDER

CALIFORNIA WONDER BELL STRAIN (Special)—75 days. This variety averaging 4 inch in length to 3½ inches in diameter with but a single taper, which makes them almost square. The walls are ¼ to ⅝ of an inch in thickness. It is an excellent shipping sort and because of the uniformity of shape they pack well. The skin is a deep rich green, smooth and glossy. The ideal pepper for home and market.

Postpaid (Pkt. 25c) (Oz. \$1.00) (¼ lb. \$3.50) (lb. \$12.00).

HARRIS' EARLY GIANT—63 days. An excellent first early sweet variety for home and market garden use. Plants dwarf, upright, very productive. Fruits gently tapered, 3-lobed, of mild flavor; deep green changing to bright red.

Postpaid (Pkt. 10c) (Oz. 60c) (¼ lb. \$2.00) (lb. \$6.00).

PIMENTO—73 days. Pre-eminently a canning variety; good also for home and market garden planting. Plants large, erect, prolific. Fruits heart-shaped, very smooth; color dark green, changing to bright crimson; flesh exceptionally thick, sweet and mild.

Postpaid (Pkt. 10c) (Oz. 60c) (¼ lb. \$1.50) (lb. \$5.50).

LARGE BELL or BULL NOSE—60 days. A popular, early sweet, prolific sort, with small, erect plants. Fruits blunt, deep green, changing to scarlet red; mild in flavor. Postpaid (Pkt. 10c) (Oz. 60c) (¼ lb. \$2.00) (lb. \$6.00).

PAPRIKA—70 days. A new item in the U. S. A. Plant of medium size, very prolific. Fruits 4½ inches long and 1½ inches wide at stem end, tapered, deep red at maturity, flavor sweet with pungency in ribs and seeds. Postpaid (Pkt. 10c) (Oz. 75c) (¼ lb. \$2.50) (lb. \$7.50).

WORLD BEATER (Wilt Resistant Strain)—75 days. A new development in peppers, a wilt resistant strain. Fruit 4-lobed, and very large. Flesh thick, mild and sweet. Pepper tapering and of a bright ruby red when ripe, very prolific. Postpaid (Pkt. 10c) (Oz. 75c) (¼ lb. \$2.00) (lb. \$6.00).

HOT VARIETIES

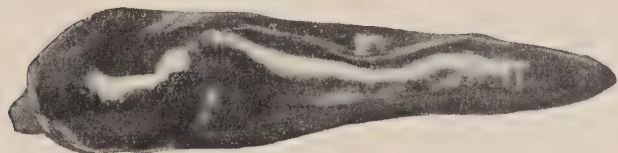

PEPPER, CHILI

ANAHEIM CHILI—80 days. A hot, late variety; used for home and market garden, and for canning and drying. Fruits tapering, deep green, changing to bright scarlet at maturity. Postpaid (Pkt. 10c) (Oz. 75c) (¼ lb. \$2.00) (lb. \$6.00).

COLLEGE No. 9—80 days. A hot variety developed by the New Mexico Experiment Station. Very similar to Anaheim but pods are smaller and more slender. Fruits dark red when mature, excellent for drying. Postpaid (Pkt. 10c) (Oz. 75c) (¼ lb. \$2.00) (lb. \$6.00).

HUNGARIAN YELLOW WAX—65 days. Long, waxy-yellow, changing to crimson. Pointed and tapering. Plants dwarf and prolific. Postpaid (Pkt. 10c) (Oz. 75c) (¼ lb. \$2.00) (lb. \$6.50).

IMPROVED THICK LONG RED—70 days. Bright red pods about 4 inches long; thicker than the ordinary Red Cayenne. Flesh thick and very hot. Very prolific and quite early. Postpaid (Pkt. 10c) (Oz. 75c) (¼ lb. \$2.00) (lb. \$6.50).

LONG RED CAYENNE—70 days. A red, hot variety. Fruits tapering, frequently twisted; very pungent; deep green changing to brilliant red. Postpaid (Pkt. 10c) (Oz. 75c) (¼ lb. \$2.00) (lb. \$6.50).

MEXICAN CHILI—70 days. A large, hot pepper used in making tamales and pungent sauces. Color is glossy green turning to red when ripe. Postpaid (Pkt. 10c) (Oz. 75c) (¼ lb. \$2.00) (lb. \$6.50).

RED CHERRY—82 days. Plants vigorous, upright, prolific. Fruits erect, conical, extremely pungent. Color yellowish green, changing to deep red. Postpaid (Pkt. 10c) (Oz. 75c) (¼ lb. \$2.00) (lb. \$6.50).

RED CHILI—82 days. Small, pointed, yellowish-green changing to deep red. Postpaid (Pkt. 10c) (Oz. 75c) (¼ lb. \$2.00) (lb. \$6.50).

PUMPKIN

CULTURE—One ounce of seed will plant twenty hills; three pounds an acre. Pumpkins are very similar in culture to the squashes and other vine crops, except that they are not so particular as to soil and cultivation. In the latitude of Denver they may be planted during May in the garden or in the corn field 6 to 8 feet each way.



DICKINSON—A large extraordinary thick fleshed sweet, deep golden yellow pumpkin, excellent for canning without addition of sugar, smooth texture, also good for stock feeding as it has a high protein content. Postpaid (Pkt. 10c) (Oz. 15c) (¼ lb. 50c) (lb. \$1.50).

SMALL SUGAR OR PIE—It is small, has deep orange skin, fine-grained flesh, is an excellent keeper and very prolific. Postpaid (Pkt. 10c) (Oz. 15c) (¼ lb. 50c) (lb. \$1.50).

GREEN STRIPED CUSHAW—18 inches to 2 feet long and 12 inches in diameter; green striped with crooked neck. Flesh thick, yellow, coarse but sweet. Postpaid (Pkt. 10c) (Oz. 15c) (¼ lb. 50c) (lb. \$1.50).

JAPANESE PIE—The flesh is thick, of a rich salmon color, fine-grained, dry and sweet. Seed cavity very small. Very early, productive and highly esteemed for pies or cooking. Postpaid (Pkt. 10c) (Oz. 15c) (¼ lb. 50c) (lb. \$1.50).

KING OF THE MAMMOTH OR POTIRON—The largest of all pumpkins, often 2 feet or more in diameter, and sometimes weighing over 100 pounds. The skin is sallow-yellow; the flesh thick and of a bright yellow; often used for pies, but grown principally for stock-feeding. Postpaid (Pkt. 10c) (Oz. 15c) (¼ lb. 50c) (lb. \$1.75).

LARGE CHEESE OR KENTUCKY FIELD—Large, round, somewhat flattened. A fine keeper. Flesh yellow, very thick and of excellent quality. Fine for family or market use; also grown for stock feeding. Postpaid (Pkt. 10c) (Oz. 15c) (¼ lb. 50c) (lb. \$1.50).

CONNECTICUT FIELD—A large, round or slightly oval pumpkin. Skin reddish-orange color, with rich orange-yellow flesh. Grown extensively for stock feeding; also good for pies. Generally planted with corn. Postpaid (Pkt. 10c) (Oz. 15c) (¼ lb. 50c) (lb. \$1.50).

TENNESSEE SWEET POTATO—Recommended for pies and custards. Pear-shaped, slightly ribbed, creamy white color slightly striped with green. Flesh creamy white, fine-grained, dry and with flavor resembling a sweet potato. Postpaid (Pkt. 10c) (Oz. 15c) (¼ lb. 50c) (lb. \$1.50).



PUMPKINS

RADISH

One ounce of seed will sow 100 feet of drill; 8 to 10 pounds will plant an acre.

EARLY SCARLET GLOBE—24 days. A very popular variety; is outstandingly good, and well adapted to both field culture and greenhouse forcing. Roots globular, very slightly elongated, with medium top; bright scarlet, crisp, tender and of fine quality.

Postpaid (Pkt. 10c) (Oz. 15c) (¼ lb. 30c) (lb. 90c) (5 lbs. \$4.00).

COMET—25 days. Bright cherry-red, with unusually firm and crisp flesh. Roots are globe to round in shape. Tops are 3½ to 4 inches. Grows to good size before getting pithy and remains firm longer than most early globe types, a desirable feature for both home and market garden use. Hot weather resistant.

Postpaid (Pkt. 10c) (Oz. 15c) (¼ lb. 30c) (lb. 90c) (5 lbs. \$4.00).

SPECIAL FORCING SCARLET GLOBE—Our special strain of short-topped Scarlet Globe bred especially for greenhouse work.

Postpaid (Oz. 15c) (¼ lb. 40c) (lb. \$1.10) (5 lbs. \$5.00).

CAVALIER—23 days. An attractive variety of short topped Scarlet Globe type; primarily for forcing in greenhouse or frames. Tops about one inch shorter than Standard Scarlet Globe; roots uniform, olive-shaped, deep scarlet.

Postpaid (Pkt. 10c) (Oz. 15c) (¼ lb. 40c) (lb. \$1.10) (5 lbs. \$5.00).

VICK'S SCARLET GLOBE—22 days. Deep scarlet radish with uniform oblong globe shape, tops medium length, good for cool season growing and makes an ideal bunch for packing.

Postpaid (Pkt. 10c) (Oz. 15c) (¼ lb. 30c) (lb. 90c) (5 lbs. \$4.00).

SAXA—22 days. Excellent forcing variety with a very small top, bright scarlet, ball shaped roots. Very early.

Postpaid (Pkt. 10c) (Oz. 15c) (¼ lb. 30c) (lb. 90c) (5 lbs. \$4.00).

CRIMSON GIANT—28 days. Large globe-shaped red variety with a large top.

Postpaid (Pkt. 10c) (Oz. 15c) (¼ lb. 35c) (lb. \$1.00) (5 lbs. \$4.50).

FRENCH BREAKFAST—25 days. Oblong roots, scarlet color with a white tip. Half inch thick by 1½ inches long.

Postpaid (Pkt. 10c) (Oz. 15c) (¼ lb. 30c) (lb. 90c) (5 lbs. \$4.00).

PERFECTION WHITE TIPPED (Sparkler)—26 days. Perfectly round or ball shaped, upper half bright scarlet, lower half a clear white; very attractive in appearance. Largely grown for market and home use.

Postpaid (Pkt. 10c) (Oz. 15c) (¼ lb. 30c) (lb. 90c) (5 lbs. \$4.00).

CINCINNATI MARKET Long Red—28 days. An improved strain of Long Scarlet, being slightly larger and with a very small top; roots 6 to 7 inches long; scarlet colored; flesh white, almost transparent; brittle and crisp.

Postpaid (Pkt. 10c) (Oz. 15c) (¼ lb. 30c) (lb. 90c) (5 lbs. \$4.00).

WHITE ICICLE—27 days. Fine, long, wax-white roots, crisp and mild. Our stock is an improved strain.

Postpaid (Pkt. 10c) (Oz. 15c) (¼ lb. 30c) (lb. 90c) (5 lbs. \$4.00).

PINK BEAUTY—28 days. Its unusual large size, splendid quality and long standing character make it a very useful variety for the home gardener. The clear pink color is something different from the ordinary. This may prove an attraction for the public. We recommend a trial.

Postpaid (Pkt. 10c) (Oz. 15c) (¼ lb. 40c) (lb. \$1.15) (5 lbs. \$5.25).

PHILADELPHIA BOX WHITE—28 days. A medium early, white variety for forcing or outside culture. Roots round, slightly top shaped, flesh white, very crisp, fine grained and tender.

Postpaid (Pkt. 10c) (Oz. 15c) (¼ lb. 35c) (lb. \$1.00) (5 lbs. \$4.50).

MIXED RADISHES—All kinds, colors and shapes. Just what is wanted for the garden where the space is limited. One sowing is all that is required for a continuous supply.

Postpaid (Pkt. 10c) (Oz. 15c) (¼ lb. 30c) (lb. 90c) (5 lbs. \$4.00).

WINTER VARIETIES

CHINA ROSE—52 days. Rose, 5-inch root, 2 inches across, cylindrical, blunt-ended and heavier at lower end. Flesh is pungent.

Postpaid (Pkt. 10c) (Oz. 15c) (¼ lb. 50c) (lb. \$1.50).

LONG BLACK SPANISH—55 days. Uniform gray-black, top-shaped, 8-inch roots, 3 inches across at thickest part. White, crisp, pungent flesh.

Postpaid (Pkt. 10c) (Oz. 15c) (¼ lb. 50c) (lb. \$1.50).

ROUND BLACK SPANISH—56 days. Gray-black, round, slightly top-shaped roots, 4 inches across and 3 inches deep. White, pungent flesh.

Postpaid (Pkt. 10c) (Oz. 15c) (¼ lb. 50c) (lb. \$1.50).

WHITE SPANISH OR CELESTIAL—48 days. Very large, white, cylindrical, smooth roots, 6 to 9 inches long and 2½ to 3 inches across with white, crisp flesh.

Postpaid (Pkt. 10c) (Oz. 15c) (¼ lb. 50c) (lb. \$1.50).

RHUBARB

CULTURE—The roots can be raised from seed sown in the spring, and are ready to transplant to the permanent bed the next spring. Seedlings cannot be relied upon to produce the variety true to type no matter how carefully the seed is raised, so the roots that produce the largest and best stalks should be used, the rest being discarded.

VICTORIA—Stalks grow very large and are light green and scarlet in color.

Seed Postpaid (Pkt. 10c) (Oz. 20c) (¼ lb. 60c) (lb. \$2.00).



RADISH, EARLY SCARLET GLOBE

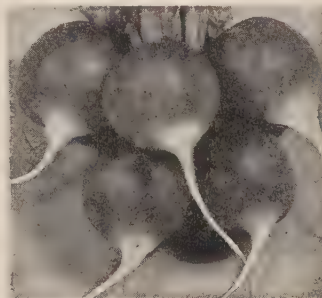

RADISH
PERFECTION
WHITE TIPPED



RADISH, FRENCH BREAKFAST

SALSIFY OR VEGETABLE OYSTER

CULTURE—A desirable winter vegetable. The roots, when cooked, are palatable and nutritious. Flavor is similar to oysters. A light, rich soil is most suitable, and it should be worked to a good depth. Seed is sown in spring in rows 12 to 15 inches apart and thinned to 4 inches apart in the row.

MAMMOTH SANDWICH ISLAND—A popular market garden sort, producing good sized roots, comparatively smooth.

Postpaid (Pkt. 10c) (Oz. 30c) (¼ lb. 85c) (lb. \$3.00).

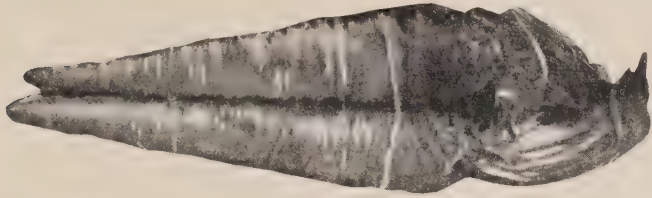

SALSIFY

SPINACH

CULTURE—One ounce of seed will plant 100 feet of drill; 10 pounds an acre. Spinach is an important crop of easy culture for the market gardener. For spring and early summer use, sow in drills 1 foot apart and 1 inch deep, as early as the ground can be worked, and every two weeks thereafter for a succession crop. For winter and early spring use, sow in September in well-manured ground. Cover with straw on the approach of cold weather.

GIANT GAUDRY (Longstanding)—A rapid growing variety producing early in the season a mass of rather smooth, thick, rounded leaves of very large size. It stands well without bolting, yields a greater bulk than other varieties, and is highly recommended for both the home and market garden; fine for canning.

Postpaid (Pkt. 10c) (Oz. 15c) (¼ lb. 25c) (lb. 65c) (5 lbs. \$3.00) (10 lbs. \$5.50) (25 lbs. \$12.50).

GIANT NOBEL (Longstanding)—Very valuable for market gardens and canning. Plants large, vigorous and spreading. It is slow to form seed stalks, and an extremely heavy yielder. Leaves huge, thick, smooth, pointed, with rounded tip; deep green, tender. The best of the Giant Thick Leaved sorts.

Postpaid (Pkt. 10c) (Oz. 15c) (¼ lb. 25c) (lb. 65c) (5 lbs. \$3.00) (10 lbs. \$5.50) (25 lbs. \$12.50).



SPINACH

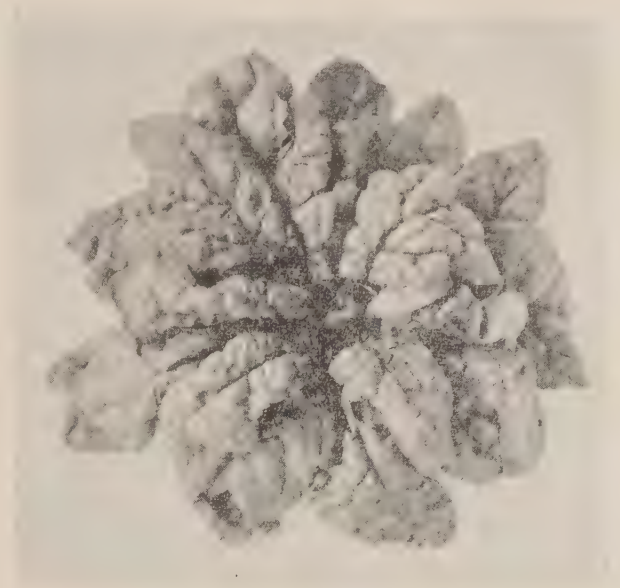

SPINACH. SAVOY

VIKING (Longstanding)—Produces very large and vigorous plants, heavy yielding and slow to bolt to seed. The leaves are very large, broad, thick, dark green and partially crumpled.

Postpaid (Pkt. 10c) (Oz. 15c) (¼ lb. 25c) (lb. 65c) (5 lbs. \$3.00) (10 lbs. \$5.50) (25 lbs. \$12.50).

BLOOMSDALE SAVOY (Reselected)—Very early and hardy, and one of the best for market and canning. Plant of upright growth, with a tendency to go quickly to seed in hot weather. Stems 3 inches long, leaves of medium size.

Postpaid (Pkt. 10c) (Oz. 15c) (¼ lb. 25c) (lb. 65c) (5 lbs. \$3.00) (10 lbs. \$5.50) (25 lbs. \$12.50).

BLOOMSDALE SAVOY (Longstanding)—Only a few days later than the regular Bloomsdale Savoy, it holds 12 to 14 days longer before throwing seed stalks. Plants are very uniform and sturdy, with very attractive, highly crumpled and blistered dark green leaves. Exceptionally valuable for home and market gardens, and for shipping.

Postpaid (Pkt. 10c) (Oz. 15c) (¼ lb. 25c) (lb. 65c) (5 lbs. \$3.00) (10 lbs. \$5.50) (25 lbs. \$12.50).

SPECIAL SUMMER SAVOY—A new selection from the popular Longstanding Bloomsdale. It is darker green, will stand 3 to 4 days longer, and is best suitable for summer planting.

Postpaid (Pkt. 10c) (Oz. 15c) (¼ lb. 25c) (lb. 65c) (5 lbs. \$3.00) (10 lbs. \$5.50) (25 lbs. \$12.50).

HOLLANDIA (Prickly Winter)—A longstanding, late maturing sort; plant very large, vigorous and hardy; leaves round, thick, medium sized and dark green.

Postpaid (Pkt. 10c) (Oz. 15c) (¼ lb. 25c) (lb. 65c) (5 lbs. \$3.00) (10 lbs. \$5.50) (25 lbs. \$12.50).

OLD DOMINION (Blight Resistant)—Resistant to Mosaic. Similar to Bloomsdale, except slightly smoother in appearance with flatter spreading growth. Leaves pointed and savoyed. Good shipper.

Postpaid (Pkt. 10c) (Oz. 15c) (¼ lb. 25c) (lb. 65c) (5 lbs. \$3.00) (10 lbs. \$5.50) (25 lbs. \$12.50).

NEW ZEALAND—Distinct from other kinds of spinach and particularly valuable for culture in hot, dry weather. Seeds comparatively large and nut-like. Plants very large and spreading; leaves numerous, small, triangular, thick, deep green. The tender leafy shoots are gathered repeatedly.

Postpaid (Pkt. 10c) (Oz. 20c) (¼ lb. 70c) (lb. \$2.00).

SQUASH

CULTURE—After danger of frost is past, plant in a warm, well pulverized, rich soil, mixing well-rotted manure in each hill. Plant 8 to 10 seed to the hill, about May 10th, for the summer varieties 4 to 6 feet apart, and the winter sorts 8 to 10

YANKEE HYBRID—45 days. This is a true first generation hybrid made by controlled crossing of inbreds of Connecticut Straightneck and Early Prolific. This cross produces a squash that is distinctly earlier than either parent. It is more productive and more uniform. The vine is bush type. Fruit medium yellow, straight and very slightly warted.

Pkt. (15c) (Oz. 50c) (¼ lb. \$1.50) (lb. \$5.50).

EARLY YELLOW STRAIGHTNECK—A lemon-yellow colored and small sized squash. Of late years the demand is for small, light yellow fruits, and this variety fills the bill. It is especially noted for its large yield of early fruits.

Postpaid (Pkt. 10c) (Oz. 20c) (¼ lb. 50c) (lb. \$1.50).

GIANT SUMMER CROOKNECK—The largest and one of the earliest summer varieties; fruit often 2 feet long, very warty and deep orange in color.

Postpaid (Pkt. 10c) (Oz. 20c) (¼ lb. 50c) (lb. \$1.50).

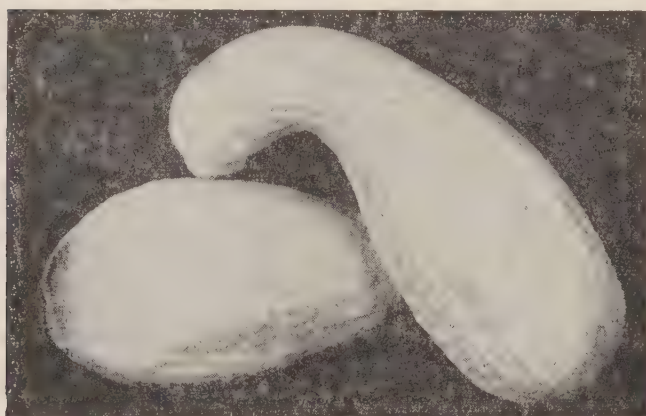

SQUASH, EARLY SUMMER CROOKNECK

GIANT SUMMER STRAIGHTNECK—A distinct improvement on the Crookneck strain, as it packs to better advantage for shipping. Popular with market gardeners and shippers. Fruits thick-necked, heavily warted, straight, orange-yellow; flesh thick, light yellow.

Postpaid (Pkt. 10c) (Oz. 20c) (¼ lb. 50c) (lb. \$1.50).

EARLY WHITE BUSH (Green Tinted)—A well-known variety of dwarf habit and upright growth. Surface comparatively smooth. Color, greenish-white while young, then changing to creamy white. One of the best and most popular sorts.

Postpaid (Pkt. 10c) (Oz. 20c) (¼ lb. 50c) (lb. \$1.50).

ZUCCHINI (Short Cocozella)—A short type of Cocozella; fruit 7 to 8 inches long and 3 inches in diameter at picking stage; color light green speckled white; bush habit.

Postpaid (Pkt. 10c) (Oz. 20c) (¼ lb. 50c) (lb. \$1.50).

COCOZELLA (Long Type)—A summer variety of bush habit; fruit oblong, 12 to 14 inches in length and 3 inches in diameter at picking stage; color dark green with light green stripes.

Postpaid (Pkt. 10c) (Oz. 20c) (¼ lb. 50c) (lb. \$1.50).



ZUCCHINI SQUASH, BLACK

feet, about July 1st. When well grown, thin out, leaving three of the strongest plants in each hill. Do not bruise or break the stems of the winter squashes when gathering. Plant summer sorts, 1 ounce to 25 hills; 3 to 4 pounds to an acre; winter sorts, ounce to 10 hills; 3 to 4 pounds to an acre.

BANANA—A late sort, cylindrical and pointed at blossom end, with thin, slate-gray rind. Flesh thick, fine grained, yellowish orange, and of sweet flavor. Seeds brown and highly enameled.

Postpaid (Pkt. 10c) (Oz. 20c) (¼ lb. 50c) (lb. \$1.50).

BUTTERCUP—100 days. Turban shaped with distinctive protruding button at blossom end of fruits, slightly ribbed, rind thin but hard and tough, skin dark green with silvery white lines and flecked with dull gray spots, size 4½ inches deep by 6½ inches in diameter. Flesh deep golden-yellow, thick, dry and very sweet. It is prolific, early and a fairly good keeper.

Postpaid (Pkt. 10c) (Oz. 20c) (¼ lb. 50c) (lb. \$1.50).

BUTTERNUT—90 days. Fruits average 3 to 4 pounds, 8 to 10 inches long, bulbous at the blossom end, where the small seed cavity is located; the thick neck is solid flesh. Rind thin, tough, cream colored, flesh fine grained, nutty and of excellent table quality. A prolific yielder and fairly good keeper.

Postpaid (Pkt. 10c) (Oz. 20c) (¼ lb. 50c) (lb. \$1.50).

CHICAGO WARTED HUBBARD—Somewhat larger than Improved Hubbard and more thickly covered with warts. Pointed at each end, very dark green; flesh deep orange-yellow, dry and sweet. A prolific, good keeping sort.

Postpaid (Pkt. 10c) (Oz. 20c) (¼ lb. 50c) (lb. \$1.50).

IMPROVED GREEN HUBBARD—Standard winter sort for home market gardeners, and for shipping. Fruits weigh 10 to 12 pounds, pointed at both ends, slightly warted, dark bronze-green in color; rind hard and tough; flesh very thick, orange-yellow, dry and sweet.

Postpaid (Pkt. 10c) (Oz. 20c) (¼ lb. 50c) (lb. \$1.50).

BLUE HUBBARD—100 days. Fruits large, round pointed at both ends. Slightly ridged, with very hard blue-gray rind; weight 12-14 pounds. Flesh yellow-orange, thick, of fine flavor.

Postpaid (Pkt. 10c) (Oz. 20c) (¼ lb. 50c) (lb. \$1.50).

VERMONT HUBBARD—105 days. Similar in size and shape to Imp. Hubbard, but more warted and uniform. Fruits about 10 lbs., dark green in color; shell very hard and strong; flesh exceptionally thick, deep orange, dry, fine grained, and of excellent flavor.

Postpaid (Pkt. 10c) (Oz. 20c) (¼ lb. 50c) (lb. \$1.50).

MARBLEHEAD—An early maturing variety of the Hubbard family, the rind is quite smooth, hard and slate gray in color. The dry, sweet flesh is very thick and quality is extra good. Curly top resistant.

Postpaid (Pkt. 10c) (Oz. 20c) (¼ lb. 50c) (lb. \$1.50).

GOLDEN HUBBARD—Similar to Green Hubbard, but earlier, smaller and more prolific. Popular with home and market gardeners and canners. Fruits somewhat pointed at each end; weight 8 to 10 pounds, moderately warted, orange-red, with faint cream colored stripes toward blossom end; flesh deep orange, dry and of fine quality; it keeps well.

Postpaid (Pkt. 10c) (Oz. 20c) (¼ lb. 50c) (lb. \$1.50).

TABLE QUEEN OR ACORN—Desirable for home and market garden use, also for shipping. Trailing in habit, with acorn-shaped fruits, ribbed, smooth, thin-shelled, dark green. Flesh light yellow, bakes well and sweet, inviting flavor. An early maturing variety.

Postpaid (Pkt. 10c) (Oz. 20c) (¼ lb. 50c) (lb. \$1.50).

MAMMOTH TABLE QUEEN—80 days. A distinctive, large fruited strain of this hard and prolific variety. Comparable in season to regular Table Queen and with fruits similar in shape and color but much larger—average 5 inches across and 6 to 7 inches deep.

Postpaid (Pkt. 10c) (Oz. 20c) (¼ lb. 50c) (lb. \$1.50).

DELICIOUS—A popular winter sort, with top-shaped fruits weighing 7 to 8 pounds. Skin dark green, with light green stripes toward the blossom end; flesh orange, dry and of good flavor.

Postpaid (Pkt. 10c) Oz. 25c) (¼ lb. 75c) (lb. \$2.00).

TOMATOES

CULTURE—Days indicated represent the time required from the setting of plants to produce marketable fruits. One ounce of seed should produce 2,000 plants. Tomatoes do best on light, warm, not over-rich soil. Success depends in a large measure upon securing a rapid, vigorous, unchecked growth during the early part of the season. For first early tomatoes select varieties of the earliest types, and start the plants under glass in hot beds or greenhouses during February and March. When the plants are about 2 inches high they should be transplanted to flats, pots or plant boxes. Never crowd the plants, but keep them short and stocky. Plants already in

bloom, if in pots or boxes, may be transplanted to the open ground without disturbing their roots, and will continue to bloom and fruit without check. When danger from frost has passed, set the plants in the field in rows about 4 feet apart each way, in warm, mellow soil of fair fertility. For main crop the plants can be started somewhat later in hot beds or cold frames and then set in the open ground the same as the early varieties. Tomatoes require very little water, just enough to keep them in good growing condition; too much water will cause them to blight. Cultivate often and thoroughly as long as the vines will permit. The last two or three workings of the soil should be shallow or the crop may be badly injured.

ASGROW SCARLET DAWN—70 days. Vines of medium growth fairly open very prolific. Fruits medium large with thick wall structure globular, smooth, free from flat sides, bright scarlet, ripening well to the stem, very attractive.

Postpaid (Pkt. 10c) (Oz. 50c) (¼ lb. \$1.75) (lb. \$6.50).

BREAK OF DAY—70 days. A cross of Marglobe and Marvana, resistant to Wilt and Nail-head rust. Plant light, of open spreading habit, with medium foliage; early and very prolific. Fruits medium large, orange-red, uniform, globe shaped, smooth.

Postpaid (Pkt. 10c) (Oz. 50c) (¼ lb. \$1.75) (lb. \$6.50).

BONNY BEST—74 days. Early mid-season sort for market, canning or shipping. Medium sized, bright scarlet fruits, smooth, solid and flattened globe shape.

Postpaid (Pkt. 10c) (Oz. 50c) (¼ lb. \$1.75) (lb. \$6.50).

BOUNTY—65 days. Fruits are globular, medium size, 2½ to 3 inches in diameter, scarlet. Core is small. Fruits smooth, borne high on plant. Vines small and self-topping.

Postpaid (Pkt. 10c) (Oz. 60c) (¼ lb. \$2.00) (lb. \$7.00).

CHALK'S EARLY JEWEL—76 days. A second-early sort for home gardens and truckers, also good for canning in the North. Plant medium, with open growth; prolific. Fruits medium large, smooth, scarlet, flattened, globe-shaped.

Postpaid (Pkt. 10c) (Oz. 50c) (¼ lb. \$1.75) (lb. \$6.50).

EARLIANA—66 days. Very productive for an early sort; fruits of fair size, round, very smooth and solid, and produced in clusters in center of plant; color bright scarlet. Plants have a distinct open habit of growth.

Postpaid (Pkt. 10c) (Oz. 50c) (¼ lb. \$1.75) (lb. \$6.50).

EARLY DETROIT—81 days. A mid-season sort with rather heavy, highly productive plants. Fruits medium large, semi-globular; purplish pink, quite smooth and solid.

Postpaid (Pkt. 10c) (Oz. 50c) (¼ lb. \$1.75) (lb. \$6.50).

EXTRA EARLY BISON—63 days. Developed at the North Dakota Agricultural Station. This variety produces an early and very heavy crop under very adverse conditions. Fruit is a little larger and earlier than Earliana, deep scarlet, meaty, few seeds and finest quality.

Postpaid (Pkt. 10c) (Oz. 50c) (¼ lb. \$1.75) (lb. \$6.50).

GOLDEN QUEEN—84 days. An attractive novelty, producing medium size, rich golden yellow fruits, slightly flattened, smooth, firm, good flavored, being milder than the red varieties.

Postpaid (Pkt. 10c) (Oz. 50c) (¼ lb. \$1.75) (lb. \$6.50).

GROTHEN'S RED GLOBE—70 days. An early maturing, smooth, productive wilt-resisting variety that is becoming popular for shipping. The fruits are deep scarlet; color and size about like Marglobe.

Postpaid (Pkt. 10c) (Oz. 50c) (¼ lb. \$1.75) (lb. \$6.50).

INDIANA BALTIMORE—80 days. A main crop or mid-season variety, fruits are large sized, good red internal color and solid structure. The vines are vigorous, leaves very coarse, heavy producer.

Postpaid (Pkt. 10c) (Oz. 50c) (¼ lb. \$1.50) (lb. \$5.00).

JOHN BAER—70 days. A few days earlier than Bonny Best, which it resembles. For local market and canning.

Postpaid (Pkt. 10c) (Oz. 50c) (¼ lb. \$1.75) (lb. \$6.50).

JUNE PINK—69 days. The earliest of the pink-fruited varieties. Vine is open, spreading, and rather short. Fruits medium sized, flattened, smooth; color purplish-pink.

Postpaid (Pkt. 10c) (Oz. 50c) (¼ lb. \$1.75) (lb. \$6.50).

JUBILEE—72 days. Fruits are large, bright golden orange, globular, heavy, full flavored and really delicious, the orange colored interior is thick-walled with few seeds. Makes delicious juice, very high in Vitamins A and C.

Postpaid (Pkt. 15c) (Oz. 90c) (¼ lb. \$3.00) (lb. \$10.00).



BOUNTY

LANDRETH—70 days. The vine is short-stemmed, usually healthy, blood-red, solid, smooth, meaty and most attractive fruit, very productive. In appearance it is like Chalk's Early Jewel but five days earlier and considerably larger fruited.

Postpaid (Pkt. 10c) (Oz. 50c) (¼ lb. \$1.75) (lb. \$6.50).

LIVINGSTON'S BEAUTY—84 days. One of the best pink fruited sorts, medium late in season. Plants sturdy, vigorous and prolific. Fruits medium large, deep-flat, smooth, purplish pink, solid, of good quality.

Postpaid (Pkt. 10c) (Oz. 50c) (¼ lb. \$1.75) (lb. \$6.50).

LOUISIANA PINK—75 days. An early maturing wilt resistant variety. Vines open with finely cut leaves. Fruits medium sized, quite smooth, deep flat, purplish pink.

Postpaid (Pkt. 10c) (Oz. 50c) (¼ lb. \$1.75) (lb. \$6.50).

MARHIO—79 days. A pink fruited Marglobe developed by the Ohio Agricultural Station. In season it is the same as Marglobe. Fruits medium large, nearly globular, smooth with thick walls and cross-sections; of fine quality.

Postpaid (Pkt. 10c) (Oz. 50c) (¼ lb. \$1.75) (lb. \$6.50).

MARGLOBE—79 days. Introduced by the United States Department of Agriculture, this main crop variety has come into wide use by truckers and shippers, and in some sections by canners. Plant vigorous, with heavy foliage, resistant to Wilt and Nailhead rust; moderately productive. Fruits medium large, nearly globular, smooth, solid, with thick walls and cross-sections, of fine quality.

Postpaid (Pkt. 10c) (Oz. 50c) (¼ lb. \$1.75) (lb. \$6.50).

MASTER MARGLOBE (Certified)—77 days. Early mid-season variety, similar to the usual Marglobe but more uniform, slightly earlier, very solid, and very free from blossom end scar and flats.

Postpaid (Pkt. 10c) (Oz. 50c) (¼ lb. \$1.75) (lb. \$6.50).

MINGOLD—73 days. Excellent yellow-fruited variety, early and prolific. Fruits of medium size, globular and smooth with mild and pleasant flavor.

Postpaid (Pkt. 10c) (Oz. 50c) (¼ lb. \$1.75) (lb. \$6.50).

NEW STONE—86 days. A fine strain of the old main crop variety. Has large, flat, scarlet fruits, smooth and solid. Very productive.

Postpaid (Pkt. 10c) (Oz. 50c) (¼ lb. \$1.50) (lb. \$5.50).

OXHEART—90 days. Vine is open, spreading, moderately productive. Fruits extremely large, somewhat rough, heart-shaped, pink, very solid, meaty and of mild flavor.

Postpaid (Pkt. 10c) (Oz. 75c) (¼ lb. \$2.25) (lb. \$8.00).

PAN AMERICA—73 days. This new variety developed by the U. S. Department of Agriculture is highly resistant to nail-head rust and Fusarium wilt. The fruits are bright scarlet in color, medium large, globular in shape, moderately thick flesh, very thick outer wall almost free of cracking. The vines have good coverage of medium dark green leaves.

Postpaid (Pkt. 10c) (Oz. 50c) (¼ lb. \$1.75) (lb. \$6.50).

PEARSON—76 days. Vigorous, self-topping plants with ample foliage to protect the heavy set of fruits, which are medium large, semi-globe and of good red color. Good canning and shipping variety.

Postpaid (Pkt. 10c) (Oz. 75c) (¼ lb. \$2.25) (lb. \$8.00).



PRITCHARD TOMATO

PRITCHARD or SCARLET TOPPER—73 days. A scarlet, self-topping, disease-resistant variety. It is a cross between Marglobe and Cooper's Special and has inherited fine qualities from each parent; heavily productive. Fruits large, smooth, globular, solid, with thick walls and cross-sections; color light scarlet.

Postpaid (Pkt. 10c) (Oz. 50c) (¼ lb. \$1.75) (lb. \$6.50).

PONDEROSA or BEEF STEAK—88 days. Large, pink fruited home garden sort, inclined to crack.

Postpaid (Pkt. 10c) (Oz. 75c) (¼ lb. \$2.25) (lb. \$8.00).

RUTGERS (Certified Seed)—It is a second early variety, fruits are medium to large, similar in shape to Marglobe, except that they are more flat in the stem end. The fruit has a thick outer and inner wall, with very small seed cavities. The flesh is firm and red.

Postpaid (Pkt. 10c) (Oz. 50c) (¼ lb. \$1.75) (lb. \$6.50).

STOKESDALE CERTIFIED—72 days. An early scarlet fruited sort with remarkably solid interior, ripening from the inside outward. Resembles Marglobe in size and shape but about 10 days earlier. Owing to its short season, it is well adapted to the northern states.

Postpaid (Pkt. 10c) (Oz. 50c) (¼ lb. \$1.75) (lb. \$6.50).

VALIANT—70 days. The fruit is smooth, very solid, free from cracks, and of excellent flavor, and of brilliant scarlet color. Excellent for slicing.

Postpaid (Pkt. 10c) (Oz. 50c) (¼ lb. \$1.75) (lb. \$6.50).

VICTOR—65 days. This tomato is a dwarf self-topping variety. Is extra early, even ripening with small vines. Color is uniform, scarlet and has a very noted smoothness of skin, fruits about 3 inches in diameter.

Postpaid (Pkt. 10c) (Oz. 50c) (¼ lb. \$1.75) (lb. \$6.50).

WASATCH BEAUTY—85 days. The fruit is round, firm, smooth and a beautiful red color, and borne in clusters of three to six good sized tomatoes. It is an especially good shipping and canning variety. The branches terminate in a cluster of fruit, making a compact plant so that more plants may be set per acre.

Postpaid (Pkt. 10c) (Oz. \$1.00) (¼ lb. \$3.00) (lb. \$11.00).

YELLOW PEAR—73 days. Fruits small and pear-shaped, rich, clear yellow in color; used for preserves.

Postpaid (Pkt. 10c) (Oz. 50c) (¼ lb. \$1.75) (lb. \$6.50).

YELLOW PLUM—73 days. A small, yellow-fruited variety much resembling a plum in size and form; for preserving.

Postpaid (Pkt. 10c) (Oz. 50c) (¼ lb. \$1.75) (lb. \$6.50).

TURNIP

CULTURE—One ounce of seed will sow 150 feet of drill; 2 pounds an acre.

PURPLE TOP WHITE GLOBE—55 days. Almost a perfect globe in form; flesh and skin white, colored purple, or red, above ground; very fine grained and sweet. A superior variety.

Postpaid (Pkt. 10c) (Oz. 15c) (¼ lb. 35c) (lb. \$1.00) (5 lbs. \$4.50).

PURPLE TOP WHITE GLOBE (Special)—55 days. This pure bred strain is noted for its uniformity and productivity. Top dark green, large, erect cut leaved. Root large, globe shaped, very smooth; upper part purple-red, white below; flesh white, sweet, crisp and tender.

Postpaid (Oz. 15c) (¼ lb. 40c) (lb. \$1.25) (5 lbs. \$5.00).

EXTRA EARLY PURPLE TOP MILAN—45 days. Extremely early and of splendid quality; bulbs of medium size, flat and white, with a bright purple top; strap leaved.

Postpaid (Pkt. 10c) (Oz. 25c) (¼ lb. 50c) (lb. \$1.50).

EXTRA EARLY WHITE MILAN—45 days. Similar to Purple Top Milan, except that the roots are a solid clear white.

Postpaid (Pkt. 10c) (Oz. 25c) (¼ lb. 50c) (lb. \$1.50).

WHITE EGG—50 days. An early oval or egg-shaped variety. Roots of medium size, smooth and clear white; of the very best quality.

Postpaid (Pkt. 10c) (Oz. 15c) (¼ lb. 35c) (lb. \$1.00) (5 lbs. \$4.50).



TURNIP, PURPLE TOP WHITE GLOBE

RUTABAGA OR SWEDE TURNIP

AMERICAN PURPLE TOP—100 days. The standard variety grown for home use, market and storage. Roots large and globular, deep purplish red above ground, light yellow below, with medium short neck. Flesh a creamy yellow, of finest texture and flavor. A good yielder and keeper.

Postpaid (Pkt. 10c) (Oz. 15c) (¼ lb. 35c) (lb. \$1.00).

LAURENTIAN—92 days. An outstanding purple top variety introduced from Canada. Clean, well shaped root, almost neckless, skin thick, good keeper. Flesh light yellow, fine grained, excellent quality. Top light green, shorter than American Purple Top.

Postpaid (Pkt. 10c) (Oz. 15c) (¼ lb. 35c) (lb. \$1.25).

VEGETABLE PLANTS AND ROOTS

In their proper season, we have large quantities of all the plants listed below, well grown and stocky and all grown from Perfegro Tested Seeds. Purchasers may rely upon having their order filled the day after received in order that we have the plants freshly pulled, the weather permitting. We recommend having all plants and shrubs sent by Express, as Parcel Post shipments are often delayed, handled roughly, kept too warm or too cold, to carry any distance and arrive in good condition, but if preferred or more convenient to have them delivered by Parcel Post, we will send them that way and see that they are properly packed for such shipment, but when so sent we cannot guarantee them to arrive on time or in good condition. No packing charge, orders will be booked at any time and plants will be sent when ready. **Not less than one dozen plants of a variety will be sold; 500 plants will be supplied at the 1,000 rate.**

Below we quote prices by Express at purchasers' expense. If wanted by Parcel Post, add 5c per dozen, 10c per hundred, 75c per thousand.

NO PLANTS SENT C. O. D.

Ready for Shipment May 1

	Dozen	100	1000
BROCCOLI , Green Sprouting.....	\$.35	\$1.25	\$10.00
CABBAGE30	1.25	10.00
CAULIFLOWER40	1.35	11.00
CELERY , Giant Pascal, Golden Self Blanching30	1.00	7.50
EGG PLANT , Black Beauty.....	.40	1.35	
PEPPERS , Sweet and Hot Peppers of Popular Varieties35	1.25	10.00
SWEET POTATO , Yellow Jersey.....	.35	1.25	9.00
TOMATOES40	1.35	11.00

ASPARAGUS ROOTS

For the home garden plant asparagus roots 18 inches apart in rows 2½ feet apart, 100 roots for a patch 20x20 feet.

WASHINGTON—A new rust-resisting variety of great promise that is being planted largely in this vicinity. The stalks are large, dark green, with a heavy purple over tone.
Postpaid: 1-year-old roots (Doz. 50c) (100 for \$1.25) (1000 for \$10.00).

PARADISE—New, early maturing variety. Large, crisp, tender stalks with fine, mild flavor, similar in appearance to Washington and rust-resisting. Producing crop one year earlier than any other variety.
Postpaid: 1-year-old roots only (Doz. 60c) (100 for \$2.50) (1000 for \$12.00).

CHIVES

Small, hardy perennial, belonging to the onion family, which grows in clusters. Leaves used for salads and for flavoring in soups and salads.

Postpaid (Per Bunch 35c) (3 for \$1.00).

GARLIC

Used for flavoring. The bulbs are set like onion sets about 4 inches apart in the row, divided into "cloves" or flakes and covered 2 inches deep. When tops die down take up the bulbs and dry in a shady place. Bulbs only.

Postpaid (¼ lb. 25c) (½ lb. 45c) (lb. 85c) (10 lbs. \$7.50).



BROCCOLI

MINT

A hardy perennial herb, grown for its leaves which are used to flavor vinegar, jellies, sauces and tea.
Per Clump, 35c Postpaid.

HORSE RADISH

Horse Radish is easily grown from sets—small lengths of roots. These sets, if planted in the spring in good, rich soil, will form large roots by fall. The set should be planted with the small end down and the upper portion 2 inches below the surface.

Postpaid (60c per doz.) (\$3.00 per 100).

SAGE

The leaves of this perennial are used to flavor meats, poultry dressings, sausages and cheese.

Per Clump, 50c Postpaid.

RHUBARB OR PIE PLANT

Rhubarb should be in every garden, as it affords the earliest sauces and pies in spring. Set roots out in spring or fall, in rows 4 feet apart, so the crowns are an inch below the surface. Do not pull stalks the first season. Plants set out in the spring will bear quite abundantly the following season.

VICTORIA—A midseason variety with large leaf stalks of clear red. The stalks are crisp, tender, juicy and fine flavored. It is an excellent sort for market or home use.
Postpaid (3 for 50c) (12 for \$1.50).

RUBY—Very high in sugar content and of exceptionally fine flavor, deep rich ruby red, the reddest of all Rhubarb. It makes a deep rich red sauce which is very beautiful and tasty.
Postpaid (Each 50c) (3 for \$1.25).

MacDONALD—Is an unusually fine flavored rhubarb, high in sugar content. Stalks green with red veins. Makes a fine pink sauce of good flavor.
Postpaid (Each 50c) (3 for \$1.25).

ROOTONE

Reg. U. S. Pat. Off.



Geranium Cuttings. Treated and Untreated

ROOTONE, the plant hormone powder. Dip cuttings in Rootone before planting to give faster, better, more successful rooting. Mix flower, vegetable or grass seed with Rootone before planting to give faster growth and stronger roots. Easy to use. ¼ oz. packet 25c. 2 oz. jar \$1.00. 1 lb. can \$5.00.

WHICH DO YOU WANT ?

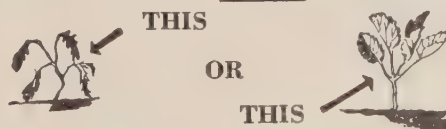

The hormones and vitamins (B, and others) found together only in

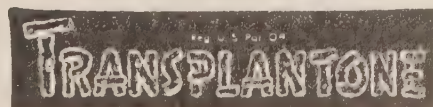

THE HORMONE-VITAMIN POWDER

Stop the shock and wilt usually inevitable after transplanting all kinds of plants. . . . Simple, Safe, Economical to use. ½ oz. packet 25c, 3 oz. can \$1.00, 1 lb. can \$4.00.

A DESCRIPTIVE LIST OF SELECTED FLOWER SEEDS

CULTURE—Sow the seeds broadcast or in rows, and cover lightly—a good general rule is to cover four to six times the size of the seeds—and press down the soil firmly. Small seeds cannot come up if covered too deep. Very fine seeds should be sown on the surface and pressed into the soil. To have the earliest blooms, flowers that stand transplanting should be sown early in boxes indoors. Water with a fine spray, do not let

the soil dry out, do not keep the plants saturated. When three or four leaves have formed, transplant one inch apart in boxes, or in the open ground if warm enough. The soil best suited to flowers is a light, rich loam, made as fine and smooth as possible. Many seeds are very small and require a fine seed-bed. Varieties marked with (a) indicate annuals, those with a (p) are perennials.

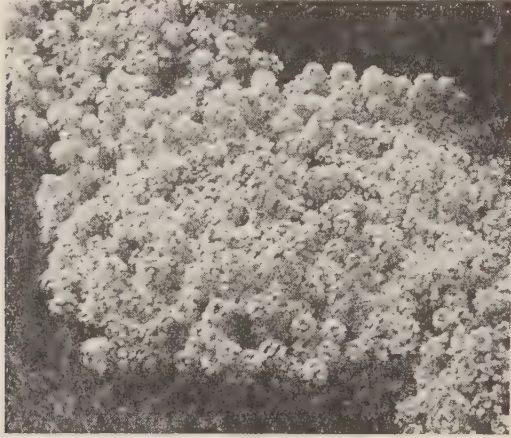

SWEET ALYSSUM

AFRICAN GOLDEN DAISY (a)

The plants are of branching habit, growing about 15 inches high, and easily cultivated. The flowers vary in color from purest white to yellow, orange and rich salmon shades, many being zoned with several of these colors around the black disk. (Pkt. 10c) (½ Oz. 75c).

AGERATUM (a)

Popular annual plants producing fluffy blue flowers all summer. The dwarf stature and compact habit permit its use as an edging plant or in the rockery where it will flourish in any soil, sun or partial shade.

BLUE PERFECTION—Flowers deep blue, growing 9 inches tall. (Pkt. 10c) (½ Oz. 40c).

ALYSSUM (a)

One of the most popular garden flowers, remaining in bloom the entire season; suitable for beds and edging in summer, or for growing in pots and boxes for winter blooming.

LITTLE GEM—Very dwarf with white flowers, 4 to 6 inches high. (Pkt. 10c) (¼ Oz. 25c).

CARPET OF SNOW—White flowers on plants only 3 inches tall. (Pkt. 10c) (¼ Oz. 20c).

SWEET—Taller variety, growing 8 inches high, white flowers. (Pkt. 10c) (¼ Oz. 20c).

VIOLET QUEEN—Dwarf, compact plants of small, sweetly scented flowers of a very rich deep shade of violet. (Pkt. 10c).

SAXATILE COMPACTUM—Sometimes called Basket of Gold. It grows compactly and is covered with a wealth of golden blossoms in early spring, hardy perennial. (Pkts. 10c) (½ Oz. 40c).

ARCTOTIS (a)

BLUE EYED AFRICAN DAISY—Silvery white daisy like flowers with delicate sky-blue eye with yellow halo. Plants 2½ ft. tall very free blooming. (Pkt. 10c) (¼ Oz. 40c).



ASTER, CREGO TYPE

ASTERS (a)

We can imagine no other flower which combines so much beauty with grace and usefulness and with which more brilliant effects can be achieved. From August until frost this flower reigns supreme in the garden, not equaled by any other. To do well, Asters require a well pulverized soil, and frequent cultivation as well as a sunny location.

IMPROVED CREGOS WILT RESISTANT—The large shaggy flowers with long curled petals are not unlike the ostrich feather for which they are commonly named. The plants are strong and heavily branched and grow about 2½ ft. in height.

Crimson—Glowing deep rose-crimson. (Pkt. 10c) (½ Oz. 40c).

Purple—Showy violet purple. (Pkt. 10c) (½ Oz. 40c).

Rose—Lovely bright carmine rose. (Pkt. 10c) (½ Oz. 40c).

Pink—Soft shell pink. (Pkt. 10c) (½ Oz. 40c).

Azure Blue—Pale blue. (Pkt. 10c) (½ Oz. 40c).

White—Purest white, large and fluffy. (Pkt. 10c) (½ Oz. 40c).

Mixed Colors—Pkts. 10c) (½ Oz. 35c) (Oz. \$2.00).

QUEEN OF THE MARKET (Wilt Resistant Strain)—Usually in bloom two weeks before most other sorts begin to flower. Flowers are nearly round, fully double, and measure 3 inches across. Plants 18 inches high. Mixed colors. (Pkt. 10c) (½ Oz. 30c) (Oz. \$2.00).

AIDS IN SELECTING FLOWER SEEDS FOR SPECIAL PURPOSES

Tall Sorts for Backgrounds: Amaranthus, Canna, Cosmos, Dahlia, Lupin, Marigolds, Ricinus, Sunflower, Zinnia.

Medium High Annuals: Antirrhinum, Arctotis, Aster, Balsam, Bachelor Button, Calliopsis, Chrysanthemum, Clarkia, Godetia, Larkspur, Lupin, Pinks, Scabiosa, Schizanthus, Statice, Stocks, Zinnia.

Dwarf Border Plants: Alyssum, Candytuft, Carnation, Daisy, Pansy, Pinks, Sweet William, Viola, Zinnias Lilliput.

Window Boxes: Alyssum, Lobelia, Nasturtium Dwarf, Petunia, Thumbergia.

Foliage Plants: Amaranthus, Cineraria, Kochia, Ricinus.

Medium High Perennials: Campanula, Columbine, Coreopsis, Gypsophila, Gaillardia, Lupin, Poppy, Shasta Daisy, Sweet William.

Tall Perennials: Delphinium, Foxglove, Hollyhock.

Rock Garden Annuals: Ageratum, Alyssum, Candytuft, Bachelor Button, Eschscholtzia, Gypsophila, Lobelia, Pinks, Portulaca, Verbena.

Rock Garden Perennials: Campanula, Candytuft, Columbine, Poppy, Pinks, Viola.

AMARANTHUS (a)

Attractive foliage plants, up to 5 ft. high; for backgrounds, groups or foundation plantings.

CAUDATUS—Love Lies-Bleeding. Long, slender, drooping dark red flower spikes often in branched clusters; green foliage. (Pkt. 10c) (½ Oz. 30c).

TRICOLOR Splendens—Joseph's Coat. Rich, scarlet crimson foliage, prettily variegated yellow and bronze green. (Pkt. 10c) (½ Oz. 35c).

DOUBLE BATCHELOR'S BUTTON (a)

This superb class of Cornflowers produces handsome, large double blooms effective out of doors and in bouquets. Easily grown from seed, if sown in early spring produces flowers from midsummer until frost.

BLUE BOY—Deep blue with black markings. (Pkt. 10c) (½ Oz. 35c).

RED BOY—Deep red with blue markings. (Pkt. 10c) (½ Oz. 35c).

PINKIE—Deep pink with blue markings. (Pkt. 10c) (½ Oz. 35c).

SNOWMAN—White with blue markings. (Pkt. 10c) (½ Oz. 35c).

DOUBLE MIXED—(Pkt. 10c) (½ Oz. 35c).

BALSAM (Lady Slipper) (a)

An old and popular garden flower of easy culture. Plants grow about 18 inches high, with clusters of double flowers resembling camellias produced in abundance, flowers are of unusual colors ranging from white to deep rose.

CAMELLIA FLOWERED MIXED—(Pkt. 10c) (½ Oz. 25c).

CALLIOPSIS (a)

Free flowering, wiry-stemmed annuals in shades of yellow, brown and crimson. The flowers resemble a daisy with raised brown centers, and are often times marked with bands or centers of contrasting tones. (Pkt. 10c) (½ Oz. 30c).

COREOPSIS (p)

One of our most popular perennials; the attractive flowers are borne in great profusion and are excellent for cutting.

DOUBLE SUNBURST—Large double flowers of brilliant golden yellow, 1½ to 2 inches across. Easy to grow. (Pkt. 10c) (½ Oz. 30c).

CALIFORNIA POPPY (Eschscholtzia) (a)

The foliage is finely cut, fern-like, and silvery green in color. The flowers are bright yellow and orange, they start to bloom in a few weeks after the seed is sown.

SPECIAL MIXTURE OF COLORS—Giant flowering poppy in soft pink, scarlet, chrome, copper red, claret, yellow, white, royal purple and orange. (Pkt. 10c) (½ Oz. 25c) (½ Oz. 40c).

GOLDEN WEST—Flowers bright yellow and orange, penciled and blotched. (Pkt. 10c) (½ Oz. 25c) (½ Oz. 40c).

SANTA BARBARA POPPY—Hunnemannia—Large yellow flowers 3 inches across, petals are crinkled like crushed satin. (Pkt. 10c) (½ Oz. 60c).

CALENDULA (Pot Marigold) (a)

The colorful flowers make a wonderful display in the garden and are always admired by those who see them. Blooms freely in early summer and continues into the fall. Even though they prefer a sunny location and rather dry soil, they require little care to grow to perfection, height 18 to 24 inches.



ART SHADES MIXED—A splendid mixture of varied shades of apricot, orange, cream and buff. (Pkt. 10c) (½ Oz. 25c).

CANARY BIRD VINE

A quick growing annual climber, with curiously cut yellow flowers, resembling canary birds in flight. (Pkt. 10c).

CARNATIONS (a)

Few flowers surpass in beauty of form or delicious fragrance as the richly hued Carnation. The plants are branching but compact, and the handsome blossoms are produced on blue-green stems that are stiff but slender. The double flowers with their thick waxy petals are spicily scented.



CHABAUD GIANT—18 inches. This variety blooms six months after seeding and continues through the summer, produces flowers of extra large size. If plants are protected during the winter they will continue to live and bloom for many years.

Cardinal Red—Dark crimson red. (Pkt. 15c).

Bright Rose—(Pkt. 15c) (1/16 Oz. 60c) (½ Oz. \$1.00).

Yellow—Lemon Yellow. (Pkt. 15c) (1/16 Oz. 60c) (½ Oz. \$1.00).

Pure White—(Pkt. 15c) (1/16 Oz. 60c) (½ Oz. \$1.00).

Chaubaud's Mixture—(Pkt. 10c) (½ Oz. \$1.25).

CANDYTUFT (a)

Well-known dwarf, profuse flowering plants of easy culture. Charming for beds, edgings and rock gardens.

DWARF MIXED (Umbellata)—Umbel or umbrella shaped flower heads made up of many small florets cover the dwarf bushy plants, which grow 1 ft. tall. Colors range from white, soft pink to dark crimson. (Pkt. 10c) (½ Oz. 30c) (½ Oz. 50c).

GIANT HYACINTH FLOWERED—Plants are very branched, each branch a massive, long and thick hyacinth-like spike of pure white. Plants 18 inches tall. Excellent for cutting. (Pkt. 10c) (½ Oz. 45c).

CANTERBURY BELLS (b)

CAMPANULA CALYCANTHEMA—Cup and Saucer Type. Perhaps the most beautiful type; distinct in form with large bell or cup-shaped flowers, surrounded at the base by a large calyx of similar color the whole resembling a cup and saucer. Flowers are white, blue and pink shades. Bloom the second year from seed or first year from seed if sown in fall. Finest Mixed. (Pkt. 10c) (½ Oz. 40c).

CASTOR OIL BEAN (Ricinus) (a)

Tall stately growing plants of tropical appearance; their luxuriant foliage makes them exceedingly ornamental.

SANGUINEUS—About 6 feet tall with green leaves. (Pkt. 10c) (Oz. 15c) (lb. 60c).

ZANZIBARIENSIS—Ornamental bronze foliage and brilliantly colored seed pods. (Pkt. 10c) (Oz. 25c) (¼ lb. 65c).

CHRYSANTHEMUM

The annual varieties or Painted Daisies, as they are called, bloom from early summer until frost.

SINGLE MIXED—These are the painted daisies and come in many brilliant colors. (Pkt. 10c) (½ Oz. 25c).

DOUBLE MIXED—Plants 18 inches high with double flowers that range in color from white to deep orange. (Pkt. 10c) (½ Oz. 35c).

CLARKIA (a)

Graceful slender upright plants, covered almost their entire length with dainty double flowers which resemble those of the flowering almond, of pastel shades, plants 24 inches tall.

DOUBLE MIXED—(Pkt. 10c) (½ Oz. 45c).

COBAEA SCANDENS (Cathedral Bells) (a)

A rapid growing annual climber. Flower lilac-blue, bell shaped. (Pkt. 10c) (¼ Oz. 45c).

COCKSCOMB (a)

Celosia—A very ornamental plant with curious flowers resembling a cock's comb.

DWARF MIXED—Flowers of red and yellow, growing about 12 inches high. (Pkt. 10c) (¼ Oz. 50c).

TALL MIXED—Plants 2 feet tall with ornamental heads of red and yellow that may be dried for winter. (Pkt. 10c) (¼ Oz. 35c).

COLUMBINE (p)

ROCKY MOUNTAIN—This is Colorado's emblematic flower. Beautiful blue and white flowers so well known that a detailed description is unnecessary. (Pkt. 25c).

COSMOS (a)

No garden is complete without Cosmos, these old favorites supply a gorgeous, colorful effect during late summer and fall. Fine for cutting as the flowers last well in water, easy to grow. We offer the newest development in Cosmos.

SENSATION MIXED—Flowers are very large, as much as 5 inches in diameter with broad heavy fluted petals, slightly overlapped. Sturdy plants 3 to 4 feet high, producing flowers 8 to 10 weeks from seed. (Pkt. 10c) (¼ Oz. 75c).

DAHLIAS (From Seed) (a)

UNWIN'S DWARF HYBRIDS—This is an improved strain of this popular flower, they grow from 18 inches to 2 feet tall and come in many delightful shades. We offer an improved strain which gives you a wider assortment of choicer colors. Produces a high percentage of doubles from seed. Mixed colors. (Pkt. 10c).

COLTNESS DWARF HYBRIDS—A very dwarf variety for bedding. This strain produces many beautiful pastel shades of single flowers. Excellent for cutting. Growing the miniature Dahlias from seed is becoming a popular garden practice. Mixed colors. (Pkt. 15c).

DELPHINIUM (p)

One of the greatest charms of hardy Larkspurs is in their shades of blue which range from soft rosy lavender to violet and deepest indigo. The magnificent tall varieties are stately and beautiful in front of shrubby background. Above the deeply cut dark green leaves rise long floral spikes. Height 6 to 8 feet.



BELLAMOSUM—Dark blue. (Pkt. 15c) (¼ Oz. 50c).

BELLADONNA—Light blue. (Pkt. 15c) (¼ Oz. 50c).

GOLD MEDAL HYBRIDS—A wonderful improved type of Delphinium. The colors range from palest lavender, through every shade of blue to pansy-violet, several shades being blended in some of the varieties. (Pkt. 15c) (¼ Oz. 50c).

EVERLASTING SWEET PEAS

LATHYRUS LATIFOLIUS—A very decorative climbing vine of the Pea family, for growing on fences, trellis, etc., as floral screens and for cutting blooms all summer. **MIXED COLORS**—(Pkt. 15c).

FOUR O'CLOCK (a)

A favorite showy annual for beds and borders. Bushy plants with red, white and yellow flowers opening in afternoon. Height about 2½ ft. **TALL MIXED**—(Pkt. 10c) (Oz. 50c).

FOXGLOVE (p)

This ornamental hardy plant is used extensively for naturalizing in shrubby borders and along fences. It grows well under almost all conditions giving a wealth of bloom during July and August. Flowers are pink, purple and white, large open-tubed on tall spikes. **GIANT SHIRLEY MIXED**—(Pkt. 10c) (¼ Oz. 40c).

GAILLARDIA

Tones of orange, yellow, red and maroon, often beautifully combined in a single blossom, makes these flowering plants gay ornaments of the garden all summer long. The foliage of soft green combines well with the flowers. The blossoms are 2 to 3 inches across.

ANNUAL MIXED—(Pkt. 10c) (¼ Oz. 30c).

PERENNIAL MIXED—(Pkt. 10c) (¼ Oz. 30c).

GODETIA (a)

Dwarf, hardy annuals of easy culture. They do best in a sunny position in rather poor soil. Sow the seed outdoors in May, thinning out well in the rows, or start in hotbeds and transplant. Flowers are large, trumpet shaped of satiny texture and rich coloring. All shades of rose. (Pkt. 10c) (¼ Oz. 25c).

GOURDS (a)

Tender annual climbers of rapid growth, vines often growing 20 to 30 feet long. They have luxuriant foliage, fruits curiously shaped in various colors by tying strings around the young fruit or by enclosing same in a carved mold while growing. Many of these fruits keep for years, being very hard shelled.



GOURDS, SMALL VARIETIES MIXED

LARGE VARIETIES MIXED—A mixture of the larger types of gourds.

SMALL VARIETIES MIXED—A mixture of all small gourds. Any of the Above: (Pkt. 10c) (3 for 25c).

GEUM (p)

Beautiful hardy perennials, bearing profusely large showy double flowers all through the summer. Beautiful flowers for bouquets.

MRS. BRADSHAW—Large, double, brilliant orange-scarlet, in flower throughout the entire summer. (Pkt. 10c). (1/16 Oz. 30c).

GYPSOPHILA (Baby's Breath)

Pretty free-flowering annuals and perennials. Their misty white panicles are largely used for mixing with other cut flowers.

ANNUAL WHITE—This is an improved large-flowering form of Baby's Breath. (Pkt. 10c) (¼ Oz. 35c).

ANNUAL PINK—(Pkt. 10c) (¼ Oz. 45c).

PANICULATA SINGLE WHITE (Perennial)—Hardy perennial. Will bloom first year if sown early, height 2 feet. (Pkt. 10c) (¼ Oz. 35c).

HELIANTHUS (Sunflower) (a)

Beautiful plants for use as backgrounds or screens on account of their stately growth. Thrive in almost any soil exposed to the sun and will bloom profusely until frost.

SUN GOLD—This sunflower makes a brilliant sea of color as all the plants burst into bloom on the same day. If planted in May will flower early in August. Blooms are all double, pure deep yellow. 5 feet tall. (Pkt. 10c).

SPECIAL GARDEN FLOWER MIXTURE**Garden Flower Seeds**

Here we offer a mixture of many easy growing annual flowers that can be sown broadcast, and with practically no care at all will produce a bright effect. This mixture will furnish an abundance of cut flowers for the house. (Pkt. 10c) (¼ lb. \$1.00).

Rock Garden Mixtures

ROCK GARDEN ANNUALS—(Mixed)—Splendid mixture of 25 varieties for rock gardens. (Pkt. 10c) (¼ Oz. 25c).

ROCK GARDEN PERENNIALS—(Mixed)—Wonderful mixture of over 50 rare and choice rock garden perennials. (Pkt. 10c) (¼ Oz. 40c).

HELIOTROPE (a)

Everyone loves the fragrance and beauty of Heliotrope. Excellent bedding plants in summer, desirable pot plants during winter. Succeeds in any good soil and full sun.

LEMOINE GIANT—Many shades ranging from pure white to violet blue. (Pkt. 10c) (½ Oz. 60c).

HOLLYHOCKS (p)

This is an old garden favorite, excellent for a background to dwarfier plants, for screening unsightly places and planting along bare walls. They are of the easiest culture, and like a warm sunny location. Bloom from late spring until mid-summer.

DOUBLE LARGE FLOWERED—Large double flowers with waved and fringed petals of many unusual colors, 5 to 6 ft. tall. (Pkt. 10c) (½ Oz. 50c).

HYACINTH BEAN (Dolichos) (a)

A rapid growing annual climber for sunny situations. Stems purplish red with purple shades in the leaves. Long spikes of deep reddish maroon followed by beautiful metallic purple seed pods. (Pkt. 10c) (Oz. 35c).

LARKSPUR (a)

Annual delphiniums are adorned with finely cut, feathery foliage of soft green which sets off to advantage the handsome long floral spikes of double blossoms.



GIANT IMPERIAL—This new form produces plants of erect habit, branching from the base, affording longer stems for cutting. We offer a splendid choice of colors.

Blue Bell—A fine medium Blue.

Blue Spire—Deep Oxford Blue.

Daintiness—Delicate Lavender.

Lilac King—Rich Lilac.

Los Angeles Imp.—Brilliant Rose.

Miss California—Pink Shaded Salmon.

Pink Perfection—Light Pink.

Pink King—Soft Salmon Rose.

White King—Glistening White.

Any one above—(Pkt. 10c) (½ Oz. 40c) (¼ Oz. 75c).

Mixed—(Pkt. 10c) (½ Oz. 35c) (¼ Oz. 60c).

LINUM (Flax)

SCARLET FLAX (Grandiflorum Rubrum)—An old favorite with large, rich crimson blooms borne profusely on plants growing 18 to 24 inches high. Though the flowers last only one day, new ones appear every morning. (Pkt. 10c) (½ Oz. 25c).

PERENNIAL BLUE—A hardy perennial; bears graceful bright blue flowers from June until frost, produces new flowers each day, fading and dropping by each evening. Feathery foliage. (Pkt. 10c) (½ Oz. 30c).

LOBELIA (a)

Plants small and compact, bearing a profusion of brilliant blue flowers. A great favorite not only for borders but for window and porch boxes as well. (Pkt. 10c) (½ Oz. 50c).

RUSSELL'S LUPINS (p)

This is without doubt the finest strain of perennial Lupins yet introduced. The flower spikes are longer, and the flowers closer placed than any of the earlier kinds. The colors are brighter and come in a wide range of solid colors and striking bi-colors. (Pkt. 10c) (½ Oz. 70c).



MARIGOLD, SUNSET GIANTS

MARIGOLD (a)

A wealth of color all summer and fall unequalled by any other flower. Easy to grow in ordinary garden loam but give the best results in a fairly rich medium one. Be sure of plant in a sunny location. All are lovely for cutting, the flowers keeping in fine condition for a long time.

GUINEA GOLD—Brilliant orange carnation like flowers flushed with gold. Height 2½ ft. (Pkt. 10c) (¼ Oz. 30c).

YELLOW SUPREME—Lemon yellow blooms 4 in. across with broad, loosely placed frilled petals that are exquisite. Height 28 inch. (Pkt. 10c) (½ Oz. 50c).

TALL DOUBLE AFRICAN MARIGOLDS

SUNSET GIANTS—A large percentage of the plants will produce the biggest marigolds ever grown—5 inches and more across. Flowers vary in size, form and come in many shades of orange and yellow 3½ ft. and more tall. In bloom from midsummer until frost. (Pkt. 10c) (½ Oz. 35c).

LEMON BALL—Sponge-like, canary flowers of wonderful substance and fine form. Long lasting. (Pkt. 10c) (¼ Oz. 30c).

ORANGE BALL—Bright orange, sponge-like, well-formed flowers on long stems. Very showy attractive color. (Pkt. 10c) (¼ Oz. 30c).

TALL DOUBLE AFRICAN MIXED—(Pkt. 10c) (¼ Oz. 25c).

CROWN OF GOLD—The first of the famous marigolds with odorless foliage; sweetly fragrant collarette flowers of brilliant orange gold. 2 in. across, plants grow 2 ft. tall. (Pkt. 10c) (½ Oz. 25c).

TALL DOUBLE FRENCH MIXED—Flowers are double with bright yellow pin cushion center crests surrounded by several rows of mahogany-red guard petals. Especially suited for beds and borders. (Pkt. 10c) (¼ Oz. 35c).

DOUBLE HARMONY HYBRIDS—Small ball shaped blooms 1½ to 2 in. across, are freely borne on dwarf compact plants which grow about 15 inches tall. The flowers come in orange, yellow and mahogany as well as combinations of these colors. Ideal for edgings and bedding. (Pkt. 10c) (½ Oz. 25c).

MEXICAN BURNING BUSH (a)

SUMMER CYPRESS—A rapid growing, highly ornamental annual forming perfect pyramids 2 to 2½ feet high, covered with feathery green branches, which in the fall turn to deep red. Makes fine summer hedge. Thin to 18 inches apart. (Pkt. 10c) (½ Oz. 30c) (Oz. 50c).

MIGNONETTE (a)

The sweet yet delicate odor of the Mignonette has endeared itself to every true lover of flowers. Small flower spikes of a reddish tint, excellent for cutting, especially when used with other flowers, 1 ft. tall. (Pkt. 10c) (¼ Oz. 35c).



PETUNIA, CALIFORNIA GIANTS IN MINIATURE

MORNING GLORY

Popular rapid-growing climbers used for growing on trellises, arbors, walls and to cover unsightly places. Soak seed in water before sowing to aid germination, and plant seeds where they are to grow.

PEARLY GATES—All American Selection for 1942. The flowers are a lovely lustrous white with creamy shading deep down in the throat. They average 4½ inches across. The vigorous fast climbing vines are covered with bloom from the middle of summer until frost. The leaves are heart shaped. Light green in color and luxurious in growth. A wonderful companion for Heavenly Blue and Scarlett O'Hara. (Pkt. 10c) (¼ Oz. 50c).

COLORADO HEAVENLY BLUE—The most popular of the morning glories, early blooming climber, literally covered with lovely sky blue flowers shading lighter toward the center. Flowers measure 3½ inches across and bloom until frost. (Pkt. 10c) (¼ Oz. 25c) (Oz. 65c).

CRIMSON RAMBLER—A bright ruby red with white throat, very attractive when planted with Heavenly Blue for contrast. Strong climber. (Pkt. 10c) (¼ Oz. 40c) (½ Oz. 70c).

OLD FASHIONED MIXED—Fast growing early free blooming climber, colors range from white through all tones of blue, red and purple, presenting a very gay appearance. (Pkt. 10c) (Oz. 40c).

MOONFLOWER (*Ipomoea Noctiflora*)

Giant White. Huge white trumpet-shaped flowers measuring as much as 6 to 8 inches across, slightly fragrant. (Pkt. 10c) (¼ Oz. 30c).

NASTURTIUM (a)

Few garden annuals respond with as little care as the nasturtium.

PERFEGRO DWARF MIXTURE—For bedding, colors range from pale yellow to deep orange. (Pkt. 10c) (Oz. 30c) (¼ lb. \$1.00).

PERFEGRO TALL MIXTURE—For climbing on trellises or over stonework. (Pkt. 10c) (Oz. 30c) (¼ lb. \$1.00).

DWARF SEMI-DOUBLE VARIETIES

GOLDEN GLEAM—The fragrant golden yellow blossoms are attractive as cut flowers. You will be astonished at the wealth of blossoms the plants produce. (Pkt. 10c) (Oz. 45c) (¼ lb. \$1.25).

SCARLET GLEAM—A sister of Golden Gleam, its semi-double blossoms are similar in size and shape to those of the popular golden Nasturtium. Rich, dazzling scarlet, sweet scented. Fine for cutting. (Pkt. 10c) (Oz. 45c) (¼ lb. \$1.25).

GLEAM HYBRIDS—A mixture of all colors of the double Nasturtiums. (Pkt. 10c) (Oz. 45c) (¼ lb. \$1.25).

NICOTIANA

AFFINIS HYBRIDS (Flowering Tobacco)—Very fragrant, petunia-like flowers, forming a beautiful five-pointed star in brilliant colors including many shades of rose, crimson and creamy white. Flowers are borne in clusters on bushy branching plants about 2½ ft. tall. (Pkt. 10c).

PENSTEMON (p)

SENSATION IMPROVED—The flowers are tubular, lobed and lipped, 1 inch long and ¾ inch across of brilliant colors ranging from pink to purple on long flower spikes. Plant 2 ft. tall, perennial. (Pkt. 10c) (1/16 Oz. 75c).

PANSIES

PERFEGRO GIANT MIXTURE—A mixture of the best pansies we can obtain. Flowers 2½ inches across on stiff stems, with ruffled and fluted petals. Colors are rich and bright with many solid colors of a deep, velvety texture. (Pkt. 25c) (¼ Oz. \$1.00) (Oz. \$6.00).

PERFEGRO FINE PANSY MIXTURE—This is our own mixture, especially designed for showy beds. We very carefully made up this mixture from different colors of the finest pansies, many of them being the expensive large ruffled kinds. The mixture is sure to produce a bright and showy display. (Pkt. 10c).

PETUNIAS (a)

No flower is better liked or more faithful than the Petunia, during the whole season they are covered with large, showy blossoms, which are always bright and fresh, in spite of heat and drought. The flowers are of an almost infinite variety of color and markings and quite as varied in form.

SINGLE BEDDING PETUNIAS

These are used extensively for mass plantings, growing about 12 inches tall.

ROSY MORN—Clear pink contrasted by a broad white throat. (Pkt. 10c) (¼ Oz. 40c) (¼ Oz. 75c).

HOWARD'S STAR—Crimson maroon with a clearly defined five-pointed star of bluish white. (Pkt. 10c) (¼ Oz. 40c) (¼ Oz. 75c).

GENERAL DOBBS—Rich crimson garnet. (Pkt. 10c) (¼ Oz. 40c).

ROSE OF HEAVEN—Exquisite shade of rose. (Pkts. 10c) (½ Oz. 50c) (¼ Oz. 85c).

SNOWBALL—Pure satiny white. (Pkt. 10c) (¼ Oz. 40c).

BLUE BEE—Violet blue. (Pt. 10c) (¼ oz. 40c).

FLAMING VELVET—Luscious velvety blood red. (Pkt. 10c) (¼ Oz. 40c) (¼ Oz. 75c).

VIOLACEA—Deep violet. (Pkt. 10c) (¼ Oz. 40c) (¼ Oz. 75c).

DELUXE BEDDING MIXTURE—(Pkt. 10c) (¼ Oz. 35c).

DWARF GIANTS OF CALIFORNIA

Flowers are three inches and more across, plants very bushy and compact. This strain of well-known ruffled petunias contains a wide range of colors and markings. Some of the blooms are so ruffled that they appear almost double.

DE LUXE OR RAMONA STRAIN—Reselect Mixture. Magnificent large flowers in a wonderful range of colors. (Pkt. 25c).

RUFFLED MONSTERS EXQUISITE MIXED—The flowers are very large and ruffled with open shallow throats. The colors are mostly the desired red and dark shades, richly marked and veined. (Pkt. 25c).

FLUFFY RUFFLES EXQUISITE MIXED—A delightful mixture of delicate shades and numerous soft tints. Flowers are so fringed and ruffled that they appear double, very choice. (Pkt. 25c).

GIANT DOUBLE PETUNIA

One of the prettiest and finest strains of petunias in existence. They come in a wide range of colors and markings, with crisply fringed petals, plants are a foot high bearing their immense all double blooms in greatest profusion. (Pkt. 35c).

PINKS (*Dianthus Heddensis*) (a)

An entirely new tetraploid variety combining the large open flowers of *Dianthus Heddewigi* and the rugged growth and long stemmed habit of *Dianthus Chinensis*. Well formed flowers in large numbers on 16-inch stems, suitable for cutting.

FINEST MIXED—All the traditional *Dianthus* colors in this new variety. (Pkt. 10c).

PHLOX

PHLOX DRUMMONDI—A valuable and showy annual highly esteemed for bedding, for massing and for borders. The plants grow about 1 ft. high, thrive in any soil if given a sunny location and bloom the entire season. A beautiful mixture of colors from pale yellow to deep purple and soft pink to dark red. (Pkt. 10c) (¼ Oz. 50c).

HARDY PERENNIAL PHLOX (Decussata)—Tall massive trusses of flowers in a wide range of brilliant colors, produced throughout the summer. Plants require good soil and plenty of sun. Seed germinates slowly. (Pkt. 25c).



SNAPDRAGON

POPPIES

ORIENTAL POPPY—One of the finest and hardiest of all perennials. The flowers are large and showy, the petals satiny, the colors range from light orange to deep red. The plants require little care and will grow in very poor soil. (Pkt. 10c) (½ Oz. 50c).

SHIRLEY POPPIES—This is the most beautiful type of poppy grown, the foliage has a soft hairy covering and the petals are immense and have a beautiful satin-like texture, the flowers are of many colors, white, pink and various shades of red and scarlet. Mixed colors. (Pkt. 10c) (¼ Oz. 35c).

ICELAND POPPIES—Dwarf perennial poppy with fern like foliage. The flowers range in color from pale yellow to deep orange of crinkly satin, on long stems above low leaf-clumps. (Pkt. 10c) (½ Oz. 75c).

PORTULACA (Moss Rose) (a)

Brilliant hardy annual of easy culture; excellent for massing in beds, edging or rock work, thriving best in a light sandy soil and sunny location. Flowers of brightest colors, height 6 inches.

DOUBLE MIXED—(Pkt. 10c) (1/16 Oz. 60c).

SINGLE MIXED—(Pkt. 10c) (½ Oz. 60c).

SALVIA OR SCARLET SAGE (a)

GLOBE OF FIRE—A compact growing early flowering Salvia, 2 feet high, covered with long spikes of brilliant scarlet flowers that stand clear above the dense dark green foliage (Pkt. 15c) (½ Oz. \$1.00).

SALPIGLOSSIS (Painted Tongue) (a)

Large, showy, trumpet-shaped flowers of velvety texture, the colors charmingly penciled, netted and veined with golden yellow, crimson and purple. In bloom from July until frost. From a low base of leaves rise slender wiry stalks about 24 inches high of brilliantly colored flowers. (Pkt. 10c) (½ Oz. 40).

SCABIOSA (Imperial Giants) (a)

An old favorite, greatly improved in the size and color of flowers as well as length of stems making them one of the most popular of the easily grown annuals for the garden and one of the best for cutting. This new type has flowers composed entirely of broad, heavy wavy petals eliminating the pin cushion center entirely. Because of its complete doubleness the flowers are extremely large, colors range from pale pink to deep maroon. Mixed. (Pkt. 10c) (¼ Oz. 45c).

SCHIZANTHUS (Butterfly Flower) (a)

Beautiful bushy plants with finely lacinated foliage and hundreds of butterfly-like blooms of many colors, prettily marked and blotched with contrasting colors. For beds, borders and pot culture, 1½ ft. tall. (Pkt. 10c) (½ Oz. 35c).

SHASTA DAISY (p)

This is a hardy perennial, bearing large white single blooms with handsome yellow centers. Flower 4 to 5 inches across. plants 18 inches tall, especially pleasing in bouquets blooming during June and July. (Pkt. 10c) (½ Oz. 50c).

SNAPDRAGON (Antirrhinum) (a)

SUPERGIANTS (Rust Resistant)—Fascinating flowers with their interesting form and glowing colors, very easy to grow and will bloom continuously until frost. Splendid for bedding. The plants grow bushy 24 inches tall.

Copper Shades—Bronze brown.

Apple Blossom—Pink with white tube.

Crimson—Fiery crimson.

Loveliness—Soft pink.

Snowflake—White.

Canary Bird—Yellow.

Any one above (Pkt. 15c) (½ Oz. 50c).

Mixed Colors (Pkt. 10c) (½ Oz. 40c).

STATICE (Everlasting) (a)

Lasts for months when dried. Effective either along or with other everlastings.

ART SHADES MIXED—(Pkt. 10c) (½ Oz. 25c) (Oz. 75c).

LATIFOLIA—Sea Lavender—Hardy Perennial. The cloud-like masses of flowers can be dried and used for winter decorations. Color, clear mauve. (Pkt. 10c) (½ Oz. 35c).

STOCKS (a)

TEN WEEKS—Plants 2 feet high, bear numerous large spikes of double, fragrant flowers of blood-red lilac, white, rose, scarlet, light and dark blue, creamy white and pink. (Pkt. 10c) (½ Oz. 35c).

GIANT BISMARCK OR IMPERIAL—One of the best stocks for outside planting; of pyramidal form, strong and robust, gives large double flowers. A splendid sort for cutting. Mixed colors. (Pkt. 10c) (½ Oz. 40c).

SWEET WILLIAMS (biennial)

Large, showy flower heads, composed of numerous good-sized individual blooms, similar to Pinks. Bloom during May and June. 1 to 1½ ft. high.

SINGLE MIXED—(Pkt. 10c) (¼ Oz. 30c) (½ Oz. 50c).

DOUBLE MIXED—(Pkt. 10c) (½ Oz. 40c) (¼ Oz. 70c).

THUNBERGIA (Black Eyed Susan)

A rapidly growing little vine for hanging baskets and boxes. Very pretty flowers of orange, yellow and white with large black centers. (Pkt. 10c).

VERBENA (a)

Colorful, dwarf plants, ideal for edgings, ground cover, rock gardens and porch boxes. The flowers are borne in large trusses from midsummer until late fall. Of robust, spreading growth, 8 to 12 inches high, 2½ ft. and more across.

VERBENA HYBRIDS



BEAUTY OF OXFORD—Rose pink.

BLUE WITH WHITE EYE—Deep blue with white eye.

COCCINEA—Scarlet, small eye.

ETNA—Geranium red with creamy yellow eye.

LAVENDER GLORY—Lavender with creamy yellow eye.

LUMINOSA—Flame pink shading to salmon.

MAMMOTH WHITE—Pure white.

VIOLACEA STELLATA—Deep violet with white eye.

Each of above: (Pkt. 10c) (3 Pkts. 25c).

HYBRIDS—Large flowering. A splendid mixture of richest colorings and immense blooms. (Pkt. 10c) (½ Oz. 50c).

VIOLA (Tufted Pansy) (a)

For rock gardens, beds or borders, these splendid plants are very popular. Violas bloom profusely from June until frost, their colors are clear and distinct. A splendid mixture of the best varieties. (Pkt. 25c).

WALLFLOWER (p)

Rich orange and yellow; fragrant, stock-like flowers for bedding; 1 ft. high. Bloom early in spring. (Pkt. 10c) (½ Oz. 30c)

SWEET PEAS

These fine late Spencer types are the most popular for summer blooming. They are large size, delicately waved and scented and produce three or four flowers on each stem.



GIANT SUMMER FLOWERING SPENCERS

SPENCER'S "BUTTERFLY" OR "ORCHID FLOWERED."

- BLUE BIRD**—Rich deep blue.
- CAPRI**—Light blue.
- CAPTAIN BLOOD**—Brilliant blood scarlet.
- DEBUTANTE**—Coral.
- ELSTREE**—Bright pink on cream ground.
- GUINEA GOLD**—Orange, shaded gold.
- HIGHLANDER**—Pure lavender.
- JUMBO**—Deep cerise.
- KAMES**—Pure white.
- MASTERCREAM**—Creamy white.
- OTHELLO**—Deep maroon.
- ROYAL PURPLE**—Rich royal purple.
- RUBICUND**—Crimson-scarlet.
- SHIRLEY TEMPLE**—Clear rose-pink.
- SMILES**—Salmon and shrimp pink.
- TREASURE**—Deep rich mauve.

Any one above: (Pkt. 10c) (Oz. 35c) (¼ lb. \$1.00).

SPECIAL COLLECTION OF BUTTERFLY OR ORCHID FLOWERING SWEET PEAS

Ten full sized packets, all separate colors: White, Pink, Yellow, Lavender, Rose, Purple, Maroon, Scarlet, Salmon, Blue. Postpaid, 75c (regular price \$1.00).

SWEET PEAS IN MIXTURE

- PERFEGRO BLEND OF RESELECTED SPENCERS**—Made up from our complete list of named varieties. (Pkt. 10c) (Oz. 30c) (¼ lb. 80c) (lb. \$2.75).
- EXTRA EARLY FLOWERING SPENCERS**—All the best early flowering varieties. (Pkt. 10c) (Oz. 30c) (¼ lb. \$1.00).
- EXQUISITE BLEND**—A mixture of the brightest Spencers and the newest novelties. (Pkt. 10c) (Oz. 25c) (¼ lb. 75c) (lb. \$2.50).
- SPENCERS MIXED**—(Pkt. 5c) (Oz. 20c) (¼ lb. 65c) (lb. \$2.00).

CUTHBERTSON SWEET PEAS

Heat Resistant

Plants are quite vigorous and produce a heavy crop of large, long-stemmed blooms. Heat resistant and therefore especially adapted to localities where Sweet Peas have been more or less unsuccessful.

- BILLY**—Bright and lovely carmine-rose.
- COLINE**—A most attractive shade of scarlet.
- EVELYN**—Beautiful delicate tones of salmon pink and cream.
- FRANK G.**—An attractive rosy-lavender.
- JANET**—Pure white.
- LOIS**—Light rose pink on white.
- TOMMY**—Most pleasing clear lobelia-blue.
- ALL COLORS MIXED**—A mixture of the above colors. (Pkt. 10c) (Oz. 35c) (¼ lb. \$1.00) (Lb. \$3.00).

ZINNIA

GIANT DAHLIA-FLOWERING ZINNIAS

These are a grand giant-flowering strain of high quality. The plants are exceedingly vigorous, growing fully 3 feet high.

- CANARY BIRD**—A delicate shade of primrose.
- CRIMSON MONARCH**—Rich crimson.
- DESERT GOLD**—Yellow turning to rich orange.
- DREAM**—Unusual shade of deep lavender.
- EXQUISITE**—Light rose with dark rose center.
- ILLUMINATION**—Deep rose.
- ORIOLE**—Orange and gold bi-color.
- POLAR BEAR**—Very large white.
- PURPLE PRINCE**—Deep purple.
- SCARLET FLAME**—Bright scarlet.
- WILL ROGERS**—Dark scarlet.
- Any one above—(Pkt. 10c) (¼ Oz. 30c) (¼ Oz. 50c) (Oz. \$1.50).
- DAHLIA FLOWERED MIXTURE**—A mixture of the above colors. (Pkt. 10c) (¼ oz. 30c) (½ Oz. 55c) (Oz. \$1.00).

SPECIAL COLLECTION OF GIANT DAHLIA-FLOWERING ZINNIAS

Six full-size packets of the separate colors listed on this page, value 60c. Your choice for 45c.

LILLIPUT ZINNIAS

DOUBLE POMPON OR LILLIPUT—So called on account of its dwarf nature. The plant is 12 to 15 inches high. The flowers are very beautiful little things about 1½ inches in diameter and very double.

- | | |
|--------------------|--------------------|
| Crimson Gem | Golden Gem |
| Salmon Rose | Scarlet Gem |
| Yellow Gem | White Gem |

Any one above—(Pkt. 10c) (¼ Oz. 40c).

MIXED COLORS—All colors in a splendid mixture. (Pkt. 10c) (¼ Oz. 35c).

SPECIAL VARIETIES

CROWN O'GOLD—Each petal of the flower is overlaid with a golden yellow at the base while carrying out the individual color at the tip. The effect is very pleasing and the color combinations are of the soft tones or perhaps they might be called pastel shades. The type is similar to the dahlia-flowered Zinnia. (Pkt. 10c) (¼ Oz. 35c).

CACTUS-FLOWERED—Large, attractive double flowers, 2 to 3 inches across, with petals partially quilled or tubular, giving somewhat the appearance of Cactus Dahlia. Many choice and unusual colors. (Pkt. 10c) (¼ Oz. 35c).

MEXICAN MINIATURES—Somewhat like French Marigolds with flowers of yellow, orange, mahogany—frequently variegated. Flowers double and single. Good for edging and long lasting bouquets. (Pkt. 10c) (¼ Oz. 35c).

CALIFORNA GIANTS—Enormous double flowers, 6 to 8 inches across, with very long stems. Centers very small and most of the flowers carrying a two-tone effect shading to a darker color at the center of the flower. (Pkt. 10c) (¼ Oz. 35c) (Oz. \$1.00).

FANTASY—It is of the curled and crested type, with blooms of medium size having shaggy ray-like petals, giving it a delicate and refined appearance. Color range includes reds, yellows, orange and pastel pinks and creams. Plants are 2 to 2½ feet tall, free-flowering. (Pkt. 10c) (¼ Oz. 35c).

SCABIOSA FLOWERED—Mixed colors. A new form. On a single corona of outside petals stands a semi-globular crown with a large number of small florets giving a most interesting effect, similar in form to the flowers of the Scabiosa. (Pkt. 10c) (¼ Oz. 35c).



ZINNIA, CALIFORNIA GIANTS



BECHTEL'S DOUBLE FLOWERING CRAB



BUTTERFLY BUSH



DOUBLE FLOWERING ALMOND

FLOWERING AND ORNAMENTAL SHRUBS

Greatly in demand for specimen use on lawns, for hedges and for making permanent background effects. Some are valuable as cut-flowers and others for their ornamental foliage. Every home-owner has room for selected shrubs which grow in beauty and usefulness from year to year with the least possible

care. They are easy to handle and endure neglect with less damage than any other plants.

Figures in parenthesis are the general height at maturity. All items on this page postpaid. No plants or shrubs sent C. O. D.

ALMOND

PRUNUS GLANDULOSA—Double Flowering—(4 to 5 ft.). The blossoms are double like roses, set closely on the twigs and appear before the leaves in the early spring. Pink. (Each 85c) (3 for \$2.25).

ALTHEA

HIBISCUS SYRIACUS—Rose of Sharon—(10 to 12 ft.). The Altheas are fine, free-growing flowering shrubs of very easy cultivation. Desirable on account of flowering in August and September, when nearly every other shrub or tree is out of bloom. Perfectly hardy and can be had in various colors if desired. We can supply RED, PINK, WHITE or PURPLE. (Each 60c) (3 for \$1.65).

BARBERRY

The Barberries are low growing shrubs especially good for front or shrubby borders and foundation planting.

BERBERIS THUMBERGI—Japanese—(4 to 5 feet). Has small light green leaves, which turn to rich colors in autumn, and its wealth of scarlet berries make it very attractive. (Each 60c) (3 for \$1.65).

ATROPURPUREA—Red Leaved—(3 to 6 ft.). Has bronzy-red foliage at all seasons; in mid-summer or fall turning a brilliant red. (Each 85c) (3 for \$2.25).

BUTTERFLY BUSH

One of the best of the late summer and fall blooming shrubs. Dies back to the roots each winter, but grows to 4 to 5 feet each year. From July until frost are covered with a wealth of flowers.

CHARMING—Long sprays covered with lavender-pink blooms, fully rounded. (Each 75c).

DUBONNET—A new dark wine, dubonnet colored buddleia with firm large spikes that do not sunburn. (Each 75c).

EMPIRE BLUE—(Pat. 557)—The color is an Aster-blue with a delicate lilac tone, the whole effect being an exquisite shade of blue. (Each 75c).

PINK DAWN—The flower is pink throughout and produced in great abundance throughout the summer, the flower sprays are 2 to 3 feet in length. (Each 75c).

ROYAL RED (Pat. No. 506)—Long flower spikes of rich dark royal purple. (Each 75c).

WHITE BOUQUET (Pat. No. 536)—A new white Buddleia carrying 8 inch spikes of fully rounded-out blooms. Splendid for cut flower purposes. (Each 75c).

DOGWOOD

CORNUS—Alba Siberica (Coral Dogwood)—(8 to 12 ft.). Has clusters of fine white flowers, succeeded by a fall crop of ornamental berries; stem and branches blood red. (Each 60c) (3 for \$1.65).

STOLONIFERA LUTEA—Goldentwig—(8 to 10 ft.). A handsome shrub with beautiful distinct yellow bark. Splendid for winter effect. (Each 60c) (3 for \$1.65).

FLOWERING CRABS

BECHTEL'S DOUBLE FLOWERING—A low, bushy tree, the most beautiful of all the fine varieties of Flowering Crabs. At a distance the tree seems to be covered with dainty little roses of a delicate pink color. Blooms when quite young. The flowers are exceedingly fragrant. 2 to 3-foot tree. (Each \$1.50).

FORSYTHIA

Forsythias are among the showiest spring-blooming shrubs. They are not particular as to soil.

FORTUNEI—(10 to 12 feet). Strong, erect habit; bright golden-yellow flowers in early spring. (Each 60c) (3 for \$1.65).

HANSEN'S BUSH CHERRY

The Bush Cherry combines two useful qualities, a beautiful ornamental shrub that produces delicious, wholesome fruit. In early spring is a mass of snow-white flowers followed by plum-shaped sweet cherries. Foliage is silvery green turning to rich red and gold in the fall. (Each 60c) (3 for \$1.65).

HYDRANGEA

ARBORESCENS GRANDIFLORA—Snowball—(3 to 6 feet). Hardy shrub with snow-white blossoms of largest size from early June until late July. Thrives in shady places. (Each 90c) (3 for \$2.50).

PANICULTA GRANDIFLORA—Peegee—(8 to 10 feet). A very hardy shrub with large trusses of showy double white flowers, blending into pink and bronze shades in autumn. Plant in shade. (Each 90c) (3 for \$2.50).

HONEYSUCKLE

LONICERA—Tatarica Rosea—(Pink Tatarian)—(8 to 10 ft.). A hardy, vigorous grower. With pink flowers in April or May. Red fruit. (Each 60c) (3 for \$1.65).

TATARICA RUBRA (Red Tatarian)—(6 to 8 ft.). Very hardy and upright with rosy-pink flowers in April. Bright red fruit. (Each 60c) (3 for \$1.65).

AVAILABLE IN THE SPRING ONLY

FLOWERING AND ORNAMENTAL SHRUBS

JAPANESE QUINCE

CYDONIA JAPONICA—Flowering Quince—(5 to 6 feet.)—Very early in spring this fine old shrub is completely covered with dazzling scarlet flowers; followed by small, quince-shaped fruits, which are quite fragrant. Growth bushy with protecting thorns. (Each 60c) (3 for \$1.65). Postpaid.

LILAC (Syringa)

Probably one of the most popular ornamental shrubs. They thrive in fertile rather moist soils.

CHINESE, ROTHOMAGENSIS—(8 to 10 ft.). An Improved Persian type, upright grower, with dark reddish purple flowers. One of the best for general planting on account of its free blooming qualities and hardiness. (Each 75c) (3 for \$2.00). Postpaid.

VULGARIS OR COMMON—(12 to 15 feet). Hardy popular shrub that blooms freely. Single flowers in large panicles during April and May.

PURPLE—Single flowers of deep lavender. (Each 60c) (3 for \$1.65). Postpaid.

WHITE—Flowers creamy white, make a beautiful contrast when planted with the purple variety. (Each 75c) (3 for \$2.00). Postpaid.

VILLOSA—A late blooming variety that has large broad plume-like panicles of delicate pink. (Each 75c) (3 for \$2.00). Postpaid.

RUBRA DE MARLEY (Vulgaris variety)—An improved strain of Vulgaris lilac, often classed as a Hybrid variety, producing a mass of single, rich reddish purple flowers. (Each 75c) (3 for \$2.00). Postpaid.

FRENCH HYBRID LILACS

Larger flowers, improved form of bush and more penetrating fragrance, with less tendency to sucker, feature these new type French Hybrids.

CHAS. JOLLY—Double flowers of reddish purple. (Each \$1.50).

CONGO—Single flowers of magenta red. (Each \$1.50).

LUDWIG SPAETH—Single, very dark, shading from purple to maroon red, one of the darkest shades grown. (Each \$1.50).

MME. A. BUCKNER—Double flowers of pink. (Each \$1.50).

MME. LEMOINE—Double pure white. (Each \$1.50).

MRS. W. E. MARSHALL—Single flowers of reddish purple. (Each \$1.50).

PRES. GREVY—Double flowers of reddish purple. (Each \$1.50).

HUGO KOSTER—Single flowers of dark lilac. (Each \$1.50).

MOCK ORANGE

PHILADELPHUS—Coronarius—Sweet Syringa—(8 to 10 feet).

A well-known shrub with pure white, sweetly scented flowers, blooming in May. (Each 60c) (3 for \$1.65). Postpaid.

VIRGINAL—(7 to 8 feet). Loaded down with beautiful fragrant semi-double flowers over a long season, beginning in May. (Each 75c) (3 for \$2.00). Postpaid.

BOUQUET BLANC—(4 to 5 ft.). Has close set branches of fragrant double white flowers with rich green foliage, blooms in late May and early June. (Each 75c) (3 for \$2.00). Postpaid.

SNOWBERRY

SYMPHORICARPOS RACEMOSUS—Common Snowberry—(3 to 5 feet). Has attractive green foliage with pink flowers in June or July; followed by large clustered, white fruits remaining far into winter. (Each 60c) (3 for \$1.65). Postpaid.

VULGARIS—Coralberry—(4 to 6 feet). This compact, rapidly growing shrub is wonderfully attractive with its dark, close-set foliage and clusters of red berries massed along the dropping branches. Berries adhere until late winter. (Each 60c) (3 for \$1.65). Postpaid.

SUMAC

RHUS TYPHINA LACINATA—Stag Horn Sumac—(10 to 12 feet). One of the best species for mass or other planting on account of its deeply cut, beautiful fern-like leaves. Its flowers are borne during June and July in dense, terminal panicles, followed by impressive dark red fruits. (Each 60c) (3 for \$1.65). Postpaid.

SNOWBALL

VIBURNUM—Opulus Sterilis—Common Snowball—(10 to 12 feet). A favorite shrub, with globular clusters of white flowers the latter part of May. (Each 85c) (3 for \$2.25). Postpaid.

OPULUS—Highbush Cranberry—(10 to 12 feet). The white flowers in June are followed in autumn by bright scarlet berries which are very attractive until very late winter. (Each 85c) (3 for \$2.25). Postpaid.

SPIREA

ANTHONY WATERER—(3 to 4 feet). Low, compact growing shrub, covered in July with flat heads of rosy crimson flowers. If cut they will bloom until frost. Makes a nice hedge. (Each 75c) (3 for \$2.00). Postpaid.

BILLARDI—Billiard Spirea—(5 to 6 feet). Has dense spikes of rose-pink flowers that crown sparsely twigged erect branches. For shrubbery groups, natural plantings and moist places. (Each 60c) (3 for \$1.65). Postpaid.

FROEBEL—(4 feet). Vigorous and spreading grower with bright pink flowers in May and June. Has purplish tips in the spring and beautiful autumn colors. (Each 75c) (3 for \$2.00). Postpaid.



SPIREA, VAN HOUTTE

VAN HOUTTE—Bridal Wreath—(5 to 6 feet). Well known, popular shrub with graceful habit of growth. Pure white flowers in April.

2 to 3-foot shrubs: (Each 60c) (3 for \$1.65). Postpaid.

3 to 4-foot shrubs: (Each 75c) (3 for \$2.00). Postpaid.

STAPHYLEA

STAPHYLEA—American Blatter Nut—(6 to 10 ft.). Upright shrub with handsome bright or light green foliage. Ornamental white flowers in nodding clusters followed by bladder-like fruits conspicuous by their size and pale green color. (Each 85c) (3 for \$2.25).

TAMARIX

HISPIDA—(15 to 20 feet). Strong, slender, tall-growing, irregular shrubs, with feathery foliage and small, delicate flowers borne profusely on gracefully bending branches. These pink flowers are very attractive during May. (Each 75c) (3 for \$2.00). Postpaid.

WEIGELIAS

Coarse, thrifty shrubs for medium and back rows. Their delightful bloom period ranging from May into July. The flowers are stemless bells strung along the arching canes in clustered profusion.

EVA RATHKE—(4 to 5 feet). The most distinct and one of the most attractive varieties; flowers deep carmine red. (Each 85c) (3 for \$2.25). Postpaid.

PLANTS FOR HEDGES AND SCREENS

For a nice ornamental hedge plant 12 to 18 inches apart. For a real pretty effect plant in double row, 10 inches apart and alternate the plants. To make a close hedge, cut back the plants the first and second years in order to start many shoots.

AMOR RIVER PRIVET—Foliage glossy green and almost evergreen; plants of dense upright habit, very hardy; useful in shaded places. Also suitable for background against foundation walls and groups on the lawn. (25 to bundle \$5.00) (100 for \$14.00) f. o. b. Denver.

ENGLISH PRIVET—A hardy plant with lustrous black berries, with dense glossy deep green foliage. Almost evergreen. Can be sheared to make a dense hedge any height desired. (25 to bundle \$5.00) (100 for \$17.50) f.o.b. Denver.

JAPANESE BARBERRY—For a low hedge this is the ideal plant. The thorny branches grow so dense as to make an almost impenetrable hedge. Used extensively for bordering lawns and dividing properties. (25 to bundle \$5.00) (100 for \$17.50) f. o. b. Denver.

AVAILABLE IN THE SPRING ONLY

HARDY CLIMBING VINES

AMPELOPSIS VEITCHI—Boston Ivy—This is one of the finest hardy climbers we have for covering walls, as it clings firmly to the smoothest surface, covering closely with overlapping foliage. The color is a fresh deep green in summer, changing to the brightest shades of crimson and yellow in autumn. (Each 75c) (3 for \$2.10). Postpaid.

CLEMATIS JACKMANI (Large Flowered Variety)—It is a strong grower, and produces a mass of intense violet-purple flowers from July on. They delight in rich soil and sun. (Each \$1.25) (3 for \$3.50). Postpaid.

CLEMATIS PANICULATA (Small Flowered Variety)—A valuable climber literally covered with white fragrant flowers in September. (Each 75c) (3 for \$2.10). Postpaid.

HONEYSUCKLE (Gold Flame)—Blooming from early summer until killing frost. Showy tubular flowers, with recurving petals, flame red outside, bright yellow inside. Very fragrant and hardy. (Each 75c) (3 for \$2.00). Postpaid.

HECKROTTI—This is truly a wonderful vine, grows to full blooming size the first year. Blooms continually from early summer until fall. The red trumpets are lined with orange and are very showy. (Each 75c) (3 for \$2.00). Postpaid.

JAPONICA HALLEANA—Rapid growing vine with beautiful foliage. Delightfully fragrant, creamy white flowers. (Each 50c) (3 for \$1.35). Postpaid.

SCARLET TRUMPET—A hardy sweet scented high-climbing variety. Dark green foliage with scarlet trumpet shaped flowers. (Each 60c) (3 for \$1.65). Postpaid.

MADERIA VINES—Climbing Mignonette—A beautiful vine, covering a large space in a short time. Heart-shaped light green leaves and clusters of pure white fragrant flowers. (Bulbs, 3 for 50c) (12 for \$1.50). Postpaid.

SILVER LACE VINE (Polygonum Auberti)—A hardy quick growing vine, doing well in almost any situation. Covered in late summer and fall with mass of creamy-white sprays. (Each 75c) (3 for \$2.10). Postpaid.

TRUMPET VINE (Bignonia Radicans)—Very hardy and rapid grower. Used for covering unsightly places, stumps, or wherever a showy flowering vine is desired. Produces clusters of trumpet-shaped, orange-scarlet flowers about 3 inches long. (Each 60c) (3 for \$1.65). Postpaid.

WISTERIA (American Purple)—A tall, vigorous, rapid climber. Has lilac-purple, pea-shaped flowers in June. (Each 60c) (3 for \$1.65). Postpaid.



JAPONICA HALLEANA

TALL BEARDED IRIS

Bearded irises are the best known of the garden sorts. They are plants of varying stature and size, but all characterized by stout rhizomes, more or less evergreen foliage and brilliant flowers in many shades, each flower bearing on the falls a linear beard of various colors, though commonly yellow. Are of easy culture, prefer shallow planting in sunny well drained locations in a deep, well worked soil.

ALICE HARDING—40 in. A large, smooth satiny yellow.

BLACK WINGS—40 in. Near black, and one of the best of this color.

BLUE GEM—44 in. Gigantic rich blue toned variety.



CROWN JEWEL—36 in. A rich blend of Talisman rose colors.

CYDALISE—38 in. The yellow background is etched around the edges with a buttonhole stitching of chocolate brown.

EUPHONY—36 in. A blend of yellow and copper.

EVELYN BENSON—39 in. Uniform carmine.

GOLDEN LIGHT—40 in. A golden brown blend.

HELIOS—44 in. Soft lemon yellow with ivory edges.

JEAN CAYEAU—36 in. Havana and coffee brown.

LIGHTHOUSE—40 in. A blend of rose-red with rose.

LORD LAMBOURNE—40 in. Rich madder crimson with soft rose and amber.

MARY GIBSON—42 in. A handsome soft rosy bronze blend with a yellow throat.

MME. LOUIS AREAU—36 in. White ground veined lavender.

MRS. MARION CRAN—48 in. A lovely tall pink iris.

RED DOMINION—42 in. Clear lustrous red toned.

SIMONE VAISSIERE—36 in. Azure blue standards, deep blue falls.

SOLFERINO—40 in. Bright pink tone.

TALISMAN—38 in. Delightfully fragrant Talisman rose colors.

THURATUS—24 in. A very deep purple, almost black.

VALOR—48 in. Very fragrant, with purple black falls and blue violet standards.

WASATCH—50 in. Huge white with a feather stitched blue border.

(Each 25c) (5 for \$1.00). Postpaid.

SPRING AND FALL FLOWERING BEARDED IRIS

These double duty Irises not only bloom in the spring along with other early flowering varieties but they flower again profusely in the autumn, beginning in September and continuing until killed by heavy frost. They are hardy and can be planted any time and require very little care.

AUTUMN DAWN—28 in. Ruffled, soft pink and yellow blend.

AUTUMN HAZE—30 in. Huge flowers of lavender-violet.

AUTUMN WHITEKING—Pure white with bright yellow beards.

ELEANORE ROOSEVELT—26 in. A rich violet tone.

SOUTHLAND—24 in. A sensational deep yellow.

SUNFIRE—18 in. Soft creamy yellow.

DORCAS HUTCHESON—18 in. Fragrant pansy violet.

Price (25c each) (5 for \$1.00). Postpaid.

AVAILABLE IN THE SPRING ONLY

HARDY EVERBLOOMING ROSES

Roses are ready for delivery April 1

Our Bushes Are All Hardy Two-Year-Old, Field Grown Stock

The following list is composed of new and sensational roses, all of considerable merit. Also more established and better known varieties. No Plants Sent C.O.D.



AUTUMN

AUTUMN—Very double blooms of rich burnt orange, yellow and red. (Each \$1.00).

BRIGHT WINGS—A two-toned rose with beautiful buds of rosy burnt orange color, opening to a coral pink. (Each \$1.00).

CALEDONIA—Large, very long pointed buds with edges gracefully rolled back; faintly fragrant large double flowers are borne singly on long stems. Lemon tinted color changes to a pure white. (Each \$1.00).

CHARLES K. DOUGLAS—Long pointed buds of scarlet opening into large double flowers, flushed with velvety crimson. (Each \$1.00).

CHRISTOPHER STONE—Lovely, long-pointed buds open to vivid scarlet blooms overlaid with velvety crimson. (Each \$1.00).

CONDESA DE SASTAGO—A marvelous colored rose with large cupped flowers of deep golden yellow on outside of petal, copper rose and scarlet on the interior. (Each \$1.00).

DAME EDITH HELEN—Soft even-tone pure pink, intense old rose fragrance, flowers very double and large size. (Each \$1.00).

DUQUESA DE PENERANDA—The hugh pointed buds are double orange apricot with deep coppery tones, sweetly perfumed and long lasting. (Each \$1.00).

E. G. HILL—Buds ideal, long and pointed on good stout stems, open into a full double bloom of crimson scarlet which retain their color until petals fall. (Each \$1.00).

EDITOR McFARLAND—Exceptionally fine brilliant pink blooms suffused with yellow at base. (Each \$1.00).

ETOILE DE HOLLANDE—The perfect buds open beautifully into glorious perfect flowers of velvety crimson, incomparable fragrance. (Each \$1.00).

FEU JOSEPH LOOYMANS—Long pointed buds of tangerine yellow with a vivid apricot center. The large open flowers have a delicious spicy fragrance. (Each \$1.00).

FLORADORA—One of the most scintillating red Floribunda roses that we have ever seen. It is that sparkling shade which immediately stops the eye. Grows to 30 inches tall and in true Floribunda style. Buds are perfect and hold well on the plant after cutting, bloom continually from June until freezing fall weather. Petals have wavy rippling edges. (Each \$1.00).

GIRONA—Here is one of the most fragrant roses in existence and one of the best of all Garden Roses for cutting. Very strong growing with good foliage and superb blooms of a beautiful red and yellow combination. (Each \$1.00).

GLOWING CARMINE—Lasting fragrant flowers of deep carmine; continuous bloomer. (Each \$1.00).

GOLDEN DAWN—Well formed flowers of sunflower yellow flushed with old rose. (Each \$1.00).

HADLEY—A rich glorious red, shading to velvety purple. Flowers exceedingly fragrant. Buds are high and pointed. (Each \$1.00).

JOANNA HILL—Light yellow with reverse of petals somewhat darker with a reddish tone. (Each \$1.00).

K. A. VICTORIA—In bud form the color is cream white but the open flower is snow white with a tint of lemon at the center. (Each \$1.00).

MARGARET McGREDDY—Full blooms or orange-scarlet are profusely borne on vigorous bushy plants. (Each \$1.00).

McGREDDY'S IVORY—Long pointed ivory buds open carefully to a perfectly formed flower of creamy white. (Each \$1.00).

McGREDDY'S SCARLET—Large, perfect blooms of vivid, luminous carmine red. (Each \$1.00).

McGREDDY'S YELLOW—This rose is pure buttercup yellow, perfect form and with the wonderful fragrance of the Irish Roses. (Each \$1.00).

MRS. SAM McGREDDY—Beautiful scarlet-copper orange flowers, heavily flushed with red on outside of petals, moderately fragrant. (Each \$1.00).

MME. JULES BOUCHE—Fragrant white blooms, center shaded blush, very free blooming. (Each \$1.00).

MME. JOSEPH PERRAUD—Bi-color, long slender buds of nasturtium orange opening to sweetly fragrant flowers of buff with a tint of pale pink at the petal edges. (Each \$1.00).

MRS. E. P. THOM—A deep lemon yellow rose, with perfect shaped buds, very fragrant, and a heavy, continuous bloomer. (Each \$1.00).

NIGHT—One of the darkest of all roses, deep crimson shaded black and maroon. Delightfully spicy clove and cinnamon fragrance. (Each \$1.00).

PICTURE—Velvety clear rose pink with undertones of salmon; very double flowers. (Each \$1.00).

PRES. HOOVER—The semi-double blooms are a combination of cerise-pink, flame, scarlet and yellow. (Each \$1.00).

POINSETTIA—Glowing poinsettia red, buds long pointed; large double open flowers, vigorous prolific bloomer, very fragrant. (Each \$1.00).

PINK RADIANCE—Rose pink buds opening to well-formed shining flowers with lighter tints on the reverse of the petals; globular in shape and very fragrant. (Each \$1.00).

RED RADIANCE—Large globular flowers of deep rose-red. (Each \$1.00).

RED TALISMAN—A sport from the regular Talisman flowers identical in shape and size but color is deep red. (Each \$1.00).

ROSE MARIE—A delightful pure rose pink, the buds are long and pointed, petals large and well rounded. (Each \$1.00).

SISTER THERESE—A fine free blooming rose of deep yellow with tints of bronze. (Each \$1.00).

SNOWBIRD—A prolific pure white rose, fragrant, perfectly formed, full petaled blooms often 4 inches across borne singly on long stems. (Each \$1.00).

SOUTHPORT—An illuminated scarlet in a perfectly formed bud, opens to a loose flower of brilliant unshaded scarlet. Free flowering and wonderfully fragrant. (Each \$1.00).

TALISMAN—A combination of shadings of gold, apricot yellow and deep pink, and as the petals unfold they become bright apricot with the reverse of the petals changing to deep rose pink. (Each \$1.00).

TANGO—Outside of petals are a unique shade of ivory while the inside of the petals are vermilion scarlet, very spicy fragrance. (Each \$1.00).

THE DOCTOR—Large, beautiful buds opening to enormous semi-double, cupped flowers of satiny pink. Fragrant. Plant vigorous and bushy. (Each \$1.00).

VICTORIA HARRINGTON—Velvety, non-fading dark red buds with a golden sheen at center of flower. (Each \$1.00).

RUGOSA OR SHRUB ROSE

We group under this heading various types and species of Roses that are of strong habit of growth and will be found especially adapted to plant in mixed Shrubbery Borders, or in separate beds or groupings or as individual specimens in the garden.

AUSTRIAN COPPER—Single, brilliant orange-red flowers inside and yellow on the reverse of the petals. (Each \$1.00).

F. J. GROOTENDORST—Small flowers of deep crimson-red borne in large clusters throughout the season. (Each \$1.00).

AVAILABLE IN SPRING ONLY

PATENTED ROSES

Hybrid Teas

- AMERICAN FLAGSHIP (Pat. 676)**—Fragrant flowers of rich crimson, dark foliage. (Each \$1.50).
- APPLAUSE (Pat. 829)**—Buds are sparkling light red in color, opening to perfectly shaped fifty petaled blooms. (Each \$2.00).
- CALIFORNIA (Pat. 449)**—Enormous flowers with a dual-tone effect of ruddy orange outside the petals and saffron yellow inside. (Each \$1.25).
- CAPISTRANO (Pat. App.)**—All America Rose Selection for 1950. One of the finest pink hybrid teas ever introduced. Rich deep glowing rose pink retaining its brilliance without fading, extra long stiff stems. (Each \$2.50).
- COUNTESS VANDAL (Pat. 38)**—Long pointed buds with color combination of pink, copper, gold and salmon. (Each \$1.35).
- CHARLOTTE ARMSTRONG (Pat. 455)**—Unique color with long, slender blood-red buds opening to brilliantly colored open flowers of spectrum red. (Each \$1.50).
- CRIMSON GLORY (Pat. 105)**—Color deep crimson, a "glory" rose, glorious in its perfect form, large size and fragrance. (Each \$1.35).
- DIAMOND JUBILEE (Pat. 824)**—Double high centered flowers of glowing buff-orange with a touch of orange yellow at base of petals. (Each \$2.00).
- DEBONAIR (Pat. 677)**—Color a deep vivid yellow, that is showy at all stages of bloom, a strong growing bush with fine foliage and flower stems. (Each \$1.50).
- FASHION (Pat. 789)**—Fascinating new Florabunda of coral pink overlaid with gold, oriental red buds open into 3½-inch blooms of clear coral. Bushy 3-ft. plants produce large clusters of delightfully fragrant flowers all season. (Each \$2.00).
- FORTY-NINER (Pat. 792)**—A noteworthy bi-color rose of brilliant rich contrast. The outside of the petals is dazzling chrome-yellow, sometimes overlaid with pink, the inside face of the petals is a vivid orient red changing to cherry red with age, buds are long pointed, opening into unusually well-shaped flowers with mild, pleasing fragrance. (Each \$2.00).
- GOLDILOCKS (Pat. 672)**—A true golden yellow Floribunda, rich yellow buds are ovoid in shape, long lasting, hardy and vigorous. (Each \$1.50).
- HEART'S DESIRE (Pat. 501)**—The color is a pure even shade of luminous red, without any shadings of maroon. It is sun-proof even in the hottest weather and does not burn. (Each \$1.50).
- HORACE McFARLAND (Pat. 720)**—Buds rich orange pink, flowers are large, with 45 petals, changing to apricot pink when open. (Each \$1.50).
- LOWELL THOMAS (Pat. 595)**—Immense bright chrome-yellow blooms, beautifully shaped buds which open with the petals rolling outward. Blooms 4 inches across when fully open. (Each \$1.50).
- MING TOY (P.A.F.)**—A new polyantha-like shrub rose. The dainty petals are so precisely placed that the high centered brilliant rose-colored flower may be compared with a miniature camellia in form. In bloom continually. (Each \$1.50).
- MIRANDY (Pat. 632)**—A strong free branching plant producing large, long pointed ovoid buds of rich dark red with black shadings, opening to Chrysanthemum red. The flower of 50 petals displays new beauties of form and is long lasting. Marvelously fragrant. (Each \$1.50).
- MISSION BELLS**—All America Rose Selection for 1950. Deep salmon-pink opening to brilliant shrimp pink when open. Vigorous free branching plants produce an abundance of large flowers on long, sturdy stems with copper green foliage. (Each \$2.50).
- NEW YORKER (Pat. 823)**—A truly red rose that does not change color, flowers are large on vigorous plants, young shoots and new growth are bright red, with a delightful almost raspberry fragrance. Sun-resistant. (Each \$2.00).
- NOCTURNE (Pat. 713)**—The long red buds of the new rose should arouse enthusiasm. The color is bright cardinal red with darker shadings. The stems are long, foliage large and luxuriant. (Each \$1.50).



PEACE
(Pat. 59)

- PEACE (Pat. 591)**—The large ovoid buds are yellow with watermelon pink picoted edging, the full open flower is cream yellow with a delicate over-all flush of pink. The blooms are 5 to 6 inches across, very double with 30 to 60 petals, its fragrance is mild and pleasant. Abundant bloomer, (Each \$2.00).
- PINKIE (Pat. 712)**—A baby rose that has blooms with a perfection of form not heretofore found in this class. Dainty little pink buds of deep pink, that are long, slender and perfect in every detail. Grows two feet tall. (Each \$1.50).
- PINOCCHIO (Pat. 484)**—The plants are literally covered from spring to frost with great quantities of beautiful salmon pink flowers flushed with gold. Buds are perfect in shape, and make beautiful corsages. Plant is compact and upright. (Each \$1.25).
- RED PINOCCHIO (Pat. 812)**—A new red Florabunda rosé with its miniature perfectly shaped Hybrid Tea flowers of deep satiny carmine borne in clusters. (Each \$1.50).
- REX ANDERSON (Pat. 335)**—An outstanding exhibition rose, perfectly formed, slow open, color delicate lovely ivory white. (Each \$1.50).
- ROSE OF FREEDOM (Pat. 791)**—Beautiful 60 to 70 petaled, long-stemmed currant-red blooms. (Each \$1.50).
- SUTTER'S GOLD**—Intensely fragrant flowers of velvety radiant yellow with copper veins. All America Rose Selection for 1950. (Each \$2.50).
- SIGNORA (Pat. 201)**—Graceful buds of warm brownish orange, open to lighter mandarin and salmon. (Each \$1.35).
- SHOWGIRL (Pat. 646)**—A perfectly formed, slender bud opens into a high centered spiral flower of deep pink which does not fade in the hottest weather, very free flowering. (Each \$1.50).
- TALLYHO (Pat. 828)**—A unique and unusually beautiful shade of pink inside the petals, crimson to cardinal red outside. Although it is a bi-color the contrast is not great but is rather a delicate and completely lovely blending of warm, widely loved colors. (Each \$2.00).
- TEXAS CENTENNIAL (Pat. 162)**—Brilliant red, with blood red buds that turn glowing carmine red in the fully opened flowers. (Each \$1.25).

HARDY CLIMBING AND RAMBLER ROSES

- CL. AMERICAN BEAUTY**—Deep rose-pink blooms of large size, borne in groups of three and four blossoms on long stems. Blooms in spring only. A vigorous grower. (Each \$1.00).
- BLAZE (Pat. No. 10)**—Everblooming scarlet-red climbing rose, a very vigorous grower and seldom out of bloom. (Each \$1.50).
- DR. J. H. NICHOLAS (Pat. 457)**—(Everblooming)—Double deep rose pink flowers 5 to 6 inches across with about 50 petals. (Each \$1.50).
- GOLDEN CLIMBER (Pat. 26)**—(Everblooming)—Large open flowers of sunflower yellow, very fragrant. (Each \$1.50).
- CL. ETOILE DE HOLLANDE**—(Everblooming)—The same beautiful dark red rose as in the bush form that has been a garden favorite for so long. (Each \$1.00).
- CL. CRIMSON GLORY (Pat. 736)**—Large urn-shaped buds opening into full well formed blooms of deep vivid crimson with velvety nap shaded ox-blood red. Delightfully fragrant. (Each \$2.00).
- CL. GOLDEN DAWN (Pat. 243)**—(Everblooming)—Flowers of lemon yellow opening to great big fragrant blooms of pale straw yellow. Flowers borne singly on long stems. Bronzy green foliage. (Each \$1.50).

ALL ITEMS ON THIS PAGE ARE POSTPAID, AVAILABLE IN SPRING ONLY

CLIMBING ROSES—Continued

- CL. HEART'S DESIRE (Pat. 663)—Everblooming**—The same luminous red as in the bush form with large flowers on long stems, very fragrant, with vigorous dark green foliage. (Each \$1.50).
- CL. K. A. VICTORIA**—White flowers slightly tinted lemon at base, foliage rich green. Everblooming. (Each \$1.00).
- CL. MRS. E. P. THOM**—(Everblooming)—Considered one of the finest yellow roses grown, profuse blooming, strong climber and flowers are excellent for cutting. (Each \$1.00).
- CL. MRS. SAM McGREDY (Pat. 374)**—A good all purpose climber with bronzy foliage, well shaped flowers of coppery scarlet, outside of petals flushed with red. Everblooming. (Each \$1.50).
- CL. NIGHT (Pat. 439)**—(Everblooming)—A rose which is the deepest yellow climber known. Large, full flowers of deep crimson, shaded black maroon. (Each \$1.50).
- CL. PICTURE (Pat. 425)**—(Everblooming)—Every bud perfectly formed and a cheerful glowing shade of light rose pink. (Each \$1.50).
- CL. PINK RADIANCE**—Fragrant, everblooming, cameo pink flowers on long stems. (Each \$1.00).
- CL. RED RADIANCE**—A clear even shade of red, flowers well formed, fragrant and everblooming. (Each \$1.00).
- CL. TALISMAN**—(Everblooming)—Produces brilliant yellow, orange and red shaded flowers. Buds are long and gracefully curved at the top. (Each \$1.00).
- CL. TEXAS CENTENNIAL (Pat. 565)**—Everblooming beautiful urn shaped buds, of a rich luminous red without any other shadings, with long lasting open flowers. (Each \$1.50).
- HIGH NOON (Pat. 704)**—Intense yellow blooms of good form, very free blooming (Pillar Type). (Each \$2.00).
- PAUL'S SCARLET CLIMBER**—Vivid scarlet blooms borne in clusters. Blooms in spring only. (Each \$1.00).

CAUTION—Unpack plants immediately upon arrival and place in container of water over night. Not longer. Plant out immediately if possible. Rose Bushes should be cut back to not more than six or eight inches above the ground. Do not use any fertilizer at time of planting. See planting instructions.

GLADIOLUS

The Gladiolus is the most attractive of all the summer flowering bulbs; it should have a place in every garden, large or small. For a succession, plant from April till June. Plant 6 inches apart and 4 inches deep. They will grow and bloom in any soil; we have never known anyone to fail with them.

The following list represents the best of both new and old favorites, both as to range of color and size of blooms. All bulbs offered by us are Colorado grown, of blooming size and are sure to give complete satisfaction.

POPULAR NAMED GLADIOLUS

- CASABLANCA**—Tall, pure white.
- COLONIAL MAID**—Light lavender with deeper flecks of purple, throat lined.
- EARLY DAWN**—Geranium pink, with red lines in throat.
- EARLY SUNRISE**—Orange red, earliest to bloom.
- ETHEL CAVE COLE**—Early, light pink, flowers extra large.
- HARVEST MOON**—Light pure yellow.
- JUNIOR MISS**—Early, ruffled, pink.
- KING ARTHUR**—Large flowers of lavender with ruffled edges.
- LAVENDER RUFFLES**—Ruffled, lavender.
- MAID OF ORLEANS**—Milky white flower with creamy throat.
- MARGARET BEATON**—White with red throat blotch.
- MAUVE MAGIC**—Tall, deep mauve.
- MINUET**—Beautiful lavender of unusual coloring.
- OREGON GOLD**—Ruffled, light yellow.
- PACIFICA**—Good, early, white with ruffled edges.
- PICARDY**—Soft shrimp pink.
- RED LORY**—Carmine-rose, purple throat.
- ROCKET**—Large flowers of pure scarlet.
- ROSA VAN LIMA**—Tall, light pink with dark markings in a lighter pink throat.
- SWEET ALIBI**—Rich pink with ruffled edges.
- PRICES ON THE ABOVE VARIETIES—(3 for 25c) (Dozen 75c) Postpaid

SPECIAL GLADIOLUS

- ANNAMAE**—Pure white.
- ALGONQUIN**—Brilliant scarlet.
- BLUE BEAUTY**—Large, light blue.
- BURMA**—Deep red rose, ruffled edge.
- CORONA**—Creamy white with pink picotee edge.
- ELIZABETH THE QUEEN**—Large, ruffled, lavender.
- LADY JANE**—Lovely cream.
- LEADING LADY**—Good, cream white.
- PANDORA**—Soft geranium pink.
- PINK RADIANCE**—Lovely, tall, clear pink.
- SPOTLIGHT**—Tall, yellow with red throat.
- STOPLIGHT**—Tall, bright red.

Postpaid (10c Each) (\$1.00 per Doz.)



PERFEGRO MIXTURE OF FINE GLADIOLUS

This wonderful mixture of Gladiolus contains all the latest flowering type; with every color of the rainbow. (50 bulbs for \$2.50).

ALL ITEMS ON THIS PAGE POSTPAID

DAHLIAS

Dahlias can be grown in any good soil but they will succeed best in an open sunny location. Plant when ground is warm and all danger of frost is past. Plant the bulbs 3 inches deep, laying the tuber on its side. Keep soil loose and mellow by frequent hoeing, drawing the soil to a slight hillock around the plants. 3 feet by 3 feet is about the proper distance to plant apart. After frost has killed the top, dig the tubers carefully; remove the soil from the roots and store in box or barrel secure from frost. As a precaution it is well to cover the tubers, so stored, with sand, leaves or moss. All clumps should be divided into several pieces before being reset the following spring.

The "Decorative" types are characterized by gracefully formed flowers of large size with broad petals, being intermediate in form between the compact and the "Cactus" varieties, which have loosely formed blossoms with long twisted petals.

- AVALON**—Clear canary yellow. (Each 50c).
- CLARA CARDER**—Beautiful shade of clear cyclamen pink. (Each 75c).
- CHEROKEE BRAVE**—The color is beautiful ruby red, will not fade under hottest sun. (Each \$1.00).
- COMMANDO**—Clear dark lavender. (Each \$1.00).
- GALLANT FOX**—Large, deep crimson red. (Each 50c).
- GLAMOUR**—True purple with each petal edged with amaranth pink. (Each \$1.25).
- DOROTHY LAMOUR**—Large, bright orange. (Each \$1.25).
- HARLEQUIN**—Color deep red, petals tipped white. (Each \$1.00).
- DAHLIAMUM**—Deep orange, with long twisted petals that roll back to the stem making a complete ball. (Each \$1.00).
- ELSIE SWOBODA**—Clear rose pink with chrome yellow radiating from the center of the flower. (Each 75c).
- JEAN TRIMBEE**—A rich petunia violet. (Each \$1.00).
- JANE COWL**—Color a glistening bronzy buff and old gold. (Each 50c).
- JEAN KERR**—A very popular white. (Each 50c).
- KENTUCKY SUN**—Bright yellow. (Each \$1.00).
- MAFFIE**—A very shaggy bright red, flowers extra large. (Each \$1.25).
- MARGARET W. WILSON**—Massive flowers of opalescent pink. (Each 50c).
- MRS. GEORGE LEBOUTILLER**—Rich velvety carmine. (Each 50c).
- MRS. I. DE VER WARNER**—A charming deep mauve pink. (Each 50c).
- MOTHER CABRINI**—Carmine overlaid with garnet red. (Each \$1.00).
- NEW YORK MARKET**—White tinted with pink. (Each 50c).
- ORIENTAL GLORY**—Cadmium orange overlaid with scarlet. (Each 75c).
- QUEEN CITY**—Large flowers of scarlet-pink. (Each 50c).
- RUBY TAYLOR**—Deep carmine. (Each 75c).
- THE COMMODORE**—Very large, bright yellow. (Each 50c).
- WATCHUNG GIANT**—Deep amber-yellow touched with orange. (Each 50c).

LARGE-FLOWERING CANNAS

For best results, plant about the end of May in beds, spaded two feet deep, enriched with well-decayed manure. Water sparingly for first two weeks after planting, thereafter water liberally.

CITY OF PORTLAND—(4 feet). Large flowers of watermelon pink, foliage bright green.

RED KING HUMBERT—(4 feet). The best bronze-leaved variety. Flowers orange-scarlet, flecked with carmine; rose tinted margin and base.

THE PRESIDENT—(5 feet). The best green-leaved Canna grown. Flowers glowing scarlet.

YELLOW KING HUMBERT—(4 feet). Green foliage with brilliant yellow flowers.

Prices on the above Cannas: (3 for 50c) (Doz. \$1.50).

MIXED CANNAS—All colors, but not labeled. (\$1.25 per doz.)



CANNA



POMPON DAHLIAS

- FAIRY**—Violet-rose. (Each 50c).
- JESSICA**—A combination of amber and salmon tinted red. (Each 50c).
- LITTLE DUKE**—Deep dark red. (Each 50c).
- SYLVIA**—Garnet red. (Each 50c).
- WILDROSE**—A perfect pink. (Each 50c).

NO. 1—SPECIAL DAHLIA COLLECTION

This collection is made up of our regular First Class bulbs only. No two alike. A wonderful assortment of 12 bulbs for \$2.25.

NO. 2—FANCY DAHLIA COLLECTION

No two alike—6 bulbs for \$1.50.

BEAUTIFUL PEONIES

Chinese Peonies are very desirable on account of their large size, fine colors and profuse blooming. They are perfectly hardy and will succeed in any ground unless so wet the water stands on the surface in the winter and spring. Avoid planting too deeply, as this is often the cause of shy blooming; 2 inches of soil over the crown (eyes) being sufficient.

MME. DE VERNEVILLE—Blooms of pure white, with touches of crimson on edge of center petals. Midseason.

FELIX CROUSSE—Brilliant, dazzling ruby-red, very double. Midseason.

PRINCE OF DARKNESS—Early deep red, almost maroon.

PRES. ROOSEVELT—Very fine brilliant red, mid-season.

EDULIS SUPERBA—Bright clear mauve-pink, extra large flowers. Early.

REINE HORTENSE—Midseason. Rose-pink flecked with crimson.

Prices on the above: (Each 75c) (3 for \$2.00), Postpaid.



PEONY

ALL ITEMS ON THIS PAGE POSTPAID

HARDY PERENNIALS, ALPINES AND ROCK GARDEN PLANTS

Varieties starred (*) are fine for Rock Gardens

These can be used to best advantage in groups and beds on the lawn, as borders for drives, walks, or in front of shrubbery, in the garden. Some of the tall-growing sorts may be planted in among the shrubbery with good effect. Soil should

***BLEEDING HEART, FERN LEAVED (Eximia)**—12 inches. Attractive fern-like leaves; lovely pink flowers all summer. Grows in sun or shade. (Each 40c) (3 for \$1.00).

BLEEDING HEART, OLD FASHIONED—2 feet, graceful heart-shaped pink flowers in April-May. Prefers partial shade. (Each 60c) (3 for \$1.65).

CARNATIONS, HARDY GRENADIN—This is the hardiest of all outdoor carnations. Very fragrant, fully double producing large flowers on long stems. Finest of all varieties. Your choice of yellow, red, rose and white. (Each 35c) (3 for 90c).

CANTERBURY BELLS (Campanula)—Cup and saucer type. 2 feet. Tall, erect plants covered with large cup and saucer shaped flowers during late May and June. A perfect plant for the old-fashioned hardy garden. In separate colors, Blue, Rose and White. (Each 35c) (3 for 90c).

CHRYSANTHEMUMS—Cushion Mums. A group of low growing mums forming mounds of blooms, reminding one of the old-fashioned Azalea. The plants grow about 10 to 12 inches high. Our stock is of improved strains, most varieties begin blooming in August and continue until frost.

Bronze Cushion—As the flowers first open they are a warm, rich red bronze, then turning to a bronzy yellow with a light red center.

Pink Cushion—Flowers open to a deep, orchid-pink, then change to a light orchid with a creamy center.

Red Cushion—Pure fiery red.

White Cushion—Snow white flowers.

Yellow Cushion—Pure golden yellow.

(Each 40c) (3 for \$1.00).

COREOPSIS, Double Sunburst—2½ ft. Large double golden yellow flowers. Blooms all summer. (Each 35c) (3 for 90c).

COLUMBINE—Mrs. Scott Elliott's Long Spurred Hybrids. The finest of the columbines and excellent for bedding or cutting. Grow in mixed colors of wide range. Being hybrids we cannot ship by color. Their delicate yet colorful beauty makes them a favorite with all flower lovers. Grow 2 feet tall. (Each 35c) (3 for 90c).

DELPHINIUM (Belladonna)—Long spikes of light blue flowers. 4 feet.

Bellamosa—Same as above but deep blue flowers.

Gold Medal Mybrids—Choice range of colors through the blue shades to red and orchid casts.

(Each 35c) (3 for 90c).

DIANTHUS, HARDY, OLD-FASHIONED CLOVE PINKS—15 inches. Lovely pink flowers with a spicy fragrance produced all summer. (Each 35c) (3 for 90c).

DIGITALIS (Foxglove)—5 to 6 feet. Most attractive for the border or woodland garden. Colors ranging from white and shell-pink to deepest rose, many dotted with crimson. (Each 35c) (3 for 90c).

FERNS (Hardy Outdoor Mixed or Ostrich Plume)—2 ft. Plant in shade. (Each 35c) (3 for 90c).

GALLARDIA, HYBRIDS—3½ feet. Much better than common Gaillardia. Flowers are larger and brighter blend of red and gold. Blooms freely from June to frost. (Each 35c) (3 for 90c).

GYPSOPHILLA, PAN (Baby's Breath)—2-3 feet. Great masses of small, pure white flowers in July and August. Fine for winter bouquets. (Each 35c) (3 for 90c).

HOLLYHOCKS, IMPROVED DOUBLE—6-7 feet. An improved strain with exquisite double flowers in the loveliest colors. Your choice of Scarlet, White, Yellow and Pink. (Each 35c) (3 for 90c).

be kept well fertilized. A light covering of coarse, strawy manure or something that will not pack is beneficial in winter.

Ready for delivery during April and early May. All are strong, healthy roots. No plants sent C. O. D.

LILY OF THE VALLEY—8 inches. Everybody loves this fragrant white flower. Grows in sun or shade, even right under trees. (Clumps each 40c) (3 for \$1.10).

THE RUSSELL LUPINS—New English Hybrids. New colors and combinations of color. The size of the florets, their number on a spike, and the length of the spikes are much larger. (Each 50c) (3 for \$1.35).

***PANSIES**—We grow large quantities of Pansy plants from seed imported from the best Pansy specialists of Europe and at home, and if well cared for they will produce blooms of finest colors, from 2 to 3 inches across. In ordering Pansy plants, we would advise, where possible, that they be sent by express. Ready about April 1. (Doz. \$1.00). Postpaid.

PHLOX—Hardy. For massing they are very effective, their flowering season begins in July and continues until frost if the old flower spikes are kept cut back.

Africa—Brilliant carmine red with blood red eye.

Apollo White—Splendid pure white.

Border Gem—A beautiful deep purple.

Charles Curtis—Sunset red.

E. J. Farrington—Salmon pink with deep rosy red blush.

Graff Zeppelin—Ivory white flowers with vermilion red eyes.

Lillian—Pure pink.

Painted Lady—An appealing peach color with a pink blush.

Silverton—Florets, the size of a silver dollar, are clear pure lavender with a glowing purple eye.

(Each 40c) (3 for \$1.00).

***PHLOX, SUBULATA (Creeping Moss Pink)**—4 inches. Completely covered with blooms in April-May. Moss-like evergreen foliage. For rock gardens, borders, for carpeting the ground and banks. Bright pink. (Each 35c) (3 for 90c).

PLATYCODON (Balloon Flower)—18-24 inches. All summer it produces its lovely bell-shaped flowers on long stems. Your choice of Blue or White. (Each 35c) (3 for 90c).

***PYRETHRUM (Painted Daisy)**—2 ft. This popular plant produces its lovely flowers in spring and early summer. Finely cut foliage. Your choice of red and rose. (Each 35c) (3 for 90c).

SHASTA DAISY, Alaska—2 feet. Large white single flowers with a large yellow center. Bloom in June and July. (Each 35c) (3 for 90c).

***STATICE LATIFOLIA (Sea Lavender)**—2 feet. Immense heads of small violet-blue flowers in July and August. Make fine winter bouquets. Plant in full sunshine and in light soil. (Each 35c) (3 for 90c).

SWEET PEA, PERENNIAL—Train this climber on a trellis, fence or bank, it will produce its lovely flowers all summer. New growth from the roots each year. Your choice of red, pink and white. (Each 35c) (3 for 90c).

***SWEET WILLIAM**—12 inches. Sweet, clove-scented flowers in great profusion during May and June. Mixed colors. (Each 35c) (3 for 90c).

TRITOMA, RED HOT POKER—3 ft. Bright orange-scarlet blooms borne on stems 3 feet tall in August-September. Protect over winter or dig up and put in sand in cool cellar over winter. (Each 35c) (3 for 90c).

***VIOLA CORNUTA, TUFTED PANSY**—Blooms from April to October, if the plants are kept sheared so they do not go to seed. Mixed colors. (Each 35c) (3 for 90c).

VIOLETS (Sweet Scented)—Flowers are extra large, deep purple and very fragrant. Blooms early in the spring and again in the fall. (Each 35c) (3 for 90c).



CARNATIONS



BLEEDING HEART



VIOLETS

ALL ITEMS ON THIS PAGE POSTPAID

FRUIT TREES AND SMALL FRUITS

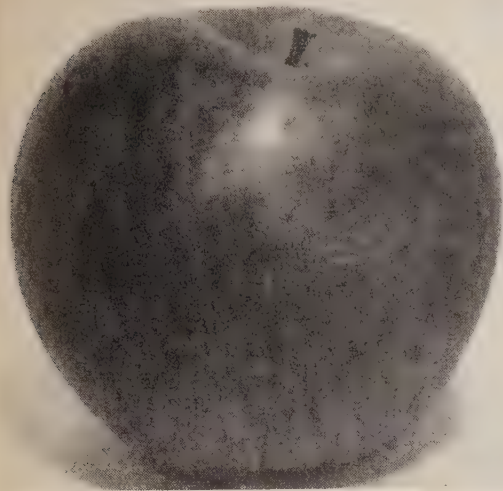

APPLE.
RED
WINESAP

APPLES

DELICIOUS—Fruit large, nearly covered with brilliant dark red, flesh fine grained, crisp and melting, juicy with a delightful aroma; of very highest quality. A splendid keeper and shipper. A regular annual bearer.

DOLGA CRAB—Has rare beauty as an ornamental lawn tree and is perfectly hardy. The apple itself is a very rich red, and jells perfectly even when dead ripe. A fine canning crab.

FAMEUSE (Snow Apple)—Medium size, round base pale yellow nearly covered with red overlay. Flesh snow white, tender, fine grained, juicy with a mild sub-acid flavor. Good eating apple fresh from tree and out of storage up to December.

GRIME'S GOLDEN—Large, golden yellow, juicy, aromatic, sub-acid. Fine dessert apple.

HARALSON—Large good, solid red apple, keeps all winter. Very hardy and good for our climate. Heavy bearer.

JONATHAN—Medium, brilliant red and yellow; tender, juicy. Fine-grained.

MINJON (Minnesota 700)—A Minnesota Jonathan developed for hardiness in northern climates. Heavy bearer of brilliant red, superb quality fruit, ripening at the same time as Wealthy but better coloring and hangs to tree well.

NEW FIRESIDE (Minnesota 993)—A Minnesota super Delicious that is hardy for the North! Flavor and texture even better than Delicious. A long keeper that's crisp, sweet, juicy—never becomes "flat and mealy."

RED JUNE—Medium size, red base with yellow. Flesh white, tender, slightly sub-acid. Good eating and cooking apples, succeeds anywhere.

RED WINESAP—Rich dark red; fine grained and juicy. Winter.

ROME BEAUTY—An improved variety, which has a solid, deep-red color. Large winter apple of good quality. Thick skinned, stands handling well and a good keeper. Bears young.

WEALTHY—Few varieties that are at once so hardy and so productive, yield fruit of such good quality—white-fleshed, juicy and vinous; of medium size, smooth, round and deep red.

YELLOW DELICIOUS—Similar to Delicious in shape. Fruit rich yellow color.

THE FAMOUS 5-N-1 APPLE TREE

FIVE SPLENDID KINDS
OF APPLES ON ONE TREE

LET 1 TREE DO THE WORK OF 5

For Those with Limited Space if You Want but
One Apple Tree

Think of having five varieties of apples on one tree!
Will provide an abundance of fresh fruit from July
until winter.

Red Jonathan, Wealthy, Yellow Delicious, Crimson
Winesap and Yellow Transparent
A Complete Orchard on One Tree

3-6 ft. size with nice growth on all varieties

Each, \$2.50

APPLES—Continued

YELLOW TRANSPARENT—Large, uniform, yellowish white apples with moderately firm, juicy flesh.

HOPA RED FLOWERING CRAB—A beautiful upright growing tree with attractive foliage. Entirely covered with rose colored flowers in April. Fruit red inside and out, hanging on until late autumn. Very hardy and free from disease.

WHITNEY CRAB—The fruit is very large and glossy green, striped with red. Good for eating and canning.

PRICES—Large, 4 to 6 foot, 2-year-old trees by express, not postpaid, at: (Each \$1.25) (3 for \$3.50). Assorted if desired.

APRICOTS

CHINESE—Large size, round deep orange-yellow fruits, flesh is firm and the richest flavor, ripe in late June. Hardy in this climate.

PRICES—2-year-old tree, by express, not postpaid, at: (Each \$1.50) (3 for \$4.00).

CHERRIES

EARLY RICHMOND—Unsurpassed for cooking. Hardest of all varieties, bears heavily. Cherries are medium size, round and dark red. Flesh tender, juicy and sub-acid. Early. Very popular and a fine variety in every respect.

BING—One of the most delicious dark red Cherries. Tree hardy, foliage heavy, productive, excellent for eating and canning.

KANSAS SWEET—The fruit is large, dark red, firm, sweet with a delicious flavor.

ENGLISH MORELLO—This is the latest cherry to ripen, fruit is good size, almost black when fully ripe. Very heavy and young bearer.

MONTMORENCY—Best of all sour varieties, most in demand at all markets, widely used by canneries. Fruit is good size, bright clear red, fine quality, sub-acid flavor. Early. A splendid all around variety.

SWEET CHERRY (Black Tartarian)—Very large, bright purplish black cherry; flesh very rich, delicious, thick, juicy, of purplish color. Very vigorous, erect grower and an immense bearer.

YELLOW GLASS—A hardy sweet cherry of golden yellow, firm, juicy and of fine quality. Blooms late.

PRICES—Large, 4 to 6 foot, 2-year-old trees, by express, not postpaid, at: (Each \$1.50) (3 for \$4.25). Assorted if desired.

PEACHES

ELBERTA—A leading market variety, large, handsome bright yellow overspread with crimson; juicy, fine shipper, freestone.

POLLY—Hardy delicious white peach, the fruit is large, blushed, free stone, ripening early, juicy but firm, with the richest most delicious flavor. When canned it stays firm, and makes excellent sauce and preserves. It was developed for the north and will stand temperatures of 25 to 20 degrees below zero. The trees bear young and produce abundantly.

PRICES—Large, 4 to 6 foot, 2-year-old trees, by express, not postpaid, at: (Each \$1.25) (3 for \$3.50).

PEARS

BARTLETT—Fruit large, clear lemon yellow, highly flavored, very juicy. Ripens in September.

PRICES—Large, 4 to 6 foot, 2-year-old trees, by express, not postpaid, at: (Each \$1.50) (3 for \$4.00).

PLUMS

DAMSON—Medium sized blue plums of finest quality, free stone. A heavy annual bearer, ripens in September.

GREEN GAGE—A mid-season plum that is very sweet, greenish yellow throughout. Excellent for eating and preserves. Medium sized.

ITALIAN PRUNE—This is a prune type plum, fine for cooking and fine for eating fresh. The fruit is large and dark blue; flesh greenish yellow; juicy, tender, firm and sweet.

LOMBARD—Fruit oval, violet red, with a yellow, juicy flesh; freestone. Ripens the end of August.

YELLOW EGG—Fruit of the largest egg-shaped beautiful yellow color, flesh yellow and very fine for canning and eating, very productive, ripe in August.

PRICES—Large, 4 to 6 foot, 2-year-old trees, by express, not postpaid, at: (Each \$1.50) (3 for \$4.25). Assorted if desired.

SMALL FRUITS

GRAPE VINES

AGAWAM—A hardy dark red table grape, very sweet and juicy, ripens at the same time as Concord. Bunches usually loose, berries, large with thick fleshy skin. (Each 50c) (3 for \$1.35).

CONCORD—One of the most popular and reliable varieties we possess. Bunch large, compact and shouldered; berry large, round, almost black with blue bloom; juicy, buttery and very sweet. (Each 40c) (3 for \$1.25).

PORTLAND—A splendid table grape, very early. This variety of white grape is very sweet and juicy and as hardy as the Concord, and a good producer. (Each 50c) (3 for \$1.35).

FREDONIA—At last has been found a real early Black Grape, one which has no rival. Juicy, tender, good cluster, equal in every way to the Concord, but fully two weeks earlier. (Each 50c) (3 for \$1.35).

GOLDEN MUSCAT—An entirely new grape, the finest of all table varieties. Berries light golden yellow with white dots, large oval shaped, very juicy, tender and sweet. Skin thin, not adhering to flesh with one or two small seeds that separate easily. (Each \$1.00).

MOORE'S EARLY—Larger berries and bunches than Concord, sweeter, better quality and ripens a week earlier. Fine for the local market and the home garden, but not a good shipper on account of its thin skin. (Each 50c) (3 for \$1.35).

BLACKBERRIES

ELDORADO—Largest and best hardy Blackberry for this part of the country. Berries large, jet black, borne in large clusters; they are very sweet, melting and pleasing to the taste. Good market sort, standing shipping and handling well. Vigorous, hardy, enormous yielder. (6 for 75c) (25 for \$2.50).

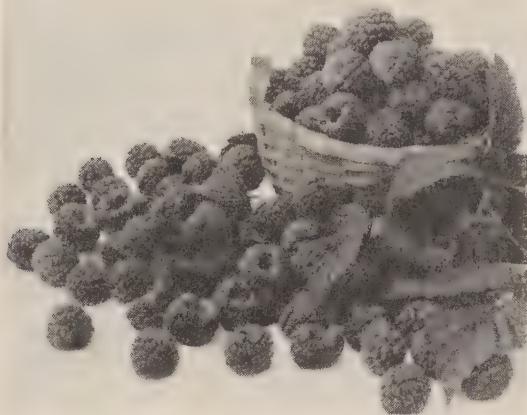

RED RASPBERRY

BOYSENBERRY

(Thornless)

The New Boysenberry is truly a glorified Youngberry. They are just as easy to grow as blackberries. Berries often measure two inches in length, have a rich, tangy flavor all their own and have few seeds. Berries fine, either fresh or canned. (\$3 for 65c) (6 for \$1.10) (12 for \$2.00).

CURRENTS

PERFECTION—This is perhaps the best variety of Red Currant that was ever introduced. It is a prolific yielder, with a rich sub-acid flavor. The fruit is very pulpy and contains but very few seeds. (Each 60c) (3 for \$1.65).

RED LAKE—The sweetest of all red currants. It is a tremendous bearer of big currants that are wonderfully sweet when ripe. (Each 60c) (3 for \$1.65).

DEWBERRIES

LUCRETIA—The Dewberry is a dwarf and trailing form of the Blackberry. The fruit is highly prized as a market fruit owing to its large size and fine quality. This variety is recommended most highly. (6 for 60c) (25 for \$2.00).

GOOSEBERRIES

CHAMPION—Fruit large, round, light green, fine flavored; vigorous and productive; smooth with distinct veins, soft, juicy, and fine skin; one of the best. (Each 60c) (3 for \$1.65).

GLENDALE—Large sized, prolific and hardy, reddish purple berries of best quality. (Each 60c) (3 for \$1.65).

Prices on This Page Are Postpaid. Available in spring only, ready for shipment April 1. No plants sent C. O. D.

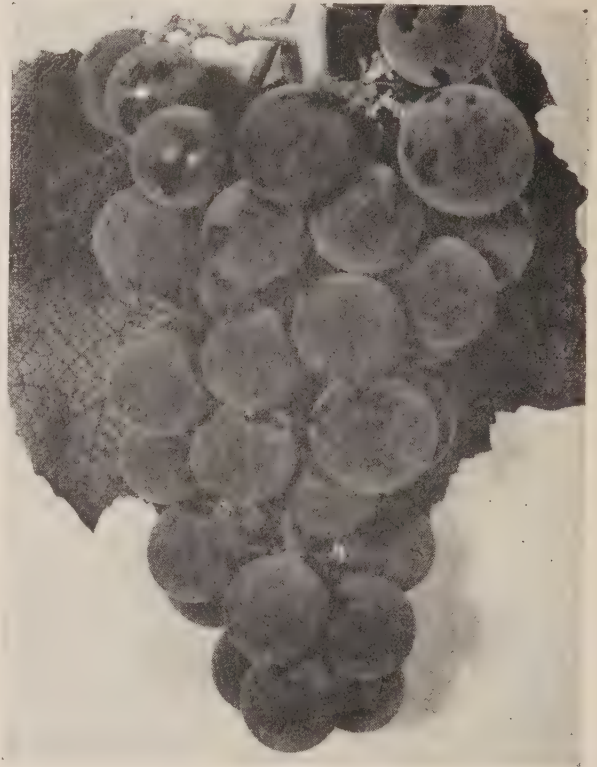

GRAPES, CONCORD

RASPBERRIES

CUMBERLAND (Black)—Healthy, vigorous, throwing up stout, stocky, well branched canes that produce immense crops. Fruits very profitable; large, firm. Midseason. (6 for 75c) (25 for \$2.50), postpaid.

ST. REGIS EVERBEARING RASPBERRY—Fruit starts to ripen with the earliest and continuing on your canes until fall. Berries bright crimson, large size, rich and sugary. (6 for 75c) (25 for \$2.50), postpaid.

INDIAN SUMMER (Everbearing)—A new two-crop red raspberry developed by the New York Experiment Station. Bears in summer and again in fall, continuing until frost. The berries are large, somewhat conical, of medium red color and high quality. Plants are hardy and vigorous growers. (6 for 75c) (25 for \$2.50), postpaid.

WASHINGTON—It is highly recommended as an abundant producer of high quality red fruit suitable for freezing, canning or for fresh market. Almost everbearing. (6 for 75c) (25 for \$2.50), postpaid.

EVERBEARING STRAWBERRIES

In Strawberries it is very necessary that you get fresh-dug plants. We grow our own plants and take every care that our customers get their plants in the best possible condition.

Cultural Suggestions: Strawberries need first-class soil and will repay generously for good care. Plant about 15 inches apart in the row and 3 feet between the rows. Spread the roots when planting and water well. After the ground freezes hard, cover the crowns with a little straw or litter, but do not smother. A bed will run out in three years and the ground should then be put to some other use for a year or two.

Ready for shipment April 1 to May 10 only.

MINNESOTA 1166—Everbearing—An Everbearer which has everything. You can depend on this exceptional new berry to give you a full fruiting row as it is a free plant maker and makes an ideal fruiting row. The berries are streamlined, large and cone-shaped, very firm, excellent shippers, easy to hull and unusually sweet. The berry is of a dark and pure dazzling red to the center and no green tips or spots. When planted in the spring this wonderful berry will produce a crop in July and continue until late in the fall. The following spring these plants will begin fruiting with the early June varieties, then after a short layoff they will bear again in later summer until snow flies. Postpaid: (25 plants for \$1.25) (100 for \$4.00).

PERFEGRO LAWN GRASS SEEDS

For making a new lawn or for reseeding established lawns, use our special re-cleaned grass seed.

There is nothing that will improve the appearance of your home so much as a well-kept lawn with a flower bed or two, and a liberal planting of shrubs along the borders. To have a good lawn it is necessary that you get your soil in fine condition, that you sow a sufficient quantity of good seed, and that you take care of the grass after you have a stand.

Our Lawn Seed has all been thoroughly re-cleaned, is of high purity and germination. Sow at the rate of 1 pound to 150 to 200 square feet.

When making a new lawn, be sure that the soil is well drained and that a sufficient amount of fertilizer has been incorporated in the soil, using a fertilizer rich in plant food.

Owing to an abundant crop of high grade Kentucky Blue Grass Seed this season prices on straight Kentucky Blue Grass and fine Lawn Mixtures are considerable cheaper. The base of all good Lawn Mixtures is Blue Grass.

As a top dressing use a balanced Fertilizer, such as Vigoro or Sacco, or incorporate the fertilizer in the soil before sowing the seed. Do not use barnyard manure for top dressing.



PERFEGRO LAWN MIXTURE—A beautiful, smooth, low-growing, dark, velvety grass. It is composed of re-cleaned Kentucky Blue Grass and White Dutch Clover together with other fine bladed perennial grasses. **Postpaid (lb. \$1.00) (5 lbs. \$4.75) (10 lbs. \$9.00).**

QUICK GROW LAWN MIXTURE—A rapid-growing mixture for producing an immediate showing that will be followed by a good permanent sod. Ready to cut two weeks ahead of any other mixture. **Postpaid (lb. 80c) (5 lbs. \$3.75) (10 lbs. \$7.00).**

SHADY SPOT LAWN MIXTURE—This is made up of grasses which naturally grow in shady places. Contains Bent Grass. **Postpaid (lb. \$1.25) (5 lbs. \$6.00) (10 lbs. \$11.50).**

KENTUCKY BLUE GRASS AND CLOVER—A special mixture of 90 per cent Kentucky Blue Grass and 10 per cent White Dutch Clover. **Postpaid (lb. \$1.25) (5 lbs. \$6.00) (10 lbs. \$11.50).**

KENTUCKY BLUE GRASS—Special Re-cleaned Seed—This is the most widely used grass for Lawns; forms a close, thick turf and is very hardy. Seed is slow to germinate and must be kept well watered with a fine spray until it is established. **21 lb. Grade—Postpaid (lb. \$1.15) (5 lbs. \$5.50) (10 lbs. \$10.50). 24 lb. Grade—Postpaid (lb. \$1.25) (5 lbs. \$6.00) (10 lbs. \$11.50).**

BUFFALO GRASS FOR LAWNS—Treated to hasten germination. This is a low-growing long-lived drought-resistant perennial grass that spread by numerous surface runners. Profuse branching of runners enables this grass to form a dense sod. The leaf surface is a gray green, turning to purplish in late fall. Seed should be applied at the rate of from ½ to ¾ pound per 1,000 square feet of lawn area. The seeding rate is readily obtained by spacing the seed ½ to ¾ of an inch apart in the rows, or by dropping 15 to 20 seeds per foot of row, in rows one foot apart. After the lawn is up requires very little water, making it an ideal grass for farm lawns, parks and cemeteries. **Postpaid (lb. \$1.75) (5 lbs. \$8.25) (10 lbs. \$16.00).**

CANADA BLUE GRASS—A more rapid grower than Kentucky Blue Grass and equally good for pasture but not as suitable for lawns. This is an excellent pasture grass for poor, dry land and should be more largely used for this purpose. **Postpaid (lb. \$1.00) (5 lbs. \$4.75) (10 lbs. \$9.00).**

WHITE DUTCH CLOVER—This is a low growing clover used principally for lawns in a mixture with Blue Grass. It germinates quickly and acts as a protection for the slower germinating Blue Grass. **Postpaid (¼ lb. 45c) (lb. \$1.50) (5 lbs. \$7.00) (10 lbs. \$13.50).**

ASTORIA BENT—This is the true Creeping Bent Grass, which spreads by underground roots and by stolons which creep over the ground and send down roots from their joints. It is very fine bladed and forms a thick velvety turf. It is quick growing and crowds out dandelions and other weeds. Sow one pound to 300 square feet. **Postpaid (lb. \$1.50) (5 lbs. \$7.25) (10 lbs. \$14.00).**

COOS OR SEASIDE BENT—This variety differs only from the Astoria Bent in that it creeps more on top of the ground, thus forming, when it has been well established, somewhat of a turf or matting on top of the soil which tends to crowd out weeds. **Postpaid (lb. \$1.50) (5 lbs. \$7.25) (10 lbs. \$14.00).**

CREEPING RED FESCUE—A fine leaved, persistent, turf-forming grass, excellent for shade and is valuable in lawn mixtures. **Postpaid (lb. \$1.00) (5 lbs. \$4.75) (10 lbs. \$9.00).**

RYE GRASS (Domestic)—A valuable grass for pastures and lawns when quick results are required. Thrives well on any soil. **Postpaid (lb. 50c) (5 lbs. \$2.25) (10 lbs. \$4.00).**

RYE GRASS (Perennial)—Rapid growing grass, useful for making lawns where immediate effects are wanted. Valuable for hay and pasture. **Postpaid (lb. 60c) (5 lbs. \$2.75) (10 lbs. \$5.25).**

MEADOW FESCUE OR ENGLISH BLUE GRASS—Grows best on moist soils. Robust in habit, yet never grows into large tufts. Superior to Rye Grass for lawns. **Postpaid: (lb. 85c) (5 lbs. \$4.00) (10 lbs. \$7.50).**

CHEWING'S FESCUE—This is used in mixtures for fine lawns for putting greens, wherever a particularly fine-leaved grass is wanted. **Postpaid (lb. \$1.00) (5 lbs. \$4.75) (10 lbs. \$9.00).**

CRESTED WHEAT (Fairway Strain)—This strain was developed in Canada for use in lawns, fairways, boulevards, school yards, cemeteries, parks and in areas where water is not readily available. It is a hardy, drought-resistant fine-stemmed grass. **Postpaid (lb. 80c) (5 lbs. \$3.75) (10 lbs. \$7.00).**

BERMUDA GRASS FOR THE SOUTH—A southern grass with dwarf habits, long creeping stems rooting at the joints that cover the ground with a matting of fine turf. Not suited for northern latitudes. Hulled seed. **Postpaid (¼ lb. 35c) (lb. \$1.10) (5 lbs. \$5.00) (10 lbs. \$9.50).**

WEDO FERTILIZER FOR LAWNS

Wedo is the new wonder product you have waited for. It's a balanced formula of grass feeding elements and weed killing 2, 4-D. No other plant food is needed when you apply Wedo. It alone supplies sufficient complete fertilizer to produce thick, healthy, luxuriant lawns while destroying common weeds. Economical—use only 1½ lbs. to 100 square feet. Wedo, containing 2, 4-D was compounded for use only on established lawns. (Do not use Wedo on Creeping Bent lawns.)

Not Postpaid (7½ lb. pkg. \$1.00) (25 lb. bag \$2.75) (50 lbs. \$4.95) (100 lbs. \$7.95).

HARDY GRASS AND FIELD SEEDS

GRASS SEEDS

FOR HAY AND PASTURE

BROME GRASS (*Bromus Inermis*)—Yields enormous crops of splendid hay, and affords early and abundant pasture. It adapts itself to almost any condition of soil and climate and to any use to which grass may be put. The roots penetrate the soil deeply and form fresh plants on every side. It starts from two to three weeks earlier in the spring than native prairie grass, and keeps green in autumn longer than any of the useful grasses grown in the West. No amount of cold seems to affect it, and it surpasses all other grasses in resisting heat and drought. It equals timothy for hay, and is splendid to sow with alfalfa, clover, meadow fescue or orchard grass for pasture.

Postpaid (lb. 85c) (5 lbs. \$4.00) (10 lbs. \$7.50). Supply limited.

SLENDER WHEAT GRASS (Western Rye Grass)—Grows in tall erect bunches which sometimes cover a space of one foot in diameter. It is a perennial, resistant to both drought and cold. Has ability to grow in alkali land and is very palatable to cattle and horses.

Postpaid (lb. 70c) (5 lbs. \$3.25) (10 lbs. \$6.00). Supply limited.

CRESTED WHEAT GRASS (Standard or Forage Strain)—It is a drought resistant, long-lived grass. It is equal or better, in feed value for hay or pasture to Brome Grass, Slender Wheat Grass, Western Wheat Grass and is relished by livestock and yields as well or better. It is adapted to a wide range of soil types. It is easily plowed up and can be killed by plowing, even though it has an extensive root system. Should be sown on a well-prepared soil, which contains a sufficient amount of moisture to give the crop a good start. The seed should be put in not over a half inch deep either with or without a nurse crop. Best without a nurse crop. Sow seed at the rate of 10 lbs. per acre, either broadcasted or drilled in or from 4 to 5 pounds per acre when planted in 3-foot rows, to be cultivated and raised primarily for a seed crop.

Postpaid (lb. 80c) (5 lbs. \$3.75) (10 lbs. \$7.00).

FAIRWAY STRAIN—See Page 43.

INTERMEDIATE WHEAT GRASS—This is a tall cool season grass, which spreads from moderately vigorous underground root stalks to produce a sod. At Fort Collins this grass starts growth in late February or early March and attains a height of 6 inches, between April 10th and 20th. It makes a lush growth of leaves in early spring, heads during July and matures in August. With good fall moisture regrowth takes place and $\frac{1}{4}$ to $\frac{1}{2}$ the normal forage production may again be produced. The leafage growth before heading is quite palatable as the leaves are broad and soft like Smooth Brome Grass. The seed is large and clean and can be drilled with an ordinary grain drill.

Postpaid (lb. \$1.75) (5 lbs. \$8.50) (10 lbs. \$16.50). Supply limited.

WESTERN WHEAT GRASS (Blue Stem)—Is a drought resistant, long-lived perennial grass. Produces excellent forage for grazing and hay.

Postpaid (lb. 70c) (5 lbs. \$3.25) (10 lbs. \$6.00). Supply limited.

MEADOW FESCUE, OR ENGLISH BLUE GRASS—Of great value for permanent pasture and for hay. Does best on strong land. Grows 2 feet high. Makes a finer and better quality of hay than Orchard Grass. Sow 25 to 30 pounds per acre.

Postpaid (lb. 85c) (5 lbs. \$4.00) (10 lbs. \$7.50).

DOMESTIC RYE GRASS—A desirable grass for pasture. It forms a heavy close sod and grows up quickly after being eaten or cut off. It is also a good grass for hay if cut when in bloom. It affords good pasture after the hay is cut. Does best on rather moist and heavy soil. Use 25 to 30 pounds of seed per acre.

Postpaid (lb. 50c) (5 lbs. \$2.25) (10 lbs. \$4.00).

PERENNIAL RYE GRASS—A very valuable variety for permanent pasture. Succeeds well on almost any soil, but is particularly adapted to moderately moist or irrigated lands. Sow 25 to 35 pounds per acre in spring.

Postpaid (lb. 60c) (5 lbs. \$2.75) (10 lbs. \$5.25).

RED TOP (Solid Seed)—Valuable for low land, as it is not injured by water. It also grows well on high land. Grows 2 to 3 feet high, and makes very good hay. Finest re-cleaned seed. Sow 8 to 10 pounds per acre.

Postpaid (lb. \$1.00) (5 lbs. \$4.50) (10 lbs. \$8.50).

TIMOTHY—One of the most popular grasses for hay and pasture. Sow 9 pounds of seed per acre if used alone. Fancy re-cleaned seed.

Postpaid (lb. 70c) (5 lbs. \$3.25) (10 lbs. \$6.00).

BUFFALO GRASS—See write-up on page 43.

Postpaid (lb. \$1.75) (5 lbs. \$8.25) (10 lbs. \$16.00).

ORCHARD GRASS—A strong growing, rather coarse, grass, good for pasture and hay. Starts very early in the spring. Grows in tufts so should be sown with other early flowering grasses. Orchard grass makes a very rapid growth after being cut and affords good pasture within a week or ten days after cutting. Stands drought well as the roots extend deep into the soil. Sow 25 to 30 pounds per acre.

Postpaid (lb. 80c) (5 lbs. \$3.75) (10 lbs. \$7.00).

ALTA OR TALL FESCUE—Tall Fescue is rapidly gaining in popularity and has supplanted Meadow Fescue in many areas. It is somewhat coarse but is more drought-resistant, more productive, and more alkali-tolerant. Livestock find it fully as palatable. The growth period and other characteristics are the same except that Meadow Fescue is preferable on marshy lands.

Ask for Prices.

REED CANARY GRASS—Is one perennial grass that will thrive in marshy places, stands under water for weeks without injury, yields enormous tonnage of hay with feed value equal to wheat bran. Sow any time before June 20th at the rate of 10 to 12 pounds per acre, broadcast. It forms a sod rapidly through the spreading of underground roots. Makes your low lands grow profitable crops.

Ask for Prices.

GRAMA GRASS—Is a perennial tufted grass adapted for the dry plains region; plants grow from 1 to 3 feet tall, used for reseeding range lands. Limited quantity of seed available this season.

Postpaid (lb. 60c) (5 lbs. \$2.75) (10 lbs. \$5.00).

SAND DROP SEED—Best on sandy or semi-sandy soils. In mixture with Wheat Grasses and Bromes, Sand drop will provide abundant forage while the slower growers are establishing themselves. Sow two to five pounds per acre.

Postpaid (lb. 40c) (5 lbs. \$1.75) (10 lbs. \$3.25).

SUDAN GRASS, for Hay and Pasture—Sudan Grass is strictly an annual, and dies each year like millet. Sudan Grass is tall, reaching a height of from 7 to 9 feet. The stems are small and are rarely larger than a lead pencil. The plant stools wonderfully and produces, under favorable conditions, as many as 100 stalks from a single root.

Postpaid (lb. 40c) (5 lbs. \$1.75) (10 lbs. \$3.25).

SWEET SUDAN—A greatly improved Sudan Grass from a hybridization of Leota Red Sorghum on Common Sudan. It has great palatability, livestock eating it to the ground before touching common sudan or other forage sorghums. Sweet Sudan has broader leaves, larger stems and makes taller growth, stooing heavier than common Sudan. It is a truly great improvement over common Sudan and in our opinion will completely replace common Sudan. We recommend that every farmer put in at least a few rows to prove to himself the many advantages for both hay and grazing over common Sudan.

Postpaid (lb. 55c) (5 lbs. \$2.50) (10 lbs. \$4.50).

WEeping LOVE GRASS—A perennial bunch grass from South Africa that is especially well adapted to all well drained soils in Oklahoma, Texas, New Mexico, Arizona and Colorado. Its uses for pasture hay and erosion control holds great promise for many areas. Grows 5 to 6 ft. tall, with luxuriant basal growth of extremely long, slender leaves. One of the earliest grasses in the spring and last to turn brown in the fall, high in protein. April seems best for planting the seed, using one pound of clean seed to the acre, covering seed to a depth of $\frac{1}{4}$ inch.

Postpaid (lb. \$1.10).

SAND LOVE GRASS—A vigorous long lived native bunch grass, thriving on sandy soils of the great plains. Grows 3 to 6 ft. tall, with slightly hairy leaf blades about 12 inches long with a distinctive purple cast. Leafy foliage, primarily basal, is abundant, roots are vigorous, spreading and deeply penetrating and therefore of value in conservation. Plants begin growth very early in spring and remain green until late fall. It is generally considered one of the most palatable and nutritious of the range grasses. It is easily established from seed and volunteers aggressively. Use one pound per acre, covering seed to a depth of $\frac{1}{4}$ inch.

Postpaid (lb. \$1.25).

HAY AND PASTURE MIXTURES

PERMANENT PASTURE AND MEADOW MIXTURE—(For all soils except low wet ground). This mixture consists of hardy deep rooted grasses and clover. It will furnish good grazing throughout the season. It consists of Meadow Fescue, Brome Grass, Rye Grass, Timothy, Red Top, Kentucky Blue Grass, and Alsike Clover.

Postpaid (lb. \$1.00) (5 lbs. \$4.75) (10 lbs. \$9.00).

PLAINS OR DRY LAND MIXTURES—Consists of 6 lbs. Brome, 4 lbs. Crested Wheat, 5 lbs. Slender Wheat, 3 lbs. Yellow Blossom Sweet Clover. Sow 18 lbs. per acre. It is made up according to specifications of the North Dakota Experiment Station.

Postpaid (lb. 85c) (5 lbs. \$4.00) (10 lbs. \$7.50).

MOUNTAIN MEADOW MIXTURE—A special mixture of Alsike Clover, Timothy and Red Top, especially adapted for our mountain meadows. Can be pastured or cut for hay.

Postpaid (lb. 85c) (5 lbs. \$4.00) (10 lbs. \$7.50).

PASTURE AND MEADOW MIXTURE FOR LOW WET GROUND—This mixture consists of Rye Grass, Kentucky Blue Grass, Brome Grass, Timothy and Alsike Clover. Sow 20 to 25 pounds per acre.

Postpaid (lb. 85c) (5 lbs. \$4.00) (10 lbs. \$7.50).

MORTON'S PASTURE MIXTURE—Our State Agricultural College recommends the following ratio for a well-balanced permanent pasture mixture: 30 per cent Orchard Grass, 30 per cent Brome Grass, 20 per cent Meadow Fescue, 12 per cent Timothy and 8 per cent Yellow Blossom Sweet Clover. Sow 25 to 30 pounds per acre.

Postpaid (lb. 75c) (5 lbs. \$3.50) (10 lbs. \$6.50).

MIXTURE FOR ALKALINE LANDS—The following is fine on lands infested with alkali: 8 lbs. Yellow Blossom Sweet Clover, 8 lbs. Slender Wheat Grass, 6 lbs. Meadow Fescue, 6 lbs. Brome Grass and 4 lbs. Perennial Rye. Sow 30 pounds per acre.

Postpaid (lb. 80c) (5 lbs. \$3.75) (10 lbs. \$7.00).

BROME ALFALFA MIXTURE—Owing to the limited supply of Alfalfa Seed a mixture of Alfalfa Seed and Brome Grass is recommended for Hay or Pasture. Use 12 lbs. Brome and 4 lbs. Alfalfa Seed per acre.

Postpaid (lb. \$1.00) (5 lbs. \$4.75) (10 lbs. \$9.00).

TIMOTHY AND 20% ALSIKE MIXTURE—Fine for hay and pasture, especially for mountain districts.

Postpaid (lb. 75c) (5 lbs. \$3.50) (10 lbs. \$6.50).

FIELD SEEDS

PERFEGRO BRAND GRASS AND FIELD SEEDS are specially re-cleaned and tested for purity and germination before shipping. If desired, we will send you samples and advise you what the purity and germination test are of any of the Grass or Farm Seeds.

ALFALFA

CULTURE—Alfalfa Seed may be sown either in spring or in fall at the rate of 12 to 20 pounds per acre. Sow with oats, barley, field peas or other grains as a nurse crop, sowing only about half the amount of grain per acre, so that the grain will not be too thick to smother out the alfalfa. Alfalfa is the great hay crop for America and can be successfully grown in many localities. Alfalfa is of two types, the Domestic or Common, which has a long tap root which penetrates into the soil for a distance of 8 to 10 feet, and the Grimm Type, which has a spreading root system. The Grimm Type is considered the hardiest, although on certain soils and in certain localities the Hardy Common varieties will stand extremes of heat and cold equally well.

All Our Domestic Alfalfa Seed is Especially Selected for Adaptability and Hardiness

The common types of Alfalfa Seed will be available in quantity this season. However, the Baltic and Grimm types are very short. Of the Domestic Type we have the following origins: Colorado, Kansas, Utah and Argentine. Prices are not quoted in the catalog owing to market changes. When you are in the market for Alfalfa and Sweet Clover Seed, please write us, advising quantity wanted, and we will quote you best prices promptly by return mail.

DOMESTIC ALFALFA—Several grades of Common Alfalfa will be available in limited quantities for spring seeding. Write for prices advising quantity wanted and we will submit samples for your inspection. Owing to limited stocks on hand, early orders are advisable.

MEEKER BALTIC—This hardy strain is produced in the same district in Colorado as the Moffat Grimm. It is of the Grimm type and by some authorities is considered the hardiest and most productive variety.

GRIMM ALFALFA—The hardiest of the hardy alfalfas and differs from the domestic or common variety in that it has a spreading root system instead of the long tap root which is sometimes broken when the ground bulges, during the spring freezes, thus causing the plant to die. Highest grade seed. Very hardy and will produce a fine hay crop.

ARGENTINE ALFALFA—This seed is imported from Argentine in South America. It is strained 10 per cent Red to meet government regulations. Government restrictions have been removed and this seed can now be planted in all districts. It is of the Common variety.

BUFFALO ALFALFA—A new hardy Wilt Resistant variety developed in Kansas. The main advantage of Buffalo Alfalfa is its high resistance to bacterial wilt. As a result of this, good stands are maintained longer than is possible with varieties that are susceptible to this disease. **Certified seed (lb. \$1.00). Postpaid.**

LADAK ALFALFA—Wilt and Drought Resistant—Introduced from the mountain regions of northern India by U. S. D. A. Showed no winterkilling for ten years at Havre, Montana. Ladak proved so outstanding that other varieties of

alfalfa could not compete with it for winter hardiness. Ladak is quite resistant to the wilt disease which has been causing such great losses in the hay-producing sections. It produces a larger first cutting than any other alfalfa and this means a larger tonnage per acre under all conditions. It is particularly well adapted to regions where only one or two crops are produced each year because of short growing seasons or where hot, dry summers prevail. Ladak continues to grow and produces a good crop of hay when other varieties are practically at a standstill. The hay is very leafy and of high feeding value and is of exceptionally high quality. Ladak has a large branching root system similar to that of (Grimm or Cossack). **Postpaid (lb. 80c) (5 lbs. \$3.75) (10 lbs. \$7.00).**

RANGER ALFALFA—Wilt and Disease Resistant—Here's the new synthetic variety you have read about. Developed by U. S. D. A. and Nebraska's Experiment Station. The result of compositing five strains from Cossack, Turkestan and Ladak parentage. Ranger has high resistance to bacterial wilt and other diseases. It is winter hardy, and has variegated blossoms, with some yellow flowers. In seed production, Ranger equals Grimm, Cossack and Baltic, and surpasses Turkestan. Ranger is well adapted in northern states, particularly where bacterial wilt reduces stand. Grimm, Ladak or Cossack will yield about as much hay as Ranger where wilt is not troublesome, but Ranger will outyield these varieties wherever wilt becomes a factor. Bacterial wilt is becoming more serious every year in many northern states.



ALFALFA

SWEET CLOVERS

The culture of Sweet Clover is practically the same as for Alfalfa. Sweet Clover, however, will make an immense growth and if cut before it is too ripe makes excellent hay. It is also valuable for pasture for hogs, sheep and cattle. Like Red Clover, this is a biennial and should be renewed every other year. The seed may be sown in the late fall and winter, or early spring as well as in the summer. Sow 12 to 20 pounds per acre.

WHITE BLOSSOM SWEET CLOVER—White Blossom makes the rankest growth of any clover. It produces the biggest hay crop and is the best soil enricher and green fertilizer. It breaks up the soil, gathers nitrogen from the air and deposits it in the soil.
Postpaid (lb. 60c) (5 lbs. \$2.75) (10 lbs. \$5.00).

HUBAM SWEET CLOVER—This is an annual White Sweet Clover that may be planted in April and will mature and make seed the first year.
Postpaid (lb. 60c) (5 lbs. \$2.75) (10 lbs. \$5.00).



YELLOW BLOSSOM SWEET CLOVER—Is a biennial like the White Blossom Sweet Clover and differs from that variety only in that it is ten days earlier. Does not grow as tall, is more spreading in habit, makes finer hay or pasture.
Postpaid (lb. 60c) (5 lbs. \$2.75) (10 lbs. \$5.00).

CLOVERS

ALSIKE OR SWEDISH CLOVER—Grows well on low, wet land where Red Clover does not thrive. Alsike being a perennial, will last for a good many years, either for hay or in pasture. It makes fine hay of high feeding value. It is very valuable in pastures, especially on wet or heavy soil. Sow 6 to 10 pounds of seed per acre if used alone.
Postpaid (lb. 75c) (5 lbs. \$3.50) (10 lbs. \$6.50).

BIRDSFOOT TREFOIL CLOVER (Broadleaf)—For pasture or hay, a perennial clover that will withstand moderate alkali, grown on many kinds of soil, withstands wide fluctuations of moisture and to take more general abuse than Ladino. Produces highly palatable nutritious forage with fine leafy stems that arise from a single crown. Flowers brilliant yellow. As far as can be determined it neither bloats nor scours. Do not expect too much growth the first season. Use 4 lbs. per acre.
Postpaid (lb. \$1.25) (5 lbs. \$6.00) (10 lbs. \$11.50).

LESPEDEZA (Korean Clover)—Lespedeza grows on poor soils and increases the fertility as well as improves the physical condition of the soil. It is an annual but will reseed itself each year so that only one sowing is necessary for a permanent pasture. For pasture about 3 pounds of seed is required per acre. On tilled land for hay or for a seed crop 10 to 12 pounds per acre should be sown. Korean Lespedeza is palatable to all classes of livestock, particularly cattle.
Postpaid (lb. 45c) (5 lbs. \$2.00) (10 lbs. \$3.50).

MEDIUM RED CLOVER—Fits better into crop rotation than any other legume. It will increase the yield of succeeding crops besides furnishing many tons of hay of high protein content. It is a biennial which means that it will grow for two seasons only and then must be reseeded. Requires medium rich well drained soil. Sow 8 to 12 lbs. per acre.
Prices quoted on request.

MAMMOTH RED CLOVER—Resembles Medium Red Clover but grows taller and the hay is coarser. It is hardy and valuable for fertilizing poor soil. Sow 8 to 12 lbs. per acre.
Prices quoted on request.

STRAWBERRY CLOVER (Trifolium Fragiferum)—Is primarily a pasture crop. It thrives on wet, seepy ground, which may be crusty with alkali and is apparently more resistant to alkali than any other clover. It is capable of spreading and establishing itself by its stout creeping runners. Three to five pounds will seed an acre.

Postpaid (lb. \$1.75) (5 lbs. \$8.50) (10 lbs. \$16.50).

LADINO CLOVER—Is regarded as a tall form of White Dutch Clover. It is a low growing, leafy plant with succulent and somewhat coarse stems. Sow in the spring or fall, sow 7 to 8 pounds per acre.

Postpaid (lb. \$2.25) (5 lbs. \$11.00) (10 lbs. \$21.50).

BUCKWHEAT

Buckwheat is easily raised and will make profitable crops on rather poor land, where other grain would fail. It is also largely used as a cover crop in orchards. Sow in June or July, using 50 pounds of seed to the acre.

JAPANESE—This is the largest buckwheat. The plant makes a more vigorous and larger growth than the common kind and yields more.

Postpaid (5 lbs. \$1.75) (10 lbs. \$3.00).

FLAX

WILT-RESISTANT—Flax is the best and most profitable crop for sod or new lands, growers frequently realizing more from flax on sod than from wheat on old ground. Sow early, as soon as possible after danger from frost has passed. To raise seed sow one-half bushel per acre; for fibre, one bushel.
Postpaid (lb. 40c) (5 lbs. \$1.75) (10 lbs. \$3.00).

FIELD OR STOCK PEAS

Field Peas are an important class of Legumes and should be more generally planted. Valuable for hay crop or fertilizer. Field Peas are usually grown with Oats, for hay, a combination equal in feeding value to clover hay. They contain more digestible crude protein and fat than Alfalfa and Corn. When grown with oats, they are threshed together, and easily separated with a fanning after threshing. Drill the Peas in four inches deep, as early as the ground can be worked at the rate of 90 to 100 pounds per acre. Then, 2 or 3 weeks later, sow the oats, drilling it in the other way, 50 pounds per acre. If the oats are sown with the peas, they grow too rapidly and check or smother the growth of the peas.

COLORADO STOCK PEAS (White)—Are extensively grown in the mountain districts, are very hardy and if mixed with oats or other grains, make very nutritious hay. If permitted to mature, make excellent feed for fattening sheep or hogs.
Postpaid (5 lbs. \$1.00) (10 lbs. \$1.75).

DWARF ESSEX RAPE

An excellent forage crop for sheep and hogs, belongs to the cabbage family. It produces a mass of broad, smooth leaves which are greatly relished by sheep and hogs. It can be pastured off and when stock is removed, if not eaten too close, it will grow up again and give a second crop. It does best on rather moist land, but will do well in any good soil. The seed is usually sown broadcast, using about 5 pounds per acre. Sow from the first to the middle of August. If sown broadcast on corn ground after the last cultivation it makes good pasture after the corn is removed.

Postpaid (5 lbs. \$2.00) (10 lbs. \$3.50).

SUNFLOWER

Quite extensively grown for feeding. Sow in rows 3 to 3½ feet apart and thin to a foot apart in the rows. Treat the same as corn. Use 10 to 12 pounds of seed per acre. Sunflower are often used to mix with corn when filling a silo. It is claimed that the mixture makes a better ensilage than pure corn.

MAMMOTH RUSSIAN—The variety commonly used to produce seed and for filling silos. The heads are often one foot across and are filled with striped seed which makes most excellent feed for poultry.

Postpaid (lb. 50c) (5 lbs. \$2.25) (10 lbs. \$4.00).

NEW IMPROVED CERESAN

A new dust disinfectant for seed oats, barley, wheat, and other cereals made by the manufacturers of Semesan. Effective in controlling seed borne diseases, such as Loose-Smut of oats, Stinking-Smut of Wheat, etc. One pound treats 32 bushels of seed.

Not Postpaid (1 lb. \$1.00) (4 lbs. \$3.40)
(40-lb. drum \$28.75) (100-lb. drum \$69.00).



SEED GRAINS



FIELD OF SHOCKED OATS

WHEAT

On irrigated lands, sow 60 to 75 pounds per acre; on dry land, 40 to 50 pounds.

THATCHER—A new beardless, hard red spring wheat, developed in Minnesota. Rust resistant and equal in milling and baking qualities to Marquis.

WINTER WHEAT—For Fall seeding, a hard, bearded winter wheat. Very prolific and stands cold and drought well. Prices quoted on request.

OATS

On irrigated land, sow 60 to 90 pounds per acre; on dry land, 40 to 50 pounds.

COLORADO 37—A mid-season white oat similar to Swedish Select, except for fewer awns, higher yield and stiffer straw. Adapted to the irrigated sections of northern Colorado and the cooler regions of other sections.

BRUNKER—A very early uniform variety of drought evading, smut resistant red oat. Well adapted to the non-irrigated plains area and high altitudes. Yielded 60 per cent more than Colorado 37 at the U. S. Dryland Field Station over an eight year period.

SPELTZ OR EMMER

A valuable grain belonging to the wheat family. Kernels are tightly enclosed in hulls which adhere at threshing. Speltz has a feeding value equal to oats, and only slightly less than barley and corn. It is extremely rust resistant and will not lodge like other grains because of its heavy stiff straw. Can be grown on any type soil. Makes wonderful feed and is especially fine for hogs and poultry. Sow about 80 lbs. per acre.

RYE

On irrigated land, sow 60 to 80 pounds per acre; on dry land, 30 to 40 pounds. In ordering spring or fall rye, please note that we supply these spring or fall as they are supplied to us, but we cannot guarantee them to be such, as it is impossible to determine the variety from the appearance of the seed.

FALL OR WINTER—This is the hardiest of any of the fall grains, and can be grown on a greater variety of soils. It will thrive in dry seasons and on light, sandy soil. It is grown for grain, for hay, for pasture and for plowing under for soiling purposes. There is no grain crop that produces as much and as good pasture as fall rye. If sown in August, makes a fine fall and winter pasture. Fall rye may also be sown in the spring, when it makes splendid summer pasture as it will not go to seed as does the spring rye.

SPRING RYE—Makes an excellent crop where winter grains have been killed or blown out or for sowing where a fall crop has not been planted. It is sown largely for early pasture and is often cut for hay. Sow seed same time as other spring grain. It does not grow quite as large straw as winter rye, but usually yields as well and the grain is of fine quality.

BARLEY

On irrigated land, sow 60 to 90 pounds per acre; on dry land, 40 to 50 pounds.

BEECHER—A semi-smooth awned barley that has outyielded Club Mariout or Flynn over 25 per cent at the U. S. Dryland Station at Akron. Also shows a better bushel weight. Stiff strawed. Adapted to dryland conditions.

LICO—This is a high yielding barley, very much like Trebi except that it is smooth awned.

TREBI—This is a six-rowed, bearded, hulled barley adapted to irrigated conditions. At the Fort Collins Experiment Station it outyielded all other barleys in a six-year test. Though it is a rough awned variety it has the advantages over most barley in that the awns thresh free from the grain, thus eliminating considerable danger in feeding.

BALD OR HULLESS—Threshes out like wheat, is beardless and equal in feeding value to corn. It is early and will make a grain crop in high altitude, and is excellent if cut for hay. Prices quoted on request.



WHEAT

ASK FOR SPECIAL QUANTITY PRICES ON FIELD SEEDS AND FARM SEEDS

Jacques Proven HYBRID SEED CORN



EARLIEST CORN THERE IS

Our Jacques Proven Hybrid Seed Corn is available in a wide range of maturities, and the maturities are dependable because of the northern breeding. You can choose the earliest hybrid there is; we can supply you with Jacques hybrids for this locality that will ripen when you want them to, extra earlies, earlies, medium earlies and full-season corns.

GET LIVE SEED

Our Jacques Proven Hybrid Seed Corn is germination tested and a statement of the test is on each bag. Also each lot is tested by Jacques for ability to grow in cold, wet diseased soil. Sample seed is planted in soil from old corn fields teeming with disease; it's kept wet and below fifty degrees for ten days. If it doesn't grow, it doesn't go in the Jacques seed bag.

DROUTH PROTECTION

Our Jacques Proven Hybrid Seed Corn comes from strains that literally fill the seedbed with roots. This not only firmly anchors the stalk, but also enables the plant to reach subsoil moisture when the top-soil dries out. It's one of the reasons why the Jacques hybrids stayed green in the same fields where some other corns wilted, curled and fired.

OVER-SHELLS CRIB MEASURE

Our Jacques Proven Hybrid Seed Corn makes corn that regularly over-shells crib or wagon box measure. It makes sound ripe corn, and sound, ripe corn over-shells immature corn. Also, it makes ears with deep, close-packed kernels on a small cob. It's the weight of dry, shelled corn that counts whether you feed or sell your corn. Get Jacques.

STALKS THAT STAND

Our Jacques Proven Hybrid Seed Corn comes from northern-bred strains that inherently grow a strong, disease-resistant stalk. That is why you often see Jacques corn standing up in the same field where some other corns are broken over. If the hybrid you have been growing has been going down, better let us fix you up with seed of sturdy standing Jacques.

The Following Numbers of Jacques Proven Hybrids Are Available in the Flat Kernel Grade

80 day series.....	Strains 802, 803
85 day series.....	Strains 852, 854, 853
90 day series.....	Strains 902, 907, 908
95 day series.....	Strains 955-J, 957, 957A
100 day series.....	Strains 1001-J, 1004
105 day series.....	Strains 1050-J, 1051-J
110 day series.....	Strains 1104-J, 1107-J
115 day series.....	Strains 1157-J, 1159-A, 1153-J
120 day series.....	Strains 1205-J, 1208-J
White Hybrids.....	Strains 925, 1075

All Hybrid Corn is State sealed and certified in bushel bags of 56 lbs. and is treated ready to plant. One bushel will plant 7 to 8 acres.

Postpaid (lb. 40c) (5 lbs. \$1.75) (10 lbs. \$3.00)
Not Postpaid—Flat Kernel Grade: Bushel 56 lbs.
(80 day to 120 day inclusive \$11.00).

SILO SALAD

A blend of evenly sized choice kernels blended for each maturity zone so that the crop will have these much desired characteristics. Just right for the Silo:

1. It will stay in prime condition for ensilage over a long period of time.
2. It will give you a very heavy tonnage per acre. Sold only in 100 lb. bags, and this is enough seed to make corn to more than fill the average silo.
3. It will make a good ear on practically every stalk and in the field there will be many well matured ears to give the silage extra richness and extra palatability.
4. The proportion of succulent green leaves and stalks and well matured plants will be such that you will get a well-cured silage, rich and sweet, not watery and sour, nor dry and mouldy.
5. It will make a high tonnage of rich silage even in adverse sections; the variation in maturity of different plants in the field will prevent uniform damage by spells of bad weather, insects or diseases.
6. It will stand up straight and strong for labor-saving harvest.

Round Kernel Grade, \$15.00 per 100 lbs.

Flat Kernel Grade, \$17.00 per 100 lbs.

F.O.B. DENVER, COLORADO

FOR BEST RESULTS PLANT

Jacques Proven HYBRID SEED CORN



FIELD CORN

10 pounds will plant an acre. The proper selection and care of Seed Corn is more important and exacting than the average grower realizes, and in appearance corn suitable for seed purposes is often deceiving and its seed qualities can only be determined by actual tests for germination and vitality. Our Seed Corn is strictly Colorado grown (except the ensilage and Hybrid varieties), is acclimated and will ripen earlier than eastern grown seed.

OPEN POLLINATED VARIETIES

WHITE AUSTRALIAN—A hardy flint corn, adapted for cool climates, short seasons and dry lands. Ears are medium size, kernels are white, smooth, shallow, round and flinty.

COLORADO No. 13—A selection out of Minnesota No. 13 by our State Agricultural College, bred for earliness and high yielding quality. The most widely used Yellow Dent variety, maturing in 100 to 110 days.

MINNESOTA No. 13—Is one of the most popular Yellow Dent Corn for Colorado and the western states. It is early maturing, stalks are tall and leafy, and is excellent for grain or silage.

REID'S YELLOW DENT—110 days. Suitable for Southeastern Colorado, and the Arkansas Valley. It produces high yields of showy ears well filled to the tip of well dented deep yellow kernels. Leaves and stalks make finest ensilage and fodder.

COLORADO YELLOW DENT—This is a variety of Yellow Dent Corn developed in Colorado and is especially well adapted for planting in the dry-land district and in the north, as it is very drought resisting and matures early. Fine for grain, fodder or ensilage.

COLORADO WHITE DENT—A corn very similar to Colorado Yellow Dent except in color. A White Dent variety that has been bred for earliness and will make a better yield per acre than the Yellow Dents, especially on thin soils.

BLUE SQUAW—It is extremely early and of very dwarf habits. Average length of ears $7\frac{1}{2}$ inches, grain of dark purple color and sugary. Better for hogging down than the White or Yellow Flints as the grain is not as hard. Ready to use in about 70 days.

SOY BEANS

LINCOLN—108 days. A new cross between Mandarin and Manchu. Plant medium height, well branched, upright. Especially adapted for hay and planting with corn for silage. Soy Beans in Corn add 10% more dry matter and 50% more protein to the silage.

MILLET

Millet is a wonderful forage and hay crop. It affords a quick, luxuriant growth of hay of good feeding value and requires no cultivation. Millet may be fed green or cured. The value of Millet for late planting and emergency crops after others fail should not be overlooked. They can be planted late in July and still make considerable forage. Sow about 20 pounds to the acre.

WHITE WONDER—A variety which has taken the place of common millet and has qualities superior to other varieties. It is early, the heads are very large and long, and the foliage is heavy yet easily cured.

MANITOBA OR HOG—A valuable peculiarity of Hog Millet is that seed ripen while the hay is yet green, which, if cured at the proper time, can be threshed for seed, while the hay makes excellent fodder after being threshed.

SIBERIAN OR RED RUSSIAN—Earlier, more hardy, rust-proof, and less liable to damage by insects, an extremely heavy cropper; stalks tall, and of finer quality than any other sort. Best variety for hay.

GERMAN OR GOLDEN—This is one of the best forage plants grown in this country. Under ordinary conditions will produce from 4 to 5 tons of hay per acre, and from 50 to 75 bushels of seed. When sown early it leaves the ground in splendid condition for wheat.

FORAGE SORGHUMS

CULTURE—For forage crops, sow 50 to 75 pounds per acre; for grain, 5 to 6 pounds, in rows and cultivate the same as corn. Forage is very palatable to stock.

NOTICE

ALL CANE AND SORGO SEED OFFERED ARE FOR FORAGE PURPOSES ONLY

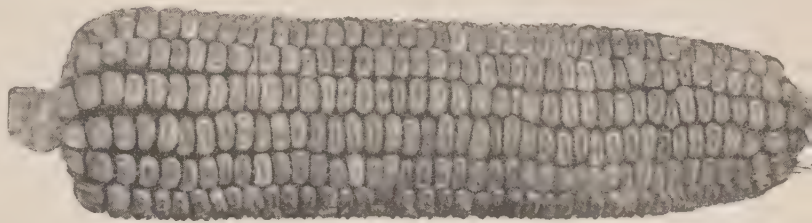

BLACK AMBER CANE—Is the best known and is the favorite on account of its earliness and resistance to drought.

MIXED CANE—This is valuable as a forage crop. Do not plant for a seed crop.

LEOTI RED—A highly recommended sorghum, for Colorado. Produces a semi-compact reddish head that droops slightly at the tip when ripe. The stalk is sweet, juicy and leafy. Matures at about average frost time if planted between June 1st and 6th.

ORANGE CANE—A heavy yielding variety grown for forage and silage. It is rather late in maturing seed, as it takes from 100 to 110 days.

RED TOP OR SUMAC CANE—Very desirable for forage as the stalks are sweet and very leafy. The seed shells out clean like the grain sorghums and is better for feed than other varieties of Cane.

COES SORGO—Is a Kafir-headed sorgho with a long, compact head and fine stem, high in sugar contents. Suckers profusely making large quantities of fine leafy feed. The grain is equal to feeding value of Kafir.

ATLAS SORGO—A large late forage sorghum developed by the Hays, Kansas Experiment Station. It is drought resistant, produces big yields under favorable conditions and is similar to Kansas Orange in growth habit. It is a sweet sorghum and will produce a good tonnage of forage in this section.

GRAIN SORGHUMS

CULTURE—For forage crops, sow 50 to 75 pounds per acre; for grain, 5 to 6 pounds in rows and cultivate the same as Corn. Forage is not quite as palatable for stock as the Sweet Sorghums.

WHITE KAFIR (Dwarf Black Hull)—Usually grows 5 to 6 feet tall in the dry land areas. Heads are heavy and compact, 10 to 14 inches long with black hulls and white seeds. The grain makes good feed for poultry and cattle.

HEGARI—This is one of the earliest maturing of the grain sorghums. It is very similar to Kafir. The grain is nearly equal to corn in feeding value. The stalks are leafy and make excellent fodder.

MIL (Sooner or Sixty Day)—A non-saccharine sorghum of high feeding value. This is the plant that is being so largely raised for its grain in the dry plains of eastern Colorado and western Kansas. The seed is larger than the seed of Kafir and not as hard and equal to corn in feeding value for stock and poultry.

MARTIN'S COMBINE MILO—An extremely short, stocky straight shanked Milo. Has erect heads and seeds—threshes free from the glumes. The seeds are yellow and of large size. Strictly a combine type grain sorghum.

VETCH

Vetches, either green or as hay, make excellent feed and are also used extensively as cover and green manure crops. They make good hay, ensilage, pasture and green feed and are very valuable as a green fertilizer and as a cover crop in orchard preventing the washing away of the soil.

WINTER, SAND OR HAIRY VETCH—Is very winter hardy and is a fine crop to sow in the fall following harvest of crop. Sow 60 lbs. per acre. May also be seeded in the fall with winter rye for a hay crop, about August 1 to 20 using about 30 lbs. of Vetch and 40 lbs. of Fall Rye per acre.

SPRING VETCH—Sow in the spring at the rate of 60 lbs. per acre or with a grain crop such as oats, wheat, rye or barley, at the rate of 30 lbs. per acre and using one-half of the normal rate of small grain. This combination makes excellent forage or hay and also aids in preventing the Vetch from lodging.

ASK FOR SPECIAL QUANTITY PRICES ON FIELD SEEDS AND FARM SEEDS

FERTILIZERS

VIGORO

Complete Plant Food
A PRODUCT OF SWIFT & COMPANY

A complete plant food, especially prepared to furnish grass, trees, shrubbery and flowers the plant elements necessary for maximum growth and flowering. It is free from dust, has no unpleasant odor, and is easy and pleasant to apply.

Postpaid (1 lb. 25c) (5 lb. Pkg. 75c) (10 lbs. \$1.25).

Not Postpaid (lb. 12c) (5 lbs. 50c) (10 lbs. 90c) (25 lbs. \$1.85) (50 lbs. \$3.15) (100 lbs. \$5.50).

VIGORO PLANT TABLETS (24 Tablets 15c). Postpaid.



VIGORO SPREADER

The Vigoro Spreader is easy to operate, making plant feeding a pleasure. Can also be used for Grass Seed. Hoppers are made of heavy sheet steel. All models are equipped with shut-off control on the handle, and a dial regulates the flow of Vigoro or Grass Seed. Forced feed assures even distribution.

MODEL "B"—14-inch Spreader (Hopper capacity 20 lbs.) Each \$8.15 f.o.b. Denver.

JUNIOR MODEL—16-inch Spreader (Hopper capacity 40 lbs.) Each \$12.38 f.o.b. Denver.

ESTABLISHED 1907

SACCO

TRADE MARK REGISTERED

PLANT FOOD

Makes things Grow!



Sacco has many times the actual plant food value of ordinary manure and is free from offensive odors. A single application brightens a lawn in one week's time and produces an extraordinary growth and bloom among flowers and shrubbery. Easy to apply. Full directions on each package.

Postpaid (2½ lb. Pkg. 45c) (5 lb. Pkgs. 75c) (10 lbs. \$1.25)

Not Postpaid (2½ lb. Pkg. 25c) (5 lbs. 50c) (10 lbs. 90c) (25 lbs. \$1.75) (50 lbs. \$3.15) (100 lbs. \$4.75)

PEAT MOSS

Peat Moss is a remarkable soil conditioner and mulch. Added to the soil, it makes it loose and friable and increases its air and moisture holding capacity. It readily absorbs 13 to 15 parts of water to one part of Peat Moss. Peat Moss supplies humus to the soil. Can be used to good advantage in hot beds and plant beds in holding moisture and developing a strong root system. Use the Horticultural grade for Greenhouse, Truck Gardens, Landscaping and Lawns.



PEAT MOSS—Extra Fine Quality. Horticultural Grade \$4.75 per bale, ½ bales \$2.75, f.o.b. Denver.

ALEXITE

GardenGro

ALL PURPOSE ORGANIC BASE PLANT FOOD

For the Finest Lawn, Vegetables, Flowers, Shrubs, Trees.

Not Postpaid (5 lbs. 45c) (10 lbs. 85c) (25 lbs. \$1.60) (50 lbs. \$2.35) (100 lbs. \$4.50)

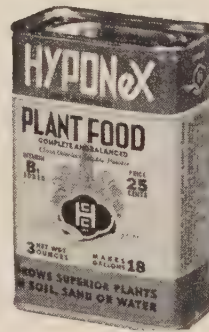

HYPONEX
Grows **BETTER**
Plants **QUICKER**

A clean, odorless, soluble powder that makes complete plant food immediately available . . . Simply dissolve in water and apply. Produces bigger plants, larger vegetables, more flowers, better lawns and trees. Stimulates root growth on cuttings, reduces shock to transplants. For use in soil, sand or water (hydroponics). Economical . . . 1 oz. makes 6 gallons balanced liquid food. Non-burning.

Postpaid (1 oz. Pkt. 10c) (3 oz. can 25c) (7 oz. can 50c) (lb. can \$1.00)

Not Postpaid (10 lb. drums \$8.00) (25 lbs. \$15.00) (100 lbs. \$40.00)

WEDO

Analysis 10-6-4

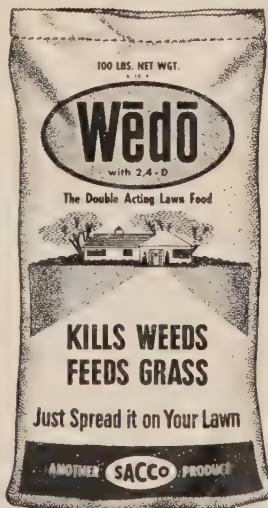

The amazing new Weed-Killing Lawn Fertilizer. Use WEDO, save back breaking work and have the lawn of your dreams—a close knit carpet of velvety green unmarred by ugly weeds. It's a balanced formula of grass feeding elements and weed killing 2, 4-D. No other plant food is needed when you apply Wedo. It alone produces thick, healthy, luxuriant lawns while destroying common weeds. (Do not use on new lawns or Creeping Bent Lawns). Use 1½ lbs. to 100 square feet of lawn.

Not Postpaid (7½ lb. bag \$1.00) (25 lb. bags \$2.75) (50 lbs. \$4.95) (100 lbs. \$7.95).



WEEDONE is the marvelous new weed-killer containing 2,4 dichlorophenoxyacetic acid (2,4-D for short). When sprayed on to the leaves of certain weeds, it is absorbed by the plant and penetrates down into the roots, and thereby kills the plant throughout. For complete kill, all the foliage must be sprayed as there is little cross-movement within the stem. WEEDONE is effective only when the leaves are green and actively growing, for the chemical does not move through dormant or dead tissue. WEEDONE usually takes a week to ten days before showing its first effect, and the plant takes two to four weeks to die. This slow action gives the chemical a chance to move all through the plant.

Prepaid (6 oz. 75c) (1 qt. \$2.50) (1 gal. \$6.50) (5 gals., per gal. \$4.25) (54 gal. drum, per gal. \$4.00).



SWIFT'S END O WEED

END O WEED is absorbed by the leaves and stems of plants and carried down to the very tips of roots with the sap flow. In three or four days you'll see the weeds start to curl. In just a week or so all signs of the weeds will be gone. Kills dandelions, chickweed, plantain and over 50 other weeds.

Prepaid (small pkt. 25c) (½ pts. \$1.00) (qts. \$2.75) (gals. \$8.50).

2,4-D FORMULA "40"

A liquid amine concentrate for greatest ease of use. One gallon contains 4 pounds of actual 2,4-D acid plus a new sequestering agent, which eliminates difficulties of sludge precipitation which many types of water (especially hard water). Particularly well adapted to low-volume spraying. For lawns, pastures and other turf areas, mix thoroughly 3 pints Formula "40" per acre in whatever amount of water is required to give good coverage. Animals feeding on treated areas are not affected. Apply during warm weather when weeds are growing actively.

F.O.B. Denver (gals. \$5.00) (5 gal. cans \$23.75).

ESTERON 44

For those more difficult to control perennial and woody weed plants. It is an ester formulation that penetrates plant tissues more quickly and is not readily washed off by rain. Use one quart of 44 per acre in whatever amount of water is required to give good coverage.

F.O.B. Denver (gals. \$5.30) (5 gals. \$25.25).

N & K 2,4-D TABLETS

A convenient and easy way to use when killing a small patch of weeds by using the 2,4 Weed Killer in tablet form. Use one tablet to one gallon of water.

Postpaid (18 tablets to a tube 75c).

SODIUM SALT—70% 2,4-D

For spray application to the leaves of such weeds as dandelion, plantain, mustard, chickweed, morning glory or bindweed, dock and ragweed. Kills the weed without killing the grasses. Use 1¼ pounds Sodium Salt 70% 2,4-D to each 100 gallons of water and spray the leaves of the weeds thoroughly. 200 gallons of spray per acre gives good coverage. Apply on a warm day using a coarse, low-pressure spray to avoid drifting. Keep the spray away from flowers, vegetables or shrubs as it can kill them, too, if they are hit by spray drift. The spray kills white clover and may temporarily injure creeping bent turf that is close cut. Do not use this 2,4-D weed killer spray in ditches which water valuable plants. The weeds take 2 to 3 weeks to die and spot sprays are usually needed to follow up on patches of weeds that were missed by the first spray.

F.O.B. Denver (5 lb. pkg. \$6.25) (10 lbs. \$11.50) (50 lb. drum \$50.00).

FOR LAWN OR GARDEN

The new easy way to kill weeds. Just a touch of the Chem-Wand and—presto—annoying weeds die and disappear! No stooping or digging—no vapors to annoy—easy to use—makes weeding fun.

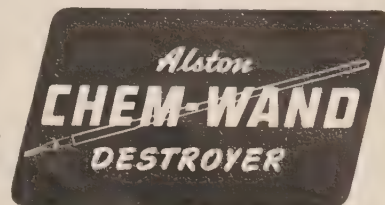

Postpaid (Each \$2.19)

NOTT'S SEL-TOX A SELECTIVE CRAB GRASS KILLER (Phenyl Mercurice)

One of the outstanding features about Sel-Tox is that it destroys crab grass without injury to lawn grasses. Turf and lawn grasses may be slightly discolored due to reduction of chlorophyll, and although withering of the outside sheathes may appear, that is only a temporary condition, and lawn grasses recover normal appearance within 10 days to two weeks. Surrounding grasses are unharmed, with clover remaining unaffected. Reseeding is recommended after crab grass has been destroyed, which will produce a luxurious growth of grass in the thinned out areas.

Postpaid (8 oz. \$1.00) (16 oz. \$1.50) (1 qt. \$2.50) (½ gal. \$4.50) (1 gal. \$8.00).



The Double Acting Lawn Food
Kills Weeds
Feeds Grass

Just Spread It on Your Lawn

Wedo should be applied evenly over the lawn with a lawn spreader. Apply 1½ to 2 pounds per 100 square feet (10 feet by 10 feet). Less than 1½ pounds is apt to give poor weed control. Over two pounds may cause temporary browning of the grass. Wedo should be applied when the grass is dry. It is desirable to wet down immediately after application. Wedo controls the following weeds: Buckhorn, Burdock, Dandelion, Ground Ivy, Gypsum Weed, Nettle, Lawn Pennywort, Mustard, Pigwood, Plantain, Ragweed and Sow Thistle. Wedo should not be used on Creeping Bent lawn, on flowers, shrubs or vegetables, or in preparing new lawn for seeding. **Not postpaid:** (7½ lb. pkg. \$1.00) (25 lb. bag \$2.75) (50 lb. bag \$4.95) (100 lb. bag \$7.95)

WEEDUST

TRADE-MARK

Kill those here-and-there weeds by shaking Weedust directly from the ready-to-use can. For smaller lawns, for scattered weeds, for jobs that don't require a sprayer, Weedust in dry powder form is the ideal 2,4D weed-killer.

12 Oz. Sifter Can 75c.



WEEDUST 5—2,4-D Weed Killer in a powdered form to be applied with a Duster. Very effective wherever wind conditions permit control of drift.

F.O.B. Denver (50 lb. drum \$7.50).

STANDARD INSECTICIDES AND FUNGICIDES

INSECTICIDES

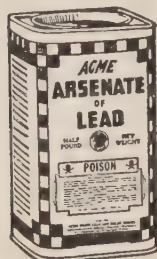

ARSENATE OF LEAD—The Standard Spray or Dust for quick, dependable control of practically all leaf eating insects. (1 lb. 65c) (4 lbs. \$1.59) F.O.B. Denver.

ACME HOPPER TOX (42% Toxaphene Chlorinated Camphene)—A new organic chemical that kills grasshoppers more quickly than poison baits and have proven better where grasshoppers are attacking tall succulent growth which is attractive food to grasshoppers. Mixes completely with any kind of water for low gallonage or high gallonage equipment—5 to 100 gallons per acre, using 3 pints of Hopper Tox per acre. (Gals. \$5.00) (5 gal. cans \$23.25), F.O.B. Denver.



ACME GARDEN GUARD (With Rotenone)—A Dust that can be used to control any insect on your vegetables or flowers. Does not leave a poisonous residue. (1 lb. sifter can 45c) (4 lb. pkg. 90c) (50 lb. bags \$9.00), F.O.B. Denver.

ACME WETTABLE DUSTING SULPHUR—Highly recommended for control of fungus diseases such as mildew, black spot, rust, red spider and thrip, on roses, chrysanthemums, snapdragons, carnations, dahlias, phlox and most other flowers. (2 lbs. 48c), F.O.B. Denver.

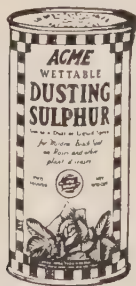

ACME TOMATO DUST—This is especially prepared to control blight and worms preying on tomatoes. While especially designed for tomatoes, it also is equally effective in the control of leaf chewing insects and blight on potatoes, cucumbers, beans and flowers. (1 lb. pump gun 65c) (50 lb. bags \$11.00), F.O.B. Denver.

API HOPPER BAR DUST (5% Chlordane Dust)—For the control of grasshoppers, alfalfa weevil, lygus bugs, ants, earwigs, squash bugs, household spiders, leaf miners, chinch bugs, onion thrip, gladiolus thrip, garden slugs. (1 lb. dust gun pkg. 62c) (5 lb. bags \$1.35) (50 lb. bags \$4.90).

API HOPPER BAR SPRAY (45% Emulsifiable Chlordane)—A powerful 45% Chlordane insecticide to be diluted in water, using 1½ tablespoons per quart of water or ½ pint per quarter of acre. Particularly effective on grasshoppers, alfalfa weevil, potato beetle, cattle lice, hog mange, ticks, house flies, and many other agricultural and livestock pests. (½ pts. 85c) (pts. \$1.50) (qts. \$2.57) (gals. \$7.45) (5 gal. drums \$36.25) (55 gal. drum prices on request).



BLACK LEAF "40"—Highly recommended as a Spray for aphids, leaf hoppers, leaf miners, most thrips, young sucking bugs and other similar insects. Kills by contact and by fumes. One ounce makes six gallons of effective spray. (1 oz. 36c) (5 oz. \$1.05) (1 lb. \$2.42) (2 lbs. \$4.15) (5 lbs. \$7.40) (10 lbs. \$12.65). F.O.B. Denver.

BUGZOFF No. 2 PLANT SPRAY—A non-poisonous liquid spray to be diluted with water, for the control of aphids, leaf hoppers, thrips, Mexican bean beetles, and many others. (4 oz. 59c) (8 oz. 98c) (qts. \$3.19) (gals. \$11.72), F.O.B. Denver.

COLORADO 44 EMULSIFIABLE CHLORDANE CONCENTRATE—Contains 4 full pounds of Chlordane per gallon. Water soluble. For crop and animal spraying, one gallon mixed with 200 gallons of water. One gallon treats 5-1/3 acres for grasshopper control. (4 oz. 75c) (pts. \$2.25) (qts. \$3.75) (gals. \$9.38) (5 gal. drum \$45.75), F.O.B. Denver.

OCTA-KILL—Water base 2½% Chlordane. Octa-Kill is especially for household uses. The killing power lasts for weeks. Ants, cockroaches, waterbugs, earwigs, moths, carpet beetles, silverfish—scores of other household and garden pests are destroyed with Octa-Kill. (qts. \$1.39) (pts. 79c), F.O.B. Denver.

COLORADO 44 KILZIT OIL SOLUTION (2% Chlordane)—Fortified with Lethane. Kilzit is especially designed for use where inside control is important. Hospitals, hotels, restaurants, etc. **MUST NOT BE USED ON VEGETABLES OR ANIMALS.** (pts. 59c) (qts. \$1.09), F.O.B. Denver.



CARCO X—For the control of maggots usually found in radishes, turnips and onions or feeding on the roots of cabbage, cauliflower and broccoli plants. These small maggots attack the plants early in the spring. Treat the ground with a solution of Carco-X 1-200 four days before setting out your plants. Two weeks later pour a thin stream along the row or all around the plant.

For Onions use a solution of 1-200 along the row and repeat every two weeks. Strawberry Root Weevil can be controlled by using 2½ tablespoonsful to two gallons of water and pour on the crown of the plants so it will soak down among the roots, several applications should be made if heavily infested.

Carco-X is also an effective contact spray against such insects as aphids, scale insects, lawn grubs, leaf miners, leaf hoppers and borers. Also an effective dormant spray on trees. (½ pts. 85c) (pts. \$1.25) (qts. \$1.95) (gals. \$4.95), F.O.B. Denver.

CYROLITE (Magnetic)—A fluorine insecticide used for the control of potato beetles, flea beetles, cucumber beetles, Mexican bean beetles and codling moth. (50 lb. bags \$7.50), F.O.B. Denver.

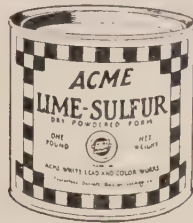

DRY LIME SULPHUR—Exactly like lime-sulphur solution except that the water has been taken out. For fall and spring spraying, use 12 to 15 lbs. to 50 gallons water. Summer spraying, 2½ to 3 lbs. to 50 gallons water. (1 lb. 49c) (5 lbs. \$1.85) (10 lbs. \$2.25) (100 lbs. \$19.00), **F.O.B. Denver.**

DDT 50% WETTABLE POWDER—Micro-fine particle size, instantly wettable. Recommended for use on apples, potatoes, and other fruits and vegetables, flowers, trees and ornamentals, in fact wherever a whitish residue is not objectionable. (4 lb. bags \$2.00) (50 lb. bags \$20.00), **F.O.B. Denver.**

DDT 50% DUST CONCENTRATE—Designed primarily for dust mixers for making lower percentage DDT dust mixtures. (100 lb. drums \$38.00), **F.O.B. Denver.**

DOW'S DN SULPHUR DUST No. 10—For the control of red spider mite, thrip and rust on carnations. Economical to use in greenhouse as one pound of dust will cover from 400 to 800 square feet of bench space. Effective for five or six days after application. Can be washed off easily. (10 lb. pkg. \$3.50), **F.O.B. Denver.**

DOW'S DN DUST No. 12—To control red spider mite, thrip and white fly on roses, calla lilies, snapdragons, gardenias, chrysanthemums and carnations. (10 lb. pkg. \$4.50), **F.O.B. Denver.**

DOWSPRAY No. 17—A new wet spray for greenhouse plants. For control of red mite and thrips on roses, calla lilies, snapdragons, gardenias, carnations, azaleas, hydrangeas, ivy and many other greenhouse plants. Does the same work as Dow's DN Sulphur Dust No. 10 and DN Dust No. 12, except that it is used as a wet spray. (¼ lb. pkg. \$2.25), **F.O.B. Denver.**

DOW'S DN-111—For the control of red mites on apples. Use 1¼ lbs. to 100 gallons of spray. Can be combined with arsenicals and sulphur. (¼ lb. pkg. 90c) (30 lb. case \$18.00), **F.O.B. Denver.**



DX SPRAY—A powerful Rotenone and Pyrethrum Spray in a patented spray base of great penetration.

It kills chewing as well as sucking insects. DX combines with summer oil, lime sulphur, arsenate of lead, etc. Non-poisonous to man or warm blooded animals. (1½ oz. 50c) (½ pt. \$1.75) (qt. \$5.30) (gal. \$13.60) (5 gals. \$55.35), **F.O.B. Denver.**

EVERGREEN—Powerful contact insecticide, the killing agent being pyrethrum. Kills chewing and sucking insects such as aphids, ants, rose beetles, etc. Leaves no objectionable residue. Non-injurious to humans or animals. One ounce makes six gallons spray. (1 oz. 35c) (6 oz. \$1.15) (pts. \$2.45) (qts. \$4.10) (gals. \$12.60), **F.O.B. Denver.**

GRAIN FUMIGANT—Dowfume EB-5 contains 5% by volume of ethylene dibromite in chlorinated solvent, is unusually efficient in controlling insects infesting the surface layer of stored grain without harming the grain, or taste of the grain. It is non-inflammable and non-explosive. The ideal time for treating grain in farm bins is during the early storage season. Treatment of grain in August or early September will usually afford good protection until the following summer. In tightly constructed bins, 2 gallons of Dowfume EB-5 will treat 1,000 bushels. (5 gal. cans \$11.25), **F.O.B. Denver.**



KRYOCIDE—An effective insecticide for the control of many chewing insects. Can be used as either a spray or dust. (1 lb. 40c), **F.O.B. Denver.**

KRYOCIDE D-50 (With Sulphur)—Same as Kryocide but contains sulphur and controls blights and some fungus diseases. (1 lb. 50c) (3 lbs. 85c), **F.O.B. Denver.**

KOPPER SHIELD—A pruning and tree wound paint. An antiseptic treatment to prevent diseases and fungi from penetrating the wounds while the tree is naturally overcoming the shock. (pts. 65c) (qts. \$1.17) (gals. \$3.75), **F.O.B. Denver.**

LETHANE B-72—A synthetic contact insecticide spray for the control of aphids, leaf hoppers and other sucking insects on beans, potatoes, peas, tomatoes and other crops. Lethane B-72 is compatible with all normally used spray materials. Use 2½ lbs. to 100 gallons of water. (5 lb. pkg. \$1.50) (case of 50 lbs. \$16.00), **F.O.B. Denver.**

LINSO SOAP—A high quality soap spreader of linseed oil base. It does not have the disagreeable odor of many soap spreaders, and is economical and highly effective. Use 1½ pints to 100 gallons of water. (½ pts. 45c) (qts. \$1.00) (5 gals. \$10.25), **F.O.B. Denver.**

ORTHO ROSE SPRAY KIT—Contains a 2-oz. bottle of Extrax and a 2 oz. bottle of Greenol for simple combination control of many rose pests and other garden pests. Also may be used on vegetables. (2 oz. kit \$1.00), **F.O.B. Denver.**



PARIS GREEN—Oldest and best brand. For chewing insects on potatoes and certain other hardy plants. Kills quickest. (¼ lb. 25c) (1 lb. 65c) (5 lbs. \$3.00) (14 lbs. \$7.00), **F.O.B. Denver.**

PARA-SCALECIDE FOR PEACH BORERS

Para-Scalecide is a combination of paradichlorobenzene and Scalecide, which makes a liquid application for peach borers that is safe and effective on young or old peach trees. It is in great demand wherever peaches are grown.

Para-Scalecide is diluted 1 gallon to 7 gallons of water and poured against the base of the trees 4 to 6 inches above the ground in the fall or spring. It requires approximately $\frac{1}{2}$ pint for 1 to 2 year old trees, 1 pint for 3 year old trees, and $1\frac{1}{2}$ pints for older trees. The diluted Para-Scalecide is also painted on the body and main limbs for lesser peach borers, and for borers on plum, cherry and apple trees. (qts. \$1.50) (gals. \$2.75).

ROTENONE SPRAY (NNOR)—One of the most useful and effective insecticide materials known. In NNOR it is combined with a patented spreader making the tremendous killing power of Rotenone more effective than ever. NNOR penetrates the hairy or waxy covering on the insect to permit the Rotenone to get in its killing punch. One ounce makes six gallons of spray. (1 oz. 35c) (4 oz. \$1.00) (16 oz. \$2.15) (gals. \$13.50), F.O.B. Denver.

ROTHANE WP-50 (D.D.D.)—Rothane is effective against many of the insect enemies of vegetables and fruit. It excels in the control of tomato hornworms, corn earworms, leaf rollers, leaf hoppers, cabbage worms and loopers, lygus bugs, tarnished plant bugs, aphid and onion thrips. (4 lb. bag \$2.40) (cases of 48 lbs. \$26.88), F.O.B. Denver.

SCALECIDE

The Dormant Oil Spray



May be used on any fruit tree, shade tree, shrub or vine that drops its foliage in winter (6 gallons to 100 gallons of water). Spray any time after foliage is off in fall or before buds show $\frac{1}{4}$ to $\frac{1}{2}$ inch of green tips in the spring. Effective against codling moth larvae, aphid, red mites, leaf rollers, scale bud moth, and various forms of canker. For the spraying of evergreens use 1-20 in the spring against spruce gall aphid before new growth starts. (qts. \$1.25) (gals. \$2.50) (5 gals. \$9.00) (larger quantities quoted on request), F.O.B. Denver.

SWIFT'S END-O-PEST—Simplified, efficient pest control for chewing and sucking insects and fungus diseases. The End-o-Pest Gun makes dusting easy. (4 oz. sifter pkg. 35c) (10 oz. applicator gun 98c) (10 oz. refill cartridge 75c) (2 lb. pouring spout pkg. \$1.98), F.O.B. Denver.

SULFOCID—A liquid sulfur fungicide which breaks down to microscopically fine colloidal sulfur on the foliage. It adds greatly to the effectiveness of sprays for red spider and spider mites. Cannot be used on foliage containing arsenical residue. (pts. \$1.05) (qts. \$1.50) (gals. \$3.15), Postpaid.



SURFISPRAY—Contains 5% DDT fortified with pyrethrum and piperonyl cyclohexanone for use against flies, mosquitoes, moths and fleas. For use in the home. (pts. 75c) (qts. \$1.25) (gals. \$3.25), Postpaid.

SUMMER SPRAY CREAM—A stabilized 83% summer oil emulsion for fruit and shade trees, greenhouses, and also dormant and summer spraying evergreens. (qts. \$1.25) (gals. \$2.50) (5 gals. \$9.00), F.O.B. Denver.

TRITON B-1956—Used as a wetting, spreading, depositing and sticking agent. Triton B-1956 is valuable when used in combination with many common spray materials such as Lead Arsenate, Sulphur, Lime Sulphur, Bordeaux Mixture, Yellow Cuprocide and other Copper Sprays. (1 gal. \$7.10), F.O.B. Denver.

VOLCK NURSERY AND GARDEN SPRAY—A summer oil spray for use against scale insects, white fly larvae, mealybugs, red spider, aphid and thrips. (4 oz. 35c) (16 oz. 85c), F.O.B. Denver.

FUNGICIDES



BORDEAUX MIXTURE—The best fungicide for curing and preventing black rot mildew, blight, leaf curl, scab or other fungoid diseases on fruits and plants. One pound will make five gallons liquid spray. (1 lb. 45c) (4 lbs. 95c), F.O.B. Denver.

DITHANE D-14—A synthetic organic fungicide to be combined with zinc sulphate for the control of aphid and flea beetles on potatoes. Use 2 quarts Dithane D-14, 1 lb. Zinc Sulphate and $\frac{1}{2}$ lb. Hydrated Lime to 100 gallons of water, 2 lbs. of 50% DDT Wettable may be added or 1 quart Miscible DDT 25% can be used for more effective control. (5 gal. can \$10.25) (30 gal. drum \$60.00), F.O.B. Denver.

DIATHANE Z-78—A fungicide for the control of early and late blight, downy mildew, mold and mildew rust, anthracnose on tomatoes, celery, cucurbits, potatoes, beans and gladiolus. Use 1 lbs. to 100 gallons of water. (3 lb. pkgs. \$3.00), F.O.B. Denver.

TRI-BASIC COPPER SULPHATE (53% Copper)—Is effectively used for the control of persistent diseases, such as blight on potatoes, tomatoes, celery and sugar beets, and black rot on grapes. In sprays this fungicide should be used at the concentration of one-half or less of the quantity of copper sulphate ordinarily used in Bordeaux Mixture. In dusts the recommended quantities of TRI-BASIC plus talc or clay has largely replaced the old fashioned Copper-Lime dusts. This is especially true where DDT is recommended inasmuch as it is generally recognized that the presence of excess lime greatly reduces the effectiveness of the insecticide. (6 lb. bag \$2.00) (48 lb. case \$14.40), F.O.B. Denver.

"26" COPPER FUNGICIDE (26% Copper)—This material is suitable as a spray for apples, cherries, pears, grapes and other fruits. For a spray we suggest from 2 to $2\frac{1}{2}$ pounds to be used per 100 gallons of spray material, plus equal quantities of lime. Results show that this material is very efficient in controlling scab, blotch, fruit spot, bitter rot and other diseases on fruits and vegetables. (6 lb. bag \$1.80) (48 lb. case \$11.52), F.O.B. Denver.

"34" COPPER FUNGICIDE (34% Copper)—This fungicide is recommended for use either as a spray or dust. As a dust, it is effectively used on melons, cucumbers, tomatoes and other truck crop vegetables. "34" Copper Fungicide is compatible with organic insecticides such as DDT, Pyrethrum, Derris Cube and Black Leaf 155 and Nicotine Sulphate. (6 lb. bag \$2.00) (48 lb. case \$12.24), F.O.B., Denver.

YELLOW CUPROCIDE—A highly effective spray material in the form of a dry powder. It suspends readily in water. For control of damping-off in its second stage, spray seed bed immediately after planting seed and once more before seedlings appear. Spray seedlings every 7 to 10 days. Especially good for the control of blight and leaf spot on celery, tomatoes and potatoes; 3 lb. package makes 200 gallons of spray. (3 lb. \$1.75) (100 lbs. \$52.00), F.O.B. Denver.

WETTABLE SULPHUR

MAGNETIC SPRAY (Wettable Sulphur)—98.5% pure. A specially processed sulphur possessing superior adhesive properties, and containing not more than 12½% wetting agents. Easily dispersed in spray tank. Use for spraying fruit trees, berries, flowers and ornamentals. (100 lbs. \$6.00), **F.O.B. Denver.**

CROWN BRAND (Wettable Sulphur)—95% pure. A processed sulphur of high adhesive properties assuring adherence to foliage. It wets quickly and easily even in hard water, remaining in suspension for an unusually long time. Recommended for use on potatoes as a wet spray. Also excellent to build up weak Lime Sulphur sprays; use 4 lbs. to replace each gallon of 32 degree Baume Lime Sulphur solution left out. (100 lbs. \$5.00), **F.O.B. Denver.**

DUSTING SULPHUR—Inert matter, 7% passing a 325 mesh screen. Its free-flowing properties make it ideal for use in combination with Rotenone bearing dusts, Pyrethrum, Arsenate of Lead, Calcium Arsenate, Nicotine Sulphate, etc. (100 lbs. \$4.50), **F.O.B. Denver.**

SPECIAL MIXTURES OF INSECTICIDES

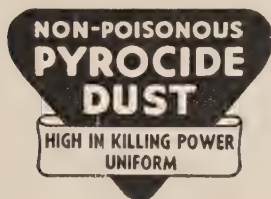
**PYROCIDE DUSTS**

No. 5-A DUST—Pyrocide Dust combined with Sulphur is recommended for the control of psyllids, flea beetles, aphids, leaf hoppers, spider mites, striped and spotted cucumber beetles, thrips, lice, blister beetles, mildew and rust. It is not recommended for greenhouse use. It should also be used with caution on raspberries and grapes since the sulphur in this mixture has a tendency to injure foliage and berries at high temperatures. When used on tomatoes and raspberries cannot be used after the fruit starts setting because of the sulphur residue on the fruit. (1 lb. 40c) (5 lbs. \$1.35) (20 lbs. \$3.50), **Postpaid; (50 lbs. \$6.50), F.O.B. Denver.**

No. 10 DUST—Is recommended as a general insecticide, including the control of web worm, cucumber beetle, bean beetle, tarnish plant bug, leaf tier, grape leaf hopper, thrips, squash bug, harlequin bug, Colorado potato beetle and the asparagus beetle. Can be used on all types of plants under all conditions. (1 lb. 45c) (5 lbs. \$1.75) (20 lbs. \$5.00), **Postpaid; (50 lb. bag \$9.50), F.O.B. Denver.**

No. 10-A DUST—Pyrocide Dust combined with Sulphur for the control of all types of pests that are found on plant as well as fungus diseases. It is especially effective on roses, delphinium, larkspur and as a control of spider mites and mildew on all ornamentals, consequently is recommended on an all-around home garden dust. It is not recommended for use in greenhouses. (1 lb. 50c) (5 lbs. \$1.60) (20 lbs. \$6.00), **Postpaid; (50 lb. \$10.00), F.O.B. Denver.**

ROCKY MOUNTAIN HI-ALTITUDE APHIS DUST—A combination of Free Nicotine, and B-71 for the control of aphid on cabbage, peas, cauliflower and broccoli. (1 lb. 40c) (5 lbs. \$1.25) (20 lbs. \$4.50), **Postpaid; (50 lb. bags \$8.00), F.O.B. Denver.**

ROCKY MOUNTAIN HI-ALTITUDE APHIS DUST WITH SULPHUR—A combination of Free Nicotine, B-71 and Sulphur for aphid control. (1 lb. 45c) (5 lbs. \$1.50) (20 lbs. \$4.75), **Postpaid; (50 lb. bag \$8.50), F.O.B. Denver.**

PYRENONE DUST No. 20 (Contains Piperonyl Cyclohexenone)

A new organic contact insecticide. Gives excellent control of many insects for which Pyrethrum and Rotenone have been used. Tests prove it is effective against Mexican bean beetle, cucumber beetles, cabbage looper, cabbage worm and leaf hoppers. Leaves no poisonous residue. (1 lb. 40c) (5 lbs. \$1.25) (20 lbs. \$4.50), **Postpaid; (50 lb. bags \$8.00), F.O.B. Denver.**

SABADILLA DUST No. 20—This dust is twice as strong as the No. 10 dust and is used for the control of squash bugs, and hard to kill insects. (1 lb. 65c) (5 lbs. \$2.00) (20 lbs. \$7.50), **Postpaid; (50 lb. bag \$14.00), F.O.B. Denver.**

75% ROTENONE DUST—Controls insects on vegetable crops, leaves no poison residue. Standardized at ¾% Rotenone content. For asparagus beetle, bean leaf beetle, leaf hopper, Mexican bean beetle, blister beetle, flea beetle, web worm, cabbage worm, plant lice, thrips, melon worm, striped and spotted cucumber beetle, rose slug, tomato horn worm and other insects. (1 lb. 40c) (5 lbs. \$1.25) (20 lbs. \$4.50), **Postpaid; (50 lb. bag \$8.00), F.O.B. Denver.**

ROCKY MOUNTAIN R-60 DUST—A combination of Lethane, Rotenone and Sulphur. Recommended for the control of many sucking and chewing types of truck crop insects such as pea aphids (and other plant lice), cabbage loopers, leaf hoppers, pea weevils and Mexican bean beetles. (1 lb. 40c) (5 lbs. 85c) (20 lbs. \$3.00), **Postpaid; (50 lb. bag \$6.00), F.O.B. Denver.**

ROCKY MOUNTAIN HOPPER DUST No. 5 (Contains Chlor-dane)—For the control of grasshoppers, alfalfa weevil, lygus bug and other insects. Apply at the rate of 20 lbs. per acre. For the control of grasshoppers, dust on weeds around fence lines, shrubs and flowers in the late evening or early morning while hoppers are quiet will give best control, contacting as many as possible with the dust. When used on fields of alfalfa there is a noted increase in both seed and hay. (1 lb. 45c) (5 lbs. \$1.50) (20 lbs. \$4.00), **Postpaid; (50 lb. bags \$7.00), F.O.B. Denver.**

5% DDT DUST—Effective in controlling a large number of different species of insects pests such as onion and gladiolus thrips, on potatoes—potato beetles, psyllid, flea beetles, leaf hoppers; lygus bugs on alfalfa and sugar beets grown for seed. Can also be used on all types of flowering plants, shrubs and trees. (1 lb. 40c) (5 lbs. \$1.75) (20 lbs. \$3.00), **Postpaid; (50 lb. bags \$5.00), F.O.B. Denver.**

10% DDT DUST—To be used when the 5% dust does not give good control, or hard to kill insects. (1 lb. 50c) (5 lbs. \$2.25) (20 lbs. \$4.00), **Postpaid; (50 lb. bag \$6.50), F.O.B. Denver.**

ROCKY MOUNTAIN 10-10 DUST—Manufactured for greenhouse use for hard-to-kill insects that cannot be controlled with the use of a straight D.D.T. Dust or Pyrocide dust we have combined 10% Dry Pyrocide and 10% DDT. Has been used on white fly and chrysanthemum midge the past season with excellent control. (20 lbs. \$9.50), **Postpaid; (50 lb. bag \$17.50), F.O.B. Denver.**

CRYOLITE CUCUMBER AND MELON DUST—A very effective control against blight and striped cucumber beetle, on cucumbers and melons. Use at the rate of 20 pounds per acre. (1 lb. 35c) (5 lbs. \$1.25) (20 lbs. \$3.50), **Postpaid; (50 lb. bag \$7.50), F.O.B. Denver.**

SULPHUR-COPPER DUST—A combination of Sulphur and Copper to control blight, mildew and rust on peas, potatoes, tomatoes, celery, as well as shrubs and flowering plants. (1 lb. 40c) (5 lbs. \$1.50) (20 lbs. \$3.50), **Postpaid; (50 lb. bag \$5.00), F.O.B. Denver.**

COPPER CELERY DUST—Recommended for the control of early and late fall blight or rust of celery. Dust plants at first sign of blight and dust at intervals of every ten days in order to keep plants thoroughly covered. Copper has a stimulating effect on the growth of the plants resulting in increased yields and higher quality produce. (1 lb. 35c) (5 lbs. \$1.25) (20 lbs. \$3.00), **Postpaid; (50 lb. bag \$4.50), F.O.B. Denver.**

TRANSPLANTONE

Reg. U. S. Pat. Off.

TRANSPLANTONE, the hormone-vitamin powder for stimulating roots in transplanting. TRANSPLANTONE contains the best known chemicals for making roots grow stronger. TRANSPLANTONE helps grow new roots and reduces loss of water so the plant starts growing again in a much shorter time.

USE TRANSPLANTONE IN THE GARDEN

TRANSPLANTONE is used for the transplanting of annuals, perennials and shrubs.

USE ON VEGETABLE PLANTS

When setting out tomatoes, lettuce, celery, peppers, cabbage, cauliflower, sweet potatoes or strawberry plants, the development of new roots can be increased tremendously by watering with TRANSPLANTONE solution.

1/2 oz. packet 25c; 3 oz. can \$1.00; 1 lb. can \$4.00

Full Directions on Package

ROOTONE

Reg. U. S. Pat. Off.

ROOTONE the plant hormone powder for cuttings, seeds, tubers and bulbs.

ROOTONE is easy to use. ROOTONE stimulates the natural tendency for roots to form on slips or cuttings. Rooting takes place in a much shorter time, heavier root systems are formed and fewer cuttings die from disease.

ROOTONE dusted onto gladiolus bulbs, dutch iris, etc., stimulates root growth and is particularly valuable on the smaller size bulbs in getting bloom the first year. It stimulates germination of gladiolus bulblets.

ROOTONE treated grass seed. The ROOTONE treatment gives a much quicker, heavier stand of grass so that you get a much thicker, drought-resisting turf the first season.

By dusting seed with ROOTONE, seedlings grow faster and more uniformly, producing stronger plants and better crops.

1/4 oz. packet 25c; 2 oz. jar \$1.00; 1 lb. can \$5.00

Full Directions on Package



ROSETONE is a proven combination of Hormones and Vitamins.

ROSETONE insures the success of your roses. Soak roots of bushes in ROSETONE before planting. Water your established rose bushes for better growth.

1/2 oz. packet 25c; 3 oz. package \$1.00

Full Directions on Package

QUICK-ROOT

FOR IMPROVING PROPAGATION OF PLANTS FROM CUTTINGS OR SLIPS

Quick-Root*, a Dow development to improve propagation of plants from cuttings or slips, is a powder containing synthetic plant growth substances. Treatment of cuttings or slips with Quick-Root hastens the production of roots, produces more roots per cutting, assures a greater percentage of cuttings that root. This is important to greenhouse operators since successful propagation of this type depends chiefly upon the quality and quantity of new roots. Application is made by dipping stem into Quick-Root. Comes in two types: Quick-Root No. 1 for varieties easy to root and Quick-Root No. 2 for varieties hard to root. Packed in 1/4 and 1-pound cans.

QUICK-ROOT No. 1—For easy to root cuttings and transplanting. (1/4 lb. cans \$1.00) (1 lb. cans \$3.00), Postpaid.

QUICK-ROOT No. 2—For hard to root cuttings. (1/4 lb. cans \$1.75) (1 lb. cans \$4.50), Postpaid.



FRUITONE—The hormone spray for stopping premature drop of fruit, flowers and leaves. When sprayed on flowers or tomatoes and beans it produces better set and larger crop. Prevents premature drop of apples and pears. Postpaid: (2/5 oz. packet 25c) (2 oz. package \$1.00).

DISINFECTANTS

TREAT BEFORE PLANTING WITH



FOR DISEASE PROTECTION

Increase Your Garden Pleasure and Your Farm Profits by Preventing Losses From Plant Diseases

Disinfect all seeds, bulbs and potatoes that are to be planted; increases germination, protects seedlings, produces stronger and more vigorous plants that will produce better crops, reduce dampening-off, prevents seeds from rotting in the ground and controls smut. We suggest that you use the following:

SEMESAN—For Vegetables and Flower Seeds and Bulbs. Price: (1/3 oz. 20c) (2 oz. 60c) (12-oz. can \$2.40) (4 lbs. \$11.00). Not postpaid.

SEMESAN BEL—For Seed Potatoes. Prices: (2 oz. 50c) (lb. \$2.00) (4 lbs. \$6.33). Not postpaid.

SEMESAN JR.—For Field and Sweet Corn Seed. Prices: (1 1/2 oz. 17c) (12 oz. 62c). Not postpaid.

NEW IMPROVED CERESAN—For Wheat, Oats, Barley, Flax, Sorghums and other cereals. Prices: (4 oz. 45c) (lb. \$1.00) (4 lb. can \$3.40) (40 lb. drums \$28.75). Not postpaid.

ARASAN—For Vegetable Seeds, including Lima Beans, Sweet Corn and Peanuts. Prices: (1 oz. 25c) (8 oz. 80c) (5 lbs. \$6.45). Not postpaid.

CERESAN M—For all crop seeds on which New Imp. Ceresan is recommended. May be used as a dust on wheat, oats, barley, rye, sorghums, millets, flax, peas and sugar beets. Recommended as a Slurry on wheat, oats, barley, rye, flax, sorghums. Not postpaid (14 oz. can \$1.00) (3 lb. can \$2.85) (40 lb. drum \$28.75).

Inoculate all Legume Seeds with

NITRAGIN

1898—FIFTY-TWO YEARS OF SERVICE—1950

When ordering, Always state name of seed.

ALFALFA (A)

Sweet, Bur, Hubam Clovers
Size Retail
1 bu. each.....\$.50
2 1/2 bu. each. 1.00

CLOVERS (B)

Red, Alsike, Crimson, White and Ladino.
1 bu. each.....\$.50
2 1/2 bu. each..... 1.00

COMBINATION (AB)

1 bu. each.....\$.50

LESPEDEZA (L)

100 lb. size (Inoculates up to 100 lbs.) ea.....\$.50

PEAS, VETCHES (All Varieties) (C)

100 lb. size (Inoculates up to 100 lbs.) ea.....\$.50

SOYBEANS (S)

Size Retail
2 bu. each\$.30
5 bu. each50
25 bu. (One can).... 2.25
30 bu. (6-5 bu. cans) 2.95

BEANS (D)

Navy, Pinto, Wax, String, Kidney and Great Northern
1 bu. each.....\$.50

PEANUTS, COW PEAS (E)

2 bu. each\$.30
5 bu. each50

GARDEN SIZE—Peas, Beans, Sweet Peas, Lupines, Lima Beans and Edible Soybeans.

Enough for 8 lbs. seed — Retail Price 15c each

HAND SPRAYERS

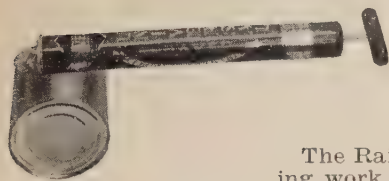

T-26 RAIDER

The Raider is adapted to any spraying work in the home or garden, for shrubbery, vines, poultry house, dairy barn, etc. Will handle insecticides, disinfectants and deodorants. Pump is securely soldered in top of tank. **Postpaid 75c.**

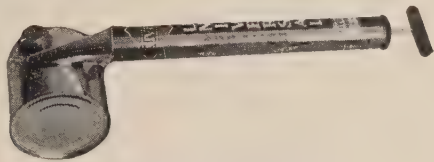

T-32 BOMBER

Quart, all tin continuous sprayer for all-around use. **Postpaid \$1.25.**

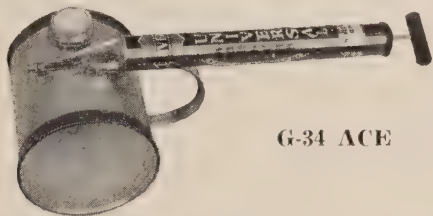

G-34 ACE

3-Quart Continuous Sprayer

This sprayer operates with ease and produces a large volume of spray, the nozzle throws an even spray. Ideal for home owners, farmers and especially for cattle sprays. **Postpaid, \$2.25.**

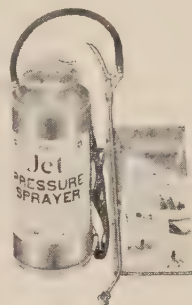

G-20 JET PRESSURE SPRAYER

Just the sprayer for the home gardener. Capacity 2½ gallons, constructed of heavy galvanized steel with attached funnel for easy filling. Brass nozzle with interchangeable discs to produce 4 patterns of spray, 18-inch extension rod and 20-inch spray hose, web carrying strap. **Each \$5.75.**

MOBL PRESSURE SPRAYER

The sprayer with free wheeling action. Constructed of heavy galvanized steel tank with brass and copper fittings, 18-inch extension rod with five-foot spray hose fitted on a rugged all-steel truck with easy rolling rubber tired wheels. **Postpaid, complete \$14.95.**



THE CHAMPION ALL BRASS SPRAYER

For all types of spraying, any kind of insecticide, cold water painting or gasoline and kerosene sprays. A high pressure of 200 lbs. provides a stream from 40 to 50 feet when opened. Adjustable nozzle, from fine mist to stream with no changing of parts. **Each \$27.95, Postpaid.**

COMPRESSED AIR SPRAYERS

UNIVERSAL SPRAY KING—Capacity about 3¼ gallons, 20½ inches high, 7¼ inches in diameter with funnel attached. Equipped with angle nozzle, 22-inch brass extension rod and leakproof release valve. **Galvanized \$8.00, Brass \$13.50, Stainless Steel \$13.50. Postpaid.**

HAND DUSTERS



D-12 AIRLINER DUST GUN—All tin construction with powder compartment 3 inches by 4 inches, pump, 1½ inches by 12 inches long. **Postpaid, 80c.**

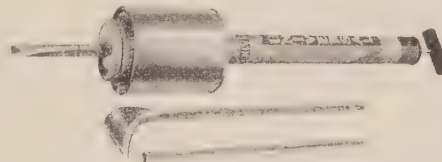

D-14 SHIP DUSTER—A good sized duster for the garden, dairy barn, poultry house. Powder compartment is 4 inches long and 4 inches in diameter, equipped with two 12-inch extensions with one flared and one straight nozzle. **Postpaid \$1.35.**

CHAMPION HAND DUSTER—The pressure created by this hand duster is so great that the operator can stand erect and dust the underside of plant leaves or the top of small trees. The powder cannot escape on the operator. Eight pounds of powder is carried in this five-pound duster. **Postpaid \$10.00.**

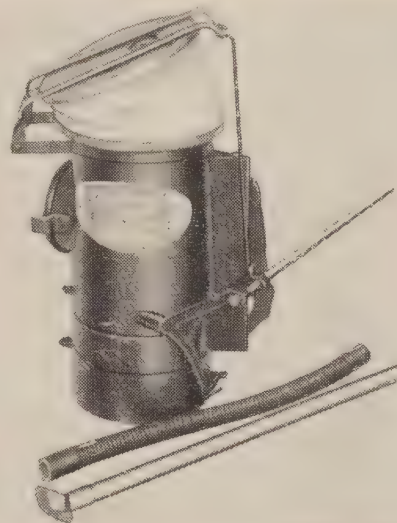

CHAMPION DUSTER (Single Action)—Knapsack type, large, powerful bellows. Easy to operate; will thoroughly crush sulphur and handle all standard dusting materials. May be adjusted for light or heavy application. Capacity, 15 to 20 pounds material. **Postpaid \$27.95.**

ROOT HAND GUN

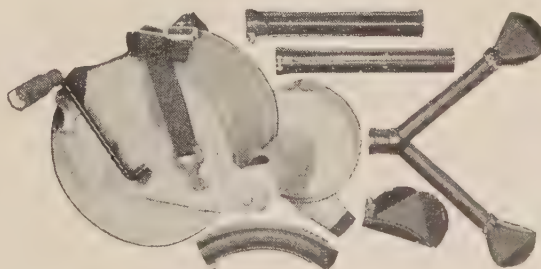

This duster is ideal for controlling insect pests and fungus growth on plants. Will easily care for eight to ten acres per season. A revolving fan designed to handle all dusts efficiently. Gun case permits swinging discharge tube from front to rear of operator. The rate of dust discharge can be adjusted from 1 to 25 pounds per acre. Weighs 12 pounds and hopper will hold 7½ pounds of fluffy dust. Price, complete with "Y" for two row dusting, **postpaid, \$25.00.**

ALL-ELECTRIC • PRECISION-ENGINEERED



HEDGE-KLIP
PORTABLE
HEDGE TRIMMER

National advertised electric hedge clipper. Long, hardened tool steel blades with 14½ inches of cutting length. Quiet motor. Precision machined, far superior to die cast types on the market. Endorsed by Good Housekeeping and Underwriters Laboratories. Complete with 15 feet of heavy rubber coated extension cord, switch and plug. **Postpaid, \$44.50.**

SUNBEAM ELECTRIC HEDGE TRIMMER

The new Sunbeam is the high speed, easiest to handle trimmer built and powered to do this tiring job. 12-inch cutlery steel blade, well balanced. The lightweight (4½ lbs.) Sunbeam is a precision instrument in every detail from the high grade cutlery steel cutter bar to the 110-V. AC-DC power plant inside the handle. None other like it. Equipped with a 10 foot rubber coated extension cord. **Price, postpaid, \$37.50.**

**STOP
FENCE POST
ROT**

with Dow Wood Preservative
a concentrate containing
PENTACHLOROPHENOL



DOW WOOD PRESERVATIVE
(A Pentachlorophenol Concentrate)

For the treating of fence posts and lumber against decay and termite destruction. No objectionable odor or appearance, adds years to the life of fence posts and other wood products, as well as the wood keeping its original strength. It can be self applied with equipment now on the farm. Dilute one gallon of wood preservative to four gallons of light diesel oil, distillate or kerosene. **5-gal. cans, \$12.50, f.o.b. Denver.**



**HOTKAPS—An Individual
Hothouse for Every Plant!**

HOTKAPS are waxed paper cones, easily set out over seed or growing plants. They guard against rain, frost, cold, wind, hail, birds and insects, and maintaining perfect mulch. Growth is forced and yield is increased 10 to 25 per cent. Crops mature 2 to 3 weeks earlier and bring premium prices.

Prices: (1000 lots \$14.65) (5000 lots \$14.50 per 1000) (Home Garden Package—100 Hotkaps and Fibreboard Setter, \$2.75) (Garden Size—25 Hotkaps and Fibreboard Setter, 70c) (Steel Setters, \$1.95 each) (Fibreboard Setters, each 25c), f.o.b. Denver.

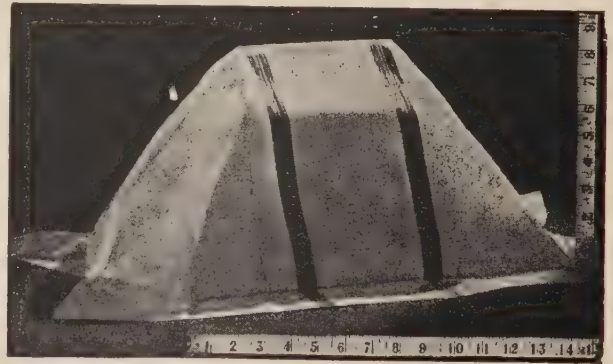

HOTENTS

"THE LARGEST AND STRONGEST PROTECTOR"
552 Cubic Inches of Protected Area

Hotents are designed to protect and force all varieties of plants where a large plant protector is needed. They are made of a paper which is extra strong. It is rot-proof and allows the rays of the sun to penetrate and at the same time retains this heat. Hotents are strong, being supported by two wire bows. All the space within the protector is available for the growing plant. Especially recommended for Melons, Tomatoes, Peppers, etc. Packed 500 to package. Weight 35 lbs.

Price: 1000 for \$27.50, f.o.b. Denver
Hotent Setter, each \$2.50

'TWIST-EMS'



Strong dark green tapes with wire reinforcing that make perfect ties for bunching vegetables, as well as for plants and vines.

7 inch per 1000.....	\$1.35
8 inch per 1000.....	1.50
12 inch per 1000.....	2.25
16 inch per 1000.....	2.80

RAFFIA—For bunching vegetables and tying up plants. In original skeins weighing 1½ to 2½ lbs. Natural color. **60c per lb., postpaid.**

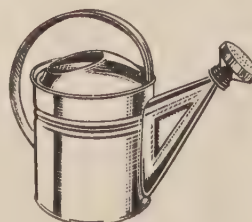

WATERING POTS

Made of heavy galvanized iron, coated with Dura-zinc alloy, guaranteed rustproof and leakproof. Hose nozzle firmly attached with screw joint, so that nozzle is easily removed for cleaning. (6 qt. \$2.00) (8 qt. \$2.25) (10 qt. \$2.60) (12 qt. \$3.00) (16 qt. \$3.25), f.o.b. Denver.

SACK HOLDERS

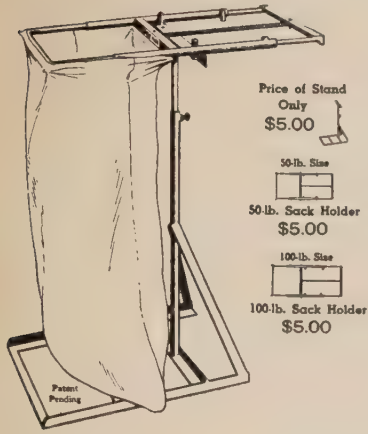

Price of Stand\$5.00
 50-lb. Head..... 5.00
 100-lb. Head..... 5.00

WELD-MADE SACK HOLDER—A special head designed to hold open cloth bags while filling. Self-adjusting to any size bag. Can be attached to scale or truck while working the field, or to a WELD-MADE Stand. Sack holder heads are made in two sizes: **SMALL SIZE**—for onions and other root crops. **LARGE SIZE**—100-lb. Potato Grain Bags.

WELD-MADE SACK HOLDER STAND—Made especially for Sack Holder Heads. Stands adjustable as to height and have metal frame base to keep stand from tipping over.

SACK LIFTERS

PAR SACKLIFTER—Puts handles on a sack. Wherever sacks are moved use "PAR SACKLIFTERS." They are easy to use, merely place them on the end of the sack and lift; a flick of the wrists and the sack is loose. They grip the sack securely but the many points prevent sack damage. Used by nurserymen for Balled Evergreens. The lifters are light-weight, weighing about a pound each, yet have great strength as they are made of stainless steel with durite handles that will not split, chip, warp or corrode. Price \$5.00 per pair, postpaid.



RUBBER COATED FARM BASKETS

For potato harvesting and other farm crops. Heavy rubber coating prevents bruising and damage to crops. Ideal for potato harvesting, handling all types of fruits, vegetables and root crops. Wire construction prevents collection of dirt and debris. Comfortable, easy-grip handles. $\frac{3}{8}$ bushel size, \$3.40 each, postpaid.



BALE HANDLE
 with easy,
 comfortable grip.

RUBBER COATING
 prevents bruising
 of crops.

BASKET SIZE
 13" Top
 11" Bottom
 11" High

CAPACITY
 $\frac{3}{8}$ Bushel.

AEROIL WEED BURNERS

99 TIME AND LABOR SAVING USES

**THAWING
 HEATING
 MELTING
 DRYING**

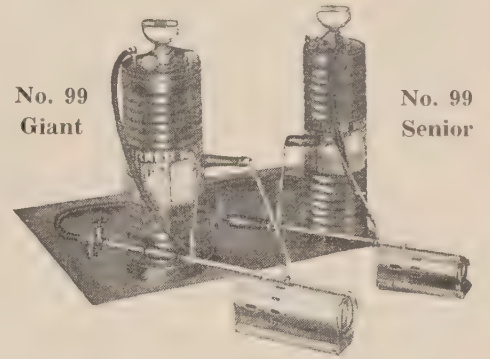

The general specifications of both of the Famous AEROIL SERIES No. 99 KEROSENE TORCHES are the same. They have welded steel fuel tanks tested to 100 lbs. pressure, $1\frac{3}{4}$ -inch all brass air pumps, a 60-lb. pressure gauge, a length of special oil-resisting rubber hose, bronze combination valve-strainer and a seamless steel removable coil kerosene burner. Each carries the AEROIL one-year guarantee against any defects in workmanship or materials. Produce a 2000° F. flame.

No. 99 GIANT—Flame 36"x4". 5-gal. fuel tank. 6-ft. hose. Combination filler cap and air release. Special burner carrying handle. Welded on metal tank handle. Shipping weight 31 lbs. Price complete, \$27.25.

No. 99 SENIOR—Flame 30"x3". 4-gal. fuel tank. 6-ft. hose. Special burner carrying handle. Web adjustable shoulder strap. Shipping weight 21 lbs. Price complete, \$22.00.

No. 99 JUNIOR—Flame 30"x3". 3-gal. fuel tank. 6-ft. hose. Special burner carrying handle. Web adjustable shoulder strap. Weight 17 lbs. Price complete \$17.00.

Aeroil Spray Attachment, \$3.50 each

CYCLONE SEEDER

Can sow fifty acres in a ten-hour day—seeded evenly, thoroughly and easily. Use any seed that can be sown broadcast or with ground bone, ashes or fertilizer. Its distribution will make three bushels do the work of four. The sower that satisfies. Each, \$3.75; postpaid, \$4.00.



MASTER RAPID PLANT SETTER

You can raise a larger, better crop of tomatoes, cabbage, cauliflower, sweet potatoes, tobacco, etc., and do it easier, if you use Master's Rapid Plant Setter.

This machine is a handy tool that positively eliminates all the hard labor of transplanting the plants. It is easy and pleasant to operate and more than three times as fast. A man simply walks along in an upright, comfortable position and will set, water and cover 8,000 to 15,000 plants per day and never has to bend his back at all. Price \$7.50, postpaid.



TRIMALAWN POWER MOWER

MODEL 85-C—21-INCH—1½ H.P.

Cuts up to 3 acres per day

Net Weight
164 pounds
Shipping Weight
193 pounds



Price \$176.50, f.o.b. Denver

EASILY OPERATED BY MAN OR WOMAN, BOY OR GIRL, BECAUSE OF "MAGIC TOUCH" CONTROL AND OTHER UNIQUE FEATURES

TRIMALAWN is essentially a trimming mower because the wheels on both sides are 3 inches inside the overall limits of the cutting blades. The wheels support the overhanging cutting unit when trimming around flower beds, walks, trees, traps on golf courses and tombstones in cemeteries. As Trimalawn cuts to within 1¼ inches of walls and other projections, at least 50 per cent is saved in hand trimming. Operating and upkeep cost is very low.

Trimalawn is precision-built to standards of fine automotive craftsmanship by Reo, one of the best-known names in the automotive field since 1904.

25-INCH TRIMALAWN WITH 1½ H.P. MOTOR

This 25-inch Trimalawn has a capacity up to 4 acres a day. It meets the needs of municipalities, cemeteries, schools, colleges, big estates and all the larger mowing jobs. Has some easy handling and trimming features that make each Trimalawn today's biggest value.

Price \$186.50, f.o.b. Denver

MICHIGAN NOISELESS LAWNMOWER

No. 75-A—For small lawns. Reo Motors have designed the Michigan noiseless Hand Mower, tops in quality, silent, easy to push, simple hand blade adjustment, of all steel construction. 17 inch width of cut, 22½ inch overall width, cuts to within 2¾ in. of obstructions, 5 steel blades, rubber tired. Height of cut can be adjusted from ⅞ inch to 1¼ inch. Weighs 39 lbs. Price, \$29.95, f.o.b. Denver.



Price \$29.95
f.o.b. Denver

Hardie Pumps and Pressure Sprayers

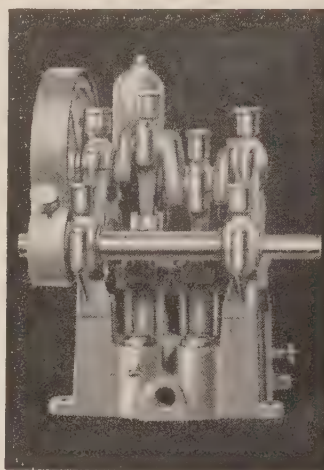

NO. 99 HARDIE PUMP—Here is a light duty high pressure spray pump which is a distinct triumph of spray pump engineering, it embodies every feature of design and construction found in the larger Hardie Pumps. Here is a small powerful pump with all the dependability, quality, durability and economy in operation for which the Hardie Pump has been famous. These pumps deliver 4 gallons per minute at 300 pounds pressure. Price, f.o.b. Denver, \$135.00.

A complete catalog of Hardie Power Sprayers, mailed free on request.

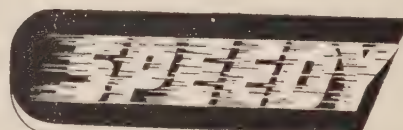

"SPEEDY" WEED KILR

America's Finest All-Purpose Sprayer . . . With New Field Tested Features

SPEEDY SPRAYER offers you a sprayer designed to fit your weed and insect problems—at a price you can afford to pay . . . Designed to "hold up" and take a lot of abuse. Aluminum construction assures rust resistance, lightness and durability.

Simply constructed—easily installed in a few minutes time . . . attachments for ALL tractors.

Hose connections are made from the finest materials obtainable. They are resistant to all types of spraying solutions, including acid and oil content sprays.

Double-action boom hinge is "crash-tested." When striking an object the boom swings with the obstruction, allows it to pass, then returns to normal position.

Fingertip control pressure manifold of the **SPEEDY SPRAYER** is the newest development in agricultural implement engineering. By a mere turn of the handle, it is possible to control all sections of the spraying booms without leaving the seat of the tractor.

Easy-to-clean filter unit is built into the manifold. Manifold pressure gauge assures accurate, controlled spraying pressure at all times. Self-regulating pressure unit assures constant, penetrating spray. Hand boom sprayer for spraying cattle, orchards, poultry houses, etc., is easily attached to the new **SPEEDY SPRAYER** manifold.

Easily adaptable to boom drops for corn borer spraying. Scientifically tested "jet-action" nozzles assure complete spray coverage.

Comes in one packaged unit. NO lost or separate shipments . . . comes ready to attach. 24-foot beam, F.O.B. Denver \$230.00.

SPEEDY HAND BOOMS FOR ALL-PURPOSE SPRAYING

25 ft. length of ⅜-inch Hose with ⅜-inch Couplings.....	\$ 6.20
50 ft. length of ⅜-inch Hose with ⅜-inch Couplings.....	11.30
Hand Boom with Single Swivel Nozzle and OC Tip.....	12.50
Hand Boom with Double Swivel Nozzle and OC Tip.....	16.00

PLASTIC GARDEN HOSE

The new deluxe garden hose; light in weight, attractive, flexible, smooth, easy to use. Comes in red, yellow or green colors. 50 ft. \$8.50, postpaid.

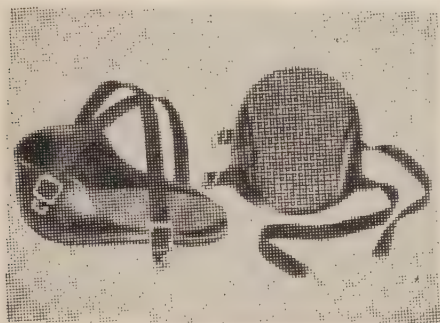
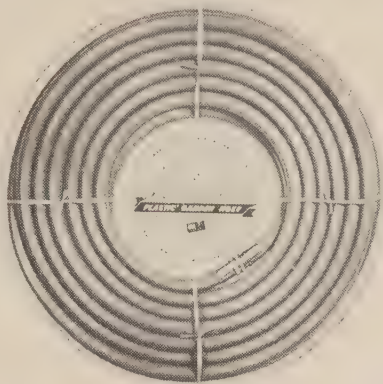

NEEGARDS

Makes kneeling on hard, rough ground or floors easy. They form-fit your knees and stay in place. Postpaid, per pair, \$2.00.

FERTILIZE

While You Water

The Hayes Fertl-Rain Applicator makes it easy to apply the new concentrated liquid fertilizers, or weed killers. Fill the bottle as directed, attach to garden hose, turn on water. Thumb up for clear, aerated water that falls as gentle, beneficial rain.

Thumb down to apply solution in correct proportions for most effective results. Ruggedly built—no moving parts—easy to clean.

The Hayes FERTL-RAIN Fertilizer Applicator Price, Postpaid\$2.45 each



GARDEN HOSE SPRAY GUNS

THE Hayes Jr.

The All-Purpose Spray Gun

Full 3 GALLON capacity sprayer, yet easily held in one hand. Replaces heavy expensive spraying equipment. Just attach the Hayes Jr. to your garden hose, press the lever and SPRAY! Sprays up, down, sideways. For spraying vegetable and flower gardens, trees, etc., with liquid or powder insecticides.



ONLY \$6⁹⁵

THE Hayes-Ette

Ideal Weed Killer Gun (2-4-D)

1½ GALLON sprayer for small gardens, etc. Ideal sprayer to apply the new 2-4-D weed killer solutions. Weighs only a little over a pound filled. Nozzle adjusts to spray up, down, sideways—with all liquid spray materials free from soap.



\$3⁴⁵ ONLY

SUNBEAM RAIN KING

Model "K"

America's only automatic sprinkler, automatically sets distance and type of spray with one setting. A turn of the control button sets the Model "K" for any desired area. Whether set for large or small circles, the spray is always broken up by the speed of the revolving arms to provide a natural rain-like shower that is best for all lawns. Made with bronze bearings and all exposed brass parts are chromium plated. Postpaid, each, \$7.95.

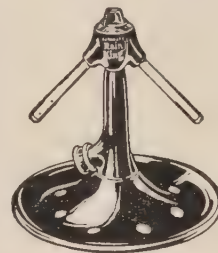

Soft—Dirt Proof—Washable

All leather, dust-proof, soft as kid. Ideal gloves for men or women, made from select, special processd leather. Economical, complete protection. Sizes: Men's Small, Medium and Large; Ladies' Small, Medium and Large. Per pair, \$1.25.

"NATURAIN" IRRIGATOR — FOR LAWNS AND FLOWERS

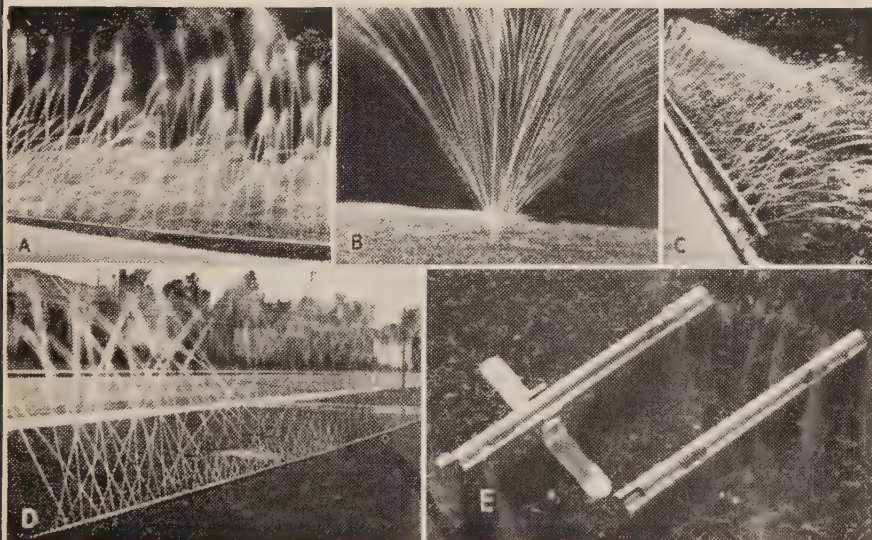

As "right as rain" when nature's showers don't come your way.

A—"Naturain" sprays in any direction. Water goes where you want it—on lawn or garden—not on sidewalk.

B—It waters as nature intended—like a gentle misty shower that soaks in and does not puddle.

C—"Naturain" is the perfect watering device for flowers. It can be controlled at the faucet, to only a few-inch spread, for use on the most fragile plants.

D—It is adaptable. You may use 5, 10 or 30 feet, depending on the area. Even in 30-ft. lengths it gives a 20-ft. spread with normal home pressure.

E-F—It's easy to use—connects without leakage with a twist of the wrist and weighs only 1 lb. per 5-ft. section. Made of durable aluminum and stainless steel—cannot corrode or rust. Gives years of service.

Complete 10-foot Sprinkler—Consisting of 5-ft. primary unit with hose connection, and 5-ft. secondary unit with end-cap. Prepaid, \$5.70.
Extension Units—Additional 5-ft. intermediate units to extend the above. Each, prepaid, \$2.75.

ASPARAGUS KNIFE OR DANDELION DIGGER



Forged from high carbon tool steel, insuring strength, durability and lasting cutting edge. No. 2500—14 inches. Each 60c, Postpaid.

LETTUCE CUTTERS

This tool was developed primarily to meet the demands of the large lettuce growers for harvesting their crops. They will be found very handy around the home garden for gathering any headed vegetables.

Style LCD has offset shank, 8-inch handle, thirteen inches long over all, 3-inch blade. Price \$1.35, postpaid, each.



GARDEN DIBBLES

For Transplanting Plants and Bulbs. All aluminum. Each, \$1.00, Postpaid.



Aluminum Garden Trowels

All aluminum. Price: 75c. Postpaid.



English Grass Hook

Tool steel blade with crucible steel, riveted handle, 32-in. length. Each, \$1.00, postpaid.

Grass Shears

"Ezy-Cut" Special Grass Shears with comfortable shaped handles, fit the hand naturally, with tempered and polished blades. Blades riveted to handle. Each \$1.75, postpaid.

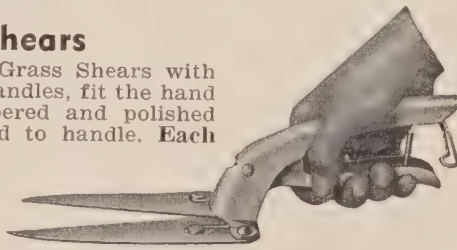

NO. 1575 STAND UP EZY-CUT GRASS SHEARS—The modern grass clipping tool, cuts from a standing position—simple as walking—no stooping, bending, sore knees or backaches. Cutting action operates by simple "squeeze action" on handles which control blades at the bottom of feather-weight steel shaft. Moves on free-running large wheels. Takes apart for cleaning and resharpening. Each \$4.10, postpaid.

V-B GRASSNIPS — A very practical all steel grass shears, with handles designed to fit the hands. The blades are polished on both sides designed of hardened steel. Each, \$1.35 postpaid.

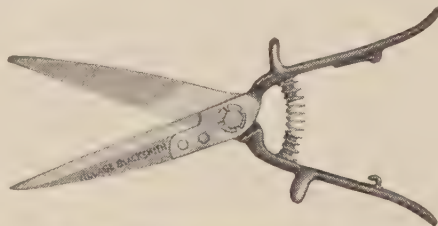

NO. 122 SEYMOUR SMITH "CLIPPER" PRUNER—Strong durable, all-steel construction. Cuts easily, closely and without injuring bark. Black, non-pinching, knurled handles. Polished and tempered blades attached to handles by small bolts. Finger tip catch. 8 inches long. Postpaid, each \$1.65.

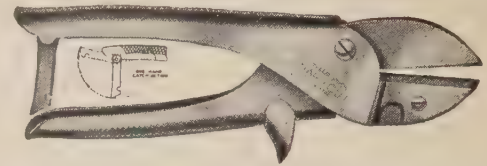
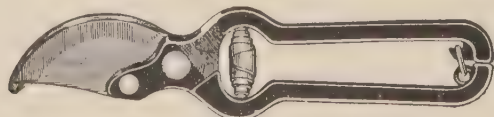

No. 419 "SNAP CUT" PRUNER

The new lightweight, streamlined aluminum alloy body, with super keen "V" blades slices cleanly into a soft metal anvil that does not dull cutting edge. All pruner parts easily replaceable. 8 inches overall length. Postpaid, \$2.50.

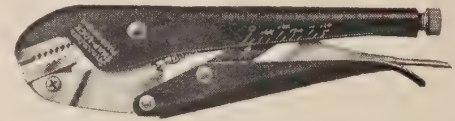

SEYMOUR SMITH "SNAP-LOCK" PLIER-WRENCH

The "Snap-Lock" Plier-Wrench, an improved hand tool for thousands of uses, is made of heavy gauge pressed steel with reserve material where extra wear and strain demand it. The jaws are of hardened tool steel, designed for rugged service. The handles are finished in black enamel with scoring top and bottom for non-slip grip. Jaws are easily replaceable. Entire tool is fully guaranteed against defects in material and workmanship. 10" size, \$2.25; 7" size \$1.75. Postpaid.

No. 45 SEYMOUR SMITH "ROCKDAL" LONG HANDLED PRUNER



Drop forged steel cutting parts, green painted ash handles 22 inches long with long tubular steel ferrules. Cuts 1¼-inch limbs. 27 inches overall length. Postpaid, \$2.75.

No. 4-N EZY CUT HEDGE SHEARS

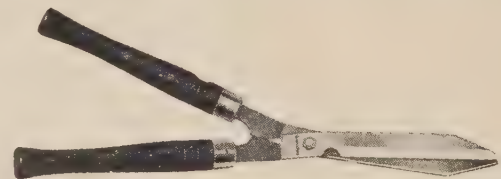

Keen ground and notched special 8-inch blades. Natural wood handles. Postpaid, \$2.00.

No. 14-N EZY CUT HEDGE SHEARS

Oval shaped, hollow ground, 8-inch cutlery steel blades, raised handles with lacquered finish hardwood ash grips. Postpaid, \$2.40.

VILLAGE BLACKSMITH "STANDARD" HEDGE SHEARS

Lacquered hardwood handles with tang burned right into the handle to insure tightness for the lift of the shear. Cutting blade 8 inches long with specially designed notch to hold limb while cutting. Postpaid, \$2.50.

No. 326 IMPROVED MULTI-POWER HEDGE SHEARS

Handles are scientifically pivoted to develop smoother, non-jolting, "Multi-Power" action that results in greater cutting power. Ease of use unbelievably enhanced by soft rubber handle grips, by shock absorbing rubber bumpers between the handles. Shanks are of special heat treated aluminum alloy. The 9½-inch blades, of high grade cutlery steel, are heat treated, fully hollow ground and beautifully polished. Multi-Power is the only hedge shear in which cutting blades can be renewed. Serrated top blade keeps branches from sliding out during action. 21¼-inch length overall. Each, postpaid, \$5.50.

PEST EXTERMINATORS



MOUSE SEED—A saucer and the seed is all you need to rid your place of mice. A natural seed, chemically treated, to appeal to the mouse, yet is fatal to them. Pour a small quantity of the seed into a saucer and place where you find traces of mice, and results will be quickly obtained. They devour the seed eagerly. **Price per pkg., 25c, 5 pkgs., \$1.00, postpaid.**

MOUSE-NOTS—Impregnated seed bait kills mice. **Trial size pkg., 9 Nots, 25c; estate size, 60 Nots, \$1.00.**

RAT-NOTS Kill Rats

RAT-NOTS—Safe way to exterminate rats. Prepared bait, containing Squill. Can be used without fear of harming humans, dogs, live stock, etc. **Trial size pkg. of 9 Nots, 25c;**

NOTT'S ANTU-RAT-PASTE (contains 5% Antu)—Recommended for big, well-fed, hard-to-catch rats which dodge cats and traps, and are finicky in their eating habits due to easy access to tasty-garbage, and feed and food warehouses. "THEIR LAST MEAL." Packaged in handy, convenient tubes. **Price: 1-oz. tubes, 35c; 4-oz. tubes, \$1.00.**

CHEMICAL CAT (20% Antu)—A powder to be mixed with any bait you wish. Usually by mixing your bait three different ways you can get better control, mix with hamburger, grains or with water in mason jar lids. Rats usually die within 10 to 24 hours after eating bait. **1-oz. can, 49c, postpaid.**

SWEENEY'S POISON WHEAT—Sure death to rats, mice, moles and gophers. **1-oz. pkg., 20c; 3½-oz., 35c; 12-oz., 70c, not postpaid.**

KILMICE—(Seed Bait)—A treated, tasty, impregnated seed bait which quickly destroys mice in house and garden. Easy to use—clean, sanitary, no mixing—no traps. **1½-oz. pkg., 15c; 2½-oz. pkg., 25c; 12-oz. pkg., \$1.00, postpaid.**



RAT LUNCHES—A new, scientifically prepared rat exterminator that may be used anywhere, bait wrapped in moisture proof packages in assorted colors. Packed in cellophane bags. **Price: 35 lunches, 50c; 75 lunches, \$1.00, postpaid.**

DEATH TO GOPHERS—Small tablets ready to use. Scatter around holes of prairie dogs, and ground squirrels, put in runways between freshly-made hills of pocket gophers. **Bottle of 50 pellets, 25c; 120 pellets, 50c; 200 pellets, \$1.00; 500 pellets, \$2.00.**

DEATH TO MOLES—Small pellets to be dropped in the Mole runways by using a pointed stick to make several holes along runways and dropping in several pellets. **Bottle of 30 pellets, 25c, postpaid.**

CYANOOGAS (A) DUST—Is a grayish powder that gives off hydro-cyanic-acid gas when exposed to the air. This gas is deadly to rodent and insect pests and will kill them almost immediately. Write us for special circulars giving full information about the use of Cyanogas. **1 lb. 98c, 5 lbs. \$3.75. Cannot be mailed.**

CYANOOGAS ANT KILLER—4 oz. can 39c.



CYANOOGAS (G) FUMIGANT—For greenhouse mushrooms, and soil fumigation. Scatter over the greenhouse walks and close to the house for the night. Generates deadly hydrocyanic acid gas which is very effective in controlling aphids, thrips, white fly and soft scale. **5 lbs. \$3.75, 25 lbs. \$12.50. Cannot be mailed.**

ORTHO RAT BAIT PELLETS—Ready to use Red Squill Bait, poisoned rats seek underground burrows before dying. **2-oz. pkg. 25c, 6-oz. pkg. 50c, postpaid.**

ORTHO RODENT DESTROYER—A strychnine poisoned grain used against rats, mice, squirrels, pocket gophers and prairie dogs. **Postpaid, 6-oz. pkg. 50c.**

LIKWIDATOR RAT AND MOUSE POISON—A liquid exterminator that is very attractive to rodents. Used by placing a small quantity in shallow dishes near their holes. **6-oz. bottle 50c, 16-oz. bottle \$1.00.**

OLD TRAPPER GOPHER KILLER—A ready to use bait treated with strychnine, to rid your grounds of gophers. **2-oz. pkg. 50c, postpaid.**

ANT-X-TRAP—Death to ants in house or garden. This safety type container carries a multi bait attractive to both the sweet and grease eating type ants. This bait kills the ants in the nest. **Price, 25c each, 6 for \$1.25.**



ANT-X-JELLY BAIT—Kills quickly. This jelly controls sweet and grease eating ants. It will also kill ants in the nest. **1 oz. 35c; 4-oz. tube \$1.00.**

SCRAM DOG REPELLENT

A special powder used to keep dogs away from shrubs, flowers, lawns, store fronts, porches, etc.

Easy to use.
Does not harm animals.

8-oz. Shaker.....49c



DOG-CHECK—The ideal repellent as a means of checking doggie habits. Safe and harmless to use. New formula will permit spraying on new growth. Unaffected by rain, one spraying lasts from two to three weeks. **3-oz. size, 60c; 8-oz. size, \$1.00.**



SKREET - CHECK — Repels mosquitoes, Deer Flies, Gnats, Black Flies, and other insects. Excellent for the Sportsmen, Gardeners,

Hikers, and all those who like to enjoy outdoor activities in comfort. **1-oz. tubes, 35c each.**

INDEX

FLOWER SEEDS 26-32
NURSERY STOCK 33-42
LAWN GRASS 43
VEGETABLE SEEDS 1-24
 Artichokes 1
 Asparagus Roots 25
 Asparagus Roots 26
 Beans—Garden 1-2
 Beets—Garden 3
 Beets—Stock or Mangels 3
 Beets—Sugar 3
 Broccoli 4
 Brussels Sprouts 4
 Cabbage 4-5
 Cabbage Plants 25
 Carrots 5-6
 Cauliflower 6
 Cauliflower Plants 25
 Celery 7
 Celery Plants 25
 Chicory 7
 Chive Plants 25
 Corn—Pop 9
 Corn—Sweet 8-9
 Cucumbers 10
 Egg Plant 10
 Egg Plant—Plants 25
 Endive 11
 Garden Roots 25
 Garlic 25
 Herbs 11
 Horse Radish Roots 25
 Kohl-Rabi 11
 Leek 11
 Lettuce 12
 Mushrooms 15
 Muskmelons 13
 Mustard 15
 Okra 16
 Onions 15-16
 Onion Sets 16
 Parsley 16
 Parsnips 16
 Peas—Garden 17-18
 Peanuts 18
 Peppers 18-19
 Pumpkins 19
 Radishes 20
 Rhubarb 20
 Rhubarb Roots 25
 Salsify 21
 Spinach 21
 Squash 22

Swiss Chard 3
 Tomatoes 23-24
 Turnips 24
 Turnip Rutabaga 24
 Vegetable Plants 25
 Watermelon 14

FIELD SEEDS

Alfalfa 45
 Barley 47
 Buckwheat 46
 Clovers 46
 Corn, Hybrid 48
 Corn, Open Pollinated 49
 Flax 46
 Grain Sorghums 49
 Hay and Pasture Grasses 44-45
 Millet 49
 Oats 47
 Rape 46
 Rye 47
 Soy Beans 49
 Speltz 47
 Stock Peas 46
 Sunflowers 46
 Sweet Clover 46
 Vetch 49
 Wheat 47

MISCELLANEOUS

Aeroil Weed Burners 59
 Fertilizers 49
 Garden Hose 61
 Gloves 61
 Hand Sprayers and Dusters 57
 Hand Tools 62
 Hotkaps 58
 Insecticides 52-55
 Lawn Mowers 60
 Naturain Sprinkler 61
 Peat Moss 49
 Plant Hormones 56
 Pest Exterminators 63
 Power Sprayers 60
 Rubber Potato Baskets 59
 Sack Holders 59
 Seed Disinfectants 46, 56
 Seed Inoculants 56
 Sulphur 55
 Weed Killers 51

Wt. In Lbs.	Local	ZONES			
		1-2 Up to 150 miles	3 to 300 miles	4 to 600 miles	5 to 1,000 miles
1	\$0.10	\$0.12	\$0.13	\$0.14	\$0.15
2	.11	.15	.16	.19	.21
3	.12	.17	.19	.23	.27
4	.13	.19	.22	.28	.33
5	.14	.21	.25	.32	.39
6	.15	.23	.28	.37	.45
7	.16	.25	.31	.41	.51
8	.17	.27	.34	.46	.57
9	.18	.29	.37	.50	.63
10	.19	.31	.40	.55	.69
11	.20	.33	.43	.59	.75
12	.21	.35	.46	.63	.80
13	.22	.37	.49	.68	.86
14	.22	.39	.52	.72	.91
15	.23	.41	.54	.76	.97
16	.24	.43	.57	.80	1.02
17	.25	.45	.60	.85	1.08
18	.25	.47	.63	.89	1.13
19	.26	.49	.66	.93	1.19
20	.27	.51	.68	.97	1.24
21	.28	.53	.71	1.02	1.30
22	.28	.55	.74	1.06	1.35
23	.29	.57	.77	1.10	1.41
24	.30	.59	.80	1.14	1.46
25	.31	.61	.82	1.19	1.52
26	.31	.63	.85	1.23	1.57
27	.32	.65	.88	1.27	1.63
28	.33	.67	.91	1.31	1.68
29	.34	.69	.94	1.36	1.74
30	.34	.71	.96	1.40	1.79
31	.35	.73	.99	1.44	1.85
32	.36	.75	1.02	1.48	1.90
33	.37	.77	1.05	1.53	1.96
34	.37	.79	1.08	1.57	2.01
35	.38	.81	1.10	1.61	2.07
36	.39	.83	1.13	1.65	2.12
37	.40	.85	1.16	1.70	2.18
38	.40	.87	1.19	1.74	2.23
39	.41	.89	1.22	1.78	2.29
40	.42	.91	1.24	1.82	2.34
41	.43	.93	1.27	1.87	2.40
42	.43	.95	1.30	1.91	2.45
43	.44	.97	1.33	1.95	2.51
44	.45	.99	1.36	1.99	2.56
45	.46	1.01	1.38	2.04	2.62
46	.46	1.03	1.41	2.08	2.67
47	.47	1.05	1.44	2.12	2.73
48	.48	1.07	1.47	2.16	2.78
49	.49	1.09	1.50	2.21	2.84
50	.49	1.11	1.52	2.25	2.89
51	.50	1.13	1.55	2.29	2.95
52	.51	1.15	1.58	2.33	3.00
53	.52	1.17	1.61	2.38	3.06
54	.52	1.19	1.64	2.42	3.11
55	.53	1.21	1.66	2.46	3.17
56	.54	1.23	1.69	2.50	3.22
57	.55	1.25	1.72	2.55	3.28
58	.55	1.27	1.75	2.59	3.33
59	.56	1.29	1.78	2.63	3.39
60	.57	1.31	1.80	2.67	3.44
61	.58	1.33	1.83	2.72	3.50
62	.58	1.35	1.86	2.76	3.55
63	.59	1.37	1.89	2.80	3.61
64	.60	1.39	1.92	2.84	3.66
65	.61	1.41	1.94	2.89	3.72
66	.61	1.43	1.97	2.93	3.77
67	.62	1.45	2.00	2.97	3.83
68	.63	1.47	2.03	3.01	3.88
69	.64	1.49	2.06	3.06	3.94
70	.64	1.51	2.08	3.10	3.99

PARCEL POST INFORMATION

C.O.D. SHIPMENTS—It is more convenient and less costly to remit with order. The post office charges a collection fee and a fee for the money order for remitting the collection to us.

NO PLANTS OR NURSERY STOCK SENT C.O.D.

PACKAGES weighing not more than 70 lbs. and measuring not more than 100 inches in length plus girth (distance around) at widest point, may be mailed to all zones at the rates shown on the right.

How to Order and Remit — Read Carefully

Use the order sheet enclosed in catalog if possible. Write your name, postoffice shipping point or nearest express office, and state.

Prepaid Orders—We prepay postage on all vegetable and flower seeds, in packets, ounces, quarter pounds and pounds at prices quoted herein, to any point within the fourth postal zone from Denver. We do not prepay postage on Beans, Peas, Corn, Field Seeds, Fertilizers, unless quoted prepaid. If wanted by parcel post, add postage at zone rate.

Remittances should be made by **POSTAL MONEY ORDER, EXPRESS MONEY ORDER, OR CERTIFIED CHECK.** Parties buying large quantities of any one variety will be quoted special prices on application.

ALL prices NET, and while we do not think there will be any serious change, are made subject to market changes and prior sales.



THE ROCKY MOUNTAIN SEED CO. gives no warranty, express of implied, as to the productiveness of any seeds, plants or bulbs it sells and will not be in any way responsible for the crop. Our liability, in all instances, is limited to the purchase price.

THE ROCKY MOUNTAIN SEED CO.

1321-27 FIFTEENTH STREET

DENVER, COLORADO

	Date	AMOUNT ENCLOSED
Name		P. O. Order
Post Office	State	Draft
R.F.D.	Box No.	Express Order
OR		Cash
Street Address		Stamps
Shipping Station		Total
Express or Railroad Company		
How ship? Mail <input type="checkbox"/>	Express <input type="checkbox"/>	
	Freight <input type="checkbox"/>	

All members of one family should order under one name. Please print or write plainly.

Where seeds are quoted postpaid these will be sent charges paid by us to the 4th postal zone from Denver. If you live beyond the 4th zone, add extra postage on all articles priced not postpaid. Be sure to add postage at zone rate.

NOTICE—While we take all possible pains to supply only pure and reliable seeds, WE GIVE NO WARRANTY, expressed or implied, as to the productiveness of any seeds or bulbs we sell and we will not be in any way responsible for the crop. Our liability, in all instances, is limited to the purchase price of the seed. When mentioned, purity and germination tests are for information only and without guarantee.

Quantity	NAME OF ARTICLES WANTED	PRICE	AMOUNT
TOTAL			



STRAWBERRIES

New Minnesota 1166 (Evermore)
The Hardy Everbearer

Extremely hardy, good heavy foliage, vigorous grower, bears big, smooth, delicious, dark red berries, spring, summer and fall.

Postpaid, 25 for \$1.25; 100 for \$4.00



RAINBOW MIXTURE OF GLADIOLUS
12 Bulbs for 75c, Postpaid



MIXED VIOLAS

Each 35c; 3 for 90c, Postpaid



WATCHUNG GIANT DAHLIA
Each 75c, Postpaid

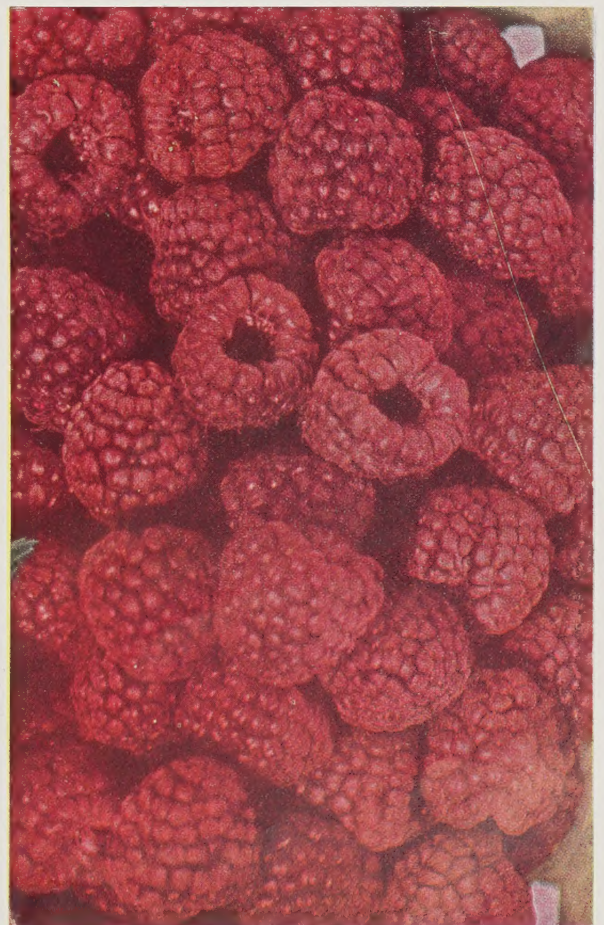

RASPBERRIES, INDIAN SUMMER
6 for 75c; 25 for \$2.50, Postpaid



PEACE (Pat. 591)—Each \$2.00



FORTY-NINER
(Pat. No. 792)

Each
\$2.00

THE ROCKY MOUNTAIN SEED CO.
MAin 6134 1321-27 15th Street, DENVER, COLORADO

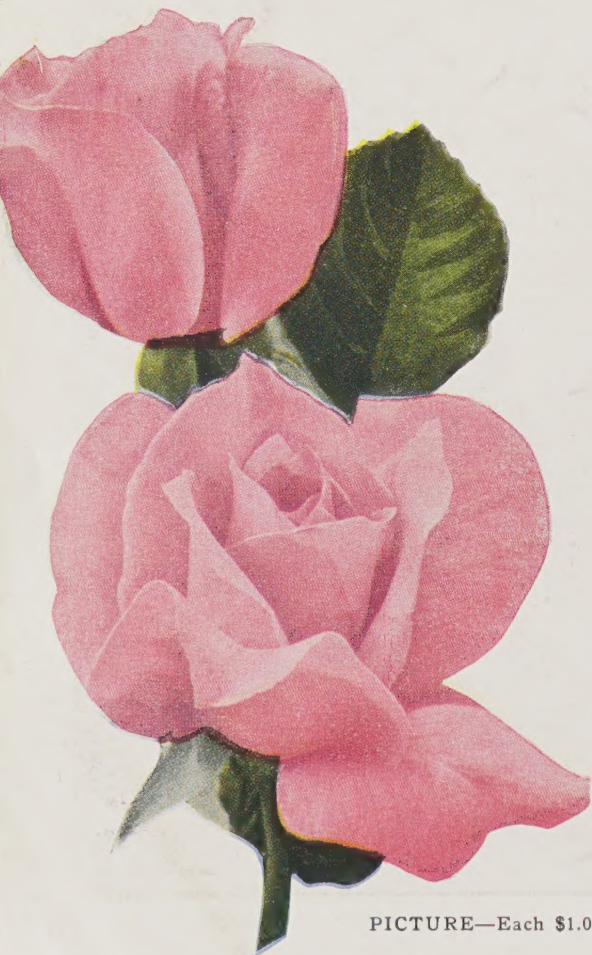

PICTURE—Each \$1.00



CRIMSON GLORY (Pat. 105)
Each \$1.35