

Herbrand
• QUALITY — TOOLS • SINCE 1881

CATALOG NUMBER 66

Herbrand TOOLS, a Division of The Kelsey-Hayes Company, presents Tool Catalog No. 66 covering its standard and special purpose automotive type hand tools. In this catalog, tool groupings have been revised to facilitate the locating of any specific tool.

GUARANTEE

The trade mark HERBRAND or Van-Chrome is your unqualified guarantee against any defect in material or workmanship. Each tool is built to more than meet the requirements of its intended use. Any tool failing in normal use should be returned to your Herbrand distributor. If his inspection reveals defective quality or workmanship, such tool will be repaired or replaced, without charge.

All Herbrand tools are guaranteed as stated above, but this guarantee does not contemplate adjustments upon any tool item which has been subjected to one or more of the following:

ABUSE, improper use; as hand sockets used with an impact gun; use of 'cheaters' producing excessive leverage; hammering upon non-striking face tools.

ALTERATION, as grinding, filing, heating, welding or other modification.

NORMAL 'WEAR-OUT', long use will wear out any tool.

SPECIAL TOOLS

We solicit your inquiries covering requirements for special or custom-built tools. These are built to your order by Herbrand, or one of its affiliates within the Kelsey-Hayes Tool Division. Full information regarding special tools or tool problems may be secured from Herbrand Contract Sales, 17640 Grand River Ave., Detroit, Michigan 48227. Phone 313-835-5131 or TWX 810-243-6410.

Herbrand Tools are built to exacting quality standards in a new manufacturing plant located near Orangeburg, South Carolina.

Herbrand
• QUALITY — TOOLS • SINCE 1881



HERBRAND DISTRIBUTION POLICY

As in the past, Herbrand will continue to recognize and support the traditional system of distribution through Warehouse Distributors and Jobbers. We are proud to number the leaders in these fields among our customers.

HERBRAND SALES REPRESENTATION

Herbrand's Field Representatives and stocking Warehouses are to be found in every trading area. These Warehouses provide tool stocks at convenient, centrally located points. Our Field Representatives offer their prompt attention and full cooperation in meeting your every tool need.

A WORD TO THE TOOL USER

Reasonable precaution and good judgment dictate the use of ordinary safety equipment; goggles, for example, whenever using striking face tools, or any other tool which, by the nature of its application, may become highly stressed.



ALPHABETICAL INDEX

Tool part numbers are shown in this catalog in bold face type, as **S-7**
The corresponding stock number, which may be disregarded at this time, appears as (H-41431).

Adapters, 1/4"-3/8"-1/2"-3/4" Drive	4-6-9-12-13	High Speed Twist Drills	28	Soft Face Hammers	51
Power and Impact	16-17	Hones, Deglazing	43	Sound Detector	42
Adjustable Wrenches	19	Hose Clamp Pliers	27	Spark Plug Sockets	6-9-46
Aligning Bars	25	Hydraulic Lifter Puller	45	Spark Plug Tools	27-39
Allen Hex Keys	7-42	Ignition Pliers	27	Spark Tester	29-46
Alternator Diode Press	36	Ignition & Tune-Up Tools	20-21-46	Starter Wrenches	44
Automatic Transmission Tools	27-47	See also Herbrand Tune-Up Equipment Catalog		Steel Tape Rule	37
Aviation Snips	40	Impact Sockets	17	Steering Wheel Puller	34
Axle Puller	35	Jimmy Bars	25	Stethoscope	42
Ball Joint Removers	47	Lifter—Hydraulic Tappet	45	Stoplight and Oil Pressure Switch Socket	7-48-50
Ball Joint Sockets	47	Lock Ring Pliers	27	Stud Removers	33-41
Ball Pein Hammers	51	Lubrication Tools	48	Tail Pipe Cutters	40
Battery and Terminal Lifter	27-36-46	Magnetic Pickup Tools	42	Tappet Adjusters	45
Battery Pliers	27-46	Main Bearing Seal Tool	44	Thickness Gauges	38-39
Battery Tools	27-36-46	Manifold Wrenches	44	Thread Restorers	41
Bearing Separator—Pullers	33	Metal Cutting Tools	40	Tie-Rod Tools	36-47
Bits, Twist Drill	28	Metric Tools	14-15	Timing Gear Puller	34
Body and Fender Tools	53-54	Midget Box Wrenches	21	Tin Snips	40
Body Hammers	53	Midget Open End Wrenches	20	Tire and Wheel Tools	51-52
Box Wrenches and Sets	21-44	Muffler Cutters	40	Torque Wrenches	18
Brake Cylinder Hone	43-50	Multiscope	42	Truck Rim Tools	52
Brake Drum Speed Nut Tool	49	Multiflex Box Wrenches	21	Tube Cutting and Flaring Tools	37
Brake Pliers	27-50	Needle Nose Pliers	26	Tube Fitting Rethreaders	41
Brake Service Tools	49-50	Obstructo Wrenches	19	Tune-Up Equipment	
Bronze Hammer	51	Offset Screwdrivers	30	See Herbrand Tune-Up Equipment Catalog	
Brushes, Steel Wire	44-46	Oil Filter Tool	48	Tune-Up Tools	20-21-46
Budd Wheel Socket	17	Oil Pressure and Stoplight Switch Socket	7-48-50	Universal Joint Tool	36
Carbon Removing Tools	42-44	Open End Wrenches	20	Upper Main Bearing Seal Tool	44
Carburetor Adjusting Tool	46	Phillips Screwdrivers	5-7-30	Valve Lifters	45
Chevrolet and Corvair Specials	5-46-48-49	Pick-Up Tools, Magnetic	42	Valve (Engine) Tools	45
Chisels and Punches	24-25	Pilot Bearing Puller	32	Vise-Grip Pliers	26
Chrysler Products Specials	10-35-47 to 50	Pipe Wrenches	19	Volkswagen Special Tools	34-48
Clutch Aligning Set	47	Piston Ring Compressor	44	Wheel Pullers	35
Clutch Head Screwdrivers	30	Piston Ring Groove Cleaners	44	Wire Brushes	44
Combination Wrenches	22-23	Pitman Arm Pullers	34-36	Wrenches	
Cutter, Muffler and Pipe	40	Plastic Face Hammers	51	Adjustable	19
Cutter, Tubing	37	Pliers	25-26-27	Allen Hex	7-42
Cylinder Glaze Breakers	43	Point Setting Tools	39-46	Brake	49
Diagonal Cutters	25	Power Sockets	16	Brake Drum Speed Nut	49
Diode Press, Alternator	36	Pry Bars	25	Box	21
Distributor Tools	39-46	Pullers	31 to 34-44	Combination	22-23
Dolly Blocks	54	Punches—Chisels	24-25	Drain Plug	48
Door Handle Tools	54	Putty Knife, Scraper	42	Electrical (Ignition)	20-21
Double Flare Tool	37	Quick Lock Jaw Pullers	31	Engineers	20
Drag Link Sockets	7-10	Ratch-A-Daptors	5-7-10	Filler Plug	7-10-48
Drain Plug Wrenches	48	Ratcheting Box Wrenches	21	Flare Nut	19
Drill Bits and Sets	28	Ratchet Handles	5-7-10-12-13	Flex-Box	21
Electrical Test Equipment, See Herbrand Test Equipment Catalog		Reed and Prince Screwdriver	7	Four Way Wheel	52
Electrical Pliers	25-26-27	Retaining Ring Pliers	27	Half-Moon	44
Engine Service Tools	44-45	Rethreading Tools	41	Hex Fit Combination	22-23
Engineers Wrenches	20	Rim and Tire Tools	51-52	Hex Key	7-42
Extractors, Screw	41	Ring Compressors	44	Ignition	20-21
Extractors, Stud	33-41	Ring Groove Cleaner	44	Impact Socket	17
Feeler Gauges	38-39	Rivet Buster	24	Lug and Wheel	52
File, Distributor Point	46	Rubber Hammers	51	Manifold	44
Filler Plug Wrenches	7-10-48	Rules, Flexible	37	Metric	14-15
Flare Nut Wrenches	19	Scrapers	42	Midget Box	21
Flaring Tools	37	Screw Drivers	5-7-29-30	Midget Open End	20
Flex-Box Wrenches	21	Screw Extractors	41	Obstructo	19
Front End Tools	36-47	Screw Starters	30	Offset	21
Ford Products Specials	7-45 to 49-54	Seal Pullers	32-44	Open End	20
Four Way Rim Wrenches	52	Shock Absorber Tools	36-49	Pipe	19
Gapping Pliers—Spark Plug	39	Slide Hammer Puller	32	Power Socket	16
Gauges, Feeler	38-39	Snap—Gap	39	Ratcheting Box	21
Gear Pullers	31 to 36	Snap Ring Pliers	27	Sockets	4 thru 17
G-M Products Specials	5-46-49-50-54	Snips—Tinner's and Aviation	40	Spark Plug Sockets	6-9-46
Grease Fitting Cleaner	48	Socket Wrenches, Handles and Sets		Starter—Half-Moon	44
Hack Saws and Blades	40	1/4" Drive	4-5	Torque	18
Half-Moon Wrenches	44	3/8" Drive	6-7-8	Truck Rim and Wheel	52
Hammers	51-53	1/2" Drive	9-10-11	Valve Tappet Adjusting	45
Hex-Fit Combination Wrenches	22-23	3/4" Drive	12	Wheel Wrenches	52
Hex Keys	7-42	1" Drive	13	Wedge Separator	36
		Metric	14-15	Zerk Cleaner (Zerk-O-Matic)	48
		Power and Impact	16-17		



M-106 TO M-114

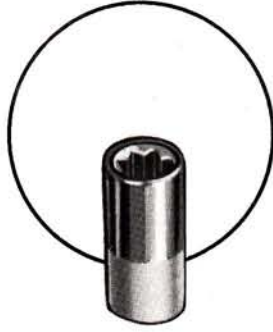

M-808 TO M-812



M-510 TO M-518



A-388, A-389

1/4 INCH SQUARE DRIVE "M" SERIES (MIDGET) SOCKETS

Herbrand Midget Series tools are especially designed for use wherever small, lightweight tools are needed. Built to highest standards from alloy steel, skillfully heat-treated and finished in chrome plate, they represent the ultimate in tool design.

12-POINT REGULAR LENGTH SOCKETS

Part Number	Stock Number	Opening	O.A. Length	Socket End O.D.	Wt. Ea. Lbs.
M-106	(H-31206-01)	3/16	7/8	19/64	.022
M-107	(H-31207-01)	7/32	7/8	11/32	.025
M-108	(H-31208-01)	1/4	7/8	3/8	.025
M-109	(H-31209-01)	9/32	7/8	13/32	.025
M-110	(H-31210-01)	5/16	7/8	29/64	.025
M-111	(H-31211-01)	11/32	7/8	1/2	.028
M-112	(H-31212-01)	3/8	7/8	17/32	.028
M-114	(H-31214-01)	7/16	7/8	5/8	.047

8-POINT REGULAR LENGTH SOCKETS

Part Number	Stock Number	Opening	O.A. Length	Socket End O.D.	Wt. Ea. Lbs.
M-808	(H-31208-08)	1/4	7/8	29/64	.028
M-810	(H-31210-08)	5/16	7/8	9/16	.038
M-812	(H-31212-08)	3/8	7/8	21/32	.055

6-POINT DEEP SOCKETS

M-510	(H-31210-07)	5/16	2	29/64	.062
M-512	(H-31212-07)	3/8	2	17/32	.062
M-514	(H-31214-07)	7/16	2	5/8	.093
M-516	(H-31216-07)	1/2	2	11/16	.124
M-518	(H-31218-07)	9/16	2	3/4	.124

SOCKET ADAPTERS

A-388	(H-41263)	1/4 F to 3/8 M	O.A.L.—15/16"	.034
A-389	(H-41362)	3/8 F to 1/2 M	O.A.L.—1"	.06



1/4 INCH SQUARE DRIVE SOCKET TOOL SETS

NO. MA-52 1/2 (H-83202) 10 TOOLS

6 Regular length sockets, 12 point, 1/4, 9/32, 5/16, 11/32, 3/8, 7/16; 3 Regular length sockets, 8 point, 1/4, 5/16, 3/8; 6" spinner handle, in box B-401 (H-81801).

NO. MA-53 1/2 (H-83203) 15 TOOLS

8 Regular length sockets, 12 point, 3/16, 7/32, 1/4, 9/32, 5/16, 11/32, 3/8, 7/16; 3 Regular length sockets, 8 point, 1/4, 5/16, 3/8; 5" Reversible ratchet, 5" Flex-handle, 2" and 6" extensions, in box B-401 (H-81801).



M-8



M-5



M-13



M-18



M-20



M-21



M-22



M-23



M-35



M-41
M-42
M-43



M-45



M-53
M-54
M-55



M-63
M-64
M-66



M-71

1/4 INCH SQUARE DRIVE "M" SERIES (MIDGET) Handles and Attachments

M-8 RATCH-A-DAPTOR (H-41233)
Converts any 1/4" drive handle into a fully reversible ratcheting tool. 1" O.D., 1 3/8" long O.A. Weight—.150 lbs.

M-5 REVERSIBLE RATCHET (H-41231)
24 tooth action; 5 1/4" long; One hand shift. Weight—.225 lbs.

M-13 FLEXIBLE OFFSET (HINGE) HANDLE (H-21241)
5 1/4" long, Weight—.162 lbs.

M-18 SHORT SPINNER HANDLE (H-41291)
Blue Tenite II grip, Overall length 3 7/8", Weight—.150 lbs.

M-20 SPINNER HANDLE (H-41248)
Blue Tenite II grip, Overall length 6", Weight—.172 lbs.

M-21 SLIDING T HANDLE (H-41244)
4" long, Weight—.088 lbs.

M-22 EXTENSION (H-41206)
6" long, Weight—.138 lbs.

M-23 EXTENSION (H-41202)
2" long, Weight—.050 lbs.

M-35 UNIVERSAL JOINT (H-41290)
O.A. length 1 7/32", Outside diameter 1/2". Weight—.044 lbs.

M-41 PHILLIPS NO. 1 BIT SOCKET (H-41271)
O.A. length 1 5/8", Weight—.031 lbs. Replaceable bit.

M-42 PHILLIPS NO. 2 BIT SOCKET (H-41272)
O.A. length 1 5/8", Weight—.031 lbs. Replaceable bit.

M-43 PHILLIPS NO. 3 BIT SOCKET (H-41273)
O.A. length 1 5/8", Weight—.031 lbs. Replaceable bit.

M-45 PHILLIPS NO. 2 SCREWDRIVER BIT (H-41275)
O.A. length 2", One piece unit, Weight—.040 lbs.

M-53 SLOT SCREWDRIVER (H-41283)
3/16" bit, 3 1/4" long, Weight—.031 lbs. One piece unit.

M-54 SLOT SCREWDRIVER (H-41284)
1/4" bit, 3 1/4" long, Weight—.033 lbs. One piece unit.

M-55 SLOT SCREWDRIVER (H-41285)
5/16" bit, 3 1/4" long, Weight—.036 lbs. One piece unit.

M-63 SLOT SCREWDRIVER (H-41276)
1/8" bit, 1 5/8" long, Weight—.031 lbs. One piece unit.

M-64 SLOT SCREWDRIVER (H-41277)
1/4" bit, 1 5/8" long, Weight—.031 lbs. One piece unit.

M-66 SLOT SCREWDRIVER (H-41278)
3/8" bit, 1 5/8" long, Weight—.031 lbs. One piece unit.

M-71 DISTRIBUTOR POINT SOCKET (H-39230)
Services 6 cyl. Chevrolet distributors. Weight—.030 lbs.

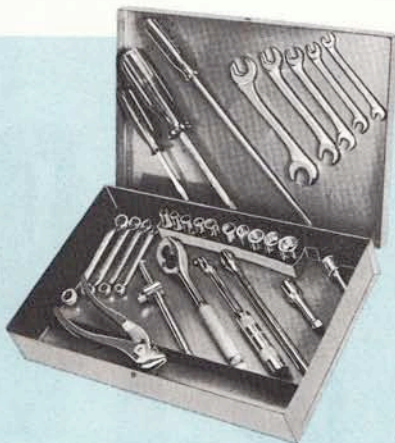

NO. MA-56 1/2 (H-83206) 29 TOOLS

8 Regular length sockets, 12 point, 3/16, 7/32, 1/4, 9/32, 5/16, 11/32, 3/8, 7/16; 2 Regular length sockets, 8 point, 1/4, 5/16; 5" Reversible ratchet, 5" Flex-handle, 6" Spinner, Sliding T handle, 2" and 6" Extensions, #2-Phillips bit; 4 Midget Box wrenches, 3/16 x 13/64, 7/32 x 15/64, 1/4 x 9/32, 5/16 x 11/32; 5 Midget Open ends, 13/64 x 15/64, 7/32 x 1/4, 9/32 x 5/16, 11/32 x 3/8, 7/16 x 1/2; 4 1/2" pliers, 2 Screwdrivers—2" and 3", in box B-402 (H-81802).

3/8 INCH DRIVE "J" SERIES JUNIOR SOCKETS

Small—Slender—Straight—Thin Walled—These new Junior Series sockets are the best of their kind. Hot broached from highest quality alloy steel for extra strength and durability.

6-POINT FLEXIBLE SOCKETS

Spring loaded construction

Number	Stock Number	Opening	O.A. Length	Socket End O.D.	Wt. Ea. Lbs.
J-912	(H-31312-09)	3/8	1 ²³ / ₃₂	1 ¹⁷ / ₃₂	.094
J-914	(H-31314-09)	7/16	1 ²³ / ₃₂	3 ⁹ / ₆₄	.094
J-916	(H-31316-09)	1/2	1 ²³ / ₃₂	1 ¹¹ / ₁₆	.100

12-POINT FLEXIBLE SOCKETS

Spring loaded construction

J-318	(H-31318-09)	9/16	1 ³ / ₄	2 ⁵ / ₃₂	.100
J-320	(H-31320-09)	5/8	1 ³ / ₄	2 ¹ / ₃₂	.103
J-322	(H-31322-09)	1 ¹ / ₁₆	1 ⁷ / ₈	5 ⁹ / ₆₄	.105
J-324	(H-31324-09)	3/4	1 ¹⁵ / ₁₆	1	.105

4-POINT PIPE PLUG SOCKETS

J-509	(H-31309-04)	9/32	1 ¹ / ₈	1/2	.063
J-510	(H-31310-04)	5/16	1 ¹ / ₈	3 ⁵ / ₆₄	.069
J-512	(H-31312-04)	3/8	1 ¹ / ₈	2 ¹ / ₃₂	.069

8-POINT REGULAR LENGTH SOCKETS

J-212	(H-31312-08)	3/8	1 ¹ / ₁₆	4 ¹ / ₆₄	.075
J-214	(H-31314-08)	7/16	1 ¹ / ₁₆	3/4	.093
J-216	(H-31316-08)	1/2	1 ¹ / ₁₆	1 ³ / ₁₆	.100

6-POINT REGULAR LENGTH SOCKETS

J-608	(H-31308-06)	1/4	1	2 ⁵ / ₆₄	.044
J-610	(H-31310-06)	5/16	1	1 ⁵ / ₃₂	.048
J-612	(H-31312-06)	3/8	1	3 ⁵ / ₆₄	.048
J-614	(H-31314-06)	7/16	1	5/8	.050
J-616	(H-31316-06)	1/2	1	1 ¹ / ₁₆	.054
J-618	(H-31318-06)	9/16	1	2 ⁵ / ₃₂	.069
J-620	(H-31320-06)	5/8	1	2 ¹ / ₃₂	.084
J-622	(H-31322-06)	1 ¹ / ₁₆	1	5 ⁹ / ₆₄	.103
J-624	(H-31324-06)	3/4	1 ¹ / ₃₂	1	.109

12-POINT REGULAR LENGTH SOCKETS

J-112	(H-31312-01)	3/8	1	3 ⁵ / ₆₄	.048
J-114	(H-31314-01)	7/16	1	5/8	.050
J-116	(H-31316-01)	1/2	1	1 ¹ / ₁₆	.054
J-118	(H-31318-01)	9/16	1	2 ⁵ / ₃₂	.069
J-120	(H-31320-01)	5/8	1	2 ¹ / ₃₂	.084
J-122	(H-31322-01)	1 ¹ / ₁₆	1	5 ⁹ / ₆₄	.103
J-124	(H-31324-01)	3/4	1 ¹ / ₃₂	1	.109

6-POINT DEEP SOCKETS

J-812	(H-31312-07)	3/8	1 ³ / ₄	3 ⁹ / ₆₄	.063
J-814	(H-31314-07)	7/16	2	5/8	.078
J-816	(H-31316-07)	1/2	2	1 ¹ / ₁₆	.097
J-818	(H-31318-07)	9/16	2	2 ⁵ / ₃₂	.134
J-820	(H-31320-07)	5/8	2 ¹ / ₄	2 ¹ / ₃₂	.192
J-822	(H-31322-07)	1 ¹ / ₁₆	2 ¹ / ₂	5 ⁹ / ₆₄	.222
J-824	(H-31324-07)	3/4	2 ¹ / ₂	1	.263
J-826	(H-31326-07)	1 ³ / ₁₆	2 ¹ / ₂	1 ¹ / ₁₆	.269

12-POINT DEEP SOCKETS

J-414	(H-31314-02)	7/16	2	5/8	.078
J-416	(H-31316-02)	1/2	2	1 ¹ / ₁₆	.097
J-418	(H-31318-02)	9/16	2	2 ⁵ / ₃₂	.134
J-420	(H-31320-02)	5/8	2 ¹ / ₄	2 ¹ / ₃₂	.192
J-422	(H-31322-02)	1 ¹ / ₁₆	2 ¹ / ₂	5 ⁹ / ₆₄	.222
J-424	(H-31324-02)	3/4	2 ¹ / ₂	1	.263

SPARK PLUG HOLDING SOCKETS— 3/8" SQUARE DRIVE

SPJ-26	(H-39326)	1 ³ / ₁₆	2 ¹ / ₂	1 ¹ / ₁₆	.275
SPJ-1426	(H-39330)	1 ³ / ₁₆	3 ¹ / ₂	1 ¹ / ₁₆	.563

SPJ-1426 has built-in reversible ratchet.

Each SPJ socket has neoprene holding insert and 3/4" male drive hex.

SOCKET ADAPTERS

Number	Stock Number	Drive Size		O.A.L.	Wt. Ea. Lbs.
		Female-Male			
A-388	(H-41263)	1/4	3/8	1 ⁵ / ₁₆	.041
A-389	(H-41362)	3/8	1/4	1	.063
A-390	(H-41463)	1/2	3/8	1 ²⁷ / ₆₄	.137
A-391	(H-41364)	3/8	1/2	1 ³ / ₁₆	.162



J-912
TO
J-916



J-318
TO
J-324



J-509
TO
J-512



J-608
TO
J-624



J-212
TO
J-216



J-812
TO
J-826



J-414
TO
J-424



J-112
TO
J-124



A-388
TO
A-391



SPJ-26



SPJ-1426

3/8 INCH SQUARE DRIVE Handles and Attachments

Herbrand "J" Series of Sockets, Handles and Attachments are manufactured from alloy steels and are finished in chrome plate.



J-8A

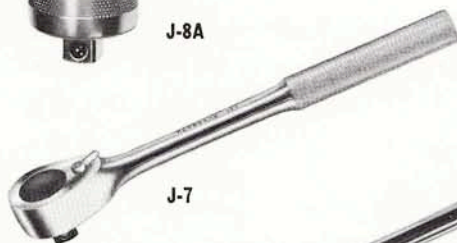

J-7



J-13

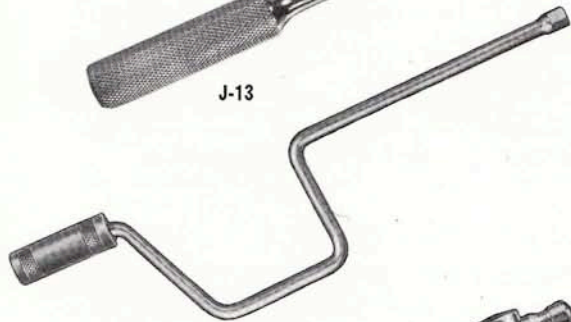

J-17

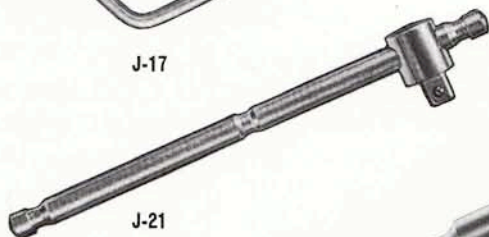

J-21

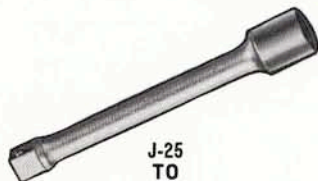

J-25
TO
J-31



J-23



J-35



J-37
J-38



J-39



J-42



J-43



J-45
J-46
J-47



J-48



J-61
TO
J-65

J-7 REVERSIBLE RATCHET (H-41331)
36 tooth action, one hand shift, 7 1/4" long. Weight—.500 lbs.

J-8A RATCH-A-DAPTOR (H-41333)
Provides fully reversible action for any 3/8" drive handle. 30 teeth, O.D. 1 1/16", length 2 1/8". Weight—.325 lbs.

J-13 FLEXIBLE OFFSET (HINGE) HANDLE (H-41341)
8" long. Weight—.294 lbs.

J-17 SPEEDER HANDLE (H-41345)
17" long, swing radius 3 7/16". Weight—1.063 lbs.

J-21 SLIDING T HANDLE (H-41344)
7 7/8" long, head width 3/4", head length 1 17/64". Weight—.325 lbs.

J-23 1 3/4" EXTENSION (H-41302)
Weight—.100 lbs.

J-25 3" EXTENSION (H-41303)
Weight—.147 lbs.

J-27 5" EXTENSION (H-41305)
Weight—.182 lbs.

J-29 12" EXTENSION (H-41312)
Weight—.378 lbs.

J-30 20" EXTENSION (H-41320)
Weight—.531 lbs.

J-31 24" EXTENSION (H-41324)
Weight—.625 lbs.

J-35 UNIVERSAL JOINT (H-41390)
1 57/64" long, outside diameter 23/32". Weight—.106 lbs.

J-37 SLOT SCREWDRIVER (H-41377)
Bit width 1/4", length 2 1/16". Weight—.075 lbs.

J-38 SLOT SCREWDRIVER (H-41378)
Bit width 5/16", length 2 1/16". Weight—.078 lbs.

J-39 DRAG LINK SOCKET (H-39339)
Bit width 11/16", thickness .116", length 1 1/4". Weight—.075 lbs.

J-42 DIFFERENTIAL PLUG SOCKET (H-41387)
3/8" hex. for Ford and Mercury, 3 1/8" long. Weight—.131 lbs.

J-43 2-IN-1 STOP LIGHT SWITCH/OIL PRESSURE SENDING UNIT SOCKET (H-39350)
3 1/8" long. Weight—.375 lbs.

J-45 PHILLIPS NO. 2 BIT SOCKET (H-41372)
2 5/8" long. Weight—.094 lbs.

J-46 PHILLIPS NO. 3 BIT SOCKET (H-41373)
2 5/8" long. Weight—.100 lbs.

J-47 PHILLIPS NO. 4 BIT SOCKET (H-41374)
2 5/8" long. Weight—.100 lbs.

J-48 REED AND PRINCE SCREWDRIVER BIT (H-41375)
1/4" dia., length 2 9/16". Weight—.088 lbs.

HEX BIT SOCKETS, 2 PIECE

Number	Stock Number	Size	Length	Weight Lbs.
J-61	(H-41381)	3/16"	2"	.082
J-62	(H-41382)	7/32"	1 3/16"	.088
J-63	(H-41383)	1/4"	1 3/16"	.100
J-64	(H-41384)	5/16"	1 3/16"	.112
J-65	(H-41385)	3/8"	1 3/16"	.125

3/8" SQUARE DRIVE Tool Sets



JA-60 $\frac{1}{2}$



JA-62 $\frac{1}{2}$

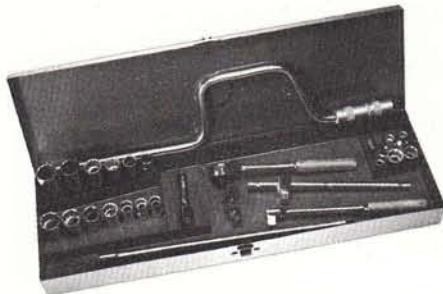

JA-65 $\frac{1}{2}$



JA-51

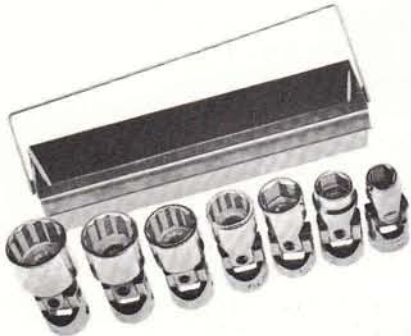

JA-52



JA-53



JA-54

3/8" DRIVE SOCKET SETS

NO. JA-60 $\frac{1}{2}$ (H-83310) 8 TOOLS

7 Regular length sockets, 12 point, 3/8, 7/16, 1/2, 9/16, 5/8, 11/16, 3/4, 8" Flex-handle, in box B-601 (H-81803).

NO. JA-62 $\frac{1}{2}$ (H-83312) 13 TOOLS

7 Regular length sockets, 12 point, 3/8, 7/16, 1/2, 9/16, 5/8, 11/16, 3/4, 7" Reversible ratchet, 8" Flex-handle, 17" Speeder, 5" and 12" Extensions, Universal joint, in box B-602 (H-81804).

NO. JA-65 $\frac{1}{2}$ (H-83315) 27 TOOLS

7 Regular length sockets, 12 point, 3/8, 7/16, 1/2, 9/16, 5/8, 11/16, 3/4; 2—6 point sockets, 1/4, 5/16; 3—8 point sockets, 3/8, 7/16, 1/2; 6 Deep sockets, 12 point, 7/16, 1/2, 9/16, 5/8, 11/16, 3/4; 11/16 Drag link socket, Universal joint, 7" Reversible ratchet, 8" Flex-handle, 17" Speeder, Sliding T handle, 3", 5" and 12" Extensions, in box B-602 (H-81804).

NO. JA-51 (H-83301) 9 TOOLS

9 Regular length sockets, 6 point, 1/4, 5/16, 3/8, 7/16, 1/2, 9/16, 5/8, 11/16, 3/4, in tray B-651 (H-81805).

NO. JA-52 (H-83302) 7 TOOLS

3 flex sockets, 6 point, 3/8, 7/16, 1/2, 4 flex sockets, 12 point, 9/16, 5/8, 11/16, 3/4, in tray B-652 (H-81806).

NO. JA-53 (H-83303) 6 TOOLS

6 Deep sockets, 12 point, 7/16, 1/2, 9/16, 5/8, 11/16, 3/4, in tray B-653 (H-81807).

NO. JA-54 (H-83304) 8 TOOLS

8 Deep sockets, 6 point, 3/8, 7/16, 1/2, 9/16, 5/8, 11/16, 3/4, 13/16, in tray B-654 (H-81808).

1/2 INCH SQUARE DRIVE "S" SERIES (STANDARD) SOCKET and ADAPTERS

12-POINT REGULAR LENGTH SOCKETS

Part Number	Stock Number	Opening	Length	Socket End O.D.	Wt. Ea. Lbs.
S-112	(H-31412-01)	3/8	1 1/2	9/16	.106
S-114	(H-31414-01)	7/16	1 1/2	4 1/64	.113
S-116	(H-31416-01)	1/2	1 1/2	4 7/64	.122
S-118	(H-31418-01)	9/16	1 1/2	1 3/16	.119
S-118V	(H-39441)	9/16		Ford Conn. Rod	
S-119	(H-31419-01)	1 9/32	1 1/2	2 7/32	.125
S-120	(H-31420-01)	5/8	1 1/2	7/8	.125
S-122	(H-31422-01)	1 1/16	1 1/2	3 1/32	.163
S-124	(H-31424-01)	3/4	1 1/2	1 1/32	.181
S-126	(H-31426-01)	1 3/16	1 1/2	1 1/8	.225
S-128	(H-31428-01)	7/8	1 1/2	1 3/16	.244
S-130	(H-31430-01)	1 5/16	1 9/16	1 1/4	.275
S-132	(H-31432-01)	1	1 3/8	1 11/32	.300
S-134	(H-31434-01)	1 1/16	1 3/4	1 7/16	.388
S-136	(H-31436-01)	1 1/8	1 3/4	1 1/2	.397
S-140	(H-31440-01)	1 1/4	1 3/4	1 11/16	.466

8-POINT REGULAR LENGTH SOCKETS

S-212	(H-31412-08)	3/8	1 1/2	1 1/16	.120
S-214	(H-31414-08)	7/16	1 1/2	1 3/16	.141
S-216	(H-31416-08)	1/2	1 1/2	7/8	.125
S-218	(H-31418-08)	9/16	1 1/2	1 1/32	.225
S-220	(H-31420-08)	5/8	1 1/2	1 1/16	.225
S-222	(H-31422-08)	1 1/16	1 1/2	1 3/16	.292

12-POINT FLEXIBLE SOCKETS

S-316	(H-31416-09)	1/2	2 7/32	1 1/16	.212
S-318	(H-31418-09)	9/16	2 7/32	2 5/32	.212
S-320	(H-31420-09)	5/8	2 9/32	7/8	.212
S-322	(H-31422-09)	1 1/16	2 9/32	1 5/16	.244
S-324	(H-31424-09)	3/4	2 11/32	1	.250
S-326	(H-31426-09)	1 3/16	2 11/32	1 1/16	.256

6-POINT REGULAR LENGTH SOCKETS

S-612	(H-31412-06)	3/8	1 1/2	9/16	.106
S-614	(H-31414-06)	7/16	1 1/2	4 1/64	.113
S-616	(H-31416-06)	1/2	1 1/2	4 7/64	.122
S-618	(H-31418-06)	9/16	1 1/2	1 3/16	.119
S-620	(H-31420-06)	5/8	1 1/2	7/8	.125
S-622	(H-31422-06)	1 1/16	1 1/2	3 1/32	.163
S-624	(H-31424-06)	3/4	1 1/2	1 1/32	.181

12-POINT DEEP SOCKETS

DS-16	(H-31416-02)	1/2	3 1/4	4 7/64	.294
DS-18	(H-31418-02)	9/16	3 1/4	5 1/64	.269
DS-20	(H-31420-02)	5/8	3 1/4	7/8	.238
DS-22	(H-31422-02)	1 1/16	3 1/4	1 5/16	.269
DS-24	(H-31424-02)	3/4	3 1/4	1 1/32	.333
DS-26	(H-31426-02)	1 3/16	3 1/4	1 1/16	.350
DS-26S	(H-39427)	1 3/16		Six point thinwall socket.	
DS-28	(H-31428-02)	7/8	3 1/4	1 3/16	.450
DS-30	(H-31430-02)	1 5/16	3 1/4	1 1/4	.500
DS-32	(H-31432-02)	1	3 1/4	1 11/32	.575
DS-36	(H-31436-02)	1 1/8	3 1/4	1 1/2	.750

SPARK PLUG HOLDING SOCKET

SPS-26	(H-39426)	1 3/16	2 1/2	1 1/16	.280
--------	-----------	--------	-------	--------	------

Has neoprene holding insert and 3/4" male drive hex.

SOCKET ADAPTERS

A-390	(H-41463)	1/2 F to 3/8 M	O.A.L. 1 27/64"	.137
A-391	(H-41364)	3/8 F to 1/2 M	O.A.L. 1 31/64"	.163
A-393	(H-41664)	3/4 F to 1/2 M	O.A.L. 1 61/64"	.400
A-394	(H-41466)	1/2 F to 3/4 M	O.A.L. 1 9/8"	.225



S-212
TO
S-222



S-112
TO
S-140



S-316
TO
S-326



S-612
TO
S-624



SPS-26



DS-16
TO
DS-36



A-391
A-394



A-390
A-393

1/2 INCH SQUARE DRIVE Handles and Attachments



S-8A



S-7



S-9



S-13
S-15

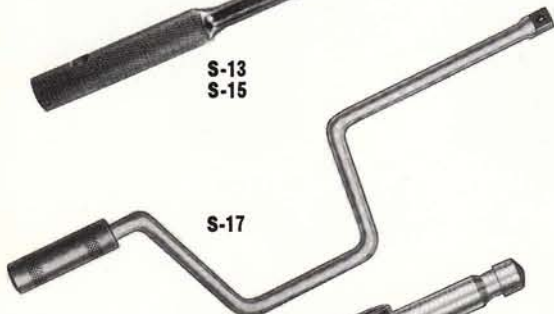

S-17



S-21



S-27
S-28

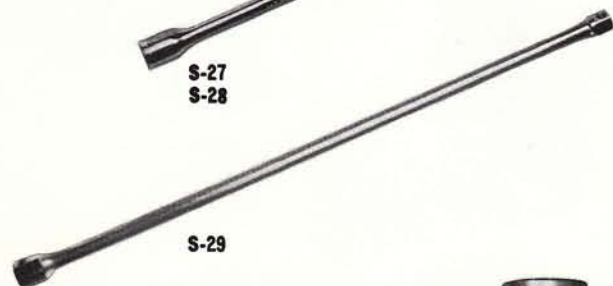

S-29



S-42



S-37
S-39



S-35

Herbrand Handles, Sockets and Attachments bear a reputation of 85 years standing for the finest of quality in all respects. They are of all alloy steel, scientifically heat-treated and finished in durable nickle-chrome plate. The name HERBRAND is your assurance of satisfaction.

S-7 REVERSIBLE RATCHET (H-41431)

36 tooth action, one hand shift, 10" long. Weight—1.25 lbs.

S-8A RATCH-A-DAPTOR (H-41433)

Provides fully reversible action for any 1/2" drive handle. 36 teeth, 2 9/16" long, O.D. 1 5/8". Weight—.688 lbs.

S-9 REVERSIBLE RATCHET (H-41432)

36 tooth action, one hand shift, 15" long. Weight—1.50 lbs.

S-13 FLEXIBLE OFFSET (HINGE) HANDLE (H-41441)

12" long, head width 1". Weight—1.30 lbs.

S-15 FLEXIBLE OFFSET (HINGE) HANDLE (H-41442)

18" long, head width 1". Weight—1.75 lbs.

S-17 SPEEDER HANDLE (H-41445)

17" long, swing radius 3 31/32". Weight—1.33 lbs.

S-21 SLIDING T HANDLE (H-41444)

9 5/8" long, 1 1/8" head O.D., head length 1 37/64". Weight—.82 lbs.

S-27 5" EXTENSION (H-41405)

Weight—.250 lbs.

S-28 10" EXTENSION (H-41410)

Weight—.731 lbs.

S-29 20" EXTENSION (H-41420)

Weight—1.73 lbs.

S-35 UNIVERSAL JOINT (H-41490)

2 3/8" long, 15/16" O.D. Weight—.250 lbs.

S-37 DRAG LINK SOCKET (H-39437)

Bit width 47/64", bit thickness .109", length 1 5/8". Weight—.175 lbs.

S-39 DRAG LINK SOCKET (H-39439)

Bit width 15/16", bit thickness .153", length 1 5/8". Weight—.225 lbs.

S-42 CHRYSLER DIFFERENTIAL FILLER PLUG SOCKET (H-39471)

9/16" male hex. Length 1 1/2", O.D. 7/8". Weight—.137 lbs.

1/2" SQUARE DRIVE "S" SERIES (Standard) SOCKET SETS

DEEP SOCKET SETS

SET NO. DS-6 1/2 (H-83423) 6 TOOLS

12 point Deep Sockets; 3/4, 13/16, 7/8, 15/16, 1", and 1 1/8 in Box B-810 (H-81811).

SET NO. DS-12 1/2 (H-83425) 9 TOOLS

12 point Deep Sockets; 5/8, 11/16, 13/16, 7/8, 15/16, 1" and 1 1/8, Sliding T handle, 5" Extension in Box B-811 (H-81812).

SET NO. DS-11 1/2 (H-83424) 6 TOOLS (Not Shown)

12 point Deep Sockets; 5/8, 11/16, 13/16, 7/8, 15/16 and 1" in Box B-810 (H-81811).

FLEXIBLE SOCKET SET

SET NO. SA-52 (H-83402) 6 TOOLS (Not Shown)

12 point Flex Sockets; 1/2, 9/16, 5/8, 11/16, 3/4 and 13/16 in Tray B-852 (H-81815).

REGULAR LENGTH SOCKET SETS

SET NO. SA-50 (H-83400) 14 TOOLS

12 point Sockets; 3/8, 7/16, 1/2, 9/16, 5/8, 11/16, 3/4, 13/16, 7/8, 15/16, 1", 1 1/16, 1 1/8 and 1 1/4 in Tray B-850 (H-81813).

SET NO. SA-51 (H-83401) 7 TOOLS

6 point Sockets; 3/8, 7/16, 1/2, 9/16, 5/8, 11/16 and 3/4 in Tray B-851 (H-81814).

MASTER SOCKET SETS

SET NO. SB-74 (H-83414) 42 TOOLS

12 point Regular Sockets; 3/8, 7/16, 1/2, 9/16, 19/32, 5/8, 11/16, 3/4, 13/16, 7/8, 15/16, 1", 1 1/16, 1 1/8, and 1 1/4. 8 point Sockets; 3/8, 7/16, 1/2, 9/16 and 5/8. 12 point Flex Sockets; 1/2, 9/16, 5/8, 11/16, 3/4 and 13/16 in Tray. 12 point Deep Sockets; 1/2, 9/16, 5/8, 11/16, 3/4 and 13/16. Adaptor 1/2F to 3/8M, 10" Reversible Ratchet, 12" Flex handle, 17" Speeder, 5" and 10" Extensions, Universal joint, 47/64" and 15/16" Drag link Sockets and Sliding T handle in Hip Roof Box B-902 (H-81818).

SET NO. SB-73 (H-83413) 20 TOOLS

12 point Regular Sockets; 3/8, 7/16, 1/2, 9/16, 19/32, 5/8, 11/16, 3/4, 13/16, 7/8, 15/16, 1", 1 1/16 and 1 1/8. 10" Reversible Ratchet, 18" Flex handle, 17" Speeder and Sliding T handle, 5" and 10" Extensions in Box B-806 (H-81810).

SET NO. SB-71 (H-83411) 10 TOOLS

12 point Regular Sockets; 7/16, 1/2, 9/16, 5/8, 11/16, 3/4, 13/16, 7/8, 15/16, and 12" Flex handle in Box B-801 (H-81809).

POWER SOCKET SETS—1/2" DRIVE

SET NO. PSB-6 (H-83436) 6 TOOLS

6 point Regular Length; 7/16, 1/2, 9/16, 5/8, 11/16 and 3/4 in fibre box.

SET NO. PSB-9 (H-83439) 9 TOOLS

6 point Regular Length; 3/8, 7/16, 1/2, 9/16, 5/8, 11/16, 3/4, 13/16 and 7/8 in Tray B-857 (H-81817).



DS-6 1/2



DS-12 1/2



SA-50



SA-51

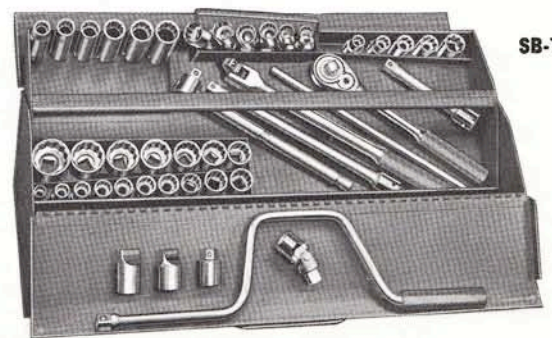

SB-74

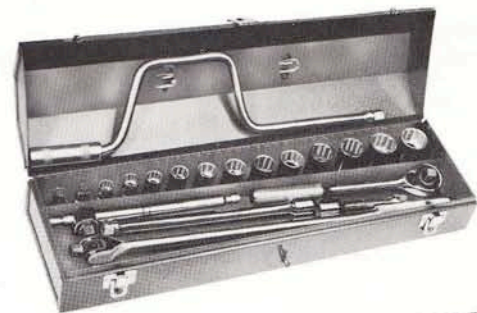

SB-73

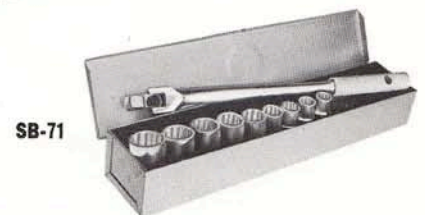

SB-71



PSB-9



PSB-6



H-128 TO H-172



2430



2429



2431



H-25 H-29 H-31



H-21



H-15



H-11

3/4 INCH SQUARE DRIVE "H" SERIES (HEAVY DUTY) Sockets, Handles, Sets

These VAN-CHROME sockets, handles and attachments are outstanding for the rugged strength built into their trim design and unusually light weight. Heads and ends are polished and heavily chrome plated.

H-11 REVERSIBLE RATCHET (H-41631)

One hand push button shift, 30 tooth action, 22" long. Weight—5.375 lbs.

H-15 FLEXIBLE OFFSET (HINGE) HANDLE (H-41641)

20 1/2" long, head width 1 49/64", head thickness 1". Weight—4.312 lbs.

H-21 SLIDING T (H-41644)

Head stops flush with ends of handle, 18" long, head length 2 1/8". Weight—2.625 lbs.

H-25 4" EXTENSION (H-41604)

Weight—.687 lbs.

H-29 8 7/16" EXTENSION (H-41609)

Weight—1.538 lbs.

H-31 17" EXTENSION (H-41617)

Weight—2.655 lbs.

CHRYSLER BALL JOINT SOCKETS—See page 47

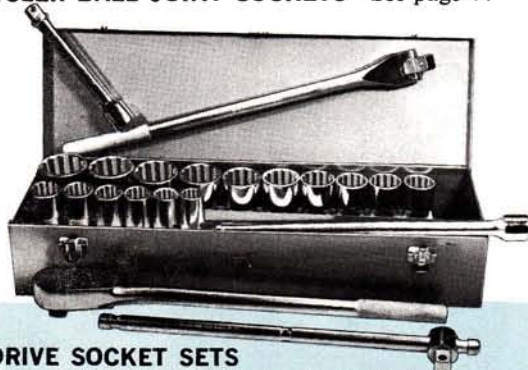

3/4" DRIVE SOCKET SETS

SET NO. HA-82 1/2 (H-83603) 21 TOOLS

Regular Length Sockets, 7/8, 15/16, 1, 1 1/16, 1 1/8, 1 3/16, 1 1/4, 1 5/16, 1 3/8, 1 7/16, 1 1/2, 1 5/8, 1 3/4, 1 13/16, 1 7/8 and 2", Rev. Ratchet, Flex-handle, Sliding T handle and 8" and 16" Extensions, in metal box B-1202 (H-81820).

SET NO. HA-82 (H-83602)

As above, but less metal box.

12-POINT SOCKETS—REGULAR LENGTH

Part Number	Stock Number	Opening	O.A. Length	Socket End O.D.	Wt. Ea. Lbs.
H-128	(H-31628-01)	7/8	2	1 5/16	.400
H-130	(H-31630-01)	15/16	2	1 3/8	.406
H-132	(H-31632-01)	1	2	1 7/16	.459
H-134	(H-31634-01)	1 1/16	2	1 9/16	.600
H-136	(H-31636-01)	1 1/8	2	1 5/8	.669
H-138A	(H-31638-01)	1 3/16	2	1 11/16	.688
H-140	(H-31640-01)	1 1/4	2 3/16	1 25/32	.775
H-142	(H-31642-01)	1 5/16	2 3/16	1 7/8	.900
H-144	(H-31544-01)	1 3/8	2 3/16	1 15/16	.950
H-146	(H-31646-01)	1 7/16	2 3/8	2	1.000
H-148	(H-31648-01)	1 1/2	2 3/8	2 1/16	1.075
H-152	(H-31652-01)	1 5/8	2 3/8	2 1/4	1.369
H-156	(H-31656-01)	1 3/4	2 1/2	2 19/64	1.150
H-158	(H-31658-01)	1 13/16	2 13/16	2 3/8	1.400
H-160	(H-31660-01)	1 7/8	2 7/8	2 15/32	1.463
H-164	(H-31664-01)	2	3	2 19/32	1.531
H-166	(H-31666-01)	2 1/16	3	2 27/32	2.363
H-168	(H-31668-01)	2 1/8	3 1/16	2 27/32	2.200
H-170	(H-31670-01)	2 3/16	3 3/8	3	2.488
H-172	(H-31672-01)	2 1/4	3 3/16	3	2.200

SOCKET ADAPTERS

A-393	(H-41664)	3/4 F to 1/2 M	1 11/64	.400
A-394	(H-41466)	1/2 F to 3/4 M	1 5/8	.230

SET NO. HA-80 1/2 (H-83601) 14 TOOLS

NOT ILLUSTRATED

Regular Length Sockets; 7/8, 15/16, 1, 1 1/16, 1 1/8, 1 3/16, 1 1/4, 1 3/8, 1 7/16, 1 1/2 and 1 5/8; Sliding T handle, 8" and 16". Extensions, in metal box B-1201 (H-81819).

NO. HA-80 (H-83600)

As above, but less metal box.



1 INCH SQUARE DRIVE SOCKETS, Handles and Attachments

1" DRIVE SOCKETS 12 Point Countersunk Openings

L-11 REVERSIBLE RATCHET (H-41831)

30-tooth action permits 12° swing for use in limited space. Exclusive push button reverse. 22" long. Weight each—5.625 lbs.

L-15 FLEXIBLE OFFSET HANDLE (H-41841)

Heavily knurled non-slip handle, 24 1/2" long. Weight each—8.250 lbs.

L-21 SLIDING T HANDLE (H-41844)

23" long. Weight each—6.125 lbs.

L-29 EXTENSION (H-41808)

8" long. Weight each—2.375 lbs.

L-31 EXTENSION (H-41817)

17" long. Weight each—4.375 lbs.

Part Number	Stock Number	Opening	O.A. Length	Socket End O.D.	Wt. Ea. Lbs.
L-46	(H-31846-01)	1 ¹ / ₁₆	2 ¹ / ₂	2	.88
L-48	(H-31848-01)	1 ¹ / ₂	2 ¹⁹ / ₃₂	2 ¹ / ₈	1.19
L-52	(H-31852-01)	1 ⁹ / ₁₆	2 ¹¹ / ₁₆	2 ¹ / ₄	1.25
L-54	(H-31854-01)	1 ¹¹ / ₁₆	2 ²⁵ / ₃₂	2 ³ / ₈	1.62
L-56	(H-31856-01)	1 ³ / ₄	2 ²⁷ / ₃₂	2 ¹ / ₂	1.75
L-58	(H-31858-01)	1 ¹³ / ₁₆	2 ⁷ / ₈	2 ⁹ / ₁₆	1.75
L-60	(H-31860-01)	1 ⁷ / ₈	2 ³¹ / ₃₂	2 ⁵ / ₈	2.19
L-64	(H-31864-01)	2	3 ¹ / ₁₆	2 ³ / ₄	2.31
L-68	(H-31868-01)	2 ¹ / ₈	3 ⁹ / ₃₂	2 ²⁹ / ₃₂	2.38
L-70	(H-31870-01)	2 ³ / ₁₆	3 ¹ / ₈	3	2.75
L-72	(H-31872-01)	2 ¹ / ₄	3 ¹ / ₃₂	3	2.81
L-74	(H-31874-01)	2 ⁹ / ₁₆	3 ⁹ / ₃₂	3 ¹ / ₈	2.88
L-76	(H-31876-01)	2 ³ / ₈	3 ⁵ / ₁₆	3 ⁹ / ₃₂	3.25
L-78	(H-31878-01)	2 ⁷ / ₁₆	3 ³ / ₈	3 ⁵ / ₁₆	3.19
L-80	(H-31880-01)	2 ¹ / ₂	3 ³ / ₈	3 ³ / ₈	3.13
L-82	(H-31882-01)	2 ⁹ / ₁₆	3 ¹⁷ / ₃₂	3 ³ / ₈	3.25
L-84	(H-31884-01)	2 ³ / ₈	3 ¹⁹ / ₃₂	3 ¹⁵ / ₃₂	3.50
L-88	(H-31888-01)	2 ³ / ₄	3 ¹¹ / ₁₆	3 ³ / ₄	4.63
L-94	(H-31894-01)	2 ¹⁵ / ₁₆	3 ³ / ₄	3 ³¹ / ₃₂	5.38
L-96	(H-31896-01)	3	3 ³ / ₄	4 ¹ / ₁₆	5.50
L-100	(H-31899-01)	3 ¹ / ₈	3 ²⁹ / ₃₂	4 ¹ / ₄	6.50

SOCKET ADAPTERS

Part Number	Stock Number	Drive Size	O.A. Length	Wt. Ea. Lbs.
A-388	(H-41263)	1/4 F to 3/8 M	1 ⁵ / ₁₆	.038
A-389	(H-41362)	3/8 F to 1/4 M	1	.063
A-390	(H-41463)	1/2 F to 3/8 M	1 ²⁷ / ₆₄	.138
A-391	(H-41364)	3/8 F to 1/2 M	1 ³¹ / ₆₄	.163
A-393	(H-41664)	3/4 F to 1/2 M	1 ⁶¹ / ₆₄	.400
A-394	(H-41466)	1/2 F to 3/4 M	1 ¹ / ₈	.225

Socket adapters permit the use of a certain drive size socket with handles having a drive square one size larger or smaller than that of the socket. As this arrangement can lead to overloading the tool, adapters are not replaceable for breakage.

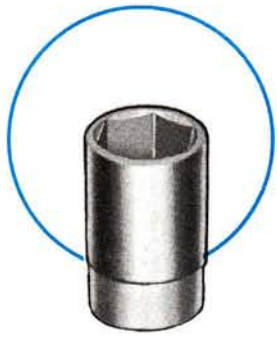

**JM-609
TO
JM-619**

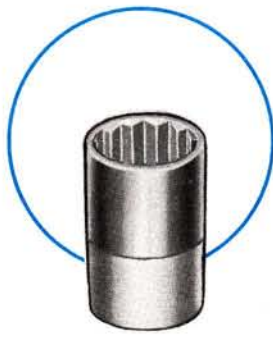

**SM-111
TO
SM-132**



JM-620

METRIC TOOLS . . . 3/8 Inch and 1/2 Inch Drive Sockets and Tool Sets

Metric sizes cover European built equipment other than that built in Great Britain. Metric sockets are hot broached alloy steel, thin wall, chrome plated.

3/8" DRIVE, METRIC 6 POINT REGULAR LENGTH SOCKETS

Part Number	Stock Number	Opening	O.A. Length	Socket End O.D.	Wt. Ea. Lbs.
JM-609	(H-32309-08)	9mm.	1 1/16	17/32	.056
JM-610	(H-32310-08)	10mm.	1 1/16	39/64	.063
JM-611	(H-32311-08)	11mm.	1 1/16	39/64	.063
JM-612	(H-32312-08)	12mm.	1 1/16	11/16	.063
JM-614	(H-32314-08)	14mm.	1 1/16	25/32	.075
JM-617	(H-32317-08)	17mm.	1 1/16	15/16	.100
JM-619	(H-32319-08)	19mm.	1 1/16	1	.112

SET NO. JA-57M (H-83307) NOT ILLUSTRATED

Consists of the 7 sockets listed above.

JM-620 SOCKET AND COMBINATION WRENCH SET (H-83956)

This new set of Herbrand Metric Sockets and Combination Wrenches covers the most popular range of sizes necessary for servicing foreign cars. Drop forged from finest alloy steel. Nickel chrome plated. Wrench heads full polished. Set JM-620 consists of seven 3/8" drive, 6 point sockets and seven combination wrenches. Sockets and combination wrenches carry millimeter openings in sizes; 9, 10, 11, 12, 14, 17 and 19 mm. in metal box B-801M (H-81827).

1/2" DRIVE, METRIC 12 POINT REGULAR LENGTH SOCKETS

Part Number	Stock Number	Opening	O.A. Length	Socket End O.D.	Wt. Ea. Lbs.
SM-111	(H-32411-08)	11mm.	1 3/8	21/32	.100
SM-112	(H-32412-08)	12mm.	1 3/8	23/32	.106
SM-113	(H-32413-08)	13mm.	1 3/8	23/32	.106
SM-114	(H-32414-08)	14mm.	1 7/16	25/32	.113
SM-115	(H-32415-08)	15mm.	1 7/16	53/64	.113
SM-116	(H-32416-08)	16mm.	1 9/16	7/8	.125
SM-117	(H-32417-08)	17mm.	1 1/2	15/16	.150
SM-118	(H-32418-08)	18mm.	1 9/16	1 1/16	.194
SM-119	(H-32419-08)	19mm.	1 9/16	1 1/16	.188
SM-120	(H-32420-08)	20mm.	1 9/16	1 1/8	.213
SM-121	(H-32421-08)	21mm.	1 9/16	1 1/8	.213
SM-122	(H-32422-08)	22mm.	1 7/8	1 3/16	.219
SM-123	(H-32423-08)	23mm.	1 21/32	1 1/4	.244
SM-124	(H-32424-08)	24mm.	1 21/32	1 1/4	.231
SM-125	(H-32425-08)	25mm.	1 23/32	1 3/8	.300
SM-126	(H-32426-08)	26mm.	1 23/32	1 3/8	.275
SM-127	(H-32427-08)	27mm.	1 19/16	1 1/2	.381
SM-128	(H-32428-08)	28mm.	1 13/16	1 1/2	.363
SM-129	(H-32429-08)	29mm.	1 13/16	1 1/16	.375
SM-130	(H-32430-08)	30mm.	1 7/8	1 11/16	.519
SM-132	(H-32432-08)	32mm.	1 7/8	1 11/16	.463

SET NO. SM-133 (H-32433-08) NOT ILLUSTRATED

Consists of the 21 sockets listed above, in metal box B-801M (H-81827).

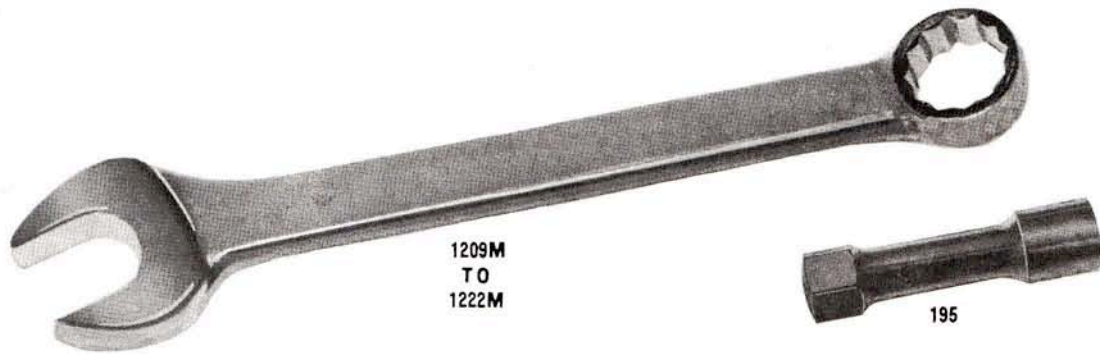

METRIC TOOLS . . . Drain Plug, Metric Combination Wrenches and Set

This new Metric size combination wrench series covers the most used range of sizes for servicing foreign vehicles other than those manufactured in the British Isles. The open end of this wrench has been changed to a 15° angle and the box end is 15° offset. Forged from finest alloy steel, polished, and nickle-chrome plated.

METRIC COMBINATION WRENCHES—6 AND 12 POINT

Part No.	Stock Number	Opening	Head Diameter		O.A. Length	Type Box	Wt. Ea. Lbs.
			Box End	Open End			
1209M	(H-25809)	9mm.	19/32	57/64	4½	6 point	.063
1210M	(H-25810)	10mm.	21/32	29/32	5	6 point	.081
1211M	(H-25811)	11mm.	21/32	29/32	5	6 point	.081
1212M	(H-25812)	12mm.	25/32	11/16	5½	6 point	.119
1214M	(H-25814)	14mm.	27/32	13/16	6	12 point	.131
1217M	(H-25817)	17mm.	11/32	13/8	7	12 point	.225
1219M	(H-25819)	19mm.	11/8	115/32	8¼	12 point	.294
1221M	(H-25821)	21mm.	13/16	111/16	8¾	12 point	.375
1222M	(H-25822)	22mm.	19/32	127/32	10½	12 point	.531

1290-MR METRIC COMBINATION WRENCH SET (H-82029)

This handy set in a vinyl coated fabric tool roll solves the problem of servicing foreign made vehicles other than British. This set consists of seven of Herbrand's new metric combination wrenches.



METRIC COMBINATION WRENCH SET NO. 1290-MR (H-82029)

7 wrenches in vinyl coated fabric roll!

Part No.	Stock Number	Opening	Type Box
1209M	(H-25809)	9mm.	6 point
1210M	(H-25810)	10mm.	6 point
1211M	(H-25811)	11mm.	6 point
1212M	(H-25812)	12mm.	6 point
1214M	(H-25814)	14mm.	12 point
1217M	(H-25817)	17mm.	12 point
1219M	(H-25819)	19mm.	12 point

SET NO. 1290-MB (H-82028)

Set above, less tool roll.



195

195 VOLKSWAGEN FILLER WRENCH (H-29995)

3/8" square drive—17mm. male hex. 3" long. Fits plugs for both differential filler and crank case drain. Bright plated finish. Weight each—.25 lbs.



PJ-612
TO
PJ-614



PJ-616
TO
PJ-620



PA-1216

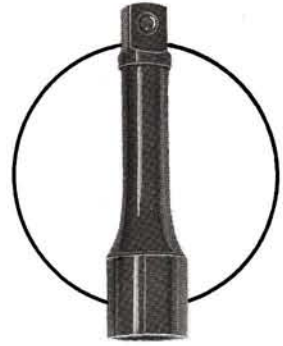

PJ-3
PJ-6

POWER SOCKETS AND ATTACHMENTS

3/8 inch and 1/2 inch Square Drive, 6 Point-Regular and Deep

VAN-CHROME Heavy Duty Power Sockets and attachments are all alloy steel with Black oxide finish.

REGULAR LENGTH—6 POINT—3/8" SQUARE DRIVE

Part Number	Stock Number	Open- ing	Outside Diameter		O.A. Length	Wt. Ea. Lbs.
			Socket End	Drive End		
PJ-612	(H-32312-06)	3/8	35/64	11/16	7/8	.062
PJ-614	(H-32314-06)	7/16	41/64	13/16	7/8	.062
PJ-616	(H-32316-06)	1/2	3/4	3/4	7/8	.070
PJ-618	(H-32318-06)	9/16	51/64	51/64	7/8	.083
PJ-620	(H-32320-06)	5/8	7/8	7/8	7/8	.118

POWER EXTENSIONS

PJ-3	(H-42303)	3" Overall length.	Weight—.13 lbs.
PJ-6	(H-42306)	6" Overall length.	Weight—.25 lbs.

POWER ADAPTERS

PA-1216	(H-42364)	3/8" F to 1/2" M	O.A.L. 1 1/2"	Weight—.20 lbs.
PA-1612	(H-42463)	1/2" F to 3/8" M	O.A.L. 1 1/2"	Weight—.26 lbs.

REGULAR LENGTH—6 POINT—1/2" DRIVE

Part Number	Stock Number	Open- ing	Outside Diameter		O.A. Length	Wt. Ea. Lbs.
			Socket End	Drive End		
PS-612	(H-32412-06)	3/8	39/64	7/8	1 1/2	.160
PS-614	(H-32414-06)	7/16	11/16	7/8	1 1/2	.154
PS-616	(H-32416-06)	1/2	49/64	15/16	1 1/2	.23
PS-618	(H-32418-06)	9/16	55/64	15/16	1 1/2	.25
PS-620	(H-32420-06)	5/8	15/16	1	1 1/2	.23
PS-622	(H-32422-06)	11/16	11/64	11/64	1 1/2	.253
PS-624	(H-32424-06)	3/4	17/64	17/64	1 1/2	.279
PS-626	(H-32426-06)	13/16	13/16	13/16	1 1/2	.305
PS-628	(H-32428-06)	7/8	117/64	117/64	1 1/2	.388
PS-630	(H-32430-06)	15/16	13/8	13/8	1 3/4	.482
PS-632	(H-32432-06)	1	17/16	17/16	1 3/4	.518
PS-634	(H-32434-06)	1 1/16	139/64	139/64	2	.689
PS-636	(H-32436-06)	1 1/8	139/64	139/64	2	.677
PS-638	(H-32438-06)	1 3/16	111/16	111/16	2	.795
PS-640	(H-32440-06)	1 1/4	149/64	149/64	2	.908

DEEP—6 POINT—1/2" DRIVE

PSD-612	(H-32412-07)	3/8	39/64	7/8	3 3/4	.358
PSD-614	(H-32414-07)	7/16	11/16	7/8	3 3/4	.381
PSD-616	(H-32416-07)	1/2	49/64	15/16	3 3/4	.432
PSD-618	(H-32418-07)	9/16	55/64	15/16	3 3/4	.427
PSD-620	(H-32420-07)	5/8	15/16	1	3 3/4	.468
PSD-622	(H-32422-07)	11/16	11/64	11/64	3 3/4	.524
PSD-624	(H-32424-07)	3/4	17/64	17/64	3 3/4	.577
PSD-626	(H-32426-07)	13/16	13/16	13/16	3 3/4	.617
PSD-628	(H-32428-07)	7/8	117/64	117/64	3 3/2	.836
PSD-630	(H-32430-07)	15/16	13/8	13/8	3 1/2	.919
PSD-632	(H-32432-07)	1	17/16	17/16	3 1/2	.965

POWER EXTENSIONS—1/2" DRIVE

PS-5	(H-42404)	5" Overall length.	Weight—.40 lbs.
PS-10	(H-42410)	10" Overall length.	Weight—.91 lbs.



PS-612
TO
PS-620



PS-622
TO
PS-640



PSD-612
TO
PSD-620



PSD-622
TO
PSD-632



PA-1612



PS-5
PS-10

3/4 INCH SQUARE DRIVE IMPACT SOCKETS Regular and Deep Length

VAN-CHROME Impact Sockets and Attachments are produced from alloy steel and designed for use with air or electric impact guns. All impact sockets are hot broached for clean, accurate openings and are finished in Black Oxide. These sockets, extensions and adapter attach to the impact gun drive square by means of a through pin held in place by an O-Ring. Rings and pins are listed below.

IMPACT SOCKETS—REGULAR LENGTH—3/4" DRIVE

Part Number	Stock Number	Opening	Outside Socket End	Dia. Drive End	O.A. Length	Wt. Ea. Lbs.
IH-624	(H-32624-06)	3/4	1 1/4	1 5/8	2 1/4	.903
IH-626	(H-32626-06)	13/16	1 3/8	1 5/8	2 1/4	.923
IH-628	(H-32628-06)	7/8	1 1/2	1 5/8	2 1/4	.993
IH-630	(H-32630-06)	15/16	1 9/16	1 5/8	2 3/8	.850
IH-632	(H-32632-06)	1	1 5/8	1 5/8	2 3/8	.890
IH-634	(H-32634-06)	1 1/16	1 11/16	1 11/16	2 1/2	1.05
IH-636	(H-32636-06)	1 1/8	1 3/4	1 3/4	2 1/2	1.02
IH-638	(H-32638-06)	1 3/16	1 7/8	1 7/8	2 1/2	1.48
IH-640	(H-32640-06)	1 1/4	2	2	2 5/8	1.47
IH-642	(H-32642-06)	1 5/16	2 1/16	2 1/16	2 5/8	1.77
IH-644	(H-32644-06)	1 5/8	2 5/8	2 5/8	2 3/4	1.66
IH-646	(H-32646-06)	1 7/16	2 3/4	2 3/4	2 3/4	2.17
IH-648	(H-32648-06)	1 1/2	2 5/16	2 5/16	2 3/4	2.22

BUDD WHEEL SOCKET—3/4" DRIVE

IH-426	(H-32626-04)	13/16	1 5/8	1 5/8	2 1/4	1.01
--------	--------------	-------	-------	-------	-------	------

IMPACT SOCKETS—DEEP LENGTH—3/4" DRIVE

IHD-624	(H-32624-07)	3/4	1 1/4	1 5/8	3 1/2	1.51
IHD-626	(H-32626-07)	13/16	1 3/8	1 5/8	3 1/2	1.51
IHD-628	(H-32628-07)	7/8	1 1/2	1 5/8	3 1/2	1.46
IHD-630	(H-32630-07)	15/16	1 9/16	1 5/8	3 1/2	1.41
IHD-632	(H-32632-07)	1	1 5/8	1 5/8	3 1/2	1.35
IHD-634	(H-32634-07)	1 1/16	1 11/16	1 11/16	3 1/2	1.42
IHD-636	(H-32636-07)	1 1/8	1 3/4	1 3/4	3 1/2	1.36
IHD-638	(H-32638-07)	1 3/16	1 7/8	1 7/8	3 1/2	1.82
IHD-640	(H-32640-07)	1 1/4	2	2	3 3/4	2.07
IHD-648	(H-32648-07)	1 1/2	2 5/16	2 5/16	3 3/4	2.87

IMPACT ADAPTER—3/4" DRIVE

Part Number	Stock Number	O.D.	O.A. Length	Wt. Ea. Lbs.	
PA-2416	(H-42664)	3/4 F to 1/2 M	1 5/8	2 5/32	.64

IMPACT EXTENSIONS—3/4" DRIVE

IH-4	(H-42604)	1 5/8	3 1/2	1.20
IH-10	(H-42610)	1 5/8	10	3.43

RETAINER PINS AND "O" RINGS (Not Illustrated)

IHP-1044	(H-39044) Pin	For IH-624 thru IH-642,
IHO-1148	(H-39048) Ring	IHD-624 thru IHD-640, IH-4, IH-10 and PA-2416.
IHP-1060	(H-39060) Pin	For IH-644 thru IH-648 and
IHO-1164	(H-39064) Ring	IHD-648.



IH-426



IH-624
TO
IH-630



IH-632
TO
IH-648



PA-2416



IHD-624
TO
IHD-630



IHD-632
TO
IHD-648

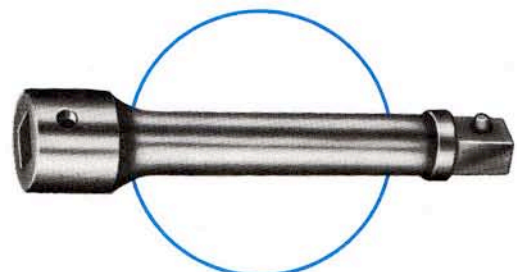

IH-4 IH-10

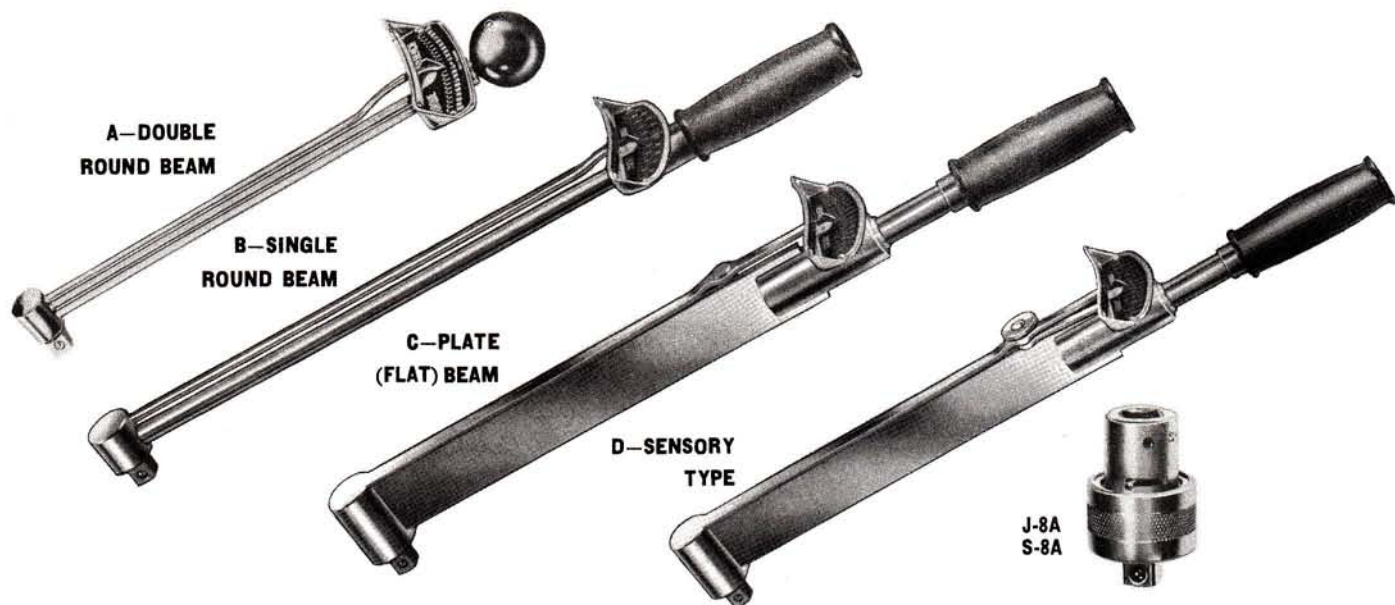

TORQUE WRENCHES

The Herbrand type torque wrench is by actual test, the most consistently accurate on the market. It is rugged—carry it in your tool box. Available in both Foot/Pound and Inch/Pound scales with visual or sensory reading as shown in the chart.

Full ratcheting action may be given to your torque wrench by attaching to it a HERBRAND Ratch-A-Daptor (J-8A, 3/8" drive or S-8A, 1/2" drive). Torque readings are not affected by the Ratch-A-Daptor.

Only the more popular Torque Wrench sizes and Types are listed here. Others, including METRIC are available upon special order.

INCH-POUND TORQUE WRENCHES

Torque Capacity In./Lbs.	Drive Sq.	Part Number	Stock Number	Graduations in./Lbs.	O.A. Length	Wt. Ea. Lbs.
A—DOUBLE ROUND BEAM						
0-50	3/8"	DJ-501	(H-28002-03)	2 1/2	9 5/16	.75
0-100	3/8"	DJ-1001	(H-28012-03)	5	10 1/8	.75
0-200	3/8"	DJ-2001	(H-28022-03)	10	11 1/8	.75
0-300	3/8"	DJ-3001	(H-28032-03)	12 1/2	14 3/8	1.25
Series "DJ" Double Round Beam, visual reading only.						
B—SINGLE ROUND BEAM						
0-600	1/2"	S-6001	(H-28054)	25	15 11/16	1.25
0-1200	1/2"	S-12001	(H-28104)	50	19 3/16	2.00
0-1800	1/2"	S-18001	(H-28154)	50	19 3/16	2.13
0-2400	1/2"	S-24001	(H-28204)	100	21 3/4	2.50
Series "S" Single Round Beam, visual reading only.						
C—PLATE (FLAT) BEAM						
0-300	1/2"	FS-3001	(H-28024-01)	12 1/2	16	2.75
0-600	1/2"	FS-6001	(H-28054-01)	25	16	2.75
Series "FS" Plate (Flat) Beam, visual reading only.						
D—SENSORY TYPE						
0-300	1/2"	FSS-3001	(H-28024-02)	12 1/2	16	2.75
0-600	1/2"	FSS-6001	(H-28054-02)	25	16	2.75
0-1200	1/2"	FSS-12001	(H-28104-02)	50	17 1/2	2.75
0-1800	1/2"	FSS-18001	(H-28154-02)	50	20 9/16	3.75
Series "FSS" Sensory Type—when desired torque is reached, signal is made by Sound and Feel, plus visual reading.						

FOOT-POUND TORQUE WRENCHES

Torque Capacity Ft./Lbs.	Drive Sq.	Part Number	Stock Number	Graduations Ft./Lbs.	O.A. Length	Wt. Ea. Lbs.
C—PLATE (FLAT) BEAM						
0-25	3/8"	FJ-25	(H-28021-01)	1	16	2.75
0-50	1/2"	FS-50	(H-28053-01)	2 1/2	16	2.75
0-100	1/2"	FS-100	(H-28103-01)	5	17 1/2	2.75
0-150	1/2"	FS-150	(H-28153-01)	5	20 9/16	3.75
0-200	1/2"	FS-200	(H-28203-01)	5	28 1/2	7.75
0-300	3/4"	FH-300	(H-28305-01)	10	34 1/4	10.75
Series "FJ," "FS" and "FH" are Plate (Flat) Beam, visual reading only.						
B—SINGLE ROUND BEAM						
0-50	1/2"	S-50	(H-28053)	2 1/2	15 11/16	1.25
0-100	1/2"	S-55	(H-28103)	5	19 3/16	2.00
0-150	1/2"	S-56	(H-28153)	5	19 3/16	2.13
0-200	1/2"	S-57	(H-28203)	10	21 3/4	2.50
Series "S" are Single Round Beam, visual reading only.						
D—SENSORY TYPE						
0-25	3/8"	FJS-25	(H-28021-02)	1	16	2.75
0-50	1/2"	FSS-50	(H-28053-02)	2 1/2	16	2.75
0-100	1/2"	FSS-100	(H-28103-02)	5	17 1/2	2.75
0-150	1/2"	FSS-150	(H-28153-02)	5	20 9/16	3.75
0-200	1/2"	FSS-200	(H-28203-02)	5	28 3/8	7.75
0-300	3/4"	FHS-300	(H-28305-02)	10	34 1/4	10.75
0-600	3/4"	FHS-600	(H-28605-02)	25	60	17.00
Series "FJS," "FSS" and "FHS" are Sensory Type, when desired torque is reached, signal is made by Sound and Feel, plus visual reading.						

RATCH-A-DAPTORS

J-8A (H-41333)

Reversible 30 tooth action, O.D. 1 1/16", 2 1/8" long, 3/8" Drive. Weight each—.325 lbs.

S-8A (H-41433)

Reversible 36 tooth action, O.D. 1 5/8", 2 9/16" long, 1/2" Drive. Weight each—.688 lbs.

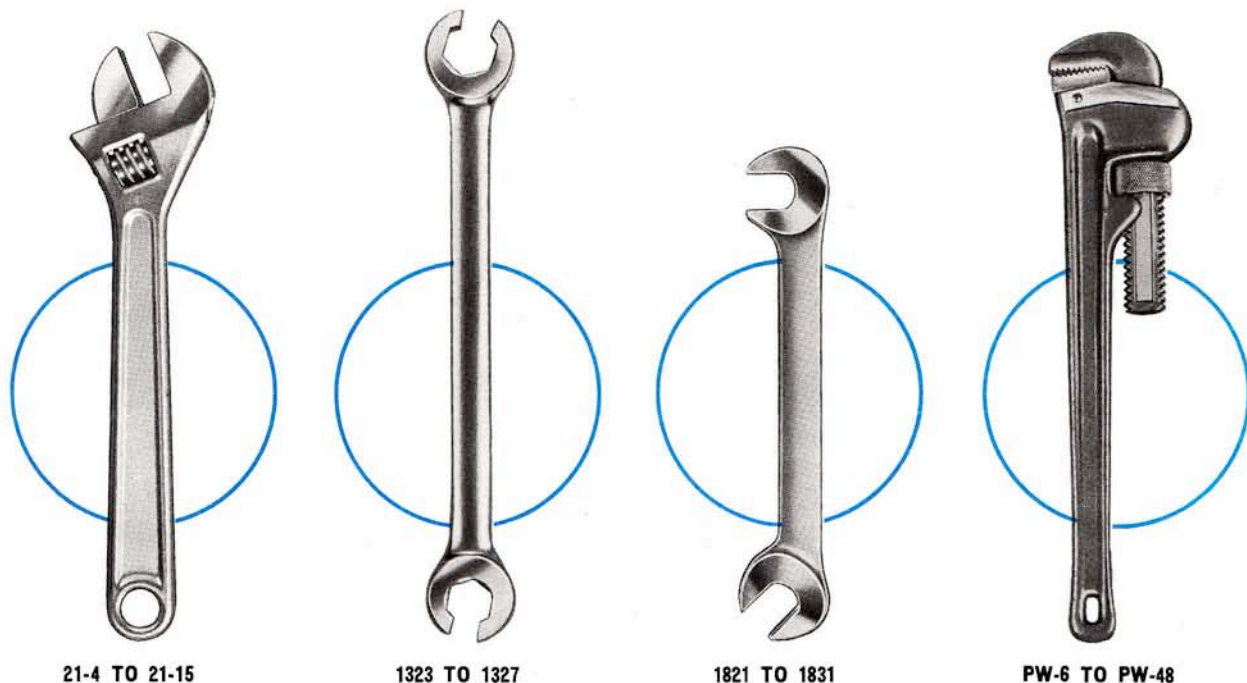

OPEN END WRENCHES . . .

ADJUSTABLE-FLARE NUT-OBSTRUCTO-PIPE

22½° OFFSET— ADJUSTABLE

Extra thin tapered jaws permit use where ordinary adjustables will not fit. Full alloy steel forging with special hardening operations. Withstands most rigorous break test. No finer adjustables made. Chrome plated, heads polished.

ADJUSTABLE WRENCHES

Part Number	Stock Number	Capacity in.	Head Thickness		O.A. Length	Wt. Ea. Lbs.
			Jaw Tip	Max.		
21-4	(H-21041)	½	⅛	⅝	4	.100
21-6	(H-21061)	¾	⅜	⅝	6	.256
21-8	(H-21081)	1⅛	⅝	1⅝	8	.475
21-10	(H-21101)	1½	⅞	1⅞	10	.875
21-12	(H-21121)	1⅞	1⅞	1⅞	12	1.46
21-15	(H-21151)	2¼	1⅞	2⅞	15	2.90

OBSTRUCTO WRENCHES

Openings are set at 45° and 90° angles to reach hexes that are inaccessible to 15° wrenches. Forged, alloy steel, chrome plated, polished heads.

Part Number	Stock Number	Openings	Head Thickness	O.A. Length	Wt. Ea. Lbs.
1821	(H-22221)	⅜	1⅞	5½	.09
1823	(H-22223)	7/16	1⅞	5½	.09
1825	(H-22225)	½	1⅞	6½	.16
1827	(H-22227)	9/16	1⅞	6½	.18
1829	(H-22229)	5/8	1⅞	7½	.24
1831	(H-22231)	¾	1⅞	7¼	.28



1836R OBSTRUCTO WRENCH SET (H-82055) 6 TOOLS

Consists of the six wrenches listed above, in tool roll K-1836 (H-87012).

NO. 1836B (H-82054)
Same tools less roll.

DOUBLE END FLARE NUT WRENCHES

6 point openings at 15° angle for maximum utility on fuel, oil and hydraulic line fittings. Especially designed with chamfered openings and high clearance heads for ease of use. Alloy steel, full polished and chrome plated.

Part Number	Stock Number	Size Openings	Head O.D.	O.A. Length	Wt. Ea. Lbs.
1323	(H-22303)	⅜ x 7/16	23/32 x 27/32	4 11/16	.106
1325	(H-22305)	½ x 9/16	7/8 x 15/16	6 5/16	.150
1327	(H-22307)	5/8 x 11/16	1 3/64 x 1 1/32	7 5/16	.268

FLARE NUT WRENCH SET (3 TOOLS)



NO. 1320R (H-82041)

in vinyl roll.

Consists of 1 each, 3/8 x 7/16, 1/2 x 9/16, 5/8 x 11/16, in roll No. K1320 (H-87009).

NO. 1320B (H-82040)

same tools, less roll.

HEAVY DUTY PIPE WRENCHES

All alloy construction with I-Beam handles and drop forged replaceable jaws. Hold perfectly under hardest pull but release easily. Meet government specifications for heavy duty type wrenches.

Part Number	Stock Number	Jaw Capacity	O.A. Length	Wt. Ea. Lbs.
PW-6	(H-21206)	¾	6	.500
PW-8	(H-21208)	1	8	.750
PW-10	(H-21210)	1½	10	1.750
PW-12	(H-21212)	2	12	2.750
PW-14	(H-21214)	2	14	3.500
PW-18	(H-21218)	2½	18	5.250
PW-24	(H-21224)	3	24	8.750
PW-36	(H-21236)	4½	36	18.50
PW-48	(H-21248)	6	48	33.50

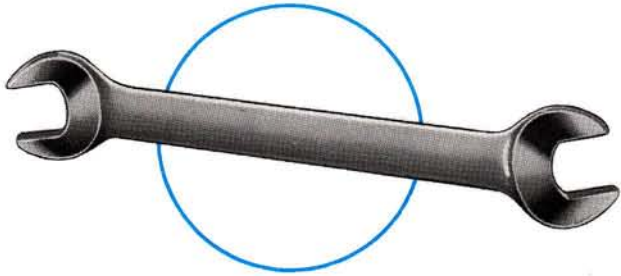

1021S TO 1036B

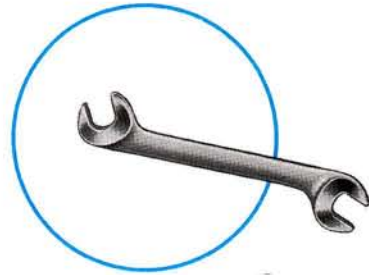

81 TO 89

OPEN END WRENCHES

Engineers, Midget (Ignition) and Tool Sets

ENGINEERS' WRENCHES

ENGINEERS' OPEN END WRENCHES

Forged alloy steel, accurately sized, 15° openings. Chrome plated, polished heads.

Part Number	Stock Number	Openings	Thickness Heads	O.A. Length	Wt. Ea. Lbs.
1021S	(H-22103)	1/4 x 5/16	5/32	3 1/2	.044
1721	(H-22107)	5/16 x 3/8	3/16	4 1/2	.056
1723	(H-22109)	3/8 x 7/16	7/32	5	.100
1725	(H-22113)	7/16 x 1/2	7/32	5 3/4	.119
1725B	(H-22117)	1/2 x 9/16	15/64	6 1/4	.169
1727	(H-22119)	9/16 x 5/8	17/64	6 3/4	.213
1027B	(H-22125)	5/8 x 11/16	9/32	7 1/2	.275
1729	(H-22127)	5/8 x 3/4	19/64	7 3/4	.319
1731	(H-22131)	3/4 x 13/16	11/32	9	.456
1731A	(H-22133)	3/4 x 7/8	11/32	9	.456
1033A	(H-22137)	7/8 x 1 5/16	3/8	10 1/4	.725
1733	(H-22139)	7/8 x 1	3/8	10 1/4	.688
1033C	(H-22141)	1 5/16 x 1	13/32	11	.863
1034A	(H-22143)	1 5/16 x 1 1/16	13/32	11	.856
1735	(H-22145)	1 x 1 1/8	15/32	12 1/2	1.263
1036B	(H-22147)	1 1/16 x 1 1/8	7/16	12 5/8	1.019
1037	(H-22149)	1 1/16 x 1 1/4	15/32	12 1/2	1.231
1737	(H-22151)	1 1/8 x 1 1/4	1/2	12 3/4	1.525
1039B	(H-22153)	1 1/4 x 1 5/16	17/32	14 3/4	1.644

MIDGET OPEN END WRENCHES

"Van-Chrome" midget wrenches with 15° and 60° openings are specifically engineered for ignition, carburetion, electronic and similar small fasteners. Forged alloy steel, polished and chrome plated.

Part Number	Stock Number	Size Openings 15°	Size Openings 60°	Heads	O.A. Length	Wt. Ea. Lbs.
81	(H-22014)	13/64	15/64	7/64	3	.025
82	(H-22016)	15/64	13/64	7/64	3	.025
83	(H-22018)	7/32	1/4	7/64	3	.025
84	(H-22020)	1/4	7/32	7/64	3	.025
85	(H-22022)	9/32	5/16	1/8	3 1/2	.038
86	(H-22024)	5/16	9/32	1/8	3 1/2	.038
87	(H-22026)	11/32	3/8	9/64	4	.050
88	(H-22028)	3/8	11/32	9/64	4	.050
89	(H-22030)	7/16	1/2	11/64	4 1/2	.088

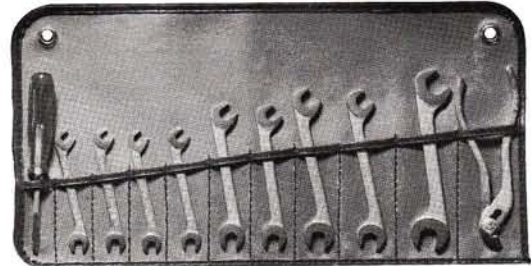

NO. 96R (H-82096) IGNITION SET, 11 TOOLS

Consists of 1 each 13/64 x 15/64, 15/16 x 13/64, 7/32 x 1/4, 1/4 x 7/32, 9/32 x 5/16, 5/16 x 9/32, 11/32 x 3/8, 3/8 x 11/32, 7/16 x 1/2, 5" ignition pliers and 1/8 x 2 ignition screwdriver in roll K-96 (H-87003).

No. 96B (H-82086) same tools less roll.

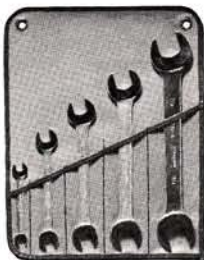

NO. 1750R (H-82043) OPEN END SET, 5 TOOLS

Consists of 1 each, 1/4 x 5/16, 3/8 x 7/16, 1/2 x 9/16, 5/8 x 11/16 and 3/4 x 7/8 in roll K-1750 (H-87010).

No. 1750B (H-82042) same tools less roll.

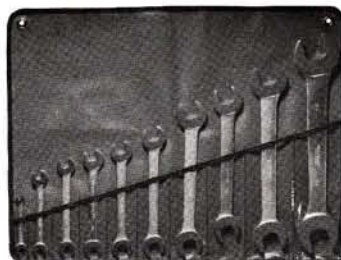

NO. 1760R (H-82048) OPEN END SET, 10 TOOLS

Consists of 1 each, 1/4 x 5/16, 3/8 x 7/16, 7/16 x 1/2, 1/2 x 9/16, 9/16 x 5/8, 5/8 x 11/16, 3/4 x 13/16, 3/4 x 7/8, 15/16 x 1 and 1 1/8 x 1 1/4 in roll K-1760 (H-87011).

No. 1760B (H-82047) same tools less roll.



NO. 97R (H-82097) IGNITION SET, 7 TOOLS

Consists of 1 each, 13/64 x 15/16, 15/64 x 13/64, 7/32 x 1/4, 1/4 x 7/32, 9/32 x 5/16, 5/16 x 9/32, 11/32 x 3/8 in roll K-97 (H-87004).

No. 97B (H-82087) same tools less roll.



BOX END WRENCHES

Single Offset—Double Offset

6 Point and 12 Point

All Herbrand box wrenches are drop forged from alloy steel and accurately broached and countersunk. Designed for greatest utility and clearance and non-tilt pull. Fully chrome plated with polished heads.

MIDGET, DOUBLE OFFSET (IGNITION) BOX WRENCH, 6 POINT

Part No.	Stock Number	Opening Sizes	O.D. Heads	O.A. Length	Wt. Ea. Lbs.
71	(H-24321)	3/16 x 13/64	19/64 x 21/64	2 7/8	.025
72	(H-24322)	7/32 x 15/64	11/32 x 3/8	3 3/8	.025
73	(H-24323)	1/4 x 9/32	25/64 x 27/64	3 3/8	.038
74	(H-24324)	5/16 x 11/32	29/64 x 31/64	3 3/4	.050

SHORT—45° DOUBLE OFFSET BOX WRENCH, 6 POINT

4623	(H-24633)	3/8 x 7/16	35/64 x 5/8	4 3/4	.106
4625	(H-24635)	1/2 x 9/16	23/32 x 13/16	5 1/2	.163
4629	(H-24639)	5/8 x 3/4	57/64 x 1 1/16	6 5/32	.253

SHORT—45° DOUBLE OFFSET BOX WRENCH, 12 POINT

4923	(H-24613)	3/8 x 7/16	35/64 x 5/8	4 3/4	.106
4925	(H-24615)	1/2 x 9/16	23/32 x 13/16	5 1/2	.163
4929	(H-24619)	5/8 x 3/4	57/64 x 1 1/16	6 5/32	.253



MIDGET BOX WRENCH SET NO. 70R (H-82010) 4 TOOLS

Includes 3/16 x 13/64, 7/32 x 15/64, 1/4 x 9/32, 5/16 x 11/32 in vinyl roll K-70 (H-87001).

SHORT DOUBLE OFFSET, 6 POINT BOX WRENCH SET NO. 4620R (H-82059) 3 TOOLS

Includes 3/8 x 7/16, 1/2 x 9/16, 5/8 x 3/4, in vinyl roll K-4620 (H-87014).

SET NO. 4620B (H-82058)

Same set less roll.

SHORT—15° SINGLE OFFSET BOX WRENCH, 6 POINT

Part No.	Stock Number	Opening Sizes	O.D. Heads	O.A. Length	Wt. Ea. Lbs.
6621	(H-24062)	5/16 x 3/8	15/32 x 9/16	4	.044
6623	(H-24063)	3/8 x 7/16	9/16 x 21/32	4 1/2	.056
6625	(H-24065)	1/2 x 9/16	47/64 x 53/64	5 1/2	.122

SHORT—15° SINGLE OFFSET BOX WRENCH, 12 POINT

6923	(H-24003)	3/8 x 7/16	37/64 x 21/32	4 1/4	.075
6925	(H-24005)	1/2 x 9/16	3/4 x 27/32	5	.106
6927	(H-24009)	5/8 x 1 1/16	59/64 x 1	5 3/4	.163

LONG—45° DOUBLE OFFSET BOX WRENCH, 12 POINT

3923	(H-24103)	3/8 x 7/16	37/64 x 21/32	7 1/2	.119
3925	(H-24105)	1/2 x 9/16	3/4 x 27/32	8 3/4	.206
3927	(H-24107)	9/16 x 5/8	27/32 x 59/64	9 1/4	.256
3929	(H-24109)	5/8 x 1 1/16	59/64 x 1 1/32	9 3/4	.338
3931	(H-24111)	3/4 x 13/16	13/32 x 13/16	12 1/2	.500
3933	(H-24113)	7/8 x 15/16	19/32 x 1 1/8	13 9/16	.769
3934	(H-24700)	3/4 x 15/16	19/32 x 1 3/8	13 9/16	.769
3935	(H-24205)	1 x 1 1/16	135/64 x 1 5/8	16	1.375
3937	(H-24207)	1 1/8 x 1 1/4	1 3/4 x 1 29/32	18	2.531
3938	(H-24208)	1 5/16 x 1 3/8	2 13/64 x 2 29/32	20	3.419
3939	(H-24209)	1 7/16 x 1 1/2	2 13/64 x 2 29/32	20	3.250

MULTIFLEX BOX WRENCHES, Hinged heads, 12 point

6823	(H-24503)	3/8 x 7/16	9/16 x 5/8	7 7/8	.23
6825	(H-24505)	1/2 x 9/16	3/4 x 13/16	8 7/8	.43
6827	(H-24507)	5/8 x 3/4	7/8 x 1-1/6	9 7/16	.63

SET NO. 6821R (H-82067) 3 wrenches above in tool roll.

RATCHETING BOX WRENCHES

Part Number	Stock Number	Opening and Type	Thick-ness	O.A. Length	Wt. Ea. Lbs.
3821	(H-24550)	1/4 x 9/16 (6 pt.)	3/8	5 1/2	.22
3823	(H-24554)	3/8 x 7/16 (6 pt.)	3/8	5 1/2	.22
3825	(H-24558)	1/2 x 9/16 (6 pt.)	1/2	6 3/4	.44
3827	(H-24542)	5/8 x 1 1/16 (12 pt.)	1/2	8	.64
3828	(H-24544)	3/8 x 3/4 (12 pt.)	1/2	8	.65
3829	(H-24548)	3/4 x 7/8 (12 pt.)	1/2	9 1/4	.75

SHORT DOUBLE OFFSET, 12 POINT BOX WRENCH SET NO. 4920R (H-82061) 3 TOOLS

Includes 3/8 x 7/16, 1/2 x 9/16, 5/8 x 3/4, in vinyl roll K-4920 (H-87015).

SET NO. 4920B (H-82060) Same set less roll.

LONG DOUBLE OFFSET, 12 POINT BOX WRENCH SET NO. 3901R (H-82057) 6 TOOLS

Includes 3/8 x 7/16, 1/2 x 9/16, 9/16 x 5/8, 5/8 x 11/16, 3/4 x 12/16, 3/4 x 15/16, in vinyl roll K-3901 (H-87013).

SET NO. 3901B (H-82056) Same set less roll.



HERBRAND "Van Chrome" HEX-FIT COMBINATION WRENCHES

Herbrand HEX-FIT Combination Wrenches represent the ultimate in wrench design. Available in long or short styles with either 6 or 12 point box openings and HEX-FIT open ends, the HEX-FIT wrench will meet your every requirement.

HEX-FIT design assures maximum working clearances, as well as accurate mating to nut or bolt.

Alloy steels, and painstaking production methods combine to give the HEX-FIT series:

1. Rich appearance—with full polished finish from end to end.
2. Better "feel"—with comfort-contoured, easy-grip, beam edges.
3. Better fit—only a HEX-FIT truly fits a hex.
4. Greater utility—Thin, new design open end heads, choice of 6 or 12 point box ends providing maximum working clearances and new beam lengths make Herbrand HEX-FIT combinations the most useful wrench built.
5. Better grip—Precision milled, 15° HEX-FIT openings and 15° offset broached box ends seat perfectly.

HEX-FIT COMBINATION WRENCHES 15° Open Ends, 15° Offset Box Ends

Short Series—12 Point

Part No.	Stock Number	Opening	Head Diameter Box End	Head Diameter Open End	O.A. Length	Wt. Ea. Lbs.
1212S	(H-23512)	3/8	39/64	13/16	4 11/16	.075
1214S	(H-23514)	7/16	43/64	29/32	5 3/16	.100
1216S	(H-23516)	1/2	3/4	1 1/32	5 11/16	.133
1218S	(H-23518)	9/16	27/32	1 5/32	6 7/32	.188
1220S	(H-23520)	5/8	15/16	1 9/32	6 27/32	.233
1222S	(H-23522)	1 1/16	1	1 13/32	7 15/32	.275
1224S	(H-23524)	3/4	1 3/32	1 11/32	8 3/8	.333

HEX-FIT COMBINATION WRENCHES

15° Open Ends, 15° Offset Box Ends

Short Series—6 Point

Part Number	Stock Number	Opening	Head Diameter Box End	Head Diameter Open End	O.A. Length	Wt. Ea. Lbs.
1208SH	(H-23408)	1/4	3/8	1/2	3 3/4	.06
1210SH	(H-23410)	5/16	1/2	1 1/16	4 1/4	.07
1212SH	(H-23412)	3/8	39/64	13/16	4 11/16	.075
1214SH	(H-23414)	7/16	43/64	29/32	5 3/16	.100
1216SH	(H-23416)	1/2	3/4	1 1/32	5 11/16	.133
1218SH	(H-23418)	9/16	27/32	1 5/32	6 7/32	.188
1220SH	(H-23420)	5/8	15/16	1 9/32	6 27/32	.233
1222SH	(H-23422)	1 1/16	1	1 13/32	7 15/32	.275
1224SH	(H-23424)	3/4	1 3/32	1 11/32	8 3/8	.333

Long Series—12 Point

1212L	(H-23712)	3/8	19/32	51/64	6 5/8	.100
1214L	(H-23714)	7/16	43/64	15/16	7 1/4	.156
1216L	(H-23716)	1/2	3/4	1 1/16	7 25/32	.188
1218L	(H-23718)	9/16	27/32	1 3/16	8 11/32	.219
1220L	(H-23720)	5/8	15/16	1 5/16	9	.281
1222L	(H-23722)	1 1/16	1	1 7/16	9 23/32	.344
1224L	(H-23724)	3/4	1 3/32	1 9/16	10 5/32	.400
1226L	(H-23726)	13/16	13/16	1 11/16	11 5/16	.600
1228L	(H-23728)	7/8	1 9/32	1 13/16	12 3/16	.750
1230L	(H-23730)	15/16	1 3/8	1 15/16	13 1/16	.875
1232L	(H-23732)	1	1 15/32	2 1/16	13 15/16	1.200
1234L	(H-23734)	1 1/16	1 9/16	2 5/8	14 27/32	1.400
1236L	(H-23736)	1 1/8	1 21/32	2 5/16	15 23/32	1.750
1240L	(H-23740)	1 1/4	1 27/32	2 9/16	16 1/2	2.050

Long Series—6 Point

1212LH	(H-23612)	3/8	19/32	51/64	6 5/8	.100
1214LH	(H-23614)	7/16	43/64	15/16	7 1/4	.156
1216LH	(H-23616)	1/2	3/4	1 1/16	7 25/32	.188
1218LH	(H-23618)	9/16	27/32	1 3/16	8 11/32	.219
1220LH	(H-23620)	5/8	15/16	1 5/16	9	.281
1222LH	(H-23622)	1 1/16	1	1 7/16	9 23/32	.344
1224LH	(H-23624)	3/4	1 3/32	1 9/16	10 5/32	.400

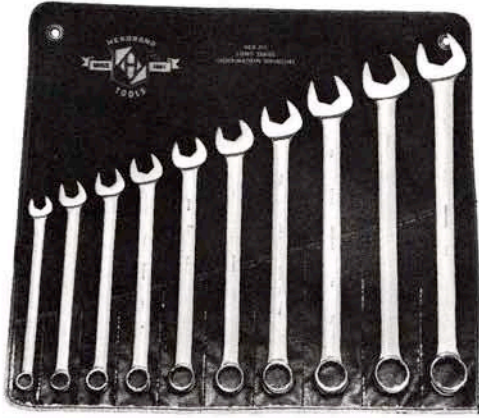

Set No. 1294LR (H-82037) 10 Tools

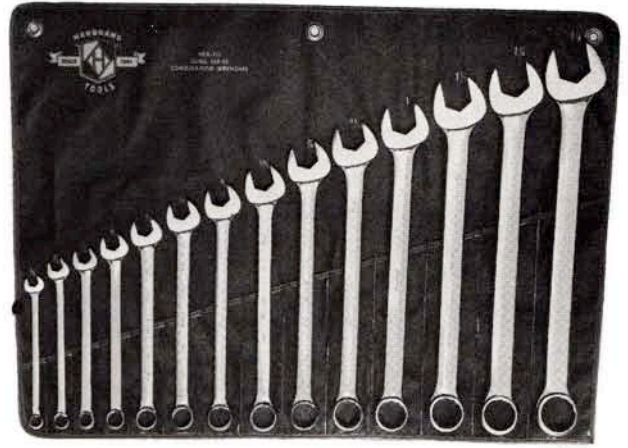

Set No. 1296LR (H-82039) 14 Tools

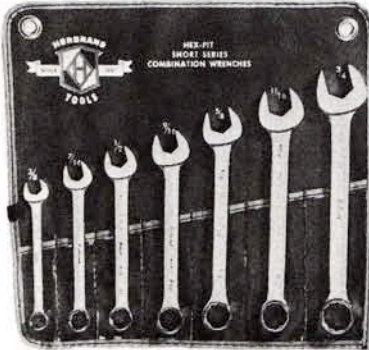

Set No. 1285SR (H-82017) 7 Tools
Set No. 1284SR (H-82015) 7 Tools
Set No. 1283SR (H-82013) 7 Tools



Set No. 1290LR (H-82027) 5 Tools



Set No. 1293LR (H-82035) 7 Tools
Set No. 1292LR (H-82033) 7 Tools
Set No. 1291LR (H-82031) 7 Tools

HEX-FIT COMBINATION WRENCH SETS

6 POINT AND 12 POINT BOX ENDS

LIST OF CONTENTS

HEX-FIT LONG SERIES COMBINATION WRENCH SETS

Set Number (Tools in vinyl roll)	Opening Size	3/8	7/16	1/2	9/16	5/8	11/16	3/4	13/16	7/8	15/16	1	1 1/16	1 1/8	1 1/4	Tool Roll	Set Number Tools only (Less Tool Roll)
1296LR (H-82039)	12 pt.	X	X	X	X	X	X	X	X	X	X	X	X	X	X	K-1296 (H-87030)	1296LB (H-82038)
1294LR (H-82037)	12 pt.		X	X	X	X	X	X	X	X	X	X				K-1294 (H-87029)	1294LB (H-82036)
1293LR (H-82035)	6 pt. 12 pt.	X	X	X	X		X	X	X							K-1291 (H-87028)	1293LB (H-82034)
1292LR (H-82033)	12 pt.	X	X	X	X	X	X	X								K-1291 (H-87028)	1292LB (H-82032)
1291LR (H-82031)	6 pt.	X	X	X	X	X	X	X								K-1291 (H-87028)	1291LB (H-82030)
1290LR (H-82027)	6 pt.	X	X	X	X	X										K-1290 (H-87007)	1290LB (H-82026)

HEX-FIT SHORT SERIES COMBINATION WRENCH SETS

1285SR (H-82017)	6 pt. 12 pt.	X	X	X	X		X	X	X							K-1283S (H-87006)	1285SB (H-82016)
1284SR (H-82015)	12 pt.	X	X	X	X	X	X	X								K-1283S (H-87006)	1284SB (H-82014)
1283SR (H-82013)	6 pt.	X	X	X	X	X	X	X								K-1283S (H-87006)	1283SB (H-82012)

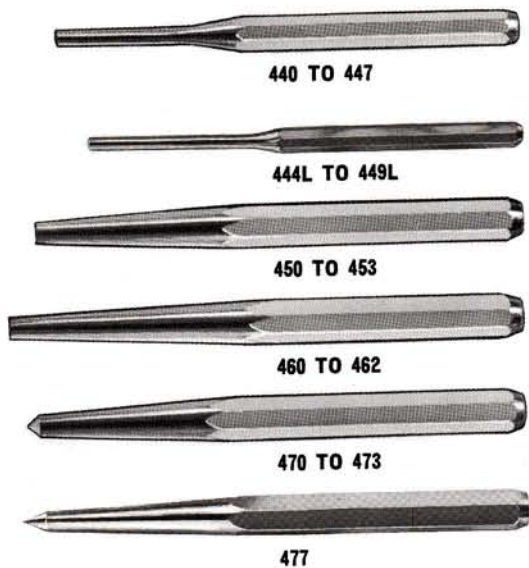

PUNCHES and CHISELS

Herbrand Punches and Chisels are forged from octagonal alloy tool steel bars, carefully heat-treated. Differential tempering produces a softer, chip-resistant striking end, but leaves working Tip, tough and hard. Finish is chrome plate.

PIN PUNCHES, SHORT AND REGULAR LENGTHS

Part Number	Stock Number	Point Dia.	Point Length	Stock Size	O.A. Length	Wt. Ea. Lbs.
442-2	(H-90402)	1/16	5/8	5/16	4	.08
442	(H-90404)	3/32	1 1/16	5/16	4	.08
440	(H-90406)	1/8	3/4	5/16	4	.07
441	(H-90408)	5/32	1	5/16	4	.08
441-6	(H-90410)	3/16	1	5/16	4	.09
443-3	(H-90422)	3/32	1 1/2	5/16	6	.10
443-4	(H-90424)	1/8	1 1/2	5/16	6	.10
443	(H-90426)	5/32	1 1/2	5/16	6	.11
444	(H-90428)	3/16	2	3/8	6 1/2	.16
445	(H-90430)	7/32	2 1/2	3/8	7	.16
446	(H-90432)	1/4	2 3/4	3/8	7	.17
447	(H-90434)	5/16	3	1/2	7 1/2	.31

LONG PIN PUNCHES

444L	(H-90444)	3/16	3	1/2	9	.48
446L	(H-90446)	1/4	3	1/2	9	.48
448L	(H-90448)	5/16	3	1/2	9	.50
449L	(H-90450)	3/8	3	1/2	9	.50

SOLID TAPER PUNCHES

450	(H-90462)	1/16	2	5/16	4 1/2	.07
451	(H-90464)	3/16	2	3/8	5	.14
452	(H-90466)	1/4	2 1/4	1/2	6	.30
453	(H-90468)	5/16	3 1/2	3/8	7	.50

LONG TAPER PUNCHES

460	(H-90482)	1/8	3 1/2	3/8	8	.20
461	(H-90484)	5/32	4	1/2	8	.36
461-6	(H-90486)	3/16	4	1/2	9	.50
462	(H-90488)	1/4	4	5/8	11	.75

CENTER PUNCHES

470	(H-90574)	1/8	—	5/16	4	.08
471	(H-90575)	7/32	—	3/8	4 1/2	.12
473	(H-90576)	—	—	1/2	6	.32

PRICK PUNCH

477	(H-90570)	—	—	3/8	5	.25
-----	-----------	---	---	-----	---	-----

COLD CHISELS OR FLAT CHISELS

Part Number	Stock Number	Edge Width	Stock Size	O.A. Length	Wt. Ea. Lbs.
400-8	(H-90312)	1/4	1/4	4 3/4	.08
400	(H-90314)	5/16	5/16	5	.10
401	(H-90316)	3/8	5/16	5	.11
402	(H-90318)	1/2	3/8	6	.18
403	(H-90320)	5/8	1/2	6	.31
404	(H-90322)	3/4	5/8	7	.55
405	(H-90324)	7/8	3/4	7 1/2	.88
406	(H-90326)	1	7/8	8	1.22

EXTRA LONG COLD (FLAT) CHISELS

403L	(H-90332)	3/8	1/2	12	.88
404L	(H-90334)	3/4	5/8	12	1.25
406L	(H-90336)	1	7/8	12	2.25

CAPE CHISELS

410	(H-90302)	7/32	5/16	5	.09
411-8	(H-90304)	1/4	3/8	5	.12
411	(H-90306)	5/16	3/8	5 3/4	.15
412	(H-90308)	3/8	1/2	6	.26

GOUGES

420	(H-90352)	7/32	5/16	5	.09
421	(H-90354)	1/4	3/8	6	.16

DIAMOND POINT

430	(H-90342)	5/64	5/16	5	.09
431	(H-90344)	1/8	3/8	6	.17
433	(H-90346)	1/4	3/8	6	.30
435	(H-90348)	3/8	5/8	6	.66

RIVET BUSTER

404B	(H-90607)	3/4	5/8	9	.90
------	-----------	-----	-----	---	-----

PRY-BARS

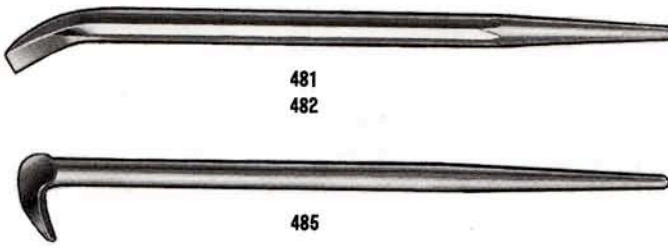

Part Number	Stock Number	Point Dia.	Width Edge	Stock Dia.	Length	Wt. Ea. Lbs.
481	(H-90600)	5/32	7/8	5/8	16	1.16
482	(H-90601)	1/4	1 1/8	3/4	20	2.15

ROLLING HEAD PRY-BAR

485	(H-90604)			9/16	15	.98
-----	-----------	--	--	------	----	-----

PUNCH AND CHISEL SETS



SET NO. C-5R (H-84205)
Consists of 1 each: 402, 403, 404, 405, 406, in tool roll KC-5 (H-87020).



SET NO. C-15R (H-84207)
Consists of 1 each: 401, 402, 403, 410, 412, 421, 431, 443, 444, 445, 446, 451, 452, 453, 471, in tool roll KC-15 (H-87022).



SET NO. C-10R (H-84206)
Consists of 1 each: 400, 440, 441, 450, 470, in tool roll KC-10 (H-87021).

PLIERS Diagonal—Cutting and Gripping Combination

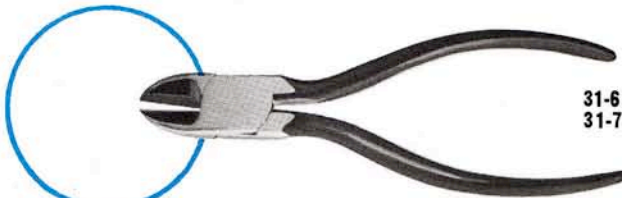

31-6 DIAGONAL CUTTING PLIERS (H-13116)
Length 6". Weight each—.33 lbs.



31-7 DIAGONAL CUTTING PLIERS (H-13137)
Length 7". (Selected alloy steel. Specially heat treated, hand honed for accuracy. Thin narrow heads. Blued finish, heads machine polished.) Weight each—.48 lbs.

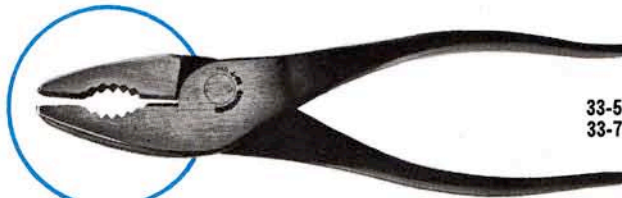

32-7 HEAVY DUTY DIAGONAL PLIERS (H-13447)
Length 7". (The heavy duty diagonal has the head specially "short-coupled" for extra leverage.) Weight each—.44 lbs.

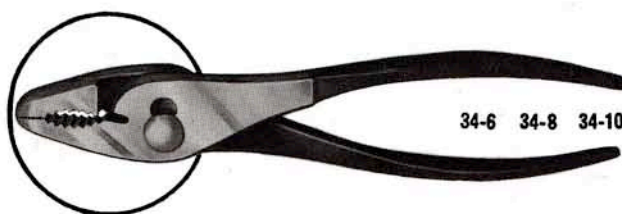

33-5 CUTTING AND GRIPPING PLIERS (H-12485)
Length 5 1/2". Weight each—.26 lbs.

33-7 CUTTING AND GRIPPING PLIERS (H-12487)
Length 7". (All around "general use" pliers. Powerful gripping jaws with side cutters. Forged from alloy steel. Blued finish with heads polished.) Weight each—.50 lbs.,

34-6 HEAVY DUTY COMBINATION PLIERS (H-12156)
Length 6". Weight each—.44 lbs.

34-8 HEAVY DUTY COMBINATION PLIERS (H-12158)
Length 8". Weight each—.68 lbs.

34-10 HEAVY DUTY COMBINATION PLIERS (H-12150)
Length 10". ("General use" pliers. Slip joint construction with notch type wire cutters. Forged alloy steel, blued finish with heads polished.) Weight each—.90 lbs.



SILVER DEMING

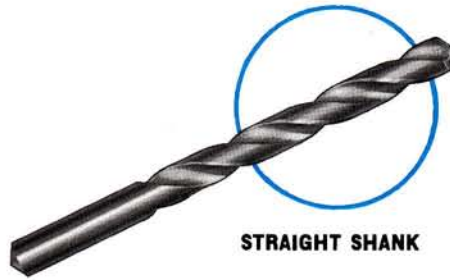

STRAIGHT SHANK

TWIST DRILLS Straight Shank and Silver-Deming

Herbrand Twist Drills Are American Made. All Are High Speed Drills

SILVER DEMING—All are 6" long with the shank reduced to 1/2" diameter. Individually packaged.

JOBBER LENGTH—STRAIGHT SHANK

Drill Dia.	Part Number	Stock Number	Drill Dia.	Part Number	Stock Number
1/2	DRS-32	(H-97132)	25/32	DRS-50	(H-97150)
17/32	DRS-34	(H-97134)	13/16	DRS-52	(H-97152)
9/16	DRS-36	(H-97136)	27/32	DRS-54	(H-97154)
19/32	DRS-38	(H-97138)	7/8	DRS-56	(H-97156)
5/8	DRS-40	(H-97140)	29/32	DRS-58	(H-97158)
21/32	DRS-42	(H-97142)	15/16	DRS-60	(H-97160)
11/16	DRS-44	(H-97144)	31/32	DRS-62	(H-97162)
23/32	DRS-46	(H-97146)	1	DRS-64	(H-97164)
3/4	DRS-48	(H-97148)			

Drill Diameter	Part Number	Stock Number	Length
1/16	DR-4	(H-90704)	1 7/8
5/64	DR-5	(H-90705)	2
3/32	DR-6	(H-90706)	2 1/4
7/64	DR-7	(H-90707)	2 5/8
1/8	DR-8	(H-90708)	2 3/4
9/64	DR-9	(H-90709)	2 7/8
5/32	DR-10	(H-90710)	3 1/8
11/64	DR-11	(H-90711)	3 1/4
3/16	DR-12	(H-90712)	3 1/2
13/64	DR-13	(H-90713)	3 5/8
7/32	DR-14	(H-90714)	3 3/4
15/64	DR-15	(H-90715)	3 7/8
1/4	DR-16	(H-90716)	4
17/64	DR-17	(H-90717)	4 1/8
9/32	DR-18	(H-90718)	4 1/4
19/64	DR-19	(H-90719)	4 3/8
5/16	DR-20	(H-90720)	4 1/2
21/64	DR-21	(H-90721)	4 5/8
11/32	DR-22	(H-90722)	4 3/4
23/64	DR-23	(H-90723)	4 7/8
3/8	DR-24	(H-90724)	5
25/64	DR-25	(H-90725)	5 1/8
13/32	DR-26	(H-90726)	5 1/4
27/64	DR-27	(H-90727)	5 3/8
7/16	DR-28	(H-90728)	5 1/2
29/64	DR-29	(H-90729)	5 5/8
15/32	DR-30	(H-90730)	5 3/4
31/64	DR-31	(H-90731)	5 7/8
1/2	DR-32	(H-90732)	6

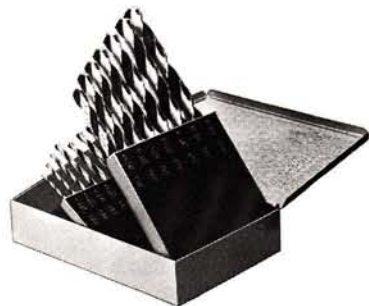

DRILL INDEX

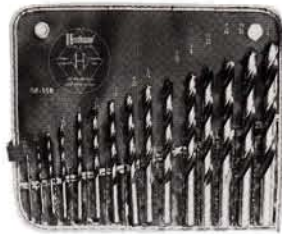

ROLL

JOBBER LENGTH DRILL SETS IN METAL INDEXES AND KITS

13 PIECE DRILL SET NO. DR-13-B (H-84932)
With Steel Index Container. Includes sizes 1/16" to 1/4" by 64th.

21 PIECE DRILL SET NO. DR-21-B (H-84934)
With Steel Index Container. Includes sizes 1/16" to 3/8" by 64th.

10 PIECE DRILL SET IN ROLL NO. DR-10-R (H-84937)
Contains sizes: 1/16", 5/64", 3/32", 7/64", 1/8", 9/64", 5/32", 3/16", 7/32", and 1/4".

15 PIECE DRILL SET NO. DR-15-B (H-84933)
With Steel Index Container. Includes sizes 1/16" to 1/2" by 32nd.

29 PIECE DRILL SET NO. DR-29-B (H-84935)
With Steel Index Container. Includes sizes 1/16" to 1/2" by 32nd.

15 PIECE DRILL SET IN ROLL NO. DR-15-R (H-84938)
Contains sizes 1/16" by 1/2" to 32nd.



302-3 TO 302-10



310 TO 311A



301-2 TO 301-6



304-3 TO 304-12



303-4 TO 303-12



304-1 TO 304-2



291 TO 295



304E TO 305E

SCREWDRIVERS—SLOT TIP

All Herbrand Screwdrivers are made with high alloy blades, ground and polished. Handles, whether wood or plastic are of ample size and shaped for comfort.

ROUND SHANK—BLUE PLASTIC HANDLE

Part Number	Stock Number	Blade Length	Bit Size	Shank Dia.	O.A. Length	Wt. Ea. Lbs.
Cabinet Type without bolster						
301-2	(H-90022)	2	1/8	1/8	4 5/16	.03
301-3	(H-90023)	3	1/8	1/8	6	.03
301-5	(H-90025)	5	1/8	1/8	6	.04
301-6	(H-90026)	6	1/8	1/8	9	.04
Cabinet Type with bolster						
302-3	(H-90043)	3	3/16	3/16	6 3/16	.09
302-6	(H-90046)	6	3/16	3/16	9 3/8	.14
302-10	(H-90050)	10	3/16	3/16	13 3/8	.17
Standard bit type with bolster						
303-4	(H-90004)	4	1/4	1/4	7 1/4	.19
303-6	(H-90006)	6	5/16	5/16	10 1/2	.32
303-8	(H-90008)	8	3/8	3/8	13	.50
303-10	(H-90010)	10	7/16	7/16	15	.68
303-12	(H-90012)	12	3/8	3/8	17 1/2	.83
HEAVY DUTY, with HEX Bolster for wrenching						
291	(H-90131)	4 7/8	1/4		8 1/2	.33
292	(H-90132)	6	5/16		9 1/2	.34
293	(H-90133)	7	3/8		11 1/2	.48
294	(H-90134)	8 7/8	3/8		13 1/2	.58
295	(H-90135)	11	7/16		15 1/2	.82

SQUARE SHANK—BLUE PLASTIC HANDLE

Part Number	Stock Number	Blade Length	Bit Size	Shank Square	O.A. Length	Wt. Ea. Lbs.
304-1	(H-90062)	1 3/4	1/4	1/4	3 3/4	.12
304-2	(H-90061)	1	1/4	7/32	2 3/4	.05
304-3	(H-90073)	3	7/32	3/16	6 1/4	.12
304-4	(H-90074)	4	5/16	7/32	7 3/4	.21
304-5	(H-90075)	5	5/16	5/16	9 1/8	.30
304-6	(H-90076)	6	3/8	5/16	10 1/4	.38
304-8	(H-90078)	8	7/16	3/8	12 3/4	.57
304-10	(H-90080)	10	3/8	3/8	15 3/4	.67
304-12	(H-90082)	12	1/2	3/8	17 1/2	.80

SQUARE SHANK—BLUE PLASTIC HANDLE

Part Number	Stock Number	Blade Length	Bit Size	Shank Square	O.A. Length	Wt. Ea. Lbs.
310	(H-90032)	2	1/8	1/8	4 1/4	.04
311	(H-90033)	3	1/8	1/8	5 1/2	.04
311A	(H-90035)	5 1/4	1/8	1/8	8 1/4	.06
312	See 304-3					

No. 310 has pocket clip.

NEON TUBE SCREWDRIVER, ROUND SHANK, PLASTIC HANDLE Used to check for current to spark plugs

304E	(H-90182)	2 1/4	1/8	3/32	5 1/4	.06
305E	(H-90184)	3 3/8	3/16	5/32	6 3/8	.11

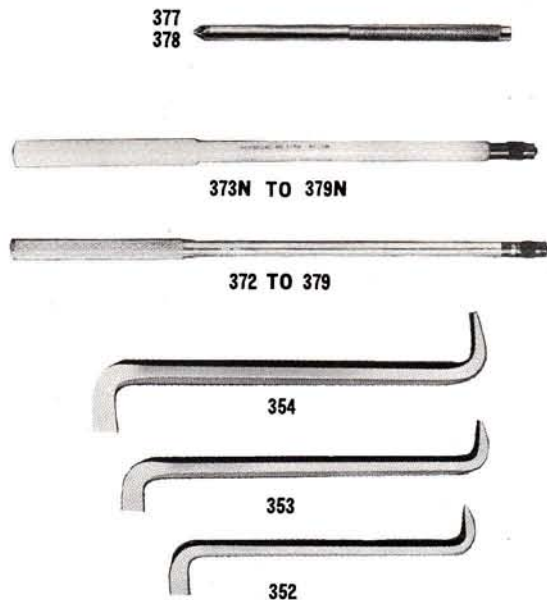
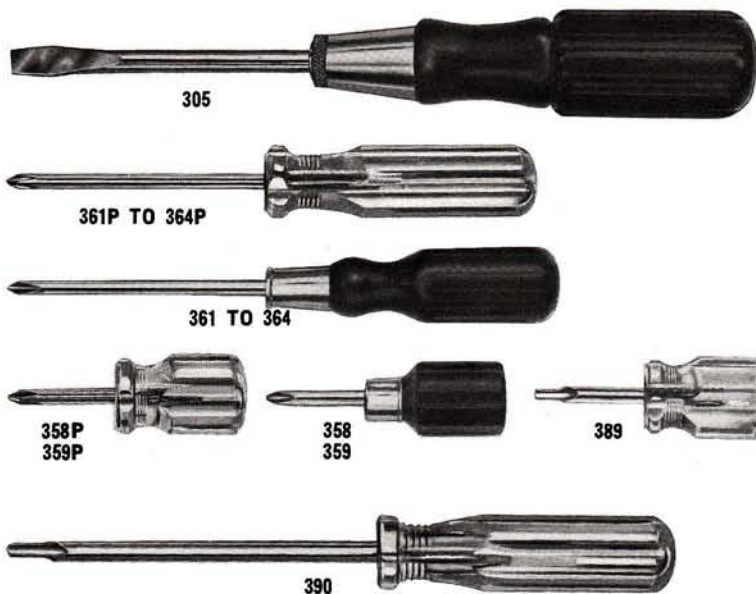

SCREWDRIVERS—MISCELLANEOUS

SLOT BIT, ROUND SHANK WITH BOLSTER, WOOD HANDLE

Part Number	Stock Number	Blade Length	Bit Size	Shank Dia.	O.A. Length	Wt. Ea. Lbs.
305-3	(H-90093)	3	1/4	7/32	7 1/2	.15
305-4	(H-90094)	3 3/4	1/4	1/4	9	.19
305-5	(H-90095)	5	5/16	5/16	10 1/4	.25
305-6	(H-90096)	5 11/16	3/32	5/16	11 3/8	.33
305-8	(H-90098)	8	3/8	3/8	14 5/16	.53
305-10	(H-90099)	10	3/8	3/8	16 5/16	.59

PHILLIPS BIT, ROUND SHANK, PLASTIC HANDLE

Part Number	Stock Number	Blade Length	Bit Size	Shank Dia.	O.A. Length	Wt. Ea. Lbs.
358P	(H-90151)	1	#1	3/16	2 1/4	.06
359P	(H-90152)	1 1/2	#2	1/4	3	.08
361P	(H-90141)	3	#1	3/16	6	.08
362P	(H-90142)	4	#2	1/4	7 3/4	.13
363P	(H-90143)	6	#3	5/16	10 1/4	.38
364P	(H-90144)	8	#4	3/8	12 1/2	.50

PHILLIPS BIT, ROUND SHANK, WOOD HANDLE

Part Number	Stock Number	Blade Length	Bit Size	Shank Dia.	O.A. Length	Wt. Ea. Lbs.
358	(H-90171)	1	#1	3/16	2 3/8	.05
359	(H-90172)	1 1/2	#2	1/4	3 5/8	.09
361	(H-90161)	3	#1	3/16	6 1/4	.08
362	(H-90162)	4	#2	1/4	8 3/4	.14
363	(H-90163)	6	#3	5/16	11	.29
364	(H-90164)	8	#4	3/8	14 1/2	.52

CLUTCH HEAD, BUTTERFLY STYLE (TYPE G), PLASTIC HANDLE

Part Number	Stock Number	Blade Length	Bit Size	Shank Dia.	O.A. Length	Wt. Ea. Lbs.
389-5	(H-90121)	1 3/4	5/32	1/4	3 3/8	.13
389-8	(H-90122)	1 3/4	1/4	1/4	3 3/8	.13
390-5	(H-90123)	4	5/32	1/4	7 1/2	.16
390-8	(H-90125)	6	1/4	5/16	10 1/4	.31
390-9	(H-90126)	6 3/8	5/32	5/16	10 3/8	.31
390-10	(H-90127)	6	5/16	3/8	10 3/8	.45

SCREW STARTERS

To start screws in hard-to-reach places. Slot type grasps screw slot with spring loaded blade. Phillips type is magnetic.

SLOT TYPE AND PHILLIPS SCREW STARTERS

Part Number	Stock Number	Screw Type	O.A. Length	Type Handle	Wt. Ea. Lbs.
372	(H-91851)	Slot	2 1/2	Aluminum	.02
373N	(H-91861)	Slot	2 1/2	Nylon	.02
375	(H-91852)	Slot	5	Aluminum	.04
376N	(H-91863)	Slot	6	Nylon	.03
377	(H-91858)	Phillips	3 1/4	Aluminum	.03
378	(H-91859)	Phillips	6 1/4	Aluminum	.06
379	(H-91854)	Slot	9	Aluminum	.06
379N	(H-91864)	Slot	9	Nylon	.05

OFFSET SCREWDRIVERS

For close quarter work, bits are set one parallel to, and one crossways to the handle.

Part Number	Stock Number	Tip Width	O.A. Length	Wt. Ea. Lbs.
352	(H-90185-09)	1/4	4 7/8	.06
353	(H-90186-09)	5/16	5 3/8	.13
354	(H-90187-09)	3/8	5 7/8	.25

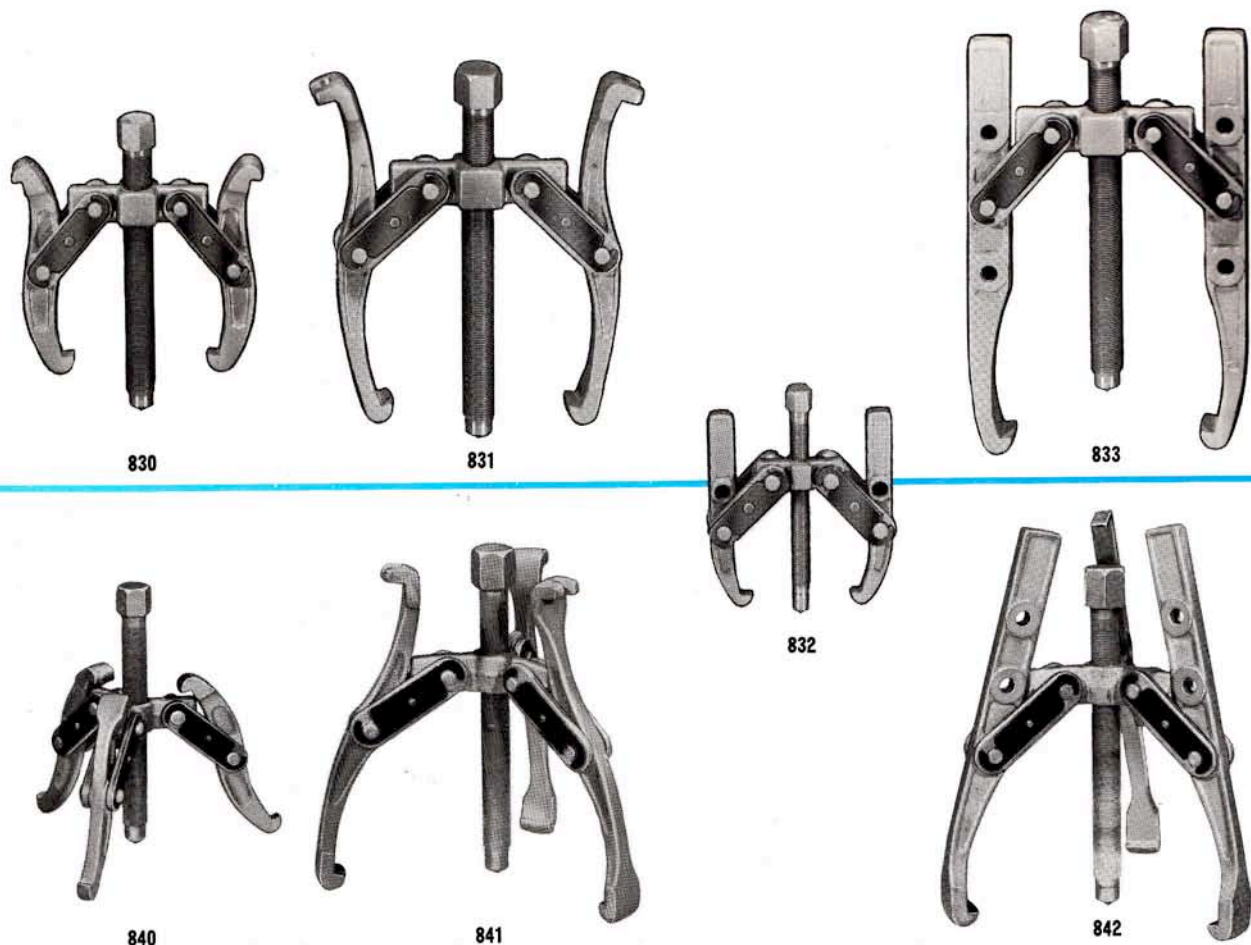

HERBRAND "QUICK-LOCK" PULLERS

The Herbrand "Quick-Lock" link is the fastest, easiest to use puller link yet devised. Grooved push pins slip into the link assembly and are locked in place by a single spring steel retainer plate which is pivoted to one link side-member. No nuts, bolts, or tools needed. Jaws are adjusted or reversed in seconds. Jaws are drop-forged, heat-treated and chrome plated. Forcing screws

are heat-treated and finished in Black Oxide. Buttress threads for longer wear and better pulling characteristics are used on all but the light duty No. 832 puller. Size for size, any 3 jaw puller makes a 2 jaw puller by substituting a 2 jaw yoke. All other parts are interchangeable. See list below, and listing in price sheet.

QUICK-LOCK PULLERS, 2 Jaw and 3 Jaw

Puller Number	Stock Number	Type	Spread	Reach	Yoke No.	Jaw Description	Wt. Ea. Lbs.
832	(H-91332)	2 jaw	4"	3½"	832-1	Straight, 2 pos. adjustable	.88
830	(H-91330)	2 jaw	6"	3½"	830-1	Reversible, 1 wide, 1 narrow	1.88
840	(H-91340)	3 jaw	6"	3½"	840-1	Reversible, 1 wide, 1 narrow	2.38
831	(H-91331)	2 jaw	8"	5½"	831-1	Reversible, 1 plain, 1 slotted*	3.69
841	(H-91341)	3 jaw	8"	5½"	841-1	Reversible, 1 plain, 1 slotted*	5.00
833	(H-91333)	2 jaw	10"	9"	833-1	Straight, 3 pos. adjustable	4.44
842	(H-91342)	3 jaw	10"	9"	842-1	Straight, 3 pos. adjustable	6.50

*Slotted jaws for cap screw pulling where work has tapped holes.

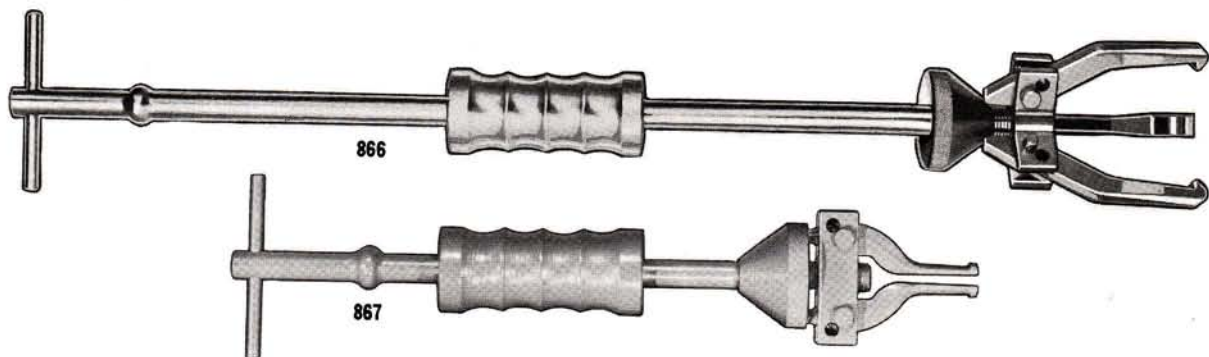

SLIDE HAMMER PULLERS

866 SHAFT HAMMER PULLER (H-91366)

Has 3 reversible jaws for either internal or external pulling. Jaws are adjustable for up to 5" O.D., and for internal pulling from 1 1/4" to 6" I.D. All alloy steel construction, chrome plated. Shaft is 24" long. Weight—7.06 lbs.

866B, shown below, added to 866 makes a 2 jaw puller.

868S, shown below, added to 866 makes a 3 jaw, reversible, screw type puller.

867 PILOT BEARING PULLER (H-91367)

2 jaw puller for internal pulling in through, or blind, holes. Removes flywheel pilot and other blind recessed bearings.

Capacity is 1/2" to 1 1/2" I.D. Shaft is 14" long and interchangeable with shaft of 866 puller.

Weight—5.06 lbs.

These totally interchangeable parts make up slide hammer and screw pullers shown on this page.



866S T Handle puller shaft, 24" long with forged no-pinch safety stop. Weight each—2.16 lbs.



867S T Handle puller shaft, 14 1/2" long with forged no-pinch safety stop. Weight each—1.34 lbs.



866H Sliding Hammer, with form fit grip, 4 1/2" long. Weight each—2.44 lbs.



866N Knurled Reversible Adjusting Cone, 2 1/4" diameter. Weight each—.65 lbs.



866E Ball Tip Expander, fits end of 866S or 867S for small internal pulling. Easy adjustment with a turn of the handle. Weight each—.06 lbs.



866B 2-way cross arm, 2 7/8" long, 2 pair of jaw pivot holes provide each arm parallel jaw alignment with greater strength. Weight each—.33 lbs.



866P Push-Pull Pin to hold jaws in place. Lock ball action, knurled head. Weight each—.03 lbs.



866Y 3 way yoke for 3 jaw pulling. Two staggered holes for each arm giving greater range and adaptability. Weight each—.49 lbs.



866J Reversible Puller Jaws 5" long, drop forged and accurately machined for positive adjustment. Weight each—.21 lbs.



866G Single Jaw, 2 15/16" long, for pulling grease retainers, bushings, brake work, etc. Weight each—.21 lbs.



867J Pilot Bearing Puller Jaw drop forged and milled to insure grip on blind recessed bearings. Weight—1.25 lbs.



868S Hex Head Puller Screw, 6 3/4" long with floating centering tip. Weight each—.46 lbs.



868T Replacement centering tip for 868S screw, push-pull design. Weight each—.05 lbs.

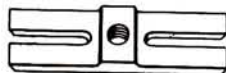

866C Deep slotted cap screw cross arm, 6" long. Use in pulling gears, pulleys, etc. Weight each—1.12 lbs.



868



868



869



868



868

BEARING SPLITTERS AND STUD PULLERS

HERBRAND BEARING SEPARATOR-PULLER ATTACHMENTS

These attachments are designed with knife-edged openings to get behind work close to a housing, or otherwise so close together as to require being wedged apart. Use to pull or separate gears, bearing cones and the like. Use with Herbrand "Quick-Lock" jaw pullers or cross-arm pullers as shown below.

872 SMALL BEARING SEPARATOR (H-91372)

Capacity, to 2 1/4" O.D. Weight each—1.38 lbs.

873 LARGE BEARING SEPARATOR (H-91373)

Capacity, to 4 1/4" O.D. Weight each—6.50 lbs.

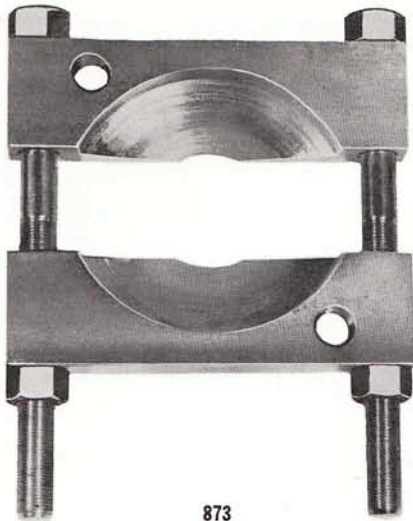

873

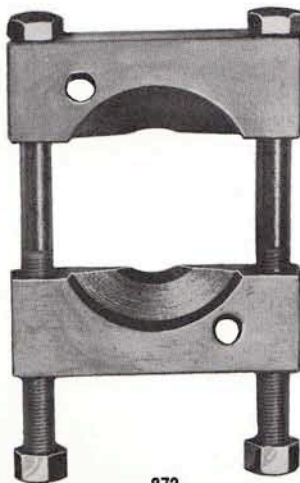

872

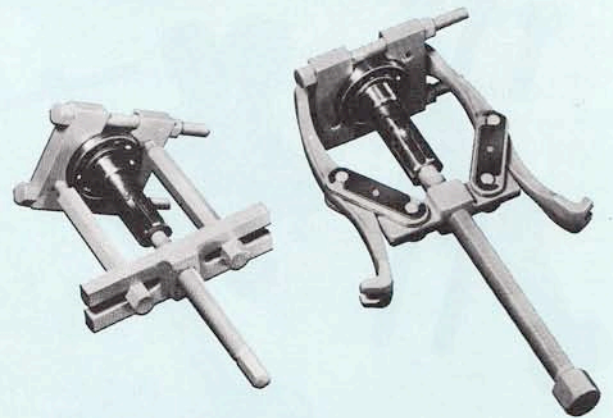

The illustrations above show the application of the Herbrand Separator-Puller Attachment as used with Herbrand No. 861 cross-arm puller (left) or with Herbrand No. 831, "Quick-Lock," reversible jaw, puller (right) to get behind a bearing or untapped gear where ordinary puller jaws will not reach.

821 STUD PULLER AND SETTER (H-91321)

This puller requires a minimum radial clearance around a stud. Gripping action is provided by a serrated wedge which tightens against stud as puller is rotated, but releases easily. All alloy steel body and wedge. Chrome plated. Capacity, 9/16" dia. stud. 1/2" square drive. 15/16" diameter, 3 1/2" long. Weight each—.90 lbs.



821



820

820 ECCENTRIC STUD PULLER (H-91320)

Especially useful on short studs as eccentric cam face is flush with bottom face of puller. Capacity range, 1/4" thru 3/4" studs. Pinned eccentric is reversible for wear compensation. Teeth are sharp-milled for "bite" and easy release. All alloy steel, chrome plated, 1/2" square drive. Weight each—1.13 lbs.

"VAN CHROME" PULLERS



835

835 STEERING WHEEL PULLER (H-91335)

Designed to pull steering wheels on most late model automobiles. Includes three sets of side screws, 3/8-16, 5/16-18, and 5/16-24. The floating swivel is recessed so as not to damage the spring tip connected to the horn wires. Slotted cross-arm, 4" long. Bright Cadmium plated. Weight—2.250 lbs.



863

863 HARMONIC BALANCER PULLER (H-91363)

Especially designed to pull harmonic balancers, the universal 2 way—3 way yoke makes it adaptable to pulling drilled and tapped gears and pulleys. Forcing screw has floating tip. Complete with 3 pair of side screws: 3/8-16 x 3/4" long, 3/8-24 x 1 3/4" long and 5/16-24 x 1 3/4" long. Minimum bolt circle 1 1/2", maximum 3 3/4". Weight each—1.25 lbs.



861

861 TIMING GEAR PULLER (H-91361)

For removal of timing gears, pulleys and other units with tapped holes. 6 1/2" slotted cross-arm for variable center to center distances. Side screws are dual threaded, 3/8-16 and 5/16-18 x 6 1/2" long. Bright finish. Weight each—2.50 lbs.



828

828 PITMAN ARM PULLER (H-91309)

Designed to remove pitman arms from passenger cars and light trucks, including Volkswagen. Forged alloy yoke and heavy-duty forcing screw for most severe requirements. Weight each—1.25 lbs.

WHEEL AND AXLE PULLERS

UNIVERSAL WHEEL HUB PULLER

The most practical and versatile hub puller made. Sliding puller arms quickly and easily adjust to fit any type hub. Because of unique arm suspension a straight pull is made on all size bolt circles up to and including 7 1/2" in diameter. The heavy duty forcing screw rides in a sliding bearing to permit use of bumping action on screw drive end or drive handle without damage to the threads. The floating cap on the contact end of the screw centers on the axle and, by its action, prevents injury to the axle or the puller screw. All alloy steel construction for added ruggedness and long life. Finished in all satin plate.

825C PULLER SET (H-91326)

As illustrated, with drive handle 825H. Weight each—11.56 lbs.

825 PULLER ONLY (H-91325)

Less drive handle 825H. Weight each—9.56 lbs.

825H DRIVE HANDLE (H-91325-08)

Use with hammer for increased leverage. Weight each—2.00 lbs.

877 FLANGE TYPE AXLE PULLER (H-91377)

This tool can be used as a regular wheel puller or hub puller as well as a flange type puller. The bolt circle range is from 4 1/2 inches to 5 1/2 inches which covers all major cars and small trucks with flange type axles. The four slots in the adapter allow this tool to be used on either 4, 5, or 6 bolt or stud designs. Has extra heavy 5 1/4 pound sliding hammer. Weight—10.00 lbs.

877-Z YOKE FOR VALIANT AND LANCER (H-91378)

For use with 877. This special yoke is designed to remove flange type axles on the Valiant and Lancer compact cars. Range: 3 3/4 inches to 4 1/2 inches. Weight—3.75 lbs.

877-Y ADAPTER—AXLE SHAFT REMOVER (H-91379)

For use with 877. This threaded coupling or adapter is needed to remove the axle shaft on Rambler and Chrysler product cars, except the Valiant and Lancer. Threaded 3/4"-16 on one end and 7/8"-14 on the other. Weight—.375 lbs.

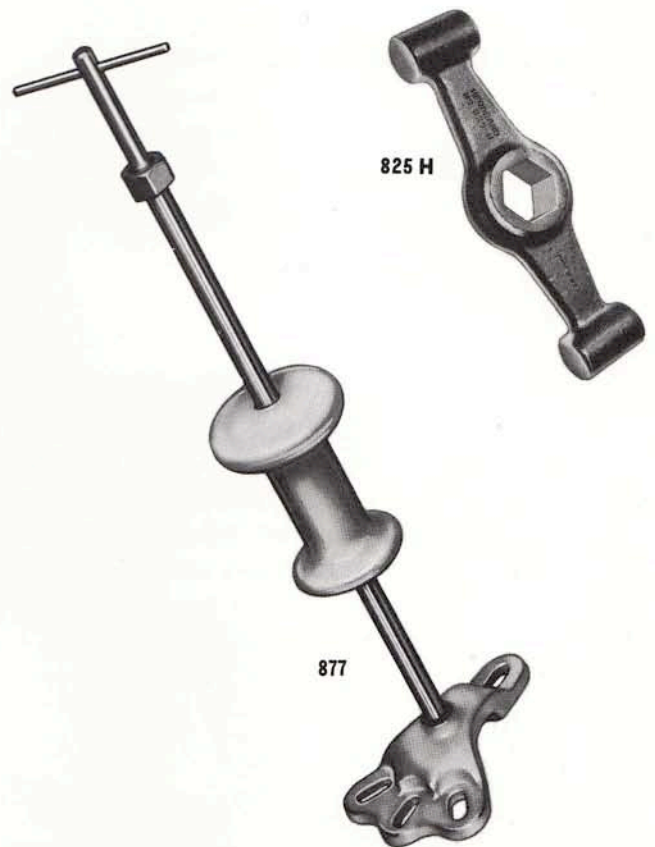



2356V



829



874



851

PULLERS—"U" JOINT-BATTERY-LINK SEPARATOR-DIODE PRESS

2356V WEDGE TYPE SEPARATOR (H-91317)

This forked wedge separator is used to free the tapered links of the shock absorber assembly or the stabilizer assembly from their mountings. Bright nickel chrome finish. Jaw opening 5/8 inch, length 16 inches. Weight—2.250 lbs.

829 BATTERY TERMINAL AND GENERATOR BEARING PULLER (H-91329)

This tool will disassemble and reassemble universal joints without damage to components, as hammering is eliminated. Job is still easier when tool is mounted in a bench vise, although such mounting is optional. Furnished with accessories as shown. Handles 95% or more of all car and light truck universal joints. Drive screw with hex for end wrench if more leverage is needed. Weight each—5.75 lbs.

874 ALTERNATOR DIODE PRESS (H-92111)

Jaw design of this puller permits it to lift cable terminals by gripping sides, as well as by hooking beneath the terminal. Used either way, damage to battery posts or cell covers, will not result. Lifts the tightest terminal easily. Rotating foot on forcing screw lets this tool double as generator bearing, and magneto gear puller. Capacity, 5/8" to 1 3/8" dia. Weight each—.56 lbs.

851 UNIVERSAL JOINT TOOL (H-91351)

For removal and installation of press-fit diodes in alternators by Delcotron, Prestolite, Chrysler, Motorola, Leece Neville and others.

Use of this press can assure the proper alignment and seating of press-in diodes for satisfactory heat transfer and freedom from damage during installation. Why risk using a hammer and punch?

Use lug at bottom to mount in bench vise. Weight each—5.25 lbs.

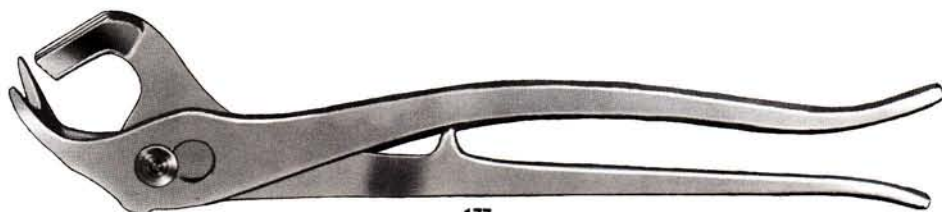

177

177 BATTERY TERMINAL LIFTER AND SCRAPER (H-18210)

Federal Stock Number 5120-293-1039.

Without a doubt, this unique tool which was developed by Herbrand engineering and is produced exclusively by us, is the most versatile battery terminal tool ever built. As a lifter-plier it will remove the most stubborn cable terminal with

absolutely no damage to battery posts, cell covers or plates. Separated by a simple sliding action, the tool becomes two scrapers, one to clean the battery posts and the other to clean out the hole of the cable terminal.

Drop forged of alloy steel, hardened and tempered and finished in chrome plate. Overall length is 10 1/2 inches. Weight each—.87 lbs.

RULES—TUBE CUTTER and FLARING TOOLS

PUSH-PULL RULES

Flexible steel blades with legible black numerals on white background. Chrome finished case. See price list for replacement blades, e.g., 206WB.

206W (H-91606).

6 foot rule. Weight each—.08 lbs.

208W (H-91608)

8 foot rule. Weight each—.10 lbs.

210W (H-91610)

10 foot rule. Weight each—.11 lbs.

761 TUBING CUTTER (H-92059)

An improved cutter for tubing from 1/8" to 1" O.D. Hardened and ground, replaceable cutter wheel. Reamer is retractable for extra clearance. O.A.L. 6". Weight each—.63 lbs.

761C—Replacement cutter wheel (H-92059-02)

750 TUBE FLARING TOOL (H-92046).

2 piece, single flare tool. 7 die openings for soft tubing with O.D. dimensions 3/16", 1/4", 5/16", 3/8", 7/16", 1/2" and 5/8". Serrated jaws hold tube positively for accurate flare forming. Die halves are hinged. Drop Forged frame carries heat treated flaring punch. Weight each—2.18 lbs.

763 DOUBLE FLARE TOOL SET (H-84931)

Seven piece set in fitted metal case. Double flares any soft tubing, to maximum wall thickness of .040". Construction of die block and punch same as No. 750, will also make single flares. Five die sizes, 3/16", 1/4", 5/16", 3/8" and 1/2". Each double flare adapter disc is marked with tube size. Weight of set—3.25 lbs.



206 W TO 210W

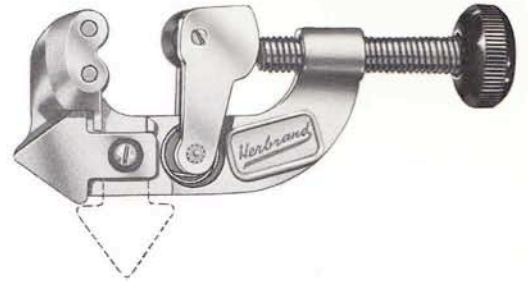

761

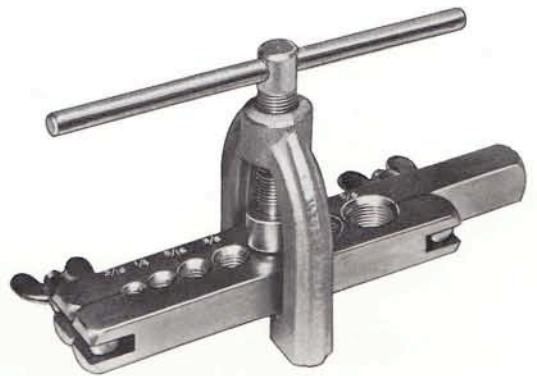

750



763

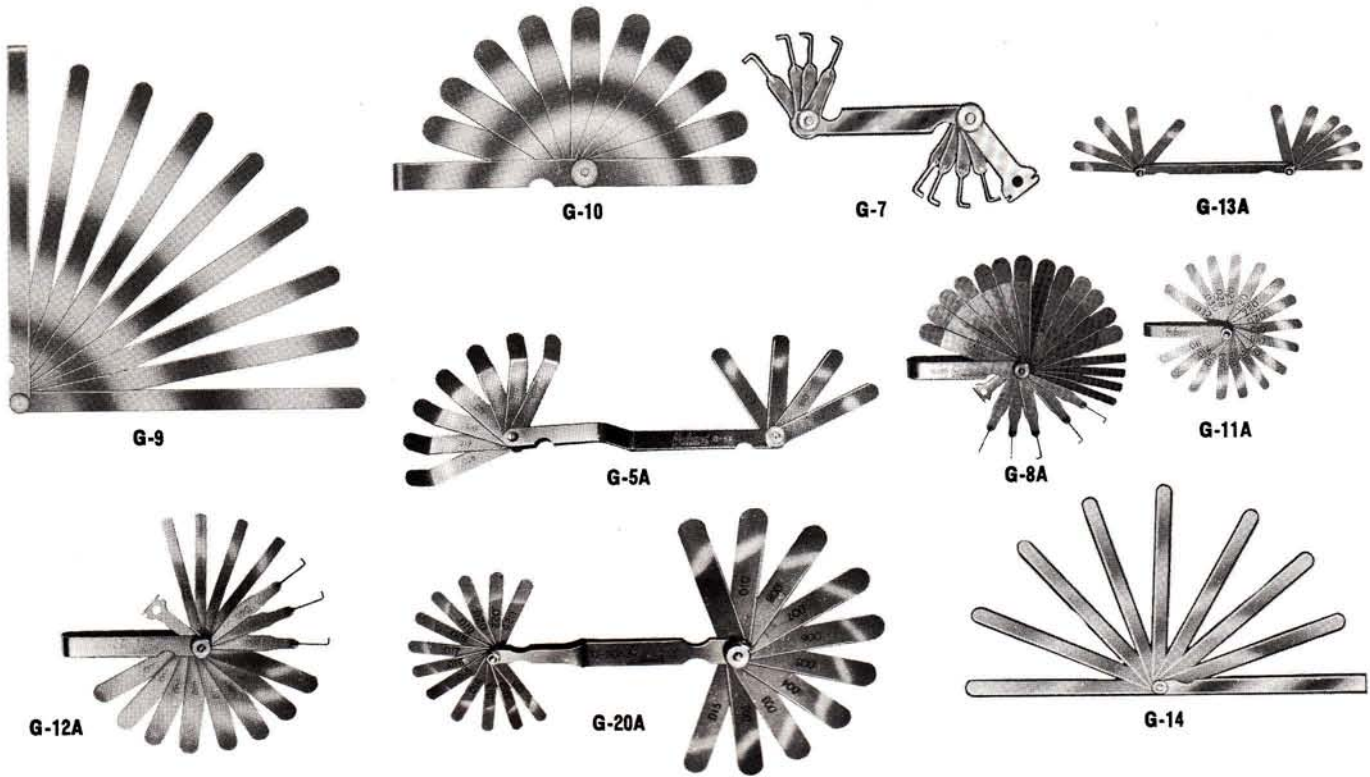

FEELER GAUGES

G-5A COMBINATION O.H.V. GAUGE (H-91258)

Contains 7 offset blades .018, .019, .020, .021, .024, .025, .026 and 4 straight blades .015, .016, .018, and .019. Designed to clear hot manifolds while adjusting tappets. Weight each—.23 lbs.

G-7 SPARK PLUG GAPPING GAUGE (H-91257)

Contains one electrode bender and eight wire gauges: .022, .025, .028, .030, .032, .035, .038, and .040 diameter. Weight each—.08 lbs.

G-8A FORD GAUGE (H-91260)

Contains 13 "go and no-go" blades 3 5/16" x 1/2" with 5/8" step: .010-.012, .011-.013, .012-.014, .013-.015, .014-.016, .015-.017, .016-.018, .017-.019, .018-.020, .019-.021, .021-.023, .024-.026, .025-.027; four ignition (1/4" wide) blades .015, .016, .020, and .025; two straight wire feelers .017 and .030; three spark plug gap bent wire feelers .025, .028, .035; and one electrode bender. Weight each—.23 lbs.

G-9 PISTON CLEARANCE GAUGE (H-91255)

Contains eight 9" x 1/2" blades: .002, .003, .004, .005, .006, .008, .010, .012, and .015. Weight each—.18 lbs.

G-10 STANDARD FEELER GAUGE (H-91254)

Contains ten 3 5/16" x 1/2" blades: .002, .003, .004, .005, .006, .007, .008, .010, .012, and .015. Weight each—.09 lbs.

G-11A MIDGET IGNITION GAUGE (H-91263)

Contains sixteen 1 9/16" x 1/4" blades: .011, .012, .013, .014, .015, .016, .017, .018, .019, .020, .022, .024, .025, .028, .030, and .032. Weight each—.06 lbs.

G-12A CHEVROLET GAUGE (H-91261)

Contains eight 3 5/16" x 1/2" blades: .006, .007, .008, .010, .012, .013, .015, and .020; four 3 5/16" by 1/4" ignition blades: .016, .018, .020, .022; 3 spark plug bent wire gauges: .032, .035, and .040; and 1 electrode tool. Weight each—.04 lbs.

G-13A DELCO-REMY DISTRIBUTOR GAUGE (H-91252)

Contains 12 blades 1 3/4" x 1/4". Special width, for point adjustment: .011, .012, .013, .014, .015, .016, .017, .018, .019, .020, .022, and .025. Weight each—.06 lbs.

G-14 BRAKE GAUGE (H-91250)

Contains nine 4" x 1/4" blades: .002, .004, .005, .006, .007, .008, .010, .012, and .015; Weight each—.05 lbs.

G-20A COMBINATION GAUGE (H-91251)

Contains ten 3 5/16" x 1/2" blades: .002, .003, .004, .005, .006, .007, .008, .010, .013, and .015; twelve 1 3/8" x 1/4" fingers: .011, .012, .013, .014, .015, .016, .017, .018, .019, .020, .022, and .025. Weight each—.13 lbs.

FEELER GAUGES and SNAP-GAP

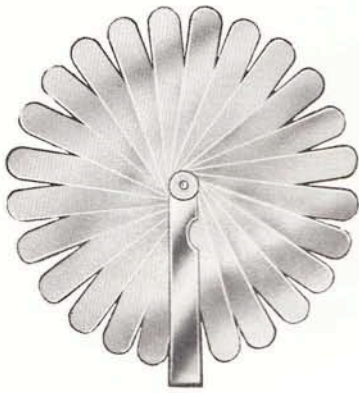

G-25

G-25 UNIVERSAL MASTER GAUGE (H-91253)

Contains twenty-five 3 5/16" x 1/2" blades: .0015, .002, .003, .004, .005, .006, .007, .008, .009, .010, .011, .012, .013, .014, .015, .016, .018, .020, .022, .024, .025, .028, .030, .032 and .035. Weight each—.25 lbs.



G-26

G-26 SPECIAL CARBURETOR GAUGE (H-91265)

For anti-percolator and fast idle adjustments. Contains twelve straight wire gauges: .010, .012, .015, .018, .020, .023, .026, .030, .040, .045, .053 and .054. Weight each—.06 lbs.

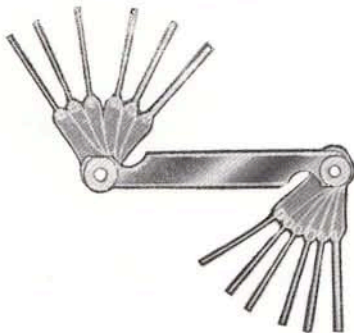

G-27

G-27 UNIVERSAL OVERHEAD VALVE GAUGE (H-91264)

Contains 16 blades offset to 45° angle for adjusting overhead valve engines: .009, .010, .011, .014, .015, .016, .017, .018, .019, .020, .021, .023, .024, .025, .026, and .027. Weight each—.21 lbs.



GT-10

GT-10 SPARK PLUG GAPPING TOOL (H-91266)

Improved design for gapping 10mm. and 14mm. spark plugs. Every gap sets the same. Revolving gauge gaps to sizes, .022, .025, .026, .028, .030, .032, .035, .036, .038 and .040. Handle end is tapered electrode spreader. Weight each—.83 lbs.

For Replacement blades, see Price List.

3 5/16" x 1/2", G0015 (.0015") thru G040 (.040").

12" x 1/2", GL0015 (.0015") thru GL040 (.040").



2167

2167 SNAP-GAP POINT ADJUSTING TOOL (H-91267)

Gap distributor in 1/3 the time. New set for conventional and Delco "window" distributors. One of 5 sleeves slips over cam to open points. Special Snap-Gap Feeler gauge sets gap. Remove ring and points are correctly gapped. Never necessary to rotate cam. Sets dual points too. Instructions and gap specifications included. Delco "window" distributor setting tool has 2 color indexed dial for accurate "1/2 turn counter clockwise" as specified by Delco.

Set consists of 7 pieces in fitted plastic box. Weight per set—.60 lbs.

METAL CUTTING TOOLS

HSF-3 DELUXE HACKSAW FRAME (H-91423)

Tubular main member gives rigidity with light weight. Will cut flush to surface, either vertically or horizontally, and will bottom in a vertical cut. Extra blade storage in tube. Pistol-grip handle, chrome and enamel frame. Uses 12" blade only. Weight each—1.50 lbs.

HSF-10 ALL STEEL HACKSAW FRAME (H-91410)

Heavy cold rolled steel frame with full formed, non-breakable pistol grip handle. Adjustable from 8-12 inches. Length 16 inches. Weight—1.375 lbs.

HSF-19 JAB SAW (H-91429)

Hack saw blade reaches 6" into $\frac{3}{4}$ " hole, extends to 10" rigidly supported. Weight—.812 lbs.

HACKSAW BLADES

Part Number	Stock Number	Length	Teeth Per/in.
HS-1018	(H-91471) High Speed	10"	18
HS-1024	(H-91472) High Speed	10"	24
HS-1218	(H-91481) High Speed	12"	18
HS-1224	(H-91482) High Speed	12"	24
HF-1018	(H-91451) Flexible-Back Hardened	10"	18
HF-1024	(H-91452) Flexible-Back Hardened	10"	24
HF-1218	(H-91461) Flexible-Back Hardened	12"	18
HF-1224	(H-91462) Flexible-Back Hardened	12"	24

AVIATION SNIPS—Compound Action

Drop-forged blades of alloy steel, ground edges, hardened and tempered. Both edges serrated to prevent slipping. Self-locking nuts keep adjustment. Spring returns blades to open position for continuous cutting.

Polished Head, Cushion-Grips with Hand Guards.

Part Number	Stock Number	Length	Length of Cut	Type	Wt. Ea. Lbs.
TS-10-L	(H-15360)	10"	1½"	L.H. cut	1.01
TS-10-R	(H-15350)	10"	1½"	R.H. cut	1.01
TS-10-S	(H-15370)	10"	1½"	Straight	1.01

TINNERS' SNIPS—Duck bill pattern.

Designed to cut straight or curved shapes. Comfort-grip handles, baked enamel finish, polished blades.

Part Number	Stock Number	Length	Wt. Ea. Lbs.
TS-7	(H-15327)	7"	.40
TS-10	(H-15320)	10"	.88
TS-12	(H-15322)	12"	1.63

MUFFLER AND TAIL PIPE CUTTERS

This matched pair of cutters will separate even badly rusted mufflers and pipes. Guide prevents damage to part being saved. Alloy steel, chrome plated, chisel edge.

Part Number	Stock Number	Type of Cut	Length	Wt. Ea. Lbs.
491	(H-92191)	Cuts inside pipe	7"	.48
492	(H-92192)	Cuts outside pipe	7"	.45
490B	(H-84920)	Set of 2, 491 and 492		Wt. set .93

497 TAIL PIPE AND PANEL CUTTER (H-92197)

Radius bit rolls metal out of cut. Handle offset for knuckle clearance. A handy, heavy duty cutter. Hardened and ground bit, length 10". Weight each—.48 lbs.



HSF-3



HSF-10



HSF-19

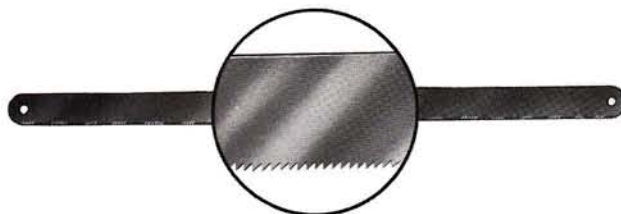

HS-1018 - HF-1224



TS10-L-R-S



TS-7-10-12



491



492



497



E1 TO E5

SCREW AND STUD EXTRACTORS

STRAIGHT FLUTE EXTRACTORS (WITH HEX DRIVE BUSHING)

Part Number	Stock Number	Stud Dia.	Drill Size	Length	Wt. Ea. Lbs.
E1	(H-91841)	1/4	3/8	2	.03
E2	(H-91842)	5/16	7/16	2 3/8	.04
E3	(H-91843)	3/8	1/2	2 3/4	.08
E4	(H-91844)	7/16	9/16	3	.10
E5	(H-91845)	1/2-9/16	1 1/32	3 3/8	.14



XX10



XX5

XX10 STRAIGHT FLUTE EXTRACTOR SET (H-84930) 20 TOOLS

In fitted die-cast metal box. Consists of: 5 straight flute extractors E1 thru E5—see chart. 10 Drill guides (bushings) for tapped holes 9/32" to 9/16". 5 Twist drills, 1/8" to 11/32"—

XX5 STRAIGHT FLUTE EXTRACTOR SET (H-84939) 5 TOOLS

Consists of 5 Extractors, E1 thru E5, complete with hex drive bushings in fitted plastic kit.

SCREW EXTRACTORS—THREAD RESTORERS



EX 1
TO
EX 5

SPIRAL FLUTE SCREW EXTRACTORS

Left hand spiral extractors. Simply drill hole in broken screw, insert extractor with light hammer blow and turn drive square to remove screw or stud. 5 sizes for stud diameters shown at right.

THREAD RESTORER FILES



809
811

Use like a file to true-up damaged male threads.

809 (H-91872)

For fine threads, 8 thread sizes: 9, 10, 12, 16, 20, 27, 28 and 32 threads per inch. Weight each—.34 lbs.

811 (H-91871)

For coarse threads, 8 thread sizes: 11, 12, 13, 14, 16, 18, 20 and 24 threads per inch. Weight each—.34 lbs.

SPIRAL FLUTE SCREW—STUD EXTRACTORS

Part Number	Stock Number	Stud Dia.	Drill Size	Length	Wt. Ea. Lbs.
EX1	(H-91831)	1/8-3/16	1/16	2 1/8	.01
EX2	(H-91832)	3/16-1/8	7/64	2 1/2	.03
EX3	(H-91833)	5/16-7/16	5/32	2 7/8	.03
EX4	(H-91834)	7/16-9/16	1/4	3 1/4	.08
EX5	(H-91835)	9/16-3/4	9/32	3 3/4	.13



X-5R SPIRAL FLUTE EXTRACTOR SET (H-84928) 5 TOOLS

Consists of extractors EX1 through EX5, in vinyl coated fabric tool roll KX-5 (H-87025).

THREAD RESTORER SETS



806B

Restorer dies are for straightening damaged threads only—will not thread new work. The die hex is the same size as the nut for a given bolt diameter for turning with any type of wrench. See parts list for replacement dies. All sets in clear plastic box.

806B DIE SET (H-84406)

Coarse threads (NC) 8 Dies. See chart for listing. Weight of Set—.50 lbs.

808B DIE SET (H-84408)

Fine threads (NF) 8 Dies. See chart for listing. Weight of Set—.50 lbs.

LISTING, RESTORER TAP SETS AND DIE SETS

TAP SIZES Set No.		DIE SIZES Set No.	
804B (NC)	803B (NF)	806B (NC)	808B (NF)
1/4-20	1/4-28	1/4-20	1/4-28
5/16-18	5/16-24	5/16-18	5/16-24
3/8-16	3/8-24	3/8-16	3/8-24
7/16-14	7/16-20	7/16-14	7/16-20
1/2-13	1/2-20	1/2-13	1/2-20
9/16-12	9/16-18	9/16-12	9/16-18

See Price List for individual taps and dies.

NC dies are Copper plated.
NF dies are Blue Oxide finish.

804B



Restorer Taps for reworking damaged threads only. Have hex heads in standard wrench sizes.

804B TAP SET (H-84404)

Coarse thread (NC). 6 Taps. See chart for listing. Weight of set—.88 lbs.

803B TAP SET (H-84403)

Fine thread (NF). 6 Taps. See chart for listing. Weight of set—.88 lbs.



805B

INVERTED TUBE FITTING RESTORER SET 805B SET (H-84405)

3 taps and 3 dies. For restoring threads of inverted brass fittings used on fuel, oil and hydraulic lines. 3 sizes for 3/16", 1/4" and 5/16" tube fittings. A real time and trouble saver.

MULTISCOPE®

MS-1 MULTISCOPE (H-92315)

The Herbrand patented Multiscope is the finest trouble-tracer available anywhere. Used as is a doctor's stethoscope this new "Hi-Fi" model isolates and amplifies noise from any operating mechanism. Pinpoints source of noise from worn bearings and gears, "hears" fluids in motion through tubes or valves, detects stress sounds in material testing. Selectively locates noisy tappets, mechanical or hydraulic, or any other noise source. An excellent preventive maintenance tool, saves unnecessary teardown for physical inspection of working parts. Weight each—.43 lbs.

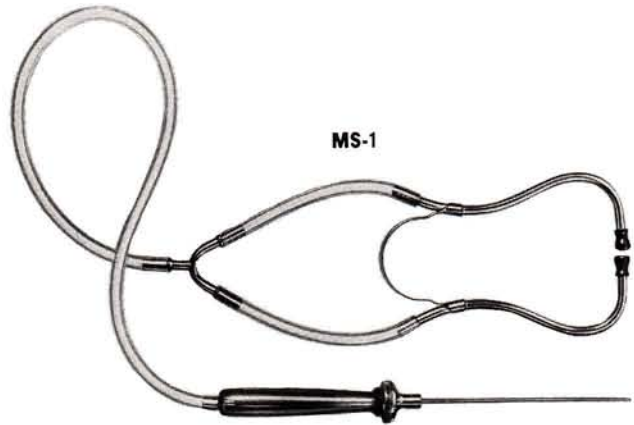

MULTISCOPE AND MISCELLANEOUS TOOLS

348 FORGED STEEL SCRAPER (H-91648)

Built for heavy duty scraping, removes hardened gaskets, carbon deposits, cleans mating surfaces. Alloy tool steel with 1" wide chisel edge. 8" long, plastic handle. Weight each—.27 lbs.

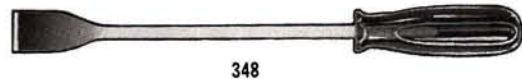

343 PUTTY KNIFE AND SCRAPER (H-91643)

Semi-stiff blade 1 1/4" wide, plastic handle. Weight each—.16 lbs.



347 PUTTY KNIFE AND SCRAPER (H-91647)

Stiff blade with chisel edge, 1 3/8" wide, plastic handle. Weight each—.19 lbs.



380-9 MAGNETIC PICK-UP TOOL (H-91811)

Hinged head, 9" long. Weight each—.10 lbs.



380-27 MAGNETIC PICK-UP TOOL (H-91812)

Hinged head, 27" long max., telescopes to 16 1/2". Weight each—.43 lbs.

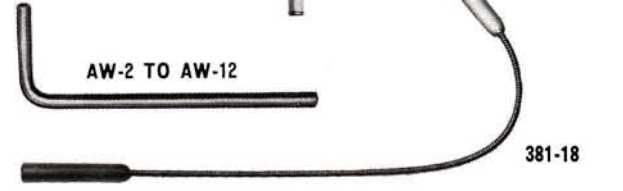

381-18 FLEXIBLE MAGNETIC PICK-UP TOOL (H-91815)

Spring wound wire shaft for flexibility, 18" long. Weight each—.22 lbs.



HEX KEY WRENCH SETS

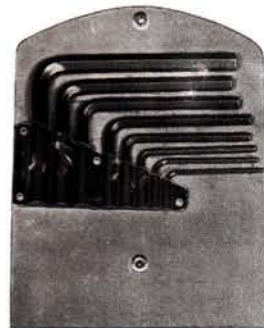

AW 80R

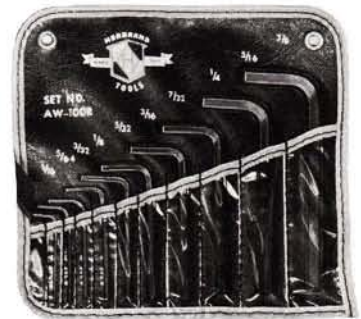

AW 100R

AW-80R 8 KEY SET (H-82080)

One each—AW—2 1/2, 3, 4, 5, 6, 7, 8, 10 in Roll KAW-80 (H-87027)

AW-100R 10 KEY SET (H-82100)

One each—AW—2, 2 1/2, 3, 4, 5, 6, 7, 8, 10, 12 in Roll KAW-100 (H-87018)

HEX-KEY WRENCHES, Allen type
Tempered alloy steel, black Parkerized finish

Part Number	Stock Number	Hex Size	Dimensions	Wt. Ea. Lbs.
AW-2	(H-29020)	1/16	1 3/4 x 1 1/16	.003
AW-2 1/2	(H-29025)	5/64	1 7/8 x 1 1/16	.006
AW-3	(H-29030)	3/32	2 x 3/4	.008
AW-4	(H-29040)	1/8	2 1/4 x 7/8	.012
AW-5	(H-29050)	5/32	2 5/16 x 1	.020
AW-6	(H-29060)	3/16	2 3/4 x 1 1/8	.031
AW-7	(H-29070)	1/32	3 3/8 x 1 1/4	.050
AW-8	(H-29080)	1/4	3 7/16 x 1 1/4	.075
AW-10	(H-29100)	5/16	3 7/8 x 1 1/8	.125
AW-12	(H-29120)	3/8	4 5/16 x 1 3/4	.200

CYLINDER DEGLAZING HONES—BRAKE HONE

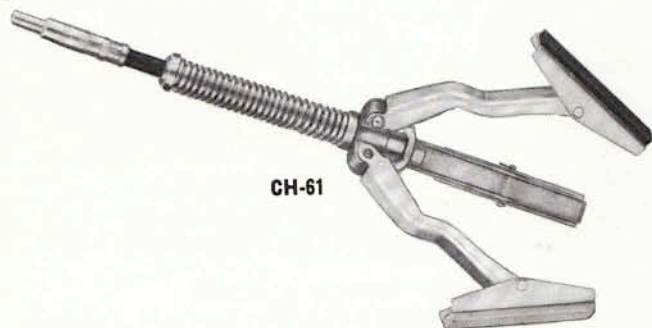

CH-61

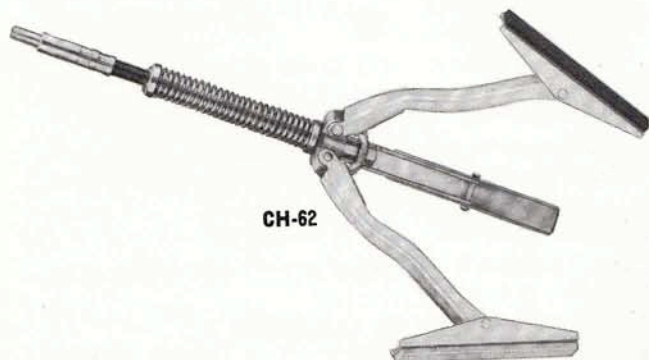

CH-62

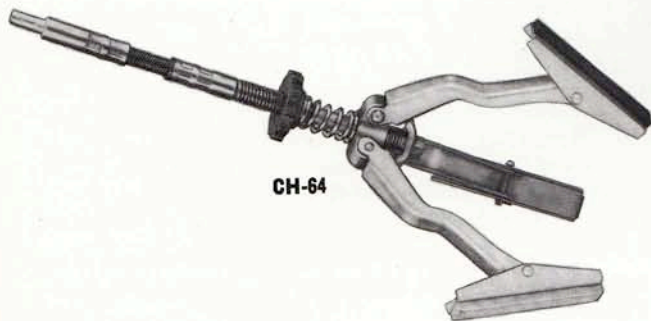

CH-64



CH-63

HERBRAND deglazing hones cover requirements for cylinder bores from 3/4 inch diameter through 7 1/4 inches. 3 arm hones, except CH-63, carry 2 stones and 1 felt insert to eliminate "chatter." These hones are designed to provide a superior cylinder wall finish for any engine large or small. All with self aligning, flexible joint drive.

CH-61 (H-92210)

Hone provides pre-set fixed spring tension for permanently correct pressure upon cylinder walls. Furnished with 3" long, medium grit stones. For cylinder diameters 2" to 5 1/4". Drive diameter 2.60".

CH-62 (H-92220)

Same construction as CH-61 but with longer arms. Furnished with 4" long, medium grit stones. For cylinder diameter 2" to 7 1/2". Drive stud diameter 2.60".

CH-64 (H-92240)

Fully adjustable spring tension for all cylinders 2" to 5 1/4" diameter. Furnished with 3" long medium grit stones. Drive stud diameter 2.60".

CH-63 (H-92230)

Small engine and brake cylinder hone. Adjustable spring tension, will bottom in blind holes and service step-cut cylinders. Furnished with 3 stones, 280 grit. Capacity 3/4" to 2 1/4" diameter. For best results, drive with 1/4" high speed electric drill.

REPLACEMENT SETS—2 Stones and 1 Felt

Hone Number	Stone Length	REPLACEMENT NUMBER 220 Grit	REPLACEMENT NUMBER 400 Grit
CH-61	3"	CH-61C	CH-61F
CH-62	4"	CH-62C	CH-62F
CH-62	3"	CH-61C	—
CH-64	3"	CH-61C	CH-61F
CH-63	1 1/8"—3 Stone, 280 grit	CH-63R	

Neither stones, nor flexible drive is replaceable for damage of any kind.

ENGINE SERVICE TOOLS

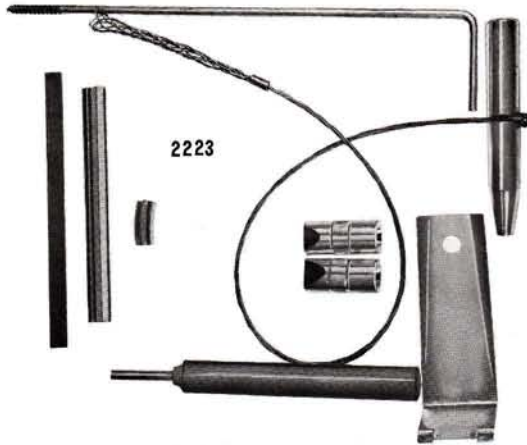
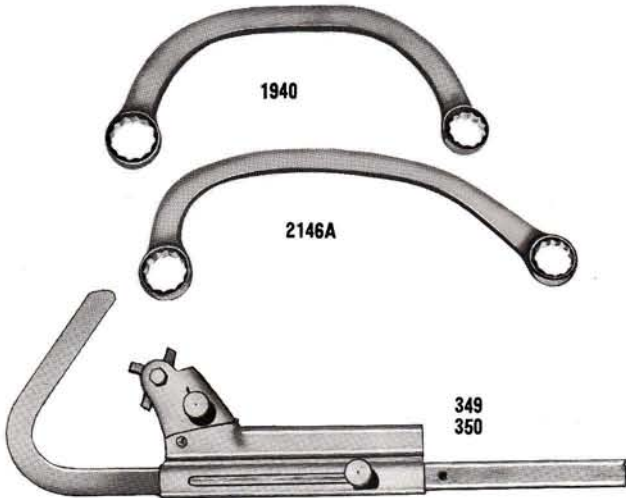

PISTON RING COMPRESSORS

Compressor body is blued spring steel. Windup mechanism drive key with each tool. Brake holds rings compressed on piston.

RC-15 RING COMPRESSOR (H-92340)

Capacity 1 1/2"-5" diameter. Width 1", Friction Brake, Single band. Weight each—.25 lbs.

RC-25 RING COMPRESSOR (H-92341)

Capacity 1 1/2"-3" diameter. Width 2", Friction Brake, Single band. Weight each—.31 lbs.

RC-35 RING COMPRESSOR (H-92342)

For Volkswagen, Corvair, etc. Narrow width, single band type with screwdriver slot drive for friction brake windup mechanism. Weight each—.25 lbs.

RC-50 RING COMPRESSOR (H-92343)

Capacity 2 1/8"-5", Width 3 1/2", Ratchet Brake, Double band. Weight each—.74 lbs.

RCT-50 TRUCK RING COMPRESSOR (H-92344)

Capacity 3 1/2"-7", Width 3 1/2", Ratchet Brake, Double band. Weight each—.81 lbs.

RCT-150 TRUCK RING COMPRESSOR (H-92345)

Capacity 3 1/2"-7", Width 6 1/2", Ratchet Brake, 4 Bands. Weight each—1.64 lbs.

STARTER AND MANIFOLD WRENCHES

Half-Moon style.

2146A (H-24946)

9/16 x 5/8, 12 point.

1940 (H-24940)

5/8 x 3/4, 12 point.

PISTON RING GROOVE CLEANERS

For piston diameters 2" thru 5".

349 (H-92303)

Four blade cutter cleans grooves 3/32"-1/8"-5/32" and 3/16". Length 11 1/4". Weight each—.52 lbs.

349B (H-92303-02)

Replacement cutter for No. 349.

350 (H-92304)

Four blade cutter cleans grooves 5/64" (2 blades)—5/32" and 3/16". Weight each—.52 lbs.

349C (H-92304-02)

Replacement cutter for No. 350.

2223 UPPER MAIN BEARING SEAL TOOL

(H-92313)

17 piece set removes and installs seal without dropping crankshaft. This set includes such small tools and accessories as are necessary to seal removal and replacement. Weight—.48 lbs.

1132 SCRATCH BRUSH (H-92132)

A good quality wood handle brush. 19 rows of straight wire bristles securely fastened. Handle curved. Length bristle section, 5 1/2", width 3/4"; O.A.L. 14". Weight—.39 lbs.

1137 WIRE CIRCULAR BRUSH (H-92137)

Finest quality, special crimped wires securely locked in steel hub to provide maximum density and long life. Standard 2" arbor hole with interchangeable adapters. Diameter 6", thickness 1 1/6". Weight each—2.00 lbs.

1138 CARBON REMOVAL BRUSH (H-92138)

Crimped wire bristles 1" long, brush diameter 1", shaft diameter 1/4". Weight each—.22 lbs.

1139 CARBON REMOVAL BRUSH (H-92139)

Heavy duty type with cabled bristles as shown in illustration. Dimensions and weight, same as No. 1138.

ENGINE SERVICE TOOLS

VL-525 HYDRAULIC VALVE LIFTER PULLER (H-91925)

For quick, efficient removal of any hydraulic valve lifter from straight or "V" type engine. Unnecessary to remove camshaft—pulls from top of engine. Completely assembled unit is 12" long. Weight each—1.05 lbs. (Unit is not guaranteed against damage of any description.)

VALVE LIFTERS, "C" TYPE

Deep throat lifters, designed to service O.H.V. and L-head engines without manifold removal. Positive adjustment to valve length, slide locks compressed spring leaving both hands free.

VL-545 (H-91945)

For springs 1" to 2" dia. Includes 1 set medium offset jaws, for O.H.V. engines. Height 9 3/4", Width 7". Weight each—5.00 lbs.

VL-550 (H-91950)

Fits springs 1" thru 2 1/2" dia. For L-head and O.H.V. engines. Includes jaw sets listed below. Height 10 1/2", Width 9 1/2". Weight each—7.00 lbs.

JAW SETS FOR LIFTER ABOVE

VL-551 (H-91951)

Straight, capacity 1"—1 3/4". Weight—.25 lbs.

VL-552 (H-91952)

Large, straight, capacity 1 1/2"—2 1/2". Weight—.25 lbs.

VL-553 (H-91953)

High Offset, Capacity 1"—1 3/4". Weight—.25 lbs.

VL-530 SPLIT LOCK REPLACER (H-91940)

The handiest tool made to hold and position valve stem split locks. Holds locks so firmly they cannot drop out until released in position. Works easily in smallest area. O.A.L. 8 1/4". Weight each—.219 lbs.

VL-540 SCREW TYPE VALVE LIFTER (H-91920)

Short, compact and rugged, this lifter is recommended for all L-head engines. Length 9". Weight each—1.32 lbs.

T-100 TAPPET ADJUSTER (H-92320)

For adjusting tappets O.H.V. engines. The spring loaded blade moves freely inside handle to permit user's hand to remain steady when engine is in operation. Notched tip keeps blade from slipping off the adjustment screw. O.A.L. 7". Weight each—.19 lbs.

T-200 FORD TAPPET ADJUSTER (H-29920)

Flex-box hinged action for ease of adjustment and reduced wear on tool and adjustment nuts. Knurled handle, bright finish. 8 1/2" long. Weight each—.50 lbs.

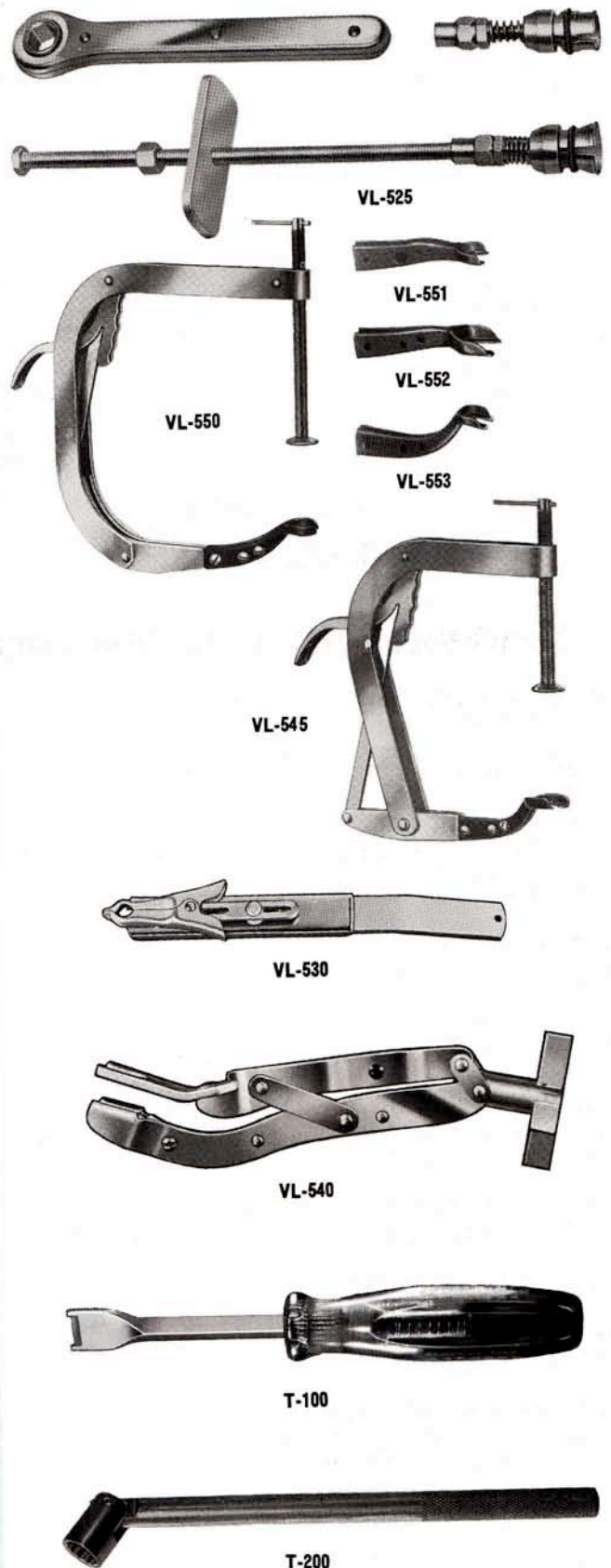

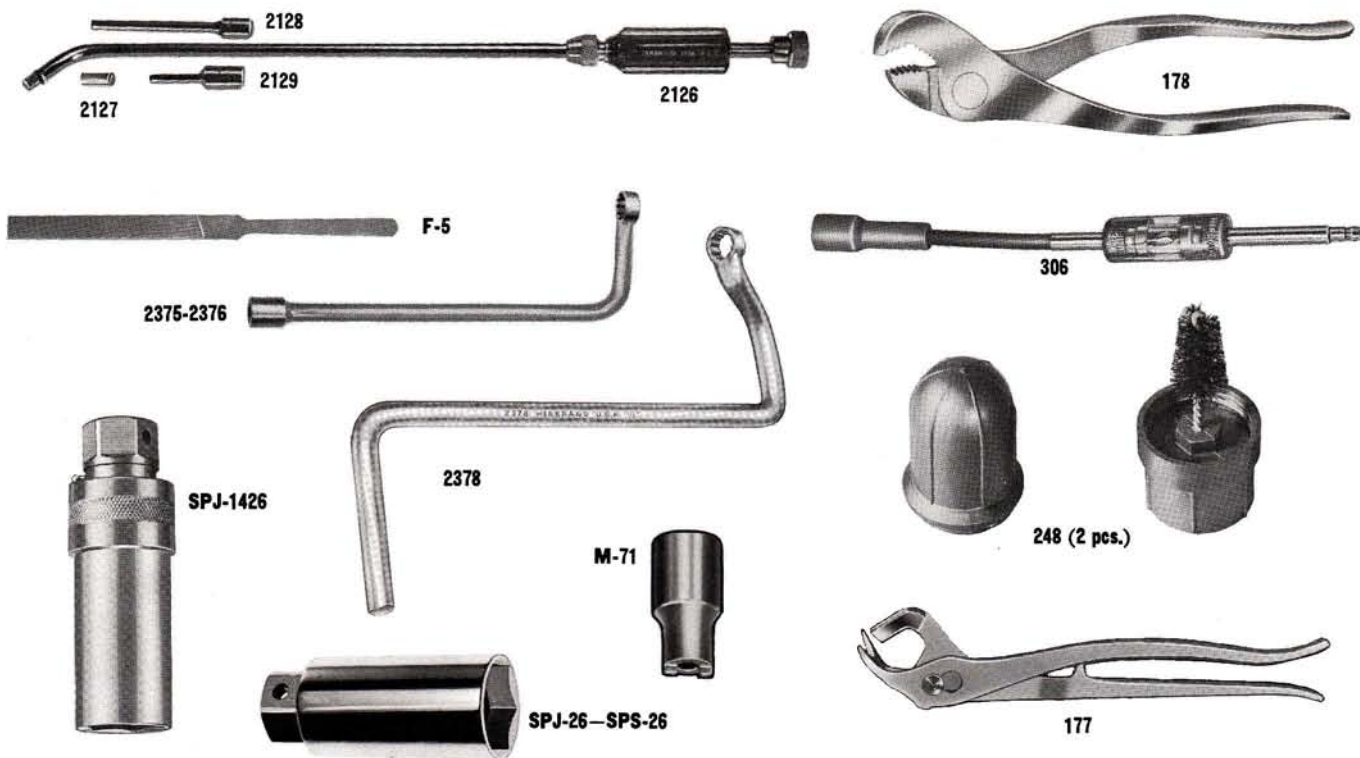

IGNITION AND TUNE-UP TOOLS

2125 CARBURETOR AND DISTRIBUTOR ADJUSTING SET (H-92306)

4 pieces described below. A safer, faster way to adjust idle air screws and Delco "window" distributors.

2126 HANDLE (H-92307)

1/4" drive square on offset shank with adjustable locking handle. 16 inch length makes it easy to watch Tach while setting idle screws.

2127 (H-92308)

Self-locating idle air screwdriver socket.

2128 (H-92309)

Holley idle adjustment screw driver, self-locating.

2129 DELCO HEX BIT (H-92310)

For setting points in Delco "window" Distributors. A must if you use a dwellmeter.

F-5 DISTRIBUTOR POINT FILE (H-91552)

Double cut, 5 1/4" long, 5/16" wide. Weight each—.022 lbs.

2375 DISTRIBUTOR WRENCH (H-24905)

12 point, 1/2" box, 8" long, use with 3/8" square drive handle. Fits Ford, Lincoln and Mercury. Weight each—.438 lbs.

2376 DISTRIBUTOR WRENCH (H-24906)

12 point, 9/16" box, 16 1/2" long. Use with 3/8" square drive handle. Fits G. M. vehicles. Weight each—.500 lbs.

2378 DISTRIBUTOR WRENCH (H-24948)

12 point, 1/2" box, 12" long. Especially for Falcon and Econoline. Weight each—.88 lbs.

M-71 CHEVROLET DIST. POINT SOCKET (H-39230)

1/4" square drive. Absolutely required to install points in Chev. 6 cylinder distributors. Weight each—.031 lbs.

178 BATTERY PLIERS (H-18217)

Thin hooked-nose jaw, sharp, milled teeth. Chrome plate. 7 1/2" long. Weight each—.375 lbs.

SPJ-26 3/8" DRIVE SPARK PLUG SOCKET (H-39326)

Spark plug holding socket also has 3/4" male driving hex—rubber liner. 6 point, 13/16" opening. Chrome plate. Weight each—.275 lbs.

SPS-26 1/2" DRIVE SPARK PLUG SOCKET (H-39426)

Same as SPJ-26, except for drive size. Weight each—.275 lbs.

SPJ-1426 3/8" DRIVE SPARK PLUG SOCKET (H-39330)

Ratcheting spark plug holding socket. Has built-in reversible ratchet mechanism, 6 point, 13/16" opening, rubber liner, 3 1/2" long. Weight each—.48 lbs.

306 NEON TUBE SPARK TESTER (H-92302)

Connects between spark plug and plug wire to check "fire" to plug. Has connector sleeve for use as timing light adapter. For all electric ignition engines of 1 or more cylinders.

248 BATTERY TERMINAL BRUSH (H-92100)

Internal and External wire brushes, clean battery post and cable terminal surfaces. In two piece plastic housing. Weight each—.25 lbs.

177 BATTERY TERMINAL LIFTER-SCRAPER (H-18210)

Lifts cable terminal with no damage to battery post or cell cover. Separates easily to make post scraper and terminal reamer. Alloy steel, chrome plated. 10 1/2" long. Weight each—.86 lbs.

FOR TIMING LIGHTS, ELECTRICAL TEST METERS, GAUGES AND OTHER TUNE-UP EQUIPMENT, See the Herbrand Test Equipment Catalog.

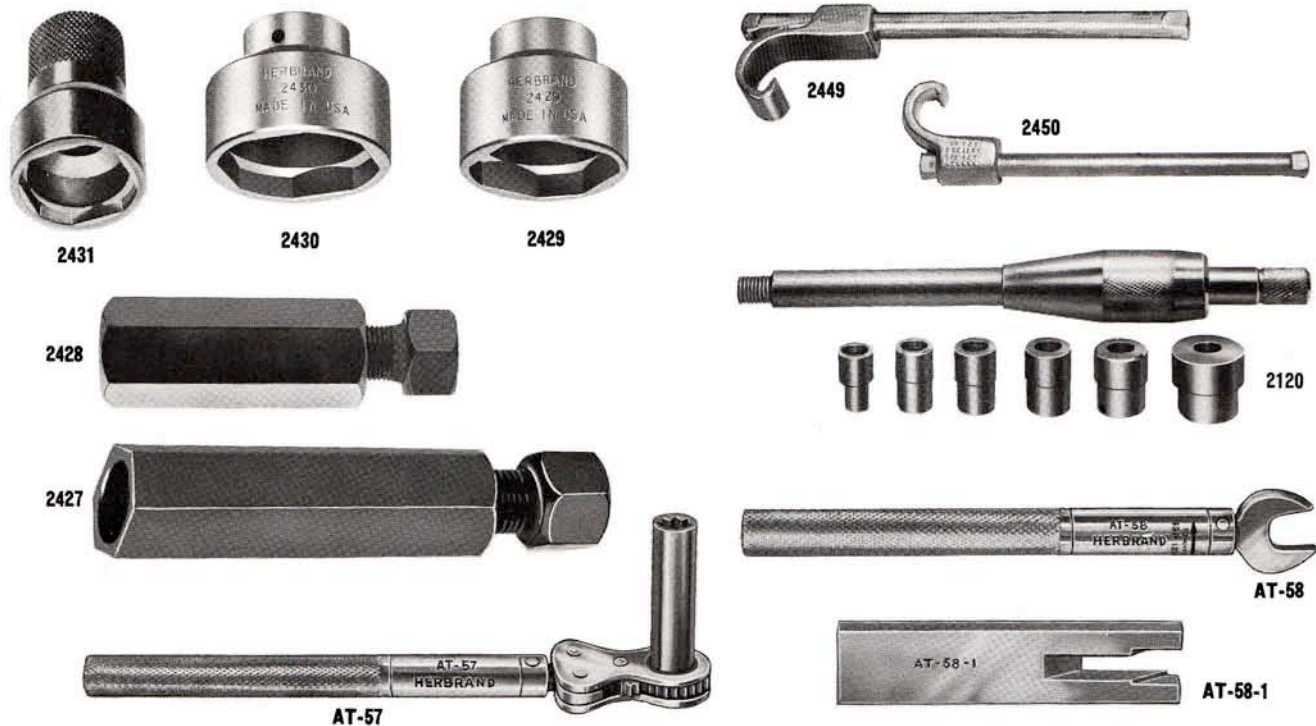

FRONT END—CLUTCH and TRANSMISSION TOOLS

BALL JOINT SOCKETS (Chrysler)

2429 BALL JOINT SOCKET (H-92180)

3/4" Drive. For Plymouth and Dodge 2 7/16" O.D., 2" long. Weight each—1.125 lbs.

2430 BALL JOINT SOCKET (H-92181)

3/4" Drive. For Chrysler, DeSoto, and Imperial. 2 21/32" O.D., 2 1/16" long. Weight each—1.625 lbs.

2431 BALL JOINT SOCKET (H-56813)

3/4" Drive. For Valiant and Lancer. 2 1/4" O.D., 3 9/16" long. Weight each—1.182 lbs.

2428 BALL JOINT REMOVER (H-56808)

An essential tool for safely separating Chrysler ball joint assemblies. Weight each—.375 lbs.

2427 BALL JOINT REMOVER (H-56820)

Valiant and Lancer. 4" O.A.L. Weight each—.31 lbs.

TIE ROD SLEEVE SPREADER AND ADJUSTING TOOL

Tool hooks into tie rod sleeve slot for positive grip while adjusting. Handle slides through head for greater working clearances. Head is alloy steel forging.

2449 TIE ROD SPREADER (H-56830)

Serves standard passenger cars and light trucks. Weight each—.52 lbs.

2450 TIE ROD SPREADER (H-56829)

Smaller throat, for compacts. Weight each—.50 lbs.

2120 CLUTCH ALIGNING TOOL (H-92120)

Aligns clutch disc and pressure plate for assembly to fly wheel. Consists of mandrel and sleeve with 6 step cut pilots for 12 sizes: .561 and .590; .614 and .624; .668 and .718; .749 and .787; .812 and .874; and .984 and 1.181. Heat treated and hardened, bright finish. Weight per set—2.25 lbs.

FORD TRANSMISSION ADJUSTING TOOLS

AT-58 PRESET OPEN END TORQUE WRENCH (H-27560)

This tool has a preset torque of 48 inch pounds; used with the AT-58-1 adjusting gage, this tool is designed to "click" as it overruns the torque setting. Rear band (reverse). Equivalent to Ford No. T59P-77423-A. Weight each—.312 lbs.

AT-58-1 ADJUSTING GAGE (H-27570)

Enables the mechanic to make simple, accurate adjustments of rear band (reverse) when used with No. AT-58. Equivalent to Ford No. T59P-77409-A. Weight—.312 lbs.

AT-57 PRESET TORQUE RATCHET (H-27580)

This ratchet with 5/16 inch, 8-point socket opening, is preset to a torque of 10 foot pounds used to adjust front band (low) on the two speed Ford-o-matic. Equivalent to Ford No. T59P-77370-A. Weight—.625 lbs.

AT-95 SET (H-27590)

Includes above three items in handy, leatherette container. Weight—1.300 lbs.

LUBRICATION TOOLS

193 DRAIN PLUG WRENCH (For Female Plugs) (H-29993)

Includes the 7 sizes required to service most cars and trucks. Drop forged alloy steel. Square lugs, sizes: 9/32", 5/16", 3/8", 7/16", 1/2", 9/16", 5/8". All satin finish. Length 8 3/16". Weight each—.776 lbs.



193

194 DRAIN PLUG WRENCH (For Male Plugs) (H-29994)

Includes 7 sizes covering most square or hex male plugs, 8 point: 1/2", 9/16", and 3/4", 6 point: 3/4", 15/16", 1" and 1 1/8". Drop forged alloy steel, heat treated and all satin finish. Length 9 3/32". Weight each—.650 lbs.



194

195 VOLKSWAGEN FILLER WRENCH (H-29995)

3/8" square drive—17mm. male hex. 3" long. Fits plugs for both differential filler and crank case drain. Bright plated finish. Weight each—.25 lbs.



195

196 UNIVERSAL OIL FILTER REMOVING AND REPLACING TOOL (H-92301)

Cam acting. Eliminates clearance problems. Works equally well on either vertical or horizontal filters on every American made car. 3/8" square drive. Weight each—.375 lbs.



196

198 ZERK CLEANER (H-92346)

Strike plunger with sledge, oil pressure blows out hardened grease. Use on straight or angle fitting. 5" long, 1/2" dia. (FSN 5120-912-3610).



198

199 CORVAIR-VALIANT DIFFERENTIAL FILTER PLUG TOOL (H-29999)

8 pt. socket end for Corvair differential filler plug and 1/2" hex end for Valiant differential filler plug. Bright finish all over. 8 5/8" long. Weight each—.750 lbs.



199

J-42 3/8" HEX FILLER PLUG WRENCH (H-41387)

For Ford and Mercury Differential Plug—3/8" Hex.—3/8" drive—3 1/8" long. Weight each—.132 lbs.



J-42

S-42 FILLER PLUG WRENCH (H-39471)

9/16" Hex. Has 1/2" drive and 9/16" hex to fit Chrysler Corp. cars using female differential carrier plug. Tool is 1 1/2" long 7/8" diameter. Weight each—.138 lbs.



S-42

J-43 TWO-IN-ONE SOCKET, STOP LIGHT AND OIL PRESSURE LIGHT SWITCH (H-39350)

3/8" drive, 2" long. Double recess services both switches. Weight each—.375 lbs.



J-43

BRAKE SERVICE TOOLS

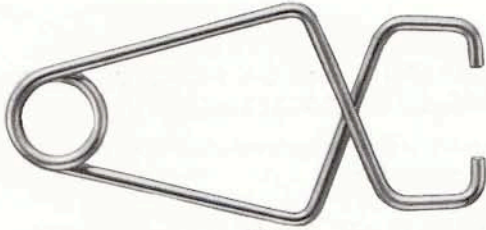

275

275 BRAKE CYLINDER CLAMP SET (H-92175)

Set of 4 spring clamps. Holds pistons in wheel cylinders when brake shoes are removed. Weight per set—.75 lbs



300

300 STAR NUT ADJUSTING SPOON (H-92150)

Notched design for clearance on G.M. compacts. Services standard Bendix brakes also. 9 3/16" long. Chrome plate. Weight each—.313 lbs.



301

301 STANDARD ADJUSTING SPOON (H-92151)

For most brakes, except Chevrolet. 7 1/2" long. Weight each—.213 lbs.



302

302 BENDIX BRAKE ADJUSTER (H-92152)

Latest maximum clearance type. 9 3/4" long. Weight each—.300 lbs.



303

303 CHEVROLET ADJUSTING SPOON (H-92153)

Special narrow width, 7" long. Weight each—.144 lbs.



250

250 BRAKE BLEEDER WRENCH (H-24922)

3/8" x 7/16" deep offset 6 point box openings, easily bleeds and adjusts Chrysler and most other makes. 8 1/2" long. Weight each—.188 lbs.



251

251 REAR AXLE SPEED NUT SOCKET (H-92171)

Removes and replaces speed nuts on Ford and Olds rear axles. A real time saver. Chrome plate, 3/8" drive. Weight each—.288 lbs.

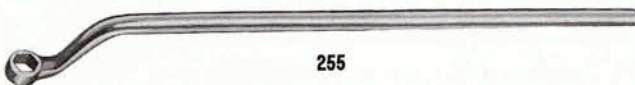

255

255 CHRYSLER CENTER PLANE BRAKE ADJUSTING WRENCH (H-24920)

7/16" 6 point opening, deep offset, (to clear tires). 12" long. Alloy steel, chrome plate. Weight each—.419 lbs.



2200

2200 SHOCK ABSORBER TOOL (H-92311)

Sockets in ends of "T" holds shaft from turning. Tapped hole in leg makes it a handle to pull shock through spring. 5 3/4" long. Weight each—.500 lbs.

BRAKE SERVICE TOOLS



J-43 STOP LIGHT AND OIL PRESSURE TELLTALE SWITCHES, 2 IN 1 SOCKET (H-39350)

Double recess to handle both switches. 3/8" drive, 2" long. Weight each—.375 lbs.

260 CENTER PLANE BRAKE TOOL (H-92160)

Removes and replaces Chrysler brake springs. 8" long with 4" offset. Weight each—.250 lbs.

261 BRAKE SPRING REMOVAL AND REPLACEMENT TOOL (H-92161)

With Bendix type remover socket. Weight each—.4 lbs.

263 PARKING BRAKE SPANNER (H-29963)

Adjusts splined brake adjusting nut on Chrysler built vehicles. 3" length clears frame members. Weight each—.20 lbs.

264 THREE-WAY BRAKE SPRING TOOL (H-29964)

One end removes Bendix brake shoe springs. Second end replaces springs. Third end is anti-rattle spring tool with slotted tip. Weight each—.63 lbs.

183 BRAKE SPRING PLIERS (H-18223)

13 1/2" long. Removes and replaces brake springs. Weight each—.812 lbs.

183A UNIVERSAL BRAKE SPRING PLIERS (H-18233)

Same as No. 183 above, but has Bendix spring removing socket in addition. Weight each—.825 lbs.

183B (H-19001)

Replacement socket and pin for No. 183A pliers.

265 BRAKE SHOE RETAINER TOOL (H-92165)

Installs and removes coil and hairpin type brake shoe retaining springs, 6" long. Weight each—.187 lbs.

270 BRAKE BLEEDER WRENCH (H-29970)

3/8" and 1/4" vented sockets permits brake bleeding without removing wrench. Satin finish. Weight each—.25 lbs.

271 RAMBLER BRAKE BLEEDER WRENCH (H-24921)

1/4" hex opening fits most compacts. 5" long, satin finish. Weight each—.063 lbs.

CH-63 BRAKE CYLINDER HONE (H-92230)

Adjustable for wheel and master cylinders (3/4" to 2 1/4"). Not for Disc Brakes. 280 grit stones. Flexible drive with 1/4" shank. Weight each—.31 lbs.

HAMMERS

HERBRAND hammers are drop forged from alloy steels and carefully heat treated and tempered to avoid chipping. Hammer faces and pein are smoothly finished and polished.

Handles are top grade, second growth hickory thoroughly seasoned and accurately fitted in the heads to prevent loosening.

HERBRAND VAN-CHROME ball pein hammer standards for quality are the highest.

Part Number	Stock Number	Weight of Head	Length	Weight Complete
BP-2	(H-90201)	2 oz.	9½"	.237
BP-4	(H-90202)	4 oz.	9¾"	.350
BP-8	(H-90205)	8 oz.	11½"	.650
BP-12	(H-90206)	12 oz.	13"	1.075
BP-16	(H-90207)	16 oz.	14"	1.338
BP-20	(H-90208)	20 oz.	14½"	1.538
BP-24	(H-90209)	24 oz.	14¾"	1.800
BP-32	(H-90210)	32 oz.	15½"	2.400
BP-40	(H-90211)	40 oz.	16½"	3.100

1164 3 LB. SLEDGE HAMMER (H-90233)

Head length, 5". Weight each—3.412 lbs.

SOFT FACE HAMMERS AND TIPS

Tough, amber plastic tips prevent damage to work.

Part Number	Stock Number	Weight (oz.)	Part Number Tips	Stock Number	Face Dia.
602H	(H-90220)	1½	602TP	(H-90220-02)	5/8"
604H	(H-90221)	4	604TP	(H-90221-02)	7/8"
608H	(H-90222)	8	608TP	(H-90222-02)	1¼"
616H	(H-90224)	16	616TP	(H-90224-02)	1¾"
632H	(H-90226)	32	632TP	(H-90226-02)	1⅞"

NO. 126 SOFT BRONZE HAMMER (H-90232)

For driving easily damaged parts, head is made of soft bronze, polished and lacquered. Handle of second growth hickory. Length, 12". Weight each—2.00 lbs.

NO. 1133B RUBBER TIRE MALLET (H-90230)

Head molded of special tough resilient rubber. Also popular for body work as soft face bumping hammer. Head diameter 3", head length 4", O.A.L. 16". Weight each—1.88 lbs.

NO. 1144 2-WAY HAMMER (H-90234)

A dual use hammer having one head of tough drop forged steel, the other a replaceable molded resilient rubber. Extremely popular because of its tremendous striking power. Length 16". Weight each—2.38 lbs.

NO. 1130 TIRE HAMMER (H-90237)

One end a tapered wedge for striking bead; other end full striking face, corners rounded. Drop forged alloy steel, O.A.L. 14". Weight each—3.50 lbs.

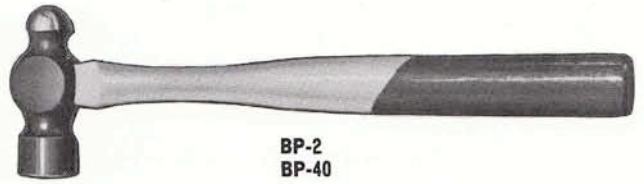

BP-2
BP-40



1164



602H TO 632H

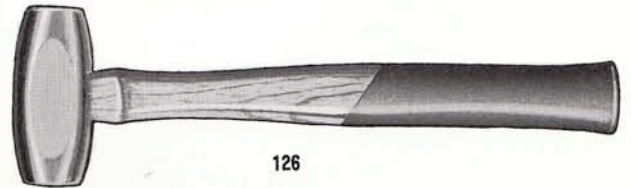

126



1133-B



1144

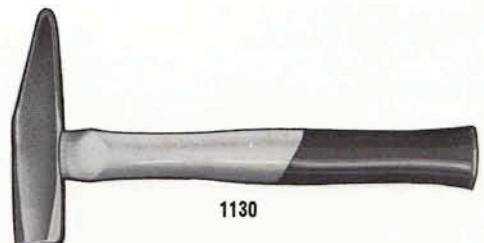

1130

WHEEL AND TIRE TOOLS

NO. 1056X FOUR-WAY RIM WRENCH (H-29156)

For passenger cars and light trucks. Arms are 22" long for wide fender clearance; 5/8" in diameter for extra strength. Tool steel with sockets accurately forged. Sizes 3/4", 13/16", 7/8" and 15/16". All satin finished. Weight each—4.15 lbs.

NO. 1057X FOUR-WAY TRUCK RIM WRENCH (H-29157)

5 opening sizes: 13/16" square and hexes 1 1/16", 1 1/8", 1 1/4" and 1 1/2"; length arms, 27". Weight each—15.00 lbs.

TIRE IRONS—SPOON TYPE

Broad, thin paddle shaped blades take hold of larger area to lift tire from rim with minimum effort. Two lengths in both straight and curved style to cover passenger cars and trucks. Selected tool steel, specially tempered. All satin finish.

NO. 1126 STRAIGHT (H-92141)

18" long. Weight each—2.00 lbs.

NO. 1126T STRAIGHT (H-92142)

23" long. Weight each—2.62 lbs.

NO. 1127 CURVED (H-92143)

18" long. Weight each—2.00 lbs.

NO. 1127T CURVED (H-92144)

23" long. Weight each—2.60 lbs.

NO. 1134 TWIN IRONS (H-92134)

"No Pinch" design for tube type tires also protects sealing area of tubeless tires. Drop forged, satin finish. Length 18", weight each—2.00 lbs.

ALL HERBRAND wrenches are hot forged from solid bars of carefully selected steels. Socket ends are evenly faced off to permit firm seating of the wrench and prevent dangerous tilt or roll off action when using extra high leverage.

HERBRAND wrenches are all provided with broached hexagonal cross handle holes to fit the hexagonal handle for powerful, non-slip leverage. Each wrench is carefully heat treated. Finished in non-peeling Black Oxide.

1150A DOUBLE END RIM WRENCH (H-29201)

3 opening sizes: 13/16" square, 1 1/8" hex and 1 1/2" hex. 16 1/4" long. Weight each—4.75 lbs.

1150B DOUBLE END RIM WRENCH (H-29202)

3 opening sizes: 5/8" square, 7/8" hex and 1 1/4" hex. 15 7/8" long. Weight each—4.25 lbs.

1150D DOUBLE END RIM WRENCH (H-29204)

2 opening sizes: 7/8" hex and 1 1/16" hex. 15 7/8" long. Weight each—3.88 lbs.

1150F DOUBLE END RIM WRENCH (H-29206)

2 opening sizes: 1 1/16" hex and 1 1/4" hex. 15 7/8" long. Weight each—3.88 lbs.

1150K DOUBLE END RIM WRENCH (H-29211)

2 opening sizes: 15/16" hex and 1" hex. 16" long. Weight each—4.063 lbs.

HEX LEVERAGE BARS FOR ABOVE WRENCHES, WITH HEX SOCKET AT ONE END

1150C LEVER BAR (H-29203)

With 1 1/16" hex. opening—20" long. Weight each—3.00 lbs.

1150E LEVER BAR (H-29205)

With 1 3/16" hex. opening—20" long. Weight each—3.06 lbs.

1152H LEVER BAR (H-92147)

Straight, no socket 20" long. Weight each—2.75 lbs.

NO. 1140 SIDE RING TOOL (H-92140)

Improved design to accommodate practically all truck rims. Does the work of several ordinary similar tools. Specially heat treated and tempered. All satin finish. Length 22". Weight each—2.125 lbs.



1126
1126T



1127
1127T



1134



1150A 1150F
1150B 1150K



1150D



1150C
1150E



1152H



1140

TRUCK RIM WRENCH SETS

NO. 1150T SET (H-82050)

Consists of 1 each: 1150A, 1150B and 1150C. Weight—12.00 lbs.

NO. 1152F SET (H-82052)

Consists of 1 each: 1150A and 1150C. Weight—7.50 lbs.

BODY AND FENDER HAMMERS

MULTIFIT BODY AND FENDER HAMMERS

HERBRAND hammers are drop forged in special, multiple impression dies for maximum grain refinement of carefully selected tool steels. Working faces are accurately machined and carefully polished for ultra smoothness. Atmosphere controlled hardening operations insure durable faces even under severe use. Perfectly balanced, each hammer is securely fastened to special top quality second growth hickory handles.

NO. BF-1 LONG BALL-END, FINISH HAMMER (H-90248)

For dual use. Ball end for raising low spots smoothly, and round flat finishing face. Face diameter 1 5/8". Head 6" O.A.L. Clearance, ball to handle 3 5/8". Length 12". Weight—.875 lbs.

NO. BF-2 SHRINKING AND BUMPING HAMMER (H-90242)

New, extra wide round and square smooth faces needed to shrink metal after heating. Round face diameter 1 7/8", square face 1 5/8". Head 4 1/4" O.A.L. Clearance 1 5/8". Length 12". Weight—1.00 lbs.

NO. BF-4 LOW SPOT, LONG PICKING HAMMER (H-90241)

Special designed pick end for use thru coating or insulated material to peck out low spots while filing. Round face diameter 1 5/8" with 1 5/8" clearance. Pick end clearance 3 5/8". Head 6" O.A.L. Length 12". Weight—.75 lbs.

NO. BF-5 LOW SPOT, SHORT PICKING HAMMER (H-90246)

Extra sharp picking point for small low spots, with perfectly balanced finishing head. Round face diameter 1 5/8" with a 1 5/8" clearance. Pick point clearance 2 3/4". Head 5 3/8" O.A.L. Length 12". Weight—.813 lbs.

NO. BF-8 DINGING HAMMER (H-90244)

The only perfectly balanced double round-face dinging hammer with deep clearance. Hits solid flat blow in hard-to-reach places. Large head diameter 1 5/8", clearance 2 3/8". Small head diameter 1 1/4", clearance 2 3/4". Head 6 1/8" O.A.L. Length 12". Weight—1.00 lbs.

NO. BF-12 NEW SHRINKING AND FINISHING HAMMER (H-90249)

Rounded corners on cross-milled face shrinks metal faster and with less damage than square-cornered types. Head diameter 1 1/2". Head 4 1/4" O.A.L. Length 12". Weight—.875 lbs.

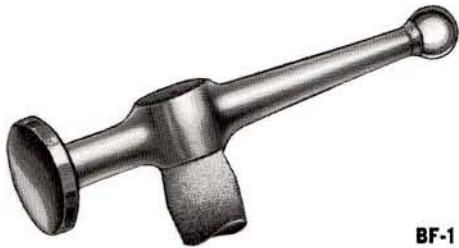

BF-1

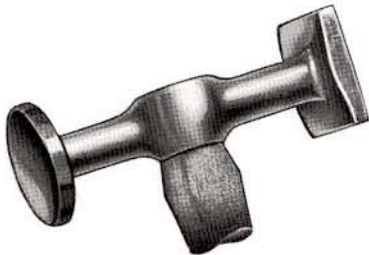

BF-2



BF-4



BF-5

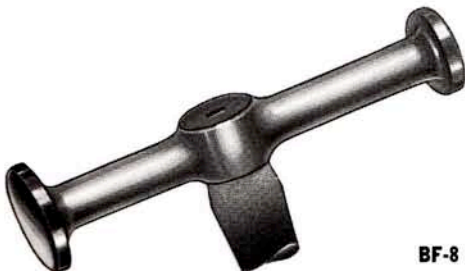

BF-8



BF-12

BF-51



BF-54



BF-55



BF-56



BF-57



BF-514



BF-92



BF-93



BODY AND FENDER TOOLS

MULTIFIT ANVIL AND DOLLY BLOCKS

All Herbrand Anvil and Dolly Blocks are departures from the "old style chunks of steel." Each Herbrand block is carefully forged of alloy steel, accurately ground and polished to special shapes and dimensions for the many needed special applications.

NO. BF-51 HEAVY WEIGHT UNIVERSAL ANVIL BLOCK (H-91751)

With its wide curved surfaces, multi-angle planes and undercuts, it fits a hundred special needs on body, fender or door work. Solid hand grip for bumping. Anvil faces 3" x 2 7/8" and 1 3/4" x 4". Length 4", height 2 3/8", width 2 7/8". Weight—3.00 lbs.

NO. BF-54 ROOF WEDGE BLOCK (H-91754)

Sharp taper for driving out roof rails or bead, and for under fender braces. Wide end for moulding curved surfaces. Length 5 13/16", width 2 5/8", length 2 3/16". Weight—3.688 lbs.

NO. BF-55 TOE TYPE BLOCK (H-91755)

Ideal for shrinking and dinging flat panels. Thinness and length provide easy accessibility to narrow pockets. Size 3 1/8" x 2 1/4" x 1 1/16". Weight—2.50 lbs.

NO. BF-56 HEEL BLOCK (H-91756)

Designed especially to reach easily into sharp corners and wide radii. Size 3 1/8" x 2 3/8" x 1 7/16". Weight 2.50 lbs.

NO. BF-57 FLANGE AND ANVIL BLOCK (H-91757)

Handles many medium curve radii and flat-crown surfaces, excellent for dinging. Has several differently crowned working faces together with two beading and flange lips. Provides comfortable hand hold for dinging. Length 2 7/8", width 2 1/4" height 2 3/8". Weight—3.00 lbs.

MULTIFIT FILES AND HOLDER

File has special milled U-type, self cleaning teeth.

BF-514 14" FLEXIBLE FILE ONLY (H-91571)

Teeth on both sides. Weight—.625 lbs.

BF-550 SET OF 6 FILES NO. BF-514 WITH WOODEN HOLDER (H-84922)

Weight per set—4.63 lbs.

NO. BF-92 DOOR HANDLE TOOL (H-91792)

Plier type tool to remove interior retaining clip from door handles of G.M. and Ford cars. Has thin narrow jaws to slip under handle—steel construction—7 5/8" long. Weight—.163 lbs.

DOOR HANDLE CLIP REMOVER

NO. BF-93 DOOR HANDLE CLIP REMOVER (H-92121)

For removing Ford and G.M. late style long handles, saves upholstery, clips do not fly. Weight—.155 lbs.

WRENCH OPENINGS

NOMINAL WRENCH SIZE	AMERICAN STANDARD								U.S. STANDARD		S.A.E. STANDARD
	NUTS				BOLTS				National Coarse Bolts and Nuts	Cap Screws	National Fine Bolts, Nuts and Screws
	Finished & Finished Thick Series	Regular Series	Heavy Series	Machine Screw Nuts, Stove Bolt Nuts	Regular Series Bolts, Finished Bolts, Hex Head Cap Screws	Heavy Series Bolts and Finished Bolts	Lag Bolts	Set Screws			
5/32	—	—	—	#0 & #1	—	—	—	—	—	—	—
3/16	—	—	—	#2 & #3	—	—	—	#10	—	—	—
1/4	—	—	—	#4	—	—	—	1/4	—	—	—
5/16	—	—	—	#5 & #6	—	—	—	5/16	—	—	—
11/32	—	—	—	#8	—	—	—	—	—	—	—
3/8	—	—	—	#10	1/4 *	—	1/4	3/8	—	—	—
7/16	1/4	1/4	—	#12 & 1/4	1/4	—	—	7/16	—	1/4	1/4
1/2	5/16	—	1/4	—	5/16	—	5/16	1/2	1/4	5/16	5/16
9/16	3/8	5/16	5/16	5/16	3/8	—	3/8	9/16	—	3/8	3/8
19/32	—	—	—	—	—	—	—	—	5/16	—	—
5/8	—	3/8	—	3/8	7/16	—	7/16	5/8	—	7/16	7/16
11/16	7/16	—	3/8	—	—	—	—	—	3/8	—	—
3/4	1/2	7/16	7/16	—	1/2	—	1/2	3/4	—	1/2	1/2
25/32	—	—	—	—	—	—	—	—	7/16	—	—
13/16	—	1/2	—	—	9/16	—	—	—	—	9/16	—
7/8	9/16	9/16	1/2	—	—	1/2	—	7/8	1/2	5/8	9/16
15/16	5/8	—	9/16	—	5/8	—	5/8	—	—	—	5/8
31/32	—	—	—	—	—	—	—	—	9/16	—	—
1	—	5/8	—	—	—	—	—	1	—	3/4	—
1 1/16	—	—	5/8	—	—	5/8	—	—	5/8	—	3/4
1 1/8	3/4	3/4	—	—	3/4	—	3/4	1 1/8	—	3/8	—
1 1/4	—	—	3/4	—	—	3/4	—	1 1/4	3/4	1	3/8
1 5/16	7/8	7/8	—	—	7/8	—	7/8	—	—	—	—
1 3/8	—	—	—	—	—	—	—	1 3/8	—	1 1/8	—
1 7/16	—	—	3/8	—	—	3/8	—	—	3/8	—	1
1 1/2	1	1	—	—	1	—	1	1 1/2	—	1 1/4	—
1 5/8	—	—	1	—	—	1	—	—	1	—	1 1/8
1 11/16	1 1/8	1 1/8	—	—	1 1/8	—	1 1/8	—	—	—	—
1 3/4	—	—	1 1/8	—	—	1 1/8	—	—	1 1/8	—	1 1/4
1 7/8	1 1/4	1 1/4	—	—	1 1/4	—	1 1/4	—	—	—	—
2	—	—	1 1/4	—	—	1 1/4	—	—	1 1/4	—	1 3/8
2 1/16	1 3/8	1 3/8	—	—	1 3/8	—	—	—	—	—	—
2 1/8	—	—	1 3/8	—	—	1 3/8	—	—	1 3/8	—	1 1/2
2 1/4	1 1/2	1 1/2	—	—	1 1/2	—	—	—	—	—	—
2 3/8	—	—	1 1/2	—	—	1 1/2	—	—	1 1/2	—	—
2 1/2	1 5/8	1 5/8	—	—	1 5/8	—	—	—	—	—	—
2 5/8	—	—	1 5/8	—	—	1 5/8	—	—	1 5/8	—	—
2 3/4	1 3/4	—	—	—	1 3/4	—	—	—	—	—	—
2 1/2	—	—	1 3/4	—	—	1 3/4	—	—	1 3/4	—	—
2 13/16	1 7/8	—	—	—	1 7/8	—	—	—	—	—	—
2 15/16	—	—	1 7/8	—	—	1 7/8	—	—	1 7/8	—	—
3	2	—	—	—	2	—	—	—	—	—	—
3 1/8	—	—	2	—	—	2	—	—	2	—	—
3 3/8	2 1/4	—	—	—	2 1/4	—	—	—	—	—	—
3 1/2	—	—	2 1/4	—	—	2 1/4	—	—	2 1/4	—	—
3 3/4	2 1/2	—	—	—	2 1/2	—	—	—	—	—	—
3 7/8	—	—	2 1/2	—	—	2 1/2	—	—	2 1/2	—	—
4 1/8	2 3/4	—	—	—	2 3/4	—	—	—	—	—	—
4 1/4	—	—	2 3/4	—	—	2 3/4	—	—	2 3/4	—	—
4 1/2	3	—	—	—	3	—	—	—	—	—	—
4 5/8	—	—	3	—	—	3	—	—	3	—	—
4 3/4	—	—	—	—	—	—	—	—	3 1/4	—	—
5	—	—	3 1/4	—	3 1/4	—	—	—	3 1/2	—	—

*Regular square only.

REPRINTED IN U.S.A. 6-66 RAD-MAR PRESS, INC. TOLEDO, OHIO

Herbrand TOOLS

HERBRAND TOOLS



KELSEY-HAYES
TOOL DIVISION