

Report No. 4171166



ASW SONAR  
TECHNOLOGY REPORT

# ACOUSTIC TRANSMISSION IN AN OCEAN SURFACE DUCT

REPORT ON AN EXPERIMENT

PERFORMED BY

U. S. NAVY ELECTRONICS LABORATORY  
SAN DIEGO, CALIFORNIA

AND ANALYZED BY

ARTHUR D. LITTLE, INC.  
CAMBRIDGE, MASSACHUSETTS

DEPARTMENT OF THE NAVY  
NAVAL SHIP SYSTEMS COMMAND

NObsr-93055

Project Serial Number SF 101-03-21

Task 11353

NOVEMBER 1966

TC  
1501  
A7  
no. 4171166

Enclosure (1) to NAL Smr 162 C-35

MBL/WHOI



0 0301 0036079 8

Report No. 4171166

ASW SONAR  
TECHNOLOGY REPORT

ACOUSTIC TRANSMISSION IN AN  
OCEAN SURFACE DUCT

REPORT ON AN EXPERIMENT

PERFORMED BY

U. S. NAVY ELECTRONICS LABORATORY  
SAN DIEGO, CALIFORNIA

AND ANALYZED BY

ARTHUR D. LITTLE, INC.  
CAMBRIDGE, MASSACHUSETTS

DEPARTMENT OF THE NAVY  
NAVAL SHIP SYSTEMS COMMAND

NObsr-93055

Project Serial Number SF 101-03-21

Task 11353

NOVEMBER 1966



### ABSTRACT

Surface duct acoustical transmission measurements were performed in two areas of the Pacific Ocean. Three frequencies, three transmitter depths and three receiver depths were employed. Both areas demonstrated a persistent surface duct but they differed in that one water mass was stable and the other unstable. Experimental transmission loss curves gave good agreement with theoretical curves based upon normal mode theory. It was not possible to distinguish between the acoustic properties of the two areas either by the experimental transmission loss data or by an analysis of the observed signal variability.



### ACKNOWLEDGEMENT

We acknowledge with pleasure the advice and assistance of F. E. Hale, M. A. Pedersen, H. Westfall and R. F. Hosmer, Code 3185, U. S. Navy Electronics Laboratory, throughout the duration of this program. It is also a pleasure to record our appreciation of the interest shown in this work by Mr. B. King Couper, Code 1622B, U. S. Naval Ship Systems Command and by Dr. G. H. Curl, Code 3102, Coordinator of Ocean Sciences, U. S. Navy Electronics Laboratory.





## TABLE OF CONTENTS

	<u>Page</u>
Abstract	iii
Acknowledgment	v
List of Figures	ix
List of Tables	xi
I. INTRODUCTION	1
II. EXPERIMENTAL RESULTS	3
III. COMMENTS ON EXPERIMENTAL RESULTS	10
IV. EXPERIMENTAL TRANSMISSION LOSS DATA	15
V. REFERENCES	83
APPENDIX A - NARRATIVE DESCRIPTION OF EXPERIMENT	A-1
APPENDIX B - OCEANOGRAPHIC DATA	B-1
APPENDIX C - EXPERIMENTAL EQUIPMENT AND DATA REDUCTION	C-1



## LIST OF FIGURES

<u>Figure No.</u>		<u>Page</u>
1	Locations of Surface Duct Acoustical Experiments	2
2	Ping-to-Ping Signal Variability: Comparison Between Areas at 3000 cps	5
3	Ping-to-Ping Signal Variability: Comparison Between 700 cps, 1300 cps and 3000 cps in Area II	7
B-1	Tracks of USS Marysville, USNS Charles H. Davis and USS Rexburg in Boundary Water Region (Area I)	B-2
B-2	Tracks of USS Marysville, USNS Charles H. Davis and USS Rexburg in Transition Water Region (Area II)	B-3
B-3	A Thermal Profile Obtained by Thermistor Chain from USS Marysville in Boundary Water Region (Area I)	B-5
B-4	A Thermal Profile Obtained by Thermistor Chain from USS Marysville in Transition Water Region (Area II)	B-7
B-5	Sound Velocity Profiles Obtained by USS Rexburg in Boundary Water Region (Area I)	B-10
B-6	Sound Velocity Profiles Obtained by USNS Charles H. Davis in Boundary Water Region (Area I)	B-11
B-7	Sound Velocity Profiles Obtained by USS Rexburg in Transition Water Region (Area II)	B-12
B-8	Sound Velocity Profiles Obtained by USNS Charles H. Davis in Transition Water Region (Area II)	B-13
C-1	Block Diagram of Acoustical Recording Equipment on USS Rexburg	C-3
C-2	Block Diagram of Transcription Equipment Used in Data Reduction	C-5



## LIST OF TABLES

<u>Table No.</u>		<u>Page</u>
1	Standard Deviations of Signal Fluctuations	9
2	Index to Experimental Curves	16
A-1	Chronology of Exercise	A-3
A-2	Transmitter and Receiver Depths	A-5
B-1	Parameters Used in the Normal Mode Calculations	B-9
C-1	Acoustical Equipment	C-2
C-2	Local Amplifier Calibration	C-6
C-3	Channel Sensitivities, $S(f)$ , Used in Data Analysis	C-8



## I. INTRODUCTION

1.1 Purpose and Scope. The acoustical experiment that forms the subject of this report, was planned as a joint program of Codes 3185 and 3190, US Navy Electronics Laboratory, San Diego, California. The object of the experiment was to determine the effects of internal waves on acoustical transmission in a quasi-isothermal ocean surface layer. The experiment was performed in December 1964. The analysis of the experimental results is presented in this report.

1.2 Description of the Experiment. The USS Marysville, under the direction of Code 3190, performed a thermal survey using its thermistor chain, in areas 200-300 miles SW of Los Angeles. Two areas were selected as experimental stations (Figure 1). The areas were similar in that both possessed well defined surface layers as described in the report by Lee, Reference (1). They differed in that Area I was located at the unstable boundary between Eastern North Pacific Central Water and Transition Water flowing southward from the Sub-Arctic, whereas Area II was located further to the east in the more stable Transition Water. The thermal survey of the area was completed 10-24 hours before the performance of the acoustical transmission experiment. (See Appendix A for a detailed chronology of the experiment, in particular Table A-1 for the times involved.) The information on thermal structure obtained by the Marysville is discussed in Appendix B, and presented in Figures B-1 and B-2.

The acoustical experiment was performed by USS Rexburg and USNS Charles H. Davis under the direction of Code 3185. At each station the experiment was the same and consisted of the Davis making three radial runs ranging from 2 to 35 kiloyards from the Rexburg. The Davis transmitted a sequence of acoustical pings at 700 cps, 1300 cps, and 3000 cps. One run was distinguished from another by the projector depth (25 or 50 feet, 80 feet and 300 feet). The Rexburg's receiving hydrophones were suspended at approximately 50 feet, 80 feet and 300 feet. At the Rexburg, the received signals were recorded on magnetic tape for later analysis. Details of the experimental program are provided in Appendix A and of the recording equipment and methods in Appendix C. During the acoustical experiment the Rexburg and Davis made regular bathythermograph casts. As discussed in Appendix B, this data provided the basis for the calculation of the acoustic velocity profiles used in the theoretical calculations.

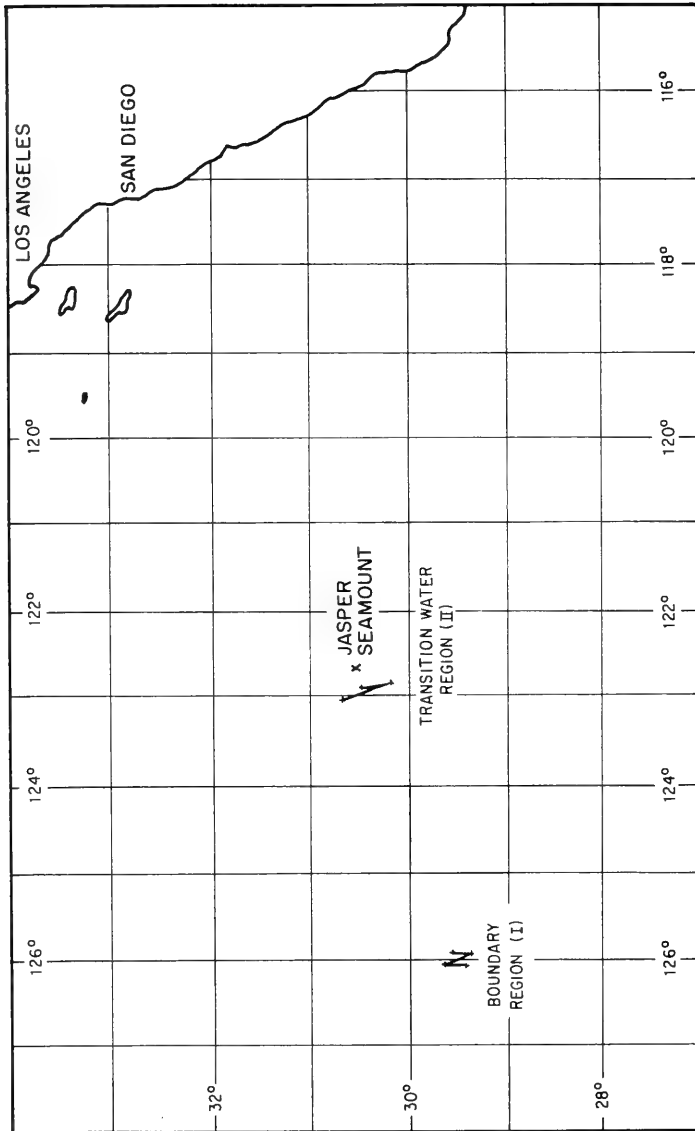

Figure 1. LOCATIONS OF SURFACE DUCT ACOUSTICAL EXPERIMENTS



## II. EXPERIMENTAL RESULTS

2.1 Averaged Data Analysis. The acoustic signals received on the Rexburg were recorded on multi-channel magnetic tape. Later, in the laboratory, the tapes were played back through narrow band audio filters and the signals recorded on galvanometer strip-charts. The circuitry is described in Appendix C, as is the detailed analysis involved in converting an observed galvanometer pen deflection to a measurement of transmission loss. Since each run provided data for nine transmission loss curves (1 projector depth, 3 receiving hydrophones at different depths, 3 acoustic frequencies) the entire program provided data for a total of 54 such curves.

Experimental data for all 54 curves were first reduced by an averaging process. The amplitudes of the ten signals received at one frequency during a five-minute period were averaged and converted to a received pressure amplitude (db re 1  $\mu$ bar). Since the source level was known, the transmission loss was derived immediately. The chosen five-minute periods were separated by ten-minute intervals. The range was determined from the time of transmission of the acoustical ping. The experimental results so obtained are presented in Curves 1-54 in Section IV. Table 2 provides an index to the curves, listing source and receiving hydrophone depths, frequency and the experimental region for each curve.

The data reduction was complicated by problems that arose during the experimental program. These included (a) interference between the clock and radio synchronization signal channels on the one hand and the receiving hydrophone channels on the other, (b) cross-talk between the audio-radio and receiving hydrophone channels, (c) extreme distortion, amounting to unintelligibility, of the radio voice link, and (d) frequency instability of the timing clock. In consequence, messages concerning calibration and attenuator settings were missed on several occasions. Analysis was made more difficult by the absence of calibrations at all frequencies on all receiving channels. The analytical method followed and the assumptions made to circumvent these omissions are described in detail in Appendix C. In the absence of calibration signals, a uniform calibration established elsewhere in the program was employed (see Appendix C). Occasionally when attenuator settings were obviously incorrect, the curves were normalized by comparing the observed noise level (ONL in the curves) with the expected noise level (ENL) and adjusting the levels of the curve in steps of 10 or 20 dbs. (Attenuator changes less than 10 dbs were not available while the original recordings were made.) Appendix C contains a detailed record of all attenuator adjustments that were considered necessary. Despite all efforts, it was not possible to produce internally consistent and reliable data from the shallow hydrophone (Channel 1) on the Rexburg. It was concluded that this channel suffered from an intermittent electronic fault, probably in the play-back amplifier section of the magnetic tape recorder. The argument in support of this conclusion

appears in Appendix C. Accordingly, it has been decided to omit further discussion of these experimental results, although the data are presented for completeness in Curves 37-54.

2.2 Point by Point Data Analysis. A principal objective of the experimental program was to permit comparison of the acoustical transmission conditions in two different ocean areas. The averaging technique, described in the preceding paragraph, was useful in determining the general validity of the data for overall comparison with the theoretical transmission losses; it did not permit a sufficiently detailed comparison of corresponding transmission loss curves in the two areas. Accordingly 11 transmission loss curves were analyzed point by point. They appear as Curves 55-65, selected on the basis of reliability of experimental data and of theoretical importance.

2.3 Signal Fluctuation Analysis. As the point by point analysis reveals in Curves 55-65 (and on the expanded scale of Curve 55A) the signal undergoes large fluctuations on either side of a mean curve. The extent of these fluctuations is important operationally and scientifically. From the former point of view they affect sonar performance; in the scientific context of this experiment the dependence of the fluctuations on locality, frequency and acoustic transmission paths may provide information on their origin. The quantities

$$\Delta_1 \equiv \alpha_n - \alpha_{n-1}$$

$$\Delta_2 \equiv \alpha_n - \alpha_{n-2}$$

$$\Delta_3 \equiv \alpha_n - \alpha_{n-3}$$

were calculated from the experimental and theoretical data where  $\alpha_n$  = transmission loss at the nth data point. The theoretical data were provided by the computer print-out at 100 yard increments corresponding closely to the range intervals between experimental points. Histograms of  $\Delta_1$ ,  $\Delta_2$ , and  $\Delta_3$  are shown in Figures 2 and 3. Figure 2 presents the results of analyzing Curves 58 and 62, the transmission loss curves at 3000 cps in Areas I and II, between an intermediate depth receiver and an intermediate depth source. Figure 3 presents data analogous to that from Curve 62 at frequencies of 700 and 1300 cps. The standard deviations of the distributions presented in the histograms are tabulated in Table 1.

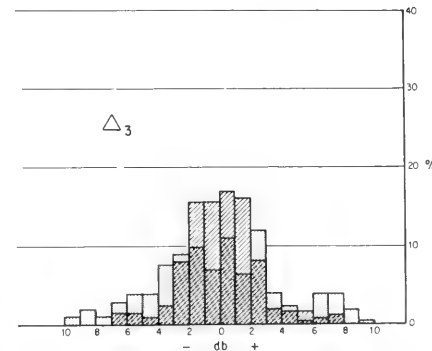
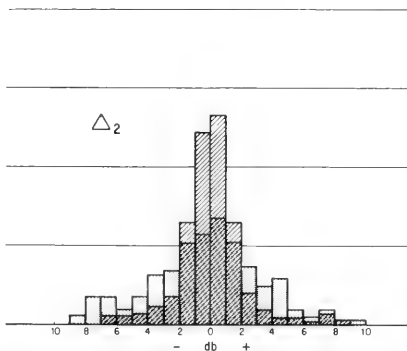
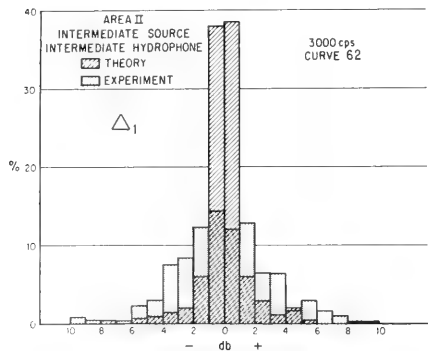
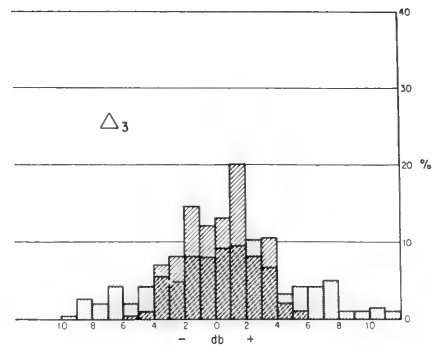
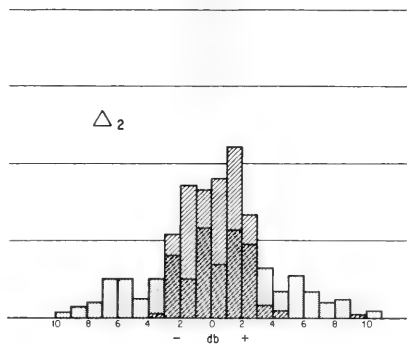
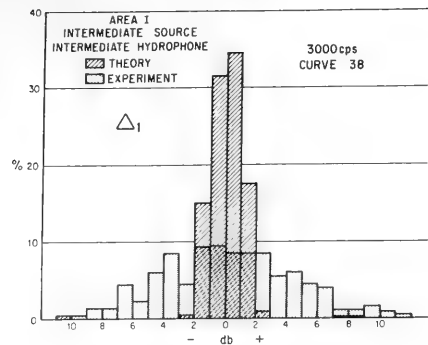

Figure 2. PING-TO-PING SIGNAL VARIABILITY: Comparison Between Areas at 3000cps



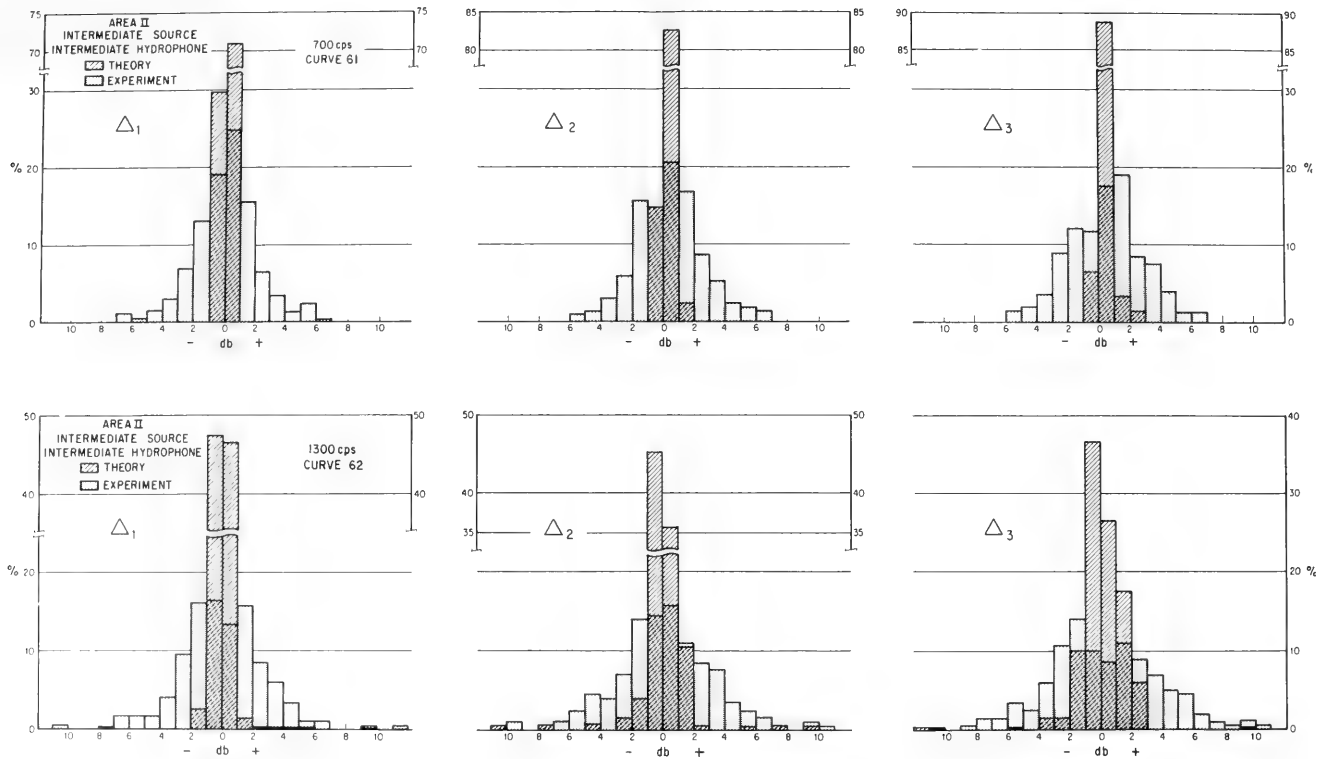

Figure 3. PING-TO-PING SIGNAL VARIABILITY: Comparison Between 700cps, 1300cps and 3000cps (Fig 2) in Area II



TABLE 1

STANDARD DEVIATIONS OF SIGNAL FLUCTUATIONS

	$\Delta_1$		$\Delta_2$		$\Delta_3$	
	Theory (db)	Expt. (db)	Theory (db)	Expt. (db)	Theory (db)	Expt. (db)
Area I, 3000 cps Curve 58	1.5	4.3	2.0	4.3	2.3	4.6
Area II, 3000 cps Curve 62	1.7	3.8	3.1	4.1	3.8	4.6
Area II, 1300 cps Curve 61	1.2	2.9	1.6	3.2	1.6	3.6
Area II, 700 cps Curve 60	.5	2.1	.4	2.2	.4	2.4

### III. COMMENTS ON EXPERIMENTAL RESULTS

3.1 Transmission Loss Curves. Theoretical transmission losses as functions of range and frequency were computed by Code 3185, USNEL on the basis of Pedersen's normal mode theory, Reference (2). A single set of surface channel constants, as listed in Table B-1, was selected for each area from the data of Appendix B. These two sets of constants were used for all theoretical curves of propagation loss in this report. The theoretical predictions are presented as solid lines in Curves 1-65.

Generally agreement between theory and experiment is good, particularly when the theoretical curve is simple. On Channels 2 and 3, the experimental data agree with the theoretical curves within 5 dbs, in approximately 67% of the cases, the exception being the following: (An index of experimental Curve numbers is provided in Table 2.)

Curves 4 - 6:	Experimental transmission loss too low
Curves 9:	Experimental transmission loss too high
Curves 10:	Experimental transmission loss too low
Curves 22 - 24:	Inadequate data (theoretical curves below expected noise level)
Curves 25 - 27:	Experimental transmission loss too high
Curves 32:	Experimental transmission loss too high

There is some evidence in the bathythermograph data (Figures B-5, B-6) of the existence of a secondary duct below the thermocline in the Boundary Region. If this is the case, then it might explain the low (compared with theory) transmission loss observed in Curves 4-6 which involve deep source and receivers. There are no obvious reasons for the discrepancies in the other cases. For the reasons noted earlier the data obtained on the shallow receiving hydrophone (Channel 1) are omitted from further discussion.

A detailed comparison between averaged experimental data and theory is difficult if in the theoretical curve, the transmission loss varies rapidly with range. Accordingly, several curves were analyzed point by point. They are presented as Curves 55-65. In one case (Curve 55A) an expanded range scale was employed to make clearer the behavior of the received signal. The point by point analysis confirms the agreement between the average transmission loss curve and the average theoretical prediction; but in general the signal fluctuations mask any close agreement with the details of the theoretical curves. In a few cases, e.g., Curves 57 and 61, there is, in fact, very good agreement.

On reciprocity arguments, transmission loss curves between two transducers are independent of which is source and which is receiver. Accordingly, we have compared the transmission loss curves between sources and receivers



located at approximately 80 feet and sources and receivers at approximately 300 feet. The paths therefore involved transmission through the thermocline. The following sets of experimental data were compared with the results noted:

- Area 1: 700 cps (Curves 1 and 16): Good - less than 5 dbs difference
- 1300 cps (Curves 2 and 17): Fair - less than 10 dbs difference
- 3000 cps (Curves 3 and 18): Poor - less than 20 dbs difference
  
- Area 2: 700 cps (Curves 19 and 34): Good - less than 5 dbs difference
- 1300 cps (Curves 20 and 35): Fair - less than 10 dbs difference
- 3000 cps (Curves 21 and 36): Good - less than 5 dbs difference

Since the cases where there is disagreement between theory and experiment represent a relatively small fraction of the experimental results it is clear that the experiment has confirmed the validity of the normal mode theory of surface duct transmission. Its value is particularly clear in predicting the effect of frequency on transmission loss (e.g., Curves 13-15). Ray-tracing theories can not, in general, predict the frequency dependence that is demonstrated here, theoretically and experimentally.

3.2 Comparison Between Results Obtained in Area I (Boundary Region) and Area II (Transition Water Region). Comparison between equivalent runs is obtained from experimental curves:

- 1 - 6 (Area I) and 19 - 24 (Area II)
- 7 - 12 (Area I) and 15 - 30 (Area II)
- 13 - 18 (Area I) and 31 - 36 (Area II)

Since the thermal structures (from the bathythermograph data) of the two areas were very similar, the theoretical curves show only minor differences. Hence any comparison between the areas must rely principally upon the experimental results. With the exception of Curves 3 and 21, the experimental data differ by much less than 10 dbs. In several cases, particularly where theory predicts a simple curve, experimental agreement is closer than 5 dbs. In general, agreement between corresponding sets of experimental data is better than between theory and experiment.

3.3 Study of Signal Fluctuations. The preceding comparison of theory with experiment and of experimental results in the two ocean areas has been based principally upon the averaged experimental data. In an attempt to discover more detailed differences, the signal fluctuations were analyzed as described in paragraph 2.3. The results are presented in Table 1 and Figures 2 and 3. The behavior of the  $\Delta$ 's as a function of frequency is given by the  $\sigma$ 's calculated from Curves 60 (700 cps), 61 (1300 cps), and 62 (3000 cps). While the absolute

values of these quantities may not be significant (particularly in the theoretical case) their magnitudes are useful for purposes of comparison. In all cases the experimental  $\sigma$ 's are greater than the theoretical values, a result which is to be expected since the theoretical  $\sigma$ 's represent only the deviation of the theoretical curve from a straight line and do not take fluctuations into account. The trends established by the theoretical  $\sigma$ 's are followed by the experimental  $\sigma$ 's, e.g.,  $\sigma(\Delta_3)$  exceeds  $\sigma(\Delta_2)$  which exceeds  $\sigma(\Delta_1)$  both theoretically and experimentally. (The sole exception is the theoretical  $\sigma(\Delta_3)$  for Curve 60.) Also  $\sigma(3000 \text{ cps})$  is greater than  $\sigma(1300 \text{ cps})$  which exceeds  $\sigma(700 \text{ cps})$  theoretically and experimentally. The two most interesting observations to be made are (1) the experimental  $\sigma$ 's increase with frequency being greatest for 3000 cps, and (2) the ratio of the experimental to the theoretical  $\sigma$ 's increases markedly with decreasing frequency in all cases, viz: the ratio is between 1.5 and 2 for 3000 cps but increases to 5 at 700 cps. These observations presumably arise from two causes: the greater simplicity of the 700 cps theoretical curves and the greater sensitivity of the higher frequency signals to perturbations such as those caused by waves and surface reflections.

A comparison between Area I and Area II can be obtained from Curves 58 and 62, both at 3000 cps. The theoretical  $\sigma$ 's are greater for the Area II curve than for the Area I curve, reflecting the change in shape of the theoretical curves, a consequence of the different acoustic velocity profiles and duct depths used in the computations. However, as discussed in Appendix B, the difference between the velocity gradients was close to the limit of experimental resolution of the bathythermograph. The experimental  $\sigma$ 's, in agreement with the discussion in the last paragraph, show the same relative behavior as the theoretical  $\sigma$ 's (increasing from  $\Delta_1$  to  $\Delta_3$ ) but the differences between the two areas as shown by the following table do not appear to be significant.

	<u>Experimental <math>\sigma</math></u>	
	<u>Area 1</u>	<u>Area 2</u>
$\Delta_1$	4.3	3.8
$\Delta_2$	4.3	4.1
$\Delta_3$	4.6	4.6

In fact there is closer agreement between the experimental  $\sigma$ 's in the two areas than between the corresponding theoretical values.

3.4 Conclusions. From the foregoing discussion of the results of this experiment the following conclusions can be drawn:

1. The validity of the normal mode theory of acoustic propagation in a surface duct is generally confirmed. Details of the predicted theoretical transmission loss curves may be masked by temporal fluctuations in the received signal strength.
2. Neither the analysis of transmission loss nor the analysis of signal fluctuations has revealed any significant acoustical differences between the two experimental areas. (But see Para. 3.5.)
3. The design of an experiment to determine the influence of internal waves upon acoustic transmission should include consideration of the following:
  - (i) The use of acoustic source and receiver at a constant range and the use of an acoustic frequency for which the transmission loss curve does not vary strongly with range.
  - (ii) In deep water, long wave lengths and large amplitudes are associated with internal waves, see, e.g., Reference (3). Accordingly, they will affect surface duct transmission through the spatial and temporal variations they cause of the depth of the duct and the velocity gradient. It is desirable therefore to select an acoustic frequency whose transmission loss depends strongly upon the width of the duct and the acoustic velocity gradient.
  - (iii) Measurement of the internal wave structure at several points along the acoustic path, simultaneously with the acoustic transmissions.

It should be noted that conclusions (i) and (ii) above would restrict the experiment to very long range in the channel or to a single frequency for which trapping of only the first mode occurred. In consequence the applicability of the results of the experiment would be limited.

3.5 Further Analysis of Signal Fluctuations. We have deferred to this final paragraph an additional set of comments on the observed fluctuations in transmission loss. While they appear to suggest a possible difference between Area I and Area II, there is inadequate experimental evidence to justify drawing conclusions at variance with those in the preceding paragraph.

We assume that the observed point-to-point transmission loss fluctuations arise from two independent causes -- the variation of transmission loss with range and a temporal fluctuation. We characterize the latter by a standard deviation  $\sigma_f$  and assume that the standard deviation of the former is given by the preceding "theoretical" standard deviation,  $\sigma_t$ , derived from the computation of the transmission loss curve. Accordingly, the standard deviation of the experimentally observed fluctuation,  $\sigma_e$ , is given by

$$\sigma_e^2 = \sigma_f^2 + \sigma_t^2$$

Using  $\sigma_e$  and  $\sigma_t$  from Table I, we have calculated  $\sigma_f$ . The results are presented in the following table.

<u>Standard Deviation of Temporal Fluctuations</u>			
[ $\sigma_f$ (db)]			
	$\Delta_1$	$\Delta_2$	$\Delta_3$
Area I - 3000 cps	4.0	3.8	4.0
Area II - 3000 cps	3.4	2.7	2.6
- 1300 cps	2.6	2.8	3.2
- 700 cps	2.0	2.2	2.4

If this approach has any validity, the results are interesting. Within Area II, the behavior of the  $\sigma_f$ 's does not appear to be related in any obvious way either to the  $\Delta$ 's or to frequency. The only obvious comment is that within Area II, the  $\sigma_f$ 's at 3000 cps, fall between 2.6 and 3.4, whereas in Area I, they range from 3.8 to 4.0 db. Numerically, the difference is not insignificant. If this result is physically significant it represents the only discoverable difference between Area I and Area II. But it should be noted that the observed  $\sigma_e$ 's are quite similar (see Table I) although wind speeds differed (see page A-2). Hence the differences between the  $\sigma_f$ 's stem from differences in the theoretical curves as reflected by the  $\sigma_t$ 's. The differences between the computed curves, in turn, arise from the small differences in duct width and velocity gradient, used in making the calculations. (See Appendix B, paragraph 3.)

IV. EXPERIMENTAL TRANSMISSION LOSS DATA

TABLE 2

INDEX TO EXPERIMENTAL CURVES

Experimental Run No. :	1	2	3	4	5	6
Area	Boundary Region			Transition Water Region		
Source Depth (ft)	310	42	100	310	40	90

<u>Receiver Depth</u>	<u>Freq. (cps)</u>	<u>Transmission Loss Curve No.</u>					
Group I: Data Sampled and Averaged							
Intermediate (80 ft)	700	1	7	13	19	25	31
	1300	2	8	14	20	26	32
	3000	3	9	15	21	27	33
Deep (300 ft)	700	4	10	16	22	28	34
	1300	5	11	17	23	29	35
	3000	6	12	18	24	30	36
Shallow (25 or 50 ft)	700	37	40	43	46	49	52
	1300	38	41	44	47	50	53
	3000	39	42	45	48	51	54
Group II: Point by Point Analysis of Data							
Intermediate (80 ft)	700			56			60
	1300	55		57	59		61
	3000			58			62
Deep (300 ft)	700						63
	1300						64
	3000						65

Curve No. 1

SURFACE DUCT PROPAGATION EXPERIMENT

Transmission Loss vs Range

Source Depth: 310 feet

Receiver Depth: 80 feet

Frequency: 700 cps

Ocean Area: Boundary Region

REL Project Plan 26-65

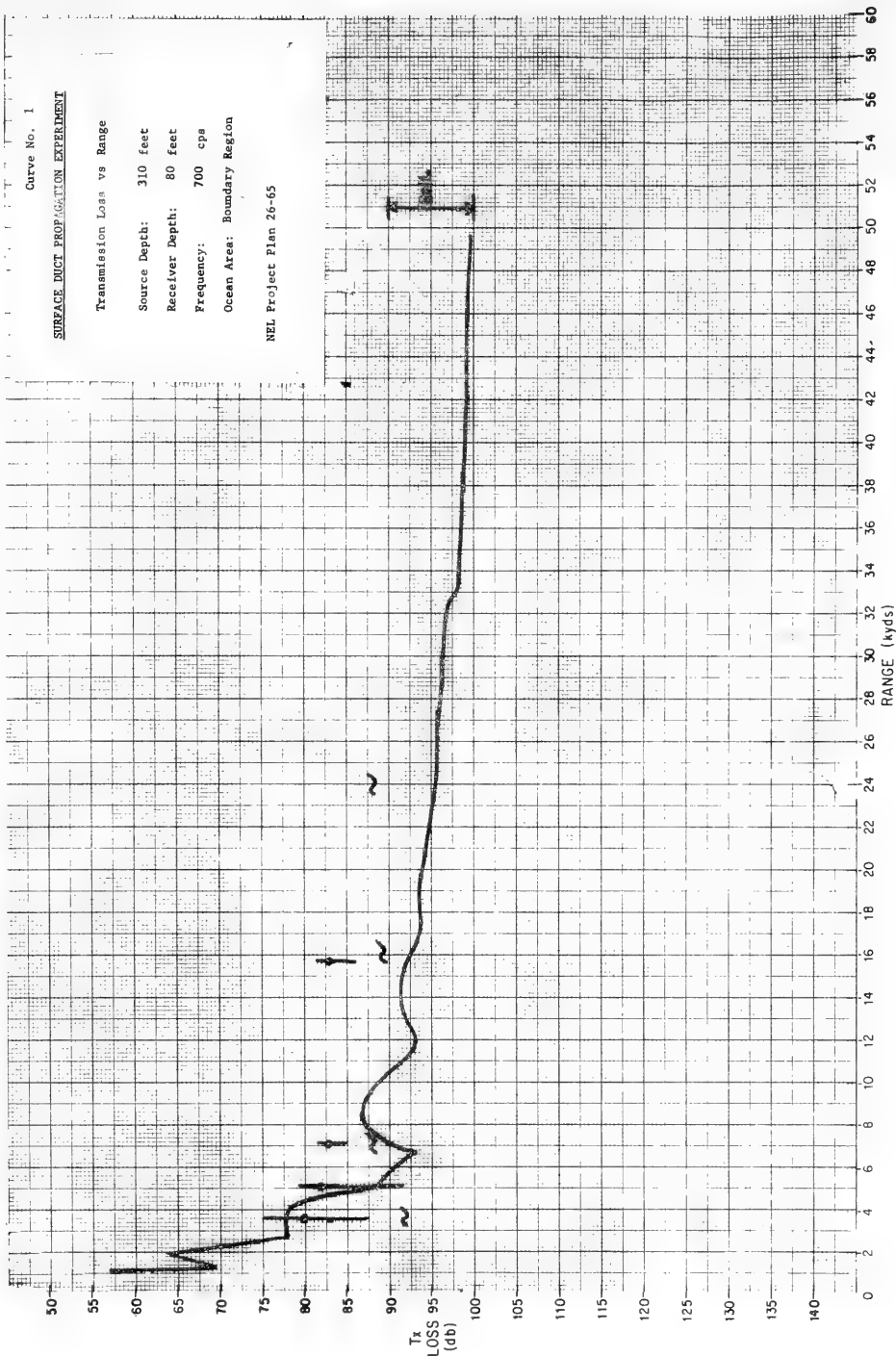

Curve No. 2

SURFACE DUCT PROPAGATION EXPERIMENT

Transmission Loss vs Range

Source Depth: 310 feet

Receiver Depth: 80 feet

Frequency: 1300 cps

Ocean Area: Boundary Region

NEL Project Plan 26-65

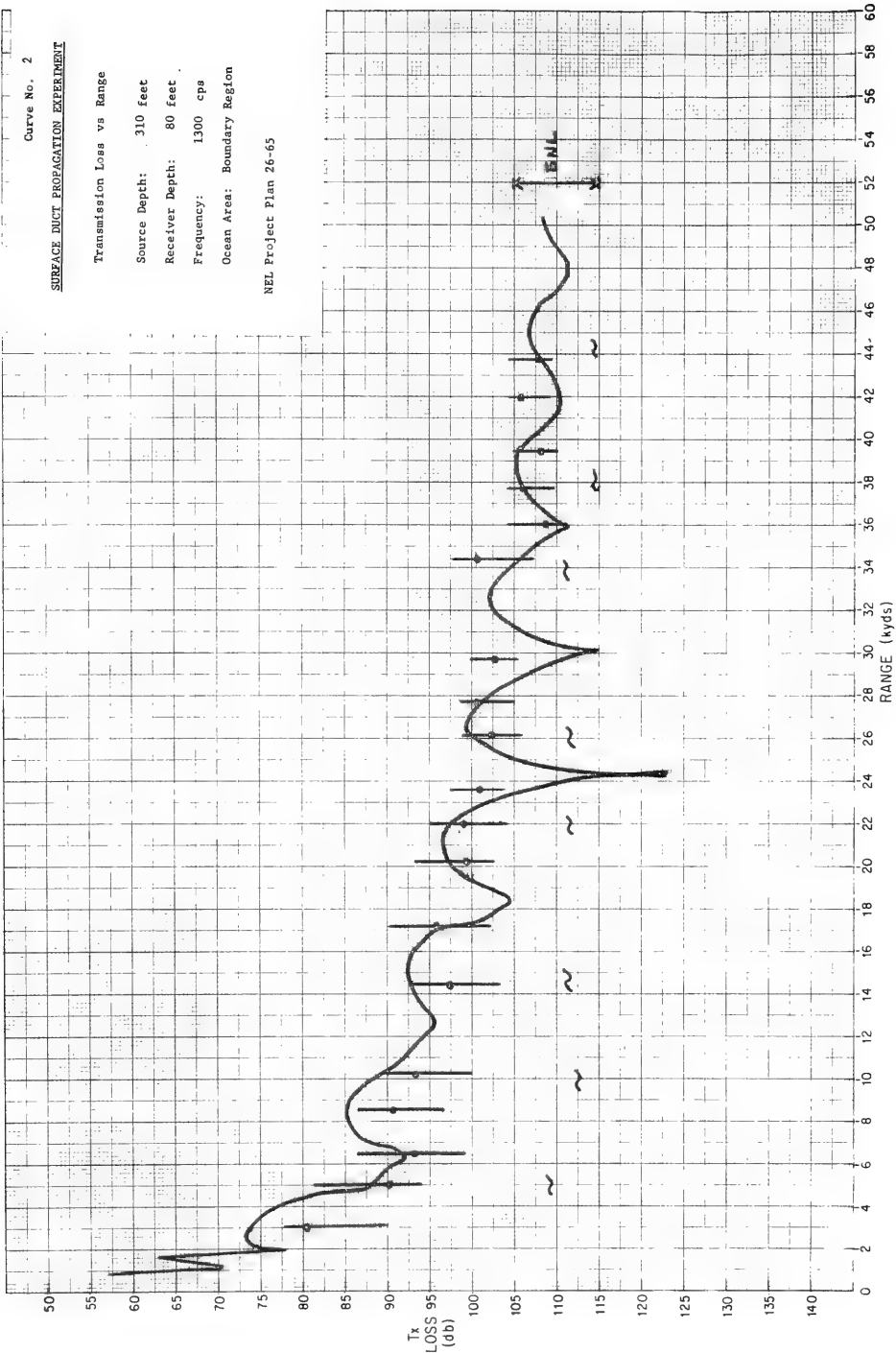



Curve No. 3

SURFACE DUCT PROPAGATION EXPERIMENT

Transmission Loss vs Range

Source Depth: 310 feet

Receiver Depth: 80 feet

Frequency: 3000 cps

Ocean Area: Boundary Region

NEL Project Plan 26-65

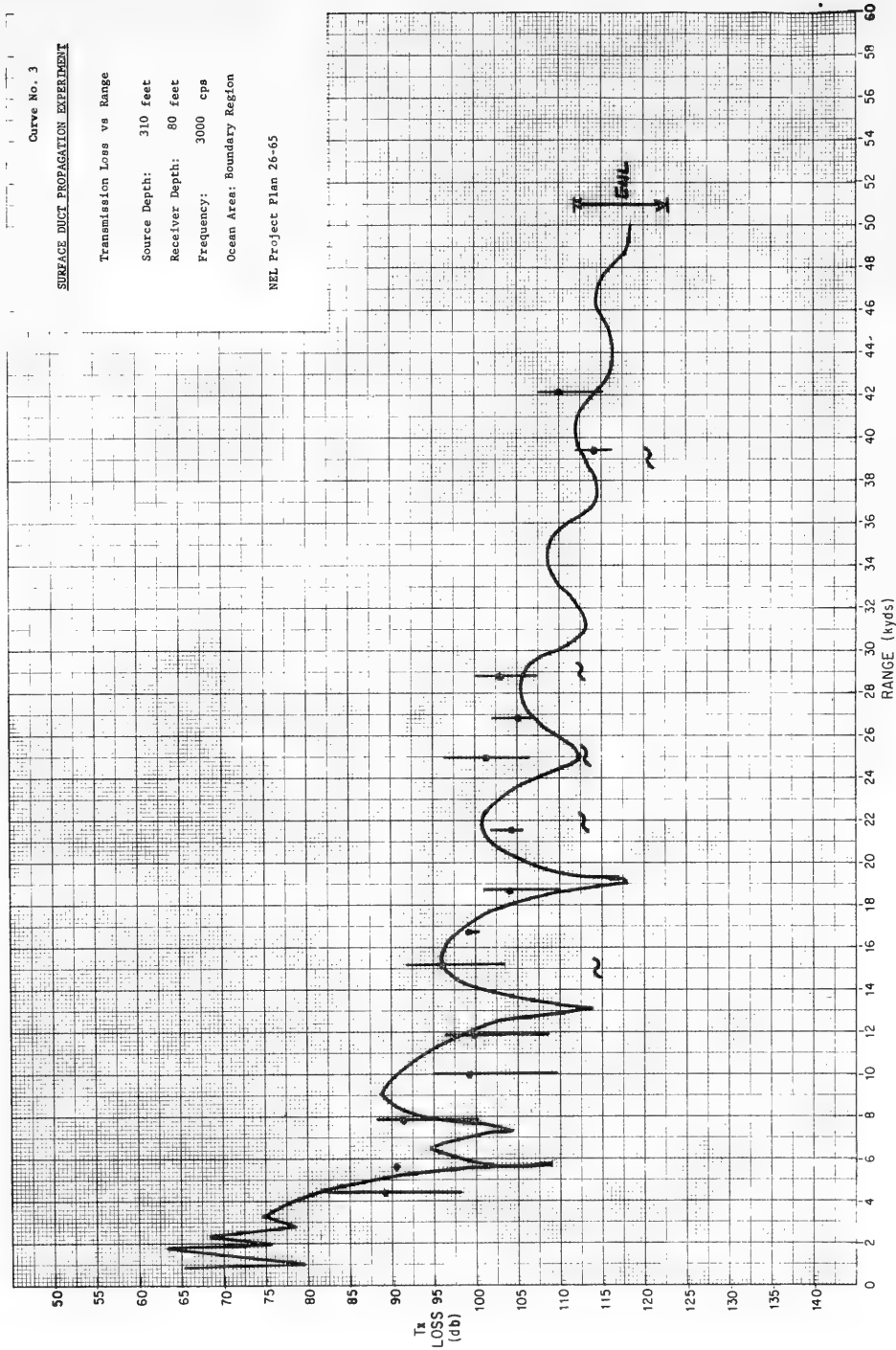

Curve No. 4

SURFACE DUCT PROPAGATION EXPERIMENT

Transmission Loss vs Range

Source Depth: 310 feet

Receiver Depth: 300 feet

Frequency: 700 cps

Ocean Area: Boundary Region

NEL Project Plan 26-65

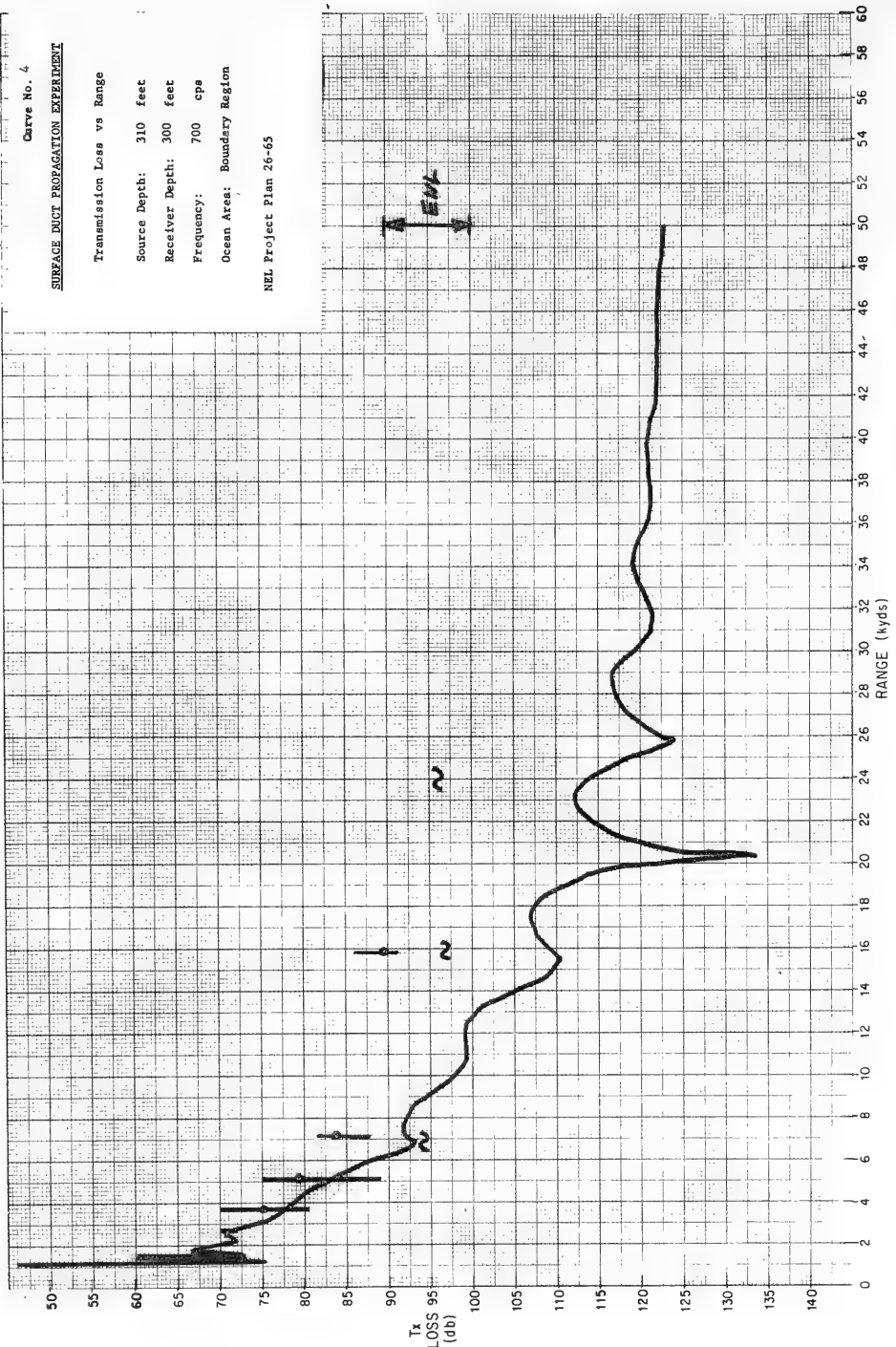

Curve No. 5

SURFACE DUCT PROPAGATION EXPERIMENT

Transmission Loss vs Range

Source Depth: 310 feet

Receiver Depth: 300 feet

Frequency: 1300 cps

Ocean Area: Boundary Region

NEL Project Plan 26-65

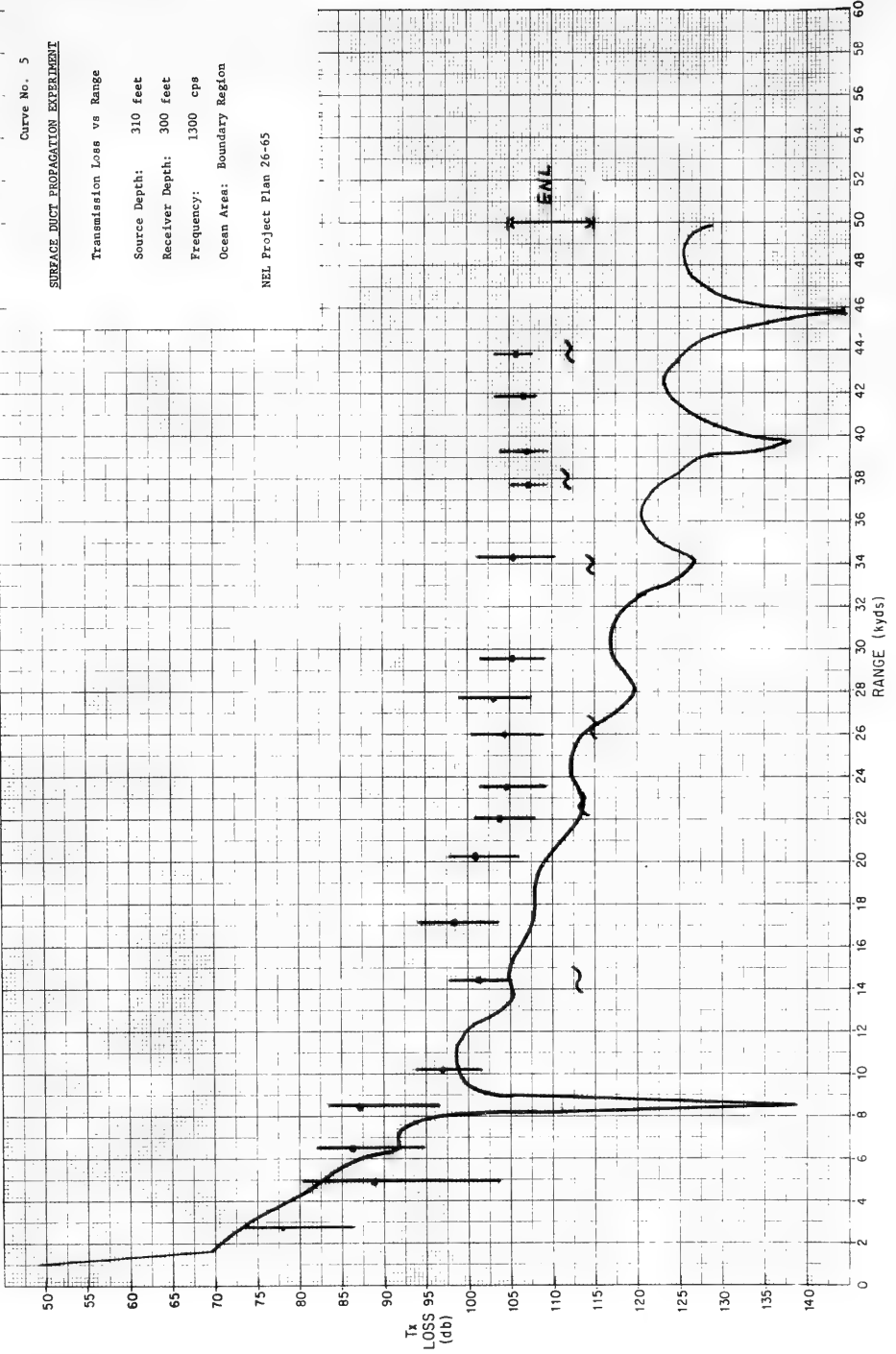

Curve No. 6

SURFACE DUCT PROPAGATION EXPERIMENT

Transmission Loss vs Range

Source Depth: 310 feet

Receiver Depth: 300 feet

Frequency: 3000 cps

Ocean Area: Boundary Region

NEL Project Plan 26-65

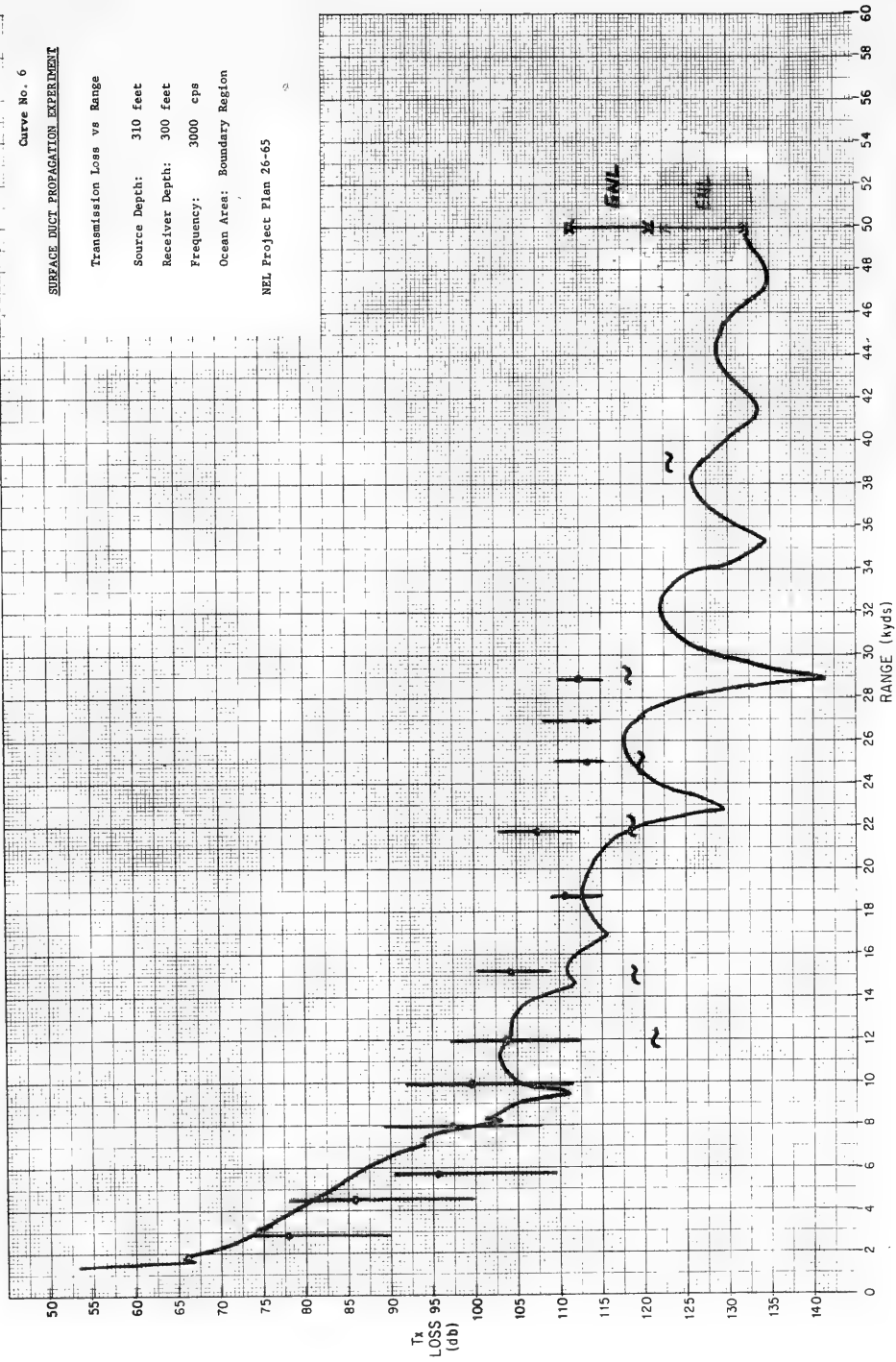

Curve No. 7

SURFACE DUCT PROPAGATION EXPERIMENT

Transmission Loss vs Range

Source Depth: 42 feet

Receiver Depth: 80 feet

Frequency: 700 cps

Ocean Area: Boundary Region

NEI, Project Plan 26-65

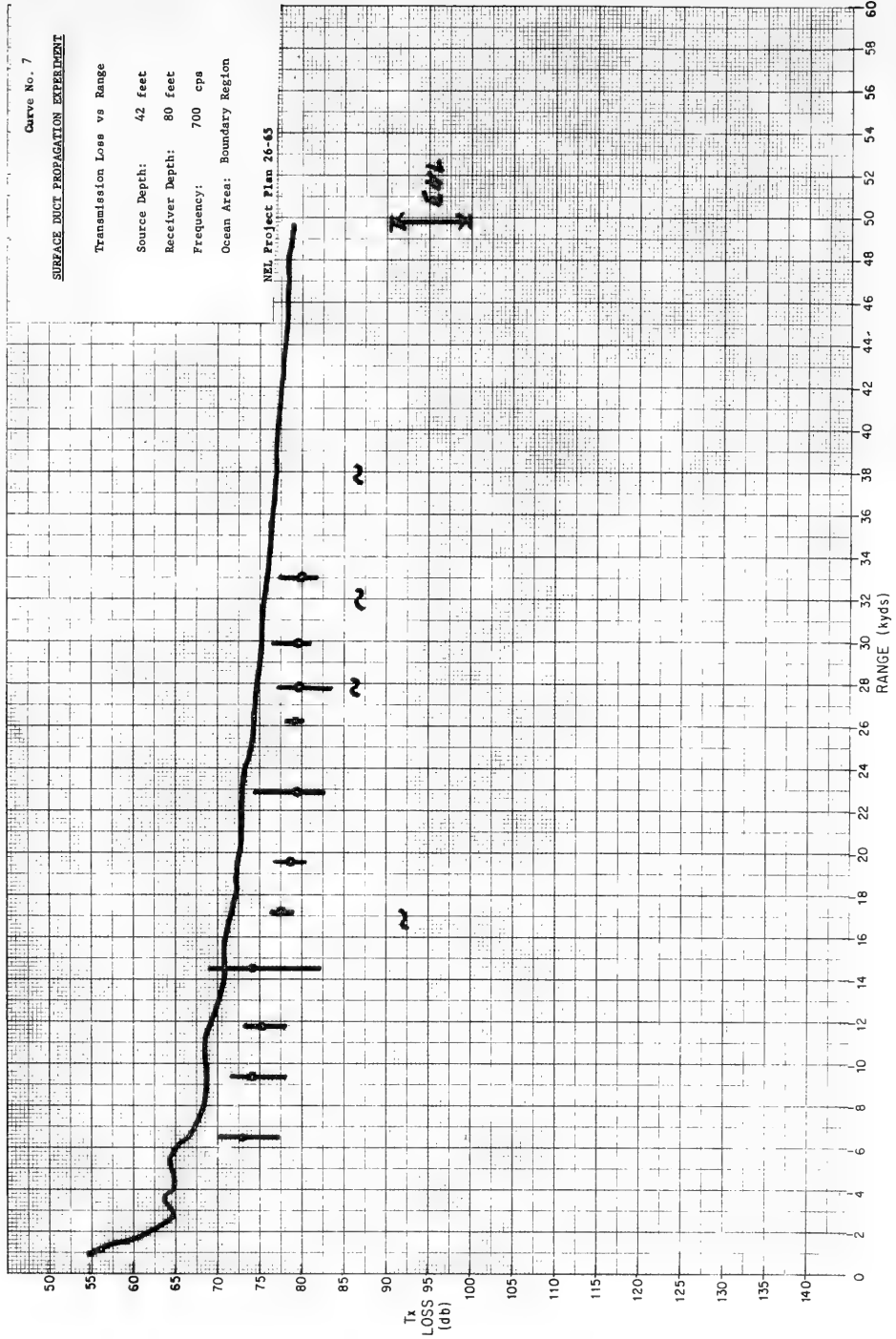

Curve No. 8

SUBSAC MUCT PROPAGATION EXPERIMENT

Transmission Loss vs Range

Source Depth: 42 feet

Receiver Depth: 80 feet

Frequency: 1300 cps

Ocean Area: Boundary Region

NEL Project Plan 26-65

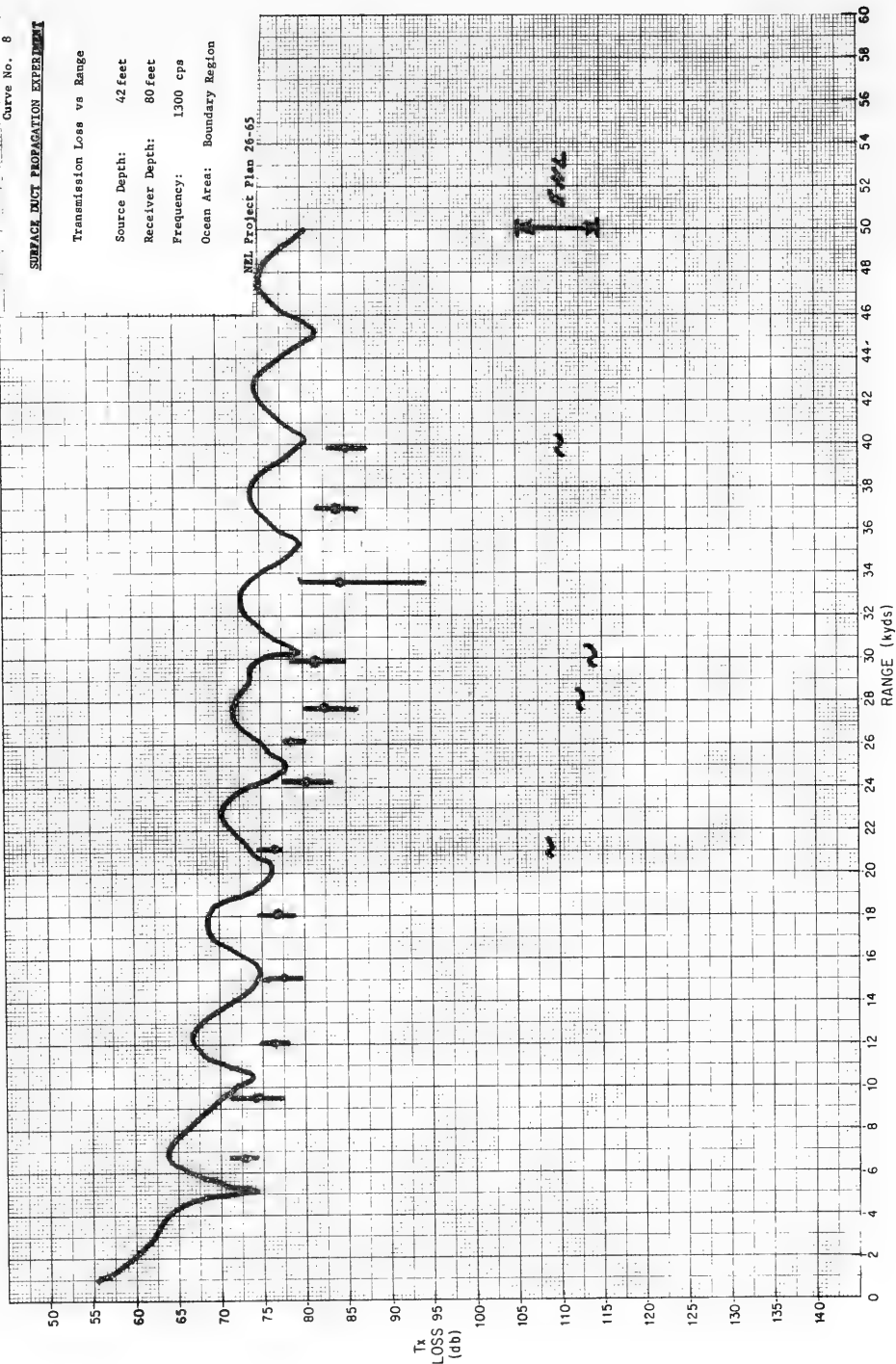

Curve No. 9

SURFACE DUCT PROPAGATION EXPERIMENT

Transmission Loss vs Range

Source Depth: 42 feet

Receiver Depth: 80 feet

Frequency: 3000 cps

Ocean Area: Boundary Region

MEL Project Plan 26-65

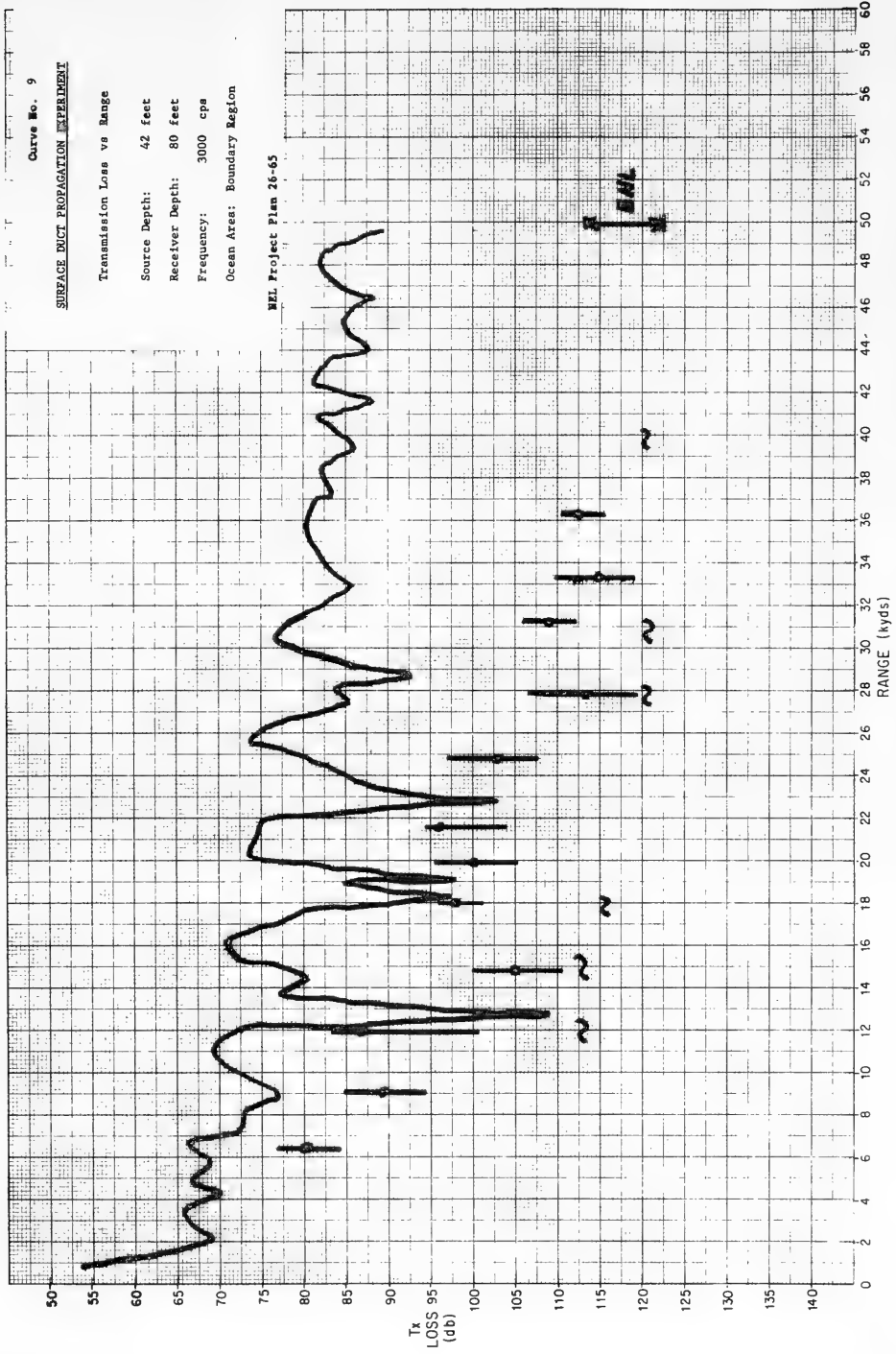

Curve No. 10

SURFACE DUCT PROPAGATION EXPERIMENT

Transmission Loss vs Range

Source Depth: 42 feet

Receiver Depth: 300 feet

Frequency: 700 cps

Ocean Area: Boundary Region

NEL Project Plan 26-65

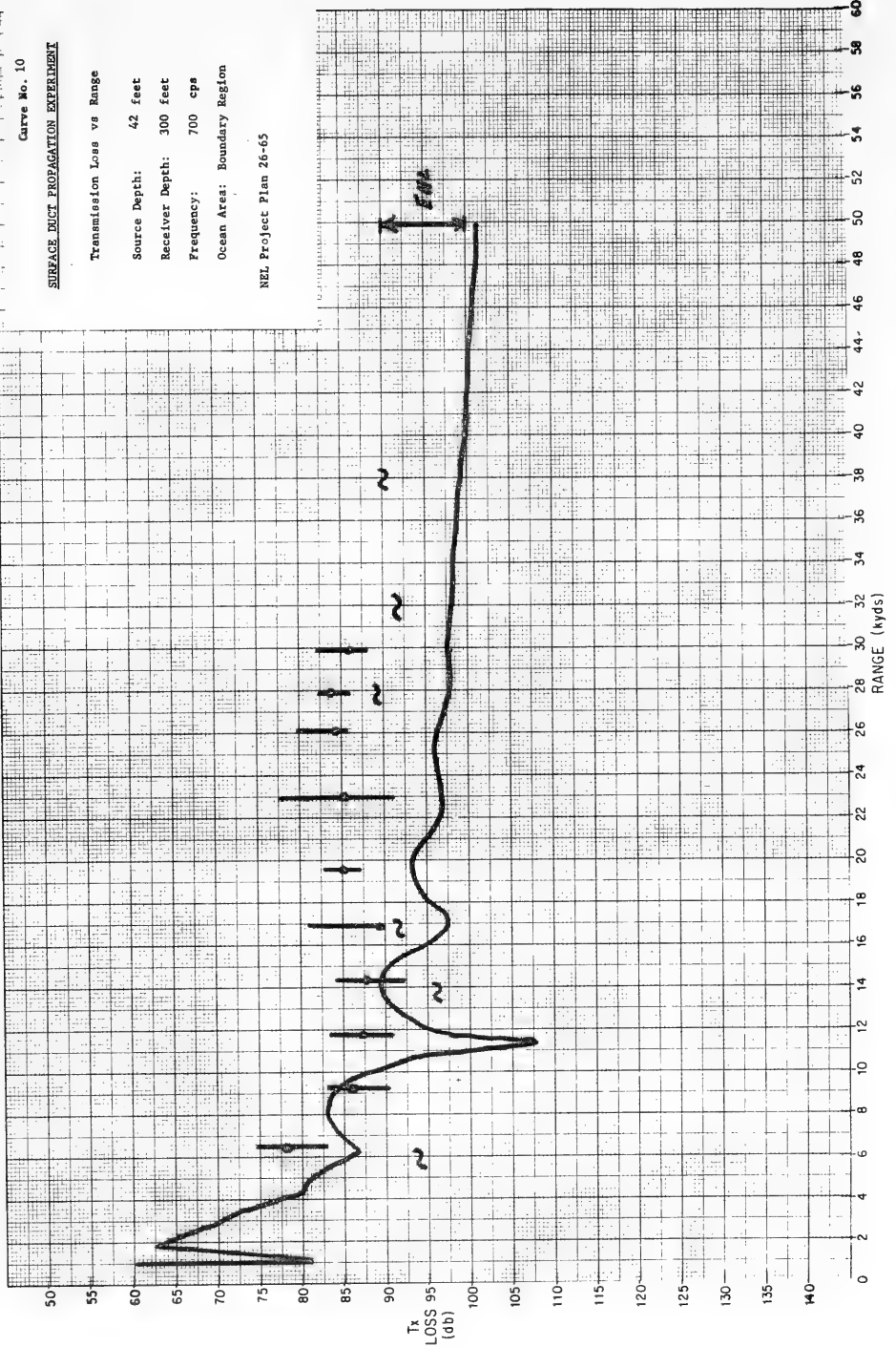



Curve No. 11

SURFACE DUCT PROPAGATION EXPERIMENT

Transmission Loss vs Range

Source Depth: 42 feet

Receiver Depth: 300 feet

Frequency: 1300 cps

Ocean Area: Boundary Region

NEL Project Plan 26-65

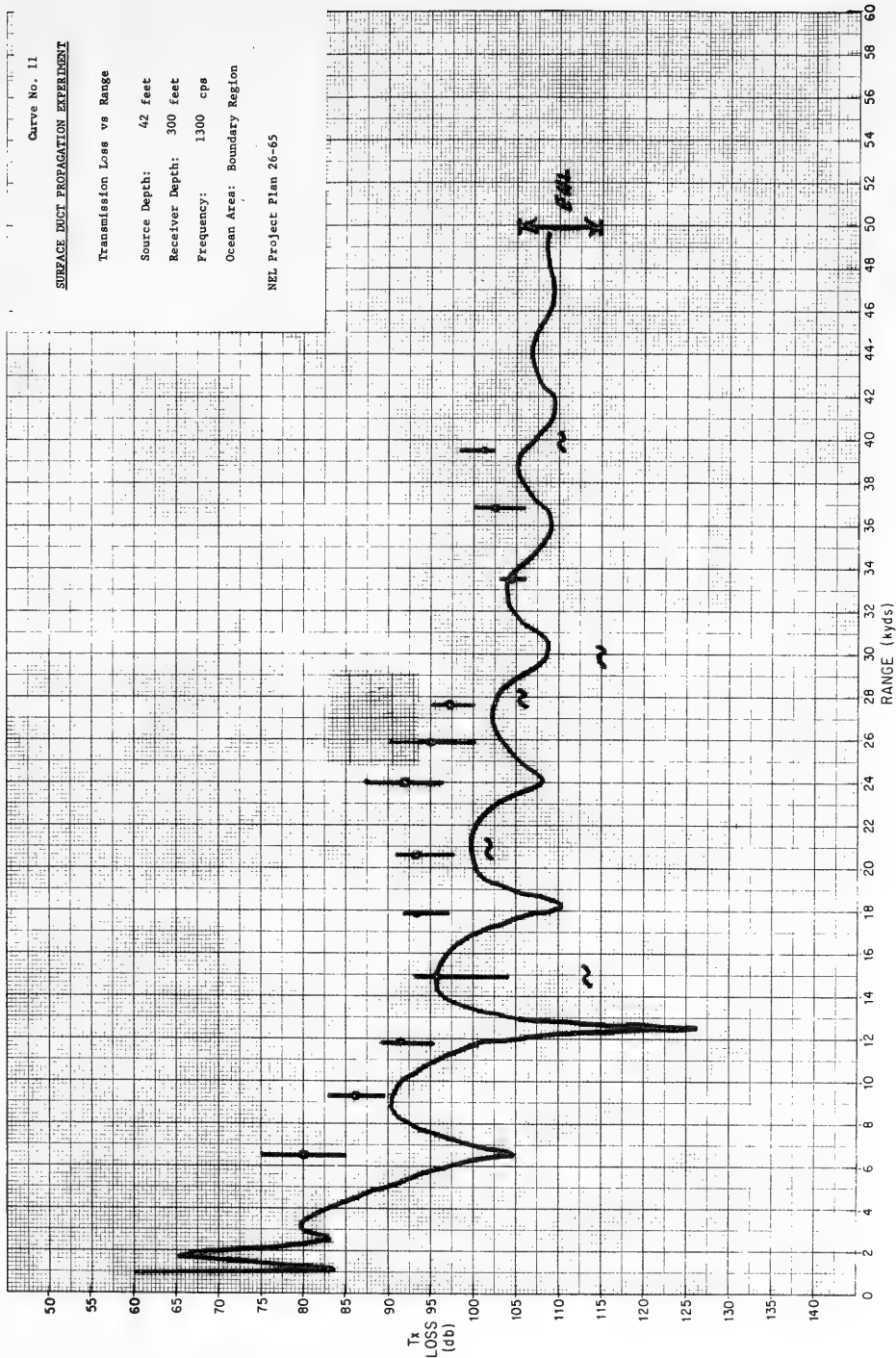

Curve No. 12

SURFACE DUCT PROPAGATION EXPERIMENT

Transmission Loss vs Range

Source Depth: 42 feet  
Receiver Depth: 300 feet  
Frequency: 3000 cps  
Ocean Area: Boundary Region

NEL Project Plan 26-65

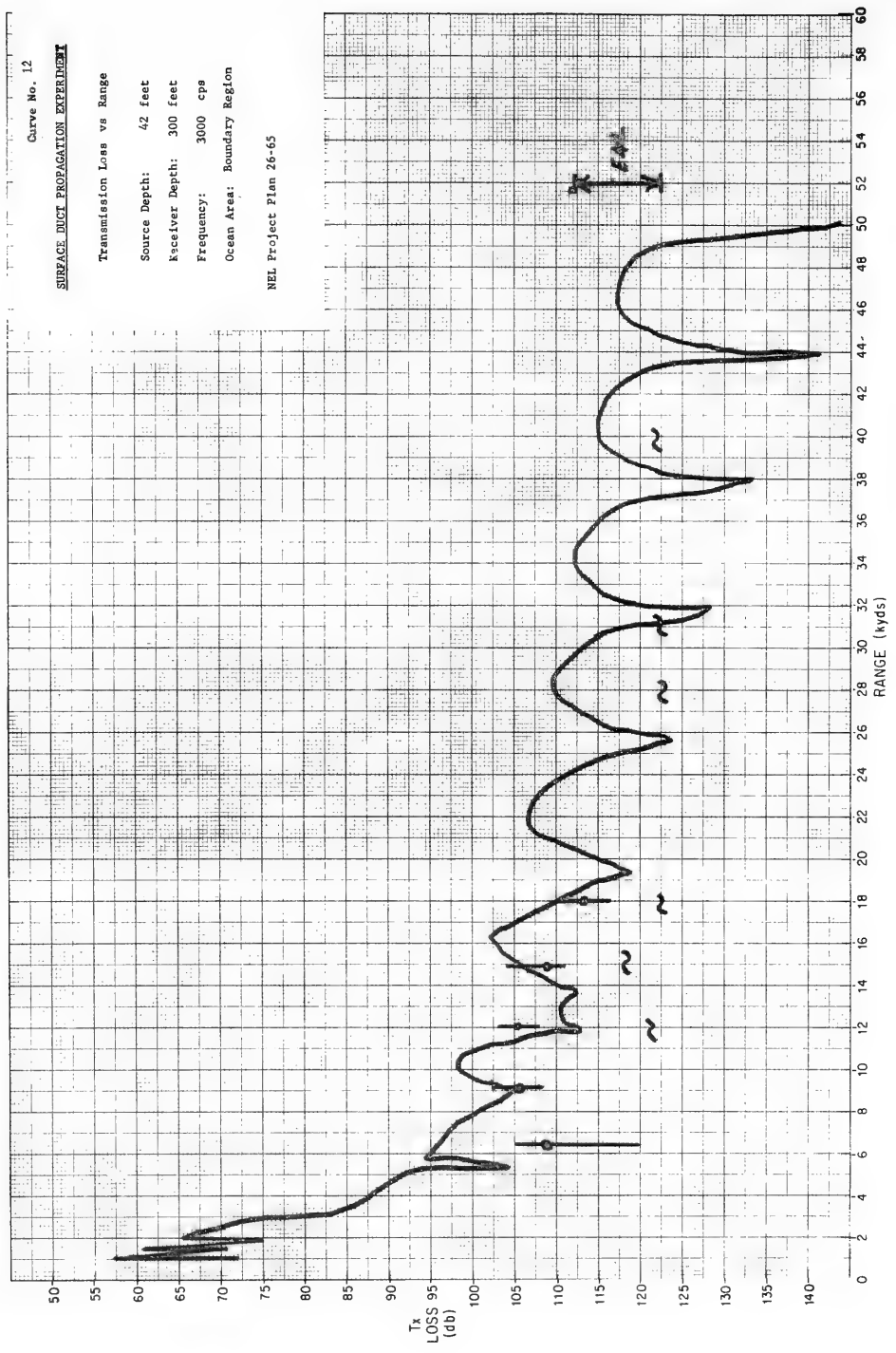

SURFACE DUCT PROPAGATION EXPERIMENT

Transmission Loss vs Range

Source Depth: 100 feet

Receiver Depth: 80 feet

Frequency: 700 cps

Ocean Area: Boundary Region

NEI, Project Plan 24-65

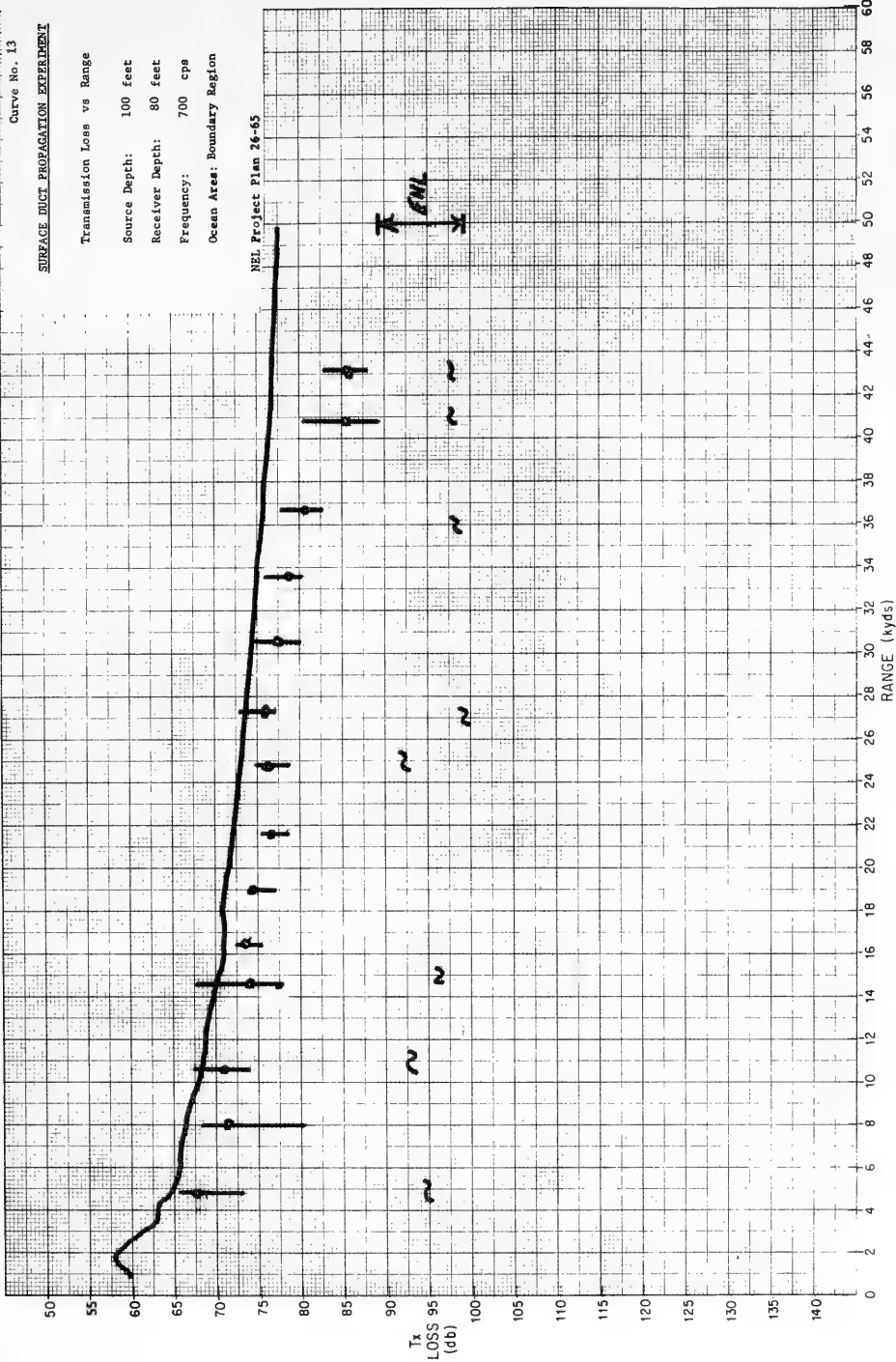

Curve No. 14

SURFACE DUCT PROPAGATION EXPERIMENT

Transmission Loss vs Range

Source Depth: 100 feet

Receiver Depth: 80 feet

Frequency: 1300 cps

Ocean Area: Boundary Region

NEL Project Plan 26-65

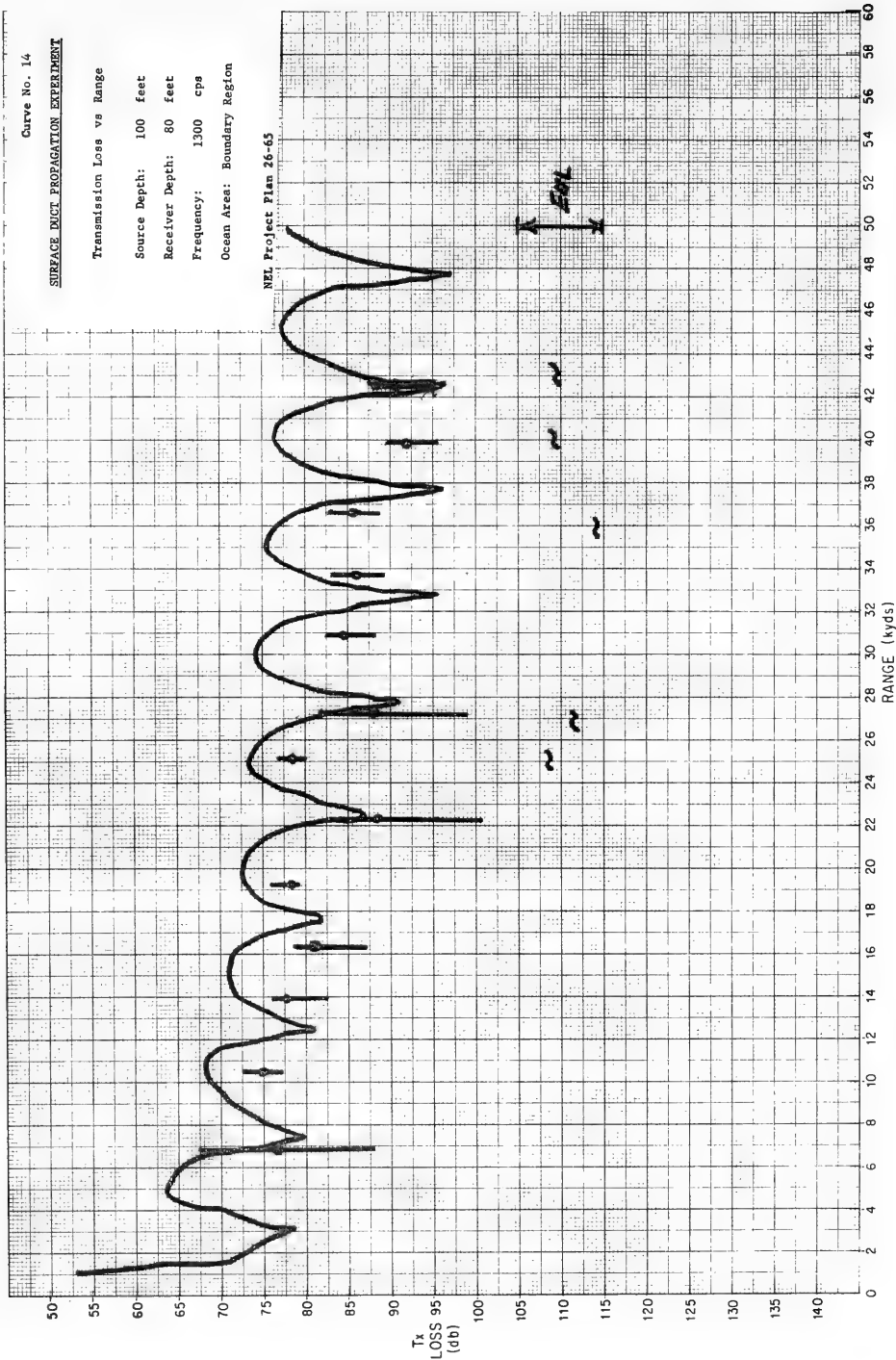

Curve No. 15

SURFACE DUCT PROPAGATION EXPERIMENT

Transmission Loss vs Range

Source Depth: 100 feet

Receiver Depth: 80 feet

Frequency: 3000 cps

Ocean Area: Boundary Region

NZL Project Plan 26-65

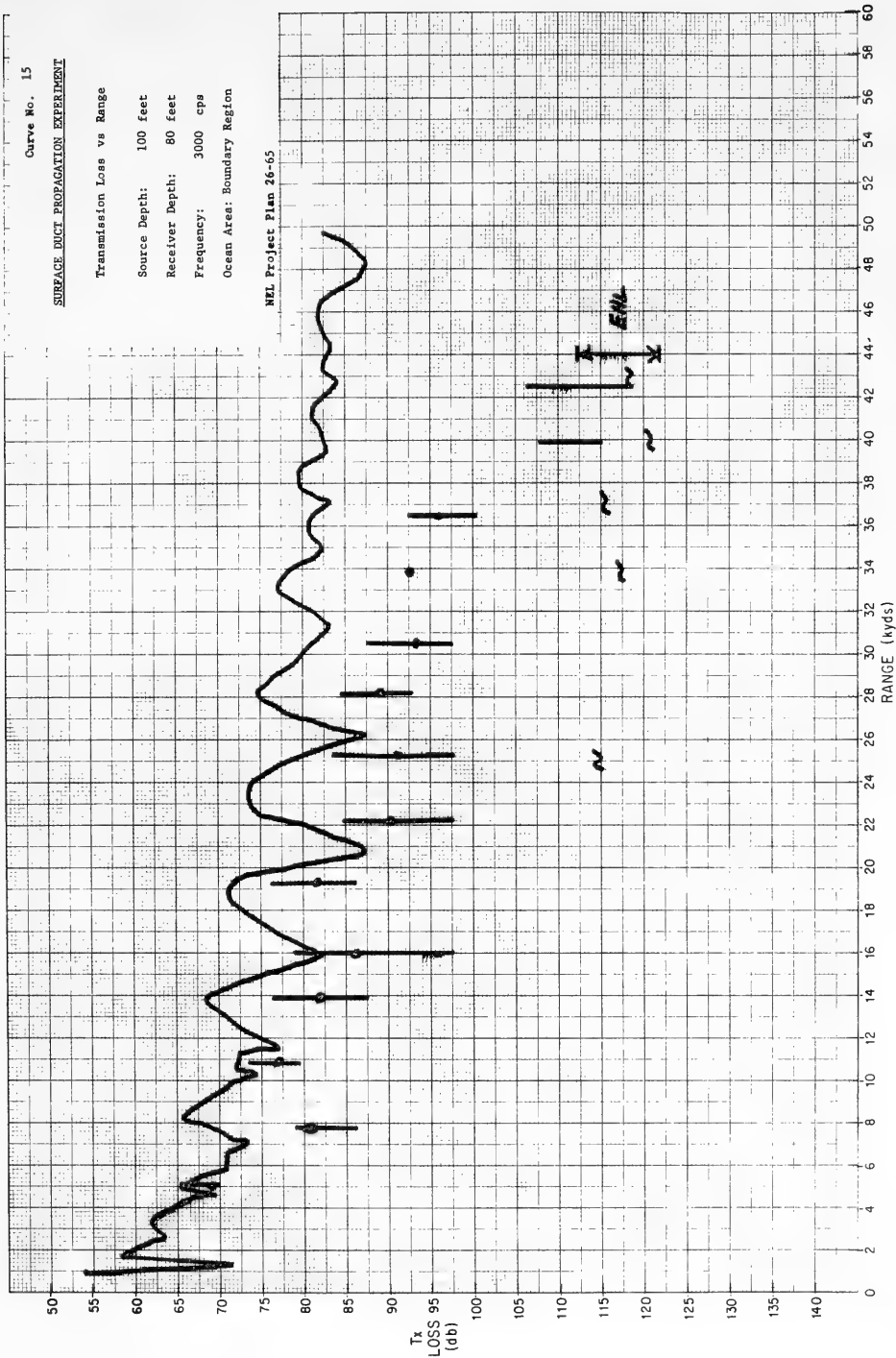

Curve No. 16

SURFACE DUCT PROPAGATION EXPERIMENT

Transmission Loss vs Range

Source Depth: 100 feet

Receiver Depth: 300 feet

Frequency: 700 cps

Ocean Area: Boundary Region

NEL Project Plan 26-65

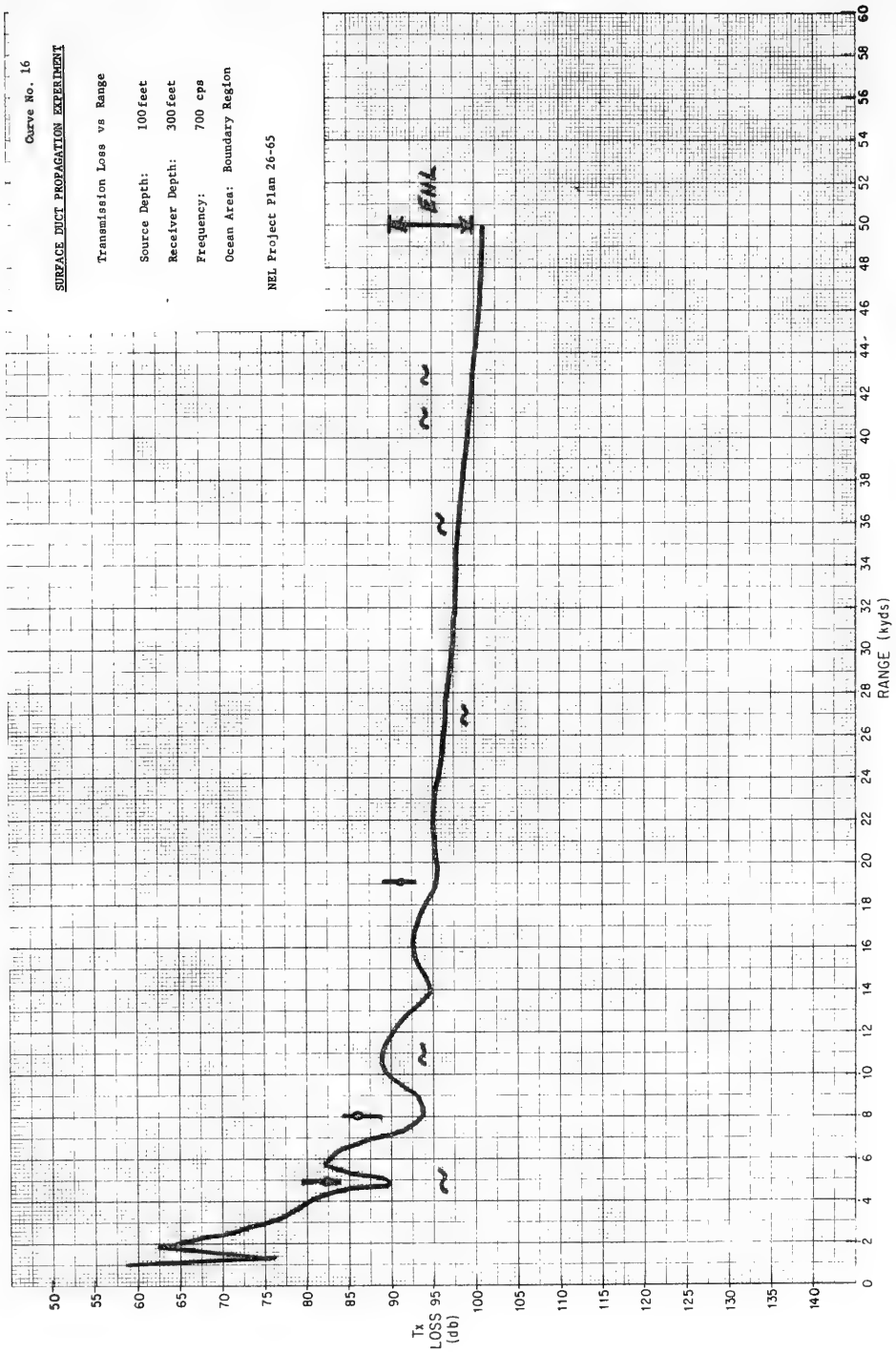

SURFACE DUCT PROPAGATION EXPERIMENT

Transmission Loss vs Range

Source Depth: 100 feet

Receiver Depth: 300 feet

Frequency: 1300 cps

Ocean Area: Boundary Region

NEL Project Plan 26-65

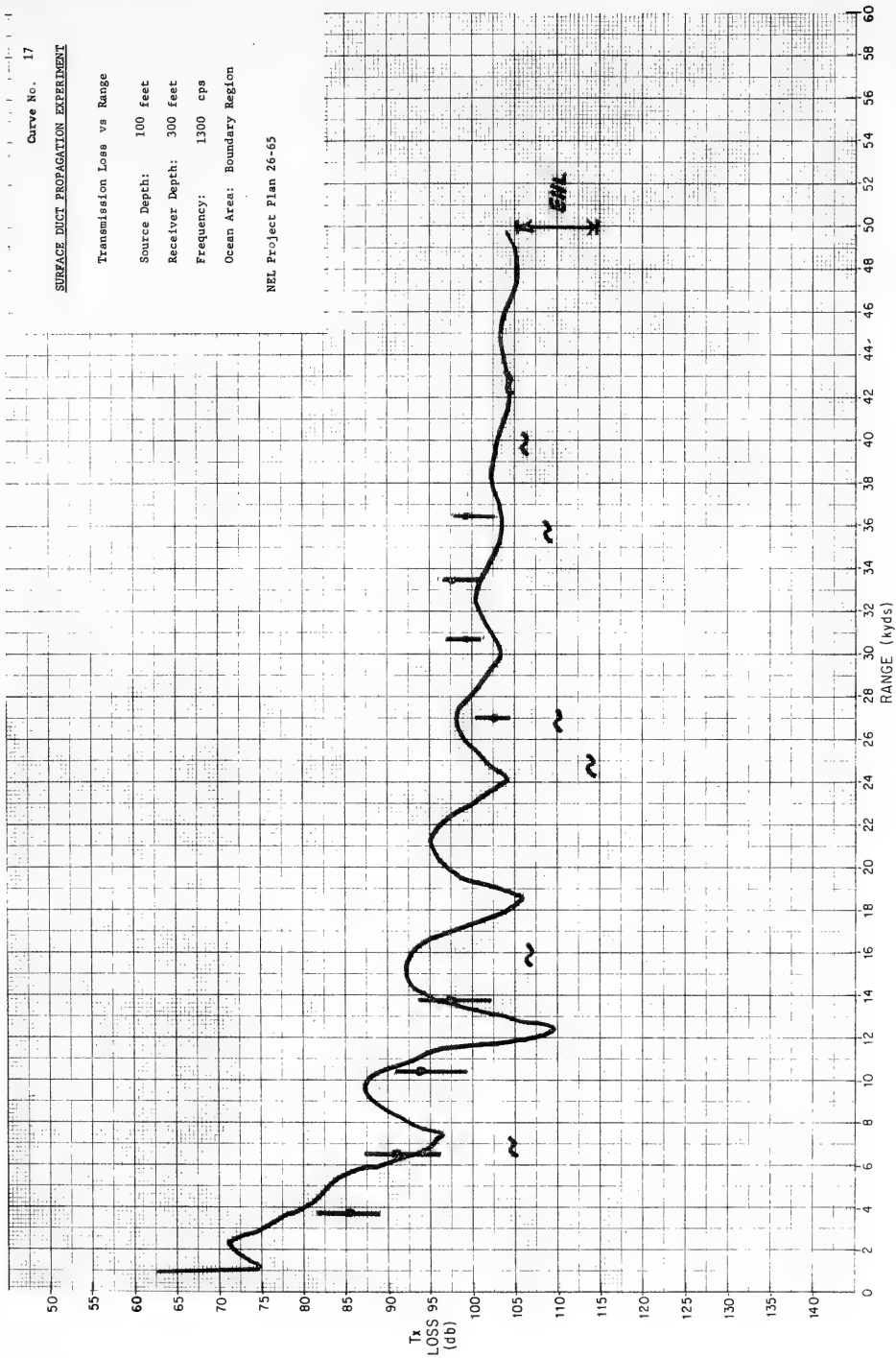

Curve No. 18

SURFACE DUCT PROPAGATION EXPERIMENT

Transmission Loss vs. Range

Source Depth: 100 feet

Receiver Depth: 300 feet

Frequency: 3000 cps

Ocean Area: Boundary Region

NEL Project Plan 26-65

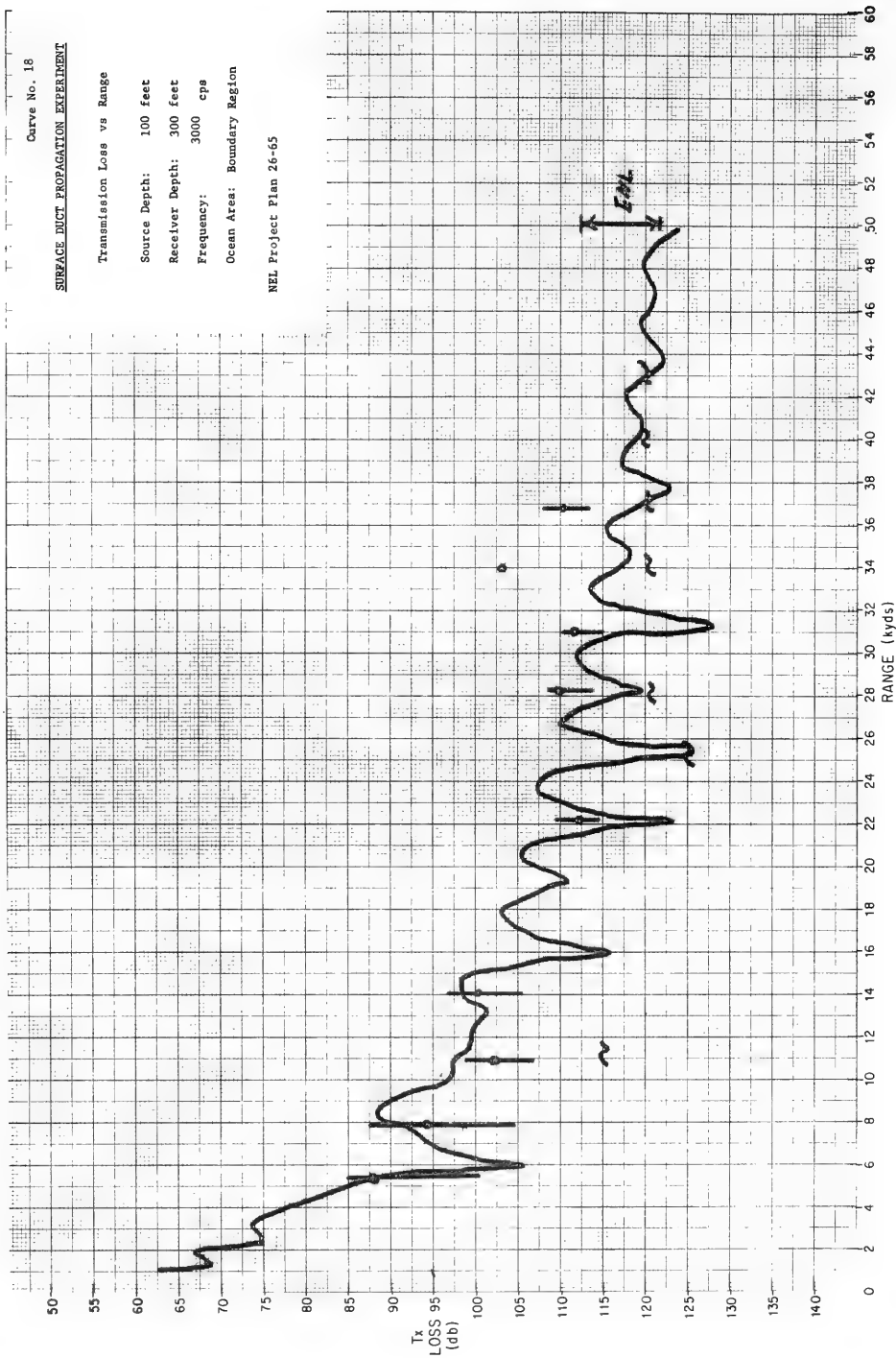



Curve No. 19

SURFACE DUCT PROPAGATION EXPERIMENT

Transmission Loss vs Range

Source Depth: 310 feet

Receiver Depth: 80 feet

Frequency: 700 cps

Ocean Area: Transition Water Region

NEL Project Plan 26-65

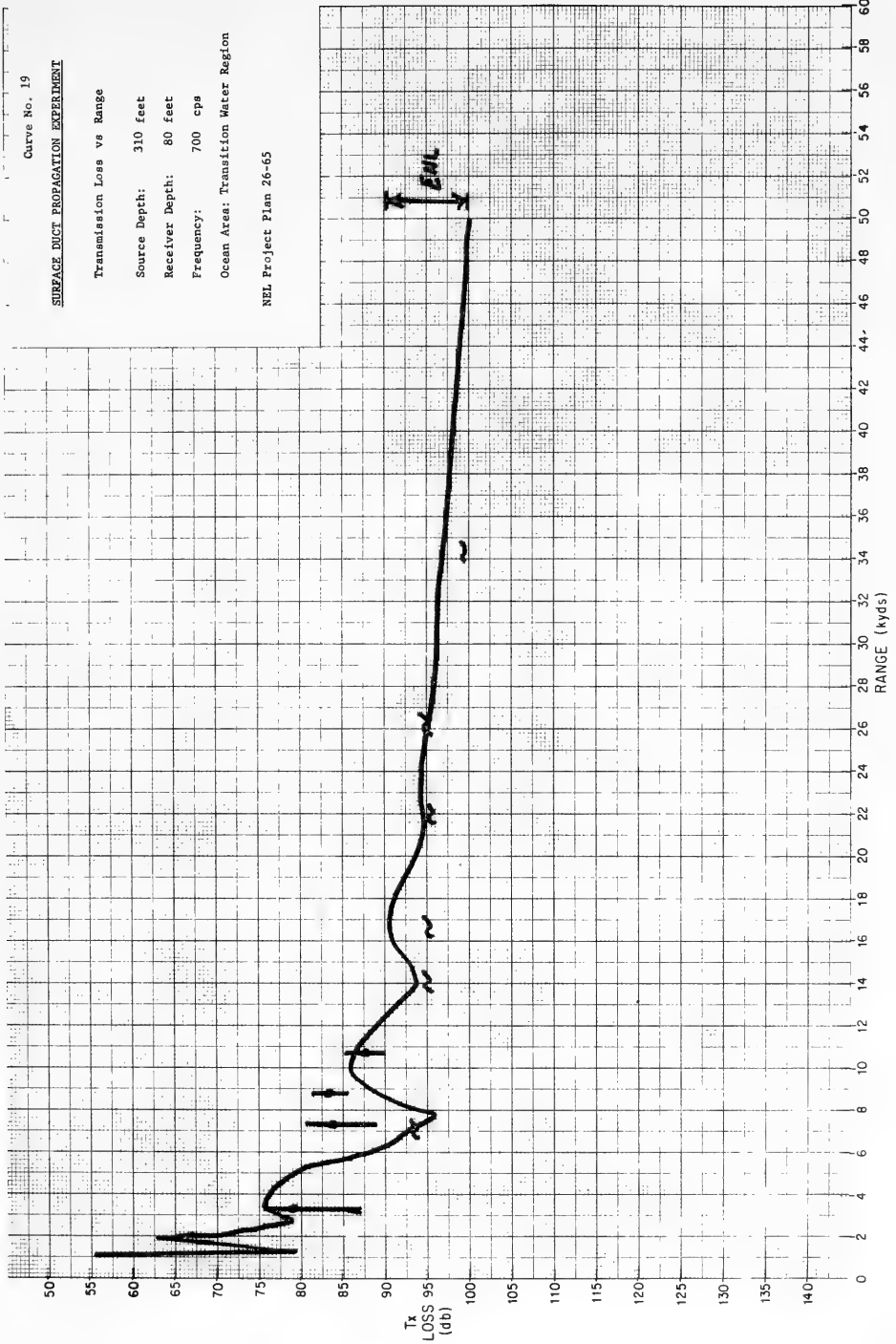

Curve No. 20

SURFACE DUCT PROPAGATION EXPERIMENT

Transmission Loss vs Range  
Source Depth: 310 feet  
Receiver Depth: 80 feet  
Frequency: 1300 cps  
Ocean Area: Transition Water Region

NEL Project Plan 26-65

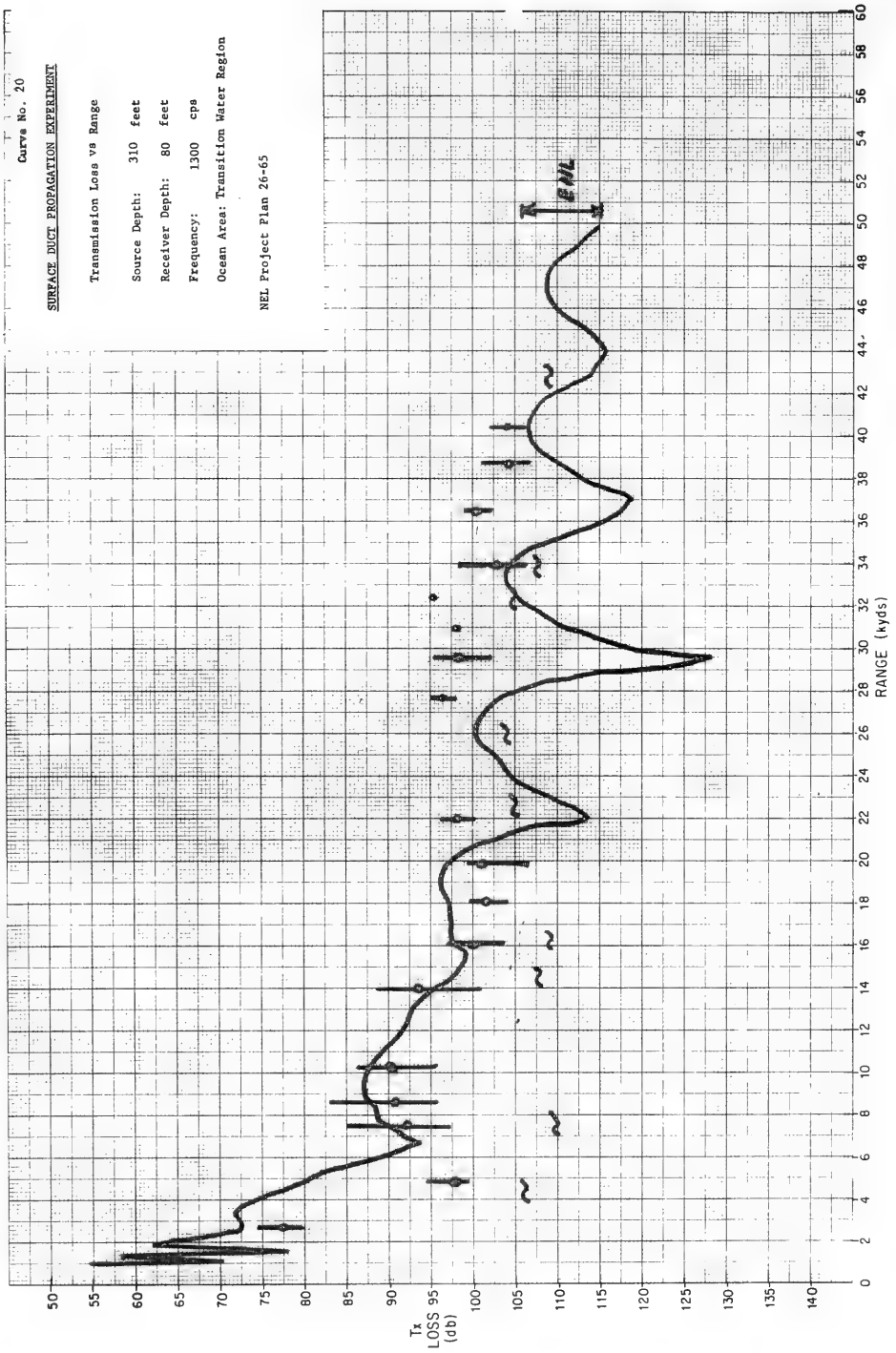

Curve No. 21

SURFACE DUCT PROPAGATION EXPERIMENT

Transmission Loss vs Range

Source Depth: 310 feet

Receiver Depth: 80 feet

Frequency: 3000 cps

Ocean Area: Transition Water Region

NEL Project Plan 26-65

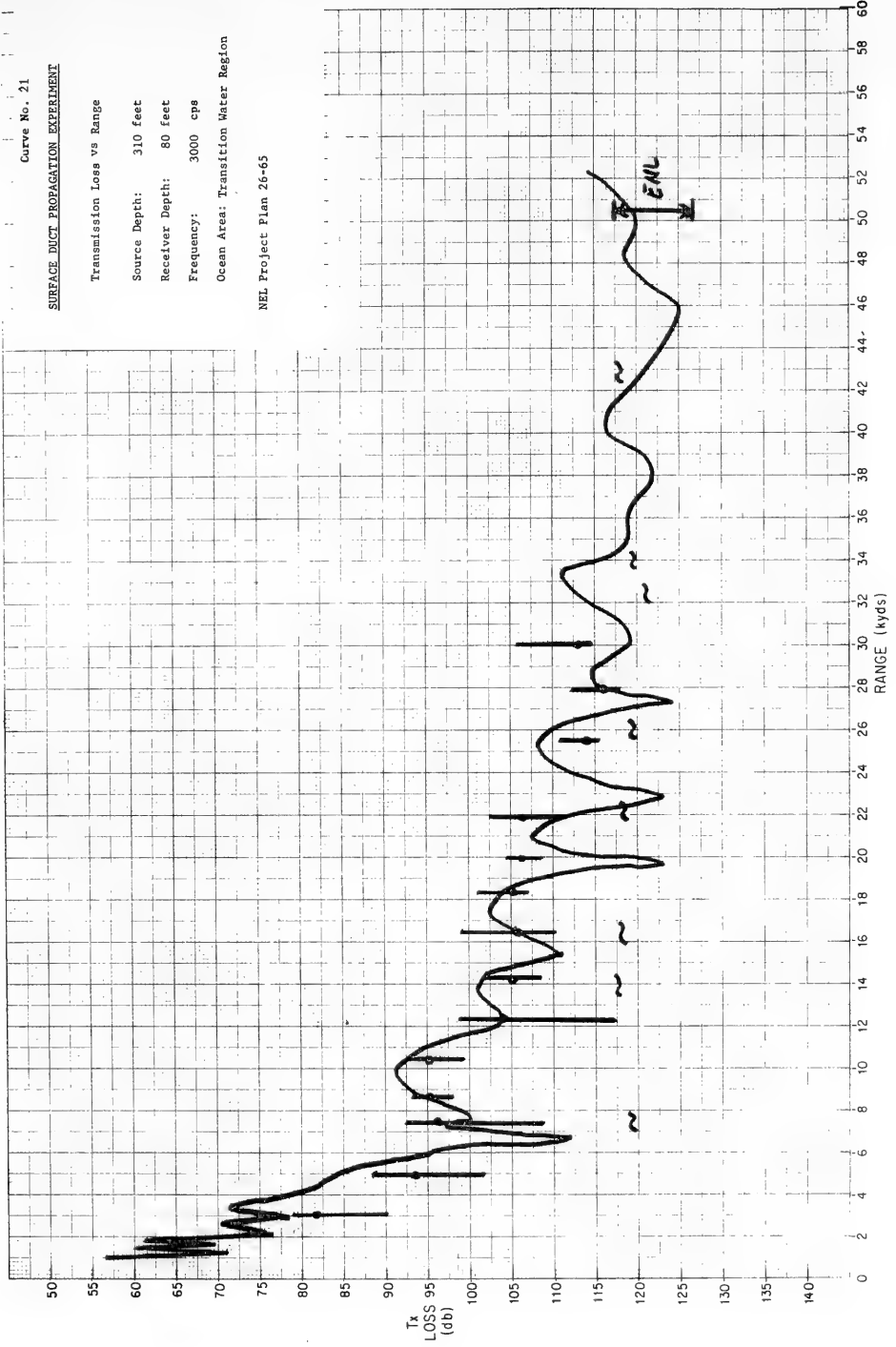

Curve No. 22

SURFACE DUCT PROPAGATION EXPERIMENT

Transmission Loss vs Range

Source Depth: 310 feet

Receiver Depth: 300 feet

Frequency: 700 cps

Ocean Area: Transition Water Region

NEL Project Plan 26-65

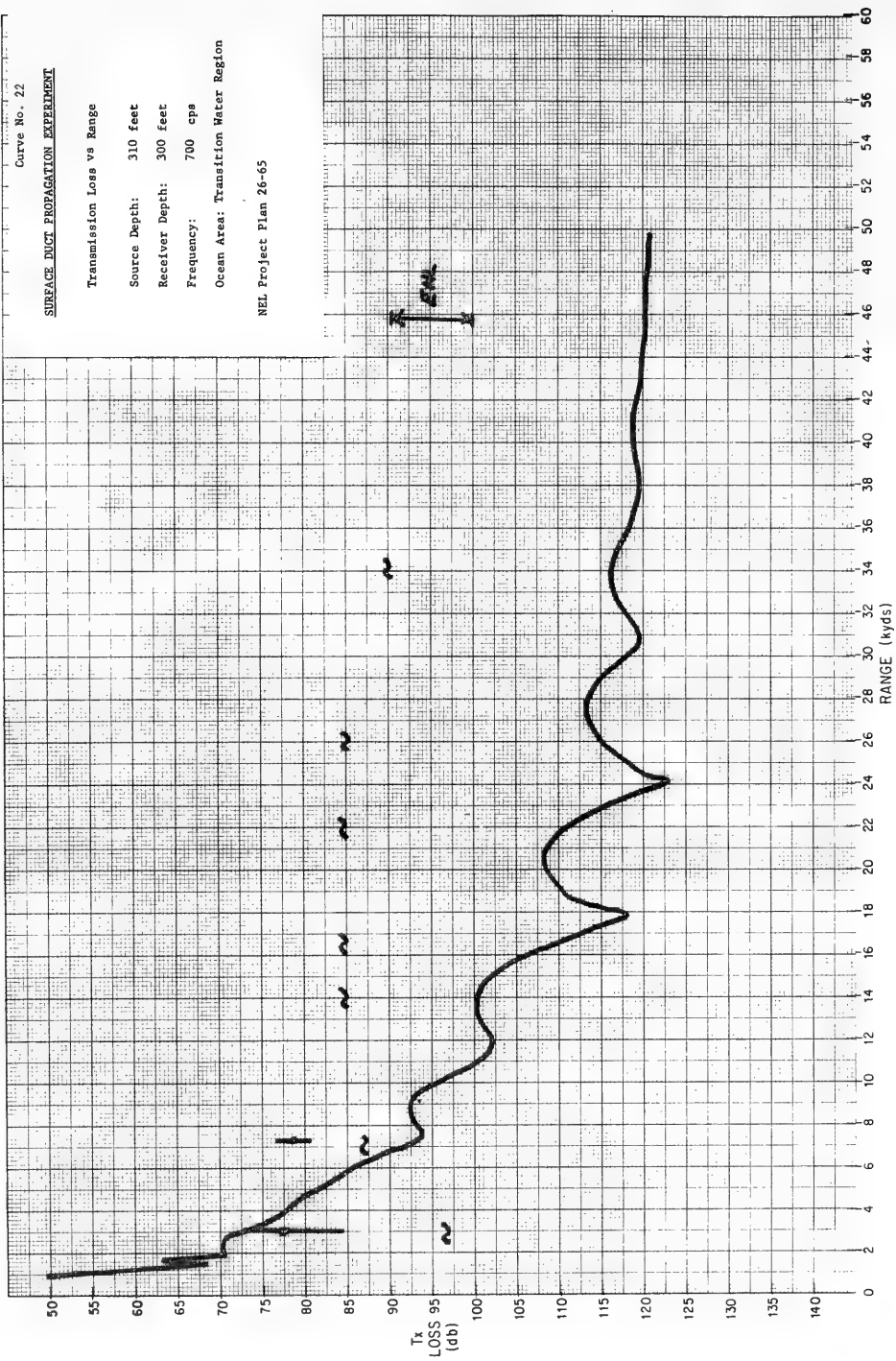

SURFACE DUCT PROPAGATION EXPERIMENT

Transmission Loss vs Range

Source Depth: 310 feet

Receiver Depth: 300 feet

Frequency: 1300 cps

Ocean Area: Transition Water Region

NEL Project Plan 26-65

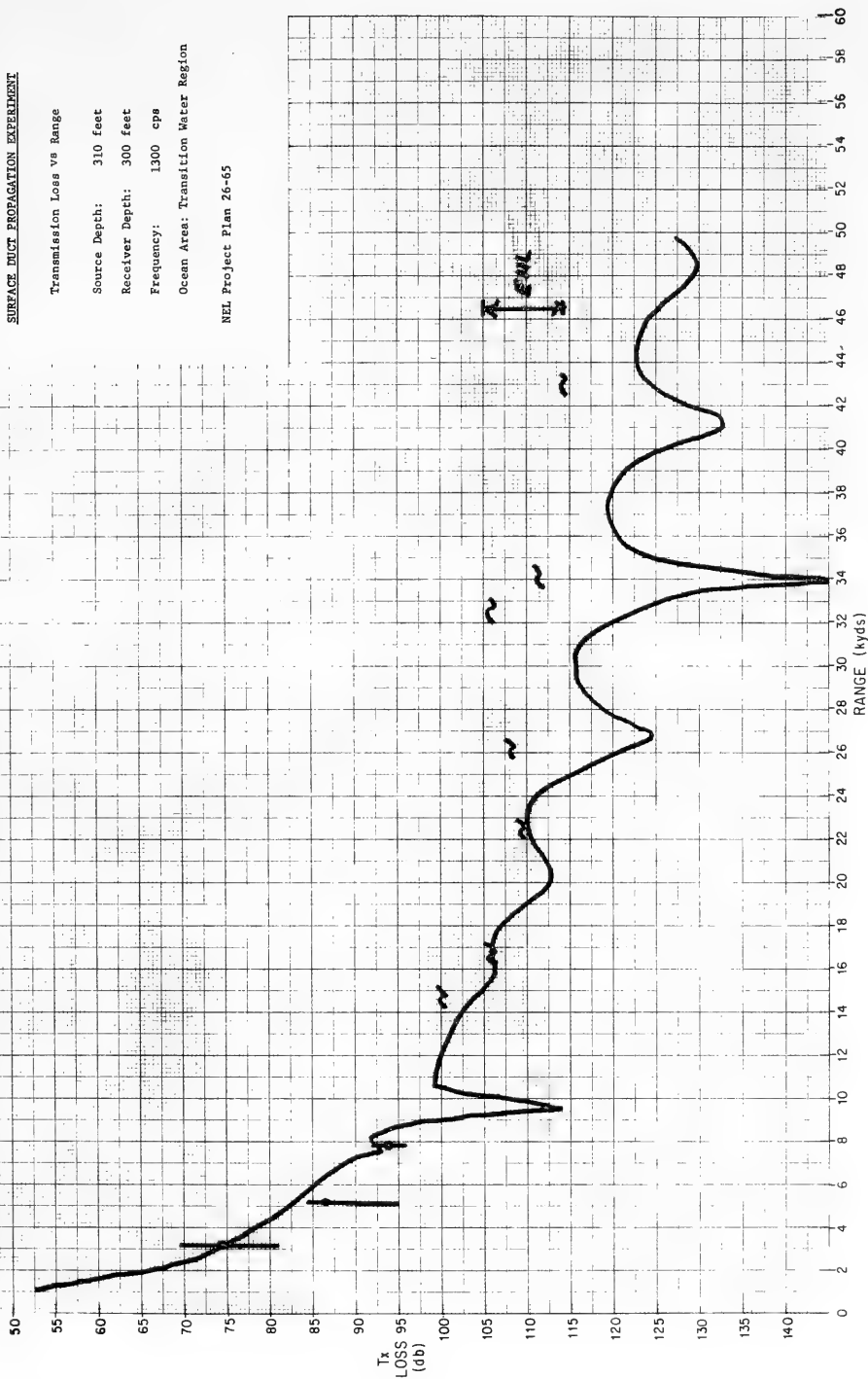

Curve No. 24

SURFACE DUCT PROPAGATION EXPERIMENT

Transmission Loss vs Range  
Source Depth: 310 feet  
Receiver Depth: 300 feet  
Frequency: 3000 cps  
Ocean Area: Transition Water Region

NEL Project Plan 26-65

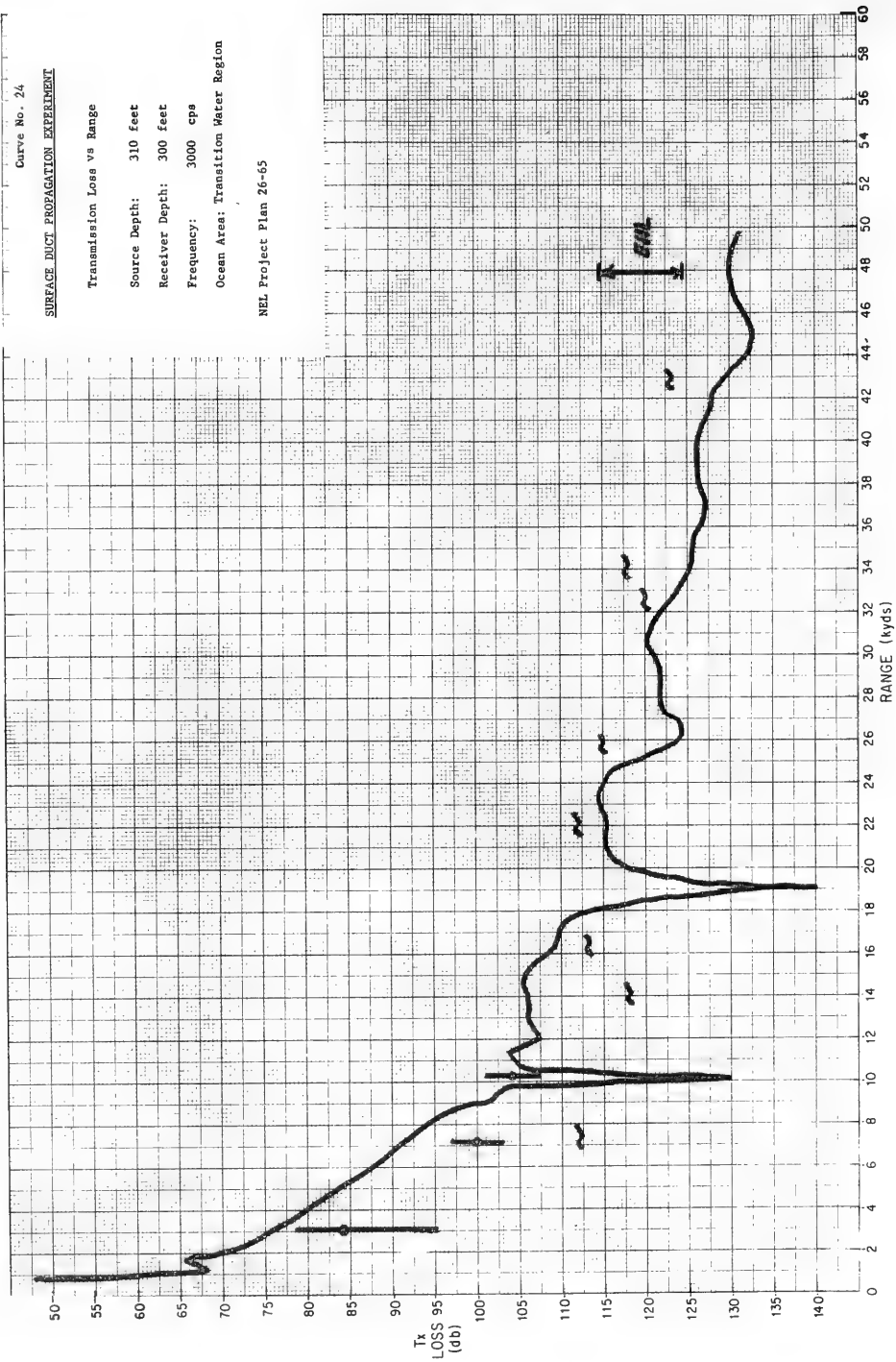

Curve No. 25

SURFACE DUCT PROPAGATION EXPERIMENT

Transmission Loss vs Range

Source Depth: 42 feet

Receiver Depth: 80 feet

Frequency: 700 cps

Ocean Area: Transition Water Region

NAI Project Plan 26-65

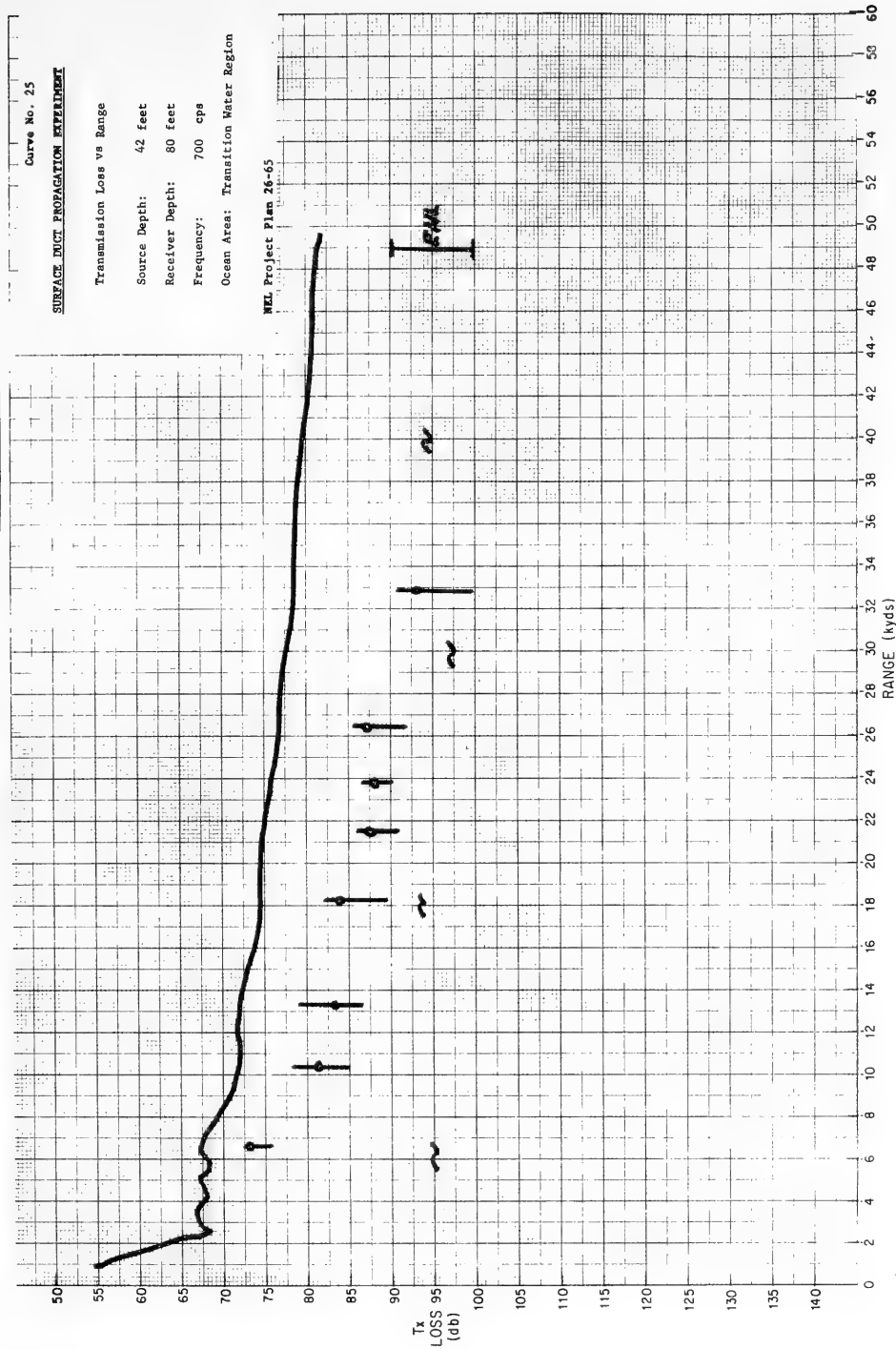

SURFACE DUCT PROPAGATION EXPERIMENT

Transmission Loss vs Range

Source Depth: 42 feet

Receiver Depth: 80 feet

Frequency: 1300 cps

Ocean Area: Transition Water Region

NM, Project Plan 26-65

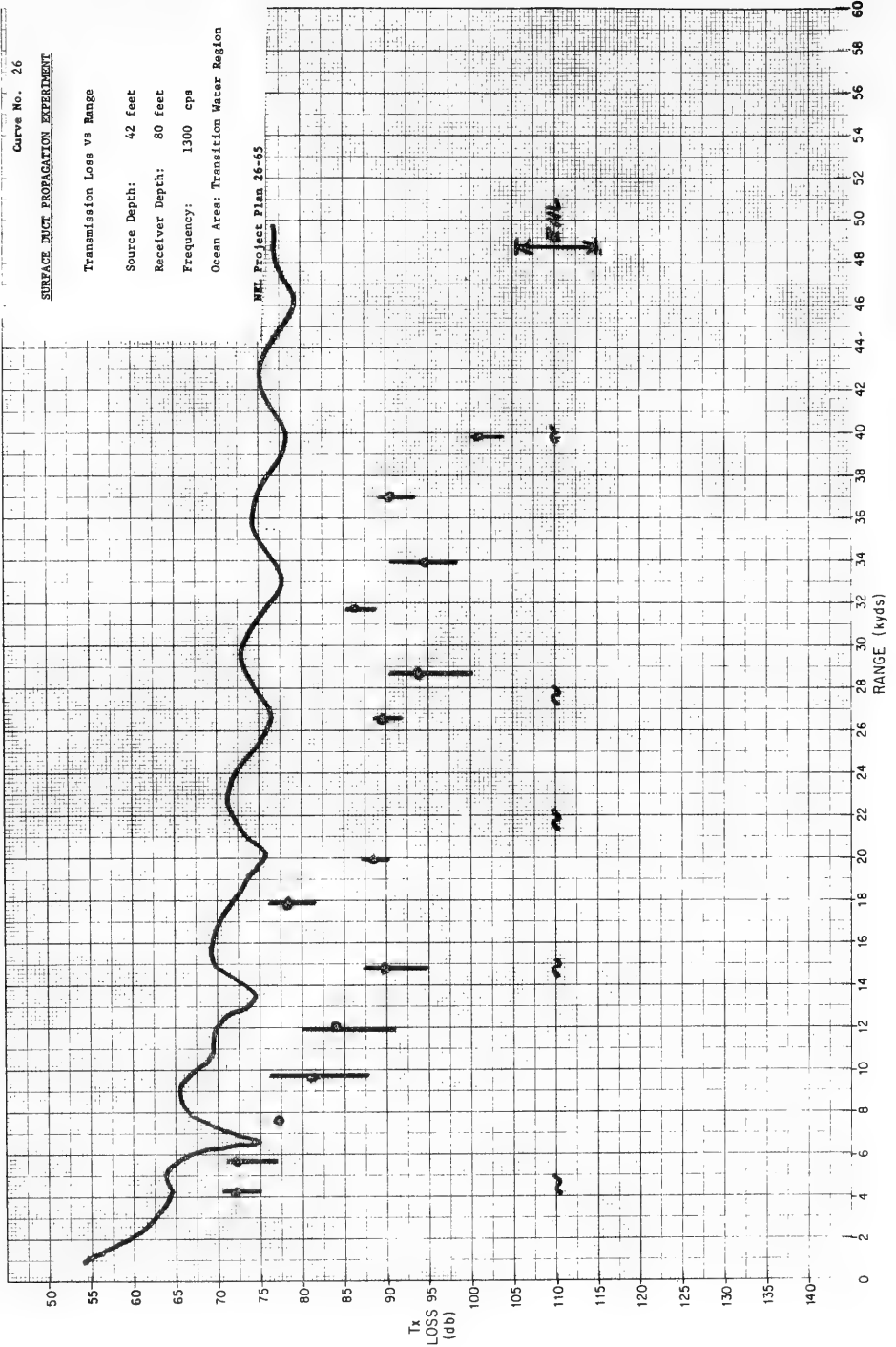



Curve No. 27

SURFACE DUCT PROPAGATION EXPERIMENT

Transmission Loss vs Range  
Source Depth: 42 feet  
Receiver Depth: 80 feet  
Frequency: 3000 cps  
Ocean Area: Transition Water Region

NEL Project Plan 26-65

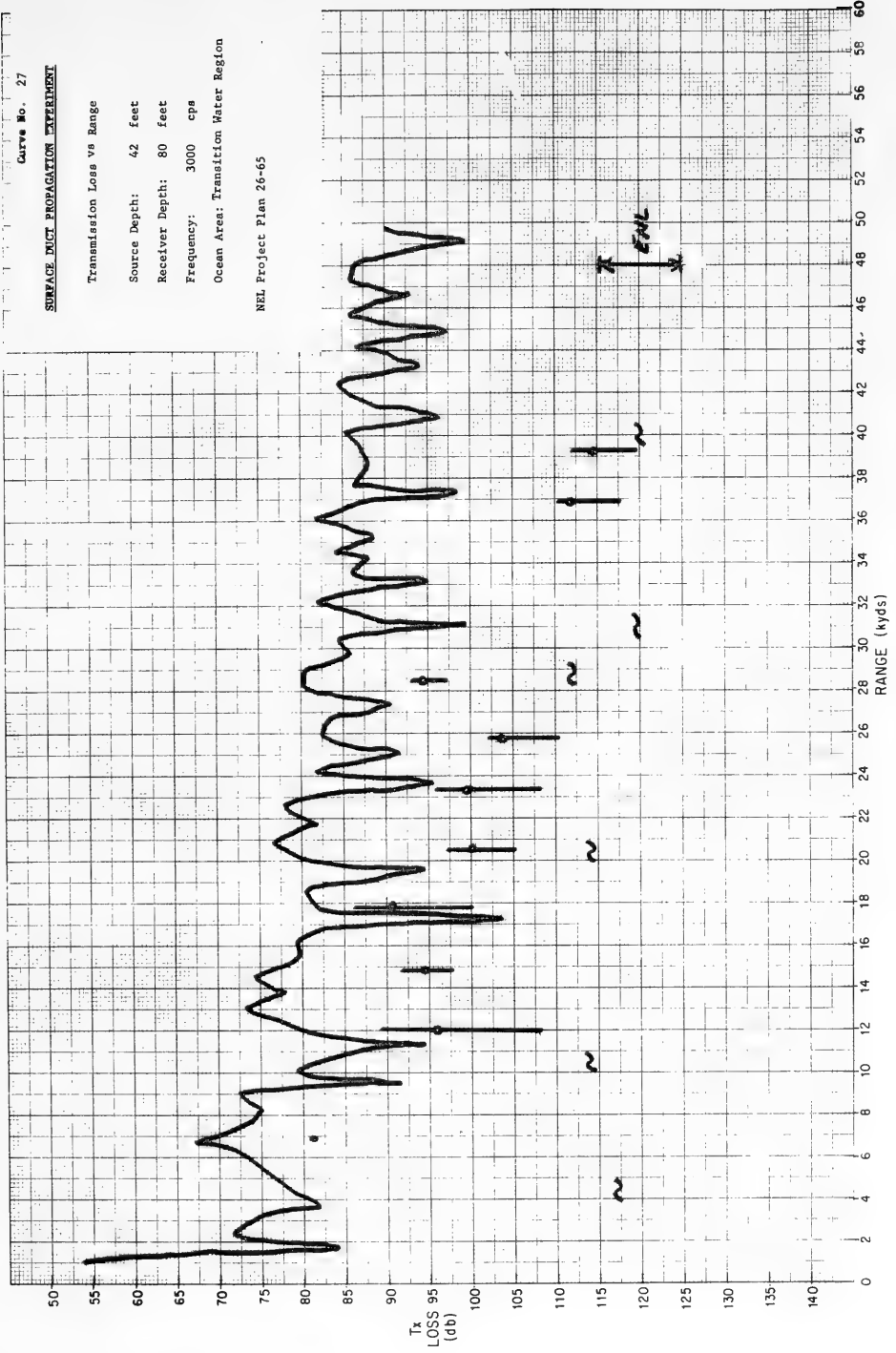

Curve No. 28

SURFACE DUCT PROPAGATION EXPERIMENT

Transmission Loss vs Range

Source Depth: 42 feet

Receiver Depth: 300 feet

Frequency: 700 cps

Ocean Area: Transition Water Region

NEL Project Plan 26-65

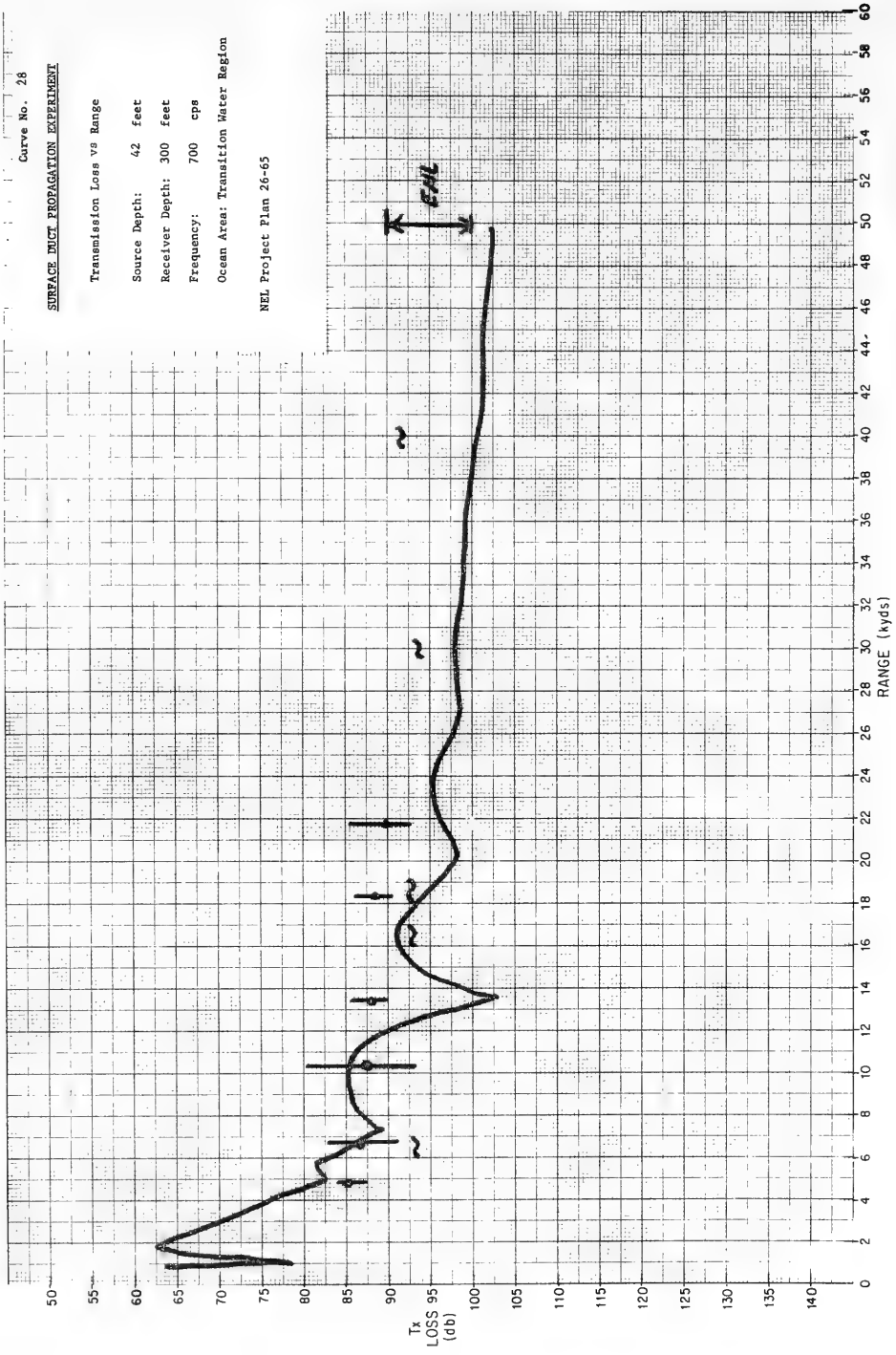

Curve No. 29

SURFACE DUCT PROPAGATION EXPERIMENT

Transmission Loss vs Range  
Source Depth: 42 feet  
Receiver Depth: 300 feet  
Frequency: 1300 cps  
Ocean Area: Transition Water Region

NEL Project Plan 26-65

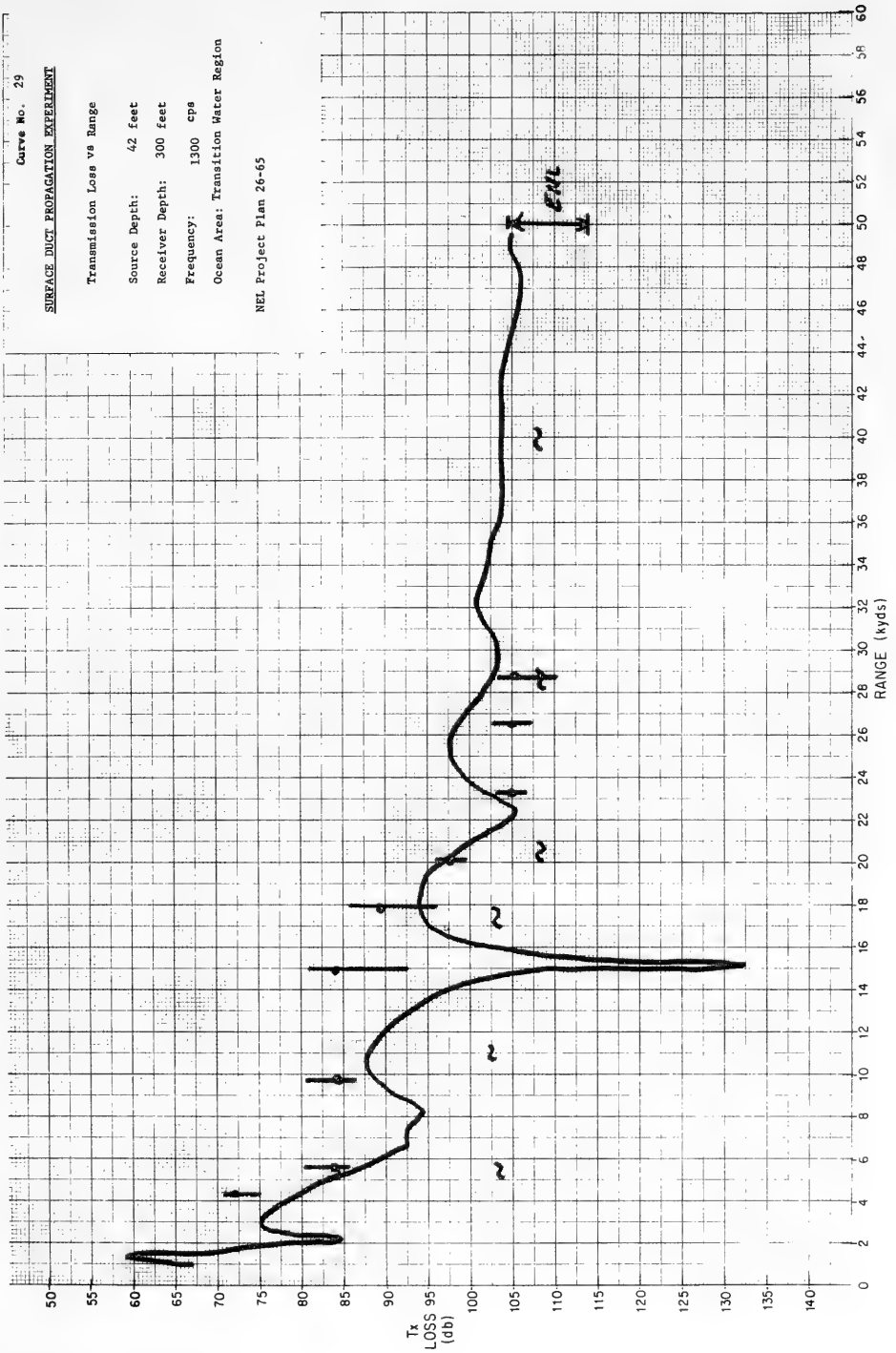

Curve No. 30

SURFACE DUCT PROPAGATION EXPERIMENT

Transmission Loss vs Range

Source Depth: 42 feet

Receiver Depth: 300 feet

Frequency: 3000 cps

Ocean Area: Transition Water Region

NEL Project Plan 26-65

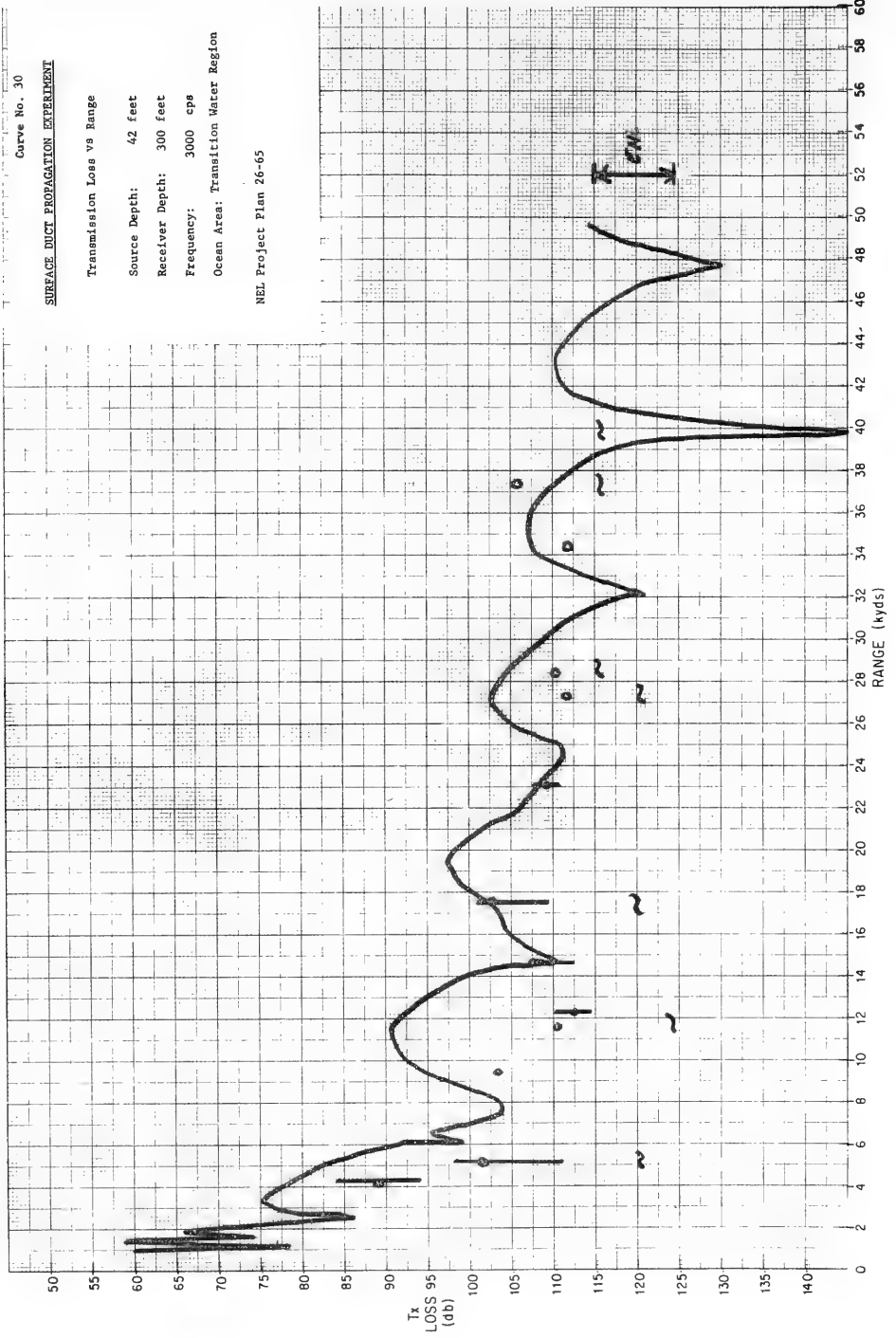

**SURFACE DUCT PROPAGATION EXPERIMENT**

Transmission Loss vs Range

Source Depth: 100 feet

Receiver Depth: 80 feet

Frequency: 700 cps

Ocean Area: Transition Water Region

NEL Project Plan 26-65

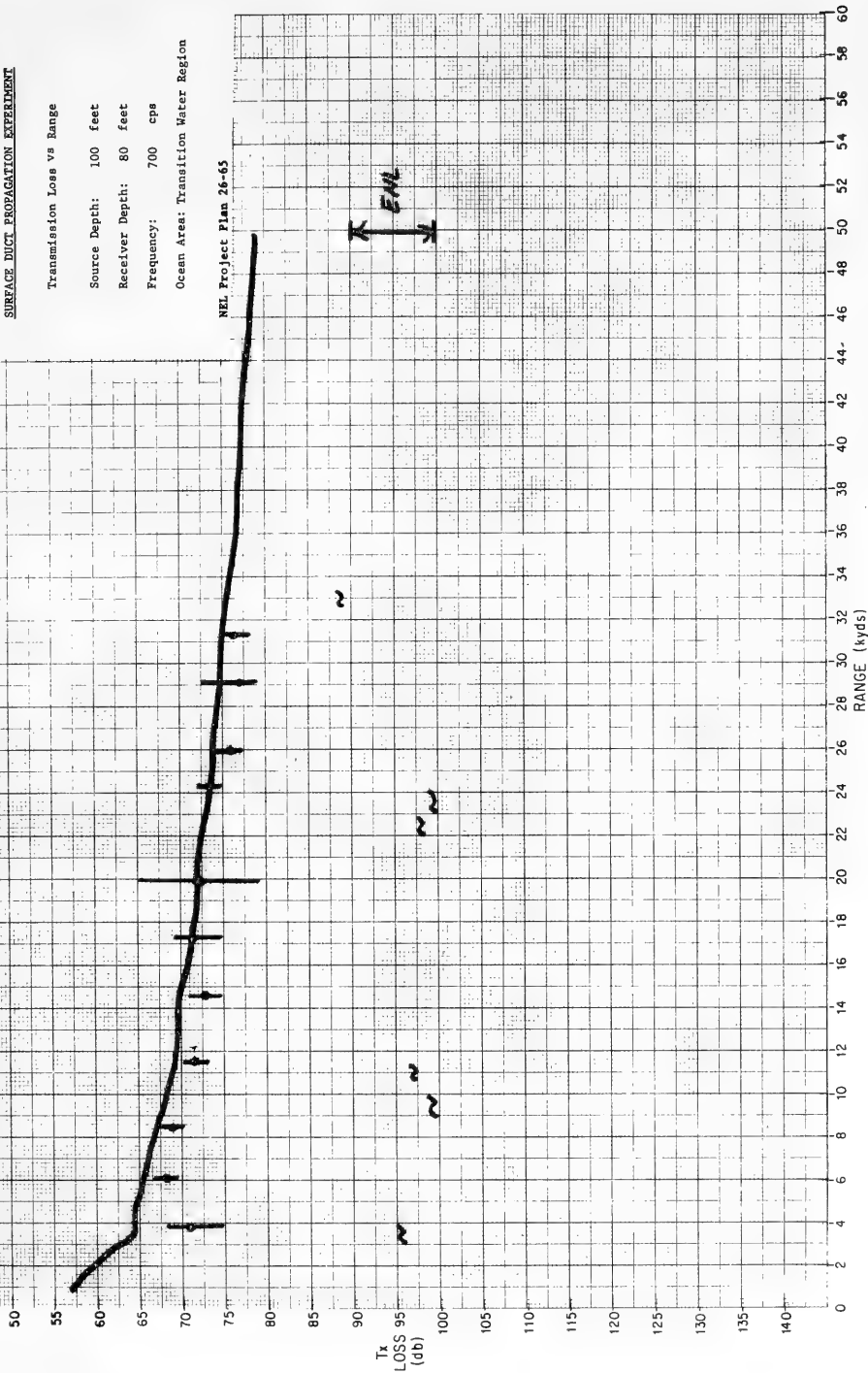

Curve No. 32

SURFACE DUCT PROPAGATION EXPERIMENT

Transmission Loss vs Range

Source Depth: 100 feet

Receiver Depth: 80 feet

Frequency: 1300 cps

Ocean Area: Transition Water Region

NEL Project Plan 26-65

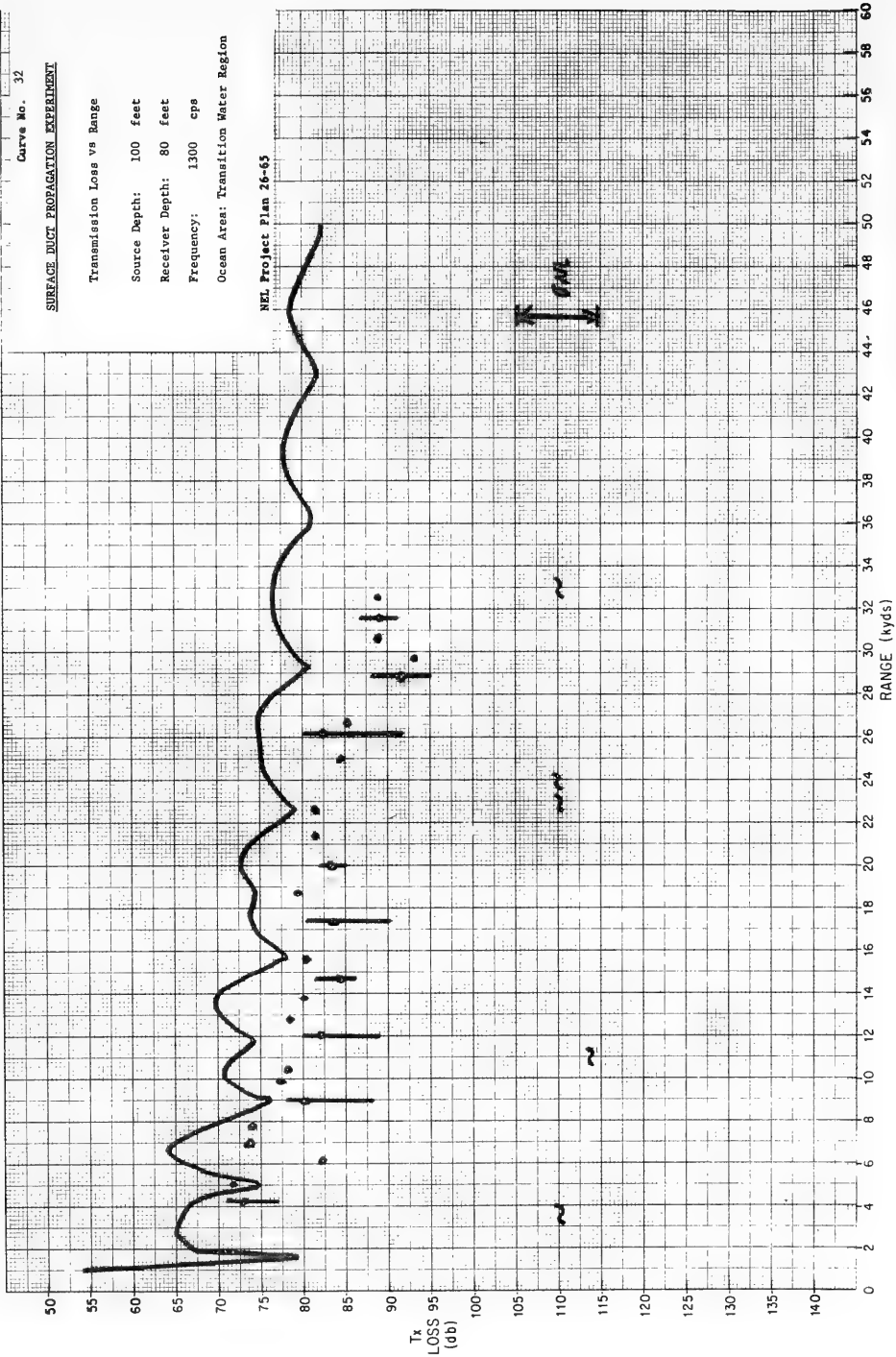

Curve No. 33

SURFACE DUCT PROPAGATION EXPERIMENT

Transmission Loss vs Range

Source Depth: 100 feet

Receiver Depth: 80 feet

Frequency: 3000 cps

Ocean Area: Transition Water Region

NEL Project Plan 26-65

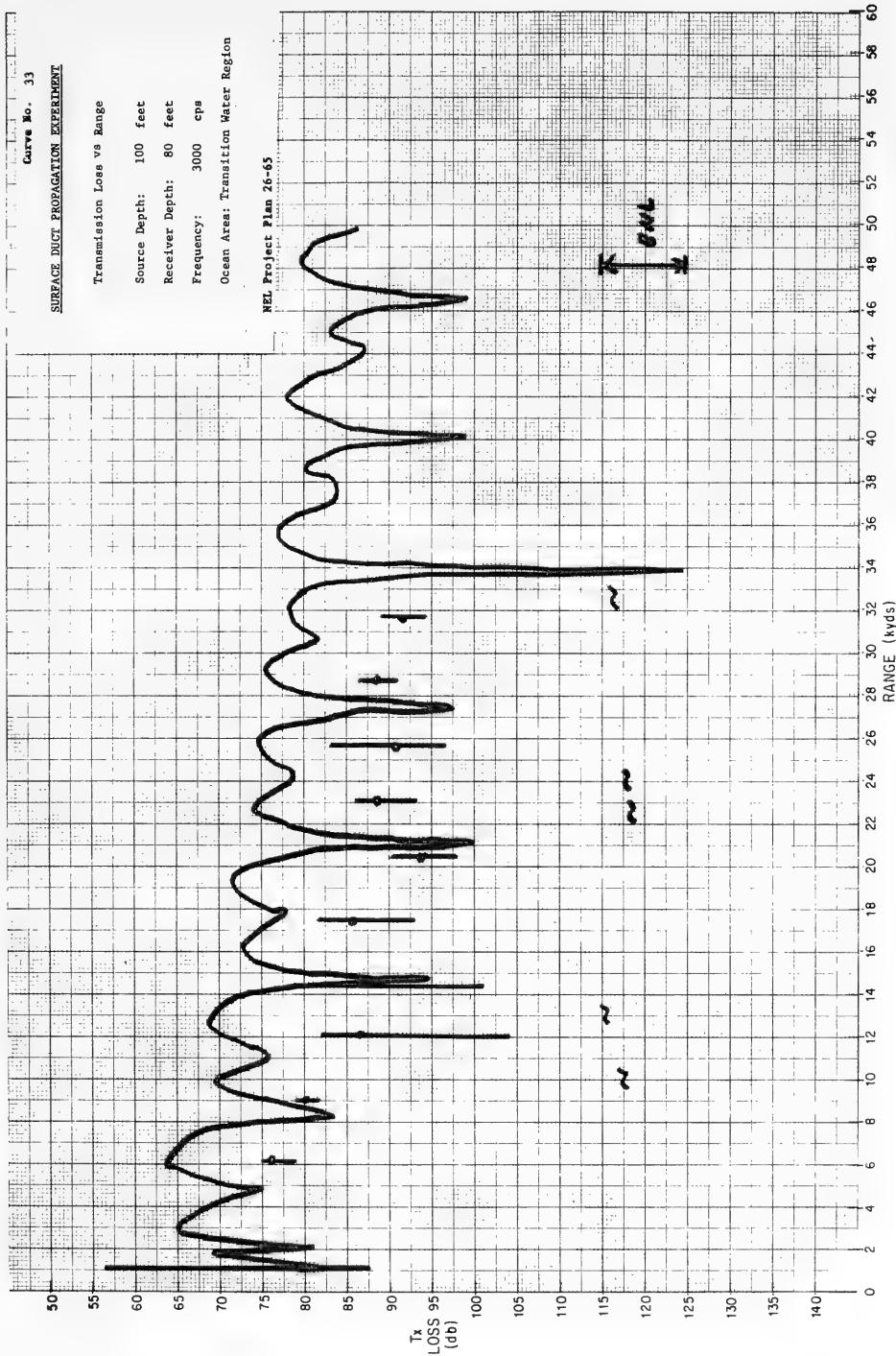

Curve No. 34

SURFACE DUCT PROPAGATION EXPERIMENT

Transmission Loss vs Range  
Source Depth: 100 feet  
Receiver Depth: 300 feet  
Frequency: 700 cps  
Ocean Area: Transition Water Region

NEL Project Plan 26-65

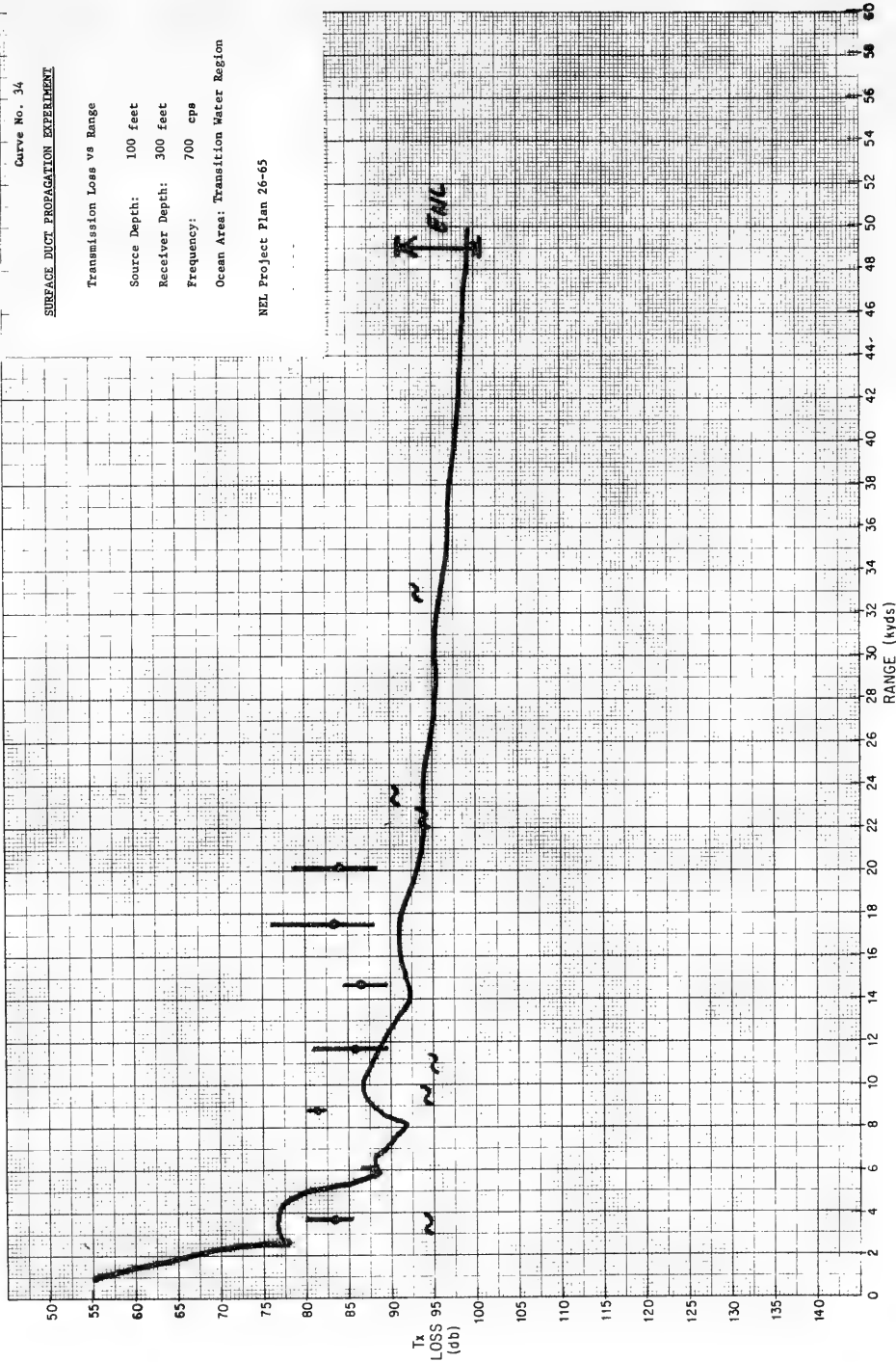



Curve No. 35

SURFACE DUCT PROPAGATION EXPERIMENT

Transmission Loss vs Range  
Source Depth: 100 feet  
Receiver Depth: 300 feet  
Frequency: 1300 cps  
Ocean Area: Transition Water Region

NEL Project Plan 26-65

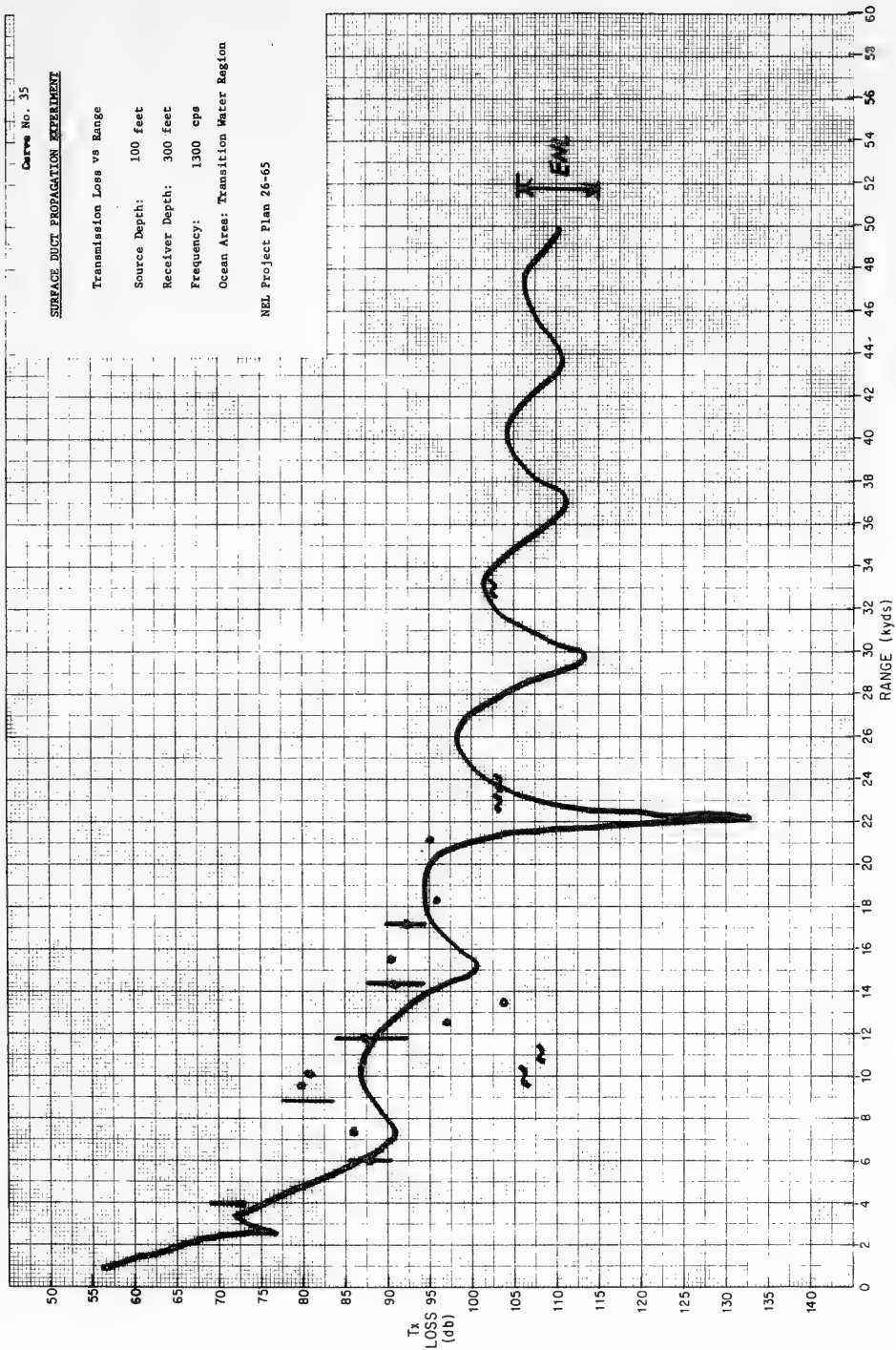

Curve No. 36

SURFACE DUCT PROPAGATION EXPERIMENT

Transmission Loss vs Range  
Source Depth: 100 feet  
Receiver Depth: 300 feet  
Frequency: 3000 cps  
Ocean Area: Transition Water Region

NEL Project Plan 26-65

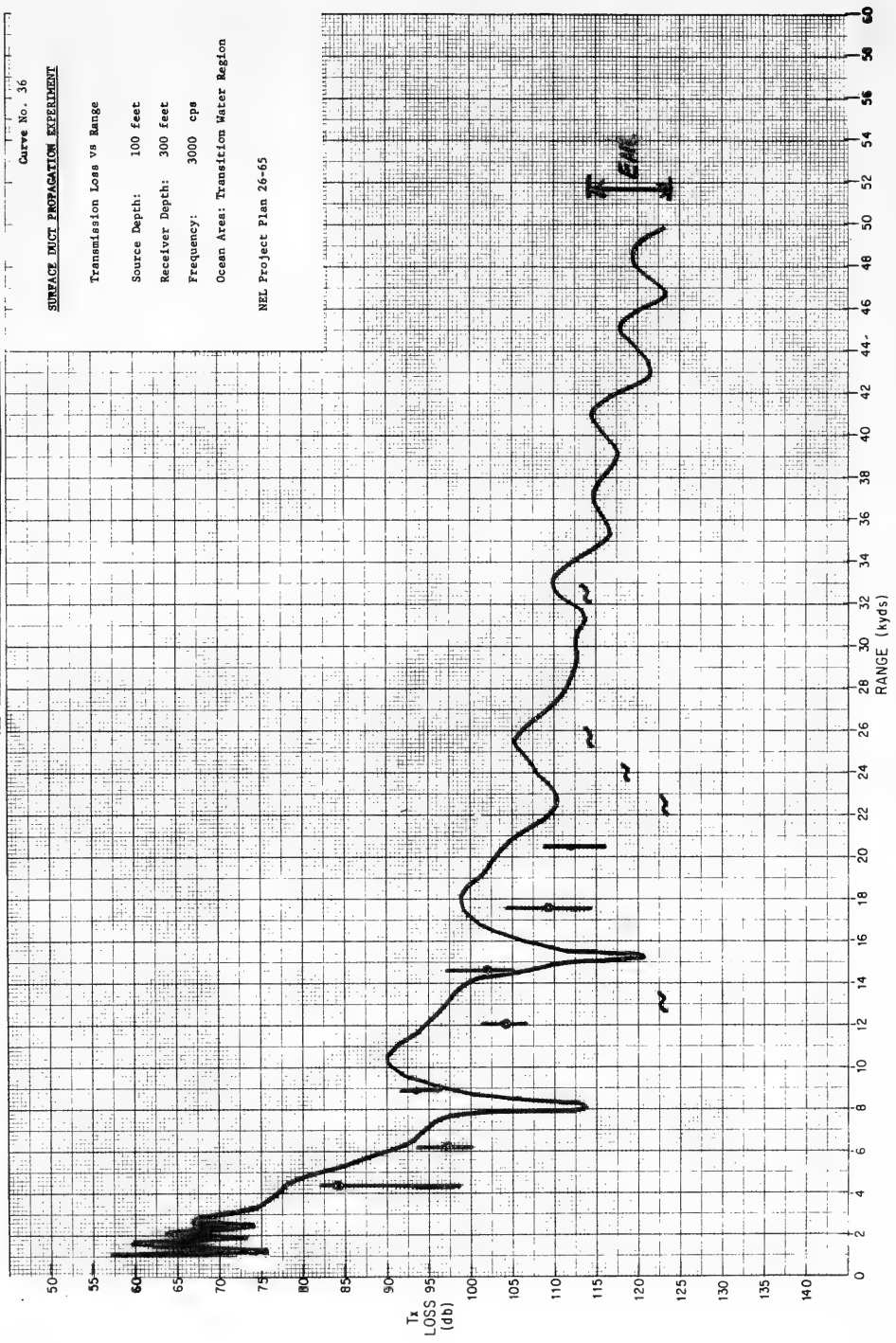

SURFACE DUCT PROPAGATION EXPERIMENT

Transmission Loss vs Range  
Source Depth: 310 feet  
Receiver Depth: 50 feet  
Frequency: 700 cps  
Ocean Area: Boundary Region

NEL Project Plan 26-65

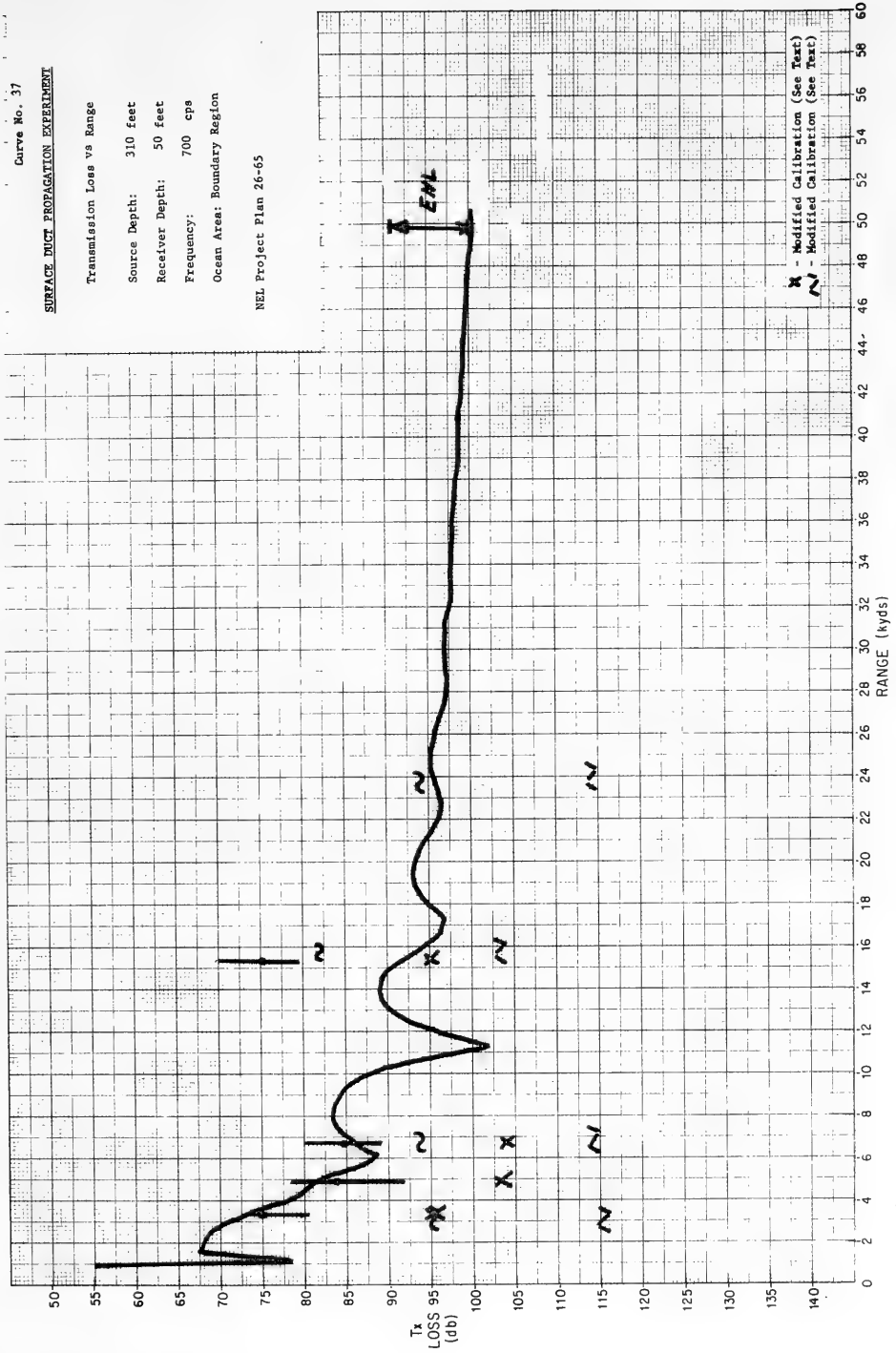

X - Modified Calibration (See Text)  
N - Modified Calibration (See Text)

Curve No. 38

SURFACE DUCT PROPAGATION EXPERIMENT

Transmission Loss vs Range  
Source Depth: 310 feet  
Receiver Depth: 50 feet  
Frequency: 1300 cps  
Ocean Area: Boundary Region

NEL Project Plan 26-65

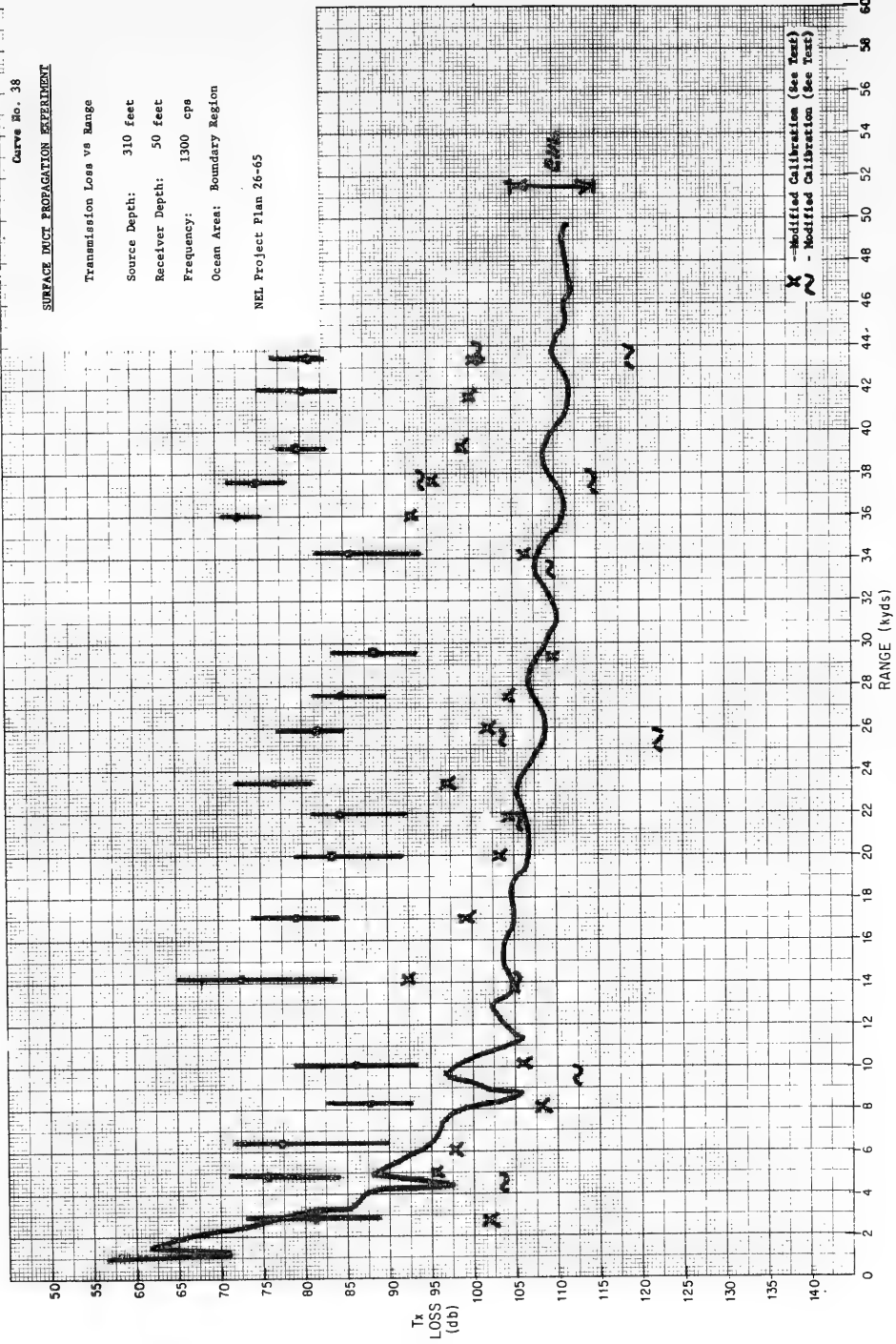

SURFACE DUCT PROPAGATION EXPERIMENT

Transmission Loss vs Range

Source Depth: 310 feet

Receiver Depth: 50 feet

Frequency: 3000 cps

Ocean Area: Boundary Region

NEL Project Plan 26-65

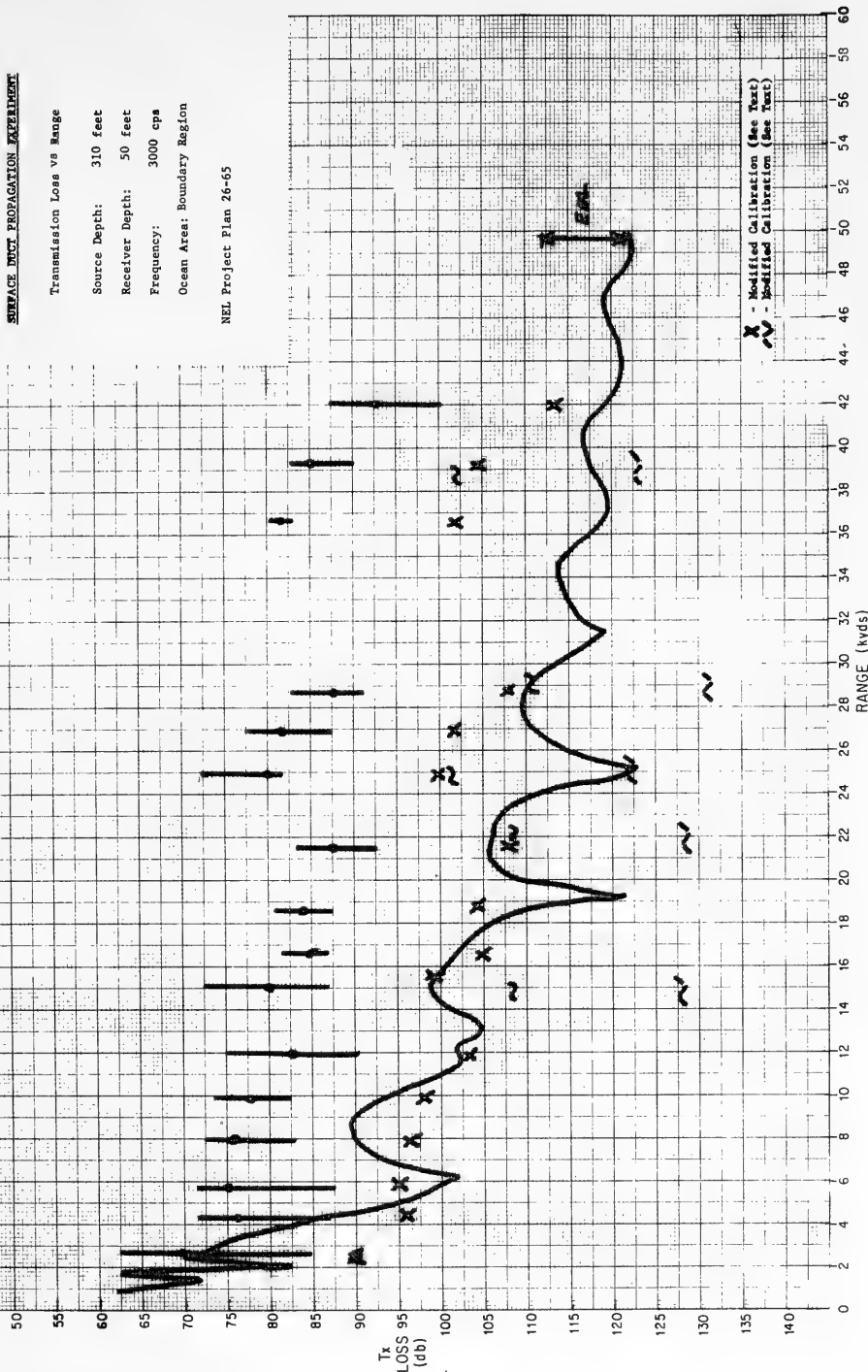

Curve No. 40

SURFACE DUCT PROPAGATION EXPERIMENT

Transmission Loss vs Range

Source Depth: 42 feet

Receiver Depth: 50 feet

Frequency: 700 cps

Ocean Area: Boundary Region

NEL Project Plan 26-65

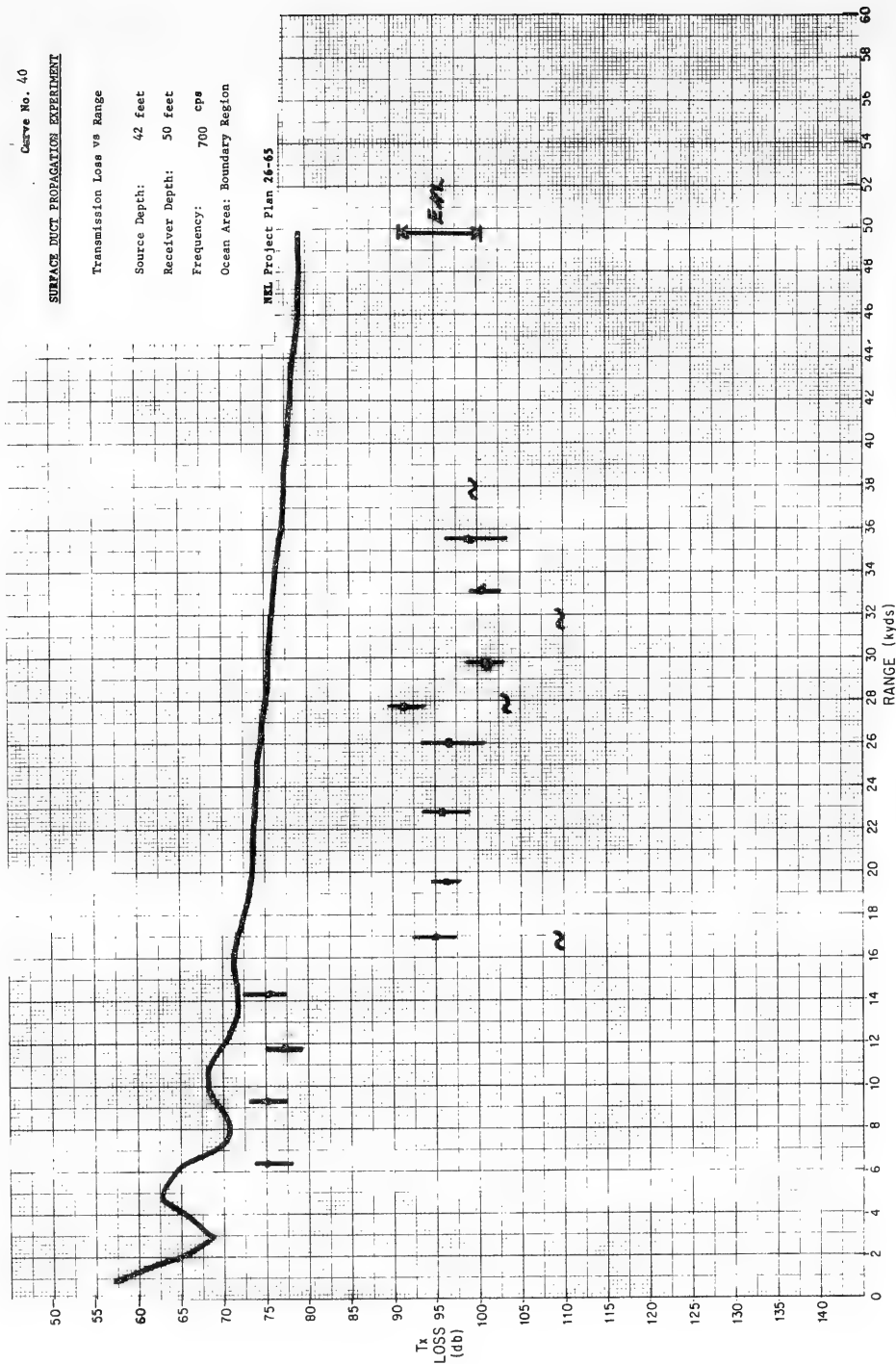

Curve No. 41

**SURFACE DUCT PROPAGATION AT 1300 cps**

Transmission Loss vs Range  
Source Depth: 42 feet  
Receiver Depth: 50 feet  
Frequency: 1300 cps  
Ocean Area: Boundary Region

NEL Project Plan 26-65

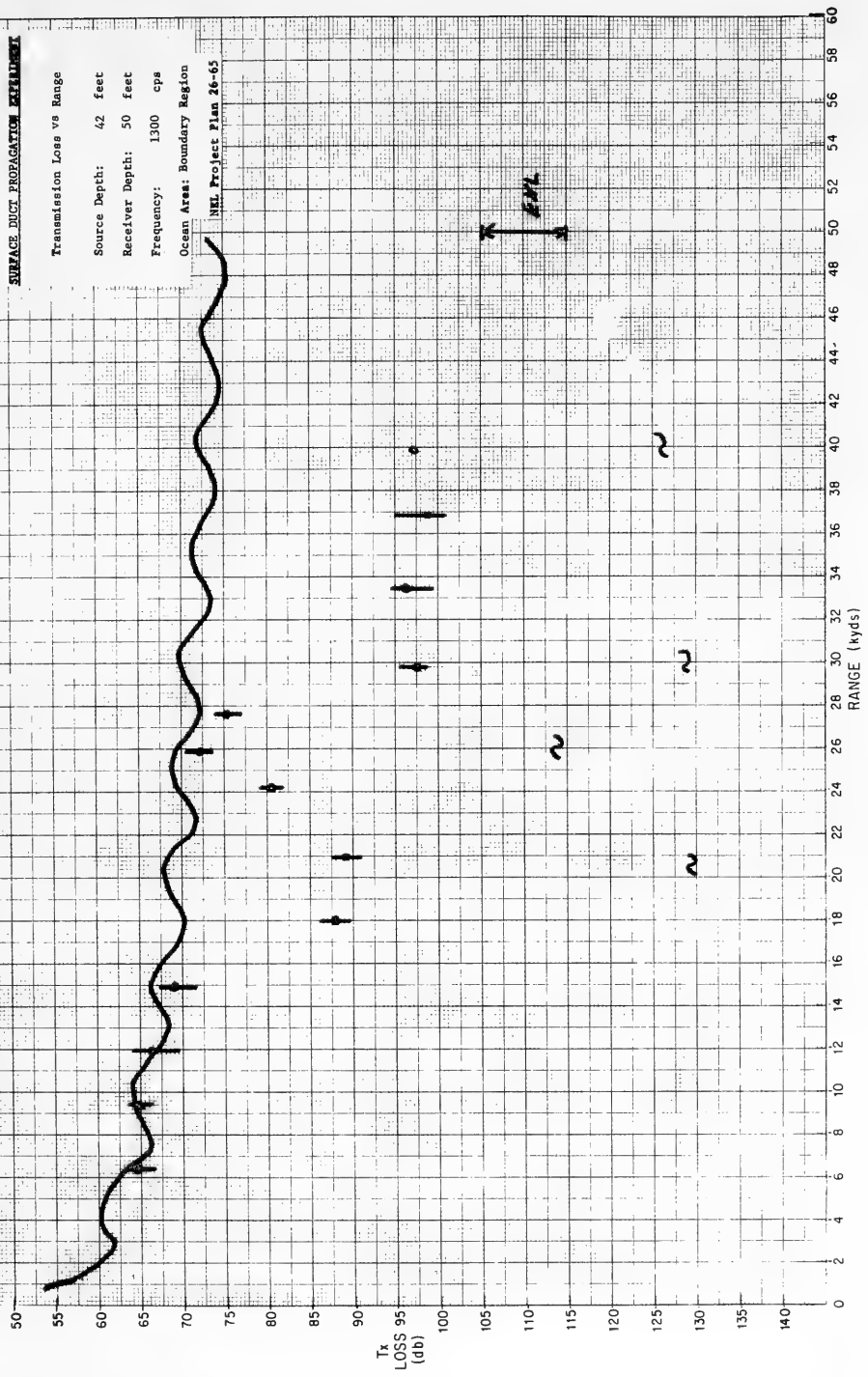

Curve No. 42

SURFACE DUCT PROPAGATION EXPERIMENT

Transmission Loss vs Range

Source Depth: 42 feet

Receiver Depth: 50 feet

Frequency: 3000 cps

Ocean Area: Boundary Region

WEL Project Plan 26-65

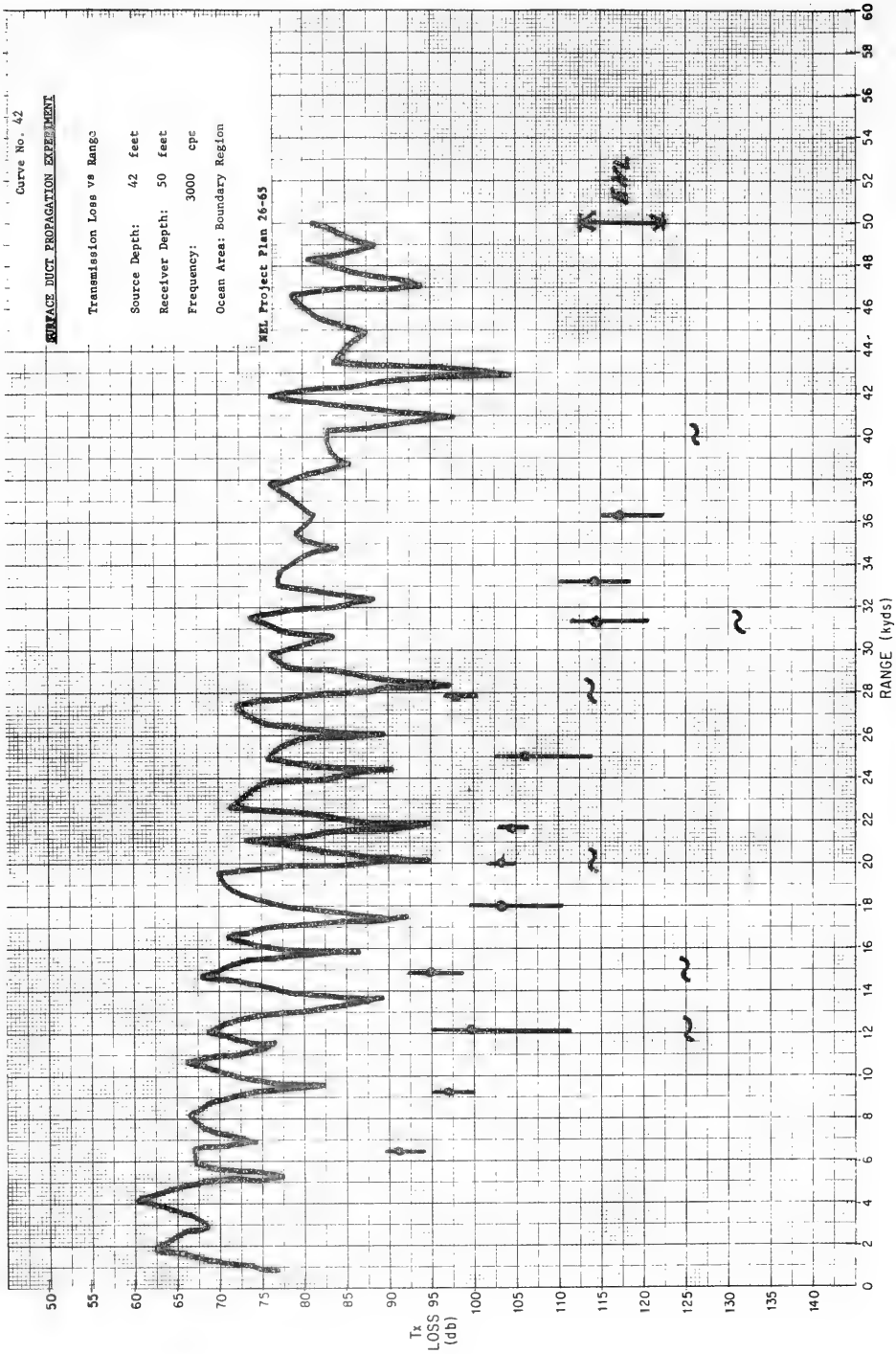



Curve No. 43

SUBMERSIBLE DUCT PROPAGATION EXPERIMENT

Transmission Loss vs Range

Source Depth: 100 feet

Receiver Depth: 50 feet

Frequency: 700 cps

Ocean Area: Boundary Region

MLL Project Plan 26-63

X - Adjusted Attenuator (See Text)  
/ - Adjusted Attenuator (See Text)

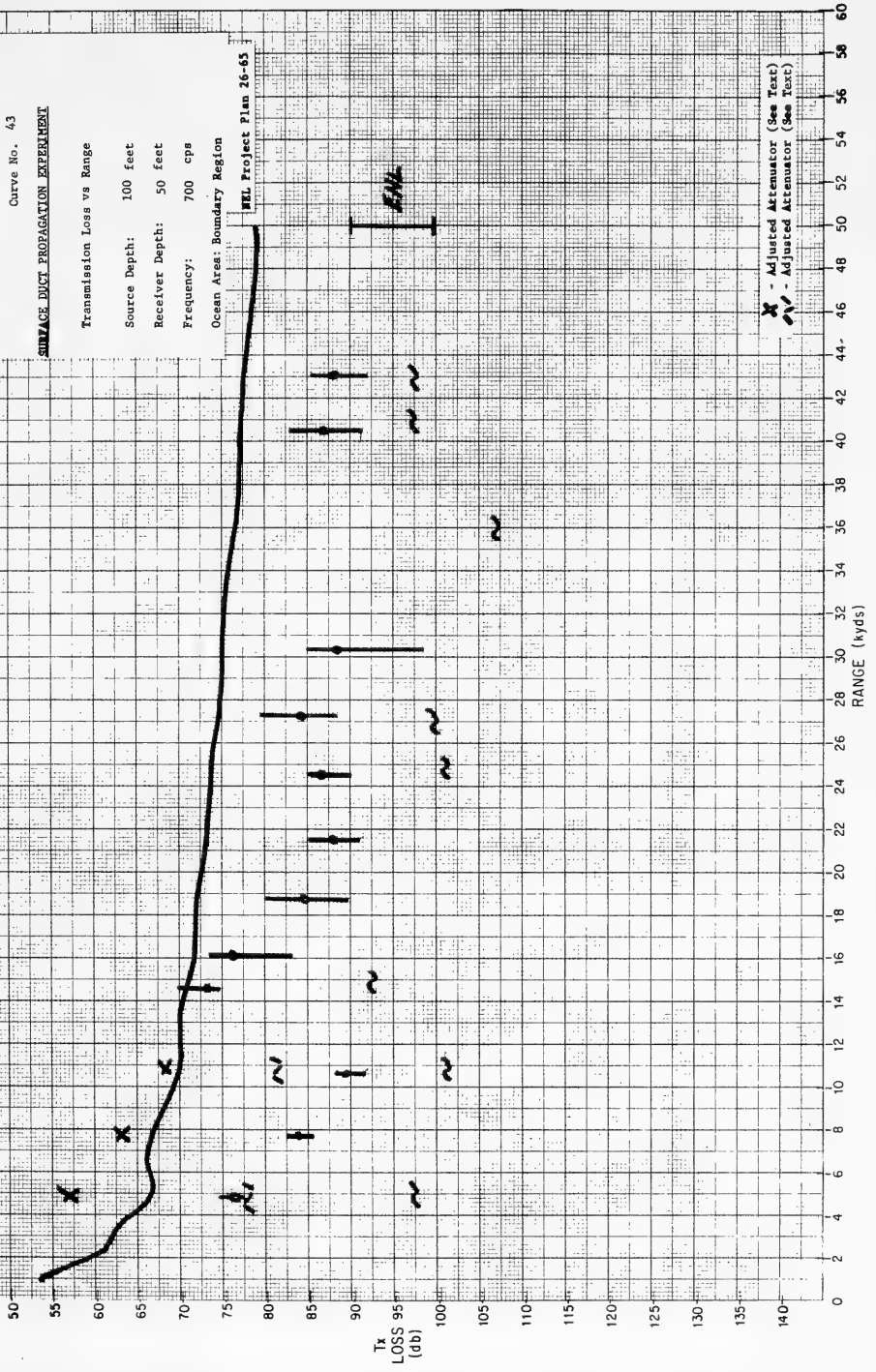

SURFACE DUCT PROPAGATION EXPERIMENT

Transmission Loss vs Range

Source Depth: 100 feet

Receiver Depth: 50 feet

Frequency: 1300 cps

Ocean Area: Boundary Region

NEEL Project Plan 26-65

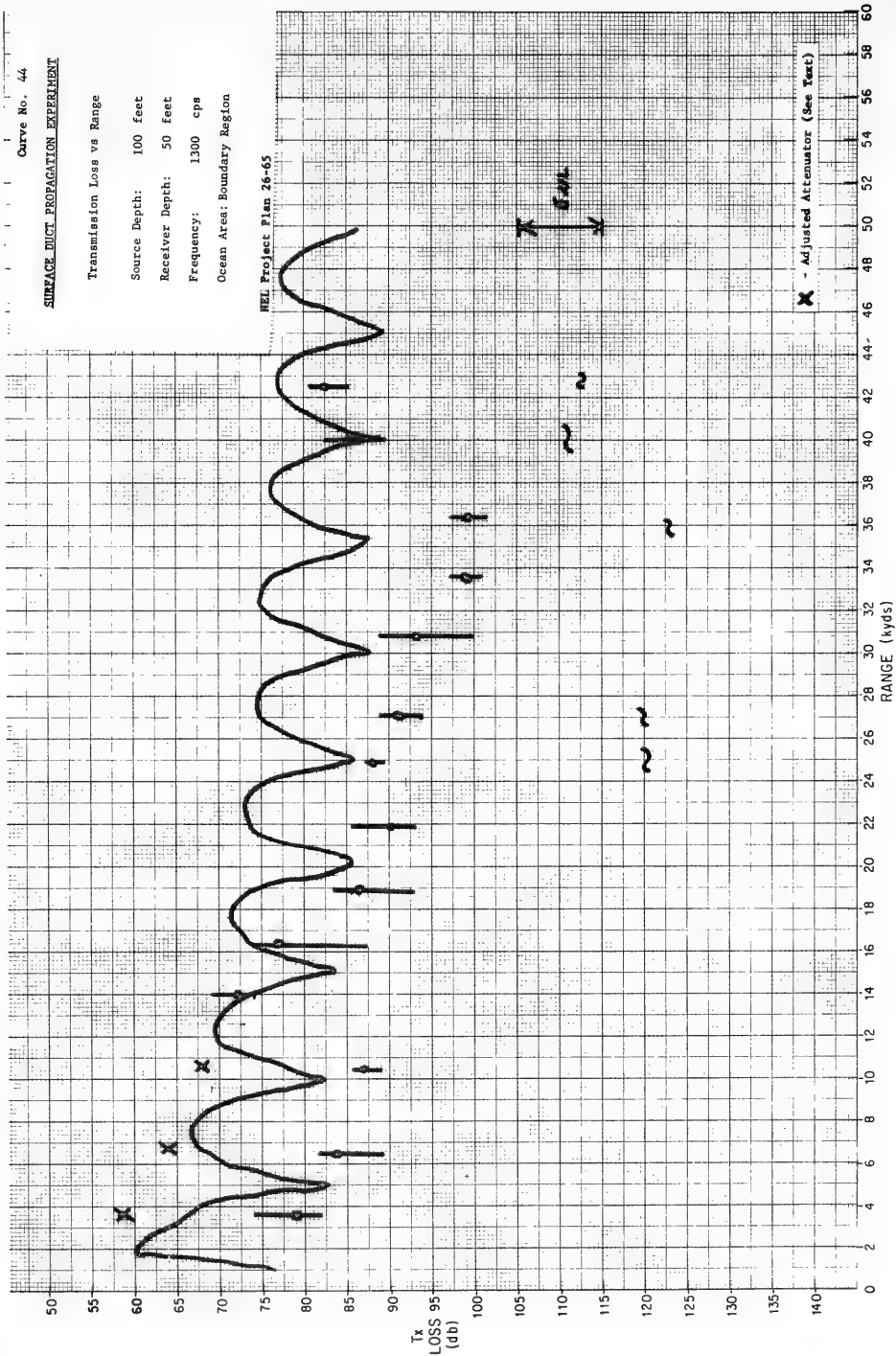

x - Adjusted Attenuator (See Text)

Curve No. 45

**SURFACE MUCT PROPAGATION EXPERIMENT**

Transmission Loss vs Range

Source Depth: 100 feet

Receiver Depth: 50 feet

Frequency: 3000 cps

Ocean Area: Boundary Region

NZL Project Plan 26-65

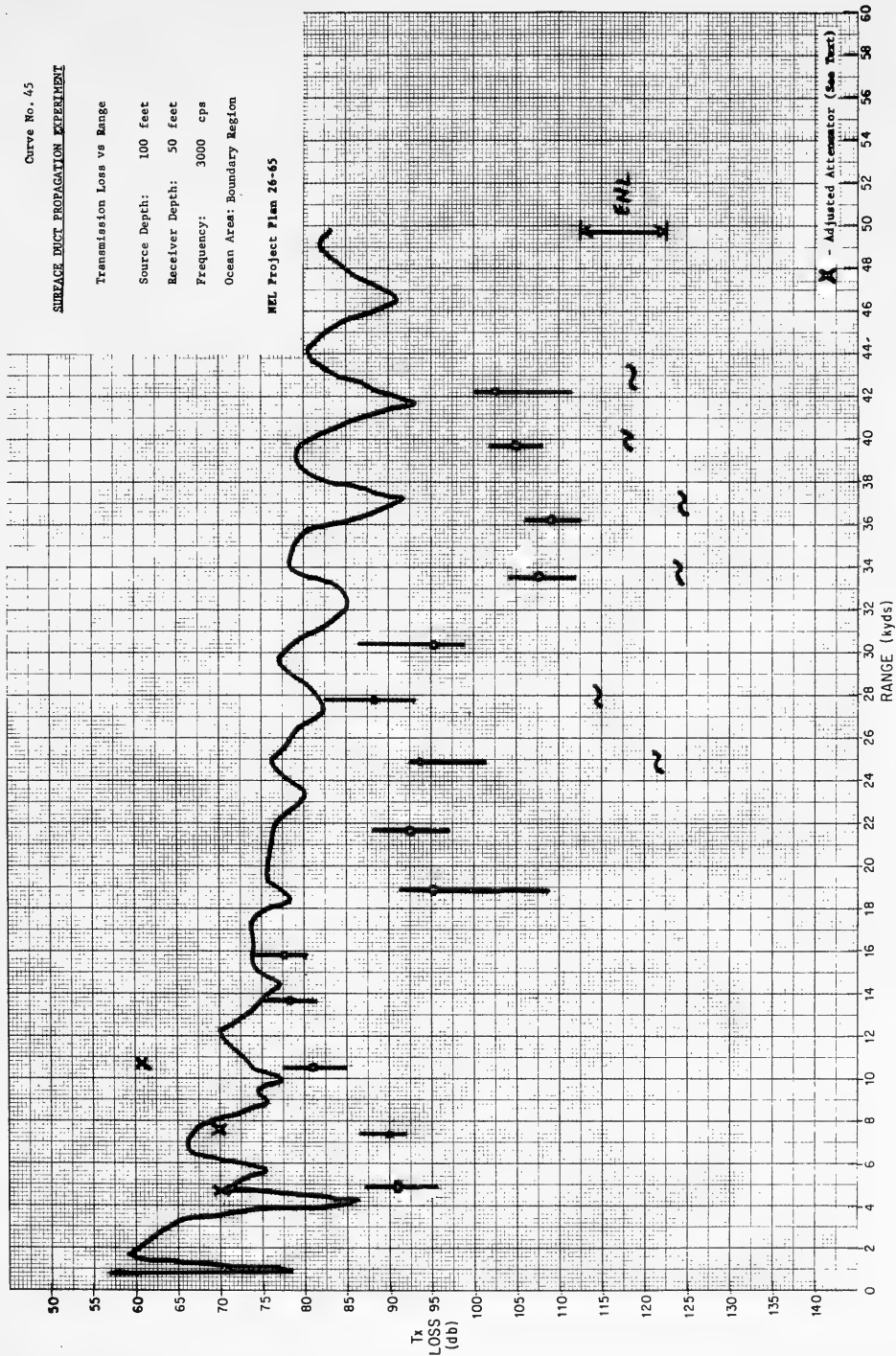

Curve No. 46

SURFACE DUCT PROPAGATION EXPERIMENT

Transmission Loss vs Range

Source Depth: 310 feet

Receiver Depth: 25 feet

Frequency: 700 cps

Ocean Area: Transition Water Region

NEL Project Plan 26-65

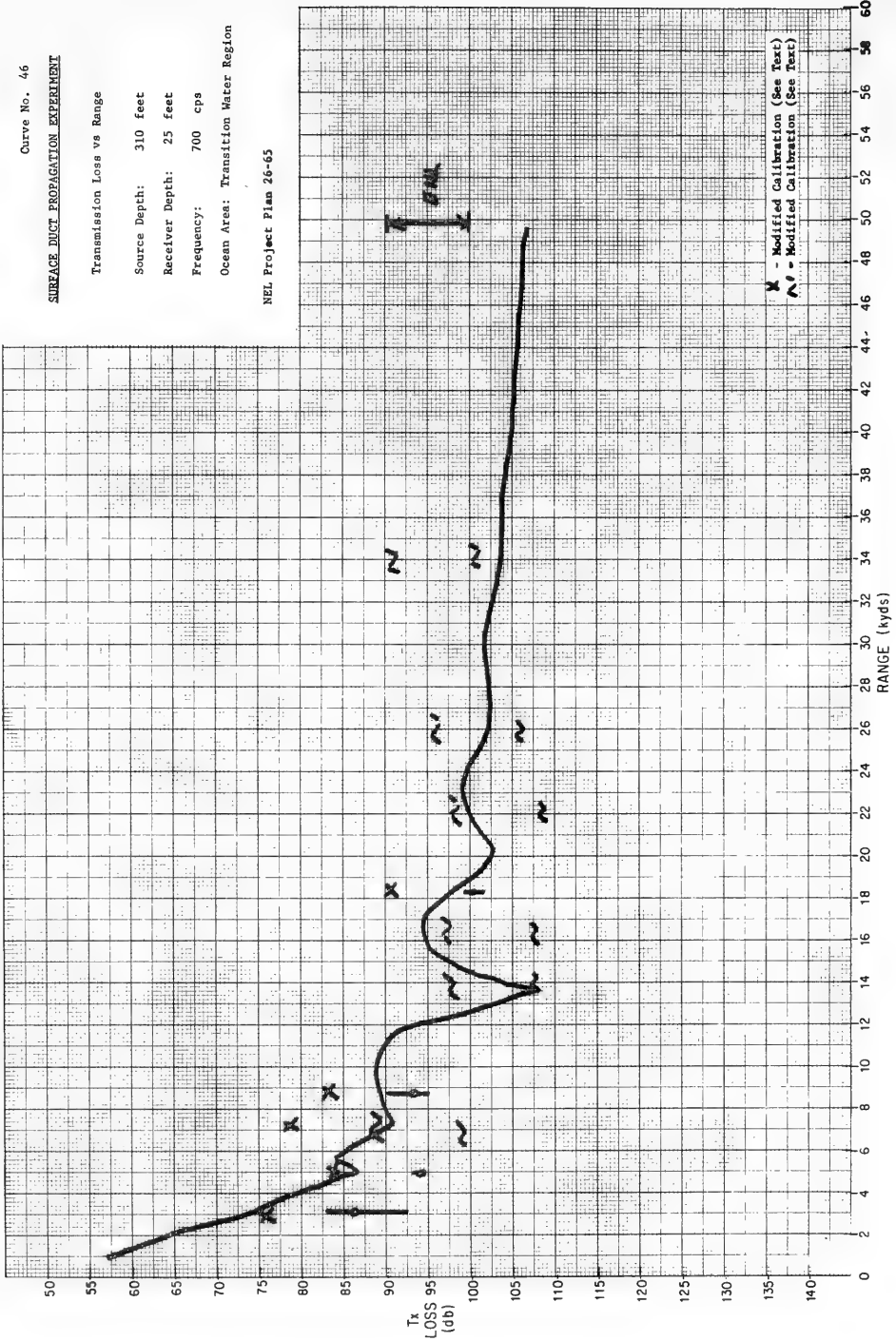

Curve No. 47

SURFACE DUCT PROPAGATION EXPERIMENT

Transmission Loss vs Range

Source Depth: 310 feet

Receiver Depth: 25 feet

Frequency: 1300 cps

Ocean Area: Transition Water Region

NEL Project Plan 26-65

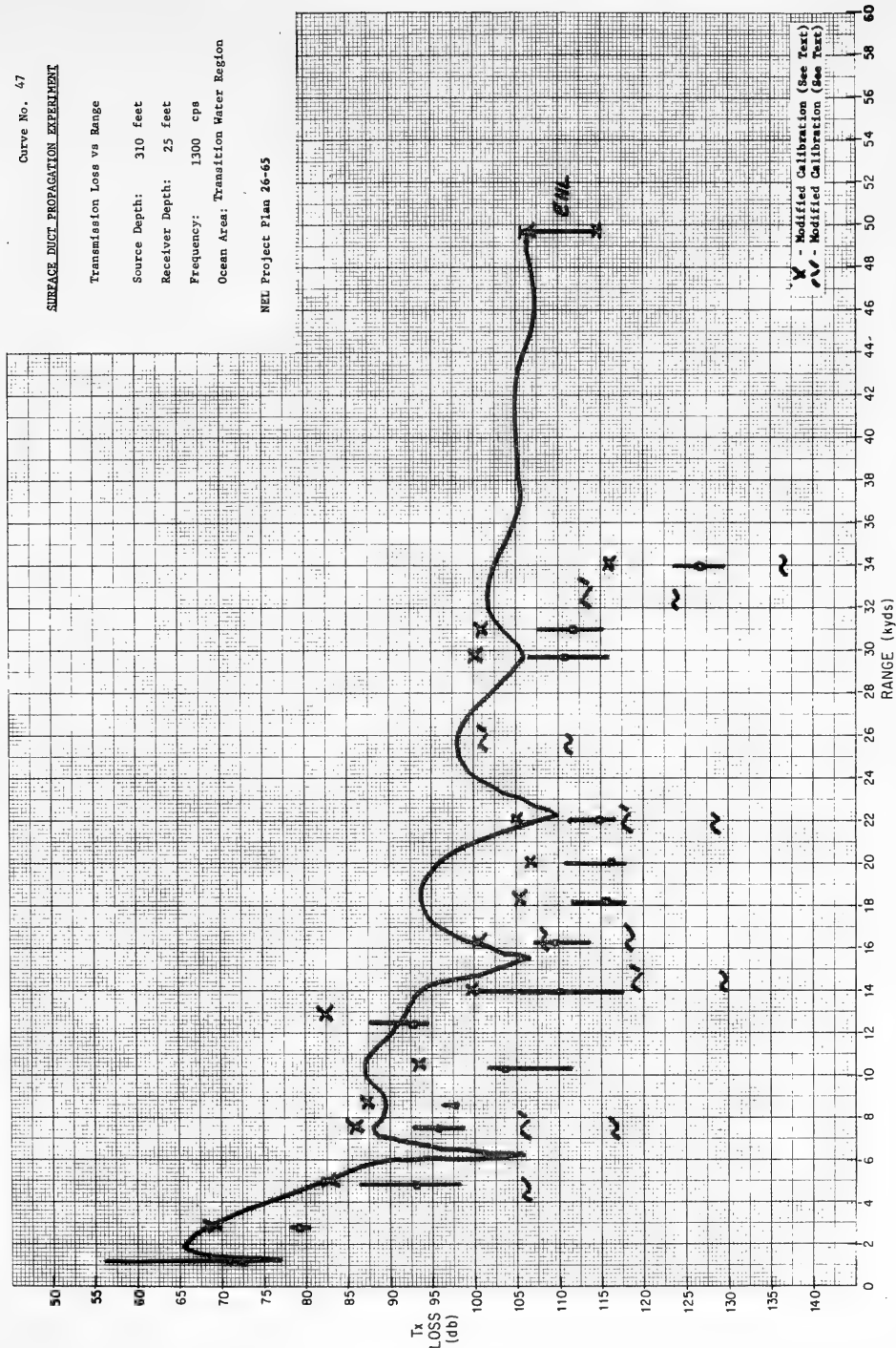

Curve No. 48

SURFACE DUCT PROPAGATION EXPERIMENT

Transmission Loss vs Range  
Source Depth: 310 feet  
Receiver Depth: 25 feet  
Frequency: 3000 cps  
Ocean Area: Transition Water Region

NEZ Project Plan 24-65

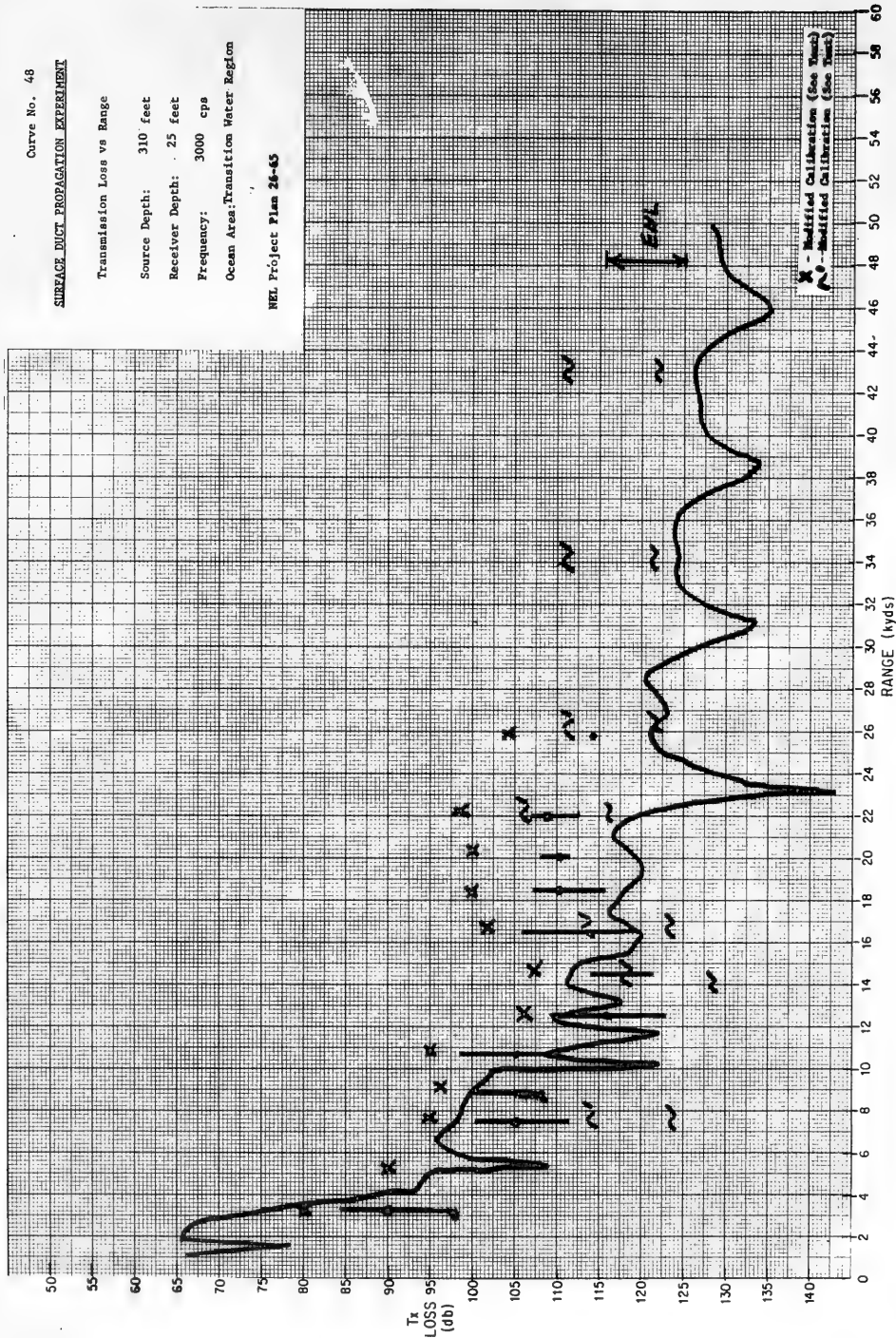

SURFACE DUCT PROPAGATION EXPERIMENT

Transmission Loss vs Range

Source Depth: 42 feet

Receiver Depth: 25 feet

Frequency: 700 cps

Ocean Area: Transition Water Region

NEU Project Plan 26-65

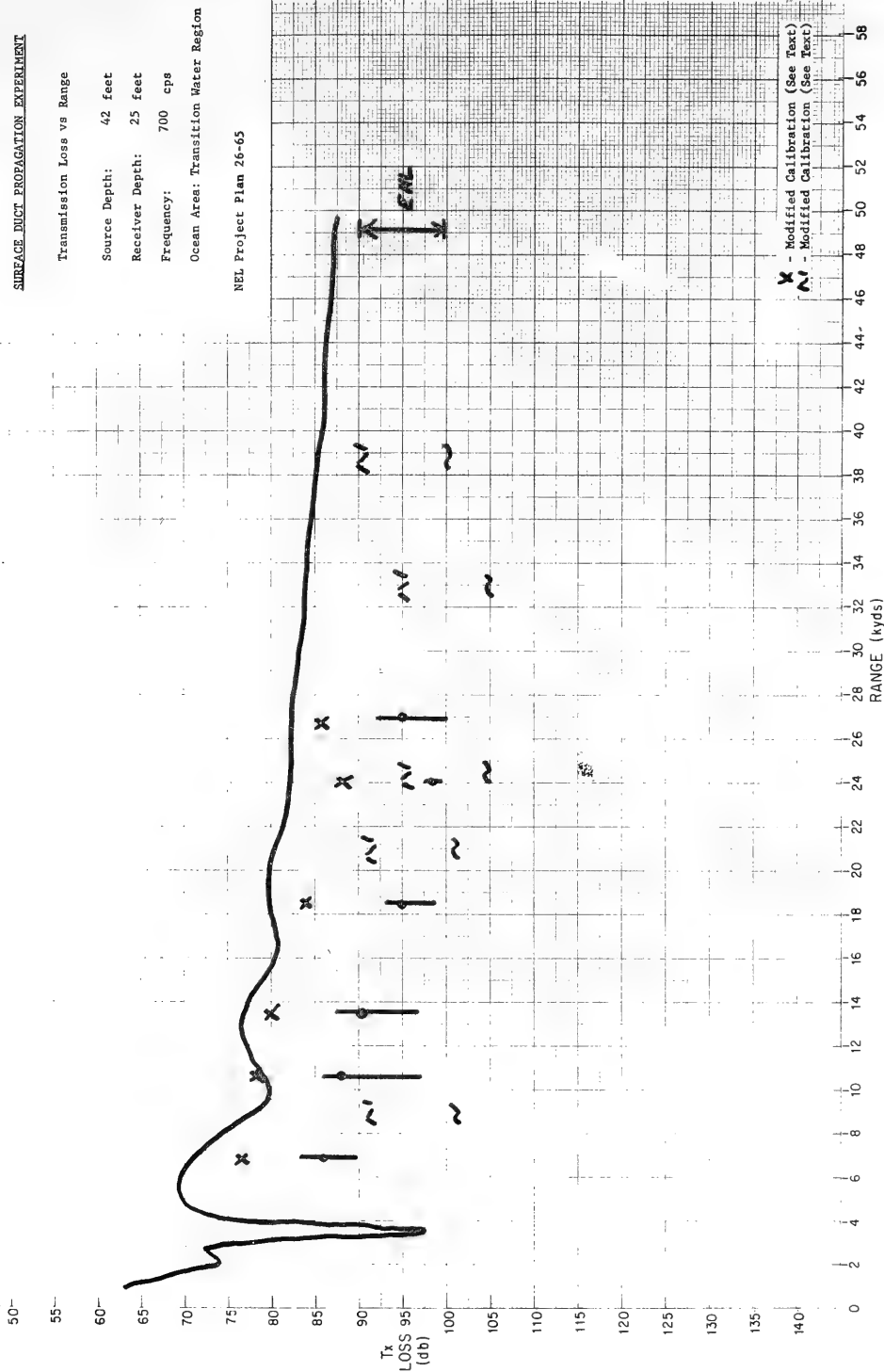

SURFACE DUCT PROPAGATION EXPERIMENT

Transmission Loss vs Range

Source Depth: 42 feet

Receiver Depth: 25 feet

Frequency: 1300 cps

Ocean Area: Transition Water Region

NEL Project Plan 26-65

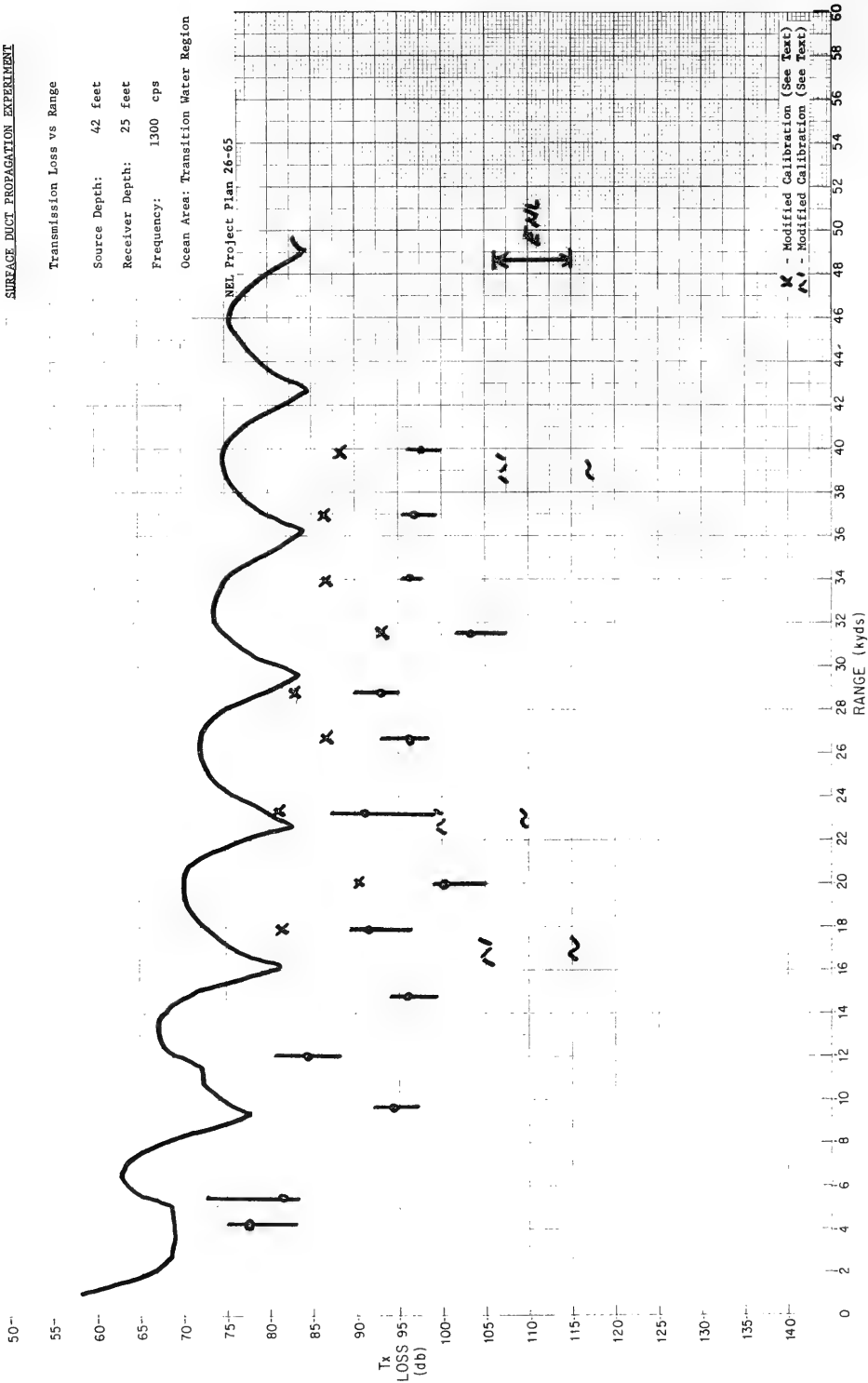

x - Modified Calibration (See Text)  
A - Modified Calibration (See Text)



Curve No. 51

SURFACE DUCT PROPAGATION EXPERIMENT

Transmission Loss vs Range

Source Depth: 42 feet

Receiver Depth: 25 feet

Frequency: 3000 cps

Ocean Area: Transition Water Region

NSL Project Plan 26-63

T<sub>x</sub>  
LOSS 95  
(db)

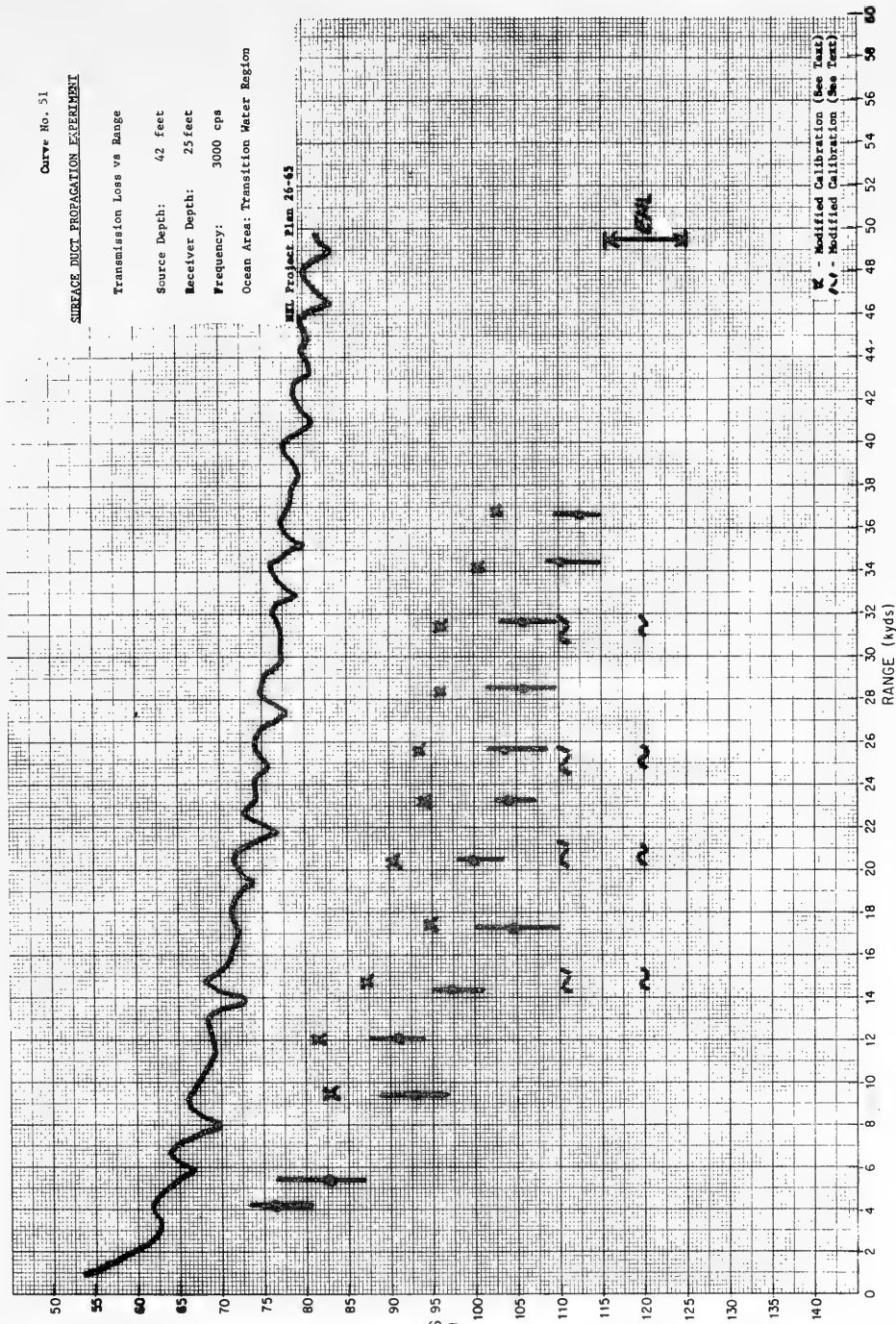

Curve No. 52

**SURFACE DUCT PROPAGATION EXPERIMENT**

Transmission Loss vs Range

Source Depth: 100 feet

Receiver Depth: 25 feet

Frequency: 700 cps

Ocean Area: Transmission Water Region

REL. Project Plan 26-65

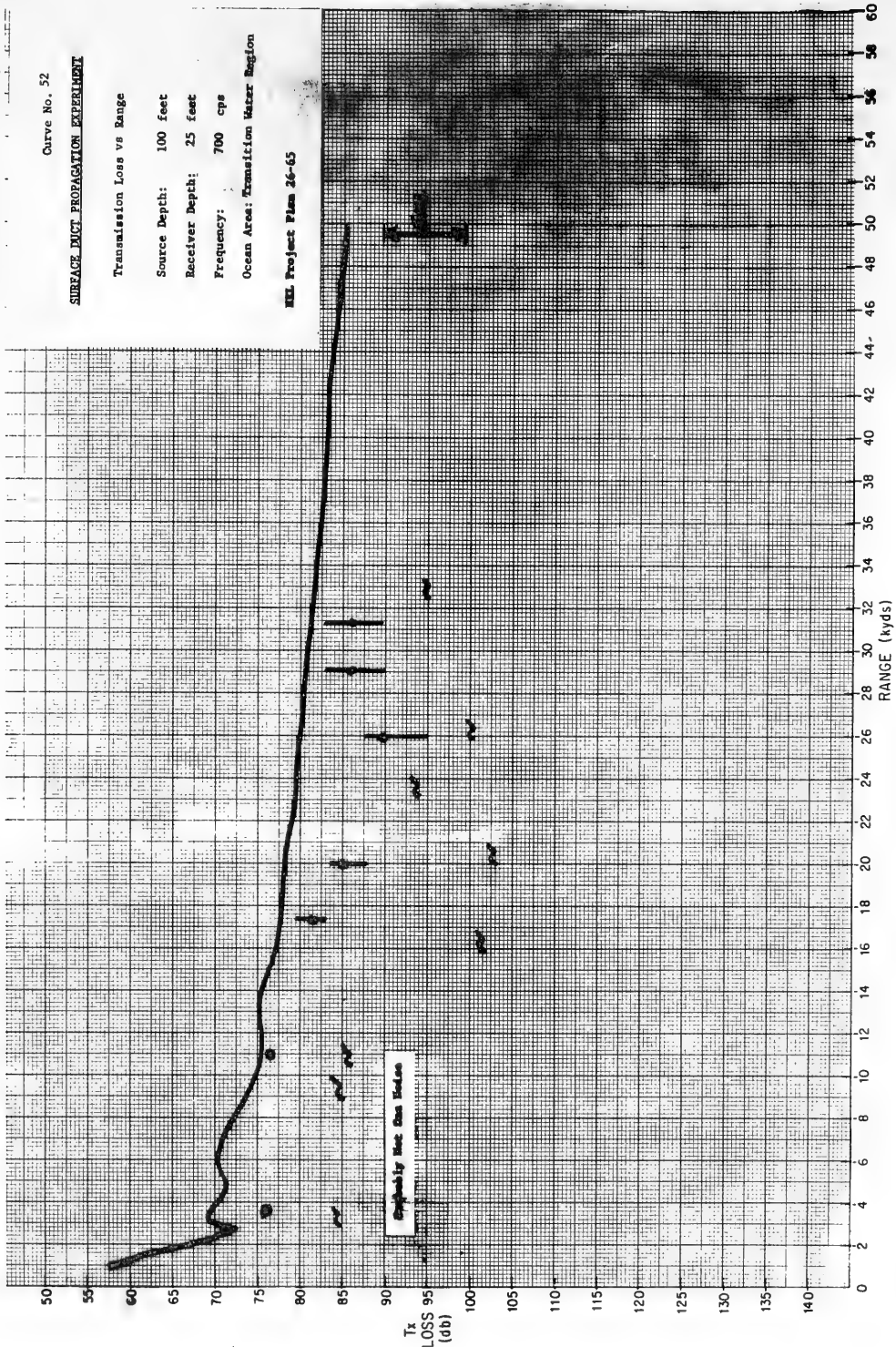

SURFACE DUCT PROPAGATION EXPERIMENT

Transmission Loss vs Range  
Source Depth: 100 feet  
Receiver Depth: 25 feet  
Frequency: 1300 cps  
Ocean Area: Transition Water Region

NEL Project Plan 26-65

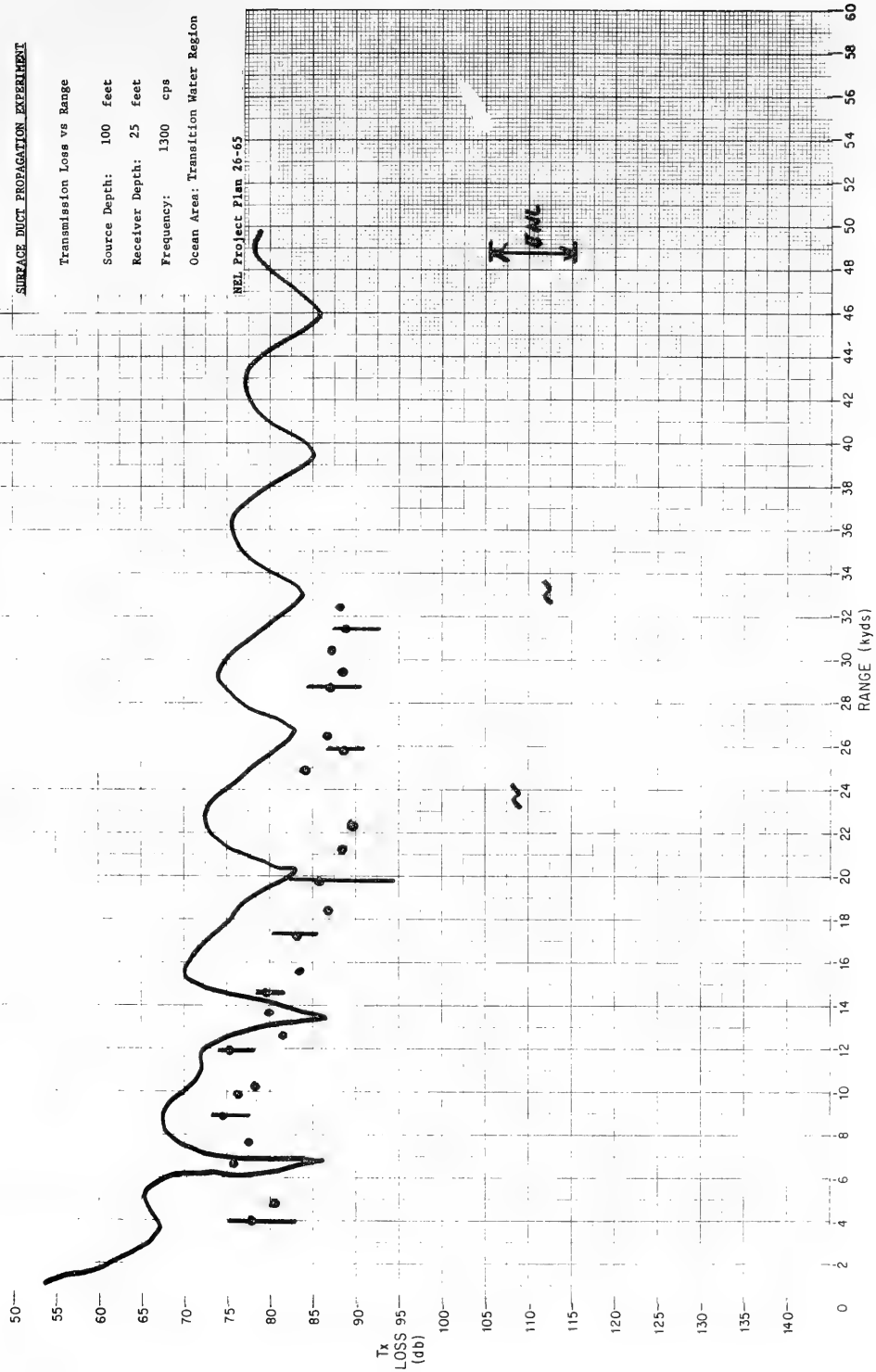

Curve No. 54

**SURFACE DUCT PROPAGATOR PERFORMANCE**

Transmission Loss vs Range

Source Depth: 100 feet

Receiver Depth: 25 feet

Frequency: 3000 cps

Ocean Area: Transition Water Region

NEL Project Plan 26-65

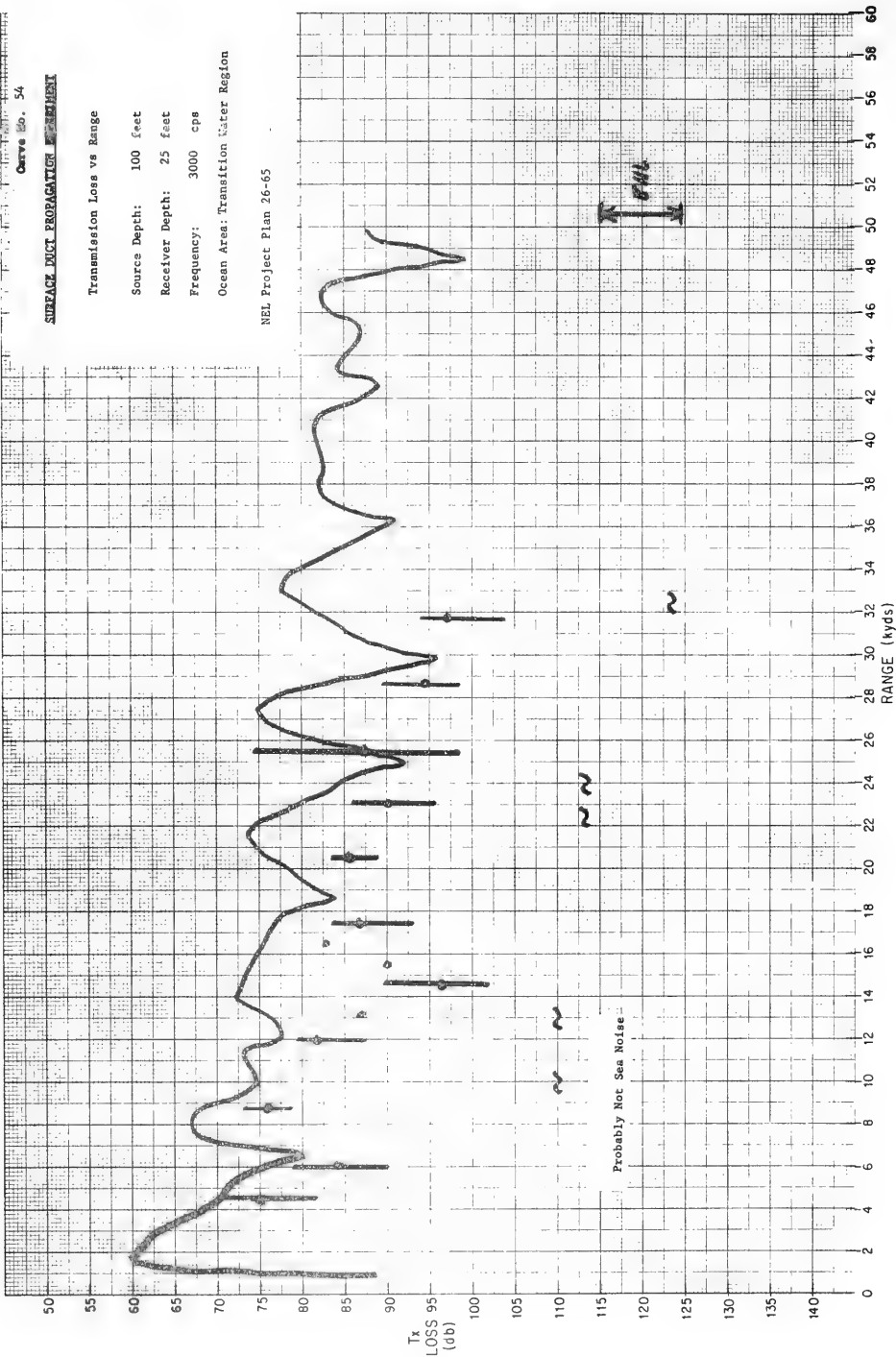

Curve No. 55

SURFACE DUCT PROPAGATION EXPERIMENT

Transmission Loss vs Range

Source Depth: 310 feet

Receiver Depth: 80 feet

Frequency: 1300 cps

Ocean Area: Boundary Region

NEL Project Plan 26-65

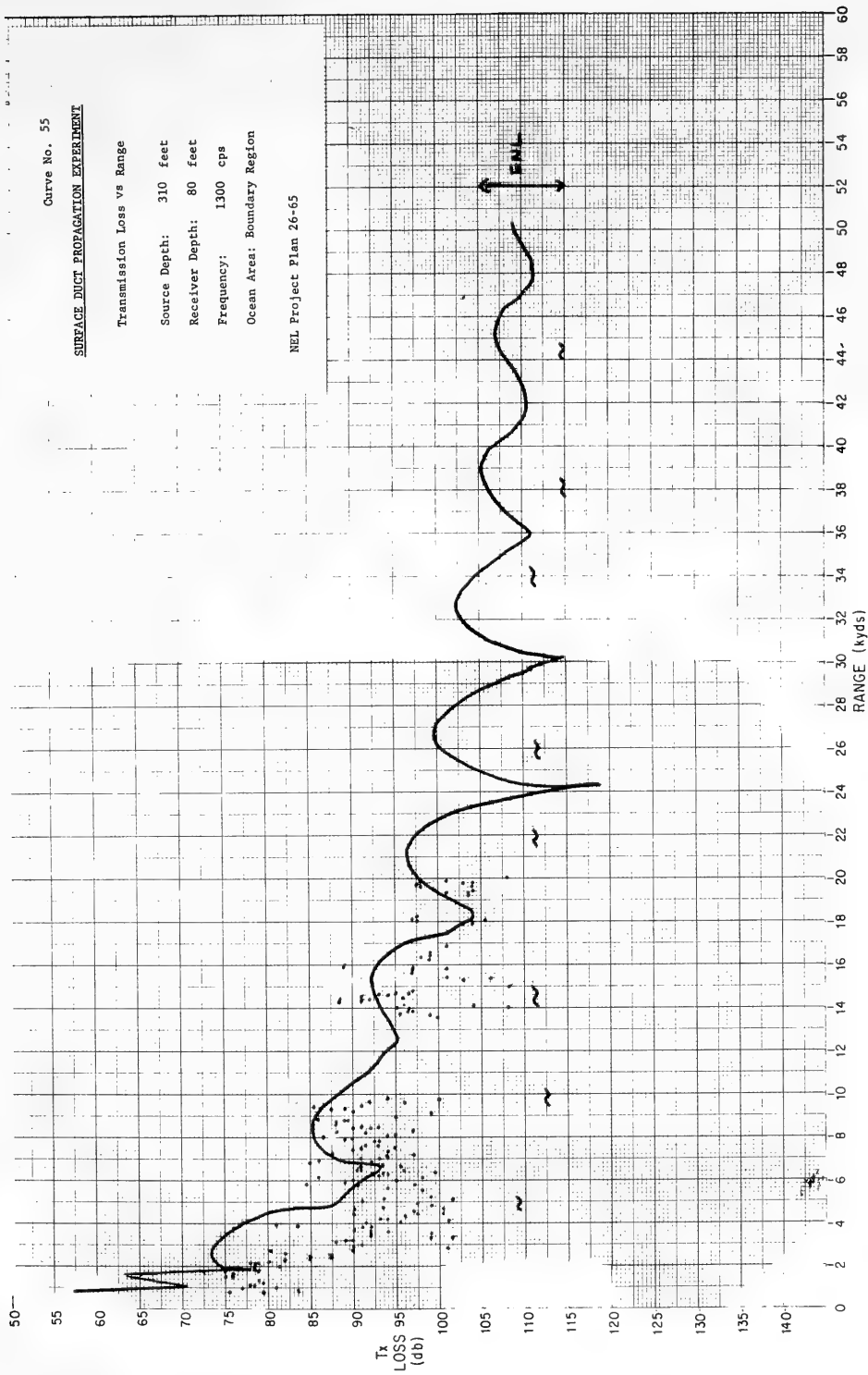

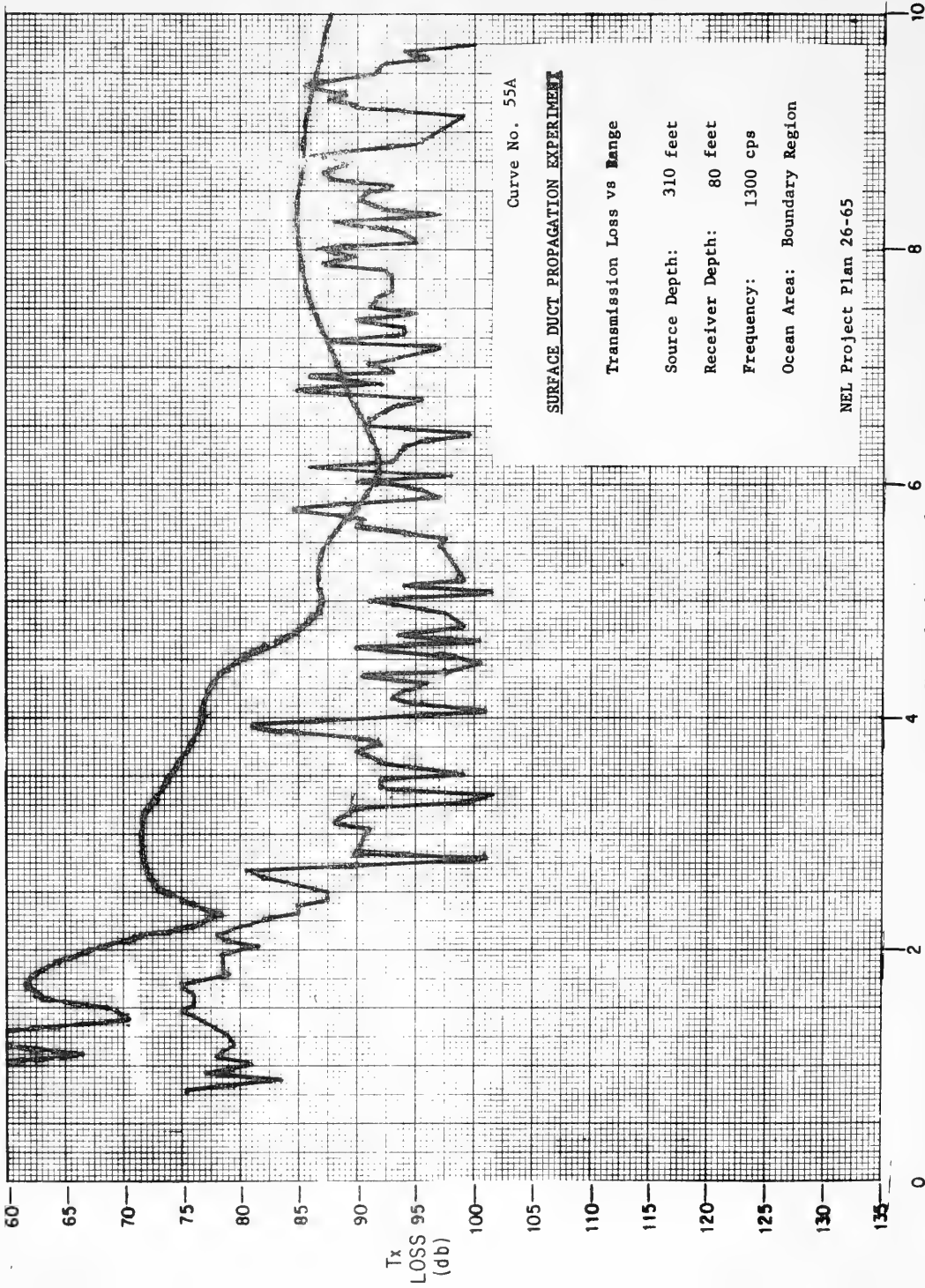

Curve No. 55A

SURFACE DUCT PROPAGATION EXPERIMENT

Transmission Loss vs Range  
 Source Depth: 310 feet  
 Receiver Depth: 80 feet  
 Frequency: 1300 cps  
 Ocean Area: Boundary Region

NEL Project Plan 26-65

SURFACE DUCT PROPAGATION EXPERIMENT

Transmission Loss vs Range

Source Depth: 100 feet

Receiver Depth: 80 feet

Frequency: 700 cps

Ocean Area: Boundary Region

NEL Project Plan 26-65

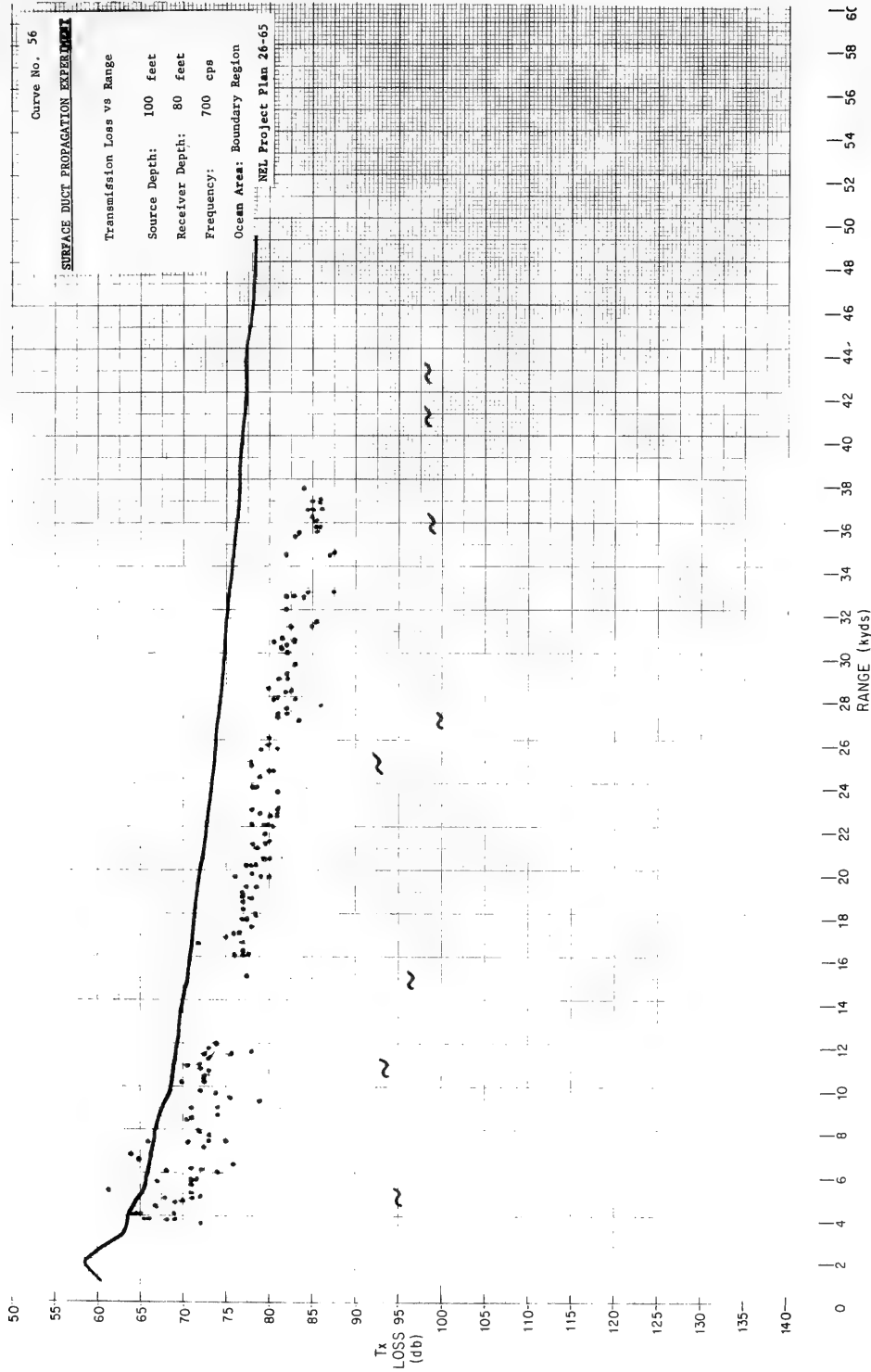

RANGE (kyds)

0 2 4 6 8 10 12 14 16 18 20 22 24 26 28 30 32 34 36 38 40 42 44 46 48 50 52 54 56 58 60

Curve No. 57

**STAGE DUCT PROPAGATION EXPERIMENT**

Transmission Loss vs Range

Source Depth: 100 feet

Receiver Depth: 80 feet

Frequency: 1300 cps

Ocean Area: Boundary Region

NEL Project Plan 26-65

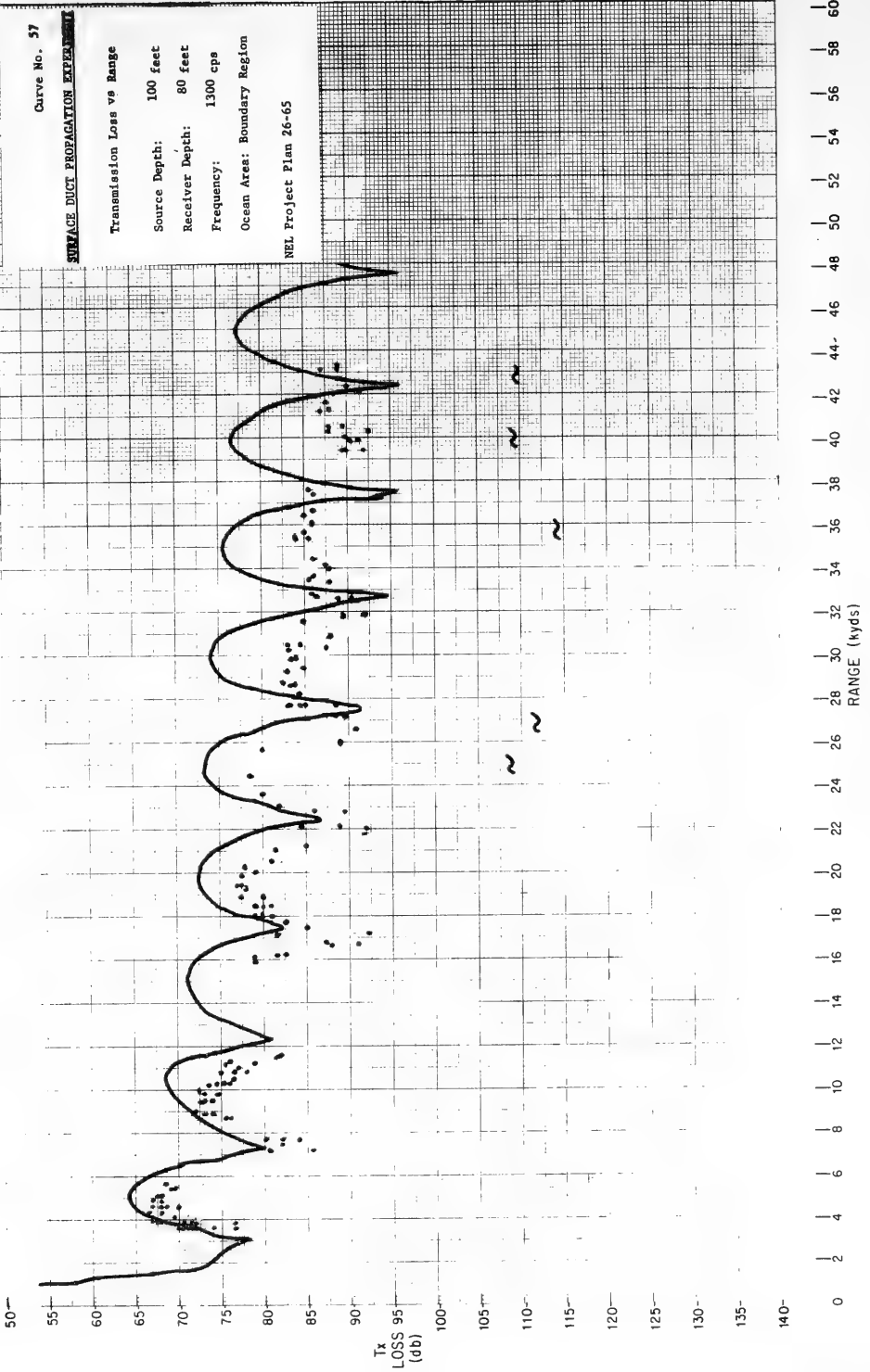



Curve No. 58

SURFACE DUCT PROPAGATION EXPERIMENT

Transmission Loss vs Range  
Source Depth: 100 feet  
Receiver Depth: 80 feet  
Frequency: 3000 cps  
Ocean Area: Boundary Region

NEL Project Plan 26-65

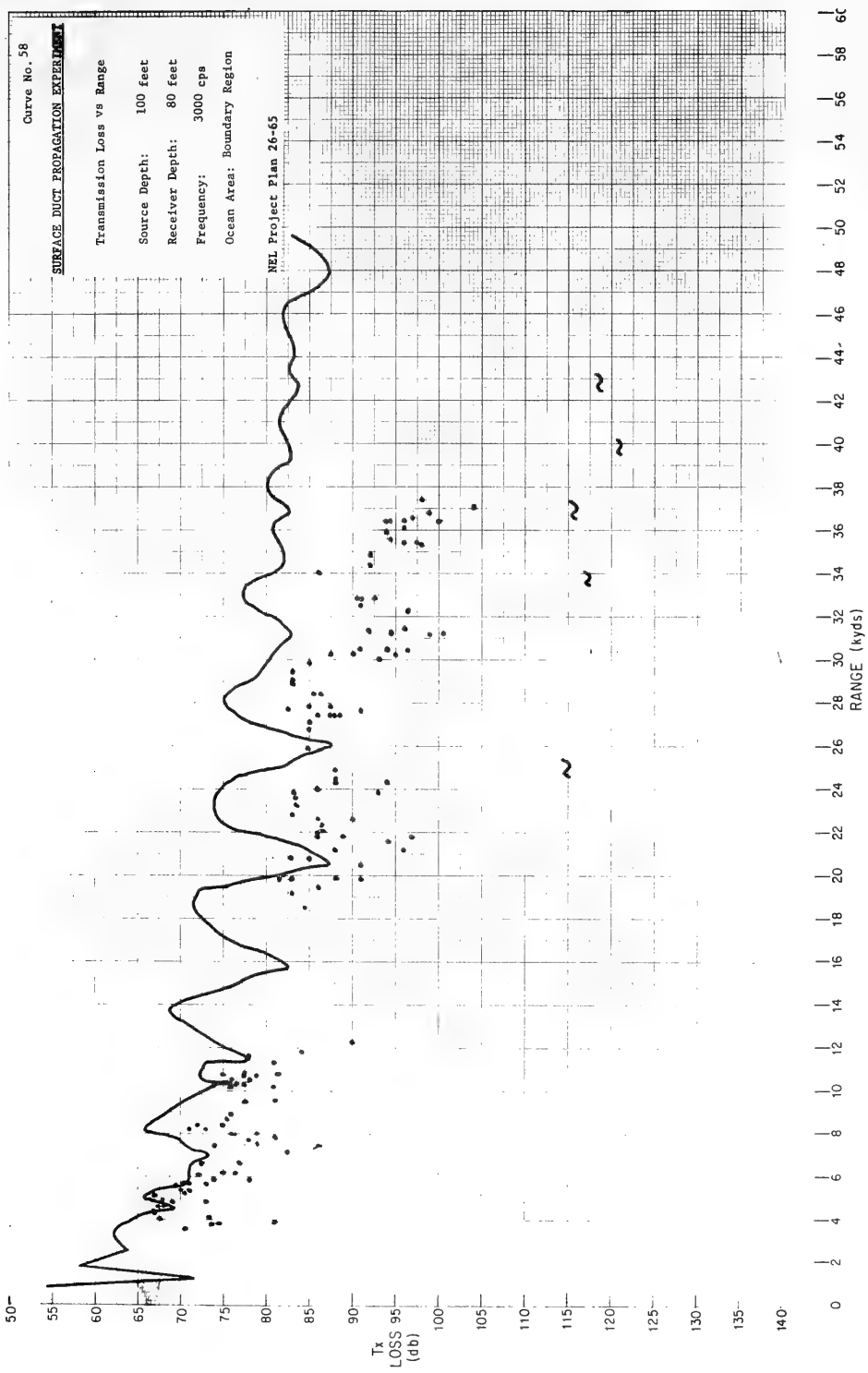

50—  
55—  
60—  
65—  
70—  
75—  
80—  
85—  
90—  
95—  
100—  
105—  
110—  
115—  
120—  
125—  
130—  
135—  
140—

0 2 4 6 8 10 12 14 16 18 20 22 24 26 28 30 32 34 36 38 40 42 44 46 48 50 52 54 56 58 60

RANGE (kyds)

Curve No. 59

SURFACE DUCT PROPAGATION EXPERIMENT

Transmission Loss vs Range

Source Depth: 310 feet

Receiver Depth: 80 feet

Frequency: 1300 cps

Ocean Area: Transition Water Region

NEL Project Plan 26-65

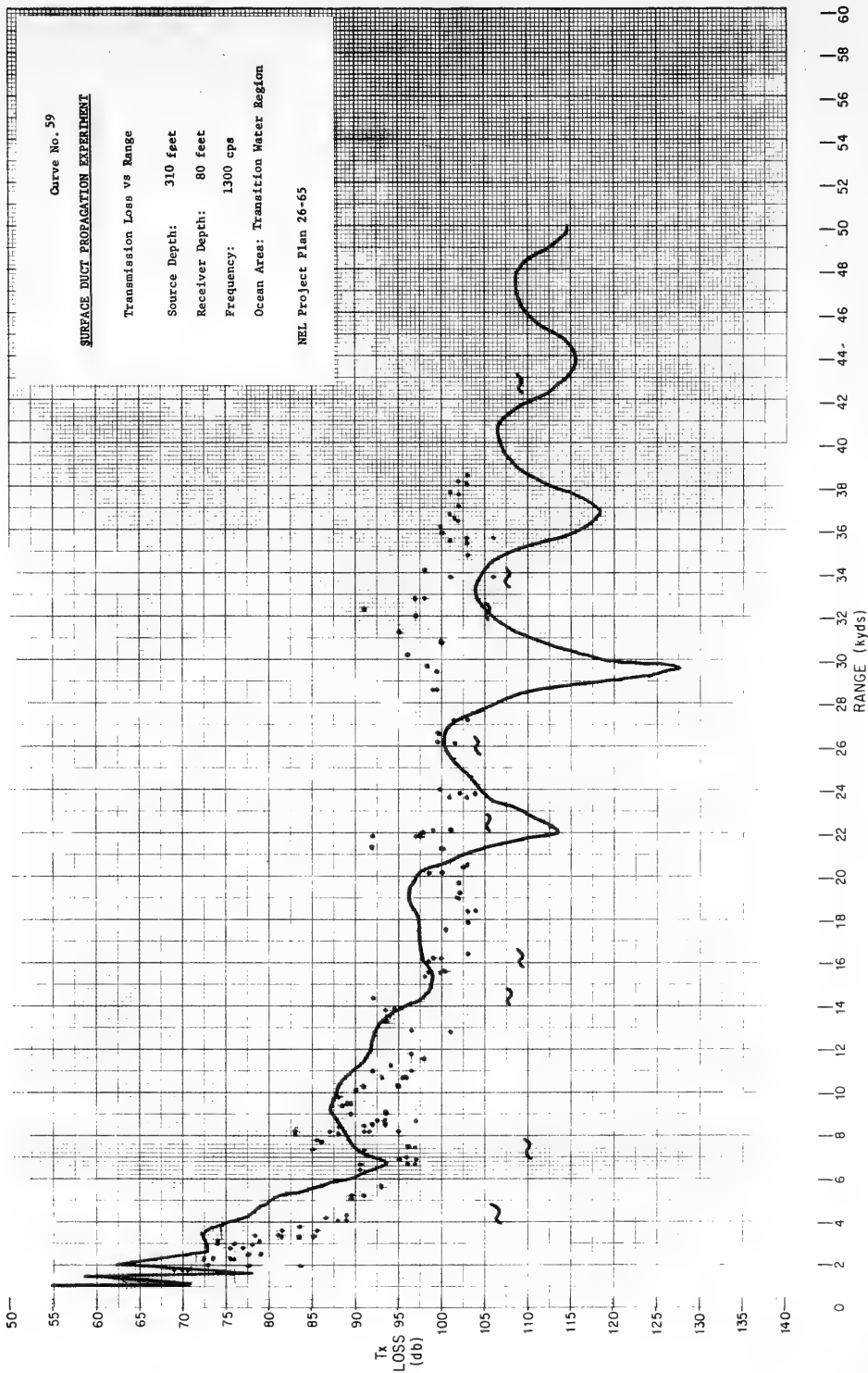

Curve No. 60

SURFACE DUCT PROPAGATION EXPERIMENT

Transmission Loss vs Range

Source Depth: 90 feet

Receiver Depth: 80 feet

Frequency: 1300 cps

Ocean Area: Transition Water Region

NEL Project Plan 26-65

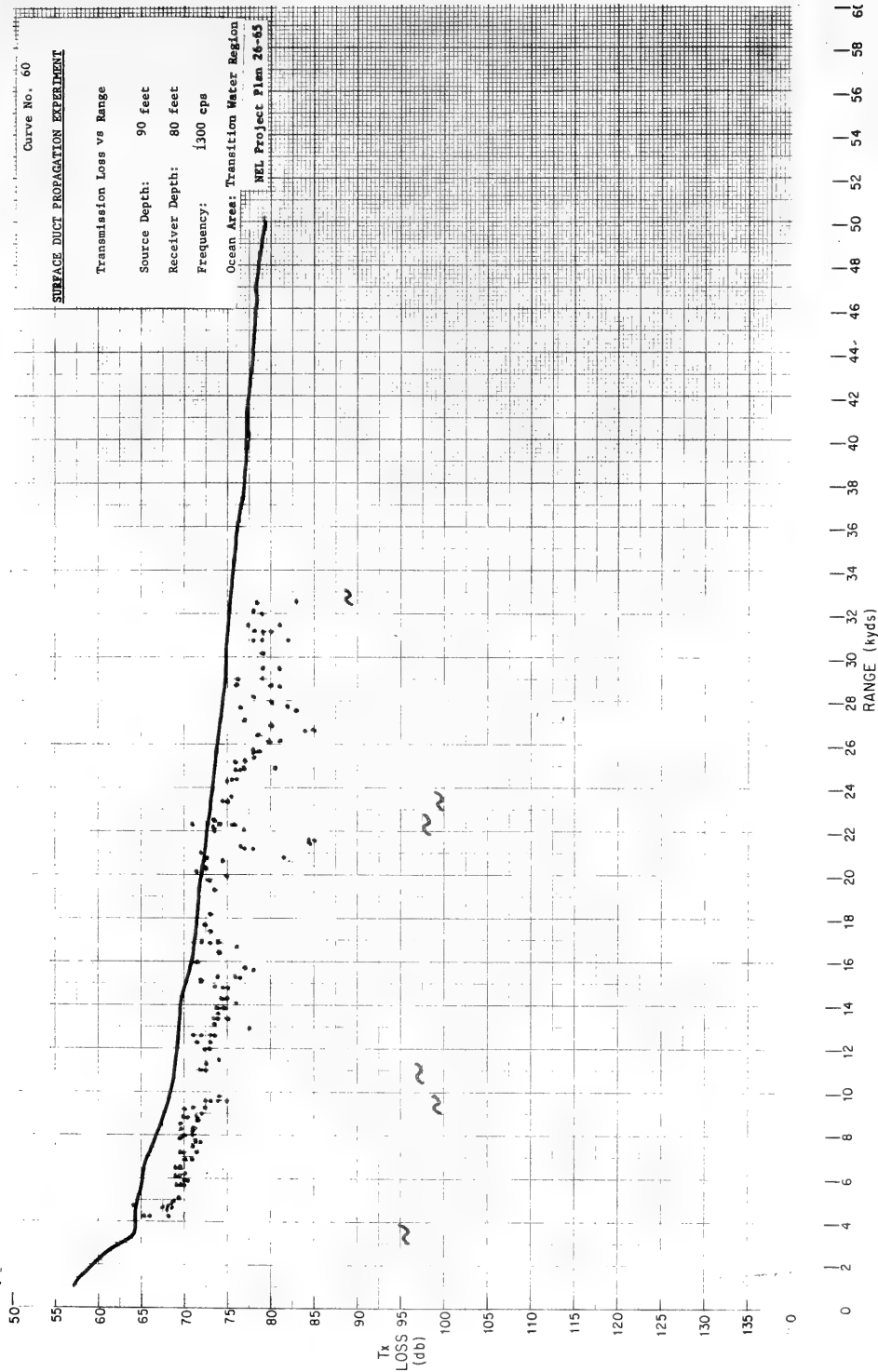

RANGE (kyds)

0 2 4 6 8 10 12 14 16 18 20 22 24 26 28 30 32 34 36 38 40 42 44 46 48 50 52 54 56 58 60

**SURFACE DUCT PROPAGATION EXPERIMENT**

Transmission Loss vs Range

Source Depth: 90 feet

Receiver Depth: 80 feet

Frequency: 1300 cps

Ocean Area: Transition Water Region

REL Project Plan 26-65

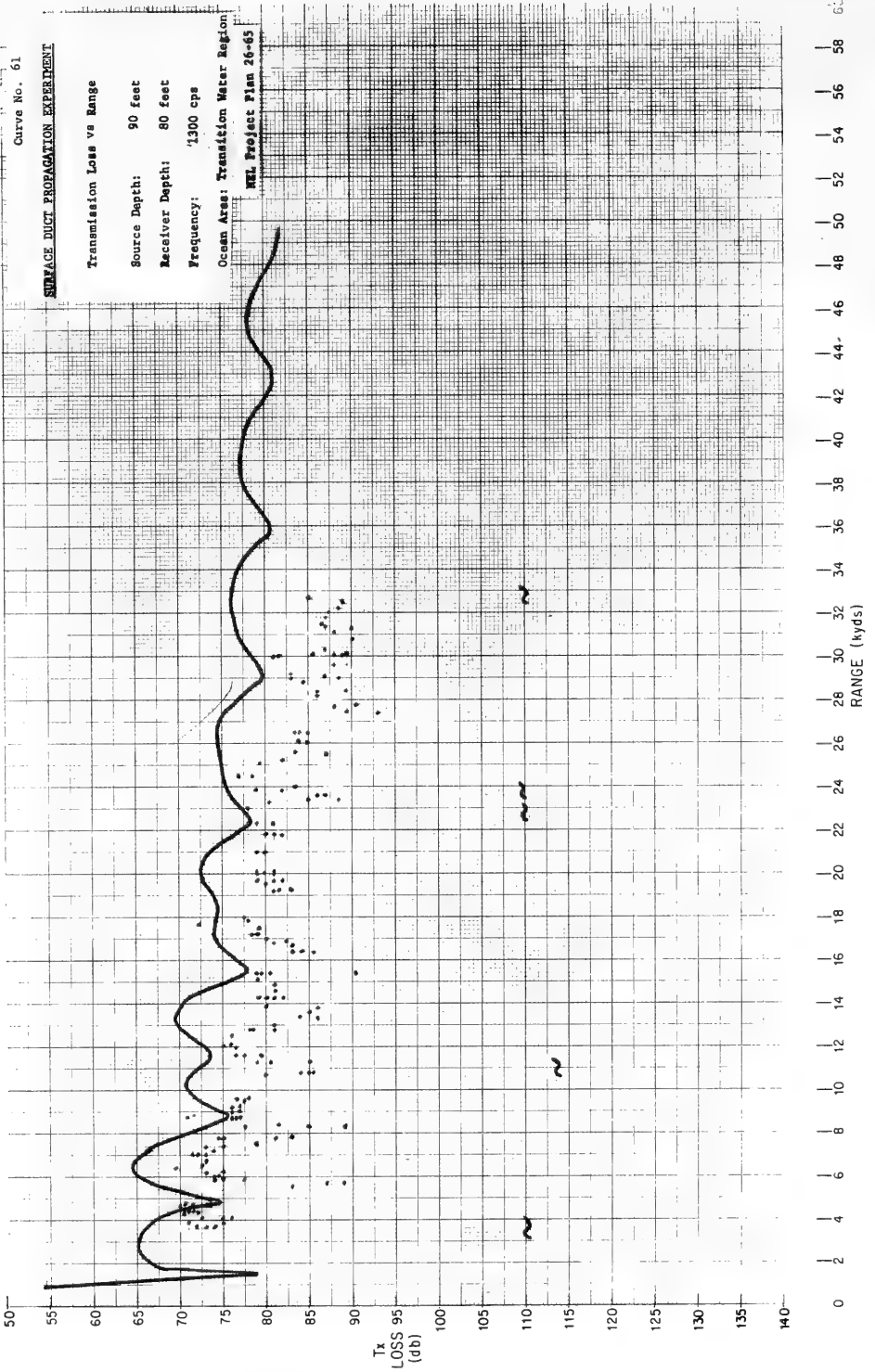

Curve No. 62

SURFACE DUCT PROPAGATION EXPERIMENT

Transmission Loss vs Range

Source Depth: 90 feet

Receiver Depth: 80 feet

Frequency: 3000 cps

Ocean Area: Transition Water Region

NEL Project Plan 26-63

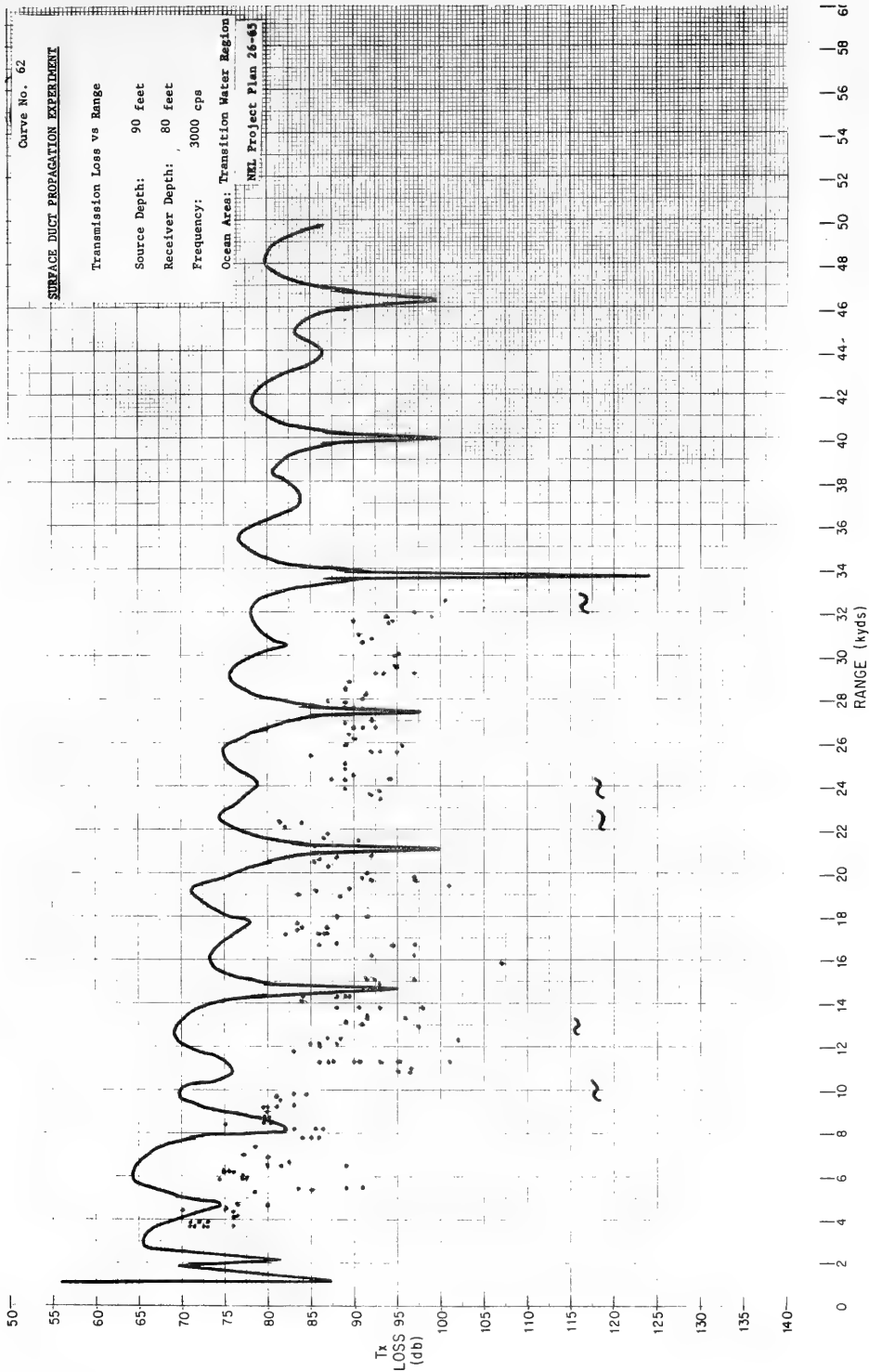

Curve No. 63

SURFACE DUCT PROPAGATION EXPERIMENT

Transmission Loss vs Range

Source Depth: 90 feet

Receiver Depth: 300 feet

Frequency: 700 cps

Ocean Area: Transition Water Region

NEL Project Plan 26-65

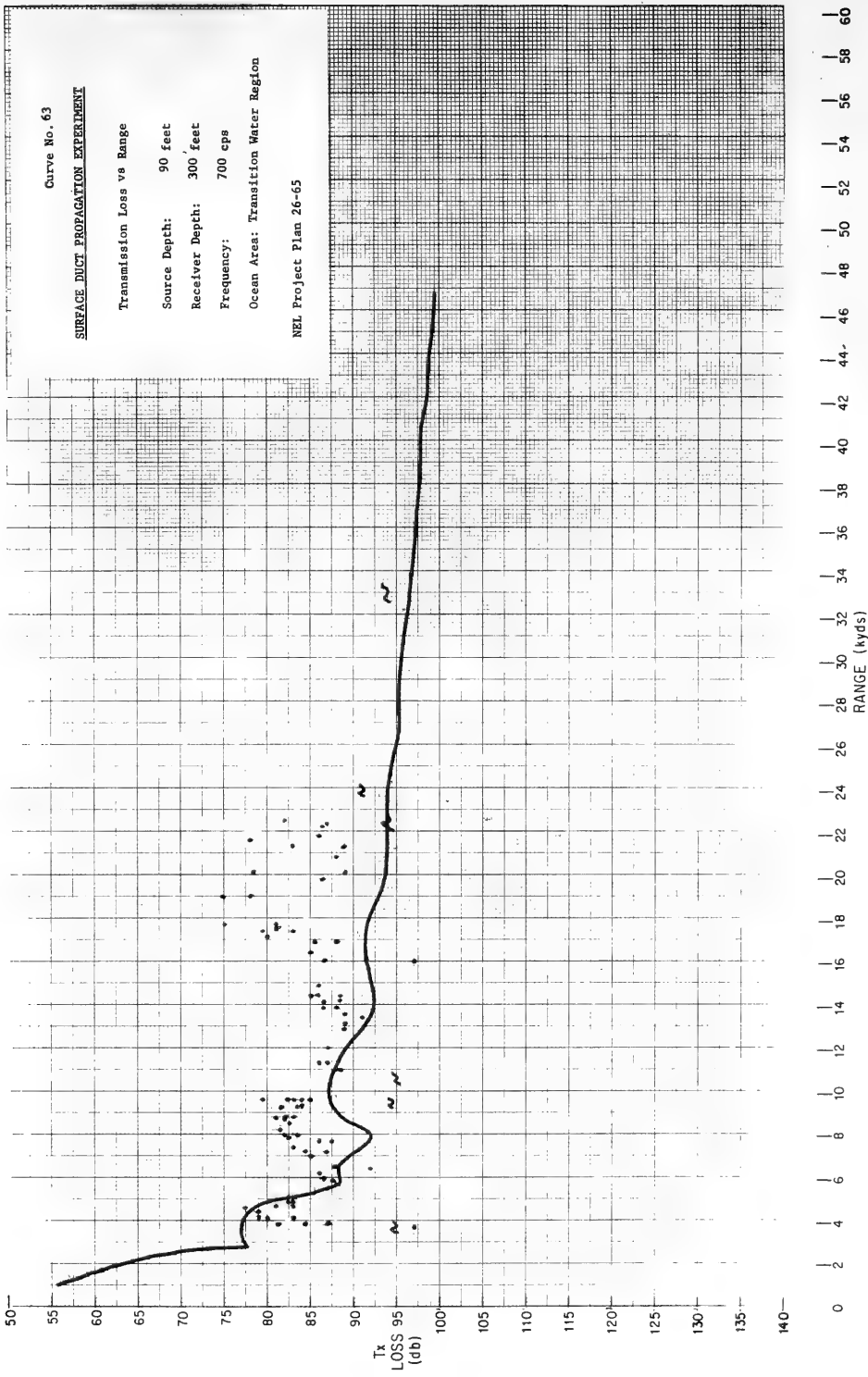

Curve No. 64

SURFACE DUCT PROPAGATION EXPERIMENT

Transmission Loss vs Range  
Source Depth: 90 feet  
Receiver Depth: 300 feet  
Frequency: 1300 cps  
Ocean Area: Transition Water Region

MEL Project Plan 26-65

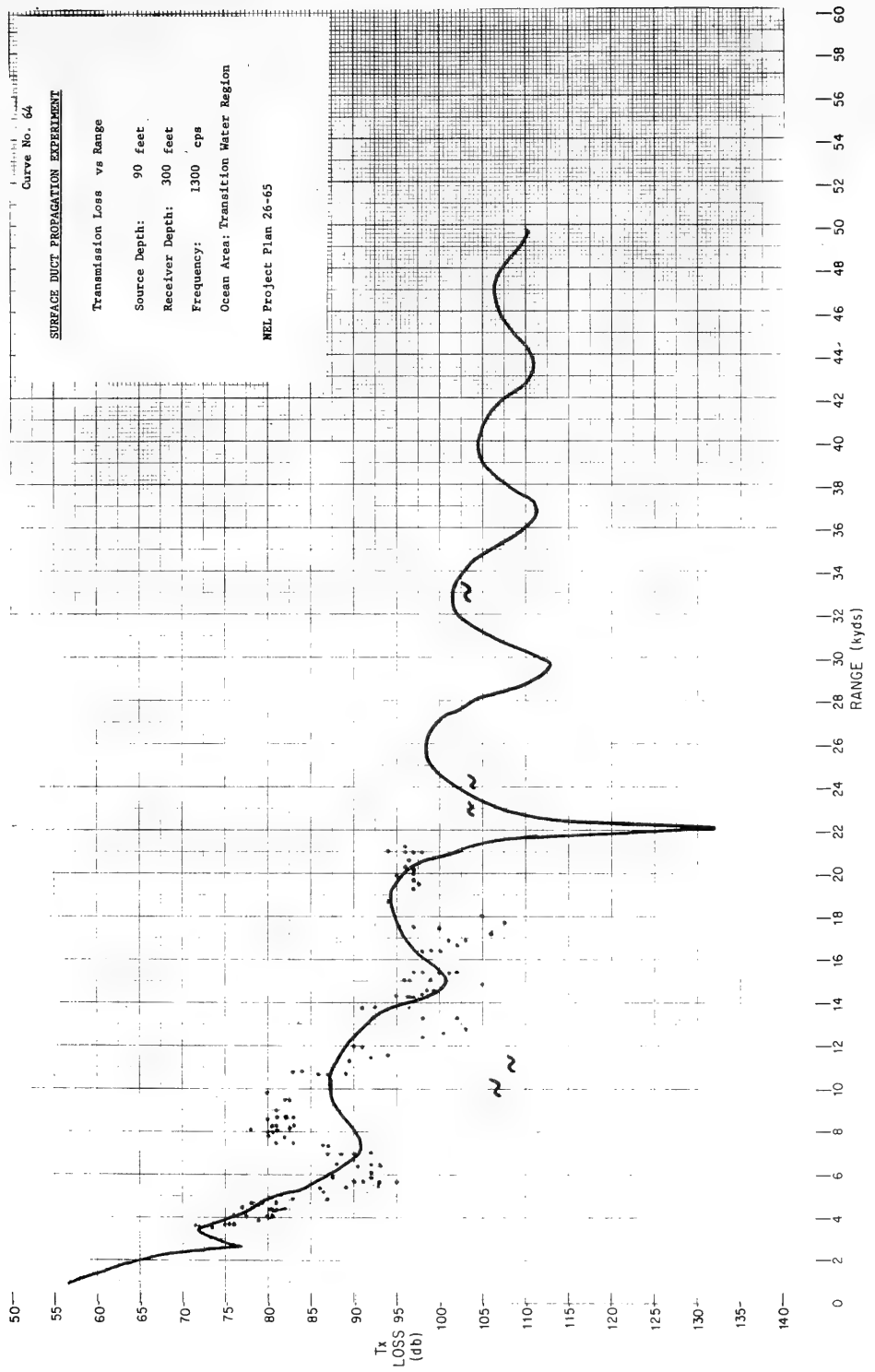

50  
55  
60  
65  
70  
75  
80  
85  
90  
95  
100  
105  
110  
115  
120  
125  
130  
135  
140

0 2 4 6 8 10 12 14 16 18 20 22 24 26 28 30 32 34 36 38 40 42 44 46 48 50 52 54 56 58 60

RANGE (ktyds)

Tx  
LOSS  
(db)

Curve No. 65

SURFACE DUCT PROPAGATION EXPERIMENT

Transmission Loss vs Range  
Source Depth: 90 feet  
Receiver Depth: 300 feet  
Frequency: 3000 cps  
Ocean Area: Transition Water Region

NEL Project Plan 26-65

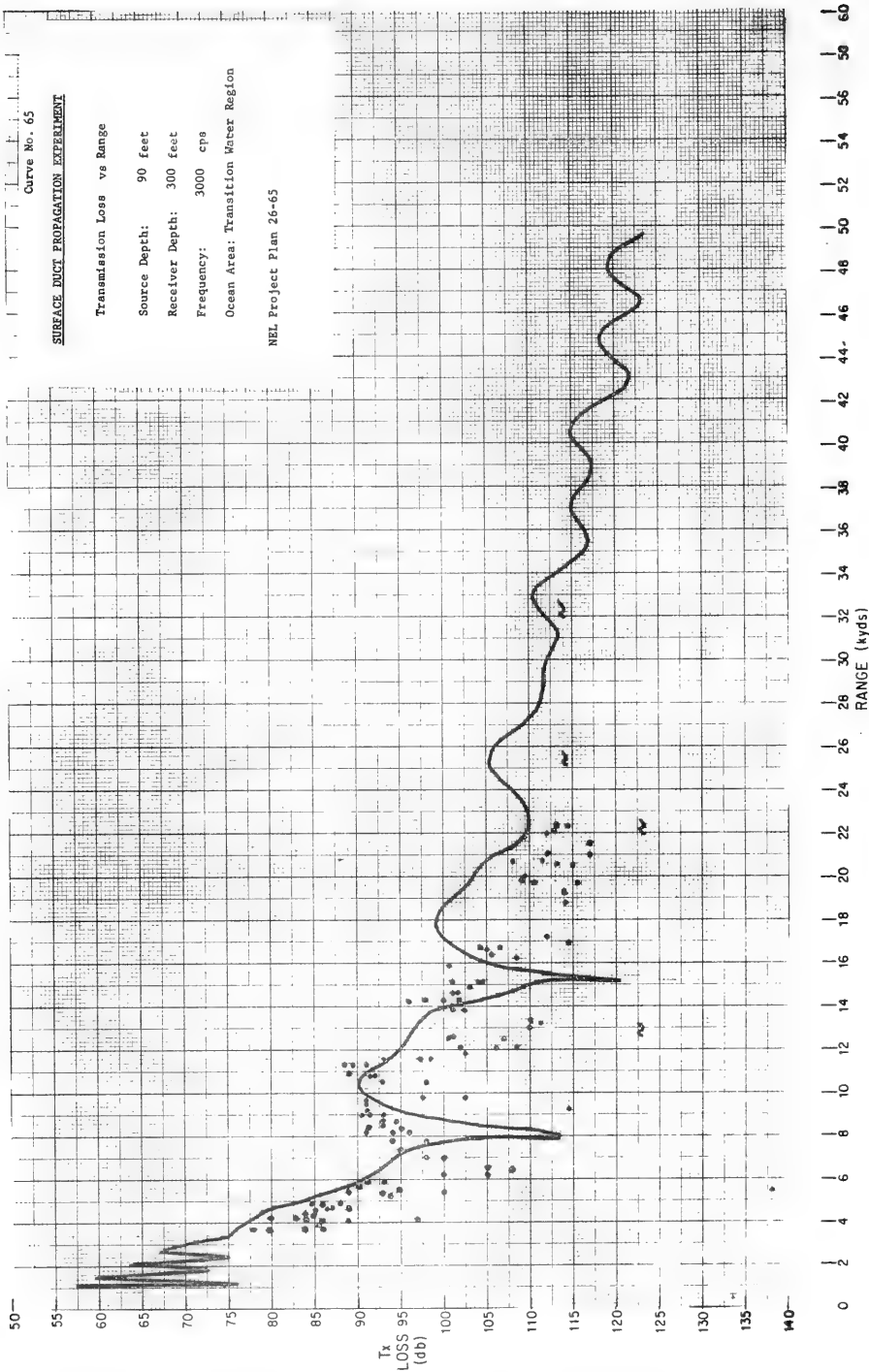



## V. REFERENCES

- (1) "Water Mass Boundary Temperature Measurements in Support of Under-water Sound Propagation Experiments," Owen S. Lee, Marine Environment Division, US Naval Electronics Laboratory, 1965
- (2) "Normal Mode Theory Applied to Short-Range Propagation in an Under-water Acoustic Surface Duct," Melvin A. Pedersen and David F. Gordon, J.A.S.A. 37, 105, 1965
- (3) "Internal Waves: Their Influence Upon Naval Operations," Arthur D. Little, Inc., Report No. 4090266, Department of the Navy, Bureau of Ships, Contract NObsr-98055, 1966



## APPENDIX A

### NARRATIVE DESCRIPTION OF EXPERIMENT

The organization of the surface duct acoustical transmission experiment was established in NEL Project Plans 25-65 and 26-65. Its purpose was to determine (1) the effect of internal waves on acoustical transmission in a surface layer and (2) the validity of normal mode theory in the analysis of surface duct transmission. Accordingly, acoustical transmission loss was measured in two ocean areas, each containing a well defined quasi-isothermal layer but differing in that the water mass in one area was stable whereas it was unstable in the other. The experiments were performed in December 1964, in ocean areas between 200 and 300 miles SW of Los Angeles (Figure 1).

The USS Marysville surveyed the ocean areas of interest and selected two sites in deep water for the acoustical measurements. The first site was at the boundary between Eastern North Pacific Central Water and Transition Water flowing southward along the coast of California. The second area was located within the Transition Water to the east of the Boundary Region in an area described by Lee, Reference (1), as the more stable of the two. The Marysville employed a thermistor chain to determine the thermal profiles (Appendix B), upon which its site recommendations to the USS Rexburg and USNS Charles H. Davis were based. The thermal surveying was completed between 10 and 24 hours before the other two ships arrived on station to perform the acoustical experiment. The latter obtained their thermal profile data from hourly bathythermograph casts.

The USS Rexburg received and recorded on magnetic tape the acoustic signals transmitted by the USNS Charles H. Davis. The Rexburg used three hydrophones: a shallow hydrophone (Channel 1) at a depth of 25 or 50 feet, an intermediate hydrophone (Channel 2) at 80 feet, and a deep hydrophone (Channel 3) at 300 feet. The outputs of the hydrophones were recorded on Visicorder and magnetic tape by means of the circuitry illustrated in Figure C-1. A local clock recorded half second time markers at five-second intervals and a local microphone was provided for the recording of verbal information from the scientist in charge.

The USNS Davis was equipped with projectors that radiated half-second pings at 700 cps, 1300 cps, and 3000 cps in sequence at 10-second intervals. The acoustical ping was accompanied by a synchronizing radio pulse transmitted to the Rexburg and recorded on the magnetic tape. For identification, every second ping at 1300 cps and the corresponding radio pulse were doubled in length.

At the two locations at which the experiment was performed the same pattern was followed. At the site chosen by the Marysville, the Rexburg lay to and drifted with the current. The Davis moved radially away from the Rexburg

from a minimum range of approximately two miles to a maximum range of approximately 20 miles with the transmitting hydrophones at a predetermined depth, e.g., 25 feet. At the end of this leg the Davis changed the depth of its projectors and reversed direction, traveling radially inward toward the Rexburg. During the turn-around the Rexburg operator injected calibration signals from a local signal generator onto the recording tape. At the conclusion of the inward run the Davis changed the depth of its projectors again and traveled radially outward once more to maximum range. This sequence of operations completed an experiment in one area. Throughout this process the relative positions of the ships were established by radar and communication was maintained by radio. The conditions of the experiment (attenuator settings, calibration signal amplitudes, etc.) were recorded verbally on the magnetic tape. At the Davis, the operator logged the input current to the projectors and recorded their depth.

A detailed chronology of the exercise is provided in Table A-1. Part 1 lists the operations of the various ships involved; Part 2 provides the details of the acoustical experiment, including the numbering of the magnetic tapes recorded on the Rexburg. The depths of the transmitting and receiving hydrophones are listed in Table A-2 for each of the runs in the two areas. During operation at the first site, the wind was from about  $000^{\circ}$  at about 15 knots with gusts of 20 knots. At the second station, the wind was from about  $340^{\circ}$  at about 8 knots with gusts of 12 knots.

TABLE A-1

CHRONOLOGY OF EXERCISE

Part I: Ships' Operations

1964	8 Dec.	2000	Thermistor chain survey by Marysville of area in Boundary Region
	9 Dec.	1000	
		1452	Davis on station at 29° 29.5' N, 126° 03' W in area previously surveyed and recommended by Marysville
		1715 - 1815	Marysville tows thermistor chain in area close to thermistor buoy*
		1745	Rexburg on station
		1920	Start of first experimental run
	10 Dec.	0830	Conclusion of experiment in Area I
	1300 - 1730	Thermal survey by Marysville of area in Transition Water Region subsequently designated as Area II	
11 Dec.	0818	Rexburg and Davis on station at 30° 20' N, 122° 55' W	
	1010	Start of second part of experiment	
	2230	Conclusion of exercise	

\* Because of instrumentation difficulties the data from the thermistor buoy chain were unusable.

TABLE A-1 (Continued)

Part 2: Acoustical Measurements Program

<u>Date</u>	<u>Run</u>			<u>Magnetic Tape</u>		
	<u>No.</u>	<u>Start</u>	<u>Stop</u>	<u>Reel No.</u>	<u>Start</u>	<u>Stop</u>
Dec. 9	1	1920		1	1925	2055
				2	2101	2206
				3	2210	2316
				4	2320	0025
				5	0028	
Dec. 10	2	0100	0030	<u>Rexburg Calibration - Note 1</u>		
						0200
				6	0200	0305
				7	0311	0415
				8	0420	
	3	0458	0423	<u>Rexburg Calibration - Note 2</u>		
						0546
				9	0549	0655
			10	0657	0800	
			11	0805		
Dec. 11	4	1010	0830	<u>Rexburg Calibration</u>		
						1046
				12	1052	1156
				13	1200	1305
				14	1308	1414
				15	1417	1523
				16	1527	
	5	1600	1530	<u>Rexburg Calibration</u>		
						1649
				17	1651	1755
				18	1800	1906
				19	1908	
	6	1947	1931	<u>Rexburg Calibration</u>		
					2030	
20				2031	2136	
		2230	21	2139	2230	

Note 1: Audio messages (calibration voltages, etc.) were unintelligible.

Note 2: Calibration not intelligible.

TABLE A-2

TRANSMITTER AND RECEIVER DEPTHS

	<u>Date</u>	<u>Run No.</u>	<u>Transmitting Hydrophone Depth (ft)</u>	<u>Receiving Hydrophone Depth (ft)</u>
<u>Boundary Region</u> (Area I)	Dec. 9-10	1	310	50
				81
				300
	Dec. 10	2	42	50
				81
				300
	Dec. 10	3	100	50
				81
				300
<u>Transition Water Region</u> (Area II)	Dec. 11	4	310	25
				84
				300
	Dec. 11	5	40	25
				84
				300
	Dec. 11	6	90	25
				84
				300





## APPENDIX B

### OCEANOGRAPHIC DATA

#### 1. INTRODUCTION

The surface duct transmission experiments performed by the USS Rexburg and the USNS Davis required persistent well defined surface layers. The areas were selected after the thermal survey by the thermistor chain on the USS Marysville.

The first acoustic experiment was performed in the Boundary Region (Area I) between the Eastern North Pacific Central Water and the Transition Water flowing southward from the Arctic along the coast of California. The second acoustical experiment was performed in the Transition Water Region (Area II) to the east of the Boundary Region. (See Figure 1.) In the Boundary Region according to Lee (Reference 1) the thermal profile generally shows some time dependence whereas the Transition Water Region is more stable.

Two sources of temperature data provided support for the acoustical experiments carried out by the Rexburg and Davis. Both ships made bathythermograph casts during the experiments at one- or two-hour intervals. In addition, the Marysville took thermistor chain data in both the Boundary and Transition Water Regions. The latter data were generally taken about a day before the acoustic experiments, the shortest time differential being 10 hours in the Boundary Region. Figures B-1 and B-2 show the location of the tracks made by Marysville relative to the acoustic runs. In the Boundary Region the Marysville's course is close to and parallel to the Rexburg-Davis acoustic experiment. In the Transition Water Region the Marysville's track was transverse to the line of the acoustic experiment.

#### 2. THERMISTOR CHAIN DATA OBTAINED BY USS MARYSVILLE

2.1 The Boundary Region. The operations of the Marysville and its thermistor chain data are described in detail in Reference (1).

For the first acoustic experiment the Marysville recommended to the Davis a location at 29° 26.7' N, 126° 03.0' W where a dome in the temperature structure occurred. Lee comments that such domes are generally time dependent. The Marysville performed three traverses over this region, the last being some 10 hours before the arrival of the Davis. These thermistor chain surveys indicated that the depth of the surface duct was about 200 feet and that this changed by less than 40 feet in the course of the three runs (12 hours). The runs indicated that the thermal profile below the layer was space and time dependent.

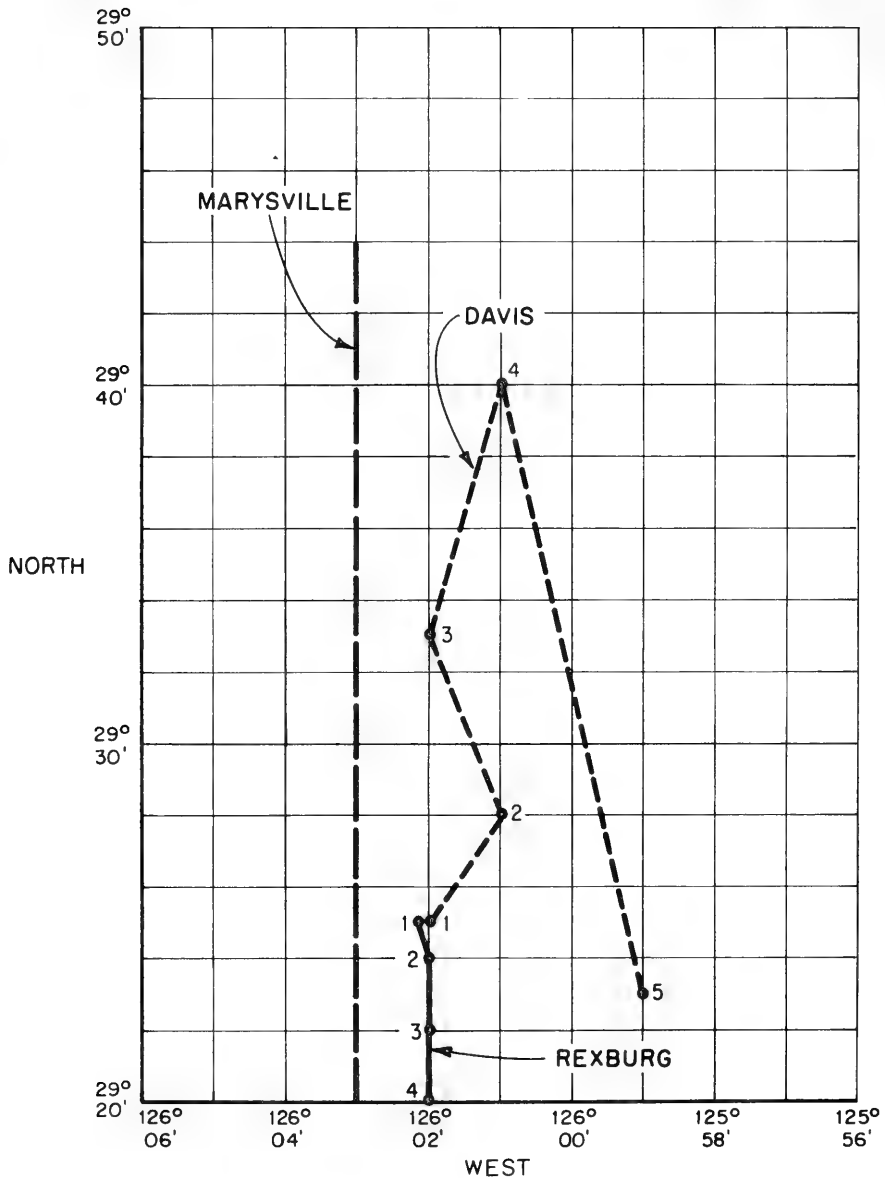

Figure B-1. TRACKS OF USS MARYSVILLE, USNS CHARLES H. DAVIS AND USS REXBURG IN BOUNDARY WATER REGION (AREA I). The numbered points on the Rexburg and Davis tracks correspond to the sound velocity profiles shown in Figs. B-5 and B-6 respectively.

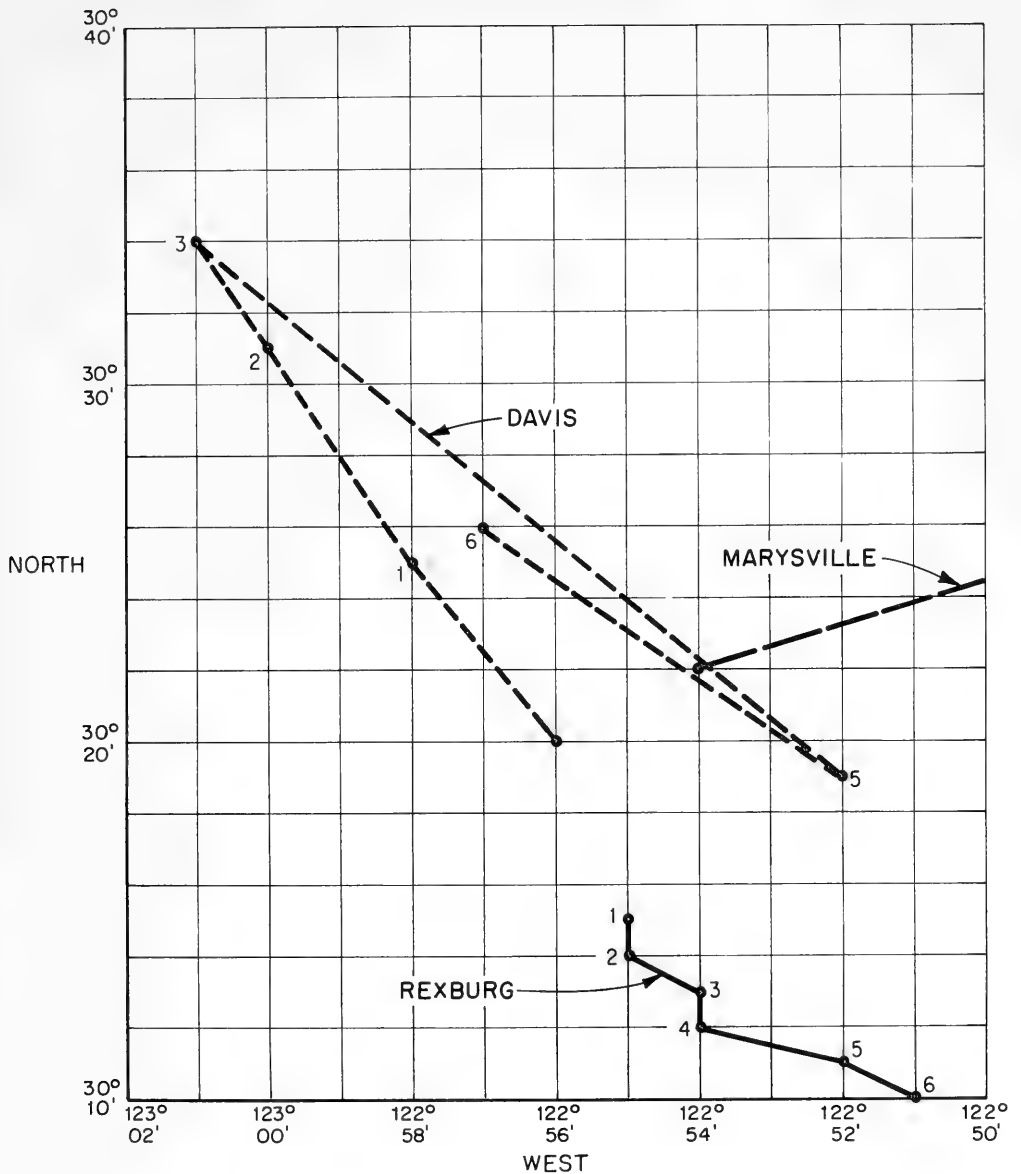

Figure B-2. TRACKS OF USS MARYSVILLE, USNS CHARLES H. DAVIS AND USS REXBURG IN TRANSITION WATER REGION (AREA II). The numbered points on the Rexburg and Davis tracks correspond to the sound velocity profiles shown in Figs. B-7 and B-8 respectively.

The Marysville data for one such traverse are presented graphically in Figure B-3 with the isotherms plotted at integral Celsius degrees. The figure shows that the depth of the thermocline varied over the course by about 30 feet and that the temperature structure was quite irregular below the thermocline. No measurements were shown above the top of the thermocline (200 feet) and the velocity at the surface was not given. Thus it is impossible to determine the velocity gradient in the surface duct from this data. However, the text of reference (1) contains the statement that there was a temperature inversion of less than 1°C in the channel. It is not possible to use the data to establish the dependence of the temperature field below the thermocline either on space or time.

2.2 The Transition Water Region. The Transition Water Region lies to the east of the Boundary Region. The Marysville carried out a single transit in this region and recommended to the Rexburg, a location at 30° 22.0' N, 122° 54.0' W. This site was selected because of the existence of a layer of constant depth over a distance of about 20 miles. The Marysville data in Figure B-4 show that the temperature structure below the layer was more regular than in the Boundary Region. It is not possible to determine if the temperature field was time dependent since there was only one transit. There are no measurements in the surface layer but in the text of Reference (1) it is stated that there were no inversions in the surface channel at this site.

The Rexburg and Davis began their experiments 18 hours after the Marysville survey.

### 3. BATHYTHERMOGRAPH DATA OBTAINED BY USS REXBURG AND USNS CHARLES H. DAVIS

During the acoustical experiments bathythermograph casts were made at one-hour intervals from both the Rexburg and the Davis. The measurements were made both in the surface duct and below the thermocline. In both regions the agreement between the data from the two ships confirms the existence of a well defined surface duct along the track between them.

The data included measurements of surface temperature and thus provided records of temperature versus depth and the depth of the surface duct. In both areas the surface layers were practically isothermal, the total change in temperature with depth in each case being nearly within the accepted error for bathythermographs, i.e., about  $\pm 0.2^\circ\text{C}$ . The bathythermograph casts showed that in both areas the depth of the thermocline varied during the acoustical experiments by approximately 50 feet. Since the ships were moving apart it is not possible to separate the spatial and temporal dependence of this variation. In the Boundary Region the depth of the duct varied from 225 to 175 feet and in the Transition Water Region from about 260 to 210 feet.

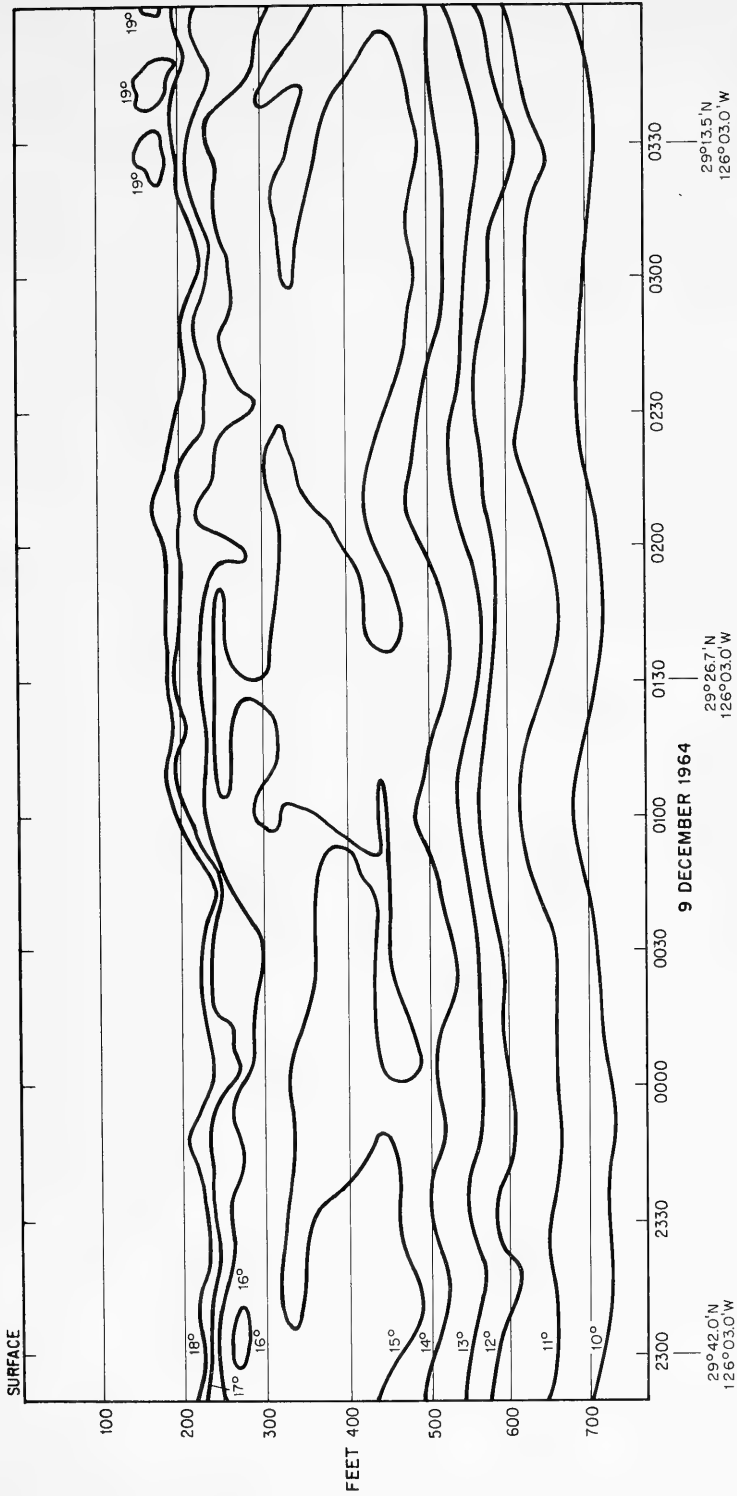

Figure B-3. A THERMAL PROFILE OBTAINED BY THERMISTOR CHAIN FROM USS MARYSVILLE IN BOUNDARY WATER REGION (AREA I)



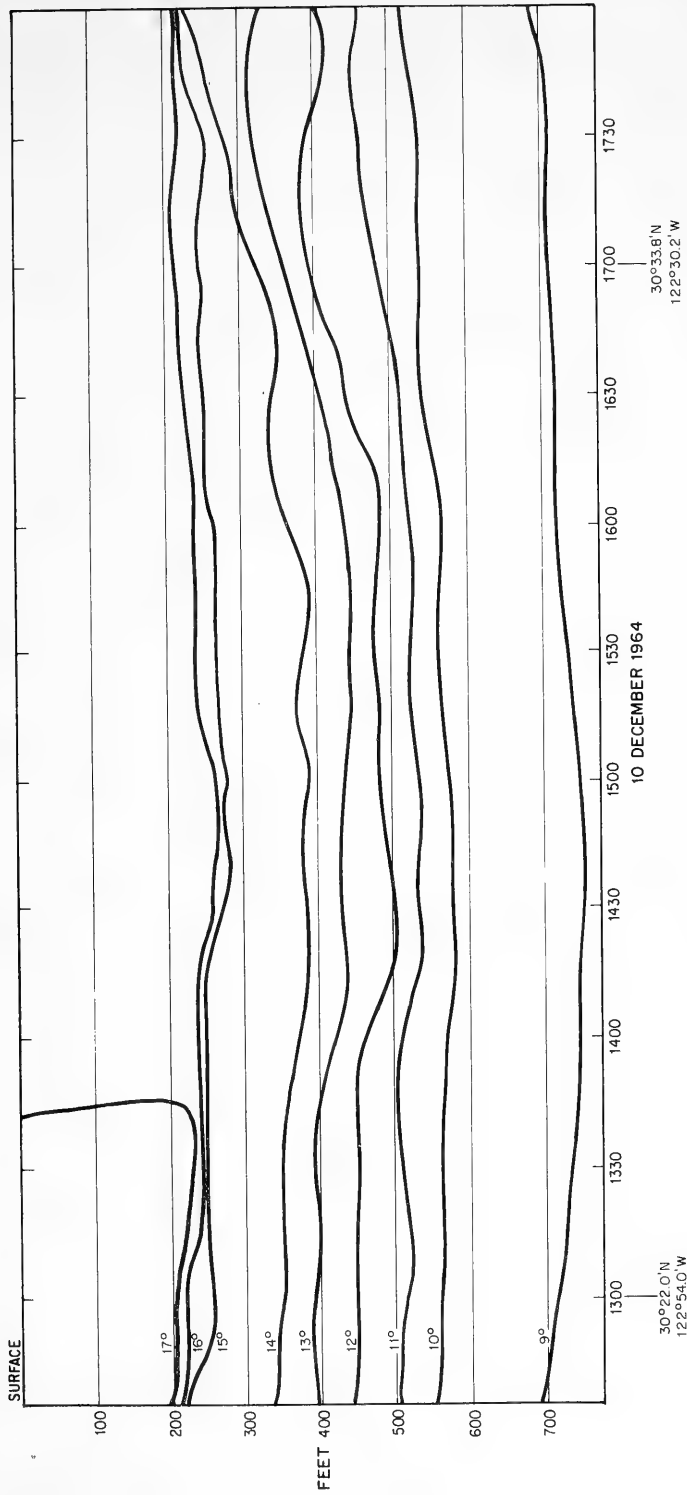

Figure B-4. A THERMAL PROFILE OBTAINED BY THERMISTOR CHAIN FROM USS MARYSVILLE IN TRANSITION WATER REGION (AREA II)





Since the surface ducts were practically isothermal the major cause of variation in acoustical velocity within them arose from the increase of pressure with depth. Figures B-5, B-6, B-7, and B-8 show the sonic velocity profiles calculated from the bathythermograph data of both ships obtained at two-hour intervals in the two regions. The numbers on the profiles correspond to the position numbers in Figures B-1 and B-2.

Based on these figures, the mean velocity gradients in the surface channels in the two regions were  $0.02 \text{ sec}^{-1}$  in the Boundary Region and  $0.013 \text{ sec}^{-1}$  in the Transition Water Region. Since the coefficient for the change of sonic velocity with pressure is  $0.018 \text{ sec}^{-1}$  and since the intrinsic error of the coefficient when derived from bathythermograph measurements in an isothermal channel of 200 feet depth is approximately  $0.01 \text{ sec}^{-1}$ , it is hard to distinguish the acoustic velocity profiles in the two areas.

Table B-1 presents the parameters used in the theoretical computations, the notation being that of Reference (2). The values were obtained from the velocity profile by a rather gross averaging since the quality and quantity of data did not justify further refinement.

TABLE B-1

PARAMETERS USED IN THE NORMAL MODE CALCULATIONS

	$C_0$ (ft/sec)	$Z_a$ (ft)	$\gamma_0$ ( $\text{sec}^{-1}$ )	$\gamma_1$ ( $\text{sec}^{-1}$ )
Area I	4970.7	207.5	.0201	-.196
Area II	4965.0	225.0	.0134	-.213

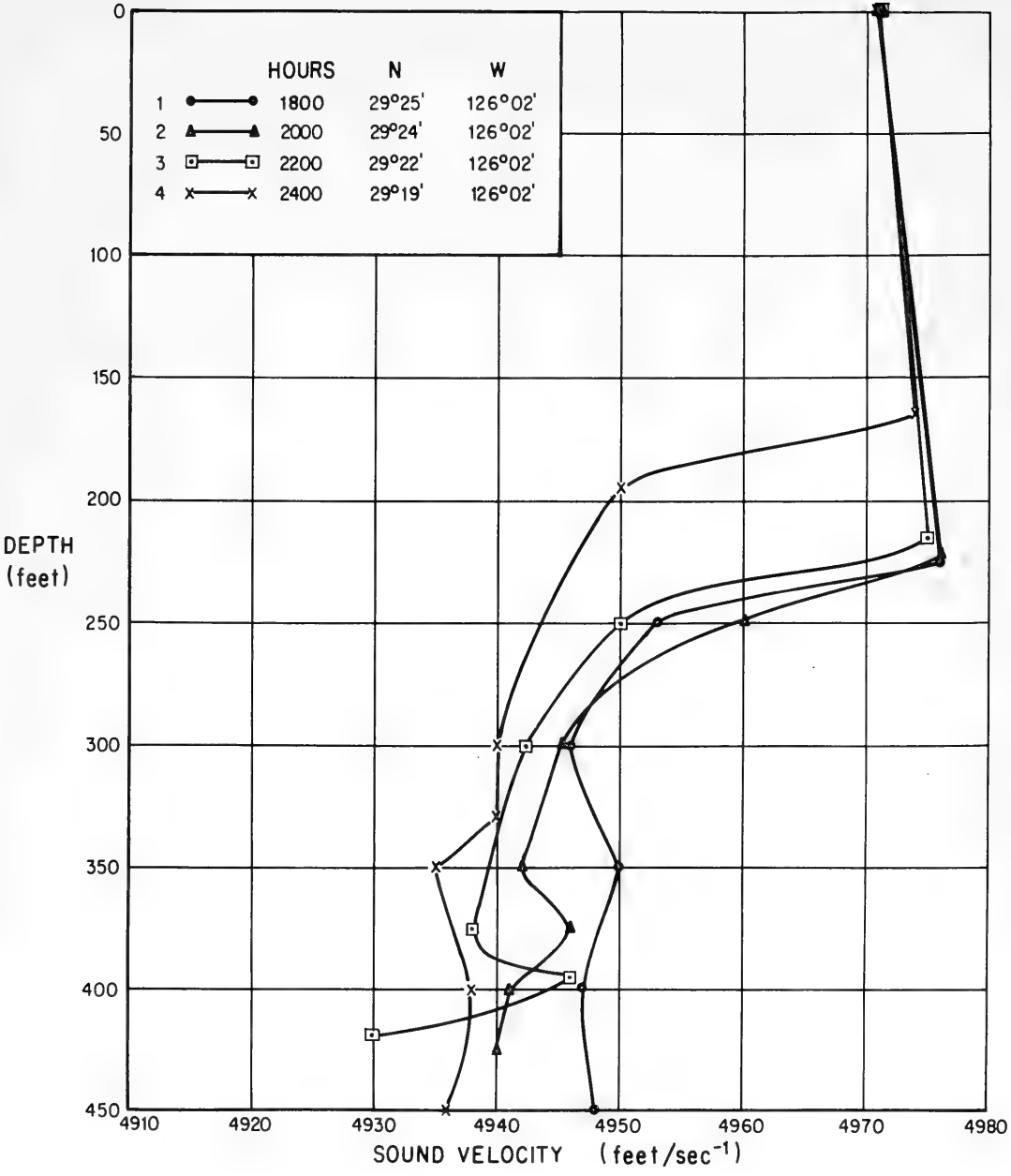

Figure B-5. SOUND VELOCITY PROFILES OBTAINED BY USS REXBURG IN BOUNDARY WATER REGION (AREA I)

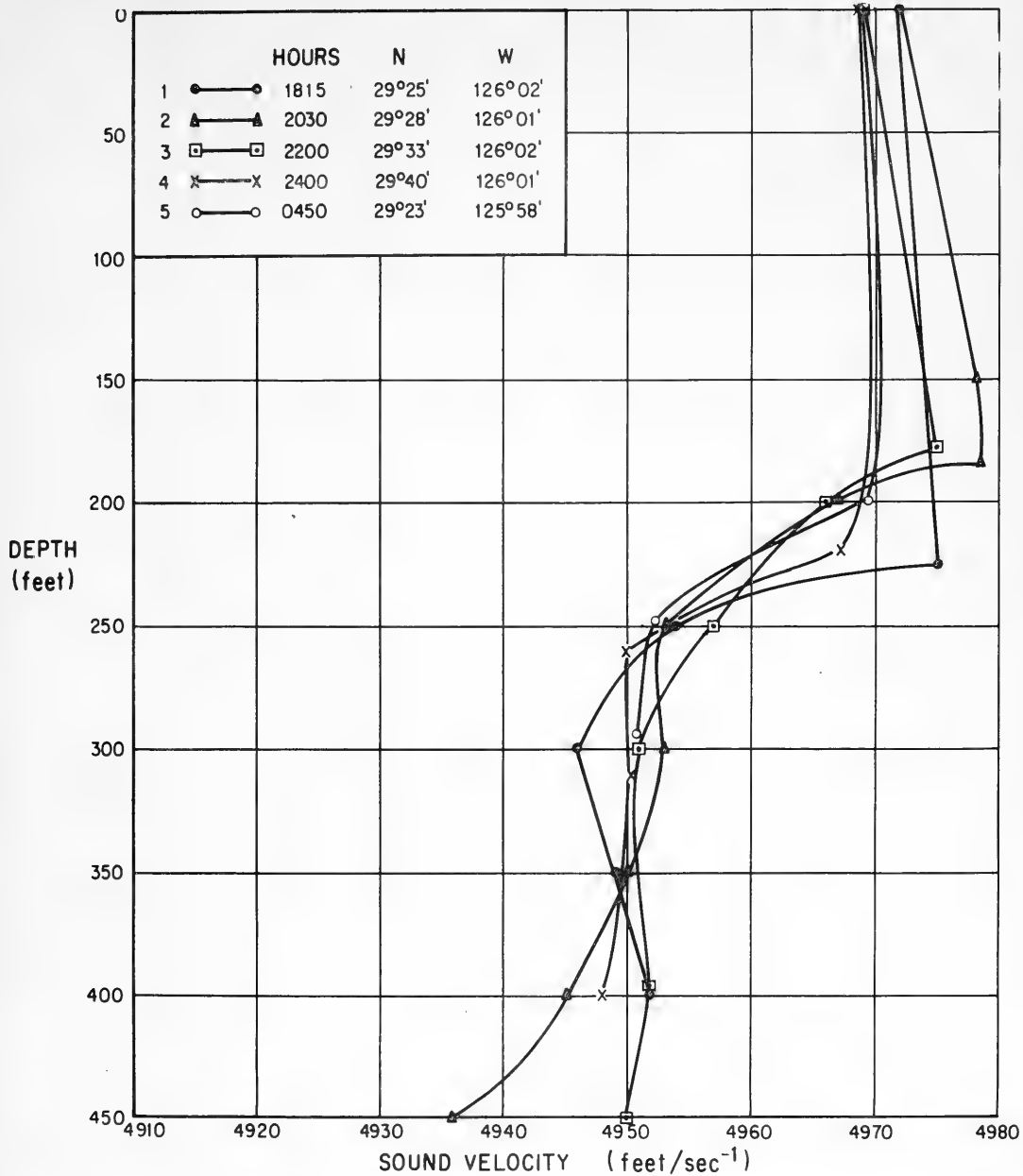

Figure B-6. SOUND VELOCITY PROFILES OBTAINED BY USNS CHARLES H. DAVIS IN BOUNDARY WATER REGION (AREA I)

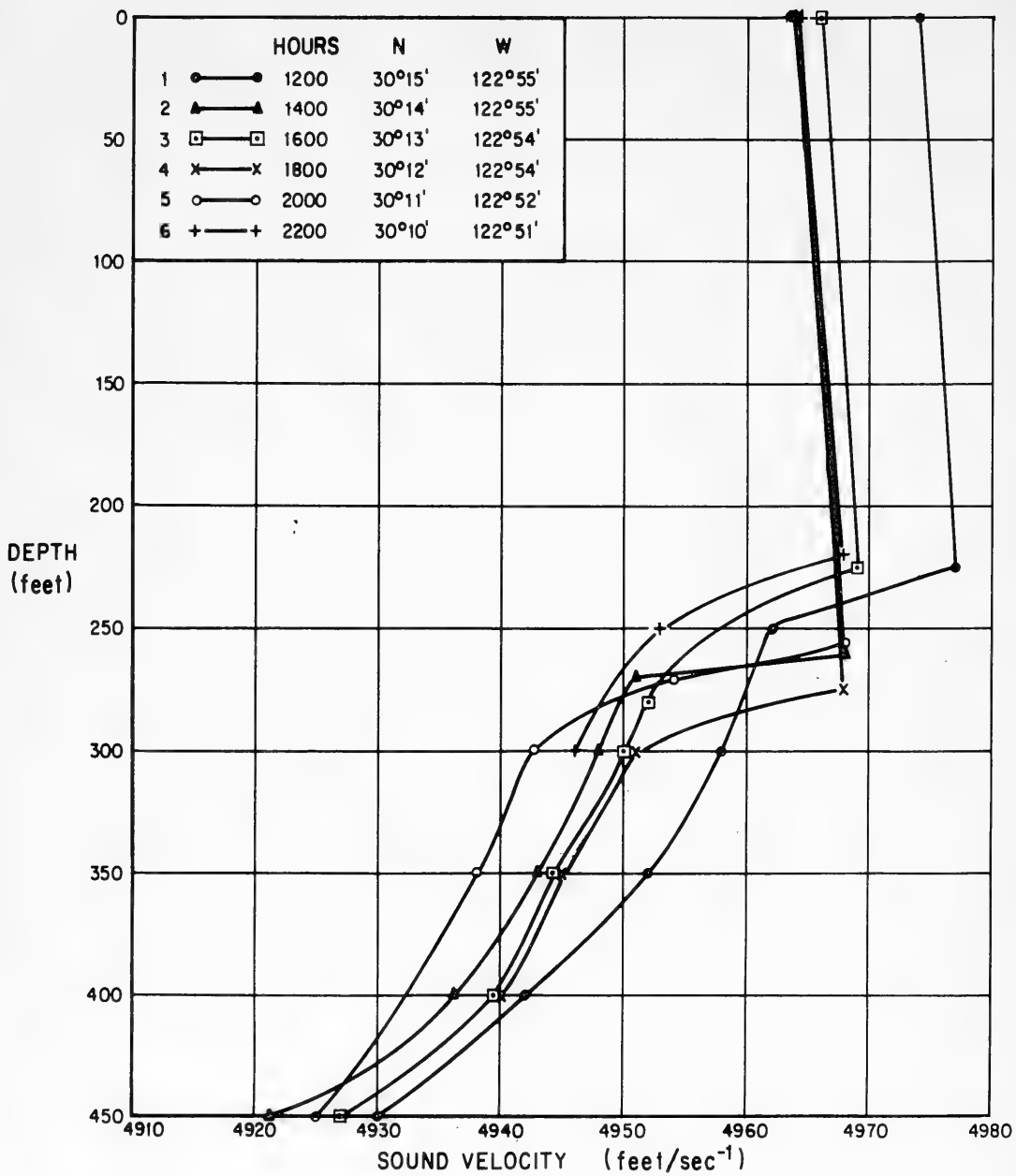

Figure B-7. SOUND VELOCITY PROFILES OBTAINED BY USS REXBURG IN TRANSITION WATER REGION (AREA II)

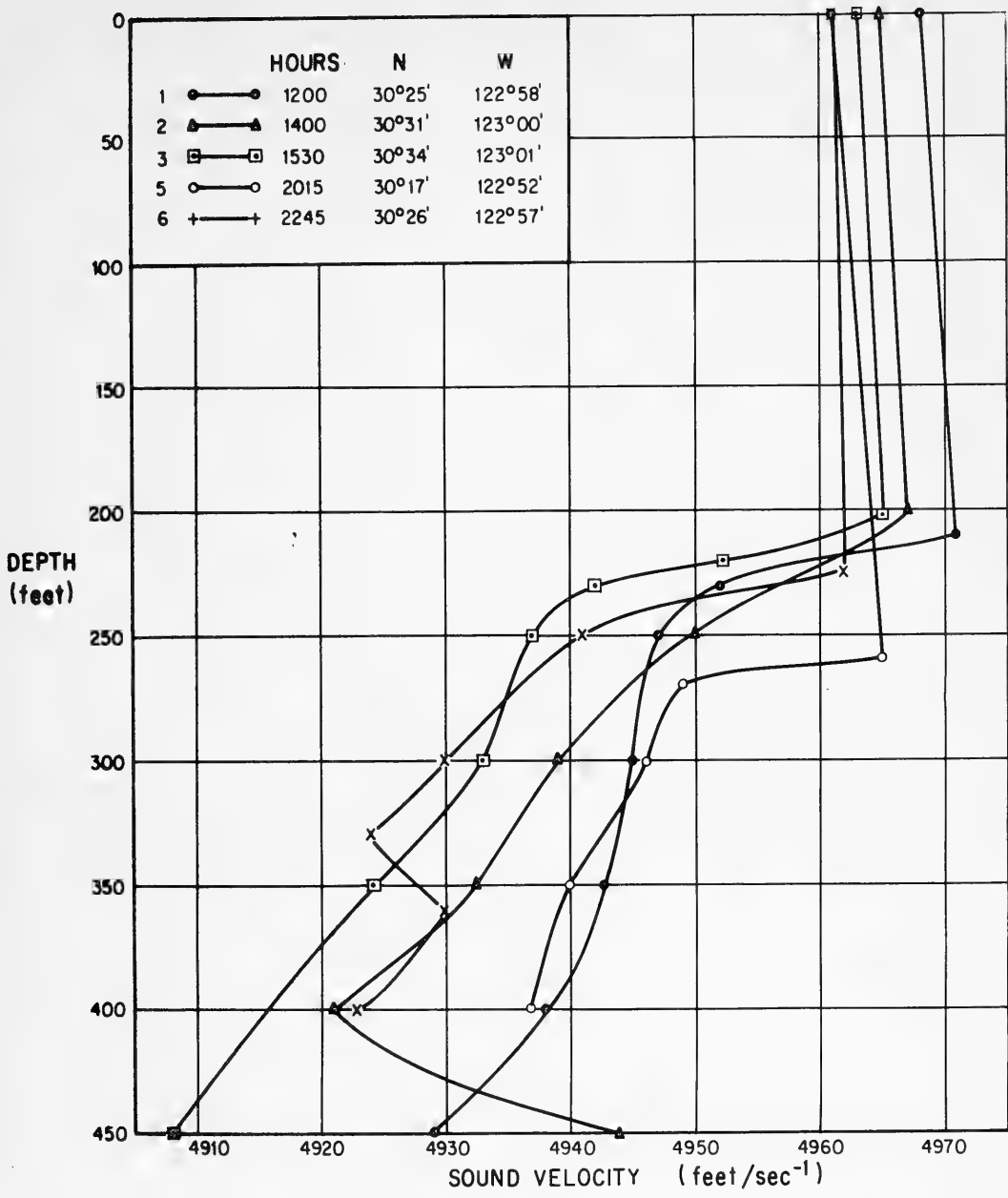

Figure B-8. SOUND VELOCITY PROFILES OBTAINED BY USNS CHARLES H. DAVIS IN TRANSITION WATER REGION (AREA II)



## APPENDIX C

### EXPERIMENTAL EQUIPMENT AND DATA REDUCTION

#### 1. EXPERIMENTAL EQUIPMENT

On the USNS Charles H. Davis, two projectors were combined in one unit to cover all three frequencies. The serial numbers and the individual sensitivities\* are listed in Table C-1. The input currents to the projectors were recorded during the experiment and used to determine the radiated acoustic source level. In analysis, it was assumed that the source level was unaffected by tilting or rotation of the hydrophones.

On the receiving ship, the USS Rexburg, three hydrophones were suspended at 50 feet, 90 feet, and 300 feet. Their sensitivities\* are presented in Table C-1. The hydrophone outputs were recorded simultaneously on magnetic tape and (at one frequency only per channel) on Visicorder paper. A block diagram of the recording system aboard the Rexburg is shown in Figure C-1. Calibration signals were injected into the three hydrophone channels by a calibrated local oscillator and attenuator loaded by a low resistance in series with the hydrophone. The use of the calibration voltages is discussed in the next section.

A radio pulse, synchronized with each of the acoustical pulses, was transmitted from the Davis to the Rexburg where it was recorded on Channel 7 of the magnetic tape. Clock pulses at 5-second intervals were recorded on tape Channel 9. Radio telephony signals from the Davis were recorded on tape Channel 14. Frequently the signals on Channels 7, 9, and 14 interfered with the hydrophone outputs on Channels 1, 2, and 3 and added to the complexity of subsequent data analysis.

#### 2. SYSTEM CALIBRATION

As described in the preceding section the output of each hydrophone was recorded on two channels on the magnetic tape. The signals were recorded continuously in each channel regardless of frequency. At the end of each of the six runs, an electrical calibration signal of suitable voltage was injected into each channel of the receiving system and recorded. These calibration signals were at 3000 cps on Channel 1, 1300 cps on Channel 2, and 700 cps on Channel 3. We will identify these particular frequencies, one appropriate to each channel, by the symbol  $f_0$ . The magnitude of the calibration signals was voice-recorded on the magnetic tape.

---

\* The calibration curves were provided by USNEL Transducer Calibration Facility.

TABLE C-1

ACOUSTICAL EQUIPMENT

Transmitting Hydrophones

<u>Frequency</u>	<u>Serial Number</u>	<u>Sensitivity</u>
3000 cps	B40CR6M	100 db re 1 $\mu$ b/amp at 1 meter
1300 cps	B38CR8M	94.5 db re 1 $\mu$ b/amp at 1 meter
700 cps	B38CR8M	76.5 db re 1 $\mu$ b/amp at 1 meter

Receiving Hydrophones

	<u>Serial Number</u>	<u>Sensitivity</u>
Channel 1 Shallow	B47CRT69	3000 cps - 116 db re 1 $\mu$ v/ $\mu$ bar
		1300 cps - 115 db re 1 $\mu$ v/ $\mu$ bar
		700 cps - 115 db re 1 $\mu$ v/ $\mu$ bar
Channel 2 Intermediate	B47CRT51M	3000 cps - 117 db re 1 $\mu$ v/ $\mu$ bar
		1300 cps - 115 db re 1 $\mu$ v/ $\mu$ bar
		700 cps - 116 db re 1 $\mu$ v/ $\mu$ bar
Channel 3 Deep	B47CRT7M	3000 cps - 120 db re 1 $\mu$ v/ $\mu$ bar
		1300 cps - 116 db re 1 $\mu$ v/ $\mu$ bar
		700 cps - 115 db re 1 $\mu$ v/ $\mu$ bar



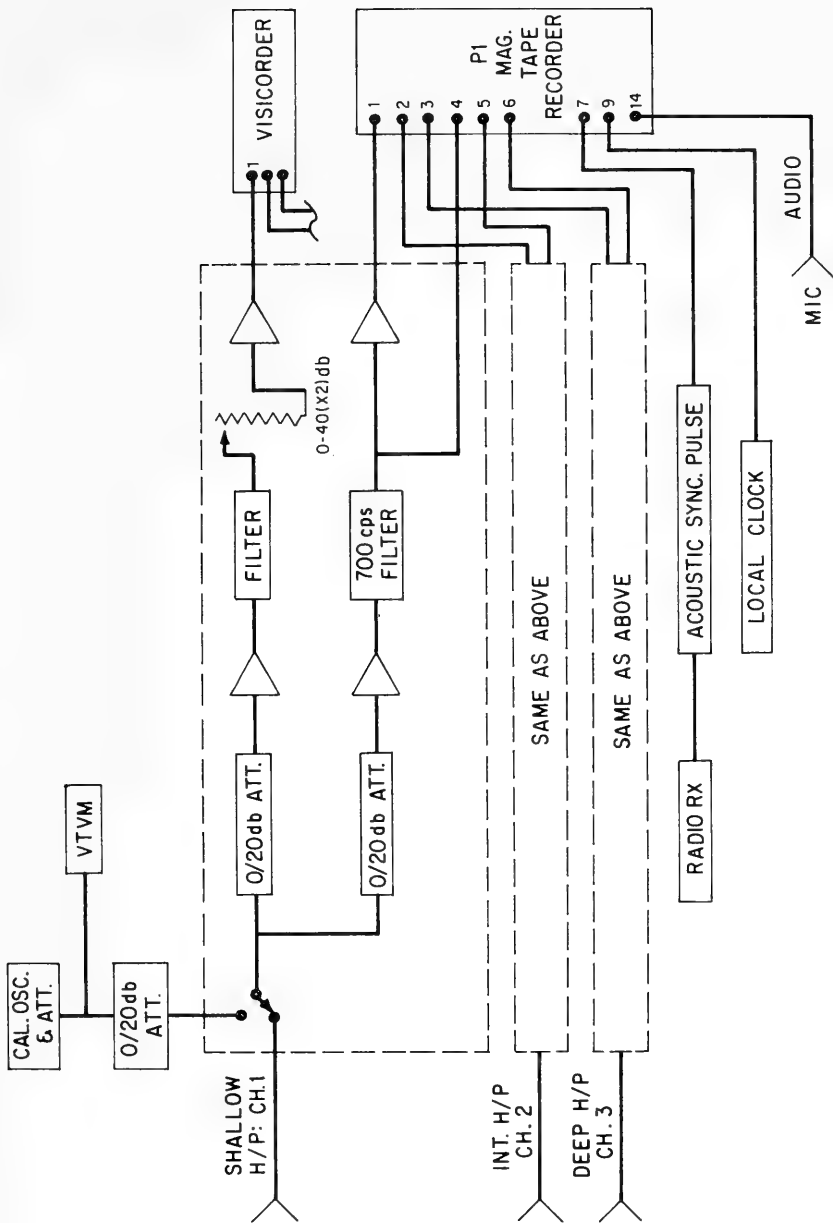

Figure C-1. BLOCK DIAGRAM OF ACOUSTICAL RECORDING EQUIPMENT ON USS REXBURG

For visual analysis, the data acquired on shipboard was later transcribed in the laboratory from the magnetic tape to paper strip chart using a six-channel recording pen galvanometer. This procedure is illustrated by the block diagram in Figure C-2. The three hydrophone channels were transcribed from magnetic tape Channels 1, 2, 3 to the paper along with the acoustical synchronization and clock pulses. By proper selection of narrow-band filters and by re-playing each channel on the magnetic tape three times, the signals received at the different frequencies were separated and recorded on the paper independently. The local attenuators were adjusted to maintain reasonable signal levels on the paper, their settings being written on the galvanometer paper whenever a change was made.

The shipboard (Rexburg) calibrations for each channel appeared with the appropriate frequency as each channel was transcribed. Thus, it was possible to calculate a recording sensitivity for each channel, at  $f_0$ , in the form  $x$  db re 1 volt per mm pen deflection. Accordingly, with a knowledge of the hydrophone sensitivity, an overall channel sensitivity,  $S(f_0)$ , can be derived in the form  $y$  db re 1  $\mu$ b per mm pen deflection (i.e., press/mm), where  $f_0 = 3000$  cps on Channel 1,  $f_0 = 1300$  cps on Channel 2, and  $f_0 = 700$  cps on Channel 3.

To determine the sensitivities,  $S(f)$ , on these channels at the other two frequencies, the local oscillator and VTVM shown in Figure C-2 provided local calibrations at all three frequencies on each channel in terms of the voltages,  $V(f)$  that produced full scale pen deflection. The values of  $V(f)$  at all frequencies, obtained during transcription, are given in Table C-2. It was assumed that the sensitivity of each receiving channel in the shipboard data acquisition and recording system was constant over the frequency range 700 to 3000 cps, and hence that changes in  $S(f)$  with frequency in any channel occurred during the transcription process. Accordingly with the receiving hydrophone sensitivities,  $H(f)$ , known for all channels and frequencies, and, using the  $V(f)$  to take account of the variation of transcription amplifier gain with frequency, it was possible to calculate the channel sensitivities  $S(f)$  for all frequencies.

If  $S(f)$  is the channel sensitivity at frequency  $f$  in db re 1  $\mu$ bar per mm pen deflection

$S(f_0)$  is the observed value of  $S(f)$  where  $f_0$  is the frequency of the Rexburg calibration, i.e.,

$f_0$  is 3000 cps for Channel 1  
 1300 cps for Channel 2  
 700 cps for Channel 3

$H(f)$  is the hydrophone sensitivity at frequency  $f$  in db re 1 volt per  $\mu$ bar

$V(f)$  is the local calibration voltage giving full scale pen deflection at frequency  $f$  and at a standard local attenuator setting

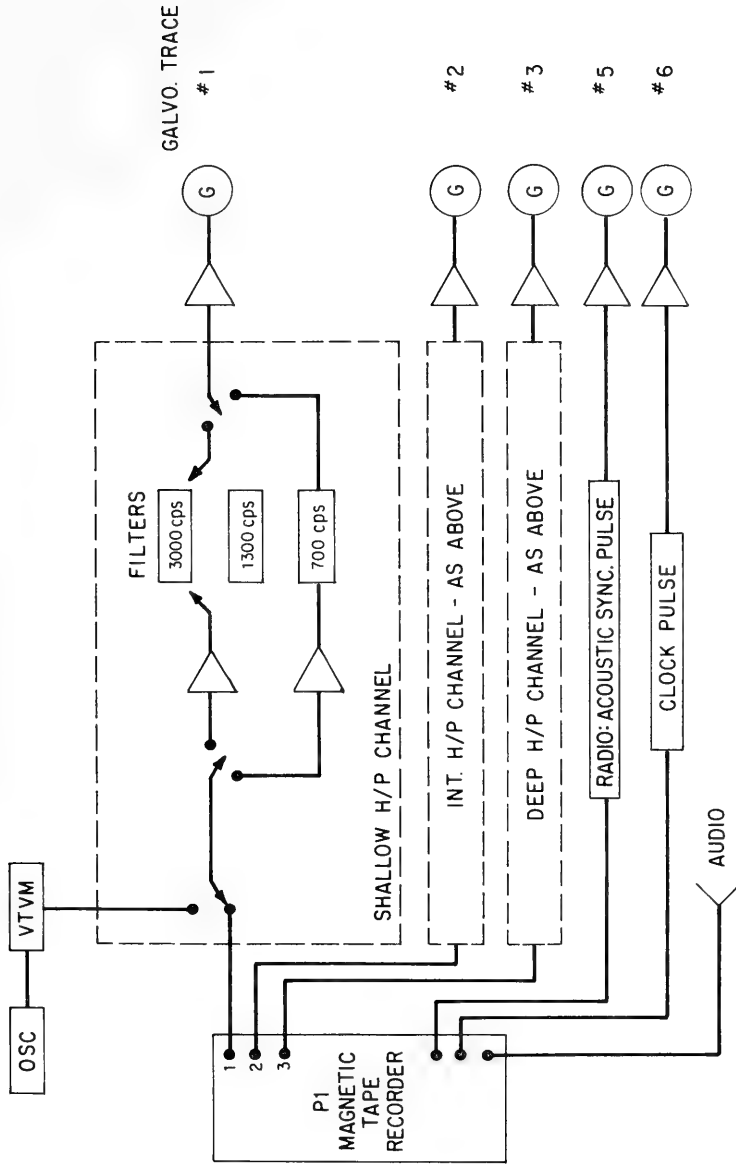

Figure C-2. BLOCK DIAGRAM OF TRANSCRIPTION EQUIPMENT USED IN DATA REDUCTION

TABLE C-2

LOCAL AMPLIFIER CALIBRATION

Voltage for full scale deflection [V(f)] at 40 db local attenuation

<u>Channel</u>	<u>3000 cps</u>			<u>1300 cps</u>			<u>700 cps</u>		
	<u>1</u>	<u>2</u>	<u>3</u>	<u>1</u>	<u>2</u>	<u>3</u>	<u>1</u>	<u>2</u>	<u>3</u>
<u>Reel</u>									
1									
2	1.1	1.1	1.0	1.3	1.1	1.0	.92	2.8	.59
3	1.1	1.1	1.0	1.2	1.0	.90	.92	2.4	.58
4	1.2	1.5	1.0	1.3	1.0	.92			
5	1.2	1.2	1.05	1.35	1.15	1.0	.80	1.4	.50
6	1.3	1.0	1.0	1.4	1.0	.90	.88	2.25	.58
7	1.2	1.1	1.0	1.1	1.1	1.05	.87	2.4	.56
8	1.5	1.1	1.0	1.1	1.0	1.0	.88	.56	.53
9	1.45	1.25	1.1	1.2	1.2	1.1	.86	.70	.54
10	1.35	1.2	1.05	1.3	1.25	1.0	.87	.89	.55
11 (1)	1.5	1.25	1.2	1.35	1.1	.92	.86	.64	.54
11 (cal.)	1.5	1.4	1.2				.85	.60	.56
12	1.45	1.35	1.25	1.45	1.05	1.05	.86	.60	.54
13	1.6	1.0	1.1	1.4	1.0	1.0	.82	.60	.52
14	1.4	1.3	1.25	1.5	1.1	1.1	.86	.61	.56
15	1.4	1.3	1.0	1.5	1.1	1.1	.86	.54	.54
16 (1)	1.6	1.3	1.1				.86	.54	.54
16 (cal.)	1.5	1.35	1.15	1.55	1.05	1.05	.86	.54	.52
17	1.5	1.2	1.1	1.5	1.05	1.0	.88	.65	.55
18	1.5	1.2	1.1	1.6	1.0	.96	.89	.58	.55
19 (1)	1.5	1.25	1.2	1.6	1.15	1.10	.88	.56	.51
19 (cal.)	1.5	1.25	1.25	1.6	1.15	1.0	.86	.56	.51
20	1.65	1.22	1.20	1.6	1.20	1.0	.90	.55	.51
21	1.47	1.20	1.1	1.55	1.20	1.0	.90	.50	.62

$$\text{Then } S(f) = S(f_0) + 20 \log \frac{V(f)}{V(f_0)} - [H(f) - H(f_0)]$$

$$\text{i.e., Rexburg Calibration} + \text{Local Amplifier Sensitivity Ratio} + \text{Hydrophone Sensitivity Change}$$

Now if  $\theta$  is the observed signal deflection on the paper (db re 1 mm), R is the attenuator setting in the receiving channel on the Rexburg, A is the local transcription attenuator setting and  $T_x(f)$  is transmitter signal strength (db re 1  $\mu$ bar at 1 yd) the transmission loss is given by:

$$\text{Transmission loss} = T_x(f) - (\theta + S(f) + R + A)$$

Calibration signals were recorded on the Rexburg at the end of each experimental run (except runs 2 and 6) as described above, thus allowing the channel sensitivities,  $S(f_0)$ , to be established.

Table C-3 lists the values of  $S(f)$  used. The values of  $S(f)$  obtained from Run 5 were used in Run 6. For Run 2 the values appropriate to Run 3 were used throughout except on Channel 2 where an obvious change in  $S(f)$  for 700 cps occurred before time 1819 hours. Presumably this was due to a playback amplifier fault since no change was found in  $V(f)$  for 700 cps.

The consistency of the results on Channels 2 and 3 indicated that the values of  $S(f)$  for Run 1 on Channel 3 were in error by 10 db suggesting a wrong attenuator setting. Accordingly, these were corrected to the values given in parentheses in the table.

The values of  $S(f)$  for Channel 1 appear to be unacceptable since they contain inexplicable variations of 10 or 20 dbs. The exception occurs after time 1819 (Run 5) where an obvious amplifier fault occurred. After this point a new clear experimental calibration obtained at the end of the run was used. For consistency it was decided that  $S(f) = -38/-34/-33$  be used on all runs on this channel before 1819 since it was derived from a clear experimental calibration and was reasonably consistent with the other channels.

The observed noise level (ONL) was used as a check on calibration changes and the general validity of the calculated transmission losses. Since the receiving system is presumed to be sea noise limited the average noise levels can be predicted and compared with the actual noise levels observed on the recordings. The values used for the estimated noise levels (ENL) within the appropriate filter pass bands were as follows:

700 cps	:	-10 $\pm$ 5 db re 1 $\mu$ bar
1300 cps	:	-10 $\pm$ 5 db re 1 $\mu$ bar
3000 cps	:	-15 $\pm$ 5 db re 1 $\mu$ bar

TABLE C-3

CHANNEL SENSITIVITIES, S(f), USED IN DATA ANALYSIS

	Channel 1 Shallow Hydrophone			Channel 2 Intermediate Hydrophone			Channel 3 Deep Hydrophone		
	700	1300	3000	700	1300	3000	700	1300	3000
Frequency (cps)									
Run No.									
1	-18	-14	-13	-31	-39	-36	-33 (-43) <sup>(1)</sup>	-26 (-36)	-22 (-32)
2	(-38)	(-34)	(-33)	(-32) <sup>(2)</sup> (-44)	(-39)	(-36)	(-43)	(-36)	(-32)
3	-38	-34	-33	-44	-39	-36	-43	-36	-32
4	-48	-44	-42	-45	-40	-37	-42	-35	-31
5	-48 -28	-44 -24	-43 -23 <sup>(2)</sup>	-45	-40	-37	-43	-37	-33
6	(-28)	(-24)	(-23)	(-45)	(-40)	(-37)	(-43)	(-37)	(-33)

Note:

- (1) The numbers in parentheses are assumed in the absence of experimental calibration. See text for discussion.
- (2) Obvious amplifier fault changes calibration during the run. See text for discussion.

The values of the observed noise level should be reasonably constant within each run and should agree reasonably with the estimated noise level. A discrepancy of 10 db's would indicate possible error whereas a discrepancy of 20 db's would indicate probable error. The values of the estimated and observed noise levels\* are shown with the data points on the experimental curves.

The following is a list of all the calibration changes and consequent adjustments of data points made on Channel 1.

- Run 1 - Adjusted data points and ONL in agreement with a uniform  $S(f) = -38/-34/-33$  instead of  $-18/-14/-13$ .
- Run 2 - No change.
- Run 3 - No calibration change. Assumed incorrect attenuator setting (decreased transmission loss) at ranges less than 11 kiloyards.
- Run 4 - Adjusted data points and ONL in agreement with a uniform  $S(f) = -38/-34/-33$  instead of  $-48/-44/-42$ .
- Run 5 - (A) 1300 cps: Used  $S(f) = (-44)$  at times before 1819 (Reel 18) and  $S(f) = (-24)$  thereafter.  
3000 cps: Used  $S(f) = (-43)$  through Reel 18, and  $S(f) = (-23)$  for Reel 19 et seq.  
700 cps: Used  $S(f) = (-48)$  through Reel 18, and  $S(f) = (-28)$  for Reel 19 et seq.  
(B) Adjusted data points and ONL in agreement with a uniform  $S(f) = -38/-34/-33$  wherever  $-48/-44/-43$  had been used.
- Run 6 - No change.

### 3. DATA REDUCTION

On a 15-minute cycle, the signals occurring in a 5-minute period were measured, the linear deflections (mm) averaged and this average expressed in db re 1 mm. This value was used in the calculation of the transmission loss as outlined above for the average range during this 5-minute interval. Range was calculated from the travel time of the acoustic signal and the velocity of sound. The experimental data are compared with theoretical predictions in the curves of transmission loss versus range contained in the body of this report. In addition, eleven experimental curves were analyzed on a ping by ping basis. These are presented along with the 54 curves based on averaged data.

---

\* Indicated by (~).





Distribution List:



Arthur D. Little, Inc.

ACORN PARK  
CAMBRIDGE 40, MASSACHUSETTS  
UNIVERSITY 4-8770

Woods Hole Oceanographic  
Woods Hole, Massachusetts

Bell Telephone Laboratory  
Murray Hill, New Jersey

Bendix Aviation Corporation  
North Hollywood, California

Edo Corporation  
14-04 111th Street  
College Point, New York

General Electric Company  
Electronics Parkway  
Syracuse, New York

Raytheon Manufacturing Co  
Old Sudbury Road  
Wayland, Massachusetts

Sangamo Electric Company  
11th and Converse  
Springfield, Illinois

University of Washington  
Director, Applied Physics Laboratory  
1013 NE 40th  
Seattle, Washington

The University of Texas  
Defense Research Laboratory  
500 E. 24th Street  
Austin, Texas

Scripps Institution of Oceanography  
8602 La Jolla Shores Drive  
La Jolla, California

Marine Physical Laboratory of  
Scripps Institution of Oceanography  
San Diego, California

Pennsylvania State University  
Ordnance Research Laboratory  
University Park, Pennsylvania

Brown University  
Research Analysis Group  
Providence, Rhode Island

This report is sent to you at the  
request of the U. S. Navy Elec-  
tronics Laboratory, Code 3185

**ARTHUR D. LITTLE, INC.**  
**CAMBRIDGE • WASHINGTON • EDINBURGH • CHICAGO**  
**SANTA MONICA • MEXICO CITY • LONDON • ZURICH**  
**BRUSSELS • SAN FRANCISCO • NEW YORK • TORONTO**