

UMASS/AMHERST



312066005809468

LIBRARY



UNIVERSITY OF MASSACHUSETTS  
LIBRARY

---

---









WASHINGTON, D. C.

1910

College

# AMERICAN BREEDERS MAGAZINE

---

---

Published by the American Breeders Association

*The New Magazine has a Place*  
SEC'Y OF AGRICULTURE JAMES WILSON

*Breeding Fat and Protein into Corn*  
DR. L. H. SMITH

*Breeding the Army Horse*  
CARLOS GUERRERO

*Poultry Breeding in Australia*  
D. F. LAURIE

*Imperfection of Dominance*  
DR. C. B. DAVENPORT

*The New Magazine—Editorials*

First Quarter

Jan., Feb., Mar.

Vol. I

No. 1

J 8258

# The American Breeders Association

## OFFICERS OF THE ASSOCIATION

*President*

HON. JAMES WILSON, Washington, D. C.

*Vice-President*

HON. WILLIAM GEORGE, Aurora, Ill.

*Secretary*

HON. WILLET M. HAYS, Washington, D. C.

*Treasurer*

HON. N. H. GENTRY, Sedalia, Mo.

*Chairman Plant Section*

DR. H. J. WEBBER, Ithaca, N. Y.

*Secretary Plant Section*

PROF. N. E. HANSEN, Brookings, S. Dak.

*Chairman Animal Section*

DEAN C. F. CURTISS, Ames, Iowa.

*Secretary Animal Section*

PROF. H. W. MUMFORD, Urbana, Ill.



### EDITORS

WILLET M. HAYS, Secretary of the Association

N. E. HANSEN, Secretary of the Plant Section

H. W. MUMFORD, Secretary of the Animal Section

*Address Communications to American Breeders Association, Washington, D. C.*

*Membership: Annual, \$2.00; Life, \$20.00; Patrons, \$1,000.*



# The American Breeders Magazine

Published Quarterly by the American Breeders Association

FOR THE USE OF ITS MEMBERS

PRICE OF SINGLE COPIES, FIFTY CENTS

Address communications to American Breeders Association, Washington, D. C.

Vol. I.

First Quarter, 1910.

No. 1.

## CONTENTS.

Charles Robert Darwin (portrait).....	2
The New Magazine Has a Place. Hon. JAMES WILSON, Sec'y of Agriculture..	3
Darwin, Mendel, and Cruikshank (biographical sketches).....	6
Gregor Johann Mendel (portrait).....	7
Amos Cruikshank (portrait).....	11
Increasing Protein and Fat in Corn. LOUIE H. SMITH.....	15
New Methods of Plant Breeding (illustrated). GEORGE W. OLIVER.....	21
The Army Horse. CARLOS GUERRERO.....	30
Imperfection of Dominance. C. B. DAVENPORT.....	39
Legislation Affecting the Raising of Deer and Elk for Profit. D. E. LANTZ...	42
Value of Wild Animals. C. D. RICHARDSON.....	48
Experience in Raising Virginia Deer. C. H. ROSEBERRY.....	50
Poultry Breeding in South Australia. D. F. LAURIE.....	52

## EDITORIALS:

The New Magazine.....	61
The American Breeders Association.....	64
The Relation of the Association to Pure Research.....	66
Building up an Export Trade in Pedigreed Animals.....	67
Eugenics, a Subject for Investigation Rather than Instruction.....	68
Effect of Recent Discoveries on the Art of Breeding.....	69

## ASSOCIATION MATTERS:

The Omaha Meeting.....	71
The Committees of the American Breeders Association.....	73
Proposed Change in the Constitution.....	75
Membership in the American Breeders Association.....	76
The Annual Report.....	76

[Copyright, 1910, by the American Breeders Association.]

## CHAIRMEN OF COMMITTEES OF THE AMERICAN BREEDERS ASSOCIATION FOR 1910.

The Association owes much of its strength to the fact that a large part of the work of investigation, collation of results, suggesting plans of breeding, promoting cooperation in research and breeding, and following up of progress in this and other countries is done by committees of specialists. In this way each committee deals only with a certain phase of breeding. Committees on new subjects are appointed as appears wise and necessary.

The following-named gentlemen, nearly all of whom were chairmen last year, have been requested to serve as chairmen of the respective committees during 1910. When completed, the full list of members of these committees is to be published.

### *Committee on Animal Hybrids.*

Prof. W. J. SPILLMAN, Washington, D. C.

### *Cooperative Work in Animal Breeding.*

Hon. W. M. HAYS, Washington, D. C.

### *Breeding Wild Birds.*

Dr. T. S. PALMER, Washington, D. C.

### *Breeding Carriage Horses.*

Mr. GEORGE M. ROMMEL, Washington, D. C.

### *Breeding Cotton.*

Dr. D. N. SHOEMAKER, Washington, D. C.

### *Breeding Corn.*

Mr. J. DWIGHT FUNK, Bloomington, Ill.

### *Breeding Cereals.*

Prof. C. A. ZAVITZ, Guelph, Ontario, Canada.

### *Breeding Fiber Crops.*

Dean J. H. SHEPPERD, Fargo, N. Dak.

### *Breeding Forage Crops.*

Dean THOMAS F. HUNT, State College, Pa.

*Breeding Fish.*

Prof. B. W. EVERMANN, Bureau of Fisheries, Washington, D. C.

*Breeding Citrus Fruits.*

Mr. W. T. SWINGLE, Washington, D. C.

*Committee on Eugenics.*

Dr. DAVID STARR JORDAN, Stanford University, Calif.

[Numerous sub-committees will be made committees if the Constitutional amendment carries.]

*Breeding Horse Hybrids.*

Prof. F. B. MUMFORD, Columbia, Mo.

*Theoretical Research in Heredity.*

Dr. H. J. WEBBER, Ithaca, N. Y.

*Breeding Draft Horses.*

Prof. W. B. RICHARDS, Fargo, N. Dak.

*Breeding Wild Animals.*

Mr. D. E. LANTZ, Washington, D. C.

*Breeding for Meat Production.*

Prof. ANDREW BOSS, St. Anthony Park, St. Paul, Minn.

*Nomenclature and Registration.*

Mr. H. H. MOWRY, Washington, D. C.

*Breeding Nut and Forest Trees.*

Prof. GEORGE B. SUDWORTH, Washington, D. C.

*Committee on Prize Competitions.*

Prof. P. G. HOLDEN, Ames, Iowa.

*Pedagogics of Breeding.*

Dean EUGENE DAVENPORT, Urbana, Ill.

*Plant and Animal Introduction.*

Mr. DAVID G. FAIRCHILD, Washington, D. C.

*Pedigreed Seed and Plant Business.*

Mr. EUGENE FUNK, Shirley, Ill.

*Breeding Poultry.*

Prof. JAMES E. RICE, Ithaca, N. Y.

*Breeding for Dairy Production.*

Mr. B. H. RAWL, Washington, D. C.

*Breeding Roses.*

Dr. W. VAN FLEET, Little Silver, N. J.

*Breeding Sheep and Goats.*

Prof. W. C. COFFEY, Urbana, Ill.

*Breeding Sugar Crops.*

Dr. C. O. TOWNSEND, Washington, D. C.

*Breeding Swine.*

Prof. D. A. GAUMNITZ, St. Anthony Park, St. Paul, Minn.

*Breeding Vegetables.*

Mr. W. W. TRACY, Washington, D. C.

*Breeding Tobacco.*

Prof. A. D. SELBY, Wooster, Ohio.

*Breeding Tea, Coffee, and Tropical Fruits.*

Dr. O. F. COOK, Washington, D. C.

*Breeding Tree and Vine Fruits.*

Prof. S. A. BEACH, Ames, Iowa.

*Establishing Types and Standardizing Judging at Livestock Shows.*

Col. R. B. OGILVIE, Union Stock Yards, Chicago, Ill.

*Breeding Bees and Other Insects.*

Dr. L. O. HOWARD, Washington, D. C.

New committees were provided for at the last annual meeting, as follows:

*Breeding Drought Resistant Crops.*

Dr. W. X. SUDDUTH, Billings, Mont.

*Exportation of Pedigreed Animals.*

Prof. H. W. MUMFORD, Urbana, Ill.

*Importation of Pedigreed Animals.*

Mr. E. B. WHITE, Leesburg, Va.

*Committee on Finances.*

HON. WILLIAM GEORGE, Aurora, Ill.





CHARLES ROBERT DARWIN.

# THE AMERICAN BREEDERS MAGAZINE

*"The organic world as a whole is a perpetual flux of changing types."*—FRANCIS GALTON.

Vol. I.

First Quarter, 1910.

No. 1.

## THE NEW MAGAZINE HAS A PLACE

Six years of successful life have proven that the American Breeders Association was organized to meet a need. This Association has brought animal breeders and plant breeders to realize that they are working under laws of heredity common alike to animals and plants. Practical breeders are beginning to understand that they need the work of the scientists who study heredity and breeding; and the scientists have proven to themselves the wisdom of being in close touch with the breeders. The annual reports of the Association have demonstrated the value of a literature covering all phases of heredity and practical breeding. Recent work in heredity and improved breeding has inaugurated a new era in research, in improved methods, and in the demand by growers for improved plants and animals. As an exponent of the newer and more scientific phases of this subject the American Breeders Magazine will have an important place.

Results already secured clearly show that our plant and animal breeders can greatly increase the product from most plants and animals used in agriculture. The experts believe that breeders can find ways of improving varieties and breeds which produce at least five billions out of the eight billions of dollars worth of our farm products. Judging from achievements already accomplished, 10 per cent is a conservative estimate of the increase which can thus be made.

The half a billion annually of added product which may thus be secured with small outlay is a great incentive for the breeders and the scientists who aid them.

Improvements by breeding are unlike those secured by adding new acres to the cultivated areas of the country, by deeper plowing, by more frequently cultivating the crop, by adding to the soil larger supplies of fertilizers, or by giving a more expensive ration to farm animals. These improvements, though they greatly increase the farmers' profits, are secured at a cost which sometimes equals the value of the added product. But the cost of improvements through breeding usually represents only a small fraction of the added



values. The increase of product secured by breeding pays the cost in a short time, and, since there is no further expense, the annual increase afterward is clear profit. The farmer will be able to retain a part of the larger production in the form of added profit, and part will help to reduce the cost of living to those in our cities. Larger production on the farm will also give increased business for the transportation company, the manufacturer, and the merchant, and will provide the nation with a larger product with which to hold our balance of trade.

Many of the scientists, teachers, and advanced breeders who are to contribute the scientific matter for the magazine and carry the burden of the editorial work and management are already enlisted. They are ready to contribute their time in committees, in research work, in preparing papers, and in attending the annual meetings of the Association.

*James Wilson*

## DARWIN, MENDEL, AND CRUIKSHANK.

The lives of the men whose pictures are given on three previous pages were contemporaneous. The middle of Darwin's life (1809 to 1882) was 1846; of Mendel's (1822 to 1884) was 1852; and of Cruikshank's (1808 to 1895) was 1852. Each man, following his own bent, wrought in a new field and each won the highest eminence as undisputed leader in his chosen work. Darwin's wonderful assembling, coordinating, and philosophical use of the biological data of his time in giving an adequate theory of the evolutionary development of living organisms, placed him at the pinnacle of fame for the century. Mendel's most brilliant stroke of genius, which led him to mathematical research concerning the unit characters of plants and animals, leading to a knowledge of the laws of segregation, of dominance, and of recombination, made him a great world benefactor. Cruikshank's achievement in showing how to use the blood of a valuable mutant, the Shorthorn sire Champion of England, was likewise the work of a genius. No other achievement in making use of the blood of a mutant has reached the proportions of the results attained by Cruikshank's cattle.

The facts wrought out, the achievements in modifying plant and animal forms, and the theories deduced by these three men form chief pillars in a structure upon which rests the modern science of heredity and breeding. The present knowledge of heredity and breeding places a different rating on the fathers of the science of breeding than did the less definite philosophy of a generation, even a decade ago. Another decade may make as great a change in this science as has the decade since Mendelism was exploited by Mendel's disciples. As in mechanics and electricity, the development of the science and use of the knowledge of heredity seems but in its beginning.

Darwin, better in position to understand the importance and bearing of Mendel's discoveries than any other savant of that time, unfortunately did not know of Mendel's work. The possession of the facts of Mendelism would have been a powerful aid to Darwin, and would probably have given certain phases of Darwin's work a different aspect.



GREGOR JOHANN MENDEL



**CHARLES ROBERT DARWIN.**

1809 - 1882.

Darwin coming of a family of scientists and naturalists, the lines of descent favored in many ways the development of the genius which he possessed. His father, Dr. Robert W. Darwin, was a physician of note and a man of unusual qualities of heart; known as a judge of men and an unerring reader of human nature, and withal of strongly scientific and philosophic trend. Darwin's mother was a woman of culture and accomplishments, the daughter of Josiah Wedgwood, the manufacturer of the well-known pottery ware of that name. The paternal grandfather, Erasmus Darwin, was a physician and scientist of note.

Darwin studied at Edinburgh University and later at Cambridge, taking his degree in 1831. The same year he joined a scientific expedition around the world on H. M. S. Beagle, returning after an absence of five years. His studies during this extended voyage furnished him with much material and really laid the foundation of his future career as a scientist. It is asserted that the study of the fauna of the Galapagos Islands suggested the ideas that led to his theory of evolution.

Simplicity and gentleness of manner, kind disposition, and personal charm were qualities which made Darwin universally esteemed. He was a man of independent means. At his country seat at Down he pursued his studies in his quiet, orderly, and systematic way. He possessed marvelous powers of observation; in his experimental work he was quick, accurate, and painstaking. He was a profound thinker. It is said of him that he wrote with difficulty, but he worked at his manuscripts with rare patience, and his writings are clear, logical, and convincing.

Darwin's book, "The Origin of Species by Means of Natural Selection, or the Preservation of Favored Races in the Struggle for Life," appeared in 1859, making an epoch in the history of science. He published considerable in various fields of natural science, but nearly all his publications were elaborations and additions to his theory of evolution.

No other man of modern times has so profoundly influenced the world of science. His followers have made many deductions

which Darwin would not make. The greatness of his mind was best shown by the sane and safe point of view to which he adhered during his last years, when biological and theological discussion aroused by his writings was intemperate and controversial to a high degree. Those of his disciples who were over-radical now appear at a disadvantage beside his calm utterances, as do also the statements of those then most radically differing with his views.

### GREGOR JOHANN MENDEL.

1822 - 1884.

Gregor Johann Mendel, the discoverer of what is now known as "Mendel's Law," and what is ranked as one of the greatest and most important discoveries in biology, was born in Silesia, Austria. His parents were farmers in fair circumstances. After having been ordained a priest in 1847, he studied the natural sciences at the University of Vienna. The love of nature which came to him through a long line of farmer ancestors asserted itself in his tastes and studies.

He found time from his duties as priest in the Cloister at Bruenn to follow his bent. Here he did much highly scientific work in breeding and hybridizing plants, using chiefly the varieties of the table pea, but including other species as *lychnis* and thistles.

It seems that the biological thought of Mendel's day did not realize the bearing and importance of his work. His writings reposed apparently forgotten in an obscure publication until 1900, when DeVries, Bateson, Tschermak, Correns, and Spillman rediscovered the facts of Mendel's Law and confirmed them, Correns at the same time discovering Mendel's manuscript.

Mendel was a man of numerous attainments. He taught at the High School at Bruenn, and at one time managed a bank. He was versed in meteorology, on which subject he wrote several papers; but on the whole he published little.

The painstaking character of the work which led to his now famous discoveries are an inspiration to students of biological processes to plan clearly and to execute faithfully all details. But his results, which, though so astounding, were so little appreciated by



AMOS CRUIKSHANK.





the biologists of his time as to receive no notice in concurrent literature, have given a new point of view and a new inspiration to biological thought and research. He has brought into the clear light the fact that unit characters are projected with mighty power through successive generations; and that the definite forces which carry these characters forward in heredity often preserve their identity when in conflict with opposing characters, retaining their unity as organic entities through a long series of generations. He showed that gametically pure heredity carriers can crowd their opposing characters out of one-fourth of the progeny, and that recombination of pure characteristics from two or more parent varieties or breeds can be effected, thus enabling the breeder to produce improved varieties and breeds in which two or more recombined characters are retained pure, and with their full power of projected efficiency in the new variety or breed.

Mendel's discoveries are leading to a clearer knowledge of heredity and breeding. The application of his principles in hybrid breeding for practical purposes has gone forward somewhat more slowly than those who have done most to bring them before the public predicted. On the other hand, the study of heredity has been accelerated beyond the dreams of those most optimistic a decade ago.

#### **AMOS CRUIKSHANK.**

1808 - 1895.

Amos Cruikshank stands out as probably our greatest example of a master breeder of animals. Personally, he was a man of sterling worth, simple in his tastes and of lofty character. He was greatly beloved by all who knew him. He came of a Quaker family and was a man of deep religious convictions.

Amos Cruikshank was born on a farm at Kinmuir, near Inverness, Scotland. In 1837, together with his brother Anthony, he leased Sittyton, a farm of about 250 acres, 12 miles from Aberdeen, and began the breeding of Shorthorn cattle. Amos had entire charge of the farm and the breeding herd. Anthony during the first period furnished the financial backing. Their holdings were eventually in-

creased until the farm comprised a thousand acres, which during the period of greatest activity carried about 300 head of cattle.

The management of this large breeding farm was of the plain and practical sort. No attempts were made at ostentation, nor was the stock pampered or artificially forced. Cruikshank was impartial to color. True, there was a predominance of red in his herd. The reason was that he endeavored to meet the demands of purchasing breeders who came from the United States and Canada. But that in his mind quality was uppermost is shown by the fact that the great bull, *Champion of England*, was a roan.

Sittyton and its master first came into prominent public notice when a bull of his breeding, *Marshal of Windsor* (then belonging to William Duthie), was chosen to head the royal herd at Windsor.

First among the forces leading to Mr. Cruikshank's success was his acquisition of an animal, *Champion of England*, the blood of which was projected with such high efficiency into his progeny, and this blood so well endured rather narrow inbreeding that it was capable of serving as the basis of a prepotent sub-breed of Shorthorn cattle of the type in demand in England, America, and other countries.

Second may be placed Mr. Cruikshank's analysis of his own work, and the judgment he adhered to, in spite of advisers to the contrary, to breed his bull's blood sufficiently narrow not to dissipate its prepotency, that he might supply that blood in relative purity in quantity to many breeders.

The blood from Mr. Cruikshank's stock, commonly called Scotch Shorthorns, may be found in nearly every herd of Shorthorns in existence. He devoted his life to the building of a strain of Shorthorn blood which practically revolutionized that breed. The progeny of *Champion of England* met the need and demand of the time for a blocky, easy feeding, early maturing, beefy type of cattle, in which milk-giving was not a prominent characteristic, and especially strong in the show-ring, at a time when outward appearance rather dominated live-stock philosophy.

## INCREASING PROTEIN AND FAT IN CORN.

LOUIE H. SMITH, *University of Illinois*

### PROGRESS OF EXPERIMENTS IN BREEDING CORN TO INFLUENCE SPECIAL CHARACTERS.

The purpose in presenting at this time a matter which may not be altogether new to most of our members is to bring before this Association the latest results of what are probably the oldest corn-breeding experiments in existence.

Some of the records now cover thirteen generations, and to those who have been watching the progress of the work, the interest naturally grows more intense as the years go by. The records become more and more valuable as they accumulate as throwing light, not alone upon those questions connected specifically with corn improvement, but also upon some of the broader general problems of heredity.

In 1896 the Illinois Experiment Station took up the proposition to influence the chemical composition of the corn kernel by selection of the seed. It will scarcely be necessary to give here more than a mere outline of the general plan of the work. The history and results of these experiments for the first ten generations are given in detail in Bulletin 128 of the Illinois Experiment Station.

The plan proposed was to breed for four different purposes, namely, (1) increase of protein; (2) decrease of protein; (3) increase of oil; (4) decrease of oil; the selection being based upon the analysis of individual ears of a single variety. The ears thus selected for the several purposes were planted together in isolated breeding plots by the well known ear-to-row method. From each of these plots selection has always been kept up in the same general manner by analysis of individual ears.

#### BREEDING TO INFLUENCE THE PROTEIN CONTENT.

An outline of the results obtained in the breeding for increase and decrease of protein content may be seen in Table 1.

Table 1 gives the average protein content of the crop produced on each plot each generation, thus giving a good general view of the progress of the work.

A glance at the figures shows that there has been great response to the selection in both directions, so that the general effect has been such that we have been able to produce, out of a single variety, two strains of corn, one of which contains more than half again as much protein as the other.

TABLE 1.—*Increase and decrease of protein.*

Year.	High protein	Low protein	Differences between crops.
	plot aver- age in crop harvested.	plot aver- age in crop harvested.	
	<i>Per cent.</i>	<i>Per cent.</i>	<i>Per cent.</i>
1896	10.92	10.02	0.00
1897	11.10	10.55	0.55
1898	11.05	10.55	0.50
1899	11.46	9.86	1.60
1900	12.32	9.34	2.98
1901	14.12	10.04	4.08
1902	12.34	8.22	4.12
1903	13.04	8.62	4.42
1904	15.03	9.27	5.76
1905	14.72	8.57	6.15
1906	14.26	8.64	5.62
1907	13.89	7.32	6.57
1908	13.94	8.96	4.98

It is important to notice in passing that there has been at times a very pronounced seasonal influence upon the protein content. For example, the high protein tendencies are brought out very distinctly in the results for the years 1901 and 1904. On the other hand, 1900 and 1907 were years favorable to low protein.

#### BREEDING TO INFLUENCE THE OIL CONTENT.

Even more striking are the results obtained in the breeding to influence the oil content as shown in the more regular and uniform response to the selection and in the greater proportionate changes produced.

Table 2 gives the record of this work. Here it is shown that the general effect has been to produce out of this same variety two other strains of corn, one of which is now practically three times as rich in oil as the other.

It is of especial interest to observe that both in the oil and in the protein breeding the limits appear to have been reached. In the case of the high protein the high percentage in the crop of 1904

has never since been attained. In the low-protein plot the minimum percentage thus far obtained was in the crop of 1907. In the high-oil strain, there was a drop in the percentage of the last year's result, but in the case of the low oil the extreme point is represented in the last year. On the whole, however, if we consider the last four or five generations, the results appear to be fluctuating around certain points, varying back and forth with the season and soil conditions.

TABLE 2.—*Increase and decrease of oil.*

Year.	High oil plot average in crop harvested.	Low oil plot average in crop harvested.	Difference between crops.
	<i>Per cent.</i>	<i>Per cent.</i>	<i>Per cent.</i>
1896	4.70	4.70	0.00
1897	4.73	4.06	0.67
1898	5.15	3.99	1.16
1899	5.64	3.82	1.82
1900	6.12	3.57	2.55
1901	6.09	3.43	2.66
1902	6.41	3.02	3.39
1903	6.50	2.97	3.53
1904	6.97	2.89	4.08
1905	7.29	2.58	4.71
1906	7.37	2.66	4.71
1907	7.43	2.59	4.84
1908	7.19	2.39	4.80

On account of these environmental influences, it cannot be decided yet whether there may not still be further advance possible in some of these directions, and there is still as much interest as ever, if not more, in the continuation of these experiments along the same lines.

#### THE QUESTION OF REVERSION.

The question that this work most frequently calls out is in regard to the permanency of these characters. Will it require constant selection to retain these qualities or will they revert to the original condition if left without special selection? Some interesting data bearing upon this point have been obtained in connection with the high-oil corn.

In 1903, after the high-oil strain had been selected for six generations and the oil content had been increased up to 6.50 per cent, two selections of ears from this plot were made for other purposes quite independent of oil content, namely, for erect ears and for

declining ears. These two new strains have been bred in separate plots since that time, with no attention whatever given to percentage of oil in the selection of seed. Incidentally we have, however, analyzed the crops harvested and the results of these analyses are given in Table 3.

TABLE 3.—*Composition of erect ear and declining ear plots.*

Year and strain	Oil.
	<i>Per cent.</i>
1896—Original corn . . . . .	4.70
1903—High oil . . . . .	6.50
1905—Erect ear . . . . .	6.90
Declining ear . . . . .	6.60
1907—Erect ear . . . . .	6.65
Declining ear . . . . .	6.23
1908—Erect ear . . . . .	6.37
Declining ear . . . . .	6.02

From these results it appears that in 1905 after two generations of non-selection there was an actual increase of oil; in 1907 after four generations the percentage was about the same as at the beginning of the new plots. In 1908 there was a decrease apparent which may quite possibly be the effect of a "low-oil season."

On the whole, we may say that after five generations of non-selection, there is certainly no great decrease of oil content, but in view of the fluctuations due to environment, it is too early to draw final conclusions in regard to this point.

A theoretical discussion of great interest is involved in these data, but it is the present purpose simply to put on record here these facts as they have been found, hoping to have the opportunity at some later date to present for more thorough discussion this phase of the experiments.

#### EFFECT OF SELECTION UPON PHYSICAL CHARACTERS OF THE PLANT.

Some other interesting examples of what may be accomplished by continuous selection for special purposes are furnished by some experiments designed to influence certain physical characters of the plant, namely, the height of the ear on the stalk and the position of the ear at maturity, with reference to the angle at which it hangs.

## SELECTION TO INFLUENCE HEIGHT OF EAR.

Seven years ago two lots of ears were selected from an ordinary corn field, one of these lots representing ears growing high on the stalk and the other those borne low down on the stalk. These two sets of ears were planted in separate breeding plots, and selection for high ears and for low ears from the respective plots has been made each year since.

The general results of this work are shown in Table 4.

TABLE 4.—*Breeding for high ears and low ears.*

[Average height in inches.]

Year.	High ear plot.	Low ear plot.	Difference.
1903	56.4	42.8	13.6
1904	50.3	38.3	12.0
1905	63.3	41.6	21.7
1906	56.6	25.5	31.1
1907	72.4	33.2	39.2
1908	57.3	23.1	34.2
1909	61.3	25.3	39.0

Here again as in the case of the selection for composition of grain, there has been a gradual response so that by breeding this variety in opposite directions two strains of corn have been produced in one of which the ears are now borne about three feet higher on the stalk than in the other strain.

Incidentally it is of interest to notice in this connection the correlation existing between the height of ear and the total length of plants, the total number of internodes, and the average length of internodes. Selection for high ears has produced a taller, later maturing plant than that resulting from low-ear selection; and interesting enough from the practical standpoint, the yields from these two strains are thus far about equal.

## SELECTION TO INFLUENCE DECLINATION OF EAR.

Another character that has likewise responded in a striking manner to seed selection is the declination of the ear at the time of maturity. The details of the plans and the early results of this work, together with those of the preceding experiments will be found in Bulletin 132 of the Illinois Agricultural Experiment Station.

The results now cover six generations, and they appear in outline in Table 5.

TABLE 5.—*Breeding for erect ears and declining ears.*

[Average angle of declination from stalk.]

Year.	Erect ear plot.	Declining ear plot.	Difference.
	<i>Degrees.</i>	<i>Degrees.</i>	<i>Degrees.</i>
1904	42.0	45.0	3.0
1905	62.2	117.1	54.9
1906	49.5	76.2	26.7
1907	42.3	81.6	39.3
1908	46.0	88.5	42.5
1909	31.2	110.7	79.5

We observe from these results that, with the exception of 1905, which appears in this respect to be an abnormal season, there has been a steady progressive response to the selection, until finally after six generations the average difference in the angle amounts to almost 80 degrees.

#### CONCLUSION.

Aside from their practical significance, there is a peculiar interest attached to these results as representing in every instance what has been accomplished by the method of breeding, sometimes designated as "continuous selection," a method in which some investigators would appear to have little faith. It should of course be recognized in this connection that we are dealing here with an open-fertilized plant. It would be interesting to have on actual record the results of parallel experiments with some self-fertilized plant such as wheat.

[Professor Smith's article splendidly represents those well-conceived experiments in heredity and breeding which are placing these subjects on a scientific basis and are showing that large economic results may be secured. Though this particular experiment was not begun with such a thought in mind, it may be that strains of corn thus made highly efficient and pure-bred in specific lines may be found useful as the basis of hybrid breeding. In other words, the characters thus highly intensified and made pure-bred may be recombined in first-year hybrids, or in fixed hybrids, which have the desired very large value per acre. This also is an illustration of the



fact that scientific work which is prosecuted primarily for science's sake often leads to economic results of large value. Here not only is the scientific proof secured that profound changes in the heredity of corn may be made, but that varieties which were not bred for all round per acre value may prove useful as the constituent units of new varieties. Corn breeding under the ear-to-row centgener plan was begun by the Minnesota Experiment Station in the early nineties; and the resulting now widely used "Minn. No. 13" Corn was widely distributed in the late nineties.—W. M. H.]

### NEW METHODS OF PLANT BREEDING.

GEORGE W. OLIVER, *U. S. Dept. of Agriculture, Washington, D. C.*

During the past few years the writer has spent considerable time in crossing certain vegetables and field crops, including some composites and legumes whose flowers, owing to their small size and very minute sexual organs, have been considered very difficult or impossible to manipulate in order to make desired crosses. Among the number of plants dealt with were the lettuce and alfalfa, and an account of how to prepare their flowers will be sufficient to give the beginner a few hints as to the best way to proceed to cross flowers having minute sexual organs and arranged in such a manner as to preclude the use of ordinary methods.

#### CROSSING DISTINCT VARIETIES OF LETTUCE.

In crossing two lettuce plants belonging to different varieties the work is rendered easy of accomplishment if the seed of both parents is sown early in the spring so that the plants will bloom in moderately warm weather and preferably indoors. In the cold months flowers are not easily produced indoors, and this is especially true of the heading varieties. Lettuce plants usually begin blooming only one flower the first day, the number increasing gradually; therefore the seed of the proposed pollen-bearing parent may be sown in the greenhouse and the seedlings planted a week or two in advance of

those of the proposed seed bearer, so that abundance of pollen will be available when the first flowers of the female parent open.

The early maturing flowers should be used in crossing as they usually are the strongest and it is natural to suppose that the resulting seed will be well developed.

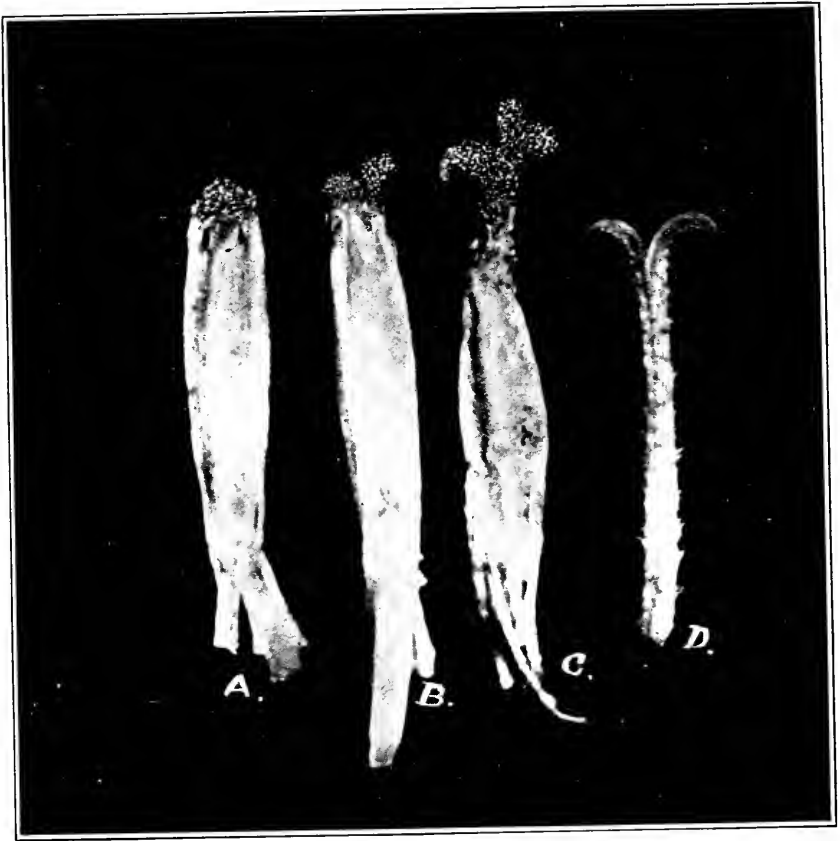

FIG. 1.—STAMINAL TUBES AND STIGMAS OF LETTUCE FLORETS (greatly enlarged).

A. Staminal tube from which the pollen is being pushed out by the pistil. B. C. More advanced stages. D. Stigma cleared of pollen by water.

The ligules of the lettuce flower head begin to expand early in the morning but the pistils do not mature until after the ligules are fully expanded, say, from 8 to 10 A. M., according to whether the weather be warm or cold.

The lettuce flowers are self-pollinating, and the pollen being slightly adhesive it is not carried from flower to flower by atmospheric disturbance. Insects are but seldom observed on the open flowers, nectar is probably absent and the flavor of the pollen grains is distasteful to pollen-eating insects. There is little doubt that the pollen from one head of florets seldom reaches that of another through the agencies of wind or insect interference.

The lettuce flower heads do not have both ray and disk florets like most other genera of the composite family such as the chrysanthemum, dahlia, and helianthus. All of the florets in each flower head of the lettuce are alike. Each one consists of a single ligule or strap-shaped corolla, stamens and pistil. In the other genera mentioned the outer or ray florets have each a single ligule either broad or narrow, some of the species have neither stamens nor pistils in the ligules or ray florets, others have the pistils developed. The disk florets in the central part of the flower head have both pistils and stamens present and the corolla of each one is regular. (Fig. 2, B, C, D.)

With a low-power magnifying glass examine the flowers of the lettuce as soon as the ligules are developed and note the development of the pistils. As soon as the two lobed stigmas are expanded each one will be found to be covered with the pollen from the stamens of its own floret. It is now too late to think of emasculation, and even during the earlier stages emasculation is out of the question because of the minute size and position of the stamens. Before the top of the pistil is exposed to view the anthers have already dehisced and the lengthening pistil aided by the minute hairs along the style force the pollen out of the top of the tube formed by the union of the anthers. (Fig. 1, A, B, C.) During the period before the lengthening of the ligule and before the stamens dehisce the small size and peculiar arrangement of the stamens will not permit of emasculation without injury to the pistil.

When the pistil is fully developed the pollen grains resting along the stigmatic surface (Fig. 1, A, B, C) have not yet sent their tiny tubes into the tissue of the stigma, therefore the removal of the pollen before this takes place, which we may call depollination, effectively takes the place of emasculation.

To depollinate the flower thoroughly so that every grain of pollen may be removed not only from the stigmas but also from the ligules

and to become thoroughly familiar with the details of the operation. remove a fully developed head from a plant, take the pedicel of the flower between the thumb and forefinger of one hand with the ends of these two fingers close up to the ligules; then train a tiny jet of water from a chip blower (Fig. 5, A, B) on to the stigmas perpendicularly

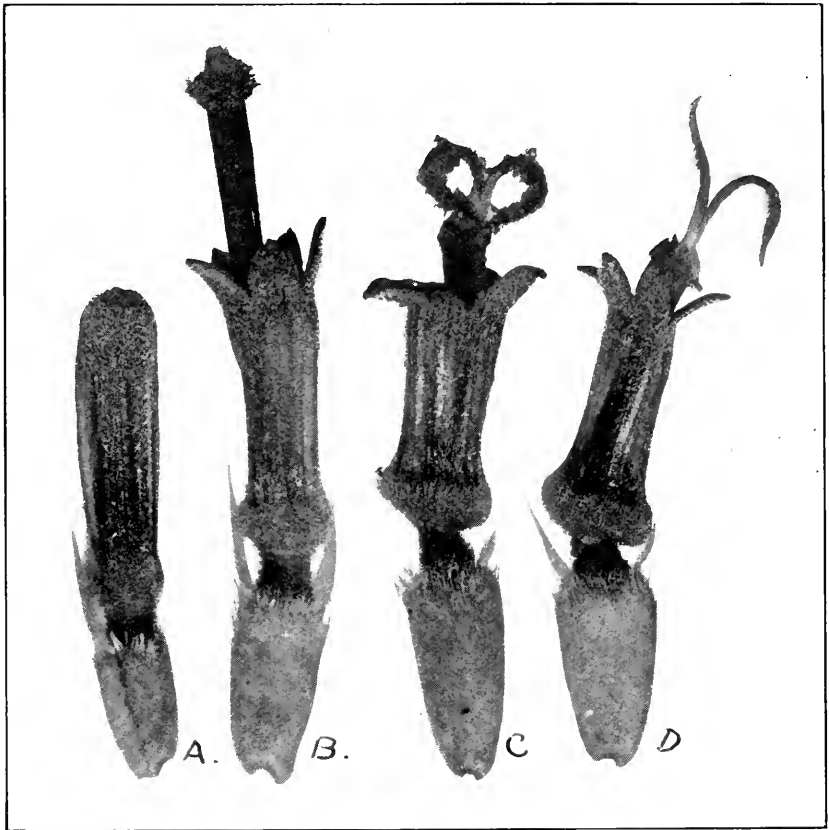

FIG. 2.—DISK FLORETS OF *HELIANTHUS* (enlarged five diameters).

- A. The bud stage. B. Pollen is being pushed out of the staminal tube by the pistil.  
 C. The stigma is covered with pollen. D. Depollinated stigma.

for a few seconds to remove the pollen grains. With a small piece of blotting paper applied edgewise to the various parts of the flower head enough of the water covering the floral parts will be removed.

The flower head should now be examined through a hand lens to ascertain if the time allowed for the jet of water to play on the stigmas was sufficient for depollination; this will give a pretty exact idea of the time required for depollination. At the same time if the jet of water was not too strong it will be seen that the pistils have been left absolutely uninjured. (Fig. 1, D.)

In order to acquire practice in the simple act of pollinating the stigmas after they have been successfully depollinated, lay the depollinated flower to one side, then pick a flower from the proposed male parent, examine with a lens and if the stigmas are covered with pollen apply them with a slight circular motion to those of the flower which has been depollinated, then examine the pollinated flower with the lens. If the pollen was plentiful on the stigmas of the proposed male, every stigma of the proposed seed bearer will have several grains on its surface.

The method described above has been successfully applied to the flowers of several genera of the compositæ and when it is possible for two plants to intercross, the merely mechanical part of the work is by its use made extremely simple. Flowers of many plants of the other orders have also been successfully dealt with by modifying the method according to the structure of the flowers.

#### CROSSING ALFALFA.

It is perhaps in the crossing of a few of the desirable forms of *Medicago sativa* with the species of alfalfa recently introduced from Siberia that this method will be instrumental in securing the desired strains possessing hardiness for those large areas having very severe winters with but little snow protection. The methods hitherto used in crossing this tiny flower have not produced satisfactory results. They have been of a slipshod nature, such as inserting a pointed piece of wood, on which grains of pollen have been dusted, into the suture formed by the outer edges of the keel and pressing against the sexual column until it trips, the idea being that when the sexual column is sprung the stigma will press against the pollen grains and imbed some of them in the soft surface of the stigma. The flower buds are sometimes emasculated at a very early stage; this is necessary because the anthers dehisce while enclosed in the unopened bud (Fig. 4, A, B), but the pollen remains inoperative while the sexual column

remains unprung. Emasculation in the bud stage, however, is almost certain to injure the pistil sufficiently to insure its collapse.

Since the discovery of the method described below there is no necessity for failure in crossing alfalfa flowers if the details are faithfully carried out.

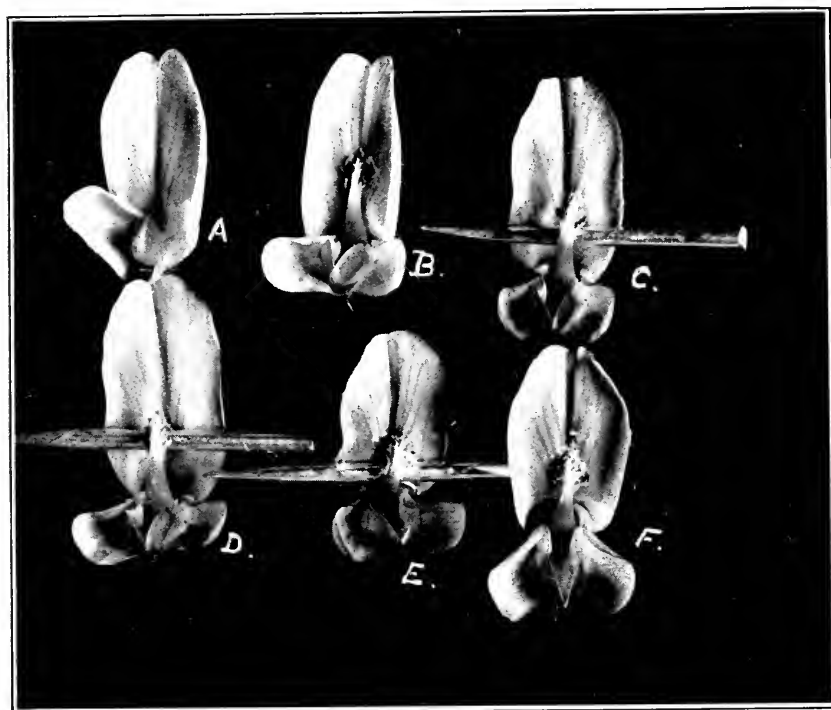

FIG. 3.—FLOWERS OF ALFALFA, SHOWING METHOD OF DEPOLLENATION AND CROSSING.

- A. Untripped flower of alfalfa. B. Tripped flower. C. Sexual column tripped on piece of pin. D. Stigma depollinated by water. E. Stigma pollinated while sexual column is resting on pin. F. Pin withdrawn, allowing pollinated stigma to press against banner.

The beginner should examine the treated flowers with a hand lens at first to ascertain for future guidance just how much of the treatment is necessary in depollinating.

It is desirable to work with strong plants in pots in the greenhouse and if all the species and varieties necessary can be grown to flower early in the season then protection from insects is unnecessary. Select

strong racemes of flowers, cut off all the old flowers and buds, having three or four open flowers just below the largest buds, as these open flowers are more likely to respond to artificial pollination than unopened flowers and those at the lower part of the raceme.



FIG. 4.—SEXUAL COLUMNS OF ALFALFA FLOWERS IN DIFFERENT STAGES.

A, B, Sexual columns from flower buds before the stamens have dehisced. C, D, Sexual columns from flower buds, with stamens dehisced. E, F, Sexual columns from which the pollen has been removed by water.

The necessary tools are as follows: two pairs of scissors, those shown in Fig. 6, A, are most convenient for removing the banners of flowers when securing pollen; those shown in Fig. 6, D, are used in removing flowers and buds not wanted on the raceme used as the seed bearer.

The self-closing forceps (Fig. 6, B) are very useful in holding the sexual column of the male in pollinating. The forceps shown in Fig. 6, C, are necessary in tripping the flower of the male when the pollen is applied direct from the sexual column. The chip blowers and other devices seen in Fig. 5, A and B, are used in applying water in depollination. Some small pins cut in half, a few pieces of blotting paper, watch glass, and camel's hair brushes complete the outfit.

In beginning the work of cross pollinating alfalfa by the method here described, one must bear in mind that no part of the flower of the seed bearer is to be mutilated. It should therefore be understood that in the open flowers while the sexual column is still unsprung from its place within the keel (see Fig. 3, A), the anthers have dehisced and the pollen is packed in masses around the stigma (Fig. 4, C and D)

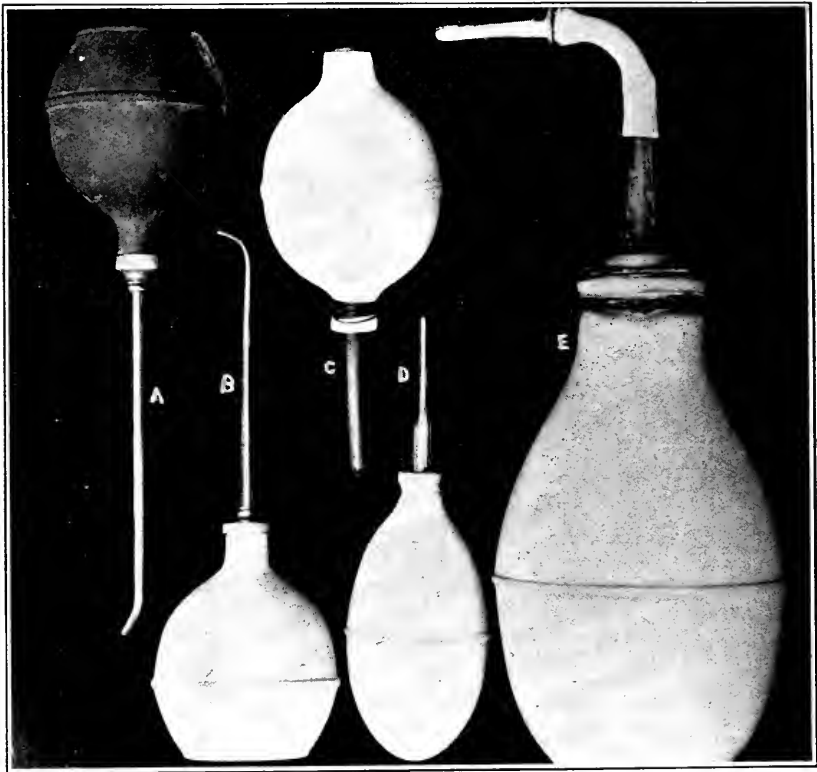

FIG. 5.—DEVICES USED IN DEPOLLINATING FLOWERS.

but seldom touching it, but even while the pollen touches the stigma while the sexual column is unsprung it is incompetent to perform the processes of pollination and fertilization, because in order to perform these missions the pollen must first be imbedded in the pulpy tissue of the stigma. Therefore the operator must strive to remove the pollen from and around the exploded anthers, and in some cases, from



and around and over the stigma without injuring any part of the pistil. This seems impossible, but by a little delicate yet withal easy manipulation every grain of pollen can be removed without injuring any part of the delicate organisms of the flower in the very least.

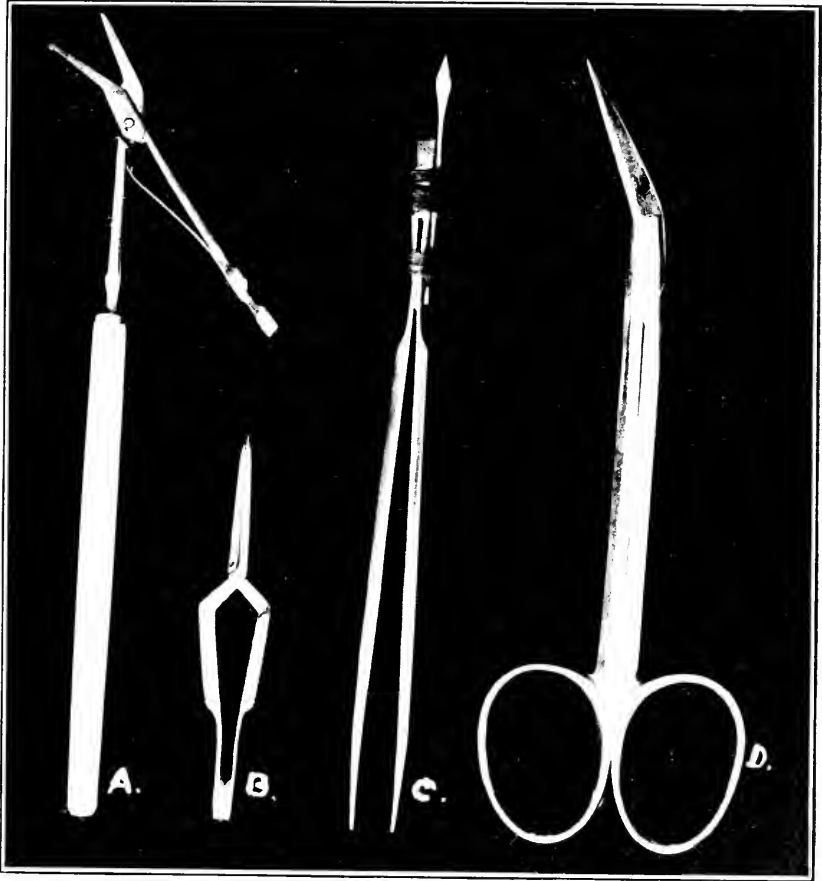

FIG. 6.—TOOLS USED IN CROSSING FLOWERS.

The first part of the operation consists in springing or tripping the sexual column, but instead of allowing it to trip on the banner, as shown in Fig. 3, B, allow it to trip very gradually on the pointed half of an ordinary small pin (Fig. 3, C) half an inch or more in length. The tripping can be accomplished very readily by placing

the piece of pin at the base of keel immediately opposite the base of the banner. Be certain that in placing the pin the blunt end is held by the fingers as this will facilitate withdrawal after pollination. Press the piece of pin against the suture of the keel, drawing it gently upward until the sexual column appears, it is thus intercepted in its ascent on the awaiting banner. Gradually allow the pin supporting the sexual column to come toward the banner and ultimately to rest upon it. (Fig. 3, C.) It will then be seen that the end of the column consisting of anther cases, pollen, and stigma is entirely free from contact with the banner. This provides the opportunity for depollination, which is accomplished with the aid of a tiny jet of water playing on and around the stigma for a few seconds. Every grain of pollen may be washed from and around the stigma in eight or ten seconds. (Fig. 4, E, F, and Fig. 3, D.) After this operation the moisture around the stigma is removed with a small piece of blotting paper applied edgewise.

While the sexual column is still resting on the pin supported in this position by the banner, the stigma must be pollinated (Fig. 3, E). If the pollen is not very plentiful it may be applied to the stigma with the aid of the flattened pin shown in Fig. 6, C, but if there is an abundance of pollen the sexual columns of the flowers of the male parent should be tripped into a watch glass and the pollen applied copiously to the stigma with the aid of a camel's hair brush moistened in a weak syrup of sugar and water, just thick enough to cause the hairs to stick together when drawn between the thumb and forefinger. When pollinated the flower is held gently but firmly between the thumb and forefinger and the pin withdrawn allowing the sexual column with the pollinated stigma to assume its natural position on the banner. (Fig. 3, F.) This action will cause the pollen grains to become imbedded in the soft tissue of the stigma.

## THE ARMY HORSE.

CARLOS GUERRERO.

*[Published also by the Agricultural Association (Liga Agraria) of Buenos Aires.]*

Through the courtesy of the Minister of Agriculture of Germany, I was enabled to make an advantageous visit to the Imperial Stud-farm of Trakehnen, where I was cordially received by Baron

von Oettingen, the head manager, and his distinguished wife. The Baron himself accompanied me on my visit to the different premises of the stud-farm.

Trakehnen is situated in the northern part of the German Empire, near Russia, where the winters are cold and severe. On my way thither, the fields I could see from the car window were barren and sandy, but, nevertheless, one admires the constant efforts of man in laboring to make them productive. The Trakehnen stud-farm is, of itself, a village of considerable size, having a hotel for visitors, six schools, a pharmacy, an infirmary, and well built houses occupied by the employees of the stud-farm and their families. Commodious stables have been erected.

The Trakehnen stud-farm, which comprises a tract of land of about 10,855 acres, was founded in 1732. In winter this area is covered with snow. About half of it is used for the cultivation of hay-producing grasses, including alfalfa, which, notwithstanding the cold, grows luxuriantly. The other half of the property contains the buildings, and fields in which to pasture the horses in summer during the day, although at night they are always housed in stables, where they are fed alfalfa and oats. The farm is divided into twelve lots.

Under the management of Baron von Oettingen, are the following employees: A head veterinarian, with 2 assistants; a director of cultivation, with 4 inspectors; a cashier; a secretary; 3 clerks; a store superintendent; an architect; a physician, with a nurse and an apothecary; 11 school teachers; 11 overseers, with 12 assistants; 100 stable grooms, with 50 boy groom apprentices; 30 workmen; 15 store workmen; 3 wood choppers; 12 laborers; 55 plowmen; 12 night watchmen; from 15 to 70 day laborers; and 477 persons engaged in gardening and other occupations. These employees, together with their families, make a population of 2,600 souls. All live comfortably, each group of houses having its private orchard for the cultivation of fruits and vegetables for the use of the employees.

The duty of this large force is to care for 1,747 head of horses—the total number now at the Trakehnen stud-farm—and the oxen required for the work connected therewith. One can easily imagine the great cost to Germany of each horse raised on this stud-farm.

The aim of this large station is the improvement and breeding of military horses, and to supply horses for the Imperial House.

From Trakehnen, also, are chosen annually 70 stallions without defects, for service at the different breeding stations of Germany. If the commission which inspects the stallions finds defective ones, these are castrated, and in April and September of each year, are sold on the premises at Trakehnen for sums varying from 1,000 to 4,000 marks (\$250 to \$1,000). The mares are treated in the same manner as the horses.

The Trakehnen stud-farm has 21 stallions, 13 of which are thoroughbred, 1 an Anglo-Arab, and 7 half bloods born in Trakehnen, but the latter, after undergoing continual cross-breeding with thoroughbreds, may be practically considered pure race horses.

The best thoroughbred stallion is "Red Prince," 20 years old, of a chestnut color, and born in Ireland. The thoroughbred stallion "Shilfa" has recently been purchased. Among the other race horses, I saw the stallion "Americus," a bay horse born in the United States, in 1892, and sired by the Emperor of Norfolk; "Aghan," a chestnut-colored horse, born in France in 1892, and sired by Flying Fox; "Pomp," born in Graditz in 1897, and sired by Chamont; and "Gordon," a bay horse, born in Russia in 1901, and sired by Gayarre.

Of the half bloods, the preference is given to the beautiful chestnut-colored stallion "Morgenstrahl," born in Trakehnen in 1896, and sired by Bue Bood, the favorite horse of the Kaiser, who always inquires concerning it. Another good horse is "Polarsbrum," of a black color, born in Trakehnen in 1900 and gotten by Optimus. I saw only one Anglo-Arab stallion, named "Nana Sakit," born in France from Rosteted and Mamir, the latter sired by Alger. The colts gotten by "Nana Sakit" are the handsomest on the stud-farm.

The brood mares are distributed into five lots of from 60 to 90 each. The group I liked best consisted of bay mares, and after that the chestnut-colored mares, some of which are very beautiful. There is a collection of black mares from which the horses for the carriage of the Kaiser are taken, but this group is not so good, as it is extremely difficult to find a thoroughbred black stallion without white marks.

When a year old the colts are separated from the mares, and treated like the rest of the horses, grazing in the pastures in summer during the day, and housed at night in the stables where they are given alfalfa and six pounds of oats.

Each lot of three stallions has its attractive pavilion, separated by paddocks in such a way that they can see each other without fighting.

The horses raised at Trakehnen are of the type of the early hunter. They are large horses with good-sized bones and strong muscles, capable of carrying considerable weight, and are handsome, impetuous, fast runners, and excellent for the steeple chase. They make a nice display in official parades, but are delicate and require much attention.

These horses, methodically fed on selected grains and grasses, brought up under shelter with great care, reared on soil prepared with loose sand so as to be soft to the tread, and unaccustomed to being galloped over bad roads, are these the horses required to withstand the hardships of a cruel war? The nation never knows where its military horses will be sent, whether over the well-kept roads of Europe, the rough steppes of Russia, the hot, dry and sandy deserts of Africa, into marshes or over rocky mountains, and perhaps to places where they will suffer thirst, be compelled to search for their own food, to obtain sustenance and strength from coarse and slightly nutritious grasses, and be compelled to endure all kinds of weather.

In Europe the test of the endurance of horses is made on good roads, and at the relay stations grooms are in waiting to refresh and feed them. They are never taken over rough or hard roads, nor are they permitted to suffer privations. Military horses should be prepared for war, brought up accustomed to hardships, and of sufficient resisting force to stand long journeys.

With the exception of Russia, Hungary, and European Turkey, none of the countries of Europe, I think, can produce genuine military horses, and should, therefore, have breeding stations in North or South America, Asia, South Africa, or Australia, where horses of the kind required may be raised at a low cost. Countries like the United States, South Africa, Argentina, and Canada, that could raise an ideal type of military horses, having in view a quick transformation and despising the herds of horses already acclimatized, have spoiled them with heterogeneous crosses. The United States, for instance, is losing its good American Morgan breed, and the Government has done nothing to improve the bronco pony. The countries just mentioned have attempted to evolve military horses by means of race horses—a breed that is degenerating, because such horses are run too young,

before the skeleton has solidified; because, for gambling purposes, great velocity for short distances is the great object sought; and because they are pampered, ignoring the fact that military horses can not be treated in this way. The only thoroughbreds that might sometimes be useful in improving our light-weight horses are those with good lungs, strong, able to endure long journeys, and solidly built like "Red Prince," for instance, but such horses are scarce.

At Bloemfontein last June, the Governor of the Colony sent a number of well known experts to buy fine horses to the amount of £10,000, which parliament had provided for that purpose. Mr. Morgan, one of the experts for the purchase of the horses, bought 12 stallions and 6 mares, which he has already sent to Durban. Eight of the stallions are thoroughbreds, and four are coach horses, one of which is from Oldenburg, Germany. How soon the Boers have forgotten the good services their hardy basuto ponies rendered during the last war! The Japanese Government is also buying horses in England and paying very high prices for them.

In Argentina, with few exceptions, we have neglected the Argentine creole, or native horse—an excellent basis on which to found the military horse, and out of which, with but little trouble, a useful horse could have been developed, suitable for travel through marshes and over rough roads, having good health, hardihood, and endurance, acquired by several centuries of exposure to inclement weather. Nearly all these qualities have been lost, owing to the influence of sport, and the desire to secure beauty of form and action. The best mares from Montes Grandes were converted into oil in the factories, and the remainder of the Argentine herds have acquired many of the faults of the European breeds. A proof of the faults of European horses is shown at Trakehnen, where, in spite of the yearly selection of horses and mares, hereditary defects resulting from artificial breeding can not be eliminated.

When this happens in Germany, where so much care is taken, what will be the result in other countries where less attention is given to breeding, and where so many defective stallions have been imported for profit and commercial purposes only, the Government having had no control nor taken any steps to avoid the reproduction of these defects?

The Minister of Agriculture of Argentina should look after this branch of natural wealth, and endeavor to improve what is left of the

creole or native breed, doing all in his power to revive and preserve the good qualities of these excellent horses, so necessary for the defense of the country in time of war. As a matter of patriotism, the ranchmen of the Republic ought to cooperate to this end, never using stallions that have not been examined and certified to by a veterinarian as being in proper condition. Expert zoologists should also be consulted as to the formation of the breeds, such experts to be provided by the Government to horse-breeders who require their services.

The Barbary tribes, known from time immemorial as thieves and adventurers, and whose existence depends on their excellent horses, have maintained a pure breed, free from admixtures of foreign blood. Turkey, which has but slightly mixed its horses with those of other nations, has at its command fine military horses, like those of the Barbary tribes, who have European cavalry and horses for the artillery stationed in the province of Vilayet.

The artificial European horse is the product of an advanced civilization, unsuited to the hardships and cruelties of war, and the savagery and barbarity of warlike peoples, but war requires a horse that appears to be rough and savage like war itself.

In our country (Argentina) are encountered the most expert horsemen in the world, the best fields, excellent stud-farms on which to breed the most desirable military horses, as efficient in charges of cavalry as they are in cutting off the retreat of an enemy. Moreover, we have a fine military school, and all these elements contribute to the gaining of the victory.

If the earlier ranchmen of our country neglected the improvement of the native stud-farms, it was because of former continual civil wars and the disturbed condition of the country in epochs that have happily passed forever; but the Government as well as the revolutionists had at their disposal the best of horses. In the revolution of 1874, from the ranch called "Laguna de Juancho," which was then under my charge, the revolutionists took 1500 horses of the noted breed known as "Los Montes Grandes," the property of my father. The stud-farm of "Los Montes Grandes," which embraced the district of Twyu and part of that of Ajó, owing to the excellent quality of its fields and the shelter of its woods, without doubt contained the best native horses in America, stout, well proportioned, and spirited.

In 1873 I began on the "Laguna de Juancho" ranch, to improve the creole or native horses by selecting the best mares from a herd of 12,000 belonging to that ranch, but owing to circumstances beyond my control—I being at the time in Europe—all of the horses were sold, and the result of twelve years of improvement was lost thereby, a fact which I very much deplore. At the same time, on another ranch belonging to my father, I made, like many stockmen of that day; many errors in the breeding of horses, by interbreeding with Clydesdales and crossing the native mares with race horses; but I learned, in time, that for saddle and carriage horses I ought to avoid crossing with heavy draft animals.

#### MAKING AN ARGENTINA MORGAN BREED.

I separated the mares that had only been crossed with race horses, quadrons, half bloods, and some native mares, and crossed them—about 25 years ago—with a Morgan and Arab stallion, obtained from Mr. Vincente L. Casares, called Huilibi, and whose sire was pure Morgan and was called "Lion," imported from the United States, and whose dam was the half-blood hunter mare "Victoria," sired by a beautiful Arab stallion from the Chiarini circus. Upon this basis I continued crossing in and in, obtaining uniformity in breeds and an excellent horse for service. It may be said that I have formed a new breed of horses in the country, different from other saddle and carriage horses, and of a type and condition similar to the Morgan.

Acknowledgment must be made to Mr. Casares, who by importing a Morgan stallion, rendered a great service to his country, inasmuch as "Lion" was the stallion used in founding the best breed of horses for general use.

The native or creole horses of America were not the originators of a pure type of Arab or Barbary horses, like those possessed by the Moors. These came, undoubtedly, from the Spanish horse, which had already commenced the crossing process at the time of the discovery of America. The Spaniards of that age, after the expulsion of the Moors, endeavored to destroy all signs of Mussulman dominion. Because of the weighty armor of horse and rider, heavier and broader horses were required, and a cross was made with the German horse. If anything is still left of the Moorish horse in Europe, it may be found in Portugal, especially on the royal stud-farms of the House of Braganza.



The history of the crossing of the Spanish horse and its change of race, may be studied in the Museum of Paintings at Madrid, from the fifteenth to the eighteenth centuries, on the pictures of Beruete, Rizzi, Bartolomé, Gonzalez, Paret, and Goya.

I have observed that the equestrian pictures painted by Bartolomé Gonzalez, such as the horse of Isabel of Bourbon, that of Margaret of Austria, compared with the vicious-faced, chestnut-colored horse, with four white legs, of Prince Baltazar, and that of the Count and Duke of Olivares, and other horses painted by Velasquez, resemble each other greatly, inasmuch as they have long manes, are corpulent, have broad breasts and rumps, large heads, bright eyes, short and strong necks, and short fore and hind legs. These horses, especially the chestnut-blossom horse of Isabel of Bourbon, with its noble mien, makes me think of the type of horse of "Montes Grandes."

Horses on later paintings, that is to say, the horse of the royal consorts of Paret, like the horse of Francisco de Palafox and Soler, Duke of Zaragoza, that of Charles IV, and other paintings by Goya, are horses with oval sheep-shaped heads represented by two painters, and proof that at the end of the eighteenth century, the type of the Andalusian horse was of the Germanic race, all of which is well established. I presume that the Emperor, Charles V, of Germany, and Charles I of Spain, and the Emperors of the House of Austria who succeeded him, influenced the change of race of the Spanish horse. It is a human weakness never to be satisfied with the good that one has.

For some years I have had on one of my ranches a herd of thoroughbred mares, running with a stallion of pure blood in complete liberty, and in good pasturage throughout the entire year, for the purpose of determining the result of their progeny begotten under natural conditions, without other feed than the grass they are able to obtain in the inclosure.

The virgin fields of Argentina have been plowed by our native horses which opened the furrows for the production of our wonderful riches of cereal wealth. With solely these rough and strong native horses have the fields, scant in nutritious grasses, been transformed into meadows of alfalfa and pastures of succulent and tender graminaceous plants, suitable for feed for all kinds of stock, and capable of fattening it to such an extraordinary degree as to preclude the fear of competition from any part of the world.

The Indian chiefs commanding the troops that invaded Buenos Aires had excellent native horses for use in their murderous incursions and continual wars of plunder and rapine waged against the Christians. Sometimes, during these invasions, the officers who guarded the frontiers were accustomed to report to the Government that, owing to the superiority of the Indian mounts, they could not overtake the Indian bands and wrest from them the fruits of their raids. These savages, whose principal element of strength consisted in their steeds, had excellent horses at their command, since, with their habitual savagery, they inured their horses to numerous tests of brutal resistance. The Indians, in determining whether the horses which they stole from the Christians were good or not, used to race them over rough and marshy fields, urging them on by pricking them with the lance and shouting at the top of their voices. The horses that showed sufficient spirit and resistance in this barbarous test were retained captive, the weak and spiritless ones being set free or despatched with the lance.

How different are the delicate and humane tests of resistance now employed by civilized nations in time of peace for selecting the best military horses, in comparison with the test just described, not taking into consideration the cruelty of actual war. If the different methods are compared—those of civilization with those of the barbarous Indians—some deductions unfavorable to the former may be drawn when it is remembered that the soldier and his horse, in time of war, form together an instrument of destruction and death.

The Ohio Corn Breeders Association is rapidly organizing branch associations in every county in that State. If in ten years this association can prove that under the leadership of Messrs. Williams and Goddard they shall have increased the production of corn from five to ten bushels per acre throughout the entire State, all States and counties in the Union will want to follow their methods. These two men mentioned have followed up the courage of their convictions in a masterful way. Corn, the great national crop, has as much right to be the subject of brilliant achievements as politics or war.

## IMPERFECTION OF DOMINANCE.

C. B. DAVENPORT, *Cold Spring Harbor, N. Y.*

The opposition to mendelian principles of heredity is gradually vanishing in the face of facts. The principle of *segregation of characters*, according to which dissimilar parental characters do not blend in the progeny but come out intact as in the grandparents, is recognized as widespread if not universal. But concerning *dominance* there still remains much skepticism without and much confusion within the fold.

What is dominance? Bateson, in his first statements of Mendel's doctrine (in 1902), says (page 9): "In the case of each pair of characters there is thus one which in the first cross prevails to the exclusion of the other. This prevailing character Mendel calls the *dominant* character." We have progressed far in the last seven years and now we think of dominance as occurring when one parent has a characteristic that the other lacks. Under these circumstances the offspring possess the character—that is the whole story and it seems simple enough.

Two complications must, however, be considered. It appears that in certain characters which show a great variety of *grades*, as pigment does in human hair, the more advanced grade, e. g. the heavier pigmentation, dominates over the lesser grade. This would seem to indicate either that a low grade of a character may act toward a high grade as absence towards presence, or else that hair, despite its apparent continuity, really consists of a multitude of discontinuous units; and that a lower grade means absence of a unit present in a higher grade.

The second complication is the fact of imperfect dominance. Even Mendel recognized that dominance is not always perfect in sweetpeas, for the hybrids between white-flowered and purple-red-flowered peas have flowers less intensely colored than the darker parent. Correns, in 1900, showed that in a certain set of crosses between good species the hybrids had the characters as in both parents, only reduced in varying degrees. Bateson and Saunders, in 1902, found that the "intensity of the dominant character (comb and extra toe) is often considerably reduced." Correns, in 1905, stated that there was known a complete series of cases at one extreme of which one "allelomorph" completely hindered the appearance of the other, while at the opposite

end of the series the hybrid character showed an intermediate condition, both "allelomorphs" appearing with equal strength. In my study of poultry such a series is striking. When the median comb is mated with no-median the median comb appears in the offspring but reduced in length between 30 and 100 per cent. Extra toe mated with normal gives extra toe in only 73 per cent. of the offspring. Syndactylism is dominant over its absence, but no syndactyl offspring were observed in the first hybrid generation; nevertheless two syndactyl parents yield about 56 per cent syndactyl offspring. Rumplessness is dominant. But a tailless cock mated to tailed hens produced no rumpless offspring; neither when mated to his daughters did any tailless appear, but the reduced "pope's nose" and shortened back showed that there was an imperfect modification. However, another strain has given results more in accord with expectation. Finally, winglessness appears not to be inherited at all, but the hypothesis is tenable that winglessness is an imperfectly dominant character. Thus the series of potency in dominance is complete.

The failure fully to recognize and accept the consequences of imperfection of dominance has led to misunderstandings and to unnecessary subsidiary hypotheses. The Mendelians, knowing the fact of imperfect dominance, have placed too much stress on dominance and recessiveness, and so laid themselves open to just criticism by their opponents. Dominance is a corollary of segregation and its discovery marks a great step in advance, but its variation in degree must be constantly recognized and insisted upon. The consequences are most important. First, because of imperfect dominance, and the accompanying diluted nature of the determiner in the heterozygotes, the character may appear in reduced amount and permit a hypostatic quality to appear. Thus poultry with deep black plumage mated with albinos show in part the Jungle fowl plumage in the offspring that is covered over by the black pigment in the dark parent. Thus a new character is revealed by the heterozygote.

Secondly, the weakened character may be retarded in development so that it fails to appear at the normal period but develops later. Thus Lang found hybrids between red and non-red snails to be at first non-red but finally red. Some authors have spoken of this as *reversal of dominance*, and even Bateson uses this terminology in his latest book. But this is obviously an unfortunate term if dominance means the presence of a quality. For, a given quality, that is due

to the absence of a factor, like blue iris color, cannot be at one time recessive and at another dominant. If a blue iris appears where brown is expected, the clear reason is that brown pigment has merely failed to develop and is potentially present. A similar case occurs in hybrids between albino and some buff birds; the chicks have a pure white down, only later acquiring the black and buff of the adult plumage. Albinism is here not momentarily dominant, but merely pigmentation, owing to the weakened stimulus to its production in the heterozygote, is delayed in development.

Not in heterozygotes only but even in homozygotes the character may fail to develop. Extra toe is dominant in certain fowls. Even in pure-bred fowls that are certainly homozygous dominants, two or three per cent of the offspring may fail to develop the extra toe. Evidently, for some reason, the proper internal stimulus is lacking to complete the development of the toe in these few individuals.

In many cases, Shull has stated, imperfect dominance may make it impossible to tell which character is dominant, so that an apparent recessive "presence" of a character may be an imperfectly dominant "presence." But I cannot follow him entirely. Between imperfect dominance and recessiveness there is clear distinction—two perfect and imperfect dominants alike may throw some recessives; but two homozygous recessive parents can throw no dominants; where neither parent possesses a character in its germ plasm their progeny will not have the character. Some families of two recessive parents will, then, throw only offspring of one kind; such are homozygous parents and their offspring are pure recessives.

Many cases of apparent blending are due to imperfect dominance. Thus I recognize 10 grades of booting or foot-feathering of poultry and one of no boot. If a booted be mated to a non-booted the grades in the offspring run from 0 to 8; it is impossible to say whether booting or clear shanks is dominant. In F-2, booted and clean shanks appear again, with boot of some grade in a large majority. All of the extracted clear-shanked mated together produce some booted birds and some of the booted, mated inter se, may produce clear-shanked offspring; such parents are clearly heterozygotes with arrested dominance. But, on the other hand, some of the booted, bred inter se, produce only booted offspring; such are clearly extracted recessives. I have a set of such matings yielding 287 offspring, 100 per cent booted. My best extracted homozygous dominant

clean-shanks produce only 90 per cent of offspring with clean shanks. Presence  $\times$  presence of a character may give *absence* through failure of the character to develop, but absence  $\times$  absence of a character can give no trace of the character.

Finally, dominance may be so imperfect that the dominant character fails completely to develop in the heterozygote and develops only imperfectly or sporadically in the homozygote. This is apparently the explanation of many cases where a character seems not to be inherited. The character has perhaps arisen once as a sport but cannot be propagated. It is probable in such cases that the internal stimulus to development of the organ is too weak. This case is illustrated by a rumpless cock which, crossed with tailed birds, produced only tailed offspring. These offspring mated among themselves and with their father produced no tailless progeny. Nevertheless a disturbance in the germ plasm was indicated by the small "pope's nose" that carries the tail feathers and by shortened, bent backs. These tailed heterozygotes mated to a tailless son of the first cock produced a large proportion of tailless birds. Indeed, taillessness proves to be dominant, but its determiner in the germ plasm is very feeble.

This study, then, leads to the conclusion that alongside of dominance we must place an important modifying factor—the factor of the strength or potency of the representative of the given character in the germ plasm. This is clearly a very variable quality. If it is very potent we get a typically mendelian result; but if it is weak, we will have imperfect dominance or failure to develop altogether.

[Presented by the Committee on Theoretical Research.]

---

## LEGISLATION AFFECTING THE RAISING OF DEER AND ELK FOR PROFIT.

D. E. LANTZ, *Chairman.*

Your committee has little that is new to report at this time. A general interest in the subject of raising deer and elk for profit has been aroused during the present year, and many inquiries about the management of the animals have been answered by the chairman of the committee. The chief difficulty has been to obtain information concerning breeding stock that may be for sale. It has been developed

that few breeders of deer are prepared to capture and crate their stock so as to be able to deliver the animals to would-be purchasers. As a result, prices have been high and offerings so few that many persons who wished to start in the business have been compelled to defer it for the present.

Considerable progress was made during the year in securing legislation more favorable to the breeders of large game animals, and the status of private game preserves has been more definitely fixed in several States. The experience of those who have worked to secure legislative recognition of the rights of private ownership in deer is encouraging, and shows that whenever the real demands of breeders are properly presented before legislative bodies, the lawmakers will respond with just enactments.

A review of the legislation which recognizes private rights in domesticated big game is here given. It will be noticed that much of it is recent.

ARKANSAS.—The act of February 23, 1907, is still in force. It provides that "nothing in this act shall be so construed as to prevent any person or persons from having in their possession, or buying, or selling, or shipping, or any railroad from receiving for transportation any deer or fawn when such deer or fawn is raised in captivity for domestic purposes and is accompanied by an affidavit from the owner to this effect."

COLORADO.—A system of licensing private parks and fish preserves is provided. No one may maintain such preserve without a license. Owners of licensed private preserves are permitted to sell and ship deer or other quadrupeds, if the carcasses or live animals are accompanied by proper invoice and a permit from the State Game and Fish Commissioner. A fee is charged for the license and for each animal shipped by permit. About a dozen deer and elk parks are now licensed under this law.

FLORIDA.—An act was passed this year to encourage the establishment and maintenance of unenclosed game preserves by protecting such preserves from trespass of hunters. The preserves must be carefully posted, are limited to 640 acres in area, and are subject to all laws of the State regulating the hunting of game. The game with which they are stocked is absolutely protected for a period of three years.

MICHIGAN.—The Legislature of Michigan also passed a law making it illegal to capture or destroy deer kept within or that have escaped from a private enclosure.

KENTUCKY.—Kentucky for many years has had a similar law protecting game in parks from poaching and trespass.

IOWA.—Iowa has a statute making it unlawful for any person other than the owner or person authorized by the owner to kill, maim, trap, or in any way injure or capture any deer, elk, or goat, except when distrained as provided by law. As Iowa has no wild deer except a few that have escaped from a private herd, the sale of venison from preserves is not prohibited.

ILLINOIS.—The provision of the law of 1907 allowing persons who raise deer within an enclosure to kill and sell the same at any time, in the same manner as other domestic animals, has now been amended to permit such sale for four months, from October 1 to February 1, this being the open season for the sale of game shipped from without the State.

INDIANA.—The law forbidding the killing of certain game has the following clause: "Provided, that the provisions of this section shall not apply to any person or persons owning or having under his domain or control any deer, buck, doe, or fawn bred or raised in any deer park." Transportation of deer outside the State is prohibited.

MISSOURI.—The former provision of law that deer or elk from private preserves must be accompanied by a tag furnished by the local game warden identifying the property has been replaced by a new proviso, saying, merely, "Nothing in this act shall be construed to prevent the shipment of deer or elk alive or dead from private preserves when such deer or elk are raised in captivity."

OKLAHOMA.—A section of the game law of 1909 permits the sale of domesticated game animals and birds within the State. The law says nothing on the subject of their export.

NEW HAMPSHIRE.—The Blue Mountain Forest Association may kill elk, deer, and moose within the confines of its game preserve and transport them outside the State at any time when accompanied by a certificate from the State Fish and Game Commission. This seems to be regarded somewhat in the nature of a private vested right. The legality of restricting such a privilege might well be questioned by any other association possessing a private park in the State.



NORTH CAROLINA.—Twenty-two counties of this State have laws, passed in 1907 and 1909, permitting the owner and keeper of an enclosed game preserve, who raises deer for use or sale, to kill, sell, or use those kept in said enclosures.

MASSACHUSETTS.—The owner of tame deer may kill or sell the animals kept on his own grounds. —Chapter 307, Laws of 1907.

During the past year three neighboring States have enacted laws that are in some respects similar to the Minnesota provision for private parks. They differ from it in requiring no fees for the permit to establish a park. For purposes of comparison the provisions made in this group of four northwestern States are placed consecutively.

MINNESOTA.—Persons who desire to domesticate deer, moose, elk, or caribou may secure a permit to do so from the State Board of Game and Fish Commissioners by paying a fee of fifty cents for each animal held in captivity and a like fee for each animal added later by natural increase or otherwise. An annual report from the breeder is required. The animals kept in captivity may be sold or shipped within or without the State upon receiving written permission to do so from the Commission.

NORTH DAKOTA.—The State Game and Fish Board of Control is authorized to issue permits to breed or domesticate any of the game birds or animals mentioned in the law. An annual report is required from persons holding such permits, and they may sell or ship game within or without the State upon receipt of written permission to do so from the board. —Chapter 128, Laws of 1909.

SOUTH DAKOTA.—The State Game Warden may issue permits to breed or domesticate deer, moose, elk, caribou, buffalo, or game birds. Annual reports are required from holders of such permits. On receipt of written permission from the game warden any of the animals held in possession in private preserves may be sold or shipped within or without the State.

—Chapter 240, Laws of 1909.

WISCONSIN.—The Fish and Game Warden may issue permits to breed or domesticate deer, moose, elk or caribou. A system of marking the animals in preserves established under permits is authorized, and such animals may be sold or shipped within or without

the State upon receipt of written permission to do so from the State Game and Fish Warden. A tag identifying the animal by number must accompany every carcass or part of carcass shipped or exposed for sale.

—Chapter 525, Laws of 1909.

PENNSYLVANIA.—A marked change of sentiment is shown in recent legislation as to private preserves in Pennsylvania. Until the enactment of the present law persons who had game preserves were unable to use them except under the provisions of the general game law of the State; that is, the owner of the preserve or each member of an association owning it could kill one male deer in a season. Deer could be sold and shipped alive within the State for propagating purposes only.

The law of 1909 provides that the State Board of Game Commissioners may issue propagating certificates to individuals or associations that desire to raise deer or other large game animals. The land must be enclosed by an approved wire fence not less than 8 feet high. All wild deer must first be driven from the land under direction of a representative of the State Board of Game Commissioners. A careful account of all game raised or brought to the preserve must be kept and reports of any increase made annually to the board. Deer may be killed inside the preserve and shipped only during the open season and for 30 days thereafter. They may be shipped alive for propagating purposes at any time. Each deer or carcass of deer shipped from the preserve must bear a tag furnished by the State board, by which it may be identified at any time.

—Act No. 204, 1909.

NEW YORK.—Until the amendment secured during the present year, the game law of New York did not permit common carriers to transport a deer carcass unless it was accompanied by the owner, who had killed it in the open season. Charles F. Dieterich, owner of a private herd of deer in Dutchess county, had been accustomed to kill off some of the bucks each year and market the venison in New York City. Under the old law the American Express Company refused to receive and transport this venison. Mr. Dieterich applied for a temporary injunction against the president of the Express Co., James C. Fargo, claiming that the law prohibiting transportation did not apply to domesticated deer. The Supreme Court of New York County, in December, 1906, decided in favor of Dieterich, but the

Express Company appealed and the decision was reversed by the Appellate Division of the Supreme Court of the State, May 10, 1907. Dieterich then carried the case to the New York Court of Appeals, which finally, February 23, 1909, reversed the decision of the Appellate court, holding that the law concerning transportation of venison did not apply to that from domesticated deer bred in confinement, and that the owner of such deer is not restricted as to the number he may kill and ship during the open season.

To market his deer in 1908, while his final appeal was pending, Mr. Dieterich resorted to the novel expedient of inviting a number of his friends from the city to visit his country preserve, he having furnished them transportation. Each man shot a deer and accompanied the carcass to market, as required by the law as then interpreted.

The law as recently amended by the State legislature permits deer to be sold during the open season, and moose, elk, caribou, and antelope from private parks to be sold during the same period. Common carriers may transport live animals into the State for breeding purposes. The section forbidding transportation of venison unaccompanied by the owner has been amended by the provision that it "shall not apply" to domesticated deer propagated in wholly-enclosed deer parks, when shipments from such parks are accompanied by a permit issued by the forest, fish, and game commission under conditions prescribed by the commissioner."

From the above review, we gather that the statutes in 15 States now permit the sale of venison from private parks, either with or without restrictions of some sort. Four other States have specific laws to protect private game parks from poaching; but in most States the ordinary trespass laws accomplish the same purpose.

Besides this direct legislation on the subject of private deer parks, sale of venison from domesticated deer would be possible in a number of other States. A few, like Delaware, Kansas, and Ohio, have no mention of deer in their statutes, there being no wild deer to protect. A few others, like Nebraska, except from the provisions of the game law, all animals and birds "held by private ownership legally acquired." Just what rights private owners possess as to shipment and sale of venison is not always clear in the absence of specific legislation on the subject.

## VALUE OF WILD ANIMALS.

C. D. RICHARDSON, *West Brookfield, Mass.*

If thou art worn and hard beset  
With sorrows that thou wouldst forget,  
If thou wouldst read a lesson, that will keep  
The heart from fainting, and the soul from sleep,  
Go to the woods and hills! No tears  
Dim the sweet look that Nature wears.

—*Longfellow.*

We as a people work too much and play too little. We are hurrying along to a nervous wreckage which is weakening to the country itself and which will in time reflect upon us as a people. To the over-wrought nerves nature ever offers a soothing balm. When the curtain of life hangs low and dark, go to the woods and learn nature's secret of how to live, for a day spent in the country gives a wealth of interests, a thorough relaxation of mind and body, and makes life seem more beautiful and rather more worth the living.

Those beautiful wooded dells should be the haunts of the wild creatures, as when first discovered by the white man. Too long they, with their wild life, have been given over to the pot hunter and to him who would despoil them of their true charm. There is a growing recognition that the strain of modern life can be best endured by often fleeing to the wilds, which calls at times to all, but louder to some than to others.

All over this great country of ours there are vast stretches of waste land, with their variety of woods, swamp, and hillside, which yield but little profit to the owner. Let us look a little into the future. Suppose we make something of this land, fence it in, reforest it, and stock it with game. It will require little care and the average farmer may realize from it more than he now does from his tilled acres. The fence problem is practically solved in the use of woven wire, and a large tract may be enclosed at a comparatively small expense.

The food problem, too, is a simple one, as grouse, pheasants, quail, etc., subsist almost wholly upon insects which if unchecked would destroy all vegetation, on noxious seeds, and on buds of unimportant trees, while the larger game animals, especially those of the deer family, feed almost wholly on twigs and leaves of vegetation which is of no real value, if not a menace to the farmer. In fact,

the finest grazing ground for such animals is an old brush pasture, in which the ordinary domestic animals would starve, but which furnishes to the wild creatures their most natural food.

The question of vermin—the fox, weasels, skunk, cat, etc., the natural enemies of the bird—must be considered and a systematic warfare waged against them. An English moor of from 100 to 500 acres often rents for 300 pounds (\$1500) a season, just for the shooting privileges of the grouse alone. The increase in bird life on such a tract is simply enormous when the vermin is disposed of.

There is a growing demand for live game to supply zoological parks, and for game as food, at increasingly high prices. The revenue which may be derived from shooting privileges and from camping parties who would steal away from the busy mart to enjoy a season with nature, in all her fullness, may not be inconsiderable.

The national parks, whose value to the country cannot be over-estimated, are too far away for the average citizen to enjoy, but he may have that which will give much pleasure and profit nearer home. A tract of waste land of from 100 to 1000 acres may be obtained in almost any section of the country and especially in the hilly and mountainous regions, at a price within the reach of every alert farmer. The cost of fencing need not exceed \$1 a rod for an 8-foot fence, and the game for stocking—birds and small game will rapidly multiply under protection—can be procured at a price no greater than that paid for domestic animals.

One of the secrets of the success of the English race is in the fact that they as a people have emphasized out-of-door life. The rugged physique and robust health of the average Englishman are due to the fact that he is able to dismiss all care and enjoy a day with rod or gun. His large landed estates together with the climatic conditions offer favorable opportunities for all out-door sports. While we believe that large landed estates are a menace to the best interests of any people, yet with our large acreage of waste land and democratic ideals there is no possible danger that we shall ever suffer by the establishment of game preserves in this country. These game preserves may not only be centers from which the surrounding covers will be stocked, but they may be object lessons in forestry, of which this country stands in vital need, to say nothing of making rural life more beautiful and attractive.

## EXPERIENCE IN RAISING VIRGINIA DEER.

C. H. ROSEBERRY, *Stella, Mo.*

I know of no other branch of the live-stock industry that returns as great a profit in proportion to the time, labor, and capital invested as that of deer raising.

My experience is limited to the Virginia white-tailed deer (*Cariacus virginianus*) and covers a period of 19 years. Doubtless the raising of elk or wapiti would be equally profitable—perhaps more so where raised for venison, owing to the greater size.

A tract of 10, 20, or 40 acres of rough brush land, enclosed with a 6½ or 7 foot woven wire fence, with provisions for a constant supply of water, either natural or artificial, is the chief requisite. It is better if there be dense thickets of underbrush, coarse weeds, and trees of pin oak, white oak, pig hickory, chestnut, etc. The twigs, leaves, and mast of these afford an abundance of natural food as well as shelter and seclusion.

It is also desirable to have a plat of three or four acres of tillable land on which to sow rye or wheat for winter pasture.

As the underbrush is gradually killed out, as it will be as the herd increases in numbers, unless the range is quite extensive, white clover and orchard grass may be sown for summer forage.

In the latitude of southwestern Missouri, feeding is not necessary between April 1 and November 1. For the rest of the year a stack of cowpea or clover hay to which the deer have free access, supplemented by a light ration of corn and bran or other mill feed in severe weather, is sufficient.

Do not feed too heavily of shelled corn. If gorged with it the results are often fatal.

If it is desired to raise venison it is, of course, not necessary that the fawns be accustomed to handling while young in order to tame them. But if raised for sale as breeding stock, requiring that they be handled and shipped alive, it is necessary to take the fawns from the does when they are ten days old and raise them by hand on cow's milk.

This, of course, involves a great deal more trouble and expense than to let the fawn run with the doe; hence the price received for breeding stock is proportionately greater than that received for the

venison carcass. For example, a yearling dressed for market may weigh 60 pounds net, and could be profitably sold for 25 cents a pound, or \$15; whereas the same raised by hand would be worth at least \$30 for a buck, or \$45 for a doe.

My method of raising by hand is as follows: A tract of 3 or 4 acres, free of underbrush, in which the fawns might hide, is fenced off from the main park. Early in May the does that are to drop fawns are confined in this small lot.

During fawning time the lot is carefully searched at intervals of two or three days, and when a fawn a day or two old is found it is at once tagged by tying about its neck a strip of cloth—red if it is a buck or white if it is a doe—and allowed to remain with the doe ten days, when it is taken from the park and confined in a 5-by-10-foot cage made of one-inch poultry netting, lined inside with cloth and bedded with clean straw. A 5-by-10 cage will accommodate 12 fawns. The bedding must be kept dry and frequently changed for cleanliness. The cloth lining is necessary to prevent injury. The youngster is exceedingly wild at first and dashes himself against the sides of the cage in frantic efforts to escape.

If allowed to remain longer than ten days with the doe, it is often impossible to capture the fawn except by a chase or by strategy. The latter consists in biding your time until the fawn is found lying beside a log, stump, or clump of bushes, when it is very stealthily approached from the leeward to within springing distance and pounced upon before it can get to its feet. When other methods of capture fail it may be run into a fish net in which it will become entangled.

The fawns remain in the cage for two weeks, during which time they learn to drink fresh milk from a bottle and become quite tame. They are then allowed the freedom of an enclosure 20 by 100 feet for two weeks longer, when they are given a still wider range. But they must not be returned to the park, else they will become wild again.

The adult Virginia buck, if raised by hand, often becomes vicious, especially during the rutting season, and should not be trusted until rendered comparatively harmless, either by sawing off his antlers an inch above the burr or by bolting a 1-by-4 hardwood board 3 feet long across the tips of his antlers. The wild bucks never lose their fear of man sufficiently to attack him.

I would not advise beginners with small means to go into the business of deer raising too heavily at first. It is better to begin on a small scale—say 10 acres and a herd of vigorous stock and let the business increase along with the increase of knowledge to be gained by experience.

Thousands of acres of rough land unsuited for cultivation that now brings its owner no returns for his investment may, by converting it into small deer farms, be made to yield the owners a handsome profit, as well as much pleasure.

[Presented by the Committee on Breeding Wild Animals. D. E. LANTZ, Chairman.]

### POULTRY BREEDING IN SOUTH AUSTRALIA.

D. F. LAURIE, *Adelaide, South Australia.*

The history of poultry breeding in the State of South Australia dates back sixty or seventy years. Soon after the foundation of the (then) colony, and with some of the first settlers, there arrived pure-bred poultry brought from England. Regular exhibitions of poultry began about forty years ago, and progressed more or less until about twenty years ago when a strong movement took place and has since continued. Numerous direct importations from England have been made from time to time, but the adjoining States have been the chief source from which fresh blood has been drawn.

There have been and still are in Australia many ardent fanciers who do not begrudge the money necessary to secure noted English winners, but there is reason for believing that in the future our breeders will show less inclination to send to England for fresh blood and prominent winners except in certain breeds. The reason for this is that our breeders do not approve the type of many breeds now fashionable in England. As regards importations from America, Plymouth Rocks (barred, buff, and white) and the Wyandottes (partridge, white, silver-pencilled, and gold-laced) have been imported into the other States in considerable numbers, and selected draughts of the progeny resulting from these importations have been added to our flocks. The popular exhibition breeds at present are:—

Orpingtons, Black, Buff and White.

Wyandottes, Silver, White, Gold; and other varieties to a lesser degree.



Plymouth Rock, the American Barred.

Dorkings, Colored, and Silver-grey.

Faverolles.

Langshans.

Old English Game, Indian Game, British Game; Malays for which the State is famous.

Leghorns, White, Black, Brown, and Buff.

Minorcas, and a fair sprinkling of other light breeds.

Ducks: Pekin, Rouen, Aylesbury, and Indian Runner.

As regards breeding, the best efforts are centered in Orpingtons, Wyandottes, Rocks, Old English Games, and White Leghorns. We have numerous skilled breeders and exhibitors, and many of our best specimens are shown in excellent style.

#### COMMERCIAL POULTRY.

During recent years far more attention has been paid to utility or commercial breeds than to mere exhibition stock. This is due to the action of the State Government in fostering poultry breeding as a national industry. The commercial sections of our poultry shows appeal strongly to the utilitarian instincts of our poultry breeders.

The great help rendered by the press in devoting considerable space to matters of interest to poultry breeders and to the publication each week of the full results and progress of the laying competitions is assisting in educating our breeders and encouraging the novice.

#### WHAT OUR BREEDERS ARE DOING.

During the last ten years, or so, a number of our breeders have paid special attention to developing what are termed utility strains of various breeds. We here take quite a different view from that of the English breeders. There the culls of any breed are disposed of at low prices to serve as utility fowls. In South Australia we place such birds in their proper category: we call them culls, and consign them to the kitchen.

Our utility strains are bred as carefully as, and even more so in many respects than, our exhibition strains. The difference is this, our breeders select for the constant improvement of utility points in the first place, and while maintaining type, allow the less important

external characteristics to take a less prominent position. While this good work is going on with many breeds there is no doubt that main results are to be witnessed in the White Leghorn as developed for egg production.

#### HISTORY OF THE WHITE LEGHORN IN SOUTH AUSTRALIA.

As our White Leghorns have attracted world-wide attention to the excellent scores made by representative pens in public competition, and under strict official supervision, a brief history of their origin may be of interest. About twenty-five years ago several importations into Australia were made; the birds hailed from America. These birds were slightly larger and more robust than specimens imported a few years ago. It will be remembered that about this period the Leghorn was fairly popular in England, and the prevailing type as seen at shows did not differ materially from the originals which also came from America. It appears then that our first draughts of blood were of American origin, and, as far as I know, we never had the type known throughout Europe as the Italian fowl. Later on fresh additions were made from time to time and in every case from England. There, as we know, the breeders had resorted to crosses to increase the size, etc. Hens, as at first imported, weighed  $3\frac{1}{2}$  to  $4\frac{1}{2}$  pounds, while occasional hens among the later importations weighed 6, 7, or 8 pounds. The blend resulted in a rather large type, square and heavy. Seven or eight years ago fresh blood came from America to Australia; and of the strains imported those of Messrs. Van Dreser and Wyckoff were most favored although their lack of size, indifferent head points and evident want of stamina were viewed with suspicion. The introduction of this new draught of blood was productive of wonderful results, the strains "nicked" and the resulting fowl is as follows:

*Size.* Perhaps not more than half or three-quarters of a pound heavier on the average in both sexes as compared with the birds imported from America.

*Type.* Practically that of the American, retaining the good shoulder and length of leg, but deeper behind, thus showing capacity.

*Stamina and General Appearance.* Hardy, robust and bold. The head points are better developed, although kept in strict moderation. These birds are just as active, and on as fine lines as are their smaller

fragile-looking American relatives. The hens are smart, active, busy, scratching cacklers, and the male birds are as full of fire and life as could be wished; they are very game, not to say pugnacious.

#### HOW THEY ARE BRED.

The success of the fresh infusion of American blood as regards laying set the ball rolling, and the new type headed the list. Our leading breeders select vigorously and adopt what is known as "Line" or "Pedigree" breeding exclusively. As the pullets grow they are subjected to constant and vigorous culling, with the result that the final selection represents the judgment of that particular breeder.

*Testing.* While a few still adhere to the old method of trap nesting, the advanced breeders pen the pullets singly in small but convenient pens. Here they undergo the ordeal, the result of which decides whether or not they are to be retained as breeders. As a rule these pullets are not unduly forced, they are supplied with suitable foods in variety but are not pampered. Few breeders would attach much value to a pullet with a 200-egg score for the year; she must lay 220 to 240 to cause any enthusiasm, and above that yield she becomes precious. Those whose test is satisfactory are specially distinguished by leg bands and numbers, and particulars are carefully recorded.

*The Male Bird.* Our breeders attach as much importance to the ancestry of the cockerel as to that of the pullet. The selected stud bird has been, up to the present time, exemplifying the doctrine of the survival of the fittest. He has, with his mates, first of all to pass muster as to type, carriage, general style and vigor. After that he holds his own in the daily battles, who crows loudest and most frequently and shows his strength and vigor in every detail becomes the apple of the breeder's eye. His pedigree is accurately known, and much thought is given to the selection of his mates from among the best second-season tested females.

*Some Additional Points.* Our breeders know that mere selection based on individual egg production does not fulfill all requirements. In pedigree breeding, where you are endeavoring to concentrate all desirable points and characteristics, you must rigorously guard against the concentration of undesirable points. What are known as latent defects show themselves; we find reversion to some point or other which must be eliminated. Many a promising pullet is dis-

carded because she shows some weak point or undesirable character. Where it is necessary to graft on some desired point the process is slow and intricate. In improving the one point others must not be sacrificed, but to the patient and skilled breeders nothing is impossible.

#### CAN A HIGH AVERAGE BE MAINTAINED?

This question seems to trouble our friends over the water more than it does us. There is not the shadow of a doubt that the adoption of this method of rigorous selection and systematic pedigree breeding must result as follows:—

1. In the production of stud birds of great laying power.
2. In considerably raising the average egg production of any flocks of laying fowls so bred.
3. By this process alone can a high level of egg production be maintained.
4. The adoption of the methods indicated must result in the elimination of undesirable characteristics and hereditary tendencies, and finally result in robust constitution and ability to assimilate the food necessary for the production of large egg yields. Toughness of fibre and ability to stand the shock and strain of constant egg production can be acquired by each method alone. We read the opinions of those who follow sheep-like and we hear sometimes their sympathetic groans. Nevertheless the fact remains that the progeny of great layers, if thus selected, are vastly superior in constitution, fecundity, and general breeding powers to the half-wild farm hen. The whole question is one for the breeder. If he is incompetent he blames the hen and talks darkly of nature and her laws (which by the way he rarely studies). Look at the history of breeds of other classes of stock; success in every case is due to the breeder, the man behind the gun! Use your brains, develop keen powers of observation, discard any bird in the slightest degree unsatisfactory and success all along the line must be the result.

I prefer single testing to the use of trap nesting, i. e. each pullet or hen in a separate compartment for the whole term of testing with no possibility of errors or mistakes.

I am absolutely certain that the only way to get a flock with a high average egg production is as follows:—

- (a) By testing all pullets during the first year before they are bred from.

(b) Selecting such candidates for testing by comparison, i. e. by outward signs such as general character, activity, fineness of head, structure, etc.

(c) Rigid rejection of inferior specimens and those showing any signs of trouble in organs of reproduction, broodiness in non-sitters, etc.

If we use as our basis a strain of birds above the average in egg production I am certain we can by careful selection always keep near the highest point.

Out of 100 first-class layers there would not be more than perhaps 30 really fit for breeding and perpetuating high-class layers. You must line breed all the time. As regards the statement that egg production by a fowl is no indication of that of her pullets, I presume this refers to line-bred birds, because surely no one would be fool enough to mate up an unknown male bird.

Every careful breeder in Australia can give ample proof that the good hens breed good pullets when line bred, but there is reason to believe that the production of eggs may vary slightly in succeeding generations. Black Orpingtons and Silver Wyandottes have had special attention in Australia, and a long course of selective breeding has resulted in many strains of high-class layers. Those strains always originate in a good layer. The foolish method of introducing fresh blood is, I am sure, answerable for many failures in other parts of the world.

#### FEEDING.

Many old breeders say "Given the breeding, the ultimate results depend upon the feeder." This is practically true. Doubtless our climatic conditions are very favorable, but at the same time we have our good feeders and our poor feeders whose results differ so markedly. I often think that much of the food that is recommended by writers not in Australia cannot be suitable even in the country where its use is recommended. The methods of feeding I have strenuously advocated for the past 20 years are as follows:—

*Chickens.* Fast 24 to 30 hours at least after hatching. First feed coarse sand; after that a mixture of cracked grain fed in litter where the little fellows must scratch and work hard for a living, and so for a month without mash or soft food. After that period a little mash made of various cereals ground and mixed. Here wheat is a

staple, to which I add hulled oats, maize, peas and occasionally millet and canary. Clean water, grit, small charcoal and plenty of scratching material always. Of cut green food they will eat a lot and it pays to give it to them. Do not force them if intended for stock birds or layers. I am not dealing with market birds. The dry mash does not appeal to me and it is not suited to our dry climate. I prefer whole grain. For mash for egg production I prefer a light feed in the morning, fed to the minute. This consists of pollard 2 parts, wheat bran 1 part, to which add of lucerne (alfalfa) chaff steamed, or cut green food, at least a third by bulk. Mix this to a crumbly state with hot soup. The mixing is of the utmost importance, do it carefully and well. At midday the birds generally have a supply of cut green food, of which lucerne (alfalfa) forms the chief part, together with cabbage, kale, green barley, etc., according to the season.

The evening meal is generally wheat, but in the winter occasional recourse is had to peas and maize (corn). At Roseworthy I seldom use oats for adults, but at Kybybolite, in the southeast, that grain is used, especially that variety known as the skinless oat, an excellent poultry food. Shell grit and charcoal are always provided. The yards are small, the houses are open-fronted with scratching shed for use in wet days. The whole floor space of the yards is occupied with straw litter about 6 to 9 inches deep. In this the grain is scattered and it keeps the birds busy all day. The mash is placed in an earthenware dish and another is provided for drinking water which is renewed twice a day in winter and three or four times a day in summer.

I consider that careful and correct feeding is of the utmost importance. Slipshod so-called labor-saving devices generally tend to sickness and loss. Fowls will not thrive and lay unless properly fed. No spices, peppers, or forcing foods of any sort are allowed to be fed, nor are they necessary. Cut green bone is not used, as, although excellent in cool weather, there is great danger of ptomaine poisoning during warm spells. I use meat meal made at the Government Freezing (cold storage) Works; it contains 60 to 70 per cent of albuminoids. This is used for making the soup in the proportion of  $\frac{3}{4}$  of a pound for every hundred adults. I hold that highly concentrated foods affect digestion, and that forcing or overstimulation must have a cumulative and degenerating effect generally.

## SOME RESULTS.

There have been six Laying Competitions in South Australia. In the first the average per hen for the twelve months laying was 130 eggs; in the last the average had risen to 190 eggs, and in that now in progress I look for a further improvement.

## WHITE LEGHORNS.

In the 1908-9 Laying Competition the average yield per pen of 25 pens, each containing 6 pullets, was 1250 eggs. The highest score was 1447 eggs and the lowest 960 eggs. These 150 pullets were the property of 24 different owners and were of various strains. In the Competition now in progress at the Roseworthy Poultry Station there are 65 pens of White Leghorns numbering 390 birds the property of about 60 owners, and they are of various strains. At the end of eight months, that is, beginning April 1 and ending November 30, the total eggs laid numbered 53,625, or an average of 825 per pen, or 137.5 per hen. There are still four months remaining during which time the birds should lay well. At this period the leading pen has laid 1010 eggs and there are eighteen pens which have laid 900 eggs and over. There are only 49 eggs between the first pen and the sixth and during the next four months a marvellously close contest should be witnessed. I will state definitely, however, that, as regards laying, a steady improvement is witnessed each year. I am confident that, whatever may be the result outside of Australia, here we shall steadily raise the annual production of our White Leghorns. This will take place through the Government Poultry Station and the stud breeders who will distribute large numbers of high-class layers yearly. With the average farmer who is steeped in prejudice and ignorance of the correct methods of breeding we may not expect more than an average increase among pure-bred flocks. Naturally the national gain will be in the gradual displacement of the farm mongrel fowl by the commercial pure-bred. This is rapidly taking place. Publicity through the press and by means of lectures, etc., is gradually showing our country poultry keepers the advantages of the pure breeds. Here farmers buy from noted breeders, and those whose names are constantly before the public as breeders of commercial poultry. The results which make our breeders famous are obtained in officially conducted public competitions. The

difference is that the value of the strains is based on actual fact, not upon the dictum of their owners as stated in advertisements. The public actually buys the correct kind of stock. In the old days the buyers depended entirely upon the results of poultry shows, and one can understand the disappointment and losses of persons who, without knowledge, purchased Cochins and Malays as market egg producers. From a national point of view I consider it is of the utmost importance that the general producer should obtain the proper class of poultry from the best sources. Looked at from a national point of view, the best results can accrue only when the general poultry breeder is thoroughly educated and at the same time supplied with reliable stock. Many of the failures of the past are due to bad stock and improper methods. Much of the lack of success is due to errors in breeding. Each country and climate I think must evolve the particular type of laying fowl best suited. Some of our Australian breeders are mongrelizing the heavy breeds in the endeavor to build laying strains; they gain an increase in eggs but they lose all other qualities. The light breeds are of little value as table fowls, but where they thrive, as in South Australia, they are veritable egg machines.

---

Dean J. H. Shepperd of the North Dakota Experiment Station reports that the Shorthorn Cattle breeding-circuit, established by the North Dakota Experiment Station and the U. S. Department of Agriculture in cooperation, is in the most flourishing condition. An employee of the Station and the Department gives nearly his entire time to this enterprise. The cooperating breeders are a settlement of German farmers west of the Missouri River, in the southern part of North Dakota. These farmers have already learned to successfully cooperate in the management of a cooperative creamery.

It has been suggested that someone assemble all authentic records of true hybrids of species of animals as well as plants. There are many problems of both scientific and economic value concerning hybridization in animals which our zoological gardens could help to work out. This would be a new and practical use to which some of the material in zoological gardens could well be adapted.



# EDITORIALS

## THE NEW MAGAZINE.

Since its organization, six years ago, the American Breeders Association has had as its printed exponent the annual reports of its proceedings. These have been received with only commendation, and as annual reports go, have served their purpose well. They have fully demonstrated the fact that there is constantly rising a body of valuable and interesting new knowledge relating to heredity and breeding. The Association has fully demonstrated that there is a common bond of interest between the scientists and breeders, and between plant breeders and animal breeders, which should and does hold them together for a common purpose. Since the Association includes annual, life, and honorary members, also active workers and committeemen, all being in many countries, and has most cordial relations with other associations with which it has much in common, this Magazine will have wide interests.

The purpose of the American Breeders Magazine will be to forward the interests of the American Breeders Association. It will have no capital stock on which to pay profits and will pay only such salaries to employees as are necessary to secure the services of competent editorial and business management, and will have only such expenditures as are necessary to pay for publishing the Magazine. The Association is strictly a co-operative public service organization, which is served by its general officers without pay, and which does not attempt to earn profits. It exists that its members may better serve the common good.

The American Breeders Magazine is not a competitor of periodicals devoted to scientific or practical agricultural, horticultural, or live-stock interests. Its leading specialties are the increase of the knowledge of heredity, creative breeding, and the commercial multiplication of the most useful improved varieties and breeds.

It will secure much of its information, inspiration, and practical points of view from contemporary publications, and in turn will try to make more rapidly available to them the advances along the lines of breeding. It seeks and bespeaks cordial relations with all periodicals interested in all phases of its work. The American Breeders Association will appreciate courtesies from other publications and especially such as are designed to help enlarge the membership of the Association.

The American Breeders Association has assumed the important function of bringing the practical breeders into closer touch with the scientists, and the scientists into a clearer knowledge of the practical problems of the plant and animal breeders. Its meetings have proven the value of an open forum where practical and scientific men interested in breeding can discuss heredity and breeding in all their relations to the living forms as found in nature and in reference to the production of races of plants, animals, and men with better heredity. The Association assumes the publication of the American Breeders Magazine because it feels that there is need of an independent open court for public expression published by a co-operative organization. The Council, under the authority of the Association, in deciding to extend this forum in the form of a magazine realizes both the difficulties and the possibilities of such a step. The effort will be to sustain a high standard of scientific excellence, and at the same time produce a readable magazine. The Association has not been organized to forward the interests of any group of men, but will give a fair and open hearing to all. It aims to achieve scientific and economic results of the highest order and of the widest scope.

---

The readers of this Magazine may hope to here learn many of the interesting scientific and practical achievements made by the scientists and breeders who are to fill its columns with things useful and things new. This journal will occupy the humble position of a means of intercommunication for the members of the American Breeders Association. It will also be a force in bringing about cooperation and organization of effort. It will find useful work in promoting worthy scientific projects, and projects for the creation of new varieties and breeds. It desires to be not controversial but

informational and inspirational. Those who have new facts or need of facts, or need of new forms of plant or animal life, are invited to come into this co-operative group of workers. Those who are preparing to work as technicians in research or teaching and those who are beginners in creative breeding and in the production of pedigreed plants, seeds, and purebred animals are urged to become members.

---

It may be assumed that history will repeat itself, and that the science of breeding will continue to bring surprises. This is a fortunate time for the American Breeders Magazine to come into existence. The new achievements in the study of heredity and creative breeding have whetted the public appetite for the rest of the story. Departments of agriculture, State experiment stations, university laboratories, and other institutions which conduct research are constantly increasing the number of workers and enlarging their equipment in this line of effort. The output of newly developed facts is growing yearly in this and in other countries. A most interesting group of scientists is forming—students who make a special study of heredity and breeding. Breeders who endeavor to conduct breeding operations according to scientific principles are rapidly increasing in numbers. The new creations, especially from plant breeding, are a rapidly growing quantity and of great interest. The steady improvement which decade by decade has been going forward in our domestic plants and animals is just now receiving a new and most wonderful impulse. Science is taking hold of the forces of heredity as it has hold of the forces of mechanics, and the Twentieth Century bids fair to be the century of breeding.

---

The officers of the American Breeders Association have reason to believe that out of the hundreds of thousands of breeders and growers of pedigreed animals and improved seeds and plants some tens of thousands will be pleased to become members and to secure the Magazine and the Annual Reports. With the co-operation of even ten thousand members, the American Breeders Magazine can be made a great success. This periodical is not launched without inspiring precedents. The American Forester, published by the American Forestry Association, is supported by more than twelve

thousand members. The National Geographic Magazine, published by the National Geographic Society, is supported by more than sixty thousand members. What numbers may be our goal no one can at present predict.

H.

### **THE AMERICAN BREEDERS ASSOCIATION.**

The American Breeders Association was organized December 29-31, 1903, at a meeting called for that purpose at St. Louis, Mo. That call was issued by an "Organization Committee" from the American Association of Agricultural Colleges and Experiment Stations.

This Committee was composed of the following named gentlemen: Prof. W. M. Hays, University of Minnesota, University Farm, St. Paul, Minn., Chairman; Director L. H. Bailey, Cornell University, Ithaca, N. Y.; Prof. Thomas F. Hunt, Cornell University, Ithaca, N. Y.; Dr. Herbert J. Webber, U. S. Department of Agriculture, Washington, D. C.; and Dean Charles F. Curtiss, State College, Ames, Iowa.

The first annual meeting was held at Champaign, Ill., in January, 1905; the second at Lincoln, Nebraska, in January, 1906; the third at Columbus, Ohio, in January, 1907; the fourth at Washington, D. C., January, 1908; the fifth at Columbia, Missouri, January, 1909; and the sixth at Omaha, Nebraska, December, 1909.

The five annual reports already issued are permanent evidence of the enthusiastic interest in these meetings, and show the substantial character of the movement centered in this Association. The Association has gradually grown until there are now nearly a thousand annual members and more than one hundred life members. The annual membership fee of one dollar was sufficient to provide for the cost of printing the earlier volumes, and for stationery and postage, but in order to prepare for launching the Magazine the meeting at Columbia, Missouri, authorized the Council to call for a vote of the membership, by means of postal cards, on changing the Constitution so as to make the annual fee two dollars; and this proposition carried by a large majority.

The objects of the American Breeders Association are the advancement of the discovery of the basic facts concerning heredity, the devising of new plans for creative breeding, and the organization of those projects which lead toward improved plants, animals and men. It functions on the skirmishing line to discover the lay of new land, helps to plan the campaign and to direct advances where the largest results may be secured. It is also alive to the work of the great army of active practical breeders which must carry out the bulk of the improvements, and to the interests of those who must use such improved varieties and breeds as are supplied to them in making plant and animal products. Its efforts are directed to the labor of improving the varieties and breeds which serve as implements of production in the hands of the farmer and stockman. Some of its efforts may seem remote from the interests of the producer, as scientific research often does, but all will accord the scientists a liberal scope to the end that every suggested new field may be explored.

The Association promotes and helps to organize cooperation among those interested in studying the laws of heredity, those devising improved methods of breeding the respective species of plants and animals, those engaged in creating new and more valuable types of plants and animals, those who multiply purebred animals, those who produce agricultural products from the newly bred forces and forms, and those interested in eugenics or heredity in man. The American Breeders Magazine is to be the bond and means of communication between all classes who will join this cooperative movement to harness up, and where necessary to recombine in hybrids, the strongest and best units of heredity to be found or created in our plant and animal forces.

The Association's plans do not stop with the study of heredity nor even with the creation of new values in plant and animal forms and forces. They are also directed toward bringing into the widest use all valuable types, as by introduction from one country or district to another, and by aiding in organizing the initial distribution and the widest commercial dissemination in order that the new values shall be secured by all growers. It is believed that much can be done to help owners devise better means for highly accrediting truly superior stocks of plants and animals that they may more generally replace the less desirable forms of both animals and plants. II.

**THE RELATION OF THE ASSOCIATION TO PURE RESEARCH.**

To the scholastic biologist of our universities the work of the "breeder" has for long been regarded with contempt. Although recognized as a department of commerce, it has been regarded in many quarters as the least dignified department, associated in mind with the cowboy, the stable boy, the "hayseed," the country jay, the peasant of Europe. "What do you do at the meeting of the Association," says my university colleague, "inspect 'hawgs,' pass around 'pertaters' and show up your biggest ears of corn?" But that attitude is changing and changing fast. It is interesting to note the reasons. For one thing, the factors of evolution were always regarded as worthy subjects of research; and the old method of discussing evolution without facts had fallen into disrepute. It became recognized that the experimental method should be applied to the behavior of the germ plasm of plants and animals. Meanwhile the work of the Agricultural Experiment Stations and that of medical investigators, who experiment largely with domesticated animals and breed them for their work, made pure biologists acquainted with the valuable experimental material offered by such organisms. And so, from many sides, as though by a common impulse, the scientific investigation of biological problems involving experimental breeding began. The American Breeders Association was organized just at the most opportune time and in this country has served as a great clearing house for the results of experimental breeding both on the part of the pure and the applied biologists. By a fortunate disregard of the conventional distinction of plants and animals, breeders of all organisms are thrown together in a close relation which has not been successfully reproduced in the breeders' society of Germany.

The future of research in breeding is bright. The topics of heredity, of effect of consanguineous matings, of reciprocal crosses, of influence of soma on germ plasm, of the origin and significance of the characteristics of organisms, of the laws of combinations of characteristics, and especially of the nature and determination of sex and of secondary sex-characters—these and many other topics of great biological import are now, and in the future still more are to be, the objects of pure scientific investigation by well-trained biologists, using the experimental method. Such investigation is now for the first time being systematically undertaken.

This new Magazine will, it is confidently expected, become not merely the archive for the results of these researches, but the forum for the discussion and interpretation of these results. It will use the most practical methods of aiding in the advancement of pure biological research in the field of breeding.

CHAS. B. DAVENPORT.

---

### **BUILDING UP AN EXPORT TRADE IN PEDIGREED ANIMALS.**

There is no business in which there is greater opportunity for deception than in trafficking in pedigreed live stock. It follows therefore that there is no business in which the integrity of the breeder counts for more. Because of the opportunity of securing greater temporary pecuniary gain by deception, individual breeders have occasionally resorted to a variety of questionable practices which have had a tendency to destroy public confidence in pedigreed live stock. It is doubtful whether breeders of the United States are yet as skillful in this regard as those of other countries, but experience teaches us that they are apt scholars.

Breeders who have at heart the best interests of general live-stock improvement and pedigreed live stock in particular (and fortunately there are many such in this country) understand that, aside from any moral question involved, deception of any sort is a short-sighted policy. It is unfortunate that reliable breeders are constantly forced to compete in the show and sale rings with the unscrupulous. Obviously, it is often the unscrupulous that win.

If such enemies of the pedigreed live-stock business would confine their practices to domestic trafficking their influence would be less disastrous. But those seeking pedigreed live stock in a foreign country are, for various reasons, peculiarly susceptible.

The possibility of securing in the United States pedigreed live stock of sufficiently high quality to compare favorably with that available elsewhere and usually at prices that are distinctly attractive is becoming a matter of common knowledge, and as a result there is a steady increased foreign interest in our improved live stock.

No one will deny the desirability of building up an extensive trade with foreign countries; it should follow logically a decline in

exports of market animals. It is not too early, therefore, to give some serious attention to this trade. Should not the American Breeders Association, through a committee, undertake to render assistance and advice to foreigners seeking pedigreed live stock in this country to the end that they may have an opportunity of seeing and securing our best?

HERBERT W. MUMFORD.

### **EUGENICS, A SUBJECT FOR INVESTIGATION RATHER THAN INSTRUCTION.**

We learn of a Eugenics Education Society in England and of an international Eugenics "movement" originating in Germany, and we hear the inquiry: Why is not a Eugenics Education Society started in America to take part in the propaganda? When told of the Eugenics committee of the Breeders Association some of these inquirers can barely restrain an expression of disgust that human interests should thus be mixed up with those of domestic animals and plants. It may, however, well be doubted if the time is ripe for education in Eugenics. Only within the last decade have we begun to learn how to investigate heredity so as to give definite results; and the facts have only begun to come. How can one, then, educate others until one is himself instructed? Lest we be blind leaders of the blind, we must first of all investigate. When precise laws of heredity shall have been determined for many human characteristics, it will be time enough to instruct the people in regard to them. Premature attempts at education will bring the whole business into deserved reproach; and will the longer defer the acceptance by the common people of the facts when ascertained. Our greatest danger is from some impetuous temperament who, planting a banner of Eugenics, rallies a volunteer army of Utopians, freelovers, and muddy thinkers to start a holy war for the new religion. The association of research in Eugenics with the American Breeders Association is a source of dignity and safety. It recognizes that in respect to heredity man's nature follows the laws of the rest of the organic world. It recognizes that human heredity is a subject of study for practical ends; the ends, namely, of race improvement. The Eugenics committee or Section of the Breeders Association will preserve by



virtue of its affiliations that ideal of hard-headed, critical, and practical study that characterizes the work of our best plant and animal breeders.

In the attempt to get facts the Committee on Eugenics is distributing blank family records, wherein may be recorded some 35 characteristics for each of these generations in the direct lines, and additional data for collaterals. These are sent to persons applying to the Secretary of the Committee, C. B. Davenport, Cold Spring Harbor, N. Y., who will send also, when desired, an additional copy to be retained by the collaborator. The records already returned to the Committee constitute a mass of data of the greatest value. Scores of pedigrees, many made out with the greatest care, far beyond the limits asked for in the blank form, have been presented, showing the inheritance of such special characters as stammering, hairiness, and peculiar finger movements. Already important generalizations have been made regarding the inheritance of certain diseases. But more facts are needed and volunteers are urgently called for.

CHAS. B. DAVENPORT.

### **EFFECT OF RECENT DISCOVERIES ON THE ART OF BREEDING.**

The breeder's art has been profoundly modified by discoveries made within the past decade, yet we are only at the beginning of a new era in which a knowledge of the principles involved gives us a science of breeding. Certain broad fundamental principles have been made out, but there is much detailed work which must yet be done before these principles can be applied universally. The first discovery of importance was, of course, that of Mendelian principles. These principles are three in number: first, the principle of dominance; second, the law of segregation of character pairs; third, the law of recombination.

The full extent to which these principles can be applied in breeding is not yet known. That they are important is evident to all. There is much yet to be done in working out the so-called unit characters. Although the principles are new, some important applications have been made of them. Breeders of Polled Hereford cattle are making deliberate use of Mendelian principles to their great advantage in dehorning one of the important beef breeds of the

country. Breeders of other polled breeds are generally familiar with these principles and are making use of them. Many new varieties of our leading crops have been produced by the deliberate application of the law of recombination. Some of the hybrid wheats produced at the Washington Experiment Station in this manner have assumed an important rôle in that state. Nilsson, at Svalöf, Sweden, is now engaged in producing new varieties of many crops, deliberately planning beforehand the combinations of characters he wishes to make. Many other practical breeders are doing the same.

One other very important principle, which has only been generally recognized within the last few years, is beginning to have a profound effect upon the practice of breeders. This is that selection within pure lines, either of vegetatively propagated crops, like potatoes, fruit trees, etc., or in self-fertilized species, like wheat and oats, is without effect in changing the characteristics of the crop, except for the rare evolutionary changes that occur in such species. Recent investigations indicate that these evolutionary changes are so infrequent that the only use the practical breeder can make of them is in the case of old varieties which have split up more or less into different types because of such changes. Selection enables the breeder to segregate the most desirable types in such a population.

One of the most important things accomplished by scientific discovery, in relation to the art of the breeder, is the dissipation of the old idea that practically unlimited improvement can be made by selection. It is now the consensus of opinion, amongst the leaders in this line of work, that selection can only accomplish the segregation of the best strains in the populations selected. It is only in cross-fertilized crops that marked effects can be produced in changing the character of the crop, and even in this case all that can be done is to secure the most favorable combinations of characters present in the original population.

There is, of course, danger of claiming too much for newly discovered principles. It remains for the future to demonstrate just how much value the discoveries hitherto made have to the practical breeder.

W. J. SPILLMAN.

# ASSOCIATION MATTERS

## THE OMAHA MEETING.

The Sixth Annual Meeting of the American Breeders Association was held at Omaha on December 8, 9, and 10, 1909, the Association being the guest of the National Corn Exposition. The meeting was well attended, in spite of a snowstorm which made travel difficult. The papers and discussions compared well with those of previous meetings. The same spirit of mutual interest between scientists and practical breeders and between breeders of plants and breeders of animals which has been manifest at all previous meetings was again abundantly shown.

The interest in the work of the Association expressed by the local press and by citizens and visitors at the National Corn Exposition demonstrated the cordial feeling which exists in the public mind toward the work of the Association. No previous meeting had accorded to it nearly the number of notices by the daily, agricultural, and scientific press as had the sixth annual meeting. It would seem that the American Breeders Magazine was to be born into a very congenial atmosphere.

Besides marking the time of the organization of a magazine, the Omaha meeting will be remembered as the date of the initial action to enlarge the scope of the Committee on Eugenics, by the proposal to make it into a third section of the Association. And whether the membership votes to change the Constitution at this time or not, the proposition marks the date of public recognition of this neglected but important line of inquiry. The election of Professor Hugo DeVries of Amsterdam, Holland, and Dr. William Bateson of Cambridge, England, to life membership is a matter of personal interest to their many friends on both sides of the Atlantic.

In the absence of the President, the Honorable James Wilson, Secretary of Agriculture, the Vice-President, Mr. William George of Aurora, Illinois, presided. In assuming the chair he called attention to the work of the Association and discussed the desirability of our country working out systems of pedigree breeding which will

better accredit our pedigreed stock so that they will be more in demand at home and abroad. Under his leadership members present made pledges to secure more than eleven hundred new members. These members are now making good their promises.

The papers presented will form the bulk of the scientific discussions in the four numbers of the American Breeders Magazine for 1910, and in the Annual Report. Some of the discussions of papers will also be given.

The following officers for the year 1910 were elected:

Hon. James Wilson, President, Washington, D. C.

Hon. William George, Vice-President, Aurora, Illinois.

Hon. W. M. Hays, Secretary, Washington, D. C.

Hon. N. H. Gentry, Treasurer, Sedalia, Missouri.

Dean C. F. Curtiss, Ames, Iowa, Chairman Animal Section.

Prof H. W. Mumford, Urbana, Ill., Secretary Animal Section.

Dr. H. J. Webber, Ithaca, N. Y., Chairman Plant Section.

Prof. N. E. Hansen, Brookings, S. Dak., Secretary Plant Section.

On motion the naming of the magazine was referred to the Council with power to act.

On motion of Dean J. H. Shepperd, the Council was authorized to present the compliments of the American Breeders Association to the American Association of Agricultural Colleges and Experiment stations, under whose auspices this Association was founded.

On motion of Messrs. Spillman and Shull, Professor Hugo DeVries, Professor of Botany in the University of Amsterdam, and Professor William Bateson of Cambridge, England, were elected honorary members. Both of these gentlemen have accepted this honorary membership.

---

The Association is peculiarly indebted to Mr. Charles Dickinson, of the W. A. Dickinson Seed Company of Chicago and Minneapolis, for the first contribution to be used in establishing the American Breeders Magazine on a basis commensurate with the work it has to perform. It was of material assistance in printing the first issue of the Magazine.

## THE COMMITTEES OF THE AMERICAN BREEDERS ASSOCIATION.

The membership lists of the committees of the American Breeders Association are now being revised. Suggestions are in order from any member as to the work of the existing committees, and as to new lines of work which might properly be taken up by committees.

It will be observed that most of the papers as well as the formal committee reports come to the Magazine and to the Annual Report through the committees. Thus the committee chairmen become assistant editors, and greatly enhance the value of the Association's publications. It is desired that the committees be made even stronger centers of work for the objects of the Association.

It is suggested that for the next year or two these committees which have charge of reporting on the improvement of classes of animals and classes of plants offer specific methods of breeding. Thus the Committee on Breeding Dairy Cattle might make a general committee report outlining a plan under which a private breeder can build up a herd of Jerseys, Guernseys, Holsteins, or other breed. The Committee on Breeding Sheep might offer plans prepared by different members outlining a method of procedure to be followed in forming a flock of pedigreed sheep, as of Rambouillets in Montana, a flock of Shropshires in Iowa, or a flock of Horned Dorsets in Michigan. The Committee on Breeding Fish might suggest a plan of improving a given species of Pennsylvania mountain stream trout; or a plan of producing hybrid breeds of trout. The Committee on Breeding Poultry might offer specific plans for building up families of Wyandottes, Orpingtons, or Leghorns with high annual egg laying efficiency. And the Committee on Co-operative Animal Breeding might outline a definite circuit breeding plan of producing high class drivers in the valley of Virginia.

In like manner, the Committee on Breeding Forest and Nut Trees might outline plans for breeding black walnuts in Kentucky, breeding pecans in Texas, and breeding birds-eye maple in Michigan. The Committee on Breeding Cotton might outline a plan under which the Oklahoma Experiment Station could produce varieties which would thrive under the relatively dry climate of western Oklahoma, or show how a farmer could breed varieties adapted to grow along

the northern zone of the cotton belt in Missouri and Tennessee. The Committee on Breeding Vegetables could outline a plan for breeding cantaloupes suited to grow along the northern zone of cantaloupe growing in Minnesota, Wisconsin, and Michigan. The Committee on Breeding Cereals could suggest the line of work which might be taken up in breeding wheat or oats at a branch experiment station, as at Crookston, Minnesota, or in Oklahoma.

The Committee on Breeding Forage Crops might offer a plan under which an experiment station in Illinois, Pennsylvania, Virginia, or Alabama might undertake to introduce and breed varieties of alfalfa suited to the several soil conditions of the State. And this same committee might offer plans under which a farmer might create a variety of alfalfa for the soil and climatic conditions of the county or valley in which he resides. Or this same committee might outline a plan under which the farmer or seed dealer in Minnesota can have his stocks of seed of hardy Minnesota alfalfa raised in Idaho and surrounding States and shipped to dealers for sale to his Minnesota farmer patrons.

The best types of this class of articles which will appear from time to time in the American Breeders Magazine and in the Association's Annual Report will give suggestions as to the form of such statements. The Association is now in position to assist in multiplying efforts at creative breeding. And on the quality of these statements as they may be published, and republished under revised form from year to year, much will depend. Their fruits will be in the form of more bread, meat, fruit, and fiber for the food and raiment of the whole people. The Association is attracting to its membership many men in foreign countries. Of no little interest and value will be their contributions to these practical plans for breeding specific animals and plants.

This class of subjects will greatly broaden out the contributions to the Magazine, by bringing out the thoughts of those practical breeders who are doing things in actually increasing values in this or that species, breed, or variety. The theoretical discussions from those who devote themselves to scientific work in heredity and breeding will be the more valuable because of the influence these writings will have among those practical breeders who are seeking mutations, and are building up new methods of controlling descent, and those who are introducing new plants and animals; or those who are es-

pecially interested in giving the widest dissemination to the most valuable standard varieties. Besides, it is only by the scientists' learning of the specific and general problems of practical breeders that they can gain for their work a practical direction.

The Secretary most earnestly requests that members communicate with him and with committee chairmen concerning this matter. If you have a plan which should be presented in the Magazine or Annual Report, or if you wish to make suggestions concerning specific plans for breeding a certain class of animals or plants, write your wishes to the officers of the Association.

### PROPOSED CHANGE IN THE CONSTITUTION OF THE AMERICAN BREEDERS ASSOCIATION.

Notice is hereby given to members that the following amendment to the Constitution of the American Breeders Association was proposed and discussed on December 9 at the Annual Meeting of the Association; and upon an affirmative vote of the Council is recommended for adoption by vote of the members of the Association:

In Article IV of the Constitution in two places put a *comma* in place of the word *and*, between the words *Plant Section* and the words *Animal Section*; and after the words *Animal Section* where first used, place the words *and a Eugenics Section*, and where used the second time, the words *and of the Eugenics Section*; and change the word *seven* to the word *nine*; and change the word *either* to the word *any*.

In Section XIII of the By Laws put a *comma* in the place of the word *and* between the word *Plant* and the word *Animal*, and place the words *and Eugenics* between the word *Animal* and the word *Section*. In Section XV remove the word *and* between the words *Animal Section* and the words *to the Plant Section*, and after the words *Plant Section* insert the words, *and to the Eugenics Section*; and substitute the word *shall* for the word *will*.

This amendment proposes to raise the status of the Committee on Eugenics to a third section of the Association, along with the Plant Section and the Animal Section. The argument is made that this section is growing so rapidly in its work that the sectional organization with committees, rather than the committee organization with sub-committees, would facilitate and strengthen its work. Those most

concerned have expressed the belief that a section of the American Breeders Association provides at present more logical auspices for this movement than would a separate organization. The Committee on Eugenics has grown rapidly and now has nearly twenty members. There are six or eight sub-committees, each of which would become a committee. This will also raise the number of members in the Council from seven to nine by the addition of the Chairman and the Secretary of the Eugenics Section.

The ballots will be mailed to the members after this number of the Magazine is mailed. All members whose dues have been paid for the year 1910 and who return their votes within thirty days after this notice is mailed are entitled to vote. Please indicate your vote, sign, and mail to the Secretary's office at your early convenience.

W. M. HAYS, *Secretary.*

*For the Council.*

---

## **MEMBERSHIP IN THE AMERICAN BREEDERS ASSOCIATION.**

The fiscal year of the Association begins December 1st of each year.

Members are entitled to the Annual Report issued in the fiscal year in which membership is taken.

Unless wish is expressed by a new member at the time of joining, to have the Magazine begin with a certain number, the first number sent will be of the issue nearest the date of receipt of membership.

---

## **THE ANNUAL REPORT.**

The supply of Volumes I, II, III, and V of the Annual Report in the office of the Association is exhausted. A number of Volume IV are still on hand and can be furnished to new members and others at the price of \$2.00 per copy post paid.

Volume VI will be published at the end of the year. Separates of any article will be printed at actual cost, at the author's request.



# *The American Breeders Magazine*

*Issued Quarterly for Practical and Scientific  
Breeders of Animals and Plants*

*Edited by Willet M. Hays, N. E. Hansen, and H. W. Mumford*

Developments in the science and practice of breeding are coming so rapidly that some vehicle for placing new facts quickly in the hands of live breeders has become essential. The American Breeders Association has, therefore, established this Magazine, to be distributed to its members without extra charge. For the present it will appear quarterly, but the Association hopes to make it a monthly.

News of the world is to be given—news of interest to breeders, both those who deal with animals and those who deal with plants. Original reports on research results and practical achievements are to form the body of each number. In the next number leading articles will be:

**A THEORY of Mendelian Phenomena**

By **Prof. W. J. Spillman**

**A NEW Hybridization Method in Corn Breeding**

By **Dr. George Harrison Shull**

**BREEDING of Grain Sorghums**

By **Prof. Carleton R. Ball**

**INHERITANCE of Hatching Quality of Eggs in**

Poultry

By **Dr. Raymond Pearl**

**REPORT of the Committee on Eugenics**

By **Dr. C. B. Davenport**

For early publication the following are promised:

**BREEDING Citrus Fruits**

By **W. T. Swingle**

**COOPERATION in Animal Breeding**

By **W. M. Hays, J. H. Shepperd, Colon  
C. Lillie, and Walker McKean**

**INDIAN Cattle in the United States**

By **A. P. Borden**

**TOBACCO Breeding**

By **A. D. Shamel**

These are only a few of the articles which will appear in coming numbers of the Magazine. Some of these were read at the last meeting of the Association at Omaha, Nebraska; some are being specially prepared for the Magazine and the Annual Report. Each article is one of vital interest, deals with a live subject, and is a distinct addition to the sum of the knowledge of breeding and heredity.

*Address AMERICAN BREEDERS ASSOCIATION  
Washington, D. C.*

# The American Breeders Association

## OFFICERS

HON. JAMES WILSON, President

WM. GEORGE, Vice-President

W. M. HAYS, Secretary

N. H. GENTRY, Treasurer

---

**T**HE AMERICAN BREEDERS ASSOCIATION is a cooperative association designed especially to develop the science of breeding and heredity and to bring that scientific knowledge to students of heredity, to the practical breeders of pedigreed animals and plants and to others interested in these subjects. It affords a means for conference among the members of the Association.

The membership is composed of progressive breeders, scientists, teachers, and others interested in all phases of heredity of plants, animals and men and the improvement of methods of breeding. The best investigators in the science of heredity and breeding and the best practical breeders of pedigreed live-stock and plants freely cooperate through the Association and donate the time required to make investigations, to prepare papers, to attend the annual meetings and to help build up the literature of the science and practice of breeding, thus to produce the largest results possible in the form of better animals and plants.

All persons interested in its work are cordially invited to become members of the American Breeders Association.

Membership entitles the holder to the American Breeders Magazine, to the annual report of the Proceedings of the Association, and to full participation in the activities of the Association.

**Membership: Annual, \$2.00; Life, \$20.00**

**No entrance fee.**

**Address AMERICAN BREEDERS ASSOCIATION  
Washington, D. C.**

WASHINGTON, D. C.

1910

# AMERICAN BREEDERS MAGAZINE

---

---

Published by the American Breeders Association

*A Theory of Mendelian Phenomena*

PROF. W. J. SPILLMAN

*New Hybridization Method for Corn*

DR. GEORGE HARRISON SHULL

*Indian Cattle in the United States*

A. P. BORDEN

*Report of Eugenics Committee*

DR. C. B. DAVENPORT

*Breeding and Use of Tree Crops*

PROF. J. RUSSELL SMITH

*Hatching Quality of Eggs*

DR. RAYMOND PEARL

Second Quarter

April, May, June

Vol. I

No. 2

# *The American Breeders Association*

## *OFFICERS OF THE ASSOCIATION*

### *President*

HON. JAMES WILSON, Washington, D. C.

### *Vice-President*

HON. WILLIAM GEORGE, Aurora, Ill.

### *Secretary*

HON. WILLET M. HAYS, Washington, D. C.

### *Treasurer*

HON. N. H. GENTRY, Sedalia, Mo.

### *Chairman Plant Section*

DR. H. J. WEBBER, Ithaca, N. Y.

### *Secretary Plant Section*

PROF. N. E. HANSEN, Brookings, S. Dak.

### *Chairman Animal Section*

DEAN C. F. CURTISS, Ames, Iowa.

### *Secretary Animal Section*

PROF. H. W. MUMFORD, Urbana, Ill.

### *Chairman Eugenics Section*

DAVID STARR JORDAN, Stanford University, Calif.

### *Secretary Eugenics Section*

C. B. DAVENPORT, Cold Spring Harbor, N. Y.



### *EDITORS*

WILLET M. HAYS, Secretary of the Association

N. E. HANSEN, Secretary of the Plant Section

H. W. MUMFORD, Secretary of the Animal Section

C. B. DAVENPORT, Secretary of the Eugenics Section

*Address Communications to American Breeders  
Association, Washington, D. C.*

*Membership: Annual, \$2.00; Life, \$20.00;  
Patrons, \$1,000.*

# The American Breeders Magazine

Published Quarterly by the American Breeders Association

FOR THE USE OF ITS MEMBERS

PRICE OF SINGLE COPIES, FIFTY CENTS

Address communications to American Breeders Association, Washington, D. C.

Vol. I.

Second Quarter, 1910.

No. 2.

## CONTENTS.

	PAGE.
Francis Galton (portrait).....	78
Heredity: Creative energy.....	79
Galton, Vilmorin, and Wallace (biographical).....	80
Pierre Louis Francois Leveque de Vilmorin (portrait).....	81
John H. Wallace (portrait).....	83
Breeding and Use of Tree Crops. J. RUSSELL SMITH.....	86
Indian Cattle in the United States (illustrated). A. P. BORDEN.....	91
Improvement of Bermuda Grass (illustrated). L. A. MOORHOUSE.....	95
Hybridization Methods in Corn Breeding (illustrated). GEORGE HARRISON SHULL.....	98
A New Zebra Hybrid (illustrated). E. H. RILEY.....	107
Report of Committee on Breeding Vegetables. W. W. TRACY.....	110
A Theory of Mendelian Phenomena. W. J. SPILLMAN.....	113
Report of Committee on Eugenics. C. B. DAVENPORT.....	126
Inheritance of Hatching Quality of Eggs in Poultry. RAYMOND PEARL.....	129
Insect Breeding. VERNON L. KELLOGG.....	133
Hybridizing Game Birds in Captivity. WALLACE EVANS.....	135
EDITORIALS:	
The Field of the Breeder. DAVID STARR JORDAN.....	138
Breeding: A Great Economic Movement.....	140
Making of Hybrids.....	141
The Section Organization.....	143
The Movement to Study Eugenics.....	143
Narrow Limits for Breeding Men.....	143
An Office for Eugenics Records.....	145
NEWS AND NOTES:	
Heredity in School Children.....	146
Two New Varieties of Winter Rye.....	146
Improvement of Bees in Hawaii. E. F. PHILLIPS.....	147
Cornell Poultry Building.....	148
James L. Reid, Breeder of Corn.....	148
Breeding Poultry for Egg Production. W. M. HAYS.....	149
ASSOCIATION MATTERS:	
Good Words.....	151
Association Publications.....	152
Send in Titles of Papers.....	152
The New Eugenics Section.....	153
Constitution of the Association.....	153

[Copyright, 1910, by the American Breeders Association.]

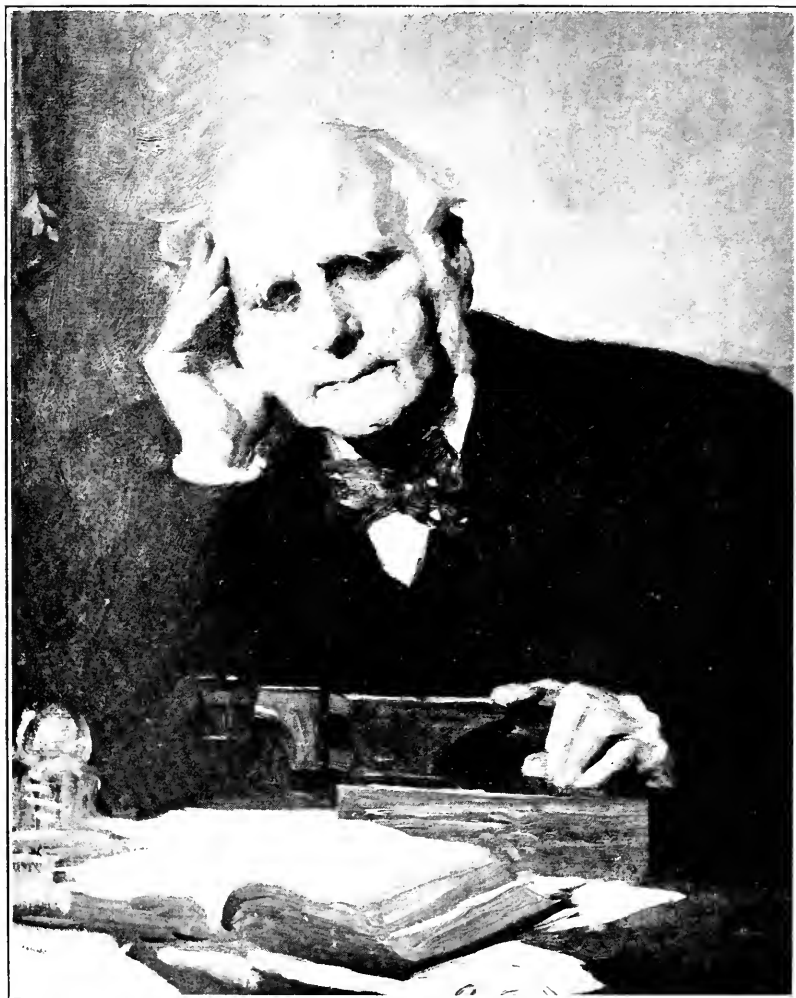

FRANCIS GALTON.

# THE AMERICAN BREEDERS MAGAZINE

"Evolution ever climbing after some ideal good,  
And Reversion ever dragging Evolution in the mud."—TENNYSON.

Vol. I.

Second Quarter, 1910.

No. 2.

## HEREDITY: CREATIVE ENERGY.

The heredity values of specially bred strains of plants and animals are as real as the seemingly more concrete values of land or goods. Potent economic values run through generation after generation as persistently and as irresistibly as the river runs from its many springs to the sea. Unseen carriers of heredity determine whether the product shall be large or small, of high or low quality, lovely or homely. Their value to the nation is far above that of gold. Gladly we pay high prices for new "blood" in plants or animals because through the sure and potent agency of heredity the enhanced values continue during succeeding years. Heredity is a force more subtle and more marvelous than electricity. Once generated it needs no additional force to sustain it. Once new breeding values are created they continue as permanent economic forces.

## **GALTON, VILMORIN, AND WALLACE.**

Francis Galton, Pierre Louis Francois Leveque de Vilmorin, and John H. Wallace stand as three prominent pioneers in the development of heredity and breeding. Galton is a great scientist whose crowning work was the introduction of statistical methods in the statement of human heredity values. His application of these methods to performance records and the distribution of "talents" in the human breed, has made possible the science of eugenics and placed it upon a practical working basis.

Louis Vilmorin is best known by his remarkable achievement of transforming the common beet into a sugar beet, making it the basis of a great temperate-zone industry. He also originated the centgener method of plant breeding.

John H. Wallace stands beside Louis Vilmorin in first comprehensively introducing centgener performance in the selection of breeding animals. He taught horsemen the value of the blood of sires and dams in the first and later generations of progeny, and also the value of authenticated records of performance made at trotting races. He taught the American breeders of live stock the centgener method of finding the projected breeding efficiency of those rare animals whose blood has a special value among the breeds of our live stock.

### **FRANCIS GALTON.**

**B. 1822.**

Francis Galton belongs to the group of evolutionary scientists who during the last half of the nineteenth century extended the boundaries of science and opened up new domains of research. He is one of the great constructive scientists. Francis Galton studied medicine, graduating from Trinity College, Cambridge, England, in 1844. He spent several years in African travel, taking part in an exploration up the White Nile and also in southwestern Africa. He afterwards engaged in the study of meteorology and was the first to attempt to chart weather conditions on an extensive scale. He wrote a comprehensive work on meteorology.

However, his fame and success rest mainly on his researches in anthropology and eugenics. His writings on eugenics—and they are classic—have thrown open entirely new fields of thought and re-





PIERRE LOUIS FRANCOIS LEVEQUE DE VILMORIN.

search. It was he who first conceived the possibilities of eugenics as applied to the human family, and he was practically the founder of this new branch of science. The ingenious statistical methods which he devised for stating facts of heredity in man are coming to be employed in connection with plant and animal heredity. Concerning the law of "frequency of error," Galton declared that "if it had been known to the Greeks it would have been personified by them and deified." He established and endowed a laboratory of eugenics at the University of London, with research fellowships and research scholarships, and the excellent work proceeding from that institution is largely responsible for the rapidly growing interest in eugenics in Europe and in fact in all civilized countries.

**PIERRE LOUIS FRANCOIS LEVEQUE DE VILMORIN.**

1816-1860.

The Vilmorins who founded the great Andrew Vilmorin Company, of Paris, France, are descended from one of the oldest families in the province of Lorraine. The family is proud of its records, which are authentically traced back to 1633. It is particularly proud of its succession of men who have attained distinction in the improvement of the seed stocks of the agricultural crops of their country, benefits which, in the nature of things, are shared by the whole world.

The first plant and tree catalogue published in France was written by Philip Victoire de Vilmorin in 1771. He was one of the founders of the firm that later was to become famous. This catalogue contained the names and descriptions of hundreds of varieties of the world's medicinal, agricultural, garden, and ornamental plants and their proper mode of cultivation. This publication is said to have had a marked influence on farming in France.

The establishment passed from Philip into the hands of the son, Andree (1776-1862), who was at once student, worker, and business man. In 1843 his son Pierre Louis Francois Leveque de Vilmorin took charge of the business interests of the firm and carried it on until his death, which occurred in 1860, two years before the death of his father, Andree.

In 1866 the firm, then a great plant breeding establishment, passed into the hands of Henry, the son of Francois; and at his death in 1899 Philip, the son of Henry, became the successor in this re-



JOHN H. WALLACE.

markable line of descent whose men combined scientific and business attainments in a most unusual degree.

Pierre Louis Francois Leveque de Vilmorin, the subject of this sketch, originated, as stated above, that phase of statistical methods in plant breeding which uses performance records to determine the projecting power of parents through excellence manifested in their progeny. He dealt chiefly with two problems. One was to collect varieties of grains from all parts of the earth, and plant them for a general comparison, that he might select those with greatest value to the farmers of his country. The second was, by breeding, to discover from among the plants or varieties those which would give strains or varieties more useful than the original foundation stocks. His work in improving the sugar beet and making a commercial possibility of beet sugar gave his name an enduring place in history. A place in this trio of noted men is given him because, so far as the editors know, his work in sugar-beet breeding introduced the cent-gener method of plant breeding. He selected many roots the juice of which upon analysis showed, along with a large yield, a high percentage of sugar and a low percentage of solids other than sugar. Seeds from each of these roots were then separately planted. Out of the rows in which the roots showed a high yield of sugar and a high coefficient of purity he selected mother plants for the next generation for scientific breeding.

#### JOHN H. WALLACE.

1822-1903.

John Wallace's fame for his share in the work of creating the American Trotting Horse will endure as long as the harness horse is admired and used. His long connection with the American Trotting Horse Register, *Wallace's Monthly*, and the Trotting Horse Year-book—creations of his own activity—and the handling of thousands of pedigrees and much horse-breeding literature gave him a peculiarly clear and extensive insight into breeding problems. In Volume II of Wallace's American Trotting Horse Register he gave expression to his ideas on breeding in an article of seventy pages on "How Should We Breed the Trotting Horse?" In that article was set forth for the first time so far as the editors have information, the use of the cent-gener method as a means for determining potent lines of descent

in animals. The application of this knowledge has been carried forward in a most remarkable way in the breeding of the Trotting horse.

John Wallace was born and brought up on a farm in Allegheny County, Pennsylvania. He left the farm at the age of 17 and settled at Muscatine, Iowa, in 1846. In 1848 he was chosen secretary of the Iowa State Agricultural Society. He compiled the pedigrees of American Thoroughbred horses and published only one volume. Then, his interest turned to the Trotting horse, and he published Volume I of the American Trotting Horse Register in 1871. Under very great difficulties he held to authenticated records and thereby placed the pedigrees of Trotting horses on an accredited basis, thus practically creating a breed of horses selected by means of performance records. Volume II of the Register was published in 1873-74. Some years later he sold his interest in the American Trotting Horse Register, in *Wallace's Monthly*, and in the Yearbook to the American Trotting Horse Register Association.

## BREEDING AND USE OF TREE CROPS.

J. RUSSELL SMITH.

The United States interests us as the home of man, and our chief means of using it for that end are agriculture and forestry. In both of these fields we are very far from having attained any approach to perfection in the adjustment of our efforts to our resources.

As a step toward the better adjustment of our partly adjusted or at times maladjusted agriculture, I call your consideration to the value of tree crops—trees that live for decades or generations or even for centuries, but have their chief usefulness in the annual crop of fruit or nuts to use as forage for beast and food for man. These tree crops can in many places be profitably substituted for the annual crops that now dominate our agriculture to an injurious extent.

The scope and breadth of this scheme is a handicap to its easy execution. It involves not only plant breeding but much experiment in crop adjustment and farm management. It touches many fields of already organized enterprise, such as the national and state work in forestry, pomology, forage-plant investigation, animal husbandry, and farm management. It must be assisted by the entomologist, the students of fungi, and the specialists in technical research in that great field in which the state and national Departments of Agriculture work.

The possible material for the development of this class of crops includes all useful trees. The possible area of its usefulness includes all hilly land and probably some flat land as well.

I. *The first line of work suggested is the breeding of special strains of tree crops.*

Nature has produced numerous collections of trees each containing within hybridizing limits the most astonishing variety of qualities which we now know how, by breeding, to combine into rare parent trees that are the basis of the varieties of cultivation.

Some of the tree crops which may be utilized are as follows:

1. *Chestnuts.*—These supply both forage for stock and food for man. The work should consist in (1) breeding new varieties—Japanese and hybrids between Japanese and American for sheep, hog, and cattle food, as all these animals eat these nuts greedily from the ground. Some nuts grow large as hen's eggs and trees are

prolific bearers, early bearers, and hardy. (2) Breeding better flavored selections and hybrids for human food. Several hundred thousand square miles of our eastern hills might be made nearly as productive as the corn belt. The Italian yield of chestnuts averages 12 bushels per acre. The price is always above that of wheat. The value of European mountain-side chestnut orchards equals acre for acre the Illinois corn belt.

2. *Walnuts*.—Breeding of new varieties—hybrids of American black, Japanese, Persian and Chinese. Small areas of moist fertile slopes totaling many million acres, east and south, might produce a nut nearly or quite as good as the Pacific Coast Persian walnut. Many persons regard the flavor of the American black walnut as highly desirable. Its shell needs breeding down.

3. *Hickories*.—Breeding new varieties for human food and pig feed—hybrids of shellbark (a much prized nut which even with a thick shell brings a high price); some western hickories (larger than a black walnut), and some Kentucky nuts with large meats, good flavor, and shells so thin that they can be crushed in the fingers. Moist mountain slopes and fertile corners might yield a nut as good as the pecan, all over the south, east, and north where the hickory grows.

4. *Mulberry for forage*.—Breed new hybrids, and experiment with existing ever-bearing mulberries as pig, sheep, and poultry food, during the whole period of summer months. It might be possible to utilize a total area of 700,000 square miles in the South and southeastern United States. Louisiana has shown a mulberry grove to be worth \$12 or more per acre per year for pig feeding with no labor.

5. *Sugar maples*.—Breeding and search for superior varieties. It is almost certain that strains of great superiority may now be found and used as a basis for varieties high in sugar. It is also possible that sugar maple is amenable to improvement similar to that which has taken place in the sugar beet. The experiment should be tried. This species thrives from Maine to Indiana.

6. *Persimmon*.—Breed new hybrids, and experiment with existing varieties for pig, sheep, and poultry food during fall and winter months. The long adherence of this fruit to the tree gives it especial value after frost has incapacitated most other vegetation. As an automatic pig feeder the steady dropping of persimmons from Decem-

ber to March is hard to beat. At present it is a persistent tree weed that fattens thousands of opossums each autumn. For human food, already the Japanese have developed persimmons as large as peaches and of acceptable flavor.

7. *Oaks*.—The acorns in the oak forests of Europe have been fattening hogs ever since our ancestors wore clothes, and California farmers regularly gather and store certain acorns for forage. Improvement can be made through hybrids and selections for heavy acorn yielders. Hilly lands throughout probably one-third to one-half of the United States may be utilized.

8. *Beech*.—What has been said of the oaks applies also to the beech except that its range is narrower and more northern.

9. *Hazel nuts, filberts, pine nuts, etc.*—These offer inviting possibilities to the breeder who would create both forage and food crops.

10. *Foreign species*.—Careful work by agricultural explorers will reveal many species to combine with our own and add important qualities in this breeding. It is probable that there are many other types of tree crops that can be evolved, such as hillside basket wood, bush forage where grass will not do well, Japanese or other bush paper plants, etc.

II. *The second field of work is the adjustment of tree crops that have already been evolved.*

There are two camps of fruit growers: (1) The cultivators, whose policy works to the ruin of hilly land and tends to make fruit growing push out other cultivated crops on best land. (2) The sod mulchers, who grow good fruit in old pastures without the use of the plow. The latter group are heretics, but their scheme certainly works into the conservation movement and some of them are making good. Just how far and under what conditions, with what varieties, or what kinds of stocks it will work, it is impossible to say, but to work out its limits requires a vast deal of experiment running through several decades. It is possible that most of the fruit needed in the United States can be grown on hillsides without in any way eroding them. If this can be done it will be a great gain to our national resources, in which the hillside gully is making one of the most irreparable inroads. This problem can have much light thrown upon it by the careful study by well trained men of some hundreds or thousands of existing orchards in the United States today.



It is only because of the short view and preconceived notions that we depend for animal forage entirely on annual tillage crops and a few perennial grasses. Letting trees continue idle is like keeping geldings when you might have brood mares.

Forty shade trees down the lane may produce nothing but the grace of the elm or the well nigh worthless soft wood of the maple. After a little tree breeding is done, they may shower down each autumn 40 bushels of hickory nuts, walnuts, or chestnuts worth from \$50 to \$100 or even more.

Ten shade trees in your pasture may in the autumn drop only dead leaves; or they may be of varieties yielding a crop more valuable than the profits on 3 acres of pasture.

Your wood lot and your wind-break may yield an occasional pole, log, or load of wood; or it may have wood as a by-product, and have its chief yield in the form of pork, mutton, or poultry, or a directly salable nut.

Kafir corn and durum wheat have yielded great service to certain sections of the West, but the full development of tree crops during the next 40 years will render a service to some part of every State in the Union, and at least a dozen States have half or more of their area which is rebellious to the plow because of a rocky, rolling, or steep surface which increases labor, reduces the yield and will in time cause the whole hillside to wash away if plowed regularly.

I want to see the elimination of the countless millions of barren maples, cotton-woods, and willows, and their replacing by trees of equal hardiness, equal or better wood value, and useful annual fruitfulness.

Virginia mountain sides with sod-grown apple crops worth \$200 net cash per acre, the profitable sugar orchards of rugged New England and the mulberry-fed pigs on the sandy hillsides of Louisiana should be the rule, not the rare exceptions.

Tree crops offer a practically virgin field for the plant breeder. The breeders of cereals have recently expressed hope for 15 or 25 per cent increase in production as result of their arduous labors. In the field of tree crops we have as a beginning an indefinite number of naturally developed parents with strong and useful characteristics fully developed and awaiting the hand of the hybridizer, who can thus give a harvest to hundreds of millions of acres of practically unused, or quarter used, or shamefully abused land. With these

crops the now practically abandoned hillsides can take their place beside the wheat fields of the West in their contribution to the welfare of the American people.

Then after the good varieties are bred up, their use needs systematizing so that the owner of the now useless or gullying hillsides may easily find out the proper hardy varieties and the proper proportion of his land to plant in nut, fruit, or sugar trees so that he may have the right succession of jobs in his reduced amount of farm labor, and also the best succession of workless harvests for his animals to walk around and fatten upon. In addition to increase of production of food and wood, this tree breeding fits right into the movement for the conservation of resources. It puts the binding tree roots into the hillsides where now the misplaced plow is the mother of gullies.

The gully, the destroyer of soil, is the worst of all resource waste because it is often the irreparable destruction of the one indispensable resource. If the forest is burned we can raise another; if we use up our coal and iron we may find substitutes; but there is no substitute for soil, from which we get all our food, our clothing and most raw materials of industry.

The gully, with its yearly harvest of millions of tons of down-carried, channel-filling mud, is the worst enemy of river navigation, and we are just beginning to appreciate the importance of river navigation.

Tree crops will further serve the conservation movement by controlling stream flow so as to aid both navigation and irrigation.

Two great handicaps that afflict this work are its slowness and unprofitableness to the individual who does the work.

If it were a new method of breeding animals some enterprising citizen of Illinois would be selling high-priced boar pigs in 5 years, and making a snug profit. A diligent plant breeder might in 10 or 20 years evolve new varieties of chestnuts, walnuts, and hickory nuts which could eventually be worth \$50,000,000 per year to hilly West Virginia, but the original creator of all these varieties probably could not make \$500 out of the lot. It is work which government, both national and state, must attend to. That alone is the reason why it has so long remained undone.

There is a great deal of work now being done along some of these lines by both State and Nation. I am convinced that it needs

to be extended, strengthened, correlated, and directed toward definite problems. Just how this harmonizing of dozens of bureaus and institutions can best be done, I, as a layman, do not feel able to say. That problem is one for the existing state and national organizations to take up and I hope they will see fit to do so at an early date.

---

## INDIAN CATTLE IN THE UNITED STATES.

A. P. BORDEN, *Pierce, Texas.*

The zebu or humped cattle of India form a distinct species and are scientifically classed as *Bos indicus*. Darwin in his work on animals and plants under domestication says that the zebu was domesticated as may be seen on the Egyptian monuments at least as early as the Twelfth Dynasty, that is, B. C. 2100. Some time in the early fifties a few animals of this breed, familiarly known as Brahma cattle, were brought into this country, and their offspring then distributed all along the Gulf coast. Observing stockmen soon learned that they stood the climatic conditions and insect pests better than any other breed. From time to time there has been a bull or two obtained from shows and added to the breeding herds of the Gulf coast country.

In 1904 Hon. James Wilson, Secretary of Agriculture, made a visit to Texas and after seeing the condition of the Brahma grade cattle as they then existed on the ranch of A. H. Pierce and comparing them with the beef breeds found on the same ranch had a special permit issued to A. P. Borden, executor of the estate of A. H. Pierce, for the importation of some purebred animals direct from India. The story of the permit for importation, my trip to India, the purchase of the fifty-one head of animals, their arrival in New York, their quarantine on Simonson's Island and their final release would make an interesting tale. The points of practical interest are that the cattle were bought with difficulty in India and could not there be tested. When put in quarantine on an island outside the harbor of New York, it was necessary to be at the expense of a long quarantine period to be sure that all brought to the mainland were free of the dread disease *surra*, which is even a more serious disease in horses than in cattle.

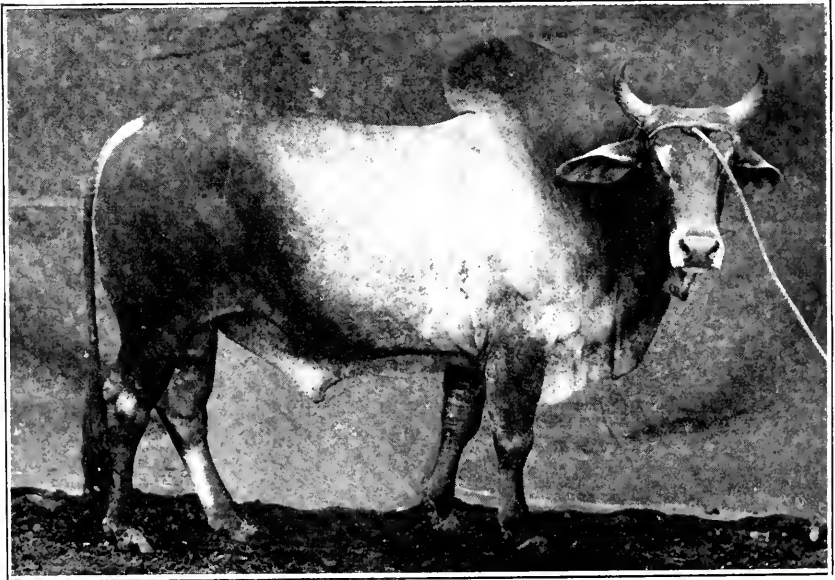
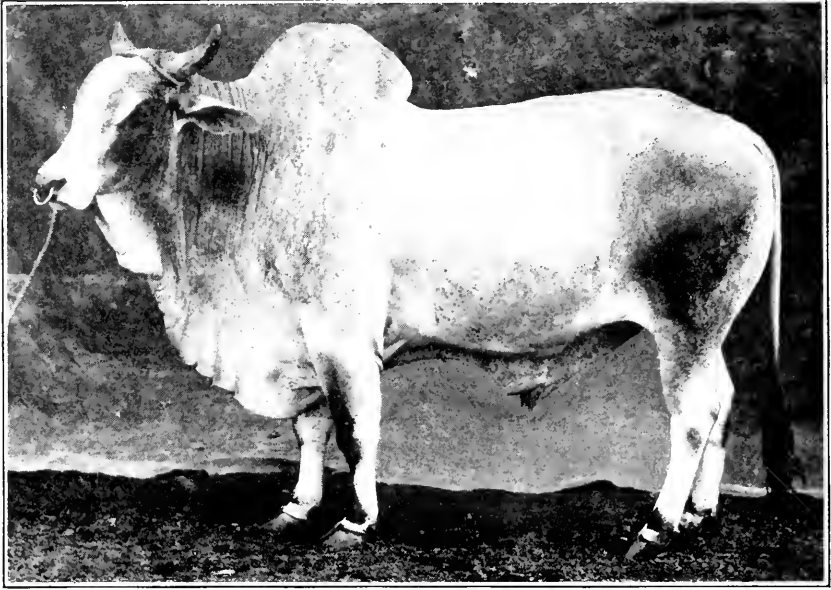

TWO TYPICAL BRAHMA BULLS.

This importation landed in New York in June, 1906, and in south Texas in November of the same year. It consisted mostly of young bulls. Upon arrival in Texas the cattle were first tested for Texas fever by Dr. Francis of our State Agricultural and Mechanical College. After carefully watching them for ten days he pronounced them to be free from Texas fever. This opinion proved correct, for in the three years since they were imported there have been no signs of this fever. The herd was divided as equally as

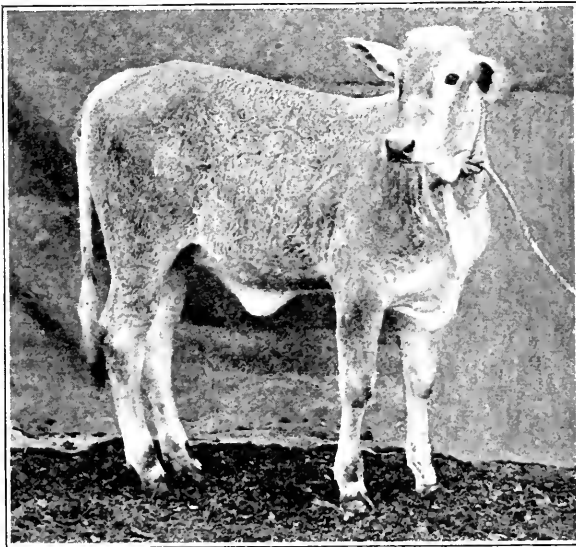

CROSSBRED CALF: BRAHMA (HISSAR) ON TWO-YEAR-OLD TEXAS HEIFER.

possible between Mr. O'Connor and the Pierce estate, who jointly had shared the expenses of the importation. I have not seen Mr. O'Connor's cattle, but he tells me they have more than met all his expectations. The object of the importation was to find a race of animals which would resist the insect pests of this section of the country, the principal one of which is the tick which causes Texas fever. These bulls were bred to the best cows on the Pierce range and to a bunch of Hereford cows in 1907 and again in 1908. The crop of calves in 1908 were fine and did remarkably well. We are in the business of raising cattle on the open range where they must care for them-

selves most of the year. Crosses of these native and grade cattle with the best European beef breed grades do well in the feed lot, yet for the range we find them delicate and susceptible to the ravages of the tick. To make a fair test of the Brahma cattle I turned the bulls on the range with the best cows I could procure in this section of the country, mostly high grade Herefords. These cows were covered with ticks all the year and as we had no dipping vats we had no way to remove them. We would occasionally find small ticks on the bulls, but were never able to find a fully developed tick on them. The first crop of calves at this writing, November 17, 1909, is from 14 to 20 months old. They have been in tick infested pastures with ticky cattle all their lives, but they fail to carry any ticks to maturity as far as I can see. It is only occasionally that we ever see a tick on one of these animals. This first crop of calves, about 300 in number, has grown upon the range as all our cattle and they are fully 50 percent heavier than our ordinary range calves. They are as heavy as the calves a year older out of the same mothers, but sired by purebred Hereford bulls. The crossbred animals are smooth, with very strong constitution, are good rustlers, of rapid growth, and are animals that have courage enough to look you in the face when you go about them. The results are better than I expected. It may be claimed for these cattle that they have the power of immunity from Texas fever. They stand a tropical and sub-tropical climate better than the other breeds of cattle. They have the power of transmitting the tick-resistant quality through several generations. An animal with only an eighth or a sixteenth of the Brahma blood in his veins shows ability to thrive in this climate. Several Indian breeds are represented in this importation. Some of these are shown in the illustrations herewith. I wish to state that I am under many obligations to Secretary Wilson and other officers of the Department of Agriculture and also to the Chairman of the Committee on the Introduction of Plants and Animals of the American Breeders Association, Mr. David G. Fairchild, whose letters of introduction and assistance were of service to me.

## IMPROVEMENT OF BERMUDA GRASS.

L. A. MOORHOUSE, *Oklahoma Agricultural Experiment Station.*

Bermuda grass is a plant which has not been carefully studied from the viewpoint of the plant breeder; hence most of the fields that may be found in Oklahoma contain a large number of types which might properly be classified as varieties. Even areas which have been planted with the Hardy Bermuda, a selection that will stand comparatively low temperatures during the winter season, carry more than

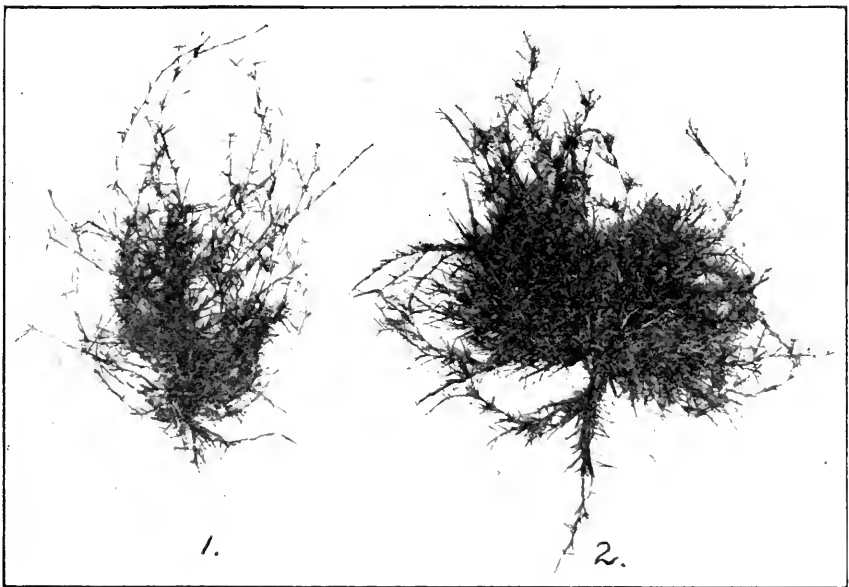

TYPES OF BERMUDA GRASS.

one type or variety, and in many instances these types have characteristics that are widely divergent. Inasmuch as improvement in plants which can be propagated by cuttings may be brought about by isolating individuals which have desirable forms and are known to be highly productive, it is certain that varieties of Bermuda grass, superior to the average mass or general planting, can be produced.

### THE BASIS OF SELECTION.

Bermuda grass has several uses, and these should be considered in making selections for specific purposes. When this grass is to

be set on hillsides, on roadsides, or on pond banks, in order to prevent excessive erosion, a type which has a tendency to spread rapidly and one that has pronounced binding qualities should be singled out. For a pasture grass, a strain should be chosen which will start early in the spring, and it should continue to produce liberal supplies of forage throughout the growing season. Although Bermuda grass has been planted mainly with such objects as those mentioned, it can be grown for the production of hay, and varieties should be produced which grow tall and produce heavily of dry forage. Still other types may be developed for lawns or parks.

#### EXPERIMENTAL EVIDENCE.

During the summer of 1909 the Oklahoma station selected several distinct types and planted these types in separate rows for further study. While these varieties were started rather late in the season, and were, therefore, checked in their growth by the dry weather, the characteristics of the respective strains could be traced from the beginning of the summer down to the middle of October, at which time several plants were photographed. These types are shown in the accompanying figures. Plant No. 1 represents the spreading form and would undoubtedly answer well for soil areas which are subjected to washing. A splendid hay type is found in No. 2, which produced a very dense growth of upright stems or branches. Plant No. 3 differs from No. 2 in that the growth is not as dense and the stems are very coarse. Nos. 4 and 5 are extreme types of No. 1. They could not be used to advantage for hay, nor are they suitable for pasture fields. In Plant No. 6 we have a type which forms an exceedingly close turf, and with this characteristic apparently well established it ought to make a perfect grass for lawn or campus.

#### METHOD OF STARTING SELECTED TYPES.

The initial step in securing improved strains will include the selection of 100, or, better, a much larger number of plants which appear to have the proper characteristics. It will be well to thus choose mother plants from a number of fields, somewhat widely separated, choosing any varieties which may be known to have special value for heavy yield, hardiness in winter, etc. These are taken from the general field, and after the roots or portions of the stems have



been cut into small pieces, the cuttings, or "clons," from a single plant can be set in a row 25 or 50 feet in length, leaving a space of some 18 inches or 2 feet between the plants in the row. The rows should be located at least 4 feet apart; 5 feet would be a more suitable distance, especially in cases where the grass sends out long, creeping stems.

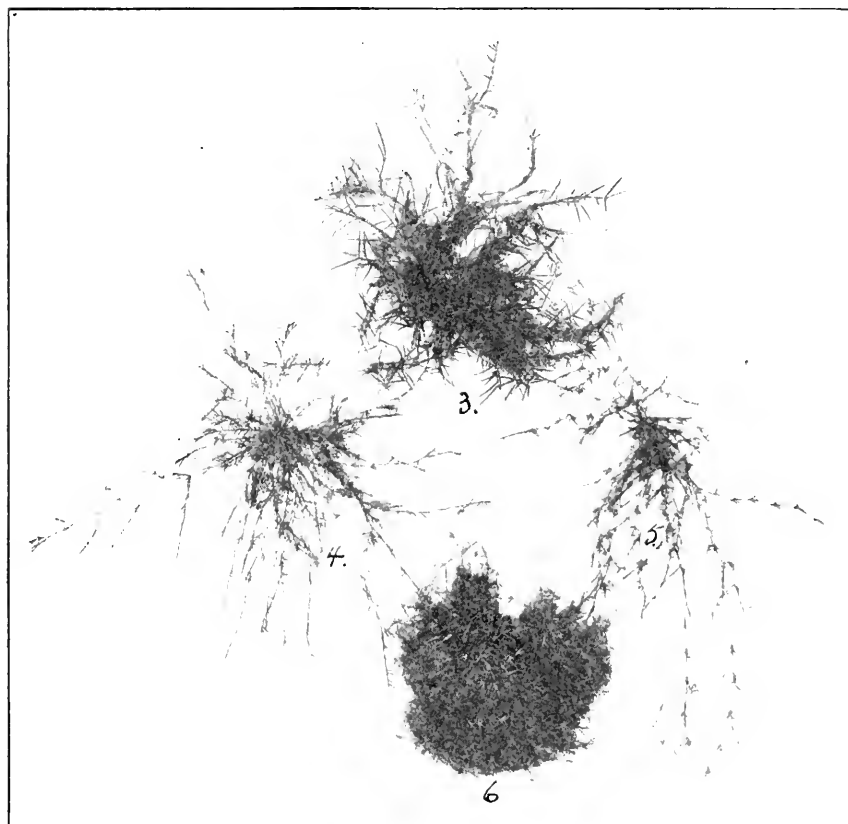

TYPES OF BERMUDA GRASS.

A nursery number is given to each mother plant, and the row planted from it is marked by that number. It is needless to recommend that the plantings be made on well cultivated soil. In fields which receive good cultivation the plants will certainly have a chance to come through the season in more vigorous form, and the contrast

between types ought to be greater under such conditions, thus affording an opportunity to isolate the more promising forms. It is not advisable to manure the land heavily prior to setting with grass, but some care must be exercised in choosing an area of uniform fertility.

#### PLANTING THE INCREASE PLAT.

After growing the nursery stock in the manner indicated for one or two seasons, it will be possible to reach some conclusion with reference to the rows which have made the strongest growth and contain plants that correspond in a measure with our ideal. Roots from these rows can be transplanted in larger plats, where they can be further compared with each other and with the parent varieties, and from this area material will be available for the general field planting.

---

### HYBRIDIZATION METHODS IN CORN BREEDING.

GEORGE HARRISON SHULL, *Cold Spring Harbor, Long Island, N. Y.*

The simultaneous preparation of papers by three different authors about a year ago, advocating the use of more or less definite hybridization in the breeding of Indian corn in lieu of the methods of selection and partial isolation now in general use, probably marks an important step in the improvement of this exceedingly valuable American crop; for the appearance of these papers indicates a growing appreciation of the real biological nature of Indian corn and the requirements necessary to the attainment of the highest and most permanent success in corn breeding.

The three papers to which I refer are, "The distinction between development and heredity in inbreeding," by Dr. E. M. East, in the *American Naturalist* for March, 1909; a circular of the U. S. Department of Agriculture on "The importance of broad breeding in corn," by Mr. G. N. Collins, issued in June, 1909; and my own paper on "A pure-line method in corn breeding," read before this Association at its last meeting at Columbia, Mo., in January, 1909, and published in its last Annual Report. These three papers are in some

particulars fundamentally alike, but as they approach the subject from somewhat different points of view it will be interesting to compare them briefly.

The suggestion for a hybridization method in corn breeding is not entirely new. A very clear outline of such a method, with experimental results sufficient to warrant the suggestion, was presented by Morrow and Gardner in Bulletins 25 and 31 of the Illinois Agricultural Experiment Station in 1893 and 1894. These bulletins were evidently unknown to two of the three writers above mentioned,<sup>a</sup> and the third, Mr. Collins, while referring to Morrow and Gardner's bulletins, makes no statement of the fact that they had devised an adequate hybridization method for the practical utilization of the advantage shown by them to be sometimes attainable by crossing two distinct varieties.

In my paper on "The composition of a field of maize," read before the American Breeders Association in Washington two years ago, I pointed out the fundamental defect of the method now in general use, which simulates to a degree the isolation methods so successfully used in the improvement of small grains, and I suggested there that "continuous hybridization is perhaps the proper aim of the corn breeder." The conceptions which formed the basis of that paper were the complex hybridity of corn as ordinarily grown and the stimulating effect to heterozygosis or hybridity. It was shown that this stimulating effect comes into play in corn breeding because self-fertilizations result in the partial or complete isolation of many quite distinct strains, and that cross-fertilization must therefore result in the production of hybrid combinations of these pure strains.

My suggestion for a pure-line method in corn breeding was a direct logical sequel of this original paper on "The composition of a field of maize." Dr. East's article on inbreeding above mentioned is also a sequel to the same paper, as shown by his references to it and also by his excellent discussion of the stimulation which results from hybridity, in regard to which he has arrived at views identical with those entertained by me at the time my original corn paper was written. It may be said, therefore, that Dr. East's paper and my

<sup>a</sup> I am indebted to Prof. W. J. Spillman for calling my attention to these bulletins. Dr. East has informed me since this was written and read at Omaha, that he, too, knew of the existence of Morrow and Gardner's bulletins on corn, but was not aware that these authors had described a method for continuous hybridization in the culture of this crop.—G. H. S.

own have grown out of the conception, first presented by myself two years ago, that what may appear to be a uniform variety of Indian corn is really a series of very complex hybrids involving numerous distinct biotypes,<sup>b</sup> which may be isolated from their hybrid combinations by self-fertilization and which owe their smaller size and inferior yielding qualities, not to any injurious effect of inbreeding as such, but to the fact that self-fertilization gradually results in their reduction to a pure homozygous state. They are thus deprived of the stimulus which had been derived from crossing with other biotypes.

It appears that my paper of two years ago was unknown to Mr. Collins, although it was read in Washington and published in the Annual Report of the American Breeders Association in 1908. As Dr. East and I have both performed many experiments which have led us to place great confidence in the practical importance of the discoveries of Mendel, De Vries, and Johannsen, it is interesting to read in Mr. Collins's paper that these new results from the scientific side are "particularly dangerous" when applied to corn breeding. As Dr. East and I by the application of the newer biological conceptions have arrived at practically the same method which Mr. Collins recognizes as necessary for the best results in corn breeding, it should become evident to him that there is no such danger as he fears in the application of the latest scientific results to practical work.

The crossing of relatively homozygous strains or of distinct biotypes in corn in order to secure the stimulus of hybridity, as advocated by Dr. East and myself, involves a much more definite conception, however, than that suggested by the term "broad breeding." The idea of hybridization between distinct strains or between biotypes calls for the use each year of those two parental strains or biotypes which careful tests have shown to result in the greatest capacity for yielding an excellent  $F_1$  (first generation hybrid) progeny. Although Mr. Collins advocates a method which is essentially identical with that proposed by Morrow and Gardner fifteen years ago and which has been invented anew by Dr. East, the idea of broad breeding would logically require the working in of a new variety or strain each year, instead of going back to the same relatively inbred strains for each successive crop. In other words, while Mr. Collins has suggested a splendid method of corn breeding, it is not one which corresponds

<sup>b</sup>A biotype is a group of individuals which do not differ from one another in any hereditary quality, and which therefore constitute a pure race.

well with the theory upon which he bases his suggestion. If the "broad breeding" idea is taken as a basis and a new variety is brought into the combination every year, it is plain that it must be done blindly, since the influence which this new variety will have upon either the quality or quantity of the crop cannot be known. However, the method advocated by Mr. Williams,<sup>c</sup> of the Ohio Agricultural Experiment Station, would overcome to a certain extent the blindness of this "introduction of new blood" by first testing its influence.

In the method of Morrow and Gardner, which, as we have seen, has been endorsed by East and Collins, involving the use of strains that, according to my experiments, are already complexly hybrid, there must be more or less resolution of characters in the resultant cross-bred plants, since the crop would not consist of  $F_1$  plants with respect to all the numerous characters in which the two chosen parental strains differed, but would be, with respect to many of them, the  $F_2$  (second generation hybrid) in which splitting up of characters occurs. The method which I described last year under the name of a "pure-line method" is the only one yet suggested in which all the plants in the resultant progeny would be first generation hybrids in regard to all the qualities which served to distinguish the parents. This does not prove, however, that my pure-line method is better than the method of Morrow and Gardner. It may be true, as Dr. East says, that the pure-line method is "more correct theoretically but less practical" than the method of Morrow and Gardner which he describes. It is conceivable that the method of using highly developed strains which have been produced by line-breeding and continual selection of the best and most vigorous ears may produce such high yields when crossed together that the expense and trouble of isolating pure biotypes will not be justified; but such a conclusion can be properly reached only as the result of extensive experimentation; and this experimentation, if undertaken in earnest by our State experiment stations, must result in the discovery of the best possible method for the breeding of Indian corn. My anxiety is not for the success of the pure-line method outlined by myself, but that serious experimentation shall be undertaken by every station within the corn-growing region for the purpose of discovering what is the best method. I feel quite

<sup>c</sup>Williams, C. G., Corn Breeding and Registration. Report American Breeders Association, 3: 110-122, 1907.

sure that the results of such investigations will lead to the adoption of some hybridization method in the breeding of this crop.

My experiments with corn during the last year have again given the fullest confirmation of my theories regarding the complex hybridity of the plants which compose an ordinary field of corn as grown at the present time; and data have also been secured having a direct bearing upon the applicability and importance of hybridization methods in corn breeding. Last year I presented the results of a single pair of reciprocal crosses between two self-fertilized strains which I called strain *A* and strain *B*. Those strains in hybrid combination produced a yield a little larger than the average of those families which had not been self-fertilized, but the difference was very slight. As strains *A* and *B* had been essentially unselected, being the first two self-fertilized strains which had become nearly pure-bred, it was anticipated that a larger number of crosses would discover some strains much superior to *A* and *B* as parents of a high-yielding  $F_1$  hybrid progeny, as well, perhaps, as some which are inferior. This belief has been fully supported by the results secured in 1909, for in eight different hybrid combinations which were tested during the past season three have proved better than the combination between strains *A* and *B*; one other combination, also having strain *A* as one of the parents, gave a result about equal to that of *A* and *B*, and three combinations produced somewhat less than those of strains *A* and *B*. Not all of these hybrid families produced higher yields than the corresponding cultures which had never been self-fertilized, but the three highest yields produced in all my cultures were the result of hybridizing self-fertilized strains which had been, no doubt, reduced nearly to a homozygous (pure-bred) state. The average of all the hybrids when compared with the average of all the corresponding cross-bred<sup>d</sup> families shows the yield of the former to be only insignificantly lower than that of the latter, these averages being respectively 78.9 bushels per acre from the hybrids, and 79.4 bushels per acre from the cross-breds. This shows how effectively the cumulative "injurious effects" of five years of self-fertilization may disappear in a single year as the result of crossing.

The large yield of two of my hybrid strains as compared with the product of the best cross-bred families is not a mere chance relation, but is a specific function of the particular hybrid combination

<sup>d</sup> I use the term "cross-bred" here to denote those families in which all self-fertilization has been prevented during the five years these investigations have been in progress.

which produced them, as may be shown by two series of facts. In the first place, the hybrids between strains *A* and *B* which were reported last year as producing from 74.4 to 78.6 bushels per acre have this year yielded 79.8 bushels per acre. A slight increase in the other cultures for 1909 as compared with those for 1908 makes this slight increase in yield of the hybrid between strains *A* and *B* simply a measure of the better climatic conditions of 1909 as compared with

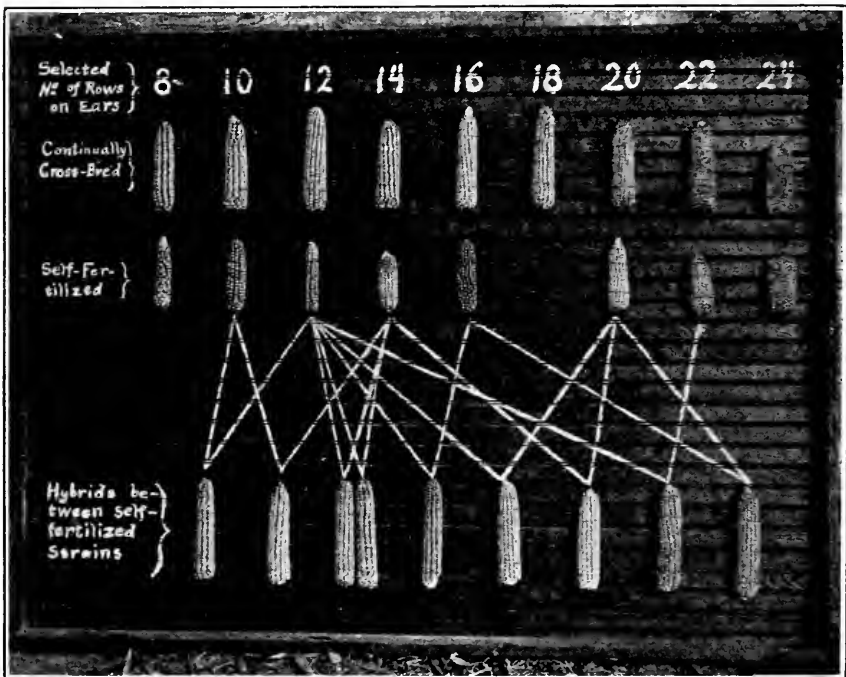

CROSS-FERTILIZED, SELF-FERTILIZED, AND HYBRIDIZED CORN.

The lines between self-fertilized and hybridized series indicate the parentages of the latter.

1908. The important feature of this result is that the  $F_1$  hybrids between strains *A* and *B* maintain essentially the same yielding capacity in successive years, while other hybrid strains produce quite different yields, varying from 61.5 bushels per acre to 98.4 bushels per acre. This fact, therefore, speaks for the view that the yield is a result of the particular hybrid combination. The second fact which

supports this view is that reciprocal hybrids<sup>c</sup> give essentially equal results. Thus, strains *A* and *B*, between which reciprocal hybrids were reported last year as yielding 74.4 and 78.6 bushels per acre, respectively, produced this year, in reciprocal hybrid families, exactly equal yields, namely, 79.8 bushels per acre. More conclusive still is the result from my best hybrid combination of the past season which has also been tested in reciprocal crosses; see figure. These crosses were made between a self-fertilized strain which had been selected continually to 16 rows and another which had been continually selected to 20 rows of grains on the ear. When the 16-rowed type was used as the mother, a yield of 98.4 bushels per acre was produced; when the 20-rowed type was used as the mother, a yield of 96.1 bushels per acre was produced. If the production of 98.4 bushels per acre had been purely a chance result which might by equal chance have appeared in any other strain, it is scarcely conceivable that the reciprocal should have so nearly approached the same extreme yield. The lower of these two yields, namely, 96.1 bushels, is 8 bushels per acre above the best yield produced during the same season by any continually cross-bred family of corn in my cultures. From all the results reported in this paragraph, it may be safely concluded that the production of the highest yield requires simply the finding of the best combination of parents and then repeating this combination year after year.

Several new evidences of the correctness of my view regarding the hybrid character of any ordinary vigorous corn plant have resulted from the past season's work. The assumption that self-fertilization results in the isolation of pure homozygous strains or biotypes and that the real purpose of cross-breeding is to secure the stimulus which comes from the heterozygous<sup>f</sup> association of alternative qualities from the two parents, requires that the first generation of the cross between two pure self-fertilized strains be relatively uniform, and that the second generation, in which these various hybrid qualities are rearranged in every possible combination, shall show greater diversity. I have now reared two families representing the second generation of such a cross between strains *A* and *B*. The variation in the number of rows in self-fertilized strains, in  $F_1$  hybrids, and in  $F_2$  hybrids, are shown in the following table:

<sup>c</sup> Formed by using one variety as the male parent in one cross and in another cross between the same varieties using the other variety as the male parent; thus  $A \times B$  and  $B \times A$  are reciprocal crosses, and their progenies are reciprocal hybrids.

<sup>f</sup> Having each separate characteristic derived from only one of the two parents.



TABLE 1.—Variations in number of rows of grains in self-fertilized strains, and in  $F_1$  and  $F_2$  hybrids.

Strain	Number of plants having ears with—						Yield—bushels per acre
	8 rows	10 rows	12 rows	14 rows	16 rows	18 rows	
Pure strain <i>A</i> ...	66	5	3				11.2
Pure strain <i>B</i> ...			10	18	12		12.1
<i>A</i> × <i>B</i> ( $F_1$ )...		2	18	9	2		79.8
<i>B</i> × <i>A</i> ( $F_1$ )...		19	58	9			79.8
<i>A</i> × <i>B</i> ( $F_2$ )...	3	32	57	16	2	3	61.0
<i>B</i> × <i>A</i> ( $F_2$ )...		1	26	10	15	2	78.0

It is clearly seen that the  $F_2$  ears show a greater range of variation in number of rows on the ear than those of the  $F_1$ . Since the empirical range of variation is capricious, and therefore is not a satisfactory measure of variability, I have calculated the mean, standard deviation, and coefficient of variation, for the numbers of rows on the ears of each of these six families. The constants thus derived are arranged for comparison in the following table:

TABLE 2.—Mean, standard deviation, and coefficient of variation for number of rows on ear.

Strain	Mean	Standard deviation	Coefficient of variation
Pure strain <i>A</i> .....	8.297 ± 0.055	0.705 ± 0.039	8.498 ± 0.474
Pure strain <i>B</i> .....	14.100 ± .145	1.363 ± .103	9.664 ± .736
<i>A</i> × <i>B</i> ( $F_1$ ).....	12.710 ± .154	1.271 ± .109	9.998 ± .865
<i>B</i> × <i>A</i> ( $F_1$ ).....	11.767 ± .070	.956 ± .049	8.128 ± .421
<i>A</i> × <i>B</i> ( $F_2$ ).....	11.841 ± .110	1.733 ± .078	14.638 ± .671
<i>B</i> × <i>A</i> ( $F_2$ ).....	13.786 ± .108	1.464 ± .076	10.623 ± .559

It will be seen by noting the numbers in the last column that the inferences as to the relative variability of  $F_1$  and  $F_2$ , drawn from the range of variation in the several families, were correct. This fact will be even more obvious if the coefficients of variation are averaged in pairs. In this way it may be found that these pure strains had an average variability of 9.081 per cent; their  $F_1$  hybrids had an average variability of 9.063 per cent; and the  $F_2$  hybrids an average variability of 12.63 per cent. My hypothesis requires that in the fertilization of the pure homozygous strains and in the production of the  $F_1$  hybrids

between them equal sperms meet equal eggs, so that in each case the resultant offspring should be exactly equivalent in all their hereditary qualities and the coefficients 9.081 per cent and 9.063 per cent must be measures of the non-hereditary variations or "fluctuations," while the coefficient 12.63 per cent in the  $F_2$  is the result of the concurrence of hereditary and non-hereditary variations.

The number of rows on the ear, which is used here as a measure of the variability, is not in itself of great practical importance, of course, but the general question of variability, which is illustrated by this character, is of very great practical value. The possibility of attaining a fair degree of uniformity in the several desirable qualities will favor a more definite specialization of the crop to meet particular desired ends. Besides, any diversity in the qualities of the crop necessarily means a lower value in regard to each desirable quality than would be attainable if all individuals were brought up to a uniformly high standard.

Another very practical point in regard to this second generation and which emphasizes the importance of utilizing the  $F_1$  plants for the crop each year, is seen by a comparison of the yields per acre (see Table 1) produced by the  $F_2$  as compared with  $F_1$ . In both of the  $F_2$  families the yield is less than the corresponding yield of the  $F_1$  families, and when taken together this difference amounts to 8 bushels per acre. When considered in connection with the increased variability, this serves to further illustrate the point made in the last paragraph, namely, that the increased range of variation means a decreased yield.

The results of all my investigations to the present time, which seem to demonstrate that there are many distinct biotypes of corn continually mingled together in complex hybrid combinations, and that there is a stimulating effect of heterozygosis, may be summarized in the following statements. The first four of these propositions were demonstrated by data presented in my paper on "The composition of a field of maize"; the next four in "A pure-line method of corn breeding"; and the present paper gives further proof of the correctness of (6), (7) and (8), and adds the last four.

(1) The progeny of every self-fertilized corn plant is of inferior size, vigor and productiveness, as compared with the progeny of a normally cross-bred plant derived from the same source. This is true when the chosen parent is above the average conditions as well as when below it.

(2) The decrease in size and vigor which accompanies self-fertilization is greatest in the first generation, and becomes less and less in each succeeding generation until a condition is reached in which there is (presumably) no more loss of vigor.

(3) Self-fertilized families from a common origin differ from one another in definite hereditary morphological characters.

(4) Regression of fluctuating characters has been observed to take place away from the common mean or average of the several families instead of toward it.

(5) A cross between sibs<sup>o</sup> within a self-fertilized family shows little or no improvement over self-fertilization in the same family.

(6) A cross between plants belonging to two self-fertilized families results in a progeny of as great vigor, size, and productiveness, as are possessed by families which had never been self-fertilized.

(7) The reciprocal crosses between two distinct self-fertilized families are equal, and possess the characters of the original corn with which the experiments were started.

(8) The  $F_1$  from a combination of plants belonging to certain self-fertilized families produces a yield superior to that of the original cross-bred stock.

(9) The yield and the quality of the crop produced are functions of the particular combination of self-fertilized parental types, and these qualities remain the same whenever the cross is repeated.

(10) The  $F_1$  hybrids are no more variable than the pure strains which enter into them.

(11) The  $F_2$  shows much greater variation than the  $F_1$ .

(12) The yield per acre of the  $F_2$  is less than that of the  $F_1$ .

[Presented by Committee on Breeding Corn.]

---

## A NEW ZEBRA HYBRID.

E. H. RILEY.

During the past few years investigations relative to the production of new and useful zebra-hybrids have been in progress at the Experiment Station (Bethesda, Maryland) of the Bureau of Animal Industry of the United States Department of Agriculture.

<sup>o</sup> Sibs are brothers or sisters or both brothers and sisters, *i. e.*, they are the offspring of one pair of parents, without reference to sex.



JENNY :  
HEIGHT 12 $\frac{1}{4}$  HANDS,  
WEIGHT 550 POUNDS.

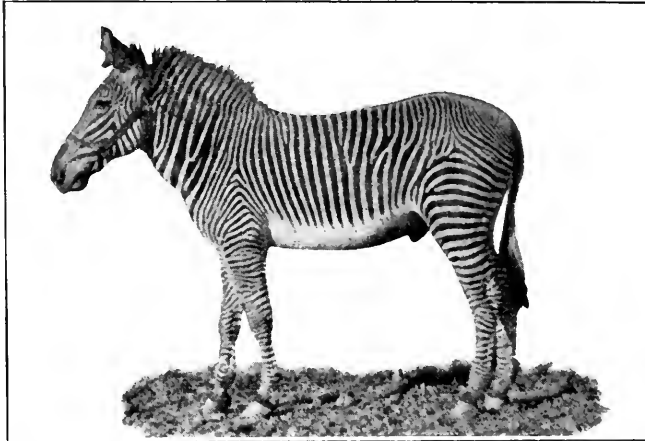

ZEBRA STALLION : HEIGHT 13 $\frac{1}{2}$  HANDS, WEIGHT 800 POUNDS.

ZEBRULE (HYBRID) :  
FIFTEEN MONTHS OLD,  
HEIGHT 12 $\frac{3}{4}$  HANDS,  
WEIGHT 500 POUNDS.

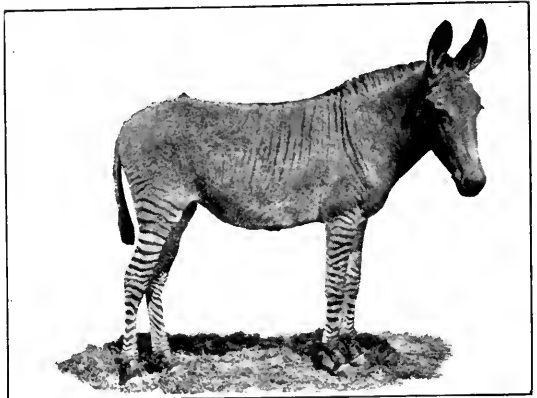

Zebra hybrid breeding is not a new line of work but has been carried on in foreign countries in a very limited way, with more or less success, since 1775. Some years ago Hagenbeck's Trained Animal Show exhibited two zebra-horse hybrids in this country which were said to have been bred by the owners, and later made use of them as work animals in connection with his show. The zebras used by these breeders were of the Burchell variety, which is among the smallest of zebras. These were mated with Shetland ponies.

The work of the Bureau of Animal Industry in producing zebra-hybrids is different from that done elsewhere in that the Grevy zebra (*Equus grevyi*) is being used. This variety of zebra is the largest and handsomest now in existence. The first one of this kind to be used in zebra-hybrid breeding work is a male about the size of a Kentucky jack—presented to President Roosevelt a number of years ago by Menelik, King of Abyssinia. This zebra was loaned by President Roosevelt to the Department for this experimental work, and was mated with donkey females. A number of resulting hybrids have since been foaled, the first of which arrived a little over a year ago. These hybrids are beautiful animals and seem to have combined the best qualities of both parents. They are much superior to either parent in conformation, disposition, style and action. The oldest, a male, was nearly as large as his dam when he was a year old. He is now being broken to harness and has been driven short distances to a light breaking cart. A filly, about a month younger than this colt, has made equally rapid growth.

There is a striking similarity between the species to which zebras and asses belong, which is quite apparent in their conformation, disposition, voice and action, the greatest apparent difference being in color, and in the size and shape of the ears. The ears of a zebra are much shorter and broader than those of a donkey. The markings of the zebra are uniformly striped black and white, while the donkey is of a solid color, many of them having a narrow stripe along the back and a stripe down over their withers, forming what is commonly known as the "cross." Considering these similarities, it is hoped that some of these zebra-ass hybrids may be fertile; this, however, will be tested at the first opportunity.

Since the work was begun, other zebras of the Grevy species have been imported from Abyssinia and are at present being used to increase the number of pure bred zebras as well as to get zebra-hybrids.

So far as known, Grevy zebras have never been domesticated. The zebras used in these investigations have been captured in their wild state, and have responded to civilization and kind treatment fully as well as horses that have been captured on our western prairies. An effort is being made to produce zebra-horse hybrids. A number of large mares have been selected for this purpose, and it is probable that hybrids of the mule type will soon be produced.

---

### REPORT OF COMMITTEE ON BREEDING VEGETABLES.

W. W. TRACY, *Chairman.*

The work of breeding vegetables is practically very closely connected with that of seed growing, and its consideration may be taken up under three heads.

1. The organization of improved varietal forms better adapted to certain specific conditions and uses.
2. The identification of these different varietal forms, each under some generally accepted varietal name which shall stand for all plants of that varietal character, regardless of their origin.
3. The growing and more general appreciation of the economic value of stocks of seeds which will develop into plants, all of which shall be alike and typical of the sort.

The first line of work is generally the most attractive to the inexperienced seed breeder, and the results, either actual or supposed, are so attractive to the planter that the professional seedsmen find the most profitable branch of their business to be furnishing, at high prices, seeds of these "novelties," or supposedly new and improved sorts, each under some new name with loud claims of superiority but little of accurate description, so that the real character of the stock used may not be too generally known and the profit coming from the higher prices need not be divided with others. These conditions result in a rapid multiplication and constant change in varietal names without any corresponding change or real improvement in the stock itself. It often happens that so-called new varieties are practically identical in character with some preexisting sort which had dropped out of general cultivation because of some defect, which though not apparent, and only to be learned through experience,

made it of no practical value. Often so-called seed breeding is simply a wild chase after new things, "creations," with little regard to their real value. Crosses and hybrids are made with no more definite object than to secure variations in the hope that some of these may be new (to the breeder) and valuable simply because they are new. This course is scarcely wiser than for the hunter to fire without aim into a wood in which he thinks game may be concealed in the hope that some of the scattering shot may kill a partridge or a woodchuck.

In order that breeding for new varieties may be wisely done it is essential that the breeder should be fairly familiar with the greatest possible number of varietal forms which are or have been in cultivation. He should also know something of the practical value of varietal qualities, such as whether an increase in the crumple and frill, or a deepening of the yellow shade of the leaves of Grand Rapids lettuce would be an advantage, and, if so, why; whether a coarse or fine netting is the most desirable in melons of the Rockyford type, and why. All of his crossing and selection should be made either with the aim of securing some definite and practically valuable variation, or with the hope of securing increased vigor and vegetative energy without loss or change of varietal character. This last is often a most useful line of breeding, for the practice of close breeding in order to secure greater uniformity of varietal character often results in such loss of vegetative vigor that a "re-origination" of the variation by direct crossing becomes very desirable. To do this work wisely necessitates a careful study of existing variations and requirements, and a familiarity with them which should not be limited to a knowledge of visible characteristics, but should include such intangible qualities as hardiness and resistance to disease and drought, which are often most important factors in determining the practical value of a sort, and its adaptation to any particular conditions and requirements.

The second phase of the work, the exact definition and nomenclature of varietal forms, is of equal practical importance, for the want of definition and permanency in varietal forms and the names by which they are known is a great obstacle to real improvement. It is true that some varietal names have continued in popular use a long time, but in many cases there have been repeated changes as to the exact varietal characteristics the names stood for. Were

we to secure from the most reliable seedsmen samples of a score of different stocks all sold under some old and popular varietal name, the probability is that we should find that there were distinct varietal forms represented. Some of the samples would be quite uniformly of one form, others as uniformly of another, while some of them would be made up of a mixture of many; and if we secured samples of all the different named varieties of this vegetable offered we should be quite certain to find that many of these were practically identical with some old and well known sort. The disadvantage of this condition, at least to the seed user, is evident, though it may be a source of temporary profit to the seed dealers. This multiplication and confusion of names might be remedied through the work of some central and generally recognized authority which should clearly define each distinct and desirable variation. In order to accomplish this it would be necessary to have full, complete, accurate, and comparable descriptions of existing varieties and their adaptations to definite conditions and requirements. There is to-day no greater need in our horticultural literature than of more complete, accurate, and comparable descriptions of existing variations in our garden vegetables and their adaptation to definite cultural conditions and market requirements.

We turn now to the consideration of the third and really the most important and practically useful phase of seed breeding—the production of stocks which shall be uniformly of a certain desired type. The fundamental object of all vegetable culture is uniformity of product. Superlative individuals often actually lessen the money value of the crop. In most cases if the best, and the poorest one-fifth, of the plants in the field were uniformly of identical character with that of the intermediate three-fifths, the cost of culture and marketing would be lessened and the profit of the crop materially increased. The essentials of success in this line of seed breeding are very simple, and consist in the breeder developing a stock which is the product of the greatest possible number of generations of plants of *exactly the same varietal character*, rigidly rejecting all variant plants regardless of their individual value.

As to progress during the past year: No great principles or laws of plant growth affecting seed breeding have been discovered, and no material change in practice developed. There has been an increasing appreciation of the difference between the transmission and the expression of inherited tendencies, and that the former may be



operative for many generations without the latter, which may then be called out by favorable conditions. The more experienced seed breeders are giving increasing and more earnest attention to the practical usefulness of variations, and are breeding with more definiteness of purpose. Seed users are coming to a better appreciation of the importance of uniformity of varietal character, and the cry for new and improved sorts is slowly giving way to one for better and more uniform stocks of varieties of proven merit.

As to existing needs we think they are (1) more full, accurate, and comparable descriptions of varietal characteristics and their usefulness for specific conditions and purposes; and (2) the establishment of some generally acceptable tribunal which shall decide upon the varietal name by which each distinct and useful variation shall be known and whose decision as to name shall be accepted and adhered to in practice by both seedsmen and planters.

We recommend that steps be taken to secure the appointment of such a joint committee from our own association, the Market Gardeners' Association, and the Seedsmen's Association, together with representatives from the United States Department of Agriculture and the State experiment stations. To this committee all supposedly new sorts should be submitted and its report should clearly state the distinctive varietal characteristics of the stock.

[Presented by the Committee on Breeding Vegetables.]

---

## **A THEORY OF MENDELIAN PHENOMENA.**

W. J. SPILLMAN, *U. S. Department of Agriculture.*

Evolutionists are at present divided into two groups, one of which we may call the Darwinians, the other the deVriesians. In the latter class I include the adherents of Weismann. Strangely enough, Darwin is the father of both these schools. Little did he think when he propounded his gemmule theory, to account for the supposed inheritance of acquired characters, that he was laying the foundation for a philosophy of heredity and evolution which should well-nigh demolish his own theory of evolution. Yet this is what he did. It seems hardly possible that so fanciful a theory as that of the gemmules could ever have gained currency amongst biologists had it

not had the sanction of a great master like Darwin. Yet it has become the basis of the philosophy of evolution which is now very generally accepted, though the original hypothesis has been more or less radically modified. The deVriesian doctrine is based on essentially the same idea originally propounded by Darwin, with this important modification: it being generally admitted that acquired characters are not transmitted, that portion of Darwin's gemmule theory which represents each cell of the soma as giving off a gemmule, or bud, which makes its way into and becomes a constituent of the germ plasm has been discarded, and we begin with the gemmules in the germ plasm. The term gemmule is, of course, inappropriate to the new conception of these small hypothetical bodies, since they are no longer looked upon as buds from the somatic cells. Packed away in the germ plasm, their permanent home, they become pangenes, determinants, etc.

The historical relation between the present schools of evolutionary doctrine is shown in the following diagram:

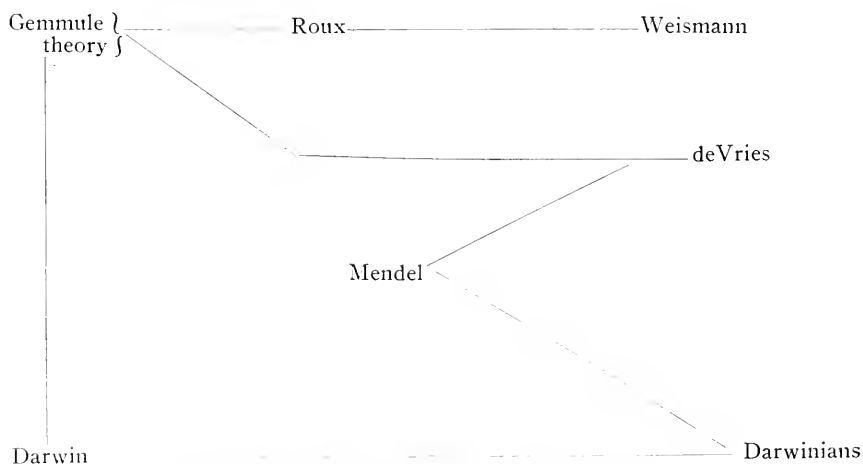

RELATION OF PRESENT EVOLUTIONARY PARTIES.

The deVriesian school have seized upon the phenomena discovered by Mendel and recently greatly extended, principally by the deVriesians, because they believed they saw in them a confirmation of their theories. Generally speaking, the Darwinians have not given Mendelian phenomena much attention, rather conceding to the deVriesians their claim to them. Being distinctly opposed to the deVriesian

philosophy, and assuming that Mendelian phenomena favored that philosophy, the Darwinians have generally looked upon Mendelism with much suspicion, and some of them have even undertaken to question the authenticity of the facts of Mendelism. It is exceedingly unfortunate, in my opinion, that nearly everyone who has been instrumental in developing our knowledge of Mendelian phenomena has accepted the deVriesian view of them. It is also unfortunate that the Darwinians generally have so little knowledge of Mendelism that they continually mention it when they unquestionably mean deVriesianism. This is distinctly the case in the recent very important paper by Riddle. He boldly, and I think successfully, attacks the deVriesian position, calling it Mendelism throughout, and through his confusion of Mendelian fact with deVriesian theory he is also led into a determined attempt to rule these facts out of court.

On the other hand, Professor Morgan, a staunch Darwinian, has himself had a good deal to do with the development of our knowledge of Mendelism, and knows that Mendelian phenomena are stubborn facts. He is just as much opposed to the deVriesian interpretation of these facts as Riddle and he is casting about for another explanation of them. Prof. S. J. Holmes has also contributed a very valuable paper on the deVriesian philosophy, in which he points out the inadequacy of this doctrine, but in which he wisely refrains from trying to minimize the importance of the phenomena uncovered by Mendel. Unfortunately, some of the most conservative and most able of the Darwinians confuse Mendelian factors, which are demonstrated facts, with deVriesian pangenesis, which are hypothetical cell organs with which it is attempted to connect the Mendelian factors.

We find that certain ontogenetic tendencies are transmitted from generation to generation. For instance, certain families of cattle develop black pigment in the hair and transmit the tendency to their offspring. In other families, we find the tendency to develop red pigment, and this tendency is hereditary. When we mate individuals from these two families, the progeny develops black pigment. If now we mate one of the cross-bred progeny with several red individuals, about half of the progeny are red and the other half black. Evidently, the cross-bred individual has transmitted the tendency to develop red pigment to part of his offspring and the tendency to develop black pigment to the remainder of them. It is these tendencies toward a

particular type of development that constitute the Mendelian factors. We can accept them as facts without giving allegiance to any particular theory concerning the cause of them. That the two tendencies are present in the cross-bred individual can hardly be called in question. That these two tendencies remain essentially intact during their sojourn together in the hybrid is also hardly to be questioned. That neither tendency is permanently influenced by contact with the other is not definitely proven, though there is much evidence that, at least in the case of many factors, the hereditary tendency is not materially modified in such cases.

The theory of the purity of gametes is not at all essential to the interpretation of Mendelian facts, but it is a fundamental in deVriesian theory. I shall later attempt to show that the phenomena of segregation can be interpreted without recourse to the idea of "unit characters" at all.

The deVriesian position is succinctly stated by Nilsson-Ehle, in his recent important monograph, entitled "Kreuzungen an Hafer und Weizen," page 12, as follows: "That organisms are aggregates of independent units (Einheiten) is a conception which the investigations of Mendel and his followers have continually strengthened."

Belief that this statement is true has led many anti-deVriesians to become also anti-Mendelians. But, as Professor Holmes has pointed out, the above statement is not justified. I have elsewhere pointed out that the phenomena of the so-called elementary species, as well as those of mutation, are entirely consistent with the Darwinian conception of evolutionary change. Gates and others have found important evidence that the mutations found by De Vries are due to irregular distribution of chromosomes in the reduction division. De Vries himself has shown that these mutants differ from each other, not in a single characteristic, but in well-nigh every characteristic, which is just what we might expect if each of the chromosomes plays an important part in the development of the whole organism. If the hereditary characters are simply those properties of cell organs and tissues by virtue of which these organs and tissues have a determining influence in development, then evolutionary changes would result from those changes, either small or large, in the properties of cell organs and structures developed from cells by virtue of which they respond differently to their environment from what they did before, or by virtue of which they themselves change the internal conditions of the organism. Evolutionary change

would also result from change in the "personnel" of the chromosomes; that is, from loss, gain, or exchange of chromosomes.

In a short paper like this, it would, of course, not be expected that I should take up all the many Mendelian factors that have been demonstrated to exist, and show how the principles to be stated below apply to them. I will select a few representative cases.

Let us first consider the cross between red and white roses. The red coloring matter of the petals of the rose may be due to the continued action of a single enzyme on a single chromogen, the original chromogenic substance being first converted into another substance by the action of the enzyme, this second substance being further converted by the further action of the enzyme, and so on through a long series of reactions till finally a stage is reached in which the products of the oxidation process give color. Possibly the process is more complex than here supposed. That is, there may be more than two original substances concerned in the reaction. But in either case the final production of red coloring matter is a result of more or less complex processes.

Let us first suppose that the process is a chain of reactions between two original substances. Presumably, both of these substances are continually produced in the cell. The final stage reached in the reaction, it seems fair to assume, will depend on the relative amounts of the two substances entering the reaction. In red flowers we may assume that under the environment existing in the developing petals these relative amounts are such as to result in red color.

The ratio between the enzyme and the chromogen does not need to be definitely fixed. It is necessary, however, in flowers which are constantly red, for the ratio between the enzyme and the chromogen, under the assumptions here made, to remain within the limits of the red part of the chain, if we may so speak. In nearly related white flowers we must suppose that the relative amounts of enzyme and chromogen differ materially from those in red flowers. Perhaps the amount of enzyme is less, and as a result the oxidation does not reach the red stages. Recent investigations by Miss Wheldale indicate clearly that shortage of enzyme is responsible for lack of color in certain cases.

We have now to consider the reason for the difference of the ratios here assumed between the amount of enzyme and chromogen in red and white flowers. The assumed shortage of enzyme in the

white flowers might be due to the lessened production of enzyme on the part of one or many cell organs, either chromosomes or otherwise. But if the shortage is due to the general lack of production of enzyme on the part of all cell organs, then in the cross between the red and the white we should not expect any such definite segregation of developmental tendencies as we find in Mendelian phenomena. On the other hand, if the shortage is due to a single cell organ and that organ behaves in the reduction division as we know chromosomes do behave, in some cases at least, then we would get the usual Mendelian phenomena. It happens that in the case under consideration we do get segregation. The indications, therefore, point strongly to the assumption that in the case under consideration the difference between red and white flowers is due to the differences which relate to a single chromosome, or some other definite cell organ which behaves like a chromosome in the reduction division.

It should be observed that in the assumptions here made concerning the relation of cell organs to the development of red coloring matter we have no single organ which can be looked upon as the "determinant" of red in the deVriesian or Weismannian sense. Rather, the "determinant" of red is a kind of general function of the cell or of cell organs. On the other hand, in white flowers the phenomena of hybridization indicate that the failure to develop red color is due to a partial or total failure of a function of a particular cell organ, as a result of which the oxidation process does not reach the advanced stage met with in red flowers.

In the preceding we have assumed, with Riddle, that the final production of coloring material is the result of a chain of reactions between two substances. Unquestionably, many of the metabolic activities in organisms are more complex than this. Consider, for instance, the production of horns in cattle. Here we have produced, in the cells, under conditions existing locally in the organism, what is presumably a definite chemical substance. Unfortunately, we do not know the steps which preceded the production of this substance. From what little we do know about organic chemistry it is probable that the whole process of converting food into horn is a complex one and that several compounds are, at one time or another in the process, necessary. We may thus look upon the end result of a series of metabolic activities as being due to the interaction of a number of substances, in some cases the number being two, in others probably

more. We have also assumed that in cases where a chain of reactions occurs between two substances the ratio between the quantity of the two reacting substances originally present, or produced, may affect the stage reached in the reactions. Similarly, it is assumed that where a reaction is more complex, involving a larger number of substances, similar differences in the ratios of the substances present may give different final results.

In a species which is fairly uniform we must assume approximately a normal condition of metabolic activities of all kinds. Changes from this normal condition give aberrant forms. When the changes are due to changes of a single cell organ which behaves as the chromosomes do, then if the assumptions here made are true we necessarily get the phenomena of Mendelian segregation and recombination.

On this view we must look upon a pair of Mendelian characters not as simply units of an aggregate constituting the organism, but as different stages of an organism. Thus, in red roses, complex metabolic activities, in which any or all of the organs of the cell may participate, give us a particular result. In white roses, the same metabolic processes may go forward but in a manner different from that in red roses. Now if the difference in these complex processes be due to differences in the functions of a single chromosome, we then get the phenomena of segregation in the reduction division of the first generation hybrid entirely independent of any assumption of unit character. It might be fair, perhaps, to speak of unit differences, by which we mean the differences which relate to integral parts of the cell.

There are some cases for which, in order that they may be explained under the assumptions here made, we must assume rather complex metabolic processes. Take, for instance, the case found independently by von Tschermak, Locke, Shull and Emerson in certain bean crosses. They found that when certain non-spotted beans were crossed the hybrid seed was spotted. When this seed was planted 50 per cent of its progeny was spotted. The non-spotted seed produced only non-spotted, while the spotted seed again produced 50 per cent of spotted progeny, and this continued as far as the experiments were carried out. This points very clearly to the appearance of spots only on heterozygote individuals. On the other hand, all these investigators found other races of beans in which the spots were transmitted to all the progeny.

I would explain this case in somewhat the following manner: Let us assume that a single chromosome produces two substances, each of which is necessary in the more or less complex chemical changes that cause the production of the spots. Representing the chromosome by  $M$  and the two substances it produces by  $a$  and  $c$ , the symbol for the chromosome and its two functions relating to this character would be  $M_c^a$ . In a race of beans in which the chromosome in question has both of these functions in normal condition, all the gametes would have the formula  $M_c^a$ . But suppose that in a certain race of beans the function  $a$  becomes so changed that the resulting product can no longer perform its part in the group of reactions necessary. The somatic formula of individuals of this race would then be  $M_c M_c$  and the spots would be lacking. In another race we must assume that while the function  $a$  remains intact the function  $c$  becomes so changed that a necessary step in the production of the spots can not be accomplished, then we get another race with the formula  $M^a M^a$ . Now if we cross these two races we get a hybrid with the formula  $M_c M_a$ , which of course would have the spots. This hybrid would give us a progeny one-fourth of which has the formula  $M_c M_c$ , one-half the formula  $M^a M_c$ , and one-fourth the formula  $M^a M^a$ , which accords with the actual results obtained. If we should cross either of the deficient races with the race which has spots on all its seeds, the hybrid would have the formula  $M^a M_c^a$  or  $M_c M_c^a$ . In this case the second generation would be three-fourths spotted and one-fourth non-spotted, a result which some of these investigators actually obtained.

Let us consider one other case, namely, that of the barring on the feathers of the Plymouth Rock poultry. Riddle has recently pointed out that in certain oxidizing reactions between tyrosinase and tyrosin certain stages of the reaction give black pigment. If the reaction be continued further white pigment results. The bars on the feathers of Plymouth Rocks, on this basis, are explained by an alternation of high and low rates of oxidization. Now it is known that this character behaves as a Mendelian factor. This indicates to me that it is due to some function of a single chromosome, or some other organ which behaves as the chromosomes behave. We may account for this alternation of high and low rates of oxidation by assuming that a single chromosome, under appropriate conditions in the organism, produces some substance that interferes with the activity of those organs in the cell which produce either the chromogen or the enzyme



required in this reaction. When this inhibiting material is present in a relatively large quantity, perhaps the amount of enzyme produced is comparatively small and we get the low rate of oxidation resulting in black pigment. But the inhibiting factor, acting upon the offending chromosome, reduces its own activity so that for a period of a few days less of the inhibiting material is produced. Meanwhile, excretory processes of the body remove this material or reduce its amount until finally the chromosome responsible for it renews its activity again. This mechanism would give us an alternation in rates of oxidation that would account for the white and black bars of the feathers. Many types of feather markings might be due to a process similar to that just outlined but operating locally in the body.

Here again, as in all the cases where we find Mendelian segregation, we must assume a more or less definite relation of a single chromosome to a given metabolic process. In no other way can we account for the phenomena of segregation.

In a somewhat similar manner we may explain the alternation of pigments found in the hairs of ordinary gray mammals.

In this connection I would suggest that since more than one kind of pigment is laid down at the same time it seems probable that we have to deal with more than one enzyme, or possibly more than one chromogen; but it is by no means necessary to assume an indefinite number of specific enzymes such as Riddle supposes is necessary to explain Mendelian phenomena. It is, however, necessary to assume for the chromosomes, or some other organs acting like them, as many definite individual functions as there are Mendelian factors.

In a few species there have been found more Mendelian factors than there are pairs of chromosomes, and some biologists have accordingly, and I believe without due consideration, assumed that this proves that the Mendelian factors can not be related to chromosomes as such. But this does not follow. I think it is probable that most of the chromosomes have functions which connect them more or less directly with every phase of development. Generally speaking, a Mendelian recessive will be due to the absence or latency or to a change in a particular function of a single chromosome. Now if a given chromosome has a relation to many characteristics of the organism, then we may have just as many Mendelian recessives depending on that chromosome as it has functions relating to development. In order, therefore, to demonstrate that Mendelian factors are anything other

than functions of chromosomes, it must be shown, in cases where we have more of these factors than there are pairs of chromosomes, that each of the factors is independent of all the others; that is, that any two of them may be transmitted together and may also be separated from each other. Both Shull and Baur have, in private correspondence, admitted the justice of this contention, and each of these indefatigable workers has planned to put this matter to test. It may turn out that Mendelian factors are not related to chromosomes as such, but I wish to call attention to the fact that as yet we have no evidence that definitely decides this point. On the other hand, we have a great deal of evidence in favor of the assumption.

For instance, the cereal rye has an exceedingly small number of chromosomes—six, I believe. In this connection it is interesting to note that rye is by far the least variable of all the cereals. But wheat has 40 or more chromosomes, and we have almost an indefinite series of varieties of this cereal. It should further be noted that the number of Mendelian factors that has been worked out for most species is less than the number of chromosomes concerned.

Of course, no one questions the great importance of the chromosomes in the economy of the cell. Some biologists do question whether these bodies maintain their integrity in all respects from generation to generation, but I believe I am safe in saying that everyone who denies the integrity of the chromosomes is an adherent of some theory which is favored by this interpretation. This is especially the case with the deVriesians.

I am confident that, whatever the relation of the chromosomes to Mendelian factors may turn out to be, these Mendelian factors are a reality and are due to some function of bodies which behave as the chromosomes do behave in the reduction division.

Most of the Mendelian terminology of the day is based upon the deVriesian doctrine of unit characters. If the view here presented proves to be correct we need some changes in our terminology. If we can not accept Nilsson-Ehle's statement that organisms are aggregates of independent units, we can not accept the idea of determinants developed by Weismann, and later by De Vries. Under the theory here presented the determinant of a character is to be sought in all those functions of cell organs which, by their combined action, result in the development of the character. On the other hand, the difference between two organisms may be due to the differences in single cell organs.

I am not sure that I have analyzed the facts here presented sufficiently to supply a terminology that will be satisfactory, and I shall not attempt to give a complete new terminology. We certainly need a word which means something different from the deVriesian definition of a hereditary character. Mendelian phenomena are based on hereditary differences, and I think that a Mendelian pair of characters can be fairly well described simply as a Mendelian difference. On the assumption that the metabolic processes in the organism are fairly complex, and that the development of any portion of the organism is a result of cooperation between many or all of the cell organs, we need to individualize the part played by definite cell organs in development. When a permanent cell organ has a function by virtue of which it affects the development of any morphological or physiological feature of an organism, I propose for such a body the term "teleomorph." This term is derived from the Greek "teleo" (make, accomplish) and "morph" (form or body). The part which the teleomorph plays in the development of any portion of the organism I propose to call the "teleone" of that teleomorph. Generally speaking, I regard a single teleone as one of a number, which, acting together, give rise to a final result. Thus, the pigment laid down in the coat of an animal may be the combined result of the interaction of a number of teleones. In a related animal which differs from the first in color, if the difference is due to a single teleone, and if the teleomorph in question is a chromosome, or other body that acts like a chromosome, then we get the phenomena of Mendelian segregation. But if the teleomorph in question is something other than a chromosome we should not get Mendelian segregation. Castle's work on the inheritance of size in rabbits indicates that the differences in the size of different races may be due to something other than differences in chromosome functions.

Ordinary hybridization experiments are greatly limited in what they can be made to reveal as to the relative importance of the chromosomes and other cell organs in the ontogenetic process, since fertile hybrids can be secured only from closely related forms. It is possible, and even probable, that if we could secure fertile hybrids at will between any two organisms, no matter how different, we might find a great many characteristics that would not follow Mendelian laws. In fact, we should not expect Mendelian phenomena except in cases of differences between homologous chromosomes that unite and separate in the usual fashion in the reduction division of the first generation

hybrid. It is probable that the non-appearance of ordinary Mendelian phenomena in very wide crosses may be due to the fact that in such crosses the chromosomes are not strictly homologous, and do not go through the process of synapsis and reduction in a normal manner. But in such crosses, if part of the chromosomes are capable of pairing and separating in the usual way, then we should expect some Mendelian phenomena, such as we actually find in some such crosses.

The theory here proposed is essentially epigenetic. It does not assume that the germ plasma of the fertilized egg contains structural elements each of which is the basis of a separately heritable character, but rather that the organs of the initial cell possess properties that in a measure predetermine the course of development. The influences which determine development are of two distinct kinds. Those of one class result from the chemical, physical, and physiological properties and relations of the cell organs themselves, by virtue of which these organs respond in a given manner to a particular environment. Influences of the other class are found in the environment itself. The environment of a given cell organ consists not only of conditions external to the organism, but of internal conditions as well. The character and amount of food supplied, the presence of substances resulting from the metabolic activities of other cell organs, and even of other and distant parts of the organism, must all be a part of the environment of every cell organ in the body. This environment changes with every step in the ontogenetic process. The conditions surrounding the cell organs in the two-celled stage differ from those in the one-celled stage. In order that a given property of a cell organ may have a determining influence on the final stages of development it is only necessary that it shall properly influence the first step of this development. Then the result of this first step becomes a determining influence on the next step, and so on.

Every tissue, every organ of the body, must be considered as a part of the environment of every other part. As development proceeds, therefore, new determining influences arise. These secondary influences arising at any stage of development, and resulting from the course taken in the earlier stages of development, may be called secondary teleones. They influence further development, and thus come within the definition of a teleone, but they were not in existence in the beginning of development. Likewise, the tissues, organs, and so forth which exert such influences should be considered as secondary teleo-

morphs. To illustrate, let us consider the deposition of pigment in the hairs and skin of the mammalia. That this pigment should finally be deposited, under appropriate conditions, was doubtless predetermined in the germ cell, by what we may call primary teleones; that is, by properties of the organs and substances composing the germ cells. But the deposition of the pigment must wait until the development of a special organ, the skin, has reached an appropriate stage, before the necessary conditions for the production of pigment exist. Thus the skin may be considered as a secondary teleomorph for the normal production of this pigment.

The behavior of those hereditary characters which obey Mendel's law of segregation and recombination may be considered to be due to those primary teleones which are the properties of the chromosomes, or other cell organs which behave in the manner in which chromosomes are known to behave, and which have a determining influence in some necessary step in the development of a given part or function of an organ or of the organism.

To admit the purity of gametes in the Mendelian sense (not in the deVriesian sense) is therefore not admitting that all the hereditary traits of an organism are represented in the germ plasm by specific bodies, but it means merely the admission that certain definite cell organs, the chromosomes, possess properties that give each, or at least a number of them, a determining influence in the development of certain characters. To admit such influence does not mean that a single chromosome is wholly responsible for the development of any organ or region of the body. It merely means that, under appropriate environment, and at an appropriate stage of the developmental process, the chromosome in question, by virtue of some property it possesses, shall affect the further course of development.

We thus see that Mendelian phenomena are consistent with an epigenetic view of development, the course of this development, however, being in a measure predetermined by properties residing in the organs and substances found in the fertilized egg.

---

## REPORT OF COMMITTEE ON EUGENICS.

C. B. DAVENPORT, *Secretary.*

The various duties of the Committee on Eugenics may be summed up in the three words: investigation, education, legislation.

The first, and for some time the main, work of the committee must be *investigation*. We want, above all, to learn as soon as possible how human characteristics are inherited. The results of the new science of heredity give reason for anticipating that many, if not most, characteristics are of an alternative sort, either not reappearing in the offspring or reappearing in predictable proportions, depending upon the distribution of these characteristics in the ancestry. We have already seen that a score or more of characteristics, largely specific diseases, are inherited in such alternative fashion, and about their behavior in progeny definite information has been given. We must ascertain the facts about other characteristics.

The data must first be collected; then analysed. This work is so vast that it must be divided between many people--specialists able to weigh and analyse scientifically the results. Consequently it has been found desirable to appoint sub-committees to collect and study the data. A sub-committee on Feeble-mindedness has been organized under the chairmanship of Dr. A. C. Rogers, Superintendent of the Minnesota School for Feeble Minded and Colony for Epileptics, and with Dr. H. H. Goddard, Director of the Department of Psychological Research at the New Jersey Training School for Feeble Minded Girls and Boys, as secretary. At the present moment this committee is collecting answers to the question: "Do two imbecile parents ever beget normal children?" This committee has most important interests, since the number of feeble-minded in the United States alone is probably not less than 150,000, of which 15,000 are in institutions.<sup>a</sup>

A sub-committee on Insanity is being organized under the chairmanship of Dr. Adolf Meyer, for some time Director of the Pathological Institute of the New York State Commission in Lunacy and recently appointed head of the Phipps Psychiatric Institute at the Johns Hopkins University. The secretary of this sub-committee is Dr. E. E. Southard, Pathologist to the State Board of Insanity, Massachusetts. This sub-committee has important work to do, for there are over 150,000 insane in the institutions of the United States alone.

<sup>a</sup> Bureau of Census. Special Reports: Insane and Feeble-minded in Hospitals and Institutions. 1904, p. 205.

Other sub-committees are contemplated to study the protoplasmic basis of eye defects, deafness, predisposition toward lung and throat trouble, toward diseases of the excretory and circulatory organs; toward cancer, skin diseases, crippled appendages and so on. Still other sub-committees should deal with criminality and pauperism, with the effects of consanguineous marriages and of such mongrelization as is proceeding on a vast scale in this country. Perhaps other sub-committees, recruited from those who make physical examinations, will study inheritance of muscular strength, of sound wind and endurance. Possibly registrars of colleges will serve on sub-committees for the study of inheritance of various intellectual traits. Other sub-committees will be added as needed.

A second class of investigation may better be undertaken by the central committee. It is the obtaining of records of the inheritance of characteristics of health, ability and temperament from typical American families. In the attempt to secure such records 5,000 blanks have been distributed and about 300 family records received back. These are being studied to determine the laws of incidence of disease and the inheritance of various other characteristics. This sort of work might be taken up by genealogists who wish to incorporate more biological data in their family histories. The limitations to this work are set only by lack of means for carrying on correspondence. It seems possible that data of this sort might be collected by the national Bureau of the Census for limited registration areas.

While the acquisition of new data is desirable, much can be done by studying the extant records of institutions. The amount of such data is enormous. They lie hidden in records of our numerous charity organizations, our 42 institutions for the feeble-minded, our 115 schools and homes for the deaf and blind, our 350 hospitals for the insane, our 1,200 refuge homes, our 1,300 prisons, our 1,500 hospitals and our 2,500 almshouses. Our great insurance companies and our college gymnasiums have tens of thousands of records of the characters of human blood lines. These records should be studied, their hereditary data sifted out and properly recorded on cards and the cards sent to a central bureau for study in order that data should be placed in their proper relations in the great strains of human protoplasm that are coursing through the country. Thus could be learned not only the method of heredity of human characteristics but we shall identify those lines which supply our families of great men: our Adamuses, our

Abbotts, our Beechers, our Blairs, and so on through the alphabet. We shall also learn whence come our 300,000 insane and feeble-minded, our 160,000 blind or deaf, the 2,000,000 that are annually cared for by our hospitals and homes, our 80,000 prisoners and the thousands of criminals that are not in prison, and our 100,000 paupers in almshouses and out.

This 3 or 4 per cent of our population is a fearful drag on our civilization. Shall we as an intelligent people, proud of our control of nature in other respects, do nothing but vote more taxes or be satisfied with the great gifts and bequests that philanthropists have made for the support of the delinquent, defective and dependent classes? Shall we not rather take the steps that scientific study dictates as necessary to dry up the springs that feed the torrent of defective and degenerate protoplasm?

Greater tasks than those contemplated in the broadest scheme of the Eugenics Committee have been carried out in this country. If only one-half of 1 per cent of the \$30,000,000 annually spent on hospitals, \$20,000,000 on insane asylums, \$20,000,000 for almshouses, \$13,000,000 on prisons, and \$5,000,000 on the feeble-minded, deaf and blind were spent on the study of the bad germ-plasm that makes necessary the annual expenditure of nearly \$100,000,000 in the care of its produce we might hope to learn just how it is being reproduced and the best way to diminish its further spread. A *new* plague that rendered 4 per cent of our population, chiefly at the most productive age, not only incompetent but a burden costing \$100,000,000 yearly to support would instantly attract universal attention, and millions would be forthcoming for its study as they have been for the study of cancer. But we have become so used to crime, disease and degeneracy that we take them as necessary evils. That they were, in the world's ignorance, is granted. That they must remain so, is denied.

The second great duty of the Committee on Eugenics, education, is not less important than investigation. For the ascertained laws would be more than scientifically interesting; they would be guides to action on the part of the reading, thinking public. As precise knowledge is acquired it must be set forth in popular magazine articles, in public lectures, in addresses to workers in social fields, in circular letters to physicians, teachers, the clergy and legislators. The nature and the dangers of unfit matings, the way to secure sound progeny, must ever be set forth.



And, finally, when public spirit is aroused, its will must be crystallized in appropriate legislation. Since the weak and the criminal will not be guided in their matings by patriotism or family pride, more powerful influence or restraints must be exerted as the case requires. And as for the idiots, low imbeciles, incurable and dangerous criminals, they may under appropriate restrictions be prevented from procreation—either by segregation during the reproductive period or even by sterilization. Society must protect itself; as it claims the right to deprive the murderer of his life so also it may annihilate the hideous serpent of hopelessly vicious protoplasm. Here is where appropriate legislation will aid in eugenics and in creating a healthier, saner society in the future.

We come now to the practical question, How can the necessary studies be made? It is believed that the Committee on Eugenics may well be entrusted with organizing the work along the lines that have been successfully begun or it would cooperate with anybody that seemed better able to organize the work. But it can do nothing without funds. The committee does not solicit funds—but it stands ready to do the nation's business by making clear the nation's need to legislators and to philanthropists. One can not fail to wonder that, where tens of millions have been given to bolster up the weak and alleviate the suffering of the sick, no important means have been provided to enable us to learn how the stream of weak and susceptible protoplasm may be checked. Vastly more effective than ten million dollars to "charity" would be ten million dollars to eugenics. He who, by such a gift, should redeem mankind from vice, imbecility and suffering would be the world's wisest philanthropist.

---

## INHERITANCE OF HATCHING QUALITY OF EGGS IN POULTRY.

RAYMOND PEARL, *Orono, Maine.*

1. There has recently been completed a general study of the influence of certain factors on the fertility and hatching quality of hen's eggs.<sup>a</sup> Amongst other factors, inheritance received particular

<sup>a</sup> Cf. Pearl, R., and Surface, F. M. Data on Certain Factors Influencing the Fertility and Hatching of Eggs. Maine Agr. Expt. Station, Bulletin 168, pp. 105-164, 1909.

attention in this study. Certain of the results obtained in regard to this factor suggest conclusions believed to be of some general significance in relation to the practical breeding of other animals than poultry. On this account I venture to present here a brief summary of these results and to point out the considerations suggested by them which seem to me likely to be of interest to animal breeders in general.

2. The actual results obtained regarding the inheritance of the developmental qualities of eggs may be first set forth. For a detailed account of these results the original paper must be consulted. By way of definition it should be said that in this study "fertility of eggs" was measured as per cent of eggs set which were infertile; and "hatching quality of eggs" was measured by the percentage of fertile eggs which hatched. Correlation tables were prepared showing (a) the mother's and the daughter's percentage in fertility of eggs, and (b) the mother's and daughter's percentage of fertile eggs hatched, for every mother-daughter pair for which complete records extending through a whole hatching season (March 1 to June 1, *circa*) were available. The numerical results obtained from an analysis of the correlation table relating to hatching quality of eggs are shown in the following table:

*Hatching quality of eggs in mothers and daughters.*

Constant	Hatching quality of eggs
Number of mother-daughter pairs .....	87
Mothers' mean percentage of fertile eggs hatched....	52.96 ± 1.23
Mothers' standard deviation.....	17.00 ± .87
Mothers' coefficient of variation.....	32.00 ± 1.80
Daughters' mean percentage of fertile eggs hatched...	47.67 ± 1.80
Daughters' standard deviation.....	24.92 ± 1.27
Daughters' coefficient of variation.....	52.27 ± 3.32
Coefficient of correlation between mother and daughter	.031 ± .072

There are a number of interesting matters brought out by this table, but we will here confine our attention to the main point, which is that there is no sensible correlation between mother and daughter in respect to hatching quality of eggs. Even though we make the appropriate corrections to allow for the selection of the mothers, it still remains the case that the correlation is insignificant. It is not, however, justifiable to conclude that there is no inheritance

of this character—"hatching quality of eggs"—because of the absence of a sensible correlation between mother and daughter in regard to it. The character may be inherited, but in a manner which is not well brought out by the ordinary parent-offspring correlation table.

3. Another line of approach shows that, as a matter of fact, this character is inherited, and in a definite and sensible degree. A correlation table was formed which showed for every possible pair of full sisters which occurred in the pedigree records the percentage of each sister's fertile eggs hatched. The coefficient of correlation indicating the degree of "fraternal" inheritance with reference to this character was calculated with the following result:

Correlation between sisters in respect to per cent of fertile eggs hatched,  $r = 0.188 \pm 0.060$ .

Or, in other words, we get here a sensible positive sister-sister correlation. There is a definite degree of what may be called "fraternal" or collateral inheritance of the character "hatching quality of eggs," even though this character is *apparently* not inherited in the ancestral line.

The apparent contradiction in the results from parental and fraternal correlation here is only apparent and not real. We may expect to get sensible coefficients of fraternal inheritance associated with low or insignificant parental coefficients, whenever the phenomenon of *prepotency* in the ancestral line occurs. This is exactly what careful study of the individual records shows to exist in the present material. The point is that the absence of a significant parental correlation does not mean that hatching quality is not inherited. It merely means that the existence of such parental inheritance is masked by the existence of varying degrees of prepotency with reference to this character amongst the mothers. The existence of such prepotency is perfectly apparent from the study of individual pedigree records and from the correlation between sisters in regard to this character. This case well illustrates the danger which may lie in too hastily drawing conclusions from *mass* material without careful study of the individual cases.

The general result which is reached from this study is that the character "hatching quality of eggs" (measured by per cent of fertile eggs hatched) is definitely inherited in the female line and probably also in the male line.

4. If hatching quality of eggs is an inherited character it is clearly something which can be improved by proper selective breeding. In the poultry breeding experiments at the Maine station selection with reference to this character is being practiced. This is done practically through the use of what has been called a selection index number.<sup>b</sup> The selection index number in actual use for poultry has the formula:

$$I_1 = \frac{5(a + b)}{c + d + 1}$$

wherein  $I_1$  denotes the selection index number;

$a$  = percentage of an individual bird's fertile eggs hatched;

$b$  = percentage of eggs actually laid by this bird to the total number it was possible for her to lay between February 1 and June 1 (*i. e.*, the breeding season) of the year for which the index is calculated;

$c$  = percentage of this bird's eggs infertile;

$d$  = percentage of total number of this bird's chicks which die within three weeks from the date of hatching.

It is clear that in this index the hatching quality of eggs is relatively heavily weighted. Results already obtained appear to show a beneficial effect of this selection, and indicate the probability of a more marked effect in future generations.

5. In all practical animal breeding one of the most important factors in the determination of relative success or failure is what may be called the "breeding capacity" of the stock. By "breeding capacity" in this sense is meant, broadly speaking, the ability of the stock to produce vigorous healthy young in relatively large numbers.

In the selective breeding of nearly all of our domestic animals, whether for fancy or utility points or both, little or no attention has been paid to the breeding capacity of the stock. Like the poor in human society, the "shy breeder" among thoroughbred animals is always with us. The experimental investigation here summarized shows definitely, however, that in poultry the chief factor concerned in "breeding capacity," namely, hatching quality of eggs, is inherited. It is highly probable that "breeding capacity" depends upon essentially and fundamentally the same biological factors in all of the domestic animals. There would appear to be three fundamental factors primarily concerned in the determination of whether a fertilized

<sup>b</sup> Pearl, R., and Surface, F. M. Selection Index Numbers and their Use in Breeding. Amer. Nat., Vol. XLIII, pp. 385-400. 1909.

ovum shall develop into a healthy and vigorous organism: (a) A normal *structure* of the developmental machine (ovum, embryo, etc.); (b) an adequate endowment of *energy* with which to carry through the developmental processes until the stage in development is reached where energy may be obtained from external sources; and (c) a normal degree of *resistance*—probably originating through the existence of (a) and (b)—to the ordinary environmental vicissitudes which every individual must meet in the course of its embryonic life. I can see no reason why these factors should not operate in an essentially similar manner in cattle, sheep, and swine, for example, as well as in poultry. But if this is the case, and at the same time, as we have shown, the general effect of the operation of these factors is definitely inherited in poultry, it strongly suggests the possibility that by paying attention to “breeding capacity” and selecting with reference to it in all breeding operations, whatever their primary objects, it may be possible to improve considerably this character in thoroughbred live stock in general.

[Presented by Committee on Breeding Poultry.]

---

## INSECT BREEDING.

VERNON L. KELLOGG.

There are so few domesticated insects—the honey-bee and silk-worm are the only conspicuous ones—that insect breeding is a field little worked. In recent years the experimental breeding of a few undomesticated kinds, notably various species of beetles in the hands of Tower at Chicago, Johnson at the Carnegie Laboratory of Experimental Evolution at Cold Spring Harbor and McCracken at Stanford, has been carried on by students interested in problems of heredity. The results of this breeding are of value primarily to pure science, but secondarily to practical science. Any specific definite knowledge of the order or laws of inheritance in insects is bound to be sometime useful knowledge.

For example of how such knowledge sought and gained by students of heredity without any particular thought of a practical application of it may nevertheless have an immediate economic importance, I may refer to a case of partly personal work.

For the last eight or nine years I have bred experimentally each year many thousands of individuals, representing pure cultures and crosses of fourteen races of silkworms, in an attempt to discover whether this insect followed Mendelian principles in its inheritance, or, if not, what other order of heredity was discoverable. Incidental to the main object of the work opportunity was afforded by this extensive and protracted series of rearings to test various other particular problems correlated with inheritance.

Practically all the generalizations that economic silkworm breeders may utter concerning the effects of crossing, based on their centuries of continued but desultory and unplanned breeding, can be printed on a single page of this size. Indeed, in the latest authoritative French manual of silkworm culture a direct attempt to sum up the knowledge of inheritance in silkworms does occupy just about that much space. Now if the results of the recent few years' work of scientific breeding by Contagne in France, Toyama in Japan and myself in this country be generalized, the statements of fact touching the course of inheritance in silkworms are much more extensive and definite than all those empirically gained during hundreds of years previous. Not that their application to practical silkworm breeding can produce conditions as much better compared with present ones as present ones are better than the first one, because no such further great biological betterment is possible. But if a silkworm breeder were to start today again from the primitive conditions without the knowledge gained by centuries of breeding, but only with that gained by the last ten years of scientific experimental work, he could reach the same breeding conditions that now exist in immeasurably less time than it has actually taken. The order of inheritance of larval and pupal (cocoon) characters of silkworms is now fairly definitely known. Hybridizations made in the light of this knowledge can accomplish with great certainty and swiftness results that would otherwise require untold time and much "trial and error" following uncertain paths.

Just as the rules of inheritance in silkworms have been worked out so they can be for the honey-bee. And this knowledge is much needed. Real and great improvement in beekeeping can be made on a basis of such knowledge; more indeed than can now be made in silk-raising.

Also there will come soon—it must have come already—a demand from the economic entomologists who are collecting and disseminating insect parasites of insect pests for a more accurate and detailed knowledge of their behavior when bred under conditions different from their usual ones. This knowledge can only be got from extensive series of experimental rearings. Whether parasites of hosts not identical with but closely allied to American pests can be “induced” by selective rearing to change their food habits a little to our advantage, or whether under new conditions parasites of promise may not tend to scatter their efforts and become less useful: these are examples of queries that must already be coming to the student of parasites and must be answered by him on a basis of planned experimental rearing. And from experimental rearing to selecting and hybridizing, that is, to “breeding,” is but a step. We shall have more domesticated insect species soon if by domestication is meant amelioration or modification by breeding.

[Presented by the Committee on Breeding Bees and Other Insects, DR. L. O. HOWARD, Chairman.

---

## HYBRIDIZING GAME BIRDS IN CAPTIVITY.

WALLACE EVANS, *Oak Park, Illinois.*

Hybridism among our native game birds in a wild state is in general not very common, but in the pheasant family it is quite prevalent, especially so among those raised in captivity. Some breeders take great delight in the crossing of these beautiful creatures.

I am sorry to say it has been a great drawback to the breeders who are striving year after year to keep their flocks pure. To illustrate the mischief done along these lines, I would refer to the Amherst and Golden Pheasants as furnishing a striking example, it being almost impossible to purchase birds of one of these varieties, either in this country or Europe, that are not tainted with the blood of the other. It is not my intention to claim in this paper that hybridism among game birds is beneficial except in a few well-selected varieties, and even then there are doubts. I can only speak of my own experience up to the present. As time passes, however, it may become apparent that what I now consider an improvement is only temporary, and the hybrids that now appear to me as an improvement may as years go

by prove otherwise. I must admit that as far as the pheasant family is concerned hybridism is detrimental, with possibly a few exceptions, and even with these few there are grave doubts as to its being beneficial in the long run.

As an illustration I will mention the crossing of the English Ring-Neck Pheasant (*Phasianus torquatus*) with the Dark-Necked Pheasant (*Phasianus colchicus*). The offspring of these two parents at first, or for the first year or so, appears to be an improvement in size, contour, and color, excepting, of course, that the white rings around the neck diminish in size. In a few years, however, it becomes very apparent that the improvement, if at all, is only temporary, for the birds now begin to show a faded or what breeders call a "washed-out" appearance. They lose their beautiful sheens or iridescent colorings and do not at all compare in beauty with the pure-bred parent stock.

The crossing of the Golden Pheasant with the Amherst Pheasant furnishes one of the most conspicuous examples of the detrimental effects of hybridism. Like *colchicus* and *torquatus*, their eggs are fertile and hatch fairly well. The male bird from the first cross when in its full nuptial plumage appears very beautiful indeed to the inexperienced breeder, but to the true fancier and breeder this gorgeous mongrel has neither charm nor place.

If hybrids of these varieties are allowed to breed among themselves year after year their colorings become mingled to such an extent as to make them displeasing to the eye of even a casual observer. They also diminish in size and lose the nice shape of the pure-bred bird. Eventually they breed out entirely unless new blood is frequently introduced. Therefore, I claim that there is nothing to be gained by hybridizing these two varieties.

A great many breeders of pheasants, especially amateurs, wail and wonder why they cannot raise successfully the young of the Golden and Amherst, also other varieties. During the breeding season I receive numerous letters from parties all over the country asking for advice and stating that they have failed to raise the young birds. Most of them in telling their troubles simply state that the young birds seem to wilt and die off without any apparent cause during the early stages of their existence. While I will admit that there are many other causes that may have had something to do with these failures, yet to those who have failed I will say that, strange and perplexing though it may seem to them, one of the chief reasons is



hybridism—the bird that laid the eggs or its mate is a hybrid, a mongrel, and the chances are that neither you, I, nor anyone else could have raised the young to maturity. Nature here has stepped in to prevent their increase; it is simply one of the many cases where man has failed to improve upon nature's handiwork, and in her wisdom she has interfered to prevent the increase of that which is not an improvement and which would soon result in the loss of the original.

Pheasants of the same genus are generally fairly prolific when crossed but the eggs of a bird mated up with one of a different genus are seldom fertile, and in the few cases where they are fertile the offspring is not capable of breeding again; there is, therefore, nothing to be gained by trying to cross birds of a different genus.

During the past breeding season I got very good results by crossing the pure-bred Mongolian Pheasant (*Phasianus mongolicus*) with *P. torquatus*, using the Mongolian male and the *torquatus* female. These two being of the same genus proved to be very prolific and the offspring seemed to be quite strong; the colorings, rich and deep; flight, high and swift. This being my first season in crossing these two varieties, I cannot say how they will turn out on the second cross; but from all appearances I think they will prove a fine game bird for this country.

Another very interesting hybrid is the offspring of the Reeves Pheasant crossed with the English Pheasant.

Waterfowl hybrids are also very interesting. One of the most singular cases of the crossing of wild geese I have accomplished was by mating a Canada gander with a female Tiger Brant (White-fronted Goose). The offspring of this union are very peculiar in appearance, having light smoky cheeks, tiger markings on the breast, and the white front at the base of the beak similar to that of the mother bird. In size they are slightly smaller than the Canada goose, but their shape and carriage is more pleasing to the eye of the observer than that of either parent.

[Presented by Committee on Breeding Wild Birds.]

---

# EDITORIALS

The decision of the Council of the American Breeders Association to publish a quarterly magazine, in addition to its Annual Report, will be hailed with pleasure by a great number of investigators and practical breeders. The art of animal and plant breeding, though rapidly advancing, is still in its infancy. It is only within the last twenty years that the laws of heredity, on which all successful work in this line depends, have become at all susceptible of comprehension or of definition. This art, like all others, cannot be long practiced as a trade by rule of thumb. It must rest on science, and science must be exact, so far as it goes, else it is not science at all.

**The Field of  
the Breeder.**

The science on which the art of selective breeding rests consists in the main of five categories of knowledge: Variation, heredity, environment, selection, and segregation. We have, first, variation, its facts and its factors. No two animals, no two plants, no two seeds, no two germ cells in this world were ever quite alike. On this rests the possibility of change in the succession of life, and with change the possibility of improvement. And by improvement the practical breeder means fitness for the use of man. In nature, improvement means greater fitness for the struggle of life, greater power of holding its own. This natural improvement is something very different from that which man seeks, and most creations of the breeder would fare badly in the rough and tumble of the desert or the woods. Both ideals are again different from that of structural advancement. It is now and then an advantage in the struggle for existence for animal or man to have structural complexity. But it is not always so. The world swarms today with one-celled animals and plants, more numerous and more varied than in the dawn of life. The development of man through sheer ingenuity rather than strength is an exception in nature, and of man there are plenty of individuals, but not many species.

With variation goes the fact of heredity. Like produces almost like, and this difference in likeness is largely due to the fact that in all the specialized groups of animals and plants each individual has

two parents. Each individual shows a mosaic of characters drawn from each parent, and through each from farther ancestors; and besides the characters shown or "dominant" there are other characters hidden or "recessive," which may be as patent in lives of future generations as the traits which are dominant. Each individual has twice as many ancestors as his father or mother had, hence no individual can be an exact or slavish copy of either parent. The physical basis of heredity is in part understood. Its laws or methods of operation are becoming each day more clearly understood, and the persistence of type from generation to generation is the solid ground on which the selective breeder rears the structure of his specific creations.

The fact that in every way the laws of heredity and the related laws of life are absolutely the same in man and the animal kingdom gives the studies of animal breeding the greatest practical value as applied to man. The evil effect of the destruction of the best, and of breeding from the weak or inert, is just as plain in the history of Greece and Rome as it can be in the history of a neglected or abused herd of cattle.

With these studies goes the investigation of the effects of the environment on the individual and on the race. With the increase of knowledge we have seen that the environment is an indirect factor in race changes. It does not influence the race by its effect on the individual, but rather by its power to determine what sort of an individual shall survive. There is still much to learn of the way in which environment influences the process of variation, and the whole subject affords material for the most clever experimentation.

Of course, all artificial race improvement must rest on artificial selection, as all natural advance is conditioned on natural selection. The art of crossing to promote variation, with choice of resultants, constitutes the fine art of selective breeding. Selection without segregation or separation is ineffective, whether natural or artificial. The results of segregation rise in greater and greater importance, with closer study of their character and meaning.

All these subjects as related to the breeding of animals and plants, and men, for men are higher animals, will find treatment in this new magazine. We are sure that such a repository of available truth on the vital questions will find a deserved welcome.—DAVID STARR JORDAN.

Through the agency of plant and animal forms the United States annually produces wealth to the amount of eight billion dollars. Of this, at least five billion is produced by cultivated plants and domesticated animals, in which the forces of heredity are, in a large measure, coming under the will of man. Authenticated records exist of instances in which the value of the product has been increased 10, 25, and even 50 per cent by systematic breeding. Practically all those who have had successful experience in creative breeding agree that it is conservative to estimate that by this means an average of 10 per cent can be added to the value of this five billion dollars worth of products.

The American Breeders Association has assumed to lead in the organization of cooperation among private and public agencies to bring about annually the addition of this \$500,000,000 of wealth. A number of States are organizing plant breeding establishments. The United States Department of Agriculture is cooperating with the State experiment stations in this work; and both have much independent creative breeding work with many species of plants and breeds of domestic animals. The State experiment stations, the United States Department of Agriculture, and other research organizations, as the Carnegie Institution, Harvard University, Cornell University, and Leland Stanford University, are studying the laws of heredity.



The American Breeders Association selects for publication in the *American Breeders Magazine*, from the papers given at the annual meetings, and reprints most of them in the bound Annual Report. For the latter are reserved other articles, but especially those rather too ultra-scientific for the *Magazine*. Thus the scientific articles appear in the bound volumes. The five Annual Reports already published show what a rich library on heredity and breeding may be built up by every member of the Association.

The plan of giving the *Magazine* when read to a friend enables the members to use their copies of the *Magazine* to help them in securing new members. Therefore when you have read a number hand it or mail it to someone who ought to be a member of the

**Give the  
Magazine to  
a Friend.**

American Breeders Association. Speak to him or write him a letter inviting him to become a member. If you think it would help write the Secretary of the Association requesting him to join you in inviting your friend to become a member. Try thus to make your four quarterly numbers help you get one or more new members.



People generally have a wrong conception of the process of creating new hybrids between varieties, breeds, or species. The hybrid is not a general compounding of the two parental forms. Often the average of a large number of hybrid individuals of the first, second, or later generation is not an improvement over the original. Sometimes the first generation hybrid is an improvement because a group of valuable characters are dominant in this generation. This dominance may not mean, however, that the average of the second and later unselected generations is superior to either parent. The mass of individuals—progeny of a union of two given species—cannot be called a hybrid variety or breed. Any such mass is made up of many varying elements; often it is apparently a tangle of unit characters. A pure-bred variety or breed can be produced only by most rigid selection from large numbers of the hybrid, both to secure excellence and to secure at least reasonable uniformity. In other words, the breeder produces many hybrid individuals and discards all but possibly one in thousands. This closely selected hybrid stock then represents not the average between the parents but the recombination of certain desired characters of both parents. The original act of hybridizing is usually a very simple matter. The scientific method, the artistic skill, and the long-continued, careful, patient effort from the second generation on are the larger factors. Intelligence almost akin to genius is required in hybridizing, to extract from the hybrid those blood lines which will make the most valuable recombination of the characters possessed by the two parents.

The experiment in hybridizing Brahma and European cattle, as described on page 91 by Mr. Borden, and the brief statement by Mr. Riley on page 107 introduce the subject of the wider introduction and hybridizing of domestic and wild animals. Wide cooperation between institutions interested in improving our domestic animals and the keepers of zoological parks has been

**Animal  
Hybrids.**

suggested in order that more may be known of the kinds of hybridizing which may be done among species and among domesticated breeds and wild species. The editor invites a general discussion of this subject.

In connection with the importation of Brahma cattle, numerous questions arise: Would pure-bred Brahma cattle pay better in our southern section from Texas to Florida than the cattle of Europe? Would it not be wise to introduce both the best milking breeds and the best meat breeds from India? Mr. Fairchild reports that there are good milking breeds in India. Would it not be well to import them and to produce for our Southern States a cross between our highly developed dairy breeds and these Brahma dairy breeds? May it not be possible to produce hybrid beef breeds with considerable dairy ability? Might not an infusion of the blood of the best European and American beef cattle form a better basis for economic meat production in India than the present breeds of Brahma cattle? Could not India greatly improve her dairy breeds by widely hybridizing the best native dairy breeds with the best pure-bred dairy blood of Europe and America? Mr. Fairchild's reference to the beef and milk breeds of Brahma cattle in Bulletin No. 27 of the Bureau of Plant Industry, 1902, seems to have opened up a most interesting question.

It would seem that there exist in the various races of horses, donkeys, and zebras characters which if recombined to the best advantage might produce hybrid work animals much superior to the forms we now possess. The fact that the horse-donkey hybrid is sterile need not be taken as an unsurmountable obstacle. There may be found ways of so crossing three or more species that fertile hybrids may be produced which include the blood of the horse, the donkey, and the wiry zebra. And it may be possible to segregate from many such hybrids a few rare individuals with the power to become a mighty race of horse hybrids. There are certainly qualities in these species which if the recombination could be made and segregated would make most valuable animals. Those in charge of investigations with horse hybrids are anxious to trace up any cases of alleged fertile horse-donkey hybrids.

**Brahma  
Cattle  
Hybrids.**

**Horse  
Hybrids.**

Under the terms of the vote changing the Constitution, the chairman of the Committee on Eugenics, President David Starr Jordan of Leland Stanford University, and the secretary, Dr. C. B. Davenport of the Station for Experimental Evolution of the Carnegie Institution, become respectively the chairman and secretary of the new section. It is understood that the sub-committees of the Committee on Eugenics will now be called committees of the Association. It is hoped that by the next issue the committee organization can be given. Dr. C. B. Davenport by virtue of his office as secretary of the Eugenics Section becomes one of the editors of the *Magazine* and of the Annual Report.



Those who led in organizing the study of heredity in man as a branch of the work of the American Breeders Association saw something of the difficulties as well as of the possibilities for good in this line of effort. It was firmly believed that the membership and the scientific leadership in this virile new organization furnished the best available auspices under which work in eugenics could be begun. Here are associated those who will conserve the formal traditions and will seek for truths upon which still better traditions may be built. The group of workers chosen by the membership of this Association to work at this problem will be sane, safe and conservative. It is believed that such a group of chosen leaders will gain an authoritative place in the discussion of the subject which will reduce to a minimum the irrational discussion of the subject by those merely seeking notoriety or by those who might carelessly weaken the morality which is growing up with family life.



None know so well as the breeders of plants and the breeders of animals the narrow limitations prescribing the selective breeding of the races of men. On the other hand, the paramount importance of the species makes even small improvements relatively of large value. While restrictions upon people with abnormal heredity may be a result of scientific investigation, doubtless much the larger work is the develop-

**The Section  
Organization.**

**The Movement  
to Study  
Eugenics.**

**Narrow Limits for  
Breeding Men.**

ment of a body of sane knowledge and its dissemination for voluntary use. The religious impulse of the human family to do that which is good for the whole people and is beneficial to posterity will no doubt serve in putting into operation such suggestions as the science of eugenics may find it important to make. In no other line can science and religion so closely cooperate as in the production of races of strong people. None should feel a more vital interest in research in eugenics than those who have been chosen to direct the moral and religious life of the community.

The extensive moral and educational movements on which eugenics must chiefly depend to carry forward its teachings will come whenever the time is ripe. But this may be added, that social workers are learning how to start, organize and carry on nation-wide and world-wide moral movements. The world is learning how to marshal its spiritual and intellectual and moral forces. That these movements do at times proceed grievously slow should not be held against them, but is rather in their favor. It would be effort well spent if as a result of an educational eugenics campaign this country could show at the close of the century a reduction or at least a check in the expenditure of \$100,000,000 annually now being made for the maintenance of hospitals for the insane, asylums for the feeble-minded, prisons, reformatories, and similar institutions.

A greater total of human happiness, higher social standards, higher average of individual efficiency, greater personal security would be the gain, if within this century it became possible to reduce the present three and a quarter million defectives, criminals, insane, vicious and incapables in various institutions in the United States by ever so small a fraction, purging the blood current of the nation of base heredity elements and producing less of the human wreckage which fills those institutions. Once the energies of man are directed to the study of heredity in his own race it may be that both the average of heredity values and the number of geniuses may be increased. In any event good and not harm is assured from the movement modestly but powerfully inaugurated.

Who knows but that students will make discoveries of stupendous moment in eugenics? This word is yet so new as the chosen symbol to name the theme of the study of heredity in man, that relatively few have even seen or heard it. Yet ere a generation has passed, it may be that the leading characters of all the members of each family



in the entire country will be card-indexed. When will there be courses of study to prepare men and women to collect, tabulate, and interpret the statistical facts of how heredity manifests itself in all families and races and in all the many mixtures of the blood of peoples which have come from all climes and represent all tongues? The fact that the Committee on Eugenics of the American Breeders Association appreciates and insists that eugenics must be investigated before it can be taught, is an assurance that this work will proceed cautiously and with due regard for all family and general social traditions. It is not unlikely that portions of these teachings can best be promulgated through the church and through other educational agencies less public than the common schools. But that the fires of science will light up many places now dark in the betterment of plant, animal and human forces is a foregone conclusion. The American Breeders Association has made no mistake in assuming to guide the thought along these lines as well as to promote great activity in their consideration.



An office for eugenics records has been opened at Cold Spring Harbor, Long Island, New York, by C. B. Davenport, secretary of the Eugenics Section. This office will be under the immediate charge of Professor H. H. Laughlin, superintendent. Through the assistance of a friend of the work, a house has been secured, a small fireproof addition will be built, and the work of installing records already collected and of gathering additional records has begun. Six field visitors, working for the most part in connection with State institutions, will assist in the study of the records. It is hoped that professional men and those successful in various lines of activity will take an interest in affording data for the study of inheritance of their family traits. Blanks for such family records are still available and will be sent out from the above mentioned office.

# NEWS AND NOTES

The London Times, of Wednesday, April 13, 1910, contains a thoughtful leader under the heading "Eugenics." It is pointed out that the systematic extension of the new science of eugenics is beginning to make itself felt in the investigation of many questions of great significance, concerning which it is important for the national welfare that we should arrive at correct conclusions.

## **Heredity in School Children.**

Investigations by Mr. Heron, Galton Research Fellow, in the Galton Laboratory for Eugenics, are referred to in the article. Mr. Heron, from research based upon the London County Committee school survey, embracing twelve schools, formulates as his conclusions from that particular investigation that "There is no sign of an environmental condition producing an effect on the mentality of the child, at all comparable to the known influences of heredity."

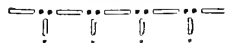

In an article appearing in the initial (January) number of the *Zeitschrift fuer das gesamte Getreidewesen* (Grain Journal, Breslau, Germany), Dr. Kurt v. Ruemker, director of the Agricultural Institute, Breslau, describes the methods by which he originated two new and commercially valuable varieties of rye, and summarizes the results, observation, and experience of eight years' work in the breeding of rye.

## **Two New Varieties of Winter Rye.**

Color of the grains of rye is an hereditarily transmissible characteristic, capable of fixation by selection, and therefore of direct practical value. The bluish green color of grain transmits more intensively and regularly than the grass-green or yellowish green shades. A characteristic of the grains of the latter two colors is that the resulting plants are coarse, the grain heavier but softer, and plants inclined to lodge. The green-grained varieties were observed to stool more freely than the yellow grained varieties. Brown-grained varieties lacked hardiness and also were low yielders of both grain and straw. The darker the shade of brown the lower were the yields.

This also applies to varieties with brown-tipped germ ends. There is objection also to short-grained ryes, because shortness of grain is intensified by heredity and is correlated in direct ratio to yield of straw and per cent of grain. No relation could be established between color of grain and shape of spike, and length of the growing and fruiting period. The per cent of grain to straw decreased almost regularly as stooling propensity increased. Where a variety shows inclination to stool abundantly, it is important, in making selections, to give preference to the heaviest yielding stalks.

Protein content has less relation to color of grain than to plumpness, increasing as that increases.

Yellow-grained varieties were more difficult to develop than the green-grained, but once developed transmitted that characteristic with greater regularity and certainty and much sooner reached the point of gametic purity than the green. Rye seems to produce xenias in the same way as corn. Yellow-grained varieties of winter rye seem convertible into spring rye more easily and quickly than the green-grained. Whatever be the color or variety, it has little established agricultural value unless its heredity is known and unless it comes of selected strains.

With open-pollinated species, selection and separation of types in the first generation is not sufficient to fix types, but must be followed by repeated selections. Even with close-pollinated species selection must be continuous.

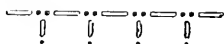

The Khedivial Agricultural Society of Egypt has voted funds for the establishment of a Mendelian Experiment Station, at Cairo, Egypt, for the study of heredity in cotton. This is probably the first institution devoted to the study and application of Mendelian principles to the improvement of plants for economic purposes.

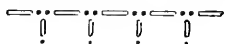

The Garden Island Honey Company, of Honolulu, H. I., is planning to establish a breeding station for the improvement of Italian bees on an isolated island of the group, as soon as necessary arrangements can be made. The company hopes not only to improve the bees but also to furnish an early supply of queens to bee keepers in the Northern States.—E. F. PHILLIPS.

The legislature of the State of New York recently appropriated \$90,000 for a poultry building at Cornell University and a 50-acre tract has been set apart for poultry work on the University Farm. The poultry division of the College of Agriculture of New York has a corps of nine technical people. Prof. J. E. Rice, the head of this division, is to be congratulated.

To most people the hen seems an unimportant part of American agriculture. They do not seem to be aware that our poultry, with a product of nearly \$700,000,000 annually, stands beside the dairy, wheat, and cotton as one of our great interests. These aggregate figures show its real significance from an economic point of view. The fact that this business is divided into so many small units on the family farms of the country results in its receiving little concentrated attention. This makes it all the more necessary that the science and practice of the feeding, breeding, and management of poultry be wrought out by public departments and experiment stations. Leaders in poultry departments in our State colleges and agricultural high schools need no longer be backward in assuming the importance of the needed public work in the interests of poultry. The achievements in education and research with poultry at the Rhode Island, New York, Maine, and other experiment stations show that public money spent under wise direction will enable our agricultural colleges and experiment stations to assist most profitably in the production of poultry.

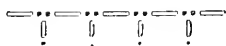

The death of James L. Reid, of East Lynn, Taswell County, Illinois, which occurred recently, has removed a highly useful man; one whose services were rendered in the simple, patient way peculiar to so many noble characters who, having found their work, pursue it singlemindedly, quietly, and perseveringly. Mr. Reid took up the improvement of corn in 1846, a time when the word plant breeder was not used as frequently as now, nor with the same peculiar significance. Mr. Reid had devoted his lifetime to the creation of the variety of yellow corn which now bears his name. He gave the world a fixed, prepotent, and characteristic variety of yellow corn. The value of his service cannot well be computed in exact sums of money, but that farming in

**James L. Reid,**  
**Breeder of Corn.**

the great corn belt has been benefited in a material way, is realized by all who know the importance of the corn crop in American agriculture.

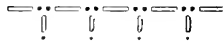

There is always a strong impulse on the part of many poultry breeders to attend too exclusively to markings of color, and to form.

**Breeding Poultry  
for Egg  
Production.**

These are valuable identifying characters in pure-bred fowls, but sometimes the egg-laying power, the thickness of meat on breast and legs, and also early maturity and other utility characters receive too little

attention. An idea has come from Australia to the American Breeders Association of a plan for use by State fairs, experiment stations, agricultural colleges, and agricultural high schools in encouraging the breeding of chickens with high egg-producing ability. The memorandum below was designed as a suggestion for the board of managers of the Minnesota State Fair. It would seem quite as valuable a suggestion for other State fairs and even more especially for experiment stations, agricultural colleges, and agricultural high schools, and is therefore presented herewith:

PRIZES FOR COMPETITION IN EGG PRODUCTION.

Prizes open to the world are offered for pens of chickens which make the best annual record of production of eggs.

The time of beginning the test shall be August 15, and the time of closing shall be the same date of the succeeding year.

Pullets shall be not more than six months old and hens shall be not less than fourteen months old at the time of entering upon the contest.

A pen shall consist of six females and one male.

- Group I. For pen of hens producing largest number of eggs (averaging 2 ounces each)..... \$50
- II. For pen of pullets producing largest number of eggs..... 50
- III. For pen of hens producing greatest profit above cost of feed.. 50
- IV. For pen of pullets producing greatest profit above cost of feed.. 50

Entries will be closed one month before the beginning of the tests, that suitable pens and runs may be provided for all entries. The management will provide for the housing, care, and feeding of the pens of fowls and will prescribe a uniform plan of feeding for the several pens. All hens will be trap-nested and individual egg records will be kept, including the weight of the eggs. In addition, an accurate account will be kept of the value of all food used and of the number and value of all eggs laid by each pen and of all other factors which enter into the competition

The fowls shall be left for exhibition at the State fair (or other show) following the completion of the contest.

A cock or cockerel suited to the production of pure-bred chicks of the same breed must accompany each pen of females. The eggs laid by the hens shall become the property of the State board of agriculture (college, or other organization in charge) and may be sold for breeding purposes at customary prices for pure-bred eggs.

Entries must be made at least a month before the date of beginning of the contest. Unless at least ten pens are entered, the management reserves the right not to proceed with this contest, and unless more than one entry is made in a group the management will not start that group for the contest.

The minimum age at the beginning of the contest will of necessity be chosen to meet the conditions as affected by the time of the year chosen for opening and closing the contest. Experience may dictate a change in the date at first chosen. Pullets usually begin laying at about six months of age. Where it is desirable to have the hens start at the same time as the pullets it may be necessary to choose a date on which they can best start into their second year of laying, as in the autumn when they are a year old.

Where the work is done on the grounds of the State or other agricultural fair, the test year may be set to begin a week or two before the opening of the fair. Those visiting the fair can then see the experiment in progress; and the birds which have finished in the previous year's contest can be on exhibition, showing their relative standing at the close of the year's contest. The outgoing pens of fowls can be on exhibition in the general poultry show building, where the details of the contest can be displayed on charts or in other suitable manner.—W. M. HAYS.

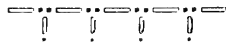

When our local, State and national live stock shows develop comprehensive exhibits showing centgener families of dairy stock, trotting horses, and poultry, these exhibits will have a profound influence in placing the breeding of the classes of live stock named on a statistical basis of individual and centgener values, which will help to lead up to a broader philosophy of breeding meat-producing and work stock.

**Live Stock Shows.**

# ASSOCIATION MATTERS

The editors have received many words of commendation, hearty good will, and encouragement upon the appearance and contents of the first number of the *Magazine*. All this is greatly appreciated and will stimulate to renewed effort and faithful service. Here is a thought which each individual member will do well to appropriate: With the intellectual, highly trained, and successful class of men who compose the membership of the Association, and each contributing, the *Magazine* can be brought to an unusually high standard of excellence and can be made very helpful and valuable. Each member should make it his duty to contribute in a way that he thinks will add to the interest and variety of contents of the *Magazine*, and will enlarge its usefulness as a means of inter-communication and as a repository of scientific facts.

**Good  
Words.**

Here is what Hon. Wm. George, Vice-President of the Association, says:

I wish to congratulate you upon the fine appearance of the initial number of the American Breeders Magazine. It certainly needs only a little of your energy and push to make it a success.

Prof. James E. Rice, Cornell University, writes as follows:

This is to congratulate you on the splendid first issue of the A. B. A. Magazine. From every standpoint it is high grade and unique. This will be a splendid inducement for securing new membership.

An editor's opinion of the *Magazine*—Edwin C. Powell, editor Farm and Home, Springfield, Mass:

I have looked over the Magazine with much interest. I want to congratulate you on not only the high type of articles but the very readable manner in which they are presented.

Another editor, John B. Conner, of the *Indiana Farmer*:

We are well pleased with the Magazine.

From W. J. Wright, Assistant Professor of Horticulture, Pennsylvania State College:

Please accept my congratulations for the excellence of Vol. I, No. 1, of the American Breeders Magazine, which has just reached my desk. As a teacher of plant breeding at this institution I shall expect to derive much benefit from its pages.

And we are no little proud and pleased over the following from Prof. Charles E. Bessey, of the University of Nebraska:

I am very much pleased with the appearance of the first number of the American Breeders Magazine. It is well gotten up and the subject matter contained in it is good and I think must prove to be useful.

---

The office of the American Breeders Association is unable to fill any orders for back volumes of the Annual Report, except Volume **Bound Reports.** IV. These may be had at \$2 per volume. There is a constant call from new members for back numbers of the Report, and we are obliged to disappoint these many inquirers. Old members who happen to have spare copies of the earlier reports which they care to dispose of are requested to give the Secretary their names and addresses and number of the volume for sale.

---

Libraries desiring to keep complete sets of the publications of the American Breeders Association will find it greatly to their advantage to take life memberships in the Association. **Association Publications.** The Secretary has on file a number of applications from libraries, for back volumes, which can be filled only with difficulty and will probably require considerable time. With the addition of the Eugenics Section the publications will assume a larger importance and command a wider interest than ever before, and will be valuable additions to general libraries.

---

Members are requested to be prompt in notifying the Secretary of changes of address, and it is suggested that city addresses be given complete as to street and number.

---

The delay in sending out the programs for the last annual meeting, held at Omaha, Neb., was due to the fact that several members



**Send in Titles of Papers.** were slow in sending in the titles of their papers. It is very desirable to avoid this embarrassing situation this year. The programs of our annual meetings display very advantageously the strong features of our organization and the immense scope of its work. Moreover, an interesting program, sent out in ample time for the recipients to make preparations to attend the meeting, may be instrumental in securing a large attendance. Notwithstanding the fact that the Association cannot complain on that score, as all meetings have been well attended heretofore, we must constantly strive for larger possibilities; while a fair attendance is good, a big attendance is still more desirable. Hence the Secretary suggests that members having papers in course of preparation should send in the titles as early as it can conveniently be done.

---

At the Sixth Annual Meeting of the American Breeders Association, following a suggestion communicated by the secretary of the Committee on Eugenics, Dr. C. B. Davenport, Professor N. E. Hansen gave notice of a proposition to change the Constitution of the Association to raise the Committee on Eugenics to a third section coordinate with the Plant Section and the Animal Section. On April 26 the Council voted to submit this proposed change to a vote of the membership. Accordingly, the Secretary mailed a vote to the members on June 2 and on July 1 the vote was counted, Mr. C. W. Warburton, Dr. C. G. Palmer, and Mr. Nat. C. Murray acting as tellers, and certifying the vote. It stood 499 for the change and 5 against, and notice of the change is hereby given.

---

From the time of the meeting in December, when the matter of submitting the change of Constitution was brought up, until a vote by the members of the Association was obtained, the printing of the Constitution of the Association was held in abeyance, although many requests have come to the Secretary's office, especially from new members, for copies of the Constitution and By-laws.

**Constitution of the Association.** The amendment having carried, the Constitution as printed herewith is brought up to date, and between the covers of the *Magazine* is in permanent and handy form for reference.

## CONSTITUTION.

ARTICLE I.—*Name*.—The name of this Association shall be the American Breeders Association.

ARTICLE II.—*Purposes*.—The purpose of this Association shall be to study the laws of breeding and to promote the improvement of plants and animals by the development of expert methods of breeding.

ARTICLE III.—*Membership*.—The annual membership shall consist of persons, societies and institutions interested in the objects of this Association and paying the prescribed annual fee. There shall also be life members, who shall have paid a fee of twenty dollars; patrons, who shall have made a gift to the Association of the value of one thousand dollars or more; and honorary members.

The names of patrons shall be retained in the lists of patrons as long as the Association exists. Any person who shall have done notable service in advancing the objects of the Association may be elected an honorary member by the Council. No more than two honorary members may be elected in any one year, and there shall be no more than ten honorary members.

Honorary members, life members and patrons shall be exempt from annual dues.

ARTICLE IV.—*Organization*.—The officers shall be a President, a Vice-President, a Secretary and a Treasurer. An honorary President may be chosen at any annual meeting.

There shall be a Plant Section, an Animal Section and a Eugenics Section, each with its Chairman and its Secretary.

There shall be a Council of nine members, which shall have charge of the affairs of the Association when it is not in session and during its meetings shall be at the command of the Association. The Vice-President, the Secretary, the Treasurer, and the Chairmen and Secretaries, of the Plant Section, of the Animal Section and the Eugenics Section shall be ex-officio the nine members of the Council.

Any action taken by any section relating to the public policy of the Association, to become operative must be approved by the general association.

ARTICLE V.—*The Council*.—All resolutions and all amendments to the Constitution and By-Laws shall be submitted to or referred to the Council and approved by them before they may properly come before the Association.

ARTICLE VI.—*Meetings*.—A meeting of the Association shall be held annually at such time and place as may be determined by the Council.

ARTICLE VII.—*Elections*.—Election of officers for the ensuing year shall be held the last day of the annual meeting, and such election shall be by ballot.

ARTICLE VIII.—*Amendments*.—Amendments to this Constitution may be made by a majority of the Council with the concurrence of two-thirds of the members of the Association voting upon the question by mail within thirty days after the notice is mailed by the Secretary, providing that the amendment shall have been discussed in general sessions at the previous annual meeting, and that printed notice shall have been given to the entire membership.

## BY-LAWS.

SECTION I.—*Membership*.—The active members shall be: *First*, delegates of societies of plant and animal breeders, horticultural societies, agricultural societies, biological societies, of colleges, universities or experiment stations, or of other organizations interested in the objects of this Association; *Second*, plant and animal breeders and those interested in the improvement of plants and animals, or in investigations or instruction relating thereto, and other persons interested in the purposes of this Association. The Council shall determine the eligibility of the applicant. Application for membership shall be made to the Secretary on a printed form furnished by the Secretary.

SECTION II.—*Privileges of Members*.—All classes of members shall be entitled to vote. Each member is entitled to one copy of the annual report issued by the Association.

SECTION III.—*Delegate Membership*.—Librarians of institutions and secretaries of societies, in their official titles, may become members and receive publications, and their official addresses may appear in the list of addresses of members.

SECTION IV.—*Dues*.—The membership dues of persons, of societies and of institutions shall be two dollars and shall be payable upon notification of election and annually thereafter.

SECTION V.—*Arrears*.—A member in arrears over one year shall cease to be an active member, but may be restored by paying all arrears.

SECTION VI.—*Officers*.—The officers shall perform such services as are ordinarily required by their positions and shall serve until the election of their successors.

SECTION VII.—*The President*.—The President shall serve for one year, shall preside over the annual meetings for which he is elected and shall give the annual address.

SECTION VIII.—*The Vice-President*.—The Vice-President shall serve for one year and shall preside in the absence of the President.

SECTION IX.—*The Treasurer*.—The Treasurer shall serve for two years, shall receive and hold all moneys coming to the Association, and shall disburse or invest as Trustee all moneys as directed by a majority vote of the Council, and shall keep an accurate and detailed account of all receipts and disbursements and make a report of the same to the Council at or before each annual meeting, and a summarized report shall be furnished the Council, which shall be made to the annual meeting. The records and accounts of the Treasurer shall be open to the inspection of members. The Council shall require a suitable bond of the Treasurer.

SECTION X.—*The Secretary*.—The Secretary shall be the executive officer of the Association, acting under the direction of the Council. He shall keep a record of all proceedings of the Association and of the Council, of membership dues and miscellaneous receipts collected, and pay all moneys received and all balances promptly to the Treasurer. He shall arrange with local committees for the annual meetings, send notices, receive, record and hold in trust property of the Association other than investments and funds in the hands of

the Treasurer, arrange for the printing and distributing of reports and other printed matter, procure all material and assistance required in the prosecution of these duties and perform all other duties delegated to him by the Council.

SECTION XI.—*Duties of the Council.*—The Council shall appoint committees of its members or of the Association, shall control the presentation, discussion and publication of papers, shall determine upon the place and time of the annual and special meetings, shall arrange through the Secretary for local committees to receive and entertain the Association, shall examine the reports and accounts of all officers and committees and shall pass upon all other business not transacted by the society. The meetings of the Council shall be called by the Chairman, through the Secretary.

Six members present, or voting by mail, shall constitute a quorum and a majority vote shall determine all questions. At its annual meeting the Council shall hear the reports of the Treasurer, of the Secretary and of committees and shall transact other necessary business. The Council may vote by mail ballot upon questions submitted to them by the Secretary, voting for or against, or to refer to the Council at its next meeting.

SECTION XII.—*Meetings.*—The Annual Meetings are to be called by the President on the approval of the Council.

SECTION XIII.—*Publications.*—The annual reports are to be edited by the Secretary, assisted by the Secretaries of the Plant, Animal and Eugenics Sections.

SECTION XIV.—*Committees.*—The Council with the concurrence of the Association may organize committees to bring about co-operation and to deal with such subjects as it may deem important. These committees, besides considering the general features of their respective subjects, shall annually report upon the progress of work in specific subjects, work in foreign countries, etc.

SECTION XV.—*Sectional Meetings.*—The Council, in making up the program for the annual meeting, shall so apportion the subjects for discussion to the general session, to the Animal Section, to the Plant Section and to the Eugenics Section as shall best serve the interests of all members.

SECTION XVI.—*Amendments.*—Amendments to the By-Laws, upon recommendation of the Council, may be made by a majority vote of the Association.

# *The American Breeders Magazine*

*Issued Quarterly for Practical and Scientific  
Breeders of Animals and Plants*

*Edited by Willet M. Hays, N. E. Hansen, H. W. Mumford  
and C. B. Davenport.*

Contributions to the American Breeders Magazine come from the membership of the American Breeders Association, which comprises the brightest students of heredity and the most successful breeders of plants and animals in America and foreign countries. These men are achieving results that loom large in science, in farming, and in commerce, contributing not only to the world's wealth but also to its real welfare. Nowhere else will one find so much important matter dealing with heredity and breeding enclosed within the covers of a single publication. Next quarter the following will be among the contributions:

## **HEREDITY OF FEEBLE-MINDEDNESS**

By **H. H. Goddard**

## **REPORT OF COMMITTEE ON BREEDING NUT AND FOREST TREES**

By **Geo. B. Sudworth**

## **THE MULE-FOOT HOG**

By **W. J. Spillman**

## **REPORT OF COMMITTEE ON ANIMAL HYBRIDS**

The study of the heredity of feeble mindedness furnishes Dr. Goddard material for an interesting article, which is illustrated by fifteen remarkable heredity charts.

Mr. Geo. B. Sudworth, as the Dendrologist of the U. S. Forest Service, is especially qualified to report on breeding nut and forest trees.

Of the breed of mule-foot hogs described by Professor Spillman there are 235 breeders in twenty-two states. The breed is not a recent production, since it seems Aristotle knew of it. The article describes its origin and history, its relation to disease, and the anatomical structure of the solid hoof. Several excellent illustrations elucidate the text.

The report of the Committee on Animal Hybrids gives a birds-eye view of the cross-breeding work carried on at the several experiment stations for the purpose of establishing new types and breeds. The breeding of cattaloes, Brahma cattle, wolf-dog hybrids, pheasant-chicken hybrids, and crosses of existing pure-bred races is briefly discussed.

Other articles will be provided, varied enough to engage the most diverse interests.

Secure the Magazine by taking membership in the Association. Dues, \$2.00 a year. Single copies may be had at 50 cents each.

*Address AMERICAN BREEDERS ASSOCIATION  
Washington, D. C.*

# The American Breeders Association

## OFFICERS

HON. JAMES WILSON, President

WM. GEORGE, Vice-President

W. M. HAYS, Secretary

N. H. GENTRY, Treasurer

---

**T**HE AMERICAN BREEDERS ASSOCIATION is a cooperative association designed especially to develop the science of breeding and heredity and to bring that scientific knowledge to students of heredity, to the practical breeders of pedigreed animals and plants and to others interested in these subjects. It affords a means for conference among the members of the Association.

The membership is composed of progressive breeders, scientists, teachers, and others interested in all phases of heredity of plants, animals and men and the improvement of methods of breeding. The best investigators in the science of heredity and breeding and the best practical breeders of pedigreed live-stock and plants freely cooperate through the Association and donate the time required to make investigations, to prepare papers, to attend the annual meetings and to help build up the literature of the science and practice of breeding, thus to produce the largest results possible in the form of better animals and plants.

All persons interested in its work are cordially invited to become members of the American Breeders Association.

Membership entitles the holder to the American Breeders Magazine, to the annual report of the Proceedings of the Association, and to full participation in the activities of the Association.

**Membership: Annual, \$2.00; Life, \$20.00**

**No entrance fee.**

**Address AMERICAN BREEDERS ASSOCIATION  
Washington, D. C.**

WASHINGTON, D. C.

1910

# AMERICAN BREEDERS MAGAZINE

Published by the American Breeders Association

*Heredity of Feeble-Mindedness*

HENRY H. GODDARD

*The Mule-Foot Hog*

W. J. SPILLMAN

*Breeding Nut and Forest Trees*

GEO. B. SUDWORTH

*Breeding for Type of Kernel in Wheat*

HERBERT F. ROBERTS

*Breeding Drought-Resistant Cereals*

ROBERT GAUSS

*Report of Committee on Animal Hybrids*

Third Quarter

July, Aug., Sept.

Vol. I

No. 3

# *The American Breeders Association*



## *OFFICERS OF THE ASSOCIATION*

### *President*

HON. JAMES WILSON, Washington, D. C.

### *Vice-President*

HON. WILLIAM GEORGE, Aurora, Ill.

### *Secretary*

HON. WILLET M. HAYS, Washington, D. C.

### *Treasurer*

HON. N. H. GENTRY, Sedalia, Mo.

### *Chairman Plant Section*

DR. H. J. WEBBER, Ithaca, N. Y.

### *Secretary Plant Section*

PROF. N. E. HANSEN, Brookings, S. Dak.

### *Chairman Animal Section*

DEAN C. F. CURTISS, Ames, Iowa.

### *Secretary Animal Section*

PROF. H. W. MUMFORD, Urbana, Ill.

### *Chairman Eugenics Section*

DAVID STARR JORDAN, Stanford University, Calif.

### *Secretary Eugenics Section*

C. B. DAVENPORT, Cold Spring Harbor, N. Y.



## *EDITORS*

WILLET M. HAYS, Secretary of the Association

N. E. HANSEN, Secretary of the Plant Section

H. W. MUMFORD, Secretary of the Animal Section

C. B. DAVENPORT, Secretary of the Eugenics Section

*Address Communications to American Breeders  
Association, Washington, D. C.*

*Membership: Annual, \$2.00; Life, \$20.00;  
Patrons, \$1,000.*



# The American Breeders Magazine

Published Quarterly by the American Breeders Association

FOR THE USE OF ITS MEMBERS

PRICE OF SINGLE COPIES, FIFTY CENTS

Address communications to American Breeders Association, Washington, D. C.

Vol. I.

Third Quarter, 1910.

No. 3.

## CONTENTS.

	PAGE
Joseph Gottlieb Koelreuter (portrait).....	158
Koelreuter, Bakewell, and Rimpau (biographical sketches).....	159
Robert Bakewell (portrait).....	161
Wilhelm Rimpau (portrait).....	163
Heredity of Feeble-Mindedness (illustrated). HENRY H. GODDARD.....	165
History and Peculiarities of the Mule-Foot Hog (illustrated). W. J. SPILL- MAN.....	178
Climate and Eugenics. CHAS. E. WOODRUFF.....	183
Report of Committee on Breeding Nut and Forest Trees. GEO. B. SUD- WORTH.....	185
Report of Committee on Animal Hybrids. W. J. SPILLMAN.....	193
Report of Committee on Breeding Fiber Crops. J. H. SHEPPERD.....	197
Walnut-Oak Hybrid Experiments. ERNEST B. BABCOCK.....	200
Report of Committee on Breeding Cereals. C. A. ZAVITZ.....	203
Breeding for Type of Kernel in Wheat (illustrated). HERBERT F. ROBERTS....	204
Acclimatization in Breeding Drought-Resistant Cereals. ROBERT GAUSS....	209
EDITORIALS:	
Need of Members.....	218
Aims of the <i>Magazine</i> .....	219
History Repeating Itself. GEORGE W. KNORR.....	220
Heredity in Man.....	221
Efficiency Records of People. W. M. HAYS.....	222
NEWS AND NOTES:	
Increasing Weight of Fleeces. NAT. C. MURRAY.....	228
Unrewarded Merit.....	229
Private Game Preserves Beneficial.....	231
Dark-Skinned Animals in the Tropics.....	233
Wild Prototypes of Wheat and Other Cereals in Palestine.....	234
Variation and Correlation in Timothy.....	234
ASSOCIATION MATTERS:	
Committee Members.....	235
Eugenics Section: Its Organization.....	235



JOSEPH GOTTLIEB KOELREUTER.

# THE AMERICAN BREEDERS MAGAZINE

"Speaking of all the generations past  
To all the generations yet to come."—J. G. HOLLAND.

Vol. I.

Third Quarter, 1910.

No. 3.

## KOELREUTER, BAKEWELL, AND RIMPAU.

Koelreuter has a place of honor as the first breeder to hybridize plants. Bakewell is in a class by himself among the early pioneers in originating the British breeds of livestock. Rimpau was first among the German breeders of cereal crops. Each of these men gained not only prominence among their contemporaries, but also a place in the history of breeding. It seems strange that the inspiration instilled by the work of Koelreuter did not earlier lead to investigations along practical lines in making hybrids. Bakewell's example in forming new breeds, on the contrary, was followed by many men and many communities in forming new breeds of domestic animals.

### JOSEPH GOTTLIEB KOELREUTER.

1733-1806.

Joseph Gottlieb Koelreuter received an intellectual endowment from his father, who was a chemist at Sulz on the Neckar, in Württemberg, Germany. In 1748 he entered the University of Tübingen, a very small German institution noted for the famous men it had put forth. He received the degree of Doctor of Medicine in 1756 and was soon called to a position in the Imperial Academy of Science at St. Petersburg. Here he had charge of the extensive collections of the Academy; here he published his observations on the sexuality of plants, and it was here that he accomplished the first artificial hybridization of plants of which botanists have record.

Koelreuter left Russia in 1761 to take the professorship of natural history at Calw, and in 1763 he was made "director of the gardens" of the Margrave Karl Friedrich at Karlsruhe, which for that time had a remarkable collection, the catalogue showing more than two thousand different species of plants.

The interest in his work was increased by the fact that the Margrave, and also his wife Margravine Karoline Louise, were botanists of some attainments and were also in close touch with Linné and other noted scientists of that day. Koelreuter's presence aided in making the Margrave's gardens a noted scientific center and place of pilgrimage, and much of the botanical work was made to relate to farming for the purpose of promoting the agricultural welfare of Württemberg.

These activities eventually led to the organization of an agricultural society by the Margrave, with Koelreuter as its most active member. The records of the society, which are still preserved, show that he outlined among many other experiments a series of trials with manures and fertilizers in which the plans used were much the same as those used in the plot experiments of the experiment stations of the present day.

#### **ROBERT BAKEWELL.**

1725-1794.

Robert Bakewell was the first of those great creative breeders primarily responsible for the origin of so many definite and valuable breeds of livestock formed in the British Isles. He was born at Dishley, Leicestershire, England, and began his breeding operations in 1755. Selecting his foundation from the native sheep of his own and surrounding countries, within his lifetime he transformed a coarse, late-maturing breed into one so early-maturing and so fat at a year old that the markets of the time considered them hardly edible. It is said that he secured some sheep from Lincolnshire to improve the wool of his sheep. To Bakewell is due much of the credit for having redirected the breeders of his time from breeding for size alone and to begin to breed for form, early maturity and long wool.

By selection and very narrow breeding he produced a flock or breed which served as a central source of prepotent or dominant blood that was a very potent factor in the formation and improvement of English long-wool and middle-wool sheep. Prices for males rose from several dollars to hundreds, and in rare instances to \$5,000.

Some of Bakewell's contemporaries criticised a certain secrecy with which he shrouded some of his operations and business, but the probability is that his contemporaries did not understand the scientific work of Bakewell. Collections of bones and pickled parts of sheep



ROBERT BAKEWELL.

anatomy, together with his habit of keeping from view certain breeding animals, notably the "black ram," presumably furnished the neighborhood the material for gossip and for questioning his methods.

Bakewell also improved the heavy "Shire" horses of his county. He was also the first great improver of the Longhorn cattle, having sold the bull of that breed for \$1,000. His impress was also placed upon the Yorkshire swine of the region. The animal forms molded by him a century and a half ago, and found today on the farms of every continent, are living witnesses to his genius.

No marble slab marks the burial place of Robert Bakewell. But his monument exists in the herds of those who are benefited by his skill as a scientific, practical, and, above all, successful breeder. Bakewell earned for himself lasting fame as a creative breeder. He truly was an originator. His peculiar service was in supplying potent material with which other breeders could work, and many improvers are carrying out the work for which he provided foundation material.

The portrait herewith is from an old print loaned the American Breeders Association by Mr. Richard Gibson, Delaware, Ontario, Canada, who furnished the facts in the above statement. Visitors to the Saddle and Sirloin Club, Stockyards, Chicago, enjoy seeing a portrait in oil painted from this original.

#### WILHELM RIMPAU.

1842-1903.

Dr. Wilhelm Rimpau was born at Schlanstedt, Germany. His father, Wilhelm August, was known as one of Liebig's most enthusiastic disciples and one of the very first to apply his teachings to practical agriculture. After graduating at the "gymnasium" or secondary school he spent two years of apprenticeship on the estate of Von Hoppenstedt at Liebenburg, to familiarize himself more widely with farm methods.

He then spent two years at the agricultural academy at Poppelsdorf and later took up university studies under the famous botanist, Julius Sachs. Returning to his father's estate, he soon became the sole tenant; and in 1892 came also in possession of the beautiful estate Langenstein, in the foothills of the Harz Mountains, where the present writer visited him in 1899. A large part of the area of the several

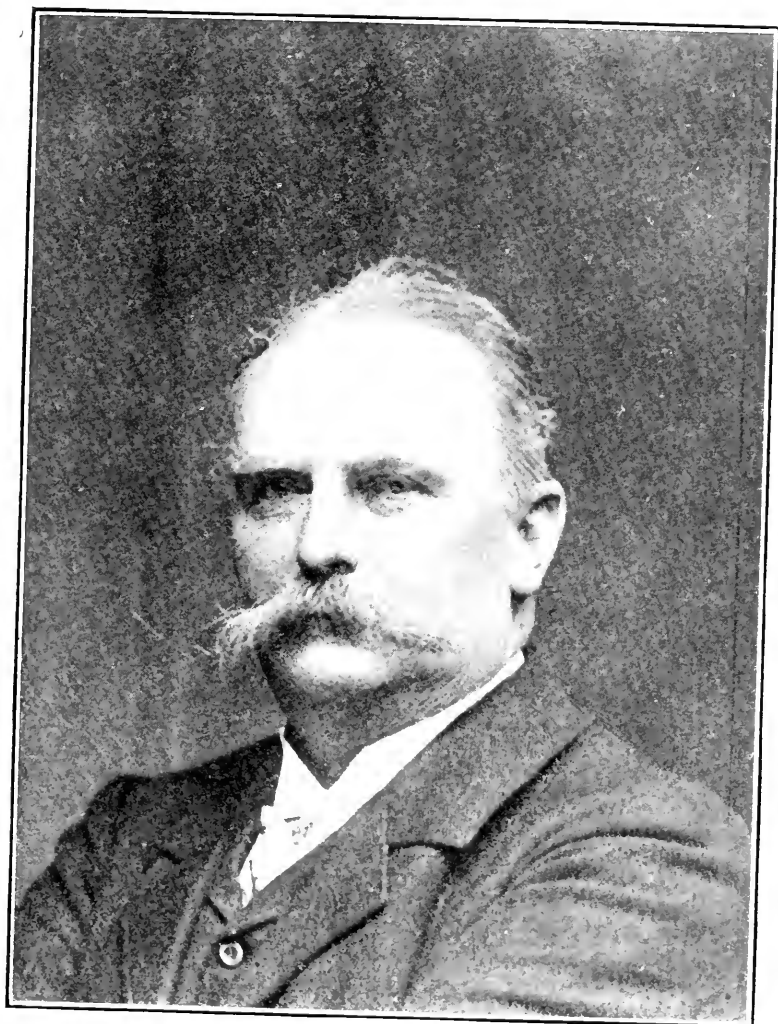

WILHELM RIMPAU

thousand acres of these two farms was devoted to the production of seed crops, chiefly cereal and sugar beet varieties of Rimpau's own origination.

While his work in plant breeding extended to many cultivated crops, he devoted most attention to the breeding of new varieties of grain, chiefly rye. His method of breeding, which was largely wrought out with rye, would be termed in the more modern nomenclature "broad breeding." The German method of broad breeding of cereal grains is sometimes contrasted with the American and Swedish cent-gener method of narrow breeding. Dr. Rimpau's publications covered a wide scope in the fields of science, agriculture and economics. He had much to do in inspiring the modern movement in systematic plant breeding, and so far as the writer knows was the earliest German breeder of field crops to work in a broad and large way to create better varieties of those great products.



## HEREDITY OF FEEBLE-MINDEDNESS.

HENRY H. GODDARD, *Vineland, N. J.*

The admission blanks of institutions for the feeble-minded generally have some questions relating to the ancestry of the applicant. Upon examination of those on file at Vineland, N. J., it was felt that the answers were not sufficiently accurate to be valuable. In some cases, at least, parents had stated that which they thought would get the child into the institution.

Recognizing the difficulty of preventing these inaccurate statements, it was decided to publish a new blank which should be called the "After-admission Blank," containing very careful, detailed questions about the relatives of the child. This blank was sent to all parents and physicians, with a little note urging them for the sake of the child to tell all they possibly could about the child's relatives, their condition, any diseases they had had, any habits, such as alcoholism, any insanity or the like which had occurred in the family. It was expected that this would only be preliminary to more detailed and careful work later. We were, however, greatly surprised at the amount of information received, which has since been proved to be generally very accurate. Upon the basis of this information, we prepared charts of the children, which were truly remarkable in what they revealed as to the etiology of feeble-mindedness.

This spurred us on to more careful and detailed work. We were fortunate enough to find some philanthropic people who were glad to furnish the funds necessary to employ two field workers. It was felt that this was very delicate business, but the relation between the superintendent at Vineland and the parents of the children is so intimate and friendly that we have had complete cooperation from the start. The field worker goes out as the superintendent's personal representative with a letter from him recommending her and urging the parents, for the sake of the child, to tell all they possibly can, and to send her on to other relatives or to any one who may be able to give the information, which may be used to help their child, or some one's child. The response has been full, free, and hearty. Parents do all in their power to help us get the facts. There is very rarely anything like an attempt to conceal facts that they know. Of course, many of these parents are ignorant, often feeble-minded, and cannot tell all that we should like to know. Nevertheless, by adroit

questioning and cross-reference, we have been able to get what we believe to be very accurate data in a very large percentage of our cases.

The charts here presented are typical of about eighty so far completed. The symbols used in the charts are the following: Square indicates male. Circle indicates female. A capital letter indicates disease, habit, or condition, as follows: A, alcoholic (habitual drunkard); B, blind; C, criminal; D, deaf; Dwf, dwarf; E, epileptic; F, feeble-minded, either black letter, or white letter on black ground (the former when sex is unknown); I, insane; M, migraine; N, normal; Sx, grave sexual offender; Sy, syphilitic; T, tuberculous; W, wanderer, tramp, or truant.

Any of these letters may be used with no square or circle when sex is unknown. When even the letter is omitted the vertical line points to the fact that there was an individual of whom nothing is known.

Small black circle indicates miscarriage—time is given (in months) when known; also cause; stillbirth is shown as a miscarriage at nine months; b = born; d = died; m = married; inf = infancy; hand shows which child is in the institution for feeble-minded; illeg = illegitimate; heavy line under any symbol indicates that the person is in some institution at the expense of society.

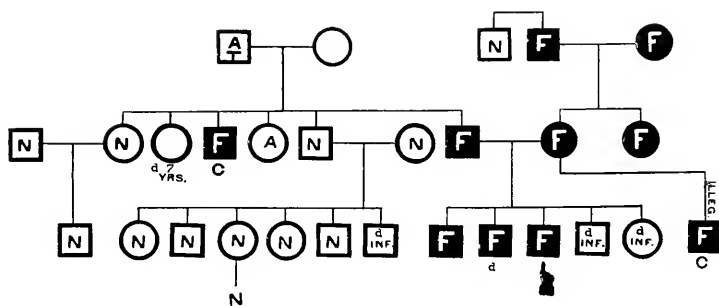

CHART I.

On the lowest line, which represents the brothers and sisters of the child in the institution, the children are indicated in order of birth—the oldest to the left. In other cases the order would be indicated, if known, by numerals placed above the horizontal line.

Chart I shows the maternal grandparents feeble-minded, and they have as usual only feeble-minded offspring—two girls. One of these married a feeble-minded man whose brother was feeble-minded and



Chart IV, also, seems to show the defect coming through the male, the grandfather, a feeble-minded man, marrying a normal woman, the result of this marriage being two feeble-minded children

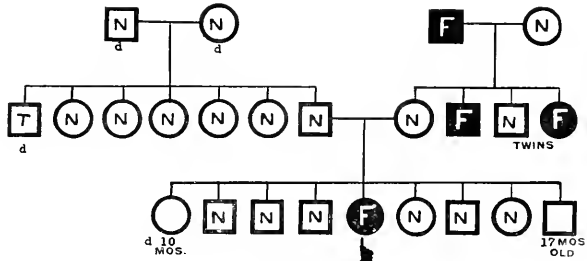

CHART IV.

and two normal ones. One of these normals married a normal man. They had six normal children, one feeble-minded, one who died in infancy, and one infant still living, but condition unknown.

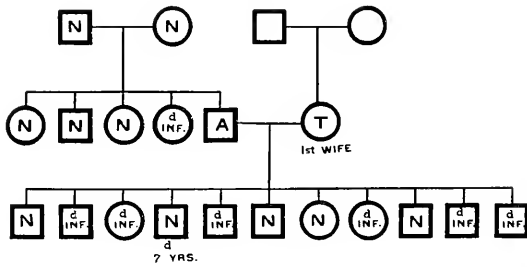

CHART V, A.

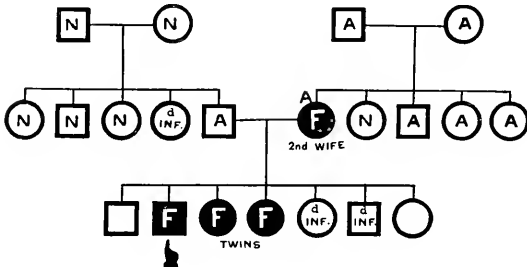

CHART V, B.

Chart V is presented in two parts—A and B. It gives us what may be called a natural experiment of extreme suggestiveness. The father of our child was twice married. He himself is alcoholic, otherwise his family seems to be very good. His first wife was a normal

woman, but a victim of tuberculosis. The result of that marriage was eleven children, of whom five are known to be normal, the others died young. This man married for his second wife a woman who was alcoholic and feeble-minded, and who had two sisters, a brother, a father, and a mother that were also alcoholic. The result of this union was seven children—three feeble-minded, two that died young, and two that are as yet unknown. It seems to be fairly clear in this case that the father's alcoholism may have caused the physical weakness that led to so many early deaths in the first family, but the mother's defect has been directly transmitted in the second family, with the result that there are at least three feeble-minded children. We might also add the two others that died young, because, according to the definition of Tredgold which describes an idiot as "one who cannot avoid ordinary dangers," these children were also defective, since they were both killed at play, apparently not being able to protect themselves in a usually harmless game.

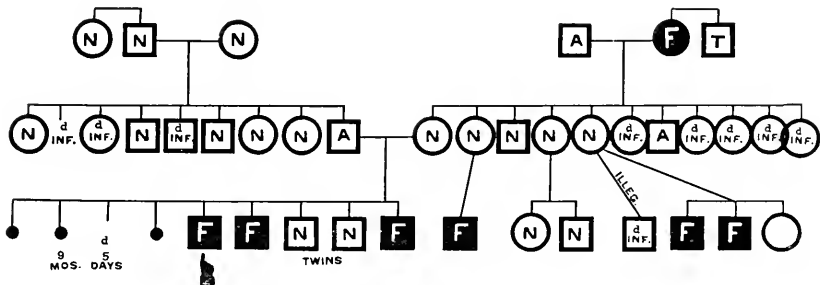

CHART VI.

Chart VI shows a marked instance of the defect skipping a generation. The maternal grandmother was feeble-minded, her husband was alcoholic, but not one of their children was defective. Indeed, four of them were distinctly normal. However, the mother of our child had had St. Vitus dance, a brother is alcoholic, a sister had had St. Vitus dance, and another hysteria, but mentally, they were not defective. The father has no history of mental defect in his family; he himself was alcoholic, but his five brothers and sisters and the parents were normal. Nevertheless the result of the union of these two is three feeble-minded children, one still-born, one that died in five days, two miscarriages, and two normals. If we had this family only, perhaps it would be too hazardous to ascribe these three feeble-

minded children to the influence of the feeble-minded grandmother, but when we look at the other children of this grandmother we find that a second daughter has a feeble-minded child, and a third daughter had an illegitimate child that died young, and later two feeble-minded children born in wedlock, and the third child of that woman was defective in eye-sight. The husbands of these women are not known to have been defective. It seems a clear case of the defect passing over from the grandparents to the grandchildren.

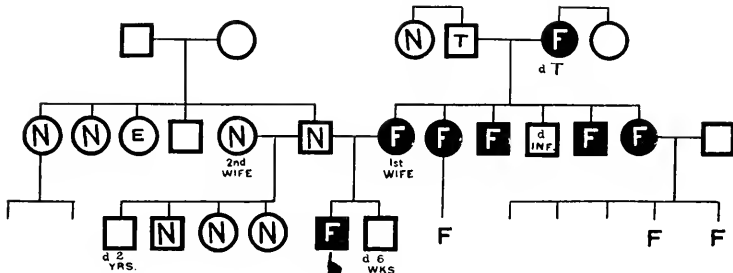

CHART VII.

Chart VII shows the father twice married. His first wife was feeble-minded, and bore him one feeble-minded child and another child that died at six weeks. As will be seen, this wife's family is a bad one, there being five feeble-minded children from a father who was tubercular and a mother who was tubercular and feeble-minded. Two of the sisters married. One had at least two feeble-minded children, the other had one. Coming back to the father of our child, he married the second time a normal woman who gave birth to three normal children and one who died at two years.

Chart VIII (in two parts) is in some ways the most astonishing one we have. There are in the institution at Vineland five children representing, as we had always supposed, three entirely independent families. We discovered, however, that they all belonged to one stock. In Chart VIII, *A*, the central figure, the alcoholic father of three of the children in the institution, married for his third wife a woman who was a prostitute and a keeper of a house of ill-fame, herself feeble-minded and with five feeble-minded brothers and sisters. One of these sisters is the grandmother represented on Chart VIII, *B*.

On *A* it will be seen that this alcoholic man was four times married. He comes from a good family but was spoiled in his bringing up, became alcoholic and immoral—a degenerate man. His first wife,



of that union was seven feeble-minded children, of whom one is a criminal and one an epileptic. Four are married. The feeble-minded epileptic woman married a normal man, who is one of a fairly good family. His mother was insane, the father died in an almshouse; however we find no mental defect. As the result of this marriage, we have seven feeble-minded children, four others that died in infancy, and there were two miscarriages. This is the fourth child of this strain that is in our institution. The fifth one referred to is a half-sister of the other girl referred to on Chart VIII, A.

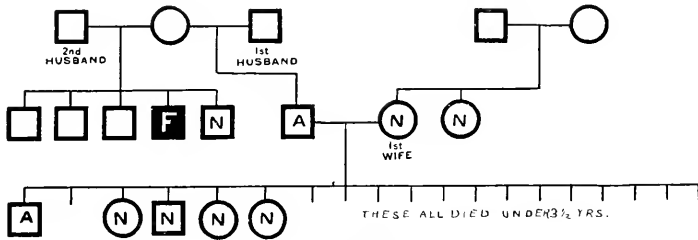

CHART IX, A.

Chart IX (also in two parts) is another one of nature's experiments. The father of the child in this institution, an alcoholic man, was married twice. His first wife was a normal woman of good family. The result of this union was nineteen children, all born within a period of nineteen years. Thirteen of these children died under three and a half years of age, three are distinctly normal, one

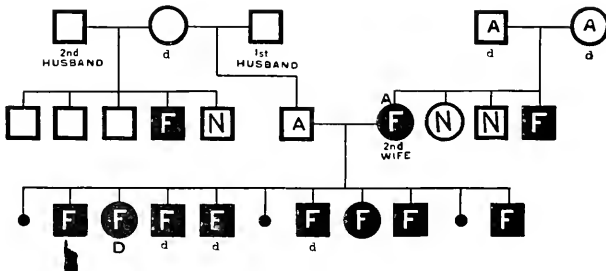

CHART IX, B.

neurotic, one alcoholic, and one unknown. This man had a congenital defect in the number of joints in the fingers. However, not one of these nineteen children showed that defect.

This man was married a second time to a feeble-minded and alcoholic woman, the daughter of two alcoholic parents. She has a



feeble-minded brother, besides a normal brother and a normal sister. The result of this union was eleven more conceptions, three resulting in miscarriages and the rest mental defectives. Every one of these children shows the father's defective fingers or toes, one of them is also deaf. Apparently the first wife was prepotent and overcame entirely the husband's defect of fingers, and there was no feeble-mindedness. In the second marriage, however, this defective woman was not prepotent in that she allowed him to transmit his physical defect, although she transmitted her mental condition.

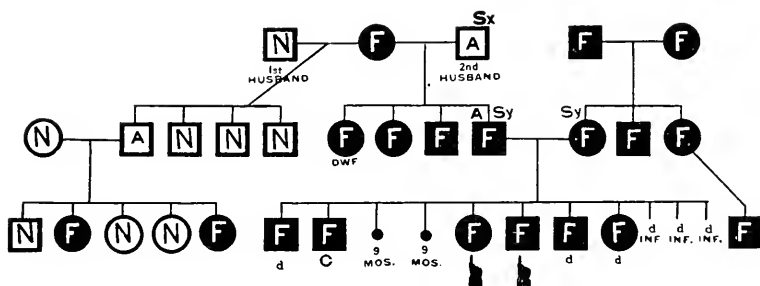

CHART X.

Chart X shows the descendants of a feeble-minded woman who was married twice. Her first husband was normal. There were four normal children, one of whom is alcoholic. This alcoholic son married a normal woman and produced two feeble-minded and three normal children. This is another instance of the defect skipping a generation, being transmitted by the grandmother through the father.

The second marriage of this feeble-minded woman was with an alcoholic and immoral man. The result was four feeble-minded children. One of these became alcoholic and syphilitic and married a feeble-minded woman. She was one of three imbecile children born of two imbecile parents. The result here could, of course, be nothing but defectives. There were two still-born, and three that died in infancy. Six others lived to be determined feeble-minded. One of these was a criminal. Two are in the institution at Vineland. The mother's sister also has a feeble-minded son.

Chart XI also brings together in its two parts (*A* and *B*) two children in the institution that were not previously known to be related. The maternal grandmother in *A* is the maternal grandmother in *B*, being the grandmother of both of these children, as well as of several other defectives. The mother of our child on *A* was

an illegitimate daughter of this woman. She was feeble-minded; she married a feeble-minded son of a feeble-minded man. The result was two children that died in infancy, three miscarriages, and two mental defectives. Going back to the grandmother, we find that she married, later, a normal although neurotic man. The result of that union was one feeble-minded, one normal and neurotic, and three that we do not know about.

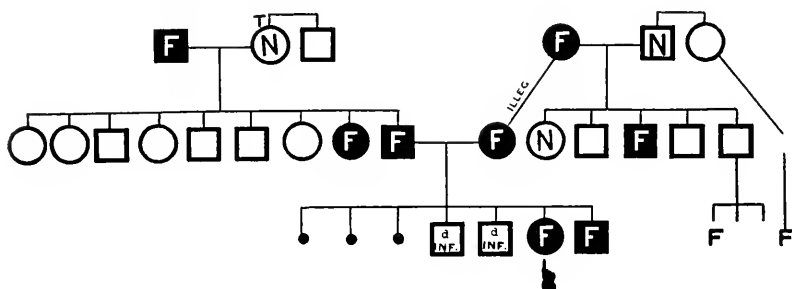

CHART XI, A.

Chart XI, B, is somewhat complicated, but shows many variations. For example, one of the sons of this same woman had three children, one of whom was feeble-minded. A neurotic daughter married a feeble-minded man who had two feeble-minded brothers and two normal brothers. The result of this union was the child that is in our

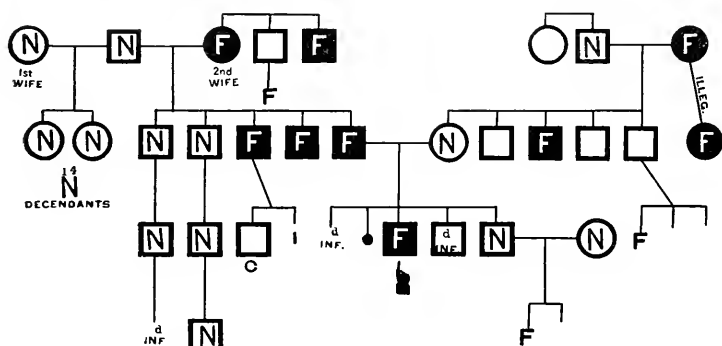

CHART XI, B.

institution, two that died young, one miscarriage, and one normal man. This normal man married a normal woman and had two children, one of whom is feeble-minded.

Going back to the father of our child, we find that one of his feeble-minded brothers married a woman who was spoken of as a pervert.

They had two children, one of whom was a criminal and the other insane. Two other brothers were normal. One had a normal son and a normal grandson; the other has a normal son, and a grandchild that died in infancy. Going back to the third generation, we find that the grandfather was twice married. He was normal; his first wife was normal. They had four<sup>a</sup> normal children and fourteen descendants, all normal. He married for his second wife the feeble-minded woman who was the mother of the children already referred to. She had a brother who was feeble-minded, and another brother whose mental condition is unknown, but whose child was feeble-minded.

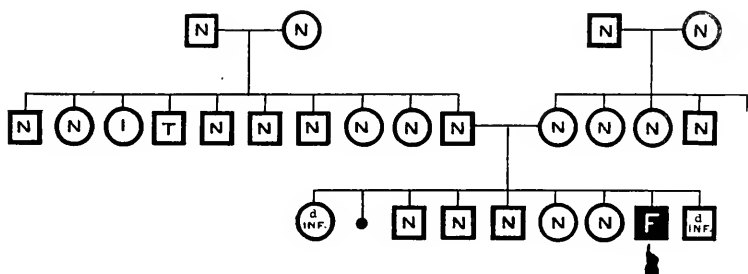

CHART XII.

Chart XII shows a type of imbecility that is clearly not hereditary. It will be seen that all this family on both sides are normal people, with the exception of one woman who is reported as being insane

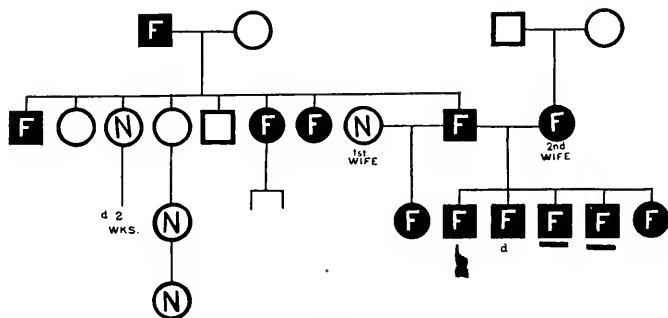

CHART XIII.

with religious mania. The child in our institution is what is known as the Mongolian type, and we have come to believe that there will be no other mental defectives found in such families. Usually such

<sup>a</sup> Only two shown on chart.

a child is the last born. In this case, there was one other child later, but he died at the age of ten months. Mongolism is an arrest of development resulting from some cause acting *in utero*, perhaps about the second month.

Chart XIII presents nothing new, but emphasizes what we have already seen. Two feeble-minded parents have five feeble-minded children. The paternal grandfather, however, seems to have been the one that transmitted the defect on the father's side.

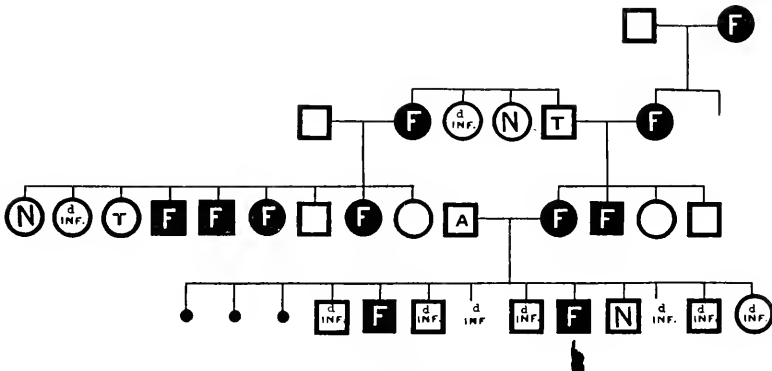

CHART XIV.

Chart XIV is particularly interesting as showing the mental defect running through four generations, and through the mother's family in three of these, although there is defect on the father's side also in the third generation.

Chart XV perhaps adds nothing new for heredity, mainly emphasizing the exhibits of the other charts. However, for a social study, it is perhaps the best of anything that we have yet found. Here we have a feeble-minded woman who has had three husbands (including one "who was not her husband"), and the result has been nothing but feeble-minded children. The story may be told as follows:

This woman was a handsome girl, apparently having inherited some refinement from her mother, although her father was a feeble-minded, alcoholic brute. Somewhere about the age of seventeen or eighteen she went out to do house-work in a family in one of the towns of this State. She soon became the mother of an illegitimate child. It was born in an almshouse to which she fled after she had been discharged from the home where she had been at work. After this,

charitably disposed people tried to do what they could for her, giving her a home for herself and her child in return for the work which she could do. However, she soon appeared in the same condition. An effort was then made to discover the father of this second child, and when he was found to be a drunken, feeble-minded epileptic living in the neighborhood, in order to save the legitimacy of the child, her friends saw to it that a marriage ceremony took place. Later another feeble-minded child was born to them. Then the whole family secured a home with an unmarried farmer in the neighborhood. They lived there together until another child was forthcoming which the husband refused to own. When finally the farmer acknowledged this child to be his, the same good friends interfered, went into the courts

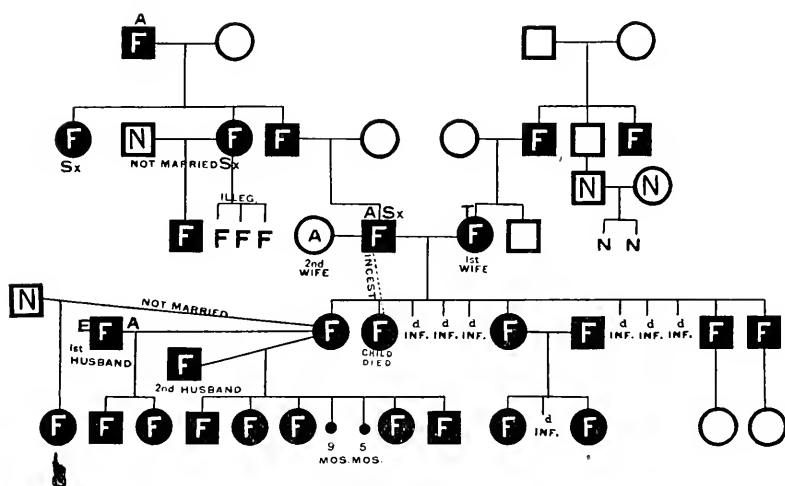

CHART XV.

and procured a divorce from the husband, and had the woman married to the father of the expected fourth child. This proved to be feeble-minded, and they have had four other feeble-minded children, making eight in all, born of this woman. There have also been one child still-born and one miscarriage.

As will be seen from the chart, this woman had four feeble-minded brothers and sisters. These are all married and have children. The older of the two sisters had a child by her own father, when she was thirteen years old. The child died at about six years of age. This woman has since married. The two brothers have each at least one child of whose mental condition nothing is known. The other sister

married a feeble-minded man and had three children. Two of these are feeble-minded and the other died in infancy. There were six other brothers and sisters that died in infancy.

Such is the bare presentation of a few of our cases already worked up. We have made no attempt to study these points, or to mark them statistically, as such labor will be more worth while when all of our cases are completed.

It should be stated that while Chart XV and Chart VIII are undoubtedly the worst cases we have come across, the others here presented are hardly exceptional. They can be matched by many that we already have on file.<sup>b</sup>

We have nearly four hundred children in the institution, and we may reasonably hope to present a fairly complete family history of at least two-thirds of these. If this prediction is verified, it will give us enough data to deduce something of importance concerning human heredity. The work is going on as fast as we can push it. We have now three workers in the field, and will perhaps add a fourth before very long. Later we shall hope to present a full report of all our findings.

---

## HISTORY AND PECULIARITIES OF THE MULE-FOOT HOG.

W. J. SPILLMAN, *U. S. Department of Agriculture.*

The principal peculiarity of this breed of hogs lies in the fact that the hoof is solid, like that of the horse or the mule, instead of being cloven, as in ordinary swine. In other characteristics they do not differ noticeably from common breeds. In color they run the whole gamut of swine colors, though most breeders are endeavoring to establish solid black as a breed characteristic. The first two illustrations show representative specimens of this breed.

### DISTRIBUTION IN THE UNITED STATES.

The idea is prevalent in this country that these hogs originated in Arkansas and the Indian Territory, or what is now the State of Oklahoma; but from what follows it will be seen that this is doubtful.

<sup>b</sup> Since this was written this family has been further investigated with the result that we now know the facts concerning 319 members, of whom 119 are feeble-minded with only 42 known to be normal.

though they have been common in that section for more than half a century. Mr. C. E. Quinn, who was formerly connected with the Department of Agriculture and who was interested in this breed of hogs, secured addresses of breeders of mule-foots as follows: Indiana, 145; Missouri, 16; Illinois, 13; Iowa, 12; Ohio, 9; Minnesota, 8; Arkansas, South Dakota, and Wisconsin, each, 4; Kansas, Kentucky, Nebraska, and South Carolina, 3 each; California and Texas, 2 each; and 1 in each of the States Alabama, Georgia, Louisiana, North Carolina, Oklahoma, Pennsylvania, and Tennessee; a total of 235 breeders in twenty-two States. This shows that the breed is rather widely distributed. Two breeding associations have been formed for the

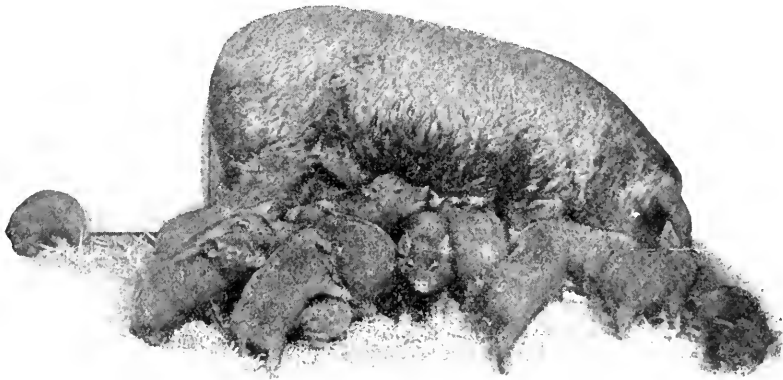

LITTER OF MULE-FOOTS.

Photo furnished through courtesy of Mr. W. H. Morris, Indianapolis, Ind.

registration of mule-foots, one at Mammoth Springs, Ark., organized in 1904, D. D. Gilson, president; the other organized in 1908 at Indianapolis, Ind., W. H. Morris, secretary.

#### HISTORY.

In the short time I have had to prepare this paper I have been unable to verify the statements which follow concerning the history of these hogs. One breeder in the State of Oklahoma says: "These hogs some sixty years ago were originally brought from the South Sea Islands and turned loose in the Kimish and Little River Mountains in the Choctaw Nation for the use of the Indians, and have lived there up to the present time." He further states that he has a considerable

trade in these hogs with zoological parks. He does not give his authority for the statement concerning the shipment from the South Sea Islands.

Other breeders, in their catalogues, make the claim that the mule-foots originated from a cross between the peccary and the hog. This claim is evidently based upon the supposition that the peccary has a solid hoof, which, however, is not the case. The peccary does lack one toe on the hind foot, but it is one of the small hanging toes, so that the peccary has a split foot like that of the ordinary hog.



OHIO CHIEF, REPRESENTATIVE OF MULE-FOOT BREED.

Weight 910 pounds. Photo furnished through courtesy of Mr. W. H. Morris, Indianapolis, Ind.

Another breeder states that the mule-foots were brought to Delaware from Sweden in the year 1637. This statement is of some interest in connection with a statement of Mr. Q. I. Simpson, of Palmer, Ill., that an old writer speaks of a solid-hoofed breed in Sweden in the vicinity of Udall. Mr. Simpson is also authority for the statement that one of his neighbors, Mr. Madison Curvey, on a trip to Texas some sixty years ago, saw these hogs in the Choctaw Nation, and states that the tradition of peccary ancestry was then held by the squaw men. Mr. Simpson further states that Darwin, in 1859, mentioned



the appearance of these hogs in Scotland. Mr. Madison Curvey, above referred to, also states that he saw mule-foot hogs at Nauvoo, Ill., in 1844. Mr. Simpson further states that Aristotle, in writings entitled "Researches about Animals," about 370 B. C., tells of solid-hoofed swine in Greece.



BONES AND HOOF FROM THE FOOT OF A MULE-FOOT HOG.

In the specimen at the left the last two phalanges are united; the remaining phalanges are separate, as in ordinary hogs. In the specimen at the right the last pair of phalanges is completely united, and the next pair partially so.

While I have not had an opportunity to verify the evidence here presented, it suggests that solid-hoofed hogs have come down from ancient times, and it is not improbable that this characteristic has been found in certain strains of hogs since these animals were first domesticated.

## RELATION TO CHOLERA.

Not the least important fact concerning this breed is that breeders are selling mule-foot hogs with the guarantee that they are immune to cholera. The writer has seen numerous statements from farmers who claim that they have exposed mule-foot hogs to cholera and that none of the hogs took the disease. He has seen one or two statements from farmers contradicting this. Recent tests at some of the experiment stations indicate that the claim of immunity to cholera is not well founded. Mule-foots exposed to cholera died as promptly as other breeds. The Indiana State Experiment Station has made such a test, and reports as follows in Bulletin No. 140 (1910):

Four pure-bred mule-foot hogs and four hogs of mixed breeding, averaging about 40 pounds in weight, were used in making the test. The hogs were exposed in the natural way, by turning them into an infected pen in which hogs having acute hog cholera had died. All of the mule-foot hogs contracted the disease, three developing the acute, and one the chronic form. Three became fatally ill and the fourth recovered after several weeks. Three of the hogs of mixed breeding sickened and died or were killed, and the fourth showed no symptoms of disease.

## ANATOMICAL STRUCTURE.

About two years ago the writer obtained from Mr. Q. I. Simpson, of Palmer, Ill., the foot of a freshly killed mule-foot hog, from which, after the flesh had been removed by boiling, a photograph was taken. (See page 181, figure at the left.) From this specimen it will be noted that the metacarpals, basilar phalanges, and middle phalanges are separate as in ordinary hogs. The ungual phalanges have coalesced. The figure at the right shows the bones from the foot of another individual. In this specimen two pairs of phalanges are united.

It is interesting to note that in crosses between mule-foot hogs and ordinary breeds the mule-foot character seems to be dominant. Some hogs of mixed breeding have hoofs that are solid at birth but in which the toes split apart usually at about nine months of age. In some individuals the rear toes split apart in this manner, while the front toes remain solid through life. An anatomical study of a series of bones of these mixed breed hogs would probably reveal facts of considerable interest in connection with the inheritance of the mule-foot character.

## CLIMATE AND EUGENICS.

CHAS. E. WOODRUFF.

It is rather remarkable that, though it is an accepted biological axiom that a species of living thing survives because it is adjusted to its environment, there is a strong reluctance to apply the same law to varieties of man. There is a widespread notion that man is independent of environment by reason of his intelligence, by means of which he can create artificial protection against adverse factors, climatic or otherwise. This is all the more amazing in view of the overwhelming mass of evidence that types do die out when they wander too far from the locality which evolved them. In this process of decay, the successive generations are more and more degenerate, until extinction ends the line. One of the purposes of eugenics is to investigate these migrants, to determine the causes of the injury, with a view to advocating means of avoiding the adversities and perhaps insuring permanent survival in places where it is now impossible.

The first step to take is to acknowledge that the characters of a type or race have been evolved to adjust it to its environment, either as a passive protection against harmful influences or as an instrument in the active struggle for existence. Color, stature, bulk, and each other character therefore means something vital to survival in the environment which evolved it; but when migration takes place a character may no longer be of use, although if it is not a disadvantage, other than the expense of producing it, it may persist permanently. Head shape may be of this nature. On the other hand, stature and bulk, by ordinary laws of radiation, are of vast importance in preserving body heat in a cold environment, and a fatal disadvantage in hot climates. The bulky are found in the one and the slender in the other, and with equal longevity, but American life insurance statistics show that our overweights are notably shorter-lived than the underweights. Von Schmedel proved fifteen years ago that pigments were evolved to exclude the dangerous short waves of light and the ultra-violet so fatal to unprotected protoplasm. The investigations of the last five years have established his generalization on a firm basis, and it has been repeatedly shown that light types are evolved in regions where it is so cloudy that there is not much need of protection, but that when they migrate to light countries they melt away. If they

happen upon cloudy places, as in the mountains of central and southern Europe, they apparently survive permanently. Similar survival will follow appropriate residence in America, but in our sunny Northwest numerous observers have reported appalling conditions even in the first generation of native-born descendants.

Here, then, is a condition of affairs which prohibits healthy, normal development, and eugenics must take it into consideration. The importance of the matter needs no comment, as it is evident that these types from northwestern Europe furnish our best citizenship and must be preserved. They are the best that Europe breeds and must be bred up here through the creation of a perfectly hygienic environment. It is of little permanent value to the race to have these types flourish for one or two generations, if the subsequent ones are to melt away from tuberculosis. Even in the more cloudy New England they do have a higher death rate and the population becomes steadily more brunet by the survival of the fittest. Ordinary men only consider present conditions and do not compare with the past as scientists, but eugenics must look forward centuries in a process of breeding in which only three generations extend over a century.

Before final extinction of a type, it necessarily furnishes one or more generations more or less unfit for the struggle for existence, and these become social parasites. An examination of the inmates of hospitals, sanitariums, asylums, prisons, and almshouses in each part of the country is a vital necessity, to show what types are in an undue percentage. My own investigations have been purely as to pigmentation, and they prove conclusively that in this latitude as in the similar ones of southern Europe the lightest types are the least fit, and that propagation of normal offspring is impossible. All other characters, like tallness and weight, must also be investigated and the inmates grouped according to their resemblance to the three main types in Europe—Nordic, Alpine, and Mediterranean—remembering, of course, that the Mediterranean type once extended all over Europe and still survives nearly everywhere, though it developed the Nordic type at or before neolithic times, and that the Alpine intruded itself about the bronze age.

The next great work is an ethnological survey of the whole population, together with a determination of whether there has been any change in families of more than four generations' residence. It must be remembered that by Mendel's law it is possible for more

or less pure types to appear even when the parents differ. Consequently, if all the blondes disappear the family may become brunet and of approximately pure type. We cannot assume amalgamation, but merely an alloy in which one metal distills off.

My investigations so far show that climate evolves type and that migrants survive or perish according as they settle in a climate similar to or different from the ancestral one. When there is a marked difference it is a bar to eugenic development. Moreover, if the adverse factor can be discovered, it may be a simple matter to guard against it and produce healthy, vigorous posterity of the brainy race of northern Europe. Of course, all hope of increasing the size of the brain by selection of proper mates must be abandoned as absurd, and in addition some of the best thinkers are physical defectives, unfit for procreation. Bizarre suggestions to select mates and breed up a physically better type may result in handsome imbeciles. A selection so far found practicable is that based upon property and has been in successful operation a long time in Europe among the upper classes. The only thing we can do is to allow the young to marry whom they please—a thing they will do anyhow—and then prevent the destruction of the offspring by avoidable factors in the environment, and the most deadly of these are climatic. An enormous birth rate has hitherto been necessary to supply material for *human natural selection*, but it is too expensive. We must utilize what the more frail modern woman can produce—a woman who would promptly perish were she to bear children as often as her ancestors. Eugenics then must devise means of rearing a higher percentage of infants, for at present the death rate among them is still appallingly high.

[Presented by the Committee on Eugenics.]

---

## REPORT OF COMMITTEE ON BREEDING NUT AND FOREST TREES.

GEO. B. SUDWORTH, *Chairman.*

This Committee on Breeding Nut and Forest Trees has, within the last few years, fully surveyed in its annual reports the field of tree breeding and pointed out its possibilities and limitations. The work now before the committee is to follow the course outlined, and to report from time to time the progress made and the results obtained.

It is only natural to expect that more rapid progress will be made in the breeding of nut trees than in the breeding of forest trees, as is shown by the papers of individual members of the committee accompanying this report. The results obtained are presented in detail in these papers. In the case of nut trees the improvement sought is in the form and quality of the nut, a fruit produced either annually or at short intervals, and, therefore, more responsive to human influences. The establishment of new varieties of nut trees can be brought about more readily by grafting and budding than by a selection of seed. In the case of forest trees the improvements sought are chiefly in the physical properties of the wood, or in the production of species or varieties resistant to drought, insects, and fungous diseases. If these qualities are to be produced alone by breeding, they can not be secured except by the long, tedious process of seed-selection, which may require several generations of trees. Since, however, the breeding of forest trees is still in its infancy in this as well as in older countries, no results can be expected within a short time. Progress, though, has actually been made along this line by the creation of the necessary means of carrying on such long-time experiments in the form of two forest experiment stations. One is located at Flagstaff, Ariz., and known as the "Coconino Experiment Station." The other is on Pikes Peak, near Manitou, Colo., and is known as the "Fremont Experiment Station."

As a preliminary step toward such experiments at these stations a study was made last season of the differences in the size, weight, and vitality of tree seeds of the same species, obtained from individuals grown under different conditions of climate and elevation. Perhaps the most interesting results along this line were those obtained with older and younger Western Yellow pine (locally the young trees are known as "black jack"). Tests of seed from old trees ranging in age from 280 to 425 years gave an average per cent of germination of 68.4; while seed from young trees, ranging in age from 125 to 145 years, gave 83.2 per cent of germination. These results demonstrate the superior value of young Western Yellow pine for seeding purposes. If to the inferiority of old yellow pine be added the greater danger of being thrown by wind, one can appreciate the importance of these results for forestry, particularly in timber forest planting.

In the table of germination tests (page 188) there have been brought together the results of seed tests of nine different species of

native conifers obtained from thirty-eight widely separated localities in the western half of the United States.

Samples of seed of *Pinus ponderosa* have been received from eighteen Forests; these Forests are so scattered that the samples may be taken as fairly representative of the variations met with in the seed of this species. While only one sample, that from the Datil Forest, was stated to be of the variety *scopulorum*, it is quite probable that several others were in reality this variety, and one or two are perhaps mixtures of the pure species with the variety.

In two characteristics the samples of *Pinus ponderosa* vary to a remarkable extent, namely, in size or weight of seed (number of seeds per pound) and in rapidity of germination (shown by the germination per cent at different times). Furthermore, these two characteristics are apparently correlated, for the light seed usually germinates much more rapidly than the heavy seed. Again, there is a distinct connection between these characteristics and the region from which the seed comes. The light quick-germinating seed comes from the eastern slope of the Rockies and from the south, while the heavy, slow-germinating seed comes from farther north and west. This connection between the characteristics of the seed and the region from which it comes has been noticed by European purchasers of American seed (Rafn); it was also pointed out in the 1907 Forest Service circular on "Germination of Pine Seed."

By means of these characteristics of the yellow pine seed, it is possible to divide the National Forests into three definite regions. The first includes the eastern part of District 1, all of Districts 2 and 3, and the southeastern part of District 4. Here the seed is usually small (it varies greatly in size, however, especially in Arizona) and germinates very rapidly. The second region includes the western part of District 1 and the northern part of District 4. Here the seed is large and usually slow (but somewhat variable) in germination. The third region is the Pacific Coast, District 6, and probably the northern part of District 5 (no samples of *P. ponderosa* have been received from California during the past winter). Here the seed is very large and very slow and irregular in germination.

The sample from the Helena Forest appears to be intermediate in character between the samples of the first region mentioned above and those of the second. The seed is considerably larger than any of the samples from the former, yet it germinated (in soil) more rapidly than any other of the eighteen samples.

## Germination tests of nine different species from thirty-eight widely separated localities.

Species.	National Forest.		Germination per cent.				Number of seeds per pound of sample that may germinate.			
	Two weeks.		Four weeks.		Six weeks.					
	Chamber.	Soil.	Chamber.	Soil.	Chamber.	Soil.				
<i>Larix occidentalis</i> .....	Blackfoot.....	17.5	15.5	37.0	29.5	42.5	34.5	45.0	40.5	53,340
Do*.....	Flathead.....	12.5	9.0	29.5	11.5	34.0	19.0	37.0	27.0	33,800
Do*.....	Helena.....	18.5	4.5	33.0	5.5	39.0	4.5	39.5	17.0	22,720
Do*.....	Lolo.....	9.0	7.5	23.5	13.5	27.0	15.5	27.0	26.0	16,760
<i>Pinus murayana</i> .....	Deerfodge.....	26.0	72.5	37.5	77.5	42.0	78.0	48.0	78.0	95,350
Do.....	Helena.....	7.0	13.0	16.0	16.0	16.0	18.0	16.5	18.0	24,350
Do*.....	Shoshone.....	47.5	27.5	65.0	61.5	69.5	61.5	70.5	61.5	54,300**
Do.....	Leadville.....	16.0	60.0	42.0	65.0	57.0	67.5	57.0	68.0	78,100**
Do.....	Medicine Bow.....	13.5	49.5	21.0	61.0	28.0	68.5	46.0	68.5	65,750
Do.....	Bonneville.....	30.0	50.0	51.5	73.0	55.5	71.5	61.0	71.5	62,500
Do.....	Tarheee.....	39.5	76.5	60.0	86.0	65.5	86.5	68.5	88.000	
<i>Pinus ponderosa</i> *.....	Cabinet.....	20.5	40.5	38.0	61.0	53.0	67.0	65.5	78.5	6,780
Do*.....	Coeur d'Alene.....	11.0	24.0	41.5	50.0	62.5	67.5	73.5	81.5	7,700
Do.....	Helena.....	48.0	70.0	57.5	71.5	62.5	71.5	63.5	71.5	7,320
Do.....	Sioux.....	78.0	80.5	86.0	84.5	87.0	86.0	87.0	86.0	13,660
Do.....	Black Hills.....	35.5	59.0	43.5	61.0	44.5	61.5	44.2	62.0	11,800
Do.....	Medicine Bow.....	24.0	30.0	39.0	40.0	42.5	42.0	42.5	42.5	7,700
Do.....	Piye.....	65.0	69.5	73.0	70.0	73.0	77.0	73.0	77.0	14,660
Do*.....	Payette.....	0.0	2.5	13.5	26.0	33.0	44.5	60.0	56.0	6,000
Do.....	Pocatello.....	10.5	12.0	28.0	21.0	47.0	41.0	60.0	56.0	3,020
Do*.....	Wesler.....	7.5	8.5	40.5	45.0	61.5	63.5	70.0	74.5	6,870
Do*.....	Columbia.....	3.5	4.5	18.5	16.0	22.5	23.5	33.5	39.5	3,600
Do*.....	Covalle.....	3.0	19.0	16.0	32.5	17.5	23.5	44.0	58.5	4,830
Do*.....	Unatilla.....	9.5	13.5	28.5	34.0	54.5	49.5	49.0	74.5	5,180
Do*.....	Wenatchee.....	5.5	13.0	28.5	38.0	42.5	56.0	53.0	73.0	6,240
<i>Pseudotsuca taxifolia</i> .....	Absaroka.....	44.0	34.0	53.0	39.0	58.0	43.0	59.5	43.5	5,270
Do.....	Helena.....	30.0	24.5	46.5	30.5	49.0	41.0	49.5	43.0	16,440
Do.....	Medicine Bow.....	18.0	10.0	23.5	12.5	25.5	12.5	26.0	12.5	20,770
Do.....	Pose.....	5.5	3.5	14.5	18.0	18.0	20.5	22.5	20.5	7,150
Do.....	Pocatello.....	47.0	11.0	64.0	50.5	72.0	61.0	76.0	62.5	17,450
Do.....	Tarheee.....	10.0	6.5	20.0	17.5	21.0	20.5	21.0	22.0	6,720
<i>Pinus edulis</i> .....	Crook.....	.....	2.5	.....	4.0	.....	4.0	.....	4.0	62
<i>Pinus coulteri</i> *.....	Angeles.....	.....	0.0	.....	6.0	.....	21.5	.....	44.5	490
Do*.....	Morse Seed Co.....	.....	0.0	.....	9.5	.....	32.0	.....	67.5	940
<i>Pinus lambertiana</i> *.....	Plumas.....	.....	0.0	.....	0.0	.....	3.0	.....	22.0	570
<i>Pinus sitchensis</i> .....	Olympic.....	6.5	5.5	21.5	48.5	26.0	51.5	26.5	51.5	96,000
<i>Cupressus arizonica</i> .....	Chiricahua.....	12.5	6.5	12.5	7.0	12.5	7.0	12.5	7.0	9,760
<i>Pinus sitchensis</i> .....	Snoqualmie.....	0.5	8.5	1.5	16.5	1.5	19.5	1.5	21.0	39,700

\*\* This figure is calculated on the basis of the chamber test; the soil test was damaged by insects.



Samples of seed of *Pseudotsuga taxifolia* have been received from thirteen Forests, located chiefly in Districts 2 and 4. The quality of the seed varies so much, however—many of the samples containing large percentages of empty seeds—that the number of seeds per pound gives little clue to the weight of the filled seeds. Furthermore, the germination per cent is mostly so low that the rapidity of germination can hardly be stated. It appears, however, that seed from Idaho takes considerably longer to germinate than seed from Colorado. It may eventually be possible to separate a quantity of filled seeds from each sample and thus obtain more useful figures.

Of the twelve samples of *Picea engelmanni* (shown in the first report), eight came from Colorado, and it is quite probable that the one sample from Montana is mixed with seed of *P. canadensis*. Thus no definite statement can be made regarding this species.

The nine samples of *Pinus murrayana* show considerable variation in size, but very little in rapidity of germination. While the samples from the Targhee and Shoshone Forests are much larger than any other, it is hardly possible to outline definite regions from this characteristic.

Some other characteristics of the seed, which are not brought out in the tables, are worth mentioning. The seed of some species appears to have two periods of germination: the majority of the viable seeds will germinate, and then, after a pause, a further number will do so. This is most noticeable in *Larix occidentalis*, all four samples of which have behaved in this way. The samples of *Pinus ponderosa* from Washington and Oregon, and one or two from Idaho, show signs of the same habit. This behavior is sometimes seen very clearly in seed which has been stored for a long time; stored samples of *Pinus ponderosa* and *P. attenuata*, tested during the past winter, have shown it in a marked degree.

The behavior of *Pinus monticola* is as yet uncertain. It is quite evident that the seed is very slow to germinate, so slow that no report on the germination of the samples can yet be made. The seed from the Coeur d'Alene Forest, sent for storage experiments, has germinated 40 per cent in twenty-two weeks. Various methods of germination are being tried, with good promise of success.

The importance of these results for planting are obvious.

The next step at these stations will be to start next spring plantations with seed obtained from different sources as to region, elevation,

age, and soundness of mother trees, and to record for the next several years the growth in height, the root development, the weight, the date when new foliage appears and the old is shed, etc. The species to be experimented with at the Coconino station will be chiefly the Western Yellow pine (*Pinus ponderosa*). Seed of this pine has already been gathered from one hundred different individual trees. Each tree receives a separate number and a description including the following points:

Tree number; height (feet); diameter breast high (inches); age (years); yield in cones (bushels); condition of cones; condition of tree; clear length; condition of crown; whether fire-scarred; whether spike-top; other peculiarities; site—slope, ground cover, stand.

At the Fremont Experiment Station the species to be tried are the Engelmann spruce, Douglas fir, Western White pine, and Western Yellow pine.

These experiments will enable us to choose intelligently just the right kind of seed for a given locality and thus save the inevitable disappointment and loss of time and money which come from the use of seeds not adapted to given soil and climatic conditions. Definite results can not be expected in less than five years.

The practical importance of such experiments will become apparent when one realizes that during the last year the national government alone has gathered about 14,000 pounds of tree seed, while the amount of seed to be used in the next five to ten years will be many times this amount. Upon the choice of this seed will depend the character and quality of the future forest that will come from it.

The improvement, however, of our forest resources does not need to be delayed altogether until we can secure, by gradual selection, species and varieties that will meet our economic needs better than the species on hand. There are other means of improving the quality of our forests besides breeding. The introduction of exotics and silvicultural treatment of the forests are two methods which may bring about identical results, and in a much shorter time than would be possible by breeding alone. The introduction of new blood and the improvement of the stock on hand are requisites for the accumulation of qualities for transmission by breeding. The introduction of exotics and silvicultural treatment must, therefore, be considered as essential parts of the general plan of breeding new varieties of forest trees, and progress has been made along these lines.

## INTRODUCTION OF EXOTICS.

During the last year an actual trial was made with the following 55 exotic species, of which 39 are eucalypts:

<i>Pinus sylvestris</i> ,	<i>Pinus chinensis</i> ,	<i>Pinus canariensis</i> ,
<i>Pinus austriaca</i> ,	<i>Casuarina equisetifolia</i> ,	<i>Cedrus libani</i> ,
<i>Pinus gerardiana</i> ,	<i>Picea excelsa</i> ,	<i>Cedrus deodara</i> ,
<i>Morus alba tartarica</i> ,	<i>Pistachia chinensis</i> ,	
<i>Eucalyptus amygdalina</i> ,	<i>Eucalyptus siberiana</i> ,	<i>Eucalyptus trabuttii</i> ,
<i>Eucalyptus diversicolor</i> ,	<i>Eucalyptus saligna</i> ,	<i>Eucalyptus microtheca</i> ,
<i>Eucalyptus globulus</i> ,	<i>Eucalyptus almenoides</i> ,	<i>Eucalyptus paniculata</i> ,
<i>Eucalyptus gonocalyx</i> ,	<i>Eucalyptus bicolor</i> ,	<i>Eucalyptus pulverulenta</i> ,
<i>Eucalyptus longifolia</i> ,	<i>Eucalyptus boristoana</i> ,	<i>Eucalyptus resinifera</i> ,
<i>Eucalyptus leucoxydon</i> ,	<i>Eucalyptus botryooides</i> ,	<i>Eucalyptus rudis</i> ,
<i>Eucalyptus marginata</i> ,	<i>Eucalyptus cornuta</i> ,	<i>Eucalyptus siderophloia</i> ,
<i>Eucalyptus melliodora</i> ,	<i>Eucalyptus corynocalyx</i> ,	<i>Eucalyptus sideroxydon</i> ,
<i>Eucalyptus mulleriana</i> ,	<i>Eucalyptus crebra</i> ,	<i>Eucalyptus tereticornis</i> ,
<i>Eucalyptus obliqua</i> ,	<i>Eucalyptus deanci</i> ,	<i>Eucalyptus viminalis</i> ,
<i>Eucalyptus pilularis</i> ,	<i>Eucalyptus gumii</i> ,	<i>Acacia melanoxylon</i> ,
<i>Eucalyptus polyanthema</i> ,	<i>Eucalyptus hemphloia</i> ,	<i>Syncarpia laurifolia</i> ,
<i>Eucalyptus punctata</i> ,	<i>Eucalyptus hemphloia</i>	<i>Quercus suber</i> .
<i>Eucalyptus regnans</i> ,	<i>albens</i> ,	
<i>Eucalyptus rostrata</i> ,	<i>Eucalyptus masculata</i> ,	

This list does not, of course, include all of the exotic species which can be tried. The following additional species are selected for trial in the near future:

<i>Pinus laricio</i> ,	<i>Pinus excelsa</i> ,	<i>Abies pindrow</i> ,
<i>Pinus pallasiiana</i> ,	<i>Picea morinda</i> ,	<i>Larix leptolepis</i> ,
<i>Pinus pinaster</i> ,	<i>Picea orientalis</i> ,	<i>Larix curilensis</i> ,
<i>Pinus pinea</i> ,	<i>Picea alcoquitiana</i> ,	<i>Larix siberica</i> ,
<i>Pinus halepensis</i> ,	<i>Abies pectinata</i> ,	<i>Cupressus sempervirens</i> ,
<i>Pinus bungeana</i> ,	<i>Abies cephalonica</i> ,	<i>Chamaecyparis obtusa</i> .
<i>Pinus cembra</i> ,	<i>Abies nordmanniana</i> ,	

If these prove adaptive to given local conditions, they may in themselves form a valuable addition to our forest resources, or by hybridizing with native species furnish material for further selections and breeding. Of these introductions the most interesting will be the sowing next spring of over 3,000 pounds of Austrian pine. This species may enable us to extend in the Southwest the lower timber line further down into the foothills, where our native yellow pine stops at an elevation of about 5,000 feet, giving way below this level to a scrubby growth of oaks and other chaparral species.

## IMPROVEMENTS BY SILVICULTURAL TREATMENT.

The quality of the wood and the growth of forest trees in a stand depend, as every observer knows, upon the way the stand has grown, that is, whether in an overcrowded, dense, or open stand; whether the leaf litter was regularly burned or otherwise removed, or allowed to remain and form a humus; whether the existing stand began under dense shade and remained suppressed for a long time, or started in dense shade of older trees, comprising trees of all ages and sizes, or whether it started in an opening and made a uniform, even-aged stand. It is empirically established that, in the case of broad-leafed species, rapid growth, all other conditions being equal, means, as a rule, a straighter grain and stronger and more serviceable wood; while slow growth means brittle, twisted, and less useful wood. The biological reason for this difference in the quality of wood of the same species grown at different rates, lies in the fact that every decrease or increase in the width of the annual ring means a decrease or an increase of the summer or winter wood, while the kind of wood formed early in the season and known as "spring wood" remains, as a rule, approximately the same in both rapid-growing and slow-growing trees. The summer or winter portion of the annual ring contains few fibro-vascular bundles, is less porous, has thick-walled wood-elements, the presence of which, in larger or smaller quantities, always determines the relative strength of the wood as a whole. Therefore, for broad-leafed trees, the wider the rings, or the more rapid the growth, the stronger the wood, while the narrower the rings, or the slower the growth, the weaker the wood.

In the wood of coniferous trees the reverse is true, owing probably to the simpler structure of their wood, less marked periodicity in the appearance of the foliage, and less transpiration.

It is entirely within the power of the forester to stimulate the growth of trees in the stand by proper and timely thinnings, to produce clear or knotty timber, and thus by silvicultural treatment to control the quality of the timber grown. To what extent improvement of the wood thus brought about may be transmitted by heredity through breeding is still an open question. If, however, as we already know, the size of the seed has an undisputed influence upon the stock produced from it, and the size of the seed varies with the position of the tree in the stand, whether it is dominant or suppressed

—a condition which may be produced artificially in any forest—it may be expected that seed obtained from cylindrical straight-boled trees will stand a better chance of producing wood of more desirable qualities than seed from suppressed knotty, crooked trees. The proof of this, however, can and will be obtained only through the experiments to be started on the relation of the source of the seed and the resulting trees.

#### SUMMARY.

To sum up, there are three important problems before us:

(1) Selection of tree seeds which are to produce our future forest.

(2) Improvement of the present forest by silvicultural treatment, thus creating better trees capable of transmitting the qualities brought about by such treatment.

(3) Introduction of exotics into regions which either do not support tree growth at all, or, have trees of inferior quality, thus adding directly to the forest wealth of this country and furnishing new material for hybridization and further selections.

Of these three problems the one which promises definite results within a short time is the selection of tree seeds.

This committee considers it most essential at present to lay down principles and methods of tree seed selection for the guidance of foresters and other tree seed collectors in whose hands rests the future of our timber forests.

---

### REPORT OF COMMITTEE ON ANIMAL HYBRIDS.

This committee recently addressed a letter to each of the experiment stations asking for a statement concerning the animal hybridization work at those institutions. The following experiment stations report more or less work of this character, either now in progress or recently so: Indiana, New Hampshire, South Dakota, Arizona, Florida, South Carolina, North Dakota, Georgia, Michigan, Illinois, New York, Oklahoma, Iowa, North Carolina, Wyoming, and California.

At some of these stations Mendelian phenomena in the crosses between the breeds are being studied, and in most of them the aim of the work is the establishment of new types or breeds. The follow-

ing table gives the lines of work being carried on at each of the stations:

*Cross-breeding work with animals at the experiment stations.*

Nature of cross.	Station doing work.	Reported by—
Yorkshire swine with representative breeds of the lard type.....	Indiana.....	J. H. Skinner.
Breeds of sheep to determine extent of operation of Mendelian law; also to produce sheep particularly adapted for raising hot-house lambs. Reciprocal crosses made with Dorset Horn and Southdown. Hampshire, Southdown, Shropshire, and Dorset rams crossed on Rambouillet ewes and New Hampshire native ewes....	New Hampshire....	T. R. Arkell.
Algerian sheep with native breeds, to combine adaptability of Algerian to hot dry climates and resistance to pests and diseases, with better mutton and wool-producing characters of other breeds.....	Arizona.....	R. H. Forbes.
Poland China hogs with large English Yorkshires.....	South Dakota.....	Jas. W. Wilson.
Beef cattle: Native cows with Shorthorn, Hereford, and native males.....	Florida.....	P. H. Rolfs.
Kentucky Standard-bred horse with German Coach horse.....	South Carolina....	J. N. Harper.
Hogs, sheep, and poultry.....	North Dakota.....	J. H. Shepperd.
Berkshire × Duroc-Jerseys.....	Georgia.....	P. N. Flint.
Swine.....	Michigan.....	R. S. Shaw.
Some work in progress; nature not indicated.....	Illinois.....	E. Davenport.
Barred Rocks and White Leghorns.....	New York.....	C. A. Rogers.
Oklahoma station contemplates some cross-breeding work with sheep, but work not yet started.....	Oklahoma.....	Jno. A. Craig.
Crosses between different breeds of cattle....	Iowa.....	W. J. Kennedy.
Grading up razor-backs by means of pure-bred Berkshires.....	North Carolina....	C. B. Williams.
Crosses between breeds of sheep.....	Wyoming.....	J. D. Towar.
Crosses between Persian and Merino sheep. (Done some years ago).....	California.....	E. J. Wickson.

The Rhode Island Experiment Station has a hybrid between a pheasant and a chicken, which was produced in some experiments conducted by Dr. L. J. Cole, formerly of that station. Dr. H. J. Wheeler, the director of the Rhode Island station, says concerning

this bird: "Its male parent is an ordinary Ring-necked pheasant and the female parent a yellow mongrel Bantam. In plumage the hybrid promises to be more or less intermediate. In build it is rather large and more rangy than the pheasant, and its head, bill, and feet are much like those of the pheasant. In disposition it is extremely wild." Dr. Wheeler states that the Rhode Island Experiment Station will later publish a full description of this hybrid.

## CATTALOES.

This committee is keeping in touch, as closely as may be, with the work of three men who are breeding hybrids between cattle and buffaloes, namely, Mr. Mossom Boyd, Mr. Chas. Goodnight, and Mr. C. J. Jones.

Mr. Boyd is continuing the important work upon which he reported to the Association two years ago, and we expect to have other important reports from him in the future. Mr. Goodnight, in answer to a request from the committee to prepare a paper for this meeting, wrote:

To go into all the details and facts leading up to what success I have made would make too lengthy an article; but as regards the practicability of getting a race or strain of these hybrids, I believe in the end it can be done and that such a race will be of much benefit, supplanting, in a measure, cattle. A grave drawback at the present time is the scarcity of the hybrids. I have bred mostly to Polled Angus. The cross can, however, be made with any cattle. I have made a list of twenty-three points in which I think the hybrids are superior to cattle. Some of the more important of these are:

- (1) They eat less.
- (2) They digest better.
- (3) They put on more flesh with the same amount of food.
- (4) They cut more good meat; as far as I can ascertain about 66 per cent of the best cuts.
- (5) They are subject to fewer diseases. They seem to be entirely immune to blackleg until they are reduced to about one-eighth buffalo blood, the buffalo itself being absolutely immune.

The extra rib of the buffalo is present in the half-breed, and in some cases in the quarter-breed. The cross-breds are more docile than the buffalo. I have animals varying from half-breed buffalo to one-sixteenth buffalo.

## BRAHMIN CATTLE.

Prof. C. L. Willoughby, of the Georgia Experiment Station, is making records of crosses between grade Brahmin cattle and other cattle in Georgia. We hope to be able to present a paper from him on this subject at this meeting, but certainly at the next meeting of the Association.

## WOLF-DOG HYBRIDS.

Mr. O. B. Shumway, of Chillicothe, Ill., reports his extensive experience with hybrids between the wolf and the dog. He has captured young wolves and raised them in captivity.

Generally speaking, those wolf characters which differ from those of the dog are dominant in the cross. Some of the hybrids have been raised for the purpose of selling their scalps as wolf scalps.

## OTHER WORK

Prof. F. B. Mumford, dean and director at the Missouri Station, has undertaken to collect a bibliography of animal hybrids.

Mr. Q. I. Simpson, of Palmer, Ill., is continuing his valuable experiments with swine hybrids.

Mr. P. E. Fogle, of North Carolina, has for several years been making careful records of the results of crosses between Herefords and Shorthorns. A brief paper by him will follow this report.

The committee would call attention to the important work of Prof. W. E. Castle in animal hybrids, and especially to the recent publication of the Carnegie Institution giving the results of his work on rabbits.

Some of the most important lines of work in animal hybrids, from an economic point of view, at present in progress in this country are the work with cattaloes, with Brahmin cattle, and with some of the sheep crosses which are being made at several of the experiment stations with a view to producing new breeds better adapted to local conditions.

The committee is in touch with most of the zoological parks in the country, and we have ascertained that at several of them arrangements can be made for the use of some of the animals they possess in crossing with farm animals.

W. J. SPILLMAN, *Chairman*,  
Q. I. SIMPSON,  
W. J. KENNEDY,  
W. E. CASTLE,  
F. B. MUMFORD,  
P. E. FOGLE,  
C. L. WILLOUGHBY,

*Committee.*



## REPORT OF COMMITTEE ON BREEDING FIBER CROPS.

J. H. SHEPPERD, *Chairman.*

Your committee consisting of Dr. Lyster H. Dewey, Professors Alvin Keyser, H. L. Bolley, and myself have not found it possible to have a committee meeting, although the chairman has met Professors Keyser and Bolley for a conference over this matter of breeding fiber crops. Dr. Dewey has furnished a brief paper for the committee, which gives a general review of the situation with the three commercial fiber-producing plants which concern this committee. This statement is as follows:

"The two fiber crops most promising for this country are hemp and flax. Prof. C. P. Bull, of the agricultural experiment station at Saint Anthony Park, Minn., is working in the selection of hemp seed in cooperation with the U. S. Department of Agriculture. Hemp can doubtless be cultivated successfully for fiber as far north as the southern part of Minnesota, and in favorable seasons good crops may be obtained in the Red River Valley; but I would regard it as too uncertain a crop for that region when it requires at least  $3\frac{1}{2}$  months for its development. I think that better results in the production of seed may be obtained in regions farther south, even south of Kentucky. Some seed of the fifth generations of selection at St. Anthony Park was tried last year at the experiment station at Lexington, Ky. The plants produced were shorter, and with shorter internodes, than plants grown under similar conditions from Kentucky seed which had not been subjected to any selection. I think this inferiority was due in part to the change of location. Professor Garman, of the Kentucky Experiment Station, tells me that in nearly all instances where he has obtained seeds of other crops from regions where the climatic conditions were different from those in Kentucky the crop of the first year from this introduced seed was inferior.

"There is not only a need for improvement in the quality of hemp, but also a very important need for an increase in the quantity of seed available. Last year the prices of hemp seed ranged from \$5 to \$7 per bushel, but there was a break in the prices at about sowing time owing to the fact that many of the hemp farmers in Kentucky, discouraged by the high price of seed, turned their attention to tobacco. The latter crop has given them handsome returns this year because the prices have been higher than heretofore. Hemp

seed is now selling at \$4 to \$5 per bushel, and some of the dealers and farmers think that the prices may rise as high as, or possibly higher than, last year. It would be impossible to secure seed to plant as large an acreage of hemp as the average of the past ten years.

"During the past year the Department of Agriculture began some work in the selection of flaxseed for fiber production in eastern Michigan. Plants were selected in the fields of flax, which is there grown primarily for fiber production. These plants were subjected to careful laboratory tests in accordance with the principles of plant breeding which have been developed at the Minnesota and North Dakota experiment stations, and the seed from the best plants will be used in setting out 100 plant-breeding plats next spring.

"There is a demand for two rather distinct fiber types of flax, one to have coarse strong fiber, suitable for the manufacture of binder twine and other coarse twines, and the other to have a fine flexible fiber, suitable for the manufacture of fine twines, shoe threads, and carpet yarns. There is no demand in this country as yet for a flax fiber for the manufacture of fine woven linens such as are imported. If the flax industry is to be developed in this country, it seems more promising to begin with the coarser and less expensive lines, which may be produced with less skilled labor, and develop gradually toward the finer linens.

"While abacá, the plant cultivated in the Philippines for the production of fiber commonly known in our markets as "Manila hemp," can not be grown in this country, we are interested in its production because we are the principal consumers of abacá fiber. A fiber expert, Mr. M. M. Saleeby, has been employed by the Philippine Bureau of Agriculture in Manila, to devote his entire time to investigations of the abacá industry. He has found that, while abacá may be propagated from seed, and in fact many abacá seedlings grow in the plantations, none of the seedling plants ever develop into a good type like the plants grown from suckers. This fact may be of quite as much value in breeding plants of similar character as it is in attempting to introduce these plants into new localities. We have tried to introduce the plants into Porto Rico by means of seedlings, because the seeds were more easily transported than the suckers, but we have never been successful in securing good plants there."

In the opinion of the other three members of your committee, the breeders of flax need more the plans and specifications from the manufacturers as to what the latter will use in a commercial way.

The breeder has shown that he can produce a 12-inch flax plant or a 4-foot plant, an attenuated plant in its shaft or a tall one which has greatly elongated branches; one that produces three, four, or five stems or one that produces a single stem. He has produced coarse-stemmed and fine-stemmed at will, but the manufacturer has failed to find a way to use the crop of fiber produced at a price for which it can be grown in this country.

With these facts in mind your committee entered on a campaign to learn the status of the manufacturers of linen fabrics in this country with a view to helping them if possible. About twenty flax fiber and tow mills were located in North Dakota within a decade and were favorably situated as regards business concessions from commercial clubs, supply of flax straw, and salvage in the form of flax seed remaining in the straw, but they have all closed down and quit business.

Some firms which claim great recent success and new developments were approached by your committee for information as to their status and what we can do to aid them, but we have met with little success. Some of these firms insist that they have processes completed or nearing completion for retting and handling flax, which will soon revolutionize the fiber business, but these processes are valuable and consequently secret. Your committee believes that further effort along this line should be put forth.

An earlier report from this committee (*A. B. A.* vol. 4, pages 219-233) indicates that the hemp plant is also very plastic in the hands of the breeder and offers good returns for systematic work which will aid the producers and manufacturers. Both hemp and flax are unusually pliable in the hands of the breeder and should prove good subjects for the man who desires to study methods.

## WALNUT-OAK HYBRID EXPERIMENTS.

ERNEST B. BABCOCK, *Berkeley, California.*

### EXPLANATORY NOTE.

In the fall of 1907 the attention of the writer was called to certain trees growing in southern California which were locally known as "walnut-oak hybrids." The origin of this name together with a description of one of the trees may be found in Jepson's "Silva of California" (now in press). Before any facts were known which would help to explain the identity of this anomalous form, experiments were begun in the effort to secure data that would substantiate or discredit the hypothesis of origin through hybridization between oak and walnut. It was reasoned that the failure of a large number of careful efforts to secure such a hybrid would discredit this hypothesis, while the production of one such hybrid artificially would tend to strengthen it. The only native walnut of southern California is *Juglans californica* Wats. The oak which was locally considered to be the male parent is the coast live oak, *Quercus agrifolia* Nee.

### EXPERIMENTS IN 1908.

Very early in the spring two wild walnut trees were selected. They were located one at the front and the other at the rear of a large city lot in the suburbs of Los Angeles. Through the courtesy of the residents, they have been well protected from any interference during the critical stage of the experiments. They will be designated below as Tree I and Tree II. By March 25 the pistillate catkins could be found terminating the new branchlets of the season. Manilla paper bags were used to cover 50 pistillate catkins on each tree. On April 9 no pollen was being shed on Tree I. Eight bags were left in place as checks. The flowers on 23 pistillate catkins were pollinated with oak pollen obtained from a large acorn-bearing coast live oak tree growing in the neighborhood. The method of gathering the pollen was to hold a wide-mouthed vial so as to include several shedding catkins as they hung on the tree, then tapping the branchlets so as to cause the pollen to fall. In this way sufficient perfectly fresh pollen was secured to treat a large number of walnut flowers by using a camel's hair brush. In the same way pollen was obtained from one of the "walnut-oak hybrids" in Garden Grove, which will be referred

to below as Freak. This pollen was used on 19 pistillate catkins on April 11. On this date also the 50 bags that had been placed on Tree II were opened, except 6 that were left in place as checks. Of the remaining pistillate catkins 27 were abandoned because most of the flowers were still very small, and 17 were pollinated with oak pollen as on Tree I. The conditions on the above dates were nearly ideal; warm, sunny mornings, plenty of fresh oak pollen, and, on Tree I, the pistillate flowers apparently in the proper stage of development, although no pollen was being shed on that tree. On Tree II some pollen was being shed, but care was taken not to expose the pistillate flowers in pollinating them. The results of this work are shown in the following table:

*Summary of walnut-oak hybridizing experiment for 1908.*

TREE I.

Source of pollen.	Number of pistillate catkins pollinated.	Number of catkins on which nuts formed.	Number of nuts produced.	Nuts that germinated in 1909.	Trees growing in 1909.
Oak . . . .	23	14	27	26	24
Freak . . . .	19	8	13	13	12
Checks . . . .	8	0	0	0	0

TREE II.

Oak . . . .	17	16	37	33	32
Checks . . . .	5 <sup>a</sup>	1	2	2	2

<sup>a</sup> One check missing.

EXPERIMENTS IN 1909.

The same walnut trees were used as in 1908, and extra effort was made to secure good control. It was planned to use pollen from other species of *Juglans* also. Double thickness oiled paper bags were tied over the new branchlets on March 16. As the season was somewhat later than in 1908, the pistillate flowers were not conspicuous, and, of the 50 bags used on Tree I, only 11, out of 43 examined, were found to contain pistillate catkins, on April 23. Of the 7 left for checks it was found later that at least 4 had covered pistillate flowers, their dried remains being present in the bags. The oak tree from which fresh pollen was obtained in 1908 had quite passed the blooming period by this time so that no pollen could be obtained. The 11 pistillate catkins were pollinated as follows: 8 catkins (18 flowers)

with pollen from *Quercus agrifolia* brought from Berkeley, collected April 20, and on that day giving a satisfactory germination test; 3 pistillate catkins (9 flowers) with pollen from *Juglans sieboldiana* brought from Niles. This was gathered April 19 but not tested. One week after being collected it failed to germinate in 10 per cent sugar solution.

On Tree II, when examined April 24, 23 out of 45 bags covered pistillate catkins, 5 bags being left as checks. The 23 pistillate catkins were pollinated as follows: 3 catkins (9 flowers) with *Juglans regia* pollen gathered in East Whittier on April 22; 3 catkins (14 flowers) with *Juglans sieboldiana* pollen, as on Tree I; 3 catkins (12 flowers) with pollen taken from one of the "walnut-oak hybrids" in East Whittier, on April 22; 7 catkins (36 flowers) with *Quercus agrifolia* pollen from Berkeley, as on Tree I; 5 catkins (17 flowers) with pollen taken from two trees of *Quercus engelmannii* in Sierra Madre on April 23.

No nuts whatever were produced as a result of any of the 1909 crosses. This totally negative result may be partially explained by some of the conditions; for instance, on Tree I, probably the pollen used was too old; on Tree II, the pollen of *Quercus agrifolia* and *Juglans sieboldiana* was the same as on Tree I; the pollen from *Juglans regia* was obtained from catkins that had shed most of their pollen already; the "walnut-oak hybrid" in East Whittier seldom bears nuts and its pollen may be sterile. Only the pollen of *Quercus engelmannii*, which was gathered less than 24 hours before it was used, was abundant in quantity, may be considered as in ideal condition, and this was applied to only 17 flowers. It is hoped that, during the coming spring (1910), similar experiments may be carried out on a large scale, with proper observations on pollen germination. Any suggestions from those interested will gladly be received.

SUPPLEMENTARY NOTE (May 1910).—There are now 151 nuts developing in the two walnut trees at Garvanza, as the result of pollinating 79 pistillate catkins with pollen from *Quercus agrifolia* as in 1908. There are also 29 nuts as a result of pollinating 16 pistillate catkins with pollen from *Quercus engelmannii* as in 1909.

The behavior of the seedlings secured from these nuts, as well as the 1908 seedlings now growing, will be carefully observed. Cions will be grafted on thrifty walnut trees in order to induce early fruiting and thus secure second generation trees as soon as possible.

[Presented by Committee on Breeding Nut and Forest Trees.]

## REPORT OF COMMITTEE ON BREEDING CEREALS.

C. A. ZAVITZ, *Guelph, Ontario, Chairman.*

### MEMBERS.

Prof. Alvin Keyser, Ft. Collins, Colo.	M. A. Carleton, Washington, D. C.
Prof. I. S. Klinck, Macdonald College, Quebec.	Dr. C. E. Saunders, Ottawa, Canada.
C. G. Williams, Wooster, Ohio.	Prof. J. H. Shepperd, Agricultural College, N. Dak.

### OBJECTS.

The duties of this committee shall be (1) to investigate and report on the methods and technique of improving the cereals by breeding, and (2) to encourage the production of improved varieties of all the cereals for each agricultural region and for each use.

### PLAN.

The committee on the breeding of cereals desires to have the work conducted along as definite and systematic lines as possible. We believe it is a good plan for breeders and breeding establishments to conduct the work with the different species of field crops along some general plan, such as the one here indicated.

- Status of the species.
- Physiological facts to be considered by breeders.
- Strong economic characters.
- Characters needing improvement.
- Securing foundation stocks.
- Plan of breeding.
- Testing progeny.
- Distribution of improved strains.

This outline has been suggested, not only to breeders, but to those who are to present special papers at the annual meeting.

In order to ascertain what is now being done at various institutions in the line of plant breeding, the chairman of the committee wrote to about sixty experiment stations, as follows:

I would greatly appreciate receiving a concise statement of the work which is being done at your institution in the breeding of cereals, especially along the following lines:

1. The main objects in view.
2. The outline of what is being done.
3. The method of operation.
4. The most important results which have already been obtained.
5. The name of the person directly in charge of this work.

The greater number of the institutions have already been heard from, and when all have reported some most excellent information will be at hand for assisting in the future work of the committee.

PAPERS PREPARED.

The papers which have been specially prepared for presentation at the annual meeting for 1909 are as follows:

The Breeding of Barley, Prof. J. H. Shepperd, Agricultural College, N. D.;

Prof. Alvin Keyser, Ft. Collins, Colo.

Wheat Breeding, Prof. H. F. Roberts, Manhattan, Kans.

The Breeding of Grain Sorghums, C. R. Ball, Washington, D. C.

A Large and Small Grain Experiment, Supt. R. L. Waldron, Dickinson, N. D.

The Problem, its Limitations and Possibilities, R. Gauss, Denver, Colo.

---

## BREEDING FOR TYPE OF KERNEL IN WHEAT.

HERBERT F. ROBERTS, *Manhattan, Kans.*

Considerable attention has been devoted to the breeding of a particular type of kernel in corn, but, to the writer's knowledge, nothing has hitherto been done to ascertain the most desirable type of kernel in wheat, as judged from the economic standpoint, or to breed for such a type.

The present paper proposes to discuss the results of a preliminary investigation directed toward this end.

In the first place, so far as the miller is concerned, there are certain well-defined preferences with respect to a desirable wheat for milling purposes. Leaving out the primary necessity, in our region at least, of a hard semi-translucent wheat, rich in gluten and preferably a winter wheat with a dark reddish-amber color, we find that, so far as the form of the wheat kernel is concerned, the millers and grain dealers desire a full, plump berry in preference to a slender berry, on account of the relatively smaller proportion of bran which such a kernel produces; and, for the same reason, a berry with a shallow crease is preferable to one with a deep crease. The deep crease is also an objectionable feature because of the considerable quantity of dirt that it holds, which must be cleaned out in the scouring process as thoroughly as possible. A type of kernel devoid so far as possible



of the mass of hairs surmounting the ovary, called the "brush," is likewise desirable because of its lesser liability to carry dirt particles. So much for the preferred type of kernel for milling purposes.

The present investigation, however, was directed in part, and so far as the data to be herein presented are concerned, toward another matter, namely, the relation of the form-factors of the wheat kernel to the volume-weight of the grain.

Wheat, before being sold, is "tested" by means of a standard "grain tester" in order to ascertain the number of pounds per bushel it will average. Upon this average bushel-weight and upon other considerations affecting the quality of the grain as judged by its appearance, hardness, etc., the grain is "graded" according to the system of standards prescribed by the grain exchange or the State inspection department as the case may be. The grade as thus fixed for any lot of wheat determines its market price. Wheat is, to be sure, sold entirely by weight in our market, but if two lots of wheat weigh 1,000 pounds each, and one tests at 56 and the other at 62 pounds to the bushel, the latter will bring the higher price (at present, in the neighborhood of 5 or 6 cents more per bushel).

What factors determine the differences in volume-weight which thus affect the selling price of wheat? On first consideration it would naturally be assumed that the specific gravity of the kernels would be the most important factor.

However, it was noticed, that, among several hundred pure races, originating from single mother plants, of wheat harvested in 1908 at the Kansas Experiment Station, certain distinctive types of kernel existed, which seemed to pack more closely into a given volume than did others, and an investigation was instituted to determine the optimum type of wheat kernel in this regard. To this end, 52 pure lines of wheat were selected, which seemed to afford a series of very diverse types of kernel in respect to length, width, contour, etc.

From each of these races, five series of 100 kernels each were taken by random samplings. In each series of 100, the average length and average width of the kernels were determined. It was found that the variations in averages among the five different hundreds of each lot were so slight that in general a lesser number than 500 would have sufficed. However, this number was adhered to in the determination of the averages in question for the entire series of 52 races. The ratio of length to width was taken as a form-factor—a large ratio

denoting a long grain and a small ratio a short grain, as a matter of course.

The determination of the average volumes of the kernels (by displacement of 95 per cent alcohol in a burette) gave a means of differentiating, say, two races having the same length-to-width ratios, but in which the kernels were of different average size.

The volume-weight of the kernels of each race was then determined by weighing as much grain as could possibly be packed into a 250-cc graduate, the packing being effected by vigorously tamping the graduate a given number of times for each fractional portion of its contents as the same was put in. This volume-weight in grams per 100 cc will be converted into terms of pounds per bushel for the purpose of this paper.

The amount of unoccupied air space left among the kernels of the packed grain was then determined in the case of each of the 52 races in the experiment, by filling the graduate, in which the grain had been packed as described, with 95 per cent alcohol. The amount of alcohol thus delivered from the burette, and necessary to exactly cover the grain, reduced to a basis of 100 cc and subtracted from 100, gave exactly the percentage of actual solid grain material in each case.

There were thus at hand data for determining the relation between any specific type of kernel as expressed in terms of the length-to-width ratio and the average kernel-volume on the one hand, and the percentage volume of grain in 100 cc on the other; and between all of these factors on the one hand and the bushel-weight on the other.

The full details of the methods followed, as well as the complete tables of the experimental data, are reserved for a bulletin prepared by the writer for the Kansas Experiment Station.

In the figure on page 207 is shown the relation of the form of the wheat kernel expressed in average length-to-width ratios, to the packing of the grain as expressed in the percentage volume of grain in 100 cc, where all of the 52 races of wheat in the experiment are taken without reference to average kernel-volumes.

Abscissæ denote the average length-to-width ratios of the kernels; ordinates denote the percentage volume of grain in 100 cc.

The plotted data indicate very plainly that as the length-to-width ratio increases the percentage volume of grain that can be packed into 100 cc diminishes, irrespective of the actual size of the kernels as expressed by their average volumes.

In the figure on page 208 is shown the relation of the size or average volume of the kernel in the same 52 pure strains of wheat to the packing of the grain as expressed by the percentage volume of grain in 100 cc.

Here the abscissæ denote average volumes of the individual kernels in cubic millimeters; the ordinates denoting again, as before, the percentage volume of grain in 100 cc.

Here the plotted data indicate even more plainly the fact, that, with the increase in the average volume of the individual kernel, there is a corresponding increase in the percentage volume of grain that can be packed into 100 cc.

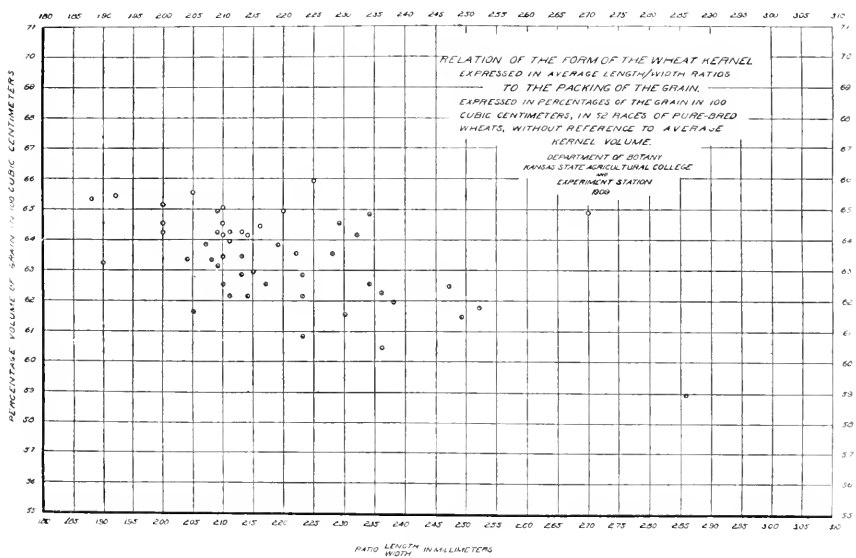

Since this is not what we should have been led theoretically to expect, it was determined to analyze the data somewhat further, eliminating if possible some of the variables, so that the relation between the average kernel volume and the packing of the grain, as expressed by the percentage volume of grain which would go into 100 cc, might be more clearly seen.

All of the cases having like length-to-width ratios of kernels were taken together, making a series of 12 pairs. In 6 of these pairs the higher percentages of grain containable in 100 cc of space followed the higher average kernel-volume; in the other 6 pairs the reverse was the case. In general, however, it occurs that in the cases with the

lower ratios, *i. e.*, the shorter kernels, the correspondence of good packing quality, as expressed by the percentage of grain containable in 100 cc, with the higher average kernel-volume, *i. e.*, with the larger-sized kernels, seems to be more marked than in the cases of the high ratios, *i. e.*, of the long kernels. The data on the whole are too few to warrant any general conclusions, but the results thus far seem to indicate that the large-kernelled races of a wheat with short grains will leave the least waste air-space in a measure, or, in other words, will pack the bushel most perfectly.

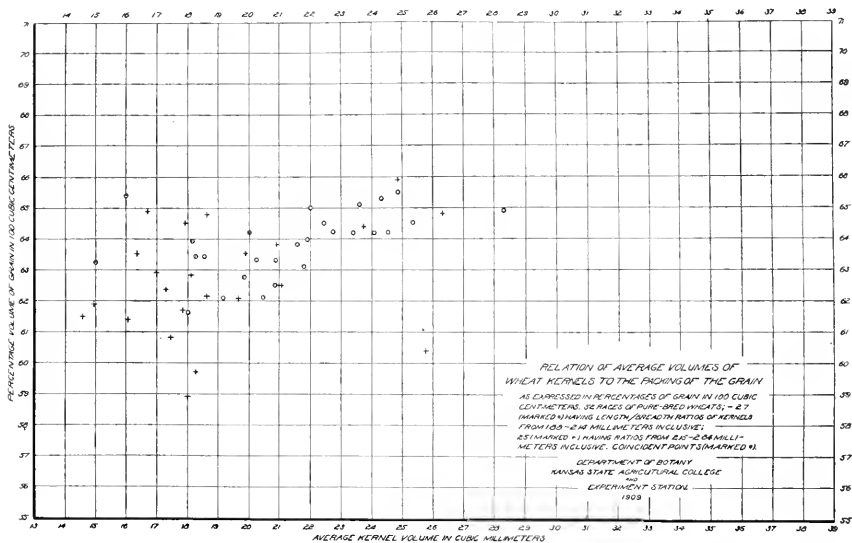

Now what relation does this have to the volume-weight as expressed in pounds to the bushel? The manner of determining the volume-weight has already been described.

Taking again all of the cases under experiment, where like length-to-width ratios of kernels existed, and plotting as abscissæ the average volumes of the individual kernels in increasing order, and with three sets of ordinates, denoting respectively pounds per bushel, percentage volume of grain in 100 cc, and average kernel-weight, it appears from the data that in every case of like ratios the bushel-weight follows the percentage volume of grain in 100 cc rather than the average kernel-weight. Where this percentage volume increased, the bushel-weight increased, and where the volume of grain in 100 cc decreased, the bushel-weight decreased, almost absolutely independently of the aver-

age weight of the individual kernels, which sometimes rose and sometimes fell.

This is not what would perhaps have been expected, and the small number of cases having like ratios makes a general conclusion of rather doubtful value. The facts thus far, however, seem to point to the following as inferences from the experimental data.

1. The shorter the wheat kernel and at the same time the larger its volume, *i. e.*, the more nearly it approaches the sphere in form, the more perfectly will the kernels pack, and the less air-space unoccupied by the grain will be left in the measure.

2. Where the kernels are long, increased average kernel-volume does not insure increased solidity of packing to the measure, but rather the reverse.

3. In general the long types of kernel pack less perfectly than the short types, and should be discarded by breeders in favor of the latter, where pure-bred wheat races are in question.

[Presented by Committee on Breeding Cereal Crops.]

---

## ACCLIMATIZATION IN BREEDING DROUGHT-RESISTANT

ROBERT GAUSS, *Denver, Colorado.*

The dominion of climate is invincible. All who come within its range must obey its laws. It grants no pardon. It makes no compromise. Compliance with the conditions imposed is the license to exist, and these conditions determine the limits of activity. Even the achievements of irrigation are the fruits of constant warfare. Every irrigated field is territory wrested from this dominion and maintained by unceasing effort and never failing vigil. The city of Denver preserves its beauty and its charm by constant struggle against the ever encroaching desert, which, encamped and entrenched, maintains sleepless siege against the town. The desolation of Nineveh and the ruin of Babylon are evidence rather of surrender to an adverse climate than of destruction wrought by the hand of man. Thus the testimony of history and the witness of nature demonstrate the truth of Montesquieu's declaration that the most enduring of all empires is the empire of climate.

Acclimatization and naturalization are two radically different methods of introducing new varieties and species. Naturalization is the introduction of plant species from foreign countries where they have become adapted to climatic conditions closely resembling those of the region to which they may be transferred. Were it practicable to find in other lands valuable species so drought-resistant that they would thrive in the arid places of this country, the problem of acclimatization could be laid aside, for its solution elsewhere would render needless its investigation here. But the fact that no such adapted varieties of the common cereals and other valuable crop species can be found makes acclimatization the supreme problem of the arid West.

Wallace defines acclimatization to be "the process of adaptation by which animals and plants are gradually rendered capable of surviving and flourishing in countries remote from their original habitat or under meteorological conditions different from those which they have usually to endure, and which are at first injurious to them." This definition contemplates not only complete acclimatization, but also those slight changes in constitution which enable a plant to endure a moderate climatic difference without the development of new specific characters. Thus one variety may be more drought-resistant than another, and it may have acquired this power by slight variations which would probably disappear upon transfer to a humid environment. Between such varieties and those less drought-resistant members of the same species which have always enjoyed the advantage of abundant moisture, there is not that specific difference which separates the plants of distinctly desert regions from those of distinctly humid regions. Complete acclimatization from humid to desert conditions involves the development of new specific characters.

That degree of acclimatization which involves the development of distinctly desert species is by some naturalists looked upon as chimerical. Prominent among these is Professor de Vries, the eminent Dutch botanist, whose writings form, probably, the most notable recent contribution to the doctrine of evolution. In a little book entitled "Plant Breeding," he expresses the belief that the desert species in the intensely arid region of southern Arizona acquired their drought-resistant qualities by mutations which occurred under humid conditions, that they were expelled from the humid environment, that they reached the desert by migration, and that the desert environment had nothing to do with their evolution.

This theory ignores the fact that adaptation is not found exclusively in the occurrence of a favorable mutation, but in both the occurrence of the mutation and its subsequent perpetuation. One might admit that a drought-resistant mutation could arise under humid conditions, but one could not admit that a mutation of that kind would be an advantage unless there were drought to be resisted. Were a drought-resistant mutation to occur in a region of abundant moisture, it would be a disadvantage, and hence, in all probability, it would disappear before the species could escape by migration. It is only when a mutation is in harmony with the environment that it gives the plant in which it occurs any advantage; and since it is through the advantage given individual plants by this harmony that natural selection operates, the guiding factor in the perpetuation of drought-resistant mutations must be the arid environment to which they conform. Thus the desert, acting as a sieve, determines that drought-resistant plants shall live and that non-drought-resistant plants shall die. From this we are bound to conclude that as a rule desert species have been developed in desert regions.

The assumption which many writers make—among them De Vries—that nutrition can be distinguished from climate in the effect upon plant growth, involves a serious as well as common error. In fact it is impossible to distinguish them, for nutrition and climate can not be separated. In the case of all vegetable organisms, nutrition is the process by which they absorb nutriment and transform it into living tissue. They do this, subject to conditions of heat, light, and moisture. But a prevalent combination of heat, light, and moisture in nature is what we call climate. Hence climate is a factor in nutrition and a measure of the ability of a plant to utilize the nutriment within its reach. A favorable climate stimulates, an unfavorable climate restricts nutrition. The all-important thing to consider is that aridity puts, as it were, hobbles upon nutrition. It is the aim of acclimatization to overcome these restrictions and enable the plant to carry on the work of nutrition in spite of the lack of water.

The way in which aridity restricts nutrition is disclosed by the fact that the service performed by water is almost exclusively mechanical. It holds in solution the nutriment in the soil, conveys it through the roots to the plant tissues, and by keeping the tissues moist facilitates the requisite physiological processes. Ordinarily, a reduction of the supply of water would reduce the nutriment and

restrict physiological activity. In the case of desert plants structural adaptation overcomes this in a measure and enables them to get greater service from the water which is available than they would without this adaptation. The fact that the water which is not retained in the plant is returned to the air by transpiration presents the possibility of a special adaptation. By this act of transpiration a plant may lose a great deal of the moisture taken into its system; and hence a structural adaptation which would check needless transpiration would promote economy in the use of water. The problem of acclimatization is to secure this and other desirable changes in structure.

One should not conclude, however, that in relation to profitable agriculture the possibility of successful acclimatization to arid conditions is confined to the development of direct modifications of the kind in question. For the argument's sake, one might admit that there would be a reduction in the aggregate growth of a plant in consequence of a reduction in the available quantity of water, although observation shows that it is really much less in the case of a plant with drought-resistant adaptations than in one not so adapted. While admitting for the argument's sake the reduction of growth, one should take into consideration the conflict between vegetal growth and reproduction, which has been recognized by botanists since the beginning of vegetable physiology. The circumstances under which this conflict becomes manifest were elaborately presented by Herbert Spencer nearly sixty years ago in one of his most interesting contributions to the theory of evolution. Botanists may differ in regard to the exact nature of the conflict; but that it exists and is closely associated with nutrition is beyond dispute. When nutrition is strong, showing itself in large vegetal development, reproduction is relatively less active; but when a check is placed upon vegetal growth, reproduction sets in. Mr. Patrick Geddes, the British botanist, has given this subject much attention, and he is one of the leading advocates of the proposition that the conflict in question plays a highly important rôle. Arthur, quoted by Professor Bailey in his work on plant breeding, says: "A decrease in nutrition during the period of growth of an organism favors the development of the reproductive parts at the expense of the vegetative parts." Although the case presented is not exactly parallel to that of plants subjected to unbroken poverty of nutrition from the beginning of their lives, the same discrimination



seems to take place when an entire species is compelled to struggle against adverse conditions. In the latter case, natural selection seems to have preserved or perpetuated a tendency to favor the reproductive. In any event, whatever favors the reproductive functions is of advantage to agriculture. Aridity may restrict the aggregate growth, but through a relatively large yield of grain discrimination in favor of reproduction may leave a margin of profit to the farmer. In further support of this view, I may point to the fact within the observation of nearly all wheat growers that a heavy growth of straw is often followed by a disappointing yield of grain, whereas an unpromising development of straw frequently precedes a harvest which yields much more than the appearance of the crop indicated.

In passing, I may remark that if the line of acclimatization is through deterioration, affecting chiefly the vegetal development, but from which the reproductive would not be exempt, the effect upon wheat would probably be seen in a reduction in the size of the grains. If this assumption is correct, small grains might be a mark of acclimatization which the breeder should not ignore.

The methods to be pursued by the breeder now demand consideration; and in this connection I find myself heavily indebted to Professor de Vries, for he has given me a new weapon with which to combat his theory that acclimatization is a dream. One who may be engaged in breeding drought-resistant cereals will have to conduct his experiments only a few years to discover that the desired end is not to be attained by adding one favorable variation upon another. When I began my experiments in 1896 I thought that could be done; but in course of time I discovered that, whereas in one year a plant might show a variation in what might seem to be the right direction, its offspring the next year might just as effectually vary back to the original standard and obliterate all that had been gained. Thus the breeder might find himself swinging like a pendulum between narrow extremes of variation without making any progress. I must confess that, when I was at that stage of my work, I knew nothing about the vicious circle of fluctuating variations concerning which Professor de Vries has so instructively written. There is little hope in the struggle with fluctuating variations. But by his theory of mutations Professor de Vries has pointed out the path of possible escape from the entanglement; and I am now convinced that the acclimatization

of cereals to our arid climate can be accomplished by taking advantage of favorable mutations. But while in theory this simplifies the problem, it greatly increases its practical difficulties. It removes the work to be done from the domain of agricultural to that of botanical experimentation. Solution of the problem calls for a large and fully equipped experiment station, ample funds for carrying on the work, and a force of botanists and other trained men to conduct the experiments. Of the truth of this I am fully convinced by both observation and personal experience. While recognizing that in my own field work I have not solved the problem of acclimatization, I think I have learned something about its nature. My investigations have convinced me that the end to be attained is beyond the reach of individual effort. The work should be done by the Government; and, since the problem is distinctly scientific in character, its solution should be intrusted exclusively to botanists of experience and proved ability. In the hope that in this spirit the work will be done, I look upon it as extremely fortunate that the Department of Agriculture has taken it up. The regret I shall feel in severing my own connection with work of this kind—which I shall have to do in the near future—will be greatly offset if my views respecting the nature and importance of the problem find acceptance. There is reason to fear, however, that a good deal of the labor at the experiment stations now maintained by the Government may be in vain so far as the problem of acclimatization is concerned. Growing numerous small plats of wheat does not hold out much promise of success. Possibly a comparison of yields may show some superiority in one variety over another; but a great deal more than that is needed. The problem is radically different from the one which presented itself to Mr. Hays when he was making his highly successful and instructive experiments to improve the wheats of Minnesota. Acclimatization was not even a factor in his problem. It is the whole problem here. Were we in possession of a fully acclimatized species of wheat, there would probably then be call for experiments like those conducted by Mr. Hays, in order to improve the species and secure a larger yield.

Probably the first thing requisite is full, clear recognition that acclimatization is in reality the problem to be solved, and that its solution calls for distinctly botanical investigations. I fear that at least some of the government experimenters are struggling with the

fluctuating variations of which I have spoken. In their case there is need of recognition that it is only through the discovery of mutations that they can hope to succeed. What is required is the discovery of a new elementary species, drought-resistant in characters distinguishing it from species adapted to a humid climate. It would probably require the trained eye of a botanist to discern these specific characters or differences; but, however this might be, the mutations giving rise to such characters will, in my opinion, have both to occur and to be perpetuated, before acclimatization to an arid environment will be fully accomplished. That mutations of this kind occur from time to time is highly probable; and so my advice to the experimenters is to look for "sports." But let them recognize that a sport showing adaptation to aridity would probably present a very different appearance from that of a sport in a region of abundant moisture. It might, measured by humid region standards, be a most unpromising looking plant—the "singled cat" of the entire field. Probably it would be short in stature, present a dense as distinguished from an open growth, possess a large though short stem, thick coarse leaves and a big development of root. In many respects the last named may be the most important. Neither late-maturing nor early-maturing plants should be rejected. The former might show greater adaptation to aridity; but if the latter should show a special adaptation to the length of the rainy season, they might prove to be very valuable from the standpoint of practical agriculture, although scientifically less interesting than the others.

One obstacle in the path of a breeder compelled to conduct his experiments upon a restricted scale is the comparatively small number of plants available for examination. There is more hope of finding the desired mutations among tens of thousands of plants than in little experimental plats. Should the Government do the work, it could afford to grow five hundred thousand individual wheat plants, if Burbank could grow ten thousand shrubs in the hope of finding a single one with the desired character. The individual plants should be grown sufficiently far apart to give room for careful examination, and they should be numerous enough to give hope of finding the desired mutation. Extensive experimental planting is a prime requisite; for it is not by a kind of training process that acclimatization is to be achieved, but by actually going out and finding the mutations in case they occur.

This leads to a suggestion respecting a way in which success might be achieved. Sheriff, the famous British breeder of fine wheat varieties, devoted his time to looking for sports in the fields, and sometimes years elapsed after finding one before he found another. But from sports discovered by him several superior kinds of wheat arose. Some of the best wheats now grown in the United States are products of similar discoveries. Bearing this in mind, and while still asserting that acclimatization is a botanical and not an agricultural problem, I may consistently suggest that any intelligent and observing man engaged in growing cereals in the arid region by the more or less precarious methods of "dry farming" might stumble upon the desired sport. Hence all dry farmers should be encouraged to look for mutations or sports of that kind. In order that they might search intelligently, it would be well if the Department of Agriculture were to publish a bulletin containing information on the characteristic appearance of drought-resistant plants, which could be distributed among the dry farmers of the arid and semi-arid regions.

One other suggestion to the Department of Agriculture remains to be made. The greatest thing which has ever been done for the study and investigation of arid region plant growth is the establishment of the desert laboratory near Tucson, Arizona. It was established upon the suggestion and under the direction of Mr. Frederick Coville, botanist in the Department of Agriculture, and Mr. Daniel T. MacDougal of New York, both of them botanists of ability and distinction. In the maintenance of that laboratory an example is set which the Department of Agriculture should follow in connection with the endeavor to breed drought-resistant cereals and other valuable crop species. As I already have said, the problem is botanical. It needs botanists for its solution. At one of the arid region experiment stations—and I know of none more suitable than the one at Akron, Colorado—a botanical laboratory should be established. This laboratory should be the center from which all the acclimatization work should radiate. Every supposed "sport" or mutation, whether discovered at the station or in the field of a dry farmer, should be subjected to careful examination; and no doubt much could be done in that way to determine its real value in respect to drought resistance. Mr. Coville did a splendid thing when, in connection with Mr. MacDougal, he secured from the Carnegie Institution the means and later established the desert laboratory near Tucson, Arizona. I should like to see

him follow up that achievement by organizing under the Department of Agriculture a similar laboratory for experiments in acclimatization under the comparatively moderate desert conditions of this part of the country.

Let no one look with indifference upon the possibility here outlined of acclimatizing valuable crop species to arid regions, or underestimate the magnitude of the achievement suggested. The problem itself is as full of interest to the biologist as the possibility of its successful solution is rich with the promise of benefit to mankind. Excluding the untillable mountains and the hopelessly irreclaimable deserts, acclimatization of the food cereals would make arable nearly 300,000 square miles of the now arid part of the United States, increase by thousands of square miles the productive area of Canada, solve some of the pressing problems of agriculture in German Southwest Africa and the South African possessions of Great Britain, extend far into the interior the tillable area of Australia, and by increasing the yield of the fields expel the specter of famine from the grain regions of southeastern Russia. So vast an achievement would rank with the discovery of a new continent in its enlargement of the sources of human subsistence; and well might the hope of success quicken the activities of the most sluggish and awaken ambition in the least daring.

[Presented by the Committee on Breeding Cereals.]

# EDITORIALS

The *American Breeders Magazine* is passing through its period of trial, of experimentation as to the makeup of its subject matter, and as to its editorial arrangement; also as to suiting the views of the members of the Association. Clearly the scientific papers presented by the members at the annual meeting and those written especially for the *Magazine* should constitute the bulk of the *Magazine*. That portion of the *Magazine* is largely the result of new research. It is the vanguard of new thought on heredity and breeding. It is the applied science of the investigators.

**Need of  
Members.**

Since the larger body of the membership can not be scientists, but must come from practical breeders of animals and plants, there is need of subject matter in which they are individually interested. The historical sketches in the front part of the *Magazine* will interest many, as will also the notes and news in the back part. The section set apart for editorials gives opportunity for expression on timely topics of general interest to breeders. And here it is designed that there shall be spun the general threads of this whole discussion. The broad philosophy of breeding stated in popular terms will form the woof into which the scientific articles will be woven, each part serving as a part of the web in making up the whole fabric of fact.

The Association will expand the quarterly *Magazine* into a monthly as soon as the financial income will provide the expense. A monthly magazine of the character already established and a bound annual report—which receives high praise everywhere—appear to be a large return for a two-dollar membership fee. But it now seems easily possible to include both of these, and eventually to enlarge the Annual Report to a book of five or six hundred pages, thus placing in bound form the most vital body of knowledge on heredity and breeding. The achievements of modern publishing make this seem entirely feasible. Once the Association has ten thousand members its own income will enable it to successfully make a campaign for a hundred thousand members. A hundred thousand members will carry American plant and animal breeding forward past all obstacles toward adding the possible billion dollars more to the nation's annual crop of raw products of food and clothing.

The American Breeders Association is a voluntary cooperation. It is the opposite of a corporation. The officers lead this cooperation without pay except the satisfaction of seeing it succeed. The teething stage of the Association has long passed. Its lusty growth shows that the youth is coming to a large majority. The annual meetings, the Annual Report and the *Magazine* have all become successful. No one need doubt the future of the Association, nor indeed stop short of large hopes for this movement to conserve and utilize the mutating heredity of the rare plants or animals which, with almost no cost, will add a billion each year to our farm products.

The time has come for the members to become full-fledged co-operators in this movement. The only way to do this is to work. And aside from writing articles, the big work for each and every member is to add to the membership. At the last annual meeting forty-four men promised to secure eleven hundred new members. Some have secured all they promised and more, others have made good progress. There is until February first to make the promise good, and we believe every one will reach at least the full quota promised. And the *Magazine* now appeals to members who were not at that meeting.

Induce friends who should do so to join, you or they sending the two dollars annual membership fee or the twenty-dollar fee as is convenient. Write to friends inviting them to become members; and at the same time write the Secretary of the Association to send a letter seconding your invitation. Ask for small folders to be inserted in your letters to breeders, and where proper to do so close your letters with a sentence calling their attention to the invitation to become a member. Indifference will not compete with other societies which seek members. With a large membership all the rest is possible. That the members can secure other members is being proven by those who made the pledges at Omaha. The Secretary assumed to secure one member for each four secured by others making promises, and his quota is already filled.



The American Breeders Association has assumed the important function of bringing the practical breeders into closer touch with the scientists, and the scientists into a clearer knowledge of the practical problems of the plant and animal breeders. Its meetings have proven the value of an open forum where practical and scientific men interested in breeding

**Aims of the  
Magazine.**

can discuss heredity and breeding in all their relations to the living forms as found in nature and in reference to the production of races of plants, animals, and men with better heredity. The Association assumes the publication of the *American Breeders Magazine* because it feels that there is need of an independent open court for public expression published by a cooperative organization. The Council, under the authority of the Association, in deciding to extend this forum in the form of a magazine realizes both the difficulties and the possibilities of such a step. The effort will be to sustain a high standard of scientific excellence, and at the same time produce a readable magazine. The Association has not been organized to forward the interests of any group of men, but will give a fair and open hearing to all. It aims to achieve scientific and economic results of the highest order and of the widest scope.



In the early days of history, when law had much less hold upon men than now, shrewd statesmen and priests ruled the masses through religious customs and observances engrafted upon practically all institutions and acts that concerned the common good. Prominent among these were the agricultural activities such as seed sowing and harvesting and the setting apart of the seed for the next year's crop. With some tribes the rites and functions connected with these events were most elaborate and impressive.

That history repeats itself, that customs though modified move in cycles, is illustrated in a recent proclamation by the Governor of Minnesota to the farmers of that State to set apart the week beginning September 12 as "seed-corn week." Surely this completes a cycle in agricultural history in America. It may be that the beginning of the cycle dates back to the dim era of the mound builders coming up through the Zuni and Mayas and Aztecs to the present silo building, milk separating, auto driving and telephone using American farmer. This modern setting apart of a time for seed saving has been developed through the efforts of the agricultural extension divisions of the State colleges. It differs from its prototype in that it is less compulsory, being no longer a religious rite. It differs also in that it is carried out not alone by the leaders but by the whole people, who appreciate the

**History  
Repeating  
Itself.**



science of seed selection. It recognizes, however, that most people need to be led into being thrifty, into preparing for a rainy day by saving in the autumn a plentiful supply of seed for the time of planting.

And in a large sense the choosing of viable seed of the best heredity and preserving its full vitality for the coming year's crop is not merely a matter of duty to self and to family. With the rise in prices of food it has become an affair of State and of Nation that each individual part of our great agricultural machine do its work well, that food may be abundant and cheap for all. The States and the Nation cooperating are doing a great work in inducing tens of thousands of boys on American farms to enter corn-judging and corn-growing contests. The part which thousands of rural district schools, hundreds of consolidated rural schools and agricultural high schools, also collegiate short courses and farmers' extension departments, are doing to teach the selection of seed corn is also productive of large results. Science is taking the place of mere formal rites and the increased production which is coming from the scientific breeding of corn and other seeds is beginning to mount up to large aggregate figures.

To plant over 100,000,000 acres of corn next year our farmers must store tens of millions of bushels of seed corn. Half a billion bushels of corn annually depend on the selection of seed corn of good heredity so preserved that each kernel will grow. To get a full crop each hill must have two or four stalks so bred as to produce on each stalk a large ear or two ears. In the light of these facts the saving of seed corn certainly looms up as a most stupendous breeding operation and one that is well worthy of the proclamation of the Governor of a great State. It is well worth observing by the large farming constituency of Governor Eberhardt and is well worth perpetuating as an "agronomic cult," as it was among the ancients.—  
GEORGE W. KNORR.



Records of the efficiency of pupils in our schools, of their success in later life as members of society, and of the potency with which parents project efficiency into their progeny, would, if carefully tabulated, provide data which would induce the more rapid increase of the more efficient strains of human blood and also bring about the less rapid multiplication of the less efficient strains. Work already accomplished under scientific direction in plant

**Heredity  
in Man.**

and animal improvement has done much toward providing satisfactory methods of recording and tabulating such data.

Now that compulsory education in many places brings nearly all youth under such conditions that their school-working abilities can be determined, very useful data may easily be recorded; and as our schools are further developed so that the manual as well as cultural studies are included, the abilities of the youth can be judged more completely and more in relation to adaptability to particular vocations, especially to the practical life of the farm, the shop, and the home. It is entirely practicable to record the personal life efficiency of each pupil; and under careful development such a plan of school records may lead to wide cooperation in making such records privately, or even in making publicly accessible the records of the characteristics and efficiency of each and every person in the country.



The accumulation of efficiency records of large numbers will make possible the tabulation of such efficiency in family records.

**Efficiency  
Records of  
People.** From a study of such records may be determined the nature of inheritance of efficiency; and (approximately) the power or value of each individual as a prospective parent of efficient children. Such records would show which are the more efficient races, families, and individuals, upon whom, under suitable social and political conditions, the burden of abundant child-bearing might be made to rest. Definite knowledge of this kind would conceivably give the less efficient races and strains of men a feeling of less responsibility in the maintenance of a large progeny, while in families where the parents represent high hereditary efficiency, and especially in families which also occasionally produce geniuses, it would undoubtedly add greatly to the desire for a goodly number of children. Again, it would presumably greatly deter from abundant child-bearing those families in which the expectancy of efficiency is low; and it ought especially to do so in those cases in which defective and criminal children occur. It seems clear that since the public has come to favor conservative scientific study of heredity in man we may have a usable science of eugenics which can be taught—possibly through some such conservative organization as our State college extension departments.

The teachings of Mendel, De Vries, and others have very greatly magnified the place which the unit character has in our consideration of problems of heredity. It is almost startling to think that the inhibitions responsible for honesty and dishonesty, morality and licentiousness, temperance and drunkenness, as well as strength of mind and defectiveness, talents for music, for poetry, for oratory, for mechanical invention, and the absence of these talents, may be even in a partial degree subject to the Mendelian laws of segregation, dominance, and recombination. The article by Doctor Goddard, of New Jersey, on page 165, reporting investigations into the heredity of feeble-mindedness, may be epoch-making in drawing the attention of Mendelian students to the importance of investigations of unit characters in man. This one line of investigation has proven to the Association the wisdom of inaugurating investigations in human heredity. "Facts are God's arguments." Facts so clear and so vitally important to the strength of mind and strength of purpose of the future race at once break down the feeling that these subjects might be made vulgar by investigation. The sunlight of fact cleanses and purifies every subject; and the normal mind is ever open to the truth. "And ye shall know the truth, and the truth shall make you free."

The almost unanimous vote of the members of the Association to raise the Committee on Eugenics to the dignity of a Eugenics Section encourages the officers of the Association to make more vigorous efforts to promote investigations along this line. Members of this Association and general readers of the *Magazine* are urged to secure members from among those interested in the subject of eugenics. And what intelligent person is not interested in heredity in man? The hope is arising that the Association may build up a very large section in its membership of persons who wish to encourage and assist the committees in promoting investigations along the line of eugenics. The officers are determined to guide the investigations along scientific lines. It is believed that the forthcoming discussion in the *Magazine* of heredity in man will be of interest to criminologists, physicians, teachers, and preachers, since these deal with the more intimate phases of the lives of men, and have especial need of a knowledge of heredity in man. It is easy to predict also that no other class will have a livelier interest in the discussions of heredity in man than

**Unit Character  
in Man.**

**Wide Cooperation in  
Eugenics Desirable.**

those who are technically interested in plant and animal breeding. Since the philosophy of animal breeding was first wrought out in a practical way the breeders of plants, adopting the philosophy of animal breeders, have in the past decade distanced animal breeders in the application of the philosophy to the technique of breeding. May it not be in the end that our students of heredity, rather than physicians, anthropologists, and humanitarians, will be most efficient in the development of the science of eugenics?

Funds are being provided by private parties to carry along work relating to heredity in man. Some public and semipublic institutions are also cooperating. There is no line in which private parties could better invest funds for public service. The laboratory established in London by Sir Francis Galton is doing a good work, and similar institutions are needed in all leading countries. Many new questions are coming up for solution, and the further the subject is developed, the more problems which seem open to solution, are presenting themselves.

The subjects of breeding plants and animals and heredity in general are passing from the stage of indefinite knowledge to a status of organized science. There is being rapidly wrought out a body of knowledge which is interesting, highly instructive, and even inspirational. This knowledge is of such a character that once it is presented in pedagogical form it will be very useful as a means of mental development. A comprehension of the laws of heredity and breeding and an intimate knowledge of many of the natural and artificial forms in which heredity manifests itself gives the mind scope to analyze facts of nature and economics. A knowledge of the philosophy, the processes, and the art of creative and practical breeding will ere long be regarded as a substantial part of culture in many college courses. But the large place which breeding will claim in schools will be in vocational courses. Men who are preparing to be technicians along plant and animal lines will demand graduate courses in natural and artificial evolution. Splendid collegiate courses in breeding will be developed for the student in agronomy, horticulture, forestry, and live-stock management. Studies on heredity in plants, animals, and men will be placed as culture studies in many general and technical courses, and especially in medical colleges.

The simple common-sense features will ere long be winnowed out of the chaff and straw. Separate text-books for secondary schools will deal with the more fundamental and practical laws and with the

**Breeding as a  
School Subject.**

methods of plant and animal introduction and creative breeding, the growing of pedigreed animals, seeds, and plants, and the dissemination of new and valuable varieties and breeds. The text-books for agricultural and other collegiate courses can be highly scientific and at the same time give comprehensive treatment to the methods of creative breeding, the production of pedigreed stock, and the principles of plant industry. Breeding is peculiarly a separate part of agronomy, horticulture, and live-stock management. That it relates most vitally to all three of these subjects gives it an unusual degree of importance, and the simpler elements may even find their way into the higher classes of the separate agricultural high school, or the high school classes of village and consolidated rural schools. This subject will continue to gain a more and more important place in such forms of college and department extension as correspondence courses, itinerant schools, farmers' institutes, and demonstration farming.

Our colleges of agriculture should begin to systematically build up divisions for instruction in breeding, that they may provide teachers of this subject for secondary schools. The first essential is to create a separate division, placing in it the best available man as leader and providing him with facilities and assistants as rapidly as he can use them to advantage. The colleges should also train men for the work of research and for creative breeding of plants and animals under public and private auspices. There is already starting a demand for men trained to be circuit superintendents in animal breeding, for men to guide associations for the cooperative ownership of males, cow testing associations, and other like institutions. Men are coming into demand to manage plant and animal breeding experiments and creative plant and animal breeding enterprises under national, State, cooperative, corporate, and private auspices. The demand for demonstrators, researchers, teachers, and practical breeders may come forward in this line of work as rapidly as classes of enterprises have demanded men in forestry during the last decade. Because this subject is larger, represents a several times larger interest, and involves a several times larger possible increase of income, it may afford employment to a larger number of technical men than even forestry does. Further, the work is even more technical and varied than forestry. The young men who are qualified by nature for this work and who will thoroughly equip themselves may hope for most enjoyable and profitable employment and may anticipate the satisfaction of having done a substantially large service.

A group of our strongest agricultural colleges, north and south, should push into the work of preparing men for the work of technical research in heredity and breeding. All States should begin to devise plans for the introduction of breeding as one of the required subjects in all secondary courses for farm youth. College extension departments should develop this subject so that it may be better presented through their various avenues for the giving of practical instruction to adult farmers.

Publishers have here a new field for profitable enterprise in getting out text-books suited to the various grades of schools. The field for the sale of manuals on breeding is also rapidly enlarging. Every five years the increase in knowledge along this line will warrant the issuance of new text-books and manuals to meet the needs of different grades of students and of the different classes of growers of plants and animals.

The experience of the officers of the American Breeders Association warrants the statement that recent developments in the science of heredity and breeding, and the developments in prospect in the near future, are revolutionizing the thought and methods in breeding throughout the world. The Mendelian study of heredity first aroused plant breeding from its position trailing far behind the work of animal improvement. And now the self-complacent animal breeders, having begun to realize that plant improvement has recently chased past them, are awakening from the sleep they entered upon soon after Charles Darwin had given them an awakening half a century ago. It was by chance that the present writer was for more than a decade practically the only American specialist who was working in both fields of animal and plant breeding. It has been an interesting experience to see plant breeding arouse itself from a position far in the rear, and push forward until it is now leading animal breeding into new scientific methods.

The bringing together in the American Breeders Association of the plant breeders and the animal breeders, as well as the scientists interested in heredity of the two organic kingdoms, was a result of the accident of the writer's dual interest, which led him to observe that, since the laws of heredity are mainly common to both kingdoms, each could assist the other. It is true that the earlier plant breeders have received the basic elements of their philosophy from the animal breeders. But it is also true that later the plant men are more than

paying the debt in the philosophies of the subject, and especially in working out many elements of practice.

Mendel, De Vries, Neilson, Burbank, Williams, Fairchild, Zavitz, and others have devised methods of experimentation, of creative breeding, and of introduction and distribution which are full of suggestions to those who improve our large farm animals, fowls, pet stock, and also the semi-domesticated and wild meat and fur animals and wild birds.

The science of heredity and the practice of creative breeding may be said to have a parallelism to the science and practice of aviation investigation. Langley bore somewhat the same relation to the new developments in the aeroplane that Mendel did to statistical records of heredity. De Vries would pronounce the achievements of both mutations. Count Zeppelin has isolated a pure race of dirigible balloons of prodigious size, evidently of a type designed for military purposes. Breeding has had no such literary character as Darius Green with his flying machine. Burbank and the Wright brothers are contemporaneous; McDougal with his saline solution evidently crossed the English Channel separating the inorganic from the organic impulses, and may have produced variations by environmental stimulus applied to the ovule at the moment of marrying the pollen grain.

While this seems a digression from the subject, the great mutating plants and animals must not be neglected in a statement concerning the development of education along the lines of breeding. Messenger, the father of the American driving horse; the original tree from which sprang the Wealthy apple; the potato seed from which came the Burbank potato; and other mutants, will stand along with the theoretic truth brought forward by De Vries. Vilmorin's monumental work with the sugar beet, in instituting centgener breeding, now spreading throughout plant and animal breeding all over the world, will long head a leading chapter in books on practical breeding.

The opportunities for brilliant achievements have not all been embraced. The cream of this subject has by no means been all skimmed off. Not only in research but in the pedagogics of the subject is there room for many brilliant careers. The science of heredity and breeding is so comprehensive, so complex and extensive that there is scope for the brightest minds. The economic goal is so large that society can well afford to devote to research and creative breeding the talents of large numbers of its brightest sons.—W. M. HAYS.

# NEWS AND NOTES

The Bureau of Statistics of the Department of Agriculture has recorded the average weight of wool fleeces each year since 1891 (except in 1892); within this period the average weight has increased from 4.9 pounds per fleece in 1891 to 6.8 pounds in 1909, an increase of 38.8 per cent. In 1910 the average weight is 6.7 pounds. The steadiness of the increase is shown in the following table of the weight per fleece in each year:

**Increasing Weight of Fleeces.**

Year.	Pounds.	Year.	Pounds.	Year.	Pounds.	Year.	Pounds.
1891	4.9	1897	5.8	1902	6.3	1907	6.7
1893	5.3	1898	5.8	1903	6.1	1908	6.6
1894	5.4	1899	5.9	1904	6.4	1909	6.8
1895	5.6	1900	6.2	1905	6.6	1910	6.7
1896	5.7	1901	6.2	1906	6.7		

The production of wool per sheep as recorded in the last decennial census was 6.7 pounds in 1900 (the average of the fleeces, exclusive of those obtained in the fall shearing of 1899), 5.6 pounds in 1890, and 4.8 pounds in 1880. The census returns for 1850 and 1860 were defective, but indicate approximate yields of 2.75 pounds in 1850 and 2.96 pounds in 1860. From these data it appears that the production of wool per sheep has increased about 150 per cent from 1850 to 1910.

It is interesting to observe that a similar improvement in the breed of sheep for wool has taken place in Australia. The official Yearbook of New South Wales for 1907-8 states: "Of late years considerable attention has been given to the question of breeding, and the result is seen in the great improvement in the weight of fleeces." The average weight of wool per fleece in New South Wales (which contains more than half of the sheep of Australia) in 1881-1885 was 5.24 pounds; in 1886-1890, 5.42 pounds; 1891-1895, 6.44 pounds; 1896-1900, 6.71 pounds; 1901-1905, 7.61 pounds; 1906-1907, 7.82 pounds.



It appears from the figures above that in these two great sheep-growing countries improvement in breed and in the care of flocks has within the last twenty years increased the average weight per fleece more than 35 per cent.—NAT. C. MURRAY.



The world continues to erect piles of enduring stone to immortalize the military hero and the statesman. The "man on horseback" has at all times, and in all countries, occupied a prominent place as decoration in parks and squares. On the other hand, a feeling is more recently arising that the real builders of our civilization have received comparatively little attention. The men who broke the prairies, cleared the forests, built up the world's commerce; who contributed to culture, education and art; who gave us books, labor-saving machinery and all the conveniences and luxuries of modern buildings, have all received too little credit. And especially has the race neglected its mothers, great and small, who have nursed into being the agencies and the builders that have made our civilization possible.

It is worth while to raise the question as to whether we have shown due appreciation to those who have domesticated plants and animals and to those who have created new forms of life useful to man. One may truly be pardoned for the rashness of proposing a monument to the creature, troglodyte or human, who for the first time rubbed out the scanty diococcum heads, placed the grains in a skin or bag and stowed it away in cave or hut, guarding it against rodents or thieves and carrying it over to the next seeding season to grow another crop. This masterful interference with nature by a dawning intelligence may have occurred before the discovery of the use of fire and even of articulate speech. However this may have been, that genius was the first farmer in history and also the first plant breeder. And, by the way, there is excellent reason for the belief that that first farmer was a woman. But passing that and approaching more recent times, one might speak of those enthusiasts, each in his day, who labored, hoped and probably starved to realize the desire that burned within his soul to give the world a fruit, a cereal, or a flower better adapted, suited to more uses, and more profitable than any that preceded it.

Take, for instance, Ephraim Bull, who gave to the world the Concord grape, now a standard variety, cultivated in thousands of vineyards, found in nearly every section where grapes will grow. He created wealth, luxury, refreshment, and food for millions. His work is today precisely as valuable as it was on the day he first gave it to the world. That first mother-vine which thrives to this day at Concord, Mass., has multiplied its potency into the tens of millions of vines, unchanged, not losing one iota from any one of the many qualities which gave it its peculiar value. Ephraim Bull died in poverty. Late in life, just before the end, kind neighbors befriended him, but their assistance came too late. Bull not only deserved a pension while he lived but a monument after his death—he never received either.

The story of how Peter Gideon, the originator of the Wealthy apple, spent his last few dollars—against the advice and will of his wife at that—for a quantity of apple seed is widely known. One of these thousands of seedlings which grew from those seeds was the mutation he had sought and hoped for. Just one. But that one was worth all the privation and waiting and patience. Its "blood" has multiplied thousand upon thousand fold, still unchanged, still the same heredity. In the course of the years it has earned millions of dollars for the farmers of the Northwest. It is now fast becoming a prominent apple in all cold countries. Peter Gideon deserves a monument. These are only two instances among many.

We have strayed far in our argument, but it was necessary to lead up to the conclusion. It is the purpose of the American Breeders Association to make a permanent collection of portraits, with short biographical sketches, of all persons who have done either creative work in the art of breeding, or notable work in the science of breeding and heredity. These portraits of breeders and scientists, both living and dead, will be continued as a permanent feature of the *Magazine*. With the help of the membership, which is fairly cosmopolitan, the editors should be enabled to build up a most interesting iconography of breeders the world over.

There are workers in all countries who have plodded and many perhaps without reward. Let us learn their names, what they have done, and if possible how they have done their work. For example, members in Japan, the country where plant breeders and gardeners have wedded nature and art with rare skill, many have knowledge of some of the geniuses who have originated some of the plant creations peculiar to that country.

Let us if possible find the men, and record their work, who were early identified with the breeding of the Percheron horse in France and the Clydesdale and the Shire horse in England; also the breeders of Rambouillets in France and Spain and of the wonderful array of excellent breeds of sheep in England; the meritorious breeders of all breeds of cattle wherever found; also breeders of flowers and vegetables and horticultural crops. The world may not, for a long time to come, accord these patient, unselfish workers the credit that is due them. But an association composed of men and women who understand, who deal with and who know the economic and commercial side of heredity values, can very appropriately make its publications the archives for the preservation of records relating to men of note in the field of breeding, and honor them by giving recognition to their work and thus reward them even if only in a small degree for their services to humanity. And the lives of men now living, especially the older, will also serve as themes for doing justice to useful service. It is most pleasant to tell a man while yet living of the good he has done, and often a man's own neighbors need to see the work of their fellow citizen from the viewpoint of the State or Nation. Few who have really performed services as creative breeders have been overestimated. Many, like Mendel, have been sadly forgotten.



An article concerning private game preserves, by the Hon. J. T. Holland, Game Commissioner of Colorado, in the *Amateur Sportsman*, New York, July, 1910, is of interest for the reason that Mr. Holland believes that the office of State game warden should be removed from politics. He asserts that "our game is fast disappearing and chiefly because, no one having an interest in the game belonging to the public exclusively, there is a tendency for every one to get all he can while it lasts."

The Colorado system of licensed game preserves and licensed lakes is warmly advocated, because "experience has shown that it is far better to attempt any legitimate traffic in game than to attempt to license all sale and traffic and thus compel persons who are not in

position to take their game but insist upon having it, to assist the game hunter in his unlawful depredations upon all varieties of game animals."

It is stated that "a single preserve alone will recommend a very great many sportsmen to our State, who, were it not for the game preserves, would necessarily go out on the range and take their share of the game belonging to the public at large. Probably the greatest advantage of the system of game and fish preserves is that this system more perhaps than anything else has tended to wipe out the market hunter of Colorado; another advantage is the taking of game in preserves by owners thereof results in leaving very much of the game on the public range for others and the regulation of the selling and shipping of game which is permitted under the laws of our State permits the people to have this desirable food," and it is Mr. Holland's opinion that "the more and the larger the game preserves, the better. A national law is advocated, as such is essential in order to do justice to each of the States, as it cannot be expected that one State will pass laws prohibiting the killing of (certain) birds within its borders while persons in adjoining States can kill them; consequently in order to be fair to all concerned a national law should be passed fixing the open seasons so that the States would all be on the same basis and each would have an equal show at the game."

The paper concludes with the statement that "fish raising and selling in Colorado has come to be a much larger industry than game raising and selling. We have in the State dozens and dozens of what are known as licensed lakes, which are conducted along the same lines as game preserves and when properly conducted are very profitable to the owners. Many of the owners of these lakes are shipping fish constantly to the markets of our State and of other States, and still through the high degree of perfection which has been attained in fish culture the sum total of our fish in Colorado to-day in all probability is far greater than it was ten years ago."

Whatever objection may be uttered against the private game preserves, there is this in their favor, that they are more likely to encourage scientific and systematic breeding of game animals than public preserves.

In a recent letter to the Secretary of the Association, Dr. Charles E. Woodruff, lieutenant-colonel in the Medical Corps of the U. S. Army, Cebu, P. I., calls attention to the fact that the breeds of domestic animals which have been produced in tropical climates have heavy black pigment in the skin, whatever may be the color of their hair, while breeds produced in the cloudy, cooler regions of northeastern Europe often have light-colored skins. He also calls attention to the fact that some of these light-skinned breeds do not do well when taken into warm sunshiny countries. He says, "The lethal effect of excessive amounts of light is harmful to all kinds of protoplasm, whether it is in a bacterium or in a hog." He quotes Prof. Robert Wallace of Edinburgh University as stating that all domestic mammals originating in the tropics have black skins.

Doctor Woodruff says, "I find that every native horse here has a black skin, no matter what its hair color—there being few albinos." These horses are of Chinese stock, and other stock does not do well there. Doctor Woodruff has long been contending that one reason why people with light complexion do not do well in warmer climates is that the sun's rays too readily penetrate through the light-colored skin. He has long argued also that tuberculosis patients accustomed to northern cloudy and cool climatic conditions are not benefited by removal to hot climates where there is much sunshine. He now suggests that this may also be true in case of cattle and that many northern cattle will not be able well to resist tuberculosis in many of the tropical and subtropical regions because of the additional amount of sunlight.

The problem of introducing domestic animals from one climate to a radically different climate is most important. Colonel Woodruff has demonstrated that this subject of light-complexioned races of men and of animals should be studied extensively. There can be no question of the wisdom of studying the problems connected with introducing breeds of animals which by centuries of natural breeding have become resistant to a disease into regions to which that disease has recently migrated, as in case of the Indian cattle in our Southern States. And the making of hybrid breeds which retain the excellence of two or more constituent breeds may prove worthy not only of thorough research but of much experimental demonstration.

**Dark-Skinned  
Animals in  
the Tropics.**

Until quite recently, wheat has been classed among those plants whose genealogy has been lost in the long space of time during which it has been cultivated by man; and this belief was quite generally accepted even among scientists. The report of A. Aaronsohn, director of the Jewish Experiment Station of Haifa, Palestine, that he had discovered the wild progenitor of wheat is therefore of decided historical interest. (Bulletin 180, Bureau of Plant Industry, U. S. Department of Agriculture.)

The type which Doctor Aaronsohn regards as a wild form of wheat is the *Triticum dicoccum dicoccoides*—the wild emmer found in Palestine and Syria. On the occasion of a visit to the Jewish agricultural colony at Rosh Pinar this wild *Triticum* was discovered, resulting in the find of only one plant. A later visit to Mt. Hermon revealed large tracts of this wild *Triticum* at an altitude of more than 9,400 feet. Its most interesting feature is its extreme variability. The forms found were so numerous that no attempt at determination could be made.

The author rejects the idea that this *Triticum* had escaped from cultivation and gives as a reason the facts that it is not cultivated in Syria or Palestine at present and that it is found only upon slopes of the most arid and rocky hills and in places most exposed to the sun. Another significant observation is that a form of wild barley seemed to be habitually associated with this wild emmer. This explains the curious fact that in ancient literature, and even in excavations made in Egypt, seeds of these two plants are almost always found together. This would indicate that the cultivation of the two grains took place simultaneously and that neither of these grains was cultivated first. This wild emmer and barley growing so abundantly on large tracts would naturally attract the attention of nomadic or local tribes, and its domestication and cultivation was a natural consequence.

In Bulletin 279 from the Laboratory of Experimental Plant Breeding, Cornell University, Ithaca, N. Y. (48 pages), several interesting illustrations accompany the text. In this technical bulletin is worked out a statistical study of the variations and correlations of the principal characters of the timothy plant. The observations cover a population of 3,505 plants and extend over a period of three years.

**Wild Prototypes of  
Wheat and Other  
Cereals in Palestine.**

**Variation and  
Correlation in  
Timothy.**

# ASSOCIATION MATTERS

A circular letter has been sent out by the office of the Secretary making the appointments to the various committees and requesting the respective committee chairmen to communicate with the committee members as to the preparation of reports for the coming meeting in February. It is to be hoped that the committee members, practically all of whom continue from last year, will carry on their work along lines mapped out in previous years. Committee chairmen should, with the help of their committee members, block out new work for two or more years ahead, so that work which requires research, correspondence, or collection of statistics may be planned with definite ends in view. Committees on breeding gladioli, sweet peas, and dahlias are in process of organization, but are not sufficiently far along to allow announcement of full membership. It would be well to obtain from committee members, as well as from non-members, titles of papers or addresses to be presented at the meeting at Columbus or for the *Magazine*.

A small folder issued by the Eugenics Record Office, describes the work and organization of the Eugenics Section and is here quoted in part:

This comprises the interests of the Association that relate to human improvement by a better selection of marriage mates and the control of the reproduction of the defective classes.

**Eugenics Section:** Its officers are David Starr Jordan, chairman, and C. B. Davenport, Cold Spring Harbor, Long Island, N. Y., secretary. With them have been associated well-known students of heredity and humanists, among others Alexander Graham Bell, Washington, D. C.; Luther Burbank, Santa Rosa, Cal.; W. E. Castle, Harvard University; C. R. Henderson, University of Chicago; Adolf Meyer, Johns Hopkins University; J. Arthur Thomson, University of Aberdeen; H. J. Webber, Cornell University; Frederick A. Woods, Harvard Medical School.

The work of the section is two-fold, that of the Eugenics Record Office and that of the committees.

The Eugenics Record Office, located at Cold Spring Harbor, Long Island, N. Y., is under the general direction of the secretary of the section and has as its superintendent Prof. H. H. Laughlin. The record office seeks to accumulate and study the records of physical and mental characteristics of human families and to educate the public as to classes of fit and unfit marriages. Its work is done by means of (a) correspondence, (b) the acquisition of family records on special blanks, and (c) the inquiries of field workers investigating either in conjunction with institutions or independently.

The committees serve as centers for special inquiries or for education. They are of two sorts, (a) technical committees and (b) local committees. Technical committees are composed of professional men trained for special inquiries. They further investigations in their subjects and advise the record office. Their composition changes from time to time. Those already organized, with their present personnel, are as follows:

Committee on Heredity of the Feeble-Minded: A. C. Rogers, chairman; H. H. Goddard, Vineland, N. J., secretary; J. C. Carson, H. H. Donaldson, Walter E. Fernald, J. M. Murdock.

Committee on Heredity of Insanity: Adolf Meyer, chairman; E. E. Southard, Harvard Medical School, Boston, Mass., secretary; August Hoch, F. A. Woods.

Committee on Heredity of Epilepsy: W. N. Bullard, chairman; Everett Flood, Palmer, Mass., secretary; J. F. Munson, E. E. Southard.

Committee on Heredity of Criminality: C. R. Henderson, chairmen; M. G. Schlapp, Cornell Medical School, New York City, secretary; W. M. Carmalt, William Healy.

Committee on Heredity of Deafmutism: Alexander Graham Bell, chairman.

Other committees are being organized.

The local committees are to serve as local centers for collection and study of data and for education. It is contemplated that such committees will be formed in connection with various universities and at other intellectual centers.

The Eugenics Section seeks to cooperate with all existing agencies for the same work. It invites correspondence of persons interested in the subject of eugenics and willing to collaborate.



# *The American Breeders Magazine*

*Issued Quarterly for Practical and Scientific  
Breeders of Animals and Plants*

*Edited by Willet M. Hays, N. E. Hansen, and H. W. Mumford*

Because we have been born into their presence we accept the domesticated plants and animals as a matter of course. Because we see dwellings built, bridges thrown across rivers and chasms, airships invented, and flying machines and railroads constructed, we stop and marvel at mechanical progress.

To justly decide whether man has made most progress in the field of mechanical invention or in exploitation of the living things—the agricultural plants and animals—is really quite a difficulty. Nor are the latter the result of chance. On the contrary, they are the product of sustained, intelligent, selective effort on the part of the breeder and farmer.

The American Breeders Association proposes to organize the various forces which have accomplished all this. The Magazine is the instrument through which some phases of its work are published for popular reading. For the next number we have in view :

## **SINGLE CHARACTER vs. TOUT ENSEMBLE**

**BREEDING IN GRAPES** By **T. V. Munson**

## **BREEDING OF GRAIN SORGHUMS**

By **Carleton R. Ball**

## **TOBACCO BREEDING**

By **A. D. Shamel**

## **BREEDING FOR IMPROVEMENT OF PHYSICAL QUALITIES IN TIMBER** By **Geo. L. Clothier**

The author of the paper on grape breeding is so well known as a successful breeder of the grape in the United States that it is needless to say more than that the contribution is interesting and valuable.

In sections of country where the grain sorghums are especially adapted, they are of greater agricultural value than is commonly realized. The improvement of this plant by breeding presents a number of problems peculiarly its own, and they are interestingly discussed and certain improvements already accomplished are recounted in Mr. Ball's paper.

Few plants are so plastic in the hands of the breeder as the tobacco plant. The excellent paper by Mr. Shamel tells of some of the problems of breeding this open-pollination plant and of the values obtained by breeding.

Now that forest planting is receiving attention in this country, the careful selection of mother trees for the production of seed for seedlings becomes a matter of importance. The manner of this selection, by microscopic and physical tests of the quality, strength, durability, and grain of the timber of mother trees is submitted by Mr. Clothier in a paper which is replete with original thought. There are other papers, all up to the usual standard.

The best way to secure the Magazine is to become a member in the Association.

Dues \$2 a year. Single copies may be had at 35 cents.

*Address AMERICAN BREEDERS ASSOCIATION  
Washington, D. C.*

# The American Breeders Association

## OFFICERS

HON. JAMES WILSON, President

WM. GEORGE, Vice-President

W. M. HAYS, Secretary

N. H. GENTRY, Treasurer

---

**T**HE AMERICAN BREEDERS ASSOCIATION is a cooperative association designed especially to develop the science of breeding and heredity and to bring that scientific knowledge to students of heredity, to the practical breeders of pedigreed animals and plants and to others interested in these subjects. It affords a means for conference among the members of the Association.

The membership is composed of progressive breeders, scientists, teachers, and others interested in all phases of heredity of plants, animals and men and the improvement of methods of breeding. The best investigators in the science of heredity and breeding and the best practical breeders of pedigreed livestock and plants freely cooperate through the Association and donate the time required to make investigations, to prepare papers, to attend the annual meetings and to help build up the literature of the science and practice of breeding, thus to produce the largest results possible in the form of better animals and plants.

All persons interested in its work are cordially invited to become members of the American Breeders Association.

Membership entitles the holder to the American Breeders Magazine, to the annual report of the Proceedings of the Association, and to full participation in the activities of the Association.

**Membership : Annual, \$2.00 ; Life, \$20.00**

**No entrance fee**

**Address AMERICAN BREEDERS ASSOCIATION  
Washington, D. C.**

WASHINGTON, D. C.

1910

# AMERICAN BREEDERS MAGAZINE

Published by the American Breeders Association

*A Pheasant-Bantam Hybrid*

H. J. WHEELER

*Natural Crossing in Cotton*

H. A. ALLARD

*Observations on Breeding Grapes*

T. V. MUNSON

*Improvement of Sugar Cane*

HAMILTON P. AGEE

*Breeding for Timber Improvement*

GEORGE L. CLOTHIER

*Field Workers' Meeting, Eugenics Section*

Fourth Quarter

Oct., Nov., Dec.

Vol. I

No. 4

# *The American Breeders Association*



## *OFFICERS OF THE ASSOCIATION*

### *President*

HON. JAMES WILSON, Washington, D. C.

### *Vice-President*

HON. WILLIAM GEORGE, Aurora, Ill.

### *Secretary*

HON. WILLET M. HAYS, Washington, D. C.

### *Treasurer*

HON. N. H. GENTRY, Sedalia, Mo.

### *Chairman Plant Section*

DR. H. J. WEBBER, Ithaca, N. Y.

### *Secretary Plant Section*

PROF. N. E. HANSEN, Brookings, S. Dak.

### *Chairman Animal Section*

DEAN C. F. CURTISS, Ames, Iowa.

### *Secretary Animal Section*

PROF. H. W. MUMFORD, Urbana, Ill.

### *Chairman Eugenics Section*

DAVID STARR JORDAN, Stanford University, Calif.

### *Secretary Eugenics Section*

C. B. DAVENPORT, Cold Spring Harbor, N. Y.



## *EDITORS*

WILLET M. HAYS, Secretary of the Association

N. E. HANSEN, Secretary of the Plant Section

H. W. MUMFORD, Secretary of the Animal Section

C. B. DAVENPORT, Secretary of the Eugenics Section

*Address Communications to American Breeders  
Association, Washington, D. C.*

*Membership: Annual, \$2.00; Life, \$20.00;  
Patrons, \$1,000.*

# The American Breeders Magazine

Published Quarterly by the American Breeders Association

FOR THE USE OF ITS MEMBERS

PRICE OF SINGLE COPIES, 35 CENTS

Address communications to American Breeders Association, Washington, D. C.

Vol. I.

Fourth Quarter, 1910.

No. 4.

## CONTENTS.

	PAGE
Ephraim Wales Bull (portrait).....	238
Bull, Gideon, and Budd (biographical sketches).....	239
Peter M. Gideon (portrait).....	241
Joseph Lancaster Budd (portrait).....	244
Preliminary Observations Concerning Natural Crossing in Cotton. H. A. ALLARD.....	247
Breeding to Improve Physical Qualities of Timber. GEORGE L. CLOTHIER..	261
Report of Committee on Breeding Fish. JOHN W. TITCOMB.....	263
A Pheasant-Bantam Hybrid. H. J. WHEELER.....	266
Propagation of Seedlings of Sugar Cane in Louisiana. HAMILTON P. AGEE..	269
Single Character vs. Tout Ensemble Breeding in Grapes. T. V. MUNSON...	274
Details for a Game Breeders' Law. DWIGHT W. HUNTINGTON.....	280
The Breeding of Grain Sorghums. CARLETON R. BALL.....	283
Report of Committee on Breeding Cotton.....	293
EDITORIALS:	
Breeding, Research, and Education.....	296
Creation of Varieties and Breeds.....	298
Procedure with Self and Open-Pollinated Varieties.....	300
Creating and Improving Breeds of Animals.....	302
Mutation Theory Most Valuable in Breeding.....	303
NEWS AND NOTES:	
Eugenics Section.....	304
Meeting of the Eugenics Section.....	304
The Fourth International Genetic Conference.....	307
Recent Publications and Articles.....	309
ASSOCIATION MATTERS:	
The Seventh Annual Meeting at Columbus, Ohio.....	310
Program Seventh Annual Meeting.....	311
A. B. A. Membership an Acceptable Gift.....	315
What Others Say.....	315

[Copyright, 1910, by the American Breeders Association.]



EPHRAIM WALES BULL.

# THE AMERICAN BREEDERS MAGAZINE

"Our oldest cultivated plants, such as wheat, still yield new varieties; our oldest domesticated animals are still capable of rapid improvement or modification."

—CHARLES ROBERT DARWIN.

Vol. I.

Fourth Quarter, 1910.

No. 4.

## BULL, GIDEON, AND BUDD.

Ephraim Bull gained a place of honor among those successful pioneers who achieved large things before the days when breeding was taught in the schools. He originated the Concord grape, thus making possible the growing of hardy grapes of high quality at low cost in the Northern States and in the colder temperate regions of the earth. He also wrought out much of the science and practice of breeding grapes and other plants which are multiplied clonally, by cuttings or buds.

Peter Gideon stands first among the pioneers in the work of extending hardy tree fruits beyond the former northern limits of the fruit zone. This rugged mind in creating the Wealthy apple and other hardy fruits inspired the people with faith that they can surround their homes with fruit trees, and thereby placed all cold countries under obligations to him.

Professor J. L. Budd was first among the pioneer teachers of plant breeding in our State colleges of agriculture. Twenty-five years ago, when the botanists of the United States Department of Agriculture were debating the propriety of using the term "plant breeding" in their publications, Professor Budd was training and inspiring the first group of college-made plant-breeding experts. He also performed great service as the first of American agricultural explorers to bring new plants from foreign lands, and as one of the pioneers in American horticulture and forestry.

These men believed that to obtain new varieties of fruit or trees peculiarly suited to the needs of the climatic and cultural conditions of their respective sections of country new forms could be called into existence through breeding. Thus they effected recombinations of unit characters in countless thousands of individuals, until one

containing the desired qualities and characteristics was evoked out of the number of infinite possibilities. The century now before us is witnessing a more scientific approach to breeding operations in the creation of new fruits, trees, and flowers, and no doubt other men of genius will earn fame for themselves, but the permanent benefits to horticulture wrought in the past century by these three strong characters will endure as a monument to their memories.

#### EPHRAIM WALES BULL.

1806-1895.

Ephraim Bull, in breeding new varieties of grapes, created the Concord. It was not a foundling or chance seedling, but the result of very patient work and waiting, not taking into account the many preceding years spent in experimentation and futile trial. Hundreds of failures in grape growing finally led him to recognize that only in a native grape could be found the mother of the hardy American grape which he desired to produce. Such mother was a *Vitis labrusca* plant on his farm, and from the seeds of this plant sprang the Concord. Eleven years were spent in growing and perfecting seedlings and in testing the selection. In 1853 the Concord was for the first time placed upon exhibition and the stock placed upon the market. Although the first vines were sold at a good price, the control of the stock quickly passed out of Mr. Bull's hands and he reaped very little benefit from it. Ten years later the Concord grape was spread over the entire northern part of the United States and is now widely used in temperate regions of most parts of the earth.

He originated other varieties of grapes, such as the Cottage, Esther, Rockwood, Iona, August Rose, and also many other but unnamed sorts. That there were no really hardy American varieties in existence and that horticulturists were experimenting with European varieties all the more emphasizes the genius of Mr. Bull in originating the Concord after many years of patient work. The Catawba and Isabella, two southern varieties, were among the improved American varieties then in existence. From Mr. Bull's statement that: "From over twenty-two thousand seedlings, there are twenty-one which I consider valuable," one may gain an idea of the numbers handled by him.





*Peter McGivern.*

Born in 1806, Mr. Bull's vocation was that of a gold beater, which he followed in Boston. A small garden afforded him the opportunity to carry on his plant-breeding operations in spare moments. Failing health in 1836 having forced him to give up his business, he moved to Concord, Mass., where he purchased a farm of 17 acres not far from the site of the historic bridge. Here he began his earnest search for the mutant grape which was to be a valuable and permanent addition to American horticulture.

Ephraim Bull counted many of the brightest minds of his day among his friends. He cultivated an intimate friendship with Hawthorne, who was his neighbor; also with Agassiz, who induced him to lecture on the grape at Harvard University. He was an indomitable worker, a close observer, a clear thinker, and a philosopher. He was a useful citizen in his community, having served it as selectman, legislator, member of the school committee, and member of the State Board of Agriculture. As a lover of outdoors, he took much delight in planting trees. He greatly adorned his home place, the beauty of which has remained undisturbed to this day.

Mr. Bull died at the age of 89 and the passers-by are informed by the epitaph on the plain slab marking Ephraim Bull's grave that "He sowed, others reaped." Whether the idea which dominated him absorbed him to the degree of neglecting all else, or whether he simply lacked the cunning requisite to accumulate property is a question which here may well be left undecided. He died neglected, in poverty, broken in spirit, all but forgotten. He left the world a fruit which has contributed to the wealth and welfare of entire States, and the aggregate, if computable, would be a sum numbering many millions, but even more valuable than this, he gave inspiration which has helped to make plant breeding one of the great forces in cheaply feeding the world.

#### **PETER M. GIDEON.**

1818-1899.

Peter M. Gideon, in his work in the third quarter of the nineteenth century, had little else to guide him than his breeder's instinct.

Intuition told him that a mingling of the blood of such fruits as the crab-apple with that of the common apple or *Pyrus malus* type might lead to the production of a very hardy apple useful in the far north. He did not relax his efforts until he had produced the Wealthy

apple, which he named for his wife, whose maiden name was Wealthy Hall. The Wealthy was Gideon's masterpiece. It earned for him a national reputation and the name Wealthy is to be found in catalogues of many foreign lands, and that name will go down to posterity with the name of Peter Gideon.

While the Wealthy apple is adding many millions to the wealth of this and other nations, Gideon's larger work lies in the fact that he gave inspiration to many breeders of plants. He demonstrated that through persistent effort we can so improve many of our varieties of fruits in hardiness that they may be grown farther north. This inspiration is beginning to make possible the family orchard and family fruit gardens farther north along the coldest zones of agricultural production and farm homes. Mr. Gideon also added something to the science of plant breeding.

Peter M. Gideon was born in Champaign County, Ohio. From his earliest boyhood his interest was in horticulture. In 1841 he moved to Illinois and in 1853 to Minnesota. He settled on a partially wooded farm protected by the arms of beautiful Lake Minnetonka. In these very earliest days of Minnesota he began to plant trees and to grow trees from seeds. After ten years of labor, expense, and waiting a cruel Minnesota winter destroyed every one of his trees. Undismayed and indefatigable, he began again, and this time succeeded. There is rugged pathos in the story of his early struggles and in the privation of his family. The story is authenticated that he borrowed money with which to send to Maine to buy apple seeds when he was in dire need for a coat to wear so that he could go out and chop wood to exchange for groceries. The Wealthy apple came from one of the many seeds thus secured. Other varieties of great merit which he produced are Gideon, Martha, Peter, September, and October.

For a time the State of Minnesota employed him on his experiment farm that he might continue his work of originating hardy fruits. During his declining years the State Horticultural Society honored Mr. Gideon by making him its special experimenter under a small annual salary, and upon his death it provided a monument to his memory.

Peter Gideon was a man of peculiar beliefs; somewhat uncompromising in his opinions, but a natural lover of trees and flowers and of a very kindly disposition toward man. Although he exhibited



JOSEPH LANCASTER BUDD.

fruit from his orchards at fairs and expositions and always had collections of surpassing value, quality, and interest, he held too high a conception of the dignity of his creative work to compete for and accept money premiums. His gardens were always at the disposal of his neighbors and he would put himself to much trouble to get flowers for his children friends, and while securing immense wealth for others he was successful in accumulating only a modest wealth for himself.

**JOSEPH LANCASTER BUDD.**

1825-1902.

Professor J. L. Budd was a commanding figure in horticultural work during the first third of a century of the existence of the American land grant colleges. He organized the horticultural department of Iowa State College and was the first professor of forestry in any American agricultural college. He was successful as a teacher and possessed remarkable initiative as an experimenter. His explorations in the early eighties in Russia and other foreign countries marked the beginning of the systematic introduction of plants into this country under public auspices. He thus introduced in the northwest part of Iowa many new fruits, forest trees and ornamental plants. Some of these have proven directly of much value and others are valuable as sources of hardy blood to serve in making hybrids from which valuable hardy varieties may be chosen for the colder regions of this country.

So far as the writer knows, Professor Budd was the first American teacher to give instruction in plant breeding as a science and as a technical college subject. Under his inspiration were trained the first group of college men who took up the subject of organizing American plant breeding and of creating new varieties by scientific methods. A number of these men have met with large success and have in turn educated large numbers of plant breeders.

During the summer of 1882 Professor Budd, accompanied by Thero Gibbs, of Canada, went to Europe and Asiatic Russia for the purpose of studying horticultural problems. Their expense was paid by the Iowa State Legislature and the Canadian Government. This exploration resulted in the introduction of many hardy varieties of fruit trees, shrubs, and forest trees. His work with the introduction of Russian cherries was especially important and resulted in many

valuable varieties. He carried on numerous experiments with apples and with roses.

Professor Budd was born at Peekskill, Westchester County, New York. When a young man of twenty he moved to Illinois and later purchased a farm in Benton County, Iowa, where he established a commercial nursery. He took a very active interest in the horticultural affairs of the State and was secretary of the Iowa State Horticultural Society from 1870 to 1902. Besides his work for the Horticultural Society, he contributed largely on horticultural subjects to the agricultural papers of his State.

His status as a horticulturist was peculiarly recognized by Charles Downing, who willed to Professor Budd his large library and notes. In 1902 Professor Budd published, with his former pupil, Professor N. E. Hansen, two volumes of the "American Horticultural Manual."

Contemporaneous with Roberts of Cornell, Stockbridge of Massachusetts, Newman of South Carolina, Knapp of Iowa, Sanborn of Missouri, and other practical pioneers without technical collegiate training in agriculture, Professor Budd did his part in giving scientific direction and inspiration to the first crop of trained agricultural technicians turned out by our State colleges.

Professor Budd's business experience was very satisfactory. He accumulated a small fortune in his early manhood as a commercial nurseryman. This enabled him during more than a quarter of a century to devote his undivided energies to his teaching and experimenting. He loved flowers and trees, and originated by cross-breeding a number of varieties of roses.

## PRELIMINARY OBSERVATIONS CONCERNING NATURAL CROSSING IN COTTON.

H. A. ALLARD, *U. S. Department of Agriculture.*

### INTRODUCTION.

Where it is intended to secure pure seed of any crop by careful methods of breeding and selection, one of the most essential considerations is first to determine to what extent the blossoms are self-fertilized or cross-fertilized. Corn is naturally adapted to extensive wind pollination, and most corn breeders, after careful investigation, concede that persistent inbreeding results in deterioration. Other crops, such as wheat, oats, and many legumes, have quite fixed the habit of self-fertilization.

In breeding crop plants, the usual method consists in making centgener comparisons by the isolation of the progeny of promising individuals. It is at once evident that the degree of isolation of these progeny rows must depend essentially upon the readiness with which they may be cross-pollinated by the agency of wind, birds, or insects. Corn is so readily intercrossed by means of air currents that a progeny can be kept pure only by wide isolation. On the other hand, close-fertilized plants like wheat, oats, or soy beans may be planted within very narrow limits without serious chances of crossing.

### NATURAL CROSSING, AN OVERLOOKED FACTOR IN COTTON.

Within recent years many skilled plant breeders throughout the world have turned their attention to the improvement of the cotton plant. At the very outset it appears that no serious attempt has been made to determine to just what extent cotton blossoms may be cross-pollinated by natural agencies under field conditions. While it is generally understood that all American cottons may readily be intercrossed by artificial methods, as in the hand-pollination to produce hybrids, it is not so generally believed that extensive natural crossing may take place. In fact, most cotton breeders and growers have surmised that that the factor of crossing must be very small, not affecting more than 5 to 10 per cent of the seeds. This view has been so generally accepted that natural crossing in cotton has been ignored as too small a matter for consideration. Cook,<sup>a</sup> however, in reporting on his work in Arizona, has contended that natural crossing in cotton is very

<sup>a</sup> Cook, O. F., "A Study of Diversity in Egyptian Cotton," Bulletin 156, Bureau of Plant Industry, U. S. Dept. of Agriculture, pp. 34-35.

frequent. Balls,<sup>b</sup> also working in Egypt, concludes from his later work that the amount of natural crossing there amounts to from 5 to 25 per cent by actual proof. From preliminary evidence now at hand, the writer is also convinced that natural crossing must be considered a most important factor, not only in all technical cotton-breeding problems, but also in the extensive field operations of the practical grower who wishes to secure increased yields and higher quality. In

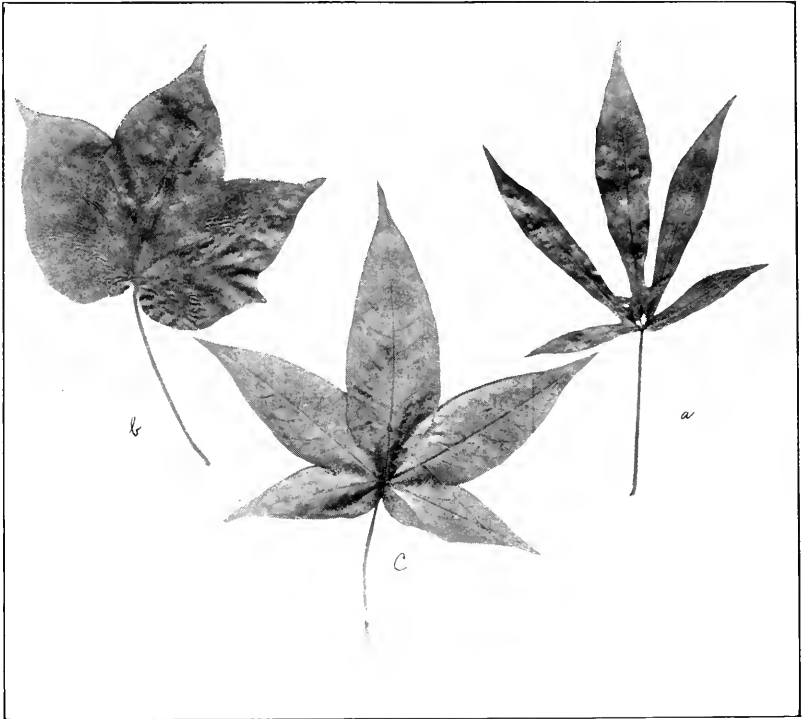

LEAVES OF COTTON PLANTS.

*a*, Okra; *b*, Keenan; *c*, first generation hybrid between *a* and *b*.

connection with a new line of plant nutrition investigations, efforts were recently begun in South Carolina and Georgia to determine the specific effects of climatic, soil, and fertilizer factors upon the oil and nitrogen content of cotton seed. It was realized at the very start that more definite evidence must be secured as to changes arising from

<sup>b</sup> Balls, W. L., "Some Cytological Aspects of Cotton Breeding," Proceedings of American Breeders Association, Vol. V, page 27.



intercrossing. The problem resolves itself into two phases: (1) To determine the number of blossoms crossed; (2) and, most important, to determine the actual number of crossed ovules. Owing to a serious interruption of the experiment in the spring, the writer could secure definite figures only for the number of bolls crossed.

In a test to determine the percentage of crossing in cotton, such varieties must be used as will readily show hybrid features in the first generation. In a cross of the pure cut-leaved Okra type of cotton or the pure Willet Red variety upon green-leaved upland cottons, the leaf characteristics of the hybrids make their identification unmistakably apparent. In those hybrids where the okra-leaved type is the male parent, the identification of the hybrid depends upon a modification in the shape of the leaf. If the red-leaved variety is crossed upon the green, the hybrid plant is readily identified by the red coloration which affects all its parts. The accompanying figure shows the Okra (*a*) and the Keenan (*b*) type of leaf, and the intermediate (*c*) leaf shape of the hybrid.

As the photograph clearly shows, the hybrid leaf is in shape as nearly intermediate between the two parents as a theoretical conception could have made it. A cross of the red-leaved variety on the green is even more apparent; but, because the differences are in color only, the contrast is not sufficiently shown in a photograph.

#### ARRANGEMENT OF PARENT TYPES TO DETERMINE NATURAL CROSSING.

In an arrangement of the parent types in the field, two methods may be followed. If the varieties are planted in alternate rows, hybrids can appear only where cross-pollination has taken place from row to row.

If the plants alternate in the rows, cross-pollination takes place not only from row to row, but among the unlike plants within each row. In either case, theoretically, the number of plants of each variety remains the same. It is probable, however, that intercrossing between the two varieties is more readily facilitated when plants are arranged alternately in the rows.

In the actual practice of cotton breeding, where the usual method has been to plant the progenies side by side, it is perhaps more important to guard against free crossing among the progenies than among plants of the same progeny. Yet in the past the work of continued selection of the best plants within the progenies has been

based upon the belief that these plants must breed true to their type because of the assumed natural process of close-fertilization of the blossoms.

PLAN OF EXPERIMENT IN NORTHERN GEORGIA.

During the progress of cooperative breeding work begun in northern Georgia in 1908, the writer made plans to determine as accurately as possible the approximate amount of natural crossing occurring in the cotton fields of this region. Three varieties were used,—the narrow-leaved Okra type, the Willet Red, and a purebred strain of the Keenan variety. A plat of about half an acre was used, and the plants of each variety were arranged in the rows, thus: Red, Keenan, Okra, Keenan, Red, Keenan, Okra, Keenan, so that a Keenan plant always stood between an okra-leaved and a Willet Red plant. Only the narrowest-leaved plants of the Okra variety and the darkest red-purple plants of the Willet Red variety were used.

In the fall 1,290 bolls of the Keenan plants were separately picked and ginned. During the spring of 1909 the seed of each boll was planted in a hill by itself. As soon as the young plant had appeared above the ground, most hybrids of the Keenan  $\times$  Red were at once apparent in the markedly red color of the stems together with the darker cotyledons of the young plants.<sup>c</sup> However, in the case of Keenan  $\times$  Okra, it was learned that these plants could not be identified until they had grown large enough to show several leaves. It will be seen later that this fact somewhat interfered with determining the actual number of crossed bolls, since in many cases the crossed seedlings were destroyed by the chopping-out process before they had grown large enough to be identified. In case of the hills showing Keenan  $\times$  Red crosses, however, a red plant was always left in the final chopping-out process, in order to examine these more carefully later in the season. After the final germination of all the seeds in each hill, it was interesting to note the actual number of crossed plants in each cross-pollinated boll. These ranged anywhere from a single Keenan  $\times$  Red plant to every one from a boll producing 30 to 50

<sup>c</sup> Further observations have led the author to conclude that a red coloration in very young cotton seedlings does not always serve to distinguish at once the red-leaved variety or the Red-Green hybrids from the pure green-leaved varieties. In the red variety and its hybrids the intensity of the red coloration in the tiny seedlings shows considerable variation, and often times appears to develop as the plant increases in size and age. Even in the stems of very young seedlings of the green-leaved varieties a more or less distinct red color may become apparent, probably more noticeable when the planting season has been very cold and wet.

plants. In most instances, several Keenan ♀ × Red ♂ crosses were evident, but in a few cases every plant was red, showing that every ovule of these bolls had in some way been fertilized by pollen from Red plants.

## APPROXIMATE NUMBER OF CROSSED BOLLS OBTAINED.

A tabulation of the crossed bolls is given below:

*Results of an experiment to determine amount of natural crossing in a cotton field.*

Row.	Keenan ♀ × Red ♂ crosses.	Keenan ♀ × Okra ♂ crosses.	Total of crosses.	Total bolls per row.	Per cent of crosses.
	<i>Plants.</i>	<i>Plants.</i>	<i>Plants.</i>		
1	27	3	30	170	17.6
2	21	4	25	179	13.9
3	28	5	33	175	18.8
4	22	5	27	177	15.2
5	28	10	38	147	25.8
6	20	8	28	146	19.1
7	28	6	34	134	25.3
8	31	6	37	119	31.0
9	6	2	8	43	18.6
	211	49	260	1290	20. +

It is at once evident that 20 per cent of the total number of bolls planted have been more or less completely crossed by natural pollinating agencies. It is evident, further, that a considerable number of the Keenan ♀ × Okra ♂ crosses must have been removed in the chopping-out process, since the seedlings were indistinguishable from the other plants at that period. It is not improbable that approximately 40 per cent or more of bolls would have shown crosses had Red plants been substituted for the Okra plants at the beginning of the experiment.

## DIAGNOSTIC CHARACTERS OF THE HYBRIDS.

In connection with the experiment to determine the amount of natural crossing, it was thought advisable to obtain a number of artificial crosses of the Keenan ♀ × Red ♂ and Keenan ♀ × Okra ♂ to serve as checks in comparison with a study of the natural crosses. Of 95 plants from carefully hand-pollinated bolls of the Keenan ♀ × Red ♂ cross, every plant without exception showed the dominant red coloration of the Willet Red parent. From bolls of the Keenan ♀ ×

Okra ♂ cross, 84 plants were obtained, every one also showing the leaf-shape intermediate between the two parents. See the figure, page 248.

A careful study of the Keenan ♀ × Red ♂ hybrids revealed a number of diagnostic characters never found in the Keenan or any other pure strain of green-leaved upland variety. In the hybrids the general leaf coloration is several shades darker than the green-leaved Keenan—about intermediate between the two parents. Should this red coloration not be sufficiently marked, as may be the case in some instances, several other diagnostic characters serve to leave no doubt as to hybrid parentage. One of these is the nectary on the midrib of the under side of the leaves. This is always red, usually a deep red, as in the Willet Red parent. An examination of thousands of these nectaries of all green-leaved varieties has failed to reveal a single instance of this red color. Again, in the Red parent, and without exception in the hybrids, the deep red-purple color of the upper surfaces of the petioles, branches, etc., extends as a distinct collar or ring about one-half to three-quarters of an inch wide completely encircling the petiole at the juncture with the base of the lamina. In none of the green varieties has the writer been able to find this band of color completely encircling the leaf stem beneath.

The involucre in the Red plants and the Keenan ♀ × Red ♂ hybrids is always red, but much darker in the parent. In the green varieties the involucre is green, or only faintly tinged with red, rarely any noticeable coloration. The main stems, petioles, peduncles, and lateral branches are dark purple-red, almost black in the pure Willet Red plants, except the brighter under portions of the petioles and branches. In the hybrids the main stem and the upper surface of the branches and petioles are nearly if not quite as dark as in the parent Red. The under sides of the branches and petioles of the hybrids, however, almost entirely lack any red coloration, with the exception of the encircling red collar at the point of the union of the leaf with the petiole. This is about as dark as in the Willet Red parent.

In several respects the Keenan ♀ × Red ♂ hybrids are almost intermediate between the red and green parents, as in the general coloration of the leaf and involucre.

The nectaries of the midrib on the underside of the leaves and the red petiole collar are quite as dark red in the hybrids as in the Red parent.

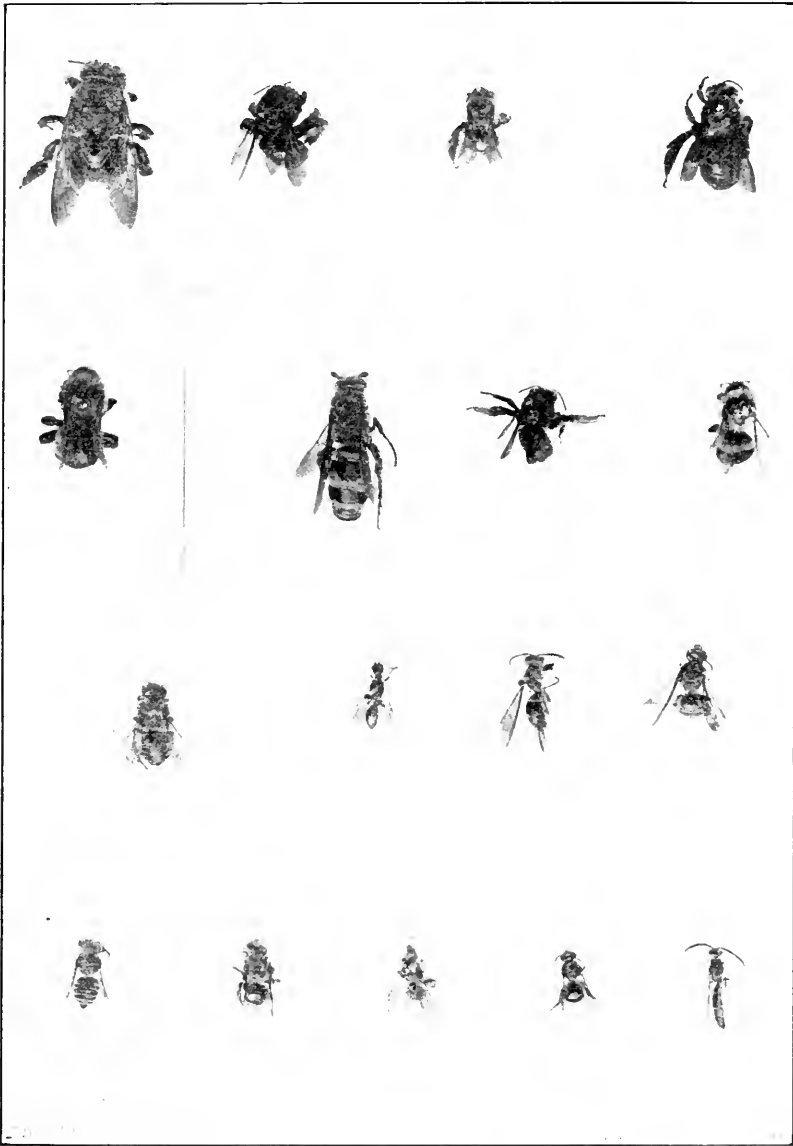

SOME BEE VISITORS OF COTTON BLOSSOMS.

- Top row, from left to right: *Ellis plumipes*, Drury; *Melissodes bimaculata*, Le P.; *Bombus impatiens*, Harris; *Apis mellifica*, L.
- 2nd row, from left to right: *Xylocopa virginica*, Drury; *Melissodes caliginosus*, Cress; *Melissodes perplexa*, Cress; *Melissodes atripes*, Cress.
- 3rd row, from left to right: *Bombus scutellaris*, Drury; *Pristocera armifera*, Say; *Polistes americanus*, Fabr.; *Agapostemon splendens*, Le P.
- Bottom row, from left to right: *Megachile brevis*, Say; *Eutechnia taurea*, Say; *Agapostemon radiatus*, Say; *Augochlora pura*, Say; *Myzine hamata*, Say.

## AGENCIES NATURALLY CROSSING COTTON BLOSSOMS IN THE FIELD.

Insects are the important natural pollinators of cotton blossoms. Among these, bees and certain species of wasps accomplish most of the work. The largest of the Hymenoptera is a handsome species of wasp (*Elis plumipes* Drury), which appears in the cotton fields of northern Georgia about August 1. The numbers of this insect and the earliness of its appearance vary greatly in different seasons. During the season of 1908 this insect appeared several weeks earlier in the season, and in far greater numbers, than during the season of 1909. In fact, during the season of 1909 I had given up seeing it at all. This wasp always visits the floral nectary at the base of the petals, and, owing to its large size and vigorous movements, succeeds in covering itself with great quantities of pollen. When present it is undoubtedly the most active pollinator of cotton blossoms in the fields. A few of the most common members of the Hymenoptera regularly concerned with cross-pollination are *Melissodes bimaculata* Le P., *Apis mellifica* L., and *Bombus impatiens* Harris.

The bee *Melissodes bimaculata* and the honeybee are probably the most abundant and constant visitors of cotton, more especially the former. This bee is extremely common in northern Georgia every season and at all times. It is the earliest bee to squeeze into the opening but at break of day; and it probably visits every blossom in a cotton field at some time during the day. So far as the writer's observations go, this bee visits only the true floral nectaries, so that at all times it is a most efficient disseminator of extraneous pollen into other blossoms.

Other Hymenoptera may frequently be found visiting cotton blossoms, but, owing to their smaller size, rarity or irregular visits, these are not especially important as pollinators. However, every additional insect visitor of cotton blossoms increases the chances of more or less crossing. The following is a list of all the Hymenoptera<sup>4</sup> and beetles which have been taken by the writer in cotton blossoms during the last two years:

## HYMENOPTERA.

<i>Bombus scutellaris.</i> Drury.	<i>Agapostemon splendens.</i> Le P.
<i>Entechnia taurea.</i> Say.	<i>Agapostemon radiatus.</i> Say.
<i>Xylocopa virginica.</i> Drury.	<i>Dianthidium interruptum.</i> Say.
<i>Melissodes atripes.</i> Cress.	<i>Myzine hamata.</i> Say.

<sup>4</sup> The writer is indebted to Mr. H. L. Viereck, of the U. S. National Museum, for the identification of all the Hymenoptera listed in this paper.

## HYMENOPTERA—CONTINUED.

<i>Melissodes caliginosus</i> . Cress.	<i>Pristocera armifera</i> . Say.
<i>Melissodes perplexa</i> . Cress.	<i>Elis plumipes</i> . Drury.
<i>Melissodes bimaculata</i> . Le P.	<i>Bombus impatiens</i> . Harris
<i>Xenoglossa pruinosa</i> . Say.	<i>Bombus scutellaris</i> . Drury.
<i>Polistes americanus</i> . Fabr.	<i>Apis mellifica</i> . L.
<i>Anopolis subviolaccus</i> . Cress.	<i>Ceratina dupla</i> . Say.
<i>Megachile brevis</i> . Say.	<i>Sceliphron cementarius</i> . Drury.
<i>Augochlora pura</i> . Say.	<i>Halictus (chloralictus) pilosus</i> . Smith.
<i>Halictus ligatus</i> . Say.	<i>Halictus (augochlora) similis</i> . Rob.

## BEETLES.

<i>Hippodamia convergens</i> . Guer.	<i>Diabrotica vittata</i> . Fab.
<i>Tetraonyx quadri-maculata</i> . Fab.	<i>Systema taeniata</i> . Say.
<i>Epicauta trichrus</i> . Pall.	<i>Phalacrus simplex</i> . Le C.
<i>Megilla maculata</i> . DeG.	

In northern Georgia region cotton blossoms are rarely visited by any of the Lepidoptera. The writer has observed but one individual butterfly (*Basilarchia astyanax* F.) visiting them. So far as cross-pollination is concerned, these need almost no consideration.

Balls,\* in Egypt, states that "the extra involucre glands are visited by Lepidoptera." These visitors, however, could in no way effect cross-pollination. A number of other insects may be found casually visiting cotton blossoms, namely, some of the bugs, a number of tiny flies, leaf hoppers, beetles, and ants. In Egypt Balls finds that ants are the chief visitors of the true floral nectaries. Although any of these insects may occasionally transfer some pollen from one blossom to another, since pollen grains can be detected on their bodies, yet, except where it is desirable to exclude every chance of crossing, these smaller insects may be neglected.

Humming birds are regular and persistent visitors of cotton blossoms. The writer has frequently watched three or four at work at the same time and heard their sharp click-click-click as they darted from flower to flower. These birds rarely, so far as the writer has observed, enter the blossoms from above, but thrust their long, slender bills down between the involucre divisions and the petal claws in order to reach the inner involucre and floral nectaries. In this approach to the blossom there is little chance for them to transfer any pollen to the pistils of other blossoms. These diminutive birds are frequent

\* "Notes on Heredity in Cotton," Year Book of the Khedivial Agricultural Society, 1906, page 68.

visitors of cotton fields and may often be seen fighting fiercely with each other, their tiny rapier-like bills striking the adversary very audibly, with a noise as if striking sharply on silk.

The writer believes that wind can transfer considerable pollen about cotton fields, and, where strict scientific accuracy is expected, this agency must be guarded against. In the heat of the day, when the anther sacs have fully opened and the pollen has become dried and dust-like, it is a simple matter to invert a cotton blossom, and produce a visible cloud of pollen. In fact, late in the afternoon an examination of the hairy leaf surfaces, etc., reveals an enormous amount of pollen scattered about. A vast amount of this pollen has been brought out of the blossoms by bees and fanned and scattered about in their flights from plant to plant. Nevertheless, it is in position to be further disseminated by every breeze that blows. The writer further tested this point by placing between the cotton rows several exposed and developed photographic plates, coated with the thinnest film of vaseline to retain any pollen which might fall upon them. The dark color of these plates readily revealed any of the yellow pollen. This was done for several days, and in every instance more or less pollen in considerable masses was caught. Bees in their flights and winds alone can account for the presence of this pollen. These tests were made at a time when very little wind was stirring. On bright, windy days the quantity of pollen flying about must be considerable. This would be especially true of the best fields producing tall long-limbed plants easily whisked about by winds. In such fields the interlocking branches, by bringing the different blossoms more closely together, very much favor chances of occasional wind-pollination. Wind-pollination, however, would necessarily play a very minor part, as the period most favoring it follows some hours later than the period of most active and thorough pollination by bees.

#### COURSE OF BEES AMONG THE COTTON PLANTS.

Whether or not insects are active pollinators of cotton depends much upon the way the blossoms are visited. The cotton blossom is amply furnished with several sets of nectaries, from the inside to the outside. In many instances the outer and inner involucreal nectaries only are visited. Such visits can effect no pollination of the pistils. Honeybees are among the most frequent visitors of cotton blossoms, but, at the same time, they are very generally visitors of the outer



involucral nectaries alone.<sup>1</sup> Bumblebees and many others rarely visit these, but enter the flowers to visit the floral nectaries, and become loaded with pollen, oftentimes so they cannot fly. It is not uncommon to see one of these bees almost helpless on a leaf or flower, from the great quantity of pollen adhering to its wings, head, and legs. Nearly all bee visitors show a marked tendency to pass from plant to plant up and down the rows rather than across. Under date of August 4, 1908, observations of the following bees in fields at Thompson's Mills, Georgia, more clearly bring out this fact:

Bee 1. A species of bumblebee, visits the blossoms of the Asiatic Hawasaki variety. It visits the inner involucral nectaries almost entirely, as in this cotton the outer nectaries are wanting. It visits alike open blossoms, buds ready to open in a day or two, and squares with young bolls already set. It visits 6 plants successively in one row, then flies elsewhere.

Bee 2. A honeybee, visits 9 plants in one row in succession, then retraces 21 consecutive plants to the end of the row. The outer involucral nectaries almost the only parts visited.

Bee 3. Honeybee, visits 2 plants in one row, then 4 plants in the next row, then flies elsewhere.

Bee 4. Honeybee, visits 4 plants in one row, then flies away.

Bee 5. Honeybee, visits 6 plants successively in one row, then 1 plant in the next row, and again 1 plant in the next.

Bee 6. Honeybee, visits 10 plants in succession, then 8 in the next row, then 6 in the first row again, then 6 in the second row, finally flying away.

Bee 7. Honeybee, visits 15 consecutive plants in one row, then flies off.

Bee 8. Honeybee, visits 11 consecutive plants in one row, then flies away.

Bee 9. Honeybee, visits 6 consecutive plants in one row, then retraces 4 and flies off.

Bee 10. Bumblebee, visits 5 consecutive plants and flies away.

Bee 11. Honeybee, visits 6 consecutive plants, then 3 in the next row, then 3 back in the first row, then 2 in another row, and flies away.

Bee 12. Honeybee, visits 6 in one row, then 6 in the next row (outer involucral nectaries only).

Bee 13. Honeybee, visits 6 plants in one row, then 6 in next row (outer involucral nectaries only).

Bee 14. Honeybee, visits 4 plants in one row, then 2 in the next row, and flies off.

<sup>1</sup> Of many hundreds of bee visitors observed in their visits to cotton blossoms at the beginning of the blossoming season of 1910, rarely did a bee visit any other portion of the flower than the inside. Considerably later, however, when blossoms were exceedingly abundant many bees regularly visited the outer involucral nectaries, especially the common honeybee. This change in the manner of visiting cotton blossoms may follow some change in the relative quantity or quality of nectar in the outer involucral and inner floral nectaries, or it may as likely be due to an awakened memory-impulse which directs the bees to the outer nectaries once these have been discovered.

These casual records are sufficient to show the enormous number of blossoms a single bee is capable of visiting in a few hours, and the probabilities of intercrossing a great number of these all over the field.

The process of cross-pollination of the blossoms by bees is accomplished most readily during the early morning hours. Following clear, hot nights, the petals begin to unfold very early, and by day-break an aperture has opened sufficiently to allow the bees to squeeze through. At this time of day the anther-sacs have hardly opened, and the pollen is so moist and adhesive that the chances are much in favor of a visiting bee introducing foreign pollen before self-pollination has taken place to any extent. Again, owing to the narrow passageway between the slightly unfolded petals, a bee is compelled to move almost directly in contact with the protruding stigmatic surface of the pistil, in order to get at the pollen or nectar beyond, thus insuring the chances of introducing more or less external pollen directly upon the receptive stigma. Almost before day, bees are forcing their way into the expanding buds, and an examination of these reveals many whose stigmas have been pollinated long before the flowers are fully opened.

#### EXTENT OF CROSSING IN DIFFERENT LOCALITIES.

It is very probable that the percentage of cross-pollinated cotton blossoms, accurately determined for different seasons and for different localities, would show wide variation. This is necessarily true, since the amount of crossing depends very largely upon the number of bees and the kinds in any particular locality. Not all bees are active pollinators, and at different seasons the relative numbers of the different species are greatly variable. The writer has mentioned the variable occurrence in northern Georgia cotton fields of that active pollinator of cotton, the wasp (*Elis plumipes* Drury). Cook, in Arizona, finds a marked difference in the kinds and relative numbers of the bees in different localities of Arizona. The writer has observed that in the near vicinity of domestic hives in northern Georgia the number of honeybee visitors is enormously increased.

#### WHEN NATURAL CROSSING MUST BE EXCLUDED.

Many lines of cotton-breeding work require that all chances of cross fertilization must be eliminated. This is especially true where problems of Mendelian interest are studied. Where strictly scientific

results are expected along certain lines of heredity, or where it is intended to determine the specific effects of soil, climate, and fertilizers upon the oil and nitrogen content of cotton seed, as in investigations now in progress, one of the first requisites must be to prevent any free crossing. A number of methods are followed toward this end. One has been to enclose the mature individual blossoms just before opening in small paper bags until self-fertilization has taken place. Another method quite as difficult and far more expensive has been to enclose the entire individual plant in a meter-square mosquito net. Although mosquito netting does effectually exclude all the larger insects, it is not a certain safeguard against the introduction of pollen by the very small insects, such as ants, or by air currents. Balls, in Egypt, in a recent letter to the writer, brings this out very forcibly in the following words: "I don't mind confessing that I can't stop vicinism, so that there must be some mighty prepotent pollen knocking about a breeding plat when it can't be excluded by a meter-square mosquito net, and flowers under the same which do not show any sign of the presence of a style in side view of the column." It will be seen, then, that carefully bagging the individual blossoms, although a tedious operation, is the only sure way of preventing intercrossing.

With regard to the prepotency of pollen of different varieties, the writer's own experiments do not as yet indicate any definite results in that direction. It appears that any and all pollen stands an equal show in the fertilization of the ovules. A study of the Red plants occurring in the naturally crossed bolls of the experiment previously mentioned seemed to indicate that the number of hybrid Reds, in any boll, was dependent only upon the number of pollen grains transferred from the Red variety. In those hills showing only a single Red plant, and there were a number of these, it can only be concluded that a single pollen grain reached the stigma in time to fertilize a single ovule.

In 1908 the writer carefully hand-pollinated a number of Keenan flowers, after emasculation, with pollen both from a Red plant and from a Keenan plant. During the chopping-out process the Red plants were given preference to remain. The following results were secured:

Boll 1—Keenan ♀ × Red ♂ and Keenan ♂. Eleven plants remained, of which 7 were red and 4 white.

Boll 2—Keenan ♀ × Red ♂ and Keenan ♂. Eleven plants remained, of which 9 were red and 2 white.

## EFFECT OF UNCHECKED NATURAL CROSSING IN THE FIELD.

In all fields of unselected cotton, there is an intermingling of many types, both desirable and undesirable. Among the worthless types are the low-linted and lintless plants, plants of low inherent productiveness, extremely small-bolled plants, and plants of weak resistance in the presence of disease. Where extensive crossing is allowed to take place under these conditions, it is evident that the presence of all these worthless types must soon result in contaminating the blood, so to speak, of all superior plants by intercrossing with them. Following this, any attempt at selection for specific lines of improvement would be rendered slow and uncertain until purity of type had again been established. The writer, within the past few years, has found just such conditions to prevail in some of the best cultivated fields of northern Georgia. In one unselected field in particular the lintless type of plant was not uncommon. This type of plant, if inbred, retains its lintless characteristics very uniformly. However, in studying the progenies of selections from this field of the most promising plants the writer has ever seen, the appearance of decidedly lintless individuals from those supposedly superior parents indicated a line of heredity resulting from a union of the best and poorest plants by natural crossing in the past.

In fields of carefully bred and selected cotton, on the other hand, intercrossing is probably a beneficial process. As a result of a more or less complete blending of parental characters in the complicated processes of inheritance, a start made with a number of pure, superior, and uniform types followed by intercrossing must tend to bind very closely within the hereditary mechanism of the future plants the original parental characteristics. Promiscuous natural crossing is undoubtedly one of the most potent factors producing variability in a cotton field. A vast amount of the so-called inexplicable fortuitous variation is without doubt traceable to this cause.<sup>7</sup>

A plant that appears to be a mutant may have resulted from some new complexity of parentage induced by intercrossing. Why should not endless readjustments of the hereditary forces tend to produce exceptional plants far more surely than by any process of pure mutation? The writer feels that this very phase of natural crossing is a

<sup>7</sup> A number of very promising distinct long staple types which have been grown several years in the experimental fields in Georgia surrounded by varieties and hybrids of all sorts have finally become, through natural crossing, almost hopelessly swamped with hybrid types of every conceivable sort.

most important basis for further improvement in cotton. What led to the origination of the striking Columbia variety? Was it the result of what we term mutation forces, or was it due to some interchange of the hereditary units? One of the most promising upland long-staple strains the writer has ever seen gives strong evidence of a cross in the past.

One of the most important conclusions, however, derived from the results of more or less extensive intercrossing in cotton, is that it is vitally necessary to practice careful and persistent seed-selection to prevent deterioration. In those cotton-growing regions where it is proven that the frequency of natural crossing is as great as 10 per cent or more, as is highly probable in northern Georgia, there is no more potent or convincing evidence needed in support of the advisability of careful seed-selection.

#### SUMMARY.

Natural crossing in cotton has been a factor much neglected by most cotton growers and breeders in the past.

In cotton fields of northern Georgia the demonstrated proportion of crossed blossoms is at least 20 per cent, with strong probabilities that approximately 40 per cent of the blossoms are crossed.

Although crossing may be very detrimental in unselected cotton, in selected cotton it is probably beneficial.

The factor of cross-pollination should be one of the most direct and potent facts in support of careful seed-selection.

[Presented by Committee on Breeding Cotton.] \*

---

## BREEDING TO IMPROVE PHYSICAL QUALITIES OF TIMBER.

GEORGE L. CLOTHIER, *Agricultural College, Mississippi.*

Plant breeders have not yet devoted much attention to the breeding of forest trees or to systematic attempts to improve the physical qualities of timber. That there is a great field for such work is the opinion of the writer, and the purpose of this paper is to stimulate the foresters of our country to efforts along this line. Every woodsman is familiar with the fact that individual trees of the same species and size vary greatly in the amount of heartwood, straightness of grain, strength,

durability, weight, elasticity and other qualities of wood. It is quite probable that many if not all the physical qualities of timber are transmissible from generation to generation by heredity. Experiments have been made by Prof. J. W. Tourney, of Yale Forest School, that seem to indicate that seedlings from mother trees of *Pinus ponderosa* with twisted grain show a decided twist of the fibers from the time of germination. If defective seed trees leave their defects impressed upon their offspring, it behooves the foresters to reverse the time-honored policy of leaving only unmerchantable trees to bear seed.

Woodsmen recognize two kinds of timber from a number of our common species according to the intensity of the color of the heartwood. Such, for example, is the case when they speak of white and yellow poplar, white and red gum, white and yellow cedar, etc. In fact the intensity of the color of wood has been taken by some writers to indicate the durability of the wood, and hence to give an index to its value. For woods from the same species, the rule holds good that the more deeply colored heartwood, where not attacked by disease germs, is more resistant to decay; but it is not safe to extend this generalization to a comparison of different species. For example, the timber from many of the white cedars lasts three or four times as long as the darker-colored red cedar; and California redwood, a pinkish-colored wood, will last several times as long as our very dark-colored black walnut. Intensity of color simply indicates a great quantity of the preservative material naturally produced by the species in question for the preservation of its own heartwood. These preservatives differ in their antiseptic qualities, according to the species producing them, and also differ in color, but darkness of color is no indication of their antiseptic power.

Breeders of forest trees can ascertain the quantity of preservative materials in the heartwood of any definite mother tree and the depth of the sapwood by the use of an instrument like "Pressler's increment borer," which extracts a small core from the bark toward the center of the tree without injury to the tree; and they can know by this means definitely whether the tree examined possesses the qualities of heartwood desired in its offspring. According to the use to which the wood is to be put, it may be desirable to have as little heartwood as possible or *vice versa*. Almost all imaginable differences in quantity and quality of heartwood of the same species will no doubt be found to exist when foresters attack this problem in a practical way.

Strength is a physical quality of wood that varies in the same species several hundred per cent. The microscope will often reveal what the timber-testing machine conclusively proves to be the condition of the woody tissues in a piece of timber. Unfortunately, the testing machine cannot be applied to the wood of living trees, but small fragments may be removed from a standing tree for microscopic study without endangering the life of the tree. The microscopic structure of wood gives a clue to its strength and other valuable qualities, and hence the timber breeder of the future will no doubt have a laboratory equipped with microscopes and accessories for the study of the cellular structure of his trees. It is a well-known fact that the stiffness of a piece of wood is dependent upon the thickness of its cell walls and that resistance across the grain to destructive rupture depends to a great degree upon uniformity in size of the cells. Wood having great tensile strength is made of long cell fibers, while wood with great elasticity usually has very uniformly fine grain.

The user of wood determines what physical qualities are technically most important, the timber tester determines the measure of these qualities, and it remains for the breeder to intensify or improve these qualities. While it takes many years of experiment to determine how far a definite quality in a forest tree is transmissible by heredity, the evidence that the physical qualities of timber are hereditary is sufficiently strong to warrant foresters in making some efforts to select their seed trees along this line. Since the majority of the desirable qualities can be identified by the unaided eye of the close observer, it would seem that there is no valid reason why foresters should continue to ignore such a promising field.

---

### REPORT OF COMMITTEE ON BREEDING FISH.

JOHN W. TITCOMB, *Lyndonville, Vermont.*

Experiments in reference to the hybridization or crossing of allied species have been continued at several stations of the United States Bureau of Fisheries. While the results have almost invariably been disappointing, it may be of future interest to record some of them.

Some hybridization experiments of the United States Bureau of Fisheries during the years 1907-1909.

Name of station.	Parents <sup>a</sup>		Results.
	Male.	Female.	
Nashua, N. H. ....	Brook trout. ....	Sunapee saibling. . .	Procreative hybrids.
White Sulphur, W. Va. . . . .	Rainbow trout. . . . .	Brook trout. ....	Imperfect embryos; no hatch.
Do. ....	Brook trout. ....	Rainbow trout. . . . .	Perfectly formed young fish, but weak.
Leadville, Colo. ....	Loch Leven trout. . . . .	Brook trout. ....	Small percentage of young fish.
Do. ....	Brook trout. ....	Loch Leven trout. . . . .	Small percentage of young fish.
Do. ....	Brook trout. ....	Rainbow trout. . . . .	Normal hatch, but accidentally mixed with other fish.
Do. ....	Rainbow trout. . . . .	Loch Leven trout. . . . .	"Glassy" eggs; no hatch.
Do. ....	Black Spotted trout. . . . .	Rainbow trout. . . . .	Normal young fish still under observation.
Craig Brook, Me. <sup>b</sup> . . . . .	Humpback salmon. . . . .	Silver salmon. . . . .	Good hatch followed by abnormal death rate and deformity of tail in survivors.
Do. ....	Humpback salmon. . . . .	Sockeye salmon. . . . .	Good hatch; after year 75% loss; rapid growth among survivors.
Do. ....	Sockeye salmon. . . . .	Blue Back salmon . . . . .	Fair hatch; small number survived; rapid growth among survivors.
Do. ....	Dog salmon. ....	Humpback salmon. . . . .	Died soon after hatching.
Do. ....	Chinook salmon. . . . .	Silver salmon. . . . .	3% hatched.

Some of the above experiments have not been carried far enough to determine whether the hybrids are procreative. None of them have produced a hybrid superior to either of their progenitors. Of the Pacific salmon hybrids, the two showing rapid growth encourage a continuation of the observations until it has been determined whether they will mature and reproduce. The salmons all show a remarkable susceptibility to the throat tumor disease.

<sup>a</sup> Brook trout, *S. fontinalis*; Sunapee saibling, *S. aurcolus*; Rainbow trout, probably *S. irideus*; Loch Leven trout, *S. trutta leuencensis*; Black Spotted trout, one of the native trouts of the Rocky Mountains.

<sup>b</sup> The Pacific salmon hybrids hatched at Craig Brook, Me., were from eggs obtained on tributaries of the Skagit River, State of Washington.



A great many similar experiments in hybridization have been conducted in the United States of which the observations have not been carried far enough or the results did not warrant it.

Experiments in the crossing and hybridizing of various species of salmonidæ have been made in Scotland and several European countries. Both the Rainbow and the eastern Brook trouts of America have been crossed with the European trouts at various fish-culture establishments. Impregnation is readily accomplished, but in all the efforts to hybridize the trouts and salmon of Europe, as well as in the crossing of American with European species of trouts, it appears to be regarded as established that, while there is a development, it soon reaches its end or leads to malformations. Some of the hybrids are procreative, but in general the results have been disappointing, and foreign fish culturists appear to have discontinued breeding experiments of this character.

It seems useless to continue the experiments until an experiment station has been established where hybridization and other experiments can be systematically conducted under scientific observation and carried to a definite conclusion.

The experiment inaugurated at the Northville station in selecting and breeding for specific bacterial immunity in Brook trout has resulted in failure, the 20,000 fish held for the purpose having succumbed to the disease.

The committee is not entirely discouraged by the failures here reported, but is unanimous in the opinion that few if any satisfactory results can be obtained until one or more experiment stations have been established at which the work can be conducted unhampered by the regular fish-cultural work that is the necessary and legitimate work of the existing State and Federal hatcheries.

The necessity for experiment stations to advance strictly fish-cultural work is quite as important as for experiments in breeding. However, fish culture and fish breeding are so interdependent that one experiment station could be utilized in the advancement of both.

---

## A PHEASANT-BANTAM HYBRID.

H. J. WHEELER, *Kingston, R. I.*

Although there have been reported, from time to time, several instances of a successful cross between the pheasant and the domestic fowl, none of these has thus far withstood the results of close investigation. The following is a brief description of the results of an actual cross secured by Dr. Leon J. Cole at the Rhode Island Agricultural Experiment Station in the spring of 1908.

Of 77 eggs of the bantam fowl laid between March 23, 1908, and August 27, 1909, only one was fertile. This egg was laid March 30, 1908. It was set under a hen on April 4, and hatched April 28, thus giving an incubation period of 24 days.

### DESCRIPTION OF THE FATHER.

This bird, a Ring-Neck pheasant, was of average size, plumage, and vigor. The feathers of the head and neck were iridescent and purplish, with a greenish cast upon the top of the head. The short feathers of the face patch were turkey-red. The measurements of the different parts of the body were as follows:

	Millimeters.
Length of upper mandible.....	27
Width of mandible at base.....	20
Ear tufts.....	15
Length of wing.....	250
Length of tail.....	540
Length of tarsus.....	70
Length of middle toe.....	58

Weight, 2 pounds, 10 ounces.

The color of the eye was bright bay.

### DESCRIPTION OF THE MOTHER.

The mother of the hybrid was a mongrel bantam. The general color was buff with faint black stripes on the neck. A large amount of black appeared in the primary wing feathers and in the inner veins of the secondaries. The tail feathers were largely black, but contained some yellow. The comb was low, but had the rose-comb characteristics, and possessed a prominent spike. The wattles and ear-lobes were very well developed. The measurements of different parts of the body were as follows:

	Millimeters.
Length of upper mandible.....	18
Width of mandible at base.....	13
Length of tarsus.....	58
Length of middle toe.....	54

Weight, 1 pound, 14 ounces.

The color of the eye was a faded yellow.

#### DESCRIPTION OF THE HYBRID.

The color of the head and neck was dark because of the presence of much black in the feathers. The yellow, however, showed through to a considerable extent, especially on the top of the head, on the forehead, and on the upper throat region. The space immediately surrounding the eye was red. A slightly purplish iridescence appeared on the feathers of the lower neck. The general color of the body and back was a mixture of light yellow, darker yellow, chestnut, and also black, in very irregular patterns. In many instances the black formed a double stripe on the feathers, while the chestnut was usually present on the edge of the feather and formed a band. The feathers of the rump and the tail coverts had many small black specks. The flights were a mixture of black and light yellow. The primaries were darker at the distal end. The tail feathers had an appearance more like the primaries. The comb was very low, having somewhat the appearance of a rose comb, but without the spike. The wattles and ear-lobes were absent. The eye had a yellowish tinge between faded yellow and a bay color. The measurements of various parts of the body were as follows:

	Millimeters.
Length of upper mandible.....	26
Width of mandible at base.....	18
Length of the wing.....	224
Longest tail feather.....	213
Length of tarsus.....	70
Length of middle toe.....	65

Weight, 3 pounds, 3 ounces.

For the first few weeks of its life, this hybrid more nearly approached pheasant chicks (Ring-Necks) in both color and call. When the feathers began to come, however, the bird lost some of its resemblance to pheasant youngsters and also ceased its call except when frightened. The bird was kept carefully cooped to avoid its destruction by vermin. In spite of being fed and watered three or four times daily,

it grew and remained very wild; two ducklings were put into the coop, but they seemed to exert no taming effect. After several months, it was transferred to a turkey yard in which were its parents, pigeons, and turkeys. Very soon, the hybrid became much more domesticated. As an adult, nothing has been observed in its behavior to indicate sex; its call (only when frightened) is of a higher note than the cock pheasant's and is somewhat like that of a cornered rat.

#### COMPARISON OF THE PHEASANT, BANTAM, AND HYBRID.

The general shape of the head of the hybrid was much more like that of the pheasant. It lacked, however, the velvety feathers on the face, and did not have the extension into the ear-lobes, which was prominent on the pheasant. The bill of the hybrid was shaped somewhat like that of the pheasant, but was rather lighter in color. It was also more grayish in appearance than that of the bantam. The general color of the body plumage resembled more closely that of the pheasant, except that the markings of the hybrid were not so regular, and more of the light yellow of the mother was apparent. The shape of the wing resembled more closely that of the bantam, but it was considerably longer. It did not, moreover, show the peculiar color and definite bars characteristic of the tail of the pheasant. The longest feathers of the tail were broad and rounded at the tip. They were much less long and tapering than those of the pheasant. They were carried, moreover, in a more erect position, showing no tendency to trail as did those of the father. The reason for this obviously lies in the anatomical structure of the tail-bearing portion, which resembles more closely that of the bantam. While in the pheasant the legs and feet were quite dark, and in the bantam a faded yellow color, in the hybrid the color was between these two. Furthermore, while the pheasant had well developed spurs, about 10 mm. in length, and the bantam very short spurs on both feet, the hybrid had on the right foot a short blunt spur and on the left only a low wart-like structure. When the hybrid was compared with the pheasant hen, it was obvious that the color-resemblance to the female pheasant was more striking than to the male bird, but that the form-resemblance to the female was less marked.

[Presented by Committee on Breeding Wild Birds.]

## PROGRESS IN THE PROPAGATION OF SEEDLINGS OF SUGAR CANE IN LOUISIANA.

HAMILTON P. AGEE.

There was presented at the 1907 meeting of the American Breeders Association, by Dr. C. O. Townsend, a paper on "The Improvement of Sugar Cane by Selecting and Breeding," which summarized in a complete manner the work of various investigators who have endeavored, since the discovery of the fertility of the seed of the cane, to propagate better varieties of this important sugar-producing plant.

A report from the Louisiana Sugar Experiment Station in 1908 told how it was long thought that this work must be confined to the Tropics, where cane seed could be secured in a fresh state for germination and be handled under the most favorable conditions of temperature. It seemed that Louisiana must depend on securing her varieties of cane from those countries where summer heat continued throughout the year; for, although the semi-tropical conditions of the southern part of that Stat are such as to permit of a profitable cane-sugar industry, nevertheless the curtailment of the growing season by the cool weather of the winter months prevents that stage of maturity which is necessary for the production of the seed-bearing arrows or tassels. This confronted Louisiana with an additional handicap in her competition against other cane-growing countries. Not only was an industry to be maintained by the growth of a tropical plant without its natural habitat, but the possibility of the propagation within her bounds of new varieties of this plant, which would thereby more likely become acclimated to her conditions, appeared to be withheld. The continuance of the sugar industry in Louisiana through its various periods of adversity may be attributed to a stroke of extreme good fortune in the introduction, as early as 1820, while the industry was yet in its infancy, of a cane which by sheer chance was one of the few varieties that can be grown with profit at a latitude of 30 degrees north.

That cane culture in the State had grown to be a thriving industry by one chance in hundreds was not fully realized until after the Louisiana Sugar Experiment Station (established in 1885) had collected from the various sugar countries throughout the world those varieties which produced the maximum returns in foreign lands noted for their large yields, and found them without exception under semi-

tropical environments to be inferior to the cane which had been grown in Louisiana since 1820.

After the inauguration of seedling work in the Tropics, the Louisiana interests received great benefit from the introduction of the two Demerara seedlings which proved to be superior to canes then grown in the State. It was well known for a long period of years that the possibilities of securing better varieties would be considerably enhanced by germinating seed in large quantities under the prevailing conditions of the section where they were to be utilized and selecting from the great numbers the few that might prove to be superior to the varieties grown on the plantations. It was not, however, until a few years ago that the proper means of handling this delicate branch of nursery work was found. Since it was Mr. A. E. Weller who was in active charge of this undertaking, he should be recorded as being the first, and, up to the present time, the only one who has succeeded in securing the germination of sugar-cane seed at a latitude without the bounds of the Tropics. His success in this work is all the more deserving of credit since it followed a series of failures by others since 1890.

The methods and the scheme of handling these seeds and the tender seedlings produced therefrom were described in the report, with an account of the work to that date. It only remains therefore to give information on the continuance of this endeavor to secure better varieties of cane for the Louisiana planters, and to point out the encouraging features which have presented themselves.

In preparing for the seedling work of the current year, letters were addressed to various government agricultural departments, experiment stations, botanical gardens, sugar companies, and individuals, throughout the girth of the globe, requesting cane seed for the work in hand. The writer is extremely grateful to those who contributed, for without this assistance the work would be impossible. A list of those who thus cooperated is given as follows, showing the wide range of sugar-producing countries from which the seed were secured and the different varieties of cane from which they came, and also the number of germinations secured from each variety:

## Contributions of sugar-cane seed.

Contributor.	Country.	Varieties from which seed were furnished.	Number of seedlings secured.
Francis Watts, Government Chemist and Superintendent of Agriculture.....	Antigua, British West Indies.....	D. 1640.....	None
		D. 116.....	None
		D. 95.....	None
		D. 109.....	None
		Sealy Seedling.....	None
		Red Ribbon.....	None
		White Transparent.....	None
		Queensland Creole.....	None
J. C. Waldron.....	Antigua, British West Indies.....	D. 95.....	5
		D. 109.....	194
		B. 147.....	77
		B. 306.....	1
		B. 208.....	None
		B. 1355.....	2
		No number.....	1
Noell Deerr, Acting Director Sugar Experiment Station.....	Honolulu, Hawaii.....	Lahaina.....	None
		White Tanna.....	None
		Hawaii No. 8.....	None
		Hawaii 355.....	None
		Hawaii 400.....	None
		Hawaii 403.....	None
		Hawaii 404.....	None
		Hawaii 5584a.....	None
		Hawaii 5586a.....	None
		Hawaii 5592a.....	None
		Hawaii 5596a.....	None
		Hawaii 5615a.....	2
		Hawaii 5621a.....	None
D W. May, Special Agent in Charge Experiment Station.....	Mayaguez, Porto Rico.	T. 77.....	1
		D. 74.....	1
J. T. Crawley, Director Estacion Central Agronomia.....	Santiago de las Vegas, Cuba.....	Crystallina.....	None
		Pappoa.....	None
		D. 108.....	None
		P. 77.....	None
		D. 74.....	None
		T. 211.....	None
		B. 6450.....	None
		John R. Bovell, Superintendent Department of Agriculture.....	Bridgetown, Barbados, British West Indies..
B. 3390.....	None		
B. 3405.....	None		
B. 3412.....	2		
B. 3696.....	None		
B. 3922.....	None		
B. 6171.....	None		
F. Evans, Acting Superintendent Botanical Department.....	Port-of-Spain, Trinidad.	T. 209.....	None

\* Hybrids.

*Contributions of sugar-cane seed—Continued.*

Contributor.	Country.	Varieties from which seed were furnished.	Number of seedlings secured.
Robert M. Grey, Harvard Botanical Station <sup>b</sup> .....	Cienfuegos, Cuba.....	Cinta (Red Ribbon).....	None
		Harvard No. 73.....	24
		Harvard No. 219.....	None
		Harvard No. 88.....	None
		White Sport.....	None
		Crystallina.....	None
Department of Agriculture <sup>b</sup> .....	Jamaica, British West Indies.....	D 95.....	None
		D. 115.....	1
Department of Agriculture <sup>b</sup> .....	Trinidad, British West Indies.....	T. 209.....	None
Director Treub <sup>b</sup> .....	Buitenzorg, Java.....	G. Z. No. 247.....	None
Colonial Sugar Refining Company, Limited <sup>b</sup> ...	Sydney, New South Wales.....	Badila.....	1
		Mobona.....	None
		H. Q. 10.....	None
		H. Q. 50.....	None
		Couve 87.....	7
		Striped Singapore.....	None
		Rose Bamboo.....	None

It is interesting to note the large number of germinations from the seed sent by Mr. J. C. Waldron of Antigua. This is the more remarkable because the opinion has been expressed by scientific investigators in Antigua that the cane arrows of that island do not bear fertile seed. The greater success of the Louisiana work on these seed than on those from elsewhere may be due to the fact that they were shipped in large bundles, which kept them in a better condition than those which were sent in small packages by mail. It is thought likely, however, that Mr. Waldron exercised good judgment in selecting tassels which were in prime condition for gathering.

Gratification is felt in securing eight germinations from the seed from Australia, as it is shown that the shipment of the delicate seed from such a great distance does not of necessity destroy its vitality, as has been heretofore supposed.

As was explained in the report of last year, canes obtained from each germination are classed as different varieties and receive a number which is prefixed by a letter indicating the country in which they originated. The entire amount is then planted out and the succeeding

<sup>b</sup> Received through Mr. David Fairchild, Agricultural Explorer in Charge, Bureau of Plant Industry, U. S. Department of Agriculture.



year a sufficient quantity is obtained to make a laboratory test of the juice and to plant an area large enough to furnish data the following year that will be indicative of the sugar-producing value of the juice and the tonnage yield per acre.

Unfortunately, the date of the meeting (Nov. 15, 1909) does not permit of a detailed report of the laboratory and field tests of this year, as this is at present in an incompleting stage.

The conclusions drawn from the work, so far as it has gone, give nothing of a phenomenal nature to report. However, the results are of such a satisfactory nature that promise is had that this Louisiana seedling work will ultimately prove of the greatest commercial value to the sugar interests of the State. If in the course of the next decade it is possible to originate a variety which has inherent properties that will cause it to yield a 10 per cent greater sugar return per acre than is had from the varieties now cultivated, it can be readily understood how great a money value will accrue from these investigations.

A disappointment is had in this year's results from the L92, which last year gave richer juices than the celebrated D74. There are four of the new varieties—L201, L248, L450, L511—propagated in 1908 (on which laboratory tests were made for the first time this year) that were superior in sugar content to the D74 on October 15. Data as to tonnage may offset this advantage, and, furthermore, the canes may retrograde another year, as was the case with the L92. But, be this as it may, the results have pointed out that what once seemed possibilities of ultimate success are now closely verging upon the probable.

The value of this work will be considerably augmented by an arrangement which has been effected with the Bureau of Entomology whereby this Bureau establishes and maintains at the Sugar Experiment Station the laboratory for the investigation of insects injurious to sugar cane. These investigations are in charge of Mr. D. L. Van Dine, formerly of the Federal Experiment Station in Hawaii. Simultaneously with the study of the sugar yield and tonnage value of the varieties newly propagated by the Sugar Experiment Station, Mr. Van Dine proposes to study their insect-resisting properties so as to aid in the selection of those canes which may be fit to be disseminated throughout the State to be grown commercially.

A similar cooperation will probably be obtained from the Bureau of Plant Industry in the way of pathological investigations along the same line.

## SINGLE-CHARACTER VS. TOUT-ENSEMBLE BREEDING IN GRAPES.

T. V. MUNSON, *Denison, Texas.*

### INTRODUCTION.

In my work in breeding grapes and other fruits, the prime object was not to discover fundamental laws of inheritance *first* and then to practice those laws to get results, but, acting on the great universally accepted truth which is impressed upon us everywhere in organic nature—that each individual, each variety, each species, reproduces closely after its own kind, and yet is ever varying one way or another from the parent form—to proceed at once by selecting and combining parents embodying to the largest extent the characters desired, to attempt the production of offspring coming nearer to my ideals than either parent. As I proceeded, I kept close observation on results of uniting different mates with the mother, so that I soon found myself unconsciously searching for “laws” or methods of action under different circumstances. After all, that is all we mean by the term law in nature—*method of action under certain circumstances*. As the circumstances are infinitely variable so the “laws” are infinitely numerous, past fully finding out.

It would be just as reasonable to instruct a chess player to make every move according to laws of chess as for a breeder to require every new individual plant or animal to be bred according to the laws of heredity. The best move in a game of chess is the one that at that particular stage of the game goes farthest toward mating the opposing king and at the same time preventing the mating of the player’s king. This, it is true, is in itself a “law”—a very vague and general law—that every chess player, good or poor, observes to his best ability, but that which makes him win most games is skill to penetrate more deeply into the possible combinations within the next few moves ahead, and to pick out that move each time most favorable to his side of the game. The skill is mostly the product of two chief factors—first and most important, natural acuteness in observation and thinking; second, much experience in the play. So it is with the breeder.

Breeding, like chess-playing, is an art. Yet there is a science of chess, and a science of breeding—classified facts with reference thereto—the knowledge of which greatly aids anyone who engages

in it to become expert. This science comes from those who have gone before. Hence each expert owes it to the race to give his accumulated clearly demonstrated facts in classified order. The study of these facts sharpens the wits and aids much in developing the expert. The best and the proper time to study them is when we are putting them into practice.

The science of breeding with all its complexities is new and only partially developed, and there yet remain to be worked out many more or less general truths and a vast multitude of details before any complete work can be compiled on breeding.

In breeding, only specialists can accomplish the greatest good. The universal breeder is even less likely to accomplish permanent beneficial results than is the "Jack of all trades" to make great success in business.

The following statements are based on the writer's experience in the breeding of grapes.

To get form, or size, or flavor; to get persistence to pedicel, non-cracking skin, even ripening, or certain season of ripening; to get resistance to parasitic enemies, especially fungus and bacterial parasites; to get drought resistance, heat resistance, cold resistance, or resistance to excessive wet; to get productiveness and long life; in fact to get any desirable character in the seedling, it was quickly seen that such character must be found in the parentage somewhere. This is simply the first universal law of inheritance in different applications, and can be practiced by any "lunkhead" if dealing with only *one* characteristic, but in general-character breeding, the keenest wit is required to get desirable results.

#### SINGLE-CHARACTER BREEDING.

If a person should seek only to produce grapes with the largest possible berries, he would neglect all other characters and choose at first such parents as Black Hamburg, Union Village, Eaton, Red Giant, etc., and cross any two of them. Then from this progeny he would select the two largest and cross again, and so continue. But the breed would soon be so weakened by in-and-in breeding that it would require "new blood" to revive it, so he would be compelled to start with four or eight parents, uniting into four pairs, and then uniting the largest product of any one pair with the largest of any other pair, and the largest product of the other two pairs united with

these, and then select seeds, and plant from the self-pollenized largest variety produced for several generations from this conglomerate parentage, until the vines would no longer endure in-and-in breeding without becoming too weak in vitality. Then the product would in all probability be valueless. So it would be had any other one character been used. Although in this kind of breeding only one character was kept in view, yet the final product is worthless in every character but size. Fortunately there are few who tend to single-character breeding, and those few should learn better ways.

#### GENERAL-CHARACTER BREEDING.

Every breeder worthy of the name seeks a product containing as many of the desirable points as possible. It is in attempting this that the real fine art of breeding begins. It requires the combining, certainly, of parents containing as many good and as few of the undesirable points as can possibly be found. This calls for wide and accurate knowledge, not only of existing varieties but also of all their characteristics and adaptabilities.

The breeder soon learns that some pairs selected, for some reason which he cannot perceive, are uncongenial, as is the case between human beings sometimes, so that no desirable progeny results, while other pairs are extra good breeders. No "law" can help him here. He has to learn by actual test. This is expensive, but it cannot be avoided.

It is quite probable that no two parents can be found to contain all the points sought. This requires the second, third, fourth, or later generations to be produced, and then only a very few of the plants of each generation approach the ideal. Bad qualities perhaps, at first concealed as "recessives" (according to the Mendelian writings), crop out and must be eliminated. So the successful breeder must not only be a careful selector but a rigid rejector, and a perpetual keen-eyed, quick-witted student.

I do not mean to say that the breeder of grapes need not know and observe the general laws of breeding already discovered; on the contrary he must observe these consciously or unconsciously to obtain success above the ordinary method of planting indiscriminately gathered seed. Happily the general laws are so few and simple that almost every person of fair observing powers and ordinary information understands them.

The great general laws may be stated thus: Like purebred parents produce like, with slight modifications produced by environments; unlike combined produce, in the first generation, all degrees of variation between the two parents; the progeny of the unlike combination, if self-pollinated, produce three classes of progeny—one-fourth like one parent, one-fourth like the other, and one-half variable between the two unlike parents of the first generation. This is known as the Mendelian Law of Heredity. In grape breeding, little is gained by combining like purebreds, but combinations of the best unlikes may be continued until a decidedly more desirable form than before existed for the purpose is secured.

It is the conceiving of ideal varieties for different seasons, climates, soils, and purposes, and the finding of those already in existence which come nearest to the ideal, and of these the ones most congenial in crossing and hybridizing and that go farthest in combination toward reaching the ideal, that makes a progressive and successful breeder. Such a breeder, taking up a single class of fruits such as grapes, if he seeks to cover all the seasons of ripening, all soils and climates capable of yielding profitable results, and all uses of the fruit, undertakes a lifetime service in experimentation which largely curtails his ability to make money.

Fortunately such work is fascinating, and, if good business methods are used in marketing the products originated, it should yield a comfortable living. Such a life yields one satisfaction that a life devoted to money getting generally lacks—the knowledge that it leaves a great beneficial legacy to coming generations.

The planters of vineyards, especially, reap profit from such work; the consumers are regaled with finer colors and richer flavors than could be enjoyed without the originator's varieties, and the breeders that follow are greatly aided by his recorded experience, if this has been duly classified and published, hence he should be paid good prices for the best products of his breeding.

As we cannot hope to excel the best examples in nature as regards ability to survive the destructive influences of climate, disease, etc., we take these best examples as a basis on which to ingraft, by crossing and hybridizing, the desirable individual characters of color, size, quality, etc., found in other individuals. But it is a general rule that the varieties of fine quality—especially the property of sweetness—are more affected by climatic extremes and more subject

to fungus and insect attacks than the hardy stock selected for resistance, and thus we find ourselves ingrafting weakness, reducing the hardiness of constitution, to gain quality. The usual result is a product reduced in quality from the high-quality parent and lower in hardiness than the extra hardy foundation. But we find that some of the hybrid individuals have retained much more hardiness than others, and some much better quality than others, and a very few possess largely both hardiness and improved quality. We seize these as the prizes vouchsafed us for our labor, and cross and recross these better combinations among themselves, and with still other fresh blood, until we have arrived at a greater perfection than is possessed by the varieties in general cultivation; when we can truly say the originator has a product worthy to be placed on the market. To ascertain adaptability to season, soil, and climate is as much the work of the prospective planter as of the originator; for, if the originator attempts to test in all regions before selling, it costs more than ever returns to him. Experiment station tests, under restrictions, should do this work; but experience proves this usually a losing game to the originator. Probably the best the originator can do is to give several years' test in different soils and situations, entirely subject to his control in propagation, before naming or introducing. Then he must charge what seems a high price per plant and advertise extensively to get a meager return for what has cost him years of most skillful work. It is in the first three or four years after introducing only that the originator derives mentionable returns. None of the bad products must be put on sale, or the reputation of the breeder suffers at once, and it is doubly difficult to regain what is lost.

The greater the number of desirable characters sought to be embodied in a variety (and a single individual is equivalent to a variety in fruits to be propagated by cuttings, budding, layering, or grafting), the longer and more difficult becomes the work. The process may be continued interminably with gradual improvement, as we are entitled to infer by comparing the poorest with the best in nature and art, and finding there is room to add to the best; and this encourages us to forever aspire with confidence to a still better future in special breeding.

## SOME SPECIAL OBSERVATIONS.

Some breeders of grapes have assumed that it is a "law" that the female parent transmits vine characteristics, while the male transmits fruit characteristics, in the vines produced by crossing or hybridizing. This, I find, is not a law of reproduction among grapes. For example, in a lot of hand-made hybrids between Rommel as mother, having a peculiarly flavored white grape and distinct vine and foliage, and Brilliant as pollen parent, having a red grape of distinct flavor and a vine different from that of Rommel, the resulting hybrids all had vines very closely resembling Brilliant, while all had berries much resembling Rommel in flavor, and in color they were very nearly the same—all white. The size and shape of clusters, however, were in all like Brilliant. In hybrids of America (black) with Delaware (as male), the vine is an even combination of the two parents, but the berries and clusters are much more like Delaware, being translucent red. The flavor is a fair combination of those of both parents. Many other examples I could mention prove that there is no such law among grapes.

It seems in many cases there is no telling beforehand which characters in the parents will be dominant and which recessive or evenly blended in the progeny. In some combinations, all the characters of one parent are dominant and, of course, all others recessive. This is true of *Vitis rotundifolia* (as female) when united with varieties of true bunch grapes, the *Rotundifolia* characters being dominant. A similar result generally follows when a species of a very uniform fixed set of characters is united with a species that is quite variable, and I think may be set down as a law among grapes, and may be stated thus: *Species of grapes very uniform in character when hybridized with species of very variable character give progeny with the characteristics of the uniform species dominant.* This I have determined with several pairs of species to the second generation.

[Presented by Committee on Breeding Tree and Vine Fruits.]

## DETAILS FOR A GAME BREEDERS' LAW.

DWIGHT W. HUNTINGTON, *New York, N. Y.*

It cannot be denied that a law permitting breeders to profitably increase our game should be enacted in every State. As I said last year, it seems idle to suggest to breeders that they should not be permitted to breed.

The resolution adopted by your Association has now been before the people for a year, and it was given a wide publicity by the *American Field*, the *Amateur Sportsman*, and other papers and magazines, yet so far as I am aware no one has openly said a single word in opposition to the resolution.

So far as I know all of our prominent naturalists are in favor of the protection and increase of North American game by breeders. A number of them have referred to this important matter in no uncertain terms. Dr. Hornaday has said: "The situation is absurd and therefore can not long endure." Dr. Merriam, chief of the Biological Survey, has written that he is strongly in favor of a regulated sale not only of deer but of game birds when properly identified. Dr. Shufeldt says: "I am thoroughly in sympathy with you in what you have to say and what many of your correspondents say on the question of game protection. There is such a thing as protecting birds off the face of the earth, and I stand distinctly opposed to much that pertains to such methods now in vogue."

So far as I am aware no sportsman of any prominence is opposed to the profitable increase of game by breeders. It is a self-evident proposition that the farmers, game dealers, and innkeepers, who will be benefited by a breeders' law, are in favor of it. Many of them have said that such a law would quickly increase the game.

Some of those who have been active in building up our restrictive system in the hope that it would increase the wild food birds, or at least save them from extermination, have made inquiries as to the form of a breeders' law which would enable breeders to sell their birds without endangering the rare and vanishing species which are supposed to be protected by the present game laws.

There are three well-known laws permitting the sale of game and game fish which may be taken as forms or precedents by those who may undertake to prepare a breeders' law for any State. (1) Colorado has had for several years a law permitting the sale of game



from preserves, and under this law the game birds are sold and served in the hotels. The State game commissioner has said the law should remain permanently. (2) Minnesota has a law permitting the sale of trout by breeders, and the executive agent of the board of fish and game commissioners informs me that this law is satisfactory and that it does not result in a loss of trout from the public waters. (3) Massachusetts has a new law permitting the sale of pheasants by breeders, and I know of no objection to this law save one which I have raised: its tendency must be to increase the foreign fowls instead of our own, which easily can be made abundant.

There are other similar laws, some relating to deer only. One law permitting the sale of birds by breeders in North Dakota has been recently enacted, but it has not been on the books long enough for us to know how it may affect the game which no one looks after properly.

My suggestions for the details of a breeders' law briefly are as follows:

Breeders should be defined so that those who own no interest in the game reared may, for the present at least, be prohibited from selling game. Permits or licenses should be issued to breeders upon the payment of a small sum, and the law might provide for the forfeiture of the license provided the person holding it ceased to be a breeder.

Provision should be made for licensing game dealers, and they should be required to give a bond to keep a game register wherein they should enter and list all game received and the names of the breeders sending it. Dealers might be required to file an affidavit at the end of the season stating that no game had been sold illegally. I have been informed that in England, where game is sold during a good part of the year, the reputable dealers are opposed to the few who are suspected of violating the laws, and willingly aid in their apprehension.

It should be far easier for game officers to watch a regulated industry than it is to oversee such sales of game as are now permitted—game birds coming from points distant 25 miles from New York, for example.

One thing we should always bear in mind—the laws should aid the vigilant and not the sleeping. Those who are willing to properly protect and increase our splendid grouse, quail, and wild fowl should be encouraged. Nothing can be accomplished without the expenditure of money, and no one can be expected to invest in an enterprise which

is practically prohibited by law. If any less should occur by reason of the proposed change in the game laws it must fall on those who do nothing, and it will be more than offset by the game reared by breeders.

Under the present game laws we have State game departments which represent only a small part of the people—a part of the sportsmen, but not all of these by any means. Necessarily these departments are hostile to the farmers, the game dealers, the innkeepers, and all of the people who would be benefited by cheap game. The State game departments under a breeders' law will represent all classes of people, as any governmental department should.

The effect of the resolution which the American Breeders Association passed last year has been good. The proposed breeders' law has been much discussed by sportsmen, and as I have observed there is none who is openly opposed to the common-sense idea that the breeders of game should be permitted and encouraged to rear game birds for the market. Ruffed grouse today are worth \$20 a pair for propagation, and there is a demand for a large number of them. I know a man who successfully reared these birds last season in a wild state on a small country place quite near New York. On the same ground he reared mallards and several species of quail and some Hungarian partridges. Since most of the birds were nesting wild they procured a good part of their food from the few acres of field and scrub oak. The cost of rearing these valuable birds under such conditions should be less than the cost of rearing poultry. No one is permitted to fire a gun on the place. Why should the owner of these birds be prohibited from selling some of them for propagation or as food? Mr. Evans, who has prepared a paper to be read before your Association, informed me (a few days ago when he was in New York) that he had about a hundred cock pheasants left over last season; since most purchasers bought more hens than cocks. Why should he be prevented from selling these extra birds as food?

In order that something may be done toward securing a breeders' law which will be satisfactory to all classes, I would suggest that you appoint a special committee to consider the form of such a law and to recommend its enactment by the various State legislatures, provided the members of the committee agree upon the form of law which will benefit all classes. I would advise that you appoint a committee of nine, to be made up as follows: Two farmers; two sportsmen; two game dealers (one to be a dealer in live game); two hotel

keepers, and one prominent naturalist. I would suggest that at least one of the first named be the president or other prominent officer of a grange; that one of the sportsmen, at least, be a prominent member of a State game protective association, and one be appointed from those who favor a breeders' law; that one of the innkeepers be the president of a State hotel men's association; and that Dr. Hornaday, Dr. Merriam, Mr. Brewster or some other naturalist be appointed to advise the committee about the natural history facts which should be considered.

I believe a law can be drawn which will prove satisfactory to all of these classes and which will be beneficial to the people who wish to see cheap game in the markets. I am sure that a law which is satisfactory to all classes will remain permanent and that it will be in pleasing contrast to the ever-changing and ridiculous game laws which are annually placed on the books and which consume from one-tenth to about one-third of the time of the legislative assemblies.

---

## THE BREEDING OF GRAIN SORGHUMS.

CARLETON R. BALL, *Washington, D. C.*

### STATUS OF THE SPECIES.

*Present View.*—It is now generally acknowledged that all the numerous cultivated varieties of sorghum belong to a single subspecies, *sativus* Hackel. It is further held that they have been derived in the lapse of centuries from somewhat parallel variations in the spontaneous subspecies, *halepensis* (L.) Hackel, represented in this country by the well-known Johnson grass of the South. These two subspecies together comprise the species *Andropogon sorghum*. This opinion forms, as it were, the apex of a nomenclatorial pyramid of widely differing views.

*Progressive Development of this Idea.*—About a century and a half has elapsed since the adoption of the binomial system of botanical nomenclature. In that period four distinct conceptions of the botanical status of the numerous wild and cultivated forms of sorghum have been held. These four ideas were developed in somewhat definite succession, though their periods of dominance overlapped. In them sorghum forms have been regarded as: (a) Distinct botanical species;

(b) subspecies and varieties of two distinct species, one the wild *A. halepensis*, the other the cultivated *A. sorghum*; (c) subspecies and varieties of a single species, including both *A. halepensis* and *A. sorghum*; and (d) agricultural varieties of a single botanic species.

The wild subspecies is found abundantly in all tropical and subtropical parts of the Old World. Its varieties are numerous, and their main lines of variation are parallel with those represented in the major groups of cultivated forms. This is especially noticeable in comparing the forms assumed by the wild and the cultivated plants in Africa and to a lesser extent in India also. It is thought to indicate the origin of different cultivated groups from somewhat parallel variations in the wild subspecies. It is also evidence of an independent origin of cultivated sorghums in the two continents.

#### PHYSIOLOGICAL FACTS TO BE NOTED.

*Cross Fertilization.*—All sorghums are adapted to open or wind pollination, and most of them are probably equally adapted to self fertilization. Just to what extent cross fertilization takes place under normal field conditions it is, of course, impossible to say. However, in the case of adjacent rows of different varieties flowering on approximately the same dates, as high as 50 per cent of the seed produced by the leeward row has been found to be cross-fertilized. It is probable that in a fairly uniform field of any given variety a similar percentage of natural crossing takes place. Many writers have stated that such cross pollination occurs also at very long distances, but this seems to be less conclusively proved. Probably a distance from 8 to 10 rods to leeward is the maximum at which appreciable hybridization occurs. In the Plains region, where sorghums are largely grown and where constant diurnal southerly winds are the rule, the greatest proportion of cross fertilization is experienced. The injury from this source would doubtless be still greater than it is but for the fact that most of the pollen is shed during the early morning hours, when the winds are usually of lower velocity than during the day.

*Extreme Variability.*—The range of variation in different groups and varieties—seen particularly in the size of the vegetative parts, in the coloring of the glumes and seed coats, and in the size and shape of the grain—is fully as great as and probably greater than in the case of any other cereal group. This variation is doubtless due to the ease and frequency of cross fertilization, as well as to the great antiquity

of cultivated sorghums, dating, as they certainly do, from the most remote historic times.

*Vegetative Vigor.*—As we have seen, sorghums are of tropical origin, and, like many annual tropical grasses, they have a natural tendency toward great vegetative vigor. This is shown, first, by the great size which many of them are known to attain in their native homes; second, by the extreme vigor of growth shown by nearly all forms when first introduced into the United States, even in semiarid regions; and, third, by the enormous size always developed by some of the resulting forms in cases of cross pollination, even though both parents be of small stature.

*Susceptibility to Improvement.*—As a corollary to the preceding observations stands the great susceptibility of these crops to selective improvement. That this has always been true may be inferred from the wide range of uses to which we find the sorghums adapted in their native lands and among more or less primitive peoples. Four entirely distinct products are commonly secured from specialized groups of sorghums, viz., grain, forage, saccharine juice, and brush. In the forage groups the plants are variously used for pasture, soiling, silage, fodder, or hay. In certain countries the culms and leaves are used for thatches, fences, baskets, etc., while both stems and roots serve as fuel. It must be remembered that in Africa, India, and China practically all varieties are grown for human food.

#### STRONG ECONOMIC FACTORS.

*Drought Resistance.*—To this factor more than to any other the sorghums owe their widespread cultivation in the United States, especially in the western portions, and in similar regions of other lands. In just what this drought resistance consists is not surely known, but there can be no doubt of its existence. It is probably due to a combination of at least three causes and perhaps more.

First of all stand its adaptations for reducing transpiration. These are the close involution of the leaves under conditions of extreme drought, and probably, also, the waxy, powder-like secretion found on the stems and sheaths where no involution of epidermal surfaces is possible. These adaptations enable sorghum crops to remain dormant during comparatively long periods of drought and to resume to a greater or less degree their normal growth when the unfavorable conditions have been removed.

The second cause is the lower water requirements of the crop in comparison with other crops having a similar habit of growth, such, for instance, as corn. By this is meant the ability to produce a maximum weight of grain upon a minimum weight of plant. Whether there is present also the ability to produce a ton of dry matter with an actually smaller tonnage of water than other crops require is another question and one not yet answerable. Of the first fact, however, there seems little doubt.

In the third place, there is a possibility that sorghums possess superior drought resistance by reason of superior ability in the mechanical extraction of capillary moisture from the soil particles. There are, however, no proven facts to substantiate this theory.

*Disease Resistance.*—There are two great groups of fungi which are the especial scourge of cereal crops, viz., rusts and smuts. The grain sorghums apparently possess a high degree of immunity to injury by rusts. Only one species of rust, *Puccinia sorghi* Schw., is known to occur on sorghums in this country, and the injury it inflicts is so slight as to be entirely negligible from the economic standpoint. Two species of smuts, the kernel smut (*Sphacelotheca sorghi* (Link) Clinton), and the head smut (*Sphacelotheca reiliana* (Kuhn) Clinton), are prevalent throughout the sorghum-growing regions of the whole earth. In this country a very large amount of damage is done by the first species, which, fortunately, is easily controlled by the hot-water treatment.<sup>a</sup> It is known to affect all the groups of domestic sorghums except milo. The resulting loss in the seed crop sometimes runs as high as 50 per cent, while a loss of 10 per cent is oftentimes quite general throughout a community. The head smut also affects all crops except milo. It is not yet of widespread occurrence in the sorghum region, which is the more fortunate in view of the fact that no successful treatment for it is known.

The cause for the peculiar immunity of milo, dwarf milo, etc., to both species of smuts is wholly unexplained. That they are immune, however, is a well-known fact and an important one also, because of their high value as grain-producing varieties, and because of the hope which it gives that smut resistance may be developed in other groups than milo.

<sup>a</sup> Freeman and UMBERGER, The Smuts of Sorghum. U. S. D. A., Bu. Pl. Ind., Circ. 8, 1908.

*Adaptability.*—Grain sorghums possess qualities which adapt them to use in a variety of ways and under widely differing conditions of soil and climate. Their extreme range of variability in stature and in time of maturing, the causes for which have been previously mentioned, are of the greatest value and promise to the breeder. Early strains have been produced for use in high altitudes and latitudes with a consequent short growing season, or for the farmer who would follow them with fall-sown crops. Dwarf varieties are now in hand for the wheat raisers who would harvest them with the grain header. Heavier and later varieties exist for the man who has a long season and the need for a combined grain and forage crop. They are adapted to growing in windy regions without loss by lodging. They are cultivated crops for use in rotations where clean tillage is desired. This especially adapts them for use in semiarid regions where methods of moisture conservation are the chief care of the farmer.

*Productiveness.*—One of the strong points in favor of grain sorghums is their comparative productiveness in the regions in which they are so largely grown. Their grain-yielding ability is indeed remarkable in view of the short time since their introduction and the low yielding power of many of them in their native homes. It is only about thirty-five years since the first grain-producing varieties reached the United States. Two durras were imported in 1874, two kafirs in 1876, and milo about 1885, less than a quarter century ago. The kafirs, however, did not come into general cultivation until a little more than twenty years ago, and milo at even a later date. The kowliangs are of very recent introduction. It is thus seen that these grain sorghum groups have been under scientific selection and improvement for periods of from three to no more than thirty years, and yet in that time they have been redeemed from some of their most glaring faults and made capable of average yields varying from 25 to 50 bushels of grain per acre.

#### CHARACTERS NEEDING IMPROVEMENT.

*Pendent Heads.*—The pendent or goosenecked heads, common in the durra and milo groups, are an especial nuisance. They not only prevent the satisfactory use of any type of header in harvesting the grain, but they are in an awkward and dangerous position to cut by hand. It is a common sight in the milo belt to see men at work with one or more bandages covering wounds on the left hand, made by the

knife while cutting heads from recurved peduncles. This recurved stem is also an objection where the whole stalk is cut with the corn binder or grain binder. It prevents the stalks from lying parallel when cut. It frequently interlocks with adjacent stems so that they can scarcely be separated in field or shock. It also makes the tops of the bundles wider than the bottoms, thus forming shocks that will neither withstand wind nor turn water. The heads are normally erect in all kafirs, kowliangs and shallu, as well as in some durras.

*Shattering of the Seed.*—This fault was so characteristic of the two durras first introduced as to practically drive them from cultivation in spite of their splendid drought resistance and extreme earliness, both most valuable qualities. The shattering habit does not yield readily to selection. Fortunately it is not present in milos, kafirs, or kowliangs.

*Incomplete Exsertion of the Heads.*—Serious loss is occasioned by the failure of the head to become completely exserted from the upper sheath. The included base usually becomes infested with plant lice, corn worms or false army worms, and finally becomes moldy and rotten. A twofold damage results, first, the loss of the seed on the basal portion of the head, and, second, the loss of often larger quantities of seed through contact in shock or bin with this decayed matter. In none of the grain-producing groups is the head normally exserted more than two or three inches on the average. The kowliangs have the greatest average exsertion, the kafirs the next greatest, and the durras and milo the least. White kafir, the variety earliest grown in this country, has been entirely discarded because it ordinarily failed of complete exsertion. In the milos and many of the durras exsertion is accomplished, not by actual projection of the head above the apex of the sheath, but by a lateral bending or inclination of the peduncle which forces the head out of the open side of the sheath. In this case the strongly inrolling margins of the firm sheath often retain a hold on the side of the panicle, with the same results already noted in normal inclusion of the head.

*Production of Suckers and Branches.*—There is in all sorghums an inherent tendency to stool or throw out suckers from the base of the stem. In cereal crops this is usually considered a desirable character because it enables the grower to secure the maximum number of stalks from a minimum quantity of seed. It also enables nature to compensate in some measure for a poor stand. The same effects are



secured in the case of sorghums. The question is, then, whether or not these effects are desirable. In the judgment of the writer they are not, for several reasons. First, the quantity of grain-sorghum seed required to sow an acre is so small that there is little need to economize in its use. Second, however it may be regarded in small grains, the later ripening of the heads on sucker-stalks can be considered only as a distinct disadvantage in grain sorghums. Early and uniform ripening is very desirable in these late-sown spring crops in order to insure escape from frost, as also for other reasons. Third, suckers do not usually grow as tall as the main stalks, which is a serious matter in tall crops designed to be harvested with any type of header.

Branching from the upper nodes is quite unknown in small grains and quite rare in corn, but fairly normal for sorghums, at least under certain conditions. It is most pronounced in humid climates or in humid seasons in dry climates. It commences at the time when the main head is nearly but not quite mature, and is a very objectionable habit. The first branch appears at the first node below the one bearing the main peduncle, the second branch a little later from the next lower node, and so on in regular sequence. This production of branches retards the ripening of the main crop of heads, makes the plant top-heavy and liable to lodging, causes difficulty in harvesting by any method, and endangers the keeping quality of heads or seed in bulk, through the introduction of unripe material.

*Tannin Content of the Seed Coats.*—Small quantities of tannin are normally present in the seed coats of all brown or red seeds. The quantity varies with the stage of maturity and with the variety. Immature seeds contain more than ripe seeds. The seeds of the sorgos or saccharine group and of brown durra contain the largest quantities, the brown kowliangs the next largest, and red kafir and the milos the least. White seeds contain practically none at all. It is probable that its presence causes damage through rendering the seed less palatable rather than through any ill effect produced by the astringency.

*Irritating Hairs.*—The glumes of many varieties are more or less densely clothed with short hairs which are exceedingly irritating to the skin, especially when it is wet with perspiration. The kafirs and kowliangs have small glumes only thinly hairy and cause little trouble. The milos have longer glumes but these are only thinly clad. The durras, on the other hand, have large glumes and a dense pubescence

which makes their threshing an exceedingly uncomfortable task. This objection is perhaps only a minor one, but seems worthy of attention by breeders. All the kowliangs and milos, as most of the durras, have small, bent, and twisted awns attached to the lemmas (flowering glumes). None of the kafirs is thus provided. These awns also add to the mechanical irritation suffered by workmen at threshing time and seem to serve no useful purpose.

#### SECURING FOUNDATION STOCKS.

*Importation of New Forms.*—As already indicated, sorghums are extensively cultivated by native peoples throughout Africa and in considerable parts of India and China. Our few domestic varieties have all come from those sources within the last 35 years. Importations within the last 10 years have numbered more than 600 separate lots of seed, consisting almost wholly of forms used for grain production by the native growers. Many of these importations seem to be wholly unsuited to use for any purpose, under our climatic conditions and methods of farming. Many of the remainder show little indication of value as grain producers. However, a small number of promising new varieties are now being developed from them. Among these are several kowliangs from Manchuria and North China, one or two new kafirs from southeast Africa, one or two durras from India, and at least one durra from the Sudan. It is quite probable that in this and other little-known parts of Africa there exist varieties awaiting our discovery which will prove even more valuable than any we now possess.

*Selections from Domestic Fields.*—Here is the most likely source of material for the breeder. These crops are such recent additions to American agriculture and so little known to the body of plant improvers that some of their most valuable characters or tendencies may easily have been overlooked. They are naturally so variable that a field presents numerous opportunities of founding new strains by selection from its component forms. In this way the writer has founded his dwarf or "baby" strains of milo and blackhull kafir, and is now fixing similar forms in other varieties. So, too, have been produced the varieties of durra and milo with erect heads.

*Hybridization.*—As we have seen, sorghums cross naturally with the greatest readiness and have doubtless been originated in their present forms largely through this agency. Crossing to obtain certain

desirable combinations of characters will probably prove one of the most fruitful fields of endeavor in the line of sorghum breeding, although a period of several years is likely to be required for fixing hybrids in forms suitable for profitable use. The writer has a number of third and fourth-generation hybrids between members of two different groups which are producing fairly uniform plats of desirable character.

#### PLANS FOR BREEDING.

The widespread need and demand for varieties of immediate value on the farm is so insistent as to leave little time for any survey of the broader scientific aspects of grain-sorghum breeding. The work has therefore been almost wholly confined to the strengthening of desirable qualities and the elimination of undesirable ones. Along these lines the work will need to proceed for many years to come.

The essentials of such breeding are to determine the lines of improvement needed; to recognize lines of variation in the plant which parallel this need; and to fix these variations in the improved crop. The chief desirable qualities or characters to be secured in grain sorghums are productiveness, earliness, dwarf stature, erect peduncles, exserted heads, seed-holding power, drought resistance, disease resistance, freedom from suckers and branches, absence of hairs and awns on the glumes, and absence of tannin in the seed coats.

In these breeding experiments the head is commonly regarded as the unit, although, of course, this is not true unless cross pollination from adjacent stalks of the same variety has been prevented by artificial means. As many seeds from the selected unit-head as may be desired are used for planting the breeding plat, which may be any desirable or convenient unit of area. From this plat are selected the heads from plants most closely complying with the requirements of the purpose for which selections are being made. Each head so selected is made the basis of a new breeding plat in the succeeding season. If strict inbreeding is to be practiced, the heads to be used must be bagged as they begin to emerge from the sheath, in order to prevent cross pollination. If cross pollination within the limits of the breeding plat is desired, it is necessary only to insure that pollination from adjacent plats does not occur. Selections for earliness should be made at the time of heading and verified at the time of ripening. Other selections are made principally at the time of maturity.

## TESTING PROGENY.

The method of measuring breeding results must vary, of course, with the purpose for which the plant is bred. Other things being equal, determining the results of selections for earliness is a matter of dates of planting and ripening. Improvement in productiveness is shown by yields and in dwarf stature by inches of height. The test of elimination of branches, suckers, recurved peduncles, and included heads is a mere matter of counting totals on units of area. Always, however, this depends on "other things being equal." But other things never are equal in experimental work. Seasonal variations and soil variations together utterly prevent such a happy result, by their influence both on the stand and on the growing crop. Obviously, the rate of annual improvement cannot be measured except by taking the average of results secured in a series of years. Properly, a portion of the selections made in all previous years should be grown adjacent to the selections of any given year. In this way a series of plants of different degrees of improvement would be growing side by side each year, subject to approximately the same conditions of environment and affording a fair indication of the annual progress being made. However, when a large series of breeding experiments is under way and is being continued through a number of years, it is manifestly impossible to duplicate them in this manner each season, even on a very small scale. Considerations of time, money, and available land ordinarily prevent.

## SOME PROBLEMS TO BE SOLVED.

In conclusion, I submit a few questions for the consideration of investigators and plant breeders.

1. At what distances does cross pollination take place under different conditions, in different sections of the sorghum belt?
2. In what does drought resistance consist?
3. How may inherent drought resistance be determined and increased where no strongly resistant sports are found?
4. Are sorghums able to produce a ton of dry matter with the use of fewer tons of water than other grain crops?
5. In what does disease resistance reside, and how is complete smut resistance of milo to be explained?
6. Is the production of suckers a desirable or an undesirable character in grain sorghums?

7. What causes the recurving of the peduncle in some varieties?
8. Is there reasonable hope of successfully growing grain sorghums drilled like small grains or millets, and harvested in the same manner?
9. Do awns and glumal hairs serve any useful purpose which will be defeated by their elimination?
10. Should selections for earliness be made at the time of heading or at the time of ripening, or both?

[Presented by Committee on Breeding Cereal Crops.]

---

## REPORT OF COMMITTEE ON BREEDING COTTON.

D. N. SHOEMAKER, *Chairman, Washington, D. C.*

The most disturbing factor in the whole cotton-growing industry continues to be the steady advance of the Mexican boll weevil. The necessity for breeding of earlier types of long-staple upland cottons has reached an acute stage, because the region where most of this cotton is grown has been invaded, and is now infested sufficiently to make a scarcity of this type of cotton. So far the damage resulting from the weevil has been greater in this humid region than in the drier parts of Texas.

This crisis is being met in two ways: First, by the use of Columbia cotton, a variety originated by Dr. H. J. Webber, by selection from Russell's Big Boll. Columbia has attained great prominence in the long-staple region in Mississippi, since it is earlier than the varieties now grown. Second, by the introduction of a variety with long-staple which is still earlier. This variety, which has been named the Foster cotton, is yet in its infancy but it is in great demand. It is a cross between Sunflower cotton, an old-time long-staple variety, and Triumph, an early big-bolled, short-staple variety.

The Department of Agriculture is this year making a distribution of a new variety of cotton for Texas conditions, which has been called Troom. It is early, large-bolled, very productive, and with a very high percentage of lint. It is a cross of Triumph on Cook's Improved, the later variety being an eastern big-boll cotton with a high lint percentage.

Mr. O. F. Cook has a strain of Mexican cotton from the state of Durango which showed very favorable results in a number of plantings in South Texas in 1909. This cotton has lint about  $1\frac{1}{4}$  inches long, and is early and productive.

The wilt-resistant varieties distributed by Mr. W. A. Orton for the eastern cotton region are giving excellent satisfaction to those regions where this disease is a serious factor in cotton production.

Since cotton is an open-fertilized plant the question of the amount of crossing becomes very important for the breeder. It is a subject which has been too much neglected in the past. The amount probably varies with localities, and with seasons, and may be different with different months of the same year, depending on the variations in the insect fauna. For this reason experiments should be planned in many places, and for more than one year.

Two papers are presented this year bearing on this subject, one on conditions in northern Georgia in 1908, and one for central Texas of the same year.

These results are not entirely comparable, but both indicate a considerable amount of crossing. It is planned to have other experiments ready for report at our next meeting.

# EDITORIALS

When in 1906 the American Breeders Association created its Committee on Eugenics the orderly study of eugenics was comparatively new, so that no clearly defined plans existed for studying it on a comprehensive scale. That committee has gradually developed plans and enlisted efficient workers to fix in the public mind the fact that this is both a proper and profitable line of inquiry. To this end attention has been directed to those larger phases of the subject which are wholesome and normal, and the efforts of those interested in eugenics will be to guide the discussion along the wholesome lines of thought in relation to the questions of heredity in the family.

**Study of  
Eugenics  
New.**

The men who have become leaders in this movement within the Association are an earnest of the conservatism and care with which this matter will be treated. Those persons who are constantly coming forward with new theories regarding such mooted questions as the control of sex will find opportunity to present any facts they may have to those officers and committeemen who are from time to time in charge of the Association's activities in relation to eugenics. But that which the Association will choose to make public along this line will be considered with the greatest care. Many of the papers with more definitely presented relations will be published only in the Annual Report. The *Magazine* will deal with the more general and popular phases of the subject. The leaders of this movement request a period of investigation and that the period of teaching may not be begun too soon. Those persons who are interested and are willing to wait for substantial results will be happy in their association with the scientists who under the auspices of the Association courageously enter upon a broad study of heredity for betterment in man.

**Conservative  
Workers.**

**BREEDING, RESEARCH, AND EDUCATION.**

The improvement of economic plants and animals by breeding is most closely associated with our institutions of research and education.

**Public Aid to Breeding.** Not only is much of the science of heredity and breeding wrought out by those institutions, and not only are the men who do the work of creative breeding trained in our educational institutions, but our departments of agriculture and agricultural experiment stations foster and direct much of the actual work of creating new varieties and breeds.

The United States Department of Agriculture is especially active and helpful in introducing from other countries, and from one State to another, species, varieties, and breeds which may prove useful in new locations. Both the United States Department and State experiment stations are developing men trained in the science and experienced in the art of selective breeding and of making hybrid varieties and breeds. And these workers are gradually assembling and testing the varieties and breeds which have the most valuable characters needed to be recombined in varieties and breeds designed best to serve the needs of each local condition. Our public research and educational institutions have assumed the responsibility, (1) of developing a science of breeding, (2) of cooperating with private individuals and institutions in assembling the best obtainable species and varieties needed for creative breeding, (3) of assisting in the actual work of creative breeding, (4) of aiding in testing and distributing valuable new breeds, and (5) in educating men for public and private efforts in creating improved plants and animals.

**Private Breeders.** The vast bulk of the actual work of variety and breed improvement, whether by simple and expeditious methods of selection, or by complicated hybridization followed by long-continued selection, must be done by private enterprise. While the public work should and will be rapidly increased it will be somewhat closely confined to research and education, and to cooperating with private breeders and with semipublic cooperative breeding enterprises. There will be a very strong temptation to nations, States, and institutions to assume the more commercial parts of this work. But, as in case of railway government, where the tendency is for public supervision of privately owned railways, so the general trend of thought in America is for private parties to own the plants and the



animals; the public to provide only supervisory and cooperative help. This plan can not be adhered to rigidly; for to do so would often place restrictions and limitations which would retard progress. On the other hand, vocational education promises to prepare farmers to cooperate much more effectively than now. With the rise of successful cooperation, farmers are more than ever ready to insist on individualism in the ownership of the family farm, and they would be loath to turn over to public management and competition such a branch of farm business as the remunerative and enjoyable business of breeding and growing pure-bred animals, seeds, and plants.

The estimate stands unchallenged that by breeding the plant and animal products of the United States can be increased \$500,000,000 annually, and the farm products of the world several billions. This would warrant that our research and educational institutions devote much effort to develop the science of heredity and to devise improved plans of breeding, and to train a large class of men to work under public auspices and privately as breeders of plants and animals. The research work in the United States Department of Agriculture, in State experiment stations, and in such institutions as the Carnegie Institute for Research could appropriately be multiplied several fold.

This is also a most fascinating field of research for men with an income who wish to do a vital service as amateur researchers and breeders. In many cases these amateur investigators associate themselves with some department of agriculture or experiment station, or with the research laboratory of a university, with mutual advantage. The association of this practical and fascinating work with the university or agricultural college is of vast benefit as a source of information, inspiration, and help to students who are ready to choose a vocation, in self directing their life work. It is not likely that the demand for men trained in research in heredity or in the work of creative breeding, or in practical breed, seed or plant production will soon be overdone. There is room and remuneration for trained men, as well as ample room for men who are able and prefer to establish a private business, or to do research work at their own expense.

**Extensive Research  
and Teaching.**

It would seem that the Federal and State governments are doing well in carefully building up plans for the employment of limited sums of public money to develop cooperations—not corporations—for the general and creative breeding both of plants and animals. The cow-testing associations, the community ownership of breeding males, circuit associations to develop centers of the most efficient blood of certain breeds and to create therefrom more valuable new strains, are all forms of this general movement. Wide-open opportunities for increasing the values of our products by all these means are known to exist on every hand. And the need of public officers charged with the administration of public funds to build up the science of heredity, to devise improved methods of breeding, to assemble needed foundation stocks of plants or animals, to do selective breeding, or to make hybrids and to select from them, to assume the leadership in large enterprises which several years ago seemed over-ambitious, and also to multiply and distribute any resulting improved varieties and breeds, is becoming more imperative year by year. And men of genius and of organizing ability are learning that there are large and enticing fields of endeavor in the science and practice of breeding plants and animals, beyond the dreams of a decade ago.



The work of creating improved varieties or breeds is annually being made plainer and easier. On the other hand, plant and animal introduction has become a most fruitful branch of plant and animal improvement. The introduction into each region of all forms likely there to be of especial value, and placing them in such rigorous long-time tests that their true economic place may be determined, is becoming a large project. Whenever for this purpose public funds are intelligently used in cooperation with private growers a great service is rendered.

The farmer of each region should know which varieties of plants will yield the most per acre on each kind of soil, under each successful cropping and fertilizer scheme; and which breed of live stock will help the crops add the largest profit per acre; and he should also know which scheme of cropping, and which plans of uniting crops and live stock in systems of farm management, will give the largest net returns per acre and per worker. And an abundance of products is necessary,

not only to make profits for the farmers, but also to supply cheap raw products for the food and clothing of non-farmers.

When each region has secured many of the plant varieties and animal breeds for production in that region, highly trained and skilled men should be privately and publicly employed in creating from them new varieties and breeds of still higher power to aid in producing large net values per acre and per farm worker. These men will need not only the best and most practical standard varieties and breeds as bases for their work, but they need also any others which may have useful unit characters, which may be recombined by hybridizing with the best qualities of the standard varieties and breeds. Thus standard varieties which may lack in some essential point by hybrid or cross breeding, followed by most rigorous selection, may be made into still better kinds of plants or animals.

Creative breeders should have the organized, cooperative assistance of growers of pedigreed plants and animals. Plans are needed for wide cooperation between the Nation, States, associations, cooperative breeding organizations, firms, and private individuals. In no other field of agricultural expenditure will a dollar make so much profit as in general cooperation in scientific breeding, to create new varieties and breeds. Once a new value is created by breeding, further expenditure is avoided; while in the case of fertilizers, deeper plowing, more frequent cultivation, though these are profitable, the expense recurs annually.



*Clonal varieties* of species of plants are propagated vegetatively. The new variety is based on a single seed producing a single plant—  
**Clonal Varieties.** as the apple, by grafts and buds; the potato, by tubers; and the strawberry, by runners. The variety is, so far as heredity is concerned, made up of vegetative parts of the one clonal parent plant. The variety is the asexual progeny of a single seedling plant. "Clonal" breeding is therefore simply the search for the remarkable seedling mother plant, not remarkable for her power to project efficiency through sexual breeding, but of remarkable varietal value when cut up into many plants, valuable for her asexual progeny. Public breeding stations, nursery firms, seed firms, and private individuals, working separately or collectively, are thus creating many varieties. More public funds with which to bring about better organization of

cooperation would enable the public to induce more private efforts. Two controlling factors are the employment of immense numbers, and intelligent tests to assure finding the one desired mutation in many plants, often in many thousands of plants. And since the new variety very soon becomes public property, the use of public money is more than justified in choosing the necessary tens and hundreds of thousands of seeds; in growing a plant from each seed; in choosing the most promising plants; in growing and testing a clonal centgener plot of the progeny of each of these best individuals, thus to determine which produces the best variety; and, finally, in disseminating those very few clonal stocks which represent the largest varietal values.



In creating *self-pollinated varieties* the new variety is based on a single seed, in this case producing a single many-seeded mother plant, each seed the result of pollination by the same floret. There is nearly as little breaking up from seminal variation as in clonal varieties; there is no adulteration by the admixture of pollen from other plants; and therefore the progeny of the one mother plant are all very much alike. Here again the work consists in finding the remarkable mother. But in this case the value must be transmitted through its seeds. The mother plant must possess the power of projecting high yields and values per acre through the generations of her progeny. She does not need to be prepotent, because no new blood is introduced. And the experience of many breeders has proven that only one of these highly efficient self-pollinated mothers is found in thousands or tens of thousands of plants.

The breeder of wheat, for example, passes through the field of wheat, and by picking one choice head out of a thousand he makes his first selection. These are weighed and the 10 per cent of the lot which have seeds of good quality and weigh heaviest are retained. These choicest heads are so planted that a short drill or hill row is grown from each head. When the crop is ripe the breeder throws out half or more of the rows, retaining only those which appear to be heavy yielders. Seed is separately saved from each stock, that the blood of each mother may be separately tested. The third year a longer drill row, a hill row, or a hill plat of a specific size is grown of the grandchildren of each mother plant, and the quantity and quality of

each of these newly born varieties is determined. Some which are poor in yield or quality are discarded. Chemical and flour-making tests are also made. In the fourth year the great grandchildren are grown in similar plats, and in the fifth year great-great grandchildren are grown in plats. Any varieties which come through all these tests with a high score are taken the sixth, seventh, and eighth years into field-test plats. The one or more very best varieties are now subjected to more rigorous tests in the mill and are subjected to field trials on experiment grounds in many sections of the country. In outcome the first trial of this kind was significant. The expenditure of \$10,000 resulted in a new variety which has already covered 5 million acres of wheat land with a crop of 2 bushels per acre larger than the mother variety which it is displacing, and is extending to other areas and other countries.

If the expenditure had been \$100,000 the result might have been a variety which would add 5 bushels per acre to our ridiculously low wheat yields. Expenditures which, as straight business propositions, return more than a million for a thousand can not be urged too enthusiastically. It costs relatively little to discover and conserve billions of dollars worth of heredity in our plant and animal forces.

In creating new varieties of open-pollinated plants we have yet another condition. Here the new variety can not be made from a single mother plant. The mutating plant can not simply project its efficiency in yield, quality, hardiness, etc., without interference. The pollen of another plant must be used in those plants which are accustomed to open pollination, and the mutating mother plant must project her unusual qualities forward through the progeny in spite of the other blood. She must be dominant in the vital characters, and the breeder must select the individual progeny in which desired dominants exist. Individually the word prepotency expresses the idea. But collectively we can not express the matter so simply. There must be dominance and the dominants must be segregated by selection, thus to secure as nearly as may be the recombination of peculiar and mutating values from the one or more remarkable mother plants in which arose the newly created values.

In the classic statement made to the American Breeders Association in 1907 by Prof. C. L. Williams, of Ohio, on breeding corn, methods are clearly portrayed for discovering what are and what are not mutating mother plants, and for discarding the blood of all mother

plants except that which makes good in the cross-pollinating network of descent which we call the new variety. These statements are not exactly easy reading, but once understood are as clear as mathematical processes, and they are eminently practical. And that Professor Williams and his associates are working out the faith that is in them is shown by the fact that they have organized a corn breeders' association in nearly every county of Ohio, with thousands of breeders producing pedigreed corn according to the Williams plan. They are striving to add 10 bushels of corn to the yield per acre in the State. That additional yield on Ohio's 4,000,000 acres would be worth \$20,000,000 annually. No matter if it is difficult, and not a simple one-man matter, as in the breeding of the clonal varieties of apples, or in breeding self-pollinated varieties of wheat. As a matter of fact, the bond of union among several thousand corn breeders, the general experience and pleasure these men get out of the work, and the training in doing something well are worth the cost. Practically speaking, the \$20,000,000 of added annual value of corn crop when it comes will be all real gain. The day has passed when plant breeders were scoffed at for assuming to talk in big figures when recounting the achievements and possibilities of this most creative of all work. Scientific breeding is a rapidly growing force in the production of food and clothing.



Comprehensive and effective creative work in animal breeding can not be done very rapidly nor with small expenditure. Here, as in corn and other open-pollinated plants, the blood of the mutating animal can successfully be used as the basis of a new breed only by a more or less complex route. Often inbreeding is resorted to with advantage, greatly lessening the amount of selection necessary to get the desired dominant characters segregated out into a network of descent which will project forward the desired result. Williams's corn breeding formulary contains basic philosophy which is applicable to creating new breeds and strains in live stock as well as in open-pollinated plants. And this is the very philosophy followed by such men as Cruikshank in creating Cruikshank Shorthorn cattle, Gentry in creating Gentry Berkshire swine, and many other breeders in

**Creating and  
Improving Breeds  
of Animals.**

creating new families and breeds. It was left to the genius of Williams to write this philosophy in the language of science.



The mutation theory of De Vries grows in practical importance with each passing year. Our problem in simple selection in producing clonal and self-pollinated varieties of plants consists in reducing to a fine art the seeking out of mutations and in carrying them forward till they have proven their peculiar economic worth over the very many others which must also be segregated and tried, that the best may have shown its superiority. When the selection is preceded by hybridizing we make added progress over simple selection in two ways. By recombining we can secure in one variety some choice of the most desirable of the qualities previously existing separately in two or more varieties. This selection can be more or less formal. By seeking for mutations incited under the conditions of the newly hybridized blood, there is range for the discovery of even more pronounced mutations than may be found under either parent variety or breed. Mutations are of all degrees of excellence. Only the occasional mutated character is along desired lines. The natural combination of a sufficient number of mutations in a given plant or animal to give all-round development is rare. Often many trials are necessary to recombine a mutated quality so as to combine it into an otherwise excellent network of descent. But we have only begun to develop the science, the technique, and the art of working up and segregating those networks of descent which yield the largest returns in quantity, quality, form, color, action, and even in mentality.

**Mutation Theory  
Most Valuable  
in Breeding.**

# NEWS AND NOTES

At Cold Spring Harbor the Eugenics Record Office was opened October 1, 1910. This office is under the general direction of Dr. C.

**Eugenics Section.** B. Davenport, secretary of the section, and under the immediate superintendence of Professor H. H. Laughlin. An office for correspondence has been fitted up and a fireproof vault, 14 by 18 feet, is being constructed. At present the Record Office maintains six workers in the field studying the pedigrees of families either in connection with or independent of institutions for defectives. These are Miss Danielson, Miss Saidee C. Devitt, Mrs. Dranga-Graebe, Miss A. B. Eaton, Dr. A. H. Estabrook, and Miss Helen Reeves. The data obtained by these field workers and, through the courtesy of the directors of the institutions at Vineland (Professor E. R. Johnstone) and at Skillman (Dr. David F. Weeks), New Jersey, by other field workers not supported by the Record Office are sent to that office to form part of a universal heredity record that will be of value for the study of defects and their transmission through successive generations.

The aid of the Record Office is also sought by institutions which wish to secure field workers. It has already supplied one institution, and part of its function is to train field workers to meet the demand. It is anticipated that, in the near future, all of the larger institutions for defectives will regard it as part of their work to maintain a field worker who shall study family histories at the homes of the patients.

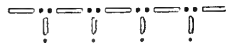

**Meeting of the Eugenics Section.** Members of the committees of the Eugenics Section, together with invited friends, met at the New Jersey State Village of Epileptics at Skillman, N. J., on Friday, October 14, 1910, at the invitation of the superintendent, Dr. David F. Weeks, and upon call of the secretary of the section. The purpose of the meeting was to give the field workers of the Eugenics Record Office and those employed by the other institutions an opportunity to get together with those who are directing the field



studies and to compare notes over common difficulties and methods. Actually the meeting had a far wider scope, both because well-known alienists, physicians, psychologists and heads of institutions from different parts of the United States were present and because several scientific papers of importance were read. Since Dr. David Starr Jordan, chairman of the section, who had just arrived in New York from Europe, could not be present, there was chosen as chairman of the meeting Mr. Bleecker van Wagenen, a layman well known for his devotion to the work of public institutions in New Jersey. Professor E. R. Johnstone, superintendent of the Training School at Vineland, was chosen secretary. Among the others present were Dr. George B. Wright, New Jersey Commissioner of Charities and Correction, Trenton; Dr. Henry A. Cotton, superintendent of the New Jersey State Hospital at Trenton; Dr. Everett Flood, superintendent, Monson State Hospital for Epileptics, Palmer, Mass.; Dr. William T. Shanahan, superintendent, Craig Colony for Epileptics, Sonyea, N. Y.; Surgeon George Stoner, U. S. N., in charge of the immigrant inspection service at Ellis Island; Dr. H. H. Goddard of Vineland, N. J., secretary of the A. B. A. Committee on Feeble-Minded; Dr. A. J. Rosanoff, Kings Park, N. Y., Hospital for the Insane; Dr. Madeleine A. Hollowell, superintendent, Institution for Feeble-Minded Women, at Vineland; Dr. P. F. Lange, Institution for Feeble-Minded, Glenwood, Iowa; Ada E. Sheffield, Massachusetts State Board of Charities; Dr. H. G. Schlapp, New York City; F. S. Hammond, State Hospital, Trenton; Mrs. Elizabeth V. H. Mansell, N. F. Dullard, C. Cromwell of the State Home for Girls, Trenton; Benjamin H. Crosby, New Jersey Reformatory, Rahway; Professor H. H. Laughlin, superintendent of the Eugenics Record Office, Cold Spring Harbor, and Helen T. Reeves and Saidee C. Devitt of the same office; Mrs. Caroline B. Alexander, Bernardsville, N. J.; Catherine F. Bell, Helen F. Hill, Elizabeth Kite, Maude W. Moore, Jane Griffiths of Vineland, N. J., and William H. Schultz, Dr. H. E. Diers, Dr. W. C. Smith, Dr. C. A. Mallon, Prof. J. E. W. Wallin, and Mrs. Woodward of the New Jersey State Village.

After invocation and address of welcome by Dr. George B. Wight, introduced by Dr. Weeks, the following program was carried out:

(1) Demonstration of the Binet-Simon test for mental grading, by Dr. H. H. Goddard and assistant. This demonstrated the value

of this test for determining whether, to what extent, and in what way a person is below (or above) the normal for his age.

(2) Inheritance of Insanity; abstract of a paper by Gertrude L. Cannon and Dr. A. J. Rosanoff, given by Dr. Rosanoff. This showed that (excluding certain types) two insane parents will have only insane offspring and that normal parents, both of whom belong to insane strains, will, in the long run, have one-quarter of their offspring defective.

(3) Inheritance of Epilepsy, by Drs. David F. Weeks and C. B. Davenport, based on studies made on the ancestry of epileptic patients at Skillman, and showing that epilepsy rarely, if ever, arises in families without trace of the defect even if the parents are normal. In most cases, if not all, a mental weakness may be discovered on both sides.

(4) Inheritance of Feeble-Mindedness, by Professor E. R. Johnstone and Dr. H. H. Goddard, of the Vineland School. This was a report on studies made at their institution into the ancestry of the feeble-minded. These studies have been carried on for nearly two years, and in one case a pedigree comprising more than 600 individuals has been obtained, the parents of a large proportion of whom—nearly one-half—are defective. There is good reason to suppose that this collection is not an exceptional case, and needs no comment, even as an economic proposition, as to why defectives should have at least custodial care for life and be restrained from passing on their condition, whether mental, moral, or physical.

Through the courtesy of Dr. Weeks an opportunity was offered to study the workings of the New Jersey Village for Epileptics, which is considered a model institution of its kind. Special tours of investigation were arranged and conducted personally by Doctor Weeks, entirely covering the 800-acre plant. One of the most enjoyable features was the concert furnished by the school band, which is the only one in the world entirely composed of epileptics, and which, although it has only been in existence for seven months, rendered a program requiring accurate knowledge and careful training.

On Friday evening a session was held for the purpose of arriving at standards for field workers. A system of nomenclature was adopted, which will be reported on separately. This was followed by a statement of experiences from field workers. The meeting lasted until late and was followed by an informal gathering at the "Bungalow," so

that it was early morning before the company broke up at the dormitory.

C. B. DAVENPORT, *Secretary*.



The Fourth International Genetic Conference will be held in Paris, September 18 to 23, 1911, and it is to be hoped that America will show its interest in this world's question by being represented in large numbers outside of the official representation of the American Breeders Association. Mr. Philip L. de Vilmorin in a letter of recent date writes regarding this:

The date of the next conference was first to be in May or June of next year. But when many "genetists" met in Cambridge last year for the Darwin celebration, the question was again discussed and we agreed upon the end of September to suit our American friends, because, of course, those interested in genetics, and especially in plant breeding, cannot easily leave America before August and must be back in October.

I know how much interest the American scientists and breeders have taken in genetics and in the practical points of Mendel's law. The breeding of plants, cattle, poultry, dogs, and all kinds of animals has profited by the recent discussion, made for a good part by Americans, and I hope that you will point out the facts to all the members of the American Breeders Association and induce them to come to our meeting, where they will meet prominent men from all over the world and where the scientists will gather to discuss the profound riddles of heredity, and where the practical breeders may find a light to help them in their work.



Mr. Wm. P. Rich, secretary of the Massachusetts Horticultural Society, and Mr. A. W. Latham, secretary of the Minnesota Horticultural Society, have very kindly loaned the half-tones of the portraits respectively of Mr. E. W. Bull and Mr. Peter M. Gideon, appearing in this issue of the *American Breeders Magazine*. The portrait of Prof. J. L. Budd was prepared from a photograph kindly loaned by the family. The editors are greatly indebted to the above named for their cooperation.

C. E. Meyers, of the Pennsylvania Experiment Station, secured a package of Jersey Wakefield cabbage seed from each of twenty-five seed firms and grew these strains in plot comparisons for two years. He found "great difference in earliness, yields, form, and solidity of heads," and "the percentage of germination in some strains was much too low." A study of the tabulated results indicates that this form of variety testing should be widely adopted at public expense as a means of greatly increasing production.

The constant introduction of new varieties and the development of many sub-varieties or strains makes the testing of varieties at public expense practically a necessity. The cost of testing through the cooperation of State and branch experiment stations with growers is relatively small, and the cost represents only a very small fraction of the loss which may come from planting varieties and strains which will habitually yield smaller values than would the best varieties available.

Cooperation between the State and the growers at once makes the growers' business more profitable and reduces the cost of food to those who must purchase the products of the farm.

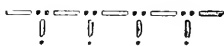

The American Gladiolus Society was recently organized, with a membership of 137, and held its meeting as a section of the American Florists, which convened at Rochester, N. Y. The officers of the society are: President, Isaac S. Hendrickson, Floral Park, N. Y.; vice president, E. H. Cushman, Sylvania, Ohio; corresponding secretary, L. Merton Gage, Orange, Mass.; financial secretary, H. Youell, Syracuse, N. Y.; treasurer, Maurice Fuld, Boston, Mass.; executive committee, Arthur Kirby, 35 Cortland St., New York City; Arthur T. Boddington, 342 West 14th St., New York City; J. K. Alexander, East Bridgewater, Mass.; nomenclature committee, Arthur Cowee, Berlin, N. Y.; Prof. L. B. Hudson, Cornell University, Ithaca, N. Y.; Leonard Joerg, St. James, Long Island, N. Y.

The botanical department of the New Jersey Agricultural College Experiment Station at Brunswick, N. J., is doing considerable work in the study of vegetable breeding. A recent report of 83 pages published by Dr. Byron D. Halsted, chief of the botanical department, is devoted to a record of breeding work and variations in wild plants. The text is abundantly illustrated. The report contains the details of work and results of crosses in corn, squashes, eggplants, tomatoes, peppers, beans, and ornamental plants. In the introduction, the report states that "the desire of originating new sorts of vegetables and fruits is being replaced by a study of breeding, out of which the novelties will come as a by-product of the investigations."



#### Recent Publications and Articles.

The Value of First-Generation Hybrids in Corn, by G. N. Collins, Bureau of Plant Industry, U. S. Department of Agriculture, Bulletin 191, 45 pages.

Production of a New Form in Wheat, by E. G. Montgomery, Twenty-third Annual Report of the Agricultural Experiment Station, Nebraska.

Plant Breeding Studies in Peas, by F. A. Wagh and J. K. Shaw, Twenty-second Annual Report of the Massachusetts Agricultural Experiment Station, Part I.

Variation in Apples, by J. K. Shaw, Twenty-third Annual Report of the Massachusetts Agricultural Experiment Station, Part I.

The Selective Elimination of Organs, by J. Arthur Harris, Cold Spring Harbor, N. Y., *Science*, October 14, 1910.

Information Concerning the Colorado Carriage Horse Breeding Station, by John O. Williams, Experiment Station, Fort Collins, Colorado.

Self Sterility of the Scuppernong and other Muscadine Grapes, by F. C. Reimer and L. R. Detjen, Bulletin 209, North Carolina Agricultural Experiment Station.

#### Publications Received.

Germinal Analysis through Hybridization. George Harrison Shull. Reprinted from Proceedings of American Philosophical Society, Vol. XLIX, No. 196, 1910.

Landwirtschaftliche Studien in Nord Amerika mit besonderer Beruecksichtigung der Pflanzenzuechtung. Prof. Dr. K. v. Ruemker and Prof. Dr. E. v. Tschermak.

Ueber Bedeutung und Methoden der Saatgutzucht. Prof. Dr. K. v. Ruemker, Breslau.

Stand der Deutschen Pflanzenzucht. Reprint from Arbeit der Deutschen Landwirtschafts Gesellschaft. Prof. Dr. K. v. Ruemker.

Native Tropical Fruits. H. A. van Hermann. Santiago De Las Vegas, Cuba.

# ASSOCIATION MATTERS

The Council of the American Breeders Association has decided to hold the Seventh Annual Meeting of the Association at Columbus, Ohio, February 1, 2, and 3. The meetings will be

**The Seventh Annual Meeting at Columbus, Ohio.**

in a room provided by the National Corn Exposition on the Ohio State Fair Grounds. In addition to the three days' meeting, the Association will take a prominent part in the educational work of the National Corn Exposition. Under the auspices of the Association talks on breeding illustrated by lantern slides and moving pictures will be given in one of the lecture halls. The effort will be made at this meeting to materially enlarge the membership of the Association among plant breeders and breeders of live stock. The National Corn Exposition promises to be a most pronounced success; it has been given the use of seven magnificent show buildings on the State Fair Grounds by the State Board of Agriculture.

A strong program for the three days' meeting of the American Breeders Association is being prepared, and it is expected that this will be a large meeting with a splendid lot of committee reports, addresses, and discussions, and papers will be sent in by those who cannot attend. The Secretary earnestly requests members to write to him or to committee chairmen at their earliest convenience suggesting titles of papers they wish to present. Suggestions also of papers which might be secured from non-members, as well as members not on committees, will be welcomed.

The Association has now reached a time when an enlarged membership is an absolute necessity. The *American Breeders Magazine* makes both possible and necessary a membership of several thousand. The Association has won a very strong place in the minds of the technicians, but they are too few in number to support it; the support must come from the active and practical breeders. The National Corn Exposition has kindly set apart Wednesday, February 1, as American Breeders Association Day, and is doing much to give the Association great prominence. Secretary Wilson has been requested to give an

address in the afternoon in the great exposition auditorium. Other brief addresses will be made. Reduced rates on all railroads are expected. The National Corn Exposition is annually expanding and gives promise of developing into a great national country-life society as well as an institution to conduct an annual exhibition. Its two weeks' educational conference will discuss the organization of agriculture in a broad way.

---

Following, is given, in somewhat condensed form, the program of the three days' meeting. There still remain some days before the printing of the program in its final form, and it is not yet too late for members who have prepared papers or addresses to be presented at that meeting to send in titles and request a place on the program. Mail communications to the secretaries of the respective sections or to the office of the Secretary at Washington, D. C.

WEDNESDAY, FORENOON, FEBRUARY 1, 10 to 12.30.

OPENING SESSION. American Breeders Association Day. Meeting held in Exposition Auditorium. Hon. William George presiding.

Report of the Secretary. Hon. W. M. Hays.

Report of the Treasurer. Hon. N. H. Gentry.

Report of the Committee on Finance. Hon. William George, Chairman.  
Appointment of Committees.

Report of Committee on Breeding Cotton. Mr. T. H. Kearney, Washington, D. C., Chairman.

Breeding for Disease Resistance in Cotton. Prof. Samuel M. Bain, Knoxville, Tenn.

Report of Committee on Nomenclature and Registration.

Report of Committee on Prize Competitions.

ILLUSTRATED TALKS. In Special Lecture Room. Separate program.

WEDNESDAY AFTERNOON, FEBRUARY 1, 2 to 5.

GENERAL SESSION. In Government Building. Dr. C. B. Davenport presiding.

Report of Committee on Breeding Corn. J. Dwight Funk, Chairman.

Plot Testing Stations as Judges of Varieties of Corn. Mr. G. N. Collins, Washington, D. C.

Report of Committee on Pedagogics of Breeding. Dean Eugene Davenport, Urbana, Ill., Chairman.

SECTIONAL BUSINESS MEETINGS, 4.20 to 5.

ILLUSTRATED TALKS. In Special Lecture Room. Separate program.

## WEDNESDAY EVENING, FEBRUARY 1, 8 to 10.

GENERAL SESSION. President David Starr Jordan presiding.

Address of the Chairman of the Section, 8 to 8.20.

Address: Heredity of Defective Children. Dr. H. H. Goddard, Vineland, N. J., 8.20 to 9.

Report of Committee on Theoretical Research in Heredity. Dr. H. J. Webber, Ithaca, N. Y., Chairman.

Address: Principles of Heredity. (Illustrated.) Dr. Charles B. Davenport, Cold Spring Harbor, N. Y., 9 to 9.50.

## THURSDAY FORENOON, FEBRUARY 2, 10 to 12.30.

GENERAL SESSION. Government Building. Hon. William George presiding.  
New Business.

PLANT SECTION. Separate Meeting. Dr. H. J. Webber presiding.

Report of Committee on Breeding Nut and Forest Trees. Prof. George B. Sudworth, Washington, D. C., Chairman.

Possibilities of Breeding the Smaller Nuts. Prof. Geo. L. Clothier.

The Possibilities of Breeding Certain Texas Species of Trees for Planting in Warmer Semi-arid Regions. Prof. Wm. L. Bray.

The Influence of Age and Conditions of Trees upon Seed Production in Western Yellow Pine. Mr. G. A. Pearson.

Production and Development of Varieties. Mr. C. R. Keeny, Leroy, N. Y.

Report of Committee on Breeding Cereals. C. A. Zavitz, Guelph, Ontario, chairman.

Morphological Variation in Pure Lines of *Vulgare* Wheats. Herbert F. Roberts, Manhattan, Kansas.

Report of Committee on Breeding Forage Crops. Dean Thomas F. Hunt, State College, Pa.

Report of Committee on Breeding Tree and Vine Fruits. Prof. S. A. Beach, Ames, Ia., Chairman.

Report of Committee on Breeding Tea, Coffee, and Tropical Fruits. Dr. O. F. Cook, Washington, D. C.

## THURSDAY AFTERNOON, FEBRUARY 2, 2 to 5.

PLANT SECTION. Government Building. Dr. H. J. Webber presiding.

Report of Committee on Breeding Tobacco. Prof. A. D. Selby, Wooster, Ohio, Chairman.

Results of Breeding Hybrid Filler Tobaccos in Ohio, 1903-'10. Prof. A. D. Selby and True Houser, Wooster, Ohio.

Comparison of Yields of First Generation Tobacco Hybrids with those of Parent Plants. True Houser, Wooster, Ohio.

A Machine for Cigar Testing. Mr. L. J. Briggs, Washington, D. C.

What Seed Selection and Breeding have done for Tobacco in Connecticut. Mr. Herbert K. Hayes, Storrs, Conn.

Report of Committee on Breeding Vegetables. Mr. W. W. Tracy, Washington, D. C., Chairman.



Report of Committee on Breeding Sugar Crops. Mr. W. A. Orton, Washington, D. C., Chairman.

Report of Committee on Breeding Cereal Crops. Prof. C. A. Zavitz, Guelph, Canada, Chairman.

Morphological Variation in Pure Lines of *Vulgare* Wheats. Prof. H. F. Roberts, Columbia, Missouri.

Report of Committee on Breeding Roses. Dr. W. VanFleet, Washington, D. C., Chairman.

Report of Committee on Pedigreed Seed and Plant Business. Eugene Funk, Shirley, Ill., Chairman.

Plant Breeding for Women. Mr. E. E. Risien, Rescue, Texas.

Report of Committee on Fiber Crops. Dean J. H. Shepperd, Fargo, N. D., Chairman.

Fibers and Fiber Plants of the Philippine Islands. Prof. M. M. Saleeby, Manila, P. I.

**EUGENICS SECTION.** Place of Meeting: Institution for Feeble-Minded, Columbus.

Report of Committee on Heredity of Insanity. Prof. Adolph Meyer, Baltimore, Md., Chairman.

Heredity in Recurrent Forms of Insanity. Dr. E. E. Southard, Boston, Mass.

Report of Committee on Heredity of Feeble-Mindedness. Dr. A. C. Rogers, Faribault, Minn., Chairman.

Report of Committee on Heredity of Epilepsy. Dr. N. W. Bullard, Chairman.

A First Study of Inheritance of Epilepsy. Drs. David F. Weeks and C. B. Davenport.

Report of Committee on Heredity of Deafmutism. Dr. Alexander Graham Bell, Washington, D. C., Chairman.

Report of Committee on Heredity of Criminality. Prof. Chas. R. Henderson, University of Chicago, Chicago, Ill., Chairman.

Report on Operations of the Eugenics Record Office. H. H. Laughlin. Conference on Methods of Field Work.

THURSDAY EVENING, FEBRUARY 2, 8 to 10.

**ANIMAL SECTION.** Meeting in Government Building. Dean C. F. Curtiss presiding.

Report of Committee on Breeding for Meat Production.

Report of Committee on Breeding Wild Animals. Mr. D. E. Lantz, Washington, D. C., Chairman.

Domestication and Acclimatization of Wild Animals in the United States. Mr. D. E. Lantz.

Report of Committee on Breeding Draft Horses. Prof. W. B. Richards, Agricultural College, N. D., Chairman.

Report of Committee on Breeding Horse Hybrids. Dean F. B. Mumford, Columbia, Mo., Chairman.

Report of Committee on Breeding Carriage Horses. Prof. Geo. M. Rommel, Washington, D. C., Chairman.

**ILLUSTRATED TALKS.** In Special Lecture Room. Separate program.

FRIDAY FORENOON, FEBRUARY 3, 10 TO 12.30.

GENERAL SESSION. Government Building. Hon. William George presiding.

Reports of special committees.

Election of officers.

ANIMAL SECTION. Dean Charles F. Curtiss presiding.

Report of Committee on Theory of Heredity. Prof. W. J. Spillman, Washington, D. C., Chairman.

Mendelian Inheritance of Unit Complexes. H. H. Laughlin, Cold Spring Harbor, New York.

Mendelian Inheritance in Sheep. Mr. T. R. Arkell, Durham, N. H.

Influence of Age in Jersey Sires. Prof. E. N. Wentworth, Ames, Iowa.

Report of Committee on Breeding Fur Animals. Dr. Vernon Bailey, Washington, D. C., Chairman.

Control of the Beaver under favorable conditions for the production of Fur. Vernon Bailey, Washington, D. C.

An Experiment in Fur Seal Conservation. B. W. Evermann, Washington, D. C.

The Blue Fox Industry on St. Paul and Otter Islands, Alaska. James Judge, Washington, D. C.

Report of Committee on Breeding Fish. Prof. B. W. Everman, Washington, D. C., Chairman.

Report of Committee on Breeding Bees and Other Insects. Dr. L. O. Howard, Washington, D. C., Chairman.

Report of Committee on Breeding Wild Birds. Dr. T. S. Palmer, Washington, D. C., Chairman.

Report of Committee on Cooperative Work in Animal Breeding. Hon. W. M. Hays, Washington, D. C., Chairman.

Report of Committee on Animal Hybrids. Prof. W. J. Spillman, Washington, D. C., Chairman.

ILLUSTRATED TALKS. In Special Lecture Room. Separate program.

FRIDAY AFTERNOON, FEBRUARY 3.

ANIMAL SECTION. Government Building. Dean Charles F. Curtiss presiding.

Report of Committee on Importation of Pedigreed Animals. Mr. E. B. White, Leesburg, Va., Chairman.

Report of Committee on Exportation of Pedigreed Animals. Prof. H. W. Mumford, Urbana, Ill., Chairman.

Report of Committee on Establishing Types and Standardizing Judging at Livestock Shows. Col. R. B. Ogilvie, Union Stockyards, Chicago, Ill., Chairman.

Report of Committee on Breeding Swine. Prof. D. A. Gaumnitz, St. Paul, Minn., Chairman.

Report of Committee on Breeding Sheep and Goats. Prof. W. C. Coffey, Urbana, Ill., Chairman.

Report of Committee on Breeding for Dairy Production. Mr. B. H. Rawl, Washington, D. C., Chairman.

Report of Committee on Breeding Poultry. Prof. James E. Rice, Ithaca, N. Y., Chairman.

Inheritance of Gold and Silver Lacing in Hens. Dr. C. B. Davenport, Cold Spring Harbor, N. Y.

Some Character Correlations indicating Prolificacy in the Domestic Fowl. Prof. James E. Rice, Ithaca, N. Y.

Report of Committee on Plant and Animal Introduction. Mr. David G. Fairchild, Washington, D. C., Chairman.

ILLUSTRATED TALKS. In Special Lecture Room. Separate program.

---

There is a peculiar value in a birthday, Christmas or New Year gift consisting of a membership in the American Breeders Association.

**A. B. A. Membership an Acceptable Gift.** If you have a friend whom you wish to thus honor and please, send in his nomination accompanied by membership dues.

By no gift can you pay a more delicate compliment to the intelligence and mental worth of the recipient than by presenting a membership in this large association with its cosmopolitan membership composed of persons of note as scientists, breeders, and originators of plant and animal forms, and students of genetic problems profoundly affecting economics and society.

Then, there is the *Magazine* and the Annual Report which go with the membership.

The giving of magazines as gifts is a common, commendable and friendly practice, always timely and always acceptable. The *American Breeders Magazine* lends itself splendidly to this purpose. It possesses dignity and substance. It exists not merely to amuse or entertain, but it has an aim and purpose and places each of its readers in touch with workers and thinkers who are taking a part in the world's work.

The Annual Report possesses more than book value. Between its covers it holds a summation of what is probably the latest and best information relating to heredity.

---

#### What Others Say.

You may count on me to do all that I can to promote the growth of the Association.

E. P. BENNETT,  
*Horticulturist Colo. Agricultural Expt. Station.*

Have enjoyed the *Magazine* very much and think there is a great deal in it that would be of interest to anyone.

J. C. ROBINSON,  
*The J. C. Robinson Seed Co., Wholesale Growers,  
 Waterloo, Neb.*

I have examined with a great deal of interest the two numbers of the *Magazine* and I want to say that I consider the contents as being most valuable. While some of the contributions are altogether too technical for the average layman, still I can see a great future for your magazine as a great educational medium for those who are trying to popularize what you might call "Farm Science." We will never get very far unless those who are engaged in this work have their own scientific knowledge grounded upon a rock foundation. I think your magazine will have a very pronounced effect in making what you might call "orthodox scientists."

You have undertaken a most difficult task in the standard you have made for the *American Breeders Magazine*, and I again congratulate you on the splendid start you have made.

JAMES ATKINSON,  
*Editor, The Iowa Homestead.*

I wish to express my appreciation of the new move of the American Breeders Association in the publishing of the *American Breeders Magazine* which impresses me as a most excellent thing.

C. S. PLUMB,  
*Professor of Animal Husbandry,  
 College of Agriculture, Ohio State University.*

I wish to make a study of the great material which the Association is putting out.

H. W. COLLINGWOOD,  
*Editor, The Rural New-Yorker.*

# *The American Breeders Magazine*

---

*Issued Quarterly for Practical and Scientific  
Breeders of Animals and Plants*

---

*Edited by Willet M. Hays, N. E. Hansen, H. W. Mumford, and  
C. B. Davenport*

---

The American Breeders Association has assumed the important function of bringing the practical breeders into close touch with the scientists, and the scientists into a clearer knowledge of the practical problems of the plant and animal breeders. Its meetings have proven the value of a forum where practical and scientific men interested in breeding can discuss heredity and breeding in all their relations to the living forms as found in nature and in reference to the production of races of plants, animals, and men with better heredity.

The Association has assumed the publication of the AMERICAN BREEDERS MAGAZINE because it feels that there is need of an open court for the discussion and teaching of this rising science; and also, because it feels, that in order to achieve scientific and economic results of the highest order and of the widest scope the members of this virile organization need an effective means of intercommunication, and this no doubt is best realized in a periodical publication.

The effort is to sustain a high standard of scientific excellence, and at the same time produce a readable magazine, and to raise the standard of the Magazine from its present to still higher levels.

The number of specially prepared articles promised for the Magazine, in addition to the papers presented at the annual meeting, assures an array of reading matter of unusual interest and variety.

Volume VI of the Annual Reports, giving papers and discussions of the Omaha meeting, held December, 1909, may be secured upon the payment of the regular \$2.00 membership fee for the year 1910. As long as the editions last all four numbers of the Magazine published during 1910, will also be sent for the \$2.00. The Magazine for the year is not sold separately, as the postal regulations require that it go only to those who pay the membership fee.

Dues \$2 a year. Single copies may be had at 35 cents.

*Address AMERICAN BREEDERS ASSOCIATION*

*Washington, D. C.*

# The American Breeders Association

## OFFICERS

HON. JAMES WILSON, President

WM. GEORGE, Vice-President

W. M. HAYS, Secretary

N. H. GENTRY, Treasurer

---

---

**T**HE AMERICAN BREEDERS ASSOCIATION is a cooperative association designed especially to develop the science of breeding and heredity and to bring that scientific knowledge to students of heredity, to the practical breeders of pedigreed animals and plants and to others interested in these subjects. It affords a means for conference among the members of the Association.

The membership is composed of progressive breeders, scientists, teachers, and others interested in all phases of heredity of plants, animals and men and the improvement of methods of breeding. The best investigators in the science of heredity and breeding and the best practical breeders of pedigreed livestock and plants freely cooperate through the Association and donate the time required to make investigations, to prepare papers, to attend the annual meetings and to help build up the literature of the science and practice of breeding, thus to produce the largest results possible in the form of better animals and plants.

All persons interested in its work are cordially invited to become members of the American Breeders Association.

Membership entitles the holder to the American Breeders Magazine, to the annual report of the Proceedings of the Association, and to full participation in the activities of the Association.

Membership: Annual, \$2.00; Life, \$20.00

No entrance fee

Address AMERICAN BREEDERS ASSOCIATION  
Washington, D. C.











