

XA
.M45

vol. 21
pt. 1
1915

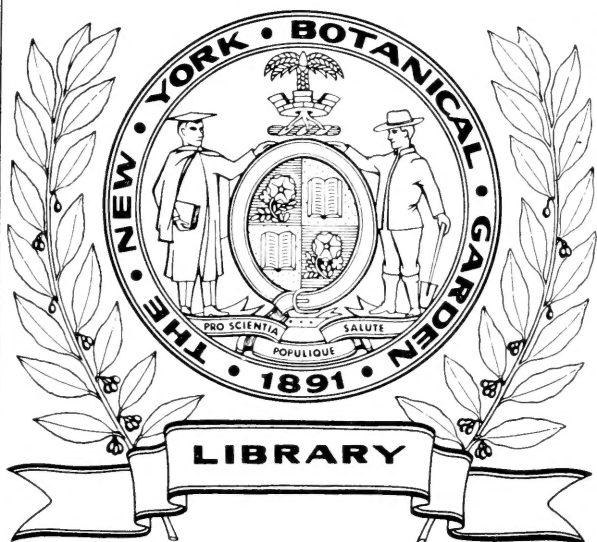

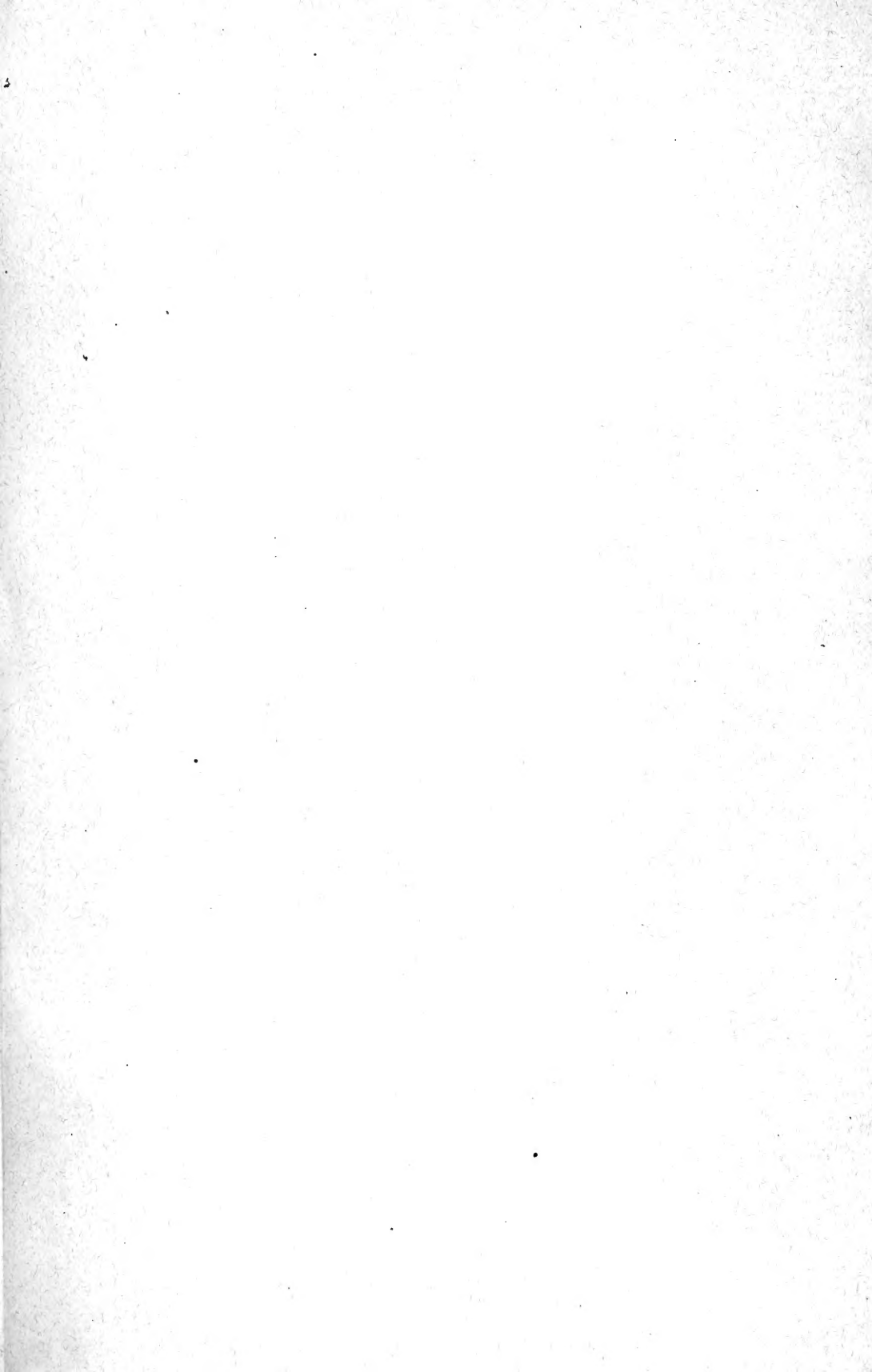



AMERICAN FORESTRY

THE MAGAZINE OF

THE AMERICAN FORESTRY ASSOCIATION

VOLUME XXI—1915

LIBRARY
NEW YORK
BOTANIC
GARDENS

January to July, Inclusive

THE AMERICAN FORESTRY ASSOCIATION
PUBLISHER

WASHINGTON, D. C.

vol 21
part 1
1915

CONTENTS OF VOLUME XXI

INDEX OF AUTHORS

	<i>Page</i>		<i>Page</i>
Alaux, Jean-Paul, article by	155	Hazen, E. B., article by	208, 576
Allen, Shirley W., article by	567	Helms, T. R., article by	527
Ayres, Philip W., article by	803	Jensen, Jens, article by	815
Bannwart, Carl, article by	46	Langille, H. D., article by	130
Betts, Norman de W., article by	128	Levison, J. J., article by	714, 797
Bigelow, Poultney, article by	607	McAtee, W. L., article by	681
Blanchard, C. J., article by	532	Martin, E. P., article by	614
Boerker, Richard H., article by	51	Maxwell, Hu, article by	34
Bowman, Louise Morey, poem by	33	Miller, Warren H., article by	543, 719, 780
Brown, W. R., article by	186, 628	Mueller, Harry J., article by	732
Buckner, N., article by	94	Pardoe, Avern, article by	817
Chamberlain, Allen, article by	64, 100	Plummer, H. W., article by	94
Chapman, Herman H., article by	168	Pullman, Raymond, article by	83
Cobb, George B., article by	109	Shinn, Julia T., article by	653
Curtis, J. Gerry, article by	199	Smith, Herbert A., article by	172
Dearborn, Ned, article by	581	Sterling, E. A., article by	55, 768
Detwiler, S. B., article by	18, 571	Van Norden, Ottomar H., article by	111
Drinker, Dr. H. S., article by	818	Washburn, Stanley, article by	755
Eckbo, Nils B., article by	693	Whitaker, Charles Harris, article by	22
Floyd, Charles B., article by	792	Williams, Mrs. Lydia Adams, article by	204
Foley, James W., poem by	581	Wilson, Ellwood, article by	71, 148, 217, 597, 674, 749, 824
Graves, Henry S., article by	47, 59	Woodward, Karl W., article by	103
Griffith, E. M., article by	559	Worcester, Dean C., article by	1
Hall, William L., article by	117	Wright, Allen Henry, article by	110, 127

GENERAL INDEX

	<i>Page</i>		<i>Page</i>
Aiding Forest Communities (Editorial) . . .	69	California Tree Novelties, Part 1—E. A. Sterling	768
Aiding Timber Owners	207	Canadian Department, The (Department of Magazine)—Ellwood Wilson 71, 148, 217, 597, 674, 749, 824	
Allen, E. T., Director of the American Forestry Association—photograph . . .	730	Canadian Lumber Competition—H. D. Langille	130
American Academy of Arborists	712	Care of Bird Houses—Ned Dearborn	582
American Forestry, A Larger	739	Carnegie, Andrew—Vice President of the American Forestry Association—photograph	201
American Forestry Magazine, The Improved	779	Chapman, Herman H.—Director of the American Forestry Association—photograph	813
American Forestry Association, Annual Meeting	143	Chinese Trees Do Well Here	564
American Lumber Market, The, Part 1—E. B. Hazen	208	Clerk's Work on a National Forest, A—Julia T. Shinn	653
American Lumber Market, The, Part 2—E. B. Hazen	576	Colorado School of Forestry	651
American Willow Industry	778	Commissioner, A New Conservation	736
Annual Meeting of the American Forestry Association	143	Competition, Canadian Lumber—H. D. Langille	130
Annual Meeting, Announcement of the . . .	57	Conference in the White Mountains, Forest	791
An Explanation	767	Connecticut Forestry Meetings	594
Another Large Elm	541	Connecticut, Largest Elm In—Norman de W. Betts	128
Arborists, American Academy of	712	Conservation Commissioner, A New	736
Ash Trees, Hickories, Elms and—Warren H. Miller	719	Conservation of Water by Storage, A Work On—Reviewed by Dr. H. S. Drinker	818
Ax Marks in Trees, Old—Avern Pardoe . .	817	Conventions—See Maine Forestry Association; New York State meeting; North Carolina meeting; Thirty-Fourth Annual meeting American Forestry Association; Connecticut Forestry meeting; American Forestry Association Day	
Battle Creek, Beautifying	198	Cornell, Farmers' Week At	183
Beautifying Battle Creek	198	Country Estate, Hardwoods on the—Warren H. Miller	780
Belgium, The Forests of—Charles Harris Whitaker	22	Court Orders Forestry Practiced	217
Bermuda's Little Trees—W. R. Brown . . .	186	Coyotes Spread Hydrophobia	214
Bird Enemies of Forest Insects—W. L. McAtee	681	Crocker, Mrs. Emmons—Mrs. Lydia Adams-Williams	204
Bird Houses, Building—Ned Dearborn . . .	660	Current Literature (Department of Magazine)	79, 152, 223, 603, 676, 751, 827
Bird Houses, Care of—Ned Dearborn . . .	582	Danger Signal for Wisconsin, A	215
Birds, Brookline Protects—Charles B. Floyd	792	Dead, Hon. Curtis Guild	645
Birkinbine Dead, John	712	Destroying Mount Mitchell—Raymond Pullman	83
Black Hawk Tree, The—Jens Jensen	815	Developing British Columbia	644
Bombardment of Papeete—By a Tahitian of High Rank	553		
Bonding National Forests—Henry S. Graves	59		
Boroughs, Tree Planting in Three—J. Gerry Curtis	199		
Boy Scouts and Forests—K. W. Woodward	103		
British Columbia, Developing	644		
British Columbia Notes (Department of Magazine)	73, 599, 750, 826		
Brookline Protects Birds—Charles B. Floyd	792		
Building Bird Houses—Ned Dearborn	660		

	<i>Page</i>		<i>Page</i>
Directory, A Forester's.....	141	Forest Fire Warnings.....	587
Does Forest Fire Protection Pay?(Editorial)	70	Forest, Harrisburg's Municipal—Harry J. Mueller.....	732
"Don'ts," Forest Fire.....	743	Forest Homes.....	737
Drinker, Henry S., President of the American Forestry Association—photograph.....	550	Forest Insects, Bird Enemies of—W. L. McAtee.....	681
Dryad's Message, The—Poem by Louise Morey Bowman.....	33	Forest Notes (Department of Magazine) 75, 150, 220, 600, 672, 746, 823	
Eastern Forest Reserves, More.....	744	Forest Products Federation—E. A. Sterling.....	55
Editorial (Department of Magazine) 68, 145, 215, 595, 670, 744, 821		Forest Ranger's Prayer, The.....	58
Education in Vermont, Forestry.....	99	Forest Reserve, New England's Federal—Philip W. Ayres.....	803
Eliot, Dr. Charles W., Vice President of the American Forestry Association—photograph.....	552	Forest Reserves, Ten Million Dollars Needed for.....	670
Elm, Another Large.....	541	Forest School, Japanese.....	814
Elm in Connecticut, Largest—Norman de W. Betts.....	128	Forest Students, Oregon.....	740
Elm, Is This the Largest.....	643	Forest Wealth, Philippine—Dean C. Worcester.....	1
Elms and Ash Trees, Hickories—Warren H. Miller.....	719	Forester's Directory, A.....	141
Enemies of Forest Insects, Bird—W. L. McAtee.....	681	Forester, Philippine Islands'.....	563
Estabrook Park.....	816	Forester, Virginia's State.....	203
Estate, Hardwoods on the Country—Warren H. Miller.....	780	Foresters in the German Army—T. R. Helms.....	527
Explanation, An.....	767	Forestry, A Larger American.....	739
Exposition, Forestry at the.....	171	Forestry and Independence.....	595
Expositions, Forestry at the—A. H. Wright.....	127	Forestry Association, Maine.....	140
Farmers' Week at Cornell.....	183	Forestry at the Exposition.....	171
Federation, Forest Products—E. A. Sterling.....	55	Forestry at the Expositions—A. H. Wright.....	127
Federal Forest Reserve, New England's—Philip W. Ayres.....	803	Forestry Club, Township—George B. Cobb.....	109
Fernow, Dr. B. E., Vice-President of the American Forestry Association—photograph.....	627	Forestry Education in Vermont.....	99
Fire "Don'ts," Forest.....	743	Forestry in Wisconsin—E. M. Griffith....	559
Fire Losses, Pennsylvania's.....	692	Forestry Laws and Legislation.....	145
Fire Losses, \$677,816, Forest.....	214	Forestry Law, Texas.....	615
Fire Protection on the National Forests in 1914, The—Henry S. Graves....	47	Forestry on a Firm Basis in New Jersey....	671
Fire Warnings, Forest.....	587	Forestry Pay, Making Private.....	647
Flame, Three Miles of—Allen Chamberlain.....	64	Forestry Practiced, Court Orders.....	217
Flowers, Tree Fruits and—Warren H. Miller.....	617	Forestry Woodlot—S. B. Detwiler.....	571
Flushing's Oldest Tree—E. P. Martin.....	614	Forestry Work, No Politics in This.....	595
Forest Conference in the White Mountains.....	791	Forests and Game Preservation—O. H. Van Norden.....	111
Forest Education in Maryland.....	78	Forests and Recreation—Warren H. Miller	543
Forest Fire "Don'ts".....	743	Forests, Bonding National—Henry S. Graves.....	59
Forest Fire Losses, \$677,816.....	214	Forests, Boy Scouts and—K. W. Woodward.....	103
		Forests of Belgium, The—Charles Harris Whitaker.....	22
		Forests of Japan—Nils B. Eckbo.....	693
		Forests, Improving White Mountain—William L. Hall.....	117

<i>Page</i>	<i>Page</i>		
Forests in the Russian War Zone—Stanley Washburn	755	Lake States, The Forestry Issue in the— H. H. Chapman	656
Forests, The Great War's Destruction of French—Jean-Paul Alaux, A. D. G.	155	Laking—W. R. Brown	628
French Forests, The Great War's Destruction of— Jean-Paul Alaux, A. D. G.	155	Larger American Forestry, A.	739
French Forests, War Notes from	612	Largest Elm In Connecticut—Norman de W. Betts	128
Game Preservation, Forests and—O. H. Van Norden	111	Lassen Eruption, The Mount—Richard H. Boerker	51
Georgia State Forest School	636	Law, Texas Forestry	615
German Army, Foresters in the—T. R. Helms	527	Laws and Legislation, Forestry	145
German Forests, The Great War and— Poultney Bigelow	607	Legislation, Forestry Laws and	145
Great War and German Forests, The— Poultney Bigelow	607	Little Trees, Bermuda's—W. R. Brown	186
Great War's Destruction of French Forests, The—Jean-Paul Alaux, A. D. G.	155	Log Hauler, A Sledding	648
Guild Dead, Hon. Curtis	645	Losses, \$677,816, Forest Fire	214
Hardwoods on the Country Estate—Warren H. Miller	780	Lot, Jamestown's Hundred Acre—Shirley W. Allen	567
Harrisburg's Municipal Forest—Harry J. Mueller	732	Lumber Competition, Canadian—H. D. Langille	130
Hauler, A Sledding Log	648	Lumber Market, The American—(Part 1) —E. B. Hazen	208
Hawk Tree, The Black—Jens Jensen	815	Lumber Market, The American—(Part 2) —E. B. Hazen	576
Hickories, Elms and Ash Trees—Warren H. Miller	719	Lumber Waste in the Woods	745
Hickory Trees Threatened with Destruction— J. J. Levison	797	Maine Forestry Association	140
Homes, Forest	737	Making Private Forestry Pay	647
How Old Was It?	659	Market, The American Lumber—(Part 1) —E. B. Hazen	208
Hundred Acre Lot, Jamestown's—Shirley W. Allen	567	Market, The American Lumber—(Part 2) —E. B. Hazen	576
Hunting on the National Forests—Herbert A. Smith	172	Marks in Trees, Old Ax—Avern Pardoe	817
Hydrophobia, Coyotes Spread	214	Meeting, New York State	141
Improved Magazine, The	779	Meeting, The Annual	57
Improving White Mountain Forests— William L. Hall	117	Meetings—See Conventions.	
Independence, Forestry and	595	Message, The Dryad's (Poem)—Louise Morey Bowman	33
Industry, American Willow	778	Mitchell, Destroying Mount—Raymond Pullman	83
Insects, Bird Enemies of Forest—W. L. McAtee	681	Mitchell Trail, The Mount—H. W. Plummer and N. Buckner	94
Is This the Largest Elm?	643	More Durable Pine Posts	200
Jamestown's Hundred-Acre Lot—Shirley W. Allen	567	More Eastern Forest Reserves	744
Japan, Forests of—Nils B. Eckbo	693	Moth, The Pine Shoot	627
Japanese Forest School	814	Mount Lassen Eruption, The—Richard H. Boerker	51
John Birkinbine Dead	712	Mount Mitchell Trail, The—H. W. Plummer and N. Buckner	94
John Muir—George B. Sudworth	184	Movies, Uncle Sam In The—C. J. Blanchard	532
Jones of Texas, W. Goodrich	738	Muir, John—George B. Sudworth	184
Junipero Oak, The—Allen Henry Wright	110	Municipal Forest, Harrisburg's—Harry J. Mueller	732
Knowledge of Trees, A (Editorial)	69	National Forest, A Clerk's Work on a— Julia T. Shinn	653

	<i>Page</i>		<i>Page</i>
National Forests, Bonding—Henry S. Graves.....	59	Protection on the National Forests in 1914, The Fire—Henry S. Graves.....	47
National Forests, Hunting on the—H. A. Smith.....	172	Ranger's Prayer, The Forest.....	58
National Forests in 1914, The Fire Protection on the—Henry S. Graves..	47	Recreation, Forests and—Warren H. Miller	543
National Forests Used.....	586	Register of Foresters.....	212
Newark, Tree Planting In—Carl Bannwart.....	46	Reserve, New England's Federal Forest—Philip W. Ayres.....	803
New England's Federal Forest Reserve—Philip W. Ayres.....	803	Reserves, More Eastern Forest.....	744
New Jersey, Forestry on a Firm Basis in..	671	Reviews, Book:	
New York's Forest Problem.....	821	Forest Valuation—H. H. Chapman	151
New York, The Crisis in—H. H. Chapman.....	168	Preservation of Structural Timber—Howard F. Weiss.....	152
New York State Meeting.....	141	Studies of Trees—J. J. Levison... ..	152
Ninety-Nine Dollars and Forty Cents for One Tree.....	197	Song of Service—Charles H. Mackintosh.....	152
No Politics in this Forestry Work.....	595	The Earth: Its Life and Death—A. Berget.....	222
North Carolina Meeting.....	142	Vertical Farming—Gilbert E. Bailey	222
Novelties, California Tree—E. A. Sterling.....	768	Our National Defense, The Patriotism of Peace—George H. Maxwell	602
Oak, The Junipero—Allen H. Wright... ..	110	Some Lumber Problems—Northern Hemlock and Hardwood Manufacturers' Association.....	662
Old Ax Marks n Trees—Avern Pardoe ...	817	The Log of a Timber Cruiser—W. P. Lawson.....	673
Oldest Tree, Flushing's—E. P. Martin... ..	614	Room for 5,000,000 Shade Trees	590
Oregon Forest Students.....	740	Russian War Zone, Forests in the—Stanley Washburn	755
Ornamental and Shade Trees (Department of Magazine)—J. J. Levison... ..	714, 797	School, Georgia State Forest.....	626
Papeete, Bombardment of.....	553	Schol, Japanese Forest.....	814
Park, Estabrook.....	816	School of Forestry, Colorado.....	650
Pennsylvania's Fire Losses.....	692	Scouts and Forests, Boy—K. W. Woodward.....	103
Philippine Forest Wealth—Dean C. Worcester.....	1	Selecting Shade Trees—S. B. Detwiler... ..	18
Philippine Islands' Forester.....	563	Selecting Trees and Shrubs.....	591
Pine Posts, More Durable.....	200	Shade Trees and Shrubs—J. J. Levison... ..	714
Pine Shoot Moth, The.....	637	Shade Trees, Ornamental and (Department of Magazine)—J. J. Levison... ..	714, 797
Pine, The Story of White—Hu Maxwell..	34	Shade Trees, Room for 5,000,000.....	590
Planting in Newark, Tree—Carl Bannwart	46	Shade Trees, Selecting—S. B. Detwiler... ..	18
Planting in Three Boroughs, Tree—J. Gerry Curtis.....	199	Shade Trees, 320 Miles of.....	729
Planting Time and Care of Trees—S. B. Detwiler.....	100	Shade Trees Worth \$17,000,000.....	32
Politics in this Forestry Work, No.....	595	Shrubs, Selecting Trees and.....	591
Posts, More Durable Pine.....	200	Sledging Log Hauler, A.....	649
Prayer, The Forest Ranger's.....	58	State Forester, Virginia's.....	203
Preservation, Forests and Game—O. H. Van Norden.....	111	States, The Forestry Issue in the Lake—H. H. Chapman.....	656
Private Forestry Pay, Making.....	647	Sterling, E. A., Director of the American Forestry Association—photograph.	731
Problem, New York's Forest.....	821	Storage, A Work on the Conservation of Water by—Reviewed by Dr. H. S. Drinker.....	817
Protects Birds, Brookline—Charles B. Floyd.....	792	Story of White Pine, The—Hu Maxwell..	34
Promote the Use of Wood, To.....	215	Students, Oregon Forest.....	740
Prospectin' (Poem)—J. R. Simmons.....	50		

	<i>Page</i>		<i>Page</i>
Swan's New Position, O. T.....	575	Trees, Room for 5,000,000 Shade.....	590
Taft, William Howard, Vice-President of the American Forestry Association —photograph.....	202	Trees, Selecting Shade—S. B. Detwiler... 18	
Tale of the Trail, A (Poem)—James W. Foley.....	581	Trees Worth \$17,000,000, Shade.....	32
Teal, Joseph N., Vice-President of the American Forestry Association— photograph.....	626	Uncle Sam in the Movies—C. J. Blanchard	532
Ten Million Dollars Needed for Forest Re- serves.....	670	Vermont, Forestry Education in.....	99
Texas Forestry Law.....	615	Victory for Amendment No. 9 (Editorial)..	68
Texas, W. Goodrich Jones of.....	738	Virginia's State Forester.....	203
The Crisis in New York—H. H. Chapman	168	War and German Forests, The Great— Poultney Bigelow.....	607
The Forestry Issue in the Lake States— H. H. Chapman.....	656	War's Destruction of French Forests, The Great, Jean-Paul Alaux.....	155
Thirty-Fourth Annual Meeting of the American Forestry Association... 143		War Notes from French Forests.....	612
Three Hundred and Twenty Miles of Shade Trees.....	729	War Zone, Forests in the Russian—Stan- ley Washburn.....	755
Three Miles of Flame—Allen Chamberlain	64	Warnings, Forest Fire.....	587
Timber Owners, Aiding.....	207	Waste in the Woods, Lumber.....	745
To Promote the Use of Wood.....	213	Water by Storage, A Work on the Conser- vation of, Reviewed by Dr. H. S. Drinker.....	818
Township Forestry Club—George B. Cobb	109	White, Capt. John B., Director of the American Forestry Association— photograph.....	551
Trail, A Tale of the (Poem)—James W. Foley.....	581	White Mountains, Forest Conference in the.....	791
Trail, The Mount Mitchell—H. W. Plum- mer and N. Buckner.....	93	White Mountain Forests, Improving— William L. Hall.....	117
Tree, Flushing's Oldest—E. P. Martin....	614	White Pine, The Story of—Hu Maxwell..	34
Tree Fruits and Flowers—Warren H. Miller.....	617	Willow Industry, American.....	778
Tree Novelties, California (Part 1)—E. A. Sterling.....	768	Wisconsin, A Danger Signal for.....	215
Tree Planting in Newark—Carl Bannwart	46	Wisconsin, Forestry in—E. M. Griffith... 559	
Tree Planting in Three Boroughs—J. Gerry Curtis.....	199	Wisconsin's Forestry Tangle.....	206
Tree, The Black Hawk—Jens Jensen....	815	Wisdom, Words of.....	216
Trees, Bermuda's Little—W. R. Brown... 186		With the Foresters (Notes).....	147, 219
Trees Do Well Here, Chinese.....	564	Wood, To Promote the Use of.....	213
Trees, Hickories, Elms and Ash—Warren H. Miller.....	719	Woodlot Forestry—S. B. Detwiler.....	571
Trees, Old Ax Marks in—Avern Pardoe... 817		Woodlot Improvement.....	616
Trees, Ornamental and Shade (Depart- ment of Magazine—J. J. Levison	714, 797	Woods, Lumber Waste in the.....	745
		Words of Wisdom.....	216
		Work on the Conservation of Water by Storage, A—Reviewed by Dr. H. S. Drinker.....	818
		Worth \$17,000,000, Shade Trees.....	32
		Zone, Forests in the Russian War—Stan- ley Washburn.....	755



American Forestry



Vol. 21

JANUARY, 1915

No. 1

Globe-Wernicke

Sectional Bookcases

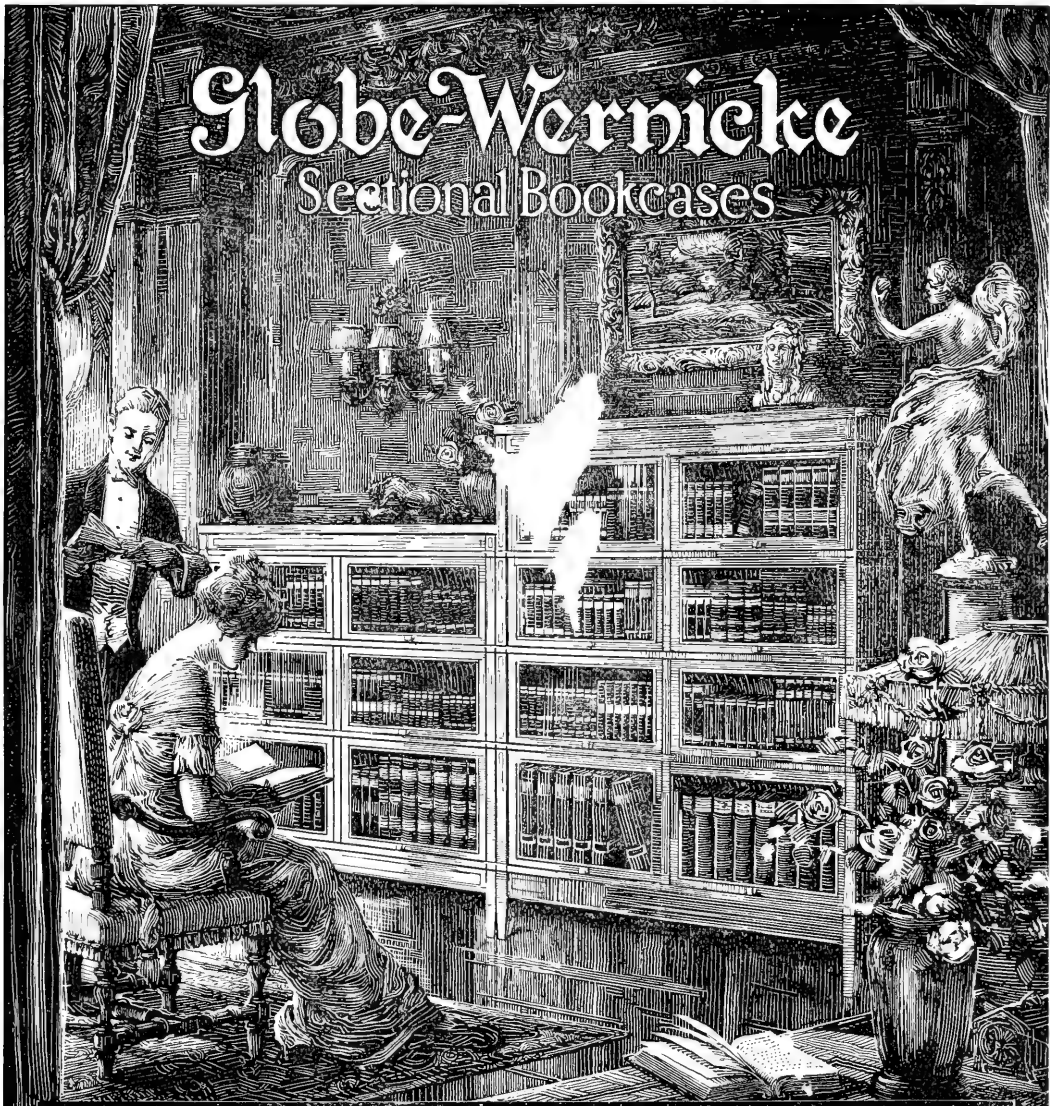

TROPIC damp and heat—the frigid rigors of northern lands—and the variable climate of the temperate zones cannot affect the stout construction of Globe-Wernicke Sectional Bookcases. Their durability is the lasting strength of fine cabinet-making and materials carefully seasoned to withstand the extremes of climate.

There's a Globe-Wernicke Bookcase in just the right finish and right size to match your color scheme and wall space. Then, as your library expands, more sections are always in stock. Built to grow and endure, they cost no more than the ordinary kind. *Write for Catalog No. 445.*

The Globe-Wernicke Co.

Cincinnati

Makers of Sectional Bookcases, Filing Equipment (Wood and Steel), Steel Safes, Stationers' Supplies.

On sale by 2000 Branch Stores and Agents everywhere. Globe-Wernicke pays the freight.



BRANCH STORES: New York, Chicago, Philadelphia, Boston, Cincinnati, Washington, D. C.



ALMAS KIRKMAN

Lumber Conditions and Problems

A SERIES OF IMPORTANT ARTICLES BY RECOGNIZED EXPERTS, PREPARED FOR AMERICAN FORESTRY

**What are the relations of Lumbering and Forest Conservation?
What are the inside problems of the Lumber Industry?
What are the economic conditions affecting the Lumber Trade?**

Here are three big questions vitally affecting the present and the future forest conditions of the United States and Canada.

WHAT ARE THE ANSWERS?

They will be found in the series of special articles prepared for *AMERICAN FORESTRY* by the big experts on the subjects.

Recognizing that these questions are of such vital importance that they cannot be adequately presented except in a series of articles written by the men best fitted by experience and knowledge, *AMERICAN FORESTRY* has completed arrangements for getting them. They will form the most valuable contributions to forestry and lumbering literature ever published by any one magazine. The subjects are discussed under the following titles:

"THE CALIFORNIA REDWOOD"—by J. H. Browne, General Sales Manager of the Pacific Lumber Company, appearing in *AMERICAN FORESTRY* for November, 1914.

"EFFECT OF THE WAR ON LUMBER IMPORTS AND EXPORTS"—by Prof. R. C. Bryant, instructor in lumbering at the Yale Forest School. To appear in December, 1914. This deals with opportunities afforded this country by the war and with the losses caused by the restriction of lumber exporting. In the December 1914 number.

"CANADIAN COMPETITION"—by H. D. Langille, Portland, Ore., Pacific Coast manager of J. D. Lacey & Co. This is a study of comparative labor, transportation, taxation and other factors and is especially valuable owing to the changes caused by the tariff bill. To appear in the February 1915 number.

"THE AMERICAN LUMBER MARKET"—by E. B. Hazen, of Portland, Ore. This discusses what the consumer should be taught and how; honesty, fairness and effectiveness in market extension campaigning and suggests methods. This is essentially practical and does not consist of general platitudes. *To appear soon.*

"CLOSER FOREST UTILIZATION"—by George M. Cornwall, Editor of "The Timberman." This is full of important facts regarding the use of odd lengths, special products, by-products and how to secure more than is now secured out of each tree cut. *To appear soon.*

"FOREIGN LUMBER MARKETS"—Author to be selected. The European war and the trade contraction of the countries involved gives special point to this article, which will discuss the present situation, the natural probabilities, and the possibility of foreign extension through expert studies of foreign consumption, transportation problems, etc. *To appear soon.*

"PROFITS IN LUMBER MANUFACTURE"—Author to be selected. An analysis of the existing profits and future possibilities which will be found of absorbing interest by the practical man. *To appear soon.*

"FROM MILL TO MARKET"—Author to be selected. This will deal with the problem of transporting lumber from the mill to the market, by rail, coastwise and off shore shipments, and will contain many wise suggestions for overcoming difficulties. *To appear soon.*

ARTICLES PUBLISHED PREVIOUSLY

Fitting in with this series are these articles recently published:

"THE LUMBER TRADE AND THE CANAL"—by Robert Dollar, of San Francisco, Cal. In *AMERICAN FORESTRY* for July, 1914.

AMERICAN FORESTRY for September, 1914.

"THE WORLD'S GREATEST WOODLOT"—by George S. Long, of Tacoma, Wash., in

"FORESTS, LUMBER AND CONSUMER"—by E. T. Allen, of Portland, Ore., in *AMERICAN FORESTRY* for October, 1914.

Everyone interested in the conservation and the utilization of our forests should carefully read and study these articles. They are the best that can be secured. They are worth while.

IF YOU DO NOT GET AMERICAN FORESTRY, ORDER IT NOW

Declaration of Principles and Policy of the American Forestry Association

IT IS A VOLUNTARY organization for the inculcation and spread of a forest policy on a scale adequate for our economic needs, and any person is eligible for membership.

IT IS INDEPENDENT, has no official connection with any Federal or State department or policy, and is devoted to a public service conducive to national prosperity.

IT ASSERTS THAT forestry means the propagation and care of forests for the production of timber as a crop; protection of watersheds; utilization of non-agricultural soil; use of forests for public recreation.

IT DECLARES THAT FORESTRY is of immense importance to the people; that the census of 1913 shows our forests annually supply over one and a quarter billion dollars' worth of products; employ 735,000 people; pay \$367,000,000 in wages; cover 550,-000,000 acres unsuited for agriculture; regulate the distribution of water; prevent erosion of lands; and are essential to the beauty of the country and the health of the nation.

IT RECOGNIZES THAT forestry is an industry limited by economic conditions; that private owners should be aided and encouraged by investigations, demonstrations, and educational work, since they cannot be expected to practice forestry at a financial loss; that Federal and State governments should undertake scientific forestry upon national and State forest reserves for the benefit of the public.

IT WILL DEVOTE its influence and educational facilities to the development of public thought and knowledge along these practical lines.

It Will Support These Policies:

FEDERAL ADMINISTRATION AND MANAGEMENT of national forests; adequate appropriations for their care and management; Federal cooperation with the States, especially in forest fire protection.

STATE ACTIVITY by acquirement of forest lands; organization for fire protection; encouragement of forest planting by communal and private owners; non-political departmentally independent forest organization, with liberal appropriations for these purposes.

FOREST FIRE PROTECTION by Federal, State and fire protective agencies, and its encouragement and extension, individually and by cooperation; without adequate fire protection all other measures for forest crop production will fail.

FOREST PLANTING by Federal and State governments and long-lived corporations and acquirement of waste lands for this purpose; and also planting by private owners, where profitable, and encouragement of natural regeneration.

FOREST TAXATION REFORMS removing unjust burdens from owners of growing timber.

CLOSER UTILIZATION in logging and manufacturing without loss to owner; aid to lumbermen in achieving this.

CUTTING OF MATURE TIMBER where and as the domestic market demands it, except on areas maintained for park or scenic purposes, and compensation of forest owners for loss suffered through protection of watersheds, or on behalf of any public interest.

EQUAL PROTECTION to the lumber industry and to public interests in legislation affecting private timberland operations, recognizing that lumbering is as legitimate and necessary as the forests themselves.

CLASSIFICATION by experts of lands best suited for farming and those best suited for forestry; and liberal national and State appropriations for this work.

THE AMERICAN FORESTRY ASSOCIATION

OFFICERS FOR 1914

President

DR. HENRY STURGIS DRINKER, President, Lehigh University, South Bethlehem, Pa.

Vice-Presidents

JOSHUA L. BAILY, Pennsylvania
ANDREW CARNEGIE, New York
HON. JOHN R. CLANCY, New York
FREDERICK A. DELANO, Illinois
DR. CHARLES W. ELIOT, Massachusetts
President Emeritus Harvard University
DR. B. E. FERNOW, Canada
Dean of Forestry, University of Toronto
HON. WALTER L. FISHER, Chicago, Ill.
Ex-Secretary of the Interior
HENRY S. GRAVES, District of Columbia
Chief of the Forest Service
HON. CURTIS S. GUILD, Massachusetts
Ex-Ambassador to Russia
EVERITT G. GRIGGS, Washington
HON. DAVID HOUSTON
Secretary of Agriculture

HON. HIRAM JOHNSON, California
Governor of California
HON. FRANKLIN K. LANE
Secretary of the Interior
HON. ASBURY F. LEVER, South Carolina
United States Representative
HON. THOMAS NELSON PAGE
Ambassador to Italy
GIFFORD PINCHOT, Washington, D. C.
FILIBERT ROTH, Michigan
Dean of Forestry, University of Michigan
DR. J. T. ROTHROCK, Pennsylvania
JOSEPH N. TEAL, Oregon
Chairman Oregon Conservation Commission
HON. OSCAR W. UNDERWOOD, Alabama
United States Representative
DR. ROBERT S. WOODWARD, Washington, D. C.
President, Carnegie Institution

Treasurer

JOHN E. JENKS, Washington, D. C.
Editor, Army and Navy Register

Executive Secretary

P. S. RIDSDALE, 1410 H Street N. W., Washington, D. C.

Directors

E. T. ALLEN, Oregon
Forester, Western For. and Conservation Asso.
HON. ROBERT P. BASS, New Hampshire
Ex-Governor of New Hampshire
W. R. BROWN, New Hampshire
Pres., New Hamp. Forestry Commission
HERMAN H. CHAPMAN, Connecticut
Professor of Forestry, Yale Forest School
DR. HENRY S. DRINKER, Pennsylvania
President, Lehigh University
ALFRED GASKILL
State Forester, New Jersey
JOHN E. JENKS, District of Columbia
Editor, Army and Navy Register

CHESTER W. LYMAN, New York
International Paper Company
CHARLES LATHROP PACK, New Jersey
Pres., Fifth National Conservation Congress
CHARLES F. QUINCY, New York
J. E. RHODES, Illinois
National Lumber Manufacturers' Association
ERNEST A. STERLING, Pennsylvania
Forest and Timber Engineer
JOHN L. WEAVER, District of Columbia
Real Estate Broker
J. B. WHITE, Missouri
Ex-President, National Conservation Congress

Auditors

E. A. STERLING, Pennsylvania

C. F. QUINCY, New York

Advisory Board, Representing Affiliated Organizations

National Wholesale Lumber Dealers' Association

ROBT. C. LIPPINCOTT, Philadelphia, Pa.
R. L. SISSON, Potsdam, N. Y.
JOHN M. WOODS, Boston, Mass.

Northern Pine Manufacturers' Association

C. A. SMITH, Minneapolis, Minn.
WILLIAM IRVINE, Chippewa Falls, Wis.
F. E. WEYERHAEUSER, St. Paul, Minn.

Massachusetts Forestry Association

NATHANIEL T. KIDDER, Milton, Mass.
FREDERIC J. CAULKINS, Boston, Mass.
HARRIS A. REYNOLDS, Cambridge, Mass.

Lumbermen's Exchange

J. RANDALL WILLIAMS, JR., Philadelphia, Pa.
FREDERICK S. UNDERHILL, Philadelphia, Pa.
ROBERT C. LIPPINCOTT, Philadelphia, Pa.

Camp Fire Club of America

WARREN H. MILLER, New York
O. H. VAN NORDEN, New York
FREDERICK K. VREELAND, New York

North Carolina Forestry Association

E. B. WRIGHT, Boardman, N. C.
ALSTON GRIMES, Grimesland, N. C.
J. C. SMOOT, North Wilkesboro, N. C.

National Association of Box Manufacturers

B. W. PORTER, Greenfield, Mass.
S. B. ANDERSON, Memphis, Tenn.
ROBT. A. JOHNSON, Minneapolis, Minn.

Carriage Builders' National Association

H. C. McLEAR, Wilmington, Del.
D. T. WILSON, New York
C. D. FIRESTONE, Columbus, Ohio

Boston Paper Trade Association

N. M. JONES, Lincoln, Maine
JOHN E. A. HUSSEY, Boston, Mass.
ARTHUR L. HOBSON, Boston, Mass.

Philadelphia Wholesale Lumber Dealers' Ass'n

ROBT. C. LIPPINCOTT, Philadelphia, Pa.
J. RANDALL WILLIAMS, JR., Philadelphia, Pa.
FRED'K S. UNDERHILL, Philadelphia, Pa.

New Hampshire Timberland Owners' Association

W. H. BUNDY, Boston, Mass.
EVERETT E. AMEY, Portland, Me.
F. H. BILLARD, Berlin, New Hampshire

Empire State Forest Products Association

FERRIS J. MEIGS, New York City
RUFUS L. SISSON, Potsdam, N. Y.
W. L. SYKES, Buffalo, N. Y.

California Forest Protective Association

MILES STANDISH, San Francisco, Cal.
GEO. X. WENDLING, San Francisco, Cal.
GEO. H. RHODES, San Francisco, Cal.

Minnesota Forestry Association

W. T. COX, St. Paul, Minn.
PROF. D. LANGE, St. Paul, Minn.
MRS. CARRIE BACKUS, St. Paul, Minn.

American Wood Preservers' Association

GEO. E. REX, Topeka, Ka.
CARL G. CRAWFORD, Louisville, Ky.
F. J. ANGIER, Baltimore, Md.

Plant Evergreens 3-25 Feet High and All Winter Planting Will Be Welcome

IF you need to screen unattractive surroundings, garage, stable, poultry house, laundry yard, or street.

IF you admire evergreens.

IF you need windbreaks to your house, garden, out door room or play ground.

IF you enjoy hunting big Cedars, Pines, Oaks, Maples, Dogwoods, Laurel, etc., and making your place look like an old place right away.

IF you have evergreens, deciduous trees or shrubs to move to other parts of your grounds or give away or sell.

The Proof

Hicks Nurseries employed 100 men last winter, except 14 days. Half were digging trees. Our winter sales for the past four years were \$16,000.00.

In January the ground freezes six inches, but is easily worked if previously mulched to keep out frost.

On the mainland the frost is deeper and more continuous, but it is easy to dig through with pick or cold chisel.

If it costs a few cents additional to plant we will bear that to keep our staff all winter.

IF you wish to prevent winter unemployment. We can provide apparatus and men to cooperate with your men or we can attend to the entire operations.

IF you wish to take advantage of present reduced prices. Carload shipments or less from the nursery of pines, spruce, cedar, 3-25 feet high.

I. HICKS & SON

Westbury, L. I.,

New York

TIMBER ESTIMATES, FOREST
SURVEYS and MAPS

D. E. LAUDERBURN

Forest Engineer

6030 Metropolitan Building, New York City

JAMES W. SEWALL

Timber Estimates

Topographic and Boundary Surveys, Planting, Logging Maps, Portable Mill Operations

Technical Training Thoroughness Experience
CENTRE STREET OLD TOWN, MAINE

READY NOVEMBER 1, 1914

A New Booklet on Estimating

Southern Timber

Southern White Cedar

Shortleaf and Longleaf Pine

Southern Appalachian Timber

Postpaid, 20 cents

HOWARD R. KRINBILL

Forest Engineer

NEWBERN, N. C.

Forestry Quarterly

*The technical forestry journal
of North America*

\$2.00 a Year

Address

AMERICAN FORESTRY ASSOCIATION

Washington, D. C.

TIMBER ESTIMATES

We make accurate cruises of standing timber, topographical maps, and advise as to forest management for—

**TIMBER OWNERS
BONDING HOUSES
MILL OPERATORS**

MUNSON-WHITAKER CO.

Consulting Forest Engineers

NEW YORK, 676 Fourth Ave. CHICAGO, 516 Comm. Bk. Bldg.
BOSTON, 622 Tremont Bldg. PITTSBURG, 906 Arrott Bldg.

American Forestry

The Magazine of the American Forestry Association

PERCIVAL SHELDON RIDSDALE, Editor

EDITORIAL ADVISORY BOARD

HERMAN H. CHAPMAN
ERNEST A. STERLING
S. T. DANA

FREDERICK S. UNDERHILL
JOHN E. RHODES
S. N. SPRING

January

CONTENTS

1915

COVER—Homesteaders Home on a National Forest.	
PHILIPPINE FOREST WEALTH—By Dean C. Worcester.	1
With fifteen illustrations.	
SELECTING SHADE TREES—By S. B. Detwiler.	18
THE FORESTS OF BELGIUM—By Charles Harris Whitaker.	22
With twelve illustrations.	
SHADE TREES WORTH \$17,000,000.00.	32
THE DRYAD'S MESSAGE—Poem—By Louise Morey Bowman.	33
THE STORY OF WHITE PINE—By Hu Maxwell.	34
With eleven illustrations.	
TREE PLANTING IN NEWARK—By Carl Bannwart.	46
FIRE PROTECTION ON THE NATIONAL FORESTS IN 1914—By Henry S. Graves.	47
THE MT. LASSEN ERUPTION—By Richard H. Boerker.	51
With four illustrations.	
FOREST PRODUCTS FEDERATION—By E. A. Sterling.	55
THE ANNUAL MEETING.	57
THE FOREST RANGER'S PRAYER.	58
MORTGAGING NATIONAL FORESTS—By Henry S. Graves.	59
THREE MILES OF FLAME—By Allen Chamberlain.	64
EDITORIAL.	68
THE CANADIAN DEPARTMENT.	69
FOREST NOTES.	75
FOREST EDUCATION IN MARYLAND.	78
CURRENT LITERATURE.	79

AMERICAN FORESTRY is published monthly by the American Forestry Association
Subscription price, two dollars per year; single copies, twenty cents.
Copyright 1914, by the American Forestry Association

Entered as second-class mail matter December 24, 1909, at the Post-office at Washington, under the Act of March 3, 1879.

BIRD HOUSES

Made by the BOYS OF ALLENDALE FARM, Lake Villa, Illinois

- Wren Houses\$1.25
- Blue Bird Houses 1.25
- Rustic Houses 3.00
- Winter Food Shelters..... 2.50
- Martin Houses....3.00 to 25.00

¶ Directions for placing houses furnished with each order. ¶ These houses are strong, well built and will last for years. ¶ Write for descriptions and pictures of the models.

Address ALLENDALE FARM
Lake Villa, Illinois

The North-Eastern Forestry Co.

CHESHIRE, CONN.

Growers of Evergreen Seedlings and Transplants
for Forest Planting

Catalogue sent on request

Seeds for Forestry Purposes

WE offer a most complete list of both Deciduous and Evergreen Tree and Shrub seeds for forestry purposes.

Seeds that are of best germinating quality

Our catalogue contains a full list of the varieties we offer, which include the best and most rare species. Send for a copy, it will interest you.

THOMAS MEEHAN & SONS

Wholesale Nurserymen and Tree Seedmen
DRESHER, PENNA., U. S. A.

HILL'S SEEDLINGS and Also Tree Seeds TRANSPLANTS

FOR REFORESTING

BEST for over a half century. All leading hardy sorts, grown in immense quantities. Prices lowest. Quality highest. Forest Planter's Guide, also price lists are free. Write today and mention this magazine.

THE D. HILL NURSERY CO.

*Evergreen Specialists
Largest Growers in America*

BOX 501 DUNDEE, ILL.

Barrett's Grade One LIQUID Creosote Oil

Cuts your wood preserving bills in half—

Especially adapted for preserving telephone poles, telegraph poles, cross arms, railroad ties, fence posts, mine timbers, underground sills, sleepers, bridge timbers, planking, ice houses, wood tanks, shingles, poultry houses, silos, boat timbers or any exposed woodwork.

Booklet on request.

BARRETT MANUFACTURING CO.

- | | | |
|-------------|----------------|--------------|
| New York | Chicago | Philadelphia |
| Boston | St. Louis | Cleveland |
| Cincinnati | Pittsburgh | Detroit |
| Birmingham | Minneapolis | Seattle |
| Kansas City | Salt Lake City | |



ENGRAVINGS for this Edition made by

National Engraving Co.

506-508 Fourteenth St. N. W.
WASHINGTON, D. C.

Engravers to the Government

- Pan American Union
- Smithsonian Institution
- Agricultural Department
- U. S. Geological Survey
- Patent Gazette
- Experimental Stations and State Institutions

HALF-TONES LINE CUTS

THREE-COLOR PROCESS PLATES
ELECTROTYPES

Printers Demand Our CUTS

ANOTHER NEW BOOK FOR THE FORESTER

FOREST VALUATION

By **Herman Haupt Chapman, M. F.**, Harriman Professor of Forest Management,
Yale University Forest School.

This is the first book in English to treat this subject in a sufficiently elementary manner.

Recognizing the frequent need for information on such subjects as damages, stumpage values and costs of forest production, the entire subject has been treated in a manner that may be readily grasped by the average reader.

xvi+284 pages, 6 by 9. Cloth, \$2.00 net

FREE EXAMINATION

NO CASH IN ADVANCE

Members of the American Forestry Association can procure the above book, or copies of any of our other publications, for ten days' free examination—the price to be remitted at the end of this time, or the books returned, postpaid.

If price is remitted in advance, you have the privilege of returning any book within ten days after its receipt.

JOHN WILEY & SONS, Inc., 432 Fourth Ave., New York
London: CHAPMAN & HALL, Ltd. Montreal, Canada: RENOUF PUB. CO.

TIMBER ESTIMATES

Why not have your timber estimated by competent Forest Engineers? Somebody will do it; why not the best?

**IT WILL PAY AND SAVE IN BONDING,
SELLING OR OPERATING**

We make preliminary examinations; complete forest surveys, including logging maps; valuations; and planting and management reports.

Also Specialists on Preservative Treatment of Wood Against Decay

Write for information

CLARK, LYFORD & STERLING

1331-2 Real Estate Trust Building

PHILADELPHIA, PENNA.

Norway Spruce and White Pine

The two leading hardy varieties for Forest Planting

COMPARE OUR PROPOSITION TO SELL ON PROMPT ORDERS

OUR FINE DOMESTIC HARDY NORTHERN GROWN STOCK, UNTIL SURPLUS SOLD, AT THE FOLLOWING ROCK-BOTTOM PRICES FOR FIRST QUALITY PLANTS

These prices may be withdrawn and are subject to change as the stock is reduced

		1,000	10,000	100,000	
NORWAY SPRUCE	4 year Transplants	\$6.50	\$55.00	} If interested by the 100,000 or more do not delay in communicating with us for we can make you THE proposition, BUT WRITE NOW	
"	3 " Seedlings	3.50	28.50		
"	2 " Seedlings	3.00	21.00		
WHITE PINE	4 year Transplants	8.50	75.00		
"	3 " Seedlings	4.00	27.00		
"	2 " Seedlings	3.00	21.00		

Orders Accepted and Stock Reserved in strict rotation as received.

This rule will be observed without deviation.

If you have these two species in your list of Forestry Requirements for Spring 1915 you cannot afford to let this Dollar-Saving opportunity pass.

Scotch Pine, Black Locust, Red Oak, Ash, etc., etc., at special prices

FORESTRY STOCK HEADQUARTERS Send us your full list of wants for quotation. We can serve you to best advantage

F. W. KELSEY NURSERY CO., 150 BROADWAY NEW YORK

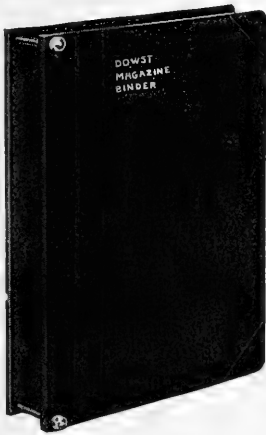

Binder Closed

Save Your American Forestry

For Future Reference

By special arrangement with the manufacturer, we have been able to secure the only practical magazine and periodical binder on the market.

Dowst Magazine Binder

which binds one issue, a dozen issues or more with a neat book appearance. This binder has no springs, catches, strings, clamps, laces or locks, and does not mutilate the periodical in the slightest manner.

PRICE
Postpaid
\$1.50

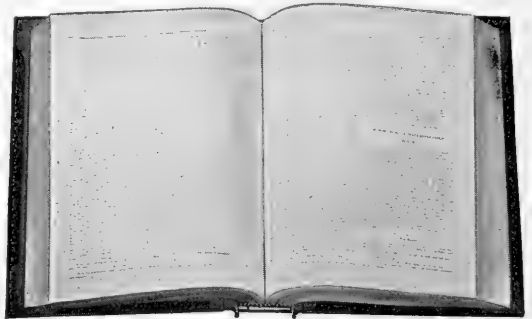

Binder Open

No mechanical labor necessary. Simple, practical, durable.

Complete with 13 Binding Rods, 10 Sectional Posts and name of Publication Stamped in Gold on Front Cover.

Send for Illustrated Descriptive Pamphlet

AMERICAN FORESTRY ASSOCIATION, WASHINGTON, D. C.

American Forestry

VOL. XXI

JANUARY, 1915

No. 1

PHILIPPINE FOREST WEALTH

AN OPPORTUNITY, WITH PROPER CONSERVATION TO MAKE THE ISLANDS' TIMBER LANDS STEADILY INCREASE IN VALUE

By DEAN C. WORCESTER

Formerly Secretary of the Interior to the Philippine Islands

THE land area of the Philippines is approximately 115,000 square miles of which no less than 40,000 are still covered by virgin forests, while second growth forests, of greater or less value, hold possession of an additional 20,000. All but an insignificant fraction of this vast area belongs to the public domain and public forest lands can be acquired for agricultural purposes only upon a proper certificate from the director of forestry that they are more valuable for agriculture than for forest purposes.

They produce timber, cabinet woods, and other valuable forest products in great abundance and endless variety, and the Philippine stand of hard wood is undoubtedly one of the most important remaining in the world. More than 2,500 tree species have now been identified.

Notable among the very valuable structural timbers is *molave*, which has a grain of such nature that it can hardly be split. It is practically impervious to the attacks of "white ants" and is capable of resisting the injurious effects of the tropical sun and rain for centuries. Let anyone who doubts the strict accuracy of this statement examine the forts, now falling into ruins, built long ago for defense against the Moros, or the window sills of the oldest buildings in the city of Manila. Numerous other woods, admirably suited to structural work of all kinds, including the hand-somest and most durable inside finish-

ing, are to be had in great abundance. There are many cabinet woods which leave nothing to be desired in beauty, workability and durability. It is a thousand pities that some of these, like red *lauán*, should have been introduced into the markets of the United States under such misleading designations as "Philippine mahogany." The woods which most nearly approach mahogany in color and texture are red *nárra* and *tindalo*, each of which is quite good enough to be known under its own name.

Good matchwood is produced in abundance. *Palma brava* makes fine bows and fishrods. *Máncono* is an excellent substitute for lignum-vitae. I once began the preparation of a memorandum on the several uses to which I had seen bamboo put, but after writing quite steadily for three days gave up the task on which I had then made only a fair beginning. One of the common bamboos produces an excellent paper pulp and doubtless a number of tree species would be available for this use.

Dye woods are to be had in considerable abundance. There are good stands of gutta-percha trees at various points in the southern islands. The pitch of the pine trees which cover great areas in Northern Luzon is exceptionally rich in turpentine and there are numerous other valuable gums and rosins of which the most important is damar, locally known as *almáciga*, used in making



TYPICAL FILIPINO HOUSES.

SHOWING THE MIXED CONSTRUCTION OF BOARDS AND BAMBOO WITH NIPA PALM THATCH. THE BETTER HOUSES HAVE IRON ROOFS AND ARE BUILT OF WOOD THROUGHOUT. THE POORER ONES ARE CONSTRUCTED CHIEFLY OF PALM LEAVES OR GRASS AND BAMBOO.

varnish. The damar of commerce is a fossil gum, dug from the earth, but the trees which produce it exist in abundance today and are steadily sending their flow of gum into the ground for the possible benefit of future generations.

Extensive mangrove swamps lining many of the more sheltered shores for long distances produce the best of fire wood and good tan bark. Valuable orchids are abundant in many of the damper forests.

The nuts of the lumbang tree are rich in a valuable drying oil, utilizable in mixing paints and varnishes, and pili nuts have now become an article of commerce and are beginning to find their way to the tables of the people of the United States. I know of no other nuts which, when fresh and properly roasted, are so delicious or so tender.

In view of the indifference which we

ourselves have shown towards the conservation of our own forest resources in the immediate past we should not wonder that the Filipinos, by which term I designate the Christianized-civilized residents of the archipelago, should still be utterly indifferent to the preservation of their forests as a permanent source of wealth. Much less would a similar attitude on the part of most of the wild tribes afford ground for surprise, and it is indeed extraordinary that two of the latter peoples, the Lepanto Igorots and the Bontoc Igorots, should have been the only inhabitants of the archipelago to appreciate the importance of conserving their forests and should have promulgated and enforced rules to accomplish this result, yet such is the case.

On my first trip to Cayan, Tadian and Bagnin in Lepanto I was struck by the



SOME PRIMITIVE ADVOCATES OF FOREST CONSERVATION.

THESE PEOPLE BELONG TO THE TRIBE KNOWN AS THE BENGUELEPANO IGOROTS. ALTHOUGH THEY ARE NOT VERY FAR ADVANCED IN CIVILIZATION, ONE SECTION OF THE TRIBE HAS LEARNED BY HARD EXPERIENCE THE VALUE OF FOREST CONSERVATION AND HAS INAUGURATED A PRIMITIVE SYSTEM WHICH INCLUDES THE PROTECTION OF YOUNG GROWTH FROM GRASS FIRES.



AN OLD STYLE SAW MILL.

NOTE HOW THE HEAVY HARDWOOD LOGS WERE CUT INTO BOARDS BY MAN POWER SOMEWHAT IN THE SAME WAY THE WORK IS DONE IN SOME DISTRICTS OF CHINA TO THIS DAY.

peculiar appearance of many pine trees from which all of the branches, except a few at the top, had been carefully cut. I found that the individual trees were all "owned" but that the owners were not allowed to fell them until they had attained a certain minimum size, although they might meanwhile cut the lower branches for firewood. Noting the excellent reproduction which was occurring on some of the hillsides I found upon inquiry that the young trees were being protected from grass fires.

Unfortunately similar wisdom has not been displayed by the inhabitants of any other region in the archipelago and wanton forest destruction has been practiced, with little interference, from the time of the Spanish discovery until the American occupation.

One might suppose that the sparse population of the islands could at the worst make comparatively little impression on their vast forests. Unfortunately this is not the case. The islands produce several rank tropical

grasses commonly known collectively as *cogon*, the wind-driven seeds of which fly for long distances and promptly germinate in land cleared for agricultural purposes. It has been difficult successfully to combat them with such machinery and implements as have heretofore been available, and for untold centuries there has prevailed the custom of obtaining land for agriculture by felling and burning the forest trees. Newly cleared lands have been abandoned as soon as *cogon* made its appearance. This pest is more than capable of holding its own against all comers. Its wide-spreading and sharply pointed roots not only make the soil acid but bore through any moderately soft obstacles which they encounter. Furthermore, *cogon* burns readily and fiercely during the dry season, destroying any young trees which may have established themselves, with the result that a deforested area which becomes a *cogonál* remains a *cogonál* unless man intervenes.

He is now intervening in the Philippines with legislation forbidding the



A MODERN SAW MILL.

FIRST CLASS STEAM MILLS, THOROUGHLY UP TO DATE, ARE NOW IN OPERATION ON THE MORE IMPORTANT TIMBER CONCESSIONS IN THE PHILIPPINES.

making of unauthorized *cañings*, or forest clearings, and with motor-drawn plows and disc harrows, which make short work of *cógon* roots.

Unfortunately incalculable damage has already been done. The great island of Cebu is practically deforested and extensive areas on other islands have suffered a similar fate with the result that in these regions firewood is scarce and dear, structural timber is almost unobtainable save by importation, and the run-off of surface water after rainfall is altogether too rapid, so that stream-beds are filled with rushing torrents one week and are dry the next.

But the damage has not ended here. In cutting *molave* and other especially valuable timbers, the Filipino has had no thought for the morrow. The desirability of leaving trees for reproduction has not occurred to him, and as a result there are extensive areas near tidewater from which the more valuable

tree species have been practically eliminated.

The Spaniards established a forest service, known as the Inspección de Montes, but its officers made little attempt to stop forest destruction, contenting themselves with collecting revenues which were chiefly derived from the timber cut and used locally for house construction.

Prior to the American occupation only one sawmill which was in any sense modern had been established, and the most primitive lumbering methods prevailed.

The narrow bitted Malay ax was used for all cutting operations. Wood cutters stood on platforms high above the ground in order to avoid the thickenings of the trunks near the roots and in consequence stumps were wastefully high. In felling no effort was made to avoid possible injury to other trees or young growth. Logs



PHILIPPINE SAIL BOATS.

BOATS OF THIS SORT, HEWN FROM SOLID LOGS AND PROVIDED WITH BAMBOO OUTRIGGERS TO PREVENT THEM UPSETTING, ARE IN GENERAL USE THROUGHOUT THE ISLANDS.

were transported on land by *carabao** power without even putting shoes under their forward ends. The great weight of many of the hardwoods made it impossible to handle in this way logs of any size, with the result that the sawing into lumber which was almost invariably carried on by hand, often took place where the trees were felled. Hardwood logs near streams were sometimes transported considerable distances by water after being buoyed up with bamboo to prevent their sinking.

Fortunately these primitive but destructive lumbering operations were limited to a comparatively small number of tree species, and many others of value were spared because their properties were unknown.

The necessity for changing the conditions above outlined was so obvious as to lead to very early action on the part of the military authorities. They promptly established a bureau of forestry in charge of Major George P.

Ahern who had not only practical experience in forest work but foresight, imagination and boundless optimism as well. Major Ahern is still in charge of forest work in the Philippines, and is now in length of service the oldest of the bureau chiefs of the insular government. He has certainly needed all his optimism for he has been obliged to face many discouragements. Hampered as he was at the outset by inadequate funds and by the lack of men experienced in tropical forestry, the building up of an efficient field force presented grave obstacles which were met in part by bringing out young and enthusiastic but inexperienced forestry men from the United States and letting them get their experience on the ground; in part by training Filipinos for subordinate positions. At first the latter class of employes received only such training as could be given them in the field, but when the college of agriculture was established regular courses in forestry

* The Philippine name for the water buffalo.



ON THE EDGE OF THE OPEN.

NOTE THE SYMMETRICAL TRUNKS OF THE TREES, AND THE HEAVY UNDERGROWTH EXTENDING TO THE VERY EDGE OF THE CLEARED FIELD SEEN IN THE BACKGROUND.

were duly provided for and an exceptionally fine body of young Filipinos are now being trained up for this important branch of the government service.

One of the most serious difficulties which confronts the lumberman in the tropics arises from the fact that few of the tree species are to be met with in clean stands. In the Philippines the mangrove along swampy coasts, the

pinus and oaks of the highlands and some of the dipterocarps afford exceptions to this rule which is nevertheless general. One very important branch of the work of the bureau of forestry has been to determine and to demonstrate the commercial value of the wood of a number of common tree species which had not previously been marketed. To this end important laboratory investigations were successfully conducted.

The completion of this work rendered possible the making of forest studies to determine the value of the stands on sample acres throughout extensive tracts, and the information thus gained, supplemented by reliable data relative to existing means of transportation and the possibility of bettering them, afforded an adequate foundation for a publicity campaign which has been persistently waged with a considerable degree of success.

The first lumbermen who attempted to introduce modern machinery and methods found that they had much to learn, especially in the matter of milling logs. Many of the hard woods are difficult to work and feeds had to be cut down to avoid stripping the teeth from the saws. Indeed up to the present time it has proved impracticable to use band saws successfully in milling the harder woods. Little by little the skidding engine and the logging railway took the place of the slow-moving *carabao* and up-to-date methods are now firmly established.

Philippine forest lands are not subject to alienation. Wood cutters pay a very moderate stumpage tax. Many lumbermen work under annual licenses which may or may not be exclusive, but such an arrangement would of course not justify the investment of large capital in the construction of logging roads or the installation of expensive machinery, and persons wishing to operate on a large scale are granted twenty-year license agreements covering tracts as large as they can reasonably be expected to utilize during the time the licenses run. Such concessions are in each case granted to the highest and best bidder after being duly advertised. They cost nothing, the "bid" covering such items as the amount to be invested, the value and character of the plant to be installed, the time within which operations will begin, the scale on which they will be conducted, the guaranteed minimum annual cut, and in some instances the percentage of the total cut which will be offered for sale to the public and the maximum



HAULING LOGS IN THE PHILIPPINES.

THIS METHOD IS AN IMPROVEMENT OVER DRAGGING THEM ON THE GROUND BUT IT HAS ITS DRAWBACKS AS THE PHILIPPINE HARDWOODS ARE HEAVY. NOTE THE SOLID WOODEN WHEELS OF THE CART.



TYPE OF KALUNTI-LAUAN.

ONE OF THE FAMOUS WOODS OF THE PHILIPPINES AND WHICH IS EXPECTED TO BECOME VERY POPULAR WHEN IT IS BETTER KNOWN.

prices which will be charged. Special attention was given to these last two items in connection with concessions covering forest tracts near Baguio, the summer capital, where the supply of timber is limited and there would be a

possibility of monopolization with resulting high prices were the interests of the public not adequately safeguarded.

There is a clause in each contract providing for its cancellation in the event that its beneficiaries fail to live

up to its conditions, the fulfillment of which is further safeguarded by the requirement of a cash bond.

In many instances the Bureau of Forestry has assisted lumbermen by preliminary field studies and by advice as to the methods which should be employed in field and milling operations, and the development of the lumber industry has been rapid, especially during the last few years, the annual cut being 77,585,180 board feet in 1911; 95,377,925 in 1912 and 112,360,000 in 1913. The officials of the Forest Service say that ten times the latter amount might be removed from the public forests annually without diminishing their productivity.

The Director of Forestry is vested with adequate authority to control all cutting operations so as to prevent needless destruction and to provide adequately for the reproduction of the more important tree species, with the result that in many instances lumbering opera-

tions have resulted in actual improvement of the forest areas affected. If the present policy is steadily adhered to the public forests of the Philippines can be made a permanent source of great wealth to the people and of revenue to their government.

From the outset preferential attention has been given to protecting the interests of the individual. The old Spanish charges on timber to be used for house construction or other non-commercial purposes have been entirely done away with. Even in the areas covered by "exclusive" concessions, neighboring residents are granted the right to obtain, free of charge, fuel and timber for their personal use, but many Filipinos have bitterly resented the restriction of the wanton destruction of valuable timber by the making of needless *cañigins*. Only a very few of the most enlightened give a thought to the future or see any real need of conservation. They wish to take from the public forest whatever



ONE METHOD OF HAULING LOGS.

WHILE THIS IS THE WAY THIS WORK WAS DONE MANY YEARS AGO THE SAME METHOD IS IN COMMON USE TODAY.



TYPICAL FOREST SCENE IN THE PHILIPPINES

IT SHOWS THE ROOTS OF THE BALETE TREE. THE TREES OF THIS SPECIES ARE GENERALLY BELIEVED THROUGHOUT POLYNESIA TO BE THE ABODES OF SPIRITS AND IN THE TERRITORY OF THE MORE BACKWARD PEOPLES OF THE PHILIPPINES IT IS SOMETIMES DIFFICULT TO GET THEM REMOVED WHEN THEY INTERFERE WITH ROAD CONSTRUCTION.

they require, without payment and without limitations of any sort. In many instances the maker of the unlawful *cañgin* is a poor native employed by a rich one. If detected he is left to pay the penalty for his wrong conduct; otherwise the land cleared is eventually incorporated with that of the rich neighbor who hired him to violate the law. It is therefore needless to say that the work of the forestry bureau has not been popular with the Filipinos.

Many of the lumbermen in the Philip-

pinas are, like many lumbermen elsewhere, not in favor of any restrictions on cutting operations, and inclined to disregard future advantage for present gain, so it has resulted that the Philippine Forest Service, which helps lumbermen and the public alike, has been rather short of friends.

Under the plea of economy and of the need of a more equitable division of the funds of the government between bureaus, the annual appropriation for the support of its work was greatly reduced



AMONG THE BENGUET PINES.

A SAMPLE OF THE ADMIRABLE ROADS CONSTRUCTED UNDER THE UNITED STATES ADMINISTRATION.

some years since. An unsuccessful effort was made at that time to have it consolidated with the bureau of agriculture, and it has since had to struggle to justify its existence as a separate entity.

As the executive official exercising control over it, I sought to accomplish two things. The first was to demonstrate that its continued existence was justified on financial grounds, regardless of the importance of preventing wasteful forest destruction, by the increase in insular revenues which resulted from its activities in stimulating healthful development of the lumber industry, and in assisting the bureau of internal revenue to collect the amounts due the government from lumbermen.

My efforts in this regard met with a

considerable degree of success. I was at first refused an increased appropriation necessary if officers of the Forest Service were to be sent into the great island of Mindanao, where practically unrestricted cutting operations were being conducted, and was advised that I could in my own discretion take such officers from other places where they were then employed and put them into this territory if I felt that their presence there would result in profit to the government. I acted upon this suggestion and the increase in forest revenue from Mindanao within a year was such as fully to demonstrate the correctness of my contention. This brought a small permanent increase in the working force of the bureau.



WHERE THE TABLE TOPS COME FROM.

THE PHILIPPINES ARE FAMOUS FOR THEIR BEAUTIFUL SINGLE PIECE TABLE TOPS OF RED SARRA. THEY COME FROM GREAT BATTERED ROOTS LIKE THE ONE HERE SHOWN OR LARGER.



THE LACAN-HAGACHAE TYPE.

THIS INDICATES IN SOME MEASURE THE DIFFICULTIES OF GETTING TIMBER OUT OF THE HEAVY FORESTS, BUT THE OPENING UP OF DISTRICTS BY THE CONSTRUCTION OF GOOD ROADS IS GRADUALLY MAKING MUCH OF THE TIMBER AVAILABLE.

The second thing which I sought to secure was the setting aside of a definite proportion of the forest revenues for the work of the Bureau of Forestry. This I deemed to be a matter of fundamental importance, for as the lumber industry of the Philippines grows the necessity for augmenting the force which supervises cutting operations increases, while

the making of careful forestry studies and the preparation of working plans for great forest tracts promotes the healthful growth of the lumber industry, and a direct interest in forest revenues is calculated to stimulate the activity of the bureau of forestry in augmenting them.

The Upper House of the Philippine



WATER POWER GOING TO WASTE.

THE DEVELOPMENT OF HYDRAULIC POWER HAS HARDLY BEGUN IN THE PHILIPPINES. IT HAS GREAT POSSIBILITIES IN REGIONS WHERE FORESTED WATERSHEDS CAUSE A GRADUAL RUN-OFF.

legislature ultimately adopted this plan in practice, appropriating an amount equal to 10% of the revenue of the previous year for work in the special government provinces which were under its exclusive legislative control, and voting for the appropriation of an amount equivalent to 50% of these

revenues for the work in the remainder of the archipelago.

It was reported that the Filipino Lower House favored the latter appropriation but there was no opportunity to test the truth of this statement as during several successive years the two houses failed to agree on a new appro-

priation bill and the old one continued in effect.

Unfortunately little faith can be placed in the willingness of the Lower House to support forest conservation. Its attitude clearly appeared in connection with recent efforts to secure important legislative reforms. Under existing provisions of law timber may be measured either in the round or after it has been manufactured into lumber. In actual practice the latter procedure is the one almost invariably followed, with the result that the government loses revenue on logs cut and abandoned in the forest and on those carried out to sea by floods while being transported by water. Wasteful manufacturing methods are encouraged, as there is no charge on what goes into slab piles. No charges are paid on lumber smuggled out of the yards and sold secretly or on that which is stolen from the yards or is burned or rots, for the reason that under the administration of a Filipino secretary of finance and justice, the bureau of internal revenue allows the mill men themselves to declare the amounts of lumber on which charges are due. Their declarations are not made until the lumber is shipped to market and there is no check on them except that afforded by the amounts of lumber actually received at the more important points of debarkation. This extraordinary administrative arrangement, not paralleled in the history of the American occupation of the Philippines, encourages fraud and unquestionably results in material loss of revenue, for although officers and employes of the bureau of forestry were finally made internal revenue officers for the purpose of enforcing collections, the exigencies of field service rendered it impossible for them to be stationed permanently at sawmills so as to perform the very large amount of work involved in measuring manufactured lumber as it comes from the saw. Measurements in the round could be easily and quickly made either in the forest or at the mill and an adequate check on operations of lumbermen could thus be established without materially augmenting the force of the bureau of forestry.

In view of these facts I drafted an act providing that timber should be measured in the round. It was thought that certain of the lumbermen would oppose this measure, but no opposition developed when the bill came up in the Commission and it was passed by that body. Unfortunately an effective bit of lobbying had been done meanwhile in the Lower House and that body promptly killed a measure which would have augmented materially the annual revenues of the government without interfering in the least with the legitimate operations of lumbermen.

The Philippine Assembly has not been content with obstructing the work of the Bureau of Forestry but has twice struck at its very existence. At the last session of the legislature it passed a bill transferring all forest work to the bureau of lands for which a Filipino chief had just then been appointed. Fortunately the Upper House has not yet become oblivious to the fact that the Act of Congress of July 2, 1902, fixed certain specific duties, of a very important character, for the director of the Bureau of Forestry and that the power of the Philippine legislature to defeat the will of Congress by abolishing his office is therefore decidedly doubtful.

In spite of the splendid service which the Bureau of Forestry has rendered in making practicable and encouraging the building up of a great lumber business in the Philippines and in augmenting the government revenues, its continued existence is probably due only to the fact that it does not at present lie within the power of Filipino politicians to do away with it. Let us hope that it will long continue to survive political vicissitudes.

Vastly more timber falls and rots annually in the Philippines than is cut by all the lumbermen. The lumber at present manufactured is not sufficient in amount to meet the local demand, to say nothing of the possibility of building up a profitable export trade. Under proper supervision the public forests will steadily increase in value and will become an important source of permanent wealth. Without such supervision deforestation will progress more



ONE OF THE USES FOR PHILIPPINE TIMBER.

THE FORESTS FURNISH ADMIRABLE TIMBER FOR BOAT AND SHIP BUILDING. GOOD NATURAL CROOKS ARE READILY OBTAINED AND SOME OF THE NATIVES SHOW CONSIDERABLE SKILL IN THE CONSTRUCTION OF SHAPELY AND SEAWORTHY CRAFT. THE PICTURE SHOWS SHIPBUILDING UNDER WAY AT DAGUPAN, IN LUZON.

rapidly than ever before, as a direct result of the application of modern lumbering methods and of the strong stimulus which agricultural development has received. The value of the remaining forests will be diminished by the destruction of the more valuable tree species. It will become excessively difficult in many regions to obtain firewood and building materials. Conditions as to rainfall and run-off will be unfavorably influenced and the supply

of water needed for irrigation during the dry season will be diminished.

It is too much to expect that the present generation of Filipinos should adopt adequate measures to provide against these dangers. The Congress of the United States should provide specifically for the continuance of the Philippine Forest Service so that the ignorance and extravagance of the present generation may not inflict irreparable loss upon the generations that are to come.

SELECTING SHADE TREES

By S. B. DETWILER

TREES are a constant inspiration to an appreciation of the beauties of nature; they cool the air in summer and temper the cold winds of winter. They furnish a nesting place and shelter for birds and counteract the adverse conditions of city life. They purify the air, encourage outdoor life and have a vast educational influence upon the citizens, especially children. They enhance the beauty of architecture, increase the value of real estate, and conserve soil and moisture.

Through a love of the trees the people of the United States are beginning to comprehend the need not only for planting shade trees and protecting them, but for the protection and more rational use of our splendid forests.

The American Forestry Association is devoting its influence to the development of public thought and knowledge about trees and forests along practical lines.

This article is limited to general information about selecting shade trees.

To those who desire detailed advice concerning forestry problems or who are in need of a complete plan for forestry operations, the American Forestry Association is prepared to mail expert advice upon application.

Attention is also called to State forestry departments, State forestry associations and city foresters Departments

from which reliable and unprejudiced information may be obtained. Those who desire to plan and direct their own forestry work are strongly urged to outline a definite and complete program of operations before the work is started. This will insure close attention to practical details and will help to avoid annoying mistakes.

SHADE TREES

The selection of species is a matter of primary importance in shade tree planting. In deciding this point the climatic and soil conditions and the location of the tree or the purpose for which it is desired must be considered. In the past the tendency has been to plant quick growing trees for immediate effect regardless of their qualifications. The results invariably have been highly unsatisfactory. In the lists given below are enumerated trees suitable for various purposes and planting sites. The trees printed in italics are those which are most desirable.

STREET TREES FOR PLANTING UNDER SEVERE CONDITIONS

Oriental Sycamore.—Hardest of all for street planting, not liable to insects, rapid growth. Deep rooted, adapted to a great variety of soils. Will require pruning on narrow streets but stands pruning well. Should be planted from

40 feet apart in poor soil to 50 feet in the more favorable sites.

Norway Maple.—Very hardy, adapted to a variety of soils, has a regular compact crown, casts dense shade, requires little pruning. Plant 35 to 40 feet apart.

Red Oak, Pin Oak, Scarlet Oak.—Best oaks for street purposes; hardy, medium growth, moderate shade, fairly free from insects, should be spaced 40 to 50 feet apart. Red Oak is the fastest growing oak, has a wide-spreading crown, and is least fastidious in regard to soil and moisture. Scarlet oak has brilliant and persistent foliage in Autumn. Pin oak has a rather narrow, pyramidal head, and is best adapted to moist soil. It grows slowly at first but makes a good growth when well established. Oaks do not stand pruning well, and branches should be cut off at the trunk. Because pin oak branches droop more than other oaks, the branches must be pruned off far up the trunk to prevent interference with street traffic.

Ginkgo or Maidenhair Tree.—Hardy, adapted to poor soils, casts light shade, free from enemies of all kinds. Suited to narrow streets, but the head can be broadened by proper pruning. The fruit is objectionable, but only for a short time. Spacing about 30 feet.

Honey Locust.—Stands smoke well, adapted to almost any soil. Casts very light shade, good growth, fairly free from enemies. Should be planted sparingly. Spacing about 40 feet.

Ailanthus.—Young trees vigorous, of good appearance, but later become unsightly. Adapted to the most adverse conditions. Thrives in very smoky atmosphere and in poor soil. Male tree has obnoxious odor, so only female form should be planted. Sprouts freely from roots, but these can be controlled by cutting back. Should not be considered where other trees will grow. Spacing about 30 feet.

STREET TREES FOR PLANTING UNDER FAVORABLE CONDITIONS

American Elm.—A graceful tree, attractive in summer and winter. Tall and stately with strong arching branches. Grows rapidly in rich, well-drained, moist soil, but adapted to many

soils. Should be planted only on wide avenues, 40 to 60 feet apart, according to soil conditions, usually about 50 feet. Very liable to attack by the elm leaf beetle. The English elm is smaller, more compact, not as graceful as the American elm, and more subject to insect attack.

Sugar Maple.—Very hardy but exacting in soil and moisture, and is sensitive to dust and smoke. Rounded symmetrical head, foliage colors brilliantly in autumn. Plant 40 to 45 feet apart.

European Linden.—Well formed, rounded head, with dense beautiful foliage, grows quite rapidly but requires good moist soil, and is very liable to insect attack. Should be spaced about 35 feet. The basswood or American Linden has larger leaves and is less valuable for street planting than the European species.

Tulip Tree.—Tall, very regular form, requires good soil. Hard to transplant on account of tender roots; best results if young trees are planted. Subject to scale and other enemies. On account of its great size, should be planted only on very wide streets and in suburban sections. Spacing 45 to 60 feet.

Red Maple.—Adapted to good moist soil, moderate growth, dense shade, fairly free from insects. Fine coloring in spring and fall. Space trees 35 to 40 feet apart.

Sweet Gum.—Best suited to very moist, rich soil. Has compact form, beautiful foliage, especially in fall. Very free from insects. Spacing about 35 feet.

White Ash.—Fairly rapid growth, hardy, suited to many soils. Grows straight and forms a round, symmetrical top. Leaves compound, and foliage in pleasing, irregular masses. Few enemies. Spacing about 40 feet.

Hackberry.—Medium sized, symmetrical tree, not exacting as to soil, moisture, or climate. Slow growth, but fairly free from pests and diseases. Spacing about 30 feet.

OBJECTIONABLE SPECIES FOR STREET PLANTING

All Poplars (Cottonwood, Carolina poplar, white poplar, Lombardy poplar, etc.).—Very rapid growth and require

constant cutting back. Wood soft, brittle, and limbs or tops frequently broken in storms. Surface roots raise flagstones and crack concrete walks, and the thick trunks push curb stones out of line. Fine rootlets clog drains, leaves fall during summer. Short-lived. Seed of female cottonwood objectionable.

Silver Maple.—Grows rapidly, but is short lived, and has brittle weak branches which break easily in storms. It is hard to prune and is affected by serious insect pests and fungus diseases.

Sycamore Maple.—Resembles the Norway Maple in habit of growth, but less desirable, and is subject to borers.

Box Elder.—Grows rapidly and under adverse conditions, but has a scraggy crown, branches easily broken, and twigs die readily; it is badly infested by insects, and the leaves start falling in summer.

Male Ailanthus.—The staminate or male flowers of Ailanthus produce a strong and highly disagreeable odor. This can be avoided by planting the female form of the tree.

Catalpa.—Common catalpa forms a short crooked trunk, and an irregular head. Not at all suited for street planting.

Hardy Catalpa is straight and with a well-formed crown, but requires good soil. Both species subject to enemies and are better as ornamental trees.

Horse Chestnut.—Leaves discolor, shrivel and fall in early summer. Subject to attacks of many insects and fungi.

The Conifers.—Are highly decorative for lawns and parks, but they cannot stand a smoky, dusty atmosphere, and the removal of the lower branches disfigures the trees.

FOR OTHER THAN STREET PLANTING

For private grounds and parks.—A great variety of trees may be used. Any tree native to the region or to regions of similar climate will grow if soil and moisture conditions are similar or if made equal by a change of soil. The species should be selected for its adaptability to existing soil and moisture conditions, and for its suitability, when full-grown, to the particular

purpose for which it is desired—ornament, shade, protection, screen, etc. Time is well spent in observing the growth of the native and planted trees of the region.

Roadside trees.—All of the trees listed for street planting and many of those named for private grounds may be used. The selection of species and the spacing should be governed by the soil and local conditions, but care should be taken that the shading of roadway and adjoining property will not be detrimental.

GENERAL INFORMATION

Trees preferring wet soil.—Pin oak, Bald cypress, Oriental sycamore, Swamp white oak, Willow oak, Sweet gum, Red maple, White birch, Black ash, Tamarack, Willows and poplars.

Tall trees with large spreading crowns.—American elm, Tulip tree, Red oak, American sycamore, Honey locust, White oak, Horse chestnut, White ash, Black walnut.

Trees with narrow pyramidal crowns.—Ginkgo, Bald cypress, European larch, Norway spruce, Colorado blue spruce, Arbor vitae, Red cedar, Red fir, Hemlock, Lombardy poplar.

Trees with very large leaves.—Catalpa, Paulonia, Ailanthus, Great flowered magnolia, Cucumber tree, Kentucky coffee tree, Black walnut, Hercules club.

Trees with narrow or finely cut leaves.—Honey locust, Bald cypress, European larch, Willow oak, Black cherry, Sumach, cut-leaved varieties of many other species and most conifers.

Broad-leaved evergreens.—American holly, Great flowered magnolia, Swamp magnolia, Rhododendron, Mountain laurel.

Trees with fragrant flowers.—Swamp magnolia, Lindens (American and European), Black locust, Honey locust, Yellowwood, Wild crab apple, Wild plum, Cherries, Hawthorns, June berry.

Trees with showy white flowers (Blooming before the leaves).—Flowering dogwood, June berry, Plums, Cherries (blooming after the leaves); Catalpa, Horse chestnut, Buckeye, Magnolias, Basswood, Yellowwood, Black locust, Hercules' club, Mountain ash, Rhodo-

dendron, Hawthorns, Sourwood, Silver-bell tree, Fringe tree, Viburnum.

Trees with showy yellow flowers.—Tulip tree, Cucumber tree, Yellow-buckeye, chestnut, willows, sassafras, Witch Hazel, Birches (staminate).

Trees with showy pink flowers.—Red bud, Wild crab apple, Clammy locust, Mountain laurel, Rhododendron.

Trees with showy red flowers.—Red maple, Sumachs, Papaw.

Trees with showy red fruits.—Mountain ash, Flowering dogwood, Hollies, Red maple, Magnolias, Burning bush, Hawthorns, Cherries, Plums, Yew, Sumachs, Red Ailanthus.

Trees with bright Autumn foliage (Leaves turning red).—Sweet gum, Tupelo, Red maple, Flowering dogwood, Scarlet oak, Red oak, Sumachs, June berry, Hawthorn, Sorrell tree, Burning bush. (*Leaves turning yellow*) Tulip tree, Ginkgo, larch, Silver maple, White ash, Ailanthus, Cucumber tree, White birch, Hickories, Beech, Walnuts, Willows, Poplars. (*Leaves turning mixed red and yellow*) Sugar maple, Sweet gum, Sweet birch, Sassafras. (*Leaves turning purple*) White ash, White oak, Red oak, Dogwood.

Hardy coniferous species (Large trees).—White pine, Red pine, Pitch pine, Limber pine, Sugar pine, Table mountain pine, Austrian pine, Scotch pine.

European larch, Norway spruce, White spruce, Red spruce, Colorado blue spruce, Engleman spruce, Douglas fir, Hemlock, Carolina hemlock, White fir, Giant arbor vitae, Bald cypress, Lauson cypress, Sitka cypress.

(*Medium sized and small trees.*)—Nut pine, fox-tail pine, Cembrian pine, Swiss mountain pine, Mugho pine, Korean pine, Lacebark pine, Dwarf umbrella pine, Black spruce, Dwarf juniper, Drooping juniper, Red cedar, Arbor vitae, White cedar (*Chamaecyparis, Retinospora*).

Trees that attract birds should be planted around houses. Thorny trees and shrubs are much sought by birds for resting places, because of the protection afforded from cats as well as other birds. Red cedar and other junipers are among the best. Others are English thorn, Hawthorn, Wild crab apple, European and American mountain ashes, smooth and staghorn sumach, Barberry, Buckthorn, Dogwood, Viburnum. The following planted near fruit trees and gardens will minimize depredations by birds; Red-berried elders, Buffalo berry, Bird cherry, Sweet cherry, Mulberry, Russian mulberry.

Street trees for Southern States.—Live oak, Water oak, Willow oak, Laurel oak, Great flowered magnolia, Pecan, Camphor tree, Palmetto, Desert Palm.

[In the February issue of AMERICAN FORESTRY Mr. Detwiler will have an article telling when and how to plant shade trees, to care for them and repair them. This will be of great value to any one wishing information and will appear in time to furnish instruction regarding spring-time planting—Editor.]

THE INDEX FOR VOLUME TWENTY

OF THE AMERICAN FORESTRY MAGAZINE IS NOW READY AND
WILL BE SENT UPON REQUEST TO ANY DESIRING IT

THE FORESTS OF BELGIUM

By CHARLES HARRIS WHITAKER

THE traveler, crossing from Dover to Ostend, or leaving the Channel to wend his way slowly up the Scheldt to Antwerp, or crossing from Harwich to the Hook of Holland, would scarcely picture the low-lying seacoast of Belgium and Holland as having once been girt with a thick forest. Yet this "nether land, hollow land"—whence we no doubt derive both of the words Netherlands and Holland—was at one time only saved from the further relentless encroachments of the sea by the tangled woods which grew about its seaward limits. They offered a barrier against which the sea beat in vain. The impenetrable network of roots and branches only aided in heaping up the dunes into those bulwarks which the skill of man was to transform later into dikes, and by their aid, turn the almost impenetrable morass into a land of fertility and abundance.

All of the territory which we once knew as the Netherlands, and which under the name of the Low Countries played so important a part in Europe's ceaseless wars of conquest and lust for power, was practically surrounded by forests. On the south, the hills and valleys of the Ardennes, densely wooded, offering an almost impenetrable obstacle to invasion, as they have today played so important a part in the war by barring the direct invasion of France by Germany. It is perhaps true that Belgium would have been spared many of the horrors which have fallen to her lot had the forest of the Ardennes not forced the German General Staff to make plans for the occupation of almost the whole of Belgium, although we must leave to the future the revelation to us of many secrets which are still unknown to the world at large. On the north was the sinister Badahuenna wood, whose only claim to historic value lies in the fact that it once resounded with the horrors of the Druidical sacrifices. On the eastern side there stretched away the great Hercynian

forest. Legend has it that nine days were required to traverse the labyrinth of its wild ways from north to south, while its eastern extent was said to be so great that no German had ever been able to find its beginning, although one, most adventurous and courageous, had pluckily held to a journey of no less than sixty days.

Of these forests comparatively little remains. The Wood, just outside the Hague; the groves of Harlem, the forests of Soignes and Ardennes are all that have been left. From Amsterdam on the north to the banks of the Meuse, and from the seacoast to the Rhine, one seldom gets a view of anything which would even suggest that a forest had ever existed in this highly cultivated land. Trees are everywhere, for the Belgians knew well how to shade their roads and protect their streams. The long rows of willows and poplars, stretching away in every direction, are familiar sights, but there is no suggestion of the forest until one reaches Brussels or until one has journeyed south and west and come up with the border of the Ardennes. Just above Dinant on the Meuse, already a victim to the devastation which has overtaken this dauntless nation, the Ardennes begin, sweeping in a southerly and south-easterly direction clear down to the confines of the Duchy of Luxembourg and the frontiers of France.

The favorite holiday ground of thousands of Englishmen, the Ardennes are scarcely known to Americans. Within the boundaries of this delightful section there are to be found some of the finest woods in all Europe. Some of them seem to have come down from the days of Caesar, but best of all, one finds the keenest pleasure in knowing that, thanks to the compulsory replanting laws of Belgium, they are as nearly certain of preservation as it is possible to make them.

The Arduenna Silva was the most extensive forest within the Gallic do-

main and Caesar evidently believed it to extend from the Rhine to the North Sea, for he has so described it. It is the scene around which hang countless legends and stories and there seems no reason to believe that it was not in truth the very Forest of Arden of Shakespeare's play. It was to this forest that there came the rich noble from the court of King Pepin. So passionately fond was he of the chase that all else was neglected. On a certain Good Friday when he was following his favorite pastime, there came within his view a noble stag, bearing between its horns a golden crucifix. On urging his horse in the direction of the animal, he was astonished to note that it showed no disposition to flight, but stood calmly regarding him, although with an imploring eye. Strangest of all, it spake to the huntsman in these words: "Hubert! Hubert! For how long will this idle passion for the chase tempt thee to forgetfulness of thy Salvation?"

The conscience-stricken huntsman threw himself prostrate on the ground, crying, "Lord, what shall I do? I am ready."

And the voice answered, "Go to Maestricht to see my servant Lambert. From him shalt thou learn what to do."

The stag then disappeared as suddenly as he came. But Hubert went his way toward Maestricht and to Saint Lambert, there to make his confession in the monastery of Stavelot. Some years later he journeyed to Rome and after the martyrdom of Saint Lambert in the valley of Liege, the Pope appointed Hubert to be Bishop of Tongre. So goes the legend of St. Hubert and so goes many another, to the perpetuation of which the forest of Ardennes forever lends its deep recesses.

So far as is at present known, the Ardennes have not suffered materially in the present war. It is true that military necessity knows no law and even in spite of the long-established

policies of forest cultivation and preservation by both Belgium and Germany, we may not assume that there would be the slightest hesitation in destroying any extent of forest in order to accomplish a tactical end. It is therefore not difficult to understand that within



VALLON DES PALISSADES.

A LITTLE VALLEY WHERE ONE MAY REST IN THAT QUIET WHICH ONLY THE FOREST GIVES.

the area of operations which has extended from east of Liege to Antwerp, great quantities of trees have been sacrificed for strategic purposes. This is especially true of the woods about Liege and those lying between Louvain and Brussels and between Brussels and Malines. The Belgians have not hesitated to make these sacrifices in defense of their country and the Germans have cut down any woods which interfered with their operations.



ETANG DU ROUGE CLOÏRE.

ONE OF THE DELIGHTFUL BITS OF WATER THAT DOT THE FOREST OF SOIGNES AND FORMING A PART OF THE GRAND ETANG DU ROUGE CLOÏRE.



ETANG MONASTIQUE DE GROENENDAEL.

THE ANCIENT POND OF THE MONASTERY IN THE FOREST OF SOIGNES.

Letters which have been received within a very recent date indicate that so far the forest of Soignes has been spared. In view of the pangs which we have all suffered at the thought of the destruction of the ancient buildings in Belgium and France, always secondary to the thought of the agony which has been heaped upon the people themselves, it seems trivial to even think about a forest. Yet those who know the forest of Soignes would experience the profoundest sorrow were they forced to believe that it too had gone the way of all the rest.

Soignes is at once the pride and the glory of Brussels, one of the most beautiful of all the world's forests, one of the most delightful spots in all Europe. For reasons which it is quite easy to understand, its loveliness is little known to the thousands of Americans who annually visit Brussels. One goes to Belgium to see its art treasures—to study Van Eyck and Memling at Bruges and Ghent, to wander through the quaintness of Malines and Louvain—alas! that it has gone forever! In Brussels one may drive to the Bois de la Cambre, one of the most enchanting of parks, but few evidently have the courage or desire to continue the drive and lose themselves in the glades and archways of the forest of Soignes itself, which is practically a continuation of the park. It means a whole day, starting early and returning late, if one is to gain any real idea of the forest, but few who have made the journey will ever forget it.

Some few months ago there came into my hands a very curious pamphlet with a title of such philosophic significance that in reading it one seemed to go back into the past of two or three centuries ago. It was entitled: "Study of an Element of the Restoration of Public Taste through a Return to the Contemplation of Forests and Natural Sites, particularly Forests and

Methods of Conserving Them, and especially the Forest of Soignes."

Its naïveté takes one back to the fugitive broadsides and pamphlets of the time of Defoe, and yet it is in reality the title of a communication presented to the Fourth Congrès Inter-



BEECHES IN THE FOREST OF SOIGNES.
THE TRUNKS ARE CLOTHED IN AN ALMOST TRANSLUCENT VEIL
OF DELICATE GREEN.

national d'Art Public, held at Brussels in 1910.

It was signed by René Stevens, the artist, and Louis Van der Swaelmen, Jr., an artist and landscape architect, and formed a part of the work undertaken by the League of the Friends of the Forest of Soignes; it puts forth a plea for revitalizing the beauties and glories of the forest, such as must have fallen upon sympathetic ears.



GRAND ETANG DE ROUGE-CLOÎTRE,
THE LARGEST BODY OF WATER WITHIN THE FOREST OF SOIGNES.



SORTIE DU VALLON DE LA SOURDINE,
LEAVING THE FOREST OF SOIGNES BY ONE OF THE VALLEYS WHICH LEAD TO THE OPEN COUNTRY BEYOND.

The origin of "Soignes" seems lost in the misty distances of the past, but the forest dates back to the prehistoric era. At the beginning of history it opposed an impassable barrier to the invasion of the Franks, and established the linguistic frontier of the countries which, fifteen centuries later, were to unite under the name of Belgium. Up to the 15th Century this ocean of verdure beat against the very foot of the hill which now forms the center of Brussels, but by the end of the 18th Century, under the Austrian domination, it had been reduced to 12,000 hectares (29,652 acres).

Under the French and until 1822 it remained of this extent; but under the Dutch, and through its exploitation by the Société Générale Néerlandaise pour favoriser l'Industrie Nationale, which bought the forest from William of Holland, it became further reduced to nearly one-third that size. Today it covers only 4,860 hectares (12,000 acres), a striking example of how the Dutch Stock Company carried out its plan of favoring national industries, and an excellent illustration of the fact that great national resources were privately coveted and exploited long before the present era.

From among the noblest of its ranks were culled the planks of the flat-boats destined to serve Napoleon in his planned invasion of England; likewise, twenty-two thousand of its specimens were cut for building palisades about towns which were thought to be menaced by the allies.

Up to 1866 the forest fell victim to one interest after another, until finally the Administration became subject to such criticism that it appointed a commission, which, however, served only to partially arrest the destruction of the forest. During the ensuing years, up to the formation of the League of the Friends of the Forest, in 1909, its

preservation was the constant subject of protest and agitation, and, as usual, this work centered about the personality of a man—René Stevens, painter, nature-lover, and an ardent champion of the inalienable right of the people to their national heritage.



AU VALLON DE BLANKENDELLE.
ON THE EDGE OF THE WOOD OF THE VALLEY OF BLANKENDELLE.

René Stevens was to the Forest of Soignes what Denecourt was to Fontainebleau, and the amazing chronicle of his efforts not only to preserve the forest but to render it known, accessible, and beloved is the crowning achievement of his life. To his aid came many others, and, with that tenacity of purpose which has won the Flemish race its proud position, the



DREVE DU COMIL.

ONE OF THE MOST MAGNIFICENT OF THE ROADS THROUGH THE FOREST OF SOIGNES, ITS ARCHED WAY OFFERING AN INDESCRIBABLE SPLendor OF LIGHT AND SHADE.

battle was carried to a point where the League now considers that it has attained the following results:

1. In relation to the preservation of the integrity of the forest:

a. That no concession of land of any kind, in the forest proper, shall be granted to any person soever.

b. That every concession solicited for land bordering upon the forest shall be rigorously examined and rejected whenever its granting would in any way impair or endanger the forest.

c. That, should the necessities of the bordering communities demand the construction of a tramway through the forest, it shall follow the line of the already established main routes, every other route being irrevocably closed.

d. That no new road, path or avenue, for any purpose soever, shall be opened in the forest.

e. That not even the tiniest parcel shall be diverted for the purpose of a so-called park, and that those spots which have been so treated shall be allowed to grow up in natural forest.

2. In relation to the forestry administration:

a. Cutting by *blanc-étoc has been completely abolished.

b. The coupes† jardinatoires, which have supplanted the coupes à blanc-étoc have been modified, so that the reserves shall be respected up to the point where their decay shall become manifest or a danger to the passer-by.

These conditions have diminished the revenue of the forest from five hundred thousand francs to two hundred thousand; but the League now desires to go further and, in addition to preserving the forest, to also accomplish the destruction of such features as have been introduced in order to give to it an "ornamental, exotic, or resinous" character, since these features are not only foreign to its

physiognomy but are also contaminated with specimens which are destructive to the indigenous flora. In other words, the League believes that the Forest of Soignes shall and must be preserved as "a national reserve of natural beauty," and it is precisely in relation to the



DREVE DES ENFANTS NOYES.

ONE OF THE INNUMERABLE FOOTWAYS WHICH MAKE THE FOREST OF SOIGNES SO THOROUGHLY ACCESSIBLE.

influence of such a reserve of beauty upon the lives, the welfare, and the development of a people that there was written the pamphlet with the quaint title.

Is it any wonder that artists such as Stevens and Swaelman made so passionate a plea for the preservation of the

* Literally "white-stump," and referring to complete deforestation of whole areas.

† After the manner of gardening; that is to say, the method of cutting out only the ripe and full-grown trees, and providing for a perpetual renewal.

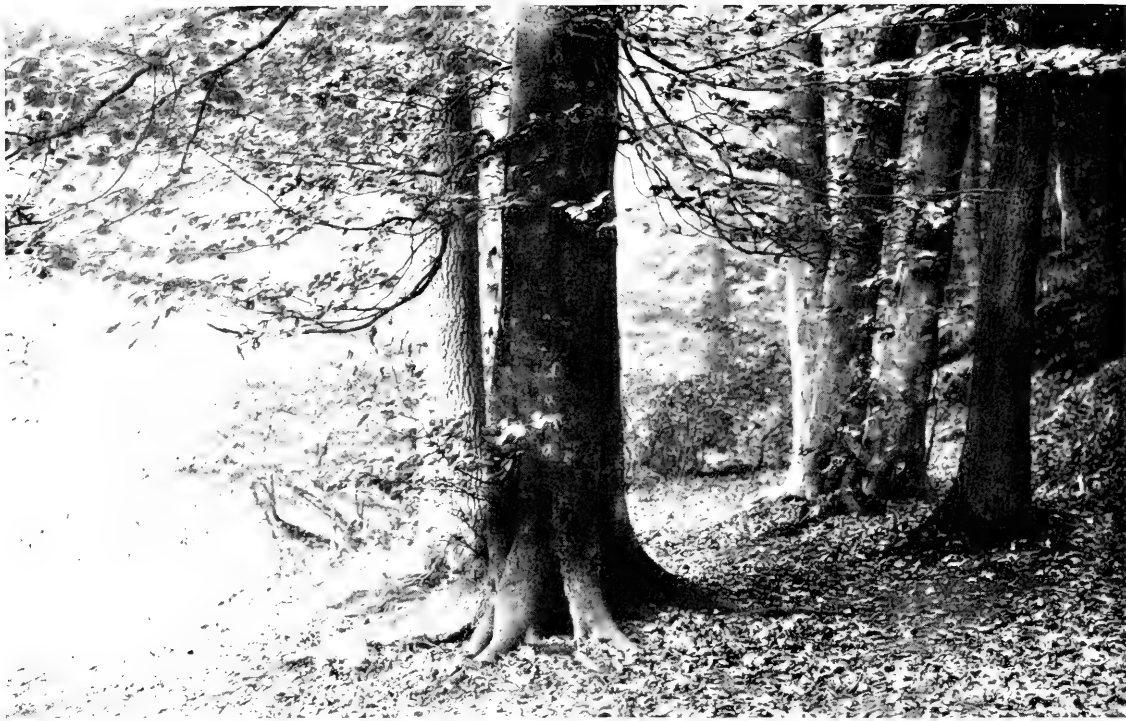

ON THE EDGE OF AN OPENING WHERE BEECHES AND OAKS STAND GUARD. FOREST OF SOIGNES.



VALLON DU PUTOIS.

A WAGON ROAD THROUGH THE FOREST OF SOIGNES, THE NATURAL BEAUTY OF WHICH IS WORTH GOING FAR TO SEE.



VALLON DE LA VUYLBEEK.

A SUPERB COMPOSITION OF SUNLIGHT AND SHADOWS, ONE OF MANY SUCH BEAUTY SPOTS IN THE FOREST OF SOIGNES.

Forest of Soignes, and wrote so elaborate and exhaustive a treatise upon its influence upon the life of men? Every city should possess such a haven of refuge; there is no other setting of such nobility and restful beauty. It is the one great glorious creation without which all the art of the architect and the landscapist shall never attain perfection. It is one of the greatest sources from which men may draw the inspiration to make all our towns and cities not alone more beautiful, but more happy, dwelling places than we have been able to evolve up to the present time.

It was in recognition of these things, as well as of the fact that the selfish interests of timber exploiters would soon have left no tree standing in Soignes, that La Ligue des Amis de la Forêt de Soignes was formed.

It was for just such a purpose that René Stevens undertook to make known to the people of Belgium the unsuspected

beauties of a forest which is theirs by irrevocable right.

There are many ways of going to Soignes. You may climb the Montagne de la Cour, with its delightful evidences of the still-living Flemish spirit and manners, and journey by way of the tram which traverses the Avenue Louise, to the entrance to the Bois de la Cambre—one of the finest of all the parks of Europe. Through this you may walk direct to the forest, and thus approach, through an avenue which affords a fresh hint at every step, of the splendors which lie just beyond the park. Or, you may take tram to Boitsfort, and enter the forest by either the Dreve de Welriekende or by the Dreve des Deux Montagnes. From Audergem, also reached by tram, you may enter the forest by way of the majestic Chaussée de Wavre; or you may take tram at the Luxembourg Station, and either halt at the northern entrance to the forest or traverse it at one of its narrow points and alight at

Groenendal. By any of these routes, all of which provide easy and cheap access, the people of Brussels may reach their forest, and wander among such miles of roads and paths as are not to be found in many a day's journey—and seldom, if ever, beside the very gates of a great and important capital.

I remember learning from Professor Agassiz, one wintry voyage on the Atlantic when we were two of a ship's company of seven, how the beech attained its greatest splendor in the "beech-belt," which bisects the western section of the plain of Northern Europe; and as the solitary occupants of the smoking-room, with a wild gale raging outside, we held, that night, a symposium *a deux* upon the glory of the Forest of Soignes. Its beeches are unequalled, although they differ from our own

variety in that the branches do not begin to leave the trunk so near the ground, thus affording longer vistas and greater heights.

One suffers in even thinking that the exigencies of war may demand that this forest, too, shall be sacrificed, for, like the architectural treasures which have already been reduced to ashes and broken fragments, the forest of Soignes is equally irreplaceable. It is the last remnant of the great forests of centuries ago, when man was slowly and painfully struggling upward, laying the foundations of that great Dutch republic, whence has descended that indomitable spirit which is today confronted with one of the saddest problems that ever befell a nation—the resurrection of Belgium.

SHADE TREES WORTH \$17,000,000

THE State Forester of New Jersey has been trying to find out what the shade trees standing on the streets of municipalities may be worth. The suggestion that a census of shade trees be taken was made to each of the fifty-odd shade tree commissions in the state upon the following basis.

1. That every tree which appeared to have at least ten years more life be tallied.
2. That every tree that was badly injured or entirely out of place be ignored.
3. That species be not considered.
4. That size and general condition be the sole factors.
5. That all trees be grouped and values assigned according to the following table.

<i>Diameter</i> <i>Breast High.</i>	Good	Fair
	<i>Values</i>	
Less than 2"	\$ 3	\$ 2
2" to 4"	5	3
4" to 6"	10	6
6" to 9"	20	10
9" to 12"	40	20
12" to 16"	80	30
16" and over	100	40

It is admitted that this scale is arbitrary, and the values assigned, especially

for the larger trees, are low, but it is at least conservative and assumes a limit to the value of fully developed trees. Though returns have been received from only seven communities the result is startling.

Bound Brook finds that it has \$83,855 worth; East Orange has \$810,000 worth; Glen Ridge has \$122,263 worth; Hackensack has \$259,863 worth; Irvington has \$184,104 worth; Newark has \$1,685,005 worth; Rutherford has \$80,000 worth.

If these figures are reduced to a per capita basis and applied to the whole State on the basis of the 1910 census it appears that New Jersey has upwards of \$17,000,000 worth of shade trees. Though the figure is almost too great for belief there is no doubt that it represents much less rather than any more than the actual value of the shade trees as they now stand. They could not be reproduced for twice the sum. This inquiry suggests that every city, town and borough in the State would probably find it profitable to inquire what may be the value of its shade trees, and to make some provision for the preservation of those that it now has even if nothing is done toward getting more where there is place for them.

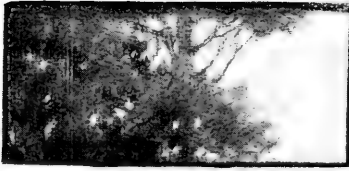

THE DRYAD'S MESSAGE

He who wantonly kills a tree,
 All in a night of God-sent dream,
 He shall travel a desert waste
 Of pitiless glare, and never a stream,
 Nor a blade of grass, nor an inch of shade—
 All in a wilderness he has made,
 Oh, forlorn without trees!

He who tenderly saves a tree,
 All in a night of God-sent dream,
 He shall list to a hermit-thrush
 Deep in the forest, by mountain stream,
 With friendly branches that lean and shade,
 All in a woodland that he has made.
 Oh, the peace of the trees!

He who passionately loves a tree,
 Growth and power shall understand;
 Everywhere he shall find a friend.
 Listen! They greet him from every land,
 English Oak and the Ash and Thorn,
 Silvery Olive, and Cypress tall,
 Spreading Willow, and gnarled old Pine,
 Flowering branches by orchard wall—
 Sunshine, shadow and sweetness of glade—
 All in a Paradise he has made.
 Oh, the joy of the trees!

LOUISE MOREY BOWMAN.

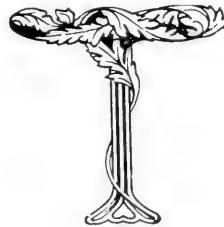

THE STORY OF WHITE PINE

By HU MAXWELL

WHITE pine's individuality is, like Napoleon's, "grand, original, and peculiar." The wood is seldom mistaken for any other, and the tree never. It is a conspicuous feature of any landscape where it occurs. No person who has once made its acquaintance will ever afterwards fail to recognize it at sight, no matter how far away, provided the characteristic arrangement of the branches can be made out. The limbs are set on the trunk in regular whorls when the tree is young; and, though as age comes on, many branches die and the wheel-like form of the whorls is broken, yet the general arrangement continues through life. Many other trees show the same arrangement in youth, but few hold to it during life as tenaciously as does the white pine. It owes its botanical name to that habit. *Pinus strobus* means "whorled pine." The order is wholly different from the tufted

tops of the southern yellow pines; the similar crowns of the Norway pine, or the irregular branching of the western yellow pine, or the slender and scattered limbs of the jack pine which is the white pine's associate in much of its westward range. It is natural that the white pine's tree form should impress those who see it for the first time as well as those whose acquaintance with it has been long and intimate. In the well-known poem by Mrs. Hemans, "The Landing of the Pilgrims," the strongest feature in the picture is caught in the first stanza:

"The breaking waves dashed high
On a stern and rock-bound coast,
And the woods against a stormy sky
Their giant branches tost."

It is the picture of the lofty white pines on the Massachusetts hills, their huge and clear-cut limbs thrashed by the December winds.



LOG BOOM IN ST. LOUIS RIVER.

TWENTY-FIVE THOUSAND PINE LOGS IN ONE BUNCH READY FOR THE SAW. BORING BEETLES DO NOT ATTACK AND FUNGUS DOES NOT DISCOLOR PINE IN THE CLEAR WATERS IN MINNESOTA. THE PICTURE REPRESENTS A CORNER OF THE COLQUET LUMBER COMPANY'S PROPERTY.

The white pine was not discovered at Plymouth in 1620, but there and then occurred its formal introduction to the white man on the American continent. The best of a splendid race of men and the finest representatives of the forests there met, and each in its own domain was the "heir of all the ages in the foremost files of time."

EARLY UTILIZATION.

Contrast the New England pine with the vast forests of mahogany on the west coast of Africa. The latter were discovered first. Yet they remained untouched for nearly four hundred years, while white pine was put to use immediately; and so long has that use continued, and in territory so extensive, that it is no exaggeration to claim for white pine that it has been the most important building wood in the history of the world. That holds in amount and also in variety of uses. Its softness and weakness have barred it from some places in modern manufacturing, and its lack of figure has disqualified it for others; but its range of usefulness has been so wide, and the supply so great, that it held first place in forest materials during two and a half centuries; and, though it has now dropped back from the first rank, it still occupies a position of great importance, and it will continue to do so for all time. As a timber tree, it is not doomed to extermination as some have been led to suppose. It will have, and it is already having, a new life. Most of the old conditions have passed, but new conditions are developing. That ought to be apparent from the fact that Massachusetts, where the first white pines were cut, still supplies considerably more than one hundred million feet of this timber yearly, and as far as the future may be judged,

Massachusetts will go on, furnishing that much yearly, for a thousand years. What one region does, others can do.

A word concerning its early uses is

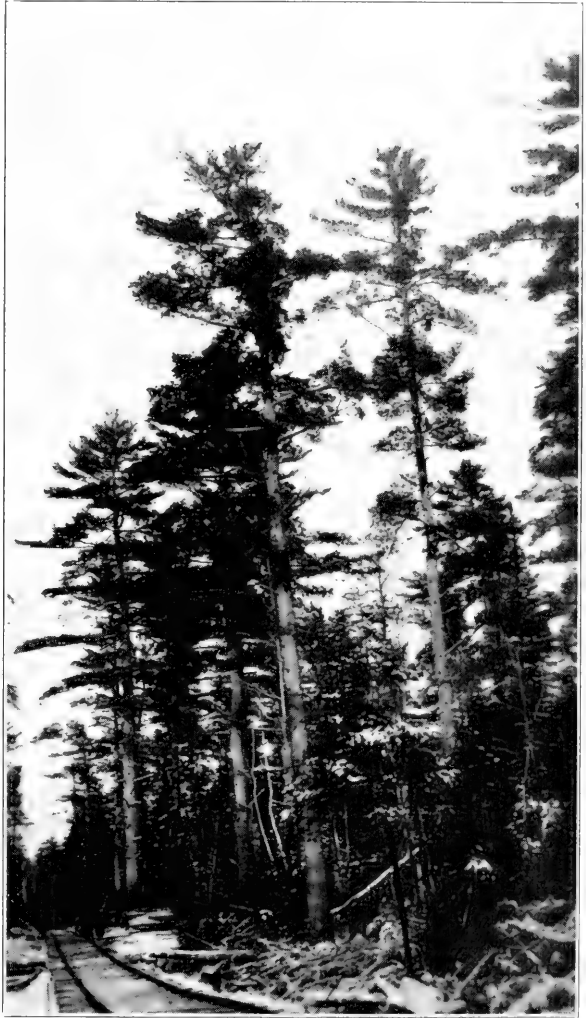

"ON THE FIRING LINE."

WHITE PINE'S EXTREME FRONTIER IN THE UNITED STATES, NEAR RAINY LAKE BETWEEN MINNESOTA AND CANADA. AXEMEN WILL SOON CHANGE THIS SCENE. NOTE THE FINELY WHORLED BRANCHES OF THE TREE IN THE BACKGROUND. SUCH IS THE TYPICAL WHITE PINE CROWN.

in order, because its first utilization was prophetic. Lacking six years of three centuries ago, the first homes of white men, within the white pine's range in the United States, were built. The forests immediately responded to the demand for building material. It is a



SQUARES FOR WINDOW SHADE ROLLERS.

MORE THAN 60,000,000 FEET OF WHITE PINE ARE ANNUALLY MADE INTO SHADE AND MAP ROLLERS IN THE UNITED STATES. THIS WOOD IS UNSURPASSED FOR THAT PURPOSE, BECAUSE OF ITS LIGHTNESS AND ITS DISINCLINATION TO WARP. HIGH GRADES ONLY ARE USED.

remarkable fact that some of the articles made of white pine within a few years after the landing of the Pilgrims are in existence yet. A door of this wood, which was swinging on its hinges within eleven years after the first foot touched Plymouth Rock, is a venerable relic today. It was one of the attractions at the Forest Products Exposition in Chicago and New York this year. It came from Medford, Mass. It cannot be claimed that it was the first door made by white men in the United States, but it is the oldest in existence.

The door is of soft, clear New England white pine. Age has somewhat browned it, but, to all appearances, the wood is as sound as it was on the day when the Puritan carpenter finished his job and swung the portal for the first time—1631. The event might be passed over as a mere incident but for the fact that it was the beginning of what has become an enormous industry. The first use of white pine in America was in door making. If the wood's selection at that time was accidental, it was a fortunate accident. The use has continued till the present, not only for doors but for practically every kind

of interior and exterior house finish. It is not improbable that this pine has made twice as many doors as any other wood of the United States, and to say this is no disparagement of the many other excellent woods which have been and are being used for doors, by millions of feet annually. But white pine was first in time, and for two hundred and fifty years it maintained its place as first in quantity. It may still be first, though the figures to prove the statement that it now leads all other woods in doormaking cannot be authoritatively quoted. Frames, sash, blinds, and other similar articles are listed together in statistics, and in the totals white pine is exceeded by the combined manufactures of the southern yellow pine, but by no other wood or group of woods; but in doors alone white pine may still occupy the first place in quantity as it unquestionably does in quality.

WHY ITS HIGH PLACE.

There is reason for the prominent position as building material occupied by white pine. It has given good service practically everywhere. It was the sleeper and the shingle, the founda-

tion and covering of houses. It is equally suitable for matches and ship-masts. The plank and picket fences which enclosed farms and gardens were of this pine before advancing price displaced them, but the wood yet fills much demand in that direction. It is the most important box and crate wood in the United States, and has always been. No other possesses so many of the desirable qualities demanded by the box industry. Fields of its usefulness might be further specified almost indefinitely.

Back of the great demand stand the two prime reasons, suitability and abundance. Neither could alone lead to so nearly ubiquitous demand. When white pine is oven-dry it weighs twenty-four pounds per cubic foot, which is equivalent to 2000 pounds per 1000 feet board measure. But wood for business purposes is never oven-dry, and an extreme lightness of two pounds per board foot is theoretical only. About 2400 pounds per 1000 feet is the weight of the lightest pine handled by the ordinary yard. Sugar pine of California is a little lighter than white pine, but all others of America are heavier. Southern longleaf yellow pine is nearly twice as heavy. Though white pine which has been subjected to a long period of air-seasoning seems absolutely dry, it really contains several hundred pounds of water to a wagon load of the lumber. It is impossible in practice to have wood absolutely dry, but white pine can be made as nearly so as any. When it has been thoroughly seasoned, there is such a small amount of moisture in it that the wood warps next to none as a result of atmospheric changes.

That is why it is so well liked for doors, frames, sash, machinery parts, and cores for veneer work. Once in

place, it is always in place. It is dependable. It holds its shape. Few woods are its equal in that respect. The New England door already mentioned



IN THE FRONT THREE HUNDRED YEARS.

WHITE PINE PICKETS HAVE PALED IN MORE YARDS AND GARDENS THAN ANY OTHER WOOD ON EARTH. THE EARLIEST NEW ENGLANDERS USED THEM AND THE VILLAGE YARDS IN THE LAKE STATES STILL SELL THEM BY THOUSANDS. THE PICTURE SHOWS A TRUCK LOAD IN THE PINE TREE MANUFACTURING COMPANY'S YARD AT LITTLE FALLS, MINN.

though it is 283 years old, is as true today as when it clicked its wooden lock for the first time. The joints are as tight as are those of Egyptian coffins.

In the museums and historical houses of northeastern states are innumerable relics of former times, such as cornice,

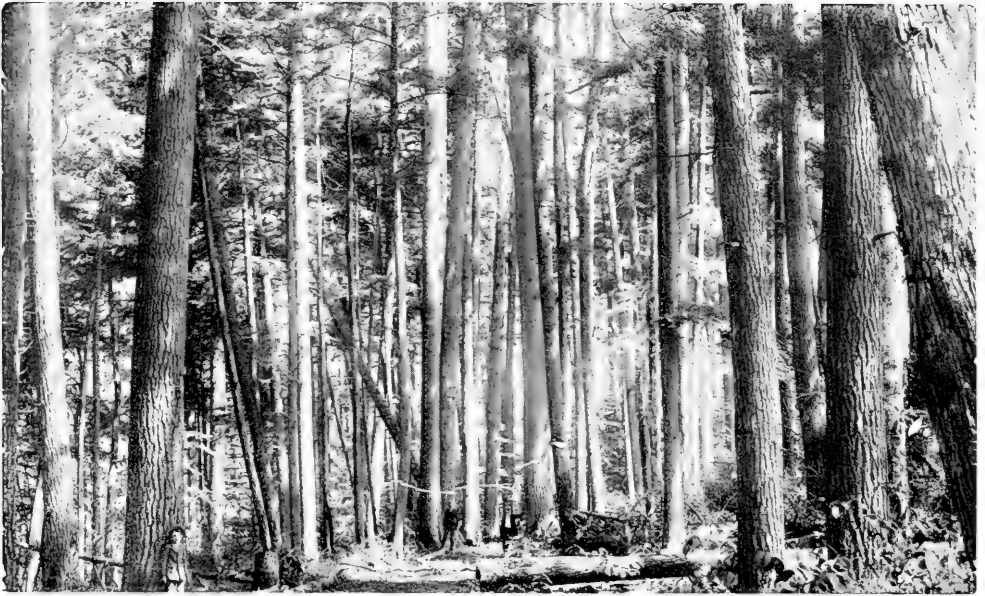

A VIRGIN FOREST OF WHITE PINE.

SUCH A FOREST IS RARE NOWADAYS, WHEREAS ONCE THEY WERE IN GREAT PROFUSION.

flooring, frames, structural timbers, chests, weather-boarding, furniture, brackets, and many more, and the white pine of which they are chiefly or wholly made has remained unwarped, unchecked, and generally without decay, since before the Revolutionary War.

The wood is rated weak and brittle in comparison with longleaf pine of the southern states or Douglas fir of the Pacific Coast. It is not now considered suitable for structural timbers intended for heavy loads; but enormous quantities of it have been used, more in early times than now. It was once so plentiful that the builder cut his structural timbers large enough to carry the load, or he put in more timbers until the required strength was secured. It was rafters and wall plates, braces and studding, joists and kingposts. White pine is too costly to be so used now; and it is not demanded, because stronger woods are available, and this one's best service is given elsewhere.

White pine is one of the plainest woods. It has no figure except that produced by the annular growth rings, and it is characterless and uninteresting. Being a coniferous wood it, of course, has no pores, and consequently the

application of stains and fillers produces only flat and monotonous effects. By chewing a splinter, a decided taste of turpentine may be had, and the odor is marked; yet, it is usual to class white pine with the tasteless and odorless woods. These terms belong to the box maker, and that is his way of stating whether a certain wood will injure articles shipped in boxes, particularly food. Most woods of white color are satisfactory in that respect, and white pine is one of the best. Vast quantities have been made into shipping boxes. Millions of pairs of New England shoes have gone to market in those containers, and millions of yards of cloth. Further west the white pine boxes have carried groceries and other household articles. The annual white pine supply to box factories in Michigan is 57,000,000 feet; in Illinois 105,000,000; in New York 133,000,000; in New Hampshire 142,000,000; and in Massachusetts 263,000,000. It is the leading box material in all of these states. It likewise leads for the whole United States. The total exceeds 1,100,000,000 feet yearly. The nearest approach to that vast figure is by the southern yellow pines, while red gum stands third with a little more

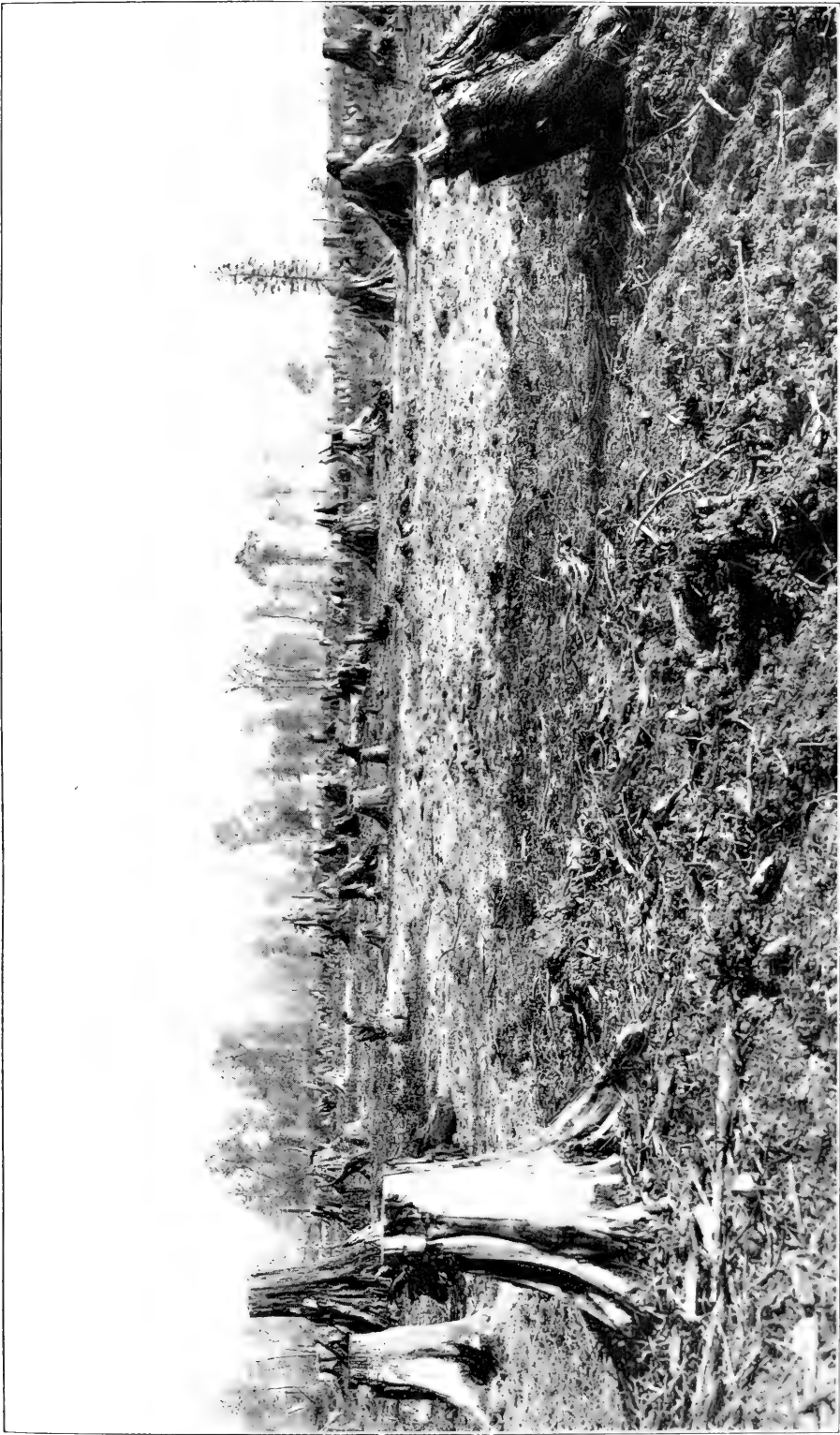

Photo by C. C. Iron Wolf, Duluth, Minn.

WHITE PINE STUMPS TWENTY YEARS AFTER.

WHEN THESE TREES WERE CUT THEY ALL WENT TO MARKET AS WHITE PINE. AN EXAMINATION OF THE STUMPS REVEALS THE FACT THAT ONE IN FIVE OR SIX IS SOUTHWAY PINE. THE LATTER ARE VALUABLE FOR DISTILLATION. THEY DO NOT DISAPPEAR BY DECAY IN LESS THAN FORTY YEARS, BUT WHILE PINE STUMPS DISAPPEAR MORE QUICKLY, LAND LIKE THAT SHOWN IN THE PICTURE IS BEING CLEARED FOR AGRICULTURE IN MICHIGAN.

than one-third as much box lumber as white pine supplies, and spruce ranks fourth.

RANGE AND NAMES.

Trees which occur over extensive geographical regions are usually burdened with names. Loblolly pine, for example, which does not cover half as much area as white pine, has twenty-three well-recognized names. White pine bears one name everywhere for the living tree, but sometimes when the quality of the wood is referred to, the terms cork, soft, and pumpkin pine are used. White oak is another noted example of a tree with wide geographical range and with but one name. In the case of both the oak and the pine the "white" in the name refers principally to the color of the wood.

The terms cork pine and pumpkin pine were formerly heard, but less frequently now, except as matters of history. They had reference to qualities of the wood. Pumpkin pine was the usual term in New England, but cork pine was preferred in western New York and in the Lake States. Both meant the same. The wood was described "as light as cork and cuts like a pumpkin." Such stock came from large, mature trees which grew in good soil and grew rapidly. The annual ring was principally springwood, therefore soft, white, and light. New England ship builders mounted a wooden ball, a foot or less in diameter, on the ship's flag-staff, for ornament. The ball was sometimes called a pumpkin, because of its shape; and since it was cut from the softest and best white pine, it was natural that the desired grade should be called pumpkin pine. The origin of the name has been ascribed by others to the fact that such pine has little of the flinty wood—which is due to the part

of the rings known as summer growth—and cuts in all directions like a pumpkin. No better reason can be given for the term cork pine than that the wood is light.

Soft pine naturally applies in the same way, but it is a more general term.

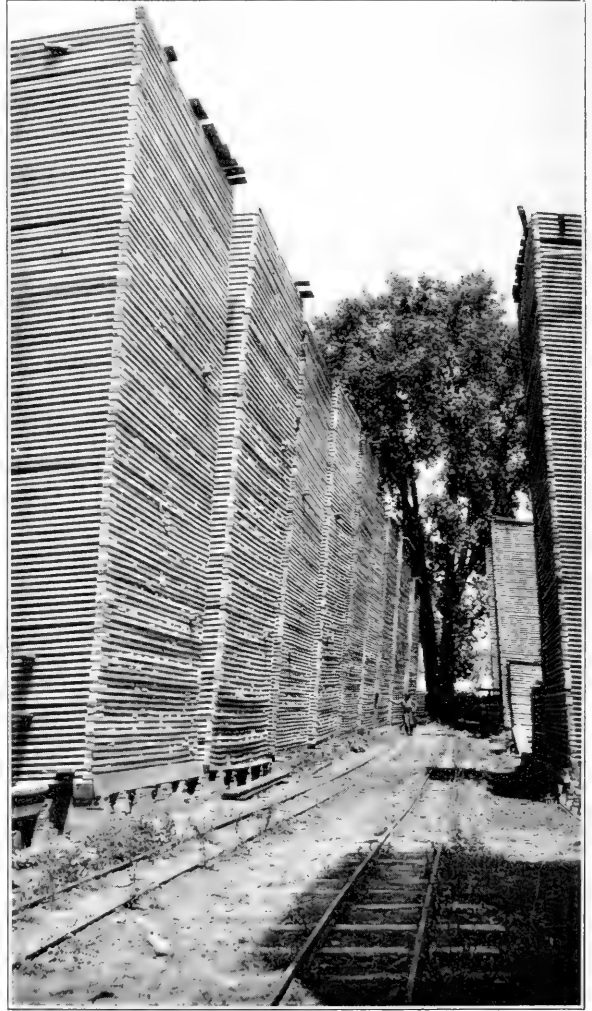

STACKS OF WHITE PINE FOR EXPORT.

HERE IS SHOWN SOME OF MINNESOTA'S BEST PRODUCT. THIS GRADE IS OFTEN CALLED "CORK" PINE AND CORRESPONDS TO THE "PUMPKIN" PINE ONCE ABUNDANT IN NEW ENGLAND. IT DRIES AS STRAIGHT AS AN ARROW. PATTERN MAKERS WANT THIS KIND.

There are thirty-seven species of pine in the United States, and twelve of them are classed soft pine. The division between hard and soft is somewhat arbitrary, if the terms are meant to

refer to the actual hardness and softness of the woods. A rapidly-growing tree in good soil may produce soft wood, while a tree of the same species in poor, dry soil will likely yield wood much harder. The difference is due principally to the rate of growth, but not wholly so.

Shortleaf pine (*Pinus echinata*) is usually and properly classed with the hard pines; yet, owing doubtless to a favorable combination of soil and climate, an area in southern Arkansas and northern Louisiana produces this pine of so soft a grade that it is actually said to sell sometimes as white pine. Another example, though it is on a small scale, will serve to emphasize further the influence of soil and situation on the texture of wood. The table mountain pine (*Pinus pungens*) usually produces wood fairly soft. Yet, on the precipitous crest of a bleak and lofty spur of the Alleghany Mountains in West Virginia there is a clump of these pines so stunted and of such slow growth that the wood will turn the edge of a pocket knife as lignum-vitae might do it, and its texture resembles that of horn. Instances of this kind are valuable for the light they throw on the soils' influence on the texture of growing wood.

The habitat of white pine extends east and west 1,800 miles, from Newfoundland to Manitoba. Approximately half of its range lies in Canada and half in the United States. Toward the northern border of its range the soil is thin and the climate cold, consequently the average size of the trees is small. The limit of the species in that direction is set by climatic conditions, but such is not the case toward the southern limits.

There the white pine came in contact with many kinds of hardwoods on good soil and was unable to make headway

against them. In the western part of its range this pine grew southward to the lower end of Lake Michigan and took possession of some of the sandy tracts in northern Indiana, where its progress ended; but in the East it followed the Appalachian mountains south-

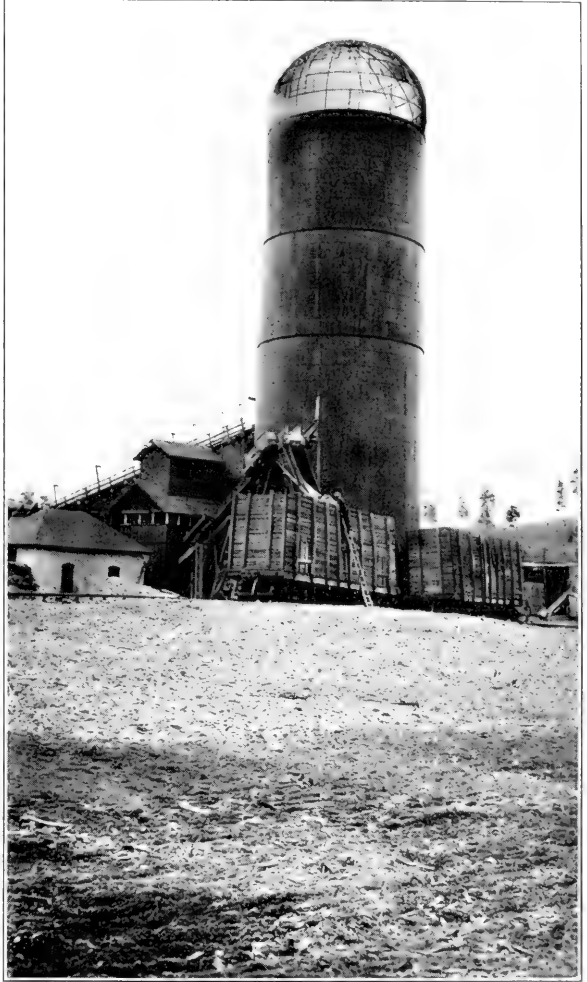

NEARLY OUT OF BUSINESS.

THE REFUSE BURNERS AT THE BIG WHITE PINE MILLS NO LONGER CONSUME MUCH MATERIAL. SLABS ARE WORKED INTO LATH, MOLDING AND OTHER SMALL ARTICLES. THE SAWDUST GOES TO STABLES AS HORSE BEDDING, THE CHIPS AND SPLINTERS ARE LOADED IN CARS TO BE HAULED TO THE TOWNS FOR FUEL, AND VERY LITTLE FINDS ITS WAY TO THE WASTE HEAP. THE PICTURE REPRESENTS A SCENE AT THE MILL OF THE NORTHERN LUMBER COMPANY AT COLQUET, MINN.

ward to Georgia. The tree's extreme range east and west extends 1,800 miles, and 1,200 north and south.

No man knows what quantity of white pine was on the stump at the



Photo by "Pine Cone," Minneapolis, Minn.

SPRINGTIME ON A MINNESOTA RIVER.

LOGS OF THE WINTER'S CUT ARE WAITING FOR THE FLOODS TO CARRY THEM INTO THE BOOM SOME SCORES OF MILES DOWN STREAM. THESE SMOOTH PINE LOGS WILL LOSE MUCH OF THEIR BARK DURING THE JAMS AND THE BUMPS OF THE DRIVE, BUT THE WOOD WILL NOT BE INJURED AND SUCH IS THE MATERIAL OF WHICH HIGH GRADE LUMBER IS MADE. ON THE RISING GROUND BACK OF THE RIVER SHORE, THE VIEW SHOWS A FINE FOREST OF WHITE PINE, APPARENTLY WITHOUT A TREE AMISS. THEIR TURN WILL COME NEXT WINTER.

coming of civilized man to these shores, but estimates have been made. It is assumed that the superficial extent of the range then was approximately the same as now. Three hundred years have not much extended or contracted the boundaries, notwithstanding the enormous lessening of the stumpage. The area actually occupied by the original forests has been estimated at 225,000,000 acres, and the stumpage at 450,000,000,000 feet. The estimated stumpage seems conservative in view of the fact that nearly half that much has been marketed from the Lake States. The total stand, in the foregoing estimate, included that in Canada as well as in the United States. The remaining stumpage south of the international boundary line is now placed at approximately 25,000,000,000 feet, of which Michigan has 2,000,000,000, Wisconsin 3,200,000,000, Minnesota 12,500,000,000, and the remainder is in New England, New York, and southward along the Appalachian ranges. The reported sawmill output of this wood in 1912 was

2,700,000,000 feet, the leading states in the production following:

	<i>Feet</i>
Minnesota.....	1,225,674,000
Wisconsin.....	397,549,000
Maine.....	280,145,000
New Hampshire.....	240,215,000
Massachusetts.....	143,119,000
Michigan.....	141,003,000
New York.....	76,355,000
Pennsylvania.....	71,870,000

Twenty-five states have white pine sawmills, the smallest number being one in Indiana.

The size of mature white pine trees varies with the region. The average is now much smaller than before the best was cut. Probably a diameter of two feet and a height of 100 will be found reasonable at this time. The pines of the Lake states were smaller than those in the original forests of Massachusetts, if reliance can be placed on the fragmentary accounts which have come down to the present. There are apparently authentic records of white pines



Photo by "Pine Cone," Minneapolis, Minn.

LOGGING CAMP IN A NORTHERN PINERY.

A TYPICAL TEMPORARY HABITATION OF THE MEN WHO FELL THE PINES AND BRING THE LOGS OUT OF THE WOODS. THE DOUBLE WALLS OFFER GOOD PROTECTION AGAINST THE WINTER COLD, FOR THE THERMOMETER HERE STAYS BELOW ZERO DURING MUCH OF THE LOGGING SEASON. THE THINNED FOREST IN THE BACKGROUND SHOWS THAT THE CUTTERS HAVE FINISHED NEARBY, AND A FEW STRAGGLING PINES AND A BRICK OR TWO ARE THE REMNANT OF THE FORMER STAND.

240 feet high and six or seven feet in trunk diameter in the primeval forests of New England, and one extreme instance is cited of a tree 270 feet high which stood on the site of Dartmouth College. It is uncertain whether these were guesses or measurements. In view of the astounding discrepancies between the guesses and measurements of some of the big trees of California and Australia, it would be interesting to know the exact origin of some of the figures for New England's famous pines. There is no question, however, that of all the pines of the United States, the sugar pine alone exceeds the white pine in size.

WHITE PINE LUMBERING.

Two and a half centuries have seen many changes in lumber operations. Practically all that is known about logging, and absolutely everything known about sawmilling have been learned in that period. The cutting of timber was on a mighty small scale before that time. Julius Caesar made more ado over getting out enough

dimension stock for his bridge across the Rhine than a contractor these days would over a contract to supply the Panama Canal. One of Solomon's great glories consisted in bringing up to Jerusalem timber for the Temple, and he had an army at work on the job during several years, yet the whole bill of lumber was less than a first-class Minnesota white pine sawmill cuts in one forenoon.

The world had no real lumbering experience until it was learned in America, and the beginning was made with white pine in Massachusetts, New Hampshire, and Maine. It continued with white pine in New York and Pennsylvania, and ended with white pine in the Lake States. As men learned more the methods changed. Ox teams dragged the logs out of the woods along the Piscataqua river, and the old sash saws wasted half in getting out the stuff. By the time the lumberman reached the vast pineries of New York and Pennsylvania the discovery had been made that wood will float, and the rivers and

lakes were utilized to carry the pine logs from forest to mill. Before the golden age of New York's white pine period had passed, the steam saw mill put in its appearance, and the chugging sash saw and the flutter wheel vanished.

By that time the railroad was carrying lumber to such markets as no boat or ship could reach, and the land market for white pine assumed proportions never heard of before. Then came Michigan, Wisconsin and Minnesota with their matchless forests of pine, and Chicago as the distributing market for the product. That was two hundred years after the first lumbering was done on the Atlantic seaboard. Michaux in his day said that the white pine lumberman moved westward twenty-five or thirty years ahead of the farmer, and De Tocqueville said that the farmer's rate of movement westward was seven-teen miles a year. Both of the writers set too rapid a pace. The average movement of the lumberman from New England to the Lake States for two hundred years was five miles a year, and the white pine lumberman led the van. They have reached Minnesota where the forests of pine end.

MARKETS AND PRICES.

It seems superfluous to designate the white pine markets. The wood not only goes everywhere now, but it has been going since the first. Within thirty years after the Pilgrims landed in New England they were sending white pine lumber to Africa and trading it for slaves. They traded the slaves in the West Indies for rum which they sold in England and Holland, and brought cash home. That was 250 years ago. This present year Minnesota lumbermen are exporting white pine to Africa where the earliest exports of this remarkable wood went; but it is needless to say that slaves are not accepted in payment, nor is it necessary to haul rum thousands of miles to complete the trade; because payment now comes back in yellow gold from the Rand and diamonds from Kimberley.

It is natural that prices vary greatly, not only now, but in past years and centuries. Formerly the place of sale

had most to do with the price; now it is the grade. When pine was plentiful everywhere, only the best was offered for sale; and, except for the matter of freight, it brought about the same figure everywhere. In 1805 rafts of choice pine from western New York sold in Pittsburgh for five dollars a thousand; but similar lumber, rafted 2,000 miles further to New Orleans, brought \$40. In early days in Michigan good pine was sometimes bought at four dollars a thousand at the mill.

Prices are more systemized now. The following list gives the average mill run values, of white pine lumber in the yard, for the whole United States:

	<i>Per 1000 feet</i>
1899	\$12.69
1904	14.93
1906	18.32
1907	19.41
1908	18.17
1909	18.16
1910	18.93
1911	18.54
1912	19.13

The wholesale prices of white pine by grades in the Lake States in 1912 were as follows: Selects C and better $\frac{5}{4}$ (M. L.), Minnesota, \$54.51, Wisconsin, \$57.06.

Inch finish, C Selects, 10" (M. L.), \$46.48, Wisconsin, \$48.04, Michigan, \$47.33.

Shop No. 1, $\frac{8}{4}$ (M. L.), Minnesota, \$47.65, Wisconsin, \$48.84, Michigan, \$53.38.

Shop No. 3, $\frac{5}{8}$ (M. L.), Minnesota, \$23.23, Wisconsin, \$24.02, Michigan, \$27.42.

Beveled Siding, C 6'-16', Minnesota, \$23.94, Wisconsin, \$24.96, Michigan, \$26.33.

Boards No. 2, 1" x 8'-16', Minnesota, \$22.43, Wisconsin, \$23.56, Michigan, \$26.38.

Boards No. 3, 12", 10'-20', Minnesota, \$20.53, Wisconsin, \$21.09, Michigan, \$25.67.

Boards No. 4, Mixed Widths, 10'-20', Minnesota, \$14.32, Wisconsin, \$14.65, Michigan, \$13.50.

Fencing, No. 2, SIS, 6''-16', Minnesota, \$25.02, Wisconsin, \$25.53, Michigan, \$28.50.

Lath, No. 1 (W. P.), Minnesota, \$3.63, Wisconsin, \$3.71, Michigan, \$3.92.

Lath, No. 1 (Mixed), Minnesota, \$3.27, Wisconsin, \$3.40, Michigan, \$3.45.

Mill run, Vermont, \$18.72, Maine, \$18.19, Minnesota, \$18.91, Wisconsin, \$20.34, Michigan, \$22.67, Pennsylvania, \$21.33, New York, \$21.07, New Hampshire, \$17.61.

Nearly all wood-using industries find a place for white pines. Lists show that in New York 44 articles are made partly or wholly of it, 48 in Massachusetts, 66 in Michigan, and 116 in Illinois.

THE FUTURE SUPPLY OF WHITE PINE.

The boundaries of this tree have not contracted much in historic time, though the total stumpage has declined to one-tenth of what it formerly was. Wherever the trees once grew, some still grow, except that tracts of small size in some instances may have been entirely de-

nuded by cutting and fire. If no seed trees are left, and all seedlings are killed by fire, white pine in that area is ended until seeds blow in from the outside or seedlings are planted by man. Complete extermination over large tracts seldom occurs, and the remaining trees here and there begin the slow process of restocking the vacant places. Fire is more destructive than the ax. Small white pine die from a slight scorching. Some one has figured out, after extensive observation, that pitch pine (*Pinus rigida*), which is often associated with white pines, will survive sixty-fold as much fire. That may be putting it strong, but no fact is better known than that white pine seedlings are so easily killed that a passing fire seldom leaves one alive. To that susceptibility to injury is due the barrenness of parts of Michigan and other Lake States where splendid pine forests once grew. It is there more than in other parts of white pine's range that total extirpation of the species has occurred over considerable



RESIDENCE FINISHED IN WHITE PINE.

THIS IS A MINNESOTA HOME AND IT DISPLAYS ONE OF THE BEST USES OF THE WOOD. IT HAS BEEN PUT TO SIMILAR SERVICE DURING ALMOST 300 YEARS AND HAS LOST NONE OF ITS POPULARITY. THIS IS THE HOME OF J. E. LYNCH, COLQUET, MICH.

areas. The well-organized efforts to keep forest fires in subjection are improving the conditions and giving the pine a chance to come back. The few remaining seed trees bear abundantly, and the winged seeds are carried long distances by the wind and are restocking many a vacant place.

In parts of New England, particularly in Massachusetts, fine stands of young white pine have taken the place of forests cut long ago. Practically every foot of this wood now passing through Massachusetts sawmills is second growth; that is, it has come on since the old stands were cut. The trees stand close together and are straight, yet, because they are still young, they are limby

and the resulting lumber is knotty. However, growth is rapid. White pines of suitable size for good saw logs are now growing on the graves of the unfortunate British soldiers killed at Concord; yet the trees were not planted until fifty years after the battle. This shows the rate of growth. New York is now doing a great work at reforestation with white pine, and Pennsylvania may be expected to do as well. The sawmill output of this pine may be expected to decline still further, but it will then have reached its lowest point, and will begin to move up, with the assurance that the country will always have white pine lumber.

TREE PLANTING IN NEWARK

By CARL BANNWART

Secretary Newark Shade Tree Commission

TREE planting is as old as the hills. But a new way of handling this old practice has come to pass with us in Newark.

Tree planting has become here a municipal function; and this new method, both in itself and in its results, is highly interesting.

If, ten years ago, we had announced that we would undertake to set out 1,500 trees along ten miles of frontage and assess the cost thereof on the properties benefited, the property owners would have been not only surprised but astonished. At the present time, however, such an undertaking does not create a ripple of interest; yet just such planting is what we propose for this present Fall season. And the fact that it creates no interest is in itself interesting, as indicating how public sentiment has fallen in with this scheme of municipal planting and has come to accept it as a matter of course.

For the past six weeks we have been subsoiling for these proposed new trees. This subsoiling amounts to something

like three tons for each tree, sixty cubic feet, approximately 4 x 4 x 3½ feet. Now we are planting: first, new plantings, second, replacing failures of our own recent plantings. Of new plantings about 1,500 trees will be set out in this way: 1,000 2" Norway Maples and 500 2" Oriental Planes (Variety *Acerifolia*). These trees are all provided with tree guards and stakes. The average cost is about \$4.00 per tree. This is the only direct charge the property owner is to bear. The trees are cultivated, pruned and sprayed. Failures, broken tree guards and stakes, are replaced without additional direct charge to the property. The guaranty is unlimited, whether a runaway or other maltreatment or whatsoever cause is responsible for the death of the tree.

We could perhaps set out more trees if it were not for the necessity of taking care of these in perpetuity after planting. Therefore we do not increase our plantings at a greater ratio than the appropriation to the Department for maintenance permits.

THE FIRE PROTECTION ON THE NATIONAL FORESTS IN 1914

By HENRY S. GRAVES

THE season of 1914 has been one of very grave emergency in preventing destructive forest fires in the National Forests. The hazard in the heavily timbered portion of the Rocky Mountain and Pacific slope regions has been in many ways the greatest since the establishment of the National Forests. The conditions of drought and other factors of forest fire hazard were fully equal in severity to those of 1910, the year of the disastrous Idaho fire, and in many sections the danger was even worse than during that year.

During the season more than 6,000 fires threatened the National Forests, or 1,000 fires more than occurred in 1910. To put out these fires and to prevent others from starting the Forest Service has been put to the severest test in its history. That it met this test successfully is indicated by the fact that the damage to timber this year is less than 4% of the damage done in 1910.

The past season has definitely demonstrated that while we cannot expect entirely to prevent forest fires from starting, their damage can be kept down to a small amount provided there is an efficient organization and adequate funds to meet every emergency swiftly and effectively.

SEASONAL CONDITIONS

The factors which create a season of large forest fire risk are variable and often complex. Primarily, the risk depends on the frequency of soaking rains. If there are good rains, well distributed through the season, the danger from fire is small. The hazard depends also to a certain extent on the total aggregate of rainfall during the season. The total precipitation, however, does not always indicate conditions of drought, for a few very heavy storms

separated by long intervals of drought would be a less favorable season for fire protection than a smaller aggregate amount of rain falling at more frequent intervals. A further factor is the depth of the winter snow, for with a light snowfall the ground is exposed early in the spring. An early spring, especially when accompanied by rains, means a vigorous herbaceous vegetation which matures and dries up early; it then becomes inflammable and a source of danger. Still another factor of importance is the behavior of the wind. In certain places on the Pacific coast, the easterly winds are the dry and dangerous winds. A dry wind lasting for only a day or two dries out the forest with great rapidity and an emergency immediately results. Still again, the condition of the nights may influence the hazard. In some sections the principal fire fighting has to be done at night. If it cools off and the wind dies down, it is much easier to get control of the fires than where the nights are hot and windy.

During the winter of 1914 there was a relatively small fall of snow. There was, therefore, an early spring throughout the northwestern and Pacific coast regions. In certain parts of California, as, for example, in Modoc County, the vegetation started growing five weeks earlier than in the normal season. In some sections fires began to occur in May, although the conditions did not become serious until early July. In north central Idaho no rain fell from July 4 until September 7, a dry spell 17 days longer than in 1910. In the north Pacific Coast region there was a continuous drought for over 70 days, which is the longest in history. During this period of excessive drought there were unusually high temperatures, high drying winds, and in many sections exceptionally dry nights. It was the

hot nights and the periods of hot winds that made the season unusually difficult in California.

The abnormally early season is illustrated by one rather unusual fire. This occurred on the west slope of the Olympic Peninsula where, on May 6, a spark from a fire, set by a road crew to burn some débris on the right of way for a road, caught in the moss in the high tree crowns. Almost instantly the fire spread from crown to crown, killing the trees, although the conditions on the ground were such that a fire could not run at all. In this particular fire it was necessary to fell many trees, some of them from 6 to 10 feet in diameter, before the fire could be stopped.

DISTRIBUTION OF FIRES

The bulk of the fires occurred in western Montana, northern and central Idaho, Washington, Oregon, and California. The seasonal conditions elsewhere in the National Forests were normal and but little difficulty was encountered. The following table shows the distribution of the fires:

<i>District</i>	<i>No. of Fires</i>
No. 1 (Montana, northern Idaho, North Dakota).....	1,975
No. 2 (Colorado, eastern Wyoming, South Dakota, Nebraska, Minnesota, Michigan).....	279
No. 3 (Arizona, New Mexico)...	509
No. 4 (Utah, Nevada, southern Idaho, western Wyoming).....	327
No. 5 (California).....	1,468
No. 6 (Oregon, Washington)....	1,239
No. 7 (Arkansas, Florida, White Mts., Appalachians)....	315
Total.....	6,112

CAUSES OF FIRES

At the time of writing this article the reports were not sufficiently complete to give an accurate classification of the fires according to their causes. A preliminary survey of them shows that the classification will not differ very materially from that of previous years. The greatest departure from the normal list

is the increase in the number of fires set by carelessness. This is due to the very large increase in the number of persons using the Forests for recreation. The careless smoker is responsible for most of these fires, and he is usually the visitor to the forest, the hunter, fisherman, or city camper. The prospector, settler, and woodsman are usually very careful with fire. There were in certain sections a good many fires caused by clearing land on homesteads. In many instances these were due to the State officials issuing permits during the dangerous period when no burning of brush should have been allowed. Incendiarism is very localized. Malicious setting of fires because of hostility to the Government is now rare. Such incendiarism as occurs is due to the mistaken "light burning" theory. Careful observation during the season showed that fires are in only very rare instances set to provide work in putting them out.

The danger of fires in September was so great that the Governor of Oregon consented to postpone the opening of the hunting season. It is probable that if he had not taken this action the number of fires would have been very much larger and the task of the Forest Service in preventing injury to the forest would have been greatly increased.

THE RESULTS SECURED

Of the entire 6,112 fires reported up to December first, 4,954 or 81%, were extinguished by the protective organization before they had covered ten acres. This is the best record in the history of the Service. Preliminary estimates show that the area burned over will probably not exceed 300,000 acres. The bulk of this area, probably 65%, was on old burns, and on brush and grass lands. In fighting the fires the effort was to keep the fire as far as possible out of green timber. The effort was very successful, for the total damage to green timber was probably not over \$450,000. This is in marked contrast to 1910 when 6,500,000,000 feet of timber was burned, valued at from ten to fifteen million dollars. The damage to reproduction will probably considerably exceed that to green tim-

ber. It is an interesting fact that during the last 5 or 6 years, the ratio between the damage to green timber and that to reproduction has steadily decreased. In 1909 the damage to green timber was about 65% and that to reproduction 35% of the total. In 1913 timber damage was 40% and reproduction damage 60%. This year the ratio will be about as in 1913.

The measure of efficiency of the fire protective work on the National Forests should be the value of the property which was threatened and which would in all probability have been destroyed if the expenditure in protection had not been made by the Department. While every possible means is taken to prevent fires from being started, it is absolutely essential that such fires as are started be extinguished as soon as possible, for under conditions such as prevailed during the past season almost any one of the fires which were put out by the Forest Service was a potential disastrous conflagration. In Montana and Idaho alone the value of specific bodies of timber which were threatened by the approximately 2,000 fires which started and were put out, aggregated the enormous sum of over \$59,000,000. It was in this section that the largest amount of money had to be spent to prevent a recurrence of the great disaster of 1910. In Oregon and Washington, the 1,200 fires which were handled by the Department threatened upwards of \$24,000,000 worth of timber. And these figures do not include the value of nonmerchantable timber and young growth on about 5,000,000 acres of land, and several million dollars worth of ranch and other private property which lay in the path of the threatening conflagrations. Figures are not yet at hand of the precise amount of damage threatened by fires in California and other National Forest States. These data will, however, add large amounts to the total value of the property threatened and saved.

There were two lives lost, one in Montana and one in the Pacific northwest. In each case the man was struck by a falling tree. It will be recalled that in 1910, 78 fire fighters were killed. There were this year a

number of injuries but chiefly of a minor character.

REASONS FOR THE FINE RECORD

The explanation of the success in preventing a great disaster during the past season is given in the single term "preparedness." Within the last four years great forward strides have been made in equipping the forests and in the organization of the force. In the first place, during that time there have been added 1,368 miles of roads, 9,617 miles of trail, 12,000 miles of telephones, 300 new fully equipped lookout stations, 695 headquarter buildings, and many other improvements. The forests have had a great increase of equipment in the way of tools and tool caches, portable telephones, tents, etc. Transportation facilities have been provided either by purchase of pack horses or arranging for hire of animals and automobiles.

Fully as great a factor, however, has been the organization of the force. During the past four years careful fire plans have been developed for all the forests, the protective force has been reorganized so as to have available a maximum patrol during the dry season, the system of detection and patrol has been intensified, arrangements have been perfected to secure at short notice labor for fire fighting, a system has been developed for officering the fire fighters by experienced foremen, and the force has been trained in the swift establishment of headquarter camps, with the necessary equipment and supplies. The fire organization worked with admirable efficiency when the test came this year.

As a single illustration, a ranger in one of the Oregon Forests stationed two miles from town received a report by telephone from a Service lookout of a fire 12 miles away. He saddled his horse, rode to town, secured four automobiles and 20 men and was on the fire line within 48 minutes after receiving word about the fire. Instances of similar and equally swift work could be recounted in large numbers.

As showing the increased efficiency of the organization over former years may be cited the results on the Colville Forest. In 1910, with 62 fires, 155,200

acres were burned, with a cost for fire fighting of \$18,000; in 1914, with 103 fires and a drier season, the total area burned was 7,653 acres, with a cost for fire fighting of \$15,900. Still again, in the Tahoe Forest in 1910, there were 84 fires, and such a serious situation developed that United States troops were called upon for aid. This year 223 fires were handled by the organization without help, and the loss was less. On the Trinity Forest 51 fires in 1910 burned over 23,191 acres; and in 1914, 53 fires burned over 459 acres. In California, the average acreage per fire in 1910 was 653 acres, in 1914 it was 37 acres; while the average for fires in the timber, excluding brush fires, was this year only 15 acres.

COST OF FIRE PROTECTION

A very large number of the fires were extinguished by the regular standing organization without hiring additional help. Fully 50% of the fires were put out by the rangers and guards before

they reached a quarter of an acre in extent. When a fire was discovered that could not be so handled assistance is secured immediately. The local officers are authorized to hire men and they act swiftly. A delay due to the fear of possibly bringing a few unnecessary men to a fire is disastrous. This was repeatedly shown on private lands when owners hesitated because of the possible expense. The result was in the end great loss and great expense in fighting the fires because these were allowed to become large conflagrations.

The total expense of fighting fires was about \$670,000. This is in contrast to over a million in 1910. The cost per acre, even where the emergency expenses were greatest, was less than many private owners spent outside the forests under conditions even more favorable than those faced by the Government.

The Forest Service has had its most successful season thus far in protecting the National Forests.

PROSPECTIN'

Up the mountain and through the burn
 We climbed. An' 'mongst the brush an' fern,
 An ole man drove his maddock home,
 An slapped a tree in the gapin' loam.
 "Mornin', Father. What's the game?"
 "Plantin' trees," the answer came.
 "You don't 'spect to live to see
 The standin' timber, do ye, say?"
 He looked, reflectin', down the hill;
 "Wal, no." "But, thunder, *some* 'un will."

—J. R. SIMMONS.

THE MT. LASSEN ERUPTION

By RICHARD H. BOERKER

MT. LASSEN, the only active volcano in the United States proper, is situated in the southeastern part of Shasta County, California, and is the last of a series of great volcanic cones which begin with Mt. Rainier in Washington. In years gone by this series of volcanoes was instrumental in upbuilding the mountainous region of the Pacific Northwest.

The first eruption occurred in the latter part of May, 1914, and it is stated upon good authority that the first outbreak seen by local inhabitants was on May 29. Since then fifty or more eruptions have occurred and with very few exceptions these have been of ever increasing violence. The last eruptions of which the writer has any knowledge are indeed said to have been accompanied by luminous bombs and fire.

The writer had the good fortune of being stationed in the proximity of Mt. Lassen most of the past summer and witnessed many of the eruptions. The first trip made to the summit was accomplished on June 4, and the trip, made for the most part over deep snow, wound up on the summit in a howling snowstorm. We were compelled to spend the night at the brink of the hissing crater in the Fire Lookout Station on the topmost pinnacle, 10,437 feet in the air. The next morning, June 5, the mountain was lost in the thick haze and snow clouds and practically nothing could be seen until noon time. At that time the descent into the old crater was made and the new crater was viewed. The huge gap measured 275 feet long and evidently was then in one of the pauses between heavy explosions. Thick volumes of

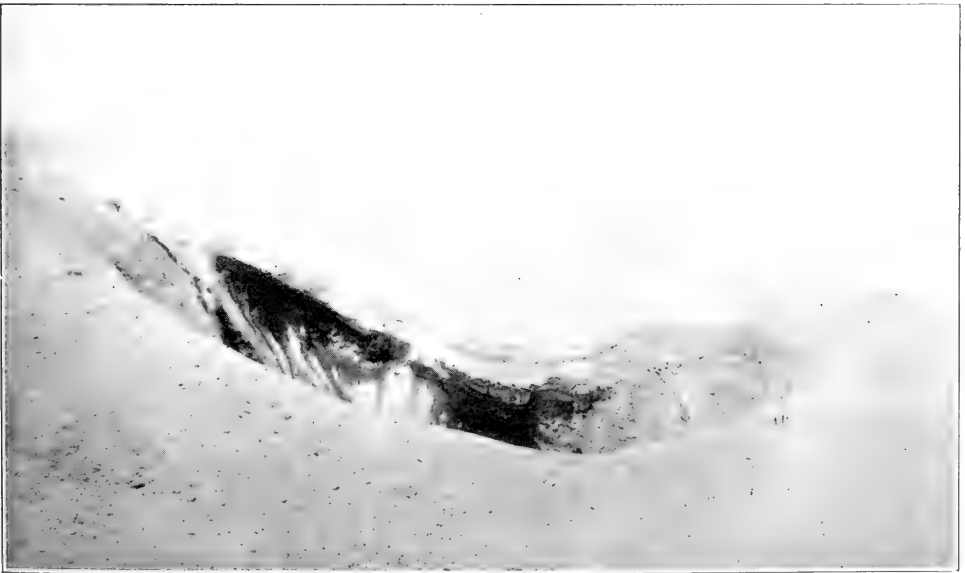

MT. LASSEN'S HISSING CRATER ON SEPT. 3, 1914.

THIS CRATER'S MOUTH WAS EIGHT HUNDRED FEET LONG AND FROM ONE HUNDRED TO FOUR HUNDRED FEET WIDE AND ABOUT ONE HUNDRED FEET DEEP. NOTE THE FIGURES OF THE THREE MEN ON THE RIGHT HAND SIDE OF THE CRATER, AND THE STEAM AND SMOKE ON THE LEFT HAND SIDE. THE PEAK IN THE BACKGROUND IS ALMOST HIDDEN BY THE SMOKE HAZE.

steam, laden with sulphur smoke were rising and cracks were appearing in the ground. The walls of the crater were perpendicular and huge icicles hung from the rim of the crater formed by the condensation of the steam rising from either end in huge volumes. On the west side of the crater everything was covered with a heavy blanket of light gray ash into which we sank over our boot-tops. So light was this ash that it flew into the air at every step. On the east side the same material seemed to have been thrown out in the form of mud and lay frozen hard as rock. What little snow remained near the crater was buried under a layer of stones and boulders. The larger boulders had sunk down into the snow, creating many treacherous pits.

The eruption of June 14 was the heaviest one up to that date. It occurred at a time when several visitors were viewing the crater and almost resulted fatally for one of the party. There have been many narrow escapes and daring ascents during the summer, most of which will never be recorded. Hundreds visited the crater during July and August and the fact that they were taking their lives in their hands seemed to have little effect upon their eagerness to see the hissing crater. The eruptions do not seem to occur with any regularity. Some days there are as many as three, all very violent, and then again there may not be an eruption for two weeks. Many of the eruptions have lasted several hours and sometimes there would be a series of eruptions, one following another.

Many geologists and volcanologists were attracted by the violence of Mt. Lassen and paid the mountain a visit. Some made several ascents. All in one accord they gave their opinions that the

old mountain was a real volcano and no imitation. They predicted earthquakes and they came. Some predicted that



Photo by R. H. Boerker.

BEGINNING OF THE BIG ERUPTION.

THIS WAS THE FIRST COLUMN OF STEAM AND SULPHUR VAPOR WHICH WAS SEEN TO SHOOT HIGH IN THE AIR.

the volcano would become very active and actually become dangerous. This stage has almost been reached, judging from the latest reports. In fact, there is no reason for overlooking the possibility of lava flow accompanied by destruction of plant and animal life.

Being engaged in making a map of the high country around Mt. Lassen, the writer made the ascent of about a dozen peaks in the vicinity of the old volcano and also climbed Lassen several



VULCAN HIMSELF.

IN THIS NOVEL FORMATION OF THE SMOKE CLOUD HANGING OVER MT. LASSEN AFTER A PARTICULARLY VIOLENT ERUPTION THE AUTHOR SNAPPED HIS CAMERA JUST IN TIME TO CATCH THE STRIKING PROFILE SEEN SO DISTINCTLY ON THE LEFT EDGE OF THE CLOUD. IT IS OF VULCAN HIMSELF.

times. The base camp was established only 2 miles from the rim of the crater and from this camp, at an elevation of over 8,000 feet many excellent pictures were possible. Many eruptions were witnessed in all their grandeur and the rumblings and tremors of the earth often made one wish he were elsewhere.

The ascents of the peak made by the writer in the latter part of August and the beginning of September were made for securing triangulation points for a general map of the region. Plane table work at the brink of an explosive volcano is not the pleasantest job imaginable, hence such visits were usually made as brief as possible and not any oftener than was absolutely necessary. These ascents showed that the crater had increased considerably in size since June. The crater was at the beginning of September about 800 feet long and 350 feet wide and the country for at least a mile around was covered by a thick blanket of light volcanic ash. Practically all the snow that was left on the mountain was covered by this ash and the water it soaked up from the snow made it look black. Hence Mt. Lassen this summer not only acted like a volcano but decidedly took on the ghastly appearance of one. The Forest Fire Lookout Station was at that time still standing but the roof and sides had numerous large and small holes in them. One noticed, while walking over the rocks and volcanic ash on top, numerous large depressions in the ash and rock where large boulders had fallen. These holes occurred as much as a mile from the crater and they serve as evidences of the severity of the explosions.

Up to the present time there has been no destruction of life of any form. No

timber or other natural resource has been destroyed as far as the writer knows. The heavy clouds of ash laden steam that are thrown out of the crater



Photo by R. H. Boerker.

THIRD STAGE OF THE ERUPTION.

THICK BLACK ASH LADEN STEAMS COVER THE ENTIRE MOUNTAIN. SOMETIMES THIS IS CARRIED FOR FIFTEEN OR TWENTY MILES. THE ENTIRE TOP OF THE MOUNTAIN IS COVERED WITH THIS FINE VOLCANIC ASH TO A DEPTH OF EIGHT OR TEN FEET.

at the time of an eruption are often carried by the wind for many miles. The most violent of these eruptions have sent these clouds with the help of the wind for 20 miles or more. The height to which these great columns of vapor are thrown has been quite accurately determined by Forest Ranger

J. M. Stark of the Turner Mt. Fire Lookout 15 miles to the southwest of Mt. Lassen and his figures range up as high as 25,000 feet for the most violent eruptions.

Many conflicting stories have been circulated concerning this mountain, especially by newspapers. No accounts should be considered authentic unless they emanate from such sources as the

United States Forest Service or the Geological Survey. The tremendous interest that this volcano has aroused in all parts of the world will undoubtedly make it a Mecca for tourists next summer. Being in the heart of the National Forest Region of California it will be visited by thousands of campers next summer.

FOREST PRODUCTS FEDERATION

By E. A. STERLING

AT a preliminary meeting called by the National Lumber Manufacturers' Association in Chicago on December 17, a tentative organization was created which combines under one head, as never before, the manufacturing, wholesale and retail lumber interests for the mutual benefit of all concerned.

The primary object is the better merchandising of lumber and solution of the related problems which this subject involves. The organization as inaugurated, opens the way for developments of great importance to the lumber industry and forest interests in developing a policy which will insure the continued use of wood in all situations for which it is best fitted. This in turn should bring about closer utilization and more rational use of forest products. If the new organization fails to grasp the larger opportunities, and to make definite progress along the lines indicated, it will demonstrate the inability of the lumber interests to cooperate broadly to their mutual advantage and will produce wide economic evils in an industry which is second only to agriculture in magnitude and importance.

The specific accomplishment at this preliminary meeting was the acceptance of a plan for the creation of a Forest Products Federation and the appointment of a committee of five to have general charge of arrangements for a mass meeting to be held two or three months later. The represen-

tative character of the Federation is indicated by the personnel of the committee of five, which is as follows: R. H. Downman, New Orleans, La., president, National Lumber Manufacturers' Association; Gordon C. Edwards, Ottawa, Ont., president, National Wholesale Lumber Dealers' Association; L. W. Crow, Chicago, Ill., president, Lumberman's Association of Chicago; Julius Seidel, St. Louis, Mo., wholesale and retail lumber dealer; J. R. Moorehead, Kansas City, Mo., secretary, Southwestern Lumberman's Association.

While the program for the coming meeting will not be definitely announced until after a conference by the committee, the general character of the work is indicated by the suggestions of Chairman J. E. Rhodes, in his opening address at the preliminary meeting. In this talk Mr. Rhodes suggested the following topics for consideration, some of which will no doubt be considered and reported upon by standing committees at the first general meeting of the Federation. The topics mentioned by Mr. Rhodes include:

Building codes.

The comparative price of lumber and other materials.

What is being done to advertise substitutes for wood.

Definite information regarding the fire prevention movement, and the part which wood plays in creating a fire menace to public life and property.

The wooden shingle in relation to fire prevention.

Educational work regarding the right use of wood, so that the wood used may accord more closely to the service requirements.

Information regarding the preservative treatment of wood against decay.

The meeting was addressed by various men, including Dr. Herman Von Schrenk, consulting timber engineer of St. Louis; L. W. Crow, president Chicago Lumbermen's Association; F. A. Hofheins, of the Transfer Lumber & Shingle Company, North Tonawanda, N. Y.; Julius Seidel, wholesale and retail lumber dealer, St. Louis, Mo.; Henry F. Weiss, of the Forest Products Laboratory; Abram W. Herbst, of the American Society for Fire Prevention, and others who represented lumber associations and city and county lumber yards.

The topics discussed included general fire prevention and the specific problem of fire-proofing wood; the anti-wood publicity and legislation in many towns and cities; the problems of the wholesale and retail dealers; while as having direct bearing on the meeting, the specific question of the necessity for close cooperation between all branches of the lumber business was thoroughly discussed.

The work before the committee of five and the individuals and committees to whom subjects are assigned for presentation at the first meeting of the

Federation, is of large magnitude and great importance. Some of the subjects will require extensive investigations and cannot be reported upon in full for some time; while other topics such as building ordinances are urgent, the definite plans for combating unfair legislation should be available in the near future. The whole range of topics gives a field for immediate and future consideration and report, which will require careful organization of the work and a liberal use of funds to support it. It is a logical assumption that the reports of the first general meeting will largely deal with the development of plans and policy.

If any suggestions were to be made regarding the Forest Products Federation, they would include reference to the need of more funds for the work of the immediate future and of a definite plan of financing future work. It might also be suggested that closer cooperation be arranged with organizations outside of the lumber industry. For example, several of the States have well organized forest departments, with State foresters, who have received strong public support, and who could be of great assistance in legislative activities and general investigations. The American Forestry Association, the stronger State association, and some of the forest schools and agricultural colleges could also offer effective assistance and cooperation.

Motors for Forest Fire Fighting

Experiences with forest fires on the national forests this year show that automobiles, where they can be used, furnish the quickest and cheapest transportation for crews of fire fighters. Motor rates are higher than those for teams for the actual time employed, but the total cost per distance traveled and in wages paid to men in getting to fires is much less. The time-saving is self-evident; trips which ordinarily require two days time by team have been made by automobile in a few hours.

THE ANNUAL MEETING

MEMBERS OF THE AMERICAN FORESTRY ASSOCIATION WILL MEET IN NEW YORK CITY ON MONDAY, JANUARY 11, 1915

To Members of the American Forestry Association:

You are urged to attend the 34th annual meeting of the *American Forestry Association*, in the Woolworth Building, 233 Broadway, New York City, on Monday, January 11, 1915.

There will be morning and afternoon sessions at 10 o'clock and 2 o'clock, and in the evening an informal dinner at the Hotel McAlpin, Broadway and 34th Street, at 7 o'clock, at which there will also be addresses.

The meeting will be essentially practical. Its chief purpose is to have addresses and discussions on how the Association may be of the best service, during 1915, to the several phases of forest conservation, national forestry, state forestry, private forestry, forestry for lumbermen, forestry for paper and pulp men, use of forests for recreation, etc.

The addresses on these subjects will be by recognized experts on each, and

the discussions will be participated in by the members and guests.

Members who expect to attend will please notify the Secretary.

Reservations for lunch in the Rathskeller of the Woolworth Building at 12:30, price \$1.00, *must be made in advance*. Reservations for the dinner at the McAlpin Hotel at 7 o'clock, price \$2.50, *must be made in advance*.

Members may bring friends and may make luncheon and dinner reservations for them.

This is the first annual meeting of the Association in New York, and as it is a convenient point for members in the East to gather, a large attendance is expected and requested.

HENRY S. DRINKER, President.

P. S. RIDSDALE, Executive Secretary.

Members of the *Society of American Foresters* and of the *Society of Eastern Foresters* will meet with *The American Forestry Association*.

THE PROGRAM.

Discussions of fifteen or twenty minutes will follow each address.

MORNING, PRESIDENT HENRY S. DRINKER PRESIDING.

- 10:00. Address of welcome. President Henry S. Drinker.
- 10:10. How the American Forestry Association Can Cooperate with the Forest Service. Henry S. Graves, Chief Forester of the United States.
- 10:45. What the American Forestry Association Can Do for State Forestry. By C. R. Pettis, Supt. of New York State Forests.
- 11:35. The Service the American Forestry Association Can Render in Educational Work. Dean Hugh P. Baker, New York State College of Forestry at Syracuse University.
- 11:50. How Can the AMERICAN FORESTRY MAGAZINE be made more useful and attractive? W. B. Howland, Publisher, *The Independent*, John Oliver La Gorce, Associate Editor *The National Geographic Magazine*.
- 12:30. Adjourn for lunch.

AFTERNOON, CHARLES LATHROP PACK PRESIDING.

- 2:15. What Shall Be the Policy of the American Forestry Association towards

- Proposed Forestry Legislation? Prof. H. H. Chapman, Yale Forest School.
- 2:45. What Practical Assistance Can the American Forestry Association Render to the Lumber Industry? R. S. Kellogg, Secretary Northern Hemlock and Hardwood Association.
- 3:15. What Can the American Forestry Association Do to Stimulate Private Forestry? Samuel N. Spring, Professor of Forestry at the New York State College of Agriculture at Cornell University.
- 3:45. What the American Forestry Association Can Do to Encourage the Use of Forests for Recreation. By Warren H. Miller, Editor of *Field and Stream*.
- 4:15. Adjourn.
- 4:30 to 6:30. Business Meeting of the Society of American Foresters.

EVENING, CHARLES F. QUINCY PRESIDING

- 7:00. Dinner at the Hotel McAlpin.
- 8:00. What the American Forestry Association Might Do on the Pacific Coast with Special Reference to the Proposed Meeting at the Panama-Pacific Exposition. E. T. Allen, Forester of the Western Forestry and Conservation Association.
- 8:30. What the American Forestry Association Might Do for Eastern and Canadian Pulp and Paper Interests. George N. Ostrander, Glens Falls, N. Y.
- 8:50. What the American Forestry Association Can Do in Helping to Solve Lumber Trade Problems. E. A. Sterling, Forest and Timber Engineer.
- 9:10. What We Can All Do to Get Together. Speaker to be selected.

THE FOREST RANGER'S PRAYER

O LORD, grant that as I make this survey called Life I may find pleasant camping-places; that the cool waters of congenial companionship may flow past my tent door; that the woods of hardship wherein we must all walk be not too heavily clad with the underbrush of hard luck; that the nettle called remorse grows not too abundantly there; that there be springs of friendship and shade of rest trees wherewith to refresh myself; that cooling breezes may blow sometimes across my forehead and drive away the remembrance of wrong deeds done and righteous deeds left undone; that as I lay out the logging-road of my life the curves thereof be tangent to Thy will and the spirals be true; that there be a down grade from my will to Thine, and that the superelevation be correct so that as I swing around the curve I may not leave the track that leads to Heaven.

LORD, grant that when the appraisal of my life is computed it may not exceed Thy original estimate; and, Lord, when I take an observation to obtain my true bearing, grant that my transit be in perfect adjustment so that I shall not deviate even so much as one second from the sight which Thou hast set at the end of that long tangent which leads through the portals of gold into the District where Thou art Chief Forester. I pray that when my road is built there shall be no trails left unblazed and no dangerous rocks or trees above the cuts to endanger the safety of any travelers over this route.

LORD, in Thine infinite tenderness, mercy, and love so encompassing that even I am included in Thy promise, listen to my prayer; and grant, finally, that when I turn over my field notes to the Chief and sign my last report He will say "Well done!"

AMEN.

BONDING NATIONAL FORESTS

By HENRY S. GRAVES,

Chief Forester of the United States

[In his annual Message to Congress, Secretary of Agriculture Houston recommends that Congress advance money to communities in and adjoining national forests on which there are few or no timber sales; this money to be repaid from future resources of the forests. The idea is to furnish these communities with money to build roads, to construct bridges and otherwise provide for their development, such money to be given only where it is apparent that the 35% of the gross receipts of future timber sales on the forests, to which the communities are entitled, may be used for repayment of the sum thus advanced. Chief Forester Graves, who worked out the details of the plan, explains it in this article—Editor.]

ALREADY the ideal of the National Forest policy is being achieved in practically all respects on a number of the Forests where conditions permit of the full utilization of all resources—timber, water power, grazing, mining, agriculture, and the recreation features. On those forests the communities are being built up through the establishment and maintenance of industries using the forest resources; there are also thousands of dollars returned directly from the forest receipts for schools and roads. In short, the forests yield a direct return equivalent to taxes and it is an increasing rather than a diminishing return such as would follow forest destruction such as has taken place so extensively in many regions under private ownership.

But in many of the forests the resources are inaccessible and the greatest resource, the timber, is not saleable under present conditions, except in small quantities. Under such circumstances, the development of the forest resources is slow, and there is but little direct return to the communities from forest receipts. While all agree that ultimately these forests will be of enormous importance to the country, people can not reconcile themselves to the fact that the forest resources are of no immediate help now, during the pioneer period of development of the country and at the time when such help is most needed. A great deal of the land in the counties in which the most heavily timbered national forests are located

is still in the condition of practical wilderness. The very foundation of any development in such sections is the construction of roads and bridges, and this is in many places enormously expensive. The clearing of the land for farming, the building of the homes, the building of schools, churches, and public improvements in the towns, in addition to the road building, are the burdens of a small struggling population, composed largely of men possessed of great perseverance and courage but with little means.

In many cases the national forests occupy from 20 to 60% of the area of the counties and contain timber of vast amount. Is there any wonder that the people are protesting that the forests which are not subject to taxes and are not yielding much from timber sales are not contributing as they should to the development of their communities? Often they use the phrase that the forests are blocking development or that the resources are locked up. This is, of course, not true, because the resources are available for use. What is meant and what is true, is that the forests are not contributing as they should to development of the communities living in the counties in which the forests are located.

This is a problem that the Government must squarely face and solve. But it must be met by a constructive program and not by tearing down the national forests, as some propose, which would result in public loss and injury not only nationally but locally.

A CONSTRUCTIVE PLAN

A plan which will fully meet the situation and at the same time be entirely practical to apply is as follows:

Congress has made a continuing appropriation of 35% of the gross receipts from the Forests to aid in community development and maintenance. Inasmuch as the objects of this provision can not be accomplished at present where the timber is inaccessible and unmarketable, a modification of the present plan is proposed to make these heavily timbered forests serviceable to the people at the present time during the most severe pioneer stage of the region's development. The proposal is that where the existing resources justify it and the public need can be shown, future receipts be anticipated and advances be made by Congress for the construction of roads, bridges and similar public works, these advances to be returned to the Treasury from the sums which will be received later on when the timber can be placed on the market. If need be, the advances could be deducted from the amounts which would later go to the communities as their share of the gross receipts from the forests. In such an event the Nation would not be making a new contribution to the communities, but merely advancing a portion of what they would ultimately receive anyhow.

APPLICATION OF THE PLAN

In application the plan would call for a specific appropriation for individual projects, each of these to be considered separately and on its merits. Probably the simplest procedure would be to use the county as a development unit rather than a National Forest which might spread over several counties. The question of whether in any given county the Government should make advances on the basis of its forest resources for the benefit of the community development would depend wholly upon the public need for such advances and upon the resources in the National Forest comprised within the county which could be used as security for the advance. In short, we are dealing with

a question of public business and no advances should be made except upon an adequate showing that existing resources are amply sufficient to cover the outlay. Thus Congress would be in the position of a board of directors of a banking institution passing on a loan. The showing of the public need and of the resources which are to repay the advances would be made by the Secretary of Agriculture through the Forest Service.

The procedure in the case of a given county would be somewhat as follows: The Forest Service and the local county officials would cooperate in the study of a county's needs for public improvements, not merely within the boundaries of the National Forest but in that portion of the county outside of the boundaries and adjacent to the Forest. The public improvement which would usually be desired would be the construction of roads and bridges. In the majority of cases the immediate purpose of such development would be to make the agricultural lands more accessible to the market. In many cases the purpose would be to open up new agricultural regions, as for example, in the logged-off lands outside of the National Forests, such as occur in great quantity in the Northwestern States. In some instances the purpose of the roads would be to open up a mining region. In still other cases it is possible that the development of the recreation resources would be the most important need of a region. Such a study would result in a general plan of needed development of public works, including the determination of the specific roads or other works which should be undertaken immediately. This plan would show also the direct public service which would be rendered by the improvements in the development of agriculture and other resources and the benefit which would result to the public at large.

In addition there would be prepared by the Forest Service a full statement showing the amount of timber and other resources in the National Forest within the county and the receipts that can conservatively be anticipated as soon as these resources can be realized upon.

In short, a business statement would be prepared which would demonstrate the desirability and soundness of the proposed expenditures and their justification from the standpoint of the National Forest resources as a security. It is not unlikely that Congress would be unwilling to make such advances as are proposed on the basis of general estimates of cost. It is probable, therefore, that the first appropriation for public works in a given county would be for surveys and estimates with a view to making a final appropriation after the completion of the surveys by the road engineers.

The plan contemplates further that the actual work of construction of roads and other improvements would be under the direction of the Government engineers. The Department of Agriculture is well equipped for such work in its Office of Public Roads. The purpose of this provision would be to guarantee to Congress that the work would be carried on in accordance with consistent engineering methods and standards and with the highest possible efficiency and economy.

One of the first questions that will be asked is how a beginning is to be made in setting this plan into motion. Probably the best plan would be to request general authority for the Secretary of Agriculture to report to Congress from time to time, with necessary surveys and estimates of cost, his recommendations concerning the construction of public works in the National Forest counties where, in his judgment, the public need requires it and there are resources within the National Forests lying within the counties sufficient ultimately to repay the cost of such improvements. With such authority the Secretary of Agriculture, through the Forest Service, could take the initiative in recommending legislation. If such general authority were granted, it would necessarily carry a recognition of the fact that appropriations would be made only upon a showing by the Secretary of Agriculture of their justification and need. Such a procedure would be an effective guarantee against the initiation of ill-advised projects and would result in

the most urgent cases being considered in the order of their importance.

The first objection which will be urged against the plan is that there would immediately develop a competition among different counties for advances from the federal government for road building and that there would be danger of sectionalism developing, and perhaps such a condition as is claimed to exist in connection with the Rivers and Harbors Bill.

It should be remembered, however, that the present plan is very different from the Rivers and Harbors problem. In that case there is a direct contribution by the Government. In the present proposal, there is merely an advance by the Government, in urgent cases, of moneys which later on will be returned to the Treasury from the resources, held and fully controlled by the Government itself, and a portion of which Congress has already decreed shall ultimately be appropriated for these very purposes. Handled as a proposition of public business, with the expenditures guaranteed by existing resources, and with the certification of the Secretary of Agriculture as to the public need and as to the engineering features, there should be ample safeguard against unwise projects being undertaken.

SOME ILLUSTRATIONS.

It is evident that the plan would not be applicable by any means to all of the National Forest counties. Many of the National Forests are already being developed and used to such an extent that the receipts are now bringing into the counties very substantial sums, in some instances fully as great as would be received if the lands were under taxation, and these are receipts which will be constantly growing for an indefinite period. Examples of Forests yielding large revenue are the Kaniksu of Idaho, with a gross revenue of \$54,000, the Kootenai of Montana, with a gross revenue of \$41,000, the Deerlodge of Montana, \$80,000, the Coconino of Arizona, \$100,000, the Whitman of Oregon, \$72,000, the Lolo of Montana, \$40,000, the Sierra of California, \$22,-

000, the Tusayan of Arizona, \$64,000, and there are many others which now yield very substantial returns. Under such circumstances there certainly is not the same need of making advances on future receipts because the citizens are already receiving a direct contribution from the forest resources for local institutions. Then again there are some forests with relatively little timber value which were established and are maintained not so much to produce forest products as to protect the water used by the local communities in irrigation, for domestic supply, and other purposes. In such forests the receipts may be very small now and in the future.

Obviously the local communities are already receiving very large benefits from these forests in the protection of their water and advances would not be made to them for this reason, and also because the resources are not of a character to justify it. Still again, certain forests have in the past been so badly abused through forest fires and otherwise that it will be a long time before the timber which is now growing up will yield substantial receipts. There is no reason why under such conditions any advances should be made by the Government. In the first place, the resources do not justify it and it happens that on most of the forests in this condition there are considerable receipts from grazing which constitute a substantial contribution to the community upbuilding.

The situation may best be illustrated by a few specific examples. We have on the Olympic Peninsula an extreme illustration of the need of applying the proposed plan of making advances for the public improvement. The Olympic National Forest occupies 62 per cent of Jefferson County and 46 per cent of Clallam County. The Olympic Forest carries the largest body of timber of any of the National Forests of its size. Surrounded as it is by private timber lands which are much more accessible, it has not been possible to place any considerable amount of the Government timber on the market at the present period of great depression in the lumber

industry. There has been, therefore, very little return to these counties from receipts from the National Forests. A great deal of these counties is still in a state of wilderness. Only a small beginning has been made in the construction of means of transportation. The conditions are such that the construction of serviceable roads is extremely expensive. The people of the counties have bonded themselves heavily in order to build roads, and with such funds as they are able to raise in this way only a small part of the work can be done which is necessary to lay the foundations for the development of the agricultural and other resources of the counties. The development problem of these counties is first of all to open up the logged-off lands outside the National Forests and to establish upon them permanent homes. This cannot be done without roads and the relatively small population already heavily burdened with taxes cannot possibly meet the situation. The Olympic National Forest contains at least 33 billion feet of timber. Ultimately there will be a return of from \$300,000 to \$500,000 a year gross receipts from this forest. Pending the time that these timber resources can be realized upon, they certainly should be made to make some contribution to the development of the counties through the plan of federal advances such as is being proposed. In my opinion, if the plan which has been outlined in this paper is adopted the first projects which should be given consideration by Congress are in Jefferson and Clallam Counties in Washington.

A number of other very urgent examples could be given, such as Curr County in Oregon, where 64 per cent of the county is in a National Forest and where there is at the present time very little return to the communities from the forests because of the inaccessibility of the timber and other resources and where there is a most urgent need for road development in order to open up the resources surrounding the National Forests as well as those within its boundaries. The small population, 2,044 people, cannot

undertake this work. The Government should help and I believe that it is entirely practicable for the Government to give help under the proposed plan.

Another urgent case is in Trinity County, California, where the National Forest covers 58 per cent of the county. This forest has a stand of over 13 billion feet of timber, which ultimately will bring in gross receipts of considerably over \$100,000 a year, but which at the present time returns to the county only a little over \$2,000. There are only about 3,500 people in the county. Its county seat is 50 miles from the closest railroad by mountain wagon road, and many of the people of the county have to pack their supplies over mountain trails because there are no roads at all. An advance by Congress on the basis of later returns which certainly can be secured from timber which is owned by the Government, but which cannot be marketed at the present time, would open the way to developing this section of California. Other illustrations could be given in the Coast States and in some of the interior States where there is heavy timber but so located that it cannot immediately be developed on account of its inaccessibility and lack of market. Such are the projects which should be taken up first.

Probably the suggestion of the foregoing plan will bring up many questions regarding the detailed operation of it in practice. For example, the question of maintenance of the roads would arise, whether the counties or the Government should assume this burden. Again, the extent of cooperation on roads in which the counties and the Government, and perhaps also the States, would participate would constitute a problem here and there. In planning a given project these questions

should be considered and a solution in each case be worked out before asking for the advance from Congress. I have no doubt of the earnest cooperation of the communities, if I may judge by the way they are working with the Forest Service in such road building as is now being carried on in the forests.

RESULTS OF THE PLAN

The proposed plan would make the public benefits of the National Forests immediately realizable; it would accomplish development not possible for the communities without public aid and would stimulate agriculture and other industries and result in the building up of many permanent homes and bring into use great quantities of land now lying idle; it would relieve the now struggling communities from a burden of taxation which otherwise they would have to assume if the development of many of the National Forest communities is to go forward as rapidly as it should; it would hasten the development of the National Forest resources themselves which are now in many cases unavailable because of lack of transportation; where roads are built in the Forests there would be an added security because of their direct use in forest fire prevention; the plan would work to the benefit of the small man in every way; and finally, there would be a clearer appreciation on the part of local communities of the important public benefits of the National Forests, and in consequence of the present realization of the purposes of the National government in this enterprise, there would be a closer cooperation between the people and the public agencies with the result of a more effective protection and administration of this property than otherwise would be possible.

Russia's Embargo on Lumber

The Russian government has placed an embargo on all kinds of lumber, to prevent its exportation; walnut lumber, including Circassian walnut, much prized by American furniture makers, is specifically mentioned.

THREE MILES OF FLAME

A CROSS-COUNTRY RIDE AND THREE DAYS OF WORK WITH A FIRE WARDEN IN NEW ENGLAND

By ALLEN CHAMBERLAIN

["I would like to establish the fact that all the picturesqueness and all the heroism in forest fire fighting isn't confined to the West," wrote Mr. Chamberlain in contributing this story. "During the drought this autumn there was a deuce of a fire in the Berkshire country that narrowly escaped developing into a calamity. I have attempted to relate in short story form the cold, hard and wholly unadorned facts concerning that fire."—Editor.]

"HELLO, warden! Back home again, are you? Then all this smoke doesn't mean that the woods are still afire back in the hills?"

"Well, all I can say is that, so far as I know, the fires in this district are out, or under control. Perhaps I'd better knock on wood, though, for something may start at any minute with the country as tinder dry as it is right now. If I could see a sprinkle of rain I'd turn in for a solid twenty-four hours of snooze. 'Believe me,' I could give the finest imitation of a man sleeping that ever was. In the last three days Jim and I have managed to edge in just about one night's sleep. Oh, yes, this fire warden business is a cinch—when it's raining."

In seven weeks there had been no rain in the hills—oh, perhaps what the Weather Bureau calls "a trace," a mere dew—but no real rain. It was as dry as a California summer, and yet it was October in New England. No rain, and persistent summer temperatures, made golden weather for pleasure parties out to see the autumn color on hill and dale. Then, too, the shooting season had just begun, opening on a holiday, which meant that thousands of men and boys with guns and matches had taken to the bush for one glorious day of killing.

It had been a worrisome seven weeks for every fire warden, and the State warden and his district deputies had lived a busy life chasing hither and yon at the summons of the local officials who needed aid or advice, for there was scarce a town that did not have its daily blaze. But mostly these district men were needed in the remote hill

towns, communities big in land area, but little in point of population and financial means. In these places, where every man is a farmer, all hands are busy at this season trying to get in their harvest, but when fire comes they must drop these private affairs to fight the common enemy. In a little town with a mere handful of voters it isn't possible to "let George" do these things. All the "Georges" have to turn out, and if any hang back without good cause the law provides a substantial penalty. Besides it isn't healthy to be unneighborly in such matters in a small town. The neighbors aren't numerous enough to hide behind, and the shirker "gets in wrong" with everybody for miles around. How those farmers hated the sight of an automobile. Too often the passage of one through some piece of woods meant a call to the fire line within an hour, the result of a heedless smoker and his match or cigar stub. And the gunners were no less unpopular for the same reason.

On this particular balmy October evening, when the deputy warden of District 6 drove his dusty little run-about into the home yard, he and his helper had spent the best part of a week chasing fires from one end of the district to the other. Fifteen hundred square miles is a tidy little area to have to keep an eye on, and when seventy-five per cent of it is forest land, with plenty of slash-covered wood and timber lots sprinkled through, and the whole territory standing on end in hills and small mountains up to three thousand feet in elevation, a man has to be definitely "on to his job" in a dangerous fire time, and without much regard for three meals a day and slumber.

It looked a little like rain, and there was no wind. The chances for at least one night of sleep seemed hopeful. That day they had taken a look at two town crews that were fighting fair-sized blazes, and had spotted and stamped out three small fires all by themselves, just as an incident of the road. Small wonder that they were ready to stop a spell.

"Run the go-cart into the shed, Jim, and tank her up with gas and water for luck. And you better hitch on that extra fire pump, too. It might be handy sometime. Then come in and we'll pick up a bite and take a turn at that sleep act. Be sure the lamps are o.k."

What a relief to get home and to get a real wash-up and a square meal. It was the next thing to luxury.

"Now, Jim, who says that there aren't compensations in a warm, dry Fall? Just look at that dish of green corn. I didn't really expect that last planting to come to anything, but there it is, so 'go to it.' 'It's an ill wind that'—Drat that 'phone! Half a mind not to answer it."

But as he said it he was across the room in a jump and taking down the receiver.

"Hello! Yep, I'm the feller. Whose this? Oh, hello chief. Why, pretty fair, thanks. Not scorched yet, anyhow. Maple Mountain, did you say? Running toward the State reservation? I see. Yep. All right. We'll trot right over. Good-night."

"Well, Jim, we'll finish our supper, if you don't mind, but that sleep will have to be 'continued in our next.' That was the chief. The reservation commissioners have wired him that Maple Mountain is all a fire, and that it's running straight for Whitetop. Why, there aren't two dozen men in that whole town, and they don't own a pump, or an extinguisher, or anything else to fight with. By, George! Just in the nick. Here's a waybill for some new fire pumps just in. Hike over and tease Jerry to open the express office and let you have those guns. Tell him it's an emergency. I'll chase you over with the car in a jiffy."

It was one of those nights known as

"pitch dark" when stars don't seem to count. A merry prospect lay before the warden and his man, for it was full fifty miles across the hills, and over some of the roughest back country roads in the State, to reach that fire. By the time the new pumps were unpacked and lashed to the car it was past ten o'clock.

For a couple of miles they tore along the river road at good speed, and then began the tedious climb of a ten-mile hill, a steady grind of 100 feet in the mile, with many a stretch much stiffer. The men who settled those townships in Revolutionary days aimed at the summits of the long glacial ridges, and ran their roads straight for the goal and across, and quite regardless of grades. At the little hamlet stranded upon the Crest, two thousand feet above the sea, the car shot along the ridge, and then down the long "ladder" on the northern side into the valley of another river. A few miles of relatively level road across the bottom land, and again the car was thrust against the contours, straight for the mountain and the fire. Shortly after midnight, as they skirted the flank of the mountain, the blaze appeared above them, a continuous line of fire the entire length of the three mile long ridge.

It had been a wild Paul Revere sort of a ride across the dark, but even with the goal not only in sight, but right at hand, the riding was not yet over. The local warden must first be found, for although the towns like to have State aid in their times of trouble and distress, the dignity of their local sovereignty may not be ruthlessly transgressed nor overlooked by the officers of the State. It was one in the morning when they whirled into the little village center, and stopped in the yard of the local warden.

"Must be they're all out on the fire line, or else—Hello, here comes a light!"

It was the warden himself, and so dead beat and weary that he could barely keep his eyes propped. No, he didn't think anyone was on the line tonight. The fire had fought them to a standstill. Every man Jack was "all in." Couldn't get any outside help, and the town men were simply worn out after two whole

days of fighting. They had checked it, and if they only could have held out that night, or got a fresh relay of men, it would have been out by morning. The fire had started in the scrub of the higher ledges on the westerly side toward the village, had spread both ways on the long north and south ridge, and finally worked its way through a gap, and started down the easterly flank straight toward the State reservation. Someone had heard shooting up on the mountain the morning that the fire started.

Whatever else was done the reservation must be protected. It was clear that the local gang would be useless, even if called out, in their present state of collapse. There wasn't a telephone in the entire township, and it was a long rough road to the nearest sizable place where help could be had. But something must be done, and quickly.

"Get back to bed, warden. We'll take a scout around the mountain and be back for an early breakfast. You'll be feeling better by that time yourself."

And with that the little car was off for a circuit of the fire, the worst eight miles of the entire night, up and down breakneck hills, in and out through the woods, bumping over rocks and gullies, and its occupant nearly choked at times with the dense acrid smoke.

But they located the limits of the fire, and found the danger points and the vulnerable spots. At one place, where the flames were working down to within a few hundred feet of the road, but coming leisurely, as fires do on the down grade, they stopped and unlimbered a pump.

"We'll just put that bit of fire to the bad right now, Jim. If she jumps this road, and gets to climbing the big mountain across the notch here it will be 'good-night.' The whole county couldn't stop it in ten miles."

A handy brook furnished the ammunition, and it wasn't long before their gun had subdued an eighth of a mile of fire. For safety's sake they swept the road clear of leaves for a stretch, and after refilling the pump and leaving it beside the road for future use in case of need, the car was started for the village. At dawn they sat down to a hurried breakfast with the local chief.

"I'm thinking we can stop that fire today. We've got to, that's all. Where can we get fifty men? Can't you rout out a few of your neighbors and get them to drive around and hire some men? Of course you'll have to go outside your town, but the Billboro and Waytown folks will help you if you shout. And I want four teams with cider barrels to haul water. Now if you'll get after these things we'll furnish the pumps and take right hold ourselves with you. What do you say?"

Inside of half an hour three neighbors were off for outside help, and the warden himself was routing out his town crew and impressing the cider barrel outfits. Back to the mountain went the district warden where he found the reservation superintendent with two of his men, and by seven o'clock the crew began to arrive. All told forty men were rounded up, which made four good gangs of ten men each, with two ten-gallon pumps to a gang. It was high time for something to be doing, for the fire had crept down closer to the leaf-littered notch road at many points, and it was already beginning to wake up a bit for an active day.

It was a terrible temptation to try back-firing along that road, but the up-to-date warden is chary of resorting to that check. The risks are too great, and the situation must be desperate indeed to warrant this fighting of fire with fire. So it was slow and heavy work lugging the hand tanks up the hill to assault the steadily oncoming crackle.

Forty men on a three mile line do not present a very continuous front. A hundred men would have been none too many. It meant a stiff and steady fight for the forty. While they beat the flames back at one point they would eat ahead at another, and gathering headway, threaten to make all the work unavailing. Once over that road—and a single spark would take it there—and the jig would be up. The fire must not be given a chance at the slope of old Whitetop across the notch.

Up and down the road buzzed the little car carrying the keen-eyed and energetic State deputy, keeping touch with the whole situation. Did the fire

get too lively at some particular point, and threaten to get away before the nearest gang could work up to it, the car brought that gang at once. It was like the Highlanders being whirled into the charge by clinging to the stirrups of the Scots Grays, the men hanging to the running boards, on behind, anywhere for a foothold or a grip.

And so it went all the morning, and all the afternoon, too, food and hot coffee being brought along the line at noon by a city man whose summer place was threatened by the fire. By nightfall the enemy was under control, but the job was not yet finished. It must be kept under control, and so, bit by bit, put out.

A competent fire warden, like a general, must be considerate of his men. It would be a reckless extravagance in human energy to keep more men on the line that night than were absolutely necessary. Another fire might break out at any time in some other part of the town or section, and with everyone exhausted, and unable to put up another ounce of fight, there would be nothing to do but to let it burn. The men who had borne the brunt of the battle that day, full half the crew, were sent home to sleep. The rest were summoned to another meal, and while they toyed with sandwiches, hot soup and coffee, the warden regaled them further with a bit of his choicest table talk.

"Boys, I'm sure enough tickled with the way you've stood to this game today. You've got things in shape now for a clean knock-out if you'll stick to it tonight. The scrap isn't going to be quite so strenuous from now on. What fire there is left wont be very energetic between now and morning, unless we should get a big breeze, which doesn't seem likely. All we've got to do is to keep on soaking it, and by morning a handful of guards can handle what's left. We'll try the scheme of putting in the night in two watches. No. 1 crew can go out on line now, I'll set you along the road with the machine, a couple here and a couple there, and keep in touch from time to time. No. 2 crew can take a leaf, and catch forty winks till their relief time comes, unless an emergency spoils their dreams."

The men were game, and the supper had put new gimp into them. All spots that still showed a lurking vigor were given first attention, all smouldering logs and stubs were drenched down, and everything was going to the Queen's taste when, along about midnight, and quite without warning, the wind hauled south and steadily freshened, stirring up latent sparks and introducing wholly new conditions.

It was No. 2 crew's time to be called, but, by the same token, it was not No. 1 crew's time to sleep under these circumstances. All hands and the cook were needed now, and for a time it was lively work. Instead of bringing discouragement the revival of the fire seemed to arouse a renewed amount of fight in the men, and by dawn they had not only conquered, but had managed to wholly clear up the leaf litter along a stretch of road to leeward and next the reservation, and, what was even more cheering, they had seen the grimy face of the warden relax into a real smile. It was evident that the battle was won. A small patrol could handle what was left. Half a dozen sentinels for another day and the incident would be closed, save for the following unromantic entry in the official returns:

Cause—Careless hunter; Acres Burned—600. Cost to Extinguish—\$250. Damage—\$2,000.

Hardly worthy of any greater fuss someone may think. But how about the little farming town that has to stand the cost and the loss? That is where the pinch comes.

To this particular town the bill of costs of \$250 amounted to just about one-fifth of its total annual public revenue, and the loss of \$2,000 worth of wood and timber on the stump meant a shrinkage of three per cent in its total assessed valuation.

But for the State's timely aid the loss to the town might have been far greater, and into the bargain the State itself stood to lose its 10,000 acre forest on Whitetop Mountain which had cost the public treasury \$150,000 to purchase and develop.

The economic question naturally arises: Does the revenue from hunting licenses cover these losses?



EDITORIAL

VICTORY FOR AMENDMENT NO. 9

THE Minnesota Forestry Association achieved a great victory in the cause of forest conservation by securing the passage at the November election of constitutional amendment No. 9, which provides that such school and public lands as are better adapted for timber production than for agriculture, may be set aside as State school forests or other State forests as the Legislature may provide, and that they shall be managed on forestry principles.

The amendment was the only one of eleven which passed. The vote was 178,954 for it and 44,033 against, but as all not voting were also counted as against it the real majority was only 501.

The victory was due to a publicity campaign such as the State had never before seen, and the method by which it was conducted will well serve as an example for other States where forestry laws are needed or where amendments to existing laws are desired.

The average voter is a fair-minded individual. Show him that a proposed measure is for a real benefit for the people and the State and it will usually have his support. But he must be shown. No glittering generalities convince him. He needs cold, hard facts. He likes concrete examples. The Minnesota campaigners for Amendment No. 9 realized this. They took editors of the chief papers in the State to the north woods and showed them actual conditions following destructive

lumbering on land unsuited for farming. These men were convinced. They described in their papers the conditions as they saw them. There was no gain-saying the facts and they presented the facts.

The smaller newspapers took up the work. The campaigners furnished them with daily news articles, many signed by prominent men of the State, and in this way the voters could not escape knowing what Amendment No. 9 provided and why it was needed.

So far so good. But the campaign did not stop there. The 17,000 members of the State Federation of Women's Clubs were enlisted. When women are enthusiastic about a measure and energetic in advocating it, it has advanced far on the road to success. The women distributed literature and posters and a day or two before election each telephoned one or more voters and asked them to vote for the amendment.

Still another admirable step was taken, and one that should appeal to every State or association conducting a forestry campaign. The clergy of the State were asked by their respective bishops to talk for the amendment and distribute literature. They exercised a powerful influence in its favor.

Perhaps no one feature of the campaign was more striking than the setting apart by the Governor of a State Forests Day to be observed in each school in the State. Each of the 14,000 teachers received a program and some literature and 400,000 school

children participated in exercises and took home a card asking for a vote for Amendment No. 9. What better way of reaching the home than this?

Other forms of publicity were also successful and before election day it was conceded that the defeat of the amendment was all but impossible. Yet the small majority indicated that every bit of work done for it was necessary.

A number of States need forestry laws; others should have existing forestry laws amended. None are likely to gain what is needed without agitation, without a campaign to arouse the voters. It takes money to conduct such campaigns and such money usually comes from progressive citizens of the

State affected and from national associations. The American Forestry Association does all it can to aid in securing State forestry laws and encouraging the cause of forest conservation wherever possible. Unfortunately its funds are limited, as are the funds of many such organizations. It is supported by the annual dues of its members and the subscription and advertising fees for AMERICAN FORESTRY Magazine and the more members it has the more subscriptions and advertising it secures the better will it be able to render the financial assistance so much needed in arousing the public interest in the need of forestry laws.

AIDING FOREST COMMUNITIES

THERE exists, and develops into proposed legislation from time to time, some opposition to the government control and administration of the national forests. Much of this opposition is based on the claim that the forests are blocking development of the localities in which they are situated and that their resources are locked up. The Forest Service officials have long recognized that communities near national forests which are not paying taxes and which yield little or no revenue from timber sales because the forests are inaccessible, have more or less cause for complaint.

Therefore it was with considerable satisfaction that AMERICAN FORESTRY was able to publish in the December number Secretary Houston's recommendation to Congress of a plan providing that such communities be ad-

vanced money for road and bridge building and general development purposes. In this issue the details of this plan are explained by Chief Forester Graves.

If Congress adopts the recommendation of Secretary Houston, and there is every hope that it will, the effects will be felt chiefly in the great northwest and the result will be the opening up of much territory which is now a wilderness but full of latent possibilities. The plan has advantages over others for the development of the country by financial aid from the government, because it provides for repayment of the money advanced, if necessary, from the resources of the forests which will become available in the future when their timber is sold.

It is hoped that Congress will take favorable action on the recommendation at the present session.

A KNOWLEDGE OF TREES

THE American Forestry Association receives so many requests for information about the selection of shade trees for various street and soil conditions, when and how to plant them, how to protect them from insects, and repair them

when injured, that such knowledge as may be generally useful to those wishing this information will be printed in a series of short, concise articles in AMERICAN FORESTRY Magazine.

The first appears in this number. It deals with the selection of shade

trees and their character. It will be found to be, in brief, readily understandable form, a compilation of answers which fit practically all inquiries about the choice of shade trees.

Next month will follow an article on how to plant them and when, with sound advice regarding their protection and care.

There is happily a noticeable growth, throughout in the entire country, of a desire to know more about trees. School children are keen to learn of them and their characteristics and many a youngster knows more about them than his parents. It is a knowledge

which should be fostered. Many a city would be infinitely more attractive if it had more and better shade trees or had made better selection of those already planted. There is hardly a progressive city in the country which does not now recognize the need of a city forester or city tree commission. Arbor Day is a recognized institution. School readers contain tree stories. The public knowledge of trees and their value is growing while the public desire for the conservation of the forests is so marked that no man can deny that our citizens are at last awakened to a realization of the need for their perpetuation.

DOES FOREST FIRE PROTECTION PAY?

IF ANY one has any doubts about the value of fire protective work in the forests they will be dispelled by reading the article "The Fire protection on the National Forests in 1914," by Chief Forester Henry S. Graves, in this issue. The fact that in 1914 there were over one thousand more fires on the national forests than in the "bad year" of 1910 indicates how much greater was the danger of tremendous damage than four years ago, while the fact that in 1910 the damage was between \$15,000,000 and \$25,000,000, and in 1914 it was only about \$450,000, indicates the wonderful progress made in the system of fire protection, and the inestimable value of such fire protection.

It is remarkable that in four short years the fire protective work could become so well systematized and its operation so perfect that, despite a large increase in the number of fires and fire conditions quite as bad if not worse, the loss should be only four per cent of what it was in 1910.

This unusual efficiency was due entirely to a systematic organization, the establishment of lookout stations from which large areas of forests could be watched, the extension of telephone lines from these lookout stations to points from which aid could be called,

and the opening up of roads and trails through the forests in order to enable the fire fighters to have ready access to points where fires started. During the past four years there have been added in the development of the national forests and as fire protective measures 1,368 miles of roads, 9,617 miles of trail, 12,000 miles of telephones, 300 fully equipped lookout stations and 695 headquarters stations. So thorough was the organization and so well was the system of fire protection aided by the facilities afforded by the new roads, trails, telephones and lookout stations for fire fighters getting to the scene of a conflagration quickly, that fifty per cent of the fires were extinguished before they had reached a quarter of an acre in extent.

It might be supposed that this wonderfully good record was made by the expenditure of sums of money much larger than the amount used in 1910, but the fact is the expenditure was smaller. In 1910 over one million dollars were spent in fire fighting on practically the same area while in 1914 the expenditure for the same purpose was about \$670,000.

What more effective answer than these facts could there be to the query, "Does fire protection on our forests pay"?



THE CANADIAN DEPARTMENT

By ELLWOOD WILSON

ANOTHER tragedy has been added to the long list of those which are told around the camp fires. About the sixteenth of November Mr. Lawrence S. Page, in charge of lumbering operations in the Shawenegan District for The Gres Falls Co., started into the woods with three guides. After about two weeks, as nothing was heard of them, a search was instituted and their canoe and Mr. Page's hat were found frozen in the ice in the narrows between Lac Caribou and Lac des Iles. The ice was cut out near where the canoe was found and the bodies discovered in about twelve feet of water and about twenty-five feet from shore, that of Mr. Page being about fifteen feet nearer shore than his companions. There were two long cuts in the sides of the canoe and it is probable that they were crossing the lake just at dusk, being cold and in a hurry to reach camp, and ran at a good rate of speed against the sharp shore ice and that this cut the canoe which must have filled and sunk very quickly. Encumbered with heavy clothes, numbed by the icy water and unable to climb out on the thin ice which broke under them they were unable to reach shore. Only those who have had similar experiences and escaped know the agony that must have been theirs when they found that the struggle was too

much for them. Mr. Page leaves a wife and four small children.

Mr. James Lawler, Secretary of the Canadian Forestry Association, has just made a lecture trip to Grand' Mere, and Shawenegan Falls where his excellent illustrated lectures on the Forests of Canada were much enjoyed.

Mr. W. C. J. Hall, Chief of the Forest Protection Service of Quebec, has resigned from the Canadian Society of Forest Engineers.

The Canadian Society of Forest Engineers is about to become incorporated under The Ontario Companies Act, and has appointed Messrs. Jacombe, of the Dominion Forestry Service, Zavitz, Forester of Ontario, and Leavitt, Forester of the Conservation Commission, to revise and consolidate the constitution.

The report of the Commission of Conservation for 1914 is just out and is a very comprehensive and interesting volume, covering practically every subject of interest to national development. The Forestry Section reports on extensive investigations of forest conditions in British Columbia, Saskatchewan, New Brunswick and Ontario. Such matters as control of watersheds, rates of

growth, value of forest cover, natural reproduction, etc., have been carefully studied. Cooperative fire protection systems, brush disposal, railway right-of-way control have also received much attention, and very practical recommendations have been made. Town planning, infant mortality and the protection of migratory birds are among other subjects treated of.

Mr. Clyde Leavitt has just returned from his fall inspection trip of the railways in the west and northwest.

Mr. S. L. de Carteret, Forester of the Quebec & St. Maurice Industrial Co., has been to Berlin, N. H., to attend the annual meeting of the Woods Department of the Berlin Mills and other allied companies. These gatherings, the idea of Mr. W. R. Brown, are a great help in bringing together men who are working for the same concern but from the nature of their work are seldom able to get together. It develops an *esprit de corps* and enables men to swap experiences, to see other methods of work and to get out of the rut and realize that there are others with the same problems and difficulties.

The Government of Quebec has increased the appropriation to the Government Forestry School affiliated with Laval University to \$8,000 per annum, which will enable many extensions to the courses. Mr. Piché, the Chief Forester, reports that his Department was engaged during July, August and September in the classification of Government lands and the inspection of settler's lots. Twelve parties were in the field besides isolated rangers, who were inspecting wood working establishments or watching the movement of timber along the railways. Their activities are now engaged in the inspection of logging operations which at present are much hampered by lack of snow.

Mr. W. J. Boyd, of the Dominion Forest Service, has just returned from a long trip from Prince Albert, Sask., beginning on May 15th last, by way of the Clearwater, Athabasca and the

Mackenzie Rivers to the Arctic Circle, thence by way of the Rat River over the MacDougall Pass into the Bell River, the Porcupine and the Yukon to Fort Yukon in Alaska, then up the Yukon to Dawson and out by way of the White Pass. Mr. E. S. Davidson accompanied Mr. Boyd and for over two thousand miles they traveled without guides. The timber conditions were observed and much valuable information obtained and the whole trip made without any mishap.

Algonquin Park, a forest reserve of the people of Ontario, consisting of about 1,750,000 acres, roughly about fifty miles on a side, covers the source of a number of important streams. It is a game refuge and the wild animals have increased to such an extent that it has been necessary to remove some of them. The Government are trapping and selling a number of fur-bearing animals, especially beaver, and of these latter are killing and selling quite a number of skins annually. Anyone wishing these animals can obtain them from the Ontario Government at the following rates: per pair, mink, \$35.00; beaver, \$50.00; marten, \$80.00; fisher, \$80.00; otter, \$150.00.

Probably the first jail sentence ever given against a man for setting a forest fire has just been awarded in Quebec. This will be a great step in helping to protect the forests from fire for hitherto the offense has not been considered serious and the judges and magistrates have generally refused even to fine a man especially if he belonged to the right political party. A better day is dawning.

The St. Maurice Forest Protective Association has reported that for the season just ended, the worst season in its history, 814,468 acres were burned over, 4,600 acres merchantable timber, 7,935 acres of old slash, 50,958 acres of old burn, and 17,975 acres of young growth. The total area patrolled was 8,132,416 acres. The chief causes of fires were river drivers and the contractors for the new Transcontinental

Railway, the worst fire being set by these latter's section men burning old ties.

Mr. John Gillies, of the firm of Gillies Brothers, and one of the best known residents of the Ottawa Valley, died on Nov. 17th. He was in charge of the woods operations of his firm and was early distressed at the inadequate care taken of her forests by Canada. He it was who protested so strenuously at the time of the Cobalt boom, at the throwing open of his firm's timber limits to destruction by the prospectors.

After a long illness the Hon. Colin H. Campbell, former Minister of Public Works and Attorney General of Manitoba, died in Winnipeg. Mr. Campbell represented the Manitoba Government at the Canadian Forestry Association

meeting, held in Victoria, B. C., and was so impressed by the need of conservation that he urged the Manitoba Government to issue the invitation to the Association to hold the 1913 Convention in Winnipeg.

Mr. Henry Sorgius, Manager of the St. Maurice Forest Protective Association, was married about three weeks ago. Mr. Sorgius has been with the Association since its inception and has done most excellent work.

The Laurentide Co., Ltd., is finding trouble in its plantations with the hares, which eat off the terminal shoots of the young spruce and balsam trees, causing them to grow bushy. They do this mostly in the fall and spring and are a great nuisance.

IN BRITISH COLUMBIA

THE Province of British Columbia is divided into eleven administrative districts, each one with its force consisting of a District Forester, under whom work rangers, scalers, forest assistants and guards. The guards are employed only during the fire season in summer, and their work is directly supervised by the rangers, one ranger overseeing a number of guards.

The total force of the Forest Branch during the height of the fire season in August was over 500, of whom nearly 350 were employed solely in fire protection. In addition were about 25 officials as chiefs of police in municipalities, construction foremen, etc., who were appointed and acted as forest guards without pay for the Forest Branch.

On the railways under Dominion Charter, as the C. P. R., G. T. P., G. N. R., about 50 special fire patrolmen were employed by the railways besides the hundreds of section men, etc., a part of whose duties is fire protection. As officers of the Board of Railway Commissioners for Canada, the officers

of the British Columbia Forest Branch supervise fire protection on the railways.

On the railways as the C. N. P. and P. G. E., under Provincial Charter the forest officers, by virtue of the British Columbia Forest Act, have even closer control of fire protection, and here the patrolmen are appointed and paid by the Forest Branch, the cost being recovered from the railroad at the end of the season.

The Dominion Forestry Branch, Crown Timber Branch, and Dominion Parks Branch employ 50 to 75 rangers and guards in the Dominion Railway Belt during the summer. Over 40 of the men were appointed acting forest guards in the British Columbia Forest Branch this year for the purpose of giving them authority to issue burning permits.

A number of private forest guards are employed in different parts of the Province by owners of large bodies of valuable timber.

Altogether in midsummer the British Columbia Forest Branch and other forest protective organizations employed over 500 men on special protection work.

Altogether there were in the Province over 1,000 whose duties were in whole or in part fire protection.

The fire season in British Columbia, 1914, was, as regards dry weather and hazard, the worst for many years. Old inhabitants say that there was not another so dry summer this century, nor in fact since the 80's. The expenditure in fire fighting was very heavy but justified, for considering the very large number of fires and the extraordinary hazardous conditions, the amount of merchantable timber and other property destroyed is remarkably small—much smaller than in the Pacific States where the fire season was also very bad.

Figures so far available are given below. It should be remembered these are as yet only approximate; the final figures will probably exceed these somewhat.

Total number of fires over 1,500, of which over 400 cost money to fight. Total cost fire fighting over \$150,000.

Total area burned over—over 350,000 acres, of which over 250,000 acres was old burn or slash, over 50,000 was valuable second growth, over 20,000 was merchantable timber, over 30,000 was range land.

Over 70 millions feet board measure, merchantable timber destroyed, of which one-fifth estimated salvageable.

Over 400 miles of fire trail were built in fighting fires during the summer.

An outstanding feature of the fire season was the valuable cooperation given to the forest officers by the people at large. It is doubtful if anywhere else in Canada there exists as close and effective a cooperation in forest protection as in British Columbia. One reason for that is that British Columbia is so universally forested and the utilization of those forests so important to her, that their fate does and always will vitally concern a very large part of her population and her industries. The railway, mining, irrigation, power, lumber, etc., companies are all more or less dependent on the forests and forest products for their existence and operation. They show their appreciation of this by the keen interest they manifest in fire protection and the ready assistance they give the forest officers.

It was shown that the only way to make logging or other slash really safe is to burn it under control in not too dry weather. Otherwise the slash is a constant hazard during dry weather and sooner or later it results in an expensive and often destructive fire.

The permit system again proved its great value and necessity. During August and the first week of September in the southern part of the Province at least, permits were cancelled and no burning allowed in or adjacent to the forests, except under the strictest safeguards. Were it not for this control by the Forest Branch of burning during the fire season, fire protection would be almost impossible.

Quite a number of prosecutions were made for violation of the fire law and convictions secured. The policy followed is to deal leniently with the unknowing offender, but to make example of the wilful lawbreaker.

IMPROVEMENTS

In spite of the bad season the Forest Branch was able to do a considerable amount of permanent improvement work during the summer, in extension chiefly of last year's projects. The telephone line up the Columbia River from Revelstoke was completed to Big Bend or Boat encampment opposite the mouth of the Canal River, the total distance now being 120 miles. Another line which connects up some of the Island to the north of the Gulf of Georgia was extended, the total length now being 65 miles. Still another line was built 20 miles up the Upper Kootenay River above Canal Flats. Over 75 miles of trail have been constructed in different parts of the Province. A number of cabins, boat houses, lookout stations and tool caches have been built.

GRAZING

British Columbia possesses great areas of summer range mostly more or less wooded and nearly all of it Crown lands.

A grazing investigation is now being carried on to determine the proper policy and methods to be adopted to encourage the fullest possible utilization of the immense amount of forage now going to waste each year.



FOREST NOTES

The Sihlwald, or city forest of Zurich, Switzerland, adds to the town's revenues \$7.20 per acre a year, reducing the amount needed to be raised through taxation by more than \$32,000.

In northern Idaho and Montana, which had many fires during the past summer, 35 per cent of the fires on national forests were caused by railroads, 26 per cent by lightning, and 10 per cent by campers. The remainder were due to brush burning and other miscellaneous or unknown causes.

A mountain lion recently killed in the Grand Canyon game preserve, which adjoins the Tusayan national forest, measured ten feet from nose to tail. Mountain lions and other beasts of prey, such as wolves, coyotes, and wild cats, are killed by forest officers and game wardens because they are a menace to stock and to game animals.

In the course of investigations of the wood distillation industry of New York by the College of Forestry at Syracuse, it finds that the removal of the tariff on grain alcohol has hurt the market on wood alcohol in such a way as to make it hardly profitable to produce wood alcohol at this time. The chief products of the destructive distillation of wood are charcoal, wood alcohol and acetate of lime. Charcoal is used for gun powder, for fuel, in the manufacture of iron, and for various poultry and animal foods. Acetate of lime is used almost wholly in the dye industries. Wood alcohol is used largely as a

solvent and for various chemical purposes. Beech, birch and maple are the best woods for the production of wood distillation products. Heartwood is better than sapwood because it does not contain so large a percentage of moisture. Elm, chestnut and cherry are not desirable woods for the wood distillation industry because they contain too much tannin, gums, etc.

J. J. Crumley, the secretary of the Ohio State Forestry Society, who is also Assistant Forester at the State Experiment Station, believes in practicing what he preaches. As soon as he engaged in his present position, he went to the southern part of the state and bought some hill land suitable only for forestry purposes. During the first two succeeding summers, he took his family of four and spent his summer vacations on this land, and combined delightful summer outings with the launching of his plan of improvement, cutting in culled over woodlands and reforesting vacant spaces. Up to date, he has most of the vacant spaces reforested; and by removing the old culls, the "left overs" from successive lumbering operations, he has given the more valuable young material opportunity to occupy the ground and air space. Incidentally he has marketed from this improvement cutting 60,000 feet of lumber, four car loads of locust posts, and fifty crossties. The net value of these products was about \$1,000. He paid \$1,600 for the place and has left the land, the finest young timber, his buildings, and small orchard.

When he gets this place improved and restocked, he proposes to buy another and keep at it.

Of two million sheep annually grazed in the State of Utah, more than a million are on the National Forests, or, including lambs which are fattening for market on the forest ranges, over a million and three-quarters.

Dr. Harry P. Brown, Assistant Professor of Forest Botany in The New York State College of Forestry, has published a paper in the January number of *Mycologia* treating of a peculiar timber rot of oak and chestnut. The decay is caused by *Hymenochaete rubiginosa* (Sch.) Lev. The rot first manifests itself through the formation of white areas in the wood, separated by sound tissue. Later, pockets are formed which have a white lining. The decay is quite similar to that of oak caused by *Stereum frustulosum* (pers.) Fr.

The Boise national forest in Idaho had 30 fires during the past summer, yet 28 were held down to less than 10 acres, and of these 15 were less than one-quarter of an acre. The supervisor says this success was due to a lookout tower, and to efficient telephone and heliograph service.

Because of the war, English manufacturers and consumers of wood pulp have been caused considerable uneasiness. Production is at a standstill in the countries at war, and in Norway and Sweden, principal sources of supply, mills have been greatly hampered because of a lack of coal and of chemicals. England has practically no domestic sources of pulp.

Black Hills white spruce has entered the market as a commercial possibility. After a series of experiments the spruce has proven itself of value for mining timbers in the coal mines of Cambria, Wyoming, and as a result several mining timber contractors have entered into contracts with the Forest Service for the purchase of white spruce from the Black Hills National Forest.

The Department of Forest Botany at The New York State College of Forestry is engaged in the classifying of the collections of forest fungi which were secured at the Summer Camp of 1914 in the Catskills. Diseased plants fungi and specimens of wood which show fungous decay are being prepared for museum purposes and for studies in connection with the decay of timber.

The forest fire season in the 28 square miles included within the boundaries of the city of Fitchburg, Mass., ended November 14. For the twelve months preceding this date the precipitation was 13 inches less than the normal. A continuous drought occurred beginning late in August and lasting 47 days. During the entire season there occurred 69 fires in the timber, sprout and brush lands of the outlying districts. The total area burned amounted to 127 acres. The cost of extinction was \$649.71. The entire fire damage amounted to \$44.00. All fires were extinguished by expert forest protective methods, most of them before they exceeded the light surface stage. Fires that developed into deep ground burns or into top fires were kept absolutely restricted to very small areas until entirely extinguished.

The annual meeting of the Massachusetts Forestry Association held in Boston on December 10 was very well attended. The Association honored Mr. Allen Chamberlain by making him a patron, the fee of \$1,000 being contributed in small amounts by about two hundred members in recognition of Mr. Chamberlain's admirable work for forest conservation. Interesting addresses were delivered by Mr. Chamberlain on the present status of the new national forest in New Hampshire; by Arthur A. Shurtleff on the Esthetic and Recreational Possibilities of Town Forests; by Secretary Harris A. Reynolds on Economics of Town Forests and by Wm. W. Colton on the management and Development of the Town Forest. The officers elected are: President, Nathaniel T. Kidder of Milton; vice-presidents, Berkshire—Heloise Meyer, Lenox; Bristol—William E. Fuller, Jr., Fall River;

Essex—Benjamin S. Johnson, Lynn; Franklin—W. B. Gaines, Greenfield; Hampden—Samuel Bowles, Springfield; Hampshire—Kenyon L. Butterfield, Amherst; Middlesex—Mrs. Fred H. Tucker, Newton; Norfolk—S. M. Weld, Dedham; Plymouth—G. R. Briggs, Plymouth; Suffolk—Edwin D. Mead, Boston; Worcester—John E. Thayer, Lancaster; Secretary, Harris A. Reynolds, of Cambridge; Treasurer, Ernest B. Dane of Brookline; members of the executive committee, Frank A. Cutting of Winchester; William P. Wharton of Groton; John S. Ames of North Easton; trustee of the permanent fund, George N. Whipple of Boston; auditor, H. Wadsworth Hight of Winchester.

Dr. L. H. Pennington, Assistant Professor of Forest Pathology of The New York State College of Forestry, is just completing the manuscript of a monograph of the temperate species of the genus *Marasmius* for publication in *North American Flora*.

The New York State College of Forestry took over the *College publication* for one issue and has issued the *Forestry Number* of the Syracuse Orange. This edition contained a great deal of data relating to Forestry in New York State and the growth of the institution in particular.

One of the most important resolutions passed at the annual meeting of the Western Forestry and Conservation Association at Tacoma, Wash., in December was the following:

"In view of the heavy expenses for fire fighting the past season both on private and National Forest lands, and since such expenses have resulted in the Federal Service expending an amount in excess of its emergency appropriation for this purpose, we urge upon Congress the need for such emergency appropriation as will fully cover the deficit incurred and for a liberal

reserve emergency fund in the future. We also urge that the government refrain from considering either this or the regular annual appropriation for national forest protection as calling for any radical attempt—especially during periods of market depression when such a policy would effect further community injury, waste and ultimate loss to nation and to consumer—to force the disposal of national forest timber for purposes of immediate compensatory revenue."

In addition to his own fire detection system, the supervisor of the Palisade national forest, Idaho, was notified of each fire by from five to ten different local settlers, who thus showed their cooperation in working for fire suppression.

The Uinta mountains of Utah, included within the Wasatch, Uinta, and Ashley national forests, should become a favorite recreation region, because of the many small lakes within depressions scooped out by glacial drifts. Seventy such lakes can be counted from Reid's Peak, and one particular township, 36 miles square, contains more than a hundred.

The Chilian Congress is seriously discussing a revision of the forestry laws of that country, with a view to preserving the large area of forests now in existence, and to increasing them in the arid portions of the country north of Valparaiso. In the last few years large areas of forest lands have been cleared for agricultural purposes, and this clearing is still going on.

Forest fires in Pennsylvania in 1914 caused damage estimated at more than \$450,000, according to a summary made up by the State Department of forestry. The summary shows that 241,486 acres were burned over and that it cost the state more than \$16,000 to extinguish the fires.

Uses of Black Locust

Outside of its use for fence posts, black locust finds its principal utilization in insulator pins and brackets for telegraph and telephone lines.

FOREST EDUCATION IN MARYLAND

DURING the past summer and fall the Maryland State Board of Forestry has carried on throughout Maryland an educational campaign in the interest of good forestry and better forest management. Part of this work has consisted of lectures and illustrated talks, by the State Forester and his Assistant, which have been given before local granges, schools and clubs. The farmers, who are the largest holders of woodland in Maryland, as elsewhere in the East, have been reached by a series of exhibits and demonstrations at the leading State and county fairs. With them the State has been thoroughly covered, and the value of both private and State forestry brought home to the class of people who own the forests.

In November, during Maryland Week, the last exhibit of the year was given in the Fifth Regiment Armory at Baltimore. The Board of Forestry has for many years been an exhibitor at the Horticultural Show held then, each year featuring some one important phase of its work. A year ago the exhibit was of forest products, but at the show just past it was the intention to give particular emphasis to the reforestation of the State's waste lands and the improvement of her highways under the

recently enacted law regarding roadside trees. To this end beds of seedlings were shown beside larger ones where the work of outplanting was well represented with transplant trees adapted to growth in the State. The stock exhibited was from the State Forest Nursery at College Park, where nearly a quarter-million small trees have been growing since its establishment less than a year ago. Along these beds of trees ran a roadway which might serve as a model for highways in the State. The road was carefully constructed and laid out, but it was to the trees which lined it in two long rows that attention was especially directed. The roadside trees, like the road, were on a somewhat reduced scale, but the same proportion was observed throughout. The trees themselves were well trimmed and symmetrical, giving emphasis to work under the new Roadside Tree Law. Tree Wardens from the State Forester's Office have supervised the trimming of 10,000 trees since July 15, 1914. This takes no account of the work done in Baltimore City under a separate Department. The new law has worked out well, and has already accomplished much in the way of improving publicly owned trees and making the highways of Maryland more attractive.



CURRENT LITERATURE

MONTHLY LIST FOR DECEMBER, 1914.

(Books and periodicals indexed in the Library of the United States Forest Service.)

Forestry as a Whole.

Proceedings and reports of associations, foresters, etc.

Bavaria—K. Staatsministerium der Finanzen. Ministerial-forstabteilung. Mitteilungen aus der staatsforstverwaltung Bayerns, heft 15. 165 p. München, 1913.

Society of American foresters. *Proceedings*, v. 9, no. 4. 97 p. Wash., D. C., 1914.

Vermont—State forester. Sixth annual report. 63 p. pl. Burlington, Vt., 1914.

Forest Aesthetics

Street and park trees

Buffalo—Park commissioners. Forty-fifth annual report. 48 p. Buffalo, 1914.

St. Louis—City forester. Annual report for the fiscal year ending April 7, 1913. 5 p. St. Louis, 1913.

Forest Education

Forest schools

University of Minnesota—College of forestry. Announcement, 1913-14. 20 p. map. Minneapolis, Minn., 1914.

Forest Description

Harper, Roland M. The coniferous forests of eastern North America. 24 p. il. N. Y., Science press, 1914.

Rübel, Eduard A. The forests of the western Caucasus. 4 p. pl. Cambridge, Eng., University press, 1914.

Forest Botany

Trees: classification and description

Lamb, William H. A conspectus of North American firs (exclusive of Mexico). 11 p. il. Wash., D. C. Society of American foresters, 1914.

Neger, F. W. Die laubhölzer. 160 p. il. Berlin and Leipzig, G. J. Göschen, 1914.

Winkenwerder, Hugo. Short keys to the trees of Oregon and Washington. 3d ed. 16 p. Seattle, Wash., University of Washington, 1914.

Silvics

Studies of species

Woolsey, Theodore S., Jr., and Chapman, Herman H. Norway pine in the lake states. 42 p. pl. Wash., D. C., 1914. (U. S.—Department of agriculture. Bulletin 139.)

Forest Protection

Insects

Stebbing, Edward Percy. Indian forest insects of economic importance. Coleoptera. 148 p. il., pl. London, Eyre & Spottiswoode, 1914.

Forest Management

Roth, Filibert. Forest regulation or, The preparation and development of forest working plans. 218 p. maps. Ann Arbor, Mich., published by the author, 1914. (Vol. 1 of Michigan manual of forestry.)

Forest Economics

Statistics

California—State board of agriculture. California forests; the lumber industry. 8 p. Sacramento, Cal., 1914.

Lewis, R. G., comp. Forest products of Canada, 1913; poles and cross-ties. 16 p. Ottawa, 1914. (Canada—Dept. of the interior—Forestry branch. Bulletin 47.)

Lewis, R. G., comp. Forest products of Canada, 1913; pulpwood. 17 p. map. Ottawa, 1914. (Canada—Dept. of the interior—Forestry branch. Bulletin 46.)

Forest Administration

United States—Dept. of agriculture—Forest service. Instructions for appraising stumpage on national forests. 70 p. Wash., D. C., 1914.

United States—Dept. of agriculture—Forest service. Report of the forester, 1913-14. 36 p. Wash., D. C., 1914.

National and state forests

United States—Dept. of agriculture—Forest service. National forest areas, June 30, 1914. 8 p. map. Wash., D. C., 1914.

Forest Utilization

Wood preservation

Goltra, Wm. Francis. The preservation of ties, poles and timbers by antiseptic treatment. 11 p. Cleveland, O., 1914.

Auxiliary Subjects

Natural resources

Argentine Republic—Ministry of Public works. Northern Patagonia: character and resources. v. 1 and atlas. pl., maps. N. Y., Scribner press, 1914.

Canada—Commission of conservation. Report of the fifth annual meeting held at Ottawa Jan. 20-21, 1914. 287 p. pl. Toronto, 1914.

Botany

Hole, R. S. Development of the culms of grasses. 13 p. Calcutta, 1914. (India—Forest dept. Forest bulletin no. 25.)

Landscape gardening

Miller, Wilhelm. Practical help on landscape gardening. il. Urbana, Ill., 1914. (Illinois—Agricultural experiment station. Circular 176.)

Hydrography

Horton, A. H. Water resources of Illinois. 400 p. pl., map, diagr. Springfield, Ill. Rivers and lakes commission, 1914.

Maine—State water storage commission. Fourth annual report, 1913. 323 p. Waterville, N. Y., 1914.

Commerce

Norway—Statistiska centralbyraa. Norges handel, 1912. 337 p. Kristiania, 1913. (Norges officielle statistik, v. 208.)

Periodical Articles

Miscellaneous articles

American city, Oct., 1914.—Town forests; a European idea by which America might profit, by H. A. Reynolds, p. 310-14.

Bulletin of the Torrey botanical club, Nov., 1914.—A superficial study of the pine-barren vegetation of Mississippi, by Roland M. Harper, p. 551-67; The production of paper from bamboo, p. 653-4.

Garden magazine, Oct., 1914.—Starting right with fall set trees and shrubs, by F. F. Rockwell, p. 81-3.

Gardeners' chronicle, Nov. 7, 1914.—*Curpeusssus torulosa*, by A. Bruce Jackson, p. 305.

Gardeners' chronicle, Nov. 14, 1914.—Dwarf conifers for the rock garden, by J. Clark, p. 320; The ringing of trees, by L. A. Boodle, p. 320-1.

Life and health, Sept., 1914.—Forestry for health seekers, by Hal Ross, p. 401-3.

National wool grower, Nov., 1914.—The forests and their users, by L. F. Kneipp, p. 16-20.

Petermanns mitteilungen, Sept., 1914.—Die verbreitung des waldes in Europa, by J. Riedel, p. 128-31.

Reclamation record, Dec., 1914.—Tree planting: Boise and Minidoka projects, p. 464-5.

Scientific American, Nov. 14, 1914.—Ocean-going log rafts, by J. F. Springer, p. 401; Forest fire fighting; construction of a 115-foot watch-tower with limited equipment, p. 405.

Scientific American supplement, Oct. 17, 1914.—Climatic influences of forests, by L. A. Fosbery, p. 246-7.

Scientific American supplement, Oct. 31, 1914.—Nodon electrical process of wood preservation, p. 286.

Southern good roads, Nov., 1914.—The Appalachian park movement as related to roads, by George N. Powell, p. 15-16.

United States—Dept. of agriculture. Journal of agricultural research, Nov., 1914.—Natural revegetation of range lands based upon growth requirements and life history of the vegetation, by Arthur W. Sampson, p. 93-147.

Trade journals and consular reports

American lumberman, Nov. 14, 1914.—The mangroves and their uses, p. 52.

American lumberman, Nov. 21, 1914.—What is the matter with the lumber industry, by H. S. Graves, p. 35.

American lumberman, Nov. 28, 1914.—Forest fires in the northwest, p. 24; Present and prospective trade in Chile, by Harold Buxton, p. 26; Sanitary portable logging camp in Washington, p. 36; Trees asso-

ciated with many historic events, by Eugene Parsons, p. 48-9.

American lumberman, Dec. 12, 1914.—Fine work of Forest service; record made in fighting forest fires, p. 38-9.

Barrel and box, Nov., 1914.—The several gums as box material; red gum, p. 37; Argentine's forest resources, by William Dawson, p. 44.

Canada lumberman, Dec. 1, 1914.—Growth of the lumber industry in B. C., by R. H. Alexander, p. 34-5.

Engineering magazine, Oct., 1914.—Durability of creosoted piling, by N. A. Bowers, p. 115-17.

Engineering magazine, Nov., 1914.—Railway tie-treating plant, p. 255-8.

Engineering news, Sept. 24, 1914.—Tie treating plant, Louisville and Nashville R. R., p. 622-6; Stump pulling machine for clearing land, p. 642-3; The creosote oil situation and the treatment of crossies, by S. R. Church, p. 658-9.

Engineering news, Oct. 29, 1914.—Effect of creosoting on strength of Oregon fir piling, by H. B. Macfarland, p. 863; A new type of creosoting plant, p. 877.

Engineering record, Oct. 3, 1914.—Applicability of yellow pine grading rules to other timbers, by J. A. Newlin, p. 387.

Gulf Coast lumberman, Nov. 15, 1914.—Forestry laws of Texas, p. 34.

Hardwood record, Nov. 25, 1914.—The greenheart industry, by C. D. Mell, p. 23-6; Shipbuilding and lumber, p. 28; Lead pencils and penholders, p. 32.

Hardwood record, Dec. 10, 1914.—The disappearing chestnut, p. 23-4; Some new kiln-drying thoughts, by Henry Hunter, p. 31; Aggressive and cowardly trees, p. 33; Turkish boxwood, p. 42.

Journal of electricity, power and gas, Nov. 7, 1914.—The purposes of national forests and their protection, by Charles H. Flory, p. 437-9.

Journal of electricity, power and gas, Nov. 21, 1914.—Producer gas from wood, p. 472.

Journal of industrial and engineering chemistry, Sept., 1914.—Chemistry of pine oil, by M. Toch, p. 720-3; Oils of the coniferae, by A. W. Schorger, p. 723-7.

Lumber trade journal, Nov. 15, 1914.—Philippine forestry director compiles descriptive list of commercial hardwoods, p. 35-6.

Lumber world review, Nov. 25, 1914.—What does it cost to manufacture your lumber, by R. B. Goodman, p. 23-5; Random remarks about wood preservatives, E. A. Sterling, p. 28-30.

Lumber world review, Dec. 10, 1914.—Scientific experiments in painting cypress, by Hermann von Schrenk, p. 25-6; National lumber manufacturers' association October report of production and movement of lumber, p. 29.

Mississippi Valley lumberman, Nov. 13, 1914.—Fire prevention through creation of public sentiment, by E. T. Allen, p. 42.

Paper, Nov. 18, 1914.—Chemical pulp for sausage casing, by W. P. Cohoe, and others. p. 20-21; Lumbermen and papermakers

- in session; 9th annual convention of the Empire state forest products association, Nov. 12, 1914, p. 24-6.
- Paper, Dec. 9, 1914.—Forest conservation and power problems, by E. N. Smith, p. 15-16.
- Pioneer western lumberman, Nov. 15, 1914.—The people, the forests and the lumber industry, by H. S. Graves, p. 9; Taxation, by E. T. Allen, p. 11; Steam distillation of needles, twigs and cones of western conifers, by George M. Hunt, p. 19-22; Growth of Douglas fir, p. 32.
- Pioneer western lumberman, Dec. 1, 1914.—The silo, by H. L. Fisher, p. 19.
- Pulp and paper magazine, Nov. 1, 1914.—Norwegian wood pulp, cellulose and paper industry, by N. W. Rogstad, p. 620-7; Reinforced concrete log chute and dam, Quebec, by Frederick Davy, p. 628-30.
- St. Louis lumberman, Dec. 1, 1914.—The forest resources of Chile, by Frank G. Carpenter, p. 31; Sugi cypress in bar fixtures, p. 76-7.
- Timber trade journal, Nov. 7, 1914.—The Trafalgar pine, by A. D. Webster, p. 686.
- Timber trade journal, Nov. 14, 1914.—The collection of forest seeds, p. 724.
- Timberman, Oct., 1914.—Standardizing yellow pine, by O. T. Swan, p. 23-4; Ring rule applied to fir, by J. B. Knapp, p. 24; Hardwoods of Honduras, by Clyde R. Dillabaugh, p. 33; Logging on island of Formosa, by F. W. Chiswell, p. 34-5; Some problems connected with national forests, by H. S. Graves, p. 39; Lumber cut of the United States, 1911, 1912 and 1913, p. 58.
- Timberman, Nov., 1914.—Compilation of specific data on lumber consumption for various uses, by H. S. Graves, p. 26-7; Inland empire timber, by A. W. Cooper, p. 35-6; The topographic map, by Newell L. Wright, p. 41-2; Training for the lumber business, p. 47-8; Lumbering in the Philippine Islands, by L. Murray Lamm, p. 48A; Review northwest fires, p. 48C-D.
- United States daily consular report, Nov. 24, 1914.—Lumber markets of the territory of Hawaii, by Franklin H. Smith, p. 881-90.
- United States daily consular report, Dec. 15, 1914.—The Greek timber market, by Alexander W. Weddell, p. 1168.
- West Coast lumberman, Nov. 15, 1914.—Two hundred ninety-two billion feet of timber in the national forests of Alaska, Washington and Oregon, p. 25; Closer utilization of lumber in silo building worked out by Tacoma man, p. 29; Utilization of wood waste, p. 29.
- West Coast lumberman, Dec. 1, 1914.—Worth of Seattle's new wood block paving quickly acknowledged, p. 24; Forest products laboratory researches affecting west coast woods, by Howard F. Weiss, p. 36, 39.

Forest journals

- Bulletin of the New York state forestry association, Oct., 1914.—State forest administration with particular reference to the state of New York, by James W. Toumey, p. 5-10; A discussion of Art. 7, Sec. 7, of the state constitution, by George N. Ostrander, p. 11-14; What is a timber sale like, national forest cuttings, by A. B. Recknagel, p. 15-16; The forestry provisions of the New York state constitution, by Samuel H. Ordway, p. 18-20; The Massachusetts forestry association, its work and policy, by Harris A. Reynolds, p. 21-6; Why we have made progress in New Hampshire, by Philip W. Ayres, p. 27; A reply to certain statements relative to the state forest preserve, by F. A. Gaylord, p. 31-9; Constitutional amendment affecting the Adirondacks, by Kenneth W. Goldthwaite, p. 40-1.
- Canadian forestry journal, Dec., 1914.—Douglas, the man and the tree; romantic life of the man after whom the Douglas fir was named, p. 118-19; Animals in Algonquin park, p. 119-20.
- Hawaiian forester and agriculturist, Oct., 1914.—Forest reserve matters, by Ralph S. Hosmer, p. 300-3.
- Indian forest records, 1914.—Oecology of sal, by R. S. Hole, p. 1-40.
- North woods, Nov., 1914.—A time for rejoicing and more work; the state forests amendment to the constitution passed, p. 3-4, 7-12; The forest school at Itasca, p. 19-20; French forests in the war zone, by Samuel T. Dana, p. 22-5.
- Zeitschrift für forst- und jagdwesen, Aug., 1914.—Jahrring und licht, by Oelkers, p. 455-72; Untersuchungen in mischbeständen, by A. Schwappach, p. 472-91.
- Zeitschrift für forst- und jagdwesen, Sept., 1914.—Zur umtriebsbestimmung der wälder, by Hans Hönliger, p. 538-49.



FORESTERS ATTENTION

AMERICAN FORESTRY will print free of charge in this column advertisements of foresters wanting positions, or of persons having employment to offer foresters

WANTED—FORESTERS—A few excellent positions open for skilled foresters or experts in shade tree work. Some of these will require all of a man's time and others can be filled in connection with his regular work. The compensation is liberal. Please state references and experience. Address P. S. R., care American Forestry Association.

WANTED—Position wanted by graduate forester. Have had one season's experience with the Government, one with a lumber company and some in city forestry. Have passed the Civil Service examination for forest assistant. Address "G. D. C.," Care AMERICAN FORESTRY.

YOUNG MAN—Graduate Surveyor with experience in that line and also in bookkeeping, desires position with lumber operator. Have had U. S. Forest Service experience and scaled for large operator in the North. Address "2," Care AMERICAN FORESTRY.

WANTED—By young man intending to study forestry, position with lumber company, surveying party, or other position by which he can gain practical knowledge. Address L. L., Care AMERICAN FORESTRY.

YOUNG MAN, 27 years old, unmarried, university training, business experience and three years of practical experience in surveying and construction, including preliminary surveys, estimates, railroad and highway location surveys and construction, topographic surveys, mapping, etc. Capable of taking charge of party, desires position with forester or lumber firm. Best references from former employers. Address "T. B. C.," Care AMERICAN FORESTRY.

FORESTER, with seven years' practical experience, desires a position as Forester. Have had considerable experience in reforestation and management, also fire protection. Address "T. F. H.," Care AMERICAN FORESTRY.

FOREST ENGINEER—Best of American and European training. Five years of practical work along lines of organization, administration, protection, cruising and appraising. Would like position with some large timber holding company, railroad, or municipal watershed. Best of references. Address "CRUISER," Care AMERICAN FORESTRY.

A forest school graduate with experience in U. S. Forest Service and with lumber company, also possessing thorough business training, will consider offer of good forestry position. Address M., Care AMERICAN FORESTRY.

FORESTER with 15 years experience Estimating, Surveying, Mapping, and in the care of private holdings desires position. Perfectly reliable in every way, and with executive ability. Address "A," care AMERICAN FORESTRY.

WANTED—By Graduate Forester, position in forestry work in South, or Tropics. Slight knowledge of Spanish and German. Scientific or experimental work preferred. Address, "F. W. H.," Care of AMERICAN FORESTRY.

YOUNG MAN, expert in all branches of shade tree work and with forestry training, desires position as forester, arboriculturist or tree surgeon. References furnished. Address C. S., care AMERICAN FORESTRY.

FORESTER of technical training, six years' teaching and practical experience in different parts of the United States, wishes to better position. Best references from university and employers, and others. Address G. O. T., Care AMERICAN FORESTRY.

WESTERN ESTATE MANAGER—Graduate agriculturist and forester, raised on Western farm, two years' experience at lumbering and for past six years with the U. S. Forest Service, engaged in timber estimating, appraisal and forest management in Washington, Idaho and Montana, desires private work. Especially equipped to advise concerning or to manage timberlands or combined timber and farm estate. References furnished. Address R. I. F., Care AMERICAN FORESTRY.

SURVEYOR—Young man 21 having three years experience as Transitman, Rodman, and Chainman with a City Surveyor desires a like position in Forestry. Has ambition to become a Forestry Expert. A No. 1 references, reliable and trustworthy. Particulars on request. Address "D. H. F.," care AMERICAN FORESTRY.

SURVEYOR—For large tracts of land, roads and railroads; furnishes instrument; capable of taking charge of party; would like position in South that will last all winter. Address "T. B. W.," care AMERICAN FORESTRY.

GRADUATE FORESTER—Practical experience in cruising, mapping and scaling. Eager to go anywhere. References furnished. Address R. L., care of AMERICAN FORESTRY.

WANTED—By Forester, a position with lumber or paper company. Experience in looking after camps and forestry work. Address W., Care AMERICAN FORESTRY.

PRACTICAL FORESTER wants situation on private estate. Has practical experience of sowing, laying, planting out, pruning, thinning, firebelts, ditching, rotation planting, mixed planting and thorough knowledge of fencing and tree felling. Has had seven years experience on best managed forestry area in Scotland. Address, "Raith," Care AMERICAN FORESTRY.

PRACTICAL FORESTER wants position with city Park Commission. Understands fully nursery work, planting, trimming and tree surgery. Best references and practical experience. Address "L. M. E.," Care AMERICAN FORESTRY.

WANTED—A position as an inspector of ties, timbers and lumber, by a forest school graduate with experience in inspecting ties, timbers and lumber. Can furnish best of references. Address Inspector, Care AMERICAN FORESTRY.

Graduate of Forestry School, having studied forestry and lumbering operations in this country and Germany, with experience in the U. S. Forest Service, and also in state and private nursery work, would like position with forest engineering firm or lumber company. Best of references. Address XY, Care of AMERICAN FORESTRY.

ENERGETIC Post Graduate Forester desires position as an assistant in park or city forestry work. Subordinate duties preferred. Best of references. Address M. M. J., Care of AMERICAN FORESTRY.

FOREST ENGINEER with Forest Service training in Colorado, Wyoming, private work in California, and six years' experience in the lumber industry on the Pacific Coast, would like field work in any part of the United States. Estimating of timber lands and topographic surveying a specialty. Four years' technical training. Address, "D.," Care AMERICAN FORESTRY.

True Time All the Time

The owner of a Hamilton Watch soon learns to rely on it implicitly, for a Hamilton tells the true time all the time. In railroad operation, where men *must* have accuracy, the Hamilton is chosen above all others.

Hamilton Watch

"The Railroad Timekeeper of America"

There are twenty-five models of the Hamilton Watch. Every one has Hamilton quality and Hamilton accuracy. They range in price from \$12.25 for movement only (in Canada \$12.50) up to the superb Hamilton masterpiece at \$150.00. Your jeweler can show you the Hamilton you want, either in a cased watch or in a movement only, to be fitted to any style case you select, or to your own watch case if you prefer.

Write for the Hamilton Watch Book, "The Timekeeper"

It pictures and describes the various Hamilton models and gives interesting watch information

HAMILTON WATCH COMPANY

Dept. 00

Lancaster, Pennsylvania



Engineer D. R. Wood, of "The Twentieth Century Limited," New York Central Lines, has carried a Hamilton Watch with perfect satisfaction for years.

YOUNG MAN—Four years' practical experience in reforestation, nursery work, improvement thinning, fire protection and tree surgery, wishes position on private estate or for state or municipal work. Experienced handling men. Best of references. Address R. A., care AMERICAN FORESTRY.

FOREST ENGINEER of ability and experience wishes the management of large timbered tract. Thoroughly experienced in Lumbering and Practical private Forestry, and capable of taking entire charge of game preserve, private estate, or other forested lands. Well recommended. Address "Woods Supt.," Care of AMERICAN FORESTRY, Washington, D. C.

WANTED.—A Position as Superintendent on Private Estate. Expert experience with 22 years' backing, on Forestry, Agriculture, Horticulture, Landscape Engineering. Graduate Civil Engineer, Practical Experience in all mentioned work. Will take full responsibility of any estate or construction of an estate and guarantee my work. Fair salary expected. Please state salary you are willing to offer with reply. I will not accept a position in "part." I will not accept position under three months' notice to my present Employer. Address "V. C. P.," Care AMERICAN FORESTRY.

YOUNG MAN, 29 years old, wishes position with forest owner or lumber mill concern, to take care of all waste timber. Have 12 years' experience in distilling and extracting by-products from forest wastes, etc. Address 1, Care AMERICAN FORESTRY.

FORESTER wants position with Consulting Forestry firm, or with lumber company or private estate. Training from Michigan Agricultural College and Yale Forest School; four years' experience with U. S. Forest Service and two winters with lumber companies. Acquainted thoroughly with Montana, Idaho and California timber as cruiser. References on request. Address E., Care AMERICAN FORESTRY.

WANTED—Position by a clean cut young man, with A-1 references, with a Forestry Expert or a surveying party, or any other business where a knowledge of the subject of forestry can be had. Address G. W. H., care AMERICAN FORESTRY.

WANTED—A job as fire ranger or guard by a strong, healthy young man twenty-one years of age. Address "3" care AMERICAN FORESTRY.

POSITION WANTED—Am graduate of Biltmore Forest School, with good record in survey, estimate and estate management and want position where I will have a chance to learn more. Have done practical work outside of school and am considered good at timber. Willing to go anywhere and be generally useful. Hard worker, don't mind long hours. Age, twenty-six. Give me interview or let me send references. Address J. U., care AMERICAN FORESTRY.

Hardwood, White and Yellow Pine Timber

Lands for sale by SAVAGE BROTHERS, Cornelia, Ga.

5-4

FOR SALE—HARDWOOD TIMBER

On five thousand acres of mountain land immediately on railroad. Principally Oak, Chestnut, Hemlock, and Poplar. Pay for as cut and sold. Address NORTH CAROLINA TALC AND MINING COMPANY, Hewitts, N. C.

10-1

BILTMORE TEXT BOOKS

The text books of the Biltmore Forest School, written by Dr. C. A. Schenck, continue for sale at Biltmore. For particulars address BILTMORE FOREST BOOKS, Biltmore, N. C.

tf

PATENTS

that properly protect

Thirty years of experience enable me to assure clients an intelligent service in securing patents that afford fullest protection. Correspondence invited.

No attorney's fee until patent is allowed

Write for free copy of "Inventor's Guide" which gives valuable information about patent protection.

FRANKLIN H. HOUGH

Loan and Trust Building

WASHINGTON, D. C.

FO 1 RE 2 ST 3 RY 4

The FOREST

is three-fourths of

FORESTRY

Your opportunities are as unlimited as our forests if you study at

WYMAN'S SCHOOL OF THE WOODS

Incorporated

Munising, Michigan

Forestry and Lumbering Problems

¶ Reports of expert investigative committees on problems vitally affecting all who are in any way interested in forestry and lumber.

¶ A most valuable addition to the literature on these subjects.

400 pages, bound in green

Price \$1.15, postpaid

American Forestry Association
Washington, D. C.

Comfort Sleeping Pocket

With Air Mattress Inside

Recommended by the members of Forest Service, Hunters, Cowboys, Campers, Canoeists and Invalids. The lightest, most compact, sanitary Sleeping Pocket made. Not a bag, but an outdoor bed.

Send for Catalog and price list. Mailed Free

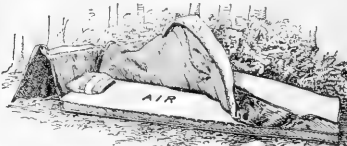

Cold, Wind, Damp and Water Proof. Guaranteed or Money Refunded

METROPOLITAN AIR GOODS CO., Haven St., Reading, Mass.

The R. P. R. Co. Tree Paint

A Scientific Preparation—a weather-proof anti-septic coating for protecting and preserving all tree surfaces exposed by trimming, injury, etc. Indispensable to Orchardists, City Foresters and Owners of shade trees.

Unlike common paint, coal tar, etc., it will not harden or blister, but will keep the growing tissues soft and insure speedy healing of the wound. It will absolutely prevent the entry of decay.

It is endorsed by eminent fruit growers and city foresters. It has a wide variety of uses. Write for further information as to its uses and the care of your trees.

If local dealer does not carry R. P. R. Tree Paint we will ship prepaid by the gallon, half gallon or quart on order.

R. P. R. CO., 104 South Warren St., Syracuse, N. Y.

ORCHIDS

ORCHIDS

We are specialists in Orchids, we collect, import, grow, sell and export this class of plants exclusively.

Our illustrated and descriptive catalogue of Orchids may be had on application. Also special lists of freshly imported unestablished Orchids.

LAGER & HURRELL

SUMMIT, N. J.

Orchid Growers and Importers

Use Press Clippings

IT will more than pay you to secure our extensive service, covering all subjects, such as Polo, Golf, Tennis, trade and personal, and receive the benefit of the best and most systematic reading of all papers and periodicals, here and abroad, at minimum cost. Why miss taking advantage for obtaining the best possible service in your line?

Our service is taken by all progressive business men, publishers, authors, collectors, etc., and is the card index for securing what you want and need, as every article of interest is at your daily command.

Write for terms; or send your order for 100 clippings at \$5, or 1,000 clippings at \$35. Special rates quoted on Large Orders.

The Manhattan Press Clipping Bureau

ARTHUR CASSOT, Proprietor

Established 1888

Cambridge Building, 334 Fifth Avenue, Cor. 33d St., NEW YORK

Send for Our Desk Calendar

Some Openings For Wood Workers

IN Northern Florida there is a good supply of timber which can be assembled advantageously at points on the Georgia Southern & Florida Railway; other conditions for profitable manufacturing in many lines. For a number of articles there is a market in the immediate section, while transportation facilities favor shipments to a wide range of markets.

Small Wood Working Plants

and will actively co-operate with manufacturers who are looking for a new and promising field.

The Southeastern States have the best opportunities and advantages for all factories using timber.

The Land and Industrial Department will aid interested parties in finding just the location desired.

For information refer to File No. 47,359

**M. V. RICHARDS, Land and Industrial Agent
Southern Railway, Room 349, Washington, D. C.**

Harvard University

SCHOOL OF FORESTRY

OFFERS specialized graduate training leading to the degree of Master of Forestry in the following fields:—Silviculture and Management, Wood Technology, Forest Entomology, Dendrology, and (in cooperation with the Graduate School of Business Administration) the Lumber Business

For further particulars address

**RICHARD T. FISHER, Chairman
Cambridge, Massachusetts**

History of Forestry

*By B. E. FERNOW
Dean of Forestry
University of Toronto*

A book every student of Forestry should buy and without which no forest library is complete.

506 pages, 8vo
Price, \$2.50, postpaid

Address
**American Forestry Association
Washington, D. C.**

FORESTRY DEPARTMENT

University of Maine

ORONO, MAINE

*J. M. BRISCOE, M. F., Professor of Forestry
C. W. EATON, M. F., Instructor in Forestry*

FOUR year undergraduate course leading to the degree of Bachelor of Science in Forestry.

Summer camp and extension courses entirely distinct from the regular course.

*For catalog or further
information,
address*

**ROBERT J. ALEY, President
ORONO, MAINE**

Yale University Forest School

NEW HAVEN, CONN., U. S. A.

YALE University Forest School is a graduate department of Yale University. It is the oldest existing forest school in the United States and exceeds any other in the number of its alumni. A general two-year course leading to the degree of Master of Forestry is offered to graduates of universities, colleges and scientific institutions of high standing and, under exceptional conditions, to men who have had three years of collegiate training including certain prescribed subjects. Men who are not candidates for the degree may enter the School as special students, for work in any of the subjects offered in the regular course, by submitting evidence that will warrant their taking the work to their own advantage and that of the School. Those who have completed a general course in forestry are admitted for research and advanced work in Dendrology, Silviculture, Forest Management, Forest Technology, and Lumbering. The regular two-year course begins the first week in July at the School camp near Milford, Pennsylvania.

For further information address

JAMES W. TOUMEY, Director
NEW HAVEN, CONN.

A technically trained

Municipal Arborist or City Forester

will soon be needed in every city in the country.

There is a growing demand for technically trained men in Arboriculture and Landscape Engineering to act as City Foresters and Municipal Landscape Engineers.

The New York State College of Forestry

offers a four year course to fit men for this new and attractive line of work.

The New York State College of Forestry
Syracuse University
Syracuse New York

In the National Forest Region

Colorado School of Forestry

A DEPARTMENT OF
COLORADO COLLEGE

THE course in theoretical and applied forestry leading to the degree of Forest Engineer covers a period of two years and is open to students who have completed two years of college work, including a sufficient amount of Botany, Geology and Surveying.

Graduate students may enter as candidates for the degree of Master of Forestry.

Fall and Spring Terms in the Manitou Forest, the College Reserve, 6,000 acres of pine and spruce timberland on the borders of the Pike National Forest. Winter Term at Colorado Springs.

For particulars address

Colorado School of Forestry
Colorado Springs, Colo.

DEPARTMENT OF FORESTRY

The Pennsylvania State College

A PROFESSIONAL course in Forestry, covering four years of college work, leading to the degree of Bachelor of Science in Forestry.

Thorough and practical training for government, state, municipal and private forestry.

Four months are spent in camp in the woods in forest work.

Graduates who wish to specialize along particular lines are admitted to the "graduate forest schools" as candidates for the degree of Master of Forestry on the successful completion of one year's work.

For further information address,

Department of Forestry
PENNSYLVANIA STATE COLLEGE
State College, Pa.

Pine Chances

in the
Inland Empire

VIRGIN white pine timber well blocked for operation is becoming scarce. The following are some of the tracts of National Forest stumpage in the Inland Empire which it will pay you to investigate. No timber investments or bonds are required. The stumpage is paid for in small installments as it is cut:

Cabinet National Forest, Montana

Martin Creek Area—5,650 Acres

White pine.....	30,000,000 bd. ft.
Larch and Douglas fir..	13,000,000 bd. ft.
White fir.....	14,000,000 bd. ft.
Spruce.....	10,000,000 bd. ft.
Hemlock.....	20,000,000 bd. ft.
Miscel. dead white pine and spruce.....	2,000,000 bd. ft.
Total estimated to be cut.....	89,000,000 bd. ft.

This chance contains white pine of very exceptional quality.

Clearwater National Forest, Idaho

Lolo Creek Area 36,000 Acres
(In Two Chances)

White pine.....	164,000,000 bd. ft.
Larch and Douglas fir.	196,000,000 bd. ft.
Yellow pine.....	27,000,000 bd. ft.
Lodgepole.....	3,000,000 bd. ft.
Spruce.....	16,000,000 bd. ft.
Cedar.....	150,000,000 bd. ft.
White fir.....	46,000,000 bd. ft.
Total estimated to be cut.....	602,000,000 bd. ft.

Pend Oreille National Forest, Idaho

Lightning Creek Area 12,000 Acres

White pine.....	47,700,000 bd. ft.
Spruce.....	6,300,000 bd. ft.
Douglas fir, larch, white fir.....	13,500,000 bd. ft.
Hemlock, cedar and miscellaneous.....	22,500,000 bd. ft.
Total estimated to be cut.....	90,000,000 bd. ft.

Detailed information about these and other National Forest logging chances in the Inland Empire will be furnished gladly upon request by the District Forester, Missoula, Montana.

TREE SEEDS

We have never looked upon Tree Seeds as a side issue. Instead, we have devoted a large portion of our time to them.

The assortment we carry more than doubles that of any house—American or Foreign. We stock even the rarest species.

Send your list to us for prices.

J. M. THORBURN & CO.

Established 1802

53 Barclay St. New York City

Forest Fire Warnings

Several kinds for posting on private estates or by fire protective associations

Furnished at cost

AMERICAN FORESTRY ASSOCIATION
Washington, D. C.

American Tools for American Foresters

ECKBO SEED PLANTER

¶ Hire a Hottentot from the jungles of Africa, and he can make the seed grow with the "Eckbo Seed Planter"—and what's more he can't help it.

¶ A *locoed* man can cover four acres per day, and save the initial cost of the implement in a week; and a *maniac* can't break it.

¶ It is used by the "United States Forest Service." Write for particulars to

N. B. ECKBO

In care of BROWNING BROTHERS' COMPANY
OGDEN, UTAH

BOOKS ON FORESTRY

AMERICAN FORESTRY will publish each month, for the benefit of those who wish books on forestry, a list of titles, authors and prices of such books. These may be ordered through the American Forestry Association, Washington, D. C. Prices are by mail or express prepaid.* :-: :-: :-: :-:

THE TRAINING OF A FORESTER—Gifford Pinchot.....	\$ 1.12
LUMBER AND ITS USES—R. S. Kellogg.....	1.15
THE CARE OF TREES IN LAWN, STREET AND PARK—B. E. Fernow.....	2.17
NORTH AMERICAN TREES—N. L. Britton.....	7.30
KEY TO THE TREES—Collins and Preston.....	1.50
THE FARM WOODLOT—E. G. Cheyney and J. P. Wentling.....	1.70
AMERICAN FOREST TREES—Henry H. Gibson.....	6.00
IDENTIFICATION OF THE ECONOMIC WOODS OF THE UNITED STATES— Samuel J. Record.....	1.25
PLANE SURVEYING—John C. Tracy.....	3.00
FOREST MENSURATION—Henry Solon Graves.....	4.00
THE ECONOMICS OF FORESTRY—B. E. Fernow.....	1.61
FIRST BOOK OF FORESTRY—Filibert Roth.....	1.10
PRACTICAL FORESTRY—A. S. Fuller.....	1.50
PRINCIPLES OF AMERICAN FORESTRY—Samuel B. Green.....	1.50
SEASIDE PLANTING OF TREES AND SHRUBS—Alfred Gaut.....	1.75
FAMILIAR TREES—G. S. Boulger.....	1.50
MANUAL OF THE TREES OF NORTH AMERICA (exclusive of Mexico)—Charles Sprague Sargent.....	6.00
AMERICAN WOODS—Romeyn B. Hough.....	5.00
HANDBOOK OF THE TREES OF THE NORTHERN U. S. AND CANADA, EAST OF THE ROCKY MOUNTAINS—Romeyn B. Hough.....	6.00
GETTING ACQUAINTED WITH THE TREES—J. Horace McFarland.....	1.75
PRINCIPAL SPECIES OF WOOD: THEIR CHARACTERISTIC PROPERTIES— Charles Henry Snow.....	3.50
NORTH AMERICAN FORESTS AND FORESTRY—E. R. Bruncken.....	2.00
HANDBOOK OF TIMBER PRESERVATION—Samuel M. Rowe.....	4.00
TREES OF NEW ENGLAND—L. L. Dame and Henry Brooks.....	1.50
TREES AND SHRUBS—C. S. Sargent.....	5.00
TREES, SHRUBS AND VINES OF THE NORTHEASTERN UNITED STATES— H. E. Parkhurst.....	1.50
TREES—H. Marshall Ward.....	1.50
OUR NATIONAL PARKS—John Muir.....	1.91
THE LONGLEAF PINE IN VIRGIN FOREST—G. Frederick Schwarz.....	1.25
LOGGING—Ralph C. Bryant.....	3.50
THE IMPORTANT TIMBER TREES OF THE UNITED STATES—S. B. Elliott..	2.00
FORESTRY IN NEW ENGLAND—Ralph C. Hawley and Austin F. Hawes.....	3.50
THE PRINCIPLES OF HANDLING WOODLANDS—Henry Solon Graves.....	1.50
SHADE TREES IN TOWNS AND CITIES—William Solotaroff.....	3.00
THE TREE GUIDE—By Julia Ellen Rogers.....	1.00
FOREST PHYSIOGRAPHY—By Isaiah Bowman.....	5.00
MANUAL FOR NORTHERN WOODSMEN—Austin Cary.....	2.12
FARM FORESTRY—Alfred Akerman.....	.57
THE THEORY AND PRACTICE OF WORKING PLANS (in forest organization) A. B. Recknagel.....	2.10
ELEMENTS OF FORESTRY—F. F. Moon and N. C. Brown.....	2.20
MECHANICAL PROPERTIES OF WOOD—Samuel J. Record.....	1.75
STUDIES OF TREES—J. J. Levison.....	1.75
TREE PRUNING—A. Des Cars.....	.65

* This, of course, is not a complete list, but we shall be glad to add to it any books on forestry or related subjects upon request.—Editor.

385,000,000,000 Feet of Southern Yellow Pine

"THE WOOD OF A THOUSAND USES"

Enough lumber to put a fine house over every family in our country and build a garage and a couple of barns for each besides. **Surely, Enough.**

THINK OF

a beautifully-grained, mirror-surfaced, easily worked finishing product for your home, capable of taking any shading of finish or stain—

"SHORT LEAF SOUTHERN YELLOW PINE"

THINK OF

strength, toughness, durability for the structural framing (Yellow pine houses have stood for a century)—

"LONG LEAF SOUTHERN YELLOW PINE"

THINK OF

adaptability in general to all building and construction operations, in all climates. and ease of handling—

"Southern Yellow Pine is the Inevitable Answer"

INEXPENSIVE? YES

Source of raw supply being the nearest to the great central consuming districts, the process of our manufacture having been developed to the greatest degree of perfection in point of finish and economy, and a **plentiful supply**, make this **wonderful material** the most economical to use, where quality and beauty and strength are desired.

A card will bring other desired information and tell you how to get the particular yellow pine for your needs; write us

OUR 8 BIG PLANTS CUT 275,000,000 FEET ANNUALLY

Short Leaf and Long Leaf Product

MISSOURI LUMBER & LAND EXCHANGE CO.

Sales Office, 1111 Long Building, Kansas City, Mo.

J. B. WHITE, General Manager

J. H. BERKSHIRE, President

O. W. FISHER, Vice-President

The Old Time Landlooker

took a look and made a guess. If he underestimated by 3,000 feet to the acre, the buyer did not complain; if he was 3,000 to 4,000 feet short, the buyer grumbled but concluded it was not a matter of great amount. For

A thousand feet of timber today is worth more than an acre of timber brought during the days of the landlooker.

On an investment basis it now costs less to secure accurate information respecting the value of timber property than it did to get a landlooker's opinion during the acre days.

Quantity and value are not closely related, Quality and accessibility govern timber values. If you wish to learn all about the value of your timber, get a report from

James D. Lacey & Co.

Timber Land Factors

CHICAGO, ILL., 1750 McCormick Building
PORTLAND, ORE., 1313 Northwestern Bank Building
SEATTLE, WASH., 1009 White Building

American Forestry

FEBRUARY
1915

Volume 21
No. 2



Globe-Wernicke

Sectional Bookcases

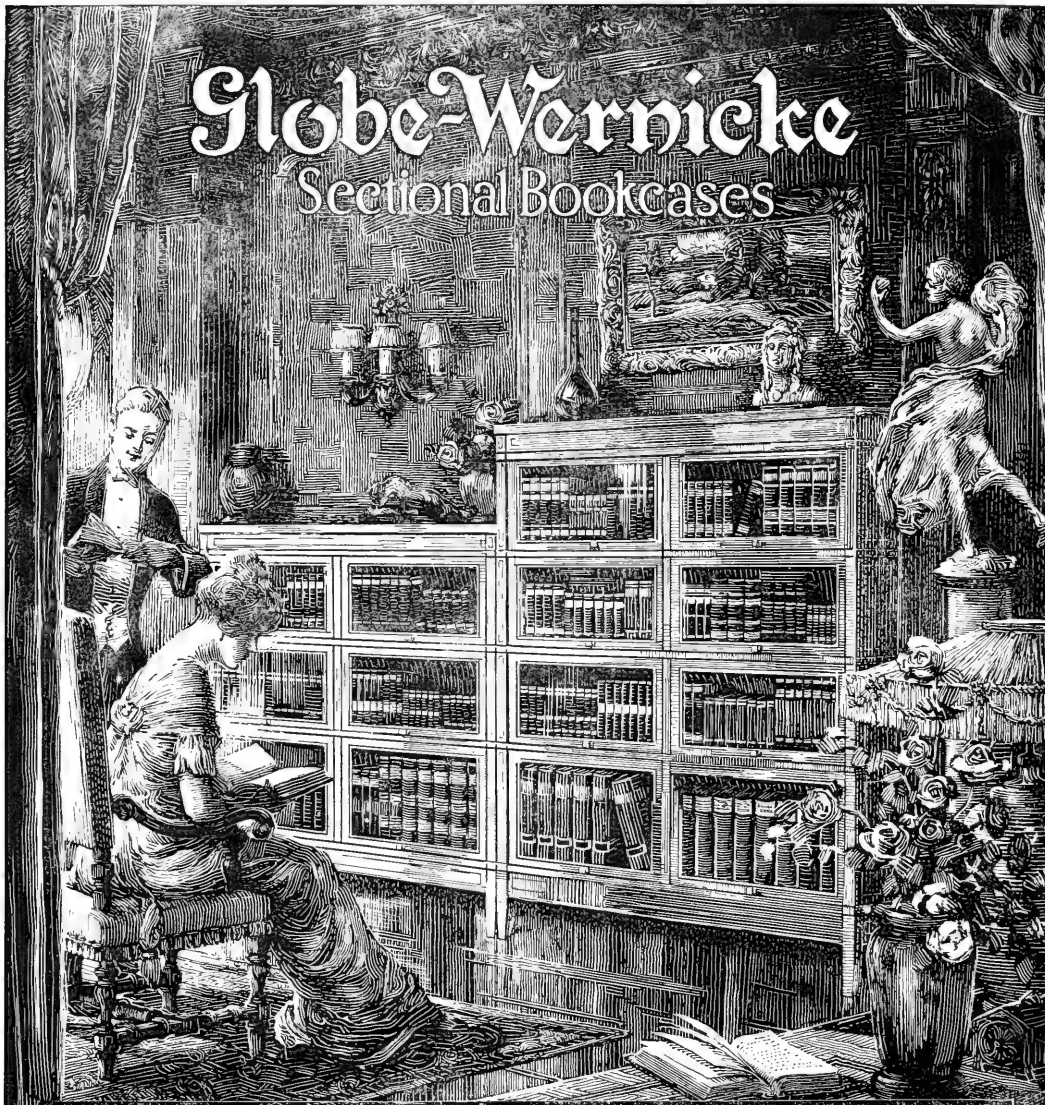

TROPIC damp and heat—the frigid rigors of northern lands—and the variable climate of the temperate zones cannot affect the stout construction of Globe-Wernicke Sectional Bookcases. Their durability is the lasting strength of fine cabinet-making and materials carefully seasoned to withstand the extremes of climate.

There's a Globe-Wernicke Bookcase in just the right finish and right size to match your color scheme and wall space. Then, as your library expands, more sections are always in stock. Built to grow and endure, they cost no more than the ordinary kind. *Write for Catalog No. 445.*

The Globe-Wernicke Co.

Cincinnati

Makers of Sectional Bookcases, Filing Equipment (Wood and Steel), Steel Safes, Stationers' Supplies.

On sale by 2000 Branch Stores and Agents everywhere. Globe-Wernicke pays the freight.



BRANCH STORES: New York. Chicago. Philadelphia. Boston. Cincinnati. Washington, D. C.



A. MAC KINNON

The New Agriculture

WRITE FOR THIS FREE BOOK

FOR 2,000 years most farmers have cultivated only 6 to 8 inches of soil. They have spent millions of dollars adding to these 6-inch farms plant foods, such as potash, phosphorous and lime, that already lay in the subsoil waiting to be made available.

VERTICAL FARMING

makes available tons per acre of new plant food, ensures abundant moisture, and largely increases crop yields.

Dr. G. E. Bailey, Geologist at the University of Southern California, has prepared a reading course of instruction in soils and vertical farming. We have printed it in a well illustrated book. It will be mailed

FREE ON REQUEST

to anyone owning a farm in the United States. Get this book about soils. Work your farm to its full capacity. Know your land. Learn its composition. Use the fertilizers nature is storing beneath your 6-inch farms. Send a postal request today for Vertical Farming Booklet 350-F. Be sure to state the acreage of the farm you own.

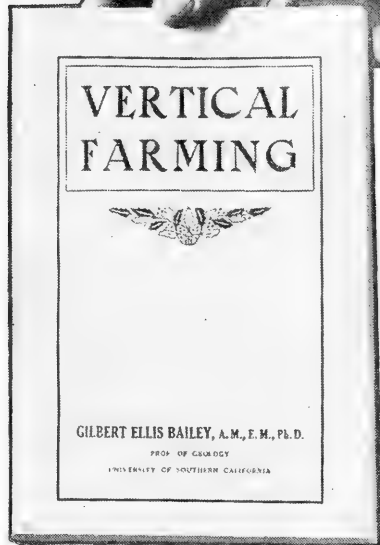

DU PONT POWDER COMPANY

Pioneer Powder Makers of America

Established 1802

Wilmington, Delaware

Plant Evergreens 3-25 Feet High and All Winter Planting Will Be Welcome

IF you need to screen unattractive surroundings, garage, stable, poultry house, laundry yard, or street.

IF you admire evergreens.

IF you need windbreaks to your house, garden, out door room or play ground.

IF you enjoy hunting big Cedars, Pines, Oaks, Maples, Dogwoods, Laurel, etc., and making your place look like an old place right away.

IF you have evergreens, deciduous trees or shrubs to move to other parts of your grounds or give away or sell.

The Proof

Hicks Nurseries employed 100 men last winter, except 14 days. Half were digging trees. Our winter sales for the past four years were \$16,000.00.

In January the ground freezes six inches, but is easily worked if previously mulched to keep out frost.

On the mainland the frost is deeper and more continuous, but it is easy to dig through with pick or cold chisel.

If it costs a few cents additional to plant we will bear that to keep our staff all winter.

IF you wish to prevent winter unemployment. We can provide apparatus and men to cooperate with your men or we can attend to the entire operations.

IF you wish to take advantage of present reduced prices. Carload shipments or less from the nursery of pines, spruce, cedar, 3-25 feet high.

I. HICKS & SON

Westbury, L. I.,

New York

TREE SEEDS

We have never looked upon Tree Seeds as a side issue. Instead, we have devoted a large portion of our time to them.

The assortment we carry more than doubles that of any house—American or Foreign. We stock even the rarest species.

Send your list to us for prices.

J. M. THORBURN & CO.

Established 1802

53 Barclay St.

New York City

Seeds for Forestry Purposes

WE offer a most complete list of both Deciduous and Evergreen Tree and Shrub seeds for forestry purposes.

Seeds that are of best germinating quality

Our catalogue contains a full list of the varieties we offer, which include the best and most rare species. Send for a copy, it will interest you.

THOMAS MEEHAN & SONS

Wholesale Nurserymen and Tree Seedmen
DRESHER, PENNA., U. S. A.

ORCHIDS

ORCHIDS

We are specialists in Orchids, we collect, import, grow, sell and export this class of plants exclusively.

Our illustrated and descriptive catalogue of Orchids may be had on application. Also special lists of freshly imported unestablished Orchids.

LAGER & HURRELL

SUMMIT, N. J.

Orchid Growers and Importers

Norway Spruce and White Pine

The two leading hardy varieties for Forest Planting

COMPARE OUR PROPOSITION **TO SELL ON PROMPT ORDERS**

OUR FINE DOMESTIC HARDY NORTHERN GROWN STOCK, UNTIL SURPLUS SOLD, AT THE FOLLOWING ROCK-BOTTOM PRICES FOR FIRST QUALITY PLANTS

These prices may be withdrawn and are subject to change as the stock is reduced

		1,000	10,000	100,000
NORWAY SPRUCE	4 year Transplants	\$6.50	\$55.00	} If interested by the 100,000 or more do not delay in communicating with us for we can make you THE proposition, BUT WRITE NOW
"	" 3 " Seedlings	3.50	28.50	
"	" 2 " Seedlings	3.00	21.00	
WHITE PINE	4 year Transplants	8.50	75.00	
"	" 3 " Seedlings	4.00	27.00	
"	" 2 " Seedlings	3.00	21.00	

Orders Accepted and Stock Reserved in strict rotation as received.

This rule will be observed without deviation.

If you have these two species in your list of Forestry Requirements for Spring 1915 you cannot afford to let this Dollar-Saving opportunity pass.

Scotch Pine, Black Locust, Red Oak, Ash, etc., etc., at special prices

FORESTRY STOCK HEADQUARTERS

Send us your full list of wants for quotation. We can serve you to best advantage

F. W. KELSEY NURSERY CO., 150 BROADWAY, NEW YORK



RANERE The True Everbearing RASPBERRY

Bears the first year, ripens in Northern New York June 10th, and continues to produce quantities of bright crimson, luscious berries every day all summer until frosts. Rich, sugary, with full raspberry flavor; firm texture, keep in good condition long after picking.

Oct. 24, 1914, growers shipping to Chicago were getting 75c. per quart.

Rugged constitution. Grows everywhere. Yield as high as \$800 per acre. A small patch is a sure source of income and supply of rich sugary berries from June till November.

Our 1915 Catalog and Planting Guide, profusely illustrated, includes Nut Culture, Fruits, Roses, Shrubs, Evergreens, etc., FREE. GLEN BROS., Inc., Glenwood Nursery, 1765 Main St., Rochester, N. Y.

The North-Eastern Forestry Co.
CHESHIRE, CONN.

Growers of Evergreen Seedlings and Transplants for Forest Planting

Catalogue sent on request

HILL'S SEEDLINGS and
Also Tree Seeds **TRANSPLANTS**
FOR REFORESTING

BEST for over a half century. All leading hardy sorts, grown in immense quantities. Prices lowest. Quality highest. Forest Planter's Guide, also price lists are free. Write today and mention this magazine.

THE D. HILL NURSERY CO.
Evergreen Specialists
Largest Growers in America
BOX 501 DUNDEE, ILL.

American Tools for American Foresters

ECKBO SEED PLANTER

¶ Hire a Hottentot from the jungles of Africa, and he can make the seed grow with the "Eckbo Seed Planter"—and what's more he can't help it.

¶ A locoed man can cover four acres per day, and save the initial cost of the implement in a week; and a maniac can't break it.

¶ It is used by the "United States Forest Service." Write for particulars to

N. B. ECKBO

In care of **BROWNING BROTHERS' COMPANY**
OGDEN, UTAH

ENGRAVINGS

made by

National Engraving Co.

506-508 Fourteenth St. N. W.
WASHINGTON, D. C.

Engravers to the Government

Pan American Union
Smithsonian Institution
Agricultural Department
U. S. Geological Survey
Patent Gazette
Experimental Stations and
State Institutions

HALF-TONES **LINE CUTS**
THREE-COLOR PROCESS PLATES
ELECTROTYPES

Printers Demand Our CUTS

Barrett's
Grade One
LIQUID
Creosote Oil

**Cuts your wood
preserving bills in half—**

Especially adapted for preserving tele-
phone poles, telegraph poles, cross arms,
railroad ties, fence posts, mine timbers,
underground sills, sleepers, bridge
timbers, planking, ice houses, wood
tanks, shingles, poultry houses, silos,
boat timbers or any exposed woodwork.

Booklet on request.

BARRETT MANUFACTURING CO.

New York	Chicago	Philadelphia
Boston	St. Louis	Cleveland
Cincinnati	Pittsburgh	Detroit
Birmingham	Minneapolis	Seattle
Kansas City	Salt Lake City	

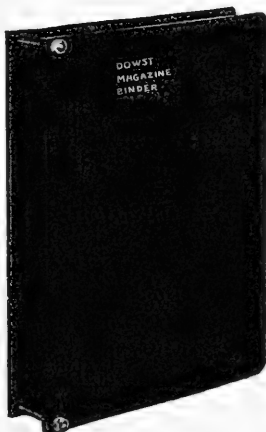

Binder Closed

Save Your American Forestry

For Future Reference

By special arrangement with the manufacturer, we have been able to secure the only practical magazine and periodical binder on the market.

Dowst Magazine Binder

which binds one issue, a dozen issues or more with a neat book appearance. This binder has no springs, catches, strings, clamps, laces or locks, and does not mutilate the periodical in the slightest manner.

PRICE
Postpaid
\$1.50

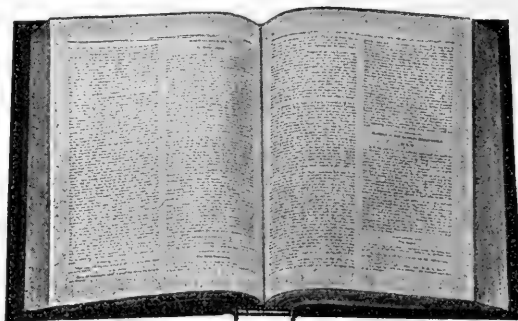

Binder Open

No mechanical labor necessary. Simple, practical, durable.

Complete with 13 Binding Rods, 10 Sectional Posts and name of Publication Stamped in Gold on Front Cover.

Send for Illustrated
Descriptive Pamphlet

AMERICAN FORESTRY ASSOCIATION, WASHINGTON, D. C.

American Forestry

The Magazine of the American Forestry Association

PERCIVAL SHELDON RIDSDALE, Editor

EDITORIAL ADVISORY BOARD

HERMAN H. CHAPMAN
ERNEST A. STERLING
S. T. DANA

FREDERICK S. UNDERHILL
JOHN E. RHODES
S. N. SPRING

February

CONTENTS

1915

COVER—Fire Lookout at Top of Pine Tree, Shasta National Forest, California.	
DESTROYING MT. MITCHELL—By Raymond Pullman.....	83
With eleven illustrations.	
THE MT. MITCHELL TRAIL—By H. W. Plummer and N. Buckner.....	94
With three illustrations.	
PLANTING TIME AND CARE OF TREES—By S. B. Detweiler.....	100
BOY SCOUTS AND FORESTS—By K. W. Woodward.....	103
With ten illustrations.	
THE JUNIPERO OAK—By Allen Henry Wright.....	110
With one illustration.	
FORESTS AND GAME PRESERVATION—By Ottomar H. Van Norden.....	111
With five illustrations.	
IMPROVING WHITE MOUNTAIN FORESTS—By Wm. L. Hall.....	117
With seven illustrations.	
FORESTRY AT THE EXPOSITIONS—By Allen Henry Wright.....	127
With one illustration.	
LARGEST ELM IN CONNECTICUT—By Norman deW. Betts.....	128
With two illustrations.	
CANADIAN LUMBER COMPETITION—By H. D. Langille.....	130
With six illustrations.	
MAINE FORESTRY ASSOCIATION.....	140
With three illustrations.	
NEW YORK STATE MEETING.....	141
NORTH CAROLINA MEETING.....	142
THIRTY-FOURTH ANNUAL MEETING.....	143
EDITORIAL.....	145
WITH THE FORESTERS.....	147
THE CANADIAN DEPARTMENT.....	148
FOREST NOTES.....	150
CURRENT LITERATURE.....	152

AMERICAN FORESTRY is published monthly by the American Forestry Association
Subscription price, three dollars per year; single copies, twenty-five cents.

Copyright 1915, by the American Forestry Association

TIMBER ESTIMATES, FOREST
SURVEYS and MAPS

D. E. LAUDERBURN

Forest Engineer

6030 Metropolitan Building, New York City

JAMES W. SEWALL

Timber Estimates

Topographic and Boundary Surveys, Plant-
ing, Logging Maps, Portable Mill Operations

Technical Training Thoroughness Experience
CENTRE STREET OLD TOWN, MAINE

READY NOVEMBER 1, 1914

A New Booklet on Estimating
Southern Timber

Southern White Cedar
Shortleaf and Longleaf Pine
Southern Appalachian Timber

Postpaid, 20 cents

HOWARD R. KRINBILL

Forest Engineer

NEWBERN, N. C.

Forestry Quarterly

*The technical forestry journal
of North America*

\$2.00 a Year

Address

AMERICAN FORESTRY ASSOCIATION

Washington, D. C.

TIMBER ESTIMATES

We make accurate cruises of standing
timber, topographical maps, and advise
as to forest management for—

TIMBER OWNERS
BONDING HOUSES
MILL OPERATORS

MUNSON-WHITAKER CO.

Consulting Forest Engineers

NEW YORK, 676 Fourth Ave. CHICAGO, 516 Comm. Bk. Bldg.
BOSTON, 622 Tremont Bldg. PITTSBURG, 906 Arrott Bldg.

TIMBER ESTIMATES

Why not have your timber estimated by competent Forest
Engineers? Somebody will do it; why not the best?

IT WILL PAY AND SAVE IN BONDING,
SELLING OR OPERATING

We make preliminary examinations; complete forest surveys, including
logging maps; valuations; and planting and management reports.

Also Specialists on Preservative Treatment of Wood Against Decay

Write for information

CLARK, LYFORD & STERLING

1331-2 Real Estate Trust Building

PHILADELPHIA, PENNA.

Declaration of Principles and Policy of the American Forestry Association

- IT IS A VOLUNTARY** organization for the inculcation and spread of a forest policy on a scale adequate for our economic needs, and any person is eligible for membership.
- IT IS INDEPENDENT**, has no official connection with any Federal or State department or policy, and is devoted to a public service conducive to national prosperity.
- IT ASSERTS THAT** forestry means the propagation and care of forests for the production of timber as a crop; protection of watersheds; utilization of non-agricultural soil; use of forests for public recreation.
- IT DECLARES THAT FORESTRY** is of immense importance to the people; that the census of 1913 shows our forests annually supply over one and a quarter billion dollars' worth of products; employ 735,000 people; pay \$367,000,000 in wages; cover 550,000,000 acres unsuited for agriculture; regulate the distribution of water; prevent erosion of lands; and are essential to the beauty of the country and the health of the nation.
- IT RECOGNIZES THAT** forestry is an industry limited by economic conditions; that private owners should be aided and encouraged by investigations, demonstrations, and educational work, since they cannot be expected to practice forestry at a financial loss; that Federal and State governments should undertake scientific forestry upon national and State forest reserves for the benefit of the public.
- IT WILL DEVOTE** its influence and educational facilities to the development of public thought and knowledge along these practical lines.

It Will Support These Policies:

- FEDERAL ADMINISTRATION AND MANAGEMENT** of national forests; adequate appropriations for their care and management; Federal cooperation with the States, especially in forest fire protection.
- STATE ACTIVITY** by acquirement of forest lands; organization for fire protection; encouragement of forest planting by communal and private owners; non-political departmentally independent forest organization, with liberal appropriations for these purposes.
- FOREST FIRE PROTECTION** by Federal, State and fire protective agencies, and its encouragement and extension, individually and by cooperation; without adequate fire protection all other measures for forest crop production will fail.
- FOREST PLANTING** by Federal and State governments and long-lived corporations and acquirement of waste lands for this purpose; and also planting by private owners, where profitable, and encouragement of natural regeneration.
- FOREST TAXATION REFORMS** removing unjust burdens from owners of growing timber.
- CLOSER UTILIZATION** in logging and manufacturing without loss to owner; aid to lumbermen in achieving this.
- CUTTING OF MATURE TIMBER** where and as the domestic market demands it, except on areas maintained for park or scenic purposes, and compensation of forest owners for loss suffered through protection of watersheds, or on behalf of any public interest.
- EQUAL PROTECTION** to the lumber industry and to public interests in legislation affecting private timberland operations, recognizing that lumbering is as legitimate and necessary as the forests themselves.
- CLASSIFICATION** by experts of lands best suited for farming and those best suited for forestry; and liberal national and State appropriations for this work.

THE AMERICAN FORESTRY ASSOCIATION

OFFICERS FOR 1914

President

DR. HENRY STURGIS DRINKER, President, Lehigh University, South Bethlehem, Pa.

Vice-Presidents

JOSHUA L. BAILEY, Pennsylvania
THEODORE L. BRISTOL, Connecticut
Ex-President Connecticut Forestry Association
ANDREW CARNEGIE, New York
MRS. EMMONS CROCKER, Massachusetts
DR. CHARLES W. ELIOT, Massachusetts
President Emeritus Harvard University
DR. B. E. FERNOW, Canada
Dean of Forestry, University of Toronto
HON. WALTER L. FISHER, Chicago, Ill.
Ex-Secretary of the Interior
HENRY S. GRAVES, District of Columbia
Chief of the Forest Service
HON. CURTIS S. GUILD, Massachusetts
Ex-Ambassador to Russia
EVERITT G. GRIGGS, Washington
HON. DAVID HOUSTON
Secretary of Agriculture
HON. FRANKLIN K. LANE
Secretary of the Interior

HON. ASBURY F. LEVER, South Carolina
United States Representative
HON. THOMAS NELSON PAGE
Ambassador to Italy
HON. GEO. PARDEE, California
Ex-Governor California
GIFFORD PINCHOT, Philadelphia, Pa.
FILIBERT ROTH, Michigan
Dean of Forestry, University of Michigan
DR. J. T. ROTHROCK, Pennsylvania
HON. WM. H. TAFT, Connecticut
Ex-President United States
JOSEPH N. TEAL, Oregon
Chairman Oregon Conservation Commission
HON. JOHN WEEKS, Massachusetts
U. S. Senator
DR. ROBERT S. WOODWARD, Washington, D. C.
President, Carnegie Institution

Treasurer

JOHN E. JENKS, Washington, D. C.
Editor, Army and Navy Register

Executive Secretary

P. S. RIDSDALE, 1410 H Street N. W., Washington, D. C.

Directors

E. T. ALLEN, Oregon
Forester, Western For. and Conservation Asso.
HON. ROBERT P. BASS, New Hampshire
Ex-Governor of New Hampshire
WM. B. GREELEY, District of Columbia
Assistant U. S. Forester
W. R. BROWN, New Hampshire
Pres., New Hamp. Forestry Commission
HERMAN H. CHAPMAN, Connecticut
Professor of Forestry, Yale Forest School
DR. HENRY S. DRINKER, Pennsylvania
President, Lehigh University
ALFRED GASKILL
State Forester, New Jersey
JOHN E. JENKS, District of Columbia
Editor, Army and Navy Register

CHESTER W. LYMAN, New York
International Paper Company
CHARLES LATHROP PACK, New Jersey
Pres., Fifth National Conservation Congress
CHARLES F. QUINCY, New York
J. E. RHODES, Illinois
Secretary Southern Pine Association
ERNEST A. STERLING, Pennsylvania
Forest and Timber Engineer
JOHN L. WEAVER, District of Columbia
Real Estate Broker
J. B. WHITE, Missouri
Ex-President, National Conservation Congress

Auditors

E. A. STERLING, Pennsylvania

C. F. QUINCY, New York

Advisory Board, Representing Affiliated Organizations

National Wholesale Lumber Dealers' Association

ROBT. C. LIPPINCOTT, Philadelphia, Pa.
R. L. SISSON, Potsdam, N. Y.
JOHN M. WOODS, Boston, Mass.

Northern Pine Manufacturers' Association

C. A. SMITH, Minneapolis, Minn.
WILLIAM IRVINE, Chippewa Falls, Wis.
F. E. WEYERHAEUSER, St. Paul, Minn.

Massachusetts Forestry Association

NATHANIEL T. KIDDER, Milton, Mass.
FREDERIC J. CAULKINS, Boston, Mass.
HARRIS A. REYNOLDS, Cambridge, Mass.

Lumbermen's Exchange

J. RANDALL WILLIAMS, JR., Philadelphia, Pa.
FREDERICK S. UNDERHILL, Philadelphia, Pa.
ROBERT C. LIPPINCOTT, Philadelphia, Pa.

Camp Fire Club of America

WARREN H. MILLER, New York
O. H. VAN NORDEN, New York
FREDERICK K. VREELAND, New York

North Carolina Forestry Association

E. B. WRIGHT, Boardman, N. C.
ALSTON GRIMES, Grimesland, N. C.
J. C. SMOOT, North Wilkesboro, N. C.

National Association of Box Manufacturers

B. W. PORTER, Greenfield, Mass.
S. B. ANDERSON, Memphis, Tenn.
ROBT. A. JOHNSON, Minneapolis, Minn.

Carriage Builders' National Association

H. C. McLEAR, Wilmington, Del.
D. T. WILSON, New York
C. D. FIRESTONE, Columbus, Ohio

Boston Paper Trade Association

N. M. JONES, Lincoln, Maine
JOHN E. A. HUSSEY, Boston, Mass.
ARTHUR L. HOBSON, Boston, Mass.

Philadelphia Wholesale Lumber Dealers' Ass'n

ROBT. C. LIPPINCOTT, Philadelphia, Pa.
J. RANDALL WILLIAMS, JR., Philadelphia, Pa.
FRED'K S. UNDERHILL, Philadelphia, Pa.

New Hampshire Timberland Owners' Association

W. H. BUNDY, Boston, Mass.
EVERETT E. AMEY, Portland, Me.
F. H. BILLARD, Berlin, New Hampshire

Empire State Forest Products Association

FERRIS J. MEIGS, New York City
RUFUS L. SISSON, Potsdam, N. Y.
W. L. SYKES, Buffalo, N. Y.

California Forest Protective Association

MILES STANDISH, San Francisco, Cal.
GEO. X. WENDLING, San Francisco, Cal.
GEO. H. RHODES, San Francisco, Cal.

Minnesota Forestry Association

W. T. COX, St. Paul, Minn.
PROF. D. LANGE, St. Paul, Minn.
MRS. CARRIE BACKUS, St. Paul, Minn.

American Wood Preservers' Association

GEO. E. REX, Topeka, Ka.
CARL G. CRAWFORD, Louisville, Ky.
F. J. ANGIER, Baltimore, Md.

American Forestry

VOL. XXI

FEBRUARY, 1915

No. 2

DESTROYING MT. MITCHELL

By RAYMOND PULLMAN

[The beauty of Mt. Mitchell, the highest mountain east of the Rockies, is being rapidly destroyed by the cutting of its fine timber. The lumberman cannot be blamed for cutting because the timber is ripe for market. The standing timber still to be cut is being protected against fire by the burning of the cut over area and thus the soil and the seed deposits are destroyed and the reproduction of the forest will be impossible. Ultimately the heavy rains will wash the soil away, the stream flow will be affected and floods will follow. Residents of North Carolina are alarmed and a movement is now on foot—late in the day it is true—to preserve some of the timber on the famous mountain.—Editor.]

THE magnificent spruce and balsam forests on Mt. Mitchell, the loftiest peak in the eastern United States and the hub of the Southern Appalachian range which rises to its greatest attractiveness in western North Carolina—"The Land of the Sky"—are being cut down and the mountain, it is feared, will become bleak and barren as a result.

Virgin stands of spruce and balsam trees which have taken hundreds of years to develop are being cut down without thought to future forest growth. Principles of forestry are not only disregarded in cutting the timber, but the lumbermen's contract gives them the authority to burn the slash behind them. The object of burning this heavy slash is to lessen the fire hazard which would exist if the slash were to stay on the ground near the standing timber or cut logs and perhaps be in danger of accidental firing. The result of the careless burning of the slash, however, is not only to kill off all of the young growth but to burn the soil which is formed of humus a foot or more thick in most places, and at the same time consume all the tree seed deposited in it.

The thinking people of North Carolina, particularly the business men of Asheville, deeply resent the devastation of the wooded slopes of Mt. Mitchell,

and, in recent weeks, a movement has been started looking toward the preservation of the forests on its slopes through action either by the State of North Carolina or by the Federal Government. Not only are the citizens of North Carolina thoroughly aroused over the situation, but Uncle Sam is interested also in the preservation of the forests on the mountain. The cutting of privately owned timber on Mt. Mitchell has been accompanied by a number of fires on government National forest land, caused by sparks from the logging engines used in the lumbering operation. The government has already purchased large sections of land in the Mt. Mitchell area, in accordance with the Appalachian National Forest Act, and this government-owned timber is in constant danger because of forest fires starting on the cut-over and burned-over areas which have been left by the lumbermen.

Mt. Mitchell is to North Carolina and, in fact, to the whole eastern United States, what Pike's Peak is to the Rocky Mountain region and what Mt. Ranier and Mt. Shasta are to the Pacific coast. It is the highest peak east of the Rocky Mountains, rising to a height of 6,711 feet above sea level. It is one of the peaks of the Black Mountain range, so named because the trees which cover the slopes look black in the distance.

FEB 13 1915



A SLOPE OF MT. MITCHELL.

HERE IS A CLOSE VIEW OF LOGGED LAND WHICH HAS BEEN BURNED OVER. NOTE THE SIZE OF THE TIMBER. THE CONDITION OF THE LOG IN THE RIGHT FOREGROUND INDICATES THE FIERCENESS OF THE FIRE.

The beauty and grandeur of this section of North Carolina has long made the region a mecca for tourists and each year the country is becoming more popular as a great National recreation ground.

Mt. Mitchell is about 30 miles north-east of Asheville, air line, and it is but natural that the citizens of this North Carolina city have been the first to protest against the lumbering operations which are resulting in denuding the mountainous slopes. At a meeting of the Asheville Board of Trade on November 28th last the leading citizens of the community discussed the serious situation which has been brought about by the cutting which has now been going on for several years, starting with the logging of the spruce forests from a large area on Clingman's Peak and now extending to the slopes of Mt. Mitchell.

The operations include the cutting of all spruce and balsam trees down to four inches in diameter. The cutting was confined to a large tract of 6,000 acres until recently but has now been extended to an additional 8,000 acres on the west slope of the mountain and the areas to be covered in the whole

operation will aggregate 15,000 to 20,000 acres, and perhaps more. This means that much of the surface of the mountain sides will be denuded, leaving the cut-over area ready both for forest fires and the wash of the heavy rains which occur in this mountain region.

The relation between forest and stream flow is now well understood by most of the people of the whole United States, and especially by citizens of the Appalachian region, who have struggled for years to promote the preservation of mountain forests either by the State or National government in order to conserve and protect stream flow. Even the children of North Carolina understand how the heavily wooded mountain sides, covered with soil formed by the successive piling up of humus season after season, for hundreds of years, act as a great sponge to soak up the rains and allow the water to flow gradually into the streams which affect the conditions and life of hundreds of thousands of people living along the valleys.

The mineral soil in the Mt. Mitchell area is Carolina gneiss formation, so



CUT OVER AND THEN BURNED.

THIS IS A SAMPLE OF CONDITIONS ON MT. MITCHELL WHERE FIRE HAS SWEEPED OVER LAND FROM WHICH THE TIMBER HAS BEEN CUT. REFORESTATION IS PRACTICALLY IMPOSSIBLE ON SUCH LAND.

named because of its extent in North and South Carolina. When the vegetal soil or humus is either burned or washed away, the mineral soil which is left is of a character which breaks up quickly and flows off into the streams, leaving bare, uncovered, rocky places everywhere.

In practically all of the lumbering operations which have been carried on on Mt. Mitchell, Clingman's Peak, and in the vicinity, no thought has been given for the future use of the land. The big trees have been cut so as to follow along the line of least resistance regardless of what they crushed and destroyed. The slash formed by the tops and branches is not piled in small, compact hillocks and burned as it is in many of the western forests, in such a manner as will do the least harm, but is left scattered six or eight feet high over broad areas.

The burning of this mass of material by the lumbermen in order to protect the standing timber and the logs means that all the new growth of trees is burned at the same time and that the

soil also is burned to a depth of eight inches to a foot at times. In most such cases the home and permanent offices of the lumberman are generally located in another State and he has absolutely no interest in the mountain regions except in the profit which he will obtain from the timber and he naturally desires all the profit he can get. This, in a word, is the reason why the work is carried on in such a destructive manner without regard for the permanent interests of the people living in the State, and it is this condition which is arousing such protest.

The people of the southern Appalachian region have always recognized forest fires as one of the great curses of the country. The mountains have frequently been swept over by fires ever since the earliest days of the occupation of the region. Many fires occurred before the lumberman started his operations, but these have not been as destructive as those which have followed the lumberman because the burning of the slash has caused far more harm than the simple burning of standing timber.

The lumbering railroad has already been built to within a mile and a half of the summit of Mt. Mitchell and the large spruce trees which run from twenty inches to twenty-six inches, and sometimes to thirty inches in diameter—the best spruce timber in the eastern United States—are being cut down and hauled to a large band-saw mill at Black Mountain which is located on the Southern Railway, sixteen miles east of Asheville. The smaller spruce and balsam trees are cut and sent to the Champion Fibre Company's large pulp mills at Canton, which is just eighteen miles west of Asheville.

Such rapid progress has been made in clearing off the land that Clingman's Peak and a considerable area on Mount Mitchell today present a scene of utter desolation and ruin. Persons familiar with this section of the country realize that the destruction of the forests here is a more serious matter than in almost any other region. Forests cut down on the northwest Pacific coast, for instance, will quickly reproduce themselves, but the destruction of forests in the southern

Appalachians and the usual burning over of land carries with it also the destruction of the soil and the seed deposits and reproduction becomes almost an impossibility.

That which nature required centuries to produce is destroyed by man in a few days because of the immediate profit which skinning the land will bring. The forests in which are the sources of many streams become rocky areas on which the heavy rains fall and rush off creating floods which destroy farms and interfere with the regular flow of the mountain streams, many of which are sources of great waterpower.

In the Mt. Mitchell lumbering operation the great skidways on which the logs are dragged to the railroad for loading and shipment form great gutters and down these gutters the waters from the rains rush in torrents and cut deep into the soil through to the red clay and the rock. Over the remainder of the face of the denuded mountain, soil washes badly after each rain, and, with its disappearance, the people of the State are losing all hopes of reforestation.



MT. MITCHELL INN, WIRELESS STATION AND FLAGSTAFF.

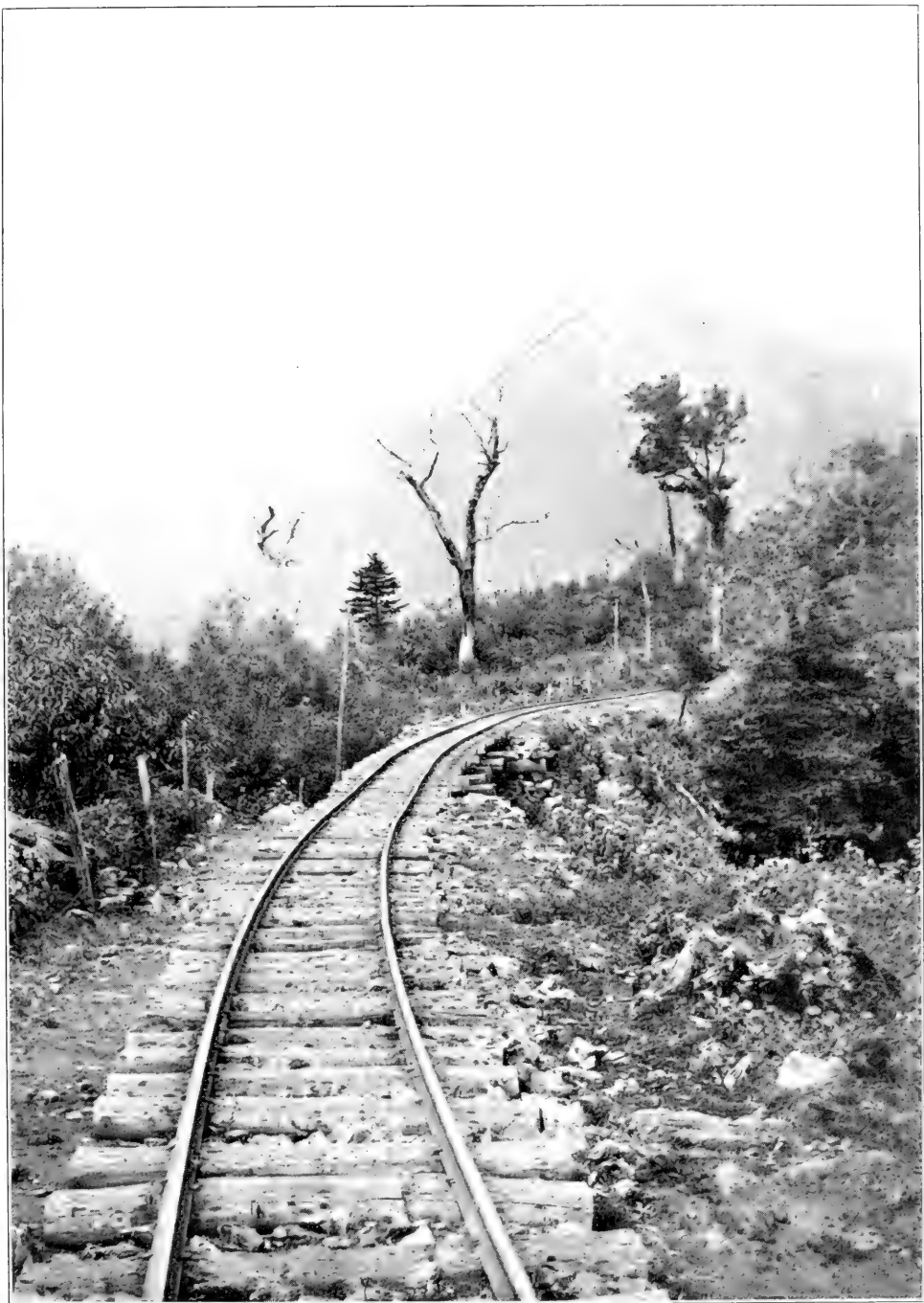

VIEW OF POTATO TOP.
TAKEN FROM THE LOGGING RAILROAD WHICH REACHES ITS LOWER SLOPES.

Mr. N. Buckner, Secretary of the Asheville Board of Trade, summed up the situation, when he said:

"We realize that timber, foliage, soil and water form the basis of all natural resources, and really govern the value of money. The man-made value of money depends absolutely on these three natural resources, and the preservation of the forests on the peaks of the

area and several crown or tree-top fires have resulted, and the whole area cut now presents a scene of unutterable desolation and blank ruins."

The Honorable Locke Craig, Governor of North Carolina, is one of the leaders in the movement to bring about some action which will check the destruction of the forests on Mt. Mitchell, and, in his address to the North Carolina

Forestry Association, on January 13th, he dealt largely with the proposition that the State purchase the area on the top of Mt. Mitchell for the purpose of preserving at least a part of the virgin forest near and including the summit of the mountain. The Governor realizes that the lumber company, which has purchased practically all of the spruce timber on the Black Mountains including Mt. Mitchell, has an actual right, although, perhaps, not a moral right, to both destroy the forest and burn over the land. Although a man in a city is not permitted, by law, to set fire to his house, for fear that the conflagration would destroy adjoining property, a man owning forest land is permitted to burn this land over even though the burning will cause the destruction of the soil, flooding of farms below in the valley after heavy rains, and the destruction of other property.

"I tell you," said the Governor, "the lumbermen—and I am not criticising them, but us—the lumbermen are destroying North Carolina. We

cannot expect them to sacrifice their business for the public good. They have bought that timber. They are entitled to every stick of it. If the people of North Carolina want to save it they must do so. They cannot expect the lumbermen to save it; they must save it themselves. They must save it from the fire that follows the lumberman:

"If I can lend any mite of influence to this movement for the protection of

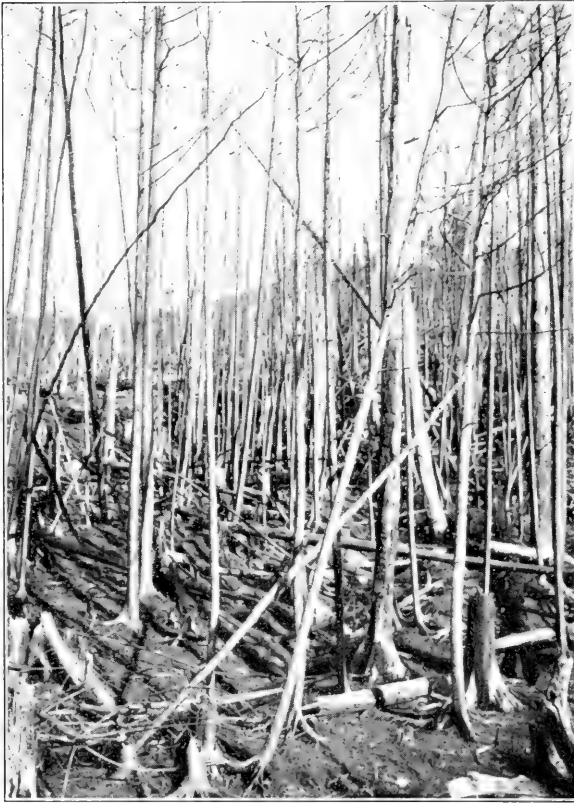

YOUNG TREES BURNED.

HERE IS A FINE GROWTH OF SPRUCE AND BALSAM DESTROYED BY A FIRE WHICH ATE DEEP INTO THE SOIL.

Appalachian mountains, especially Mt. Mitchell and nearby peaks, is really a matter of vast vital concern to the people of the commonwealth of North Carolina and the whole United States. It is earnestly to be hoped that the people of the nation will rise up in a strong sentiment against the future forest devastation of the monarch of the east, Mt. Mitchell. Already forest fires have burned over the cut-over

our forests, I will do it; for in the protection of the forests we are protecting the fields, we are protecting the place where crops must grow, and where men and women must grow in North Carolina; we are protecting the whole State."

As the result of the widespread interest by the people of North Carolina in the preservation of the Mt. Mitchell area, under the leadership of Governor Craig and prominent business men, State Senator Zebulon Weaver has introduced in the North Carolina legislature a bill which provides for the purchase of a large area on Mt. Mitchell and the establishment of a park there so that the scenic value of the peak may be preserved for future generations.

The bill recognizes the value of Mt. Mitchell because of its being the most prominent peak east of the Rocky Mountains and because the region is the source of many important streams of the State, whose value will be damaged if the forests are cleared away and destroyed at the headwaters. State Senator Weaver's bill provides for the creation of a Mitchell Peak Park Commission, consisting of five practical men who shall be appointed by the Governor and who shall hold office until the desired area on Mt. Mitchell needed for a park shall have been purchased and a deed made to the State of North Carolina. The members of the commission will receive no compensation but their expenses.

The total amount to be expended under the act shall not exceed \$20,000. The bill provides for the appointment of a valuation board of three competent men in all cases when the park commission and owners of the land cannot agree as to its value. While this bill will provide for starting the State in the purchase of the land for a Mt. Mitchell Park, it is believed by persons familiar

with values in the vicinity that the limitation of the amount of \$20,000 will not permit the accomplishment of as much as is needed at this time.

As is generally known the destruction of the forests of the southern Appalachians is not a new movement and it was because of conditions caused by deforestation in the whole region that the Congress of the United States four



A PICTURE OF DESOLATION.
HERE THE FIRE, FOLLOWING THE CUTTING OF TIMBER, HAS BURNED THE SOIL AND DESTROYED THE TREE SEED DEPOSITS.

years ago passed the Appalachian National Forest Bill, providing for the purchase of lands necessary to preserve the regularity of stream flow. Under this act more than 1,200,000 acres of land have been purchased. Much of the more valuable timber land, however, is still in private ownership and only through State action or cooperation of State authorities with timberland

owners will this privately owned land be so managed as to reduce to a minimum the danger which follows all lumbering operations in this region.

As long as fourteen years ago the seriousness of the damage which was being done in the southern Appalachians was realized and at that time a thorough investigation was made of the forests, rivers and mountains of that region, by the United States Government. The then Secretary of Agriculture, James Wilson, twice visited the section and observed at first hand the destruction of the forests and the consequent enormous damage by floods. He examined many of the largest mountains, himself, and climbed Mt. Mitchell, the highest peak of the range.

The late Overton W. Price, associate forester of the United States Forest Service under Gifford Pinchot, was one of the men who made the 1901 investigation, and, at that time, he said: "The protection of the headwaters of important streams in order to prevent

floods and perpetuate water powers, the preservation of a great natural health resort and of important agricultural resources are perhaps the most valuable results which would follow the creation and proper management of the Appalachian forests."

Few men in the United States know more about the topography and the geology of the southern Appalachian mountains than Arthur Keith, one of the experts in the United States Geological Survey, who has gone over almost every square mile of the country in the southern Appalachian region. In speaking of the great value of the forests in protecting the land, Mr. Keith has said:

"The chief agent which checks the removal of the soil by rains in this mountain country is the forest cover. Even though the penetrating roots and acids due to vegetation produce rock decomposition, these same roots, however, hold the loose material in place and hinder its tendency to slide down hill.



BOUND FOR A LOAD OF LOGS.

EMPTY CARS OF A LOGGING TRAIN ON THEIR WAY TO THE MT. MITCHELL LUMBERING OPERATIONS.



CLINGMAN'S PEAK ON THE RIGHT.

ON THE LEFT IS SEEN POTATO TOP WHILE IN THE CENTER IS THE LINE OF THE LOGGING RAILROAD RUNNING INTO THE HEART OF THE WOODS.

With its assistance loose soils are piled on slopes at angles fully double those which they could maintain unaided. The action of forests is great in another way: Loose materials are washed down hill during rainstorms by even the tiniest rivulets. In open fields these gather in a few minutes and form deeper and deeper channels with each succeeding storm, finally removing the loose material down to bare rock. This process is almost wholly prevented by the network of roots and the cover of leaves both living and dead, and the water seeps through the soil so slowly that it carries no sediment.

"The value of forest cover is illustrated better in the southern Appalachian region than in almost any other section. Streams which drain considerable areas of deforested land rise fast and soon become turbid with mud. Those which drain areas protected by forests rise much more slowly and by comparison the water could be called clear, except in the most violent storms.

In addition to the loss inflicted by forests cutting upon the steep slopes themselves, great damage also results to the lands lying farther down the streams. The deep clay soil and underlying rocks form a sort of gigantic sponge which soaks up water when it is abundant. When the forests are stripped away the water collects and runs off with vastly greater speed and much evaporates, so that not only is less soaked up, but the discharge is very irregular and destructive, floods result, and therefore are wider spread. Thus, viewed from the standpoint either of utility or beauty, these unrivaled forests are the keystone of the arch."

The value of this testimony of one of the Government's trained geologists is understood by all persons who have ever visited the southern Appalachian region. People knowing what will happen when the forests are cut off are therefore getting almost solidly behind the movement to do what is possible not only to preserve the large area on Mt. Mitchell as a park, but, if possible,



MONUMENT TO PROF. MITCHELL.

THIS WAS ERECTED SOME YEARS AGO TO THE MAN WHO GAVE MUCH OF HIS TIME TO EXPLORING THE MOUNTAIN, WHO FIRST ASCERTAINED ITS ALTITUDE AND WHO FINALLY LOST HIS LIFE ON THE MOUNTAIN DURING ONE OF THE EXPLORING EXPEDITIONS.



PROF. MITCHELL MONUMENT DYNAMITED.

THE MONUMENT WAS BLOWN INTO THREE SECTIONS BY THE EXPLOSION AND EACH WAS SO BADLY BATTERED AND CUT THAT IT CAN NOT BE USED AGAIN. A NEW MONUMENT OF STONE IS TO BE ERECTED IN ITS PLACE BY THE STUDENTS AND FACULTY OF WEAVER COLLEGE, WEAVERVILLE, N. C.



HOMEWARD BOUND FROM MT. MITCHELL.

to bring about some form of co-operation between the State authorities and the timberland owners so that no man will be allowed to handle his land in a manner which will affect the welfare and destroy the property of his neighbor.

A mysterious and quite dramatic incident which followed the start of the movement to preserve the beauty of Mt. Mitchell for the people was the recent discovery that the monument marking the last resting place of Dr. Elisha Mitchell, after whom the mountain was named, had been blown up by dynamite. It is not known what was the motive for the act nor has any clue which might lead to the arrest of the vandal been discovered at the time of this writing. It may have been done by some drunken men carousing at the top of the mountain. The people prefer to believe that this is the case, and not that an agent of some of the interests which oppose the preservation of the forest committed the act.

Dr. Mitchell came from Yale to the University of North Carolina as a member of the faculty, and the monu-

ment to his memory on the top of the mountain was erected twenty-six years ago by the alumni of the State University. The monument was constructed of composition metal, and was cast in six sections and base. It was twelve feet high, and the base was thirty inches square. Dr. Mitchell, during the time he was a member of the University faculty, spent much time in exploring the mountains, and studying the geography, geology and botanical specimens of the region, and was killed on one of his daily trips, falling over a precipice. It was considered peculiarly fitting that his grave and the memorial monument should be located on the top of the mountain.

At a mass meeting held on the day following the blowing up of the monument, the students and faculty of Weaver College, at Weaverville, nine miles from Asheville by trolley, agreed to rebuild the monument in stone, in which will be set a tablet to be given by the North Carolina Historical Society. The rebuilding of the monument will begin in the spring.

THE MT. MITCHELL TRAIL

By H. W. PLUMMER AND N. BUCKNER

IN STARTING from Asheville to Mt. Mitchell over the trail which has been completed under the supervision of the Good Roads Association, one leaves by way of Merrimon Avenue and the fine new sand-clay road, up Beaverdam Creek to Craven Gap, where he will strike the Howland traction road, following this about two and three-fifths miles to Bull Gap. This is as far as one can go by wagon, the trail commencing at that point at the boundary of Dr. Ambler's property.

A ride of less than two miles along the trail brings one to the doctor's country home, Rattlesnake Lodge. From there to the top of Lane's Pinnacle, four miles, then on to Ivy Gap on the side of Craggy, about three miles; thence along the north side of Craggy to the south side of Craggy Pinnacle; around to the north of Craggy Dome, to the north of Bull Head, thence to Balsam Gap; through Balsam Gap to the sides of old Blackstock, one of the most attractive of the mountains; possibly on account of its forbidding aspect from a distance, being covered as it is with the black balsam, but on near approach furnishing a cooling and grateful shade, the trail over this mountain being cut out through the balsam timber. The mountain is so steep at this point that considerable engineering work was necessary to make the grade up the side of the mountain, but finally its crest is reached and followed for about half a mile. Then conquering Blackstock, the next hard climb is over Potato Top, then over Mt. Gibbs to Stepp's Gap, where a bold spring, the water as cold as ice, furnishes plenty of water for both man and beast; the last chance of watering your horse before climbing Mitchell, 6,711 feet. The distance from Asheville, 32 miles; to the top of Mitchell from Rattlesnake Lodge about 20 miles.

One of the interesting features of these mountains is that except in time

of extreme drouth, one finds plenty of water along any of the trails; often on the highest mountains and almost at the very peaks fine springs are found.

With comparatively little humidity in the atmosphere, these towering peaks act as condensers and consequently rain is much more frequent than in the plateaus of low altitudes. The leaves and branches of the forest break the force of the raindrops; the shrubs, ferns and humus below catch the water and pass it slowly downward into the soil and rock crevices; and from this great natural reservoir weeks and even months later this water emerges into the numberless springs about the lower mountain slopes.

In riding along this trail at different points and especially through the Black Mountain, the views obtained are superb; without equal anywhere in the United States.

In some cases one's attention will be attracted to a nearby peak to the exclusion of everything else, while in other instances, an immense panorama will spread out, with a view of from 50 to 80 miles, according to atmospheric conditions, and comprising within the scope the Smokies, the Blue Ridge, the Blacks and the Craggies.

In making the trip the following mountains are crossed, sometimes along the side, sometimes over the very summits:

	<i>Altitude, Feet</i>
Richland Knob.....	4,979
Lane's Pinnacle.....	5,277
Craggy Pinnacle, about.....	6,000
Craggy Dome.....	6,105
Bull Head.....	5,985
Blackstock Knob.....	6,386
Potato Knob.....	6,419
Clingman's Peak.....	6,611
And on to Mt. Mitchell.....	6,711

Here we rest in a cabin now operated during the summer season by J. W. Dunne as Mt. Mitchell Inn. It is well,



ALONG THE MT. MITCHELL TRAIL.



ON THE WAY TO MT. MITCHELL.

ALONG SUCH A ROAD AS THIS THOUSANDS OF SIGHTSEERS HAVE DRIVEN, RIDDEN OR WALKED ON THEIR WAY TO MT. MITCHELL.

however, for each man to provide himself with sufficient food for the trip.

Off to the north of Mitchell, the continuing range of Black Mountains comprise the Black Brothers, 6,690 and 6,620 feet, respectively, Balsam Cone 6,645 feet, Cat Tail Peak 6,609 feet, Potato Hill, 6,487 feet, and so on to the northeast to the Toe River valley.

These Black Mountains lying west of the Blue Ridge are a series of short ridges and form the watershed of the Toe River, Cane River, and with the Pinnacle of the Blue Ridge, Gray Beard, etc., the north fork of the Swannanoa River.

In President Roosevelt's message to Congress transmitting the message of the Secretary of Agriculture, appears the following: "The Southern Appalachian region embraces the highest peaks and largest mountains east of the Rockies. It is the great physiographic feature of the eastern half of the continent, and no such lofty mountains are covered with hardwood forests in all North America."

Along the southeastern margin of this southern mountain belt is the Blue Ridge proper, which, as it crosses North Carolina, is a fairly well-defined mountain range standing more than 3,000 feet above the sea and rising in four peaks to more than 5,000 feet, and in one (the Grandfather) to practically 6,000 feet.

Bordering this region on the northwest are the Unaka Mountains (or Smoky Mountains). Extending out from the two great mountain borders, the Blue Ridge and the Unakas, into the elevated region between them, and connecting them in places, are a series of more or less interrupted cross ridges which have altitudes comparable to, and in the case of the Black Brothers greater than those of, the Blue Ridge or the Unakas.

Some of these peaks are sharp, rugged and rocky; others like the "Bald Mountains" are rounded domes covered with grass and rhododendron; while still others, like Blackstock, Potato Knob and Mitchell, are heavily forest covered.

The haziness of the atmosphere which has found expression in the name

"Blue Ridge" and "Smoky Mountains," often limits the distance of vision, but combines with the forest cover to soften the details and to render this southern Appalachian region attractive beyond compare.

In ascending any of the higher mountains, as Mount Mitchell, which, with its elevation of 6,711 feet, is the loftiest of them all, one may penetrate in the rich and fertile coves about its base, a forest of oaks, hickories, maples, chestnuts and tulip poplars, some of them large enough to be suggestive of the giant trees on the Pacific Coast. Higher up, one rides through forests of great hemlocks, chestnut oaks, beeches and birches, and higher yet through groves of spruce and balsam. Covering the soil between these trees is a spongy mass of humus sometimes a foot and more in thickness, and over this in turn a luxuriant growth of shrubs and flowers and ferns. At last as the top is reached, even the balsams become dwarfed, and there give place largely to clusters of rhododendron and many of them such as are commonly seen about the hills and valleys of New England and southern Canada.

In such an ascent one passes through, as it were, the changing of the seasons. Half way up the slopes one may see, with fruit just ripening, the shrubs and plants, the matured fruit of which was seen two or three weeks before on the Piedmont Plateau, 3,000 feet below, while 2,000 feet higher up the same species have now just opened wide their flowers. Fully a month divides the seasons above and below, separated by this nearly 6,000 feet of altitude.

Mt. Mitchell is not only the pride of North Carolina, but of the entire East inasmuch as it is the monarch of eastern mountain peaks. Its sides are covered with a great forest of magnificent balsam—great forest giants, straight as an arrow, and in many instances nearly 100 feet to the first limb. About two years ago a development, so called by financial interests, of this magnificent forest area of about 9,000 acres was begun. As a result erosion of this mountain peak has already started to a considerable extent.

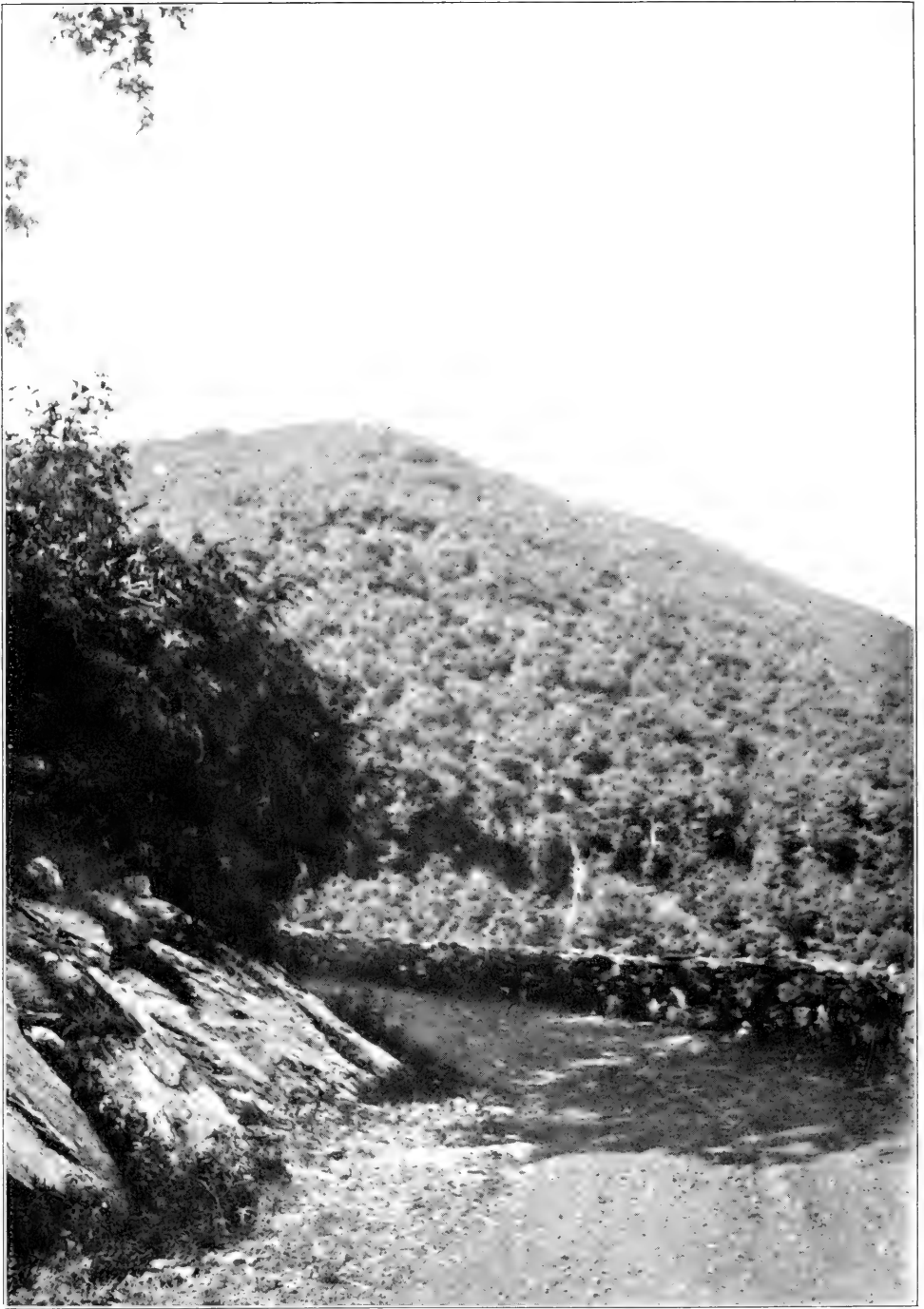

PISGAH MOTOR ROAD.

HERE IS A FINE WELL-BUILT AND WELL-PROTECTED MOTOR ROAD LEADING TO THE SUMMIT OF MT. PISGAH.
NOTE PISGAH'S WELL-WOODED SIDES.

The logging road has been extended to within a mile and a half of the summit of Mt. Mitchell, approximately 1,000 acres of spruce and balsam have already been cut off and most of the cut-over land has been fire swept several times, giving the appearance of a vast, desolate waste. Unless prompt measures are taken by the Government of the United States or the State of North Carolina, this great king of mountain peaks will soon be denuded of its magnificent balsam and spruce forest, destroying watersheds of infinite value from these mountains to the Atlantic Seaboard east, and to the Mississippi River and Gulf of Mexico west.

While the agitation for the Appalachian Park has progressed during the past nearly ten years to the extent that the Government has already purchased in North Carolina more than 225,000 acres of land, it would seem that strenuous efforts should be made by the people of the East to preserve the wonderful

balsam forests of Mt. Mitchell to the people of the Nation, as a part of this Appalachian National Park.

Many millions of dollars are spent annually by American tourists in Switzerland, where more than \$164,000,000 are invested in hotels alone. This will give some faint idea of the benefits that would accrue to the eastern mountain section of the United States as a country if these mountains were properly developed into a great park threaded with good roads, as is the case in the National Parks of the West.

Mount Mitchell can be reached over the Southern Railway or by motor to Black Mountain, where guides can be procured, and thence over the trail sixteen miles, afoot or horseback. Or to Graphiteville, 23 miles from Asheville by rail, thence by walking trail, constructed by the Government, to summit of Mt. Mitchell, a distance of twelve miles.

FORESTRY EDUCATION IN VERMONT

ACCORDING to the new curriculum of the University of Vermont and State Agricultural College, Forestry is made a required subject for all agricultural students. All sophomores are to have a half year's course in Farm Forestry, which may be followed by a two week's forestry camp, and other courses. The University of Vermont has been modest in its aims, and has never attempted to establish a forestry school, but so far as is known, it is the first agricultural college to require forestry of all students. It does this believing that its graduates will need a certain amount of forestry whether they become farm managers, teachers of agriculture, or pursue other lines of agriculture. Those intending to become professional foresters are encouraged to continue their studies at

a technical forest school. It is interesting to note, in this connection, that an elementary course in forestry is also given at the state agricultural school at Randolph, Vermont. The forestry class of thirty wide awake boys recently visited the Downer State Forest, and inspected the four-year-old plantations of white, Scotch and Norway pines, and Norway spruce, as well as the forestry cuttings.

The Agricultural College and Experiment Station have just completed a forestry exhibit for the San Francisco Exposition, illustrative of the extension work in forestry, and the various lines of forest investigations, including the establishment of permanent sample plots for the accurate study of natural reproduction.

PLANTING TIME AND CARE OF TREES

By S. B. DETWILER

THE time to plant is either late fall or early spring. Usually the amateur gets better results with spring planting. Fall planted evergreens should be transplanted about the middle of September. Broad-leaved trees should be transplanted only when the buds are dormant. Trees transplanted from the woods should be seedlings. Forest grown trees are more successfully transplanted by cutting off the roots several feet from the trunk a year or more before the tree is moved. This enables the tree to develop an auxiliary root system; it is also well to prune back the top at the time the roots are pruned.

Nursery grown trees are best for shade tree planting on account of their better root development. A tree $1\frac{1}{2}$ to 2 inches in diameter one foot above ground is large enough for street planting and smaller trees are cheaper and may be used to advantage for lawn or roadside planting. Because of the better proportion between roots and top, small trees usually outgrow larger trees planted at the same time. The trees should have a compact root system, a straight trunk and a well-balanced top.

Tree pedlars should be held in suspicion.—Trees should be purchased from reliable nurserymen of good reputation. If you are not acquainted with a reliable firm the American Forestry Association can supply you with lists of reliable dealers.

Trim off all torn or broken roots and branches with a sharp pruner before planting. Street trees should have the lower branches trimmed to a height of 7 to 9 feet from the ground. When a tree is transplanted, a large part of the root system is cut off, and it must start new feeding roots before it can establish itself. Unless the top is severely pruned, proportionately to the root system, excessive transpiration

from the leaves is very apt to kill it. The trees should be free from scars and bruises due to carelessness in handling.

If the tree is purchased from a nearby nursery, as is most desirable, have it delivered for planting on a cool or cloudy day. In every case the root system must be protected *at all times* from the sun and air, from the time it leaves the nursery until it is planted. Moist blankets or a canvas wrapped tightly around the roots will give adequate protection.

Preparing the tree for the hole.—Several weeks before planting the hole for street planting should be dug, 5 to 7 feet long, 3 or 4 feet wide and about 3 feet deep. These holes should be covered to prevent people falling into them. A few days before planting, the hole should be partly filled with the best soil available, and well packed. A cubic yard of rich loam, well pulverized, should be placed close at hand for use when the tree is set. In lawn planting smaller trees are usually planted, and the hole may be reduced in size. If the top soil is good, it may not be necessary to bring in other soil, but in *every case it will pay to use the very best soil* and plenty of it. Fresh manure should not be used, as it is liable to burn the roots.

Planting.—The tree should be planted slightly deeper than it stood in the nursery, and the roots spread out naturally, without twisting or crowding them. Fine soil is sifted between the roots and worked under and between them, filling every space. The tree should be held upright during planting, by an assistant. Working the tree up and down and sidewise aids in packing the dirt firmly about the roots. The soil is packed in layers by trampling, care being taken not to break or tear the fine feeding roots. The top 3 or 4 inches of soil is thrown on loosely, to act as a mulch. The tree may be thor-

oughly watered before the top soil is applied. The tree should stand midway between the curb and sidewalk, perpendicular and in line with other trees.

Tree Guards.—Young trees, especially street trees, should be protected and supported by tree guards placed around them immediately after planting. For street trees, a wire or metal guard is most economical. For lawn trees, a single stake firmly driven into the soil is usually sufficient. Leather or canvas straps should be used to attach the tree to the support.

Cultivation.—Cultivation of the soil for three feet around the tree is beneficial during the first years of growth. Loosen the top soil with a spade or hoe a sufficient number of times during the season to keep down weeds and grass. A mulch of leaves or manure in the fall retains moisture and acts as a fertilizer when spaded under. During the hot, dry periods of the summer months, watering should be done once or twice each week, not oftener. The feeding roots which take up the moisture are located at a distance from the trunk equal to the length of the branches, and the water should be applied liberally, but not too frequently, to these feeding roots.

CARE AND REPAIR OF SHADE TREES

Training, trimming and pruning.—Low branching will cause more rapid growth in trunk diameter. The lower branches should be pruned for shade and street trees at intervals of a year or more, as they interfere with street traffic, until a clean stem of ten or twelve feet is reached. Lawn trees require little attention, since low branching, and unsymmetrical form give them character. If possible, trees should be left with single leaders, since crotches are likely to split in later years. If two or more main stems develop, leave the central stem and severely trim or entirely remove the others. When it is necessary to restrict the spread of trees within certain bounds on narrow streets and roadways, the ends of the branches should be shortened so as to develop a compact symmetrical crown. Any time after midsummer is suitable

for pruning. Shaping can best be done while the foliage is on the tree. Heavy pruning is better done in fall or winter.

Old, neglected trees should first have all dead and imperfect limbs removed. Thin out dense tops by leaving main limbs and the branches immediately radiating from them and limit cutting to the third and fourth divisions in branching. As far as possible preserve the character and natural shape of the tree, making the finished tree look as if no limbs had been removed. Start pruning at the top of the tree and work downward. All cuts should be made smooth, close to the base of a limb, and parallel to the axis of the stem. At all times avoid unnecessary wounds by cutting or tearing the bark in making the necessary cuts and in climbing the trees. The surface of scars should be smoothed and painted with a mixture of two parts coal tar to one of creosote. It is safer to follow this with a heavy coat of coal tar (the kind used for roofing is best). Large scars should be re-coated every few years.

Control of insects and fungus disease.—Leaf-eating insects can usually be killed by spraying the foliage with a solution of arsenic in some form. Success depends upon the poisonous quality of the insecticide and upon the time and manner of spraying. The principal leaf-eating insects are; Tussock moth, Gypsy moth, Brown tail moth, Fall webworm, Bag worm, Elm leaf beetle. Sucking insects are usually destroyed by contact poisons such as kerosene emulsion, whale oil soap and lime—sulphur wash which close up their breathing pores. Important sucking insects are the Cottony maple, woolly maple, San Jose, scurvy, and oyster shell scales, and plant lice. Boring insects such as the leopard moth, maple borers and bark borers, are more or less successfully combated by running a wire into the burrows, cutting off infected branches and twigs, injecting carbon bisulphide into the galleries. Fungus diseases affect leaves, branches, bark, sapwood and heart wood and roots, but are less serious than injuries by insects, except the chestnut blight for which no remedy is known. Diseases

of the leaves may usually be controlled by proper spraying with a good fungicide, such as Bordeaux mixture. Fungi affecting the wood usually gain lodgment in wounds. They may be excluded by proper care, and when present may be checked by tree surgery methods. To successfully combat tree pests of any description requires special methods adapted to each particular pest. Detailed information should be obtained from city, state or national authorities. The American Forestry Association will refer inquiries on these subjects to the proper officials, on request.

Tree surgery consists in cutting out the diseased parts of trees and filling the cavities with cement so that they are water-proof. All decaying, discolored, water-soaked wood should be removed, with gouge, chisel and mallet, until only sound, uninfected wood is exposed. The bottom of the cavity should be shaped so that if water were thrown in the cavity it would promptly run out. The top and bottom of the cavity should be V-shaped rather than square or rounded, as this aids proper healing. The interior of the cavity should be sterilized by thorough painting with coal-tar creosote, followed by a heavy coating of coal tar. Fill the cavity with mortar made of one part cement to three (or less) parts sharp sand, and bring the filling to a smooth, water-tight finish, exactly even with the cambium (growing layer of the tree). Before filling large cavities, flat-headed wire nails $2\frac{1}{2}$ to 3 inches long are driven about half their length into the interior, to hold the cement. The cement is reinforced with iron rods and cross bolts. The filling is then built up in blocks of 8 to 12 inches, each block being separated by sheets of heavy tar paper. Large solid fillings of cement are apt to be cracked when the tree sways in the wind. When it is not advisable to go to the expense of filling, much good is done by treating the cavity as recommended above, following

with an extra coating of tar. Split crotches should have all decayed wood removed from the split, and creosote and tar applied. Bring the limbs back to their proper position, using rope and tackle if necessary, and hold them in place by means of bolts through each limb, connected by chains. Counter-sink the head of the bolt. Thoroughly coat with tar the cuts made for the bolt, and the edges of the crack. Cavity filling is advisable only when the tree is a highly valued specimen. Old, unsightly cripples and trees of poor species are much better taken down and replaced with new trees of desirable kinds. The need of tree surgery at a future time will be very largely removed by promptly attending to the fresh injuries of today.

Beware of fake tree doctors.—There are reliable tree surgeons, and many who are not. The owner should investigate before employing outsiders to repair his trees. If the owner chooses to do the work, it is mainly a matter of common sense to make needed repairs. However, if it is desirable to employ an expert to do the work, the owner should investigate his standing before employing him, and should closely superintend the work to see that it comes up to the specifications of the written contract.

Coordination of effort is necessary in any community, large or small, to obtain the greatest beauty and benefit from shade trees. In this way it is possible to secure uniformity in the use of species, proper pruning, and efficient control of insect and fungus invasions. A number of States have laws governing the planting of street and roadside trees. If there is no Shade Tree Commission or City Forester systematically developing the tree welfare of your community, interest yourself in forming a local forestry improvement association. If such an organization exists, do all you can to make this work successful by fully cooperating with it.

To Distribute 1,000,000 Trees

The State School of Forestry at Bottineau, North Dakota, announces that it will have one million trees for distribution to the citizens of the state during 1915.

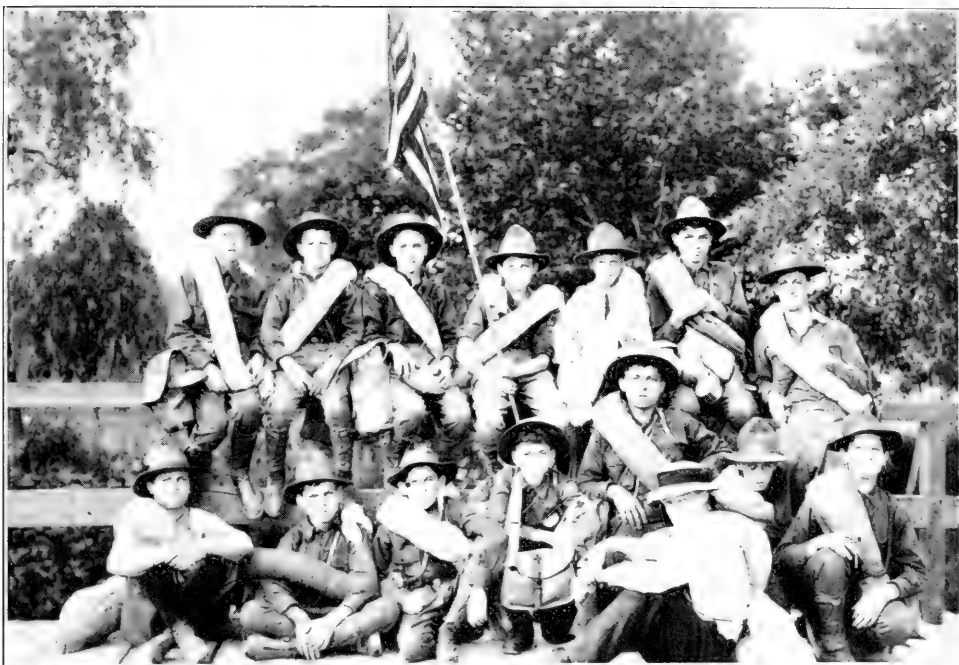

READY FOR A HIKE INTO THE WOODS.

THE BOYS CARRY BLANKET ROLL AND KIT AND ARE EQUIPPED FOR CAMPING OVER NIGHT. THE SCOUT MASTER IS IN THE FRONT ROW.

BOY SCOUTS AND FORESTS

By K. W. WOODWARD

ROBIN HOOD is the prototype and patron saint of the Boy Scout. What Scout of today would not give his most precious possession for the privilege of spending a day with the Merry Men of Sherwood Forest? Astir with the earliest dawn in order to shoot with bow and arrow the deer that formed their main food their whole day was a round of outdoor activity in which any healthy boy would be glad to share. And at night around the blazing camp fire would be told tales of daring in the hunt and the meting of rough justice to tyrannous knight, grasping bishop, or thieving serf which would thrill him with eager desire for emulation. The mere mention of Robin Hood calls up visions of green forest and deeds of valor chivalrously undertaken to right some wrong. For-

tunately, too, our own American history is full of names that carry down to the present the traditions of the Merry Men of Sherwood Forest. Daniel Boone, Davy Crockett, Andrew Jackson and Abraham Lincoln were all men of the woods.

It is the lives of these frontier heroes that Boy Scouts seek to emulate in their hikes in the woods.

Even a short trip may be made replete with inspiration to fuller knowledge and that self expression which leads to better self control. There are grasses, herbs, shrubs and trees to become acquainted with, each one with its individuality and uses. If he is permitted to hunt he learns the habits of a few game birds and animals, but if a camera or pair of field glasses are his weapons his interest is broadened and



THE ARRIVAL.

REACHING THE CAMP GROUND THE BOYS ARE SOON READY TO PUT UP THEIR TENTS AND ARRANGE THEIR QUARTERS.

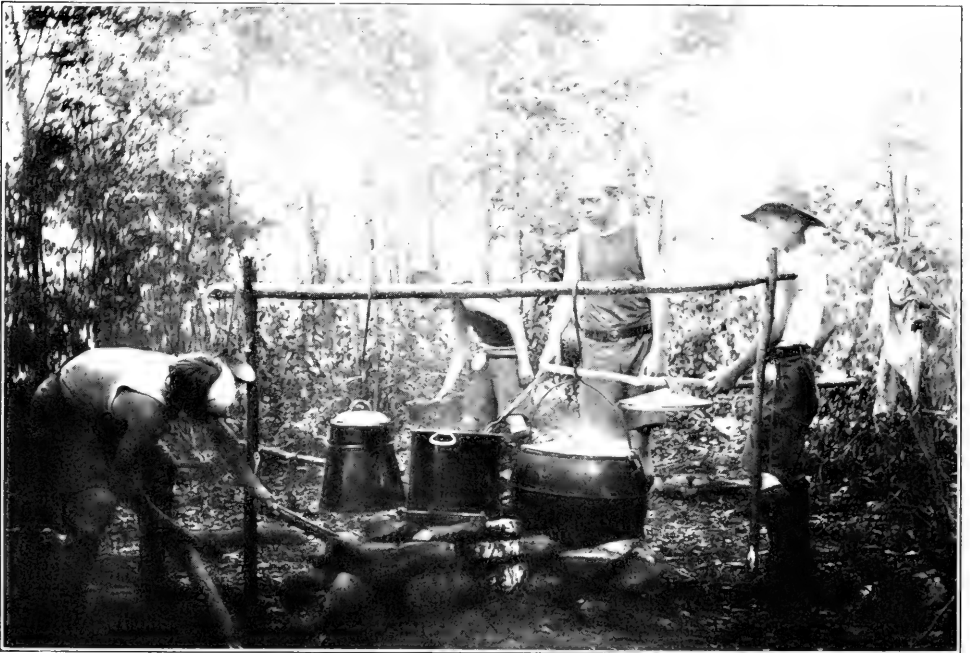

THE COOKS GET BUSY.

THE FIRST WORK IS TO BUILD THE KITCHEN AND SET THE POTS TO BOILING FOR THE AVERAGE BOY SCOUT ALMOST DOUBLES HIS USUAL GOOD APPETITE WHEN HE GETS INTO THE WOODS.



THE CAMP IS READY.

THE TENTS, WELL FLOORED TO PREVENT DAMPNESS, ARE UP AND THE COSILY BLANKETED COTS ARE READY TO GO UNDER CANVAS.

includes everything that creeps or flies or runs. A covering of new snow becomes a fascinating book upon whose pages are traced the pranks, the squabbles and struggles of the woods folk. Then, too, there are numerous games to which the woods form the best setting. The pursuit of big game by marking the trail with tracking irons fastened to the shoes of the boy chosen to represent the quarry, limitless variations of the reenactment of our ancestor's struggles with robbers and Indians, and miniature models of the war games played by the army make up the admirable collections of contests compiled for the use of Scouts by the National Headquarters.

It is the chase, the mimic warfare with robbers or Indians, the hidden camp, and roaring fire that appeal to the boy's imagination and develop in him the rugged primitive virtues upon which the superstructure of our modern life is built.

The permanent camp is even better for this purpose than the short hike and every Boy Scout organization has come to realize that camping out in the woods gives an opportunity to educate, or draw out, the boy in a way that no

other surroundings will. Scout and Scoutmaster come closer together and gain mutual respect in the common performance of camp duties and pleasures. As an illustration of how permanent camps are conducted in the woods the camp maintained by the Washington Branch may be cited. This was located on the shores of Chesapeake Beach in a grove of timber. The organization owned a tract of 50 acres at this point which furnished an excellent place for the Scouts to be given practical instruction in the identification of tree species and the tending of woods. Another year it is planned to start a nursery in order that the boys may learn something about setting out trees. Nearly every local organization now maintains a similar camp, and although a stretch of water in which the boys can swim is essential the presence of woods is equally important. There are so many Scout activities which can only be carried on in a forest that a Boy Scout camp is always located as a matter of course in or near woods.

Another illustration of the large rôle which life in the woods plays in the scheme of Scout instruction is indicated by the first and second class Scout



READY FOR MORNING INSPECTION.

requirements. These include cooking, swimming, tracking, woodsmanship, a small amount of astronomy, tree identification and a knowledge of animals and birds. They are, in fact, merely the minimum tests which a woodsman has to pass. In order to encourage the boy to keep on with the work of equipping himself for life in the woods, merit badges are offered in the following

subjects—archery, astronomy, camping, cooking, first aid, horsemanship, path finding, personal health, swimming. Every thoroughly equipped woodsman is an expert in practically every one of these subjects. Through the knowledge of this kind, Scouts like Daniel Boone and David Crockett were able to outwit the Indian and win for us the country west of the Alleghany Mountains.



A HIKE THROUGH THE WOODS.

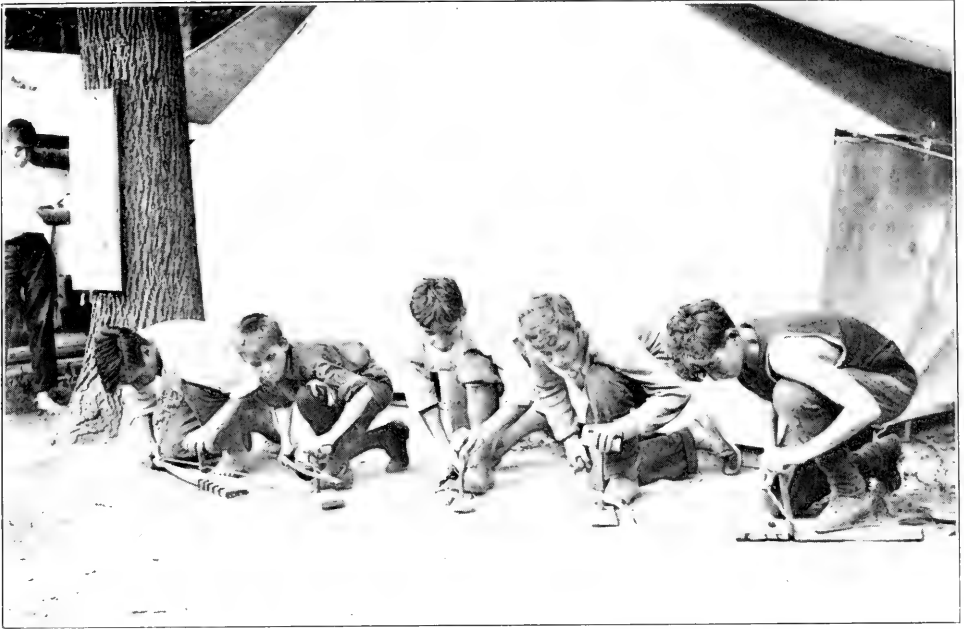

TRYING TO MAKE FIRE BY RUBBING TWO STICKS TOGETHER.

But it is not only as a place in which to seek adventure and learn hardihood that the forest interests the Boy Scout. To it he goes when he wishes to hunt,

fish or trap. In other words, it is a storehouse from which he may gain a very fair living if he has the wit. Even in woods from which game has been



THE HIKERS ON THE MARCH.



CLIMBING THE FLAG POLE.

exterminated there are berries and nuts which make it worth while for him to spend his spare time there. Furthermore, there is nothing as interesting to a boy as the construction of a log cabin and for this purpose he must of course go to the forest for his material. Many Troops have constructed cabins in which they hold their meetings.

Very early in his school work the normal boy takes up carpentry. This

his own material he can carry through from the stump to the finished product the process of shaping the wood for the end in view.

The following merit badges, whose purpose is to encourage the boy to make himself thoroughly familiar with the resources of the forest, are offered to first class Scouts for special proficiency: Angling, tree study, carpentry, craftsmanship, marksmanship, pioneering, stalking and taxiderming. All of these studies may be best practiced in the woods or on raw material derived from the forest.



POSING FOR THEIR PHOTOGRAPH.

shows him another use for which he is indebted to the forest. Even a little work with the saw and plane soon brings out the wide variations in the qualities of different woods. All wood is wood to the youthful carpenter who has received no instruction, but a Boy Scout is early taught that the hardwoods while pretty to look at when polished are relatively unimportant. For his camp fires, boats, and log houses softwoods are better.

If he is fortunate enough to be in a community where he can go out and cut

Since the boy repeats in his development the history of the race his interest in the forest is an evolution. Like the pioneer and frontiersman he regards the woods at first merely as a place in which he may seek adventure. Later he comes to realize that the forest yields many products which can be made useful. In other words, he passes from the point of view of the frontiersman to that of the lumberman. But the Boy Scout organization has been wise enough to see that these two points of view do not represent the highest type of interest in the forest. Merit badges are offered in agriculture, art, conservation, forestry and surveying through which a Scout may learn something about conservation of game and fish, water, timber and the beauty of the forest. Some branches of

the organization have even made this interest concrete by calling in the assistance of the boys in fire fighting. The State of Michigan has made a notable contribution in this way and annually employs a large number of Boy Scouts during the fire season to help in the protection of its forests from fire. Besides the active aid which the boys give this campaign has also had the good effect of showing that there is something more worth while doing than setting fires to the woods, a com-

mon pastime of all boys a few years ago. Other ways in which the Scouts have aided directly in the conservation of trees are the recent census of shade trees in New Jersey and the help which they have furnished in protecting the street trees in Pittsburgh. The planting out of seedlings either for forest purposes or as shade trees is likewise a field in which Boy Scouts have done much.

It will readily be seen that the boy who enters the Scout organization, passes through the three stages of tenderfoot, second and first class Scout and then tries for the various merit badges referred to above, can attain

an excellent grounding in the ways of taking care of himself in the woods, and a thorough understanding of the importance of the forests in our national life. In fact, if he cares to do so he may easily equip himself as well as most Forest Rangers are when they start to work in the woods. Should he decide to take up forestry as a profession he will find himself far ahead of young men who have not had the advantage of a Scout training. In case he chooses to go to one of the higher professional schools he will have a foundation upon which to build a solid superstructure of technical knowledge.

TOWNSHIP FORESTRY CLUB

By GEORGE B. COBB,

Secretary Forestry Club, Tryon, N. C.

TO TRYON, Polk County, North Carolina, belongs the distinction of organizing and putting into practical operation the first township organization for the express purpose of preventing forest fires, and conserving and perpetuating the timber tracts of the old North State. The State has, in years past, suffered greatly from fire, insect pests and blight. Now special committees of this club are successfully safeguarding, and at very small cost, the trees of the county from such ravages.

This Forestry Club, organized more than a year ago, has over sixty active members.

A chief warden directs the fighting at all forest fires in the township, which, as soon as discovered, are reported to him by telephone or signal. With several lookout stations established in the "Thermal Belt" section along the south side of the Blue Ridge range of mountains, and across the Pacolet and Skywicker Valleys below, practically overlooking the entire area of the township, it has been possible to cope successfully with every fire that threatened in 1914.

The organization of this club was the outcome of an idea advanced by George B. Cobb Editor of *The Polk County*

News, Tryon, N. C., in an editorial published in October 1913, enumerating the many benefits forest landowners would realize from the systematic cooperation of all interested. The idea met with universal approval, resulting in organization of the Club the following November.

The officers are: E. R. Rankin, President; W. B. Stone, Vice-president; W. H. Stearns, Treasurer; George B. Cobb, Secretary; C. M. Howes, Fire Warden.

Standing Committees of three members each for Forest Protection, Forest Preservation, Forest Perpetuation, and Finance, complete the organization.

This small Club has proven so satisfactory to all interested, and its work so efficient, that it has met the approval of the State Forester and The North Carolina Forestry Association, which advocate the formation of like township organizations for forest protection, in place of County organizations which in many cases have proven too large, and too scattered for quick, effective work in forest fire fighting.

Through the efforts of this Club the Commissioners of Polk County offer a standing reward of \$50.00 for the apprehension and conviction of any person setting fires in the open, contrary to the laws of the State.

THE JUNIPERO OAK

By ALLEN HENRY WRIGHT

THERE have been many famous trees in history, which have become as shrines to many enthusiasts. Thus we have the trees which are associated with the names of George Washington, William Penn and others. Overlooking the ancient city of Smyrna, on Mt. Pagus, there stands a tall cypress-tree which is said to mark the spot where Polycarp, one of the early Christian fathers, was burned at the stake in the year A. D. 168.

In the old city of Monterey, California, which is replete with buildings and things of historical interest, there is to be found, in the rear of the San Carlos Mission, all that remains of an ancient oak. An inscription on a stone at the base reads: "The Junipero Oak. At Monterey June 3rd, 1770, the ceremony of taking possession of California for Spain was enacted by Father Junipero Serra under the shade of this tree. Placed here for preservation by R. M. Mestres and H. A. Greene, 1905."

Padre Junipero Serra was the leader of the Franciscans who established and maintained the chain of Missions along the Pacific coast, starting with the Mission of San Diego de Alcala, near the present city of San Diego, California, in 1769.

At San Diego there still stand some of the palms and olive trees which were planted by the padres. Beautiful pepper trees are also features of the landscape which date back to their time.



Photo by A. H. Wright

THE JUNIPERO OAK AT MONTEREY, CAL.



FORESTS AND GAME PRESERVATION

By OTTOMAR H. VAN NORDEN, *of the Camp Fire Club of America*

IT HAS been said in jest of the Camp Fire Club of America apropos of our Game Protection activities, that "we are an association of criminals organized for the prevention of crime." Perhaps it is that our too short days on wilderness trails, beside limpid lakes or under beetling mountains has shown us what is the real spirit of the wilderness and has made us eager missionaries in the cause of the spreading of the gospel of the forest.

Three centuries ago our ancestors found on coming to this continent a vast forest stretching unbroken from the Atlantic to the Mississippi. They had come to make this new land their home and the great forest was a serious obstacle—to be cut and girdled and burned—that the land might be cleared.

When they became involved in warfare with the Indians the forest presented a new menace—it furnished a perfect cover for their enemies. And so they destroyed it, secure in the

knowledge that it was inexhaustible, and with it in the same manner they destroyed its wild life—its myriads of birds and mammals.

Later, with the growth of population, there came a demand for lumber and then followed that orgy of destruction of the 19th century, when we used a little and wasted much, when we lumbered without thought of the future, and the always ready fire closely followed the lumberman, and left desolation.

So now in this 20th century our game and forests are about gone. Like the Prodigal we have spent our patrimony but unlike him we have no indulgent father to divide our older brother's heritage with us. We must eat the husks.

Have you ever considered how fortunate for us it was that our ancestors found a bleak coast, a dark primeval forest, and resourceful and dangerous enemies instead of sunny and fertile



IN THE MOUNTAIN SHEEP COUNTRY.

PORTIONS OF THE NATIONAL FORESTS IN THE WEST ARE IDEAL FOR BIG GAME HUNTERS AND WILL BECOME MORE SO, AS IT IS PLANNED TO MAKE SECTIONS ABOVE TIMBER LINE WILD GAME REFUGES.



GREAT BLUE HERON AND WHITE EGRET.

THE HERON IS IN THE FOREGROUND, THE EGRET FURTHER UP THE CREEK WHICH IS WEST CACHE CREEK ON THE WICHITA NATIONAL FOREST, OKLAHOMA.

plains? Do we fully appreciate what we owe to that great wilderness? For a full century and a half our forefathers battled with it for mere survival, for 150 years they developed courage, resourcefulness, hardihood and individuality, and without a Moses to lead them on or a daily shower of manna from heaven to feed them, they shook off the habits of centuries of European convention and developed the American spirit that spoke in the Declaration of Independence, in the War of the Revolution, and that in another short hundred years conquered and settled this great country. For all that wonderful achievement, for our very American nation today, we must thank the wilderness.

But today the great forests are gone. We are city dwellers. Instead of our noble frontier we have the tenements

and the slums. Instead of the noble Indian we have the degenerate gun man. We face many serious social and economic problems which must be solved.

Are we developing the high moral standards, the individualism, the courage and self reliance which as a nation we must have to solve these problems?

Certainly we need the qualities of Washington and Lincoln, of Daniel Boone and Davy Crockett,—and they were educated in the wilderness school.

Our answer is this: We must preserve some real wilderness, in parks of course, for our coming generations. We must give them a chance to know and love the real woods. As far as we can we must reintroduce them to the out of doors and instill in them and keep alive the spirit and love of the wilderness.

You may well wonder what forest and game protection has to do with

history, and sociology and economics. It has much to do. We must have the incentive to go to the forest, and there we must have the inspiration of the woods, natural and beautiful; of the wild life as it once existed when the forests were primeval. No artificial forest this; no dollars or cents in it—just nature at her best without the regulations and improvements of man.

We believe in scientific forestry. There are many millions of acres of denuded lands within our borders which must be replanted. There are many other millions of acres of forests which must be cut, in order that the demands of commerce may be met, and those lands must be so lumbered that the cover shall be preserved, that reproduction may be assured and that fire may be controlled.

We, as a nation must so develop our lumber resources that we shall supply our own wants and export—if we find a market. That is a business proposition and we believe in it as business men. For those lands let us utilize the best and latest practice in silviculture. Let us develop the highest efficiency upon them so as to secure the greatest yield, as we would in a silk factory or a steel mill.

But let us remember that such tracts of lands are tree orchards, not parks, and that they are operated for commerce and not for inspiration.

WE WANT REAL WILDERNESS PARKS

Remember what I have said about the old wilderness. Remember what I have said about the sturdy national character that wilderness built, and then you will know why we want some tracts of forest land to be natural in both trees, scrub and wild life. Why we want forests where birds and game can live; where the trees grow to maturity and die and fall; where the moss on the rotted trunks, the maple scrub, the poplar and the alder furnish food to the deer and moose and beaver and the decayed branch furnishes a home and food to the woodpecker and the chickadee.

A real forest is as much more than a collection of trees as a city is more than

a collection of houses. The life of a city is in its population, without which it would be a mere empty skeleton. But the teeming activities of a city, with all their complex interrelations, are no more intricate and wonderful than the life of a natural forest with its myriads of creatures large and small deriving their life from that forest and doing their part in its support and maintenance.

Take for example an eastern forest, such as our old North woods. The trees, though all important, are merely the framework around which the complex structure is built.

Its foundation is in the deep moist duff, rich with the accumulation of ages of life and death and decay, and from this foundation springs, not only the trees, but the undergrowth which is as much a part of the forest as the leaf cover overhead. For here in this undergrowth live and move the myriad forms of animal and bird life. The shrubbery furnishes food for the deer and the moose. The smaller growth sustains the rabbits, mice and other mammals, which in their turn are food for the fox, the bobcat, the great horned owl and the eagle.

And these wild creatures not only derive their livelihood from the forest but play as well an important part in its care and maintenance. The small birds, the warblers, vireos, and chickadees—with their incessant activities are ridding the trees of worms and caterpillars and other destructive insects. The nuthatches and the creepers are climbing up and down the trunks picking eggs and larva from the crevices of the bark. The hard working woodpeckers are busily hunting out and destroying borers that live under the bark where man cannot find them, while the great pileated wood-pecker, with infinite pains, hews an opening into the very heart of the trunk and reaches the colonies of ants that have honeycombed it with their galleries.

By far the greater part of these birds make their homes in the undergrowth and when man clears this out should he wonder why his trees are overrun with insect pests?

Tree surgery is well enough, in its place, but if all the dead trees and branches were removed from a forest where would the woodpeckers and chickadees and wrens find holes for their nests. And remember—many of the little creatures reared in those holes migrate later throughout the length of our country and perform an inestimable service for the farmer.

But these birds and animals not only protect their forest home, they help to perpetuate it. The red squirrel and the much persecuted grey squirrel are excellent tree planters when they bury a nut and forget where they put it. The seed and berry eating birds scatter undigested seed which takes root and makes new cover—who has not noticed the rows of Red Cedar along the old fence lines, all planted by the birds.

And so we might go on at length showing how the woods people work and live and do their part in producing that marvelous organic mechanism, nature's greatest work—a natural living forest.

Compare this, for instance, with such a carefully groomed and combed scientific product as a German forest. There we have tree orchards, tree farms, carefully selected and planted, the floor clean and garnished, useful as a lumber supply, but without character and life—like a city without people—splendid perhaps as an exhibition of architecture, but lifeless. For as hordes of people through a city so the natural forest is thronged with its workers which are as important as the tree itself, and as necessary to make it a wilderness.



BISON IN WICHITA GAME PRESERVE.

THESE BIG FELLOWS FIND GOOD FEEDING ON THIS FINE RANGE ON THE WICHITA NATIONAL FOREST, OKLAHOMA.



LARGE BULL ELK.

THIS NOBLE ANIMAL IS WELL CONTENTED WITH HIS LIFE ON THE BUFFALO RANGE ON THE WICHITA NATIONAL FOREST, OKLAHOMA.

ARE WE IDEALISTS?

We have been accused of being idealists, dreamers. May we ask who awakened the American people to the necessity of conservation? Was it a lumberman? Was it a man versed in the principles of scientific forestry? Was it a college professor? No, it was a naturalist, an idealist, a big game hunter. To our Roosevelts, our John Muirs and our Joaquin Millers, and many others, as enthusiastic but less prominent, we must give due credit for awakening us to the peril of the total loss of our national domain to private greed and sowing for us, as a national heritage for all time, our national parks and forests.

We Americans are apt to look at things through the dollar sign but in this let us become a little sentimental and realize that the development of character, of self reliance by the love

of the real wilderness in our coming generations is as important as money making.

Here may I suggest that perhaps our American Forestry Association—and I speak as a member of it—might well advocate the extension of our system of national and state parks, and their maintenance as natural wild forests, as happy recreation grounds, where the ax might never be applied except where the welfare of the forest required it in the making of fire lines and the necessary roads and trails. We have a number of such parks but we need more—not to interfere with our commercial forests, but to be a thing apart from them.

In this connection may I mention the proposed Grand Canyon National Park which the Camp Fire Club is advocating. The most beautiful section of the canyon is now a national monument,



Photo. by Dr. J. J. Kirkleride.

MOOSE HUNTERS CAMP.

THIS IS ON ELLIS BROOK, MAINE, AND IN A COUNTRY FAMOUS AS MOOSE HUNTING GROUND.

made so by a proclamation of Ex-President Roosevelt. To assure the protection of this great National wonder it should be made into a National Park, both the Canyon and a wide strip of forests on either side. May we have the cooperation of the American Forestry Association in this great and necessary work?

And now to conclude, we believe in so-called scientific forestry and in commercial forests. We must have great areas of them.

But we want also National and State parks where the forests can remain untouched, except for fire protection, where we can preserve for all time bits of wilderness, where the game and forests may exist under natural conditions. Here we and those that will come after us may get an idea of what our continent was like before it was civilized, and here perhaps we may help to develop in the coming generations some of those sturdy qualities our forefathers had.

* From an address at the 34th Annual Meeting of the American Forestry Association, New York City, January 11, 1915.

IMPROVING WHITE MOUNTAIN FORESTS

By WM. L. HALL, *Assistant Forester U. S. Forest Service*

[The first sale of Government timber on the White Mountain forests has been made and the reason for it is of decided interest to the many millions living in New England and along the Appalachians. Twenty-five per cent. of the money derived from this sale is returned to the towns and counties in which the timber is located in lieu of taxes. The writer explains the situation clearly and his article should attract much attention.—Editor.]

THE Federal Government having acquired large tracts of forest lands in the White Mountains is now beginning the necessary improvements to make the forest fully useful to the Nation. Construction of roads, trails and telephone lines necessary to make the tracts accessible for purposes of protection and use have been under way during the past two years. Uses of the lands for purpose of summer cottages, camps and other purposes in line with the objects of the Government have begun.

As a further step in the policy of development the first sale of 500,000 feet of Government timber has just been awarded. Very naturally the question may arise as to why it is desirable to cut any of the Government's timber. Why not leave it just as it is? The answer may best be given by stating the purposes of the sale. This I will do and then discuss some of the fundamental considerations which are involved.

Briefly the purposes of this sale are to clear away a large amount of mature, overmature and defective timber and liberate a fine stand of young trees which is already present, to test methods of removing this material with minimal damage to the young growth, to ascertain the best means of disposing of the resulting brush, and to get revenue. The first object is the improvement of the stand, the second to ascertain by experiment the best methods to employ and the third to secure financial returns.

First let me discuss the third, and as some will think the least important object, the securing of financial returns. It is important that the lands the

Government buys yield a return on the investment. It is absolutely necessary in the long run that they do so. The Nation will not regard the project as a success unless they do. The ones chiefly interested in having some returns from these lands, however, are the towns and counties in which they are situated. When these lands were acquired by the United States they were removed from taxation and the tax burden on the other lands was correspondingly increased. Congress has met this situation by providing that 25 per cent. of the gross returns from the sale of the timber and from other sources be returned to the States and counties concerned in lieu of taxes. It would be unfair to the towns and counties to hold back on the cutting of extensive bodies of timber and deprive them of the revenues they need.

But to come back to the main object, which is the improvement of the forest. Much of the cutting done in the White Mountains in the past left the forest in bad condition. The poor trees should have been taken and some of the good ones left. But the other thing was done. Good ones were taken and poor ones left. A great tangle of brush was left, too, which has been increased by the blowing down of some of the defective trees left standing. In its purchases the United States has acquired a great deal of this class of culled and cutover timber land. Now the problem is how to get that forest back into good condition. This sale is the first step taken in that direction and it has been made on a representative area and in a situation where the work can be handled advantageously. It



IN THE WHITE MOUNTAINS.

THIS IS IN COOS COUNTY, NEW HAMPSHIRE, AND THERE IS A FINE GROWTH OF HARDWOOD AND SPRUCE NEAR THE TOP OF THE RANGE.

covers 162 acres and occupies a strip $1\frac{1}{2}$ miles long and $\frac{1}{4}$ mile wide adjacent to the west side of the Tunnel Road which passes through the notch west of Mt. Moosilauke. At the nearest point the area is $1\frac{1}{2}$ miles from the railroad station of Glencliff and the average haul will be $2\frac{1}{4}$ miles over a good down grade road. The nearness to a shipping point and the presence of roads will make it possible to utilize most of the sound material which the trees contain, including some of the fuel wood.

The different parts of the area will receive somewhat different treatment due to the varying conditions. Some 31 acres are characterized by a second growth forest. On this part the former stand must have been clean cut, some portions as much as 60 other portions not over 35 or 40 years ago. In the younger present growth which is of excellent quality, paper birch, yellow

birch, maple and popple make up the bulk of the stand. But few trees have reached the size for removal. In as much as the stand is not crowded, only a tree here and there will be taken out with a result which will scarcely be noticeable.

In the older second growth stand there is a larger proportion of paper birches, many of which are mature and are of optimum size, form and condition. Beneath is a fine understory of 10 to 12 foot high spruce and balsam which needs only the sunlight to spring into rapid growth. Here it is expected to remove the paper birch and popple above 8 inches in diameter and the yellow birch and maple above 10 inches, measurements being made $4\frac{1}{2}$ feet above the ground. There will be removed about 2400 feet of timber per acre while the young trees to be left

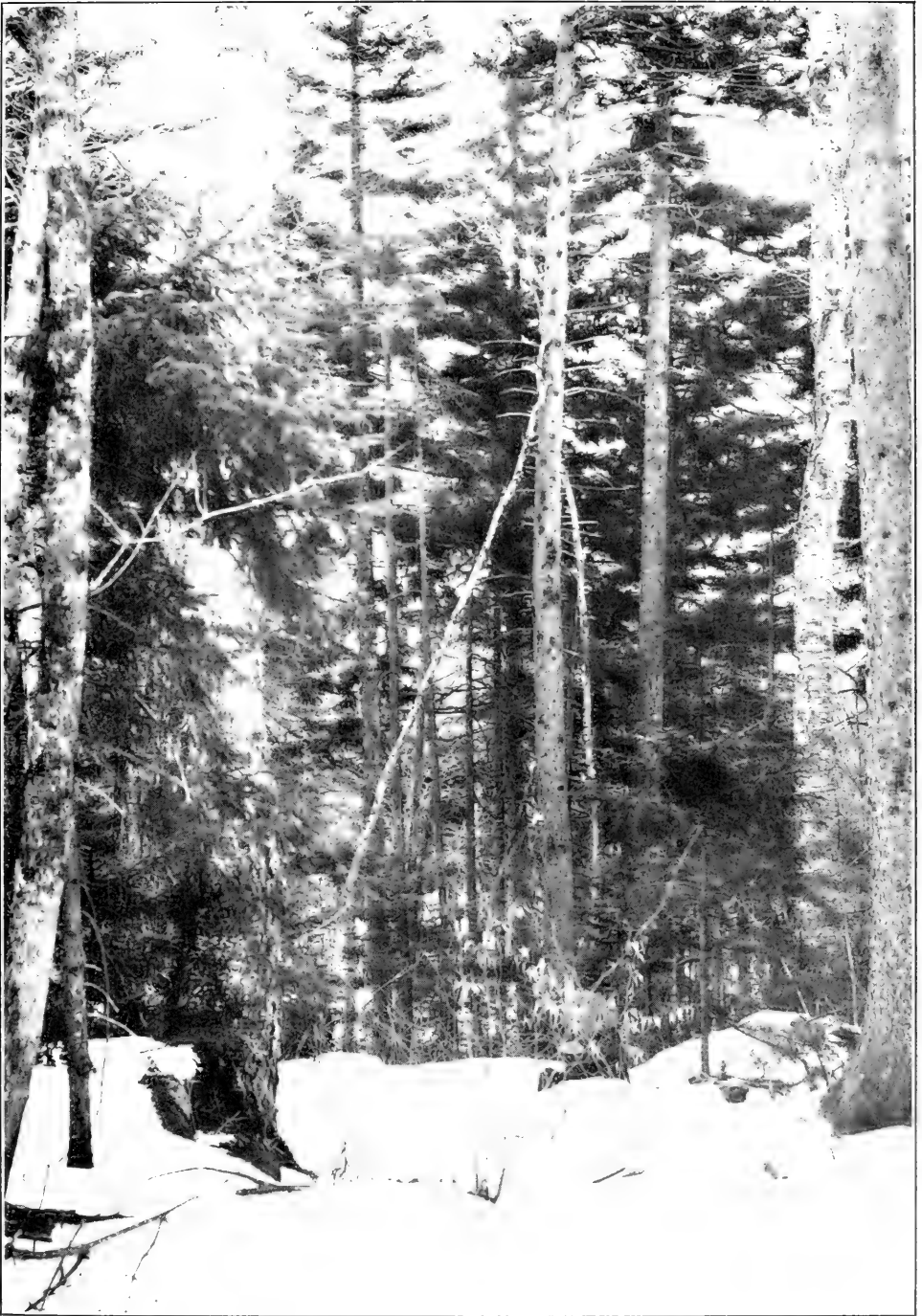

Photograph by E. D. Fletcher.

HARDWOODS AND LARGE SPRUCE TO BE CUT.

IN THE CLUMPS OF SPRUCE THE FOREST OFFICER IN CHARGE MAY REMOVE THE ENTIRE GROUP PROVIDED THIS DOES NOT LEAVE A HOLE OF MORE THAN A QUARTER ACRE IN EXTENT, HE MAY THIN THE GROUP BY TAKING OUT THE LARGER TREES OR HE MAY LEAVE THE GROUP INTACT. IN THIS PARTICULAR GROUP THE HARDWOODS AND THE LARGER SPRUCE WOULD BE TAKEN, LEAVING A GOOD NUMBER OF YOUNG SPRUCE.



Photograph by E. D. Fletcher.

YOUNG GROWTH PREDOMINATES.

A FINE STAND OF YOUNG GROWTH COVERS ALMOST THE ENTIRE CUTTING AREA. OF THE TREES WHICH WILL BE LEFT ON EACH ACRE AFTER CUTTING SOME 40 TO 80 WILL BE OVER 6 INCHES IN DIAMETER, 500 TO 750 WILL BE BETWEEN 5 FEET HIGH AND 6 INCHES IN DIAMETER, WHILE THE NUMBER UNDER 5 FEET HIGH WILL BE 5,000 OR MORE.



Photograph by E. D. Fletcher

WILL ENCOURAGE SPRUCE AND BALSAM.

IN THE OLDER SECOND GROWTH STAND THERE IS A LARGE PROPORTION OF PAPER BIRCHES MANY OF WHICH ARE OF OPTIMUM SIZE, FORM AND CONDITION. BENEATH IS A FINE UNDERSTORY OF SPRUCE AND BALSAM WHICH NEEDS ONLY THE SUNLIGHT TO SPRING INTO RAPID GROWTH. THE PAPER BIRCHES ABOVE EIGHT INCHES AND THE YELLOW BIRCHES AND MAPLES ABOVE TEN INCHES IN DIAMETER WILL BE REMOVED.



Photograph by E. D. Fletcher

HOW THE THINNING WILL BE DONE.

AS THE PRESENT CULLED AREA LOOKS FROM THE STATE HIGHWAY. THE CUTTING HERE WILL BE LIGHT AND HAVE AS ONE OF ITS CHIEF OBJECTS THE IMPROVED APPEARANCE OF THE STAND. AT THIS PARTICULAR SPOT THE LARGE MAPLE AT THE RIGHT AND THE LEANING TREE WILL BE CUT AND SOME THINNING DONE IN THE GROUP AT THE LEFT. ALL THE REST WILL BE LEFT. ALL THE BRUSH ALONG THE HIGHWAY WILL BE BURNED.

will number 5157 per acre of which 80 will be over 6 inches in diameter.

The principal part of the sale area, 118 acres, is occupied by a mixed forest of hardwoods and spruce from which the better trees were culled some 15 years ago. There remain numerous defective and old hardwoods with here and there clumps of spruce and balsam, the trees in which have made considerable growth since the last cutting. This type presents a very unattractive appearance. One sees at first glance some very good looking large maples and birches but a casual examination shows some to be defective and others to be overmature and on the decline. The previous cutting left several big holes in the forest where all the trees were removed. In other places small clumps and single trees which were left have blown down making an almost impenetrable tangle. It will be an easy matter to put this kind of forest into much better condition for growth but it will be difficult to make it look well. But let it be remembered that it does not look well now.

It is proposed to remove the yellow birches and maples above 10 inches in diameter and the paper birches and other species above 8 inches. Spruce will not be cut under 12 inches except as a tree may be subject to windfall if left standing. Trees larger than the cutting limits will be left where they are needed to fill up the stand. The forest officers in charge of the sale will have a good deal of latitude in deciding whether to take or leave an individual tree. The effect in this type will be to remove about 4000 feet of timber per acre with a considerable thinning of the stand but care will be exercised to make no large gaps. If after the operation there appear to be considerable areas which have been clean cut they will be those which resulted from the former and not from the present cutting. There will be left on the ground some 6900 young trees per acre of which 38 will be over 6 inches in diameter, while 750 will be between 5 feet in height and 6 inches in diameter.

Fartherest from the road and highest on the mountain is a small section of

virgin mixed forest which at the very highest point changes to a pure stand of small sized spruce. This latter will not be cut at all. From the mixed portion the large trees of both spruce and hardwoods will be removed leaving the ground well covered with a vigorous stand of young spruce, paper birch, yellow birch and maple.

No timber will of course be cut until it is marked by the forest officer in charge of the sale and the following instructions have been issued to guide him in marking the mixed hardwood and spruce type:

"In those portions of the type in which there is considerable merchantable spruce a selection system, by which all the overmature, mature, and deteriorating timber of all species will be removed, should be followed. Windfall must be particularly guarded against, especially in the spruce. For this reason the diameter limits specified should not be adhered to except as they may serve as an indication of the maturity of the timber. Thrifty trees which may be expected to further develop within the next 30 years and form a part of the succeeding cutting should be left. Spruce frequently occurs in the form of a group. In marking spruce, therefore, it will be advisable to form a group wherever practicable of at least one-fourth of an acre in extent and (1) leave the group intact; (2) thin out the larger hardwoods and spruce over 12 inches, leaving the remainder of the group, where the thinning can be done without danger from windfall; or (3) clear cut the group. The method to be followed must depend upon the composition of the group, the site, the condition of the timber, and the degree to which any cutting within the group can be conducted without making serious openings and endangering the remaining trees from windfall. The point to be borne in mind is that it is desired to have all mature or deteriorated spruce and hardwoods removed, and where they can not be removed from a spruce group without endangering the remaining trees in the group from windfall, the marker has the alternative of leaving the entire group or clear cutting."



CRYSTAL CASCADE IN TUCKERMAN'S RAVINE.

THIS IS ON THE SLOPE OF MT. WASHINGTON IN COOS COUNTY, NEW HAMPSHIRE. NOTE THE DENSE FOREST GROWTH ON EACH SIDE OF THE FALLS.

It must be recognized that no matter what the purpose of cutting in the forest there must result an accumulation of brush. We cannot avoid brush in cutting timber any more than we can avoid dust in sweeping the floor. One of the most important questions in this as well as in all sales on Government lands in the White Mountains will be how to handle this brush so as least to damage the forest and offend the eye.

The softwood brush will not make much trouble. The stand is only about one-half softwoods, the tops are small and the trees are either scattered or in small groups. Furthermore, the softwood trees are to be used down to 4 inches in diameter at the top so that the amount of brush will not be great. The regulations provide that the softwood brush shall be piled and burned.



GLEN ELLIS CASCADE, WHITE MOUNTAINS.

ONE OF THE NUMEROUS WATER FALLS WHICH WILL BE PRESERVED BY THE PRESERVATION OF THE FORESTS UNDER THE CONTROL OF THE GOVERNMENT.

It is the hardwood brush that gives most concern. The big maples and birches have huge tops and in the first place they will cause some damage

in felling. This, however, can be kept at a minimum by careful supervision of the cutting operations. The big hardwoods can not be used down to as

small a diameter in the tops as the spruces and firs. Generally it will not be possible to use them below 8 inches and often the top is dissipated into limbs at a point where the trunk is 12 or 15 inches in diameter. Such trees invariably result in a large quantity of brush. The regulations require that all of the limbs be cut from the trunk and that the brush three inches in diameter and smaller be piled or scattered at the discretion of the Forest Officer in charge. It is the purpose of the Forest Service to ascertain by careful study the best means of handling this kind of brush. There is to be a great deal of it in the White Mountain sales and we want to learn as soon as possible how to deal with it.

The branches larger than three inches in diameter are to be trimmed up and left flat on the ground unless they can be utilized as cordwood. The contract has been drawn on the supposition that much of this material can be utilized as fuel. If so it will be easier to clean up the sale area and leave it in neat and tidy condition.

SPECIAL TREATMENT FOR STRIP ADJACENT TO HIGHWAY

It is proposed to give special treatment to an 8-rod strip bordering the State Highway. On this strip the utmost care will be taken to do the cutting and to handle the material to be removed and the brush in such a way as to give no offense to the critical observer. Before the sale was awarded a special marking Board, consisting of three experienced men of the Forest Service, went over and marked the trees to be removed on most of the strip. The purpose was to determine in advance the trees to be removed, and to provide a sample marking for the purchaser and for the forest officer who will have charge of the sale. The result of this special study and marking is to leave slightly more good young merchantable timber on the ground here than on other portions of the area. If a thrifty birch 12 or 15 inches in diameter is needed as a cover or to fill a gap it has been left. The

ground was gone over tree by tree and nothing was marked for removal unless it was defective or could be removed without damage to the appearance of the area.

Also on this 8-rod strip pains will be taken to dispose of the brush. As elsewhere the softwood brush will be piled and burned and the hardwood brush will be handled in the same way unless the cost is found to be prohibitive. Another thing which will be done to improve the appearance of this border strip is to cut down the decayed snags and dead trees, of which unsightly specters the strip contains more than a hundred. These will be brought to the ground, and while it may not be possible to remove them, lying flat upon the ground it will not take them long to decay.

RESULTS

We confess to a feeling of considerable responsibility in undertaking to cut any timber in the White Mountains where the public interest in forest protection is so keenly active. The knowledge that this keen interest exists makes us all the more anxious to try to put the forest in the best possible growing condition. In many places the condition is bad now and there is no doubt but that it can be greatly improved. The question is whether we can do the work successfully by meeting the three essential requirements:

- (1) Give the forest the grooming it needs for future thrift and production.
- (2) Accomplish the work without alarming a watchful public which has come to abhor the old destructive method of timber removal.
- (3) Secure returns which will cover the cost of the timber to the Government and the cost of making the sale.

This is the first sale and we may not succeed as well with it as with later ones but because it is the first sale and because we believe the purpose is right, we bespeak the sympathetic interest of the public. Let us try to restore to these mountain slopes a forest that is as good and if possible better than the virgin stand.



FORESTRY EXHIBITION BUILDING.

IN THE NEW MEXICO BUILDING AT THE PANAMA-CALIFORNIA EXPOSITION AT SAN DIEGO, CAL., IS THE UNITED STATES FORESTRY SERVICE EXHIBIT IN CHARGE OF DON CARLOS ELLIS.

FORESTRY AT THE EXPOSITIONS

By ALLEN HENRY WRIGHT

IT IS in the New Mexico building at the Panama-California Exposition in San Diego, California, that the United States Forest Service is making its official exhibit, with Don Carlos Ellis in charge. On the second floor of this structure, which is a reproduction of one of the oldest buildings in the State of New Mexico, the mission of Acoma, Mr. Ellis has arranged the model fire-fighting station, with all its equipment, the charts showing the work of the Forest Service, maps upon which are shown the National Forests, and models of some of the forests, particularly of New Mexico. Then, too, there are specimens of the various kinds of commercial woods which are grown in the National Forests, and specimens of the grasses that are good for range cattle and those which are bad.

This exhibit has attracted much

interest since the Exposition opened on New Year's Day, and much credit has been given Mr. Ellis for the manner in which he has arranged it. From San Diego he will proceed to San Francisco, where he is to install a similar exhibit for the government at the Panama-Pacific Exposition. During the year he will divide his time between the two cities and their big fairs.

Aside from the forestry display made by the United States government, the San Diego exposition has much of interest to the student of forestry and the reclamation of barren wastes, for the very site of the exposition was little more than a waste spot only two years ago while it is now a garden of floral beauty, with thousands of fine trees, like the acacia, pepper, eucalyptus and palm, lending themselves to the charm of the whole.



A FULL VIEW OF THE BENEDICT ELM.

LARGEST ELM IN CONNECTICUT

By NORMAN DE W. BETTS

LOCAL tradition has it that the Benedict Elm in the township of Wilton, Fairfield County, is now the largest elm in the State of Connecticut. The circumference measured on January 1, 1915, at about four and a half feet from the ground was 14 feet, $11\frac{3}{4}$ inches. The spread was paced in the direction of the highway which it borders and was estimated to be 105 feet. The trunk, as is shown in the photographs, soon breaks up into a great number of large branches

which in turn form a very symmetrical and imposing crown.

In a State noted for its elms, it would be of interest to know how large these veteran shade trees have grown. It might be wise to put on record the descriptions of some of the grandest among them before insects and fungi have brought them down. Perhaps there are other Connecticut elms that have local traditions; where is the largest specimen of this splendid tree?

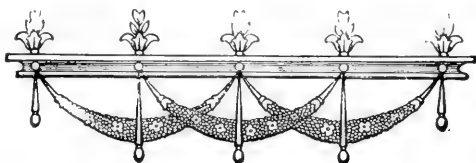

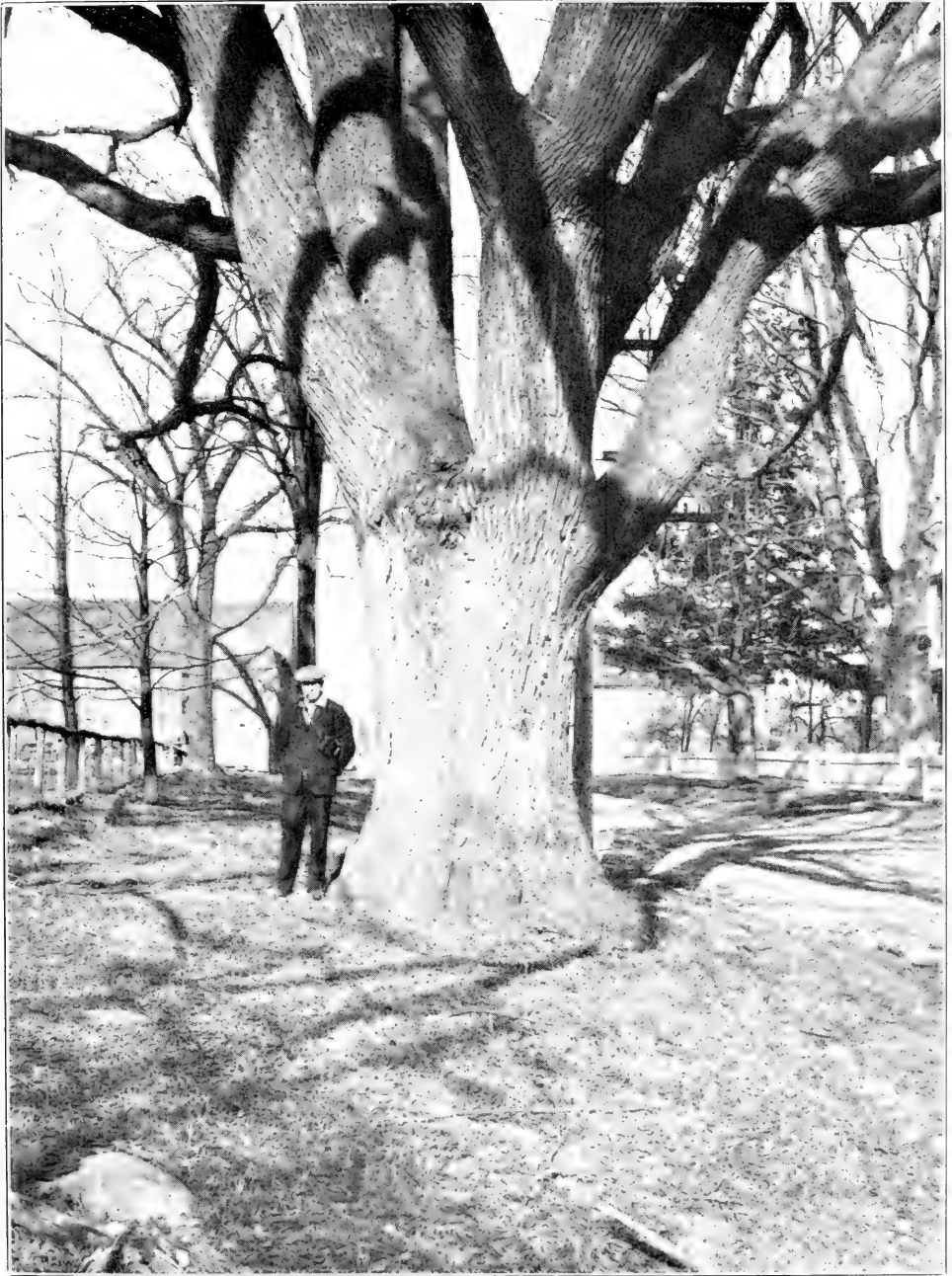

THE BENEDICT ELM.

THIS ELM IS IN WILTON TOWNSHIP, FAIRFIELD COUNTY, CONN. THE CIRCUMFERENCE IS FOURTEEN FEET, ELEVEN AND THREE QUARTER INCHES; AND THE SPREAD ABOUT 105 FEET. IT WAS MEASURED AND PHOTOGRAPHED BY NORMAN DEW. BETTS, JANUARY 1, 1915.

CANADIAN LUMBER COMPETITION

By H. D. LANGILLE

TWENTY-FIVE hundred miles of peaceful, unfortified boundary separates two countries hardly less similar in racial qualities than two contiguous States of the Union. In physical characteristics the two draw apart—the one reaching northward into the Great Barrens; the other southward into tropical luxuriance. The one yields only sustenance for sturdy types; the other is adaptable to every race and productive of almost every product required by humanity. The United States may be self-sufficient; Canada cannot be so. Its greatest development has taken place at its southern extremities, almost within its southernmost two degrees of latitude. Its population in 1911 was only 1.9 souls per square mile. The Silent Places are vacant.

The forest geography of the two countries is not dissimilar. Eastward from Manitoba there was once a vast forest of white and Norway pine corresponding to that of Minnesota and Michigan; while in the southern peninsula of Ontario was an almost solid forest of hardwoods. Quebec was the home of spruce. The Maritime Provinces were densely forested with pine, spruce, hackmatack, balsam, hemlock and various hardwoods. The Height of Land defines the northern boundary of the pine forest. Northward stretches a great scope of spruce woods reaching to Hudson's Bay and thence north-westward almost to the Arctic Sea in latitude nearly seventy degrees.

The earliest records of lumber manufacturing in the provinces runs back to 1696 when planks for gun platforms were cut in New Brunswick. In 1761 it was reported that thirty-one saw mills were in operation in Nova Scotia. Continually since that time the Dominion has given of its forests to the world and despite restrictive tariff measures enacted by the United States there has been an almost constant increase

in the volume of lumber exported across the border. As early as 1813 the value of wood exports was \$29,397,534. In 1897, the fiscal year preceding the adoption of the Dingley bill, the exportation of sawed lumber to the United States was 883,770,000 feet. In 1898, "the year following the restoration of the old duty of \$2.00 on lumber, the imports of boards, deals, etc., dropped to 353,134,000 feet."¹ The total lumber production of Canada in 1912 was 4,389,723 M. In the United States it was 39,158,414 M. The average annual cut per mill in Canada was 1800 M against 1300 M in the States.

The white pine cut of Canada reached its maximum in 1908 and the depletion of its hardwood supply has been rapid. The volume of hardwoods imported during 1910 exceeded by 50 per cent. the value of the hardwoods manufactured into lumber in Canada during that year. As in the United States the scene of greatest production by a single state or province has shifted to the western coast.

The forests of the eastern and northern United States, like those of Eastern Canada, are fast disappearing. With their disappearance has passed the most romantic period in the history of the lumber woods. The chanties are forgotten.

Alike in forest physiography, the forest development of the two countries has followed parallel lines. The spread of prairies on both sides of the international boundary has been spanned. The scenes of greatest activity have been transferred to the western side of the continent where another expanse of forest invites the energies of the men of the woods. Under new physical and economical conditions the contest has been renewed. The last act in the tragedy of America's coniferous forests is staged in British Columbia and the

¹ "History of the Lumber Industry."



INTERIOR OF BRITISH COLUMBIA.

THIS SCENE IS TYPICAL. THERE ARE DENSE FORESTS OF SMALL ENGLEMANN SPRUCE, CEDAR, HEMLOCK, DOUGLAS FIR AND SUB-ALPINE FIR AND IN THE DISTANCE ARE HILLS WHICH HAVE BEEN SWEEPED BY FOREST FIRES.

coastal States of Washington and Oregon.

Like the forest of the Atlantic side that along the Pacific and on either side of the boundary is comprised of the same species. The chief difference is in the percentages of species and the conditions under which they grow.

West of the great prairies, in the intermountain region, the boundary marks approximately the dividing line between two important forest zones, namely, that of western and white pine in the States and an inferior forest of cedar, spruce and hemlock in the Province; although there is some pine north of the boundary and much of the other type south of it. In that region the forest is light in comparison with the coastal forest, the trees are small and the lumber they yield is mostly of low grade; although well adapted to the needs of the adjoining prairie districts.

The optimum region of Douglas fir is between 44 and 48 degrees of north latitude, west of the Cascade Mountains. Interlocking with it on the north is British Columbia's wonderful stand of Pacific red cedar, comprising a very important part of the forest northward to latitude 51 degrees. Northward from that zone, hemlock and silver fir are the prevailing species. Alpine forms descend to sea-level.

The area of the forests of the Province has been variously estimated to be from 182,000,000 acres to less than 17,000,000 acres. The best information available indicates that there may be about 17,000,000 acres of merchantable saw timber. In the opinion of the author, based upon actual cruises and examinations of 1,328,000 acres of this area, there is 335 billion feet in the Province, in place of 240 billion feet as conjectured by the Royal Commission



BRITISH COLUMBIA CEDAR FOREST.

A TYPE OF THE CEDAR FROM WHICH THE FAMOUS BEVELED SIDING AND SHINGLES ARE TAKEN. NOTE THE FIGURE OF A MAN AT THE FOOT OF A TREE.

of Inquiry in its report made in 1910. The area is less than was formerly supposed but the stand is heavier. The total timber supply of the Province approximates that of Washington.

But British Columbia's forest is inferior as to quality and species as the value of species is differentiated at this time. The following table of comparisons, based upon Lacey & Company's cruising in both territories, outside of national forests, parks and reservations, shows the difference existing in the respective regions west of the Cascade Mountains:

COMPARISON BY SPECIES

	Oregon. ²	British Columbia.
Douglas Fir	82.3 per cent.	21.3 per cent.
Cedar	2.4 per cent.	34.4 per cent.
Western Hemlock	9.1 per cent.	28.5 per cent.
Spruce	2.1 per cent.	4.3 per cent.
Silver Fir (A. Amabilis)	1.5 per cent.	11.0 per cent.
Miscellaneous	2.6 per cent.	0.5 per cent.
Average stand per acre	41.6 M feet.	22.2 M feet.

The best timber is most available. Present-day cutting is going on in the most accessible and superior forest. The topography of the coastal region is extremely mountainous and the mountains are generally steep, with bald, rocky crests and narrow valleys between. The commercial forest is on the lower levels. In the interior, glacial formation characterizes the country. The valleys are wider and the slopes are usually less abrupt where merchantable timber grows. The mountain chains are mostly bare and snow-covered during the greater part of the year.

TENURE

Nearly one-half of British Columbia's forest is held under Special Timber Licenses; the remainder under various kinds of grants and leases, and reservations. With the exception of certain Crown grants it is all subject to the payment of royalties when cut. The Forest Act of March 4, 1914, embodies wise forest legislation, virtually making the holders of licenses and other tenures partners with the government. It provides for a royalty of 85 cents per M

upon all No. 1 or No. 2 Douglas fir, spruce, cedar, pine or cottonwood cut west of the Cascades after January 1, 1915, and 50 cents upon all other timber suitable for lumber and shingles. East of the mountains the royalty shall be 50 or 65 cents, according to locality. After January 1, 1920, the royalty shall be increased at the end of five-year periods by amounts equivalent to different percentages "of the increase (if any) in the average wholesale selling price of lumber f.o.b. mill, over \$18" per M. The license fee is fixed during the period to December 31, 1954, at \$140 per license of not more than 640 acres west of the Cascade Range and \$100 east of the Cascades. This rental is approximately equivalent to the average tax per M feet on fee lands in the States. It is fixed and not subject to the caprices of tax levying bodies.

STUMPAGE AND LOG VALUES

In normal times log values are the same in the province as across the line; and as a general statement it may be said that the difference between log cost and log value, which is stumpage, including royalties, is about the same for logs of equal quality. In each territory original purchasers acquired timber at prices which are almost negligible in the cost of logs but latter-day buyers in British Columbia have been required to pay as much for timber of equal log value as is paid in the States. There is but little, if any, foundation of fact in the statement often made by operators in the States that our neighboring manufacturers can sell for less because their timber is cheap. Timber that the market of these years will absorb is not comparatively cheap in the log.

MANUFACTURING COSTS AND LABOR

The initial cost of logging equipment and maintenance is higher in British Columbia than in Washington or Oregon owing to heavy import duties. Supplies and woods labor are higher and the labor, as a rule, is less efficient. The provincial laws prohibit employment of Oriental labor in provincial forests

² Similar figures for Washington have not been compiled but the percentage of cedar is greater.

or on public works, and the standard government wage fixes a high rate for all labor. Eighty per cent. of the donkey engines and blocks, etc., is made in the United States. The wire rope comes from England, while saws and small-mill machinery is mostly made in Canada. Large mills use American-made burners, bands, gangs, log-deck and electrical machinery. The proportion of American-made goods is decreasing but Canadian prices are based on American prices, plus duty. A comparison as between wage scales of mill and woods workers shows that wages in British Columbia are about 10 per cent higher than in Oregon. Considerable Oriental labor is used in the yards but its cost, per unit of production, is equal to that of the labor employed in the western States.

The climatic conditions are similar except that the heavy rains of the northern coast cause more loss of time in the camps. Cutting is less advanced amid the intricate system of interior waterways in the province, hence the haul to water is shorter. The conditions are similar to those which prevailed

along Puget Sound and Columbia river in the days of small loggers. The waterways may offset in a measure the disadvantages alluded to but small operations cannot be economical and the day of the hand logger has passed. It is generally claimed by provincial loggers and manufacturers that operations in the Province cost 20 per cent. more than in the States; and this is unquestionably true in the inter-mountain districts, at least. It is the log value at points of manufacture that counts in a discussion of competition and this has been shown to be equal; excepting that in the States log prices of water-borne logs are made as at booms while in the Province they are usually for logs delivered at points of manufacture.

With its wealth of good cedar British Columbia is able to produce enormous quantities of shingles. Unopposed by restrictive duties it may easily capture the shingle business of the United States where the supply of cedar is comparatively limited. The Province also bears an immense amount of pulp timber and water power for its



AMONG INLETS AND INSIDE WATERS IN BRITISH COLUMBIA.

THIS SCENE IS CHARACTERISTIC. NOTE THE NARROW SHORE LANDS, WELL FORESTED, RISING TO HIGH PEAKS EITHER BARREN OR BEARING POOR TIMBER.

development. One paper mill is now producing 225 tons daily. A sulphite fiber plant is producing 40 tons of fiber per day. "A small portion of this suffices to supply the Provincial market, while freight rates prevent the shipment of newsprint to points east of Alberta. A small quantity of newsprint is shipped to be distributed from Calgary and Edmonton, the balance (comprising over 75 per cent of the output) being marketed in the North-western States. About 25 per cent of the sulphite fiber is sold to paper mills in the same market."³ This in the face of the fact that pulp logs in those States cannot be sold for enough to return the cost of logging. The first shipment of wood pulp from British Columbia to the Atlantic coast was consigned to New York in September of this year.

CANADIAN MARKETS

In 1911 the population of Canada was 7,207,000. The five western provinces with an area of 1,723,700 square miles had 1,321,748 people or less than the present estimated population of Philadelphia. But during recent years there has been an unparalleled influx of settlers into that territory seeking homes on the boundless prairies within the range of grain production. A great boom was experienced. Railroads were built and towns followed. The vacant places were sparingly peopled. As a result an enormous demand for lumber was created—greater per capita than was ever before known. To the west was the almost untouched forest reaching to the sea and the government invited its exploitation. Millions of dollars were invested in timber and manufacturing equipment. Plants sufficient to supply the normal demands of ten million people were erected in frenzied haste to supply one and one-half millions.

Then, by 1913, immigration practically ceased. Stagnation followed inflation and in rapid succession the mills went down, leaving capital and labor unemployed. In 1910 there were 225 saw mills in British Columbia with a

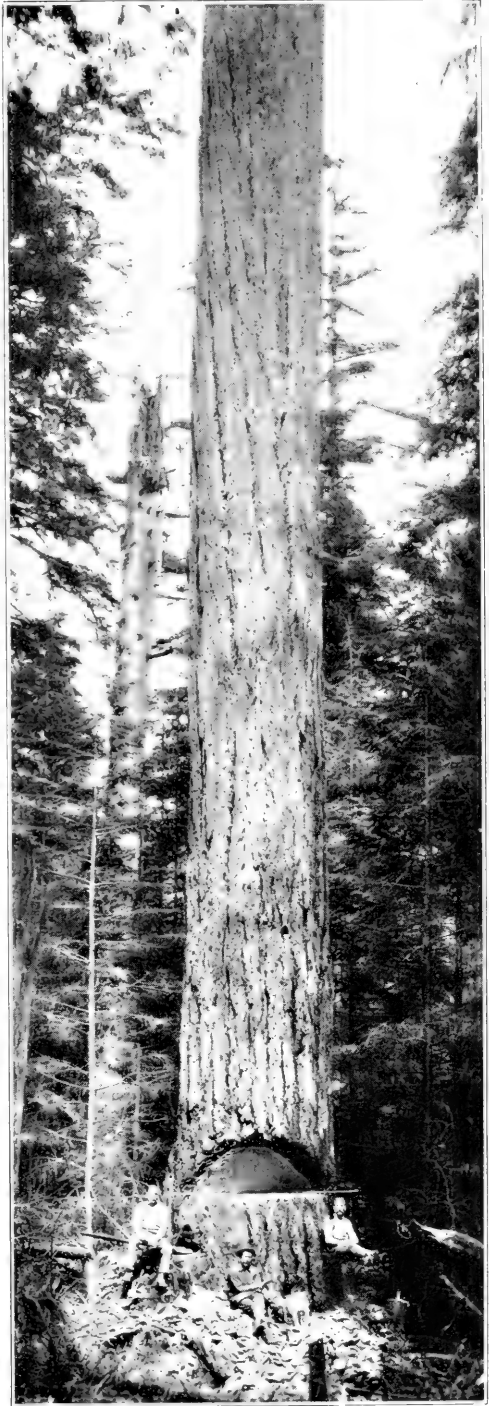

A PERFECT DOUGLAS FIR.

THIS IS ON VANCOUVER ISLAND, BRITISH COLUMBIA. SUCH SPECIMENS ARE LESS COMMON IN THE PROVINCES THAN IN THE STATES.

³ Report of the Minister of Lands, 1913.



WESTERN HEMLOCK IN BRITISH COLUMBIA.

THIS SPECIES IS COMPARABLE TO EASTERN HEMLOCK ONLY IN NAME. THE AUTHOR CLASSSES THIS AS A GOOD STAND.

daily capacity of $4\frac{1}{2}$ million feet. In 1912 it was estimated that \$52,000,000 of American capital was invested in mills and timber in the Province. There are now about 365 saw mills and 61 shingle mills in British Columbia and in 1913 they cut 1,515,828 M feet of lumber and about 480,000,000 shingles, raising the Province to first place in the Dominion as a lumber producer. In 1909 it produced only one-fifth of the total cut of Canada.

So great was the consumption of lumber in the prairie provinces that besides four-fifths of British Columbia's output that market absorbed 479,169,300 feet of lumber, 121,940,000 lath and 90,093,000 shingles imported from the States during 1911 and 1912. It was a dumping ground for low-grade lumber from the Inland Empire. No effort was made to develop a foreign market. When the slump came there was distress.

Eastern Canada has an important trade with foreign countries and its relations with the eastern United States are fixed. The problem of overshadowing moment is what British Columbia shall do with the products of its surplus of mills.

Through time beyond reckoning the prairie provinces will be large consumers. Settlement and wheat growing will reach northward to latitude 55 degrees and the sparsely settled districts will fill with farms, but the abnormal demand of the years just past will never develop again. Years may pass before the capacity of today will be reached. In the meantime the capital invested cannot remain unproductive. Impatient of returns from timber new mills will be built. As in the United States, government will look to its forests for revenue, encourage waste and aid in destroying the industry by selling whenever and wherever it can on terms which foster incompetence and invite affliction.

With capacity to supply ten millions of people and one and one-half millions to supply, the manufacturers are seeking to know what they shall do to survive.

The answer must be found among ten millions of people outside of Canada. Lumber is a bulky product. Its best market is that nearest the source of supply; hence Canadian manufacturers turn to the one hundred millions of people across the line—the most prodigal users of lumber in the world. The tariff bars are down, international railroads have reduced their rates to equal those of all-American lines; the way to a market is open and buyers in the States may now rejoice at the spectacle of a demoralized industry struggling from both sides of the boundary to increase consumption by cutting prices to or below cost of production. The day of Canada's retribution dawned on October 3, 1913, when the Underwood tariff took effect.

During the fiscal year ending June 30, 1914, 472,245 M feet of lumber worth \$11,481,431 was exported to Canada from the United States and there was received in return 892,833 M feet worth \$16,936,930.⁴ In the last nine months under protective tariff British Columbia sent into the United States 1,861,100 feet of lumber, while during the first nine months of free trade the shipments amounted to 12,030,799 feet,⁵ an increase of 546 per cent. but withal not an alarming amount when compared with shipments into the prairie provinces from the States during 1911. During the first eight months of 1913 importations of Canadian shingles amounted to 288,047 M valued at \$743,030; while during a corresponding period in 1914 the importations amounted to 765,627 M worth \$1,776,930, an increase in volume of 139 per cent. Of the 765,627,000 shingles imported this year 201,842,000 were shipped from British Columbia through the Puget Sound gateway, as compared with 30,706,000 received through the same gateway during the first nine months of 1913 under a protective tariff.⁶ This indicates the ascendancy of British Columbia shingles over those made in Washington and Oregon. The total value of all wood products imported into the United States from Canada in the year

⁴ Bureau of Foreign and Domestic Commerce

⁵ "The Timberman" November, 1914.

⁶ West Coast Lumberman, November 15, 1914.

ending June 30, 1914, was slightly less than that of 1913. Only a profitless market, over-production and general impoverishment of the industry in the United States will prevent heavy importations this year. The British

Parliament aids in developing industry at home and abroad. In the United States, Congress authorizes the expenditure of a million or two of dollars that a mythical, impossible trust shall be sought for.

Canada is seeking preferential tariff relations with her sister countries of the empire, seeing in them parts of the ten million consumers she needs.⁷ An effort will again be made to impose an import duty upon American lumber entering the Dominion. The time is opportune for trade extension at home and abroad and with the return of normal conditions in the States the wheels of industry will again turn in the Province prolonging the idleness of labor and capital from which the northwestern States are now suffering.

British Columbia will not hope in vain for an American market. The Panama Canal and our shipping laws invite participation in the trade of the Atlantic seaboard. Cheaper vessels, smaller crews and lower wages paid them combine to this end. Shippers and vessel owners aver that it costs from 20 to 25 per cent more to transport lumber to the Atlantic seaboard from American ports on the Pacific than from British Columbia ports—and America dug the canal. With rail rates the same as and water rates say \$3.00

per M lower, British Columbia manufacturers have an opportunity to reach the coveted ten million people and they will grasp it.

Among the lumbermen of the west there is an urgent demand for the restoration of an import duty on lumber, at least sufficient to prevent dumping



WESTERN PINE.

A TYPICAL STAND IN SOUTHERN BRITISH COLUMBIA NEAR THE NORTHERN LIMIT OF THE SPECIES.

Columbian manufacturer cannot compete successfully with present prices.

A notable difference is found as between the attitude of government in Canada and the United States. In Canada, and particularly British Columbia, a partnership has been established between lessees and actual owners.

⁷ See "The Timberman," November, 1914.

in times of stress. Admittedly their business is demoralized. As in the case of British Columbia there is an excess of productive capacity which cannot adjust itself to demand because of small-unit production and the facility with which supplies of raw material may be obtained. On both sides of the line the industry is in a helpless condition. Every thousand feet of lumber unmarketable at home which can be sold on the opposite side of the line is sold at any price above the cost of the labor applied in producing it because such sales reduce the cost of the output and add to the profits of the producer by helping him meet his overhead. Under the conditions which have prevailed during the greater part of the past seven years lumber manufacturers have followed receding hope until many are seeking the only direction of motion their perspicacity reveals—the return of their investments in stumpage through the immediate agency of the saw. Lumbering is a primitive industry in which countless men having primitive ideas of business are able to engage. It is undergoing enforced readjustment because it has at last reached the period when it must yield to the demands of modern business. Neither protective tariffs nor any other legitimate forms of legislation can save it in the absence of large control of raw material, large scale production and applied modern business principles.

From the standpoint of national economy there would be danger in restoring a duty on lumber. The immediate effect would be to attract into a less profitable industry capital that would have been invested in more productive channels. As a result waste would be further increased with corresponding loss to communities and countries. Temporary depression has

reduced the Canadian demand for British Columbia lumber and the United States will be made a dumping ground for the surplus of its mills at prices as close to the cost of production as may be necessary to sell their product, until such time as the surplus of productive capacity shall be forced out of business or more profitable markets can be found.⁸

British Columbia mills cannot compete with American mills *and earn a profit*; but so long as a market can be found they will avail themselves of it and be large factors in continuing the present bootless condition. It is a raw, primitive country engaged in primitive industries. Its forests comprise its chief resource. It sends to us its lumber, shingles and pulp in return for our manufactured and agricultural products. If free trade be continued each country will tend to produce only those things for which it is best adapted and rely upon the other for the things desired and in the production of which it has a relative advantage. While the United States produces an enormous volume of raw materials it is destined to be a great manufacturing nation. Our markets for manufactured goods must be found in countries like Canada. During the fiscal year ending June 30, 1913, we sent to each individual in Canada about \$52 worth of exports and took from each individual about \$15 worth of imports.

Unless we give we cannot receive. The problem resolves itself into the economic question of whether or not those lumbermen of the United States who are impoverished by their own inability to apply fundamental principles of efficiency should be protected at the cost of other industries until an enforced readjustment is complete. The advantages of the contest are theirs.

⁸ In these paragraphs the author has borrowed liberally from "Modern Business."



E. E. RING, PRESIDENT MAINE FORESTRY ASSOCIATION.



CHARLES D. BARTLETT, VICE-PRESIDENT MAINE FORESTRY ASSOCIATION.

MAINE FORESTRY ASSOCIATION

WITH an enthusiasm which it is evident will carry it along to a large membership and a successful career, the Maine Forestry Association, which has been dormant since 1908, was reorganized and revived at a largely attended meeting held in Bangor, Maine, on Friday, January 22nd. This was accomplished largely through the efforts of Prof. John M. Briscoe, head of the forestry department at the University of Maine at Orono, and Mr. E. E. Ring, secretary of the first organization. The meeting was attended by former members, representatives of railroads, lumber companies, pulp and paper companies; members of the State legislature, State officials and people generally interested in improving the forest laws of the State.

Considerable forestry legislation is needed at the present time, or will be in the near future, and quite the best way to secure it is to organize a strong State Forestry Association which, working in cooperation with the American

Forestry Association, will be able to arouse the people of the State to an



W. A. HENNESSEY, SECRETARY-TREASURER MAINE FORESTRY ASSOCIATION.

appreciation of the need of better legislation, and with them to obtain the attention of the State legislators to bills which will be presented.

Charles E. Bartlett of Bangor presided at the meeting, and addresses were made by Prof. Briscoe, P. S. Ridsdale, Secretary of the American Forestry Association, State Forestry Commissioner Viles, Senator Forrest Colby, Chairman of the State Forestry Committee and by a number of others.

The officers elected are Hon. E. E. Ring, president; Charles D. Bartlett, vice president; W. A. Hennessey, secretary-treasurer; Hon. John A. Bass, Bangor; Hon. Blaine S. Viles, Augusta; Hon. Forrest Colby, Bingham; Fred A. Gilbert, Bangor; George B. Dunn, Houlton; H. P. Buck, Bangor; Prof. J. M. Briscoe, Bangor; Alfred K. Ames, Machias; and Frank P. Thomas, Rutherford, directors.

NEW YORK STATE MEETING

THE third Annual Meeting of the New York State Forestry Association, which now has a membership of over 500, was held on January 13 and 14 at the Powers Hotel, Rochester, New York.

The evening of January 13 was given over to an illustrated address by J. Horace McFarland, President of the American Civic Association, on "Efficient Trees for American Streets." After Mr. McFarland's address an informal buffet luncheon was served at which unusual spirit and enthusiasm was shown by those present.

On January 14 the regular business of the Association was taken up after which short talks were given as follows: Mr. C. R. Pettis, Superintendent of State Forests, spoke on the advisability of the Association offering prizes to Boy Scouts for fire protection, tree planting, etc. A committee was appointed with power to expend certain funds in this matter. Professor Bristow Adams of Cornell University spoke on publicity work by the Association. Hon. John B. Burnham spoke extemporaneously, recommending the use of white cedar for planting in the eastern half of the State. Professor S. W. Allen of the State College of Forestry at Syracuse took up the subject, "What a State College of Forestry can do for the Association." The principal address of the morning was given by Mr. Harris Reynolds, Secretary of the Massachusetts Forestry Association, on "The Massachusetts Forestry Association's

Work and its Application to Conditions in New York."

In the afternoon Hon. Henry W. Morgan of Rochester talked very interestingly on the planting of shade and fruit trees along highways about our cities. Commissioner John D. Moore of the State Conservation Commission spoke at length on the year's work of the Commission.

The meeting was adjourned, after a few remarks by Dr. J. S. Whipple, President, on the future of the Association, and the election of the following officers:

President, Dr. J. S. Whipple; Secretary, Prof. Frank F. Moon; Treasurer, Sen. H. S. Holden; Vice-Presidents, Hon. John D. Burnham, Mr. Frank L. Moore, Hon. Franklin D. Roosevelt, Dr. A. S. Downing, Mrs. E. G. Whitmeyer, Dr. C. M. Dow, Sen. J. B. Mullin, Hon. John R. Clancy, Mr. John G. Agar, Mr. M. H. Hoover, Mr. E. L. Perry, Mr. Eugene S. Bruce, Mr. Thos. McCabe, Mr. K. W. Goldthwaite, Dr. Geo. G. Atwood, Mr. James Annin, Mr. John D. Moore, Mr. Frank A. Cutting, Mr. Jacob Hasslacher, Mr. F. Ambrose Clark.

Executive Committee: For three years, Dr. E. H. Hall and R. S. Hosmer; for two years, C. R. Pettis, Dr. Hugh P. Baker; for one year, Mr. Geo. N. Ostrander and O. H. Van Norden. Auditors: For two years, Mr. S. N. Spring; for one year, Mr. W. G. Goward. Trustees Permanent Fund: For three years, Mr. Chas. M. Dow; for two years, Mr. Frank E. Kendall; for one year, Walter C. Witherbee.

NORTH CAROLINA MEETING

LUMBERMEN, club women, foresters, railroad men, legislators, and public officials met together at the fifth annual convention of the North Carolina Forestry Association in Raleigh, January 13, and joined in urging upon the General Assembly the necessity of taking some definite and immediate action to preserve the forests of the State from the present frequent and destructive fires. Nearly every speaker touched in no uncertain terms upon this subject and strong resolutions were endorsed calling upon the State Legislature to make possible a State fire protective system and to create a State park on Mt. Mitchell. Resolutions were also passed asking Congress to continue the appropriations for cooperative fire protection under the Weeks law; urging the public school authorities to include at least some study of forestry in their curriculum and make the observance of Arbor Day general; approving the organization of local forestry clubs for the purpose of fire prevention; and urging the extension of the Stock law all over the State.

Governor Locke Craig's address dealt largely with the proposition that the State purchase an area on the top of Mt. Mitchell for the purpose of preserving part of the virgin forest and including the summit of the mountain. The President of the Association, Mr.

Hugh MacRae of Wilmington, in his annual address enforced the two principles of conservation and efficiency. "I look to an enlightened public opinion to bring about the protection of the forests. If people realized that the small trees belonged to the children they would feel differently. . . . No group can progress without lifting up the community. Education along these lines is essential."

Dr. Joseph Hyde Pratt, State Geologist, emphasized the need for forest protection in North Carolina in order to insure a permanent supply of timber for our own use. He urged that the State provide a forest fire protective system; State forests for demonstration purposes; and a State forest nursery to provide forest tree seedlings at cost. Fire protection, however, he emphasized as of first importance.

Representatives of four out of the five large railroads of the State spoke, strongly endorsing the campaign for forest protection, and promising cordial cooperation in publicity work.

A number of others spoke on various phases of forestry work in the State.

Mr. Nathan O'Berry of Goldsboro, President of the North Carolina Pine Association, was elected President of the Forestry Association for the ensuing year. Mr. J. S. Holmes of Chapel Hill was reelected Secretary-Treasurer.

A Forester's Directory

The American Forestry Association wishes to compile and to keep up to date, a directory of foresters, in the United States, its possessions, Canada and Mexico.

This will be of considerable benefit to the members of the profession, as the Association is frequently asked for information concerning the whereabouts of foresters, and is also often asked to recommend foresters for various positions.

The American Forestry Association therefore requests each forester, whether he is a member of the Association or not, to send his full name, address, name of school or schools of which he is a graduate, and the feature, if any particular one, of his profession, in which he specializes.

This directory will be kept up to date from year to year, and will be available for any inquirers at any time.

THIRTY-FOURTH ANNUAL MEETING

DEPARTING from its usual plan of holding the annual meeting in Washington the American Forestry Association held its 34th annual session in New York City on January 11th, and the change met with great favor among the many members in New England, New York, New Jersey, Pennsylvania and other contiguous territory who were but seldom able to get to Washington for a meeting.

There was a gratifyingly large attendance and much enthusiasm over the work of the Association and what it has been able to accomplish, while the papers and discussions during the day resulted in many admirable suggestions for the activities of the Association during the present year.

The officers elected are:

President, Dr. Henry S. Drinker, president of Lehigh University, who was reelected.

New Vice-presidents: Hon. Wm. H. Taft, former president of the United States; Hon. John W. Weeks, U. S. Senator from Massachusetts; Hon. George Pardee, former Governor of California; Mr. Theodore L. Bristol, former president Connecticut State Forestry Association; and Mrs. Emmons Crocker, of Fitchburg, Mass., former chairman of the Conservation Department of the General Federation of Women's Clubs.

Treasurer, John E. Jenks, Washington, D. C., reelected.

Directors—for three years—W. R. Brown, Berlin, N. H.; John E. Jenks, Washington, D. C.; Charles F. Quincy, New York City; E. A. Sterling, Philadelphia; and Capt. J. B. White, Kansas City, Mo.; all reelected.

Director—for two years—William B. Greeley, Washington, D. C.

Auditor—E. A. Sterling, Philadelphia, reelected.

President Drinker reported that the financial statement for the year, which was being examined by the auditing committee, showed that the Association was sound financially and without any debts.

The Secretary's report in brief was as follows:

"Nineteen hundred and fourteen was marked by considerable development work by the Association. A campaign was successfully conducted in Virginia for the passage of a State forestry law and the creation of a State forester; and the people of South Carolina, Alabama and Texas were aroused by publicity measures to a realization of the need of similar laws in their States. Texas organized a State Forestry Association, which, aided by the American Forestry Association, is now striving to get a forestry law passed by the Legislature. A draft of a model forestry law was prepared for Game and Fish Commissioner John H. Wallace, of Alabama, and is embodied in his recommendations to the Legislature. The Association also cooperated in the organization of some county and township forest conservation and fire protective associations. There was a marked increase in requests for advice and information about trees, woodlots and forests from all over the country, indicating not only an increase in interest but extension of the knowledge of the work the Association is doing. Forest schools were supplied with valuable unpublished reports of the Forest Service needed for their libraries, and to a number of schools, societies and individuals was sent information relating to forest conservation.

"Among other features of the Association's educational work was the maintenance of a booth and the distribution of forest literature at the Forest Products Expositions at Chicago and New York, and the addresses on forestry at the Chautauqua, New York assembly, were valuable. Another feature of this work is the wide publication in magazines and newspapers during the year of articles about the Association and its work, and the republication of illustrations and articles from AMERICAN FORESTRY in some of the leading magazines of the country.

"During the year the Association acquired in E. T. Allen, Forester of the Western Forestry and Conservation Association, a Pacific Coast representative, and in Ellwood Wilson, of the Society of Canadian Forest Engineers, a Canadian representative, and the articles they have written and secured for the magazine have added much to its value.

"The Association authorized a bond issue of \$50,000 to provide funds for the further improvement of the magazine and increase in its circulation. \$16,000 has been subscribed and \$14,000 has been paid in. \$7,000 of this amount was personally secured by President Henry S. Drinker from some friends of forestry.

"Considerable improvement was made in the magazine during the year, better paper, more and better illustrations, a picture cover and a number of special articles adding greatly to its attractiveness and its educational value. Thanks are due to Mr. Charles Lathrop Pack for a donation of \$1,000, and to J. B. White for a donation of \$100, to aid in paying for these improvements.

"The Association is now in a solid condition financially, ending the year without one cent of indebtedness, and having a growing surplus invested in bonds.

"One thousand three-hundred and seventy-eight new members and subscribers were secured during the year, while deaths, resignations and members dropped for non-payment of dues totaled 1,012, making a net gain for the year of 366."

The day was devoted to hearing practical addresses and discussions on what the American Forestry Association might do in furthering its work in

various directions, and these suggestions, many of them being most valuable, will be carefully discussed and considered by the Executive Committee. The addresses were by Henry S. Graves, chief forester of the United States; C. R. Pettis, forest superintendent of New York State; R. S. Kellogg, secretary of the National Lumber Manufacturers Association; George N. Ostrander of Glen Falls, N. Y., who is identified with the paper pulp and paper business; Dean Hugh P. Baker of the New York State College of Forestry at Syracuse; Prof. S. N. Spring, of the forestry department of the New York State College of Agriculture at Cornell; Warren H. Miller, editor of *Field and Stream*, Wm. B. Howland, publisher of the *Independent*; John O. LaGorce, associate editor of the *National Geographic Magazine*; Prof. H. H. Chapman of the Yale School of Forestry. Discussions followed and there was general participation in them with the result that every one present was much impressed and pleased by the practical suggestions for the kind of work which the Association might do.

President Henry S. Drinker presided at the morning session and E. A. Sterling at the afternoon session, while in the evening Charles F. Quincy of New York was toastmaster at the annual dinner at the Hotel McAlpin where addresses were made by Chief Forester Graves, Ottomar H. Van Norden of the Camp Fire Club of America, Hon. Cabot Ward, president of the Park Board of New York, who represented Mayor Mitchel; Dr. B. E. Fernow of the University of Toronto, President Henry S. Drinker of the American Forestry Association; and Dr. J. T. Rothrock of Pennsylvania.

**THE INDEX FOR VOLUME TWENTY
OF THE AMERICAN FORESTRY MAGAZINE IS NOW READY AND
WILL BE SENT UPON REQUEST TO ANY DESIRING IT**



EDITORIAL

FORESTRY LAWS AND LEGISLATION

AT THIS season, during the sessions of the National Congress and of the legislatures of the different States, many measures of vital importance to forestry are being considered, some of which are good and some bad. The beneficial legislation should pass; the injurious measures must be vigorously opposed. But how are congressmen and legislators to distinguish good forestry laws from bad? The American Forestry Association assumes that forestry itself is good—that its necessity is proved and its benefits demonstrated. Good laws, on this basis, are laws which promote forestry and make it possible to grow trees successfully, whether under National, State or private management.

The experience of a century in Europe and of two decades in this country has indicated the conditions demanded for successful forest production. Two requisites are fundamental—forest land set aside for tree growth and a body of foresters independent of party politics, trained in their profession, and employed permanently to develop the forest and bring the work to a successful conclusion. The development of the actual practice of forestry on the National Forests is due wholly to the personal ability and training of the men who compose the present Forest Service. In the fourteen years preceding 1905, when these lands were under the United States Land Office, practically no development took place. Whatever has been accomplished since then is due to

their transfer to the Department of Agriculture, under the management of Gifford Pinchot and Henry S. Graves, trained foresters.

Any measure which proposes to remove these National Forests from the control of the trained organization of the Forest Service, whether by transfer to some other Government bureau or by grants of additional lands to Western States, strikes at the fundamental condition which promises efficient forest management.

This is a defect in Secretary of Interior Lane's proposed plan for a local commission to govern Alaska which may be overcome by the appointment of a forester or a man capable of efficient forest management as a member of the commission, as well as the understanding that the forests shall be administered in the same efficient manner as under the Forest Service, and with the Forest Service acting in a close advisory capacity.

Reprehensible is H. R. Bill 1602, which proposes to throw open for homestead settlement all lands now protected by National ownership which have especial value for recreation. Under the guise of "summer homesteads" this bill permits the private acquisition of camping sites, lake shores and other lands of inestimable future value to the public.

In the class of good legislation before Congress falls the appropriation to continue the work undertaken through the Weeks Law—the purchase of additional lands in the Appalachians and

White Mountains. This measure receives the unanimous support of the Eastern States, and no plea of economy should suffice to interrupt this work. Congress is asked to continue the annual appropriation of \$2,000,000 until 1920, and the constituents of Congressmen within these States must make plain their hearty approval of this enterprise.

Meanwhile, forestry legislation in several States demands attention. The most serious aspect of State forestry today is the need for the establishment of a strong and efficient State forest service similar in character to that of the National Government, and based on merit and training. Several States, notably Minnesota, have secured this result by giving the control of the work to a non-partisan board whose sole responsibility is forestry. In other States, the State work has been the cat's-paw of party politics, and in some by a short-sighted policy of pretended economy, this work has been combined with the administration of the fish and game laws, with the conservation of minerals and even with the problem of waterpower. The public is led to believe that this consolidation is satisfactory where tried. We speak with full knowledge of the facts in stating that it is decidedly unsatisfactory. There is a limit to the capacity of a board, and the administration of forestry laws is all that can be properly attended to by one commission. When to this duty is added the control of the game warden system, and other functions, forestry suffers proportionately.

Facts speak for themselves. Under the consolidated Forestry, Fish and Game Commission of New York but one out of the entire list of commissioners ever gave any special attention to forestry—and New York stands today where she was twenty years ago, prohibiting cutting of timber on forest lands of the State. Under the more recent consolidation by which waterpowers were added to the duties of the Conservation Commission, even the time-honored policy of purchasing lands has been allowed to lapse, solely through loss of initiation in the Commission. The State is now struggling to secure the

non-political reorganization of this department which must precede any attempt at the practice of forestry by constitutional amendment.

As a result of the creation of a Public Domain Commission in Michigan combining the functions of a board of Forestry with that of Immigration, and Public Lands, the Commission suffered a marked loss of initiation in forestry.

Louisiana, under a Conservation Commission which combines fish and game protection with forestry, has failed to even make a beginning in the creation of a State forest service, and is expending almost her entire appropriation on fish, game and minerals. Oregon, formerly under this form of organization, has taken her forest fire service out of the hands of the Fish and Game Commission in order to get results. New England is a unit in support of separate forest organizations. New Jersey, Maryland, Ohio, and the Western States of Montana, Idaho, Washington and California believe in separate forestry boards. And in this list of States are included practically all which have laid the foundations of a sound State policy by the employment of foresters on a permanent basis.

On this evidence we claim that measures looking to the consolidation of other State departments with forestry are bad. The Legislature of Wisconsin is now considering such a measure. For a decade the forestry affairs of the State have been managed by a non-partisan board. It is now proposed to supersede this board by one appointed by the Governor, which shall combine public lands, and fish and game with forestry. One advocate of this plan cites Michigan and New York as examples, and claims that the measure is in line with a general tendency. If passed, it can have but one result—the definite relegation of the forestry work of the State to a subordinate position, similar to the conditions prevailing in Michigan, New York and Louisiana.

Alabama, after eight years of trial of this combined forest, fish and game commission, and a complete dearth of results, is this year considering the

establishment of a separate forestry board—such a measure should pass. Texas is planning to create an entirely independent forestry commission. In Pennsylvania the work of the Forestry Commission has been separate from all other forms of State activity from its origin, and the great progress of the

State through the purchase and management of forest lands, and the establishment of a State Service, is due almost wholly to this fact. Specialization, not consolidation, must be the watchword of American forestry, if we are to accomplish any practical results within the next decade.

WITH THE FORESTERS

Mr. C. S. Judd, who for several years has been connected with the United States Forest Service as Assistant District Forester in the office of Silviculture at Portland, Oregon, has recently resigned to accept the position of Forester for Hawaii and Executive Officer of the Board of Agriculture and Forestry there. Mr. Judd assumed his new duties on January 15th.

R. Brooke Maxwell, city forester of Baltimore, writes that the Division of Forestry of Baltimore has been fortunate enough to secure a slight increase in its working funds for this season. The increase was \$5,000, making the total appropriation for tree work \$12,900. The value of the work which the department has been trying to do seems to be appreciated, and this present increase is only the beginning of larger and better things.

The Board of Governors of the National Lumber Manufacturers' Association has accepted the resignation of Mr. J. E. Rhodes as secretary and he has become secretary of the Southern Pine Association. Mr. R. S. Kellogg, secretary of the Northern Hemlock & Hardwood Manufacturers' Association, has been elected secretary to succeed Mr. Rhodes.

Mr. H. H. Tryon, a graduate of Harvard College and the Harvard Forest School, has been appointed an instructor in Forest Utilization at the New York State College of Forestry at Syracuse. This appointment has been made to handle the greatly increased work in the Department of Forest Utilization.

Prof. Nelson C. Brown represented the New York State College of Forestry at Syracuse at the annual meeting of the American Wood Preservers Association in Chicago, January 19, 20 and 21. Dean Hugh P. Baker and Prof. Brown are both members of the Association.

Dr. C. A. Schenck, former director of the Biltmore Forest School, is alive and well, and the news will be welcomed by his many friends in this country who have recently heard the unconfirmed rumor that he was killed in action while leading an attack on the Russians in Poland. Dr. Schenck, who is an

officer in a German Regiment, has been in the campaign in Poland since early in the fall. On Dec. 18th, Mrs. Schenck, according to advices received here, heard that he was in good health and unwounded. A few days later he was seriously wounded. But on Jan. 8th, he had so far recovered that he was preparing to return to the front.

In writing to J. Gordon Dorrance, a forest engineer in the Maryland State Forestry Department, Dr. Schenck said: "Thank God, by some miracle I am up and well again, ready to go back to my regiment. Of course, no one of the Biltmore students expected me to stay behind when my country was in danger, and I am sure that all Biltmoreans will do the same when the good old U. S. A. is at war."

Coert Du Bois, district forester with headquarters in San Francisco, spent several days in Washington in January in relation to affairs in his district.

Gifford Pinchot is now in England where with Mrs. Pinchot he is aiding his sister, the wife of Sir Alan Johnstone, British minister to the Netherlands, in relief work. He expects to remain abroad for some months.

W. B. Greeley, assistant forester with headquarters in Washington, D. C., has been elected a director of the American Forestry Association for a term of two years.

News print paper has been made by the Forest Service laboratory from 24 different woods, and a number compare favorably with standard spruce pulp paper.

The Forest Service is cooperating with 54 railroads, mining companies, pole companies, and cities in making tests of wooden ties, timbers, poles, piling, and paving blocks which have been given preservative treatments.

Recent sales by the government totaling 126,000,000 feet of saw timber in the Olympic National Forest, in western Washington, mark the opening of this hitherto inaccessible storehouse of timber, estimated to contain a stand of 33 billion board feet.



THE CANADIAN DEPARTMENT

By ELLWOOD WILSON

AMONG the New Year's honors this year are two of interest to Forestry. The head of the Canadian Conservation Commission has been made Sir Clifford Sifton. Sir Clifford has done much to make the Conservation Commission efficient and its work is bound to have a great influence in the development of Canada.

Mr. William Price, the head of Price Bros. Ltd., Paper Manufacturers and holders of one of the largest timber limits in the Province of Quebec, has been made Sir William Price. He was instrumental in organizing and laying out the Camp at Valcartier near Quebec for the First Canadian Contingent and it was in large measure due to him that the whole camp was so efficiently organized. His firm is the only one in Canada to have its limits insured against fire, this insurance having been placed in England. The limits are insured in separate blocks, and there must be a loss of at least \$50,000 before the insurance company will settle for damage. This insurance is probably the reason why this large company has never joined the local cooperative Fire Protective Association.

The building for the Dominion Forests Products Laboratory in connection with McGill University is approaching com-

pletion and the experimental machinery which has already been delivered will soon be installed. Messrs. Bates and Campbell, the Director and Assistant, read papers before the last meeting of the Montreal Section of the Society of Chemical Industry.

Capt. J. B. White, Manager of the Woodlands Department of the Riordan Pulp & Paper Co., and the Canadian Member of the National Lumber Manufacturers Association, expects, if his military duties will permit, to attend the meeting of the American Forestry Association in New York. Capt. White has been in charge of guarding some of the canals in the neighborhood of Montreal.

Mr. D. C. A. Galarneau, Forester for the Algoma Central & Hudson Bay Railway, has a little daughter.

Mr. R. D. Prettie, Chief Forester for the Canadian Pacific Railway, has just returned from a trip to the Pacific Coast where he attended the meeting of the Northwestern Forestry and Conservation meeting.

Mr. H. R. MacMillan, Chief Forester of British Columbia, will read a paper before the Conservation Commission at its meeting in Ottawa on the Organization of a Fire Protective System, and

before the Society of Canadian Forest Engineers on Organizing a Provincial Forestry Service.

The Canadian Forestry Association will hold its Annual Meeting in Ottawa on the 19th and 20th of January, as will also the Society of Canadian Forest Engineers. These two Societies usually meet in February but the meetings will be held as above so as to coincide with that of the Dominion Conservation Commission.

Mr. F. McVickar, of the Canadian Society of Forest Engineers, is serving in the British Army with the First Canadian Contingent.

Mr. Stetson, of the West Virginia Pulp and Paper Company while on a visit to Montreal last week, said that his company now had a plant in operation for making denatured ethyl alcohol from sulphite waste liquor and that it was a profitable commercial enterprise. His company controls the patents for the United States.

The Lumbermen and Members of the wood working industries in the neighborhood of Ottawa have formed a Safety Association to prevent accidents to their employees and will incorporate under the Ontario Companies Act. This is in accordance with the privileges granted by the Ontario Workman's Compensation Act.

Sir Thomas Shinner, Governor of the Hudson's Bay Company and a Director of the Canadian Pacific Railway, has become a Director of the Laurentide Company, Ltd.

The Forestry Department of the Canadian Pacific Railway which has been in charge of Eastern Lines, i. e., from Lake Superior to the Atlantic Coast, has been transferred from the

Department of Natural Resources to that of Operating and under the General Manager, Mr. A. D. MacTier, has done splendid work toward eliminating fires along the right of way. The Forestry work is in charge of Mr. B. W. Winegar and is being conducted along liberal and broad-minded lines. Damage claims have been very numerous in the past and an effort will be made this coming season to eliminate them entirely. The C. P. R. has become a member of the Kennebec Valley Fire Protective Association in Maine. Their claims for the past year totaled \$600,000 and caused a great deal of trouble. The following work is being done. All section men must fight fires and all train crews must report fires discovered at the first station. During dangerous times and along dangerous stretches extra patrolmen are used. Help is given to adjacent owners on the right-of-way in extinguishing fires. The Railway Commission's Fire Service is co-operated with and also all Provincial Agencies. After fires are extinguished, crews of trained men are sent to assess the damages, which are ascertained by strip surveys, growth studies, careful maps of the areas and so forth. They then offer to settle on the basis of actual damage. In this way a great deal of money is saved and fraudulent claims are eliminated.

As showing what can be done along these lines, the celebrated "Carter Case" may be cited. This was a claim for damage said to have been caused by a fire originating on the C. P. R. right-of-way, the amount asked being \$358,000. In the investigation of this claim twenty-two men were engaged for eight months and the area burned was most carefully gone over with the result that the damage was determined to have been \$2,500 and on this amount the Company settled. One of the investigating party, Mr. Porter Shaw, was unfortunately drowned.



FOREST NOTES

The Public Domain Commission of Michigan has made arrangements with the U. S. Department of the Interior to secure a herd of twenty-five Elk for the State of Michigan. These will be brought from the Yellowstone National Park and placed on the Houghton Lake State Forest, in Roscommon County. This Forest affords an extensive range, and very favorable conditions as to natural forage and shelter for this species of deer. It is therefore expected that these animals will do quite well here and increase rapidly. Should the venture prove a success, other of the larger State Forests in both the Lower and Upper Peninsulas will be stocked from the increase of the herd and in time these places may become sources of big game supply for the entire State.

The State Board of Forestry in Maryland is preparing this winter a detailed report of the annual lumber production in that State. This estimate is being based on the cut of 1,100 timber operators in Maryland as sent in by them to the Board, and will give the amount of lumber and timber they are getting out annually in different products—lumber, ties, piling, poles, etc. These reports, combined with those made of preceding years, will give an accurate idea of the extent of the timber business in Maryland. Later this information will be combined with other data showing how this material is utilized by the numerous wood-working industries of the State, with its value in the rough and finished states of production.

Winter weather has not prevented the carrying out of work under the Roadside Tree Law, and the Board of Forestry has a large force of State Wardens in the field engaged in the supervision of public tree work. Orders for stock from the recently established State Forest Nursery are being received for spring planting. A large amount of reforestation work was done a year ago, and this year, with a well-stocked nursery supplying suitable planting stock at cost, it is planned to make an even better record in planting up the State's waste lands.

The New York State College of Forestry at Syracuse University has placed an order for several models to be used in its exhibit at the Panama Exposition. There will be three relief map models of an area in the Adirondacks including Whiteface Mountain. The first will represent the area with its original covering of virgin forest; the second will show the same area cut over, burned and eroded; and the third will show the area reforested by plantings.

A fourth model will depict the activities of the State College of Forestry. It will be a relief model of an imaginary area. In the center will be the College of Forestry with

lines leading to the forests of the State, the State Ranger School, the villages, cities, high schools, farms, etc., of the State.

The New York State College of Forestry has just moved its summer school equipment from its property in the Catskills to the Adirondacks. It has been decided to have the next summer school in the Adirondacks and of three months' duration. This will result in some very valuable data being gathered regarding the State forest lands in the Adirondacks.

B. F. Porter, a timber and lumber operator of Eureka, California, recently felled a redwood tree on his tract that equaled the record value of any yet cut in California. It was 380 feet high, 26 feet in diameter 7 feet from the ground, 261 feet to the first limb, where the diameter was 11 feet, and scaled over 344,000 feet of lumber. Fifty per cent. will sell at \$35, 30 per cent. at \$18, and the remaining refuse at \$8. The total value is estimated at more than \$9,000.

The Hammond Lumber Company is cruising the immense timber holdings of the Metropolitan Redwood Lumber Company in the Humboldt district, California. Some of the holdings of this company are the finest in California, there being single acres that will cruise 1,000,000 feet and 100-acre tracts that will average 750,000 feet to the acre.

Governor Whitman of New York in his inaugural address puts himself on record as being in favor of keeping the various divisions of the conservation department separate. He says: "The conservation department as at present organized has three divisions:

"First. A division of lands and forests;

"Second. A division of inland waters, covering water supply, water storage, drainage, navigation, etc.;

"Third. A division of fish and game.

"It is very important, in my opinion, that the work of these three divisions should be kept entirely separate and that each of these divisions should have an expert administrative head, who is specially qualified by training and experience to do the work as it ought to be done. The actual administration of the work of each one of these divisions can be properly done only by a man who is familiar with the special line of work and has had really sound training and experience along these lines. For these reasons I favor three separate bureaus or divisions in the department, and I think that it is most important that the law should specifically provide that the head of each bureau or division should be a trained expert."

Only 7½ per cent. of last season's 400 fires in National Forests of Utah, southern Idaho, western Wyoming, and Nevada caused losses in excess of \$100.

There were 400 fires this year on the National Forests of Utah, southern Idaho, western Wyoming, and Nevada, or 15 more than in the most disastrous season of 1910. Yet the cost of extinguishing them was only one-third and the damage only one-thirtieth of that of the earlier year. The difference is due to better organization now, and to more roads, trails, and telephones.

Only one modern sawmill is operated in the territory of Hawaii.

In District 4 of the Forest Service, with headquarters at Ogden, Utah, lightning caused 36 per cent. of this year's fires and campers 27 per cent.

As showing the possibilities for tree growth in regions where irrigation has to be depended upon, it is pointed out that Boise, Idaho, has as many as 94 different kinds of ornamental and shade trees.

The Laurentide Company of Quebec, producers of pulp and pulpwood, is reforesting its non-agricultural cut-over lands. It is also importing reindeer from Newfoundland, to see if they can take the place of dogs in winter woods work.

A small railroad operating an oil-burning locomotive on the Tahoe national forest, California, had a breakdown during the past summer and burned wood instead of oil for one day. On this day fifteen fires started along the right of way. During the preceding year only one fire occurred near the railroad and it was not thought that the engine was responsible for that one.

Lodgepole pine, one of the principal trees of the Rocky Mountains, makes good strong wrapping paper and pulp board.

Osage orange wood is a source of dye and can be used to supplement the imported fustic wood, as a permanent yellow for textiles.

During the past two years forest officers have killed nearly 9,000 predatory animals, more than three-fourths of which were coyotes.

BOOK REVIEWS

FOREST VALUATION. pp. 310. By Herman Haupt Chapman, John Wiley & Sons, Inc. New York. \$2.00.

With the development of forestry in this country has come an increasing demand for definite information concerning the value of standing timber, mature and immature, of forest soil, and of the forest as a whole. Professor Chapman's book affords the means for determining these important points and for answering such perplexing questions as: Does forestry pay? Is forest property a good investment? How shall young timber be valued? How shall damages to standing timber be appraised? How are stumpage values accurately determined? What is the basis for deciding whether a given tract is chiefly valuable for agriculture or for forest production?

The reader of this book will realize that contrary to common belief these problems are not in a class by themselves but are solved in much the same manner that all values are determined, for the principles of forest valuation are shown to be in strict accord with the customs and principles of ordinary business accounting. The chief distinction is that forest valuation is concerned with much longer periods of time than are most financial calculations.

In order that the student or reader may fully appreciate these relationships the first four chapters of this book are devoted to a résumé in simple terms of the general principles underlying economics. Especial emphasis is

laid upon the theory and application of compound interest as a mathematical means of determining value.

To the layman as well as to the average student the presence in a book of many seemingly complex formulae is likely to give the impression that the subject is too difficult for them to master. If, however, the introductory chapters of the present volume are carefully read and the significance of the mathematical symbols is once understood this difficulty vanishes. The subject demands thought, to be sure, but if the reader is reasonably painstaking in the beginning he will be surprised at the readiness with which he is able to grasp the subsequent details.

This book is designed with special reference to the needs of American conditions. Instead of emphasizing, as most European treatises on the subject do, the determination of the expectation value of forest soil, greater consideration is given to matters of more practical import here, such as stumpage values, sale values, and appraisal of damages. No problems have been included in the text, apparently on the assumption that if the principles underlying them are fully understood such problems can be readily supplied and solved by the instructor or reader.

Teachers and students in forest schools and others who are interested in this important subject will welcome this book for it is the first American treatise on forest valuation to cover the field in a manner at once comprehensive and simple.

S. J. R.

PRESERVATION OF STRUCTURAL TIMBER.
Howard F. Weiss. (McGraw-Hill Book Co.,
New York.) Price \$3.00.

The wood preserving industry has long been looking for a compilation of existing information, and this Mr. Weiss has supplied in his new book, "The Preservation of Structural Timber." The arrangement of the subjects and chapters is logical, and to the uninitiated a reading of the book gives practically the whole story of wood preservation. The chapter on Causes for the Deterioration of Structural Timber is particularly to be commended, and under the heading of Decay a very large subject has been well summarized.

The chapter on Construction and Operation of Wood Preserving Plants outlines briefly the general forms of construction, but will be of little value to the inexperienced man in search of information on specifications and details. In fact the illustrations in some cases are of plants and devices which are considered out of date.

One looks in vain in this book, as in all current literature on the subject, for some of the essential facts regarding the relation of treatment to service requirements, and as to the influence of various local conditions on the life of treated material. Mr. Weiss is to be commended for avoiding many of the technical points on which it is so easy to split hairs without getting anywhere, and also on quoting specifications of the American Railway Engineering Association for creosote, rather than the unaccepted division of temperatures and fractionation of the Forest Service.

On the whole, Mr. Weiss' book is a very valuable compilation of engineering knowledge on the subject of timber treatment. It is but natural that the findings of the Forest Products Laboratory and the various publications from the same source are given prominence, since Mr. Weiss has been the author of some of the most acceptable government bulletins, and his knowledge of the wood

preserving industry comes largely through a laboratory acquaintance with many of the problems.

STUDIES IN TREES, J. J. Levison, forester to the Department of Parks, Brooklyn, N. Y. (John Wiley & Sons, Inc., New York) \$1.60.

The author is one of the pioneer trained foresters to specialize in the care and planting of ornamental and shade trees and his intimate knowledge of the subject as well as his understanding of the students needs are in accord with his varied experiences as forester for the Brooklyn Park System, as lecturer on ornamental and shade trees at Yale University and as Secretary of the American Association of Park Superintendents.

The book covers the whole range of tree study including the identification of trees; their nature, habits and growth; insects and diseases which attack them; their grouping and planting; the pruning and care of trees; the identification of commercial woods; the care of the woodlot and Forestry in its many aspects.

The treatment is concise, systematic and free from an undue use of botanical terms. The author's aim throughout is to give only the salient points and to so present his text that the reader is enabled to reach at a glance, the main features of the subject under discussion.

SONG OF SERVICE, by Charles H. Mackintosh (M. I. Stewart Co., Duluth, Minn.) \$1.00.

The author is the versatile editor of *Steam Machinery* and the book is an artistic little volume of excellent verse which may earn for Mr. Mackintosh the title of "The Omar Khayyam" of the willing workers, those who serve. Note the first verse:

"Who loves must serve, and we who love our
kind
Must also serve them, serve with hand and
mind;
Thus only may we live not all in vain;
Thus only may we hope to live again."

CURRENT LITERATURE

MONTHLY LIST FOR JANUARY, 1915.

(Books and periodicals indexed in the Library of the United States Forest Service.)

Forestry as a Whole.

Proceedings and reports of associations, forest officers, etc.

New Hampshire forestry commission. Biennial report for the years 1913-1914. 114 p. pl. Concord, 1914.

New South Wales—Department of forestry. Report for the year ended 30th June, 1914. 17 p. Sydney, 1914.

Norway—Skogdirektoren. Indberetning om det Norske skogvaesen, for kalender aaret 1913. 240 p. pl. Kristiania, 1914.

United States—National forest reservation commission. Report for the fiscal year 1914. 16 p. maps. Wash., D. C., 1914.

West Virginia—Forest, game and fish warden. Third biennial report, 1913-1914. 109 p. pl. Belington, 1914.

Forest Education

Forest school

Cornell University. Proceedings at the opening of the forestry building, May 15, 1914:

- open meeting of the Society of American foresters, May 16, 1914. 70 p. Ithaca, N. Y., 1914. (Official publications, v. 5, no. 19.)
- Montana, University of. Short course for forest rangers, January 5 to April 10, 1915. 48 p. Missoula, Mont., 1915.
- Yale forest school. Prospectus, 1914-15. 36 p. New Haven, Conn., 1914.

Forest Description

- Mississippi—Geological survey. Forest conditions of Mississippi, being a reprint with additions of Bulletins nos. 5 and 7. 166 p. il., pl. Jackson, Miss., 1913. (Bulletin 11.)
- Moss, C. Edward and others. The woodlands of England. 37 p. il. Cambridge, Eng., 1910.

Forest Botany

Trees: classification and description

- Levison, Jacob Joshua. Studies of trees. 1st ed. 253 p. front., il. N. Y., etc., J. Wiley & Sons, 1914.

Silviculture

Planting

- Lamb, George N. Basket willow culture. 34 p. il. Wash., D. C., 1914. (U. S.—Department of agriculture. Farmers' Bulletin 622.)

Forest Protection

Insects

- Cecconi, Giacomo. Manuale do entomologia forestale. fasc. 1-2. il. Firenze, 1914.
- Hopkins, A. D. Contributions toward a monograph of the scolytid beetles. II. Preliminary classification of the superfamily Scolytoidea. 68 p. il., pl. Wash., D. C., 1915. (U. S.—Dept. of agriculture—Bureau of entomology. Technical series, no. 17, pt. 2.)

Diseases of trees.

- Pennsylvania chestnut tree blight commission. Final report, Jan. 1 to Dec. 15, 1913. 121 p. pl., maps. Harrisburg, Pa., 1914.
- Tourney, James W. What should be done with the chestnut stands in southern New England. 6 p. Wash., D. C., Judd and Detweiler, 1914.

Forest Management

- Akerman, Alfred. Farm forestry; a text book dealing with the wooded parts of southern farms and the problems growing out of them, for use in agricultural high schools and colleges. 54 p. pl. Athens, Ga., 1914.

Forest Administration

- Tourney, James W. State forest administration with particular reference to the state of New York. 6 p. il. New Haven, Conn., 1914.

National forests.

- United States—Dept. of agriculture—Forest service. The national forest manual; regulations and instructions. rev. ed. pt. 1-6. Wash., D. C., 1914.

Forest Utilization

Wood-using industries.

- Jayne, S. O. Wood pipe for conveying water for irrigation. 40 p. il., pl. Wash., D. C., 1914. (U. S.—Dept. of agriculture. Bulletin 155.)

Wood technology.

- Stone Herbert. The timbers of commerce and their identification. 311 p. front., pl. London, W. Rider & Son, 1914.

Auxiliary Subjects

Conservation of natural resources

- National conservation association. Report, 1913-14. 15 p. Wash., D. C., 1914.
- Oregon conservation commission. Report, Nov. 1914. 111 p. il. Portland, Ore., 1914.

Political economy

- National civic federation—Dept. on regulation of interstate and municipal utilities. Commission regulation of public utilities; a compilation and analysis of laws of 43 states and of the federal government for the regulation by central commission of railroads and other public utilities. 1284 p. N. Y., 1913.

Manufactures

- Matthews, Joseph Merritt. The textile fibres. 3d ed. 630 p. il. N. Y., etc. J. Wiley and sons, 1913.

Hydrography

- Pennsylvania—Water supply commission. Report, 1912. 318 p. pl., plans. Harrisburg, 1914.

Irrigation

- Newlands, Francis G. Development of the west; articles on western topics entitled "Watering the desert," "National irrigation as a social problem," and "Dry farming." 16 p. Wash., D. C., 1914. (U. S.—63d congress—2d session. Senate document, no. 588.)

Periodical Articles

Miscellaneous articles

- American museum journal, Oct.-Nov., 1914. Series of photographs suggestive of the progressive policy of our national and state governments in regard to forest conservation, p. 220. Forestry in the state of New York, by Mary Cynthia Dickerson, p. 221-4.
- Breeders' gazette, Jan. 7, 1915. Winter work of a forest ranger, by Will C. Barnes, p. 11-12.

- Conservation, Jan. 1915.—Charcoal burning; wood now destroyed might be profitably converted into charcoal, p. 2.
- Country gentleman, Dec. 12, 1914.—Christmas trees; a crop that is harvested once in 16 years, at a cent a foot in height, by C. O. Ormsbee, p. 1983.
- Country gentleman, Dec. 26, 1914.—The harvest of forest seed, by T. W. Venemann, p. 2050.
- Country gentleman, Jan. 2, 1915.—Camphor in Florida, by E. P. Powell, p. 7.
- Gardeners' chronicle, Nov. 21, 1914.—The collection and storage of forest seeds, p. 335-6.
- Gardeners' chronicle, Dec. 5, 1914.—Cupressus goveniana, by A. Bruce Jackson, p. 364-5.
- In the Open, Nov.-Dec. 1914.—The forestry series; course of instruction in tree culture, by G. H. Wirt, p. 30-34; West Virginia's important program; forest, fish and game protective association holds annual meeting, p. 55-7.
- National electric light association. Bulletin, Dec. 1914.—The use of blight-killed chestnut for poles, by Jesse C. Nellis, p. 693-5.
- National wool grower, Dec. 1914.—Distribution and functions of range plants, by Arthur W. Sampson, p. 20-3.
- Popular mechanics, Jan. 1915.—Guarding and developing national forests, by Roy Boothe, p. 110-11.
- Scientific American supplement, Oct. 17, 1914.—Climatic influence of forests; results of the destruction of timber on climate and soil, by L. A. Fosbery, p. 246-7.
- United States—Dept. of agriculture—Office of Information. Weekly news letter to crop correspondents, Jan. 13, 1915.—The fuel value of wood, p. 1.
- Trade journals and consular reports*
- American lumberman, Dec. 19, 1914.—Two views of economic aspects of forestry, by Barrington Moore, p. 23-4; Students of Michigan agricultural college in annual forest show, p. 37.
- American lumberman, Dec. 26, 1914.—Impregnation of timber to protect it from fire, by Friedrich Moll, p. 32-3; Fighting the gypsy moth in Massachusetts, p. 33; Promoting uses of wood in its various forms, by J. E. Rhodes, p. 34-5; Michigan assured dividends from reforestation, p. 36-8.
- American lumberman, Jan. 2, 1915.—Romance of lumbering on the Saskatchewan, by John S. Woodward, p. 28-9; Stimulating the building of poultry houses; a California lumberman's idea for utilizing low grade lumber, p. 35; Fustic a wood of importance, p. 64.
- American lumberman, Jan. 9, 1915.—Showing forestry to the world; exhibited at the Panama-California exposition, p. 32; Economical use of wood; choice of grades housing and use of preservatives are factors, by E. W. Bright, p. 36-7.
- Canada lumberman, Dec. 15, 1914.—Forest policies of Canadian provinces, by H. R. MacMillan, p. 32-3; Successful fire prevention in B. C., p. 37; Interesting facts about Quebec's forests, p. 38.
- Canada lumberman, Jan. 1, 1915.—Counting the cost of lumber, by E. H. Newton, p. 29-30.
- Engineering record, Oct. 17, 1914.—Bleeding and swelling of yellow pine paving blocks, by C. H. Teesdale, p. 444.
- Engineering record, Oct. 31, 1914.—Effect of steaming process of creosoting on strength of Oregon fir piling, p. 487-8.
- Gulf coast lumberman, Jan. 1, 1915.—Timber in Australia, by W. D. Hornaday, p. 29-30.
- Hardwood record, Dec. 25, 1914.—National forest fires in 1914, p. 19; An easy identification of the oaks, by S. J. Record, p. 23.
- Lumber trade journal, Dec. 15, 1914.—Meeting of dry kiln users and manufacturers, p. 32-7.
- Lumber trade journal, Jan. 1, 1915.—Arkansas annual lumber output, p. 23-4.
- Lumber world review, Jan. 10, 1915.—National lumber manufacturers' association November report of production and movement of lumber, p. 30.
- Municipal journal, Jan. 7, 1915.—Selection of paving material; method of determining the relative values under given conditions of stone, brick, wood, asphalt and other bituminous pavements, by George W. Tillson, p. 3-7.
- New York lumber trade journal, Jan. 1, 1915.—Water mains of a century ago, p. 38.
- Paper trade journal, Jan. 7, 1915.—The manufacture of papers, by James Scott, p. 44, 48.
- Pioneer western lumberman, Dec. 15, 1914.—The best type of silo; redwood recommended by experts, p. 9; British Columbia's lumber business, p. 13; An interesting address to the forest officers in District No. 5, by Coert DuBois, p. 15; Lumbering industry in the Philippines, by John R. Arnold, p. 19.
- Pioneer western lumberman, Jan. 1, 1915.—Douglas fir; the best structural timber, p. 20; Average strength values of structural timbers, p. 21.
- St. Louis lumberman, Dec. 15, 1914.—Prevention of decay in factory timbers, p. 71-2.
- Southern lumberman, Dec. 19, 1914.—Red gum; wider recognition of its worth, by John M. Pritchard, p. 48-9; The utilization of saw-mill waste, by Rolf Thelen, p. 53-5; Utilization of pine waste by distillation, by H. S. Sackett, p. 55-6; Making paper from long-leaf pine, p. 56-7; Kiln-drying wagon stock, p. 59; Heartwood and sapwood; the relative value and properties of each, by Samuel J. Record, p. 60-1.
- Southern lumberman, Jan. 9, 1915.—Remarkable fire test of treated wooden shingles and composition roofing at Birmingham, p. 40-1.
- Timber trade journal, Dec. 19, 1914.—Austrian and other oaks, by Percy Groom, p. 913-14.
- Timberman, Dec. 1914.—Western forestry and conservation association holds annual

- convention in Tacoma, p. 25-48 H; World's survey of box shoo industry reflected by consular reports, p. 48 L-O; Weight of western woods, p. 56.
- United States daily consular report, Dec. 21, 1914.—Paper supplies and pulp mills in Ontario, by Edwin W. Trimmer, p. 1244.
- United States daily consular report, Dec. 28, 1914.—Wood products of British Honduras, by Garrard Harris, p. 1326-7.
- United States daily consular report, Dec. 31, 1914.—Conditions in British Columbia timber industry, by R. E. Mansfield, p. 1394-5.
- West Coast lumberman, Dec. 15, 1914.—H. R. MacMillan, British Columbia forester, discusses lumbering future, p. 20, 37; E. A. Sterling, of Philadelphia, declares timber insurance now practical, p. 22, 38-40.
- West Coast lumberman, Jan. 1, 1915.—Sawdust briquettes solve problems in wood waste utilization and fuel, by Ralph Thelen, p. 40; An analysis of the various systems for handling lumber at the mill, by J. S. Williams, p. 42, 46-8.
- Forest Journals*
- Canadian forestry journal, Jan. 1915.—Planting spruce for commercial purposes; description of what the Laurentide company is doing, p. 3-6; Planning for street trees; suggestions for improving conditions in Canadian towns and other cities, p. 10-11.
- Centralblatt für das gesamte forstwesen, May-June, 1914.—Hofrat Adalbert Schiffler, by Janka, p. 169-70; Studien über die Alpen- und Sudetenlärche, by A. Cieslar, p. 171-84; Studien über die vielfarbigkeit von schwarzkiefern Samenkörnern, by Pit-tauer, p. 185-202; Untersuchungen über den einfluss von beobachtungsfehlern bei höhenmessungen an stehenden holze, by Wilhelm Tischendorf, p. 202-21.
- Forest leaves, Dec. 1914.—Narrative of the annual meeting of the Pennsylvania forestry association, p. 178-84; Fungous foes of the forest and the farm, by Jos. S. Illick.
- Forstwissenschaftliches centralblatt, Aug.-Sept., 1914.—Anbau von exoten, by Franz Harrer, p. 405-34; Baumästung, by Thaler, p. 434-43; Ist die kiefer des Pfälzerwaldes eine langholz- oder blochholzart, by Stamminger, p. 443-59; Zur pflanzenbeschaffung, by Krug, p. 459-62; Der 3. forstliche fortbildungskurs in Heidelberg, p. 468-78; Der private charakter der waldwege im grossherzogtum Baden, by Fieser, p. 478-82.
- Hawaiian forester and agriculturist, Nov. 1914.—New uses for India rubber, p. 329-33.
- Indian forester, Sept. 1914.—Antiseptic treatment of chir pine sleepers in the Kumaun circle, U. P., by J. E. C. Turner, p. 427-9; Teak in Burma, p. 450-1; Remarkable growth of Eucalyptus rudis, by R. N. Parker, p. 452-3; Cultivation of natural teak seedlings in the Haliyal teak pole forests worked on the coppice-withstandards system, by Copleston, p. 461-3.
- Indian forester, Oct. 1914.—A plea for the distillation of pine-needle oil in India, by Puran Singh, p. 503-10.
- Indian forester, Nov. 1914.—Natural preservation of mine timbers in the northern Shan states, by D. P. Hewett, p. 523-5; Flowering of Kyathaung bamboo in the Prone division, Burma, by J. W. Bradley, p. 526-9; Reinforced concrete boundary pillars for forest reserves, by A. J. Butterwick, p. 529-37; Forestry in Scotland, p. 548-53; The varieties of shellac, p. 554-5.
- Naturwissenschaftliche zeitschrift für forst- und land-wirtschaft, Sept.-Oct., 1914.—Bozen; schilderungen und bilder aus dem Münchener exkursionsgebiet, by Carl von Tubeuf, p. 409-83; Neuere versuche und beobachtungen über den blasenrost der Weymouthskiefer, by Carl von Tubeuf, p. 484-91; Tuberculina maxima, ein parasit auf dem blasenrost der Weymouthskiefer, by Eckley Lechmere, p. 491-8.
- North woods, Dec. 1914.—A very instructive meeting of rangers of the Minnesota forest service, p. 5-9; Foresters in the great war, by S. T. Dana, p. 13-20.
- Schweizerische zeitschrift für forstwesen, July-Aug., 1914.—Kurzer bericht über den forst von Bellême, by A. Barbey, p. 193-7; Die bewirtschaftung der Alpengenossenschaftswälder im lichte des bernischen forstgesetzes, by T. Christen, p. 197-207, 250-64; Weiters zur kenntnis der chermesiden der Schweiz, by N. Cholodkovsky, p. 207-11; Nochmals die "Förderung des plenterwaldes," by F. Fankhauser, p. 212-15; Beschaffung guter waldsamen von geeigneter herkunft durch den bund, by A. Engler, p. 220-2.
- Schweizerische zeitschrift für forstwesen, Sept.-Oct., 1914.—Die nutholz verwertenden industrien der Schweiz, by Decoppet, p. 245-50; Eine exkursion in einen buchenwald der Normandie, by H. Barbey, p. 265-8; Brennholzvorräte für 1914-15, p. 269-71.
- Yale forest school news, Jan. 1, 1915.—The training in forestry during the next decade, by W. B. Greeley, p. 3-5; Progress of professional forestry in the United States, by T. S. Woolsey, Jr., p. 5; Fire protection in Arizona and New Mexico, by W. A. Waha, p. 8; Winter marking in the Alps of Utah, by N. B. Eckbo, p. 9.
- Zeitschrift für forst- und jagdwesen, Oct. 1914.—Die höhe der schneedecke im walde und im freien, by Johannes Schubert, p. 567-72; Anzucht von waldmänteln, by Frey, p. 572-5; Beitrag zur hebung der holzproduktion und der erträge aus der waldwirtschaft, by Pelissier, p. 576-95; Das absterben der eichen in Westfalen, by Hey, p. 595-8; Die wälder des Semirjättschinskischen gebiets und ihre bedeutung im leben des landes, by Guse, p. 598-601.

FORESTERS ATTENTION

AMERICAN FORESTRY will print free of charge in this column advertisements of foresters wanting positions, or of persons having employment to offer foresters

WANTED—FORESTERS—A few excellent positions open for skilled foresters or experts in shade tree work. Some of these will require all of a man's time and others can be filled in connection with his regular work. The compensation is liberal. Please state references and experience. Address P. S. R., care American Forestry Association.

WANTED—Position wanted by graduate forester. Have had one season's experience with the Government, one with a lumber company and some in city forestry. Have passed the Civil Service examination for forest assistant. Address "G. D. C.," Care AMERICAN FORESTRY.

YOUNG MAN—Graduate Surveyor with experience in that line and also in bookkeeping, desires position with lumber operator. Have had U. S. Forest Service experience and scaled for large operator in the North. Address "Z," Care AMERICAN FORESTRY.

WANTED—By young man intending to study forestry, position with lumber company, surveying party, or other position by which he can gain practical knowledge. Address L. L., Care AMERICAN FORESTRY.

YOUNG MAN, 27 years old, unmarried, university training, business experience and three years of practical experience in surveying and construction, including preliminary surveys, estimates, railroad and highway location surveys and construction, topographic surveys, mapping, etc. Capable of taking charge of party, desires position with forester or lumber firm. Best references from former employers. Address "T. B. C.," Care AMERICAN FORESTRY.

FORESTER, with seven years' practical experience, desires a position as Forester. Have had considerable experience in reforestation and management, also fire protection. Address "T. F. H.," Care AMERICAN FORESTRY.

FOREST ENGINEER—Best of American and European training. Five years of practical work along lines of organization, administration, protection, cruising and appraising. Would like position with some large timber holding company, railroad, or municipal watershed. Best of references. Address "CRUISER," Care AMERICAN FORESTRY.

A forest school graduate with experience in U. S. Forest Service and with lumber company, also possessing thorough business training, will consider offer of good forestry position. Address M., Care AMERICAN FORESTRY.

FORESTER with 15 years experience Estimating, Surveying, Mapping, and in the care of private holdings desires position. Perfectly reliable in every way, and with executive ability. Address "A.," care AMERICAN FORESTRY.

WANTED—By Graduate Forester, position in forestry work in South, or Tropics. Slight knowledge of Spanish and German. Scientific or experimental work preferred. Address, "F. W. H.," Care of AMERICAN FORESTRY.

YOUNG MAN, expert in all branches of shade tree work and with forestry training, desires position as forester, arboriculturist or tree surgeon. References furnished. Address C. S., care AMERICAN FORESTRY.

FORESTER of technical training, six years' teaching and practical experience in different parts of the United States, wishes to better position. Best references from university and employers, and others. Address G. O. T., Care AMERICAN FORESTRY.

WESTERN ESTATE MANAGER—Graduate agriculturist and forester, raised on Western farm, two years' experience at lumbering and for past six years with the U. S. Forest Service, engaged in timber estimating, appraisal and forest management in Washington, Idaho and Montana, desires private work. Especially equipped to advise concerning or to manage timberlands or combined timber and farm estate. References furnished. Address R. I. F., Care AMERICAN FORESTRY.

SURVEYOR—Young man 21 having three years experience as Transitman, Rodman, and Chainman with a City Surveyor desires a like position in Forestry. Has ambition to become a Forestry Expert. A No. 1 references, reliable and trustworthy. Particulars on request. Address "D. H. F.," care AMERICAN FORESTRY.

SURVEYOR—For large tracts of land, roads and railroads; furnishes instrument; capable of taking charge of party; would like position in South that will last all winter. Address "T. B. W.," care AMERICAN FORESTRY.

GRADUATE FORESTER—Practical experience in cruising, mapping and scaling. Eager to go anywhere. References furnished. Address R. L., care of AMERICAN FORESTRY.

WANTED—Position with surveying party or in any work whereby practical experience in forestry can be gained, by strong, clean-cut young man, not afraid of work. Address "4.," Care of AMERICAN FORESTRY.

PRACTICAL FORESTER wants situation on private estate. Has practical experience of sowing, laying, planting out, pruning, thinning, firebelts, ditching, rotation planting, mixed planting and thorough knowledge of fencing and tree felling. Has had seven years experience on best managed forestry area in Scotland. Address, "Rath," Care AMERICAN FORESTRY.

PRACTICAL FORESTER wants position with city Park Commission. Understands fully nursery work, planting, trimming and tree surgery. Best references and practical experience. Address "L. M. E.," Care AMERICAN FORESTRY.

WANTED—A position as an inspector of ties, timbers and lumber, by a forest school graduate with experience in inspecting ties, timbers and lumber. Can furnish best of references. Address Inspector, Care AMERICAN FORESTRY.

Graduate of Forestry School, having studied forestry and lumbering operations in this country and Germany, with experience in the U. S. Forest Service, and also in state and private nursery work, would like position with forest engineering firm or lumber company. Best of references. Address NY, Care of AMERICAN FORESTRY.

ENERGETIC Post Graduate Forester desires position as an assistant in park or city forestry work. Subordinate duties preferred. Best of references. Address M. M. J., Care of AMERICAN FORESTRY.

FOREST ENGINEER with Forest Service training in Colorado, Wyoming, private work in California, and six years' experience in the lumber industry on the Pacific Coast, would like field work in any part of the United States. Estimating of timber lands and topographic surveying a specialty. Four years' technical training. Address, "D.," Care AMERICAN FORESTRY.



TIME—the Great Factor in Business

The day when a business man could afford to carry an inaccurate watch is long passed. The successful man has no use for a watch whose time must be confirmed. In railroad service, where accuracy is an absolute necessity, the Hamilton is an absolute favorite.

Hamilton Watch

"The Railroad Timekeeper of America"

There are twenty-five models of the Hamilton Watch. Every one has Hamilton quality and Hamilton accuracy. They range in price from \$12.25 for movement only (in Canada \$12.50) up to the superb Hamilton masterpiece at \$150.00.

Write for the Hamilton Watch Book—"The Timekeeper"

It pictures and describes the various Hamilton models and gives interesting watch information.

Your jeweler can show you the Hamilton you want, either in a cased watch or in a movement only, to be fitted to any style case you select, or to your own watch case if you prefer.

HAMILTON WATCH COMPANY, Dept. 00, Lancaster, Pennsylvania

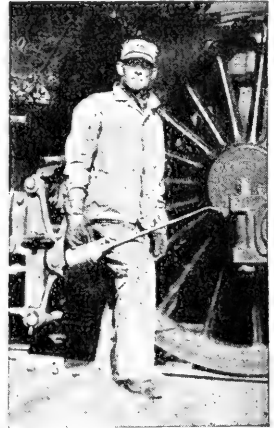

Engineer T. P. Howard, of the "California Limited," Iron Mountain R. R., has carried a Hamilton Watch with perfect satisfaction for many years.

YOUNG MAN—Four years' practical experience in reforestation, nursery work, improvement thinning, fire protection and tree surgery, wishes position on private estate or for state or municipal work. Experienced handling men. Best of references. Address R. A., care AMERICAN FORESTRY.

FOREST ENGINEER of ability and experience wishes the management of large timbered tract. Thoroughly experienced in Lumbering and Practical private Forestry, and capable of taking entire charge of game preserve, private estate, or other forested lands. Well recommended. Address "Woods Supt.," Care of AMERICAN FORESTRY, Washington, D. C.

WANTED.—A Position as Superintendent on Private Estate. Expert experience with 22 years' backing, on Forestry, Agriculture, Horticulture, Landscape Engineering. Graduate Civil Engineer, Practical Experience in all mentioned work. Will take full responsibility of any estate or construction of an estate and guarantee my work. Fair salary expected. Please state salary you are willing to offer with reply. I will not accept a position in "part." I will not accept position under three months' notice to my present Employer. Address "V. C. P.," Care AMERICAN FORESTRY.

YOUNG MAN, 29 years old, wishes position with forest owner or lumber mill concern, to take care of all waste timber. Have 12 years' experience in distilling and extracting by-products from forest wastes, etc. Address 1, Care AMERICAN FORESTRY.

FORESTER wants position with Consulting Forestry firm, or with lumber company or private estate. Training from Michigan Agricultural College and Yale Forest School; four years' experience with U. S. Forest Service and two winters with lumber companies. Acquainted thoroughly with Montana, Idaho and California timber as cruiser. References on request. Address E., Care AMERICAN FORESTRY.

WANTED—Position by a clean cut young man, with A-1 references, with a Forestry Expert or a surveying party, or any other business where a knowledge of the subject of forestry can be had. Address G. W. H., care AMERICAN FORESTRY.

WANTED—A job as fire ranger or guard by a strong, healthy young man twenty-one years of age. Address "3" care AMERICAN FORESTRY.

POSITION WANTED—Am graduate of Biltmore Forest School, with good record in survey, estimate and estate management and want position where I will have a chance to learn more. Have done practical work outside of school and am considered good at timber. Willing to go anywhere and be generally useful. Hard worker, don't mind long hours. Age, twenty-six. Give me interview or let me send references. Address J. U., care AMERICAN FORESTRY.

FOREST ENGINEER with training in this country and abroad, will consider position as Secretary of Fire Protective, Forestry or Conservation Association. Thoroughly experienced in Forestry and publicity work, and competent to handle affairs of such organization. Well recommended. Address "SECRETARY." Care of AMERICAN FORESTRY, Washington, D. C.

WANTED—Position as City Forester or Park Superintendent. Willing to consider position as an assistant. University training; experience in forestry, nursery and landscape work. Twenty-seven years old and married. Best of references. Address "F. S.," Care of AMERICAN FORESTRY, Washington, D. C.

FOR SALE—BULLETINS AND CIRCULARS

Almost complete series of Forestry Bulletins and Circulars Bulletins Nos. 5 to 127, except 17 of the earlier ones; Circulars Nos. 5 to 216 except 12. A valuable set. State offer in first letter. Address U. A., Care AMERICAN FORESTRY.

382,000,000 Feet National Forest Timber For Sale

AMOUNT AND SPECIES—Unit I, 85,000,000 feet B. M., more or less, of western yellow pine, sugar pine, lodgepole pine and western white pine timber, approximately 96 per cent western yellow pine.

Unit II, 297,000,000 feet B. M., more or less, of same species, approximately 97 per cent western yellow pine.

On both units there is an unestimated amount of other species, the removal of which is optional with the purchaser.

LOCATION—Unit I—Within the Crater National Forest, Oregon, in Twp. 35 S., R. 6 E., and Twp. 36 S., Rs. 5 and 6 E., W. M., on Four Mile, Lost and Woods Creeks.

Unit II—Within the Paulina National Forest, Oregon, in Twps. 28, 29 and 30 S., R. 6½ E., and Twp. 30 S., R. 7 E., W. M., on Bear Creek watershed.

STUMPAGE PRICES—Lowest rates considered for Unit I, \$3.00 per M. for western yellow pine, sugar pine, lodgepole pine and western white pine, and \$0.50 per M. for other species.

Unit II, \$3.25 per M. for western yellow pine, sugar pine, lodgepole pine and western white pine, and \$0.50 per M. for other species.

Rates to be readjusted on January 1, 1920, and every three years thereafter.

DEPOSIT—With bid on Unit I, \$5,000; on Unit II, \$20,000, to apply on purchase price if bid is accepted, or refunded if bid is rejected. Ten per cent may be retained as forfeit if the contract and bond are not executed within the required time.

FINAL DATE FOR BIDS—Sealed bids will be received on either or both units by the District Forester, Portland, Oregon, up to and including April 10, 1915. The time for receiving bids on either unit may be extended sixty days upon the request of responsible parties desiring additional time for the examination of the timber, or for other reasons in the discretion of the Forester.

The right to reject any and all bids is reserved.

Before bids are submitted full information concerning the character of the timber, conditions of sale, deposits, and the submission of bids should be obtained from the District Forester, Portland, Oregon, or the Forest Supervisor, Medford, Oregon.

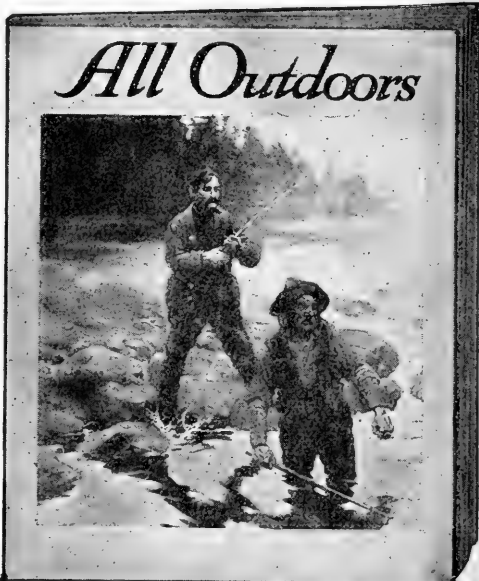

A Beautiful Color Painting

Of the Salmons' last rush is the ALL OUTDOORS cover for February.

The Angler's Work Shop

Gives hints and helps on fly-tying. Making your own rod. First aid to injured tackle, etc.—But

Outdoors in Winter

Is not forgotten. Snow-Shoeing. Skiing. Winter togs for winter camping. Tracking and the track-maker. All are covered.

Something for Everyone

Is the ALL OUTDOOR policy. Each month more than 150 articles. More than 100 illustrations. All selected for your service and entertainment—now. If you do anything out-of-doors you will like ALL OUTDOORS.

At your nearest newsdealer 15 cents—or better use the coupon.

ALL OUTDOORS, Inc. AF
145 West 36th St., New York.

Send me ALL OUTDOORS for six months on trial. 50 cents is enclosed. (\$1.00 for a year.)

Name

Address

Some Openings For Wood Workers

IN Northern Florida there is a good supply of timber which can be assembled advantageously at points on the Georgia Southern & Florida Railway; other conditions for profitable manufacturing in many lines. For a number of articles there is a market in the immediate section, while transportation facilities favor shipments to a wide range of markets.

Small Wood Working Plants

and will actively co-operate with manufacturers who are looking for a new and promising field.

The Southeastern States have the best opportunities and advantages for all factories using timber.

The Land and Industrial Department will aid interested parties in finding just the location desired.

For information refer to File No. 47,359

M. V. RICHARDS, Land and Industrial Agent
Southern Railway, Room 349, Washington, D. C.

Harvard University

SCHOOL OF FORESTRY

OFFERS specialized graduate training leading to the degree of Master of Forestry in the following fields:—Silviculture and Management, Wood Technology, Forest Entomology, Dendrology, and (in co-operation with the Graduate School of Business Administration) the Lumber Business

For further particulars address

RICHARD T. FISHER, Chairman
Cambridge, Massachusetts

PATENTS that properly protect

Thirty years of experience enable me to assure clients an intelligent service in securing patents that afford fullest protection. Correspondence invited.

No attorney's fee until patent is allowed

Write for free copy of "Inventor's Guide" which gives valuable information about patent protection.

FRANKLIN H. HOUGH

Loan and Trust Building WASHINGTON, D. C.

FO R E S T R Y
1 2 3 4

The FOREST is three-fourths of FORESTRY

Your opportunities are as unlimited as our forests if you study at

WYMAN'S SCHOOL OF THE WOODS
Incorporated Munising, Michigan

GEORGIA State Forest School University of Georgia

COMPLETE four-year undergraduate course in theoretical and applied forestry leading to the degree:

Bachelor of Science in Forestry

¶ Wide range of specialization offered—

Logging Engineering
Commercial Administration
Forest Management

City Forestry State Forestry
Dendrology Research

¶ Provision for four months field work—two following each of Freshman and Sophomore years—on McHatten Forest, a large forest estate in the Blue Ridge Mountains. Numerous excursions in Dendrology and Logging. Provision for practical work in specialization during Junior-Senior vacation

For announcement address

FOREST SCHOOL
Georgia State College of Agriculture
ATHENS, GEORGIA

Yale University Forest School

NEW HAVEN, CONN., U. S. A.

YALE University Forest School is a graduate department of Yale University. It is the oldest existing forest school in the United States and exceeds any other in the number of its alumni. A general two-year course leading to the degree of Master of Forestry is offered to graduates of universities, colleges and scientific institutions of high standing and, under exceptional conditions, to men who have had three years of collegiate training including certain prescribed subjects. Men who are not candidates for the degree may enter the School as special students, for work in any of the subjects offered in the regular course, by submitting evidence that will warrant their taking the work to their own advantage and that of the School. Those who have completed a general course in forestry are admitted for research and advanced work in Dendrology, Silviculture, Forest Management, Forest Technology, and Lumbering. The regular two-year course begins the first week in July at the School camp near Milford, Pennsylvania.

For further information address

JAMES W. TOUMEY, Director
NEW HAVEN, CONN.

A technically trained

Municipal Arborist or City Forester

will soon be needed in every city in the country.

There is a growing demand for technically trained men in Arboriculture and Landscape Engineering to act as City Foresters and Municipal Landscape Engineers.

The New York State College of Forestry

offers a four year course to fit men for this new and attractive line of work.

The New York State College of Forestry
Syracuse University
Syracuse New York

In the National Forest Region

Colorado School of Forestry

A DEPARTMENT OF
COLORADO COLLEGE

THE course in theoretical and applied forestry leading to the degree of Forest Engineer covers a period of two years and is open to students who have completed two years of college work, including a sufficient amount of Botany, Geology and Surveying.

Graduate students may enter as candidates for the degree of Master of Forestry.

Fall and Spring Terms in the Manitou Forest, the College Reserve, 6,000 acres of pine and spruce timberland on the borders of the Pike National Forest. Winter Term at Colorado Springs.

For particulars address

Colorado School of Forestry
Colorado Springs, Colo.

DEPARTMENT OF FORESTRY

The Pennsylvania State College

A PROFESSIONAL course in Forestry, covering four years of college work, leading to the degree of Bachelor of Science in Forestry.

Thorough and practical training for government, state, municipal and private forestry.

Four months are spent in camp in the woods in forest work.

Graduates who wish to specialize along particular lines are admitted to the "graduate forest schools" as candidates for the degree of Master of Forestry on the successful completion of one year's work.

For further information address,

Department of Forestry
PENNSYLVANIA STATE COLLEGE
State College, Pa.

What the Forester Should Read

Forest Valuation

By HERMAN HAUPT CHAPMAN, M. F.,
Harriman Professor of Forest Management,
Yale University Forest School.

This is the first book in English that treats this subject in a sufficiently clear manner.

Has been treated in a manner that can be readily grasped by the average reader.

Damages, stumpage values and costs of forest production have been discussed at length.

284 pages, 6 x 9. Cloth, \$2.00 net

Forest Working Plans

By A. B. RECKNAGEL, A. B., M. F., Professor Forestry, Cornell University.

In preparing this book the author constantly kept in mind the experience which he gained while doing active work for the Forest Service in various parts of the United States.

230 pages, illustrated, 6 x 9
Cloth, \$2.00 net

FREE EXAMINATION

NO CASH IN ADVANCE

Members of the American Forestry Association can procure the above book, or copies of any of our other publications, for ten days' free examination, the price to be remitted at the end of this time, or the book returned, postpaid.

JOHN WILEY & SONS, Inc., 432 4th Ave., New York

London: CHAPMAN & HALL, Ltd.

Montreal, Canada: RENOUF PUB. CO.

We make the ENGRAVINGS

for the
AMERICAN FORESTRY
MAGAZINE

OUR SPECIALTY

is the "better" grade finish of
DESIGNS & ENGRAVINGS
in one or more colors
for Magazines, Catalogues,
Advertisements, etc.

HALF TONES	LINE PLATES
DULLO-TONES	COMBINATION LINE AND HALF TONES
COLOR PROCESS	MULTI-COLORS

Established 1889

GATCHEL & MANNING

SIXTH and CHESTNUT STREETS
Opposite Olde Independence Hall
PHILADELPHIA

Use Press Clippings

IT will more than pay you to secure our extensive service, covering all subjects, such as Polo, Golf, Tennis, trade and personal, and receive the benefit of the best and most systematic reading of all papers and periodicals, here and abroad, at minimum cost. Why miss taking advantage for obtaining the best possible service in your line?

Our service is taken by all progressive business men, publishers, authors, collectors, etc., and is the card index for securing what you want and need, as every article of interest is at your daily command.

Write for terms; or send your order for 100 clippings at \$5, or 1,000 clippings at \$35. Special rates quoted on Large Orders.

The Manhattan Press Clipping Bureau

ARTHUR CASSOT, Proprietor Established 1888

Cambridge Building, 334 Fifth Avenue, Cor. 33d St., NEW YORK

Send for Our Desk Calendar

RED OAK ACORNS

New crop—prime—fresh, excellent quality. Collected in Northern Illinois. Have between 40 to 50 bushels still on hand—price while they last \$2.00 per bushel (50 pounds), 10 bushels \$18.50. Also complete stock Evergreen Tree Seeds. Write for price-list.

THE D. HILL CO., Box No. 501, Dundee, Illinois

BILTMORE TEXT BOOKS

The text books of the Biltmore Forest School, written by Dr. C. A. Schenck, continue for sale at Biltmore. For particulars address **BILTMORE FOREST BOOKS, Biltmore, N. C.**

Hardwood, White and Yellow Pine Timber

Lands for sale by **SAVAGE BROTHERS, Cornelia, Ga.**

BOOKS ON FORESTRY

AMERICAN FORESTRY will publish each month, for the benefit of those who wish books on forestry, a list of titles, authors and prices of such books. These may be ordered through the American Forestry Association, Washington, D. C. Prices are by mail or express prepaid.* :-: :-: :-: :-:

THE WOODS—Douglas Malloch	\$1.15
RESAWED FABLES—Douglas Malloch	1.15
THE TRAINING OF A FORESTER—Gifford Pinchot	1.12
LUMBER AND ITS USES—R. S. Kellogg	1.15
THE CARE OF TREES IN LAWN, STREET AND PARK—B. E. Fernow	2.17
NORTH AMERICAN TREES—N. L. Britton	7.30
KEY TO THE TREES—Collins and Preston	1.50
THE FARM WOODLOT—E. G. Cheyney and J. P. Wentling	1.70
AMERICAN FOREST TREES—Henry H. Gibson	6.00
IDENTIFICATION OF THE ECONOMIC WOODS OF THE UNITED STATES— Samuel J. Record	1.25
PLANE SURVEYING—John C. Tracy	3.00
FOREST MENSURATION—Henry Solon Graves	4.00
THE ECONOMICS OF FORESTRY—B. E. Fernow	1.61
FIRST BOOK OF FORESTRY—Filibert Roth	1.10
PRACTICAL FORESTRY—A. S. Fuller	1.50
PRINCIPLES OF AMERICAN FORESTRY—Samuel B. Green	1.50
SEASIDE PLANTING OF TREES AND SHRUBS—Alfred Gaut	1.75
FAMILIAR TREES—G. S. Boulger	1.50
MANUAL OF THE TREES OF NORTH AMERICA (exclusive of Mexico)—Charles Sprague Sargent	6.00
AMERICAN WOODS—Romeyn B. Hough	5.00
HANDBOOK OF THE TREES OF THE NORTHERN U. S. AND CANADA, EAST OF THE ROCKY MOUNTAINS—Romeyn B. Hough	6.00
GETTING ACQUAINTED WITH THE TREES—J. Horace McFarland	1.75
PRINCIPAL SPECIES OF WOOD: THEIR CHARACTERISTIC PROPERTIES— Charles Henry Snow	3.50
NORTH AMERICAN FORESTS AND FORESTRY—E. R. Bruncken	2.00
HANDBOOK OF TIMBER PRESERVATION—Samuel M. Rowe	4.00
TREES OF NEW ENGLAND—L. L. Dame and Henry Brooks	1.50
TREES AND SHRUBS—C. S. Sargent	5.00
TREES, SHRUBS AND VINES OF THE NORTHEASTERN UNITED STATES— H. E. Parkhurst	1.50
TREES—H. Marshall Ward	1.50
OUR NATIONAL PARKS—John Muir	1.91
THE LONGLEAF PINE IN VIRGIN FOREST—G. Frederick Schwarz75
LOGGING—Ralph C. Bryant	3.50
THE IMPORTANT TIMBER TREES OF THE UNITED STATES—S. B. Elliott	2.50
FORESTRY IN NEW ENGLAND—Ralph C. Hawley and Austin F. Hawes	3.50
THE PRINCIPLES OF HANDLING WOODLANDS—Henry Solon Graves	1.50
SHADE TREES IN TOWNS AND CITIES—William Solotaroff	3.00
THE TREE GUIDE—By Julia Ellen Rogers	1.00
FOREST PHYSIOGRAPHY—By Isaiah Bowman	5.00
MANUAL FOR NORTHERN WOODSMEN—Austin Cary	2.12
FARM FORESTRY—Alfred Akerman57
THE THEORY AND PRACTICE OF WORKING PLANS (in forest organization) A. B. Recknagel	2.10
ELEMENTS OF FORESTRY—F. F. Moon and N. C. Brown	2.20
MECHANICAL PROPERTIES OF WOOD—Samuel J. Record	1.75
STUDIES OF TREES—J. J. Levison	1.75
TREE PRUNING—A. Des Cars65

* This, of course, is not a complete list, but we shall be glad to add to it any books on forestry or related subjects upon request.—Editor.

385,000,000,000 Feet of Southern Yellow Pine

"THE WOOD OF A THOUSAND USES"

Enough lumber to put a fine house over every family in our country and build a garage and a couple of barns for each besides. **Surely, Enough.**

THINK OF

a beautifully-grained, mirror-surfaced, easily worked finishing product for your home, capable of taking any shading of finish or stain—

"SHORT LEAF SOUTHERN YELLOW PINE"

THINK OF

strength, toughness, durability for the structural framing (Yellow pine houses have stood for a century)—

"LONG LEAF SOUTHERN YELLOW PINE"

THINK OF

adaptability in general to all building and construction operations, in all climates. and ease of handling—

"Southern Yellow Pine is the Inevitable Answer"

INEXPENSIVE? YES

Source of raw supply being the nearest to the great central consuming districts, the process of our manufacture having been developed to the greatest degree of perfection in point of finish and economy, and a **plentiful supply**, make this **wonderful material** the most economical to use, where quality and beauty and strength are desired.

A card will bring other desired information and tell you how to get the particular yellow pine for your needs; write us

OUR 8 BIG PLANTS CUT 275,000,000 FEET ANNUALLY

Short Leaf and Long Leaf Product

MISSOURI LUMBER & LAND EXCHANGE CO.

Sales Office, 1111 Long Building, Kansas City, Mo.

J. B. WHITE, General Manager

J. H. BERKSHIRE, President

O. W. FISHER, Vice-President

We Are Not Prophets

We know timber prices cling tenaciously to every advance they make, that values increase, remain dormant for brief periods and again increase. To our personal knowledge that has been the history of timberland values for thirty-five years, but

We Do Not Know How High Timber Prices Will Go

Probably prices will continue to increase until they reach par—that is until it costs as much to buy timber as to grow it—which is several times the present value of stumpage.

With a three to five fold profit in prospect timber lands should interest you. Therefore you should know more about timber and we should know more about your plans.

James D. Lacey & Co.

Timber Land Factors

CHICAGO, ILL., 1750 McCormick Building
PORTLAND, ORE., 1313 Northwestern Bank Building
SEATTLE, WASH., 1009 White Building

American Forestry



Vol. 21

MARCH 1915

No. 3



California Expositions

THE vacation you're longing for—new sights and magic scenes—the wonders of the Expositions—the sunshine and roses of California.

Waiting to take you there is a world famous train that glides in its smooth, swift journey over a world famous route, protected by the latest Automatic Electric Block Signals.

Sunset Limited

(Every Day in the Year—No Extra Fare)

Southern Pacific—Sunset Route

"The Exposition Line—1915"

New Orleans Los Angeles San Diego San Francisco

A thousand wonders to enjoy through open windows—Oil-burning locomotives—No cinders, no dust—Through Dining and Observation Cars.

Choice of Water or Rail Lines to New Orleans

Write for illustrated literature and other information.

NEW YORK CITY
366 Broadway

NEW ORLEANS
Metropolitan Bank Bldg.

HOUSTON
Southern Pacific Bldg.

SAN FRANCISCO
Flood Bldg.

Agencies all over the United States, Mexico, Cuba, Europe



Vertical Farming Proved

By Effects of
ORCHARD BLASTING
 WITH



Red Cross
FARM POWDER

TREE
 SET IN
 SPADE
 DUG
 HOLE



THESE cuts are made from photos showing comparative growth of pear trees from spring of 1913 to August, 1914, Belle-mont Orchards, Inc., Norfolk, Va.

TREE SET
 IN BLASTED
 GROUND



ALL progressive farmers and orchardists know that trees planted in blasted ground grow much faster than those planted in the old way, and bear fruit earlier. This proves the truth of the principles of Vertical Farming, which aims to cultivate *downward* as well as to till the top soil.

Three years ago tree planting in blasted holes was experimental—now millions of trees are set out by the Vertical Farming method every Spring and Fall.

In like manner, blasting the subsoil to increase general crop yields—now regarded as experimental—will in a few years be common.

To learn how and why Vertical Farming may double the yields of your farm, get the Free Reading Course in Vertical Farming by Dr. G. E. Bailey—one of the best works on soils and soil culture ever published. Sent free with every request for our Farmer's Handbook No. 350-F. Write now.

DU PONT POWDER COMPANY

Established 1802

Wilmington, Delaware

Plant Evergreens 3-25 Feet High and All Winter Planting Will Be Welcome

IF you need to screen unattractive surroundings, garage, stable, poultry house, laundry yard, or street.

IF you admire evergreens.

IF you need windbreaks to your house, garden, out door room or play ground.

IF you enjoy hunting big Cedars, Pines, Oaks, Maples, Dogwoods, Laurel, etc., and making your place look like an old place right away.

IF you have evergreens, deciduous trees or shrubs to move to other parts of your grounds or give away or sell.

The Proof

Hicks Nurseries employed 100 men last winter, except 14 days. Half were digging trees.

Our winter sales for the past four years were \$16,000.00.

In January the ground freezes six inches, but is easily worked if previously mulched to keep out frost.

On the mainland the frost is deeper and more continuous, but it is easy to dig through with pick or cold chisel.

If it costs a few cents additional to plant we will bear that to keep our staff all winter.

IF you wish to prevent winter unemployment. We can provide apparatus and men to cooperate with your men or we can attend to the entire operations.

IF you wish to take advantage of present reduced prices. Carload shipments or less from the nursery of pines, spruce, cedar, 3-25 feet high.

I. HICKS & SON

Westbury, L. I.,

New York

TREE SEEDS

We have never looked upon Tree Seeds as a side issue. Instead, we have devoted a large portion of our time to them.

The assortment we carry more than doubles that of any house—American or Foreign. We stock even the rarest species.

Send your list to us for prices.

J. M. THORBURN & CO.

Established 1802

53 Barclay St.

New York City

Seeds for Forestry Purposes

WE offer a most complete list of both Deciduous and Evergreen Tree and Shrub seeds for forestry purposes.

Seeds that are of best germinating quality

Our catalogue contains a full list of the varieties we offer, which include the best and most rare species. Send for a copy, it will interest you.

THOMAS MEEHAN & SONS

Wholesale Nurserymen and Tree Seedmen
DRESHER, PENNA., U. S. A.

ORCHIDS

ORCHIDS

We are specialists in Orchids, we collect, import, grow, sell and export this class of plants exclusively.

Our illustrated and descriptive catalogue of Orchids may be had on application. Also special lists of freshly imported unestablished Orchids.

LAGER & HURRELL

SUMMIT, N. J.

Orchid Growers and Importers

Headquarters for Forestry Stock

AND EVERYTHING WORTH PLANTING

Exterior Decorations

In Everything Worth Planting

SEND FOR COPY IF INTERESTED

Efficiency
of
Service

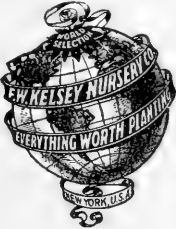

Quality
of
Material

Quality should be the first consideration in purchasing Trees, Shrubs and Hardy Plants for the estate. **Our Quality Evergreens, Hardy Rhododendrons, Shade Trees, Vines, Roses, etc.,** as for many years furnished to the leading country places, always give satisfaction.

F. W. KELSEY NURSERY COMPANY
150 Broadway, New York

You may be interested in our new illustrated book on "Exterior Decorations in Everything Worth Planting." If so please write for a copy. Mailed free.

Specials in Forestry Material

	1,000	10,000
NORWAY SPRUCE. 4 yr. Transplants.	\$6.50	\$55.00
NORWAY SPRUCE. 3 yr. Seedlings...	3.50	28.50
NORWAY SPRUCE. 2 yr. Seedlings...	3.00	21.00
WHITE PINE. 4 yr. Transplants.....	8.50	75.00
WHITE PINE. 3 yr. Seedlings.....	4.00	27.00
WHITE PINE. 2 yr. Seedlings.....	3.00	21.00

The finest Hardy Domestic Northern Grown Stock at very favorable prices.

FOUR MILLIONS

of these two leading hardy varieties for Forestry Purposes. We began the season with this surplus. Are you going to take advantage of this favorable opportunity for superior FOREST PLANTING AT THE EXTREME MINIMUM COST? We can make you a special proposition by the 100,000 or more that will merit the award of your order if interested in planting these species. Let us also quote you other Forestry Requirements.

F. W. KELSEY NURSERY CO., 150 BROADWAY, NEW YORK



HARDY ENGLISH WALNUT TREES, Rochester Grown will succeed wherever Peach trees are safe to plant. Plant an English Walnut orchard this Spring. Make a beginning and add to it each season. We believe this is the only Northern locality where commercial orchards of English Walnuts may be seen, containing hundreds of trees which have been bearing more than twenty years. For the lawn or driveway, English Walnut is exquisitely beautiful with its smooth gray bark, dark green foliage, symmetrical growth. Rochester parks and streets contain many beautiful bearing trees, thriving under exactly the same conditions as the Maples and Elms and producing delicious nuts as well as shade.

No matter what you may be interested in get our Catalog and Planting Guide, profusely illustrated, includes Nut Culture, Fruits, Roses, Shrubs, Evergreens, etc., FREE.

GLEN BROS., Inc., Glenwood Nursery, Est. 1866, 1766 Main St., ROCHESTER, N. Y.

RED OAK ACORNS

New crop—prime—fresh, excellent quality. Collected in Northern Illinois. Have between 40 to 50 bushels still on hand—price while they last \$2.00 per bushel (50 pounds), 10 bushels \$18.50. Also complete stock Evergreen Tree Seeds. Write for price-list.

THE D. HILL CO., Box No. 501, Dundee, Illinois

JAMES W. SEWALL

Timber Estimates

Topographic and Boundary Surveys, Planting, Logging Maps, Portable Mill Operations

Technical Training Thoroughness Experience

CENTRE STREET OLD TOWN, MAINE

HILL'S SEEDLINGS and TRANSPLANTS

Also Tree Seeds

FOR REFORESTING

BEST for over a half century. All leading hardy sorts, grown in immense quantities. Prices lowest. Quality highest. Forest Planter's Guide, also price lists are free. Write today and mention this magazine.

THE D. HILL NURSERY CO.

Evergreen Specialists
Largest Growers in America

BOX 501 DUNDEE, ILL.

EVERGREEN

"We Raise Our Own Trees"

Seedlings Transplants



From our specialized collection of young conifers you will find what you want for every place and purpose. Our stock is hardy and field grown and admirably adapted for forest planting and lining out.

Your order will have personal attention and the price will be right.

Send for Catalogue and save money

The North-Eastern Forestry Co.

Tree Seeds, Nursery Stock. Box A, Cheshire, Conn.

ENGRAVINGS

made by

National Engraving Co.

506-508 Fourteenth St. N. W.

WASHINGTON, D. C.

Engravers to the Government

Pan American Union
 Smithsonian Institution
 Agricultural Department
 U. S. Geological Survey
 Patent Gazette
 Experimental Stations and
 State Institutions

HALF-TONES

LINE CUTS

THREE-COLOR PROCESS PLATES

ELECTROTYPES

Printers Demand Our CUTS

Barrett's
Grade One
 LIQUID
Creosote Oil

**Cuts your wood
 preserving bills in half—**

Especially adapted for preserving tele-
 phone poles, telegraph poles, cross arms,
 railroad ties, fence posts, mine timbers,
 underground sills, sleepers, bridge
 timbers, planking, ice houses, wood
 tanks, shingles, poultry houses, silos,
 boat timbers or any exposed woodwork.

Booklet on request.

BARRETT MANUFACTURING CO.

New York	Chicago	Philadelphia
Boston	St. Louis	Cleveland
Cincinnati	Pittsburgh	Detroit
Birmingham	Minneapolis	Seattle
Kansas City	Salt Lake City	



APPLICATION FOR MEMBERSHIP

Date.....

THE AMERICAN FORESTRY ASSOCIATION

1410 H Street, Washington, D. C.

Dear Sir: I hereby signify my desire to become an Annual Member and sub-
 of the AMERICAN FORESTRY ASSOCIATION, and scriber (\$3)
 enclose \$..... for dues. a Contributing Member (\$10)
 a Sustaining Member (\$25)
 a Life Member (\$100)
 a Patron (\$1,000)

Very truly yours,

Name.....

P. O. Address.....

American Forestry

The Magazine of the American Forestry Association

PERCIVAL SHELDON RIDSDALE, Editor

EDITORIAL ADVISORY BOARD

HERMAN H. CHAPMAN
ERNEST A. STERLING
S. T. DANA

FREDERICK S. UNDERHILL
JOHN E. RHODES
S. N. SPRING

March	CONTENTS	1915
--------------	-----------------	-------------

COVER—Falls on Rock Creek, Polk County, Tennessee.	
THE GREAT WAR'S DESTRUCTION OF FRENCH FORESTS—By Jean-Paul Alaux, A. D. G.....	155
With eleven illustrations.	
THE CRISIS IN NEW YORK—By H. H. Chapman.....	168
FORESTRY AT THE EXPOSITION.....	171
HUNTING ON THE NATIONAL FORESTS—By Herbert A. Smith.....	172
With twelve illustrations.	
FARMERS' WEEK AT CORNELL.....	183
With one illustration.	
JOHN MUIR—By George B. Sudworth.....	184
With one illustration.	
BERMUDA'S LITTLE TREES—By W. R. Brown.....	186
With twelve illustrations.	
BEAUTIFYING BATTLE CREEK.....	198
With one illustration.	
TREE PLANTING IN THREE BOROUGHES—By J. Gerry Curtis.....	199
With one illustration.	
MORE DURABLE PINE POSTS.....	200
ANDREW CARNEGIE, Vice President of the American Forestry Association.....	201
WILLIAM H. TAFT, Vice President of the American Forestry Association.....	202
VIRGINIA'S STATE FORESTER.....	203
With one illustration.	
MRS. EMMONS CROCKER—By Lydia Adams-Williams.....	204
With one illustration.	
WISCONSIN'S FORESTRY TANGLE.....	206
AIDING TIMBER OWNERS.....	207
THE AMERICAN LUMBER MARKET—Part I, By E. B. Hazen.....	208
TO PROMOTE THE USE OF WOOD.....	213
FOREST FIRE LOSSES \$677,816.....	214
EDITORIAL.....	215
CANADIAN DEPARTMENT—By Ellwood Wilson.....	217
WITH THE FORESTERS.....	219
FOREST NOTES.....	220
BOOKS RECEIVED.....	222
CURRENT LITERATURE.....	223

AMERICAN FORESTRY is published monthly by the American Forestry Association
Subscription price, three dollars per year; single copies, twenty-five cents.

Copyright 1915, by the American Forestry Association

AMERICAN FORESTRY ASSOCIATION MEETING

SAN FRANCISCO, OCTOBER 20

The Most Comfortable Route
Is The All Water Service

N. Y.—San Francisco THROUGH THE PANAMA CANAL

By the American-Built
Transatlantic Liners

"FINLAND" "KROONLAND"

22,000 Tons Displacement

The Trip of a Lifetime
Every Mile a Delight

Ask for Our Brochure

PANAMA PACIFIC LINE

9 Broadway, New York
319 Geary Street, San Francisco

Agents Everywhere

READY NOVEMBER 1, 1914

A New Booklet on Estimating Southern Timber

Southern White Cedar
Shortleaf and Longleaf Pine
Southern Appalachian Timber
Postpaid, 20 cents

HOWARD R. KRINBILL
Forest Engineer NEWBERN, N. C.

TIMBER ESTIMATES

We make accurate cruises of standing
timber, topographical maps, and advise
as to forest management for—

TIMBER OWNERS
BONDING HOUSES
MILL OPERATORS

MUNSON-WHITAKER CO.

Consulting Forest Engineers
NEW YORK, 67½ Fourth Ave. CHICAGO, 516 Comm. Bk. Bldg.
BOSTON, 622 Tremont Bldg. PITTSBURG, 906 Arrott Bldg.

TIMBER ESTIMATES

Why not have your timber estimated by competent Forest
Engineers? Somebody will do it; why not the best?

IT WILL PAY AND SAVE IN BONDING,
SELLING OR OPERATING

We make preliminary examinations; complete forest surveys, including
logging maps; valuations; and planting and management reports.

Also Specialists on Preservative Treatment of Wood Against Decay

Write for information

CLARK, LYFORD & STERLING

1331-2 Real Estate Trust Building

PHILADELPHIA, PENNA.

Declaration of Principles and Policy of the American Forestry Association

- IT IS A VOLUNTARY** organization for the inculcation and spread of a forest policy on a scale adequate for our economic needs, and any person is eligible for membership.
- IT IS INDEPENDENT**, has no official connection with any Federal or State department or policy, and is devoted to a public service conducive to national prosperity.
- IT ASSERTS THAT** forestry means the propagation and care of forests for the production of timber as a crop; protection of watersheds; utilization of non-agricultural soil; use of forests for public recreation.
- IT DECLARES THAT FORESTRY** is of immense importance to the people; that the census of 1913 shows our forests annually supply over one and a quarter billion dollars' worth of products; employ 735,000 people; pay \$367,000,000 in wages; cover 550,000,000 acres unsuited for agriculture; regulate the distribution of water; prevent erosion of lands; and are essential to the beauty of the country and the health of the nation.
- IT RECOGNIZES THAT** forestry is an industry limited by economic conditions; that private owners should be aided and encouraged by investigations, demonstrations, and educational work, since they cannot be expected to practice forestry at a financial loss; that Federal and State governments should undertake scientific forestry upon national and State forest reserves for the benefit of the public.
- IT WILL DEVOTE** its influence and educational facilities to the development of public thought and knowledge along these practical lines.

It Will Support These Policies:

- FEDERAL ADMINISTRATION AND MANAGEMENT** of national forests; adequate appropriations for their care and management; Federal cooperation with the States, especially in forest fire protection.
- STATE ACTIVITY** by acquirement of forest lands; organization for fire protection; encouragement of forest planting by communal and private owners; non-political departmentally independent forest organization, with liberal appropriations for these purposes.
- FOREST FIRE PROTECTION** by Federal, State and fire protective agencies, and its encouragement and extension, individually and by cooperation; without adequate fire protection all other measures for forest crop production will fail.
- FOREST PLANTING** by Federal and State governments and long-lived corporations and acquirement of waste lands for this purpose; and also planting by private owners, where profitable, and encouragement of natural regeneration.
- FOREST TAXATION REFORMS** removing unjust burdens from owners of growing timber.
- CLOSER UTILIZATION** in logging and manufacturing without loss to owner; aid to lumbermen in achieving this.
- CUTTING OF MATURE TIMBER** where and as the domestic market demands it, except on areas maintained for park or scenic purposes, and compensation of forest owners for loss suffered through protection of watersheds, or on behalf of any public interest.
- EQUAL PROTECTION** to the lumber industry and to public interests in legislation affecting private timberland operations, recognizing that lumbering is as legitimate and necessary as the forests themselves.
- CLASSIFICATION** by experts of lands best suited for farming and those best suited for forestry; and liberal national and State appropriations for this work.

THE AMERICAN FORESTRY ASSOCIATION

OFFICERS FOR 1914

President

DR. HENRY STURGIS DRINKER, President, Lehigh University, South Bethlehem, Pa.

Vice-Presidents

JOSHUA L. BAILEY, Pennsylvania
THEODORE L. BRISTOL, Connecticut
Ex-President Connecticut Forestry Association
ANDREW CARNEGIE, New York
MRS. EMMONS CROCKER, Massachusetts
DR. CHARLES W. ELIOT, Massachusetts
President Emeritus Harvard University
DR. B. E. FERNOW, Canada
Dean of Forestry, University of Toronto
HON. WALTER L. FISHER, Chicago, Ill.
Ex-Secretary of the Interior
HENRY S. GRAVES, District of Columbia
Chief of the Forest Service
HON. CURTIS S. GUILD, Massachusetts
Ex-Ambassador to Russia
EVERITT G. GRIGGS, Washington
HON. DAVID HOUSTON
Secretary of Agriculture
HON. FRANKLIN K. LANE
Secretary of the Interior

HON. ASBURY F. LEVER, South Carolina
United States Representative
HON. THOMAS NELSON PAGE
Ambassador to Italy
HON. GEO. PARDEE, California
Ex-Governor California
GIPFORD PINCHOT, Philadelphia, Pa.
FILIBERT ROTH, Michigan
Dean of Forestry, University of Michigan
DR. J. T. ROTHROCK, Pennsylvania
HON. WM. H. TAFT, Connecticut
Ex-President United States
JOSEPH N. TEAL, Oregon
Chairman Oregon Conservation Commission
HON. JOHN WEEKS, Massachusetts
U. S. Senator
DR. ROBERT S. WOODWARD, Washington, D. C.
President, Carnegie Institution

Treasurer

JOHN E. JENKS, Washington, D. C.
Editor, Army and Navy Register

Executive Secretary

P. S. RIDSDALE, 1410 H Street N. W., Washington, D. C.

Directors

E. T. ALLEN, Oregon
Forester, Western For. and Conservation Assn.
HON. ROBERT P. BASS, New Hampshire
Ex-Governor of New Hampshire
WM. B. GREEBLEY, District of Columbia
Assistant U. S. Forester
W. R. BROWN, New Hampshire
Pres., New Hamp. Forestry Commission
HERMAN H. CHAPMAN, Connecticut
Professor of Forestry, Yale Forest School
DR. HENRY S. DRINKER, Pennsylvania
President, Lehigh University
ALFRED GASKILL
State Forester, New Jersey
JOHN E. JENKS, District of Columbia
Editor, Army and Navy Register

CHESTER W. LYMAN, New York
International Paper Company
CHARLES LATHROP PACK, New Jersey
Pres., Fifth National Conservation Congress
CHARLES F. QUINCY, New York
J. E. RHODES, Illinois
Secretary Southern Pine Association
ERNEST A. STERLING, Pennsylvania
Forest and Timber Engineer
JOHN L. WEAVER, District of Columbia
Real Estate Broker
J. B. WHITE, Missouri
Ex-President, National Conservation Congress

Auditors

E. A. STERLING, Pennsylvania

C. F. QUINCY, New York

Advisory Board, Representing Affiliated Organizations

National Wholesale Lumber Dealers' Association

ROBT. C. LIPPINCOTT, Philadelphia, Pa.
R. L. SISSON, Potsdam, N. Y.
JOHN M. WOODS, Boston, Mass.

Northern Pine Manufacturers' Association

C. A. SMITH, Minneapolis, Minn.
WILLIAM IRVINE, Chippewa Falls, Wis.
F. E. WEYERHAEUSER, St. Paul, Minn.

Massachusetts Forestry Association

NATHANIEL T. KIDDER, Milton, Mass.
FREDERIC J. CAULKINS, Boston, Mass.
HARRIS A. REYNOLDS, Cambridge, Mass.

Lumbermen's Exchange

J. RANDALL WILLIAMS, JR., Philadelphia, Pa.
FREDERICK S. UNDERHILL, Philadelphia Pa.
ROBERT C. LIPPINCOTT, Philadelphia, Pa.

Camp Fire Club of America

WARREN H. MILLER, New York
O. H. VAN NORDEN, New York
FREDERICK K. VREELAND, New York

North Carolina Forestry Association

E. B. WRIGHT, Boardman, N. C.
ALSTON GRIMES, Grimesland, N. C.
J. C. SMOOT, North Wilkesboro, N. C.

National Association of Box Manufacturers

B. W. PORTER, Greenfield, Mass.
S. B. ANDERSON, Memphis, Tenn.
ROBT. A. JOHNSON, Minneapolis, Minn.

Carriage Builders' National Association

H. C. McLEAR, Wilmington, Del.
D. T. WILSON, New York
C. A. LANCASTER, South Bend, Ind.,

Boston Paper Trade Association

N. M. JONES, Lincoln, Maine
JOHN E. A. HUSSEY, Boston, Mass.
ARTHUR L. HOBSON, Boston, Mass.

Philadelphia Wholesale Lumber Dealers' Ass'n

ROBT. C. LIPPINCOTT, Philadelphia, Pa.
J. RANDALL WILLIAMS, JR., Philadelphia, Pa.
FRED'K S. UNDERHILL, Philadelphia, Pa.

New Hampshire Timberland Owners' Association

W. H. BUNDY, Boston, Mass.
EVERETT E. AMEY, Portland, Me.
F. H. BILLARD, Berlin, New Hampshire

Empire State Forest Products Association

FERRIS J. MEIGS, New York City
RUFUS L. SISSON, Potsdam, N. Y.
W. L. SYKES, Buffalo, N. Y.

California Forest Protective Association

MILES STANDISH, San Francisco, Cal.
GEO. X. WENDLING, San Francisco, Cal.
GEO. H. RHODES, San Francisco, Cal.

Minnesota Forestry Association

W. T. COX, St. Paul, Minn.
PROF. D. LANGE, St. Paul, Minn.
MRS. CARRIE BACKUS, St. Paul, Minn.

American Wood Preservers' Association

GEO. E. REX, Topeka, Ka.
CARL G. CRAWFORD, Louisville, Ky.
F. J. ANGIER, Baltimore, Md.

American Forestry

VOL. XXI

MARCH, 1915

No. 3

THE GREAT WAR'S DESTRUCTION OF FRENCH FORESTS

By JEAN-PAUL ALAUX, A. D. G.

[Monsieur Alaux is attached to the French Army and has been at the front almost since the beginning of the war. He is an eminent architect of Paris and the French correspondent of the Journal of the American Institute of Architects. This article was written for AMERICAN FORESTRY by M. Alaux and was translated by Charles Harris Whitaker. It is a first hand description of the effect of the war on the Forests and not the least interesting part is the fact that the Germans are cutting the French Forests in their possession and shipping the timber back to Germany. They are probably doing the same with Belgium Forests. M. Alaux estimates that it will be thirty years before the damaged French Forests are again a source of revenue.—EDITOR'S NOTE.]

THE great war which, during the last six months, has convulsed Europe, has had its repercussions throughout the world. Even Nature herself, who generally remains impassable during great human crises, will long bear the cruellest marks of this frightful hurricane of battle, involving a degree of destruction and devastation which are without precedent in history; and nowhere will these marks be more conspicuously and painfully in evidence, than in the Forests, so far as the natural aspect of things is concerned.

During the last six weeks I have been able to gather a series of narratives and accounts, to which I am adding the result of my own observations. Some of these things are both interesting and curious, as related to forest destruction, and I take a great, even though a somewhat melancholy, pleasure in the thought that the result of my labors may be of interest to the lovers of forests in America.

The great task of gathering statistics and of making a valuation of the damage done to French Forests must of course wait for the close of the war, but up to the present time it may be said that the chief damage wrought

has been due to one or the other of the following causes:

I. Cuttings by the military authorities for strategic reasons and for permitting the more effective use of artillery.

II. Cuttings for the purpose of building trenches, shelters and roads.

III. Cutting for firewood for the military kitchens and for fuel with which to warm the shelters.

IV. Cutting by the enemy and the taking away of timber as valuable booty.

V. Damages by projectiles and by fires, whether due to accident or design.

At the moment when the Germans, through their invasion of Belgium, were able to penetrate France, Paris found itself temporarily menaced. Under General Gallieni, the outer defenses were immediately organized and by his direction, an extensive series of preparations were undertaken, among which was the necessity of clearing away the numerous forests which surround the city. To the North, by which the investment of the city was thought likely to be attempted, the forests were particularly doomed. I am informed that the forest of Montmorency, for example, suffered greatly by reason of



Copyright by Underwood & Underwood, N. Y.

EFFECTIVE TREE SCREEN IN THE TRENCHES.

HOW SOME INDUSTRIOUS FRENCH SOLDIERS MADE THEMSELVES COMFORTABLE IN THE TRENCHES AND HOW THEIR IMPROVISED HOME WAS PROTECTED FROM OBSERVATION BY TREE BRANCHES.

the wholesale cuttings which were necessitated in order to give full play to the artillery and remove all growths which might serve the enemy as masks and ambushes. On the contrary, the forests of Vincennes and Boulogne, which practically touch the outer barriers of Paris to the East and South, have scarcely been touched. The territorials quartered there have made some slight cuttings for use in shelters.

ROADS MADE OF TREES.

The winter rains have rendered most of the roads impassable, especially in the wooded regions. In the forest of Bouvigny, near Arras, and in the forest of Berthonval, the artillerymen were unable to move their guns over the muddy and intrenched roads, and it was impossible to even transport ammunition. In order to keep the guns supplied, it was necessary to cut new roads, in all directions, through the forests, using the felled trees for the

purpose. The trunks, in sections of about twelve feet, are laid side by side and bound together with ropes and with galvanized iron wire. They are further securely fastened to stakes driven deep in the ground. The first layer of trees having proven insufficient, a second was added. This again failing to suffice, a third became necessary, until, in many cases, three layers of trees are superposed in order to permit the passage of convoy wagons. To avoid the too rapid wear of the wood through the grinding of the heavy wheels and the tearing of the horse's shoes, earth mixed with straw, bark, and the twigs and small branches of the fallen trees is strewn plentifully over these improvised roadways.

Other cuttings have been made in these forests, both for shelters and for firewood. Concealment of the heavy guns on the edge of the forest has necessitated the use of large quantities of the bigger branches, so that the sum



Copyright—International News Service.

TREE ROAD FOR ARTILLERY TRANSPORTS.

THREE LAYERS OF SMALL TREES ARE USED FOR THIS ROAD WHICH IS SHOWN HERE IN AN UNCOMPLETED STATE, HAVING BEEN HASTILY LAID IN ORDER TO RUSH A FIELD PIECE TO THE FIRING LINE. HUNDREDS OF THOUSANDS OF YOUNG TREES HAVE BEEN USED IN THE DIFFERENT SECTIONS WHERE FIGHTING HAS OCCURRED BY ALL THE COMBATANTS.



Copyright by Underwood & Underwood, N. Y.

METHOD OF HIDING ARTILLERY.

FRENCH SOLDIERS IN THE REGION OF THE AISNE SHELLING THE GERMAN TRENCHES. SO WELL IS THIS GUN HIDDEN THAT IT COULD NOT BE SEEN BY AN AVIATOR UNLESS HE WAS FLYING SO LOW THAT HE WOULD BE SUBJECTED TO RIFLE FIRE.

total of what has been already cut represents a very considerable damage. A wood merchant, in my regiment, tells me that it will require at least thirty years to renew the growth of that which has already perished, so that the forests shall return a revenue.

DESTROYED FOR ARTILLERY PURPOSES.

The forest of Vitrimont, behind Lunéville, has been completely razed. In the forest of Meaux, lanes from one hundred and fifty to three hundred feet in width have been cut at intervals of every thousand feet. This was of course for the purpose of allowing the artillery to shower its murderous fire over a wide area, as though through some gigantic loophole. One cannot find a remnant of copse or thickets;

all the trees and saplings have disappeared throughout the razed area.

Near Neufchâteau, the fort of Bourlémont had been built upon land which had been donated for the purpose by the Count of Alsace. The magnificent forest in front of it was entirely felled.

In the forest of Champenoux, every tree was cut down, leaving the trunks standing to a height of about three feet. This was the method of cutting generally followed at the beginning, when strategic reasons demanded that an area be cleared. The standing trunks made it easy to construct the barbed wire entanglements and barriers which prevented any raids by either cavalry or infantry. Recently, this method has ceased, by order of the Minister of War, as it was deemed



Copyright by Underwood & Lothrop, N. Y., U.S.A.

FRENCH SOLDIERS IN A FRENCH FOREST. A WAR TIME SCENE IN A TYPICAL FRENCH FOREST. A SCOUTING PARTY OF FRENCH HUSSARS HAS ENCOUNTERED AN INFANTRY PATROL. NOTE THE TYPE OF TREES.

useless and unnecessary in view of the entrenched method of fighting which now prevails. But a considerable damage has already been done, and in order that the next growth may properly take place, it will be later necessary to again cut away these remnants of trunks.

In the plateau of Amance, before Nancy, the trees were all felled for strategic reasons. The woods of Crévie, between Dombasle and Arancourt, were destroyed by fire (August 22 and 23, 1914). I have not been able to learn whether the fire was due to the accidental spreading of the kitchen fires, a careless match, or to the explosion of an incendiary shell.

For several weeks I have been quartered in the vicinity of Arras. In the wood of La Haye, all of the trees and undergrowth have been cut practically throughout the whole area of the forest. It was done for the purpose of providing firewood for the kitchens and shelters. Daily, I have seen the men file away, axe and billhook in hand, to return later laden down with great bundles of wood, which they threw down beside their shelters, and which they would afterward split with wooden wedges.

USE FOR SHELL PROOF SHELTERS.

To construct our subterranean shelters, which are practically shell-proof, we use roof supports consisting of small trunks of trees from four to six inches in diameter. Resting on these are the split slabs, in two courses, separated by small branches or straw. Over the whole is strewn earth to the depth of about eighteen inches. In order to keep the rain and melting snow from finding its way through this roof, a shelter-roof is built overhead. This is composed of bundles of small branches and straw, which are laid at a proper angle and which rest upon a small sapling stretched across the roof area. They serve as an umbrella to protect the roof beneath.

The shelters vary considerably both in plan and in dimensions. Generally they are entirely beneath the ground. Occasionally, they are built by taking advantage of a steep slope which offers

protection from the enemy's fire. They are sometimes large enough to contain fifty men, but that is the maximum. Many of them contain but two, three, or four soldiers.

I have spent many long days in a shelter whose construction and plan are indicated in the accompanying sketch. Stairs, cut in the earth, descend to this subterranean dwelling, from which issues a chimney. It was cut through the clay soil and the smoke escapes from our fire through a piece of terra cotta pipe. The walls are insulated against dampness by wisps of straw. A small bench provides a sitting place facing the room. The straw of our beds is disposed upon mattresses composed of branches, sufficiently thick to protect us from the moisture of the ground. An umbrella, such as I have already described, protects our shelter from the rain and snow. The real roof is of course even with the ground.

While it is true that much of the wood employed in constructing these shelters and in building trenches and roads will not be wholly lost, it will of course serve no other purpose than that of firewood. But even this service is problematical and will of course depend largely upon the duration of the campaign. We also cut off large branches with which to mask the heavy guns and the caissons of ammunition, which are generally stationed near the edge of the wood. This practice is everywhere in vogue as a means of preventing the discovery of their location from the prying eyes of the aeroplanists. It is impossible for one of these, obliged to fly, for the sake of protection, not nearer than six to seven thousand feet, to distinguish the ambush under which the guns and caissons are hidden. It is impossible, even in winter, when the branches employed are of course quite leafless.

CUT TO PIECES BY ARTILLERY.

In respect to the damage done by shells and projectiles, it is worthy of note that the war of 1870 led to the publication of an important work on this subject, either through the Académie Stanislaus of Nancy, or through the Société des Sciences Naturelles, of the



Copyright by Underwood & Underwood, New York.

DUGOUT SCREENED BY BRANCHES AND USED AS A STABLE.

THIS PICTURE TAKEN IN THE WOOD OF LA CHALADE IN THE ARGONNE DISTRICT, ILLUSTRATES ANOTHER USE FOR TREE BRANCHES. NOTE HOW THICKLY THE ROOF IS COVERED BY THE BRANCHES. IT IS DIFFICULT, EVEN AT A SHORT DISTANCE IN FRONT OF SUCH A PLACE, TO DISCOVER WHETHER IT IS NATURAL OR ARTIFICIAL.

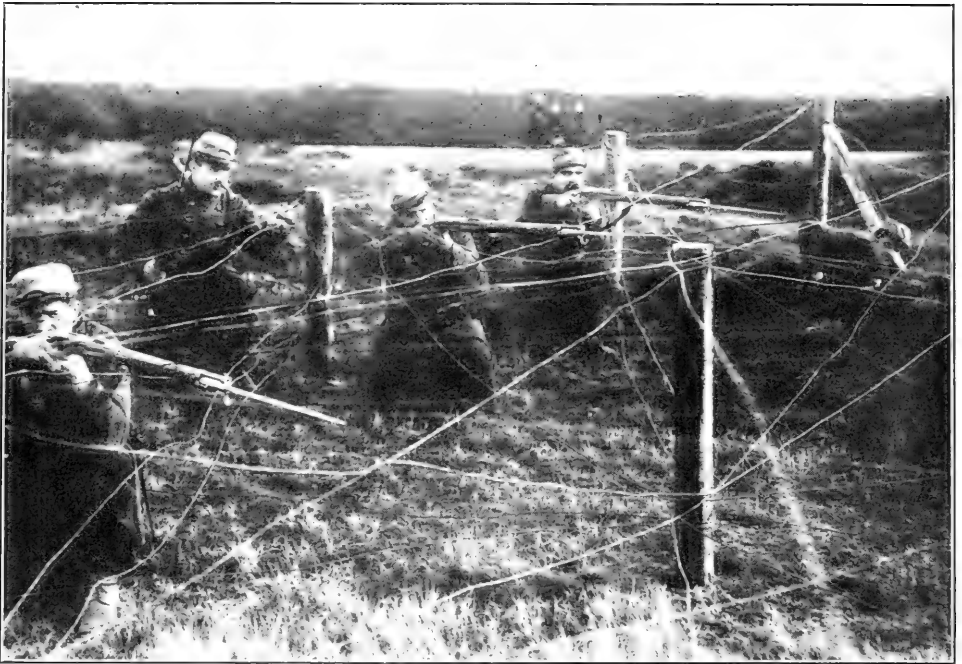

Copyright by Underwood & Underwood, N. Y.

TREE STUMPS USED FOR WIRE ENTANGLEMENTS.

THE AUTHOR SAYS THE MILITARY AUTHORITIES HAVE NOW DISPENSED WITH THE USE OF TREE STUMPS FOR THIS PURPOSE ALTHOUGH MANY WERE SO USED IN THE FIRST PART OF THE WAR.

same city. It was written by an ancient officer, Monsieur de Metz Noblat, who died soon after the beginning of the present hostilities.

The forests in the East, which were the scene of some of the most violent encounters at the beginning of the campaign, were literally cut to pieces by artillery fire. The trees within the zone of fire were completely ruined. The forests of the Argonne have suffered particularly in this respect, while the official French statements still mention almost daily combats in the woods of La Grurie, Le Prêtre, de Forges, and Champenoux, all of which must have already suffered heavy damages.

The wooded sections in the East have endured the most terrible bombardments. They are reduced to a ghastly array of skeletons; torn to bits by the bursting of shells; riddled by fire; blackened with smoke, these forests must be entirely cleared away and the area reforested.

In certain forests such as that of Arancourt, where the French troops lay in concealment, and where the Germans

attempted to dislodge them with artillery fire, the shells were hurled upon carefully calculated lines, which, converging toward the outlet, rendered the woods absolutely untenable. But after the first effect of the bombardment became visible, the French officers ordered their men to return to the forest and take shelter in the craters which had been made by the bursting shells. In this manner the men were so well protected from the enemy's fire that few were killed or wounded, and the position was held. But the bombardment produced an enormous damage. Such trees as were not cut down by the fire were entirely denuded of their branches.

SHATTERED BY SHELLS.

I have seen enormous trees cut down as though they were mere tinder. Thus, near Mont St. Eloi, by the towers of the celebrated abbey and during the destruction of which by bombardment, I was a sad spectator, I saw a magnificent balsam poplar which had been cut off at its base and which lay stretched



SECTION OF A TREE ROAD.

Copyright by Underwood & Underwood, New York.

BY LOOKING CLOSELY AT THE FOREGROUND THERE MAY BE SEEN ONE OF THE TREE ROADS WHICH THE AUTHOR DESCRIBES. IN THE UNITED STATES IT IS KNOWN GENERALLY AS A CORDON ROAD. FRENCH ENGINEERS USE THREE LAYERS OF TREES TOPPED BY BARK, BRANCHES, AND SOIL. THIS ROAD BUILDING HAS RESULTED IN GREAT DESTRUCTION OF YOUNG GROWTH.

upon the prairie. It measured sixty inches in circumference. All about it, as though shorn off by an enormous scythe, lay the stricken branches and the mown undergrowth. Just beyond it I noted the hollow crater made by a shell, which, in bursting, had projected a large tree some ten or twelve feet in the air. In falling, it dropped athwart another tree, their branches interlaced.

In the forest of Lattay, I observed a most curious effect, produced by two shells which had passed through a tree, at the same height from the ground, one to the right and one to the left, so that the tree was practically shorn off. This was due to the fire of a piece which was situated only a few meters behind the tree. During the firing by night, the gunners had been unable to perceive the tree which lay in the trajectory of their fire. If the shells used had been of the percussion type, all of the men serving the piece would have been blown to bits.

To the East of Amance and near Nancy, the forest of Champenoux has also suffered greatly through bombardment. The damages due to fires in these woods have been insignificant because at the beginning of the war, the troops were forbidden to make fires. Those who had not tinned meat, were obliged to eat it uncooked and to go without hot soup or coffee.

The beautiful forests of Chantilly and Compiègne escaped destruction by the enemy, who were not permitted to remain there long, on account of the victory of the Marne. Only about five hundred men were able to penetrate as far as the Château of Chantilly, where they remained barely one night. At the same time, I am credibly informed that the forest of Compiègne suffered somewhat from our own artillery fire, directed upon the extremity of St. Etienne, where we had reason to believe that the Germans had taken up a position at the Villa des Gaules.

In our principal forests, the Forestry Department has placed limits to the cuttings which could be made for military purposes. But these limits will be greatly exceeded, and the indis-

criminate "gashing" which is generally the custom in such work, will render the damage much greater than one thought would be the case, even though the regulations were properly observed. Happily the forest of Compiègne is composed principally of beech, oak and hornbeam, and is thus less likely to destruction by fire than the forest of Fontainebleau, for example.

In 1870, it is recorded that the forest of Compiègne suffered a loss of three hundred thousand francs through indiscriminate cutting by both the inhabitants of the interior and on the outskirts. Let us hope that the hand laid on by the army in this present war will be a less costly affair.

I am told that the enemy have cut down huge quantities of trees in the

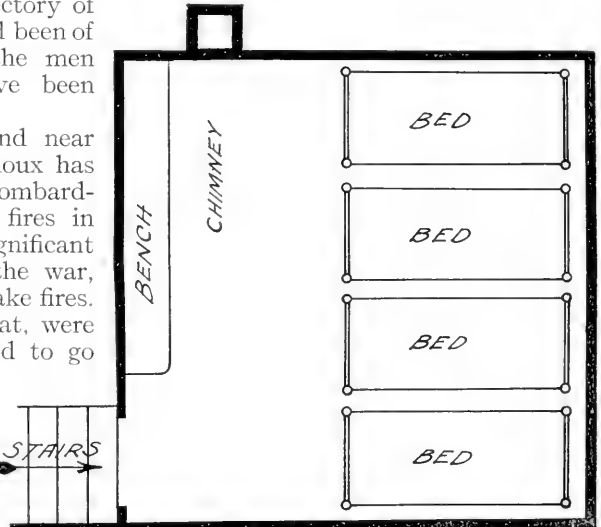

DIAGRAM OF THE TRENCH OCCUPIED BY THE AUTHOR AND HIS COMRADES, FROM PEN SKETCH BY THE AUTHOR. THE TOP OF THE CHIMNEY IS JUST LEVEL WITH THE GROUND.

Argonne, transporting the timber to their own country, as booty of quickly realizable value. This represents a real disaster—one which it will require long, long years to repair.

In the battles in the eastern area, they have employed the stratagem recounted by Shakespeare in *Macbeth*,—the "Birnam Wood" which went to Dunsinane. The soldiers, to render themselves invisible while advancing, have hidden their movements behind



Copyright by Underwood & Underwood, New York.

SAPLINGS USED AS PALISADES.

GREAT DESTRUCTION OF YOUNG GROWTH ON FRENCH FOREST LAND OCCUPIED BY THE GERMANS IS EXPLAINED IN PART BY THE USE OF SAPLINGS TO FORM HIGH FENCES TWELVE TO EIGHTEEN FEET HIGH FOR THE DOUBLE PURPOSE OF SCREENING AND PROTECTING TRENCHES AND ARTILLERY POSITIONS.



Copyright by Underwood & Underwood, N. Y.

A BIG GUN IN THE WOODS AT ARGONNE.

SURROUNDED BY TREES, COVERED BY BRANCHES AND SHOOTING DOWN ONE OF THE LANES CUT THROUGH THE FOREST THIS BIG FRENCH GUN IS WELL SHELTERED FROM OBSERVATION.

large branches cut from the trees, which they cautiously deployed in front of their bodies.

It is on the road of Rayon l'Etape that one sees the first pines and that one begins to climb the first foot-hills of the Vosges. The forests of La Chipotte, which command the valleys below, there begin. Slowly approaching the summit of the mountain, one begins to remark the traces of one of the most heartrending combats that it is possible to imagine. In the woods, on the slopes, in the ravines, there is scarcely anything to be seen save fractured trees, shell holes, and countless graves. The ground is strewn with a chaos of withered branches, shorn away by shrapnel fire.

The forests of La Chipotte, with these old pines which lent such grandeur to the severe slopes of the mountain, held extensive trenches covered with wattles and fascines. Today, nothing is more moving than the sight of this ancient forest, haunted with legends which peopled it with gracious fairies. It has now been sown with the dead. Their

tombs, marked with crosses, lie among the branches which were swept down like chaff. Scattered here and there are uniforms, cartridge boxes, broken guns, empty knapsacks, helmets, and caps, soiled with mud. The somber remnants of the pines throw melancholy shadows across this tragic landscape. The trunks bear terrible evidences of the fierceness of the battle. Mutilated, even though not wholly destroyed, they are eloquent—these silent defenders of the country.

THIRTY YEARS FOR REGROWTH.

In conclusion it is fair to assume that the woods which have been the scene of almost daily artillery fire, are wholly destroyed. Thousands of acres will practically require reforestation. Those trees which have been mutilated by shell fire will have to be cut down and new ones set out. For at least thirty years, these forests may be considered as non-existent, so far as the production of revenue is concerned.

As to the forests of the North and those situated about Paris, there will

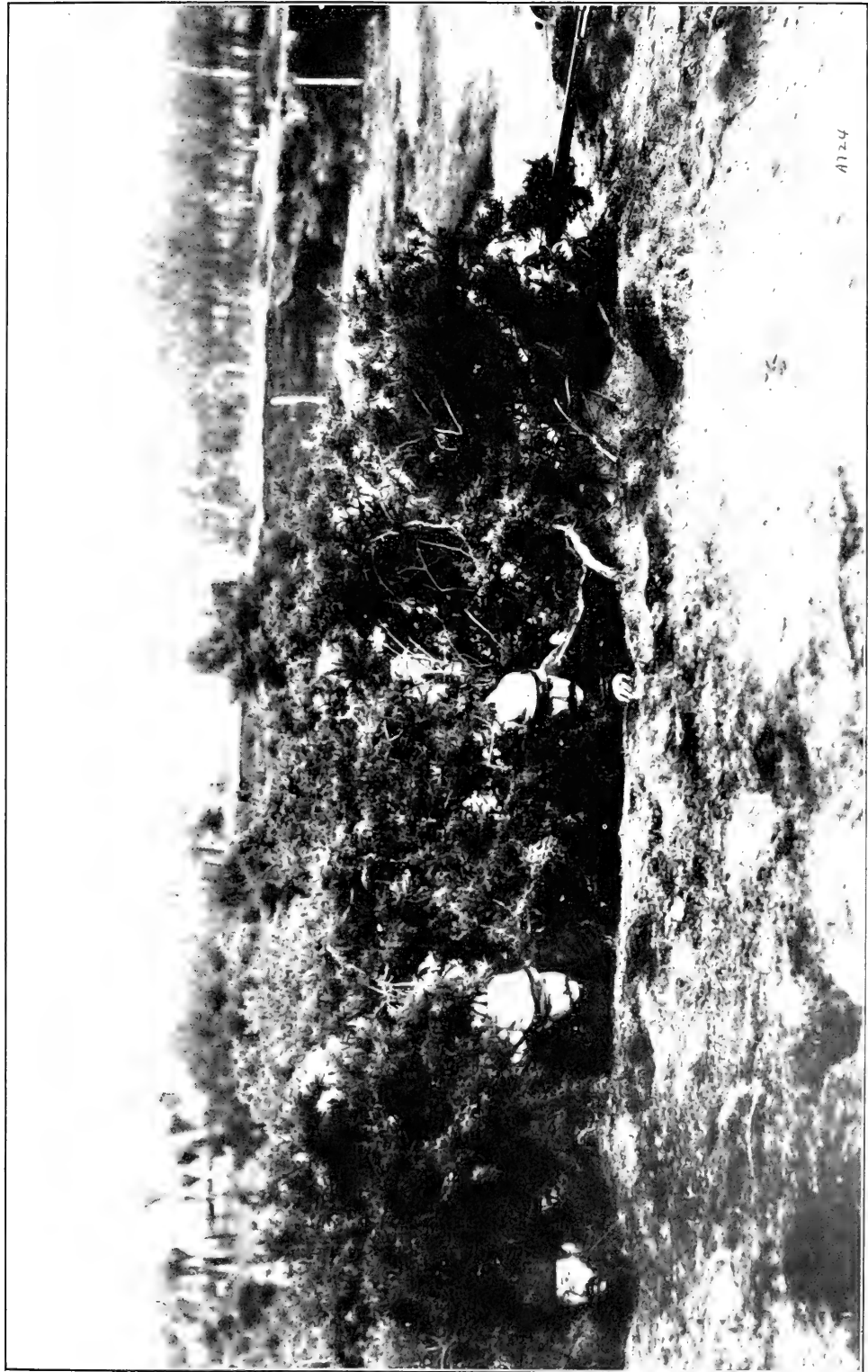

4124

Copyright by Underwood & Underwood, New York.

TREE BRANCHES USED TO SCREEN TRENCHES.

THOUSANDS OF TREES IN NORTHERN FRANCE HAVE BEEN CUT DOWN AND THE BRANCHES USED TO COVER THE TRENCHES AND RENDER THEM PRACTICALLY INVISIBLE FROM SCOUTING AVIATORS WHO FLYING AT THE SAFE HEIGHT OF 5,000 TO 6,000 FEET CANNOT DISTINGUISH TRENCHES SO HIDDEN FROM THE UNDERBUSH.

have to be recorded huge losses for the French Forestry Domain. In that part still actually occupied by the enemy, we still hope that the amount of timber cut down and carried away as booty, will be much less than we are at present led to believe.

May I terminate my narrative in quoting the noble and far-seeing words of that grand man among men—Bernard Palissy—words which the lovers of forests in America should cause to be graven in letters of gold:

“When I consider the value of these most humble of shelters, the trees, I

marvel at the ignorance of men, who today, seem only to study how to break, cut and destroy the beautiful forests which their predecessors have so preciously guarded. They give no thought to the days to come—to the great damage done to their children of the future. I cannot sufficiently detest such a thing—and call it not a fault but a malediction and an evil to the country, because when the trees are gone all arts will cease and the country be abandoned by all artisans who must ‘eat grass as oxen,’ as did Nebuchadnezzar.”

THE CRISIS IN NEW YORK

By H. H. CHAPMAN

TWO measures of vital importance to the future welfare of the State of New York are to be decided within the year; the first is a reorganization of the Conservation Commission having control of the State Forest Preserve; the second is a revision of the Constitution to permit a more rational use of these State possessions.

New York was the first American State to adopt the deliberate policy of retaining permanently the State tax lands, and increasing these holdings by purchase, on a large scale. In 1872 a legislative committee advocated this policy of retention, which went into effect in 1883 in the Forest Preserve Counties of the Adirondacks and Catskills. Up to this time few owners considered these lands worth the taxes. The well nigh universal custom was to cut off the pine timber and permit the lands to revert to the State. Later the same lands were acquired from a complaisant Government on various flimsy pretexts and the spruce or other valuable timber was stripped off, when the lands again reverted to the State for taxes. Disgust at this slipshod procedure, and a growing interest in the region as a recreation ground were the underlying

causes for the reversal of policy, by which, in '83, the State declared its intention of holding title to some 700,000 acres of tax lands.

Even at this early day a few farsighted persons were looking forward to the time when the State should devote these immense areas to the practice of forestry and derive a large net annual revenue from the sale of timber from her forest reserves, in much the same way that the European state forests are conducted. But these hopes have been deferred for thirty years, while the State wrestled with the far more immediate and vital problem of safeguarding her heritage from insidious attacks. Every acre of tax lands which was coveted by an individual was in danger of being lost to the State through the numerous loopholes sanctioned by the customs of a century which had sought only to get rid of these lands in order to raise more taxes on them. A statute passed in '85 giving the State absolute title to these tax lands after the lapse of a reasonable period was fought through the courts, and not until 1897, twelve years later, was its constitutionality upheld. The burden of defending the people's titles in these suits, in the early days, fell on Col.

William F. Fox, Secretary to the Forestry Commission, and later Superintendent of Forests, who, though a democrat, was retained by Commissioners of both parties till his death in 1910.

Old customs die hard, and the doctrine that public property is public spoils was still in its vigorous prime when the State undertook this momentous enterprise. It was one thing to set aside these lands, but quite another thing to protect them. Beaten in their efforts to filch away the titles, the spoilers continued to trespass boldly and almost with impunity, and the State's timber continued to disappear. The Forestry Commission was short of reliable agents, lacked good maps, and had few surveys. The lands were widely scattered. Worse still, some of the trespassers had powerful political influence and many cases were overlooked or compromised.

These conditions culminated in '93, when an investigation was ordered which revealed a most scandalous inefficiency on the part of the Commission. The Constitutional Convention was about to meet. Most unfortunately, this same legislature had been persuaded by prominent foresters to pass a law permitting the legal cutting of timber on the State lands. No wonder the people were alarmed. If the timber thieves could operate so boldly without this law, what would happen when the last barrier was removed?

The earlier law of '85 had contained a clause which read "The lands now or hereafter constituting the Forest Preserve shall be forever kept as wild lands. They shall not be sold, nor shall they be leased or taken by any person or corporation, public or private." This clause, which so well set forth the policy of perpetual ownership, was now presented as a constitutional amendment, with a slight change and a significant addition, so that it read "They shall not be leased, sold or exchanged, or be taken by any corporation, public or private, *nor shall the timber thereon be sold, removed or destroyed.*" This amendment was overwhelmingly adopted. Its effect was far more drastic than was intended, for it has interfered with the

construction of roads and trails, prevented the disposal of fire killed timber, and impeded the development of the Preserve for recreation.

Meanwhile, the State committed a serious blunder by combining the functions of the Fish and Game Commission with the forestry work, in 1895. In 1899, Colonel Fox in a private conversation stated "The chief difficulty is that the Commissioners are not interested in forestry. You can't get them to give any attention to the question; but if a man comes along who wants to know whether he must fish through the ice with a string held in the hand or can tie it to a tip-up, they will go into executive session at once!" This condition was later improved by the adoption of a policy constantly urged by Colonel Fox, of employing technically educated foresters. New York in 1900 hired R. C. Bryant, the first graduate of the Cornell Forest School. Later two more Cornell men were employed, one of whom, Clifford R. Pettis, engaged in 1902, has been in the State Forestry Service ever since, and in 1910 was made Superintendent of Forests. The principles of civil service have been applied rigidly to the small force of State Foresters whose numbers have never exceeded seven. The result is that in spite of the frequent changes not only in the personnel but in the form of the Commission, there has been a continuity and efficiency in the work which is the direct result of this trained executive force of foresters. New York State forest nurseries have a national reputation, and her forest plantations are among the best.

But aside from the dangers of defective titles and trespass, fires threatened to completely destroy the Adirondack wilderness. An inefficient system of town wardens failed to cope with this danger. In 1909, Commissioner Whipple secured the adoption of modern methods, already successful in New England and the far West, and established a paid force of lookout watchmen, whose towers now overlook and triangulate practically the entire forested area of the Preserve Counties. These supplemented by patrolmen and fire wardens, began to cope successfully

with the fire risk. The technically trained Superintendent of Forests was in charge of this force, but the appointments were made by the Commission. In an earlier day, such a force would have immediately sunk to a low level through the substitution of party loyalty for efficiency as a basis of appointment, and the retention of worthless incumbents through political influence. Party politics, unfortunately, are still made a condition of many of these appointments under the present system of organization, but it speaks well for the future that the Superintendent of Forests is able in most instances to secure the prompt removal of inefficient men, and has in this way built up the force to a fairly high standard of performance. But New York cannot safely permit its partisan principle to affect these appointments in any way. The fire fighters are the backbone of the protective system, and the best service can only be secured by basing such appointments entirely on the standard of merit.

In 1897, encouraged by constitutional protection and the winning of the test case which secured the tax titles, the legislature appropriated \$1,000,000 to purchase additional lands in the Preserve, and created the Adirondack and Catskill Parks with boundaries defined by law. The area was rapidly increased, until at present, including water surface, the State owns 1,800,000 acres of land. No limit was set as to price or quality of land, and the magnitude of the transactions involved called for the exercise of great care to protect the State against extortion and deception. During this period, political influences were still at work to a considerable extent and many questionable deals were engineered through the Commission, thus laying the foundation for trouble later on. In some instances lands were sold which on later survey proved to contain much less than the stipulated acreage. In other instances lots of different values would be turned over on the basis of an average price per acre, subject to proof of title, and later, the titles of the more valuable land would be found defective, while the State paid the average price for the

poor land. In other cases, where title was disputed, a complaisant Commissioner permitted the private claimants to acquire title by means of judgments, in suits brought by the State ostensibly to protect its own interests. Trespassers were permitted to erect costly residences on certain State lands, and were not ejected.

The conditions created by these acts demanded still further efforts to safeguard the State's property. The lesson was a hard one, but it is nearly learned. Many suits have recently been entered by the present Commission to recover titles, to eject trespassers and to make a clean sweep of these troublesome questions. In a recent decision of the State Court of Appeals, many acts of a former Commissioner by which title to State lands was lost, were set aside. The values involved are considerable, and there are strong indications that the defendants may seek, through political means, to accomplish indirectly what they cannot achieve otherwise.

But this is practically the last gasp of the old order. The Constitutional Convention draws near. Enlightened sentiment throughout the State realizes that the time has come to permit a rational opening up and development of the State Preserve. But the lessons of the last twenty years must not go unheeded. If the State of New York is going to entrust the cutting of timber on her Forest Preserves to a Commission, she must first insure the permanent maintenance of technical, efficient, non-political administration, and take no more chances with a political system. The present legislature contemplates another change in the form of commission by which the former plan of a single commissioner appointed by the Governor is resumed, and under him, chiefs of divisions, one of which is Forestry, shall be appointed who must have technical qualifications. This differs from the present form by the abolition of several highly paid positions, and especially by elimination of Deputy Commissioners, who under the present law need no technical training. This plan may work well, depending solely upon the character and ability of the Commissioner who may be

appointed and his selection or retention of the present trained force of foresters. But apparently, a far better plan is that of an unpaid board appointed for overlapping terms, whose sole duties are to select the executive heads of departments, free from political pressure, and to decide important questions of policy. The executive power would be lodged in the appointee, who, being selected solely for his training and fitness as well as his knowledge of the affairs of the department, would be able to give to the State the maximum of efficient service. Many states are operating under this plan of organization, notably Minnesota, Oregon, and Wisconsin. In

New York this principle is successfully applied to the management of the public schools through a board of regents. The State may yet be forced to adopt it as the best possible plan for protecting her Forest Preserve. Meanwhile, the good faith shown by the present legislature in their handling of the problem of reorganizing the Conservation Commission, and their attitude towards the principle of non-political management of the people's resources, will have a profound influence upon the attitude which the Constitutional Convention takes towards proposed amendments permitting timber cutting on the Forest Preserves.

FORESTRY AT THE EXPOSITION

American Forestry Association Day at the Panama-Pacific Exposition at San Francisco will be Wednesday, October 20, 1915.

The Association will participate in a joint three day meeting, October 19th, 20th and 21st, with the Western Forestry and Conservation Congress and the Pacific Logging Congress, each organization having one day for its work and its special program.

This will be the first time the American Forestry Association has ever met on the Pacific Coast, and, as such a large percentage of the standing lumber of the United States is West of the Rockies, it is appropriate that the meeting should be held there, particularly at a time when the Exposition will also attract so many Eastern members of the Association.

State Forestry, Fire Protective and Conservation Associations and all organizations interested in the forests and their care and perpetuation, will be invited to be represented at the meeting.

The program will deal largely with Forest Fire protective work and the more important phases of forestry. It will be announced in a short time.

Members of the American Forestry Association attending the meeting will not be asked to travel from the East in one party or to go by any special route, but will find it more convenient to form their own parties and select the routes which most appeal to them.

Further information may be secured by writing to Secretary, American Forestry Association, Washington, D. C.

Deer in Grand Canyon.

It is estimated that the government's Grand Canyon game refuge, in Arizona, now contains about ten thousand deer.

9,000,000 Trees Planted.

More than nine million young trees and ten thousand pounds of seed were planted on the National Forests in 1914.



ON THE APACHE NATIONAL FORESTS.

A HUNTERS' CAMPFIRE AND LOUNGING TENT IN A BEAUTIFUL LOCATION ON THE WELL-KNOWN ARIZONA FOREST.

HUNTING ON THE NATIONAL FORESTS

By HERBERT A. SMITH

HALF a dozen weather tanned men were sitting around the sheet-iron stove in a ranger station on the Wyoming National Forest one night last Autumn, when the howling of a distant wolf punctured the conversation.

"Having much trouble out this way with varmints?" said one, a visiting officer of the Forest Service.

One of the others took his pipe from his mouth and laughed. "*He is,*" he answered, pointing the pipe stem at a sheep herder who had come in last and was warming his hands over the stove.

The sheepman grinned. "Twa'n't exactly what you'd call trouble," he said, slowly.

"Tell him about it," the smoker suggested, nodding sidewise in the direction of the visitor.

It seemed that the sheepman the day before was in a canyon several miles away, working his herd toward camp to bed them down for the night, when a rattling of earth and stones on the hillside above attracted his attention. Looking up, he saw near the top of the canyon two animated brown spots which he took for a cow elk and her calf. Hidden by the trees and brush at

the foot of the descent, the herder was not visible to the newcomers until they came out of a thicket a few paces away. The smaller animal saw him at once, gave a shrill squeal, and plunged sideways into the brush; the other turned quickly and came straight for the herder like a runaway locomotive on a down grade. The sheepman suddenly and poignantly realized that he was idly lingering in the path, not of a cow elk, but of a mother grizzly bear.

Somehow he got into a tree before Mrs. Silvertip could get a purchase on his legs and there he clung gazing wistfully at the rifle he had dropped in his

hurry to reach safety, while the bear walked around the tree, clawing the bark and gnashing her teeth, until the cub cautiously reappeared, sniffing and whining plaintively. The mother bear squatted on her haunches and considered the situation for a moment; then got up and lumbered toward the sheep, which were huddled together and bleating in fear.

"Well, I sets up there about four hours," the sheepman drawled. "She goes down an' kills a sheep for the cub and comes back before I can get off the limb I'm on. Then she goes an' kills another sheep an' I can't get as far as



BOTH GOOD HUNTERS.

THE QUARRY IS A HANDSOME 250 POUND WHITE TAIL BUCK KILLED AT THE SHORE OF LOWER PRIEST LAKE, KOOTENAI COUNTY, KANIKSU NATIONAL FOREST, IDAHO.



A CINNAMON BEAR.

THIS FINE SPECIMEN WAS ONE AND A HALF YEARS OLD WHEN HE WAS KILLED AT CASTLE MEADOW, NEAR BALLOON DOME, AT THE JUNCTION OF THE MIDDLE AND SOUTH FORK OF THE JOAQUIN RIVER, SIERRA NATIONAL FOREST, CALIFORNIA.

the ground before she's back on the run, reachin' for my toes. Six times she goes down, wipes out one o' my lil band every time, an' gets back to me before I can move. By-an'-by, though, she gets tired and goes away with the cub—an' him so full of fresh sheep he can hardly walk."

Whether the sheepman has yet carried out his threat to trail that grizzly to her lair and "fill her just plumb full of lead" is not a matter of record; but that Forest Service hunters have, in their efforts to lessen the losses of stockmen from beasts that prey both on sheep and cattle accounted for a grand total of 1,216 bear in the last six years, is officially certified in their reports. Not only bear but mountain lion, lynxes, wildcats, wolves, and, most of all, the crafty, swift coyote have been warred

on. Altogether over 36,000 animals of these various kinds have been made way with since 1908, in the effort to clear the National Forests of what are regarded as pests. Primarily this has been done to increase the production of domestic meat supplies on the Forests which play so important a part in the economy of the western livestock industry; but for sportsmen also the lessening of the number of these wild animals, which kill game as well as domestic stock, is a matter of decided interest.

Before domestic livestock appeared on the scene the meat-eaters of course found their quarry in the native species which for ages had formed their sole subsistence. Deer, elk, antelope, buffalo, mountain sheep, and the not-to-be-despised prairie dog and other small



THE JEMEZ NATIONAL FOREST, NEW MEXICO.

SHOWING THE KIND OF COUNTRY IN WHICH GAME IS PLENTIFUL AND ALSO THE ROUGH GOING WHICH FACES THE HUNTER.

animals were to be found in abundance; but their killing called for powers of swiftness, strength, or cunning which inexorably demanded fitness for the hunt as the condition of survival. When the stockman began to use the range the wild game perforce gave place, but left in their stead a relatively defenseless and eventually a more abundant prey. Life became so easy that organized effort was necessary to keep the hunting animals from multiplying beyond all bounds. Where wild game is left the effect of the organized fight on predatory animals has been much in its favor, and sportsmen are the gainers.

Bears of all kinds kill much less domestic stock and wild game on the National Forests than do the smaller

animals; in fact, agitation has developed recently in favor of protecting black and cinnamon bears as game, on the ground that they commit no serious depredations. They are very fond of berries and other wild fruits, though if these are scarce they eat almost anything, including sheep and calves. Thus, for example, the unusually heavy losses suffered by stockmen last year in certain parts of Oregon and Washington have been ascribed to the shortage of the wild huckleberry crop in those regions.

Elk, deer, and Rocky Mountain sheep, or bighorn, are increasing on many of the National Forests, thanks to the enforcement of the various State game laws by Federal as well as local officials, and to the establishment of

game refuges where the animals can not be hunted but breed and in time overflow into the surrounding country. Such refuges become game reservoirs. Bears, wild cats, and mountain lions also inhabit and breed in the National Forests, though the game refuge does not afford them sanctuary; but coyotes and wolves, by far the most destructive of the predatory animals, are only transients, wintering and breeding in the foothills and plains outside of the Forests and trailing the domestic stock into the mountains as the advancing season brings forward the forage crop.

The National Forests embrace millions of acres of the best big-game country in the United States, but hunting on them has two aspects. One is a matter of business; the other is sport for sport's sake. From the business point of view, the game is a resource

of great value. The income from hunting licenses is an important source of revenue in some States. Many western towns thrive mainly because of the money which sportsmen spend for guides, outfits, and supplies. The town of Cody, Wyoming, for example, is a favorite starting point for parties which push thence westward into the rich game country embraced in the Shoshone National Forest, adjoining the Yellowstone. Sometimes these parties combine a hunting trip with a visit to the Yellowstone National Park. All guns must of course be left behind while the followers of Nimrod are converted into tourists and take in the sights of this wonderful and unique national possession; for no firearms can be carried within the Park. But going or coming there is plenty of opportunity to take advantage of the fact



STARTLED BY THE CAMERA'S CLICK.

A DEER PHOTOGRAPHED IN THE SAN ISABEL NATIONAL FOREST, CUSTER COUNTY, COLORADO.



WILD DUCKS IN PROFUSION.

A FAVORITE FEEDING PLACE FOR THESE WILD DUCKS ON THE WICHITA GAME PRESERVE, WICHITA NATIONAL FOREST, OKLAHOMA.



WILD TURKEYS, WICHITA NATIONAL FOREST.

THERE WERE THIRTY PLUMP BIRDS IN THIS FLOCK AND THE PHOTOGRAPH WAS TAKEN CLOSE TO THE FOREST HEAD-QUARTERS. THE WICHITA NATIONAL FOREST IS IN OKLAHOMA.

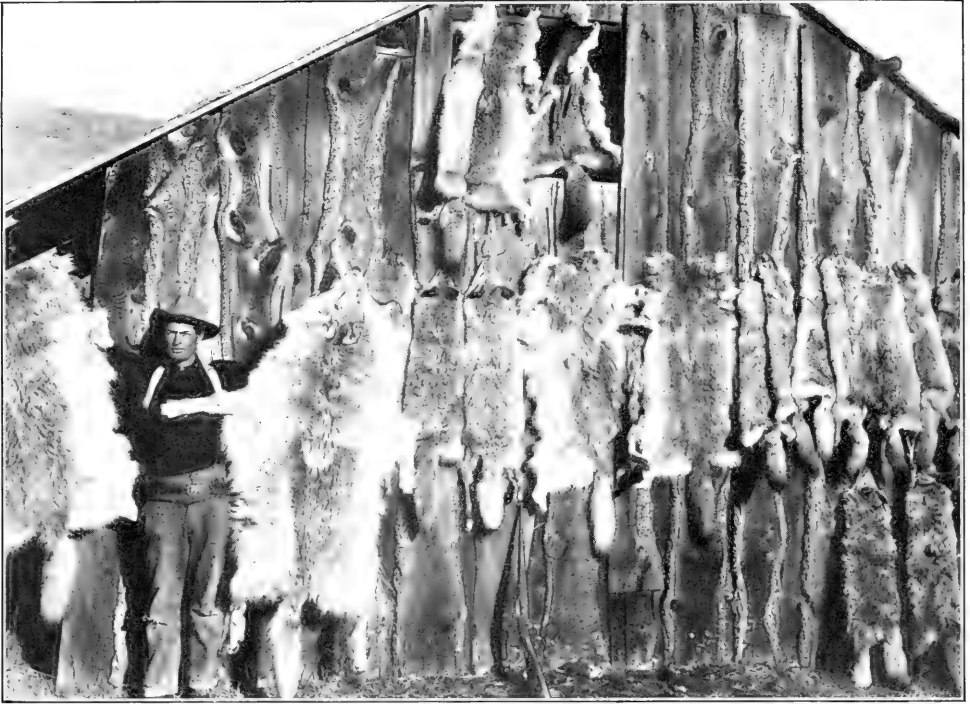

G. N. BROWN, GOVERNMENT TRAPPER.

BROWN WORKS ON THE GALLATIN NATIONAL FOREST, MONTANA AND THE PELTS ARE ONLY A FEW OF THOSE WHICH HE HAS ACQUIRED.

that, when thus protected inside the Park, the wild life overflows into adjacent territory.

All true sportsmen realize that, if there are to be any game animals to hunt, provision must be made for the game to breed. Support of measures looking to the preservation and increase of game comes from three sources. Those who profit directly or indirectly from the expenditures of sportsmen must, if they have reasonable foresight, wish to keep the goose of the golden eggs alive, and laying well. There is now an increasing number of people who wish game preserved not to be hunted but in order that it may flourish undisturbed in its native haunts. Between those who are actuated by this purpose and those who belong to the third class—that is, those who wish game to be abundant that they may find good sport—there is of course an irreconcilable conflict of motive; but for practical ends they can consistently join forces up to a certain point. Though they

may anathematize each other as sentimentalists or as butchers, both must welcome restrictions upon indiscriminate killing. Further, in the case of big game at least it is hard to see how to escape the conclusion that in the long run some way must be found to utilize or dispose of the surplus production, which, as the Yellowstone Park illustrates, in the end overflows from a district where all hunting is prohibited. The game preserve or refuge supplements the restrictions supplied by closed seasons, limits of bag, and similar game law provisions, and is already an important feature of National Forest game preservation. Undoubtedly more refuges will be created. Sportsmen and nature-lovers may well work together to secure their increase.

Were the killing of all forms of wild life on these refuges prohibited, they would be vigorously and properly opposed by stockmen and settlers who would suffer from the multiplication of noxious animals in them. Both for



ONE DAY'S BAG.

THIS GAME WAS SHOT IN THE YOSEMITE NATIONAL PARK, TUOLUMNE COUNTY, CALIFORNIA.

the protection of domestic stock and in the interest of the game, the "varmints" need to be hunted down. An example of what can be done by putting a stop to big-game hunting within a definite area while holding in check the beasts of prey is afforded by the Grand Canyon Game Refuge, in Arizona. This game refuge covers nearly 1,500,000 acres of rough country, ill-adapted to grazing use by domestic stock, on both sides of the Grand Canyon. Within it the Forest officers have waged an active campaign against the mountain lion and bobcat which in that region are the worst natural enemies of the deer. The prohibition of game hunting has been effectively enforced. As a result the deer have multiplied rapidly until their number is now estimated at 10,000 head; and they are apparently overflowing into the surrounding country where they can be hunted in the open season.

The Grand Canyon Game Refuge was established by a special act of Congress; and the Wichita Game Pre-

serve of 57,120 acres, which is coterminous with the Wichita National Forest in Oklahoma, was the result of a similar act. These are the only game preserves within the Forests which have been established by Federal authority, and before the number of such National preserves can be further increased legislation must be enacted either empowering the Executive branch of the Government to create such preserves where they are found to be desirable or specifically designating certain areas within which game may not be killed or taken. There are, however, fourteen National Parks, in twelve Western States, on all of which the game is absolutely protected; and the same is true of the Olympic National Monument which shelters the Roosevelt elk in its sole habitat. There are also a number of game preserves or refuges on the National Forests which have been established by State laws—two in Minnesota, four in Wyoming, five in Montana, two in Idaho, and one each in Utah, Oregon, and Washington.

Some of these were created without sufficient consideration of all the interests and practical conditions involved. Experience makes abundantly clear that to be effective and beneficial a careful study must be made of the local situation and needs. State laws have generally been passed on the initiative of those who are interested in sport either for sport's sake or on business grounds. The enactment of such laws is often opposed by livestock interests because the prohibition of grazing in order to provide feed for the game is often a logical accompaniment of the preserve. One or two of the State preserves are of little or no practical effect. It is foolish to pass laws against hunting if they are not to be enforced; and the enforcement of game laws is exceedingly difficult if it is attempted in the face of strongly adverse local sentiment. In some of the preserves an attempt is probably being made to provide for game where adequate winter

feed is not available. In still others the desirability of making room for the game by displacing the necessary amount of livestock is at least open to question. In short, the most appropriate location for preserves is not always chosen by State legislatures. In any case it is plain that the best results are not likely to follow a method by which the partisans of one side bring pressure to bear on a legislature to get what they want and those whose interests would be interfered with try to bring pressure to bear on the other side in an effort to head the law off. A method is needed which will permit action to be based on a careful, impartial study of the situation that will bring to light all the essential facts.

Just as Maine benefits largely by the expenditures of those who seek its wilds to fish, hunt, and enjoy the woods, so the Rocky Mountain and far Western States will increasingly realize returns from the power of the National Forests



PELTS AT A RANGER'S CAMP.

ALL OF THESE ARE FROM ANIMALS SHOT IN THE WHITE RIVER NATIONAL FOREST, COLORADO. THE WOLF IN THE FOREGROUND WAS SHOT ONLY A FEW HOURS BEFORE THIS PHOTOGRAPH WAS TAKEN.



HUNTERS IN THE SHOSHONE NATIONAL FOREST.

HERE ARE JOHN GOFF AND HIS SON WHO WERE EX-PRESIDENT ROOSEVELT'S GUIDES ON HIS WESTERN HUNTING TRIPS. THE SHOSHONE NATIONAL FOREST IS IN WYOMING.

to attract visitors from afar. Many sportsmen come from Europe to hunt American game in the diminishing wild west. The National Forests offer the finest opportunities for big-game hunting to be had in the United States. As civilization advances upon the wilderness and conquers it, there will be left many areas which are the natural habitat of game animals and which are too rough in character for much settlement or for advantageous use by livestock. It would be from every point of view a misfortune not to adopt a policy, in administering such lands, which recognizes the value of big game both from the sportsman's and from the nature-lover's standpoint, and which provides for its perpetuation. Of course such a policy must take account of all interests involved, and be fair to all. The National Forests can not in their entirety be closed to other forms of use in order to make them first of all a huge set of game preserves; nor would any sane person be likely to

advocate such a course. There must be a careful determination of how far the Government should go in providing for game propagation; and where game is to be given special protection there must be a definite estimate of the needs of the game in the way of feeding grounds, with such provision for meeting these needs that the animals will not breed only to starve to death.

In a state of nature the tendency of animals to multiply indefinitely is held in check by the inevitable balance which prevents any one form of life from overrunning the earth. The check is imposed partly by the multiplication of natural enemies which automatically takes place as the food supply of these enemies is increased, partly by the necessity of competing for a limited food supply; or, most often in the case of animals which subsist on vegetation, by both causes together. As the meat-eaters are killed off by man for the protection of domestic stock one of the natural checks on the



FOREST SERVICE RANGER STATION.

J. K. CARPER, FOREST SERVICE HUNTER AT BILLY MEADOW, WALLOWA NATIONAL FOREST, OREGON, WITH A FEW SPECIMENS OF THE BEAR AND OTHER ANIMALS KILLED IN AND ABOUT THE STATION.

multiplication of game animals is removed. If no other check is introduced, the game will become so numerous that eventually, no matter how large the area of their feeding grounds, it will be insufficient. Around the Yellowstone Park many elk now die miserably in hard winters, when they must seek feed below the level of their summer range, because the ranchman and the stockman have closed in about them. Obviously feeding grounds for wild game can not be provided indefinitely; somewhere the line must be drawn. Hunting is one means of holding in check the natural increase. It is clear that in handling the game question there must be applied the same conservation principle which is involved in many other matters. The natural balance of nature must be replaced by an artificial

balance, devised with a view to the largest possible satisfaction of human requirements.

Man makes the earth over. He can not do otherwise. He must enter the struggle for existence, and interfere with what is, in order to live. The only question is whether he shall make it over intelligently or blindly; by foreseeing consequences and bringing to pass that which he has deliberately chosen, or by running amuck. The game question requires the exercise of foresight and intelligent choice, to the end that where the best interests of all of us allow and call for the preservation of this form of wild life it may be so preserved as to afford the largest measure of human satisfaction, with the smallest measure of drawbacks—including the drawback of unnecessary suffering to the game animals themselves.

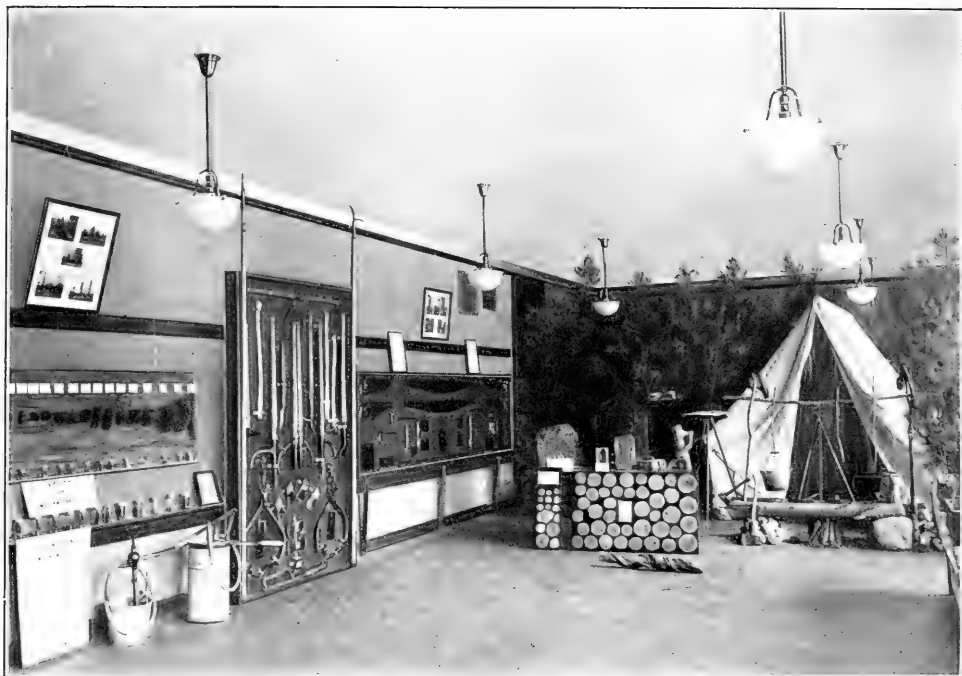

FORESTRY EXHIBIT AT CORNELL.

THIS WAS ARRANGED FOR FARMERS' WEEK AND WAS USED AS AN OBJECT LESSON IN FORESTRY FOR THE SEVERAL THOUSAND WHO VISITED ITHACA FOR THE OCCASION.

FARMERS' WEEK AT CORNELL

FARMERS' Week has become one of the big events of the college year at Cornell University.

Several thousand persons from all parts of the State visit Ithaca at that time to listen to lectures, attend demonstrations, inspect exhibits, enjoy social gatherings and in general to get in touch with the faculty of the New York State College of Agriculture. Each of the Departments of the College makes a point of presenting to the visitors the ways in which its work is of practical benefit to the individual and the community.

During the Eighth Annual Farmers' Week held this year from February 8th to 13th, the Department of Forestry offered ten lectures, given by the several members of the Forestry faculty. The topics included forest planting, the care and improvement of woodlots, methods of measuring growth and yield, a

discussion of the value of town forests for New York State, a talk on the work of the United States Forest Service, and a demonstration of methods of increasing the durability of farm timbers by the open tank method. During the week a portable sawmill was in operation in one of the laboratory rooms in the basement of the Forestry Building.

In addition to the lectures a forestry exhibit further emphasized the points covered in the lectures. The exhibit included small plots of trees showing the size and kind of plant stock, both of conifers and hardwoods, suitable for planting; cones and tree seeds of species of commercial importance; wood sections showing the growth and value of planted forests; and photographs and slides of good stands of timber, of fighting fire, of planting trees and of reconnaissance work by forestry students. Collections of saws and of

logging tools, loaned the Department by commercial companies, proved a center of interest.

One end of the large laboratory in which the exhibit was held, portrayed realistically a complete camp outfit for forestry work, giving the visitors a good idea of how foresters live and work in the field.

For the convenience of Farmers' Week visitors, and incidentally to draw a larger crowd to the Forestry Building, the students' organization,

the Cornell Forestry Club, helped out in the program by running a lunch counter, thereby as well somewhat increasing the funds in the Club's treasury.

Judged by the number of persons in attendance and the interest shown, the Department of Forestry had reason to feel that this Farmers' Week was one of the most successful ever held. Essentially it brought the practical importance of forestry directly home to the people in New York State whom it most concerns.

JOHN MUIR

By GEORGE B. SUDWORTH

IN THE passing of John Muir, poet-naturalist and author, the State and Nation loses one of the most profound students of nature and its boundless treasures. Deep love of the wild solitude of the mountains impelled him always to explore his home State as no one else has done. On foot and alone he toiled ceaselessly over desert, through canyons, up mountain slopes, and to the deep recesses of trackless forests that he might learn their every secret. Undefined nature, in all of its magnificent grandeur, ever possessed an appeal to him that few only of his intimate friends could fully appreciate. To him the life even of the humblest flower was sacred. He was not a hunter-naturalist, nor a collector of dried plants or of other natural objects, for he would have left them all as he had found them. He preferred rather to see each denizen of the wild, each wild flower in its chosen home, and to learn its life-history from nature's own museum and herbarium. Love of the Creator's work, as he saw it on every hand, was profound and it pained him deeply to see animal life destroyed, to see the woodman's ax lay low a giant tree, or grazing herds despoil the delicate humbler plants he knew so well.

His was a poetic nature that saw in plant and animal life the greatest interest to human beings only through a

knowledge and an enjoyable use of them that affords protection and preservation.

John Muir's explorations extended far beyond the confines of his home State—even to the Old World, whither he journeyed in search of nature's truths. But those of us who value his effort in forest preservation, like to dwell upon the great work he did here in saving the Big Trees of his State. No one knew so well as he the wonderful natural heritage California holds for future generations in the giant sequoias of the Sierras and the lofty redwoods of its coast hills. He had not the lumberman's view of long ago, that these forests were for use, without regard for their duration, or for their unique historical interest to future generations. Nor had he the forester's view that may be even these rare timber resources might be preserved by wise use. He saw only that these greatest of living plants, which number their ages by thousands of years, would some day be swept away by human greed and irrevocably lost to posterity. It seemed to him that the American people would not be forgiven this needless sacrifice, and that it would forever cloud the good name of his home State. He undertook to save them. He brought to his task an eloquence of word pictures which no one possessed, and to him belongs in large measure the honor of having first



JOHN MUIR—IN ONE OF HIS FAVORITE NOOKS.

awakened public interest to the point of permanently preserving the finest remnants of these ancient tree giants. Parts at least of most of the other notable sequoia forests of the Sierra Nevada Mountains were later included in National Forests, and National Parks, where the Federal Government is carefully guarding their life. He knew them all, for he had many times journeyed to their retreats, and in the last days of his life it was a comfort for him to know that he had helped to save to posterity what no other Nation possesses. But one regret remains, and that is, that some group of these ancient giant trees could not have borne the name of him who knew and loved them best.

But the name and work of John Muir, friend and life-long student of the forest, will not be forgotten. Memory of him will live in the somber depths of "Muir Woods," a sister species of giant sequoias to which grateful and loving friends have dedicated the name of California's greatest poet-naturalist. And to those who knew the kindly heart of John Muir and his deep love of nature, his life work and simple teachings will always be an inspiration. In his own words others will "Climb the mountains and get their good tidings. Nature's peace will flow into you as sunshine flows into trees. The winds will blow their freshness into you and the storms their energy, while cares will drop off like leaves."

Trail and Road Building.

The government built more than two thousand miles of trail and three thousand miles of telephone line on the National Forests in 1914.

Mistletoe Kills Larch.

At least 25 per cent of the larch timber over large areas in eastern Oregon has been killed or weakened by mistletoe, and the Forest Service is taking steps to combat the pest.

BERMUDA'S LITTLE TREES

By W. R. BROWN

THREE things impressed the writer on a recent trip to the Bermuda Islands. Their accessibility, for they are but two days from New York; their equitable climate the year around of from 55° to 85° Fahrenheit; and the opportunity they afford for a visitor to become acquainted with the flora and fauna of the tropics.

The little group—one for every day

in the year—form a glorified letter C seven hundred miles out in the midst of the Atlantic Ocean directly East of Charlestown. They are perhaps thirty miles in circumference and one can bicycle or ride the whole distance from land's end to land's end on fine hard white coral roads reaching one island after another by the aid of connecting bridges.

Here a Northerner can get a glimpse

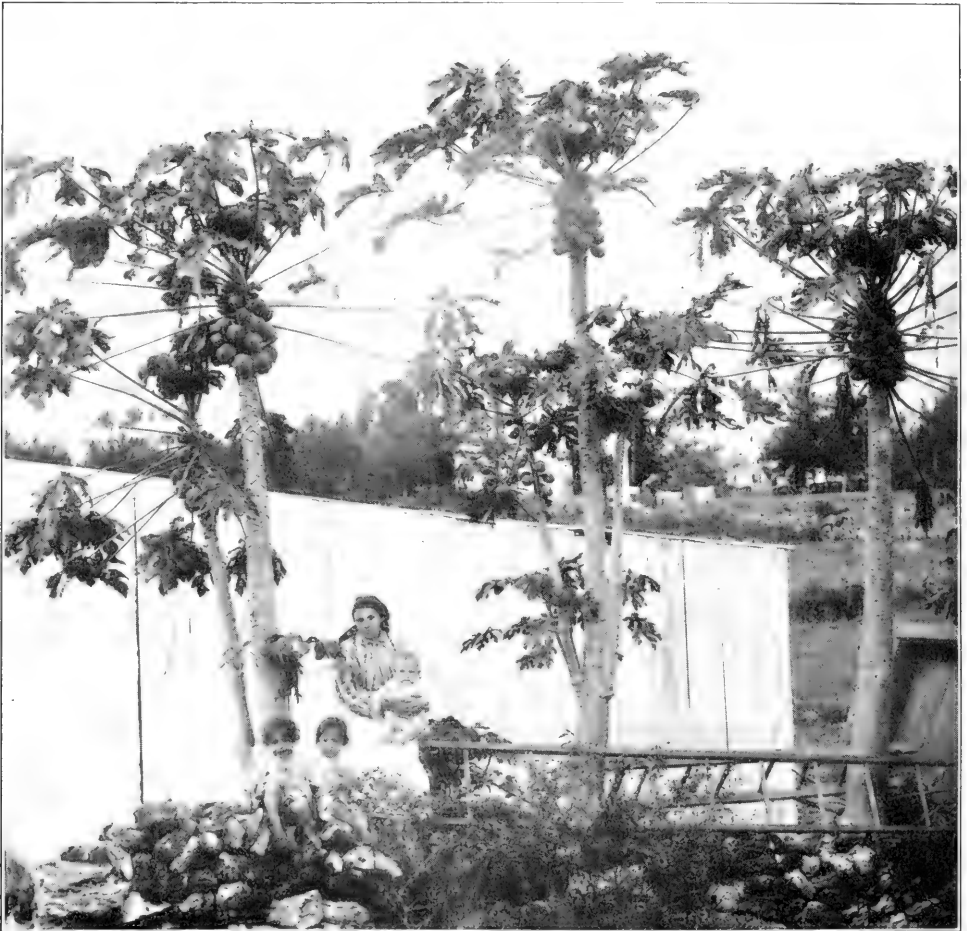

THE PAW-PAW TREE.

THESE TREES THRIVE IN THE BALMY AIR AND IN THE SEMI-TROPICAL SUNSHINE AND ARE TO BE FOUND IN ALL PARTS OF THE ISLANDS.

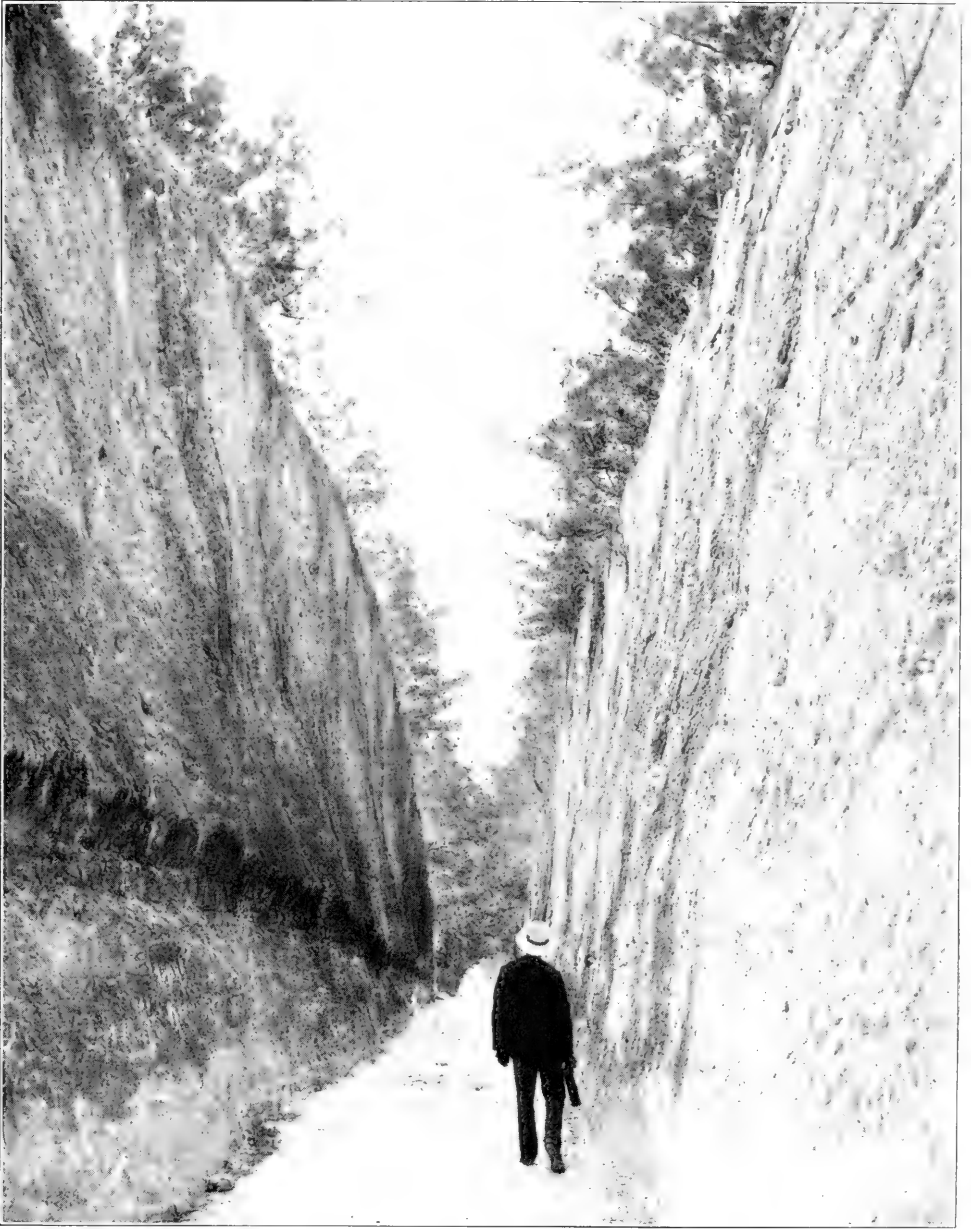

ROAD CUT THROUGH CORAL.

ONE OF THE CUTS MADE IN THE CORAL TO SECURE A GRADED ROAD. THE SIDE OF SUCH CUTS ARE FREQUENTLY COVERED WITH BEAUTIFUL MAIDEN HAIR FERN.

of many forms of strange vegetation, for due to the Gulf Stream's effect upon the climate and the importations made by the early colonizers, there flourishes, transplanted from Europe, Africa and the West Indies, a multitudinous variety

of palm, cacti and flowering shrubs, luxuriantly fresh and green, continually watered by the soft mists of midocean and forced to constant growth by the ever breaking radiance of a semi-tropical sun. Going from New York



A STREET IN ST. GEORGE.

ONE OF THE ODD OLD-FASHIONED NARROW STREETS, PICTURESQUE DESPITE THEIR CONDITION, WHICH ARE SO INTERESTING TO THE SIGHTSEERS IN BERMUDA.

to the Bermudas in the middle of January is like entering a vast conservatory, fragrant with the warm damp smell of fresh watered earth and green growing things. From out of the Maxfield Parrish branches of the native cedar, peep solid little white bungaloes built of coral blocks and of a near Colonial style. Every roof is agleam with white-wash, for the roofs catch rain water, the porous coral permitting

of no wells. This coral when quarried with an ordinary hand saw and hardened in the air, makes excellent building material. Occasionally a great cut is made in it for a graded carriage road and one stops to pick maidenhair fern growing wild in the crevices on the perpendicular sides of these attractive and novel roads. Small ponds or inlets of the sea, between the islands, shine with the clearest water of an

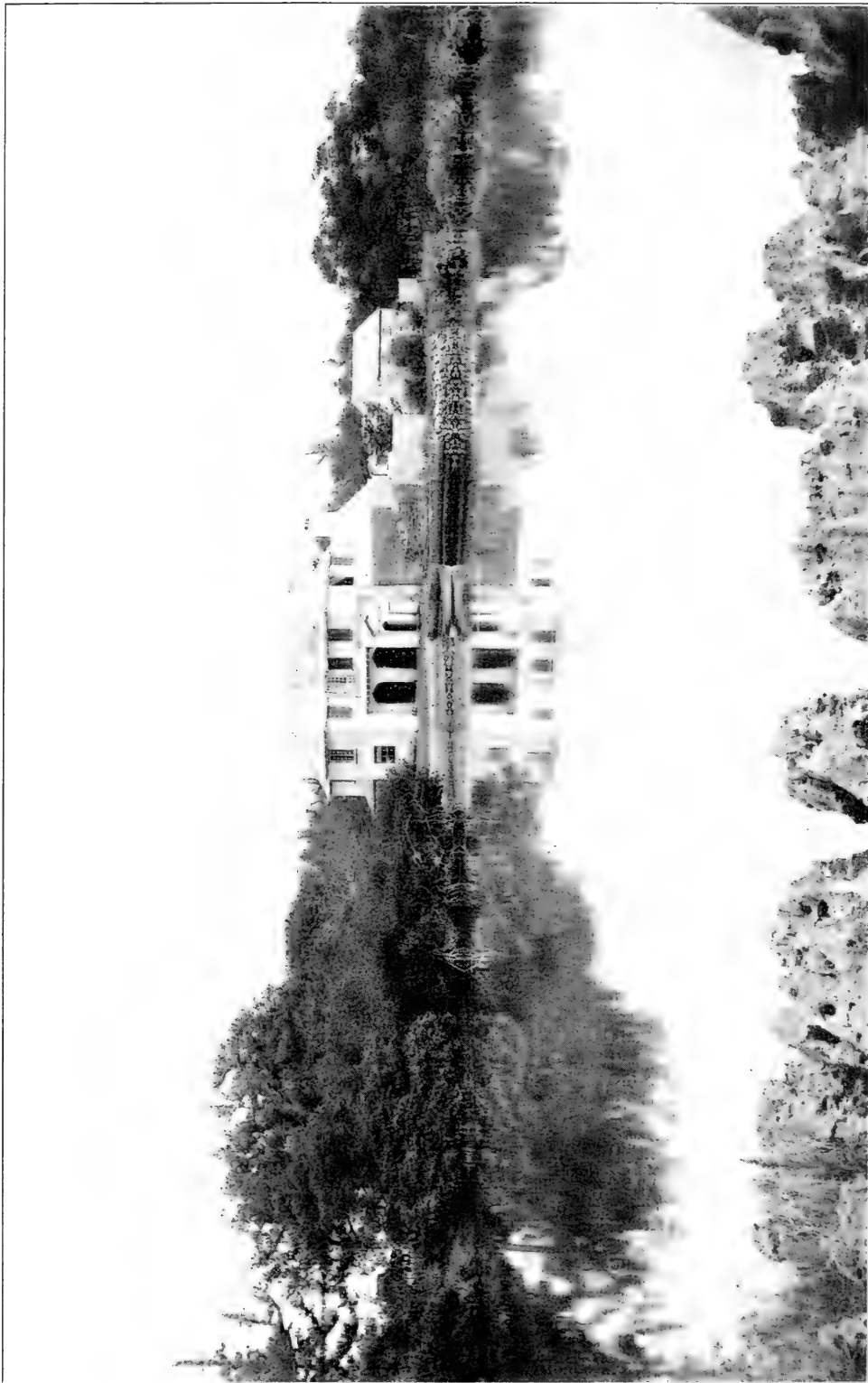

HERE LIVED TOM MOORE, THE IRISH POET.

THIS WAS ONE OF THE GREAT POET'S FAVORITE RESIDENCES AND HERE WAS WRITTEN MUCH OF HIS BEST POETRY. THE CHARMING HOUSE, ITS DELIGHTFUL LOCATION, THE PICTURESQUE LITTLE LAKE AND THE WHOLE SURROUNDINGS ARE CALCULATED TO INSPIRE POETRY.

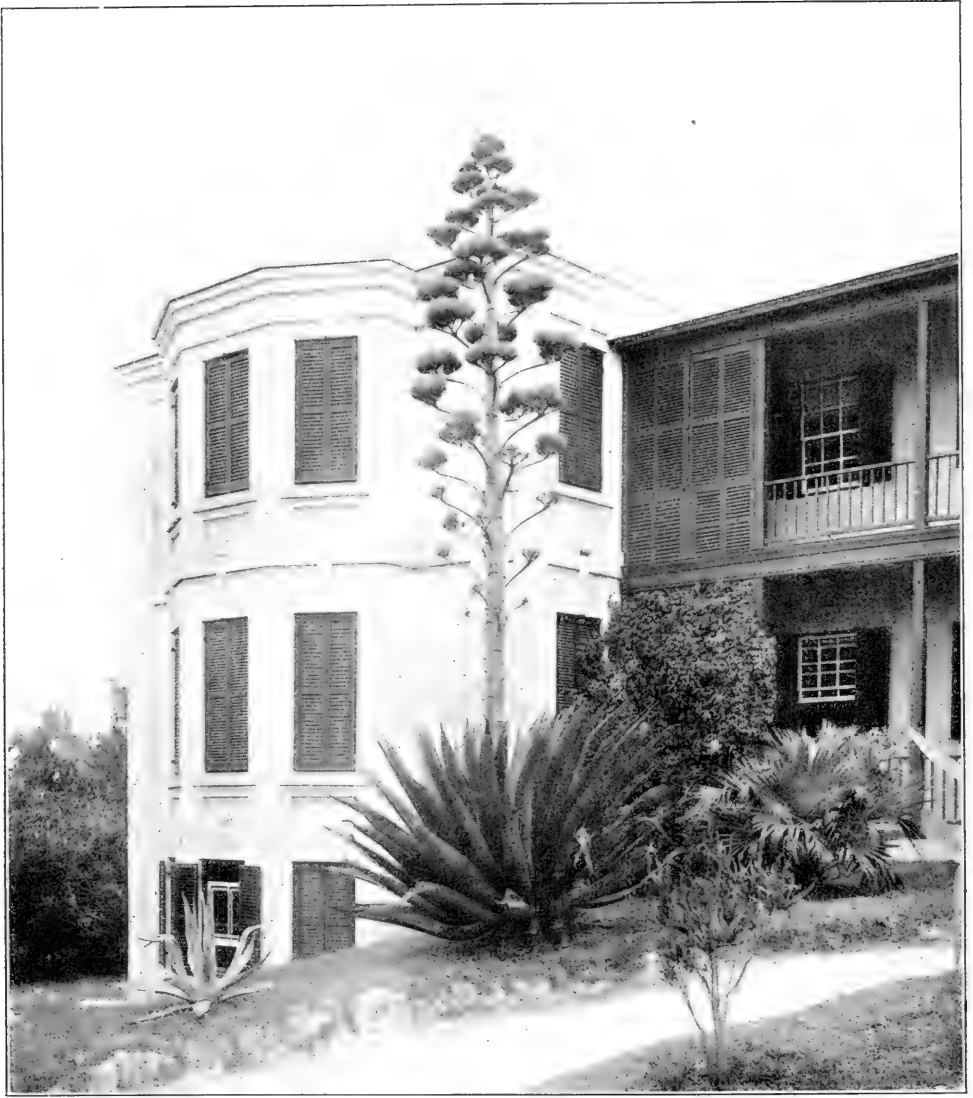

A CENTURY PLANT.

Alpine emerald hue, in whose depths close observation discloses bright colored fish and odd sea plants. Stylactic caves with their fairy figments abound. On the South shore during a storm, crested waves roll in over the hidden reefs, and dash spray high over the cathedral rocks which have been worn away by the constant erosion into arch and minaret of dainty pattern.

From the reports of these wonders by the early navigators and from the

shipwreck of Sir George Sommers here in 1609 in an effort to colonize Jamestown, Shakespeare was no doubt furnished with the motive for *The Tempest*. In history, the part played by this mid-ocean refuge for mariners, in the early colonization of Virginia, in the Revolutionary War and as a refuge for blockade running in the Civil War, reads like a romance.

As one approaches the northern end from the sea, the islands appear scat-

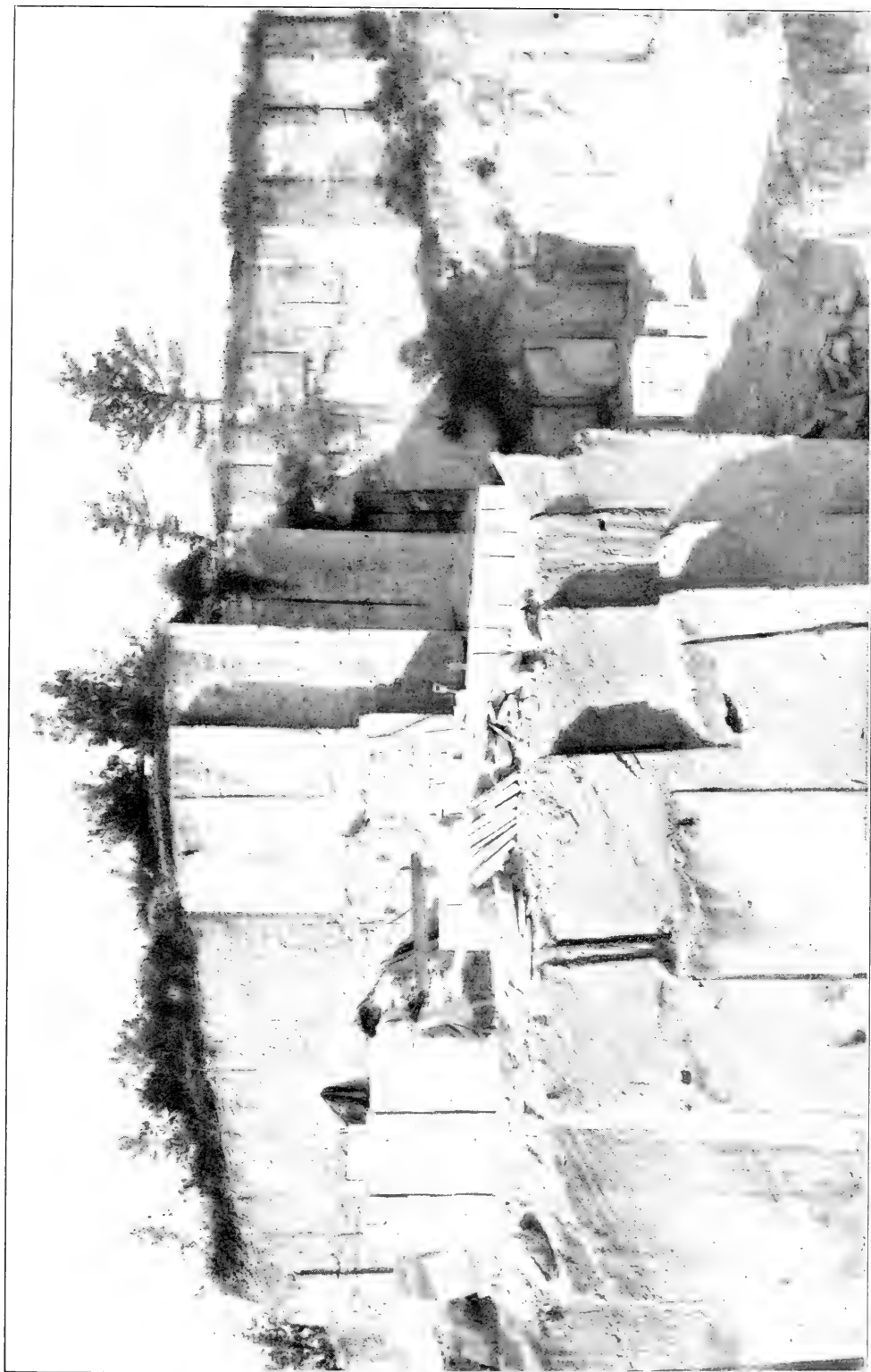

A CORAL QUARRY.

THESE BLOCKS OF CORAL ARE SAWED WITH AN ORDINARY HAND SAW, BUT WHEN EXPOSED TO THE AIR THEY GROW HARD AND MAKE EXCELLENT BUILDING STONE.



WATER SO CLEAR THE FISH MAY BE SEEN.

AN UNUSUAL PHOTOGRAPH OF THE FISH POOL AT ONE OF THE MANY BEAUTY SPOTS IN BERMUDA MUCH VISITED BY TOURISTS.



THE OLDEST CEDAR TREE IN BERMUDA.

OUT OF CEDAR TREES OF THIS SIZE SIR GEORGE SUMMERS AND HIS CREW, WRECKED ON THE ISLANDS, BUILT IN NINE MONTHS A PINNACLE OF FORTY TONS BURDEN, TWENTY-NINE FEET LONG AND FIFTEEN FEET BEAM.

teringly covered with a small, scraggly red juniper cedar which was the original plant indigenous to the pulvery soil of decaying coral rock. Little trees as we know them, scarcely ever exceeding thirty feet in height and perhaps also dwarfed by the constant winds, but pictureque with a Japanese daintiness and forming a dark olive green

background for the brighter vegetation disclosed upon a nearer approach.

History relates that of these tiny cedars, Sir George Sommers and his crew, after being wrecked, built in nine months a pinnacle called "Patience" of forty tons burden, twenty-nine feet in length and fifteen feet in beam, in which he made two successful voyages



AN AVENUE OF CEDARS.

THESE LITTLE CEDARS, SMALL AND SCRAGGY AND KNOWN AS A RED JUNIPER CEDAR WAS THE ORIGINAL PLANT INDIGENOUS TO THE PULVERY SOIL OF THE DECAYING CORAL ROCK.



A SCREW PALM.

THE ODD FEATURE OF THIS LITTLE TREE, SO NUMEROUS IN THE BERMUDA ISLANDS, IS THE DOWN SHOOTING ROOTS.

to America; but one feels that he must have been greatly helped by timbers out of his wrecked vessel. A peculiarity of the wood, however, was well known to pirates and privateers who built here; it does not shrink in seasoning and can be used for planking when it is green. It was found to splinter badly by cannon ball.

The berries of this cedar can be eaten. What is said to be the oldest tree on the island is shown in one of the accompanying photographs.

Of the multitudinous importations, the most striking are avenues of royal, date or cocoanut palm. A thicket of Bamboo gives an atmosphere of the Far East or a cabin thatched with the



ROOTS OF THE RUBBER TREE.

THESE WIDE, SPREADING TREES IN THE BERMUDAS REACH A HEIGHT OF ABOUT FORTY FEET.

broad leaf of the palmetto and surrounded by a banana plantation suggests a scene from the West Indies. Cacti have spread all over the islands, the candelabra sometimes fifteen feet high like a branched candle stick, the Snake winding its sinuous tentacles through the branches of a supporting tree, the prickly pear with its ever ripening fruit for the indigent native, the medical or green aloe of commerce, the century plant, Spanish bayonet and night blooming cereus.

Among the oddities are the giant rubber tree of forty feet in height; the sleeping mimosa the fern like leaves of which at night or in dark days close in sleep; the calabash tree, which is covered with the gourds from which pipes and dishes are made; the screw palm with its many down shooting roots; the monkey-puzzle tree with a bark so thickly covered with sharp thorns that no monkey can obtain a hand hold to climb up and disturb the

birds nesting in its branches, and the life plant whose leaves pinned to the wall keep green for months and even send out new sprouts.

As commercial possibilities orange and peach trees increased rapidly over the islands to the advantage of the inhabitants, until attached by a destructive fly, that unfortunately has greatly interfered with the quality of the fruit. Lemon trees are in abundance. The Australian or South Sea pine grows rapidly and is an addition to the beauty of the gardens. The original Fiddle Wood tree, introduced some eighty years ago, can be seen. Small tamarisks, locally called spruce, with their feathery drooping branches, form pleasant hedges along the sides of the roads. One would not give a fair idea of the Bermudas without mentioning their wide fields of growing onions and Easter lilies in little sheltered valleys of rich red soil, of the great masses of oleander bushes growing



OLEANDER AND PALMS.

THE GREAT MASSES OF THE OLEANDER BUSHES GROW ALONG HILL AND ROAD SIDES IN GREAT PROFUSION.

along hill and road sides in the utmost profusion, of rose bushes over houses and garden, abloom all the year.

All told, these are intimate and comprehensible little islands, a land of diminutive plants, houses and distances, along whose bright by-ways one bicycles or rides, for autos are taboo,

in Summer flannels, and returns with the sense of quiet approval with the hospitality of a peaceful land, richer by acquaintance with new forms of infinite nature, and entertained by the history of towns and harbors redolent with the traditions of conquest and the romance of the sea.

\$99.40 FOR ONE TREE

THE government has received \$99.40 in settlement for a single sugar pine tree which was cut in trespass in the Stanislaus National Forest, in California, and which yielded more than enough actual lumber to build a good-sized suburban frame house. The tree scaled 18,933 board feet and was valued at \$5.25 per thousand feet.

Not many trees contain enough lumber to build a two-foot board walk nearly two miles long, and this is believed to be the first case on record in which a single tree felled in a National Forest was valued at almost \$100 on the stump, although National Forest timber is frequently sold at considerably higher rates.



LIGHT STANDARDS AND FLOWER BOXES.

ONE OF THE FEATURES IN THE WORK OF BEAUTIFYING BATTLE CREEK, WHICH ATTRACTS MUCH ATTENTION AND ADDS GRATEFUL TOUCHES OF GREEN TO BUSY BUSINESS STREETS.

BEAUTIFYING BATTLE CREEK

THE beautiful maple trees in the residential district of Battle Creek, Mich., have for years been a source of shade, comfort and favorable comment, and for the past five years the Horticultural Society, in connection with the Chamber of Commerce, has carried out a plan suggested by the late C. C. Beach of this city—a man who spent his life in promoting the planting and growing of trees.

Mr. Beach's plan was to carry down town into the busy retail district the plan of beautifying the streets with flowers and vines by utilizing the ornamental street light standards in producing a harmony of color.

For several years the metal flower boxes have been planted each spring—with blossoms and vines and watered when necessary during the dry summer

months and as the light standards are only 60 feet apart in the retail district the appearance in the summer is very attractive. The Battle Creek plan is now used in many other cities.

While the plan originated in Battle Creek, the trimming of shade trees there was not started until two years ago after some lengthy litigation to determine who had a right to trim the trees. For several years the late C. W. Post designated a fund of \$500 a year to be used as prizes for the most attractive homes in the city. Those winning in any one year are barred from contesting the next year and thus the prizes have been divided among many people. The result is today that nearly every home is made attractive with blossoms from June until December.

Sand Hill Planting Successful.

Success has followed forest planting on the sandhills of Nebraska. Jack pines planted there by the Government Forest Service ten years ago now have a height of over 15 feet and a diameter of 4 inches.



BEAVER AVENUE, SEWICKLEY—FALL OF 1914.

TREE PLANTING IN THREE BOROUGHS

By J. GERRY CURTIS

WHEN Western Pennsylvania is mentioned most people think first of a country devoid of trees and vegetation, where the steel mills, blast furnaces and coke ovens are paramount. True, with the advancement of civilization the sturdy oaks which abounded in that section rapidly disappeared and the towns and cities were noticeably lacking in proper shade trees. But a change has come. During the session of legislature in 1907 a shade tree law was created giving all cities, towns and boroughs in Pennsylvania the power to establish Shade Tree Commissions for the purpose of planting and maintaining trees along the thoroughfares.

The borough of Sewickley was the first to realize the opportunity of the new law, and in the Spring of 1912, with the appointment of three commis-

sioners the Borough Shade Tree Commission was established.

Since then over 1,000 trees have been planted and today Sewickley boasts of street after street lined with a uniform planting of vigorous trees comprising seven different varieties.

The task of setting out the trees each year and the care for same was greatly lessened by the cooperation of the property owners who, realizing the value of the work, entered into the spirit of the movement.

The Boroughs of Wilkesburg and Dormont soon followed the example set by the pioneer borough and each year have planted several hundred trees.

The difficulties which have beset this work vary in each borough.

Sewickley enjoys a wide parking space on the majority of its streets,

due to a recent ordinance that all sidewalks be laid next to the property line. In places where soil conditions were bound to be unsuited for tree life it was necessary to excavate and replace with top soil.

Gas leaks and overhead wires, have caused considerable trouble but the assistance of the Public Service corporations have helped somewhat to eliminate these features.

In the borough of Wilkesburg the poplar tree predominates, causing unfavorable conditions such as clogging sewers, lifting sidewalks and nesting places for insect pests. The Commission each year is removing several hundred of these trees, replanting with better suited trees. The sidewalks are placed about one foot from the curb, necessitating cutting into the walk wherever a tree is to be planted. Soil

conditions are most unfavorable and good top soil is at a premium.

In the borough of Dormont, situated on the South Hills and protected to a certain extent from the menace of smoke, the walks are placed against the curb with the planting on the inside, giving the trees all possible advantage for growth. Shale formation predominates, blasting has in many instances been resorted to with satisfactory results.

Norway Maples are being planted almost exclusively, the results after three years, showing several streets of sturdy well shaped trees.

The slogan, "Plant a Tree," is the by-word which is making these boroughs a wave of green during the summer months. With the many difficulties to overcome the "planting game" continues and each citizen is taking his or her part.

MORE DURABLE PINE POSTS

LODGEPOLE pine posts are made decay resistant by Supervisor Benedict, of Hailey, Idaho, at a cost of 7 cents each. Mr. Benedict reports he needed 500 posts to construct a pasture fence at the Greenhorn Ranger Station on the Sawtooth forest, and could not obtain juniper, or red cedar, except by shipping a long distance. In the ground, lodgepole pine untreated rots quickly. Given a bath in hot creosote from the bottom to a point above the ground line when set sufficient to penetrate the outermost layers of the sapwood and all the openings through which decay could enter the post should last from 12 to 20 years. To this end all the posts were given a bath of an hour in creosote, which was heated in two of the 50-gallon steel barrels, from which the tops had been removed. Larger tanks would be better. About 15 posts were placed in each tank, and 16 tanks full were treated in a day,

one man, John Sims, doing all the work in practically two days at a cost, including the creosote, of \$35.

The posts were cut from live timber in latter May and seasoned three months. The absorption was about three-fourths of an inch, and since the seasoning checks had formed and were therefore reached with the preservative, it is believed this treatment should be adequate.

A total of seventy-five gallons of creosote, or three-twentieths of a gallon per post, was used. The treated posts will be interspersed with untreated ones for comparison of durability. Two tanks of corrugated iron have been purchased for treating pine stubs for stubbing the forest service telephone line from Ketchum to Pole Creek, built in 1909 and 1910. These are 5 feet high, and should each hold 15 stubs or 35 posts.

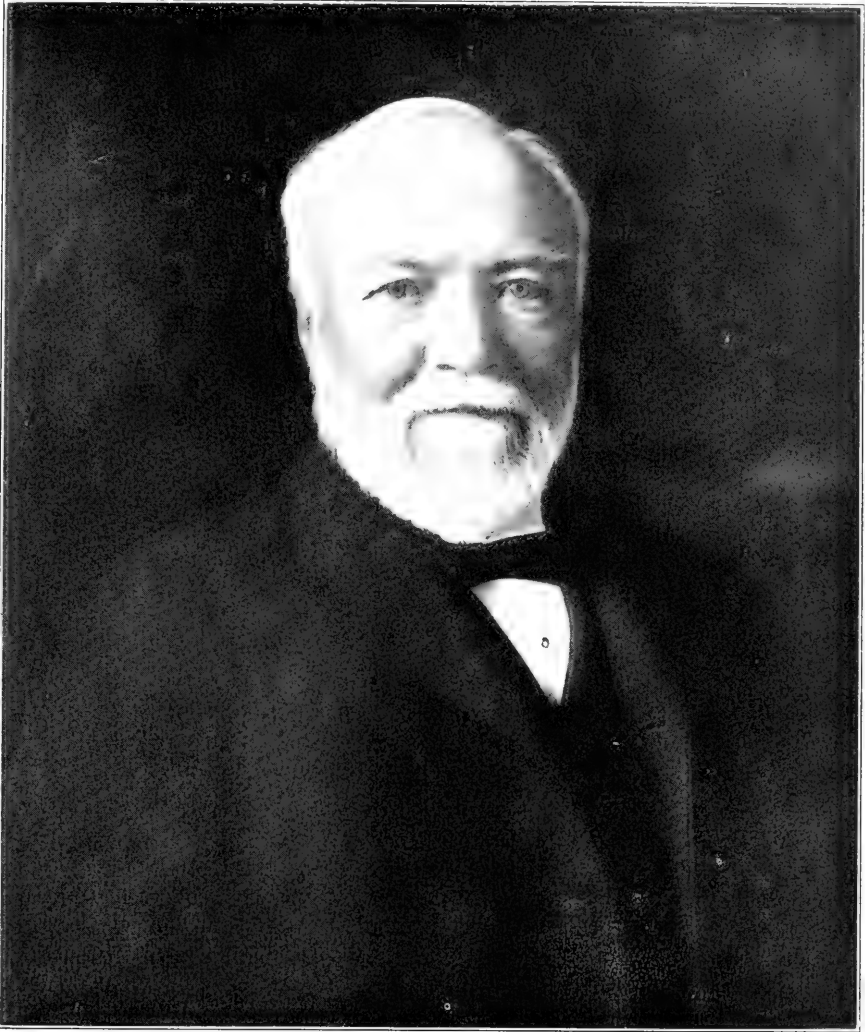

*Photo by Marceau,
New York.*

*Truly Yours
Andrew Carnegie*

Mr. Carnegie is a Vice President of the American Forestry Association and is much interested in the work which it is doing for the conservation of the forests and for extending to all parts of America a knowledge of trees, their value and their care, as a measure of public education.



Copyright by Harris & Ewing, Washington, D. C.

*For The American Forestry Association
with best wishes.*

Wm. H. Taft

Former President William H. Taft, who was elected a Vice-President of the American Forestry Association at its Annual Meeting in New York City on January 11, 1915, has for many years been an earnest advocate of Forest Conservation.

In expressing his views on the subject for AMERICAN FORESTRY he says:

"Of course I am in favor of Forest Conservation. We need to extend the scientific knowledge of the subject into every State in such a way that we may bring about the conditions in the preservation of our trees and our lumber supply which obtain in Germany and in France. This cannot be done except by iteration and reiteration and such an Association as the American Forestry Association must assume the heavy task."

VIRGINIA'S STATE FORESTER

THE first State Forester of Virginia, just appointed, is Chapin Jones, who since August, 1912, has been assistant State Forester of Maryland. Mr. Jones' selection is announced by Dr. Alderman, head of the University of Virginia at Charlottesville-

in every branch of State Forestry work, has specialized in fire protection and recently has been devoting himself to publicity work and lecturing.

Mr. Jones was born September 26, 1885, at Des Moines, Iowa, being a son of Dr. Richard Jones, formerly Professor of English at Vanderbilt University, and other institutions, and now at Tufts College.

He graduated at Vanderbilt University, with A. B. Degree, in June, 1904, and then took two years post-graduate work at Vanderbilt, the second year being a "Fellow" in Biology, assisting in Laboratory, etc., and teaching one class. He graduated from Yale Forest School in June, 1909, with degree of Master of Forestry, having taken the regular post-graduate course. He worked in forestry during vacations for the State Forester of Connecticut and the Forest Service. He was a Forest Assistant in the Forest Service from July, 1909, to July, 1910, being stationed in Montana and Idaho, and specializing in cruising and mapping. He was a Forest Assistant in the Forestry Department of the Pennsylvania Railroad Company from July, 1910, to January, 1911, specializing in reforestation. He secured a furlough and travelled in the interests of his father in Florida and in Canada, and managed his father's fruit farm in Massachusetts from January, 1911, to April, 1912. He went back into forestry work in New Hampshire as Field Assistant to the State Forester, April, 1912, to July 31, 1912, specializing in fire prevention methods and August 1, 1912, became Assistant State Forester of Maryland. He is a member of the Society of American Foresters, the Eastern Forester's Association and the American Forestry Association.



CHAPIN JONES.

THE FIRST STATE FORESTER OF VIRGINIA, RECENTLY APPOINTED. HE WILL BE STATIONED AT THE UNIVERSITY OF VIRGINIA AT CHARLOTTESVILLE, VA.

ville, Va., which will be the headquarters of the State Forester. The appointment was made and the work will be started as a result of the State Forestry law passed by the Assembly early in 1914, the American Forestry Association being largely instrumental in securing the passage of this law by giving its aid to Senator R. S. Blackburn Smith, the author of the bill.

Forester Jones, who is admirably fitted for the position, will begin his work at once. He has had experience

Small Timber Sales Increase.

Increasing use of the National Forests by local farmers and settlers to supply their needs for timber is shown in the fact that small timber sales on the forests numbered 8,298 in 1914, against 6,182 the previous year.



MRS. EMMONS CROCKER

By MRS. LYDIA ADAMS-WILLIAMS

Mrs. Emmons Crocker was elected a vice president of the American Forestry Association at the annual meeting in New York City on January 11, 1915. She is an ardent conservationist. The following is a graceful tribute to her work in the cause. —Editor.

WOMEN are particularly apt in grasping the significance of a great idea. They are not only endowed with the great gift of foresight, but their intuitive reasoning power is undisputed and unquestioned. The inherent desire of woman for the betterment of the world,

and the heaven-born mother-love which impels her to protect her family, to provide for their present and to preserve and look out for their future, gives her a broad, practical grasp and a comprehensive insight into the present as well as the future needs of humanity. This unselfish mother-love, this protective

instinct, this far-seeing intuitive reasoning, woman is now applying to the great public questions of the day.

Women have organized national and international societies—notable among them the General Federation of Women's Clubs, 1,200,000 members,—with active, working branches in every country, state, county, city and hamlet; and, at a word from their leader, they can, almost immediately, put its entire machinery in motion to educate public opinion on vital questions—a sort of endless chain system by which letters or circulars to men in public life, to newspapers, and to other publicity agencies, may be increased in number and volume with the force and velocity of a ball of snow rolling down a steep hill. And few there are who have the temerity to oppose or stand in the way of this approaching avalanche of public opinion.

It would take the wealth of a Croesus to finance these large national and international associations and to pay for clerical labor; but women carry on the work of these great reform agencies with practically no capital to speak of, as women do the work without compensation and pay their own traveling and hotel expenses because of their unselfish and self-sacrificing love for humanity. The only reason men have not such organizations is because men will not, as a whole, give their time and their services without compensation for patriotic public duty.

In an article, "Conservation—Woman's Work," published in the Governors' Conference issue of the *AMERICAN FORESTRY Magazine* in June, 1908, I made this statement: "From time immemorial when any great work is to be accomplished—any achievement which vitally concerns the life and the welfare of humanity, any uplift of the children of men in the home, or in the broader field, the world—to woman's integrity, resourcefulness, genius and capacity for endurance has the final triumph been due."

I once heard the president of a large waterway congress say that when a man's name was placed upon the board of directors or upon the rolls as state vice-president, etc., that the matter

usually ended there. "But," he added, "when a woman is elected to so responsible a position, she goes ahead and does something." Witness the work for prison reform of Katherine Bement Davis as Commissioner of Corrections for New York City; Mrs. E. Borden Harriman as member of the National Board of Industrial Relations; and Miss Julia C. Lathrop as head of the Federal Children's Bureau. Innumerable other instances might be cited.

At the thirty-fourth annual meeting of the American Forestry Association held in New York City on January 11th, Mrs. Emmons Crocker of Fitchburg, Massachusetts, was elected a vice-president of the Association.

This is the first time that a woman has been chosen to fill this responsible position, and the American Forestry Association, in its noble work to save from devastation and extinction the unparalleled forest resources of our country, is to be congratulated upon having upon its staff of workers one whose efforts are as untiring, whose enthusiasm is as great, and whose heart and soul are as fully in the work, as is Mrs. Emmons Crocker.

That her unselfish and self-sacrificing work and ability has been so signally recognized is a source of gratification to the more than a million club women of the United States whom Mrs. Crocker has so ably served for four years as National Chairman of Conservation in the General Federation of Women's Clubs.

Mrs. Crocker took up the work for Conservation several years ago, and has since given all of her time to the propaganda of that great cause. She has spoken at a number of large conventions and congresses, and the principles she has advocated have met with the approval of the most up-to-date, the most progressive, the most advanced and the most patriotic of our citizens.

She has worked unceasingly for the integrity of the National Forests and for the perpetuation of the Forest Service.

At the Biennial Federation of Women's Clubs at Cincinnati in 1910, Mrs. Crocker spoke on "Wilful Waste Makes Woeful Want." She told of the

waste of soils, fertilizers (emphasizing phosphates), sewage, minerals (giving a list of ten in the order of the value of their production—coal, iron, copper, clay products, petroleum, gold, stone, cement, natural gas, and lead. Silver was not put in this list because it is not found by itself and is often a by-product.) The pitiful waste of animal life, including fish, flesh and fowl, concluded her address.

Mrs. Croker has, at her own expense,

compiled, printed and distributed much valuable material pertaining to her subject, notably a twenty-page circular giving the biennial report for the years 1912-1914 of each chairman of Conservation in the General Federation of Women's Clubs, for all the states; a perusal of this book gives one a very clear idea of what women are doing for the conservation of forests, waterways, soils, birds, and state and national parks.

WISCONSIN'S FORESTRY TANGLE

A DECISION of the Wisconsin Supreme Court in February declares in brief that the law under which the State Forestry Department has acquired, by purchase, lands for use as State Forest Reserves is unconstitutional and that such lands must now be sold and the money derived must be returned to the fund from which it was taken.

This is a most serious blow to forestry work in Wisconsin and creates, judging by comments in the newspapers and from leading citizens of the State, a condition which it is earnestly hoped may be overcome. Just how this is to be effected is at this writing not apparent.

The State is prevented by law from incurring an indebtedness over \$100,000, except for defense in time of war. It is also prevented from expending State money in "internal improvements," such as improvement of streams for public navigation, construction of public highways, etc.

In 1907, two constitutional amendments were passed which authorized the State to appropriate money for the acquirement and improvement of water powers and for acquiring and maintaining lands for State forestry work. Under this amendment some \$200,000 worth of land was purchased for forestry purposes. Also certain lands belonging to the State Schools were also acquired by the Forestry Department.

The Supreme Court's decision that this purchase and this acquirement of

school lands were both unconstitutional and unlawful compels the Forestry Department apparently to relinquish all claim to the lands and cuts the State Forestry Board and the State Forester down to such narrow limits that the service is not much more than a police power for the prevention of forest fires. It cannot engage in reforestation or buy lands for that purpose.

Probably a new amendment to the constitution will be necessary to overcome the existing difficulty but it will take two years to get this adopted.

The State now holds 20,000 acres granted by the United States for forestry purposes and also a small acreage acquired by private donations. These the State Forestry Department can hold and care for but cannot expend money for reforestation because this is considered an "internal improvement" and is therefore unlawful.

Chief Justice Marshall of the Supreme Court while agreeing that the constitutional amendments of 1907 are unlawful declares that reforestation cannot be considered an "internal improvement" and argues that it is necessary for public welfare and should be provided for by special taxation.

He says:—"My difficulty with the opinion, stated in a general way, is this: It so limits and circumscribes the powers of the State with regard to reforestation and afforestation that it leaves little more than a shell behind. At least this is the way the opinion impresses me and the way I think it will be generally understood.

"There are three general propositions which I think should be stated in this case clearly and fully, without hedging them about with limitations, qualifications and provisos which render them practically useless, and those propositions are as follows:

"First, the acquisition, preservation and scientific care of forests and forest areas by the State, as well as the sale of timber therefrom for gain in accordance with the well understood canons of forest culture, is pre-eminently a public purpose. It would be a mere affection of learning to dwell upon the value to a State of great forest areas. That has been established long since and is not open to question. The lamentable results which have followed the cutting of forest over large areas, the serious effects of such cutting upon climate, rainfall, preservation of the soil from erosion, regularity of river flow and other highly important things which go to make up the welfare of the State are matters of history. They need not be descanted upon.

"Second, being a public purpose of the first rank in importance, there can be no question of the power of the State to levy taxes for the accomplishment of the purpose. The power of taxation exists for every public purpose unless some constitutional prohibition, either Federal or State, has taken it away. I find no such prohibition. I confess my inability to understand the reasoning which finds it in that clause of the constitution which commands the Legislature to levy an annual tax to defray

the estimated expenses of the State. The power of taxation is one of the necessary attributes of sovereignty. To say that because the constitution makers thought best to make a specific provision that taxes should be levied for certain purposes they intended thereby to interdict taxation for all other public purposes is to my mind unthinkable. Besides if afforestation and reforestation be public purposes, then the moneys spent in carrying them on are necessarily and properly expenses of the State and come within the Constitutional command. The expenses of a State include the moneys which it spends in carrying out the public purposes which the Legislative judgment directs to be carried out.

"Third, afforestation and reforestation of large areas are not 'works of internal improvement' within the meaning of the constitution.

"Now I affirm, that it is not to be expected in the light of human experience in this land at least, that the establishment and conservation of large forest areas for the public good should be undertaken by private enterprise, and I also affirm my belief that such work is preeminently a public work, and hence one of the essential functions of government."

These views of Chief Justice Marshall are well worth reading by the citizens of every State. The belief expressed in the last paragraph is particularly pertinent.

AIDING TIMBER OWNERS

PARTICULAR attention is being given this winter by the Maryland State Board of Forestry to its work of cooperation with local woodland owners.

Where the assistance of the Board has been requested, a preliminary examination of timber tracts is made by the State Forester or his Assistant, a working-plan drawn up to cover plans of management and improvement, and the timber gone over a second time by men experienced in such work. Defective, diseased, and mature trees, and those of undesirable species, are marked for removal, and an estimate of the whole secured.

The owner pays the actual expense of putting the men in the field, and their work is later summarized at the State Forester's Office free of charge. The stand and value of the timber is tabulated, the estimate of stumpage being

sent to a list of timber operators in the same locality. This has been found a satisfactory and successful way of getting in touch with the market and securing buyers.

Within the past few months the timber marked for removal on one tract of woodland in Maryland has been sold for a sum 200 per cent in excess of that originally offered to the owner. The latter would probably have accepted the first offer if this work had not been done. Through it, however, he gained an accurate idea of the value of his property, and the entire proposition, from marking the timber to drawing up the deed of sale, was undertaken for him by the Board of Forestry. The present and future value of this stand was considerably increased, and illustrates one way by which the State of Maryland is extending aid of a very practical nature to local timber owners.

THE AMERICAN LUMBER MARKET

PART I

By E. B. HAZEN

[Perhaps no lumberman can speak with greater knowledge of the conditions or with more authority on the subject of the American Lumber Market, than Mr. Hazen. His article, the first part of which is now printed, was prepared with painstaking care and attention to detail. It is a straightforward discussion and presentation of facts regarding the third greatest industry in the United States and it warrants careful reading and attention. The second part will appear in AMERICAN FORESTRY for April.—Editor.]

FIFTY years ago we built of wood and used white pine from the North. Twenty years later we built of wood, but we had a choice. Yellow pine from the South had become an alternative. Another score of years passed and still we built of wood, but chose from among the woods of the North, South and West. The rising cost of northern stumpage gradually enabled Southern and Western lumber to compete with white pine.

Lumber is no longer the necessity it used to be. Wood is only one of many competing building materials. In the last ten years a dozen substitutes have offered themselves. Lumber must now be sold by methods of competitive salesmanship against products of cement, steel and other commodities which are superior only in some uses but which are merchandized so effectively that oftentimes where wood is better it is supplanted by these materials.

Until recently lumber manufacturers did not have to consider the importance of selling. There was a universal demand for lumber and they turned it loose to find its user through whatever agency would move it from the mill. They concentrated their energies upon the pioneering and producing end of the business and became masters of the science of manufacturing. Manufacturing has always held them, for they are manufacturers by training, experience and heredity. But now, besides the manufacture of supply, they must undertake the manufacture of demand.

There are two fields to consider in developing the lumber market, namely, the export and the domestic. The

former now consumes 10 per cent of the output of the United States and this proportion may be increased. The export market has not been entirely neglected, for the ship-chartering exporters have satisfied the expressed demand for American lumber in a thorough manner, but they have not created a demand nor can they be expected to assume the business-creating task of the producer. The manufacturer must enter the foreign field direct with strong trade-developing effort. Sales in some foreign markets will always be limited by competition from the forests of British Columbia, Mexico, South America, Siberia, the Black Sea and the Baltic, but the United States will be the principal source of supply for territory from which its product is not excluded by high freight cost, and for all territory seeking the best grades of soft woods. Nevertheless, the domestic field is the one to which the manufacturer must look for the greatest possibilities.

SURVEY OF DOMESTIC FIELD

Let us divide the consumers of lumber into two classes, urban and rural. Two-thirds of this country's people live in towns and cities. More lumber is sold in thickly settled communities than in country districts but the volume is much less per capita. The use of stone, brick, concrete and steel in city buildings is increasing and displacing wood; partly because some other materials are more suitable, as for instance in the modern skyscraper, but largely because lumbermen have not actively interested themselves in keeping their products before consumers.

There are countless old and new uses for which wood is best, but the superiority of wood has not been revealed to the people, while house-to-house sellers of other materials have forcefully urged to the contrary. Lumber salesmen vie with each other in selling to retailers for less, but few direct their efforts among the actual users. Any lumberman will concede the superiority of cement for certain uses, and it should have its place, but ingenious popularizing of other materials should not be permitted to eliminate wood from the uses for which it is best.

Wood blocks are superior for street, road and bridge paving and for factory and warehouse floors. The slow-burning, heavy-timbered type of factory building, properly designed, is safe, serviceable and comparatively inexpensive. It is the contents of buildings that burn, and so long as our buildings are filled with inflammable articles a hazard will exist. In case of fire there is less danger from sudden collapse in a wooden structure than in a so-called fire-proof building.

In the rural districts lumber is still the staple construction material despite the fact that energetic sellers of substitutes have introduced to the farmers steel fence posts, concrete buildings and silos, cement troughs and other farm accessories. The manifest superiority of lumber for general farm use makes rural districts the logical field for the strongest efforts toward market extension. Decreasing cost of automobiles, interest in good roads and improvement of interurban service combine to entice city dwellers away from crowded, hazardous apartment houses to suburban homes, good air, green gardens, lower fire hazard and healthful conditions.

For country construction wood has countless qualities. Lumber is lasting. It is the cheapest and most adaptable material for houses, barns and sheds. Wood silos have been proven by test and experience to be the most durable and satisfactory. Treated wood blocks make the most sanitary and serviceable flooring for barns. Lumber will repay its cost over and over again in the housing of farm machinery, and low-priced material serves the purpose. Lumber

is the one handy, easily preserved, easily applied building material for farm repairs. Children or adults may fashion it at will into useful and ornamental things.

According to the Forest Service, 50 per cent of all of the lumber manufactured in 1909 was used in the form of rough timbers, 25 per cent in planing mill products, 10 per cent in boxes and crates, 3 per cent in car construction, 2 per cent in furniture, one-half of 1 per cent in tanks and silos, and one-sixth of 1 per cent in paving blocks. In some of these uses wood must yield to materials which are better; in others it has no equal and its use could easily be increased, and must be increased if the production of today is maintained.

SOUTH AND WEST SPARSELY SETTLED

The Southern States have developed rapidly during recent years. A greatly increased local demand for lumber has resulted and the close-at-home market will develop more and more as the fertile lands are occupied. With an average crop value already reaching \$40 per acre, the South will soon need its timber supply for home consumption. The same is true of the Lake States. West of the Missouri is an area of two million square miles supporting only sixteen and one-half million people. Japan and all of Europe, exclusive of Russia, have approximately the same area with a population of nearly four hundred millions. Only race-destroying cataclysms can prevent the dense occupation of this great domain. To be sure, much of the land west of the Rockies is arid or semi-arid, but irrigation, dry farming and human need will demand the use of much of it.

THE SOURCE OF SUPPLY

In 1909 there were 2800 billion feet of standing timber in the United States; sufficient to last, at the present rate of cutting, for seventy-five years. The Forest Service reports that there are 250 million acres of forest area on which there is sufficient natural reproduction to insure a fair second crop. No reforestation on a large scale will be undertaken by private capital, but the

government will take steps to insure a continuous supply of timber sufficient for the country's needs. In 1909, 22 per cent of the timber in the United States was in the South, and 57 per cent west of the Rockies, largely on the Pacific Coast.

At present the yellow pine forest supplies 37 per cent of the lumber manufactured and Douglas fir 9 per cent. At the 1913 rate of cutting, the former will be exhausted in twenty years. The West Coast must then supply practically all of the country's needs, besides all over-seas demands.

The kind of lumber used in any locality is largely determined by stumpage cost and freight. White pine reaches the market on an average freight rate of about \$3 per thousand. Yellow pine pays about \$7.50. Formerly West Coast woods paid \$23 to New York. Now the canal permits western mills to ship by water for half the rail freight, and this, together with lower stumpage values, enables them to compete with northern and southern woods within a zone as far back from the Atlantic as Indianapolis. The southern lumber displaced will be diverted to former territory of western lumber. Lower freight rates will not materially increase use. Other means must be found, and the lumberman's greatest problem is "how to sell more lumber."

Increased use of any species of wood benefits manufacturers of other species. There must be cumulative value to the industry if we extend the use of yellow pine paving blocks, cypress tanks, spruce pulp, western pine sash and doors, Douglas fir construction and car materials, redwood silos and cedar shingles. But the exploitation of any species must not make conflict between woods which will actually promote the use of substitutes. All lumber interests should unite in a campaign to revive old uses, discover new uses, combat unfair encroachments, support wood construction and secure to lumber its deserved use as a building material.

A BIT OF HISTORY

Products of the forest have taken a most intimate part in the life of this nation. We have been prodigal users

of wood. The per capita consumption of lumber doubled in fifty years, reaching 500 feet per annum in 1909. The production of forty-five billion feet in that year was the largest in the history of any country. Lumber manufacturing has always been pioneering. It has preceded and closely followed early immigrants in their search for new homes. It has served the settler for fencing and buildings. It has furnished the ties, bridge materials and building lumber for the first railroad. It has supplied lumber to build the little towns which have appeared by hundreds as civilization pushed its way southward and westward.

The demand for lumber prior to 1906 fluctuated; yet the output was absorbed and it yielded a profit to the hardy woodsmen, particularly of the North, whose courage and ingenuity gave to their fellows so essential a product. A period of unprecedented prosperity, augmented by the San Francisco and Valparaiso earthquakes of 1906, stimulated the demand for lumber, and consequently the price ran high. Conservationists sounded alarms of fast-disappearing supply. Investors turned to the west in a rush to secure a foothold. Stumpage was cheap. Much of it was bought by lumber men of the North who, after years of struggle, were realizing handsome returns from their white pine, owing to constantly increasing consumption and an unimpaired demand. Southern operators were doing the same with yellow pine, and all firmly believed that history would repeat itself in the west. They urged the younger generation to follow in their footsteps as lumber makers. Speculators, from all classes, lured by the prospect of immediate riches, bought timber. Forests which a few years before were vacant public domains suddenly became valuable. The second transfer took place. Bull team loggers sold for a substantial price per thousand feet timber bought for a few hundred dollars per quarter section, and became rich overnight. In this period the public came to believe that ownership of trees meant unavoidable wealth.

The second owners after sale by the government eagerly awaited another

doubling of selling prices. Had they not been told that in twenty or twenty-five years the streams would run dry amid the waste of denuded hills? Conscious only of taxes and interest on investments, and unmindful of the hundreds of billions of feet of timber remaining in the north and south, they set in motion machinery to reduce the forests of the west. Impatient for realization, owners incapable of carrying an investment which cannot be converted at pleasure lost sight of the fact that stumpage return is only the difference between the cost of production and distribution, and the selling value of lumber. But few foresaw that because of indifference on the part of lumbermen to the trend of economic conditions and because of the discovery and exploitation of other materials of merit, the demand for lumber would fail. Lumbermen minded their mills but neglected their markets.

History should repeat itself as regards stumpage values in the west but history is chiefly a record of human action. Owing to distance from present centers of consumption, transportation will take up some of the return that in the north and south is a part of the profits. In no forest region has stumpage become valuable until the supply was diminished; and today white pine stumpage in the north is worth \$15 per M despite competition from the north, south and west. Every day brings that time nearer on the Pacific Slope. Western forest history is young.

The average timber buyer, however, perhaps failed to consider some of the important factors contributing to the enhancement of stumpage values. The lumber business of the north, for instance, was largely fostered by the wonderful agricultural and manufacturing development of the Mississippi Valley, with its thirty million people reached at low freight cost. Wages were low. Competition of substitutes and other woods had not disturbed the market. Lumber was bought. But the territory within a \$3 freight haul of the western forests is not so easily developed. The product must be hauled long distances to reach an extensive market and the cost is heavy. Last

year 70 per cent. of the Douglas fir produced was shipped beyond an estimated \$3 freight zone. Moreover, the eastern market, formerly reached with northern lumber and latterly counted upon as a market for Douglas fir, is fast growing to be a country of cities in which brick, stone or concrete displaces wood. Manufacturers are just awakening to the need for merchandising.

It may be said that stumpage bought by the third owners since 1906 cannot be sold today at an advance sufficient to pay interest, taxes and fire patrol. In 1907 came a reaction in the lumber market and the price realized by the manufacturer has since then continued so low that many mills have, on an average, sold lumber below the cost of production, leaving cost of raw material out of the calculation. This, however, may not affect the ultimate value of stumpage held until it is needed.

The true value of stumpage has never actually increased by speculation. Advances have followed, not preceded, the establishment of manufacturing industries and they have been due almost entirely to demand. The situation is the same in the case of every primary commodity. In the end the consumer must pay the bill; but to meet legitimate competition and produce a fair return to capital and labor lumber manufacturers must so change their methods that economies will result from closer utilization of the raw product and cheaper distribution to the consumer. Substitute materials will always intervene against excessive prices for lumber. In the western country the cost of stumpage is still an unimportant factor in the cost of lumber to its users. Waste and costs added after the finished product leaves the producer are more important. Today practically all of the timber in the United States and Canada is under the ax and every community is competing in an effort to force greater consumption; not by improved business-developing methods, but by profitless destructive price-cutting which injures both the community and the capital invested in manufacturing. Stumpage owners must wait until this strife shall end.

The market absorbed more lumber in 1909 than ever in the history of the country. This was due in part to continued railroad building and development which followed the entry of roads into new regions. And, despite the unsatisfactory prices of 1907-8-9, mills continued to multiply until, in the latter year, there were nearly 50,000 making lumber in the United States. The cutting capacity to carry this peak load has since been grinding away on part time or intermittently. Some have been eliminated through the inexorable law of survival of the fittest. More will be eliminated. In 1913, according to government figures, the market absorbed only thirty-eight billion feet, a decrease in four years of over 15 per cent. Although in ten years the population of the country has increased 21 per cent, lumber consumption during that time has increased but 14 per cent. Building operations in North America as a whole increased from 1909 to 1912 but lumber consumption decreased one-seventh. The American lumber market absorbed less lumber in 1913 than in 1909, irrespective of increased population.

What may we expect of the future? Will the nation use more or less?

[The second part of this article, which deals with the reasons for the decline in the lumber industry and suggests means for rebuilding and improving it, will appear in the April number of AMERICAN FORESTRY.—Editor.]

ESTIMATED CONSUMPTION OF THE FUTURE

The per capita consumption in the United States in 1909 was 500 feet. In densely populated Germany it was 48 feet. Let us not account for the small consumption of lumber in Germany by supposing that it is costly there. The consumer in Germany probably pays no more for his lumber than does the consumer in America. The manufacturers in Europe realize about the same price per thousand at the mill as do the yellow pine manufacturers of the South. To be sure, the product is low grade, but so is 80 per cent of ours, and the freight to the consuming centers is much less than in the United States.

Suppose that our present consumption per capita, 425 feet, is maintained for twenty years and that our population shall increase every year by one and one-half million as it has during several years past. This continued increase is improbable, although a heavy influx of immigrants may be expected after the European war. But even on this sanguine estimate, 1935 will consume but little more lumber than 1909, unless the inherent instinct of mankind to use wood is fostered.

with the reasons for the decline in the lumber and improving it, will appear in the April

REGISTER OF FORESTERS

WITHIN a few weeks the American Forestry Association will close the register of Foresters which it proposes to publish.

While the names of a majority of these Foresters have been secured there are un-

doubtedly some which are not on the list.

It is therefore desired that Foresters who have not as yet sent in their names do so at once and that they also send the names, positions and locations of any others whom they think may be missing from the list.



TO PROMOTE THE USE OF WOOD

A meeting of most of the leading lumbermen and lumber manufacturers of the country at Chicago on February 24th and 25th, called by the Forest Products Federation, plans were perfected for organizing a Trade Extension Department of the National Lumber Manufacturers Association. This will be for the purpose of promoting the use of wood and all forest products. It marked a decisive step forward in the lumber industry following a realization of the need of a propaganda, education and publicity among the consumers of lumber.

It was decided by the Executive Committee that its field of activity in this work will be:

(1) To compile full and reliable information upon fire losses, insurance rates, building codes, uses of wood substitutes for wood and anti-wood legislation.

(2) To cooperate with and assist other organizations of woodworking and consuming interests.

(3) To disseminate information by speakers, bulletins, newspapers and magazine articles, exhibits, advertising, etc., upon the properties and uses of wood.

(4) To oppose unfair discrimination against wood in building codes, regulations, ordinances, legislation, etc.

(5) To conduct technical investigations of the properties of wood as a construction material.

(6) To develop and extend practical fire prevention methods and processes.

This plan of work, together with the proposal to create a Trade Extension Department of the National Lumber Manufacturers Association for conducting it, was approved by the meeting and

operation will commence as soon as the money necessary for the work is secured.

The Committee in presenting its plan emphasized the need of the work by saying:—"The need is apparent since the lumber industry is suffering for want of a national champion of its interests in matters of trade extension. Neither the manufacturers nor distributors have told the consumers how, when, and where the wood may best be used, nor have they aggressively met competition, but instead have allowed other building materials to beat wood out on its own ground. This supine acceptance of what comes in the way of orders, with no attempt to fight for business or to promote grades and kinds of wood to meet specific service requirements, simply gives the other fellow an open field. Not only are the other materials sold for purposes where lumber would be as good or better, but they are constantly improved and made to serve the consumers' needs more perfectly. Such methods win permanent trade, and the materials thus perfected and adapted to specific uses become so firmly entrenched that wood will never get back its lost ground. In fact, the existing information regarding the best use of wood in relation to service requirements has not even been compiled, much less made available to either the consumer or the lumbermen themselves. Much prejudice against wood exists because its merits have not been convincingly presented, its uses wisely advocated, nor its availability explained. This lack of knowledge has been increased and misconceptions created by the active propaganda for other materials which in many cases are not as economical or desirable as wood.

Profitable Town Forest

Forbach, Germany, is said to have the most profitable town forest known; it yields an annual net gain of \$12.14 an acre.

FOREST FIRE LOSSES, \$677,816.

Fire on the National Forests of the West in 1914 caused a loss to the Government of not quite 340,000,000 board feet of merchantable timber, valued at \$307,303, and of reproduction, or young growth of trees, valued at \$192,408, according to statistics just compiled by the Forest Service. There were 6,605 fires, of which only 1,545 burned over an area of ten acres or more. About 77 per cent of all the fires did damage of less than \$100 each. In addition to the losses suffered by the Government, timber on State and private lands within the forests, totaling 228,008,000 board feet and valued at \$175,302, was lost. The total area burned over was 690,240 acres, of which 310,583 acres were State and private lands.

Notwithstanding that it was an exceptionally bad year for fires, on account

of high temperatures, heavy winds, and prolonged drought, the average loss per fire was \$103, as against \$131 in 1911, when there were only about half as many fires. Eighty-five per cent of the total loss was caused by fires in Idaho, Montana, Oregon, and Washington, where more than half the timber in all the National Forests stands. Less than one-tenth of 1 per cent of this timber was affected. Of the 6,605 fires reported, 3,691, or 55.9 per cent, occurred in these States, and of the ninety-nine fires causing losses of more than \$1,000 each, eighty-one were in this region.

Lightning was the chief cause, starting 2,032 fires; campers came next with 1,126, followed closely by railroad locomotives, with 1,110. Incendiaries lighted 470 and the rest were attributed to brush burning, sawmills, etc., or their origin was unknown.

COYOTES SPREAD HYDROPHOBIA

THE spreading of rabies by infected coyotes among cattle grazing in the National Forests has assumed a grave aspect, according to a report received by the Forest Service from the district forester in charge of the forests in Washington and Oregon. Numerous townships in eastern Oregon, it is reported, have ordered that all dogs be muzzled lest

those that have been bitten by rabid coyotes develop hydrophobia and attack humans or domestic animals.

Efforts are being made by the State authorities of Oregon to stop the spread of hydrophobia by this means and officers of the Forest Service are cooperating in attempts to kill off the coyotes. In one county alone a loss of 300 head of cattle is charged to rabid coyotes.

Changes of Address

Members of the American Forestry Association are requested to send notification of any change in address so that the AMERICAN FORESTRY Magazine and other mail will not be delayed in reaching them.

Such notices are desired before the 25th of each month so that the address may be changed for the monthly mailing of the magazine.



EDITORIAL

A DANGER SIGNAL FOR WISCONSIN

THE committee of eight appointed by the legislature of Wisconsin to investigate and report to that body upon the advisability of continuing the policy of State forest reserves in Northeastern Wisconsin, has made a very dangerous recommendation, in proposing the abolition of the present Forestry Board and consolidation of the forestry work with fish and game protection.

The committee approves the previous work of the State Forestry Commission and recommends the continuance of the reserves, and a careful soil survey to more effectively carry out the present policy of disposing of agricultural lands to actual settlers, and purchasing more lands unfit for farming. Their findings are based upon extensive research into the present practice of forestry in Eastern States, and a thorough examination of the State reserves.

But the bill which the committee proposes under which to continue its work, abolishes the non-political forestry board, under which these results have been attained, and places the office of State Forester in the hands of the Governor and Senate as a political appointment. The proposed measure presents in its worst form the doubtful plan of combining the work of enforcing the State fish and game laws with that of administering the forest reserves—a plan which has failed of effectiveness under trial in several States, and has tended to loss of efficiency and interest in forestry on the part of the commission.

The proposed bill provides for a commission of three, one to be State Game Warden, the second, State Forester and the third an engineer. These men have joint, not separate, authority, by the terms proposed, and in the absence of one member—who might happen to be the forester—the other two are given authority to pass upon all measures touching forestry. The forester likewise is required to know about and pass upon fish and game business, conservation and all the affairs of this Conservation Commission. These men are solely responsible, with no board to consult or to advise them. The law as proposed makes no change in the present system of appointing the State Game Warden, but merely extends his authority to include a supervision over forestry as well. What it *does* do is to wipe out the present efficient and unpaid forestry commission, make the forester's office a party plum, and burden the forester with duties wholly outside his professional scope.

The proposed consolidation is urged in the interest of economy. Wherein will this economy be effected? The Forestry Board incurs but trivial expenses for travel. The salary of the forester remains practically the same, but his efficiency will be greatly lowered by multiplicity of duties. The clerical force required to do the necessary office work connected with forestry will not be diminished by the consolidation, for we must assume that no more clerks are

employed now than will suffice to do the work.

The worst feature of this proposed bill is the situation which it creates with regard to the division of appropriations for the work of the commission. Even if these were made separately for the different classes of undertakings, they must be recommended by a triple-headed commission, whose individual interests lie along wholly separate lines. What is given to forestry may be looked on as taken from game and fish protection, and vice versa.

Governor Whitman, of New York, in his recent message, stated: "The work of the divisions of forestry, and of fish and game, must be kept entirely separate" and in this State, so often quoted as a model in recommending the consolidation of forestry with fish and game, the two classes of work maintain entirely distinct sets of wardens, overlapping in the same territory. They have *never* attempted to combine the field work of fish and game wardens with that of a forest fire warden; and those who are familiar with conditions in our wooded regions will readily understand the necessity of keeping these two kinds of State work entirely distinct in the minds of the settlers and public. We believe that the economy urged as a reason for this consolidation cannot be demonstrated. It may be that Wisconsin does not need her present form of separate conservation commission nor a separate State Park Board. But to make the consolidation of these boards a reason for combining forestry with fish and game protection will result inevitably, as it has elsewhere, in greatly

lessening the efficiency of forestry work in the State.

Have the citizens of Wisconsin any complaint to urge against the present form of State forestry commission, that they will stand by and see it abolished? Minnesota is expending \$75,000 annually, in forest fire protection, under a similar board. Oregon recently abandoned the plan of combining forest fire protection with fish and game protection and created a separate forestry board similar in character to the one which Wisconsin legislators propose to do away with. Oregon took this step to secure efficiency. Which State is right?

One thing is certain. The present form of separate, non-political control of forestry in Wisconsin has been demonstrated to be the best existing plan to secure the desired progress in forestry, and to this statement a dozen States bear witness, namely, New Hampshire, Vermont, Massachusetts, Connecticut, Pennsylvania, New Jersey, Delaware, North Carolina, Kentucky, Tennessee, Minnesota and Oregon. The proposed consolidation is discredited and has failed in the States of Oregon, Kentucky and Alabama, and has given very unsatisfactory results in Michigan and Louisiana.

It is for the people of Wisconsin to choose. They are at the parting of the ways. So clearly is the issue presented that the American Forestry Association has incorporated in its platform a plank calling for the maintenance of non-political, departmentally independent State forestry boards as of the first importance in State forestry.

WORDS OF WISDOM

ALLENTOWN, one of the most progressive of Pennsylvania cities, is ignoring the most important subject of the preservation and increase of the shade trees on her streets. The *Chronicle and News* of that city editorially sounds the following warning:

"Rather than encouraging by non-action the demolition of the city's

fine shade trees on some of the older streets, Allentown should have from fifty to one hundred thousand noble, beautiful trees upon her streets and open places, and she would have them had we, in time, placed their planting, trimming, care and maintenance under public, expert control, as has been done in the most progressive and wideawake cities of the world. As it

is there is doubt as to whether we are as well provided with trees, in proportion to our population, as we were fifty years ago.

"We ought not to delay a single day longer than is necessary to pass the requisite legislation, to place all the trees upon the streets under municipal control. A thousand examples showing the wisdom of doing so might be cited. It is the only sensible and the only business way. The streets are a part of the beauty and comfort of our highways, and it is just as necessary that they should be subject to public authority as the sidewalks, the paving and the curbing. We will never realize the great advantage of trees to a city until we take this step.

"Even now the tree butcher is starting upon his annual rounds, and in the absence of any public control, in the next few weeks, he will mar and maim and disfigure and kill thousands of trees that might otherwise grow and spread their branches, furnish grateful

shade and beautify the city. He knows nothing about trees, their growth and maintenance. He simply hacks away at random and in ninety-nine cases out of a hundred he disfigures the tree, stunts and distorts it and dooms it to a lingering death. To prove this, the pedestrian upon our streets only needs to cast his eye aloft to see how more than half the trees have been mistreated and tortured out of all normal resemblance of arboreal health and symmetry."

These are words of wisdom. Far too few people realize that shade trees have a value beyond that of giving shade and adding attractiveness to a street. They also increase the value of real estate. It is conservatively estimated that each shade tree increases property values at the rate of \$20.00 a tree. Therefore if Allentown acquired 100,000 trees as advised by the *Chronicle and News* her real estate values would increase approximately two million dollars. Yet how does this appeal to property owners?

COURT ORDERS FORESTRY PRACTICED

THE Supreme Court of Maine in a recent decision practically insists upon the practice of forestry in the administration of trust estates, a provision calculated to get the greatest value possible out of sections of such estates as are best suited for the production of timber.

The decision was in the case of an estate of "wild lands," held in trust for the production of salable timber, but no directions were given by the

testator as to how the lands were to be operated. The Court by Chief Justice Savage therefore directed the trustee "to operate the timberland according to the precepts of good forestry, and not so as to reduce the quantity of available timber below what it was at the commencement of the trust."

Such a decision cannot be too strongly commended to the attention of the courts of other States and to trustees of estates bearing timber land.

THE CANADIAN DEPARTMENT

By ELLWOOD WILSON

January was a busy month in forestry circles. The most important event was the meeting of the Conservation Commission held in Ottawa on the nineteenth of January at which Sir Clifford Sifton, the Chairman, presided. Very interesting papers were read on mineral resources, water power development, town planning and other important topics. Sir Clifford Sifton in his opening address gave a résumé of the Commission's activities during the past year and of the general forestry situation. The fire season of 1914 was the worst since 1910

and had it not been for the fire protective associations established during the last three years the loss might have reached the proportions of a National disaster. While the results show that these organizations are effective, more money needs to be spent by them. This should not be looked on in the light of an expense but as an investment which will pay high dividends in the future.

The inventory begun in 1913 by the Commission has been continued and goes to show that the resources of Canada in timber have

been much over-estimated and that an intelligent stock taking is essential for the development of rational plans for conservation and proper use. In British Columbia during 1913-14 data have been collected over 200,000 square miles at an average cost of 6 cents per acre. This low cost is explained by the fact that the British Columbia Government had at great cost already collected a good part of the data, as had also the Dominion Forestry Branch, Canadian Pacific Forestry Branch, and many Limit Holders. It is hoped that one more year's work and the report on the resources of British Columbia will be completed, and will give land classifications, forest regions, silvicultural types and range of principal tree species.

In Saskatchewan about 60,000 square miles have been covered and another year will about complete the work. So far the investigations show that the total amount of spruce in the timber limit belt is discouragingly small. Fire is largely responsible for this and better protection is urgently needed.

While the figures thus far obtained are only rough approximations, they show clearly the depleted condition of the forests which beyond a doubt is due to fires set by the white man, who found many times the present stand of timber.

Investigations were made by Dr. C. D. Howe, of the Faculty of Forestry of the University of Toronto, in cooperation with the British Columbia Forest Branch, of the conditions under which the reproduction of commercial tree species occurs most advantageously in the coastal region. The report shows that nature unaided will not satisfactorily replace forests on cut-over and burnt-over lands. Also that the burning of the logging slash not only reduces the fire hazard, but by exposing the mineral soil favors the reproduction of Douglas fir. Where sufficient seed trees are left after cutting, succeeding forest fires gradually reduce their number until there are not enough to restock the forest by natural means.

The steady improvement in Railway Fire Protection is a source for great congratulation. All the Provinces with the exception of Nova Scotia are cooperating with the Railway Commission and this Province is still much behind the times. Many provincially chartered roads have been brought under the jurisdiction of the Railway Board and this will materially improve the situation during the coming season. The Government-owned railways are still a source of danger, and it is to be hoped that they will come into line. The Department of Land and Forests of Ontario in cooperation with the Grand Trunk Railway have done an especially creditable piece of work in cleaning up the right-of-way through The Algonquin Park and thus reducing the fire hazard. This last season there were many fires there. The Department of Indian Affairs has also cooperated with the Canadian Pacific in cleaning up the right-of-way through the Shawanaga Reserve.

An anomalous situation still exists in the Dominion Forests Lands administration. The reserves are all under the Forestry Branch

which has a fine staff of trained men, but the lands for which licenses to cut have been granted, although situated in the Reserves, are handled by the Timber and Grazing Branch which has not one trained forester in its employ.

The situation in Ontario still needs improvement. There are many millions of acres of cut-over or burned-over lands in this Province which are now practically without fire protection, but which contain a great deal of young growth and much timber at present below merchantable size, but which if protected from fire would ultimately become merchantable. The present annual revenue is about \$2,000,000 from woods and forests and if this is to be maintained new areas must continually be opened up for lumbering and this of necessity means the protection of these lands or else when they are wanted there will be no timber on them. At present large future revenues are being sacrificed in order to keep down present expenses and show a surplus. This is mostly due to a popular demand but is a ruinous policy, and the situation might be met by setting aside each year definite areas to be protected which seem most certain to become well stocked with timber. Also the question of watershed must be considered, for Ontario is very dependent on her water powers.

The question of the Trent Watershed is of vital importance. Most of this watershed is non-agricultural land and chiefly valuable for forestry purposes. On account of financial considerations it is necessary to protect more valuable lands in other parts of the Province, but as the Trent Canal is dependent on this watershed for its success and the Dominion Government has spent some \$10,000,000 on this project its protection is of vital importance, and it is believed that under the circumstances the Dominion Government would be amply justified in protecting this Territory in order to safeguard the investment already made and future expenditures. In order to do this some arrangement could be made with the Province of Ontario and this area turned over to the Dominion Forestry Branch.

Mr. R. H. Campbell, Dominion Director of Forestry, spoke on the forest fire situation during 1914, contrasting it with the season of 1910, when the conditions were very similar. There was more damage in the former than in the latter but this was due to two fires which caused four-fifths of the damage and which occurred in such an out of the way locality in the mountains that it was practically impossible to reach them. There has been a great improvement in permanent works on the Dominion Reserves, there being now some 300 miles of roads, 1,249 miles of trails, 500 miles of plowed fire-guards, 400 miles of cut fire lines and 200 miles of telephone lines. The system of look-out towers has proved of the greatest value and they are being constructed not only in the Reserves but on high points outside. They now number eighteen. Rangers now have cabins so that they are always near their work. The railways have improved very greatly and the situation in regard to railway fires is well on the way to efficiency. There is one notable exception, The Edmonton, Dunegan & Peace

River Railway Company which entirely ignored the Railway Commission's instructions. Their locomotives were defective, their section men hostile, they even set fire to a large tract of country to protect a pile of ties. Two hundred and fifty fires—more than half the total number reported—were set by them. They were, however, summoned before the Board and the officers were told that they ought to be in the penitentiary and were threatened with drastic measures if they did not obey the law this coming season. In conclusion Mr. Campbell stated three things which were necessary for an adequate forest policy for Canada.

1. The development of the forest reserve policy until all non-agricultural lands are included and the completion of the system of effective protection.

2. Teaching the value of the forest from the business point of view.

3. Statutory enactment to insure permanency of tenure of office for men engaged in the Dominion forestry work so that a proper spirit of public service may be infused and maintained.

Mr. Piché, Chief Forester of Quebec, outlined the Quebec Forest Service work and of the Forestry School conducted in cooperation with Laval University.

He paid a well-deserved tribute to the work of his colleague, Mr. W. C. J. Hall, who has charge of Forest Fire Protection, and who, with a very small appropriation, has done most excellent work.

Mr. MacMillan, Chief Forester of British Columbia; Dr. B. E. Fernow, of the University of Toronto; and Mr. MacTier, Head of the operating Department of the Canadian Pacific R. R. of Toronto, read interesting and valuable papers.

The meeting of the Canadian Forestry Association was held in the Carnegie Library on the evening of the nineteenth of January. Officers were elected and routine business transacted. Only one resolution of importance was passed,

i. e., to ask the Minister of Railways to adopt the same regulations on the Intercolonial, National Transcontinental and International Railways, all owned by the Dominion Government, as those already adopted by the Railway Commission for the privately owned and Provincially chartered railways.

The Secretary who has served the Association faithfully for six years, Mr. James Lawler, resigned to accept a position with the Dominion Forest Service.

A very interesting meeting of the Canadian Society and a dinner were held on the evening of the twentieth of February with quite a large attendance. The constitution was consolidated and amended and it was decided to incorporate the Society. This Society is growing in numbers and importance and now has seventy-two members many of whom are in the van of progressive forestry work. The general discussions and informal talks were most enjoyable, and their tone shows how this body of men stands for progress and efficiency and for the development of the highest standard of professional achievement. Its influence is being widely felt.

The Forest Products' Laboratories of the Dominion Government are rapidly getting into shape and have already issued two very interesting Bulletins describing the work to be undertaken and "Chemical Methods for Utilizing Wood Wastes."

The St. Maurice Forest Protective Association held its third annual meeting at Three Rivers, Quebec, on Friday, the twelfth of February. Its annual report was a model of careful work and gave a large fund of information on fire protection. In this connection it might be noted that the figures for areas burned over on the Territory controlled by this Association were given as 814,468 acres, but should have been only 81,446 acres.

WITH THE FORESTERS

W. A. MacDonald, of The New York State College of Forestry at Syracuse University, has left for San Francisco where he will have charge of the exhibits of the College. The large cabinet illustrating various phases of wood utilization has been shipped.

The Forest Supervisors recently made up their allotment estimates for the fiscal year. In this connection the following interesting as well as self-explanatory communication has been submitted by the Supervisor of the Shoshone Forest.

DISTRICT FORESTER RILEY,
Denver, Colorado.

"Will you please make some changes in my allotment estimate. I would like to have Statutory Salaries increased by \$1200 to take

care of the salary of new man for the Forest. He is not very big yet, having arrived last evening, but he is a dinger and well worth the salary.

"Buckner of Accounts suggests that I increase Forage allotment also; this should be Forage (in terms of milk) increased by \$50.

"He weighs only 7½ pounds but will surely take this much."

The Dendrological Department of the New York State College of Forestry is getting out a collection of native woods for distribution among the High Schools of the State. A set will comprise 35 species and 1,000 sets will be ready for distribution in the near future. Each specimen is to be 3 inches by 4 inches by ½ inch and will bear a label giving the names and general range of the species. A pamphlet

will accompany each set giving additional information on the structure and properties of the wood.

Syracuse and vicinity is the center of the Basket Willow industry of the United States. Not only is a greater acreage devoted to the production of ozers for this purpose here than in any other section, but practically the entire output is converted into the different lines of wicker ware manufactured by local concerns.

The New York State College of Forestry at Syracuse University has its own experimental holt where it is testing the different varieties under different conditions of growth to determine best methods of culture. It also follows the different species through the process of manufacture to determine which is best adapted for particular purposes.

The New York State Conservation Commission has recently added to its list of State Foresters Benson Howard Paul of Berrybrook, N. Y., a graduate of Cornell University. Mr. Paul has been enrolled as a professional student in the Department of Forestry in the New York State College of Agriculture at Cornell. He received his degree of Bachelor of Science in 1913 and for the past year has

been doing graduate work in that department. The notice that he had successfully passed his Civil Service examination came to him the day following his final examination in the Department of Forestry that will give him his degree of Master in Forestry. During the past summer Mr. Paul has been making a careful survey of typical forest plantations in different parts of the State. His report on this work, which constitutes his thesis for the Master's Degree, is entitled "An Ecological Study of Typical Forest Plantations in New York State."

The Madison, Wisconsin, State Journal of February 21st publishes the following:—Edward N. Griffith, State Forester, promised his resignation from that office at the end of the present session of the Legislature, before the Legislative Committee investigating Commissions and Boards yesterday afternoon. During the session of the Committee the reforestation program was attacked by several legislators, among them B. N. Moran. The recent decision of the Supreme Court, adverse to the work of the Forestry Board together with difficulties encountered in carrying out the work in the Northern part of the State, is thought to have determined Mr. Griffith to announce his resignation. He has been with the State for ten years.

FOREST NOTES

The possibility of a dangerous spring and summer fire season in the National Forests in the West is presaged by reports that two forest fires occurred in January and that the snowfall in much of the Rocky Mountain region and in the foothills has been much below normal. January fires are almost unheard of in the National Forests and the snow reports are regarded as especially significant as they indicate that unless the deficiency is made up the forests will be dry earlier in the Spring than usual, with a consequent increase of the fire menace. The fires occurred in the Pike Forest, in Colorado, and the Black Hills Forest, in South Dakota, the latter believed to have been of incendiary origin, according to the District Forester at Denver. About 75 acres was burned over all told. They were the only National Forest fires reported for January. The District Forester at Ogden, Utah, in charge of the National Forests in Nevada, Utah, and Southern Idaho, reported that the snow in this region also is far below normal.

A study of the effects upon seeds and roots of disinfectants used to prevent the damping off disease has just been published by the U. S. Department of Agriculture as a professional paper under the title of "Injury by Disinfectants to Seeds and Roots in Sandy Soils." Experiments show that the use of sulphuric, hydrochloric, and nitric acids, or of copper

sulphate, will not injure dormant pine seed, but in some soils will kill the root tips of germinating seedlings immediately after germination. In consequence these disinfectants can only be employed by persons able to recognize and prevent such injury. Injury to pine seedlings can be prevented by very frequent watering during the germinating period. This watering does not prevent the killing of annual weeds in seed beds treated with these disinfectants. The addition of lime to the soil shortly after it has been treated with the acid prevents injury to both pine and weed seedlings. The use of lime is not desirable in the case of pine, but may result in making possible the use of acid as a disinfectant for truck crop seed beds. Formaldehyde and mercuric chloride must be used several days before seed sowing if at all.

Those familiar with the eastern mistletoe only have no idea of the great losses due to this parasite in the forests of the west, where it counts next to fire and insects in the amount of damage done.

In parts of the west where trees are scarce, sage brush is used for fuel. In Nevada the large main stems are trimmed by Indians at \$3 a cord and delivered to the user at about \$6.50. Sage brush burns rapidly and is rather dirty, but produces good heat.

The report which prevailed for some time that Dr. C. A. Schenck, former head of the Biltmore School, had been killed while serving in the German army is fortunately without verification. The last news of him received in this country came from Mrs. Schenck who wrote that on December 18 he was alive and well. He was then and for some weeks had been serving with the German army in Poland.

The farm woodlot is in more ways than one the balance wheel of the farm. It may easily be so located as to protect the home buildings against wind and at the same time furnish supplies of domestic timber, thereby keeping horses and men busy during the idle seasons of the year. It may also be one of the most attractive playgrounds on the farm. The New York State College of Forestry at Syracuse is helping to solve the problem of marketing the farm woodlot by developing cooperative marketing of the woodlots of an entire community. Woodlots should be marketed by the carload, not by the single tree.

Of the 503 fires reported by the forest service as having occurred in 1914 on the national forest purchase areas in the White Mountains of New England and the southern Appalachians 319, or 60 per cent, were caused by sparks from locomotives. More than half of these fires, or 272, occurred in Virginia alone, and of these 227 were from locomotive sparks.

Three hundred and seventy-nine of the fires were confined to areas of less than ten acres each, and 296 were extinguished before one-quarter of an acre had been burned. The total loss amounted to \$2,192 and the cost of fire-fighting to \$1,300, an infinitesimal sum compared with the value of the timber and reproduction protected. As the areas swept by fire were mostly cut-over, the greater part of the damage was suffered by young growth.

In a recent study of forest plantations in New York State by Mr. B. H. Paul, a graduate student of Cornell, some interesting figures on yield were secured as follows:—1. *White pine (small per cent other species) 44 years old, 38,000 feet, B. M. 2. *Norway spruce and Scotch pine, 40 years old, 26,000 feet, B. M. 3. *Scotch pine, 35 years old, 27,000 feet, B. M. 4. †White pine, 31 years old, 18,500 feet, B. M. 5. *White pine, 28 years old, 24,000 feet, B. M. 6. †Scotch pine and European larch, 25 years old, 13,000 feet, B. M. 7. †Norway spruce, 22 years old, 10,000 feet, B. M.

* First quality site.

† Third quality site.

By timely and proper use of the right timber in the Adirondacks and Catskills, the State of New York can save annually from destruction by fire, insects and fungi millions of feet of lumber. Ninety per cent of the forest fires in the forests and woodlots of the State are preventable.

The scientific nut grower pins his faith on the hybrid nuts of man's making in the future. The natural hybrid nuts are commoner than one would suppose. Several have been sent in to the competition for nuts that has just been concluded by the Northern Nut Growers Association. Many of these are merely curiosities but some are of great promise. A shagbark-bitternut cross is one of these and a shellbark-pecan cross another. There was also a shagbark-pecan hybrid and one between the pignut and the pecan. These are all natural accidents but the results from man's purposive crossings should far surpass them. Mr. Risien of Texas has already had good results with pecans, as also has Dr. Van Fleet of the U. S. Department of Agriculture with chestnuts, and the results of the experiments of Dr. Morris of New York with hickories and other nuts are expectantly awaited. For results with these things must be waited for. In the American Nut Journal for next month will appear an article on natural hickory hybrids, by John Dunbar, Assistant Superintendent of the Rochester, N. Y., Park Department.

The New York State College of Forestry at Syracuse University is urging the Municipalities of the State to take up public control of street tree planting and preservation in the same manner as public control is exercised over other street improvements. During the past year the College has made investigation of the shade trees in many cities and towns of the State including New York City, Syracuse, Binghamton, Amsterdam, Mount Vernon, Newburgh and Olean. It has been found that thousands of shade trees are dying along the streets of the cities due to past mistake in selection of varieties and in spacing the trees at the time of planting which has forced the trees to grow with weakened vitality inviting decay by tree diseases and by the attacks of insect pests. There is a great need for systematic work in planting trees to replace those that have failed to fill in the many unplanted areas along city streets. It has been estimated that within the cities of the State there are 20,000 miles of streets capable of sustaining a growth of 5,000,000 shade trees which can be made worth \$100,000,000 in increased property value.

Land clearing is usually considered a warm weather proposition, April and September being the most popular periods, but the introduction of low freezing explosives now makes it possible to blast stumps in March and in early winter. In any weather in which it is feasible to bore the holes under the stumps these modern explosives work well without thawing. This point is of particular importance right now because there never has been a time when land clearing was more desirable than at present. By clearing cut-over land in March it is possible to seed it this coming spring and get a big crop off this virgin soil during 1915, and the low freezing explosives make March blasting feasible.

The Seniors in Forestry at The Pennsylvania State College have just returned from their two weeks' lumbering trip to Saginaw and Cadillac, Michigan. Professor R. R. Chaffee was in charge of the party and it was one of the most successful ever undertaken by the Department of Forestry. The lumbermen in Cadillac and the manufacturers in Saginaw did much to make the trip highly profitable and educational. Much credit is due Mr. J. C. Knox, Secretary of the Michigan Hardwood Association and the Cummer Diggins Company for the success of the trip.

The Indiana State Board of Forestry desires that all the schools of Indiana be given an opportunity to study forestry, as this will lead to a better conservation of our remaining forests and to the establishment of new plantings on non-agricultural lands by the succeeding generations.

The Board offers \$40 in prizes as follows: For essays on "Forestry in Indiana:" \$12.50 is to be given for the best essay and \$7.50 for the second best essay by pupils in the high schools of the State. Also \$12.50 is to be given for the best essay and \$7.50 for the second best essay by pupils in the grades and country schools.

The essay must be written in ink on good white paper and is not to exceed 2,000 words. It must be mailed to Elijah A. Gladden, Secretary of the State Board of Forestry, Indianapolis, Ind., not later than May 1, 1915.

The New York State Ranger School maintains

a policy of teaching men to do things by letting them do it as a part of their training. With this purpose in view a fully equipped blacksmith shop has been installed at the School, and in it the men are taught not only how to make tools and handle iron and steel, but do a sufficient amount of this kind of work to teach them general handiness with the tools that are found in the shop. To understand the reason for this departure from the set curriculum of forest schools, it must be understood that these students are being trained for usefulness in lumber camps, and logging operations, and that the blacksmith shop is a feature of every logging camp.

At the recent meeting of the Board of Governors of The National Lumber Manufacturers' Association in Chicago the following resolution was unanimously adopted regarding the resignation of Secretary J. E. Rhodes on January 1, 1915:

"RESOLVED that while it is with a unanimous sentiment of regret that we have accepted the resignation of Secretary Rhodes, we do so because we realize the importance to the lumber industry of the country of an efficient organization of the Yellow Pine manufacturers, and knowing as we do, that no one else is perhaps so well fitted to develop and perfect such an organization as Mr. Rhodes, we wish him the utmost success in his new undertaking, and in behalf of The National Lumber Manufacturers' Association, stand ready to promote in every way possible, the work of the Southern Pine Association."

BOOKS RECEIVED

THE EARTH: ITS LIFE AND DEATH, by A. Berget, Professor at the Institut Océanographique. (G. P. Putnam's Sons, New York, \$1.75.)

Professor Berget describes the various phenomena that go to make up the life of the world and those earlier phenomena which have marked its growth and evolution, after which, by way of an epilogue to a story of intense fascination, he permits us to witness the death of the globe, that final inevitability which the earth, like the individual, faces, notwithstanding its present abundant vitality.

The titles of some of the chapters will indicate the character of the volume: "The Birth of the Earth;" "The Age of the Earth;" "The Form, Magnitude, and Mass of the Earth;" "The Movements of the Earth;" "Rhythmic Movements of the Crust of the Earth;" "The Force of Gravity;" "Sudden Movements of the Crust;" "The Circulation of the Earth, Marine and Atmospheric;" "The Attack and the Defense of the Continents;" "Old Age and Death of the Earth."

VERTICAL FARMING, by Gilbert Ellis Bailey, Professor of Geology, University Southern

California. (Dupont Powder Co., Wilmington, Del.)

This book is quite as interesting as its title, which indicates the nature of its contents. Dr. Bailey believes the time has come for the farmer to extend his study and effort to greater depths in the soil than are reached by the usual agricultural implements, and he sustains his point of view very ably with arguments showing the latent fertility of the subsoil and its capacity for storing moisture, once it has been disturbed, to a depth of five or six feet by the use of explosives. Dr. Bailey also argues that blasting the subsoil is but a logical extension of the theory of cultivation. Incidentally, the book contains a very thorough and well illustrated discussion of the origin of soils which is well worth reading. The increase in use of subsoil plows, deep tillage machinery and the explosives for breaking up resistant and impervious subsoil, indicates that many progressive farmers will agree with Dr. Bailey's opinions, and now that the price of all food crops is so high, farmers in general are interested in any means for increasing crop productions. The book is distributed without charge and is certainly well worth sending for.

CURRENT LITERATURE

MONTHLY LIST FOR FEBRUARY, 1915

(Books and periodicals indexed in the Library of the United States Forest Service.)

Forestry as a Whole

Proceedings and reports of associations, forest officers, etc.

- East Indies (Dutch)—Dienst van het boschwezen. Verslag over het jaar 1913. 153 p. pl. Weltevreden, 1914.
- India—Forest dept. Annual return of statistics relating to forest administration in British India, 1912-13. 27 p. diagr. Simla, 1914.
- Maine—Forest commission. Tenth report, 1913-14. 165 p. pl. Augusta, 1914.
- Ohio—Agricultural Experiment station. Sixth annual report on forestry operations. 14 p. Wooster, O., 1914. (Bulletin 276.)
- Oregon—State board of forestry. Fourth annual report of the state forester, 1914. 63 p. il. Salem, Ore., 1915.
- Royal Scottish arboricultural society. Transactions, vol. 29, pt. 1. 128 p. il., pl. Edinburgh, 1915.
- Sociedad forestal Argentina. Boletin, v. 2, no. 6-7. 16 p. Buenos Aires, 1914.
- Western forestry and conservation association. Proceedings, 1914. 34 p. il. Portland, Ore., 1914.

Forest Aesthetics

Street and park trees

- Stone, George E. Electrical injuries to trees. 19 p. il. pl. Amherst, Mass., 1914. (Mass.-Agri. experiment station. Bulletin 156.)
- Tree planting association of New York City. Report on the condition of the street trees of the city of New York. 28 p. il. Syracuse, N. Y. State college of forestry, 1914.

Forest Legislation

- Wisconsin—Legislature—Special legislative committee on forestry. Report made to the members of the 1915 session of the Wisconsin legislature. 77 p. pl. Madison, Wis., 1915.

Forest Botany

Trees, classification and description

- Bean, William Joseph. Trees and shrubs hardy in the British Isles. v. 1-2, il., pl. London, 1914.
- Illick, J. S. Pennsylvania trees. 231 p. pl. Harrisburg, Pa., 1914. (Pennsylvania—Department of forestry. Bulletin no. 11.)

Silvics

Studies of species

- Frothingham, Earle H. The eastern hemlock.

43 p. pl. Wash., D. C., 1915. (U. S.—Dept. of agriculture. Bulletin 152.)

- Mason, D. T. The life history of lodgepole pine in the Rocky Mts. 35 p. pl. Wash., D. C., 1915. (U. S.—Dept. of agriculture. Bulletin 154.)

Silviculture

Planting

- Tillotson, C. R. Forest planting in the eastern United States. 38 p. pl. Wash., D. C., 1915. (U. S.—Dept. of agriculture. Bulletin 153.)

Forest Protection

Fire

- Coeur d'Alene timber protective association. Ninth annual report, 1914. 24 p. il. Spokane, Wash., 1914.
- North Carolina—Geological and economic survey. Forest fire protection demanded by the thinking public; opinions of representative men as expressed at the convention of the North Carolina forestry association. 6p. Chapel Hill, N. C., 1915. (Press bulletin 139.)
- Potlatch timber protective association. Annual report, 1914. 44 p. Potlatch, Idaho, 1914.
- Washington forest fire association. Seventh annual report, 1914. 19 p. Seattle, 1914.
- Western forestry and conservation association. Why are forest fires more numerous now than formerly? History of the age-old struggle by Pacific northwest forests. 4 p. Portland, Ore., 1914.

Forest Management

Forest valuation and finance

- Chapman, Hermann Haupt. Forest valuation. 310 p. N. Y., J. Wiley & Sons, 1915.

Forest Economics

Taxation and Tariff

- Idaho—Tax commission. First biennial report 1913-14. 112 p. Boise, Idaho, 1914.

Statistics

- Philippine Islands—Bureau of forestry. Forest resources of the Philippines. 10 p. map. Manila, P. I., 1914.
- Pratt, Joseph Hyde. What the forests of North Carolina mean to her citizens and why they should be preserved. 5 p. Chapel Hill, N. C., 1915. (N. C.—Geological and economic survey. Press bulletin 140.)

Forest Administration

- United States—Dept. of agriculture—Forest service. January field program, 1915. 28 p. Wash., D. C., 1915

National and state forests

North Carolina—Geological and economic survey. Mount Mitchell state forest; opinions of representative men as expressed at the convention of the North Carolina forestry association. 5 p. Chapel Hill, N. C., 1915. (Press bulletin 138.)

Forest Utilization*Lumber industry*

Lumbermen's credit association. Reference book, Feb. 1915. Chicago and New York, 1915.

National lumber manufacturers' association. Official report, 12th annual convention. 190 p. Chicago, 1914.

Switzerland—L'inspection fédérale des forêts. Produktion und verbrauch von nutzholz: B—Der verbrauch. 166 p. maps. Zürich, 1914. (Schweizerische forstatistik, 4. lieferung.)

Forest by-products

Smythies, E. A. The resin industry in Kumaon. 14 p. pl. Calcutta, 1914. (India—Forest dept. Forest bulletin no 26.)

Wood preservation

Dominion paving and contracting co. Peerless carbolite carbolineum wood preservative. 16 p. Toronto, Ont., 1914.

Weiss, Howard F. The preservation of structural timber. 312 p. il., pl. N. Y., McGraw-Hill book co., 1915.

Auxiliary Subjects*Natural resources*

Louisiana—Conservation commission. The more important and conspicuous mammals, birds and fish of Louisiana, together with a list of the principal trees of the state. 31 p. New Orleans, 1914.

Botany

Harper, Roland M. Geography and vegetation of northern Florida. 289 p. pl. Tallahassee, Fla., State geological survey, 1914.

Engineering

Hatt, W. H. Flood protection in Indiana. 51 p., incl. maps. Indianapolis, 1914. (Indiana—Bureau of legislative information. Bulletin no. 4.)

Periodical Articles*Miscellaneous periodicals*

American botanist, Nov. 1914.—The mistletoe, by Willard N. Clute, p. 121-4; Eucalyptus vs. sequoia, p. 154-5.

Bulletin of the Torrey botanical club, Dec. 1914.—The correct name for the hemlock spruce, by Oliver A. Farwell, p. 621-9.

Bulletin of the Torrey botanical club, January, 1915.—Phytogeographical notes on the Rocky Mt. region; 4. Forests of the subalpine and montane zones, by P. A. Rydberg, p. 11-25.

Country gentleman, Jan. 16, 1915.—A disappearing tree; how to meet the loss of the chestnut, by P. L. Buttrick, p. 104.

Country gentleman, Jan. 30, 1915.—Making money out of moss; it appears on the market as Spanish hair, by Samuel J. Record, p. 192, 194.

Country life in America, Jan. 1915.—The forest fire, by Enos A. Mills, p. 42-5.

Fire prevention news, Jan. 1915.—Bad season for forest fires in the northwest, by Chas. H. Flory, p. 3.

Gardeners' chronicle, Dec. 19, 1914.—Wood used in the manufacture of gunpowder, p. 401-2.

Journal of the Washington academy of science, Jan. 19, 1915.—The place of forestry among natural sciences, by Henry S. Graves, p. 41-57.

Lippincott's, Oct. 1914.—Forestry as a profession, by Gifford Pinchot, p. 501-2.

Outlook, Jan. 20, 1915.—Red tape in Alaska, by Franklin K. Lane, p. 135-40.

Plant world, Jan. 1915.—The relative transpiration of white pine seedlings, by George P. Burns, p. 1-6.

Reclamation record, Jan. 1915.—Tree planting Black feet, Flathead, Fort Peck and Huntley projects, Mont., p. 29-30.

Resources of Tennessee, Jan. 1915.—West Tennessee gullied lands and their reclamation, by R. S. Maddox, p. 8-22.

Scientific American supplement, Dec. 5, 1914.—Musical woods, p. 355; Marine wood borers; little known crustaceans of destructive habits, by Clyde H. Truesdale, p. 356-7.

Scientific American supplement, Dec. 12, 1914.—Spanish cedar; sources of supply of this substitute for mahogany, p. 369, 372-3.

Technology monthly and Harvard engineering journal, Feb., 1915.—Controlling our streams by forestry, by Allen Chamberlain, p. 5-11.

Trade journals and consular reports

American lumberman, Jan. 16, 1915.—A novel wood of many uses; the lowly mesquite one of most important Texas trees and widely utilized, by I. M. Lewis, p. 27; Deductions from strength tests of woods, by J. A. Newlin, p. 32-3; Argentina's export and import trade, by Max Rothkugel, p. 40, 60; Urges branding of structural timbers, by F. E. Davidson, p. 43; Results of investigations of kiln drying, p. 53-4.

American lumberman, January 23, 1915.—Conserving and developing natural resources, by Henry S. Drinker, p. 35.

American lumberman, Jan. 30, 1915.—Plan to save historic trees; insects that destroy Harvard elms under control; proper irrigation all now needed, p. 27; Cost of carrying timberlands and its relation to lumber market, by C. H. Worcester, p. 34, 63-4.

- American lumberman, Feb. 6, 1915.—Conservation of natural resources, by J. B. White, p. 29; Income tax and the lumber industry, by Edwin B. Parker, p. 30-1.
- Canada lumberman, Jan. 15, 1915.—Specifications for kiln-dried lumber, by Harry D. Tiemann, p. 39; Some new kiln-drying thoughts, by Henry Hunter, p. 48.
- Canada lumberman, Feb. 1, 1915.—Ontario production shows a decrease; output of lumber during 1914, p. 36-8; Review of New Brunswick trade in 1914, p. 44-5; Trade of Quebec province during 1914, p. 46-7; Nova Scotia's lumber trade during 1914, p. 48-9; Great Britain trade during 1914, p. 54-5.
- Hardwood record, Jan. 25, 1915.—Problems in southern New England, by S. J. Record, p. 18-19.
- Hardwood record, Feb. 10, 1915.—Some wrong uses of wood, p. 21.
- Logging, Jan. 1915.—World-wide timber movements; a résumé of conditions up to the commencement of the European war, by James Adrian Byrne, p. 25-31.
- Lumber trade journal, Jan. 15, 1915.—The preservation of timber by the use of fluoric salts, by Friedrich Moll, p. 23; Texas forestry association will demand state forestry legislation, p. 30.
- Lumber trade journal, Feb. 1, 1915.—Dry kiln practice conference, Jan. 20, 1915, p. 23-5; Principles of kiln drying lumber, by H. D. Tiemann, p. 30-1; Capt. J. B. White talks to college students on conservation, p. 52-3.
- Mississippi Valley lumberman, Jan. 29, 1915.—Taxation of timber lands, by W. A. Holt, p. 65.
- Packages, Feb. 1915.—World's box shook industry, by J. B. Knapp, p. 28-45.
- Paper, Jan. 13, 1915.—Characteristics of paper-making fibers, p. 17-19, 32.
- Paper, Jan. 20, 1915.—The Müntzing woodpulp digester; details of the production of chemical woodpulp by the Müntzing method, by J. Gustav V. Lang, p. 15-17; Pulp and paper history from Norway; origins, development and present position of the industry interestingly sketched, p. 18-20; American forestry association in session in New York, p. 24-5.
- Pulp and paper magazine, Jan. 1, 1915.—Forest products laboratories of Canada, by John S. Bates, p. 9-11; "Only a scrap of paper," by J. Grove Smith, p. 11-12.
- Pulp and paper magazine, Jan. 15, 1915.—The technology of the common paper-making fibres, by Henry Aldous Bromley, p. 37-41.
- St. Louis lumberman, Feb. 1, 1915.—Treated timber for factory construction, by F. J. Hoxie, p. 30-1; How a log is sawed into lumber, p. 70.
- Southern lumber journal, Jan. 15, 1915.—Economical use of lumber, by E. W. Bright, p. 46.
- Southern lumberman, Jan. 23, 1915.—Cost of production, by F. R. Gadd, p. 39-42; Report on specifications for the purchase and preservation of treatable timber, by the American wood preservers' association, p. 43-5.
- Southern lumberman, Jan. 30, 1915.—Some troubles of the lumber industry, by R. S. Kellogg, p. 37-8.
- Timber trade journal, Jan. 16, 1915.—Forestry as a business, by William Dawson, p. 109-10.
- Timberman, Jan. 1915.—Distributive facilities for lumber provided by New York barge canal, p. 32 F-G.
- United States daily consular report, Jan. 23, 1915.—Honduran lumber trade, by Walter F. Boyle, p. 328-9.
- United States daily consular report, Jan. 26, 1915.—Conditions in Bavarian woodworking industry, by Charles S. Winans, p. 361.
- United States daily consular report, Feb. 1, 1915.—Indian pencil making industry, by Henry D. Baker, p. 444.
- United States daily consular report, Feb. 6, 1915.—Brazilian lumber resources and imports, by Robert Frazer, p. 514-18; American lumber on London markets, p. 523.
- United States daily consular report, Feb. 13, 1915.—Crisis of the German paper industry, by Julius G. Lay, p. 613.
- West Coast lumberman, Jan. 15, 1915.—Sawdust flour worth \$13 a ton, p. 38; Should federal forests underwrite pioneer local improvements?, by Henry S. Graves, p. 44.
- Forest journals*
- Allgemeine forst- und jagd-zeitung, Oct. 1914.—Ueber die wichtigsten volkswirtschaftlichen und rechtlichen Grundlagen der Waldwertrechnung, by Robert Fischer, p. 309-14; Forstliche und jagdliche verhältnisse unserer kolonien, by O. Thyen, p. 314-20; Ueber den streit um die forstlichen reinerträge, by Th. Glaser, p. 320-2; Der plentersaumschlag Wagners im vereinsgebiet, by Schering, p. 332-4.
- Forestry quarterly, Dec. 1914.—A mechanical model of a regulated forest, by O. L. Sponsler and Luebben, p. 511-13; The creation of an ideal, by James B. Berry, p. 514-19; The size of state forests, by J. S. Illick, p. 520-31; Notes on germination and reproduction of longleaf pine in southern Mississippi, by P. L. Buttrick, p. 532-7; Forest planting in New England as an investment, by J. W. Toumey, p. 538-43; Taxation of forests in Massachusetts, by Charles J. Bullock, p. 544-5; Forest taxation and the single tax, by Louis S. Murphy, p. 546-7; Pitfalls of timber bond issues, by Montgomery Rollins, p. 548-58; The problem of food movement in trees, by S. B. Elliott, p. 559-61; An appreciation of Dr. Schenck, by Austin Cary, p. 562-6; Notes on forestry in Russia, by M. Tkatchenko, p. 567-77; Suggestions for forest administration in China, by P. C. King, p. 578-92.
- Forstwissenschaftliches centralblatt, Oct. 1914.—Der weisstanne wesen und verjüngungsweise, by Eberhard, p. 501-8.
- Forstwissenschaftliches centralblatt, Nov. 1914.—Zur ausnutzung des chemischen stand-

AMERICAN FORESTRY'S ADVERTISERS

- ortsfaktors durch waldpflanzen, by H. Bauer, p. 549-78; Der ordentliche fruchtgenuss im niessbrauchwalde, by Siegfried Heun, p. 578-88.
- Indian forester, Dec. 1914.—The Forest research institute buildings, Dehra Dun, p. 557-60; Forest policy, p. 560-70; Note on the method of laying sleepers in England and India, by R. S. Pearson, p. 570-2; Marking standards in the coppice with standards system, by P. S. Govinda Rao and others, p. 573-75.
- Quarterly journal of forestry, Jan. 1915.—Forestry and the war, by Wm. Schlich, p. 1-7; On the mode of infection of larch canker and the possible means of preventing it, by W. E. Hiley, p. 7-17; Average returns from the afforestation of waste lands, by P. Trentham Maw and A. M. Caccia, p. 18-44; Pinus maritima at Knocksboy, Ireland, by A. C. Forbes, p. 44-6; List of trees in Tubney arboretum, p. 79-93.
- Revue des eaux et forêts, Dec. 1, 1914.—Les forêts de l'Alsace-Lorraine, by J. Madelin, p. 512.
- Schweizerische zeitschrift für forstwesen, Nov. 1914.—Chermes der weisstanne und ihr auftreten im Neuenburger Jura, by A. Barbey, p. 277-81; Holzverkehr der Schweiz im jahr 1913, by Decoppet, p. 281-7; Forstliche studiereise nach Deutschland, Juni 1913, by H. Wyss, p. 287-91.
- Tharandter forstliches jahrbuch, 1914.—Natürliche oder künstliche preisbildung bei den gemeinschaftlichen stammholz-massenversteigerungen in Sachsen, by R. Maucke, p. 306-17; Die biologische schädlingbekämpfung und ihre bedeutung für die forstwirtschaft, by Fr. Schwangart, p. 318-45.
- Zeitschrift für forst- und jagdwesen, Nov. 1914.—Betrachtungen über das wesen der waldesschönheit, by Albert Conrad, p. 615-25; Der gemeindewald und die entwicklung der auf ihn anwendung findenden staatsaufsicht, by Carl Baltz, p. 626-38; Anweisung zur edelpilzkultur (Psalliota campestris), by Richard Falck, p. 639-45; Beiträge zur durchforstungsfrage, by Milani, p. 646-54; Blitzschutz des weidviehs, p. 661-2.

FORESTERS ATTENTION

AMERICAN FORESTRY will print free of charge in this column advertisements of foresters wanting positions, or of persons having employment to offer foresters

YOUNG MAN, expert in all branches of shade tree work and with forestry training, desires position as forester, arboriculturist or tree surgeon. References furnished. Address C. S., care AMERICAN FORESTRY.

FORESTER of technical training, six years' teaching and practical experience in different parts of the United States, wishes to better position. Best references from university and employers, and others. Address G. O. T., Care AMERICAN FORESTRY.

FORESTER with 15 years experience Estimating, Surveying, Mapping, and in the care of private holdings desires position. Perfectly reliable in every way, and with executive ability. Address "A," care AMERICAN FORESTRY.

WANTED—By Graduate Forester, position in forestry work in South, or Tropics. Slight knowledge of Spanish and German. Scientific or experimental work preferred. Address, "F. W. H." Care of AMERICAN FORESTRY.

SURVEYOR—For large tracts of land, roads and railroads; furnishes instrument; capable of taking charge of party; would like position in South that will last all winter. Address "T. B. W.," care AMERICAN FORESTRY.

GRADUATE FORESTER—Practical experience in cruising, mapping and scaling. Eager to go anywhere. References furnished. Address R. L., care of AMERICAN FORESTRY.

PRACTICAL FORESTER wants situation on private estate. Has practical experience of sowing, laying, planting out, pruning, thinning, firebelts, ditching, rotation planting, mixed planting and thorough knowledge of fencing and tree felling. Has had seven years experience on best managed forestry area in Scotland. Address, "Raith," Care AMERICAN FORESTRY.

PRACTICAL FORESTER wants position with city Park Commission. Understands fully nursery work, planting, trimming and tree surgery. Best references and practical experience. Address "L. M. E.," Care AMERICAN FORESTRY.

WANTED—A position as an inspector of ties, timbers and lumber, by a forest school graduate with experience in inspecting ties, timbers and lumber. Can furnish best of references. Address Inspector; Care AMERICAN FORESTRY.

Graduate of Forestry School, having studied forestry and lumbering operations in this country and Germany, with experience in the U. S. Forest Service, and also in state and private nursery work, would like position with forest engineering firm or lumber company. Best of references. Address XY, Care of AMERICAN FORESTRY.

WANTED—A job as fire ranger or guard by a strong, healthy young man twenty-one years of age. Address "3" care AMERICAN FORESTRY.

AMERICAN FORESTRY'S ADVERTISERS

WANTED—Position by a clean cut young man, with A-1 references, with a Forestry Expert or a surveying party, or any other business where a knowledge of the subject of forestry can be had. Address G. W. H., care AMERICAN FORESTRY.

POSITION WANTED—Am graduate of Biltmore Forest School, with good record in survey, estimate and estate management and want position where I will have a chance to learn more. Have done practical work outside of school and am considered good at timber. Willing to go anywhere and be generally useful. Hard worker, don't mind long hours. Age, twenty-six. Give me interview or let me send references. Address J. U., care AMERICAN FORESTRY.

FOREST ENGINEER with training in this country and abroad, will consider position as Secretary of Fire Protective, Forestry or Conservation Association. Thoroughly experienced in Forestry and publicity work, and competent to handle affairs of such organization. Well recommended. Address "SECRETARY", Care of AMERICAN FORESTRY, Washington, D. C.

YOUNG MAN—Four years' practical experience in reforestation, nursery work, improvement thinning, fire protection and tree surgery, wishes position on private estate or for state or municipal work. Experienced handling men. Best of references. Address R. A., care AMERICAN FORESTRY.

FOREST ENGINEER of ability and experience wishes the management of large timbered tract. Thoroughly experienced in Lumbering and Practical private Forestry, and capable of taking entire charge of game preserve, private estate, or other forested lands. Well recommended. Address "Woods Supt.," Care of AMERICAN FORESTRY, Washington, D. C.

WANTED.—A Position as Superintendent on Private Estate. Expert experience with 22 years' backing, on Forestry, Agriculture, Horticulture, Landscape Engineering. Graduate Civil Engineer, Practical Experience in all mentioned work. Will take full responsibility of any estate or construction of an estate and guarantee my work. Fair salary expected. Please state salary you are willing to offer with reply. I will not accept a position in "part." I will not accept position under three months' notice to my present Employer. Address "V. C. P.," Care AMERICAN FORESTRY.

YOUNG MAN, 29 years old, wishes position with forest owner or lumber mill concern, to take care of all waste timber. Have 12 years' experience in distilling and extracting by-products from forest wastes, etc. Address 1, Care AMERICAN FORESTRY.

FORESTER wants position with Consulting Forestry firm, or with lumber company or private estate. Training from Michigan Agricultural College and Yale Forest School; four years' experience with U. S. Forest Service and two winters with lumber companies. Acquainted thoroughly with Montana, Idaho and California timber as cruiser. References on request. Address E., Care AMERICAN FORESTRY.

ENERGETIC Post Graduate Forester desires position as an assistant in park or city forestry work. Subordinate duties preferred. Best of references. Address M. M. J., Care of AMERICAN FORESTRY.

FOREST ENGINEER with Forest Service training in Colorado, Wyoming, private work in California, and six years' experience in the lumber industry on the Pacific Coast, would like field work in any part of the United States. Estimating of timber lands and topographic surveying a specialty. Four years' technical training. Address, "D." Care AMERICAN FORESTRY.

WANTED—Position as City Forester or Park Superintendent. Willing to consider position as an assistant. University training; experience in forestry, nursery and landscape work. Twenty-seven years old and married. Best of references. Address "F. S.," Care of AMERICAN FORESTRY, Washington, D. C.

SURVEYOR—Young man 23 years old, 2½ years experience as rodman and draftsman on preliminary, location and construction for western railroads, desires position of like nature where there is an opportunity for learning forestry. Location is immaterial. Address Box 5, Care of AMERICAN FORESTRY.

WANTED—Timber estimating by postgraduate forester with experience in Eastern Canada and Lake States. References. Address P. T. A., Care of AMERICAN FORESTRY, Washington, D. C.

GRADUATE FORESTER desires position; practical experience in timber estimating, nursery work, also especially qualified for shade tree work; have passed Civil Service examination for forest assistant. Address "D. B.," Care of AMERICAN FORESTRY.

FOR SALE—BULLETINS AND CIRCULARS

Almost complete series of Forestry Bulletins and Circulars Bulletins Nos. 5 to 127, except 17 of the earlier ones; Circulars Nos. 5 to 216 except 12. A valuable set. State offer in first letter. Address U. A., Care AMERICAN FORESTRY.

BILTMORE TEXT BOOKS

The text books of the Biltmore Forest School, written by Dr. C. A. Schenck, continue for sale at Biltmore. For particulars address BILTMORE FOREST BOOKS, Biltmore, N. C. tf

TIMBERLANDS FOR SALE

Hardwood, White and Yellow Pine Timber

Lands for sale by SAVAGE BROTHERS, Cornelia, Ga. 5-4

CANADIAN AND NEWFOUNDLAND PULPWOOD

BIRCH and PINE LIMITS, for sale. Write JOHN A. MOODY, London, Canada.

REAL TIMBER BARGAIN

50,000,000 feet seventy per cent. N. C. Pine, Poplar and Cypress, all original growth. On Southern Railroad in South Carolina. Liberal terms and low price.

J. P. MULHERIN (Owner), Augusta, Ga.

FOR QUICK SALE, 25,000 ACRES

of Virgin timber at war prices, includes land and timber, in fee simple. Titles good. Payments reasonable. Address Box 21, Care of AMERICAN FORESTRY.

INTERIOR TRIM PLANT FOR SALE

For quick sale, the best factory in the South for manufacture of furniture or interior trim. Special advantages in rates, taxes, labor, raw material both yellow pine and hardwoods. Plant is new, fireproof and insurance rate is 66 cents per \$100.00. Sale price is less than half the cost. Write for particulars and photographs.

J. P. MULHERIN, Trustee,
Augusta, Ga.

FOR SALE—STANDING TIMBER

Now is the time to buy timber. You will never again have an opportunity to buy good stumpage as low as at present. Owing to the burning of our lumber plant we offer for sale 100 million feet of pine and hardwoods, principally red gum, oak, cypress and pine. This timber is very large and of fine quality, and can be logged at any season of the year. It is located in South Carolina, with favorable rates to market, climate healthy, labor cheap and plentiful. Additional timber can be secured for as large an operation as desired. Address Box 20, Care AMERICAN FORESTRY MAGAZINE, Washington, D. C.

True Time All the Time

The owner of a Hamilton Watch soon learns to rely on it implicitly, for a Hamilton tells the true time all the time. In railroad operation, where men *must* have accuracy, the Hamilton is chosen above all others.

Hamilton Watch

"The Railroad Timekeeper of America"

There are twenty-five models of the Hamilton Watch. Every one has Hamilton quality and Hamilton accuracy. They range in price from \$12.25 for movement only (in Canada \$12.50) up to the superb Hamilton masterpiece at \$150.00. Your jeweler can show you the Hamilton you want, either in a cased watch or in a movement only, to be fitted to any style case you select, or to your own watch case if you prefer.

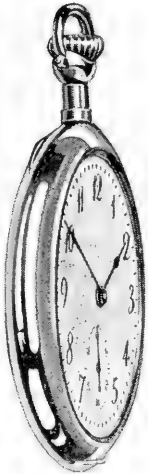

Engineer D. R. Wood, of "The Twentieth Century Limited," New York Central Lines, has carried a Hamilton Watch with perfect satisfaction for years.

Write for the Hamilton Watch Book, "The Timekeeper"

It pictures and describes the various Hamilton models and gives interesting watch information

HAMILTON WATCH COMPANY

Dept. 00

Lancaster, Pennsylvania

For Your Planting This Spring



Use White Pine

Use it for Shelter Belts, Windbreaks, Snowbreaks, Dustbreaks, Noisebreaks, Screens and Tall Hedges. Use it for beautifying estates and waste lands. It increases land values tremendously. White Pine is the standard tree of commerce, and "the aristocrat of the evergreens." Grows rapidly and vigorously. Transplants easily.

Explain your problems. We grow Many Millions of Ornamental, Shade, Forest and Windbreak Trees.

WRITE NOW for our Free Illustrated Spring 1915 Catalogue of Evergreen and Deciduous Trees.

UNPRECEDENTED PRICES
(because of our production by the million)
For Very Superior Stock

TWICE-Transplanted White Pines

3 to 4 feet	In lots of 1000, each	29½c	In lots of 100, each	34c	10 trees for \$7.00
2 to 3 feet	In lots of 1000, each	17c	In lots of 100, each	20½c	10 trees for \$4.50

PLANT THE TWICE-TRANSPLANTED STOCK FOR QUICK RESULTS

ONCE - Transplanted White Pines

2 to 3 feet	In lots of 1000, each	8½c	In lots of 100, each	10c	10 trees for \$2.50
1½ to 2 feet	In lots of 1000, each	5½c	In lots of 100, each	8c	10 trees for \$2.00
1 to 1½ feet	In lots of 1000, each	3c	In lots of 100, each	4½c	10 trees for \$1.50

Prices are f. o. b. South Framingham, Mass., and include containers, careful packing and prompt delivery to the transporting company.

Little Tree Farms of America

Nurseries of

AMERICAN FORESTRY COMPANY

Dept. 1, 15 BEACON STREET, BOSTON, MASS.



One of our Twice-Transplanted 2 to 3 foot grade White Pines. Finely-branched, straight-stemmed, well-rooted stock. Note prices!

382,000,000 Feet National Forest Timber For Sale

AMOUNT AND SPECIES—Unit I, 85,000,000 feet B. M., more or less, of western yellow pine, sugar pine, lodgepole pine and western white pine timber, approximately 96 per cent western yellow pine.

Unit II, 297,000,000 feet B. M., more or less, of same species, approximately 97 per cent western yellow pine.

On both units there is an unestimated amount of other species, the removal of which is optional with the purchaser.

LOCATION—Unit I—Within the Crater National Forest, Oregon, in Twp. 35 S., R. 6 E., and Twp. 36 S., Rs. 5 and 6 E., W. M., on Four Mile, Lost and Woods Creeks.

Unit II—Within the Paulina National Forest, Oregon, in Twps. 28, 29 and 30 S., R. 6½ E., and Twp. 30 S., R. 7 E., W. M., on Bear Creek watershed.

STUMPAGE PRICES—Lowest rates considered for Unit I, \$3.00 per M. for western yellow pine, sugar pine, lodgepole pine and western white pine, and \$0.50 per M. for other species.

Unit II, \$3.25 per M. for western yellow pine, sugar pine, lodgepole pine and western white pine, and \$0.50 per M. for other species.

Rates to be readjusted on January 1, 1920, and every three years thereafter.

DEPOSIT—With bid on Unit I, \$5,000; on Unit II, \$20,000, to apply on purchase price if bid is accepted, or refunded if bid is rejected. Ten per cent may be retained as forfeit if the contract and bond are not executed within the required time.

FINAL DATE FOR BIDS—Sealed bids will be received on either or both units by the District Forester, Portland, Oregon, up to and including April 10, 1915. The time for receiving bids on either unit may be extended sixty days upon the request of responsible parties desiring additional time for the examination of the timber, or for other reasons in the discretion of the Forester.

The right to reject any and all bids is reserved.

Before bids are submitted full information concerning the character of the timber, conditions of sale, deposits, and the submission of bids should be obtained from the District Forester, Portland, Oregon, or the Forest Supervisor, Medford, Oregon.

Harvard University

SCHOOL OF FORESTRY

OFFERS specialized graduate training leading to the degree of Master of Forestry in the following fields:—Silviculture and Management, Wood Technology, Forest Entomology, Dendrology, and (in co-operation with the Graduate School of Business Administration) the Lumber Business

For further particulars address

RICHARD T. FISHER, Chairman
Cambridge, Massachusetts

GEORGIA

State Forest School

University of Georgia

COMplete four-year undergraduate course in theoretical and applied forestry leading to the degree:

Bachelor of Science in Forestry

¶ Wide range of specialization offered—

Logging Engineering
Commercial Administration
Forest Management

City Forestry State Forestry
Dendrology Research

¶ Provision for four months field work—two following each of Freshman and Sophomore years—on McHatton Forest, a large forest estate in the Blue Ridge Mountains. Numerous excursions in Dendrology and Logging. Provision for practical work in specialization during Junior-Senior vacation

For announcement address

FOREST SCHOOL
Georgia State College of Agriculture
ATHENS, GEORGIA

"Oh that mine adversary had written a Book"

GEORGE H. MAXWELL

has written a Book

Our National Defense— The Patriotism of Peace

advocating the formation of a

Construction Corps of Citizen Soldiery

in which

All Foresters Would Be Enlisted as Reservists

and the work of the Forest Service extended to every State in the Union and the cost of planting and care of forests covered by an issue of Forestry Construction Bonds.

It is practically conceded that the Atlantic and Pacific Coasts of the United States are undefended.

*They cannot be defended by Coast Defenses
They cannot be defended by a Standing Army
They cannot be defended by a Larger Navy*

The only way they *can be defended* is squarely presented and demonstrated in OUR NATIONAL DEFENSE.

No Patriotic American Citizen who is interested in forestry can afford to be without the knowledge which can be gained from reading that book.

Copies will be mailed to any address in the United States on receipt of \$1.25 by the

RURAL SETTLEMENTS ASSOCIATION

Cotton Exchange Building

New Orleans, Louisiana

Important Books on Forestry

Mechanical Properties of Wood

By SAMUEL J. RECORD, M. A., M. F.,
Assistant Professor of Forest Products,
Yale University.

This book is divided into three parts, as follows:

Part I. Fundamentals, Considerations, and Definitions, Strength and Toughness, etc. Part II. Factors Affecting the Mechanical Properties of Wood. Part III. Timber Testing. The appendix contains sample working plans and tables of strength of various woods.

165 pages, 6 x 9, 52 figures, 22 tables.
Cloth, \$1.75 net.

GRAVES'

The Principles of Handling Woodlands

325 pages, 5¼ x 8, 63 figures.
Cloth, \$1.50 net.

LEVISON'S

Studies of Trees

253 pages, 5¼ x 7½, 155 figures.
Cloth, \$1.60 net.

BRYANT'S

Logging

598 pages, 6 x 9, 133 figures.
Cloth, \$3.50 net.

FREE EXAMINATION If you have an account with us, or can supply a reference, our books will be sent for ten days' free examination, without cash in advance. At the end of this time you are to remit their purchase price, or return them, postpaid.

If cash accompanies the order and you should find any of the books unsatisfactory, we will refund your money provided the books are returned postpaid, within ten days after their receipt.

JOHN WILEY & SONS, Inc., 432 4th Ave., New York
London: CHAPMAN & HALL, Ltd. Montreal, Canada: RENOUF PUB. CO.

HEAD FORESTER, GARDENER, GENERAL MANAGER

Expert at Forestry, Horticulture, and Agriculture

Thoroughly familiar with the *American, German, French and Hungarian* forest systems. Fire protection—forest nurseries—laying out new territory—bringing old ones under system—roads—telephones—fencing—game keeping, fish and fowl. Persian lambs a specialty. If you want to have a model estate to be proud of I have the experience gathered all over the globe connected with a thoroughly theoretical training. Expert on landscape gardening, green houses, and on everything *new, scientific, practical* in agriculture connected with the breeding of horses, cattle and in the erecting of buildings—draw my own plans. Would like to run very large model estate, with full power and responsibility. Wages *high but moderate*. At present in position. Please send full particulars. Personal interview by three days' notice—at liberty after two weeks' notice. *References*, genuine and stamped from authorities. There is no competition to scare me! Address, please, to the **American Forestry Association, Box 5, Wash., D. C.**

FO 1 RE 2 ST 3 RY 4

The FOREST is three-fourths of FORESTRY

Your opportunities are as unlimited as our forests if you study at

WYMAN'S SCHOOL OF THE WOODS
Incorporated Munising, Michigan

We make the
ENGRAVINGS
for the
**AMERICAN FORESTRY
MAGAZINE**

OUR SPECIALTY
is the "better" grade finish of
DESIGNS & ENGRAVINGS
in one or more colors
for Magazines, Catalogues,
Advertisements, etc.

HALF TONES LINE PLATES
DULLO-TONES COMBINATION LINE
COLOR PROCESS AND HALF TONES
MULTI-COLORS

Established 1889

GATCHEL & MANNING
SIXTH and CHESTNUT STREETS
Opposite Olde Independence Hall
PHILADELPHIA

Yale University Forest School

NEW HAVEN, CONN., U. S. A.

YALE University Forest School is a graduate department of Yale University. It is the oldest existing forest school in the United States and exceeds any other in the number of its alumni. A general two-year course leading to the degree of Master of Forestry is offered to graduates of universities, colleges and scientific institutions of high standing and, under exceptional conditions, to men who have had three years of collegiate training including certain prescribed subjects. Men who are not candidates for the degree may enter the School as special students, for work in any of the subjects offered in the regular course, by submitting evidence that will warrant their taking the work to their own advantage and that of the School. Those who have completed a general course in forestry are admitted for research and advanced work in Dendrology, Silviculture, Forest Management, Forest Technology, and Lumbering. The regular two-year course begins the first week in July at the School camp near Milford, Pennsylvania.

For further information address

JAMES W. TOUMEY, Director
NEW HAVEN, CONN.

Special Courses offered in **LUMBERING** *and* **WOOD UTILIZATION, PULP and PAPER MAKING**

Other Special Courses in Forestry

Men with technical training along the lines of Lumbering and the various branches of Wood Utilization will be needed in the future.

Four and five year students in these courses will have constant access to the new Eastern Forest Products Laboratory.

The New York
State College of Forestry
At Syracuse University
Syracuse, N. Y.

In the National Forest Region

Colorado School of Forestry

A DEPARTMENT OF
COLORADO COLLEGE

THE course in theoretical and applied forestry leading to the degree of Forest Engineer covers a period of two years and is open to students who have completed two years of college work, including a sufficient amount of Botany, Geology and Surveying.

Graduate students may enter as candidates for the degree of Master of Forestry.

Fall and Spring Terms in the Manitou Forest, the College Reserve, 6,000 acres of pine and spruce timberland on the borders of the Pike National Forest. Winter Term at Colorado Springs.

For particulars address

Colorado School of Forestry
Colorado Springs, Colo.

DEPARTMENT OF FORESTRY

The Pennsylvania State College

A PROFESSIONAL course in Forestry, covering four years of college work, leading to the degree of Bachelor of Science in Forestry.

Thorough and practical training for government, state, municipal and private forestry.

Four months are spent in camp in the woods in forest work.

Graduates who wish to specialize along particular lines are admitted to the "graduate forest schools" as candidates for the degree of Master of Forestry on the successful completion of one year's work.

For further information address,

Department of Forestry
PENNSYLVANIA STATE COLLEGE
State College, Pa.

BOOKS ON FORESTRY

AMERICAN FORESTRY will publish each month, for the benefit of those who wish books on forestry, a list of titles, authors and prices of such books. These may be ordered through the American Forestry Association, Washington, D. C. Prices are by mail or express prepaid.* :-: :-: :-: :-:

THE WOODS—Douglas Malloch	\$1.15
RESAWED FABLES—Douglas Malloch	1.15
THE TRAINING OF A FORESTER—Gifford Pinchot	1.12
LUMBER AND ITS USES—R. S. Kellogg	1.15
THE CARE OF TREES IN LAWN, STREET AND PARK—B. E. Fernow	2.17
NORTH AMERICAN TREES—N. L. Britton	7.30
KEY TO THE TREES—Collins and Preston	1.50
THE FARM WOODLOT—E. G. Cheyney and J. P. Wentling	1.70
AMERICAN FOREST TREES—Henry H. Gibson	6.00
IDENTIFICATION OF THE ECONOMIC WOODS OF THE UNITED STATES— Samuel J. Record	1.25
PLANE SURVEYING—John C. Tracy	3.00
FOREST MENSURATION—Henry Solon Graves	4.00
THE ECONOMICS OF FORESTRY—B. E. Fernow	1.61
FIRST BOOK OF FORESTRY—Filibert Roth	1.10
PRACTICAL FORESTRY—A. S. Fuller	1.50
PRINCIPLES OF AMERICAN FORESTRY—Samuel B. Green	1.50
SEASIDE PLANTING OF TREES AND SHRUBS—Alfred Gaut	1.75
FAMILIAR TREES—G. S. Boulger	1.50
MANUAL OF THE TREES OF NORTH AMERICA (exclusive of Mexico)—Charles Sprague Sargent	6.00
AMERICAN WOODS—Romeyn B. Hough	5.00
HANDBOOK OF THE TREES OF THE NORTHERN U. S. AND CANADA, EAST OF THE ROCKY MOUNTAINS—Romeyn B. Hough	6.00
GETTING ACQUAINTED WITH THE TREES—J. Horace McFarland	1.75
PRINCIPAL SPECIES OF WOOD: THEIR CHARACTERISTIC PROPERTIES— Charles Henry Snow	3.50
NORTH AMERICAN FORESTS AND FORESTRY—E. R. Bruncken	2.00
HANDBOOK OF TIMBER PRESERVATION—Samuel M. Rowe	4.00
TREES OF NEW ENGLAND—L. L. Dame and Henry Brooks	1.50
TREES AND SHRUBS—C. S. Sargent	5.00
TREES, SHRUBS AND VINES OF THE NORTHEASTERN UNITED STATES— H. E. Parkhurst	1.50
TREES—H. Marshall Ward	1.50
OUR NATIONAL PARKS—John Muir	1.91
THE LONGLEAF PINE IN VIRGIN FOREST—G. Frederick Schwarz75
LOGGING—Ralph C. Bryant	3.50
THE IMPORTANT TIMBER TREES OF THE UNITED STATES—S. B. Elliott	2.50
FORESTRY IN NEW ENGLAND—Ralph C. Hawley and Austin F. Hawes	3.50
THE PRINCIPLES OF HANDLING WOODLANDS—Henry Solon Graves	1.50
SHADE TREES IN TOWNS AND CITIES—William Solotaroff	3.00
THE TREE GUIDE—By Julia Ellen Rogers	1.00
FOREST PHYSIOGRAPHY—By Isaiah Bowman	5.00
MANUAL FOR NORTHERN WOODSMEN—Austin Cary	2.12
FARM FORESTRY—Alfred Akerman57
THE THEORY AND PRACTICE OF WORKING PLANS (in forest organization) A. B. Recknagel	2.10
ELEMENTS OF FORESTRY—F. F. Moon and N. C. Brown	2.20
MECHANICAL PROPERTIES OF WOOD—Samuel J. Record	1.75
STUDIES OF TREES—J. J. Levison	1.75
TREE PRUNING—A. Des Cars65
THE PRESERVATION OF STRUCTURAL TIMBER—Howard F. Weiss	3.00

* This, of course, is not a complete list, but we shall be glad to add to it any books on forestry or related subjects upon request.—Editor.

Globe-Wernicke

Sectional Bookcases

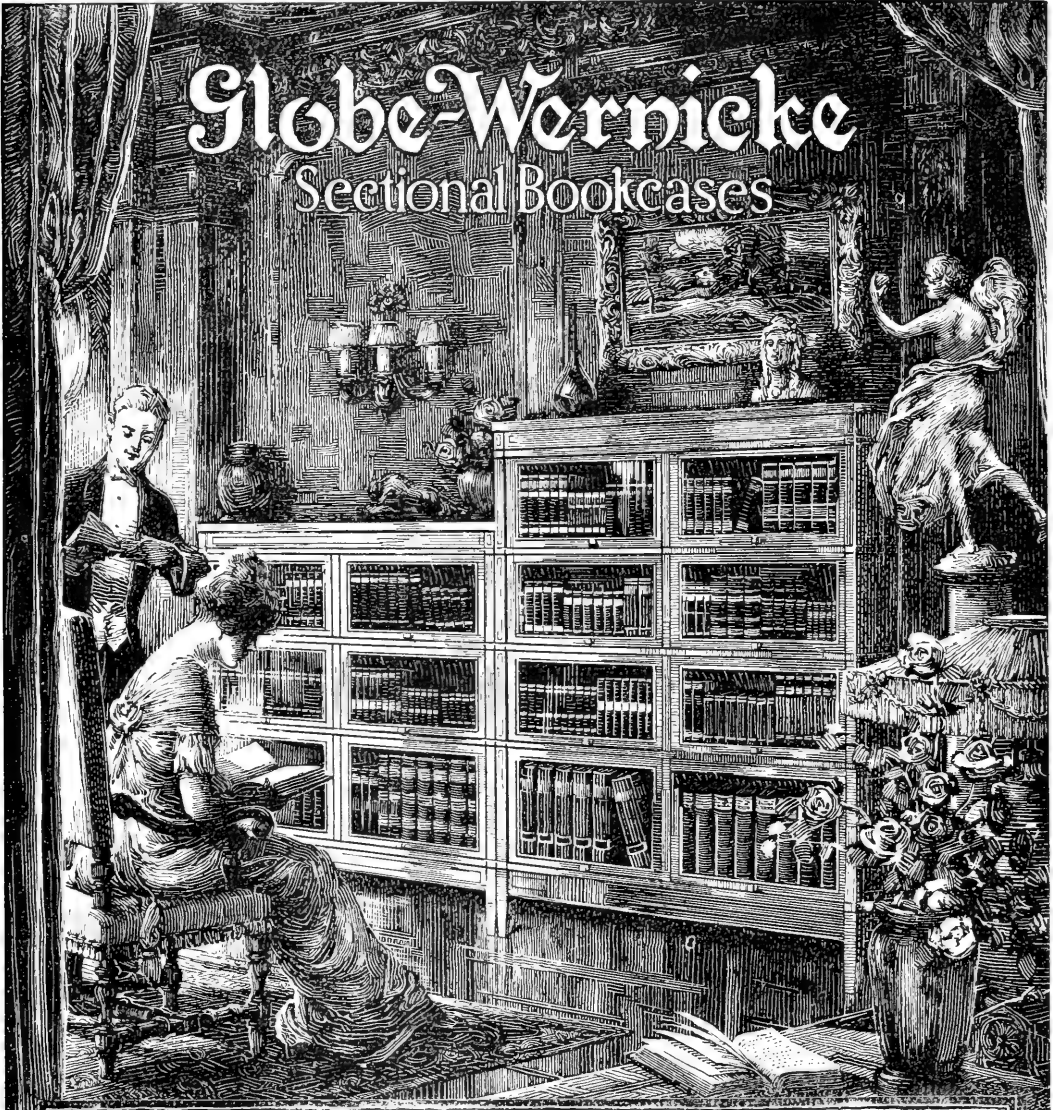

TROPIC damp and heat—the frigid rigors of northern lands—and the variable climate of the temperate zones cannot affect the stout construction of Globe-Wernicke Sectional Bookcases. Their durability is the lasting strength of fine cabinet-making and materials carefully seasoned to withstand the extremes of climate.

There's a Globe-Wernicke Bookcase in just the right finish and right size to match your color scheme and wall space. Then, as your library expands, more sections are always in stock. Built to grow and endure, they cost no more than the ordinary kind. *Write for Catalog No. 445.*

The Globe-Wernicke Co.

Cincinnati

Makers of Sectional Bookcases, Filing Equipment (Wood and Steel), Steel Safes, Stationers' Supplies.

On sale by 2000 Branch Stores and Agents everywhere. Globe-Wernicke pays the freight.



BRANCH STORES: New York, Chicago, Philadelphia, Boston, Cincinnati, Washington, D. C.



W. MAS KIRBY

385,000,000,000 Feet of Southern Yellow Pine

"THE WOOD OF A THOUSAND USES"

Enough lumber to put a fine house over every family in our country and build a garage and a couple of barns for each besides. **Surely, Enough.**

THINK OF

a beautifully-grained, mirror-surfaced, easily worked finishing product for your home, capable of taking any shading of finish or stain—

"SHORT LEAF SOUTHERN YELLOW PINE"

THINK OF

strength, toughness, durability for the structural framing (Yellow pine houses have stood for a century)—

"LONG LEAF SOUTHERN YELLOW PINE"

THINK OF

adaptability in general to all building and construction operations, in all climates. and ease of handling—

"Southern Yellow Pine is the Inevitable Answer"

INEXPENSIVE? YES

Source of raw supply being the nearest to the great central consuming districts, the process of our manufacture having been developed to the greatest degree of perfection in point of finish and economy, and a **plentiful supply**, make this **wonderful material** the most economical to use, where quality and beauty and strength are desired.

A card will bring other desired information and tell you how to get the particular yellow pine for your needs; write us

OUR 8 BIG PLANTS CUT 275,000,000 FEET ANNUALLY

Short Leaf and Long Leaf Product

MISSOURI LUMBER & LAND EXCHANGE CO.

Sales Office, 1111 Long Building, Kansas City, Mo.

J. B. WHITE, General Manager

J. H. BERKSHIRE, President

O. W. FISHER, Vice-President

We Are Not Prophets

We know timber prices cling tenaciously to every advance they make, that values increase, remain dormant for brief periods and again increase. To our personal knowledge that has been the history of timberland values for thirty-five years, but

We Do Not Know How High Timber Prices Will Go

Probably prices will continue to increase until they reach par—that is until it costs as much to buy timber as to grow it—which is several times the present value of stumpage.

With a three to five fold profit in prospect timber lands should interest you. Therefore you should know more about timber and we should know more about your plans.

James D. Lacey & Co. Timber Land Factors

CHICAGO, ILL., 1750 McCormick Building
PORTLAND, ORE., 1313 Northwestern Bank Building
SEATTLE, WASH., 1009 White Building

American Forestry

Vol. 21

APRIL 1915

No. 4

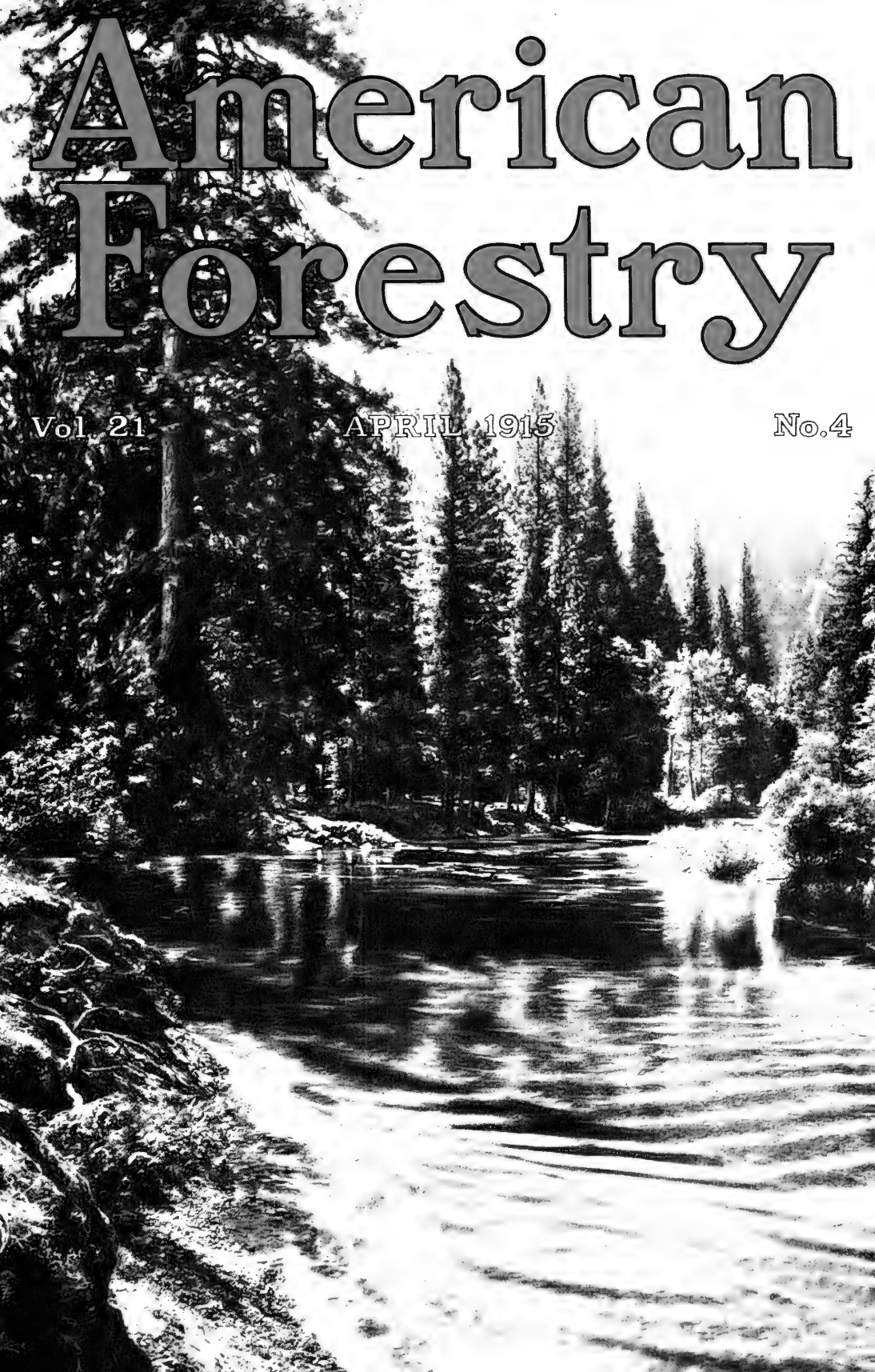

BOOKS ON FORESTRY

AMERICAN FORESTRY will publish each month, for the benefit of those who wish books on forestry, a list of titles, authors and prices of such books. These may be ordered through the American Forestry Association, Washington, D. C. Prices are by mail or express prepaid.* :-: :-: :-: :-:

THE WOODS—Douglas Malloch	\$1.15
RESAWED FABLES—Douglas Malloch	1.15
THE TRAINING OF A FORESTER—Gifford Pinchot	1.12
LUMBER AND ITS USES—R. S. Kellogg	1.15
THE CARE OF TREES IN LAWN, STREET AND PARK—B. E. Fernow	2.17
NORTH AMERICAN TREES—N. L. Britton	7.30
KEY TO THE TREES—Collins and Preston	1.50
THE FARM WOODLOT—E. G. Cheyney and J. P. Wentling	1.70
AMERICAN FOREST TREES—Henry H. Gibson	6.00
IDENTIFICATION OF THE ECONOMIC WOODS OF THE UNITED STATES— Samuel J. Record	1.25
PLANE SURVEYING—John C. Tracy	3.00
FOREST MENSURATION—Henry Solon Graves	4.00
THE ECONOMICS OF FORESTRY—B. E. Fernow	1.61
FIRST BOOK OF FORESTRY—Filibert Roth	1.10
PRACTICAL FORESTRY—A. S. Fuller	1.50
PRINCIPLES OF AMERICAN FORESTRY—Samuel B. Green	1.50
SEASIDE PLANTING OF TREES AND SHRUBS—Alfred Gaut	1.75
FAMILIAR TREES—G. S. Boulger	1.50
MANUAL OF THE TREES OF NORTH AMERICA (exclusive of Mexico)—Charles Sprague Sargent	6.00
AMERICAN WOODS—Romeyn B. Hough	5.00
HANDBOOK OF THE TREES OF THE NORTHERN U. S. AND CANADA, EAST OF THE ROCKY MOUNTAINS—Romeyn B. Hough	6.00
GETTING ACQUAINTED WITH THE TREES—J. Horace McFarland	1.75
PRINCIPAL SPECIES OF WOOD: THEIR CHARACTERISTIC PROPERTIES— Charles Henry Snow	3.50
NORTH AMERICAN FORESTS AND FORESTRY—E. R. Bruncken	2.00
HANDBOOK OF TIMBER PRESERVATION—Samuel M. Rowe	4.00
TREES OF NEW ENGLAND—L. L. Dame and Henry Brooks	1.50
TREES AND SHRUBS—C. S. Sargent	5.00
TREES, SHRUBS AND VINES OF THE NORTHEASTERN UNITED STATES— H. E. Parkhurst	1.50
TREES—H. Marshall Ward	1.50
OUR NATIONAL PARKS—John Muir	1.91
THE LONGLEAF PINE IN VIRGIN FOREST—G. Frederick Schwarz75
LOGGING—Ralph C. Bryant	3.50
THE IMPORTANT TIMBER TREES OF THE UNITED STATES—S. B. Elliott ..	2.50
FORESTRY IN NEW ENGLAND—Ralph C. Hawley and Austin F. Hawes	3.50
THE PRINCIPLES OF HANDLING WOODLANDS—Henry Solon Graves	1.50
SHADE TREES IN TOWNS AND CITIES—William Solotaroff	3.00
THE TREE GUIDE—By Julia Ellen Rogers	1.00
FOREST PHYSIOGRAPHY—By Isaiah Bowman	5.00
MANUAL FOR NORTHERN WOODSMEN—Austin Cary	2.12
FARM FORESTRY—Alfred Akerman57
THE THEORY AND PRACTICE OF WORKING PLANS (in forest organization) A. B. Recknagel	2.10
ELEMENTS OF FORESTRY—F. F. Moon and N. C. Brown	2.20
MECHANICAL PROPERTIES OF WOOD—Samuel J. Record	1.75
STUDIES OF TREES—J. J. Levison	1.75
TREE PRUNING—A. Des Cars65
THE PRESERVATION OF STRUCTURAL TIMBER—Howard F. Weiss	3.00

* This, of course, is not a complete list, but we shall be glad to add to it any books on forestry or related subjects upon request.—Editor.

EVERY STUMP HOLDS A DOLLAR

The ground covered by an average stump and its roots will grow 25c. to 50c. worth of food crops per year. A hundred-stump acre will produce \$50 worth of food per year after clearing. Why leave these dollars buried under stumps and pay taxes on stump land when the whole world offers big prices for American farm products?



Red Cross Stumping Powder

Will get them out in cold and wet weather, when you have plenty of time. Clear land early and crop it this year. This explosive is low freezing, hence works well while snow is on the ground. It takes less Stumping Powder in wet weather than in dry. Turn the cold wet days of Spring into cash.

Order Red Cross quickly from any hardware dealer or

Du Pont Powder Co.
Wilmington, Del.

1915

How Many Dollars Are Buried In Your Farm?

Plant Evergreens 3-25 Feet High and All Winter Planting Will Be Welcome

IF you need to screen unattractive surroundings, garage, stable, poultry house, laundry yard, or street.

IF you admire evergreens.

IF you need windbreaks to your house, garden, out door room or play ground.

IF you enjoy hunting big Cedars, Pines, Oaks, Maples, Dogwoods, Laurel, etc., and making your place look like an old place right away.

IF you have evergreens, deciduous trees or shrubs to move to other parts of your grounds or give away or sell.

The Proof

Hicks Nurseries employed 100 men last winter, except 14 days. Half were digging trees. Our winter sales for the past four years were \$16,000.00.

In January the ground freezes six inches, but is easily worked if previously mulched to keep out frost.

On the mainland the frost is deeper and more continuous, but it is easy to dig through with pick or cold chisel.

If it costs a few cents additional to plant we will bear that to keep our staff all winter.

IF you wish to prevent winter unemployment. We can provide apparatus and men to cooperate with your men or we can attend to the entire operations.

IF you wish to take advantage of present reduced prices. Carload shipments or less from the nursery of pines, spruce, cedar, 3-25 feet high.

I. HICKS & SON

Westbury, L. I.,

New York

Thorburn's Tree Seeds

WE have, for many years, devoted a great deal of attention to tree seeds.

Even the rarest varieties are stocked by us, and you may be assured of prompt shipment of anything shown in our catalogue.

We should be glad to have you send us your lists for pricing. If you haven't a copy of our 1915 Catalogue one will be sent you on request.

J. M. Thorburn & Co.

53 Barclay Street through
to 54 Park Place
NEW YORK

Seeds for Forestry Purposes

WE offer a most complete list of both Deciduous and Evergreen Tree and Shrub seeds for forestry purposes.

Seeds that are of best germinating quality

Our catalogue contains a full list of the varieties we offer, which include the best and most rare species. Send for a copy, it will interest you.

THOMAS MEEHAN & SONS

Wholesale Nurserymen and Tree Seedmen
DRESHER, PENNA., U. S. A.

ORCHIDS

ORCHIDS

We are specialists in Orchids, we collect, import, grow, sell and export this class of plants exclusively.

Our illustrated and descriptive catalogue of Orchids may be had on application. Also special lists of freshly imported unestablished Orchids.

LAGER & HURRELL

SUMMIT, N. J.

Orchid Growers and Importers

THE AMERICAN FORESTRY ASSOCIATION

OFFICERS FOR 1914

President

DR. HENRY STURGIS DRINKER, President, Lehigh University, South Bethlehem, Pa.

Vice-Presidents

JOSHUA L. BAILEY, Pennsylvania
THEODORE L. BRISTOL, Connecticut
Ex-President Connecticut Forestry Association
ANDREW CARNEGIE, New York
MRS. EMMONS CROCKER, Massachusetts
DR. CHARLES W. ELIOT, Massachusetts
President Emeritus Harvard University
DR. B. E. FERNOW, Canada
Dean of Forestry, University of Toronto
HON. WALTER L. FISHER, Chicago, Ill.
Ex-Secretary of the Interior
HENRY S. GRAVES, District of Columbia
Chief of the Forest Service
HON. CURTIS S. GUILD, Massachusetts
Ex-Ambassador to Russia
EVERETT G. GRIGGS, Washington
HON. DAVID HOUSTON
Secretary of Agriculture
HON. FRANKLIN K. LANE
Secretary of the Interior

HON. ASBURY F. LEVER, South Carolina
United States Representative
HON. THOMAS NELSON PAGE
Ambassador to Italy
HON. GEO. PARDEE, California
Ex-Governor California
GIFFORD PINCHOT, Philadelphia, Pa.
FILIBERT ROTH, Michigan
Dean of Forestry, University of Michigan
DR. J. T. ROTHROCK, Pennsylvania
HON. WM. H. TAFT, Connecticut
Ex-President United States
JOSEPH N. TEAL, Oregon
Chairman Oregon Conservation Commission
HON. JOHN WEEKS, Massachusetts
U. S. Senator
DR. ROBERT S. WOODWARD, Washington, D. C.
President, Carnegie Institution

Treasurer

JOHN E. JENKS, Washington, D. C.
Editor, Army and Navy Register

Executive Secretary

P. S. RIDSDALE, 1410 H Street N. W., Washington, D. C.

Directors

E. T. ALLEN, Oregon
Forester, Western For. and Conservation Asso.
HON. ROBERT P. BASS, New Hampshire
Ex-Governor of New Hampshire
WM. B. GREELEY, District of Columbia
Assistant U. S. Forester
W. R. BROWN, New Hampshire
Pres., New Hamp. Forestry Commission
HERMAN H. CHAPMAN, Connecticut
Professor of Forestry, Yale Forest School
DR. HENRY S. DRINKER, Pennsylvania
President, Lehigh University
ALFRED GASKILL
State Forester, New Jersey
JOHN E. JENKS, District of Columbia
Editor, Army and Navy Register

CHESTER W. LYMAN, New York
International Paper Company
CHARLES LATHROP PACK, New Jersey
Pres., Fifth National Conservation Congress
CHARLES F. QUINCY, New York
J. E. RHODES, Illinois
Secretary Southern Pine Association
ERNEST A. STERLING, Pennsylvania
Forest and Timber Engineer
JOHN L. WEAVER, District of Columbia
Real Estate Broker
J. B. WHITE, Missouri
Ex-President, National Conservation Congress

Auditors

E. A. STERLING, Pennsylvania

C. F. QUINCY, New York

Advisory Board, Representing Affiliated Organizations

National Wholesale Lumber Dealers' Association
ROBT. C. LIPPINCOTT, Philadelphia, Pa.
R. L. SISSON, Potsdam, N. Y.
JOHN M. WOODS, Boston, Mass.

Northern Pine Manufacturers' Association
C. A. SMITH, Minneapolis, Minn.
WILLIAM IRVINE, Chippewa Falls, Wis.
F. E. WEYERHAEUSER, St. Paul, Minn.

Massachusetts Forestry Association
NATHANIEL T. KIDDER, Milton, Mass.
FREDERIC I. CAULKINS, Boston, Mass.
HARRIS A. REYNOLDS, Cambridge, Mass.

Lumbermen's Exchange
J. RANDALL WILLIAMS, JR., Philadelphia, Pa.
FREDERICK S. UNDERHILL, Philadelphia, Pa.
ROBERT C. LIPPINCOTT, Philadelphia, Pa.

Camp Fire Club of America
WARREN H. MILLER, New York
O. H. VAN NORDEN, New York
FREDERICK K. VREBLAND, New York

North Carolina Forestry Association
E. B. WRIGHT, Boardman, N. C.
ALSTON GRIMES, Grimesland, N. C.
J. C. SMOOT, North Wilkesboro, N. C.

National Association of Box Manufacturers
B. W. PORTER, Greenfield, Mass.
S. B. ANDERSON, Memphis, Tenn.
ROBT. A. JOHNSON, Minneapolis, Minn.

Carriage Builders' National Association
H. C. McLEAR, Wilmington, Del.
D. T. WILSON, New York
C. A. LANCASTER, South Bend, Ind.,

Boston Paper Trade Association
M. M. JONES, Lincoln, Maine
JOHN E. A. HUSSEY, Boston, Mass.
ARTHUR L. HOBSON, Boston, Mass.

Philadelphia Wholesale Lumber Dealers' Ass'n
ROBT. C. LIPPINCOTT, Philadelphia, Pa.
J. RANDALL WILLIAMS, JR., Philadelphia, Pa.
FRED'K S. UNDERHILL, Philadelphia, Pa.

New Hampshire Timberland Owners' Association
W. H. BUNDY, Boston, Mass.
EVERETT E. AMEY, Portland, Me.
F. H. BILLARD, Berlin, New Hampshire

Empire State Forest Products Association
FERRIS J. MEIGS, New York City
RUFUS L. SISSON, Potsdam, N. Y.
W. L. SYKES, Buffalo, N. Y.

California Forest Protective Association
MILES STANDISH, San Francisco, Cal.
GEO. X. WENDLING, San Francisco, Cal.
GEO. H. RHODES, San Francisco, Cal.

Minnesota Forestry Association
W. T. COX, St. Paul, Minn.
PROF. D. LANGE, St. Paul, Minn.
MRS. CARRIE BACKUS, St. Paul, Minn.

American Wood Preservers' Association
GEO. E. REX, Topeka, Ka.
CARL G. CRAWFORD, Louisville, Ky.
F. J. ANGLIER, Baltimore, Md.

Southern Pine Association
J. B. WHITE, Kansas City, Mo.
J. E. RHODES, New Orleans, La.
E. A. STERLING, Philadelphia, Pa.

ENGRAVINGS

made by

National Engraving Co.

506-508 Fourteenth St. N. W.
WASHINGTON, D. C.

Engravers to the Government

Pan American Union
Smithsonian Institution
Agricultural Department
U. S. Geological Survey
Patent Gazette
Experimental Stations and
State Institutions

HALF-TONES **LINE CUTS**

THREE-COLOR PROCESS PLATES

ELECTROTYPES

Printers Demand Our CUTS

Barrett's
Grade One
LIQUID
Creosote Oil

**Cuts wood
preserving bills in half—**

For preserving telephone poles, telegraph poles, cross arms, railroad ties, fence posts, mine timbers, under-ground sills, sleepers, bridge timbers, planking, ice houses, wood tanks, shingles, poultry houses, siloes, boat timbers or any exposed woodwork. Especially adapted for brush and open tank treatment.

Booklet on request.

BARRETT MANUFACTURING CO.

New York	Chicago	Philadelphia
Boston	St. Louis	Cleveland
Cincinnati	Pittsburgh	Detroit
Birmingham	Minneapolis	Seattle
Kansas City	Salt Lake City	



RED OAK ACORNS

New crop—prime—fresh, excellent quality. Collected in Northern Illinois. Have between 40 to 50 bushels still on hand—price while they last \$2.00 per bushel (50 pounds), 10 bushels \$18.50. Also complete stock Evergreen Tree Seeds. Write for price-list.

THE D. HILL CO., Box No. 501, Dundee, Illinois

JAMES W. SEWALL

Timber Estimates

Topographic and Boundary Surveys, Planting, Logging Maps, Portable Mill Operations

Technical Training Thoroughness Experience
CENTRE STREET OLD TOWN, MAINE

APPLICATION FOR MEMBERSHIP

Date-----

THE AMERICAN FORESTRY ASSOCIATION

1410 H Street, Washington, D. C.

Dear Sir: I hereby signify my desire to become an Annual Member and subscriber (\$3) of the AMERICAN FORESTRY ASSOCIATION, and a Contributing Member (\$10) enclose \$----- for dues. a Sustaining Member (\$25) a Life Member (\$100) a Patron (\$1,000)

Very truly yours,

Name-----

P. O. Address-----

American Forestry

The Magazine of the American Forestry Association

PERCIVAL SHELDON RIDSDALE, Editor

EDITORIAL ADVISORY BOARD

HERMAN H. CHAPMAN
ERNEST A. STERLING
S. T. DANA

FREDERICK S. UNDERHILL
JOHN E. RHODES
S. N. SPRING

April

CONTENTS

1915

COVER—Sierra Point, Yosemite Valley, California	
FORESTERS IN THE GERMAN ARMY—By T. R. Helms.....	527
With three illustrations.	
SWEDISH FOREST FIRE INSURANCE, From "Skogen"—Translated by C. A. Lindstrom.....	531
UNCLE SAM IN THE MOVIES—By C. J. Blanchard.....	532
With thirteen illustrations.	
ANOTHER LARGE ELM.....	541
With one illustration.	
FORESTS AND RECREATION—By Warren H. Miller.....	542
With six illustrations.	
HENRY S. DRINKER, LL.D., President of the American Forestry Association.....	550
With one photograph.	
CAPT. J. B. WHITE, Director of the American Forestry Association.....	551
With one photograph.	
CHARLES W. ELIOT, Vice-President of the American Forestry Association.....	552
With one photograph.	
BOMBARDMENT OF PAPEETE—By A Tahitian of High Rank.....	553
With six illustrations.	
FORESTRY IN WISCONSIN—By E. M. Griffith, State Forester.....	559
PHILIPPINE ISLANDS' FORESTER.....	563
With one photograph.	
CHINESE TREES DO WELL HERE.....	564
With four illustrations.	
JAMESTOWN 100 ACRE LOT.....	567
With four illustrations.	
WOODLOT FORESTRY—By S. B. Detwiler.....	571
With four illustrations.	
O. T. SWAN'S NEW POSITION.....	575
With one photograph.	
THE AMERICAN LUMBER MARKET—By E. B. Hazen (Part II).....	576
A TALE OF THE TRAIL—By Matt Daly—Poem.....	581
CARE OF BIRD HOUSES—By Ned Dearborn.....	582
With eight illustrations.	
FOREST FIRE WARNINGS.....	587
Showing eight samples.	
ROOM FOR 5,000,000 SHADE TREES.....	590
SELECTING TREES AND SHRUBS—Lists covering all sections of the United States... ..	591
NOTICE OF MEETING OF THE AMERICAN FORESTRY ASSOCIATION IN SAN FRANCISCO.....	593
CONNECTICUT FORESTRY MEETINGS.....	594
EDITORIAL:	
No Politics in This Forester's Work.....	596
Forestry and Independence.....	595
CANADIAN DEPARTMENT—By Ellwood Wilson.....	597
BRITISH COLUMBIA NOTES.....	599
FOREST NOTES.....	600
BOOK REVIEWS:	
Our National Defense, The Patriotism of Peace—By George H. Maxwell.....	602
Some Lumber Problems—Northern Hemlock and Hardwood Manufacturers Association.....	602
CURRENT LITERATURE.....	603

AMERICAN FORESTRY is published monthly by the American Forestry Association

Subscription price, three dollars per year; single copies, twenty-five cents.

Copyright 1915, by the American Forestry Association

Entered as second-class mail matter December 24, 1909, at the Post-office at Washington, under the Act of March 3, 1879.

THE IDEAL ROUTE

To or from the Fall Meeting
of the

AMERICAN FORESTRY
ASSOCIATION

San Francisco, October 20, 1915

N. Y.—San Francisco

Through the

PANAMA CANAL

Large Transatlantic Liners
Under the American Flag

"FINLAND" 22,000 Tons Displacement
"KROONLAND"

Circular tickets one way by water, the
other way by rail

PANAMA PACIFIC LINE

9 Broadway, New York
319 Geary Street, San Francisco

Agents Everywhere

READY NOVEMBER 1, 1914

A New Booklet on Estimating Southern Timber

Southern White Cedar
Shortleaf and Longleaf Pine
Southern Appalachian Timber

Postpaid, 20 cents

HOWARD R. KRINBILL
Forest Engineer NEWBERN, N. C.

TIMBER ESTIMATES

We make accurate cruises of standing
timber, topographical maps, and advise
as to forest management for—

TIMBER OWNERS
BONDING HOUSES
MILL OPERATORS

MUNSON-WHITAKER CO.

Consulting Forest Engineers

NEW YORK, 676 Fourth Ave. CHICAGO, 516 Comm. Bk. Bldg.
BOSTON, 622 Tremont Bldg. PITTSBURG, 906 Arrott Bldg.

TIMBER ESTIMATES

Why not have your timber estimated by competent Forest
Engineers? Somebody will do it; why not the best?

IT WILL PAY AND SAVE IN BONDING,
SELLING OR OPERATING

We make preliminary examinations; complete forest surveys, including
logging maps; valuations; and planting and management reports.

Also Specialists on Preservative Treatment of Wood Against Decay

Write for information

CLARK, LYFORD & STERLING

1331-2 Real Estate Trust Building

PHILADELPHIA, PENNA.

Declaration of Principles and Policy of the American Forestry Association

- IT IS A VOLUNTARY** organization for the inculcation and spread of a forest policy on a scale adequate for our economic needs, and any person is eligible for membership.
- IT IS INDEPENDENT**, has no official connection with any Federal or State department or policy, and is devoted to a public service conducive to national prosperity.
- IT ASSERTS THAT** forestry means the propagation and care of forests for the production of timber as a crop; protection of watersheds; utilization of non-agricultural soil; use of forests for public recreation.
- IT DECLARES THAT FORESTRY** is of immense importance to the people; that the census of 1913 shows our forests annually supply over one and a quarter billion dollars' worth of products; employ 735,000 people; pay \$367,000,000 in wages; cover 550,000,000 acres unsuited for agriculture; regulate the distribution of water; prevent erosion of lands; and are essential to the beauty of the country and the health of the nation.
- IT RECOGNIZES THAT** forestry is an industry limited by economic conditions; that private owners should be aided and encouraged by investigations, demonstrations, and educational work, since they cannot be expected to practice forestry at a financial loss; that Federal and State governments should undertake scientific forestry upon national and State forest reserves for the benefit of the public.
- IT WILL DEVOTE** its influence and educational facilities to the development of public thought and knowledge along these practical lines.

It Will Support These Policies:

- FEDERAL ADMINISTRATION AND MANAGEMENT** of national forests; adequate appropriations for their care and management; Federal cooperation with the States, especially in forest fire protection.
- STATE ACTIVITY** by acquirement of forest lands; organization for fire protection; encouragement of forest planting by communal and private owners; non-political departmentally independent forest organization, with liberal appropriations for these purposes.
- FOREST FIRE PROTECTION** by Federal, State and fire protective agencies, and its encouragement and extension, individually and by cooperation; without adequate fire protection all other measures for forest crop production will fail.
- FOREST PLANTING** by Federal and State governments and long-lived corporations and acquirement of waste lands for this purpose; and also planting by private owners, where profitable, and encouragement of natural regeneration.
- FOREST TAXATION REFORMS** removing unjust burdens from owners of growing timber.
- CLOSER UTILIZATION** in logging and manufacturing without loss to owner; aid to lumbermen in achieving this.
- CUTTING OF MATURE TIMBER** where and as the domestic market demands it, except on areas maintained for park or scenic purposes, and compensation of forest owners for loss suffered through protection of watersheds, or on behalf of any public interest.
- EQUAL PROTECTION** to the lumber industry and to public interests in legislation affecting private timberland operations, recognizing that lumbering is as legitimate and necessary as the forests themselves.
- CLASSIFICATION** by experts of lands best suited for farming and those best suited for forestry; and liberal national and State appropriations for this work.

PROFIT BY THESE PRICES on "America's Greatest Evergreen"



One of our Twice-Transplanted 2 to 3 foot grade White Pines, Finely-branched, straight-stemmed, well-rooted stock. Note prices!

WHITE PINE

Use it for Forest, Park, Grove, Lawn and Garden. Excellent for Windbreaks, Snowbreaks, Dustbreaks, Noisebreaks and Tall Hedges; for borders and avenue planting; and for otherwise beautifying estates and waste lands; for country roadsides; for underplanting in shade and woodlands; for brightening dry, barren hillsides and improving lands generally. White pine is "the very foundation of ORNAMENTAL and COMMERCIAL tree planting."

Grows rapidly; transplants easily.

WRITE TO-DAY for *New Free Catalog*. Many millions of trees for Ornament and Shade; for Forests, Hedges, Windbreaks.

NO. 1 QUALITY—Root Pruned and TWICE-Transplanted (Heavy)

3 TO 4 FEET HIGH
1000 trees **\$295**
100 trees **\$34** 12 trees **\$7**

2 TO 3 FEET HIGH
1000 trees **\$170**
100 trees **\$20** 12 trees **\$4.50**

Plant the TWICE-Transplanted Stock for QUICK Results

A Lighter Grade—ONCE-Transplanted

2 TO 3 FEET HIGH
1000 trees **\$85**
100 trees **\$10** 12 trees **\$3**

1 1-2 TO 2 FEET
1000 trees **\$55** 100 trees **\$8**

ALL F. O. B. FRAMINGHAM, MASS.

Little Tree Farms of America

Nurseries of

AMERICAN FORESTRY COMPANY

Dept. 1B, 15 BEACON STREET, BOSTON, MASS.



Headquarters for Forestry Stock

AND EVERYTHING WORTH PLANTING

Exterior Decorations

In Everything Worth Planting

SEND FOR COPY IF INTERESTED

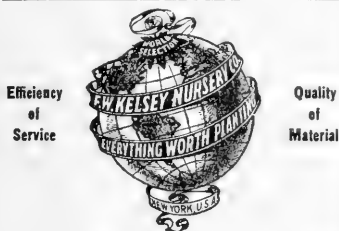

Efficiency
of
Service

Quality
of
Material

Quality should be the first consideration in purchasing Trees, Shrubs and Hardy Plants for the estate. Our Quality Evergreens, Hardy Rhododendrons, Shade Trees, Vines, Roses, etc., as for many years furnished to the leading country places, always give satisfaction.

F. W. KELSEY NURSERY COMPANY
150 Broadway, New York

You may be interested in our new illustrated book on "Exterior Decorations in Everything Worth Planting." If so please write for a copy. Mailed free.

Specials in Forestry Material

	1,000	10,000
NORWAY SPRUCE. 4 yr. Transplants.	\$6.50	\$55.00
NORWAY SPRUCE. 3 yr. Seedlings...	3.50	28.50
NORWAY SPRUCE. 2 yr. Seedlings...	3.00	21.00
WHITE PINE. 3 yr. Seedlings.....	4.00	27.00
WHITE PINE. 2 yr. Seedlings.....	3.00	21.00

The finest Hardy Domestic Northern Grown Stock at very favorable prices.

FOUR MILLIONS

of these two leading hardy varieties for Forestry Purposes. We began the season with this surplus. Are you going to take advantage of this favorable opportunity for superior FOREST PLANTING AT THE EXTREME MINIMUM COST? We can make you a special proposition by the 100,000 or more that will merit the award of your order if interested in planting these species. Let us also quote you other Forestry Requirements.

Deciduous Seedlings and Transplants of all kinds, including Tulip Poplar, Liriodendron Tulipifera, etc., etc. Write for quotation.

F. W. KELSEY NURSERY CO., 150 BROADWAY, NEW YORK

American Forestry

VOL. XXI

APRIL, 1915

No. 4

FORESTERS IN THE GERMAN ARMY

By T. R. HELMS

A GERMAN Army Corps, as known, is a complete unit—it consists of Infantry, Cavalry, Field Artillery, Siege Artillery, Pioneers, Railroad Service, and one Battalion of Jaegers (foresters). Each Army Corps has one Jaeger Battalion which in the Garde Corps is called the Garde Schützen Battalion.

The Jaeger Battalions of all the Prussian Army Corps are not classed as ordinary Infantry, but are under a separate head, known as "The Inspection der Jaeger und Schützen," which prescribes all tactics, service, etc. The uniform, equipment and arms of the Jaeger Battalions differ radically from the equipment of the other infantry. While in ordinary times the coats of the infantry are blue, the Jaegers have green uniforms; the infantry have the bright spiked helmet, the Jaegers have a leather headgear like the "Landwehr" and there is absolutely nothing bright about it.

The back cover of the knapsack of the infantry is calfskin with the hair on, and colored a reddish brown. The knapsack of the Jaegers is adorned with the skin of a badger even with its head on and its natural long hair and natural color. While the infantry is equipped with the uniform rifle and bayonet, the Jaegers have a lighter and shorter rifle, known as "Jaeger Büchse," Hunters Rifle, and their side arm, which is also fixed so that it can be used as a bayonet, is longer than that of the Infantry, and is known as "Hirschfänger"—Deer Knife.

The tassels, which fasten to the belt and adorn the side arms of the infantry,

are of different colors, and each respective color signifies the respective company of the battalion. The tassels of the Jaegers are green and the tassels of the noncommissioned officers of the Jaegers are made of green silk and silver, much more ornamental than the tassels of the noncommissioned officers of the Infantry, which are made of cotton. The tassels of the officers of the Jaegers are made of poor silver.

The noncommissioned officers of the infantry are called Unterofficier and Sergeant, while in the Jaeger Battalions they are called "Oberjaeger."

The Jaegers are trained principally for Scout Service, and their formation, tactics, rules and regulations are different from those of the Infantry. These are formulated by the "Inspection der Jaeger und Schützen." The target practice is much more extended, exacting and elaborate than that of the Infantry and a much higher percentage of markmanship is required from the Jaegers and accurate shooting in any and all positions, is the object of the shooting practice. The bayonet drill is practised to the same extent, but at the same time the rules forbid the placing of the side arm as a bayonet on the rifle. The reason is, that the muzzle of the rifle might be damaged and thereby injure its efficiency.

In times of war or at army maneuvers, the Jaeger Battalion is attached to a brigade or division of Infantry by orders of the Commander of the Army Corps, and then sometimes curious incidents and quite often confusions occur on account of the difference in their formation and tactics. When an



Copyrighted by Underwood & Underwood, New York.

GERMANS SAWING FRENCH TREES.

IN THIS FIELD SAW MILL IN THE VALLEY OF THE AISENE THE GERMANS ARE MAKING PLANKS FOR BRIDGES, PONTOONS, ETC., FROM SOME OF THE TIMBER THEY HAVE CUT FROM FRENCH FORESTS. THE JAEGERS ARE CHIEFLY USED FOR THIS WORK. MUCH FRENCH TIMBER HAS BEEN SHIPPED TO GERMANY AND THERE SOLD OR USED FOR GOVERNMENT WORK.

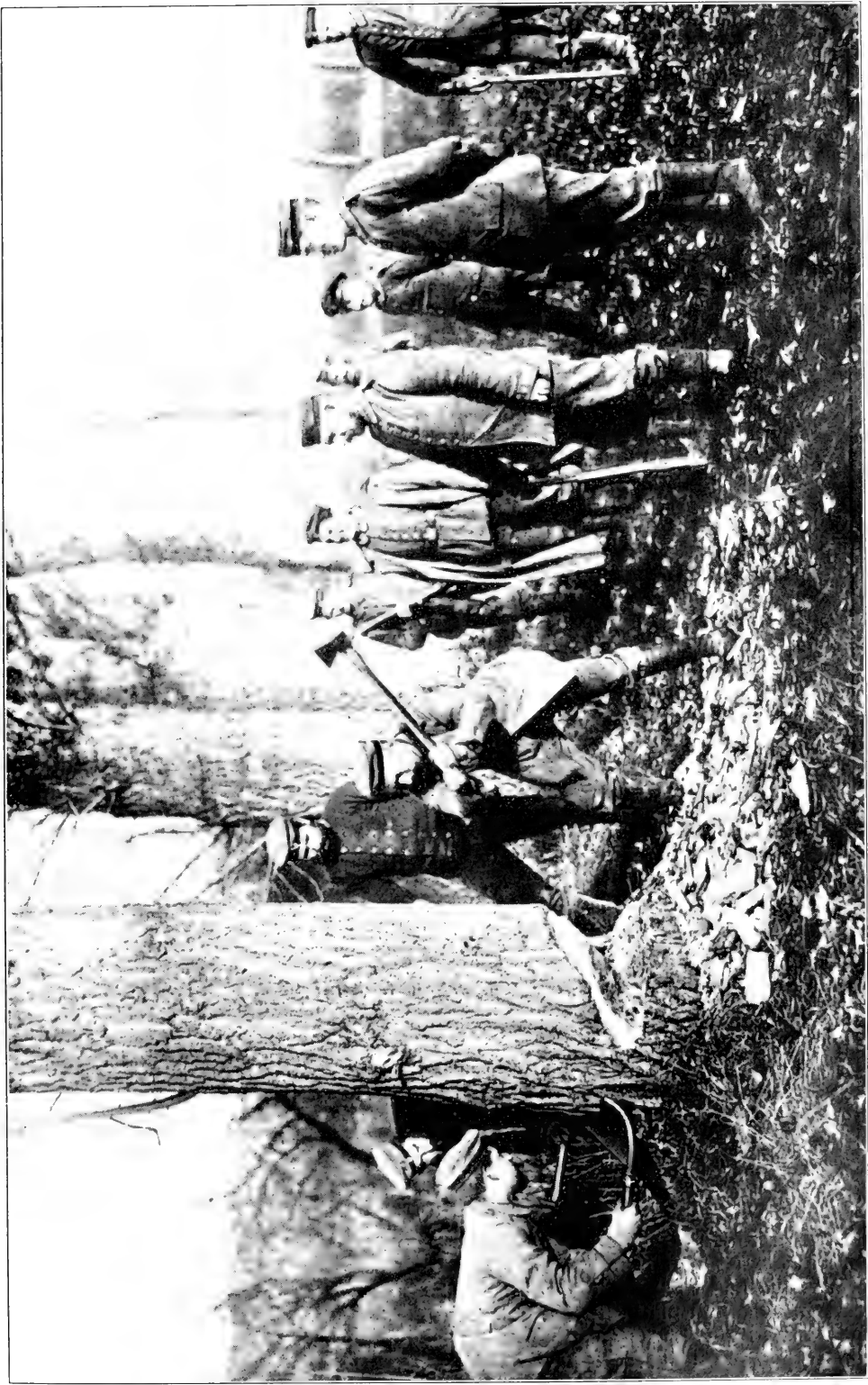

Copyrighted by Underwood & Underwood, New York.

GERMANS CUTTING FRENCH TREES.

REPORTS SAY THAT THOUSANDS OF TREES IN THE FORESTS OF NORTHERN FRANCE WHICH ARE OCCUPIED BY THE GERMANS ARE BEING CUT DOWN BY THEM AND USED EITHER ON THE FIELD FOR VARIOUS PURPOSES OR SOLD IN GERMANY. THIS PHOTOGRAPH WAS TAKEN IN THE VALLEY OF THE AISNE.



Copyright by Underwood & Underwood.

FOOT BRIDGE BUILT BY THE GERMANS.

THIS HASTILY CONSTRUCTED BRIDGE OVER THE YSER CANAL WAS BUILT BY GERMANS OUT OF TIMBER MANUFACTURED IN THEIR FIELD SAW MILLS FROM TREES CUT ON THE FRENCH FORESTS.

Army Corps or a division, or brigade parades before a General or the Kaiser himself, and the orders of the commanding general are for all infantry to parade with fixed bayonets, the Jaegers do not fix their bayonets.

As is known, the active service in the Infantry is two years. In the Jaeger Battalions it is from two to three years.

Each Army Corps has one Jaeger Battalion, consisting of four companies, of one hundred men each in times of peace, but in times of war or complete mobilization the battalion numbers 1,000 men and each company contains 250 men.

Under the law of Prussia, every male citizen, in the year that he reaches the age of twenty, has to present himself at a certain time and place, designated by the authorities, for inspection in regard to his physical condition for army service, and as many men as are

needed, are picked out, and assigned to the different arms of service. But if any person desires to serve in a special regiment, or has a liking for cavalry, artillery, etc., he volunteers at the age of nineteen, and has the privilege then of choosing the kind of service that most appeals to him. Under this ruling all the foresters, apprentices and those in the Forestry Service when they reach the age of nineteen, volunteer, and of course choose the Jaeger Battalion of the Province in which they live. As there are not enough foresters to complete the quota of men needed, the balance of recruits is furnished by the recruiting commission, which picks out men that in their opinion are mentally and physically fit for service in a Jaeger Battalion.

When the time arrives for the recruits of the year to join the colors, the volunteer foresters present themselves at the

Headquarters of the Battalion two weeks before the conscripted recruits arrive. This gives them seniority over the other soldiers, who as a rule are considered by the foresters only as an adjunct to fill out the ranks. The foresters form the nucleus of the Battalion, and all non-commissioned officers are foresters; none but a forester can rise higher than a private. The common soldier only serves two years, whereas the forester has to serve three years, in order to make a better soldier out of him and prepare him to be a non-commissioned officer in case of need. Those who become noncommissioned officers, and stay with the colors for twelve years, are given positions as Government Foresters. While the foresters serve in the Jaeger Battalion to

receive a military training, they also get technical and practical training in forestry.

All this applies to the common foresters; the "Oberförsters," Head Foresters, must secure a thorough education and study forestry at an Academy of Forestry. They attain standing as commissioned officers in the military service and serve mainly in a Special Organization known as "Berittene Feld Jaegers," Mounted Field Dispatch Carriers, and in times of war are attached mostly to the staffs of the different organizations.

By all this it will be seen that the forestry service personnel occupies a distinct and exclusive place in the German Army.

SWEDISH FOREST FIRE INSURANCE

From "SKOGEN," Stockholm, January, 1915

Translated by C. A. Lindstrom

STEPS are under way in Sweden to organize the Swedish Mutual Forest Fire Insurance Company.

The company has issued its first memorandum to forest owners and others interested in forest protection. This memorandum reads in part as follows:

"The company will issue insurance adjusted to the needs of owners of both small and large forest areas, and the terms of insurance are to be adjusted to meet the actual requirements of individual cases. For instance, the company will issue insurance,

1. On the soil, the ground cover and the non-merchantable timber,

2. On the above and the merchantable timber,

3. On either of the above, with proviso for certain risks to be assumed by the owner.

"Through appropriate combinations of these forms of insurance, the Swedish Mutual Forest Fire Insurance Company hopes to satisfy the insurance needs of the owners of large as well as small tracts, and at rates easily within the reach of the insured, who hitherto each

summer have had to shoulder the burden and worry of the fire risk.

"The company's organization committee begins its work with great expectations, since it has been able to enlist the support of the necessary capital and besides will have the backing of a large insurance company. Furthermore, the committee believes that it can rely on the general interest in forest fire protection, and the knowledge of its importance, to aid in the movement to establish a rational forest culture and care.

"The memory of the tremendous forest fires of 1914, and the anxiety with which these have caused forest owners to view the situation, should also prompt them to cooperate towards the establishment of an effective protection against this hazard, especially since now, after many groping attempts, a powerful initiative is under way.

"Letters and other communications from those interested should be addressed to Organisationskommitten för Svenska Skogsbrandförsäkringsbolaget, Oceans kontor, Storkyrkobrinken 11, Postbox 24, Stockholm."

UNCLE SAM IN THE MOVIES

By C. J. BLANCHARD

Statistician U. S. Reclamation Service

THE value of the moving picture has been recognized for several years but the Government has been rather slow in adopting it in connection with its publicity work. Last year, there was a general awakening and under the impetus of a big National exhibit at San Francisco, the bureaus of several executive departments set their operators at work with the result that many thousands of feet of film were

exposed and a comprehensive exhibit of Federal Activities in motion pictures is now available. The Reclamation and Forest Service Bureaus, for several years, have been collecting negatives, both still and moving, illustrating progress and development, all of which have proven of value in educational work. The pictures showing the engineering work of road building, construction of huge dams, excavation of tunnels



PEACHES—BOTH.

THIS WAS THE TITLE WHICH UNCLE SAM'S MOVIE OPERATOR THOUGHT SHOULD BE ATTACHED TO THIS PICTURE; ONE OF A FILM SHOWING FRUIT GROWING IN THE WEST.

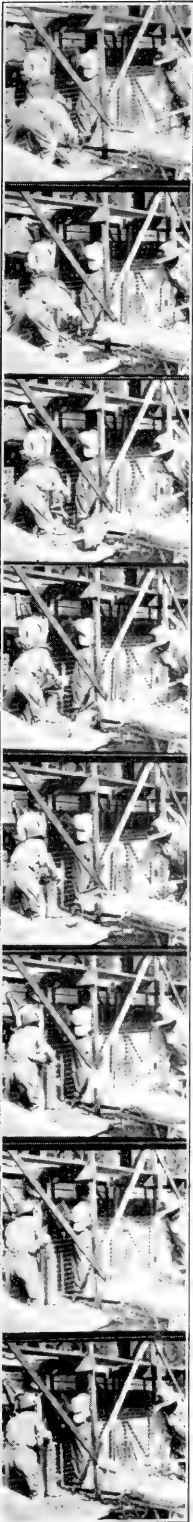

and canals, modern and scientific methods of forestry and lumbering and the use of new machinery in placing concrete, have been widely used and have resulted in increased efficiency on all works underway.

On several of the irrigation projects, where important work is in progress, the camps have been provided with a theatorium and evening picture shows are given, open to employes and their families. The small admission charged has sufficed to return all expenditures for films and equipment. These entertainments have provided amusement and relaxation for the employes located as they are, far from the cities and cut off from the enjoyments of the towns.

They have served another purpose to those actually engaged upon the work, enabling them to study the methods of other engineers. They have stimulated the men with greater zeal in their work and have encouraged the development of new and original plans for labor saving devices. The plan of exchanging films between projects has familiarized the men with all the work and has resulted in speeding up their own activities.

Arrangements are made with reputable film exchanges for the latest and best dramas and educational subjects so that the usual entertainments are as good as those given in the large cities.

Last summer, with funds contributed from the Exposition appropriation and by civic associations and railroads, I laid out a western trip covering about 17,000 miles of Reclamation territory and including subjects on Indian Reservations en route. I was accompanied by our official photographer, Mr. H. T. Cowling, with a full photographic equipment of cameras, films, etc. Nearly 20,000 feet of film were exposed and about 800 negatives of still pictures were taken. We were quite fortunate in having good weather throughout most of the trip and secured excellent film and photographs.

Our first stop was in the Rio Grande Valley, New Mexico-Texas, and our subjects covered an area about 120 miles long. Our experience at Elephant Butte was somewhat exciting as our movies included a number of spectacular

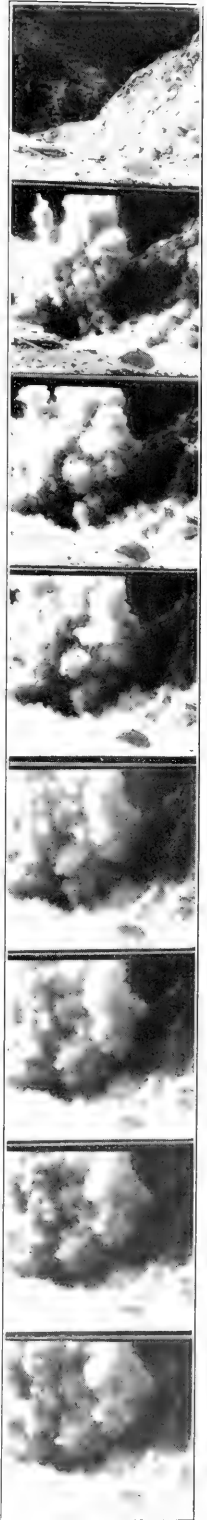



IN SHOSHONE CANYON.
THE CAMERA WAS STRAPPED IN THE AUTOMOBILE FOR A DASH THROUGH THIS PICTURESQUE CANYON.



SHOWING DEVELOPMENT OF A HOMESTEAD.
THE HARVESTING STAGE OF A HOMESTEAD SETTLEMENT DRAMA WHICH FOLLOWED THE DEVELOPMENT OF THE LAND
FROM A NON-IRRIGATED DESERT TO AN IRRIGATED AND PRODUCTIVE FARM.

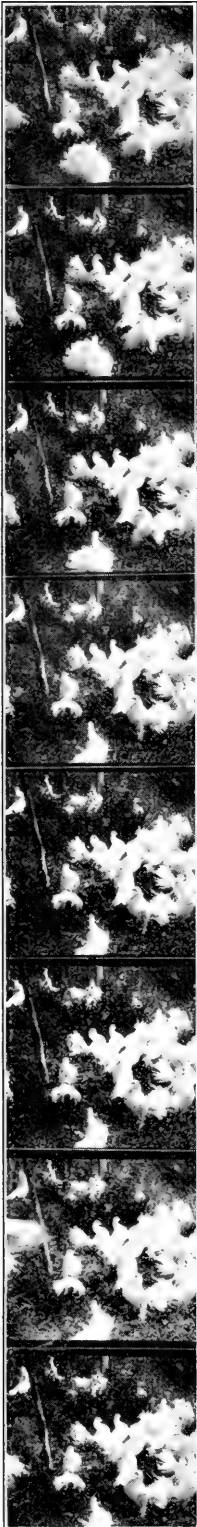

incidents in connection with the construction of the huge dam in the Rio Grande Canyon. Taking pictures from a skip while crossing the canyon on the cableways, 400 feet above the river, furnished some thrills but did not result in very good film owing to the swaying of the car and perhaps also to the nervousness of the operator and those who assisted in holding the camera steady. Standing directly under a 17-ton derrick while it was being swung skyward on the cableways tested our composure but in this instance, we secured a splendid film.

On the Salt River project, we found excitement in taking pictures from a rapidly moving auto on a ticklish piece of mountain road skirting a canyon 1,000 feet deep, and later in a trip across the top of the Roosevelt Dam where the speed limit was overlooked. The camera was tightly strapped to the car and then held in place by two men who clung to the tripod while the operator turned the crank. There were moments when the taking of pictures ceased to interest us, particularly when the car swung sharply on the curves and a chasm, which seemed bottomless, yawned below us.

On the big ostrich farm in the valley, the camera was set up in a lane and 1,000 full grown birds were driven directly toward it. If you have never faced an army like this, you can not appreciate the tremors you feel, particularly when you recall the fact that a Missouri mule has nothing on a full grown ostrich in the way of a kick. It was a toss up, however, as to which was the more frightened—the operator or the birds.

At Yuma, on the fourth of July, with the thermometer at 118, we gathered excellent material for our exhibit, in quarry blasts, huge steam shovels and a trip on the new Government railway, down the levees on the Colorado River. A close-up view of the cars dumping rock and the leveller smoothing the levee top gave excellent results. A week later, at Riverside, California, 1,000 feet of excellent film were made at the Indian school. Our subjects here covered the whole institution and showed the Indian boys and girls at work and play.





Five days at the Grand Canyon were productive of some extraordinary film. Here the operator used a filter with splendid results. This great chasm has proven a difficult subject for the moving picture man. The Canyon, which is more than a mile deep, is always partly obscured by a bluish haze which the lens seldom penetrates. The opposite cliffs, nearly a dozen miles away, are usually indistinct and blurred. By using a filter and slackening the speed of the shutter, the distant cliffs and their delicate and intricate carving were sharply revealed, while, at the same time, the towering pinnacles and numerous lesser canyons between were all in view.

The Colorado in flood, offered a fine subject for the camera, and a touch of excitement for the operator whose pictures were taken while standing on slippery rocks, splashed with the spray of huge waves dashing at his feet. We utilized a number of Hopi Indians to add a touch of life and the picturesque to these views.

In Nevada, we were so fortunate as to be on hand when the last bucket of concrete was placed in the Lahontan Dam, a unique structure with enormous concrete spillways arranged in steps. In addition to numerous farm and crop scenes, our films show an interesting experiment in cooperation. Nearly 100 farmers with teams, cleared and levelled ten acres of sage brush desert for a new school site, the land for which had been donated by Secretary Lane. There is also a round-up of about 1,000 head of steers with a little bucking broncho and bulldogging thrown in for good measure.

In Idaho, on the Minidoka project, our subjects were varied. Standing on a boulder in Snake River immediately below the Minidoka Dam, the operator focussed on the big Tainter gates and gave the signal to open. A wall of water 10 feet high, shot out like a catapult straight at him, and the spray of the mighty wave as it dashed against the rocks drenched him to the skin. Quick action in closing the gates prevented any more serious consequences of his daring but the picture was fine. There were many interesting

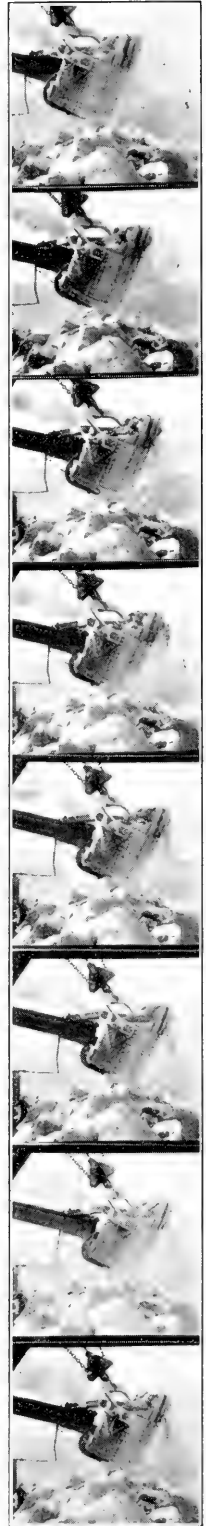

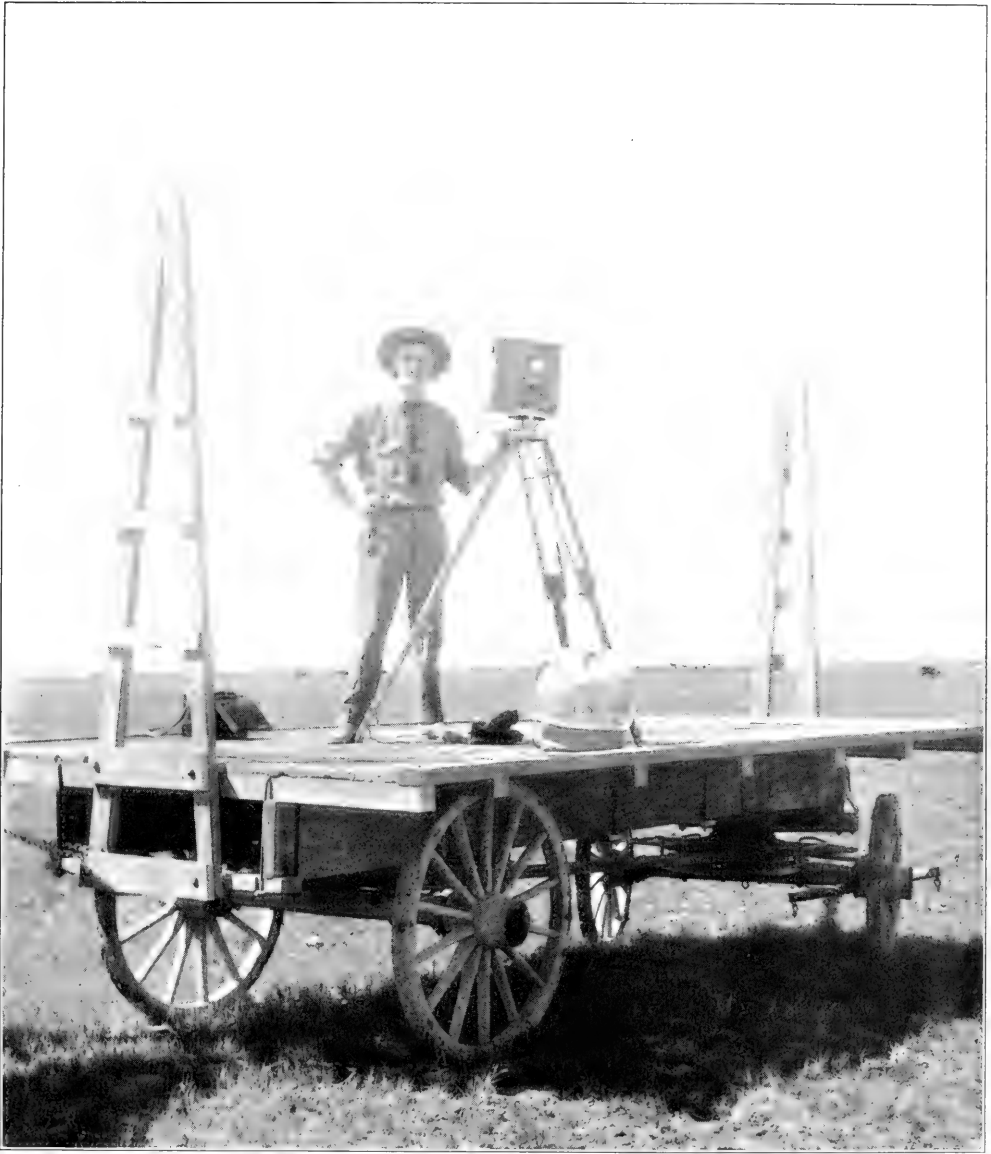

MOVING PICTURE OF A ROUND-UP

THE OPERATOR POSTED TO PHOTOGRAPH THE ROUND-UP OF 1,000 NEVADA STEERS ON A PIECE OF LAND IRRIGATED BY ONE OF THE RECLAMATION SERVICE PROJECTS.

views showing caterpillar drag line excavators and scoop wheels lifting water, all electrically operated.

On the Boise project, a number of exposures were made from the top of Arrowrock Dam, which is to be the highest in the world. Perched on a narrow platform 300 feet above the river, the camera was set to show the entire process of placing concrete. An

entirely new and exceedingly unique method is employed, the whole presenting an especially fine subject for a picture. From a large mixing plant on the side of the canyon, two huge buckets were in operation, loading concrete and then swinging on the cableways to receiving buckets on top of the dam. The receiving buckets, suspended from the cableways, took their loads and

discharged them through pipes to various sections of the dam. The pipes were movable, permitting the spreading of concrete to any point within a given radius. By this method 60,000 cubic yards of material go into the structure each month. One piece of film was made from the Government train which

Valleys during the fruit picking season, and excellent orchard views resulted.

In Montana, the scenes on the Lower Yellowstone and Huntley projects were of crops. The harvesting of sugar beets furnished an excellent subject.

Encouraged by our successes on other projects, when we reached the Shoshone

project in Wyoming, we determined to enter the dramatic field. Accordingly, we devoted some time in staging a Reclamation photo play, the characters for which we had to seek on the project. Westerners, you know, are versatile. It was no trick at all to round up the very people we needed, although the full cast called for no small amount of talent. Our drama, founded upon fact, is the story of a settler who takes up a Government farm. The heroine, a school teacher from Illinois, decides to quit her job and ventures into the new West. She, too, locates a farm and hires her neighbor, the bachelor homesteader, to put it into crops. Through the various steps of making the desert blossom, there runs a vein of romance and a touch of tragedy for the heroine's home is burned down during



THE HEROINE OF THE GRAND CANYON FILM.

THIS CHARMING YOUNG LADY WAS THE STAR OF THE PICTURE STORY TAKEN FOR THE RECLAMATION SERVICE IN THE GRAND CANYON OF THE COLORADO.

carried us through the big camp and into the steep walled canyon. All the views were impressive as this great structure is to be the most spectacular work ever undertaken for irrigation in this country. It will be 350 feet high and 1,200 feet long on top, and will contain 500,000 cubic yards of material.

In Colorado, our views were mostly crop scenes. We were fortunate in being in the Uncompahgre and Grand

her absence. The betrothal comes when the young farmer tries to comfort the heroine in her loss. The film, in progressive steps, shows the desert, plowing, levelling, irrigating, seeding, harvesting, and threshing, and in the final chapter, two years later, in the new home, there is a baby.

These films are to be shown in daily lectures at the Panama-Pacific Exposition and should serve to acquaint the



A WESTERN PEACH TREE.

THIS IS ON LAND WHICH ONCE WAS A BARREN DESERT BUT WHICH NOW BOUNTIFULLY PRODUCES FINE FRUIT AND FARM PRODUCTS. THIS FILM SHOWS THE WONDERS OF IRRIGATION.

public, not alone with the activities of the Service, but also with the opportunities for homemaking in the West.

After the Exposition is over, they will be useful in the lectures which have become an important function of the publicity work of the Reclamation Bureau.

The War and Navy Departments are entitled to special mention in connection with the utilization of the moving picture. Orders are about to be placed for more than 100 projecting machines which will be installed in numerous forts, in the field and on several battle-

ships. Soldiers and sailors are to enjoy the same films which today are viewed in every city and town in the world, the service to be obtained through the regular exchanges. Films will be used also for educational purposes in connection with the training and fitting of the men for their various duties.

Excellent film was obtained last summer by several bureaus of the Department of Agriculture, by the Bureau of Mines, the Geological Survey and Life Saving Service. The activities of the Government in Alaska are quite fully



OPENING THE GATES OF THE DAM.

HERE THE MOVIE OPERATOR TOOK A DARING CHANCE IN ORDER TO CATCH THE GUSH OF WATER WHEN THE GATES OF THE BIG MINKOKA DAM IN IDAHO WERE OPENED.

portrayed on several thousand feet of film.

The presentation of these films at the Panama-Pacific Exposition, and later,

before popular audiences throughout the country is bound to make the general public more familiar with our Government and its functions.

Grow Half an Inch a Day.

Observations at the Utah Experiment Station show that aspen sprouts from good stumps attain a maximum height growth during the summer season of over one-half inch per day.

Coyote Hunting Profits.

Nine hundred coyote pelts were submitted to the Lincoln County, Wyoming, Woolgrowers' Association, at its recent meeting, for the bounty of \$2.50 apiece, offered by the association.

Wood Pulp Timber on the Teton Forest.

The Forest Service has just completed an estimate of the timber of the Teton Forest, adjoining the Yellowstone Park on the south, and finds that it contains sufficient spruce, fir, and pine timber suitable for wood pulp to supply a mill of 150-ton a day capacity. Power for such a mill can be supplied by Pine or Rainey Creek, tributaries of the Snake River, and the Snake River will transport the bolts of wood from forest to mill.



THE STIRLING ELM.

ANOTHER LARGE ELM

THE statement that the Benedict Elm in the township of Wilton, Fairfield County, is the largest elm in Connecticut, is challenged, and with just cause, by the claim that the Stirling elm on the country place of Mr. Henry E. Pellew, at Sharon, Litchfield County, Conn., is considerably larger. The Sharon elm at $4\frac{1}{2}$ feet above the ground, is 14 feet $11\frac{3}{4}$ inches in circumference and the spread about 105 feet, while the Stirling elm, which was planted between 1750

and 1755, and is now about 160 years old, is 18 feet in circumference at a point 4 feet above the ground. Six years ago it was 6 inches larger, the reduction since then being due to the necessity of scraping the bark which was infected by the elm bark beetle. The greatest spread of the Stirling elm is about 90 feet, it being exceeded by the Benedict elm in this particular alone.

In the neighborhood are several white oaks and sugar maples which are over 16 feet in circumference.

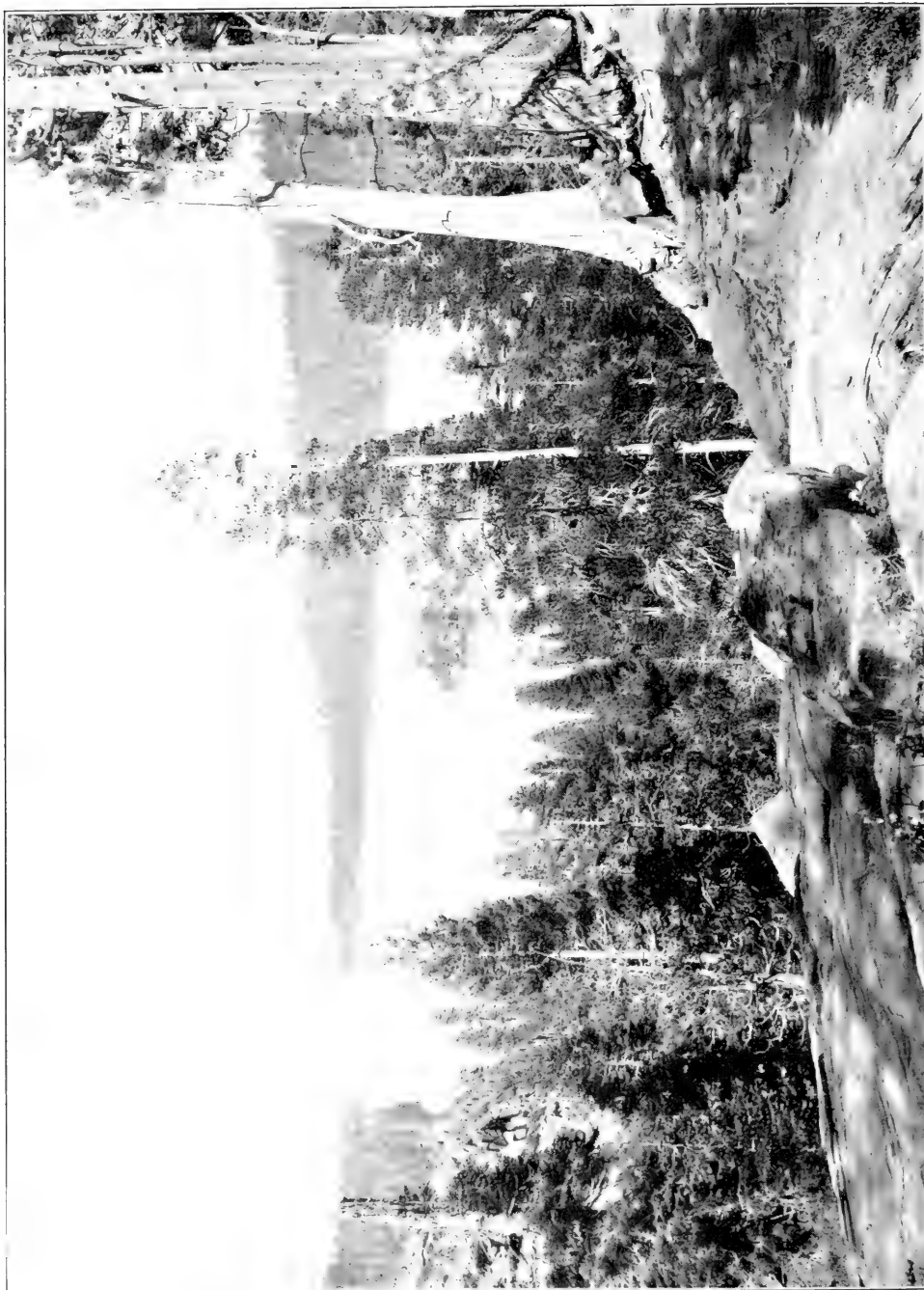

THE FOREST WILDERNESS.
WHO WOULD NOT BE ATTRACTED BY THIS BEAUTIFUL COMBINATION OF FOREST, LAKE AND MOUNTAIN, OFFERING AS IT DOES SUCH GREAT VARIETY OF
RECREATION.

FORESTS AND RECREATION

By WARREN H. MILLER, *Editor Field and Stream*

AT LEAST once a year, even to the most cultured of us, there comes that primitive appeal, the call of the Red Gods, and we long to get away from the worry of civilization and plunge into the wilderness, alone, or with that treasured possession, a real friend.

The mountained forests stretch endlessly before our eyes; the oaks and maples and hickories clothing the hardwood ridges; the pines, the balsams and the hemlocks filling the rocky ravines and lining the water-courses. Here a lake, looking up to the sky in spotless azure; there a tiny pond, girt with dead timber; yon a tangled marsh grown over with dense thickets of alder, briar and gum. Within the green depths the wild creatures, these children of Nature, go about their life work; the shy deer nibbling the green grasses in the hollows; the lordly elk feeding in the mountain meadows; the predacious creatures—wolf, lynx and mountain lion—watching the trails and runways; the mink, otter and weasel following the water-courses; the wild turkeys and ruffed grouse scratching acorns and weed seeds on the hardwood ridges; while over it all

the song and movement of the smaller bird life attracts the eye. A dimple on the placid surface of the lake speaks of the rise of a large trout, while a sudden splash and the interrupted croak of a frog tells of the swift strike of the black bass at his prey on the lily pads.

Nature is kind, and abundant, and lavish in her hospitality to the forest man who really knows her, to whom her trees are not just trees but oaks, maples, balsams, hemlocks, each having their own particular uses and virtues in her scheme of existence; to whom her plants and rocks are known by name; to whom her birds and animals are brethren of the wild whose habits and customs are familiar; her fishes and reptiles a matter of everyday knowledge. Such a man, possessed of the skill and knowledge which fits him to take his niche in the life of the forest, has the cornucopia of plenty showered upon him; his burden of life is light; he has ample time to develop those nobler qualities of the soul too often grown up with tares in the worry and fret of civilian existence. For, out of the wilderness have come the great truths that are the foundations of right living:



BASS FISHING IN A MOUNTAIN LAKE.

WERE IT NOT FOR THE WELL FORESTED HILLS AND MOUNTAINS THERE WOULD BE NONE OF THIS BASS FISHING AND NO ATTRACTIONS AT THESE LAKES FOR THE RECREATIONIST.

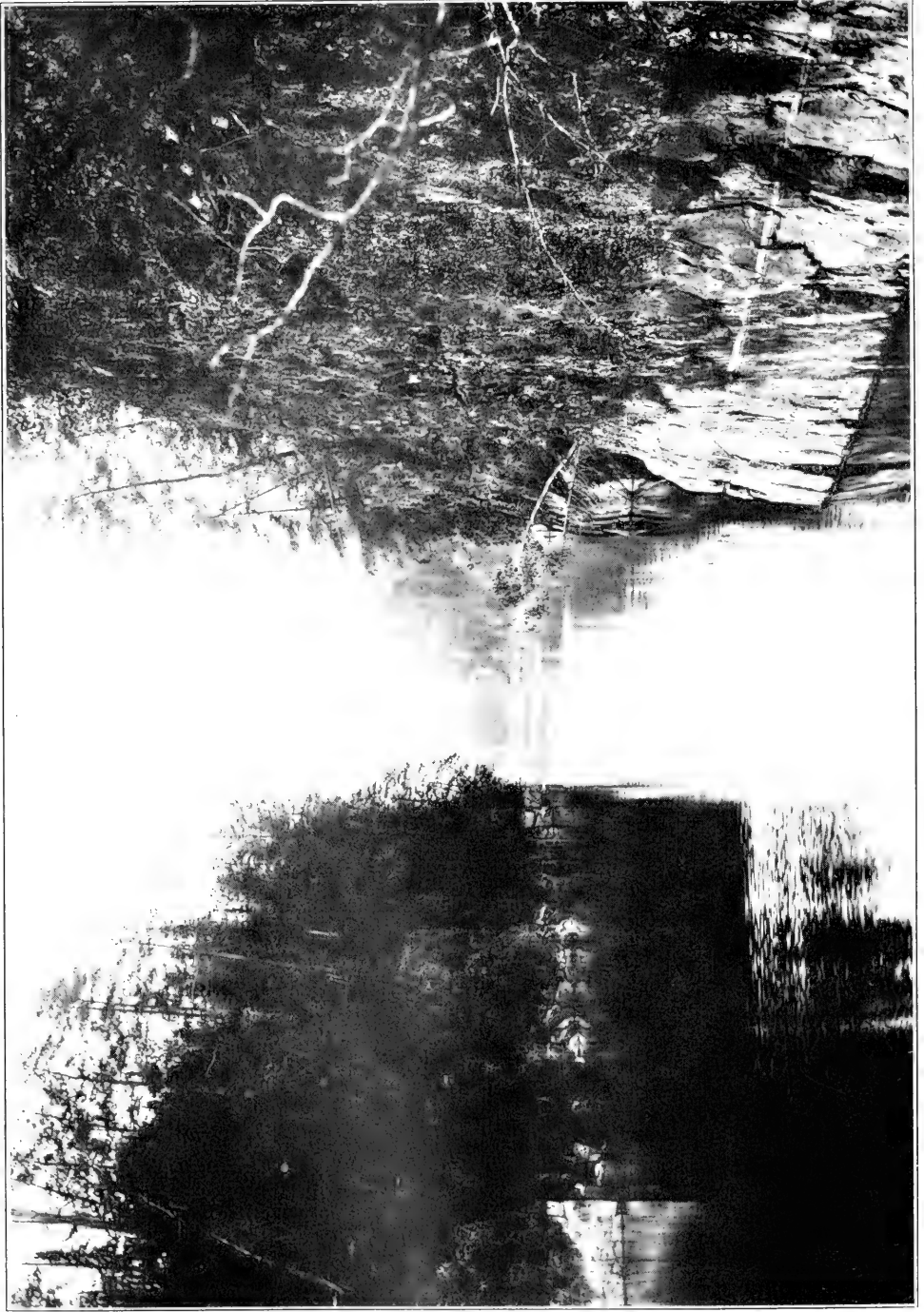

A CANOE ROUTE IN THE NORTHLAND.
WINDING THROUGH HEAVY FORESTS THIS STREAM OFFERS A DELIGHTFUL AND EASY TRAIL FOR THE HUNTER OR RECREATIONIST ON HIS WAY TO OR FROM THE WILDS.



TROUT FISHING IN THE WEST.

THIS TROUT STREAM RISES IN A DENSE FOREST AND FLOWS THROUGH FORESTED LAND ALONG ITS ENTIRE COURSE. THE FACT THAT IT IS PROTECTED BY THE FOREST INSURES PURE WATER, FEW IF ANY FLOODS, AND FINE SPORT.

out of the voice of the wilderness have spoken the prophets that have swayed mankind.

We go into the forest to think; to observe the ways of the wild things; to sweeten our souls with the contemplation of scenes of natural beauty—not to worry and fret and use up our time in contending for the right to live. And, to put this necessity under our feet requires knowledge, power, skill, judgment, the first requisites of a woodsman.

Everything nature requires of you, personally, is somehow learnt with a far greater zest than any lesson taught you in preparation for the battle of civilized life.

How old must a boy be to start his lessons in the school of the woods? Well, I know many of seventy, and not a few of seven years; the former pathetic in their unconscious regret for all those years that have gone forever, when now, at the evening of life, they are learning the lessons, so long neglected. I hear the wail, again and again, from these grey-beards—"too old!" "What, I go canoeing down a wilderness river? I camp out in the mountains with rod or rifle? I hit a flying quail with a shotgun?—alas! young man, my shooting days are over; in fact, they never began!"

How absurd! What of John Burroughs, and Dan Beard and John Muir, that grand old man of the forest lately gone from amongst us in the prime of a hale old age. I will tell you a miracle, one of the secrets of the forest;—the man who attends her school grows young—actually and physically, year by year, younger! With most of us age is not a matter of years but of wear and tear. The ravages of civilization are hard to repair and never can be eradicated; but I have seen young men of twenty-eight who looked forty-five, and in four years of assiduous attendance upon the school of nature put on the physical trim of forty, and in another two years actually catch up with their own age in years and come out, at thirty-four, actually thirty-four in physical body. And what of the mind, meanwhile? Broadened, sweetened, increased fourfold in vigor, cleansed of

pessimism, of the little cantankerous affections of the temper that had been slowly eating away the soul—all this and more, those four years as really earnest devotees of the outdoors!

Another wail:—"I am too old to learn—now." One that we hear on every hand. He doesn't know where to begin; nature-books put him to sleep; and, as fast as he loads on a store of facts, they slip away from an indurated memory-pad that long since has had to depend upon notebooks to retain them.

You are going at it wrong, brother; your idea is one of those man-imagined artificialities that Nature does not recognize. Nothing in Nature can be learnt from a book. You can read it in a book; but if it is going to stay with you, to become part of you, the lesson must be practiced in the forest itself. Take the book in hand into the forest, if you will; but take the object studied in your own hand; do with your own body the directions written in the book; work at it until you really know—that is Nature's way! I tell you that to become proficient in the six weapons of the outdoorsman alone—rifle, revolver, shotgun; fly rod, baitcasting rod and surf rod—will furnish ambition enough for a lifetime of recreation; and that takes no account of the side arts that go with the Big Six—camp craft; canoeing, both salt and fresh water; woodcraft; forestry; horsemanship; dog training; outdoor photography; snow travel; and all the branches of natural science. The more you know, the greater your enjoyment of the forest—you can begin anywhere in the school of the woods, and specialize according to your tastes.

There is an old legend connected with the custom of clinking glasses when men drink together. It is that it was done to produce a sound, so that all the five senses, the whole man, should partake in the ceremony of a toast. In the same way, at least one of the Big Six arts of the outdoorsman should be present in the equipment of any man who goes into the forest, so that the whole man may be present; for the Six Arts—rifle, revolver, shotgun and the three fishing rods—represent the mastery of man over the forest; without



THE GREAT WELL FORESTED VALLEY LIES IN THE MIDDLE DISTANCE, AND IN THE FAR BACKGROUND ARE THE SNOW-CAPPED MOUNTAINS.

THE COMPANIONSHIP OF TREES.



IN THE FORESTED NORTH COUNTRY.
ONE OF THE DELIGHTS MADE POSSIBLE BY THE USE OF THE FORESTS FOR RECREATION.

at least one of them he cannot feed himself, cannot take his share of the food that is spread abundantly in her scheme of things, cannot support himself in her world.

Of what avail is the most exhaustive knowledge of botany, of bird life, of photography, of canoe and camp craft, if a man is impotent to secure for himself the food to keep life in his body! Need be or need not be, one should be able to say: "This game I *can* take, in case of necessity; I have the conquering skill to wrest from Nature my share of her bounty, nor all her wiles nor all her wariness shall deny me! I am a whole man! I can support myself in this world of hers and still have the time to pursue such studies as interest me!"

Choose one of the Six Arts or choose them all; there is infinite pleasure in store for you in acquiring the skill to use them efficiently. And none of them is essentially a young man's art. Unlike the strenuous labors of the football field, the diamond, the tennis court, there is nothing in the Six Arts that demands the muscles of youth; nothing that is forbidden to the settled and less flexible bodily organs of age.

The steady hand that sights the rifle; the swift arm that points the shotgun; the delicate muscles that wield the trout rod, or place the bass lure with ease and accuracy, or cast the pyramid sinker out into the ocean's surf, belong quite as much if not more to the grey-beard as to the youth. Beginner's awkwardness there will be, at first, and the training of many little muscles long since atrophied by the disuse of civilization, but the older man, with his keener directing mind, is likely to acquire proficiency sooner than impatient and careless youth, too prone to tolerate faults that make for poor form.

In the most representative body of sportsmen that I know, the Camp Fire Club of America, the best rifle shots, the winners with the fly rod, with the revolver and the baitcasting rod, are grey-haired men in their fifties—the younger element is not to be compared with them in these essentials of the outdoorsmen. The latter win in the canoe and portage, horse packing, tomahawk, and to a certain extent with the shotgun; but the grey-beards outshoot them and outcast them when it

comes to weapons of precision, the weapons that count in Nature's world.

And the charm, the thrill that comes with mastery of these tools of the forest, the woodcraft and animal craft and fish craft that accompanies their successful use on wild game!—no man-made artificial sport, hemmed about with arbitrary restrictions, can in the least compare with these great games of life as played in Nature's school!

And, as you learn them, all the lesser and concomitant arts follow, as the premise and conclusion. You cannot hunt big game with a rifle without picking up the ways of trail and forest, without learning much of the natural history of your quarry. You become initiated into the mysteries of canoe and pack saddle; of the ways of white water and how to manage a canoe in it; of the stories told by faint tracks and the bend of a blade of grass in a mountain meadow; of the intricacies of the diamond hitch and the perversenesses of pack horses; of the signs of the weather and the shifts of the wind—a thousand things that the school of the woods has to teach you, the ignorance of which spells failure.

You cannot follow the double gun very far without learning, from intimate contact, something of the appeal of brown uplands clothed in October colors, of vast marshes teeming with every kind of life, without getting some appreciation of the matchless cunning and wariness of the wildfowl, and the grouse and quail.

And to succeed with them—ah! that takes the whole of a man! For, nowhere else are you so absolutely dependent upon your own individual skill. A guide may lead you to big game, furnishing the woodcraft that you may lack, asking only that you do not spoil the stalk with cracked twig or incautious exposure; he may even, let us whisper, kill the game for you on your miss! But, in wing shooting—it's up to you! Hit or miss, full bag or empty, it depends alone on you!

And then the devotee of the fly rod! He may be, and probably is, a student

of botany and a nature lover; but he is first of all an angler. The school of the woods made him curious to learn more of the forest, and its beauties attracted his mind to a more intimate acquaintance. The winding trout stream, flowing through the most beautiful scenery that the forest affords, makes his way one of charm and plentiful delight, but the actual taking of the wily trout—that is another story. A story of sternness, of skill, of keenness of mind and of willingness to go through any amount of discomfort and tribulation to outwit a fish that seems all cunning and brains! Hats off to the trout fisherman!—he is no lady of the outdoors as popular fancy pictures him, but rather one who needs to be all man if he is going to succeed against the trout!

And the bait caster! What memories of lily-padded lakes, shimmering in the burnished gold of the setting sun, of a roseate twilight peace, when the lake is one vast mirror; of furious battles with that bulldog of the sweet waters, the black bass, are his! A most difficult art, one that requires more than a modicum of practice to acquire;—to place that lure precisely in a given spot, forty or fifty feet away, where a bass may lurk,—not near the spot but right in it, mind you—to so land that lure as to simulate a frog or minnow naturally leaping or jumping to escape possible attack by a bass; to do all this with a short rod and high-speed reel casting the lure as a small boy throws an apple from the end of a stick—to do this with accuracy and deftness, gentlemen, is no unworthy ambition! And, after the strike comes a battle between a five-pound fish and a hundred-and-fifty pound man, equalized by fair tackle, that will put the exhilaration of eternal youth into any man!—especially if he proves himself worthy to beat the fish at his own game, to take him with all the handicaps imposed by the necessary tackle, and win out against all the snags, tactics, leaps, and plunges, rushes, and feints employed by the battling bass.



HENRY S. DRINKER, LL.D., PRESIDENT OF LEHIGH UNIVERSITY, AND PRESIDENT OF THE AMERICAN FORESTRY ASSOCIATION.

"Conservation does not consist in hoarding our natural resources. Perhaps the best definition ever given is that attributed to Dr. C. W. Hayes, when Chief Geologist of the U. S. Geological Survey, to the effect that Conservation is 'Utilization with a maximum efficiency and a minimum waste.' In taking wise and broad measures to avail best of our undeveloped natural resources, the need is not so much to withdraw and set them aside for the use of future generations, when other resources may have been developed, as to be sure they are not wasted in their use by the present generation."

HENRY S. DRINKER.
President American Forestry Association.



CAPT. J. B. WHITE, DIRECTOR AMERICAN FORESTRY ASSOCIATION, EX-PRESIDENT NATIONAL CONSERVATION CONGRESS.

"Forest Conservation will never be a success in America until uniform Forestry Laws are established in all the States, or forestry is practiced in all the timber States under the direction of Government rules and Government expert foresters; as is now done on the Government lands, and as has been done by European countries for 300 years. There must be laws enforcing restrictions in cutting timber in a manner to prevent waste, and according to the law of supply and demand. The timber owner should cut for the market what the market demands, as to kinds and size of timber required for various commercial purposes. In 1650 the so-called Blue Laws of Connecticut had a section as follows: 'No timber shall be felled at unseasonable times, from the beginning of April to the end of September, and that it be improved into pipe staves or some other merchantable commodity within one month after the felling thereof.' This was the first law enacted in America for the conservation of the forests.

"'Let the tax follow the saw' should be a universal motto. To tax a forest annually for a generation or more while the one crop is growing is an injustice no more defensible than taxing a man annually for the fortune he expects to inherit fifty years hence. Forests will not be grown by the State and cannot be grown by the individual at a loss, for this would be waste and not conservation by wise use. Let the tax come at the harvesting, like other soil products, and thus encourage men to grow trees according to adaptation of soil and climate."

J. B. WHITE.

Director American Forestry Association.



CHARLES W. ELIOT, LL.D., PRESIDENT EMERITUS, HARVARD UNIVERSITY; VICE-PRESIDENT AMERICAN FORESTRY ASSOCIATION.

“My view of forest conservation is, that it is right effort on the part of the present generation to prevent waste of an important National resource, and to pass on to coming generations that great resource not only unimpaired, but improved and made permanent. It adds greatly to the importance of conservation that forests are not only economic resources, but means to the human enjoyment of natural beauty.”

CHARLES W. ELIOT.

Vice-President American Forestry Association.

BOMBARDMENT OF PAPEETE

By A TAHITIAN OF HIGH RANK

[An article in the December AMERICAN FORESTRY on "Tahiti," the French possession in the South Pacific, by E. T. Allen, referred briefly to the recent bombardment of the island port, Papeete, by the German cruisers Scharnhorst and Gneisenau (later sunk by the British in an engagement near the Falkland Islands). This article attracted so much attention that Mr. Allen was asked to contribute a further description of the German attack upon the surprised little Polynesian capital. He replied by sending the following account written a few days after the bombardment by an English-speaking Polynesian (whose name is omitted for obvious diplomatic reasons) and reproduced here without change. It is an interesting document with many traces of the well-known Polynesian humor.—Editor's Note.]

“AT BREAK of day of the twenty-second of September, 1914, two big cruisers were lying right in front of the passage Toata Papeete, attended by a big steamer supposed to be a coal tramp. As they had no flag up the naval commander who is in charge of the French defense force on the little gunboat Zelee and on land gave orders to fire blank cartridges to demand the cruisers to show their colors, which were utterly ignored. A second blank shot was fired. No answer. Still the two cruisers came nearer and nearer to the mouth of the passage. The third

shot was with a real shell across the bows of the first cruiser. At this the two backed out and steamed slowly to the N. E. until both had gained the position about a mile and a half between the island of Motu utu and Fareute Point.

“When they reached this point up went the Kaiser's flag and two shots followed which raked the Chinese stores by Donald's Store, followed by two more shots which raked the stores of Mr. John Brander on the other side of the street of Donald's Store. This shot passed right through the meat market. The following shots were fired at the Zelee, the gunboat lying in



THE PUBLIC MARKET BURNED.
THE SHELLS OF THE GERMAN CRUISERS SET FIRE TO THIS MARKET AND IT WAS BURNED TO ITS CONCRETE FOUNDATIONS.



THE DISMANTLED FRENCH GUNBOAT ZELEE.

THE FRENCH SHIP ARRIVING AT PAPEETE WITH THE CAPTURED GERMAN TRAMP "WALKURE," AUGUST 13, 1914. THE "WALKURE" IS IN THE DISTANCE AWAITING MEDICAL INSPECTION. NOTE THE UPPER RIGGING OF THE "ZELEE" WHICH HAS BEEN SENT DOWN SO SHE COULD BE SUNK, IF NECESSARY, WITHOUT BETRAYING THE BLOCKADE THEREBY OF THE PASSAGE IN THE REEF. SHE WAS SUNK BY THE GERMAN CRUISERS LATER. PHOTO BY E. T. ALLEN AS THE ZELEE BROUGHT IN HER PRIZE.

front of the mail steamers wharf. The firing was pretty straight—considering.

"After two and a half hours firing the Zelee sank with her colors flying. Two blocks of building were in flames. By supposition one of the cruisers was hit by the shots fired from the fort and when they sheered off at 11 a. m., the smaller of the two had a very bad list and seemed to be heavy in the bows. Anyhow, when the two steamed away the big cruiser kept quite close to her consort, so close that the two of them looked as one. From the Signal Station the cruisers appeared in a battered condition and had very few boats. They looked as if they had

been in a fight. Found out by Moana (a later British steamer) they were the two vessels that escaped from Kiau Chau and one was the Admiral's of the cruiser fleet on the Pacific Station.

"On the day of the bombardment some plucky actions were done by the French sailors on the Zelee. Three of them stuck to their guns until they could not fire any more, as the vessel was sinking. The water had reached their feet when they jumped overboard and swam ashore.

"The big cruiser wirelessed ashore to surrender the place, but the commander of the Zelee, M. Decrement, refused and sent back the answer that he would fight the cruisers until there were no



THE GERMAN "WALKURE" SUNK BY GERMAN SHELLS.

A HUMOROUS INCIDENT OF THE BOMBARDMENT WAS THE SINKING OF THE GERMAN STEAMER "WALKURE." SHE WAS CAPTURED BY THE FRENCH GUNBOAT "ZELEE" SHORTLY BEFORE THE BOMBARDMENT (PRACTICALLY THE FIRST FRENCH NAVAL EXPLOIT OF THE WAR) AND WITH HER CAPTAIN AND CREW PRISONERS LAY IN PAPEETE LAGOON. THE ATTACKING GERMAN CRUISERS SUPPOSED HER TO BE A FRENCH VESSEL AND PROMPTLY SUNK HER WITH HER CAPTOR, "THE ZELEE."

more men to fire the guns in the forts. Vive La France!

"Of course, there was a regular stampede for the mountains. Houses were left, some open, some shut. Other houses were locked up and the doors nailed. I don't think the ones who live in these houses ever intend to come back. Our troops behaved splendidly. They went straight to the beach to cut up the landing party: but no such party came. Something else was going on, too.

"A native of Faaa called Taihia had been out fishing on Monday night and caught quite a lot of fishes which he took to Papeete market in his canoe at four in the morning of the twenty-second. He sold his fish and was returning back home by way of Pare's saloon. At 7 a. m. he saw the two cruisers trying to come in and saw the firing of the first gun. Some wag told him that the shore batteries were saluting the cruisers because they were English and when the ships began to bombard the town he thought it was a return of the compliment. So he quietly

paddled his canoe back home to Faaa. A lot of people who saw the man paddling back admired his pluck. But when Taihia arrived at Faaa and saw the people running along the road, he asked: 'What is this? Why are you all running away?'

"'Don't you know,' was the answer, 'that Papeete has been fired upon and is in flames?'

"'No! Taihia replied. 'Is it true? What an escape for me!' He turned and looked at the burning town. 'Well, I am going to get.'

"And he got and he did not stop getting until he had reached the 'fei' valleys up in the mountains. He told me that seeing the smoke rising over Papeete in thick clouds, and thinking of the narrow escape he had paddling his canoe past the passage, made him lose all his sang froid, made him fly right up the valley.

"Later we found out that the two cruisers were the Scharnhorst of 11,420 tons, 1,200 men, Admiral Graff von Spee and the Gneisenau. On the twenty-first of September these two

cruisers arrived at Bonabora. The Admiral went in and anchored at 9 a. m.; the other stopped outside. Some of the officers of the Scharnhorst went ashore and bought cattle for which they only paid \$20 per head. When the owner of the cattle wanted more money they told him he should be thankful for what he got as otherwise the men would take all that he had for nothing. So shut up, said those German officers.

"After feeding up some of the European residents that went on board the Scharnhorst with champagne, cold storage delicacies and cigars, the Admiral wormed out of them all the important items he wanted to know. Namely: 1, Where was the French Admiral and his vessel the Montcalm? 2, What was the time and route of the New Zealand steamers? 3, What time would the San Francisco steamer pass or call at Tahiti and her route? 4, Were there any coals at Tahiti? 5, What strength of guns did the city of Papeete have and what were the different lights for entering the passage at night?"

"The traitorous fools were so scared or drunk they told the Admiral everything appertaining to Tahiti and the position of the different stores, more especially the Societe Commerciale de l'Océanic, the one belonging to the German trading company. The vessels left Borabora at 3 p. m. and were off Papeete bright and early on the morning of the twenty-second. The bombardment began about eight. Through the commander of the Zelee refusing to deliver the town, their demands and wants came to naught. Report is spreading that the parties who furnished the information to the German Admiral will be brought to trial for high treason. Of that anon. But the visit to Borabora explained why the S. C. O.'s stores and buildings were not fired on and why

they steamed to the N. N. E., to intercept the Moana going up and the Maitai coming down from San Francisco. And, likely as not, they have gone on to the Marquesas as the different stores of the S. C. O. up there are full of all kinds of provisions and nothing to trouble the cruisers either.



EIGHT-INCH SHELL IN A CLUB.

THIS MISSILE FROM THE GERMAN CRUISERS PASSED RIGHT THROUGH THE POPULAR CLUB "CERCLE BOUGAINVILLE." THE CLUB MEMBERS WERE NOT PRESENT.

"Although the Admiral made a statement to some at Borabora that he was accompanied by the Gneisenau and the Nurnburg, this is not sure. The steamer that accompanied them was an English tramp full of coal which they had seized. She was called the Titania. Although the Moana, when two days off from Tahiti on her way from New Zealand, caught a wireless message from the Scharnhorst to a cruiser at some distance informing her of the bombardment of Papeete and that the town was in flames.

"Three dead shells were picked up and on the back plate of each was said to be marked the name of two prominent



A TREE CUT OFF BY A 5-INCH SHELL.

SHOWING A PORTION OF THE DESTRUCTION AT PAPEETE IN THE BOMBARDMENT BY THE GNEISENAU AND THE SCHARNHORST.

firms in the United States. Report has it that the Governor has written Paris per Moana about the matter as the Nurnburg was the consort of the Leipsic when this vessel was at San Francisco a month ago and the two cruisers met off a small island north of the Marquesas. The Leipsic may have passed over some shells to the Nurnburg for the Admiral's ship. Nobody knows. Everybody is supposing, and the shells are here with U. S. A. stamped on them.

"I hope, in fact all of us do the same, that the United States would not be forced to break her neutrality. It would be a big misfortune for us, as San Francisco is our only outlet now. That is, if she sides in with Germany and Austria. The German Admiral Von Spee during the breakfast at Borabora

mentioned that the United States would remain neutral only a short time longer as she was already hand in glove with Germany and it would greatly benefit her to side in with the Germans. He gave a toast: 'To our new Allies, the United States of America.' Let us hope it is only some more bluff.

"On the morning of the twenty-second, the stampede of the people from Papeete was ludicrous and at the same time pitiful. The beach was full of people eager to see the two cruisers. Then the shot from the fort went across the Scharnhorst's bows. Up went the flags on both of them and a shot came crashing ashore. Up went a yell: 'It is the Germans!' Then came the famous stampede.

"All along the road to Point Venus went carriages drawn by galloping



RUINS OF TAHITIAN TRADING COMPANY BUILDING.

THIS PLACE WAS ONE OF THE FIRST TO SUFFER FROM THE GERMAN SHELLS. IT WAS THE PROPERTY OF AN AMERICAN FIRM OF WHICH E. T. ALLEN IS A DIRECTOR.

horses, honking automobiles, men, women and children on foot, running until they were out of breath; yelling, screaming, accompanied by the reports of the guns from the cruisers. Some went up Pataua Valley, some up Pirae Valley; some went to Arue, some went over the hills to Point Venus. On our side whole crowds went up into the hills. The houses were emptied, the doors left open. The people grabbed the first thing that came to hand and flew. In carriages, in automobiles, on horseback and on foot, they streamed along and the first valley they were not too scared to notice they went up.

"My little cottage sheltered thirty persons. I was forced to move out and a little higher up to a small house by the hill where I had a fine view of the firing. It was five days before the excitement subsided as the news kept flying about that the cruisers were still in sight. They fired in all about seventy odd shells and they killed one native boy and a Tinito (Chinaman).

"The amount of damage done in the bombardment reaches 2,000,000 francs which the local Government will try and pay the losers by lumber, goods, etc., etc., out of the German store, the

S. C. O. And we all think this right. It was only the grit of our head officials in refusing to pull down the flag that saved us from paying indemnity and other demands which would have been imposed upon us all.

"Eighteen days after the great event there was another stampede, a false alarm. Some Chinaman with a Chili imagination saw a lot of drifting trees out at sea off Papenoo River and hearing yarns about submarines and destroyers, took the trees for these kind of craft. He gave the alarm and came rushing into town with the tale that the Germans were coming again and had sent two small men-of-war ahead to seize the port. And then there was another stampede. Hundreds and hundreds left town as before. They tore away in carriages, in autos, on horseback and on foot. Old people were put in hand-carts, wheelbarrows were trundled along to bring luggage. Some sixty stopped at my place this time.

"And before evening it turned out to be a false alarm. And some people went out to find the Chinaman and some simply returned to town. It was not much fun for the ones who had run all the way. When they came out they

looked strong and able, when the excitement was over and they had to return they moved like invalids and cripples.

"So much for the present. We are still waiting for the signals announcing the return of these two cruisers. According to the talk they wont have much show. It is something wonderful the amount of men of valor we have here now. Why, it would be too easy for us to conquer the world. I sit and listen, I do not speak. I was never sick of the ague and I never had an

attack of the shuddering fit. But you cannot imagine how badly I was seized on that morning. I shook like an aspen leaf or as if somebody was tickling me with a white feather and it was not until the cruisers were well out of sight that my ague and shivering passed.

"And so now I say nothing but sit and sip cocoanut water and listen. Truly, for my part I would rather have these brave fellows tell what they could do and would do than have the poor Germans come back and suffer. Ja ora na! (Good bye.)"

GERMAN STEAMER CAPTURED

[Editor's Note.—The writer of this interesting description of the bombardment did not describe one feature of it which really belongs in the story. It was the sinking by shots from the German cruisers of the German steamer "Walküre" which lay, the prize of the "Zelee," in the harbor.

When war broke out and the news reached the far off little French colony at Tahiti the commander of the "Zelee" learned that a big German steamer the "Walküre" was loading pearl shell at a small island some 50 miles away, and he resolved to capture her.

The "Zelee" found her, hoisted the French flag and called on the "Walküre's" Commander to surrender. The German laughed at what he considered a joke and invited the "Zelee's" captain on board to dinner. He had not heard there was a war or any likelihood of one and it was sometime before he could be convinced. Then fuming with rage he became with his ship the captive of the little French gunboat.

This was probably the first French naval engagement of the war.

The Walküre was mistaken by the German cruisers for a French merchant steamer and during the bombardment she was sunk while the frantic German captain, on shore with his crew, raved at the misfortune of war which compelled him, helplessly, to see his own steamer sunk by his country's cruisers.]

FORESTRY IN WISCONSIN

By E. M. GRIFFITH, *State Forester*

WISCONSIN'S forest reserves, established 10 years ago, are being sought by private interests. In the past when private interests have wanted any part of the State's public heritage, they have gone, directly or indirectly, to the State Legislature, and the desired legislation has been promptly forthcoming. There are in the State about thirteen million acres of land awaiting development and yet it is a question whether the 374,452 acres of forest reserves will be allowed to continue as such.

For 48 years two forces have been working side by side, one to save some small portion of the wonderful natural heritage of the State, another to gain private possession of the timber wealth,

to despoil it and turn it into money. The net result of the efforts of these two forces are small tribute to the past quality of Wisconsin's statesmanship.

As far back as 1867 a commission of three members was provided for by law to report to the State Legislature "on the disastrous effects of the destruction of forest trees, now going on so rapidly in the State of Wisconsin," and on the duty of the State in regard to the matter. The report of this commission dealt very comprehensively with all phases of the question and contained the following paragraphs:

"A State that finds authority to regulate the times and seasons when its citizens may catch fish, or shoot game, may certainly assume such as may be needed to preserve the civilization of the

present times; it would require no greater stretch of power to regulate the cutting of timber where it would obviously entail a public calamity, or to encourage its production where it is so much needed for the public good.

"One of the most serious evils this State has to contend with is the purchase of large tracts of land by persons who reside in some other States, or who, if residing here, still have no permanent and living interest in the land. It is purchased by such persons not for the ordinary, legitimate and proper purpose of converting it into a farm or homestead for himself and family, but solely with a view of stripping it of its valuable timber. Leaving the worthless trees and bushes to encumber the ground, he sells it for what it is worth, and renews his depredations upon other lands."

In 1878 the legislature set aside the State Lands in twenty-three townships in Iron and Vilas counties, some 50,000 acres, as a State Park with an express provision that no authority should be given to anyone to cut down or destroy any timber on such lands. Thus was the first State Forest Reserve established.

For 19 years the State Park lands were held intact. But in 1897 the lumbermen who were operating in that part of the State were getting to the end of the timber supply on their own lands. They wanted more timber, and how quickly, how easily and how cheaply they got the "State Park" lands was soon a matter of history.

The results of this sale give some astounding figures, 31,988.30 acres were sold at an average price of \$8.14 per acre. One man bought, in his own and his company's name, 4,455.51 acres. More than one-third of the entire acreage sold went to four companies. More than two-thirds went to only eleven purchasers. 5,604.71 acres went to ten other purchasers, which left only 4,641.01 acres for smaller purchasers. Add to this the fact that the State has since bought back 8,949.40 acres of this very same land *without the timber* at an average cost of \$3.32 per acre, and it is easy to see how much more quickly legislatures respond to the demands of a small body of private citizens than to any pleas for public welfare.

Many newspapers of the State violently opposed the sale of the State Park lands. The *Oshkosh Daily Northwestern* made a plea for the preservation of the park on February 8, 1897. The *Ashland Press* said, "Why does the legislature wish to sell the timber on the State Park lands? Is there a crying need of more money to spend?" Both the *Milwaukee Daily News* and the *Superior Evening Telegram* published on February 4, 1897, vigorous warnings against the bills.

In spite of the warnings of the newspapers in February, the bill for the sale of the park lands passed.

It had been the policy of the State to give the widest opportunities to the lumbering interests in the sale of State Lands, as will presently be instanced, and so the sale of the State Park lands was no violation of the prevailing policy except that the lands had been set aside and dedicated to use as a Forest Park, had been held for 19 years for that purpose, and were in a region full of lakes and streams and eminently suited to park or forest reserve purposes. To those who would say that 50,000 acres was too large a tract to be retained by the State, we would reply that 50,000 acres was not too much to be retained for *all* the people by a State that would sell unlimited amounts to any one man and that did sell in little more than a single year 16,390.46 acres to one man, George Baldwin of Appleton, from January 6, 1882, to January 13, 1883, and also sold to his firm, Feind & Baldwin, 8,397.90 acres within practically the same period, April 5, 1882, to January 23, 1883. In fact, between January 1, 1882, and February 1, 1883, a period of only 1 year and 1 month, the State of Wisconsin sold 258,820.65 acres of land.

An analysis of the sales of that period gives some startling results: Five purchasers bought 48,030.46 acres, the lowest single purchase being 5,760 acres; three others acquired 10,211.27 acres; eleven others acquired 27,129.69 acres; twenty-seven others acquired 36,005.63. Thus forty-six purchasers acquired a total of 121,377.05 acres or an average of 2,638.63 acres apiece. Fifty-two others took amounts ranging between

500 and 1,000 acres. When it is remembered that these sales covered only 13 months, that the same men and others had the same opportunities in other years, and that certain classes of these lands were sold on contracts with an initial payment of only 25 per cent of the appraised value and that the balance could run 10 years and as a matter of fact did run 20 and 30, and even more years at 7 per cent interest, we are aghast at the free-handed methods employed of enriching private interests at a frightful sacrifice to the great public interest, and cease to be surprised at the slaughter of the State Park, the one bit of earth that had been held for public use.

It was legislative action that made possible this condition of affairs. The public interest, voiced in the newspapers of the State, and to some extent in the legislature, had no weight against private demands. An employee of the State Land Office obtained a request from the State Senate for a report of the land sales of 1882 and the legislature was put in possession of the facts, but no action resulted at that time.

The very legislature that put the State Park lands on the market in 1897, had already passed a law providing for the appointment of a Forestry Commission of three members, who were to draw up a plan for the protection and utilization of the forest resources of the State, and for the organization of a forestry department and the creation of a forest reserve. Thus it is evident that the legislature was fully enlightened as to the public needs at the very moment that it yielded to private demands and gave over the beautiful forest park to be stripped of its timber and left to the ravages of forest fires. The chief argument which was used by the lumbermen and land speculators to induce the legislature to throw the 50,000 acres of park lands on the market was that settlers were needed to help build up that portion of the State. Today, eighteen years after the sale was made, the records show that in twenty-two townships, an area of 500 square miles, there are only twenty-one farmers.

Six years elapsed before a forestry department was actually created and a forest reserve established. It was not until the State had given up to private enterprise about all it had to give, that it was allowed to start a forest reserve with the fragments that were left. The timber was gone from much of the land and private interests now had an opportunity to sell back to the State the cut-over, burned-over tracts that had served their purpose. The reserve was established.

For about 8 years work was prosecuted diligently by the Forestry Department. The region of the old State Park was on the headwaters of the important rivers of the State and included a great natural reservoir of numerous lakes and swamps. Here the reserve was started with the remnants of the old State Park lands as a nucleus. Cut-over tracts were purchased and protected from fire. Young forest growth thrived and in a few years there was a marked change in the face of nature. Then came the protest of private interests again.

The relation of the forest reserve to the general welfare of the State may be summarized as follows: There are 13,000,000 acres of undeveloped land available for settlement in the State; hence the retention of the relatively poor lands in the forest reserve is not retarding general agricultural development. The rivers of the State furnish water power to the extent of 1,000,000 horse power and the region of their headwaters should be kept under forest cover to maintain a more uniform streamflow. The wood-using industries in the State, aside from lumber or paper and pulp manufacture, use more than 930 million feet of timber annually, worth about \$20,000,000, employ many men, and turn wood into products of greatly increased values. They now get 50 per cent of their raw material outside of the State, and if a supply of raw material is not maintained, they will remove to new fields in other States. The forest reserve region, full of lakes and streams, is a natural resort region. Ninety-one public resorts are now in operation there. The preservation of the forests here will, incidentally,

increase and perpetuate the natural attractions of this region, furnish a pleasure ground for all people, and put the resort business on a permanent basis.

The private and local interests that have been affected by the forest reserve are the following: Land dealers and speculators had been charging \$15 or \$16 per acre for lands in the forest reserve region. When the State began to buy large tracts at prices that averaged only \$3.32 per acre, the land men were aroused and claimed that the character of the lands in that vicinity had been grossly misrepresented, and that settlers did not care to buy because the forest reserve was being developed in that region. It was found, also, that private interests desired to get possession of lands and lake frontage in the reserve. At least one lumbering interest is believed to be working to obtain possession of timberland that composes part of the reserve. These private interests are working against forestry *ostensibly* for the purpose of forwarding settlement in their community; are, in fact, using the same arguments that were used 18 years ago to get the State Park lands on the market. The only just grievance local interests ever had, was the removal from the tax rolls of land purchased by the State.

No legitimate private interest is really affected. Good agricultural lands in tracts of sufficient size will be sold, lake frontage is available for camps or cottages by lease, and mature or deteriorating timber is sold.

It would seem that Wisconsin should have a settled forestry policy by this time, when its Forestry Department has been in existence nearly 12 years; but the hand of the opposition is still busy trying to shape the public destiny into conformity with a few, a very few, individual interests.

Six years ago a legislative investigation was made, necessarily at great expense, of forestry, waterpowers and drainage, which resulted in a report that

was unanimous in favor of the forestry work. And yet again, 2 years ago, the expense of another legislative investigation of forestry was foisted upon the State by local influences, which desired to hinder forestry work; and the legislature was induced also to halt purchases of land as additions to the forest reserve until a soil survey of the region could be made. Again there has been a report favorable to the continuance of forestry work. The best citizens of the State of all political parties are in favor of the forestry work. The Wisconsin branch of the German-American Alliance has declared itself in favor of the forestry work. And still an organized effort is being made to influence the legislature.

The legislature is now in possession of full information secured by its own representatives, in regard to the public need of forest preservation and in regard to the progress already made in the State of Wisconsin. It seems incredible that a legislature of the present day, with the expensive mistakes of the past before them, should again sacrifice the welfare of the public at the behest of a handful of men who are seeking personal benefits behind the thin mask of seeking local welfare.

RESULT OF THE DECISION

The recent decision of the Supreme Court was outlined in AMERICAN FORESTRY for March. It is almost impossible at this time to say what the result of the Court's decision will be. The legislature must decide whether the 375,000 acres of land shall continue to be managed as a forest reserve, the income to be paid into the school fund, or if the entire forest reserve, which it has taken 10 years to build up, shall be thrown upon the market and sold. The land speculators are working to secure the sale of the lands, but it does not seem possible that the legislature will again sacrifice the interests of the people in order to enrich a few land agents and speculators.

PHILIPPINE ISLANDS' FORESTER

READERS of AMERICAN FORESTRY and friends of conservation in general will be interested in the appointment of William Forsythe Sherfesee to the position of Director of Forestry in the Philippine Islands, succeeding Major George P. Ahern, who resigned in November of last year. Mr. Sherfesee is well known to foresters in the United States, as before leaving for the Philippines in 1909 he held the position of Chief of the Office of Wood Preservation in the Forest Service.

Mr. Sherfesee's appointment to the head of the Philippine Bureau was confidently expected by those who have kept in touch with the progress of forest conservation in the Islands. He received the Degree of Master of Forestry from Yale University in 1905, and his subsequent work both in the United States and in the Philippines has been such as to make his present promotion the logical and expected course.

It also argues well for the future of forest work in the Philippines to note the uniformity of approval with which Mr. Sherfesee's appointment has been received by Americans and Filipinos alike in the Philippines, as well as by the organs of the different political parties. In this connection the *Manila Times* of December 22 says:

"The appointment of Mr. Sherfesee to the office of director of the Bureau of Forestry, made vacant by the recent resignation of Major Ahern, should—and doubtless will—meet with general approval. It ensures a continuance of the policy which has made the bureau one of the most useful and efficient of the department of Government Service, and it promotes a man whose past work is an earnest of ability and enthusiasm. Much as has been accomplished in past years, there yet remains vastly more for the Bureau to do before the forest wealth of the Philippines is developed as it should be. Under Mr. Sherfesee the work

will lose nothing that can be supplied by energetic and capable leadership."

The *Manila Daily Bulletin*, discussing the appointment editorially, also says in part:

"The action of the governor general in appointing Mr. Sherfesee to succeed Major



WILLIAM FORSYTHE SHERFESEE.
DIRECTOR OF FORESTRY FOR THE UNITED STATES IN THE
PHILIPPINE ISLANDS.

Ahern as the director of the Bureau of Forestry will be approved generally. It is a deserved promotion and gives an assurance that the duties of that important position will still remain under the supervision of an official thoroughly trained in the work by years of study and practical experience, who has demonstrated his capability successfully in the service of the Government."

The *El Ideal*, the organ of the Philippine "Nacionalista," also comments most favorably on the appointment.

CHINESE TREES DO WELL HERE

THAT the climate of Eastern China is similar to that of Eastern North America seems to be the reason for the success which has attended the introduction of many Chinese plants into this country; at least this is the opinion of the specialists in the United States Department of Agriculture's Office of Foreign Seed and Plant Introduction. In a new publication of this office which lists seeds and plants imported during the fall of 1912 a definite report is given on the growth of seventy-nine different importations from China, most of which may be termed successful. Plant introductions from foreign countries are distributed by the office until sufficient time has elapsed to give some indication of their possibilities in this country.

A maple which grows seventy-feet high, whose leaves turn a golden

yellow in autumn, is one of the ornamental trees introduced from China of which something may be expected. A Chinese elm particularly adapted for dry sections for windbreak purposes has proven very satisfactory and will be more generally introduced. A pine tree also has grown here. It is hoped that these may all prove as ornamental and useful as the ginkgo tree (also known as the maiden hair fern tree) which has grown so well along a number of the streets of Washington.

A peach which bears an edible fruit containing a smooth stone (something quite unknown heretofore among peaches) has been brought from China, and may be used to improve our commercial peach. A tree that grows in roadside thickets in parts of China bears a fine variety of quince, golden on one side and reddish on the other.



Photo by Frank N. Meyer.

CHINESE CHESTNUT, CHILI PROVINCE, CHINA.

THIS IS A VIGOROUS GROWING GROVE OF CHINESE CHESTNUT AT THE VILLAGE OF SCHO DJA DIEN TZE AND WAS INSPECTED BY MR. MEYER IN HIS INVESTIGATION OF THE CHESTNUT BARK DISEASE. THE LOW BRANCHING HABITS OF THIS TREE MAKE IT OF NO VALUE AS A TIMBER TREE. NOTE THE BURIAL MOUNDS UNDER THE TREES.



CHINESE WOOD OIL TREE, TALLAHASSEE, FLORIDA.

THIS, KNOWN AS THE RAYNES TREE, IS THE LARGEST OF THIS SPECIES IN THE UNITED STATES, AND THE ONE FROM WHICH THE MOST VALUABLE DATA REGARDING THE POSSIBILITIES OF THIS TREE IN AMERICA HAVE BEEN SECURED. IF THE WOOD OIL TREES IN ORCHARD FORM BEAR COMPARABLY AS MANY NUTS AS THIS TREE HAS BORNE THE GROWING OF THE WOOD OIL SHOULD BE A PROFITABLE INDUSTRY ALONG THE GULF COAST. IT IS NOW IN AN EXPERIMENTAL STAGE.

This also has done well in its new environment. So have a new hazelnut bush bearing large nuts, and three new varieties of holly.

The adaptability of the Chinese wood-oil tree for cultivation in northern

Florida seems to have been proven by recent experiments. A tree at Tallahassee, Florida, bore two bushels of the fruit last season. In addition to being an economically important tree, it is a decidedly ornamental one. It bears



Photo by Frank N. Meyer.

NEAR VIEW OF TRUNK OF DWARF ELM.
THIS TREE IS GROWING IN A PUBLIC PARK AT HARBIN, MANCHURIA.



DWARF ELM, HARBIN, MANCHURIA.

A LARGE SPECIMEN OF THIS SO CALLED DWARF ELM IN A PUBLIC PARK AT HARBIN. THIS ELM IS ONE OF THE MOST PROMISING TREES FOR DRY COLD CLIMATES. THE PHOTOGRAPH WAS TAKEN BY FRANK N. MEYER WHO SECURED PROPAGATING MATERIAL OF THIS ELM.

clusters of white flowers with reddish-yellow centers, and in full bloom resembles a catalpa.

Chinese plants are not the only ones that have been doing well in the Depart-

ment of Agriculture's gardens for foreign plants. Others from the West Indies, Australia, Spain, South America, Hawaii, and the Philippines are showing interesting possibilities.



A FAVORITE HAUNT OF THE BOY SCOUT.

THEY FIND THE HUNDRED-ACRE LOT AN IDEAL PLACE FOR THEIR GATHERINGS AND ESPECIALLY FOR LEARNING SOMETHING ABOUT TREES.

JAMESTOWN'S HUNDRED ACRE LOT

By SHIRLEY W. ALLEN

Forester with The New York State College of Forestry at Syracuse University

WHAT one of us has not wished for a stretch of woodland near enough to our homes to be available for walks during short periods of leisure, and secluded enough to retain all of its wild charm? It is not too much to say that the absence of such a tract has prevented many a man from developing an acquaintance with nature,—an acquaintance which could not help strengthening both body and character.

The school children and citizens of Jamestown, New York, are purchasing

just such a piece of woodland; one which they have used for years. Many a wonderful nature study trip has followed the brooks and paths in these woods, and hardly a resident of the town fails to look back with pleasure on happy days spent in "The Hundred Acre Lot" as it has always been known.

The purchase covers an area of 52 acres, the level part of which lies within and adjacent to the city limits. Back of this lies a sloping stretch of country and the whole tract, except 3 or 4 acres, is well wooded with many

native species. Forty different kinds of trees have been noted, over 100 different wild flowers, twenty-five shrubs, and twenty-five different ferns. And besides, there are over 100 kinds of birds. What a wealth of wild things! "So accessible and so secluded," as one teacher has expressed it. The free and unquestioned use of a place of this sort over a long period of time, and the resulting love for its charms, will instill into any community a sense of ownership of some of the real things of nature. And so it was with a good deal of consternation that the people learned in the fall of 1912 that the heirs who controlled the tract, and who did not at that time live in Jamestown, had sold off all the timber. All the larger trees were to be cut into lumber and everything above 4 inches in diameter was to be worked up into crating.

Today the people own this place and within a short time a Board of Trustees will hold it, clear of debt, in trust for the children of Jamestown. Here is how it happened:

In order to save a part of the woodland for the town, it was necessary to act quickly and the response to the appeal made to the people is a great monument to their love of the wild things and their public spirit. During the winter and the following spring the matter of purchase was agitated by the local press and the teachers in the public schools. The idea of retaining a portion of the tract for park purposes was talked of in homes, shops, stores and on the streets. The immediate outcome of the agitation was the organization, by the local teachers, of the School Park Association of Jamestown.

This association was organized in July, 1913, and all citizens, whether connected with the school or not, invited to join. In fact, any person interested, who is over sixteen years of



A WOODLAND STREAM.

THE POSSIBILITIES OF MAKING THIS CORNER OF THE HUNDRED-ACRE LOT A MOST ATTRACTIVE PLACE MAY READILY BE SEEN.

age, is eligible to membership and may join by signing the constitution and paying the annual due of 10 cents. The representative nature of the list of officers is interesting. The President, Mr. M. J. Fletcher, Principal of the High School; Vice President, Mr. Clare A. Pickard, a lawyer of the city; Treasurer, Mr. Arthur W. Swan, Cashier of the National Chautauqua County Bank of the city; Secretary, Miss Mildred R. Falconer, Secretary of the Board of Education. The trustees are Mr. A. A. Amidon, a lumberman, Mr. Fred Curtis, a manufacturer, and four members of the teaching force who have worked hard to secure the purchase of the tract, Miss Clara Ross, Miss Ella Schildmacher, Miss Elsie E. Leet and Miss Augusta Hornden.

A price of \$8,250 (\$6,250 for the land and \$2,000 to satisfy the claims of those who had purchased the timber) was secured on a portion of the area and with splendid courage the Association undertook the purchase. In order to stop the cutting and to make the first payment on the land it was necessary to raise \$3,000 in two weeks' time and this was done by means of a demand note. The signatures of forty or fifty interested citizens were secured and these people agreed to be responsible for the payment of the note. During the summer vacation the sum of the note was raised. After school started in the fall, a city-wide canvass was organized through the schools whereby something over \$4,000 was raised toward paying for the property. Early in 1914 the committee of the Association having in charge the raising of the funds to cancel the entire indebtedness, suggested a plan which is now being followed. The balance, it was agreed,

should be paid off on Arbor Day, 1916, at the latest. The balance should be apportioned definitely among the various schools, Citizens Committee and Foreign Alumni. A definite amount was suggested for each group to raise and no uniformity in method of raising the money was recommended except that no further personal solicitation be resorted to. The ingenuity of the pupils of the school has done much toward making the raising of the final amount an assured thing. Entertainments, candy sales, collection and sale of old rubbers and bottles, and a dozen other methods have been used and on November 1, 1914, the debt had been reduced to \$2,300.

During the Spring of 1914 a Forester from the New York State College of Forestry at Syracuse University was called on for a lecture before the schools, and from time to time advice has been given on the handling of the



MOBILIZATION OF BOY SCOUTS.

THE TROOP HAS VOLUNTEERED TO TAKE CHARGE OF A BRUSH-BURNING BEE ON THE HUNDRED-ACRE LOT.



A PICNIC IN THE HUNDRED-ACRE LOT.

tract by representatives of the extension work of the College.

An interesting time came last Arbor Day when a brush burning bee was planned for the Hundred Acre Lot. All the pupils of the schools and many of the citizens joined in one great cleaning campaign; old brush, stumps and rotted timber were piled and much was done to improve the looks and the condition of the splendid tract. The Boy Scouts were in their glory, picnic dinner was in order, all the joy of camp coffee and "hot dogs" tied up nicely with the ravenous appetite of the folks who were "doing it for Jamestown."

During the past winter a man has been employed by the Association for the purpose of trimming out all the dead and down timber which is good for wood, and for piling the brush. Plans for the future improvement of the area are not entirely definite but there is opportunity for planting up the cleared portion of 3 or 4 acres and the management of the area so that the great out-of-doors with all its charm shall be near at hand.

The opportunity for such work by the communities of this country is unlimited and any Jamestown citizen will tell you that it is worth while.

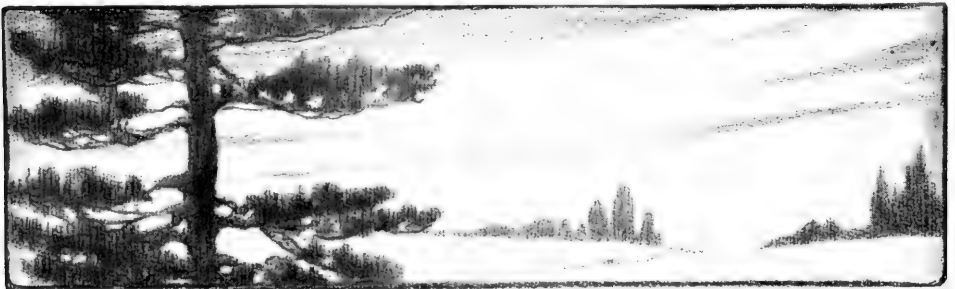

WOODLOT FORESTRY

By S. B. DETWILER.

[Here are a number of brief practical suggestions regarding the care, management and development of the woodlot which will be of great value to the man who owns one and who does not realize how much of an asset it is and can be made.—Editor's Note.]

PRACTICAL forestry for the ordinary farm woodlot consists of:

Protection principally against fire and grazing, and to a lesser extent against diseases and insect attacks.

Damage cuttings of waste material on the ground, dead or dying trees, etc., which make the worst fire traps, and breeding places for diseases. This, in nearly every case, can be done at a profit, as the material yielded will pay for the labor.

Avoiding waste. This means the use of better and more careful methods in the woods—cutting low stumps; working up all material in tops and limbs; working everything into its most profit-

able form; taking care not to injure remaining trees when cutting or hauling in the woods, etc. All this is closely connected with:

Improvement cuttings made of standing trees, in which the principal aim is the removal of individuals which should be cut for the benefit of the remaining stand, and:

Reproduction cuttings in which the main idea is to secure a satisfactory young growth from seed of the most desirable species.

Planting either on the open waste places; or in existing woodlots, where these are too open, or where they contain too great a proportion of inferior



Photo by E. T. Kirk.

FOREST PLANTING NEEDED HERE.

EROSION IS ALREADY NOTICEABLE, AND IN TIME THE SOIL WILL ALL BE WASHED AWAY. FOREST PLANTING WILL SAVE IT AND AT THE SAME TIME PRODUCE A CROP OF MARKETABLE TIMBER.



Photo by E. T. Kirk.

A SAMPLE OF NATURAL SEEDING.

THE FINE YOUNG WHITE PINE STAND IN THE FOREGROUND, WAS SEEDIED BY THE ADJOINING SEED TREES. THE BLANK SPACE IN THE IMMEDIATE FOREGROUND COULD EASILY BE PLANTED TO MAKE THE STAND FULLY STOCKED AND INCREASE ITS VALUE IN THE FUTURE.

species; or for windbreak or for aesthetic effects, etc.

Cultivation of the forest crop, as outlined above, will prove just as profitable as the proper tillage of other farm crops. It has the advantage of being a winter crop and the work is done when other work is slack.

Proper forestry methods aim, so far as practicable, to insure enough light to the best individuals of the best species, so as to allow them to make their best growth, and at the same time to maintain the stand dense enough to produce good, tall, clean trunks. Light is absolutely essential to tree growth, as it causes the raw material taken from the soil and air to be manufactured by the leaves into plant food; the more light, the more food is available and

the more rapid is the growth of the tree. From a forestry standpoint, light and moisture are the most important factors, because they are the ones most susceptible to control by forestry methods.

A guide to proper forest practice is to maintain such a cover as will improve the soil conditions. This is generally accomplished by maintaining, as nearly as possible, a complete shade for the ground. The leaves and other decaying vegetable matter add very much to the richness of the soil, forming a good humus and leaf mold. But if exposed to too much light and heat, this humus does not form from the leaves, and their nourishment is wasted.

To prevent drying out of soils, a dense border at the edge of the woods should be maintained. Should the border of

the woods be open, it would be best to plant several rows of such trees as Norway spruce to act as a windbreak.

Most woodlots are unfit for the immediate application of systematic forestry. Improvement cuttings must be made for the purpose of putting them into order. These cuttings should remove all trees which the forest is better without, but they should be made gradually so as not to open the cover too much and expose the soil to the wind and sun. It is unwise to cut more than 25 per cent of the poles and older trees in a dense mature forest or to cut oftener on the same ground than once in five years. Particular care must be taken to preserve the trees which are to form the future crop. Remove the spreading older trees over promising young growth, poor trees which are crowding more valuable ones, unsound, decrepit or crooked trees whose places will be taken by others of greater value. Trees of undesirable species should be cut wherever possible to prevent them from reproducing themselves.

Cuttings should be so planned that the tops will just meet by the time the next cutting is made, except in reproduction cuttings where it is necessary to make large openings to stimulate the growth of the young seedlings. Reproduction cuttings should follow only a good seed year.

Go over the woodlot before beginning cutting and carefully determine which trees are to be cut. Mark them with yellow lumber crayon, or an axe, so that the choppers will make no mistakes. Instruct the workmen how to fell and remove the trees with the least possible damage to the standing trees, especially young growth, and see that useless waste in stumps and tops is avoided. Close supervision of the work will add much to the profit of the cutting, particularly in the matter of working up the material into marketable form.

The result of improvement cutting will be a fully stocked stand of rapid growing trees of the best species. Systematic forestry management may then be applied. The selection system is best adapted to woodlots. Under this sys-

tem only the fully matured trees are cut each year, the cut not exceeding the volume growth for the year. If the cut is less than the annual growth a reserve of larger timbers for cutting at more or less definite intervals will be accumulated.

Only in special cases should the woods be pastured, such as turning in hogs to

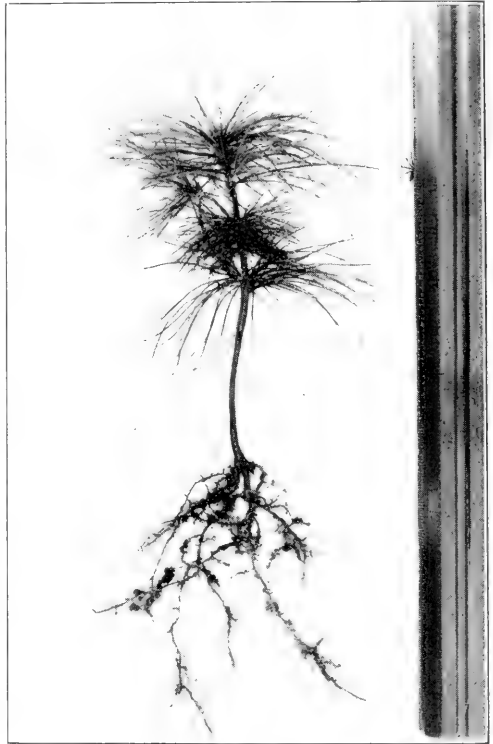

SMALL WHITE PINE SEEDLING.

THIS WAS DUG IN THE FOREST, IT HAS AN EXCELLENT ROOT SYSTEM AND IS WELL ADAPTED FOR TRANSPLANTING.

root up the ground just before the seed falls in a good seed year, thus making the seed bed conditions better. A piece of land should be used exclusively either for woods or for pasture. Well managed for either use the return will be greater than from use for both woods and pasture.

Fire prevention is an absolute necessity. Fire injures a woodlot by destroying the litter and making the soil poor. It checks the growth and reduces the vitality of the trees, and causes wounds



Photo by E. T. Kirk.

A GULLIED HILLSIDE.

THIS HILLSIDE SHOULD BE DEVOTED TO THE PRODUCTION OF A TIMBER CROP. NOTE HOW THE STRIP OF TIMBER HAS PROTECTED THE LOWER SLOPE.

through which rot and insects enter. Fire also kills young growth, and usually of the best kinds. Thus evergreen seedlings may be wiped out, and hardwoods, especially the poorer species like birch or aspen, given opportunity to increase. Employees should be instructed to use extreme care to prevent and extinguish fires. Brush from the

tops of felled trees should be peeled and burned where it will do no harm, or lopped so it will lie close to the ground and decay rapidly. Where there is danger of fire from railways, highways or adjoining timber tracts, fire lanes 10 to 20 feet wide, or wider, should be cleared and burned at the approach of danger seasons.

Proceeds of a Timber Sale.

Sufficient ties were cut from the Wasatch Forest from July to January to amount, at 8 cents a piece stumpage, to \$24,000, more than is required to administer the entire forest for twelve months.

Forest Utilization.

Examination last summer of remote parts of the Salmon and Challis Forests is resulting in more complete utilization. A stockman of Mountain Home has been granted permit for 10,000 sheep on the Salmon, and other stockmen will be shown over at present unused ranges as soon as snow conditions permit.

Rotation Grazing Planned.

The Emmett-Payette National Forest Woolgrowers' Association at its recent annual meeting decided to use the rotation or deferred system of grazing the coming season in handling their bands of sheep on the Payette Forest ranges. This means that the forage on a different portion of each allotment will be allowed to mature and disseminate its seed each year before being grazed, thus assuring reseeding of the entire area at least once during every three to five years.

O. T. SWAN'S NEW POSITION

O. T. SWAN has been elected secretary of the Northern Hemlock and Hardwood Manufacturers Association, succeeding R. S. Kellogg who has become secretary of the National Lumber Manufacturers Association with headquarters in Chicago. Mr. Swan was in charge of the office of Industrial Investigations for the Forest Service for some time. Mr. Swan's earlier years in the Forest Service were employed in timber measurements, topographical surveys, and general forestry work in Western States. Later he specialized in the preservative treatment of timber by creosoting and other commercial processes; eventually having charge of a large cooperative project in California to determine timber treating policies for the Pacific Electric Company of Los Angeles, and nine other California electric companies. This work resulted in the building of three wood preserving plants on the Coast.

In 1908 he was in charge of an administrative office of the Forest Service at Albuquerque, New Mexico, developing wood utilization lines for the National Forests of that region. He was sent in 1909-1910 to England, France and Germany to investigate lumbering, wood utilization and chemical wood preservation treatments in those countries, creosoting, etc. He introduced into the United States the French Boucherie pole preserving process for use on the National Forests, and on sap pines of the Southeast.

In 1910 he was placed in charge of the Eastern Division of Products of the Forest Service, which work, upon the discontinuance of the Chicago office of Wood Utilization of the Forest Service,

absorbed the latter, and the entire work now given National scope and administrative direction, was designated as the Office of Industrial Investigations. As Chief of the latter office, Mr. Swan has organized lines of work dealing in



O. T. SWAN, SECRETARY OF THE NORTHERN HEMLOCK AND HARDWOOD MANUFACTURERS ASSOCIATION.

commercial investigations of interest to the lumber and wood-using trades. He has followed the work of trade association secretaries through correspondence, reports, and personal acquaintance, and by frequent attendance at Trade Conventions. He has had the opportunity of meeting all of the

lumber association secretaries and those of many other related trades in their home offices where their work and problems were reviewed and the work of the Forest Service correlated; he has had the opportunity of studying conditions through travel in every State in the Union, and of discussing with the leading men in the principal

industries their various trade problems in their broader aspects.

Mr. Swan is a member of the American Forestry Association, Society of American Foresters, the Committee on Structural Timbers of the American Society for Testing Materials, and the Committee for the Standardization of Shipping Containers, Boxes, etc.

THE AMERICAN LUMBER MARKET

(PART II)

By E. B. HAZEN

[The first part of this article appeared in the March number of AMERICAN FORESTRY and was received with the attention it deserved. This, the final part, deals with the reasons for the decline in the industry and the remedy, and is based upon conclusions following long and careful study and wide experience.—EDITOR]

THE most important factor in the decline of lumber consumption is the encroachment of substitutes, chief among which are steel and cement.

The output of iron has trebled since 1890, and that of steel bars for reinforcement has increased 72 per cent in 3 years. Cement increased 220 per cent in 10 years, reaching the enormous total of ninety-two million barrels in 1913. This output, reduced to board measure, is equivalent to more than one-half of the lumber cut. Brick sales increased 50 per cent in 15 years; patent roofing 200 per cent in 10 years. Substitutes such as steel sash and trim in imitation of wood, steel lath, fiber containers, wall board and hollow tile are sold in increasing quantities to supplant wood. They are merchandised by modern, aggressive methods, well advertised and exploited, and in many cases actually sold for the lumber dealer by the manufacturers. No such effort has been applied in the lumber industry. The lumber yard of today is a building supply depot selling 30 to 50 per cent of commodities which are substitutes for forest products.

A segregation of freight car construction in 1913 shows that 217,000 cars were built—more than in any year since 1899 excepting 1906 and 1907. Steel under-frame and wooden superstructure represented 27 per cent;

all-steel, except sheathing and decking, 15 per cent; and all-wood box cars represented only 5 per cent of the total. About 42 per cent, largely ore and gondola cars, were of all-steel construction. The increase in the steel frame type, covered by the 15 per cent item, meant a loss to lumber of over eighty million feet in 1913.

Although wood block paving is recognized as the best in such cities as London, Berlin and New York, less of it was laid in the United States in 1912 and 1913 than in 1911. Forest Service statistics show that only 5 per cent of the pavement of this country is of wood block. Why, if wood blocks are better? Simply because wood block paving is not sold as other paving is sold.

"Safety First" has entered the lumber market as a factor. Under its guise the aggressive manufacturer of so-called fire-proof materials has created a strong public sentiment against frame construction. This has been reflected in the building codes and fire-limit regulations of many cities and towns with telling effect. Lumbermen have allowed printers' ink and business-getting methods to displace their product with an often inferior product.

OTHER REASONS FOR DECLINE

The drift of population to cities, the consequent decrease in rural population, the temporary decline of pioneer land

development, the purchase of automobiles instead of homes, the increased number of apartment buildings displacing houses, the 16 per cent increase in farm tenancy in 5 years which tends to lessen improvement of the property—all of these influences have affected adversely the consumption of lumber. To what extent they shall continue to affect it depends upon those engaged in the industry.

EFFECT OF SUBSTITUTES ON PRICE

In late years all substitutes have declined in price, partly because of new discoveries in their manufacture. Industrial chemistry has worked wonders with steel and cement. Efficiency has been applied in producing and marketing. Some substitutes are actual and some alleged economies, but at least 75 per cent of our lumber meets them in competition. In 1911 the Boston Chamber of Commerce secured bids on various types of houses according to identical plans, and found that one with a 12-inch solid brick wall would cost 12 per cent more, and one of stucco or hollow block 6 per cent more than a frame house. The timberman says that the lumber equivalent of a barrel of cement worked into concrete is 700 feet board measure. Therefore, whenever the two meet on an equivalent use value, the price of cement will govern the price of lumber. Other substitutes affect it in the same manner under similar conditions.

It is easily seen that there are conditions in the lumber business requiring new and vitalized methods of procedure if lumbering is to maintain its position among the leading industries of the nation.

WHAT IS TO BE DONE?

There are so many lumber manufacturers operating under different conditions that it would be impossible to secure a unanimous opinion as to the steps necessary to remedy existing conditions. There is no general agreement as to what is wrong, nor thorough understanding of the economics of the situation. The lumber papers of the country have for 2 years given much space to an analyzation of the causes

for depression in the business. Today there is much better understanding of the problem among manufacturers, but the basis of constructive effort must be a thorough study of the question and self help by lumbermen themselves.

Only a few of the remedies which should be applied will be mentioned here. Good business can only be realized through

1. Publicity.
2. Salesmanship.
3. Research work.
4. Initiative.
5. Better producing organizations.
6. Cooperation.

PUBLICITY

Publicity must remind the public of neglected uses for lumber. It must visualize the warmth and beauty of lumber, appealing to an inherent preference for wood in exterior design, panel effects, furniture, etc.; it must show its permanent utility, its workableness, its adaptability to individual tastes, its susceptibility to remodeling and improvement to suit changing conveniences and customs; it must demonstrate the safety, superiority and lower cost of fire-proof, "mill constructed" factories, warehouses and public buildings, equipped with automatic sprinklers, and the application of the same principles in modified design to the house; it must point out the efficacy and reasonable cost of means to prevent decay in wood; and, most important of all, it must correct the fallacy that lumber is becoming scarce or timber supply exhausted.

By giving publicity to the distribution of the cost of the product, manufacturers will correct the erroneous impression that lumbermen are privileged exploiters of the nation's resources and that they receive disproportionate gains. The public must learn that lumber is the product of an industry which employs more workers than any other and ranks third in the United States in the point of capital invested. It produces two and three-quarter billion dollars worth of merchandise annually, about 80 per cent of which is represented by labor. The public is interested because of its ownership of National

Forests and because in certain sections timber pays a major portion of the taxes and public improvements. These reasons, together with a realization of the public's constant need for a timber supply, will lead to more equitable taxation, better support of fire protection laws, the establishment of a permanent National Forest policy and the enactment of constructive legislation.

SALESMANSHIP

Hand in hand with publicity must go stimulation and satisfaction of demand by efficient salesmanship. Modern business has shown that salesmanship is more than order-taking. It involves a thorough knowledge of the product to be sold and methods of manufacturing; a study of markets; possibilities of development; the production of material to fit those possibilities; and the easy acquisition of that product by the consumer at the lowest price consistent with sustained, reasonable profits. The manufacturer should definitely classify and perhaps even brand building materials for the benefit and protection of the user, grade to fit common and technical uses, and cut to fit ultimate uses according to plans. Salesmen will assist consumers with information, plans and instructions; cooperate through distributing agencies with helpful personal service, and make good all material that fails owing to mechanical imperfections, carrying honesty of purpose to the user.

As an example of well-directed selling effort, suppose that each of the 6,200,000 farms of this country should consume 1,000 feet more lumber per annum than it is now using: the entire cut of Oregon and Washington would be absorbed. Suppose that every farm upon which animal food is wasted would erect a silo: the lumber consumed would require one-half of the entire cut of the United States for one year. Suppose wooden blocks were used as they deserve to be used on the streets and country roads of the United States: the increased use of lumber would be beyond comprehension, *and every foot used would mean economy to the user.*

Up to the present time lumber makers have made little effort to deliver

lumber in shapes, sizes and lengths ready for the ultimate user. Much lumber is cut before being put to final use, so the time shall come when cutting will be accomplished at the mill where the waste can be utilized, freight saved and delivery made in the sizes desired with economy to all concerned. Knocked-down houses, barns, garages, chicken houses, and even baby cradles are cut-up possibilities. Shelves, ironing boards, knocked-down boxes, and packages of short boards of assorted sizes for the boy carpenter will be stocked by merchants equipped to deliver such packages with other goods. Improved roads and auto truck service will revolutionize delivery from lumber yards.

The modern methods which must be practised by manufacturers' salesmen will make demands upon distributing agencies. They will call for development along the progressive lines that some lumber retailers and many distributors of other merchandise are following. More retailers will carry ample stock, comb the field for business, and advise buyers intelligently and honestly in selecting material. They will depend upon intensified effort, large volume and reasonable profit, rather than upon mediocre effort, limited volume, high prices and speculation. There should be fewer yards, larger and better equipped, with competent selling forces. Railroads will cooperate with distributors by giving in-transit rates, under which lumber may be re-shipped from central distributing points at low cost.

RESEARCH WORK

Research work, fostered by the manufacturer, will assist materially in market extension. There should be engineering research, dealing with structural problems, wood blocks, wood pipe and silos; chemical research developing the uses of such products as wood pulp, wood flour, ethyl alcohol, tanning materials, distillates, producer gas and similar products, as well as the further development of fire-proofing paints and other coverings. There should be research by business economists to find and emphasize old and new uses for lumber, by-

products and forest and mill waste, and determine districts in which to concentrate selling effort according to the needs and purchasing ability of those communities.

INITIATIVE

The initiative of the manufacturer should lead him into graded schools to foster manual training; into colleges to foster wood engineering to accompany courses in steel and concrete engineering and construction; into public affairs to foster proper public use of wood for bridges, roads, pipe-lines and other utilities, to encourage immigration, irrigation, back to the farm movements, intensive farming and low rates of interest to agriculturalists; into city administrative matters to correct and prevent unjustly discriminatory building codes; and into the organization of paving companies, home loan associations and the platting of suburban additions.

BETTER PRODUCING ORGANIZATION

Better producing organization is necessary in order to keep pace with such thorough selling effort. Demands will be made upon it for quick service, more perfect milling and more thorough and exact grading of products, further and more specialized manufacture to fit particular uses, and methods and means for conserving every possible item of lumber, waste and by-product.

COOPERATION

The sum and substance of all these requirements is that *lumber manufacturers must effect one combination in restraint of waste and another in promotion of legitimate trade*. To accomplish them is not a task for one manufacturer nor for the 46,000 separately owned and operated saw mills in the United States today. No successful business can point to a history of achievement through the wasteful competition of so many grossly inefficient producing units.

Consider the number of such units in the lumber business today. Thirty-three thousand mills make less than 20 cars of lumber each per year; the annual production of each is an equivalent of

less than fifty Douglas fir trees. Twelve thousand other mills make less than 200 cars each per annum; 500 Douglas fir trees would supply any of them a year. When we realize that one-half of the National supply of lumber comes from mills of these capacities with necessarily poor and limited equipment, we can better understand why unsatisfactory lumber reaches our markets, and why lumber is furnished to dissatisfied buyers.

These small units cannot accomplish the results demanded of the industry. If the greater part of our Nation's needs were supplied by large, efficient units, consisting of eight to twelve plants, under highly skilled management, the problem of distribution and close utilization would be worked out in a manner helpful to all. This would not mean control of the industry by monopoly. It would simply make possible the efficiency required in handling the product at the lowest cost to consumers.

The trend is already toward larger individual mills, because it has been found that they can produce more economically; but a single mill cannot market its output scientifically. Large-scale production and twentieth-century distribution must be accomplished.

The advantages of large units to producers and consumers will be apparent but there are vital requirements that even these units cannot meet. Some are questions for the industry as a whole to solve through associated effort, and some must be dealt with by Government. Associations will deal with matters of general publicity, traffic, insurance, workmen's welfare, building code revision, conservation, irrigation, and some of those matters of research and education which are of general interest to the industry and the public.

The Government is constantly increasing the scope of its Forest Service and chemical research work. It is now undertaking a constructive investigation of the lumber industry, and from it will result a better understanding of the situation than has yet been published. Its presentation of the present condition of the industry will prove illuminating to the public, valuable to lumbermen and of service to legislators;

and, above all, helpful in establishing a stable governmental forest policy.

“THE PROBLEM OF THE HEAVY LOAD”

Two fundamental influences affect the American lumber market. One is over-production, the other is over-supply of capitalized raw material. It is asserted by some that betterment of market conditions by large-scale production would induce increased over-production, owing to a demand for returns from capital invested in stumpage. It has always been true that the lumber manufacturing industry cannot carry the burden of all of the raw material supply if capitalized. It is the experience of operators that a 20-year supply of trees is as much as any operating property can carry at any period, if purchased at current market value.

Based upon a possible maximum cut of forty-five billion per annum, 20 years will be required to convert one-third of our trees into lumber. Taking Douglas fir stumpage at the valuation placed upon it in the Government's report on the lumber industry, and figuring out the selling return necessary 20 years hence to pay stumpage and interest, without any conversion profit for the operator, it is found that an increase of about 40 per cent over the 1913 lumber price must be realized. This calculation allows interest and other carrying charges on 20 years' supply of timber, depreciation of equipment and interest on working capital. To achieve these results, with an added conversion profit for the operator, it is apparent that all of the efficiency prescribed must be applied, and that the selling return on lumber must increase. An increase of 40 per cent over the normal average price for Douglas fir 20 years hence will not be necessary provided maximum efficiency is applied, resulting in less producing cost through improved methods of logging, manufacturing and distributing, more complete utilization of raw material and salvage of by-products.

The contention of authorities is positively correct, however, when they insist that there must be a means applied to withhold from the manufac-

turing market the two-thirds of the present timber supply which cannot be utilized during the coming score of years. One-fourth of the standing timber of the Nation is in National Forests.

Of the surplus stumpage which cannot be absorbed during the next 20 years, the private owner holds 62 per cent and the Government 38 per cent. The latter must be withheld if private owners are not to be compelled to destroy a national resource, honestly acquired, safe-guarded at private expense and necessary to the future welfare of the country; for should it be converted at this time its value would fall below the cost of conversion, and loss to labor and community would result. The Government, having no capital invested, no taxes to pay and no carrying charges other than nominal administration, can afford to hold their timber until it is needed. Closer utilization in that period will pay the cost. The first step toward cooperation and the solution of “the problem of the heavy load” should be to withhold government timber from sale except in localities which cannot be supplied from other sources. Individual owners of timber cannot look for early returns on their investments. Such investments are fixed and cannot be withdrawn at will. If not financially able to hold it, owners should pool their interests in stock companies to the end that our remaining private timber shall pass to organizations financially strong enough to save it from destruction or profitless exploitation.

It has been urged* that a trade commission be created with power to authorize cooperation so far as it shall not be inimical to the public welfare. To this it may be added that when a natural resource is jeopardized, such a commission should require compulsory cooperation to such a degree that it shall not be destroyed without profit to the community that produced it.

The duty that lumbermen owe to themselves, their communities and the Nation at large has been neglected. A great and vital industry has suffered because the brains and energy engaged

*Professor Van Hise, Wisconsin University.

in it have been directed toward mechanics rather than economics. Years of profitless, destructive effort have impaired the credit of the industry and fastened the stigma of incompetence upon it; yet these years have awakened those concerned to needs and good will result. We will learn to value our trees, conserve them under reasonable expense, convert them with profit to the labor and capital employed and apply them to legitimate uses.

Putting the industry in order will mark the passing of the lumbermaker and the advent of the merchant-manufacturer. New organization, new methods, new capital and new brains will be applied. Together these forces will maintain The American Lumber Industry in a proud position among the industries of men. Its future is secure. It waits on large-scale production, maximum efficiency and cooperation.

A TALE OF THE TRAIL

MATT DALY

Mr. Daly's work in the logging camps of Minnesota is along the general lines of the other camp missionaries, except that he brings to it a very unique personality, which is absolutely essential to success in dealing with the class of men with whom he comes in contact. He is not a preacher, but he is something very much more effective; a man, who because of his own peculiar experiences, can meet the lowest on common ground, and influence them in the right direction.
—Editor's Note.

This life's a middlin' crooked trail, and after forty years
Of knockin' around, I'm free to say that the right ain't always clear.
I've seen a lot of folks go wrong—Get off the main high road
An' fetch up in a swamp somewhere almost before they knowed.
I don't set up to be no Judge of right and wrong in men,
I ain't been perfect all my life and may not be again,
An' when I see a chap who looks as tho he'd gone astray,
I want to think he started right an' only lost his way.

I've seen a lot of folks start out with grit and spunk to scale
The hills that purple over there an' somehow lose the trail.
I've seen 'em stop an' start again, not sure about the road,
And found them lost on some blind trail almost before they knowed.
I've seen 'em circling, tired out with every pathway blind,
With cliffs before 'em mountains high, an' sloughs and swamps behind.
I've seen 'em circling through the dust when twilight's gettin' gray,
An' looking for the main road—Poor chaps who've lost their way.

It ain't far from right to wrong, the trail ain't hard to lose.
There's times I'd almost give my horse to know which one to choose.
There ain't no guides or signboards up to keep you on the track.
Wrong's sometimes white as snow, an' right looks awful black.
I don't set up to be no Judge of right an' wrong in men,
I've lost the trail sometimes myself and may get lost again.
An' when I see a chap who looks as tho he'd gone astray,
I want to shove my hand in his an' help him find the way.

CARE OF BIRD HOUSES*

By NED DEARBORN, Assistant U. S. Biologist

EACH spring before birds return from the South all filth and litter should be carefully removed from bird houses. In addition to the relics of previous occupancy, houses are likely to contain cocoons of insects, and nests of bees or squirrels. Attention to this one item of spring cleaning is a substantial factor in attaching birds permanently to their

guard them. Among these is the English sparrow, whose persistent attacks too often drive more desirable birds away from their nests and from the neighborhood. European starlings, which at present are not distributed beyond a narrow strip of the Atlantic coast region centering about New York, are to be condemned for their pernicious interference with native house birds.

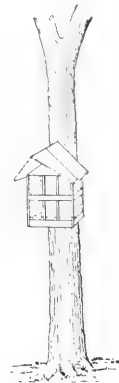
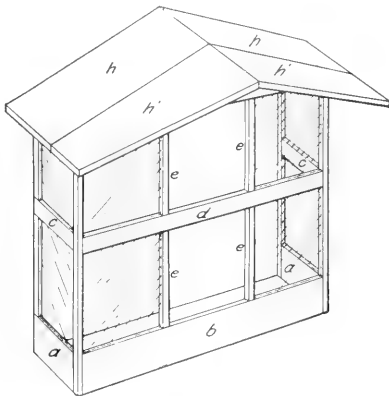

FIG. 1.—FOOD SHELTER FOR ATTACHMENT TO TRUNK OF TREE.

houses. A little sulphur scattered about a house is a good remedy for parasites. When bluebirds or swallows take possession of a martin house it is a good plan to put up a one-room house in the vicinity and remove the nest from the martin house. Interlopers, thus evicted, often transfer their house-keeping to the small house. Houses designed for woodpeckers should always have an inch or so of sawdust in the bottom for the reception of eggs, as woodpeckers do not gather nest materials. Due attention should be given to repairs. It is easier to keep houses in good order than to build new ones.

ENEMIES OF HOUSE BIRDS

Birds have numerous enemies from which a careful landlord will try to

Cats and large snakes are enemies of birds, the former perhaps killing more birds than any other mammal. Trees and poles supporting houses should be sheathed with tin or galvanized iron to prevent these enemies from climbing to the nests. Squirrels give more or less trouble by gnawing houses, eating eggs, and killing nestlings. Red squirrels in particular, have a very bad reputation in this respect, and many experimenters keep their grounds free from them. Some regard flying squirrels as but little better than red ones. Even gray and fox squirrels are occasionally troublesome. It is not necessary, however, that bird lovers should wage indiscriminate warfare against all squirrels. It is far better to adopt the rule never to kill a squirrel unless there is reason to believe that it has acquired

* From a Bulletin of the U. S. Bureau of Biological Survey.

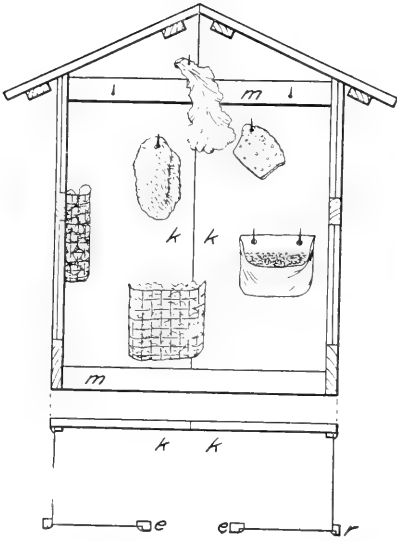

FIG. 2.—VERTICAL SECTION, SIDE TO SIDE, WITH SUGGESTIONS FOR LARDER; DIAGRAMMATIC AND CROSS SECTION OF FOOD SHELTER SHOWN IN FIGURE 1.

shelters that will protect food in all kinds of weather, the food may be fastened to trunks or branches of trees or scattered in sheltered places on the ground. A decided advantage in having shelters, aside from that of protecting food, is that they may be placed where the birds can be watched conveniently. When shelters are used the birds are first baited by placing food, such as suet, seeds, or cracked nuts, in a conspicuous place, and then led by degrees to enter the inclosure. Designs for two food shelters are exhibited in figures 1 and 5, one of which is supported by a post, the other by a tree. Structural details are shown for both. There is no bottom to either of them.

LOCATION OF HOUSES

The location of a bird house or food shelter has much to do with its success, for the reason that birds have decided notions as to proper surroundings for a dwelling. Martins prefer to breed near houses, but not within 20 feet of trees or buildings. Bluebirds are inclined to select orchards or pastures having scattered trees. Wrens, thrashers, and catbirds live in thick shrubbery. Robins like trees with sturdy trunks and branches. Titmice, nuthatches, and most of the woodpeckers are woodland species, although flickers and red-headed woodpeckers are more at home among the scattered trees of roadsides and pastures. Song sparrows frequent weedy swales and brush fences. Swallows do not enter woods so that a house would be as attractive to them in one open

the habit of eating eggs of young birds; the result will probably be that not more than one red squirrel in fifty nor more than one gray squirrel in a hundred will have to be killed. Where squirrels are numerous they give more or less trouble by gnawing and disfiguring houses. This damage may be prevented, however, by covering the parts about the entrance with tin or zinc.

FOOD SHELTERS

Another means of attracting birds about human habitations is to furnish an abundance of food, preferably in food shelters. If one is unable to make

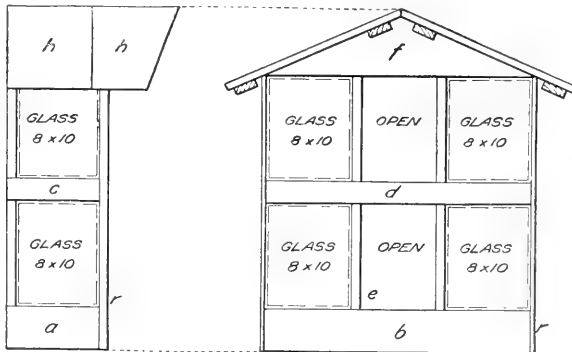

FIG. 3.—FRONT AND SIDE ELEVATIONS OF SHELTER SHOWN IN FIGURE 1.

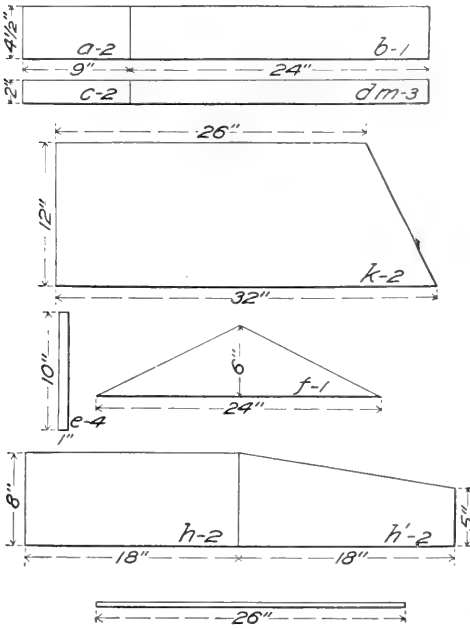

FIG. 4.—LUMBER DIAGRAM OF FOOD SHELTER SHOWN IN FIGURE 1.

place as in another. The eastern phoebe, the black phoebe, and the house finch, while not limited to the haunts of man, are noticeably partial to them. Crested flycatchers, screech owls, barn owls, and sparrow hawks are governed more by convenience than by taste; although normally inclined to hold aloof from man, they have in many instances reared their broods in close proximity to dwellings. Barn owls, true to their name, accept suitable quarters in buildings without hesitation.

Before erecting bird houses one should first determine the kind of birds to which his premises are adapted. The question usually next arising is as to the number of birds that can be accommodated. Unless grounds are large, it is generally useless to expect as tenants more than a pair of each species, except martins. However, the singular intolerance shown by most birds during the breeding season to others of their kind does not operate between those of different species. A dozen different kinds of birds will pursue their several modes of hunting and raise their families on the same lot, but rarely two of the same sort. The fact that

birds are more tolerant toward strangers than toward relatives was well illustrated by an observation made recently by the writer in New Mexico. A one-story tool house 10 feet square had nailed to three corners of its roof rough bird houses made from packing boxes. One was occupied by violet-green swallows, another by western blue birds, and the third by English sparrows. A still more remarkable association of different species has been reported by Otto Widmann, of St. Louis, Mo., who once had a pair each of flickers, martins, house wrens, and English sparrows nesting simultaneously in the same

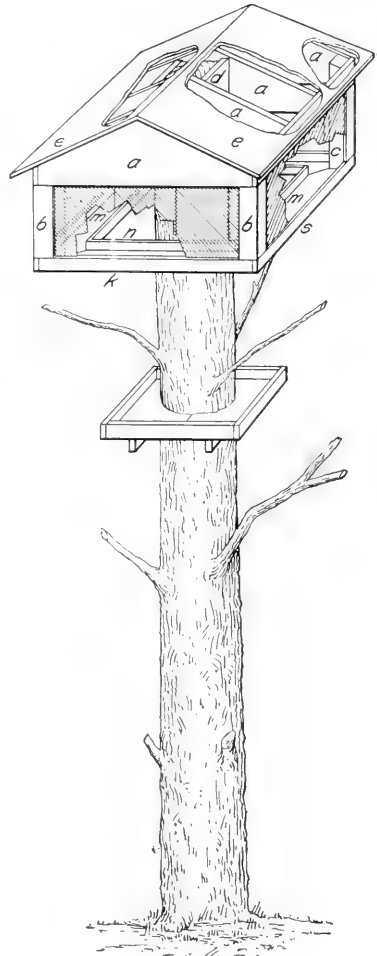

FIG. 5.—FOOD SHELTER FOR ATTACHMENT TO POST. ROOF CUT AWAY TO SHOW CONSTRUCTION. SIDES MADE OF GLASS; SIZE OF PANES 8 BY 10 INCHES.

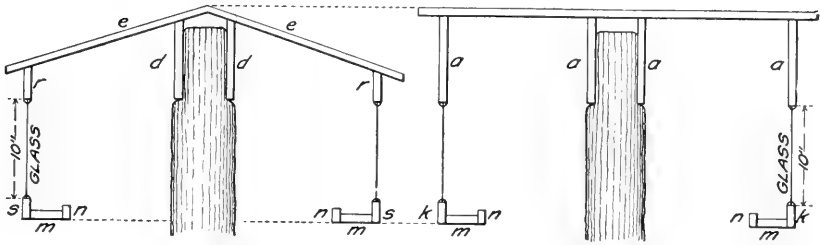

FIG. 6.—CROSS AND LONGITUDINAL SECTIONS OF FOOD HOUSE SHOWN IN FIGURE 5.

house. Of all our house birds, martins alone are social. The fact that there is a limit to the possible bird population on any given tract must be taken into consideration. When the probable tenants have been decided upon, the selection of sites is in order, for the site often decides the style of house that is to occupy it. In the final placing of bird houses, care should be taken to

have them face away from the winds prevailing in stormy weather. The strongly developed homing instincts of birds can be relied on to attach them to the neighborhood where they first saw the light, and the identical pairs which nest in the houses provided for them one year will often return the next season to enjoy the same bounty and protection.

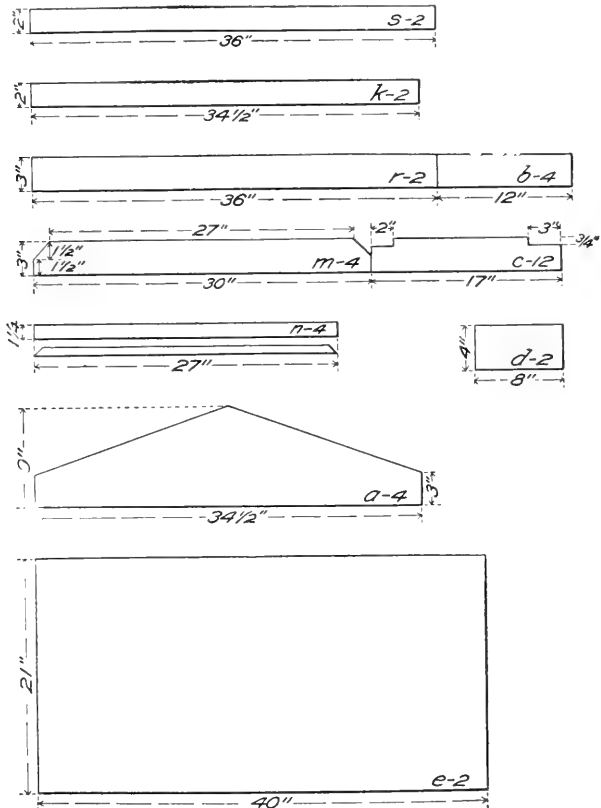

FIG. 7.—LUMBER DIAGRAMS OF FOOD SHELTER SHOWN IN FIGURE 5.

NATIONAL FORESTS USED

SELLING some billion and a half board feet of timber and supervising the cutting on several thousand different areas, overseeing the grazing of more than 1,500,000 cattle and 7,500,000 sheep, and building more than 600 miles of road, 2,000 miles of trail, 3,000 miles of telephone line, and 700 miles of fire line are some of the things which the Forest Service did last year, as disclosed in the report by Chief Forester Graves, for 1914. These activities were on the National Forests, which at present total about 185,000,000 acres.

There is need, says Chief Forester Graves, to increase the cut of timber from the National Forests wherever a fair price can be obtained for the stumpage, because a great deal of it is mature and ought to be taken out to make room for young growth. Unfavorable conditions in the lumber trade caused new sales of National Forest timber to fall off somewhat during the past year, though the operations on outstanding sales contracts brought the total cut above that of the previous year by 130,000,000 board feet. There was, however, a big increase in small timber sales, these numbering 8,298 in 1914 against 6,182 the previous year. Desirable blocks of National Forest timber have been appraised and put on the market, and it is expected that these will find purchasers when conditions in the lumber industry improve. All told, the Government received \$1,304,053.66 from the sale of timber on the forests in 1914. The receipts from all sources totaled \$2,437,710.21.

After eight years of experience stockmen are well satisfied, says the Chief Forester, with the way the grazing of livestock on the forests is regulated, and have even urged upon Congress the application of the same method of control to the unreserved public range. Almost 29,000 permittees graze stock on the National Forests, and these paid to the Government in the fiscal year 1914 fees amounting to over a million dollars. The present tendency to raise

fewer sheep and goats and more cattle and horses is shown in the fact that the number of cattle and horse permittees on the western forests increased last year by 1,579, while the number of sheep and goat permittees fell off by a total of 268. The western stock business, the forester points out, is becoming attached to the soil, and the itinerant sheep grower and the speculator in cattle are giving place to the permanent resident and owner of improved ranch property. The latter is always given preference in the use of National Forest range.

Some \$400,000 was spent by the Forest Service during the year for permanent improvements on the National Forests to make them accessible and to insure their protection from fire. These improvements include 270 miles of new road, 2,153 miles of trail, 3,063 miles of telephone line, 775 miles of fire line, and 106 lookout structures, besides bridges, corrals, fences, and cabins. In addition, 642 miles of road were built for the public by the use of 10 per cent of the National Forest receipts, as authorized by Congress.

Under another law, 25 per cent of the National Forest receipts for the year, amounting to \$586,593.39, were paid over to the various States in which the forests lie for the benefit of county schools and roads.

Since 1909, when systematic classification of National Forest lands was begun, more than 10,000,000 acres have been eliminated. Scattered interior tracts which it is not practical to eliminate are opened to settlement through listing, which allows them to be taken up under the Forest Homestead Law. Anyone may apply to have land within a forest examined to determine whether it is best suited for agriculture, and if found so it is opened to settlement under this law. During the year 2,690 tracts, totaling 282,483 acres, applied for by individuals, were opened for entry. By elimination and listing the percentage of unpatented agricultural land within the National Forests, never large, has been reduced to a very small amount.

FOREST FIRE WARNINGS

This is the time of year when it is wise to post warnings against carelessness which may result in great forest fires and heavy losses. Models of such warnings are here given and any of these may be selected for use where they are suitable or new ones may be composed of the best and most desirable sections of those here reproduced.

As a basis for calling attention to the need of great precaution against fire in the woods the following rules are well worth remembering:

Rules for Care with Fire in the Woods.

1. Be sure your match is out before you throw it away.
2. Knock out your pipe ashes or throw your cigar or cigarette stump where there is nothing to catch fire.
3. Don't build a camp fire any larger than is absolutely necessary. Never leave it, even for a short time, without putting it OUT with water or earth.
4. Don't build a camp fire against a tree or log. Build a small one where you can scrape away the needles, leaves or grass from all sides of it.
5. Don't build bonfires. The wind may rise at any time and start a fire which you cannot control.
6. If you discover a fire, put it out if possible; if you can't, inform the nearest Forest Ranger or Fire Warden as quickly as you possibly can.

YOU CAN HELP!

PREVENT FOREST FIRES!

DON'T Drop Burning Matches or Tobacco in the Woods.

DON'T Build Fires in Brush or Leaves or Against a Rotten Log.

DON'T Leave a Fire Until You Are Sure It Is Out.

Exercise the Same Care With Fire in the Woods that You Do at Home.

If You Find a Forest Fire, Put It Out.

If You Can't Control It Alone, Get Word to the Nearest Town Supervisor.

You Must Help Protect the Forests and Timber

YOUR OWN INTERESTS DEMAND IT!

THE LAW REQUIRES IT!

CONSERVATION COMMISSION, ALBANY, N. Y.

AMERICAN FORESTRY ASSOCIATION, WASHINGTON, D. C.

FOREST FIRES

YOUR HELP IS ABSOLUTELY NECESSARY TO PREVENT WOODLAND FIRES. READ THESE LAWS, OBEY THEM AND HELP ENFORCE THEM IN YOUR TOWN. GET PERMIT FROM WARDEN BEFORE KINDLING FIRES IN SPRING OR FALL. DO NOT THROW DOWN LIGHTED MATCHES, CIGARS OR OTHER MATERIALS. NOTIFY THE NEAREST WARDEN IN CASE OF FIRE AND GET BUSY YOURSELF.

EXTRACTS—CONNECTICUT FOREST FIRE LAWS.

1. Kindling a fire upon public or private land without permission of the owner is subject to fine and imprisonment. See 1220 Gen. Stats.
2. Kindling a fire in woodland without clearing space of 20 feet around it is punishable by fine and imprisonment. Fires must be extinguished before leaving. Chap. 43 Pub. Acts 1907.
3. Kindling a fire in the open air which damages property of another is subject to fine and imprisonment. Chap. 128, Sec. 3, Public Acts 1909. Persons setting fires which runs on land of another are liable to the owner for all damages caused. Sec. 1096 Gen. Stats.
4. Kindling a fire by throwing down a lighted match, cigar or other burning substance is punishable by \$500. fine or imprisonment six months or both. Sec. 1220 Gen. Stats.
5. Permits required for kindling fires March 15th to June 1: Sept. 15 to Nov. 15. Written permission from a local warden is required for kindling a fire in the open air except in a ploughed field, garden or public highway not less than 200 feet from woodland, brushland or land covered by dry grass or other inflammable material. (This law does not apply to kindling fires in cities, boroughs, organized fire districts, and on land controlled by railroad company.) Violation of this law is punishable by \$200. fine or six months imprisonment or both. Chap. 124, Sec. 2, Public Acts 1911.
6. Any fire warden may arrest without warrant persons taken in the act of violating any laws for the protection of forest and timberlands. Chap. 238, Sec. 4, Public Acts 1905.
7. The law provides a penalty of \$10. for injuring this notice. Chap. 238, Sec. 10, Public Acts 1905.
WALTER O. FILLEY,
State Forest Fire Warden.

FOREST FIRES

BURNING BRUSH OR SETTING FIRE in or near the woods IS UNLAWFUL throughout the year in this township WITHOUT A WRITTEN PERMIT from the local Firewarden. Penalty for violation, \$50 to \$200.

A permit is not necessary if the fire is at least 200 feet from woodland or growth that may carry fire to the woods. Any legal FIRE MUST BE WATCHED UNTIL it is ENTIRELY OUT. Penalty for failure, \$50 to \$200.

To cause A FOREST FIRE IS A VIOLATION OF THE LAW. Penalty, \$50 to \$200.

A Firewarden's permit gives no release. Ignorance of the law is no excuse. Poor judgment or mishap relieves no one.

SMOKERS are warned that dropping lighted matches or tobacco in or near the woods may render them liable to this fine and do unguessed damage as well.

FIREWARDENS CAN ARREST ANYONE FOUND VIOLATING THE LAW

Small fires may grow larger and do your neighborhood much harm. Each fire stopped when small means increased property value to you and your neighbors. Put out at once any that you find, or if you cannot do so, summon help.

All such fire-fighters are paid for their work if the local Firewarden is told of and approved the service within ten days after the fire.

_____ Firewarden

_____ Township

BY ORDER OF THE FOREST PARK RECREATION COMMISSION OF NEW JERSEY,
STATE HOUSE, TRENTON.

APR-4-1911

FOREST FIRES MENACE PROSPERITY

**A Little Care on YOUR PART
May Result in the Saving of
THOUSANDS of DOLLARS
to CITIZENS of OREGON**

**Do You Realize that Oregon
Timber Pays About One-
third of the State's Taxes?**

**That Oregon's Forests Distribute More
Wealth in the State than Grain, Fruit,
Vegetables and Fish Combined?**

**GOOD CITIZENSHIP DEMANDS OB-
SERVANCE OF THE FOREST FIRE LAWS**

OREGON FOREST FIRE ASSOCIATION
718-719 Teon Building, Portland, Oregon

STOP

**You Are Interested In
This Notice. Read It.**

You can help save California millions of dollars yearly by being careful in the use of fire. Remember that for every 1000 feet of timber burned it means a loss to you and the community of over \$8.00 while the owner's loss will be \$1 or \$2.

Observe The Following Rules

Never to burn brush, grass or slashings during the dry season without a permit from the fire warden. Never leave a camp fire until it is out. Don't toss away any matches or tobacco. Don't make a camp fire in leaves, rotten wood or against a log--keep a clear space around your fire. If you find a fire put it out if you can, if not, notify a Fire Warden or State Forester at once. Care with small fires means few large ones. Be as careful with fire when out in the forests, as you would be in your own home

**The Law and Good Citizenship Require Observance of
These Rules. HELP ENFORCE THEM**

Redwood Fire & Protective Association
Fort Bragg, California

FORM 1

State Board of Forestry

NOTICE

All Hunters, Trappers, Fishermen, Campers, Surveyors, Land Locators, Travelers or other persons, are required by Section 4405a, Statutes of 1898, to totally extinguish ALL FIRES BUILT BY THEM before leaving them and to use all possible precautions to prevent the escape of the fire from their control at any time.

A fine of not more than 50 DOLLARS OR IMPRISONMENT IN THE COUNTY JAIL not more than six months for each offense is imposed by said section for failure to comply with its provisions, and all violations will be vigorously prosecuted whenever detected.

E. M. GRIFFITH,
State Forester.

NOTE--Any person who destroys or removes this warning notice is punishable by a fine of from \$15 to \$100, or by imprisonment from 10 days to 3 months, or by both fine and imprisonment.

SAVE IDAHO

MILLIONS OF DOLLARS YEARLY

BY BEING CAREFUL IN THE USE OF FIRE

FOREST FIRES MEAN—

DANGER TO LIVES AND HOMES OF SETTLERS
LABOR TURNED AWAY EMPTY-HANDED
REDUCED MARKET FOR OUR CROPS
HEAVIER TAXES ON OTHER PROPERTY
STREAM FLOW DISTURBED

For every dollar lost by timber owners, the

Community Loses Five times as much in

WAGES AND MARKET FOR SUPPLIES

GOOD CITIZENSHIP FORBIDS— THE LAW PUNISHES—

Tossing away burning matches or tobacco;
Building camp fires in leaves, rotten wood or against logs, where they may spread or be impossible to extinguish;
Leaving any camp fire before it is out;
Burning brush or slashings in dry season without permit;
Using spark-emitting engines in the dry season;
Refusing to fight fire when summoned by a fire warden.

CARE WITH SMALL FIRES, BY PREVENTING LARGE ONES, MEANS PROSPERITY INSURANCE

Violation of these rules may cause injury and distress beyond calculation. Help Enforce Them! Put out any fire you find if you can. If you cannot, notify a fire warden, some other public officer or the land owner.

For the law send to—

STATE LAND COMMISSIONER
BOISE, IDAHO

FOREST FIRES! WARNING

It is Unlawful and Punishable by Fine and Imprisonment

First—To set and leave any fire that may spread to adjacent timber or other property.

Second—To burn slashings, choppings, and the like, from June 1st to October 1st, without a permit issued by a Fire Warden or Forest Ranger.

Third—To operate spark-emitting locomotives, engines or boilers without using safe and effective spark arresters.

Fourth—To deface, destroy, or remove this notice.

Campers, hunters, fishermen and others are warned against building campfires in moss, rotten wood or against old logs, where the fire may smoulder and finally burst into flame and spread to adjoining timber or other property. Never leave your fire until you are sure it is out.

Help Protect the Forests from Fire

We ask your co-operation and assistance in protecting timber and other property from fire. Use the same care with fire in forest regions that you would use in your own home or in a city. Put out a fire if you can. If you cannot, notify the nearest Fire Warden or Ranger.

Approved by the

State Board of Forest Commissioners

E. W. FERRIS

STATE FORESTER AND FIRE WARDEN

PLATE 8. LARGEST SIZE. PRINTED GREEN

ROOM FOR 5,000,000 SHADE TREES

THE New York State College of Forestry at Syracuse University is urging the municipalities of the State to take up public control of street tree planting and preservation in the same manner as public control is exercised over other street improvements. During the past year the College has made investigation of the shade trees in many cities and towns of the State including New York city, Syracuse, Binghamton, Amsterdam, Mount Vernon, Newburgh and Olean. It has been found that thousands of shade trees are dying along the streets of the cities due to

past mistake in selection of varieties and in spacing the trees at the time of planting, which has forced the trees to grow with weakened vitality, inviting decay by tree diseases and by the attacks of insect pests. There is a great need for systematic work in planting trees to replace those that have failed to fill in the many unplanted areas along city streets. It has been estimated that within the cities of the State there are 20,000 miles of streets capable of sustaining a growth of 5,000,000 shade trees which can be made worth \$100,000,000 in increased property value.

Pine Used by Box Industry.

White pine and yellow pine are the woods most used for boxes, and each contributes more than a billion feet to the box industry annually.

British Columbia's Timber Protection.

The annual cut of British Columbia timber is approximately two billion feet. There are 420 mills and 790 logging camps in the province, employing about 60,000 men.

SELECTING TREES AND SHRUBS

ONE HALF of the success of growing shade trees and ornamental shrubs is in selecting the kind of trees and shrubs best suited to soil and climatic conditions. These vary greatly in different sections of the

United States. The following tables have been prepared in order to aid as much as possible in making this selection of trees and shrubs best suited for general use on private grounds, streets, private parks and school yards.

For New England States, New York, Pennsylvania, New Jersey, Ohio, West Virginia, Kentucky, Indiana, Michigan, Illinois, Missouri, Iowa.

Deciduous Trees

Sugar maple
Norway maple
Scarlet maple
Green ash
White ash
American white elm
Red oak
White oak
Pin oak
American linden
Scarlet oak

Evergreen Trees

White spruce
Colorado blue spruce
White pine
Scotch pine
Balsam fir
Hemlock
Arbor vitae

Shrubs

Lilac
Exochorda
Viburnums
Philadelphuses
Hydrangea
Japan quince
Flowering currant
Calycanthus
Cornuses
Spiareas
Weigela
Coral berry
Snow berry
Sweet pepper bush
Loniceras
Wild roses
Rosa rugosa
Barberries

For Delaware, Maryland, Virginia, North Carolina, South Carolina, Georgia, Tennessee, Florida, Alabama, Mississippi, Louisiana, Arkansas, Oklahoma, and Texas.

Deciduous Trees

Tulip
Sycamore
Pin oak
White oak
Scarlet oak
Black oak
Red oak
White ash
Bald cypress
Norway maple
Scarlet maple
Red elm
American white elm
Kentucky coffee
American linden
Catalpa
Liquidambar
Hackberry
Sour gum
Willow oak
Camel oak

Evergreen Trees

White pine
Long-leaf pine
Magnolia
Live oak
Cedar of Lebanon
American holly

Shrubs

Golden bell
Lilac
Eloeagnuses
Loniceras
Hibiscus
Roses
Japan quince
Calycanthus
Smoke tree
Viburnums
Jasmines
Hydrangeas
Crape myrtle
Cornuses
Spiareas
Privets
Barberries
Hollies
Abelia

South of Charleston, S. C.—Camelia, japonica, prunas caro, liniana (mock orange), oleo fragrans, Bay trees, Azalea Indica, Viburnum Finus.

For Wisconsin, Minnesota, North Dakota, South Dakota, Nebraska, Kansas, Colorado, Wyoming, Montana and Idaho.

<i>Deciduous Trees</i>	<i>Evergreen Trees</i>	<i>Shrubs</i>
Bur oak	Scotch pine	Lilac
Linden	Austrian pine	Barberry
Norway maple	White pine	Cornus
Green ash	Norway spruce	Tamarix rensis
Wild cherry	Colorado blue spruce	Japan quince
Larch	White spruce	Rosa rugosa
American elm	Red cedar	Crataegus
Black walnut	Arbor vitae	Eloagnus hortensis
Hackberry		Shepherdia argentea
Honey locust		Wild Roses
Black locust		Missouri currant
		Coral berry
		Spiraeas

Less desirable—Cottonwood, catalpa, box elder.

For New Mexico, Arizona, Utah and Nevada.

<i>Deciduous Trees</i>	<i>Evergreen Trees</i>	<i>Shrubs</i>
Hackberry	Arbor vitae	Althea
Honey locust	Cedrus deodara	Wild rose
Green ash	Box	Spiraeas
American elm	Euonymus	Flowering currant
Black locust		Elder
Bur oak		Lilac
Valley cottonwood		Tamarix
Mountain cottonwood		Rosa rugosa
Mountain ash		Thurbergi barberry
Box elder		Privet
		Coral berry

For California, Oregon and Washington.

<i>Deciduous Trees</i>		<i>Shrubs</i>	
<i>Coast Region</i>	<i>Columbia Basin</i>	<i>Coast Region</i>	<i>Columbia Basin</i>
Large-leaved maple	Scotch elm	Roses	Lilac
Tulip tree	American elm	Weigela	Hardy roses
Mountain ash	Norway maple	European holly	Philadelphus
European linden	European linden	Lilac	Eloagnus hortensis
Sycamore	Sycamore	Laburnum	Laburnum
Weeping willow	Green ash	Deutzia	Spiraea
	Silver poplar	Hydrangea paniculata	Tamarix amurensis
	Russian poplar	Mock orange	Rosa rugosa
	White willow	Japan quince	Barberry

PLANTING SUGGESTIONS

The beauty of a shade tree depends upon its normal and symmetrical growth. In order to insure this, before planting cut off the ends of all broken or mutilated roots; remove all side branches save upon evergreens, so that a straight whip-like stalk alone remains.

Dig holes at least 3 feet in diameter and 2 feet deep in good soil, and make them 4 feet across in poor soil. The sides of holes should be perpendicular and the bottom flat. Break up soil in the bottom of the hole to the depth of the length of a spade blade. Place 12 or 15 inches of good top soil on the bottom

and use the fine top soil, free from sods or other decomposing organic matter, about the roots. On top of this place the roots of the tree, spread them as evenly as possible over the earth, put in and cover with 2 or 3 inches of fine top soil. Tramp firmly with the feet and fill the hole with good earth, leaving the surface loose and a little higher than the surface of the surrounding soil. When the work of planting is completed, the tree should stand about 2 inches deeper than it stood in the nursery.

In order to insure symmetry of growth, trees must be allowed unrestricted area for development. At least 40 feet should be allowed between trees intended to occupy the ground permanently. Quick-growing temporary trees may be planted between the long-lived ones to produce immediate results, but because of the probability they will not be removed as soon as they interfere with the development of the permanent plantations, this practice is not to be recommended.

Our Association at the Exposition

It is expected that a large number of members of the American Forestry Association will attend the meeting of the Association at the Panama-Pacific Exposition at San Francisco on Wednesday, October 20. This will be officially known on the program of the Exposition as American Forestry Association Day.

During the same week will occur meetings of the Society of American Foresters, the Western Forestry and Conservation Association and the Pacific Logging Congress. Thus there will be gathered at San Francisco during the week representatives of forestry interests from all over the United States and Canada.

The program will be announced in good time and other details will be stated in AMERICAN FORESTRY before the gathering. Many members of the Association who plan to attend the Exposition will arrange to do so at a time when they can also attend the Meeting of the Association.

Change in Address

Members of the American Forestry Association are requested to send notification of any change in address so that the AMERICAN FORESTRY MAGAZINE and other mail will not be delayed in reaching them.

Such notices are desired before the 25th of each month so that the address may be changed for the monthly mailing of the magazine.

CONNECTICUT FORESTRY MEETINGS

AN INSPIRING series of forestry addresses were presented on the eighth and ninth of March at Middlebury and Waterbury, Connecticut, under the auspices of the American Forestry Association, in cooperation with the Forestry Associations of Pennsylvania, Connecticut, Massachusetts and New Hampshire.

A most forcible address was presented by Dr. J. T. Rothrock, the first Commissioner of Forestry in Pennsylvania, and for many years an active member of Pennsylvania's Forest Reservation Commission, who with a striking series of lantern pictures, showed the desolate condition on the hills of Pennsylvania outside of the one million acres of forest reserve that that State has purchased. The force with which this address brings home the approaching scarcity of timber in this country may be inferred from the fact that Mr. Herbert Welsh, of Philadelphia, who had previously heard this address in Witherpoon Hall in that city, has had 10,000 copies printed, fully and attractively illustrated. It may be had by sending 5 cents postage to Mr. Herbert Welsh, 995 Drexel Building, Philadelphia, Pa.

Mr. S. B. Elliot, of Pennsylvania, read a very able article on "Our Forest Conditions and Needs." Mr. Elliot's deep interest in forestry, his long experience as an active member of the Pennsylvania Forestry Reservation Commission, and his wonderful vigor and power of thought and expression in the evening of a life devoted to forest interests, gave to his address a personal touch and force that was very impressive.

Another strong address was that of Professor J. W. Toumey, Director of the Yale Forest School, upon State and Town Forests. He pointed out that it is unwise in this country to depend upon private individuals for a future timber supply. This matter of saving the remnants of our forests must be

taken up through State enterprise, and it is even now too late to grow a new crop of trees before the scarcity will be upon us. State planting on a large scale should begin without further delay.

Able addresses from other parts of New England, by Mr. Harris A. Reynolds, Secretary of the Massachusetts Forestry Association, and Mr. Philip W. Ayres, Forester of the Society for Protection of New Hampshire Forests, showed the same general conditions in New England that Dr. Rothrock pointed out in Pennsylvania. Mr. Ayres' address was illustrated with pictures thrown on the screen showing scenes from the National Forests in the White Mountains, the Southern Appalachians and on the Pacific coast.

It was the consensus of opinion of all present that larger and more important efforts to conserve the remnant of forests that remains in this country, and to replant on a large scale, must be taken immediately by the Towns, State and Federal Governments.

It was also pointed out that under the Weeks Act \$3,000,000 did not become available, and that an effort should be made in the next Congress to reappropriate this amount in order that the original plans of the Act may be carried out in the White Mountains and the Southern Appalachians. The friends of forestry everywhere are urged to lend their help to secure this measure at the next session of Congress.

The three sessions were presided over by Mr. Herbert Welsh, of Philadelphia; Mr. Frederick J. Hillman, of Springfield; and Dr. Henry S. Drinker, President of Lehigh University and of the American Forestry Association.

Hon. Robert S. Conklin, Commissioner of Forestry in Pennsylvania, Mr. Walter O. Filley, State Forester of Connecticut, and a number of others prominent in the forestry movement were present.

EDITORIAL

NO POLITICS IN THIS FORESTRY WORK

COMPLETE vindication in the recent Oregon Legislature of the principle that State forest work should be both independent of politics and independent of other State activities should be a lesson to other States where these points are at issue.

Oregon has more timber than any other state; indeed it has a fifth of all the timber in the United States. Forest industry employs nearly two thirds its industrial population. Consequently its forest laws are important. It has a Board of Forestry wholly non-political, consisting of representatives of the several chief interests involved such as the timber owners' patrol organizations, the lumber manufacturers, the U. S. Forest Service, the State Forest School, the Grange, etc. These elect the State Forester and govern his administration. There is a compulsory patrol law making every forest owner do his share. The State policy is to coordinate State, Federal and private protective effort under a cooperative system in which each has due representation. Forest owners are encouraged to organize and have voice in this system. Funds for patrol are jointly contributed and jointly spent. The system is efficient. Fire losses are negligible.

In the recent Legislature there were many attacks on this system. Reluctant timber owners who sought protection without expense secured the introduction of a bill abolishing compulsory patrol. They believed their neighbors would continue the work for them. Another bill sought to do away with State Forest work entirely, theoretically

to save expense to the tax payer but actually as a "sandbag" measure to secure control through compromise. A third proposed to make the Board and the State Forester politically appointive, in order to build up a patronage machine. A fourth was for consolidation of forest work with the State's land and water work.

Each of these supported its contention by attack upon the existing system, resulting in the presentation of every conceivable argument and charge involving its principle, administration and personnel. All had the favorable auspice of an "economy Legislature" listening willingly to any criticism of an appropriation-supported institution. The fighting was sharp and prolonged throughout the session.

The result was a rally of almost the entire population of the State to the support of the existing non-partisan independent system. Lumbermen, business men, women's clubs, organized labor—indeed practically every element—protested against change. The Governor himself declared against putting forest work into politics, even under his own appointment. The attempt to consolidate forestry with other State Boards was greeted with such indignation that it was repudiated by the very committees appointed to seek consolidation in State work wherever this should be practicable. The system went before the people on its principle, record, and achievement and was triumphantly sustained without a single change. And Oregon is a Forest State, with plenty of bitter experience in matters of forest protection.

FORESTRY AND INDEPENDENCE

SOME states, after securing a State Forestry Board which is independent of other State boards, independent of politics and independent of any affiliation or

condition which detracts from its best service for the good of the public, make the grave mistake of endeavoring to combine such departments with others. Invariably such change has

resulted in more or less incompetent management and proved costly to the state.

Despite this, efforts to secure changes from present systems, which are effective, to others which have proved to be ineffective, are being made in some states at the present time.

The men who favor such changes would do well to read the following extract from a letter written by Mr. E. T. Allen, a Director of the American Forestry Association, to a member of the Oregon House Committee on the proposed consolidation of the State Forestry Board with other boards in that State.

After stating that the present board is unsalaried, that its work does not overlap any other State work, and that its work is most important owing to the great value of Oregon's forest resources, Mr. Allen goes on to tell of its duties. He says:

"The purpose and duties are most specific and real, as the minutes of past meetings will show. The board has not only to obtain competent non-political officers to protect life and property, but to deal with live, practical and difficult problems where error or neglect would be very costly to the State. The protective work must be with full understanding of, and in harmonious cooperation with, that of private owners and the Government. The laws must be administered with justice alike to struggling settler and wealthy timber-owner. To a very large extent, therefore, the board's work is technical, requiring special competence in the beginning and improving directly with attention and experience. This forest State particularly needs the building up of such a board. No inexperienced ex-officio service will suffice.

"There is no political significance under the statutory composition of the board. Its membership cannot become a political reward; its own composition precludes the use of its authority to build a political machine or spend State funds to pay political debts. It is the one board in the State absolutely free from political possibilities.

"So it seems to meet every count. Now let us consider the danger of

change—the same danger that has wrecked the forest work of many other states.

"There are practically only three other methods: (a) a Governor's straight appointive board; (b) an ex-officio board of selected State officials; (c) a combination of existing boards having some theoretical relationship. The first is necessarily political, or capable of being made so, and is satisfactory to no one but the "ins." Even to them it may prove embarrassing. Such boards have never done good work long, especially when involving a large paid force. The ex-officio board of State officials is practically useless or worse. Being busy and without interest or technical knowledge, its members give the State Forester no real help. If they do anything, it is to exert political pressure without even understanding its influence.

"The third method, that of combining all the State's relations to natural resources under one board, has more plausibility than the other two but has always failed in practice for certain unavoidable reasons. First of these is the impossibility of getting competence in any one line as a *board*, however competent each member is in his own specialty. The very proficiency which has led to appointment of a fish member, or a mining member, or a forestry member, means he has specialized too much on that to understand the other things. *So whatever the topic before the board, it is acted on by a majority that does not understand that topic.* There cannot be a competent majority on any, if the board is fairly chosen. If it is not so chosen and there is a fish, forestry, or other majority, then obviously the minority subjects always suffer. This is an inherent weakness in a mixed topic board of *technical nature*. It is doubly dangerous if the funds are also made general. Finally, the combined board of this kind always manages, if it makes a mistake in any subject, to bring down public disapproval on all. For example, if you combine forestry with fish and game work and the latter makes enemies, the latter will fight the forestry appropriations, too, in order to punish the

board. With these weaknesses to contend with even if politics is kept out, and with the added danger of marrying political troubles, too, our present efficient forestry system would be sure to suffer, as it always has elsewhere, if it is tied to anything else. It is looked at as a model now. Why endanger it?

"Finally, there is one thing which differentiates State forest work from all other State work. This is that under the modern development of forest protection, the latter is not purely a State function any more than it is a

private or Federal one. The three protective agencies cooperate, at great mutual advantage in economy and effectiveness. They act together as a sort of board of public welfare. While the State runs its business independently in most functions, it cannot in this. Therefore, it must have its Forestry board so constituted as to deal most effectively with the other two agencies. As these are purely forestry agencies, the present system is logical and harmonious. A combined board would have no such simple machinery.

CANADIAN DEPARTMENT

By ELWOOD WILSON

The most important need of forest protection in Canada at present is that the Government owned and operated railroads, The Intercolonial, International and National Transcontinental, should have an adequate fire protection system. As they run for the most part through heavily forested areas and on the eastern section of the National Transcontinental there is no possibility of any freight except that which comes from the forest and its products.

Last August the management of these roads issued orders to their roadmasters, section foremen and train crews to keep a sharp lookout for fires and to extinguish them wherever found. Everyone who has ever had any experience with section men knows that they have so much other work to do and so many miles of track to keep in order, that without proper inspection, they will not pay much attention to forest fires. This matter is considered so important that the following important bodies have taken action and have written the Hon. Frank Cochrane, Minister of Railways and Canals, asking him to make effective the same regulations on the Government Railways which have proved so successful on privately owned railroads under the jurisdiction of the Dominion Railways Commission. The Canadian Forestry Association, the Department of Lands and Forests of Quebec, the Quebec Limit Holders Association, the St. Maurice Forest Protective Association and Sir William Price. The Conservation Commission has for two years been urging the same action. The regulations mentioned above, require that a competent inspector shall have supervision of fire protection work, that during dangerous times extra patrols in addition to section men shall patrol the right-of-way and that the same shall be properly clean of all debris and inflammable material. In an interview had with Mr. Cochrane in January by a

committee of the Canadian Forestry Association, he said that he wanted to do all in his power to aid the cause of forest protection and to save Canada's forests and it is hoped that everyone who has any interest in this important matter will write the Honorable Frank Cochrane, Minister of Railways and Canals, asking him to take prompt action along the above lines before the middle of April, when the danger season commences.

The Railway Commissions regulations have been so practically framed and under its system of inspection so well carried out that forest fires from railroads privately owned have materially declined and will soon be a thing of the past. The Canadian Pacific Railway has gone at this matter with characteristic vigor and under Mr. A. D. MacTier, assisted by Mr. B. M. Winegar, has built up a splendid system of fire protection which bids fair to wipe out fire claims at an early date.

Mr. Piché, Chief Forester of the Department of Lands and Forests of Quebec, has just completed some valuable tables which should be distributed to the lumber companies and limit holders. These are a table of the contents of tree in board feet measure based on the measurement of 4,525 trees and giving the amounts which can be deducted for different defects; also tables showing the total number of board feet contained in balsam, white and black spruce trees, based on measurements of 2,187, 2,886 and 1,638 trees, respectively.

The following gentlemen have been elected to the Canadian Society of Forest Engineers, active member, Mr. Gutches, Forest Supervisor for Alberta, and for associate membership, Mr. Geo. Tunstell, Mr. Davis W. Lusk, Jr., Mr. Geo. S. Smith and Mr. W. J. Boyd, all of the Dominion Forest Service.

Mr. A. K. Shives, Forest Assistant, Fort George, B.C., has just been making a trip to the East and congratulations are being extended to him by his friends because of the rumor that he is buying two tickets for the return journey, on which he visited the Forestry Department of the Laurentide Co. and looked over the work at Grand' Mere.

The Hon. Jules Allard, Minister of Lands & Forests, Quebec, has been in poor health for some time and in March made a trip to the Expositions at San Diego and San Francisco. The Minister is always progressive where forestry matters are concerned and has made a grant of \$300 to issue in cooperation with the St. Maurice Forest Protective Association, a small leaflet on preventing forest fires, which will be distributed to all the school children in the Province, both French and English. He has also under way a bill to be introduced in the next session of the Legislature, regulating the taxation of planted lands.

Mr. Avila Bedard, Assistant Forester of Quebec, has just published a very interesting article in the French Review "La Nouvelle France," called "L'influence immatérielle des forêts" dealing with the influence of the forest on poetry, prose, philosophy, religion and civilization.

Chancellor Jones, of the University of New Brunswick, has taken an active part in the work to have the Intercolonial Railway placed under the Railway Commissions Forest Fire Regulations and has done much to forward the cause of forestry in his Province.

Mr. R. F. Grant, Manager of the St. Maurice Lumber Company, has just returned from a trip into the woods and reports having seen two large wolves caught in traps in one of his logging operations on the Trenche River. Wolves are increasing in this section.

Mr. F. A. Sabbaton, Assistant Manager of the Laurentide Company, was taken suddenly ill with appendicitis about 10 days ago. He was successfully operated on at the Western Hospital in Montreal and is making a rapid recovery.

Early in February Mr. Cowles, of W. H. Parsons & Company, of New York; Mr. Hart, of New Haven, and Mr. Rothery of New York, made a trip to The Parsons Company's holdings in Quebec and New Brunswick to look them over and to consider a new system of management and control of logging operations. They also visited the Brown Company at La Tuque and The Laurentide Company at Grand' Mere. At the former place they had a very exciting time on the toboggan slide which has a drop of about 90 feet in the first 200 and one slide is said to be enough for one day.

W. R. Brown, of The Berlin Mills Co. and Director of the American Forestry Association, was in Quebec on his way to look over some of

his logging operations in Quebec. Mr. Brown takes a very active interest in forestry matters in Canada.

At the Annual Meeting of the St. Maurice Forest Protective Association held in Three Rivers, Quebec, on the fourth of March, a very satisfactory showing was made. Mr. R. L. de Carteret, of the Brown Company was elected President; Mr. Ellwood Wilson, of The Laurentide Company, Vice-President; Mr. Henry Sorgius, Secretary-Treasurer and General Manager, and Messrs. R. F. Grant, of the St. Maurice Lumber Company, J. M. Dalton, of the Union Bag & Paper Company and Gres Falls Company, Charles Lebrun, of the Belgo-Canadian Pulp & Paper Company, and Frank I. Ritchie, of the Wayagamack Pulp & Paper Company, were elected Directors. The Tourville Lumber Mills Company withdrew from the Association because one of their foremen was not allowed to use the Association's fire rangers to take him around on his woods trips and do other work besides fire-ranging. In the old days fire rangers were used as depot keepers, canoe men, guides, dam keepers, etc., and consequently fires were frequent.

The Laurentide Company will continue its planting operations this Spring on wild and burnt overlands, putting in about 750,000 trees, mostly Norway spruce, 3 year old seedlings planted about 1,700 trees per acre. The trees, planted last year did remarkably well making an average of over 6 inches in height for the season.

Mr. Gustave A. Kuhring, a graduate of the Forestry Department of the University of New Brunswick, has enlisted with the Third Canadian Contingent.

The Report of The Dominion Parks' Commissioner has just been issued and is a very interesting book, excellently illustrated. The number of people who visit and use these parks is surprisingly large and shows what a National asset they are, bringing people from all parts of the world. The reports on the wild animals, buffaloes, elk, moose, antelope, deer and so on are delightful reading and the pictures of scenery are well worth looking at. Any one who wishes an interesting place to spend the summer should write for a copy of this report.

New war tariff on lumber entering Canada has been increased on practically every sort by 7½ per cent. This will somewhat help the cause of conservation in Canada by raising the prices for home grown timber.

At the request of the Dominion Parks Branch the E. B. Eddy Company, of Hull, is now printing in striking colors and attractive design on their match boxes an effective fire notice, warning the public not to throw away burning matches, especially in the woods. The Eddy Company is also installing machinery to impregnate their match sticks so that after the head and a small portion of the stick has burnt the rest will not glow or burn.

The Canadian Pacific Railway has also posted warning notices in its cars urging smokers not to throw lighted matches or cigar or cigarette butts out of the windows.

The Annual Meeting of the British Columbia Loggers' Association was held recently at Vancouver and elected Mr. J. M. Dempsey as President; Mr. I. A. Bearce, Vice-President, and Mr. James R. McGrath, Secretary-Treasurer.

Mr. Maurice Leahy, late with Geo. F. Hardy, Consulting Engineer, of New York, has been appointed Manager of the Abitibi Power and Paper Company, at Iroquois Falls, Ont. The works are located 350 miles north of Toronto and 200 miles south of Hudson's Bay where a new town is springing up. Mr. Leahy worked on the construction for the Laurentide Company at Grand' Mere and was an enthusiastic golfer, winning all the competitions during the season.

One of the problems which the lumber companies in Quebec are trying to solve is how to get a supply of good men for scaling, superintending drives and such work. Men of fair education are no sooner broken into the work than they get tired of the woods, or get ambitious and leave. The pay is good, \$75 per month and expenses, and the conditions of work are excellent, good camps in winter and on the drives and in the towns in summer. The work at first for the grade of assistant, is hard but gives a man good experience and when he is promoted to scaler, it is still hard but more interesting and with more responsibility. On promotion to inspector the work is easier and more varied. The life is somewhat similar to that of a "Ranger" in Europe or the West but here of course a knowledge of both French and English is essential. A Ranger School properly run would be a great thing for the Province.

BRITISH COLUMBIA NOTES

Mr. C. MacFayden, formerly District Forester at Tete Jaune, is now heading a private exploration party in the Peace River country. He recently visited Victoria and in talking about the country said that the journey from Fort George over the Giscombe Portage and down the Crooked, Pack, Parsnip and Peace Rivers is one of the finest canoe trips imaginable. He and his partner used an 18-foot Chestnut canoe and were delighted with it.

P. S. Bonney, formerly Forest Assistant at Fort George, is now Acting District Forester at Tete Jaune.

H. B. Murray, formerly Forest Assistant at Cranbrook and Acting District Forester at Tete Jaune, is now Acting District Forester at Kamloops.

P. Z. Caverhill, recently District Forester at Kamloops, is now Deputy District Forester at Vancouver. This change is in the nature of a promotion for Mr. Caverhill, the forest management work in the Vancouver district amounting to about two-thirds of that in the entire Province.

J. B. Mitchell, who was Deputy District Forester at Vancouver, has enlisted for active service in the Army Service Corps, Vancouver, which is expected to leave for England in the near future.

F. McVickar, Forest Assistant, went with the First Contingent, and is now probably in France. His address is—A Squadron, Royal Canadian Dragoons, Care of War Office, London.

G. Melrose is now assigned as Forest Assistant to the Vernon District.

The Forest Branch has so far lost, only temporarily it is hoped, upwards of a dozen members of its permanent force through enlistment for active service. Some of them are already at the front, others are on their way, and the remainder will be leaving with their battalions in the near future. Their names are as follows: J. B. Mitchell, Deputy District Forester; F. McVickar, Forest Assistant; Wm. Black, Ranger; M. M. Gibson, Ranger; M. V. Allen, Ranger; F. Edwards, Ranger; J. Turnbull, Ranger; T. Brewer, Ranger; J. Milroy, Check Scaler; J. Ketteringham, Clerk; J. R. Stone, Draughtsman; J. Eddie, Messenger. In addition to the above men a fairly large but unknown number of Forest Guards and patrolmen have enlisted for active service.

A reconnaissance of the Pine River and Upper Parsnip River last summer resulted in the discovery of thirteen billion F. B. M. of valuable spruce and balsam fir timber. This timber is all directly tributary to the extension of the P. G. E. which is to be built through Pine Pass. It will form a very valuable future timber supply for the prairie market.

During the past year roughly 48,000,000 feet of saw timber was sold by the Forest Branch at an average stumpage price of \$1.15 per thousand over and above royalty of 50 cents. For the most part these sales were small fractions which would be logged inside of one or two years and a large proportion of them were in the Coast District, where Douglas Fir, Cedar and Western Hemlock predominate. A total of 67,000 acres was closely cruised for timber

sale purposes during the year, on which there was an estimated stand of 560,000,000 feet.

Land classification is carried on by the Forest Branch for the following three-fold object: (1) To prevent alienation of land valuable chiefly for timber. (2) To make available for settlement all areas suitable for agriculture. (3) To hold under reserve lands which are unfitted for agriculture. The area which has been so classified during the past year is close to half a million acres, of which 170,000 acres have been reserved,

carrying a stand of timber of approximately one billion feet.

On the first of January the B. C. Log Scale came into use over the entire Province, in accordance with the Provisions of the Royalty Act. This rule has been in use for a number of years on the Coast, but the Doyle Rule has been, until now, the accepted rule for that portion of the Province east of the Cascade Mountains. This change will make a uniform scale available for the whole Province, and will appreciably increase the log scale for the Interior.

FOREST NOTES

The Minnesota House and Senate Committees have recommended for passage a bill providing \$20,000 a year for two years to purchase land for improving the City Park, the plan being to supplement the present park system by a great municipal forest or forest park. The Jay Cooke estate has turned over to the State 2,500 acres of forest land for use as a park by the city of Duluth and it is proposed to acquire, 3,500 acres adjoining this tract, which is valueless for general agricultural purposes. The plan is to use this Municipal Forest for camping, rest and recreation and to manage it by the most approved forestry methods with the thought that in time it may become as valuable an asset to the City as are some of the German Municipal Forests. One plan is to have homes in the forest for the families of workmen, homes that may be had for a nominal rent and where the City would have control of every arrangement which might tend to make such places most desirable in every way. A number of the leading residents of the city are most enthusiastic over the plan and the possibility of its being adopted.

The E. B. Eddy Company of Hull, Canada, match manufacturer, is aiding in the work of forest fire protection, by printing on their match boxes a circular design in three colors, red, green and white, bearing the words: "Safety First Applied to Fire—Do Not Throw Away Burning Matches Especially In The Woods." Underneath the design is the statement that it is printed by request of the Dominion Government.

Purley D. Bailey, a young Forester, and son of Prof. George D. Bailey of Cazenovia, N. Y., disappeared on March 8, and foresters are asked by his anxious father to aid in the search for him. The young man, who was suffering from nervous trouble, left his home to go to Syracuse for a treatment and has since then been missing. He is 5 feet 6 inches tall, complexion deeply tanned, brown hair and brown eyes. He wore a gray suit, mixed gray and black shaggy overcoat with brown

fur collar and a gray hat. He is a member of the Phi Gamma Delta fraternity.

The Class in Lumbering of the New York State College of Forestry under Professor Nelson C. Brown has returned from the trip to several logging and milling operations in the Adirondacks, including Conifer, Cranberry Lake, Piercefield and McKeever. A careful investigation and study were made of the logging operations of the Emporium Forestry Company on their 85,000-acre tract in St. Lawrence county and their sawmill and yards at Conifer near Childwold.

The third annual session of The New York State Ranger School at Wanakena, N. Y. has opened under the direction of Professor E. F. McCarthy. Twenty-two students have enrolled for the one year course of instruction in forestry and are now actively engaged in practical forestry work in the field.

Arbor and Highway Day in Maryland, April 9, has this year a special significance, because it is the first anniversary of the passage of the Roadside Tree Law by the Legislature of 1914. This law places all trees now growing beside the roadways or along the streets of incorporated towns under the supervision of the State. In addition to the care and protection of existing trees, the law provides for the planting of new ones.

The State has spent approximately \$15,000,000 in constructing improved roads which compare favorably with any in the country. The next step in their improvement is to beautify them and make them more attractive by the planting of shade trees. What is more attractive than a well-shaded street or roadway, particularly if the trees are uniform in size and kind, giving a distinctive character that cannot be obtained except by systematic effort and the execution of carefully thought out and well executed plans? The State Board of Forestry, which is charged with the administration of the Roadside Tree Law, is prepared to cooperate with towns, associations and individuals in the work of planting trees along the streets and highways.

The Pennsylvania Lumbermen's Association has appointed as members of the Committee on Forestry, S. C. Creasy of Bloomsburg, Pa.; M. P. Cooper, Christiana, Pa.; and Watson Craft of Ambler, Pa.

A bill now pending in the Maine Legislature for the preservation, perpetuation and increase of the forests in Maine embodies three important provisions:

First, that the public lands of the State shall be under the superintendence of the State land agent, and that he shall have authority to sell seedlings from these lands at cost; second, when deemed necessary for the preservation and conservation of the forest interests of Maine, the State may take private lands in the same way that lands are taken for railroad beds, making just compensation therefor; third, owners of growing timber of certain kinds may cause the timber on certain tracts to be exempted from taxation by filing a plan of the tract, with description, in the files of the State kept for that purpose, no timber under 12 inches in diameter to be cut from these exempted tracts at any time and taxation to begin only when logging operations are undertaken.

A bill to legalize the acceptance by the Board of Trustees of the New York State School of Agriculture at Morrisville of a large tract of forest land in the town of Georgetown, which the present owner, Charles O. Newton of Homer, wishes to give to the school for the purpose of teaching the students in the school better methods of management of farm woodlots, has been introduced into the New York State Assembly by Hon. M. E. Tallett of Madison County. The school plans to operate this tract with the cooperation and help of the Forestry Schools at Syracuse and Cornell and through establishing fall and spring camps give the boys practical training in farm forestry so that they may know how to appreciate and care for the possibilities of the timber on the farm.

Colonel Joseph Battell, of Middlebury, Vermont, who was widely known among tourists because he debarred automobiles from his big forest preserves, founds a National Forest in Vermont in his will, probated in March. He presents Ellen Mountain, in the towns of Lincoln and Warren, to the Government, the only restrictions being that its thousands of acres of primeval forest be kept intact.

Middlebury College is bequeathed, in addition to \$10,000 in cash, 20,000 acres of uncut woodlands and seven well-equipped farms. These woods, too, must be kept in their primitive beauty.

The various towns in which these possessions are situated are given funds to cover taxes

for many years. Middlebury Village gets a fine park preserve, too. A thousand dollars a year is set aside to educate a poor Middlebury student. A fund of \$5,000 is founded for road maintenance on the estates.

The Department of Forest Utilization of The New York State College of Forestry has established a successful bureau of cooperation in which the producer and consumer of forest products in the State are being brought together to mutual advantage.

A new annual publication devoted entirely to the activities of forestry students has made its appearance under the title of *The Empire Forester*. It is the official organ of the student body of The New York State College of Forestry at Syracuse and treats of the various activities and experiences of the students in camp and college. Much space is given to short articles by various members of the upper class, which relate their personal experiences in the field. Contributions of a lighter vein in the form of jokes and pithy sayings of the camp wag add the final touch.

Mr. W. A. McDonald is in charge of The New York State College of Forestry Exhibit in the State Building at the Panama Exhibition. A unique feature has been added in that Mr. McDonald is giving lectures daily, explaining the work and activities of the college with the help of moving pictures.

Some of the forest lands in the southern Appalachians recently acquired by the Government have just been examined to determine the extent to which they may be used for livestock without impairing the value of the watershed protection. The National Forests of the western States produce enormous quantities of forage and are strongly in demand for pasture.

Heavy rainfall and mild climate combine to promote a heavy growth of vegetation in the southern Appalachians, and the capacity of the land is said to be considerably in excess of that of lands in the West. Within the areas so far examined the department of agriculture says there is practically no indication of injury from grazing, though some of the mountain lands have suffered from various forms of injury and lack of proper methods of use and protection.

Approximately 97 per cent of the lands acquired by the Government are now covered by timber or undergrowth. The remainder consists of land potentially valuable for forest purposes but at present cleared of timber. Of the non-timbered lands a part are "balds" supporting heavy growths of excellent grasses, while the remainder are lands on which cultivation has been attempted, but which will grow up again to trees.

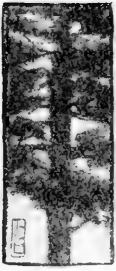

BOOK REVIEWS

OUR NATIONAL DEFENSE, THE PATRIOTISM OF PEACE, by George H. Maxwell, Rural Settlements Association, Washington and New Orleans, price \$1.25.

The portion of this book which will most appeal to foresters is the argument made by the author for the establishment of a large reserve of trained soldiers who in time of peace shall be employed in perpetuating the forests of this country in such manner that the forests shall be made to pay for maintaining them.

Such a reserve, contends the author, must not be composed of men in ordinary industry because to take them from such employment would be detrimental to the industries on which we are dependent. They must be engaged in such work as foresters are engaged in, from which they can be instantly available for military service, without disturbance to industry. If such a reserve were properly organized unemployment would no longer be an issue. Men out of work could be absorbed into the reserve when work is slack and returned to ordinary industrial employment when their labor was needed there. All further suffering from lack of employment by sober, industrious men would cease.

"We could in this country," says the author, "enlist an army of men and perfectly organize it to plant forests and care for them, build the great works necessary for flood control and for river regulation, waterways and highways, and do all the work necessary to control, use and perpetuate our natural resources, and they would do that work in time of peace and make the best soldiers in the world in time of war.

"We would then have defense against the invasion of Nature's forces in times of peace, against floods and forest fires and drouth and overflow, and against the invasion of an armed force in time of war. Pittsburgh would be protected from floods, as would the Ohio and Mississippi valleys.

"It is impossible to defend a coast line extending from Nova Scotia to Florida, besides the Pacific Coast, if we have no defense but a navy and fortifications. Any of the great European nations could land an invading force on the Atlantic coast, as Japan could on the Pacific, in the event of war unless we oppose

them with troops instantly ready and properly trained, equipped and organized.

"There is only one solution, and that is to enlist a reserve modeled after the German or French forestry systems. The reservists in those systems are foresters in time of peace and soldiers in time of war."

SOME LUMBER PROBLEMS—Northern Hemlock and Hardwood Manufacturers Association, Milwaukee, Wis., 50 cents.

The Association deserves to be complimented for the production of this book which contains a number of valuable addresses on important lumbering subjects. Matt Daly's paper on "Camp Missionary Work" is unique; W. W. Brown's paper on "Lumber for Factory Trade," as well as Enos Colburn's on "Birch for Interior Finish" are extremely practical contributions from the consumer's standpoint and would be of interest to any hardwood manufacturer. Charles H. Crownhart's paper on "Various Phases of Compensation" is one of the most complete and scientific studies of this subject yet made and is of interest to every employer of labor in the country. Chas. F. Simonson's article on "Inter-Insurance," and B. G. Dahlberg's on "Classification of Lumber Rates," are of universal interest to lumbermen. Edward Hines' address on "Better Business Methods" shows its author's wonderful grasp of detail. It is a paper that should be read by every lumberman in the United States who hopes to keep abreast of the times. In the same class with Mr. Hines' address is R. S. Kellogg's paper on "Troubles of Lumber Industry." This paper has been read by Mr. Kellogg at several important association meetings and whenever read has provoked a great deal of interest. Mr. Kellogg is the foremost practical statistician in the lumber industry. His arguments are invariably based on figures, and figures of a kind that cause the lumberman to sit up and take notice.

O. T. Swan has presented the question of "Timber Utilization" in a comprehensive and concise form, combining the technical with the practical sides of the problem. W. A. Holt's paper on "Timberland Taxation" and C. H. Worcester's paper on the "Cost of Carrying Timber" are papers that every owner of timberland should read.

CURRENT LITERATURE

MONTHLY LIST FOR MARCH, 1915

(Books and periodicals indexed in the Library of the United States Forest Service.)

Forestry as a Whole

Proceedings and reports of associations, forest officers, etc.

British Columbia—Dept. of lands—Forest branch. Report for the year ending December 31, 1914. 63 p. Victoria, B. C., 1915.

Colorado—State forester. Biennial reports, 1st-2d. Fort Collins, Colo., 1912-14.

Minnesota—Forestry board. Fourth annual report of the state forester. 99 p. il., maps. St. Paul, 1914.

North Carolina—Geological and economic survey. Forestry in North Carolina; further extracts from the Proceedings of the North Carolina forestry association. 6 p. Chapel Hill, N. C., 1915. (Press bulletin 141.)

Forest Legislation

Minnesota—Legislature. Forest laws. 24 p. St. Paul, 1913.

Forest Botany

Trees: classification and description

Henry, Augustine. The black poplars. 12 p. il. London, 1914.

Henry, Augustine. Woods and trees of Ireland. 9 p. pl. London, 1914.

Mathews, Ferdinand Schuyler. Field book of American trees and shrubs. 465 p. il., pl. N. Y., G. P. Putnam's sons, 1915.

Silvics

Studies of species

Matthews, D. M. Ipil-ipil, a firewood and reforestation crop (*Leucaena glauca* (L.) Benth.) 18 p. pl. Manila, P. I., 1914. (P. I.—Bureau of forestry. Bulletin 13.)

Silviculture

Planting

Hartley, Carl. Injury by disinfectants to seeds and roots in sandy soils. 35 p. il., pl. Wash., D. C., 1915. (U. S.—Dept. of agriculture. Bulletin 169.)

Other cultural operations

Henry, Augustine. The artificial production of vigorous trees. 20 p. pl. Dublin, Dept. of agriculture and technical instructions for Ireland, 1914.

Forest Protection

Insects

Busck, August. The European pine-shoot moth; a serious menace to pine timber in America. 11 p. pl. Wash., D. C., 1915. (U. S.—Dept. of agriculture. Bulletin 170.)

Hopkins, A. D. Classification of the Cryptalinae, with descriptions of new genera and species. 75 p. il., pl. Wash., D. C., 1915. (U. S.—Dept. of agriculture. Report no. 99.)

Snyder, Thomas E. Biology of the termites of the eastern United States, with pre-

ventive and remedial measures. 73 p. pl. Wash., D. C., 1915. (U. S.—Dept. of agriculture—Bureau of entomology. Bulletin 94, pt. 2.)

Diseases

Davey institute of tree surgery. Instruction books no. 1-12. il. Kent., O., 1914.

Heald, F. D. & Studhalter, R. A. The strumella disease of oak and chestnut trees. 15 p. pl. Harrisburg, Pa., 1914. Pennsylvania—Dept. of forestry. Bulletin 10.)

Fire

Kennebec Valley protective association. Third annual report. 14 p. Bingham, Me., 1915.

Pend d'Oreille timber protective association. Annual report, 1914. 25 p. Sandpoint, Idaho, 1914.

Smoke and vapors

Wislicenus, H. Ueber die äusseren und inneren vorgänge der einwirkung stark verdünnter saurer gase und saurer nebel auf die pflanze. 91 p. il., pl. Berlin, 1914. Königl. sächsische forstliche versuchsanstalt zu Tharandt. Mitteilungen, band 1, heft 2.)

Forest Management

North Carolina—Geological and economic survey. Demonstration forests for North Carolina. 4 p. Chapel Hill, N. C., 1915. (Press bulletin 142.)

Forest Mensuration

Klemme, William, comp. Volume tables for round timber. 118 p. Manila, 1912. (P. I.—Bureau of forestry. Bulletin 12.)

Kunze, Max. Untersuchungen über die genauigkeit der inhaltsberechnung der stämme aus mittenstärke und länge. 54 p. Berlin, 1912. (Königl. sächsische forstliche versuchsanstalt zu Tharandt. Mitteilungen, band 1, heft 1.)

Forest Economics

Taxation and tariff

Washington—State tax conference. Taxation in Washington; papers and discussions, at the University of Washington, May 27-29, 1914. 302 p. Seattle, 1914. (Washington, University of. Bulletin, University extension series no. 12; general series no. 84.)

Forest Administration

United States—Dept. of agriculture—Forest service. Instructions for the scaling and measurement of national forest timber. 91 p. Wash., D. C., 1915.

United States—Dept. of agriculture—Forest service. General selling prospectus of national forest timber, Arizona and New Mexico. 23 p. il., map. Albuquerque, New Mex., 1915.

United States—Dept. of agriculture—Forest service. Sale prospectus: 382,000,000 feet national forest timber, Four Mile Creek and Bear Creek units, Crater and Paulina national forests, Oregon. 25 p. il., maps. Portland, Ore., 1915.

Forest Utilization*Wood-using industries*

Great Britain—Board of agriculture and fisheries. Report on supplies of home-grown pit-wood in England and Wales. 13 p. London, 1914.

Forest by-products

Vermont maple sugar makers' association. Proceedings of the 20th annual meeting, 1913. 59 p. St. Albans, Vt., 1913.

Wood technology

Janka, Gabriel. Die härte der hölzer. 114 p. pl. Wien, 1915. (Mitteilungen aus dem forstlichen versuchswesen Oesterreichs, heft 39.)

Philippine Islands—Bureau of forestry. Export timbers of the Philippines. 12 p. Manila, P. I., 1914.

Auxiliary Subjects*Conservation of natural resources*

California—Dept. of public instruction. Conservation of natural resources. 2d ed. 111 p. il. Sacramento, 1915.

National parks

Campbell, Marius R. The Glacier national park; a popular guide to its geology and scenery. 54 p. pl., maps. Wash., D. C., 1914. (U. S.—Geological survey. Bulletin 600.)

Yellowstone national park. Report of the acting superintendent, 1914. 29 p. map. Wash., D. C., Govt. printing office, 1914.

Hydrology

Pennsylvania—Water supply commission. Annual report, 1913. 396 p. pl. Harrisburg, Pa., 1914.

Periodical Articles*Miscellaneous articles*

Country gentleman, Feb. 6, 1915.—The sugar tree, by C. O. Ormsbee, p. 217-18; Wood for the work-shop, by Samuel J. Record, p. 250, 252.

Country gentleman, Feb. 13, 1915.—White or red oak—which? How to distinguish the woods, by Samuel J. Record, p. 311.

Country gentleman, Feb. 20, 1915.—The inside of a graft, by F. A. Waugh, p. 328-9.

Country gentleman, Feb. 27, 1915.—Forests for waste land, by Samuel J. Record, p. 418-19.

Fire prevention news, Feb. 1915.—Fire retarding process for wood tested, p. 15.

Gardeners' chronicle, Jan. 30, 1915.—Notes on conifers: Cupressus macrocarpa, by A. Bruce Jackson, p. 53.

Gardeners' chronicle, Feb. 13, 1915.—Cupressus macrocarpa, by William Somerville, p. 76-7; Cupressus sempervirens, by A. Bruce Jackson, p. 78.

International institute of agriculture. Monthly bulletin of agricultural intelligence and plant diseases, Nov. 1914.—The present condition of forestry in Hungary, by Károly Schmidt, p. 1391-1400.

International institute of agriculture. Monthly bulletin of agricultural intelligence and plant diseases, Dec. 1914.—The forests of Chile, by Federico Albert, p. 1535-41.

Journal of heredity, Jan. 1915.—A new walnut; mutant somewhat similar to live oak

appears in California in four different localities, by Ernest B. Babcock, p. 40-5.

Modern woodman magazine, March, 1915.—Modern wood craft and forest fires, by T. B. Wyman, p. 6-8.

National wool grower, Feb. 1915.—How the Forest service is developing the range, p. 9-11, 19; The killing of coyotes, by Moroni A. Smith, p. 27-8.

Plant world, Feb. 1915.—Natural reforestation in the mountains of northern Idaho, by Harry B. Humphrey and John Ernst Weaver, p. 31-47.

Popular mechanics, March 1915.—Ocean-going lumber rafts of the Pacific, p. 398-9.

Popular science monthly, March, 1915.—The volcanic activity of Lassen Peak, California, by Ruliff S. Holway, 290-305.

The Public, Feb. 26, 1915.—The single tax in relation to forestry, by Louis S. Murphy, p. 217-24.

Reclamation record, Feb. 1915.—Tree planting; Mills river and Sun river projects, Montana, p. 81.

Science, Feb. 26, 1915.—Effect of cyanide of potassium on trees, by C. H. Shattuck, p. 324.

Tree talk, Feb. 1915.—Transplanting large trees, by C. E. Hunn, p. 15-19.

United States—Dept. of agriculture—Office of information. Weekly news letter to crop correspondents, March 3, 1915.—Remedies for keeping the white ant from damaging timber, p. 4.

Wood-preserving, Jan.-March, 1915.—The B. & O. timber preserving plan, p. 8-9.

Trade journals and consular reports

American lumberman, Feb. 13, 1915.—Preserving timber by Kyan's process, by Friedrich Moll, p. 40; Solving timber taxation problems; how lumbermen and farmers of the far northwest have cooperated, p. 40-1.

American lumberman, Feb. 20, 1915.—Timber utilization, by O. T. Swan, p. 46-8; Evolution of American forestry, by Frank W. Rane, p. 48.

American lumberman, Feb. 27, 1915.—Engineers discuss long-leaf problem, p. 27-9.

American lumberman, March 6, 1915.—Kyanized spruce, p. 23; Forestry work for unemployed; improving the woodlands in Massachusetts gives employment to 1,600 men, p. 26; Combating dry rot in factory timbers, by Fred J. Hoxie, p. 30-3.

Canada lumberman, Feb. 15, 1915.—The merits of Austrian and British oak, by Percy Groom, p. 46-8; Some problems in kiln drying lumber, by Malcolm E. Miller, p. 48.

Engineering record, Dec. 26, 1914.—Lumber mattresses for bank protection in Louisiana, p. 686.

Engineering record, Jan. 2, 1915.—Costly highway clearing in dense forests, p. 21.

Engineering record, Jan. 9, 1915.—Wood block pavement without cushion layer of sand, p. 52-3; Wood block pavement after six years' service, p. 53.

Furniture journal, Feb. 25, 1915.—Developing a market for porch furniture, by Waldon Fawcett, p. 37-41.

- Gulf Coast lumberman, March 1, 1915.—Forestry problems of Texas, p. 34.
- Handle trade, Jan. 1915.—Canes—umbrellas—whips; variety of woods used in industry; list of manufacturers, p. 7-10; What the toy field offers; European war shifting the center of manufacturing in America, p. 15-16; Good field for wood turners; candle sticks and lamp stands made of wood and tastefully turned, p. 17; Contributing to sports; all kinds of wood used in the industry; list of manufacturers, p. 22-6; Making pencils is big industry in America, p. 27-8.
- Hardwood record, Feb. 25, 1915.—Sawdust unsuitable for bread, p. 16-17; The sale of wood ashes, p. 18-19.
- Hardwood record, March 10, 1915.—Mesquite in semi-arid regions, p. 13; The prospect for walnut supply, p. 15; Possibilities of hardwood distillation, p. 17.
- Lumber world review, Feb. 10, 1915.—National lumber manufacturers' association December report of production and movement of lumber, p. 32.
- Lumber world review, Feb. 25, 1915.—The wood block pavement of London town, by Jack Brooks, p. 30-1.
- Lumber world review, March 10, 1915.—The effect of the war upon the lumber trade, by Warren F. Hickernell, p. 25-6.
- Packages, March, 1915.—World's box shook industry, p. 16-19.
- Paper, Feb. 17, 1915.—Forest conservation in New York state, by Jacob Gould Schurman, p. 15-16; Pulp and paper periodicals of the world, p. 25.
- Paper, Feb. 24, 1915.—Four thousand years of papermaking, by J. Newell Stephenson, p. 34-8; Spruces and firs available for paper pulp, by Nelson C. Brown, p. 46-52; America's pulp and paper school; a new branch of education successfully given at the University of Maine, by J. Newell Stephenson, p. 52-60, 64; Progress in paper-making chemistry, by Ralph H. McKee, p. 62-4; Woodpulp from yellow pine waste, p. 176; Forestry legislation in Maine, p. 182.
- Paper, March 10, 1915.—Hemlock as a pulp wood, p. 19.
- Paper trade journal, Feb. 18, 1915.—The pulp and paper industry in Newfoundland, by P. T. McGrath, p. 63-6, 75-85; Forest products laboratories of Canada, by John S. Bates, p. 193-5; The hazards of paper and pulp making, by Edward T. Walsh, p. 197-205.
- Paper trade journal, March 4, 1915.—Bamboo pulp, p. 48-50.
- Pioneer western lumberman, Feb. 15, 1915.—Electricity in the lumber industry, by E. F. Whitney, p. 11-15, 23-4.
- Pulp and paper magazine, Feb. 1, 1915.—Conservation commission discusses forestry problems; address of Sir Clifford Sifton, p. 72-7; The fire situation during 1914, p. 77-80; Forestry situation in Quebec, by G. C. Piche, p. 80-2; The essential features of a successful fire protective organization, by H. R. MacMillan, p. 82-4; Cooperation in management of Dominion timber lands and cooperation with Ontario on the Trent watershed survey, by B. E. Fernow, p. 84-6.
- Railway review, Feb. 20, 1915.—Mixing tar with creosote, by P. C. Reilly, p. 242-7.
- St. Louis lumberman, Feb. 15, 1915.—Timber utilization, by O. T. Swan, p. 58-60.
- St. Louis lumberman, March 1, 1915.—Dry rot in factory timbers, p. 46-7; Forest products federation meeting in Chicago, Feb. 24th and 25th, p. 59-63.
- Timberman, Feb. 1915.—New system for drying larch, by D. T. Mason, p. 43-5; Cable tramways in the Philippine Islands, p. 45; Logging in Alaska, p. 48 L; Constructing a high pile bridge, by C. R. Pope, p. 49-50.
- United States daily consular report, Feb. 24, 1915.—Arbor day obligatory in Spain, by Carl Bailey Hurst, p. 761.
- United States daily consular report, Feb. 26, 1915.—New Chinese school of forestry, by Thomas Sammons, p. 791.
- Veneers, March, 1915.—Methods for finishing walnut, by Rudolph Kilbourne, p. 15-16; The utilization of waste veneer, p. 17-18.
- West Coast lumberman, March 1, 1915.—United States Forest products laboratory on how to dry cedar, by Harry D. Tiemann, p. 35.
- Wood-worker, Feb. 1915.—New uses for sawdust, p. 33; Some hints for sawyers, by C. R. Lake, p. 42.
- Forest journals*
- Forest leaves, Feb. 1915.—What can be done for forestry, by S. B. Elliott, p. 2-4; Forest conservation in Switzerland, by Marie Widmer, p. 9.
- Naturwissenschaftliche zeitschrift für forst- und landwirtschaft, Nov.-Dec., 1914.—Die bohrruschel (Genus Teredo Linné), by F. Moll, p. 505-64.
- North woods, Feb. 1915.—The grain car door industry, p. 17-21.
- Proceedings of the Society of American foresters, Jan. 1915.—The invasion of a planted prairie grove, by Raymond J. Pool, p. 1-8; Notes on the relation of planting methods to survival, by E. E. Carter, p. 9-17; A formula for normal growing stock in selection system forests, by Thornton T. Munger, p. 18-21; Land classification rules for an Arizona forest, by John D. Guthrie, p. 22-31; The construction of a set of taper curves, by W. B. Barrows, p. 32-40; Sand-dune reclamation on the coast of northern California and southern Oregon, by Frank B. Kellogg, p. 41-64; Reading and replotting curves by the strip method, by W. B. Barrows, p. 65-7; Monterey pine, by Louis T. Larsen, p. 68-74.
- Revue des eaux et forêts, Jan. 1, 1915.—Les déboisements stratégiques et le droit des propriétaires, by G. Géneau, p. 521-7.

FORESTERS ATTENTION

AMERICAN FORESTRY will print free of charge in this column advertisements of foresters wanting positions, or of persons having employment to offer foresters

YOUNG MAN, expert in all branches of shade tree work and with forestry training, desires position as forester, arboriculturist or tree surgeon. References furnished. Address C. S., care AMERICAN FORESTRY.

FORESTER of technical training, six years' teaching and practical experience in different parts of the United States, wishes to better position. Best references from university and employers, and others. Address G. O. T., Care AMERICAN FORESTRY.

FORESTER with 15 years experience Estimating, Surveying, Mapping, and in the care of private holdings desires position. Perfectly reliable in every way, and with executive ability. Address "A," care AMERICAN FORESTRY.

WANTED—By Graduate Forester, position in forestry work in South, or Tropics. Slight knowledge of Spanish and German. Scientific or experimental work preferred. Address, "F. W. H.," Care of AMERICAN FORESTRY.

WANTED—By young man intending to study forestry, position with lumber company, surveying party, or other position by which he can gain practical knowledge. Address L. L., Care AMERICAN FORESTRY.

YOUNG MAN, 27 years old, unmarried, university training, business experience and three years of practical experience in surveying and construction, including preliminary surveys, estimates, railroad and highway location surveys and construction, topographic surveys, mapping, etc. Capable of taking charge of party, desires position with forester or lumber firm. Best references from former employers. Address "T. B. C.," Care AMERICAN FORESTRY.

FORESTER, with seven years' practical experience, desires a position as Forester. Have had considerable experience in reforestation and management, also fire protection. Address "T. F. H.," Care AMERICAN FORESTRY.

FOREST ENGINEER—Best of American and European training. Five years of practical work along lines of organization, administration, protection, cruising and appraising. Would like position with some large timber holding company, railroad, or municipal watershed. Best of references. Address "CRUISER," Care AMERICAN FORESTRY.

A forest school graduate with experience in U. S. Forest Service and with lumber company, also possessing thorough business training, will consider offer of good forestry position. Address M., Care AMERICAN FORESTRY.

WANTED—Position by practical experienced man as tree surgeon. Am familiar with trees of all kinds. Special terms on orchard work. Terms reasonable. Small jobs will not be considered. Will send book upon request. Do not write for book out of idle curiosity. Address Box 6, care of AMERICAN FORESTRY.

MAN with practical experience in lumbering, timber estimating, mapping and compass work. Have had one year of college training and would like position where there is an opportunity to acquire further knowledge of forestry. Address Box 7, care of AMERICAN FORESTRY.

POSITION WANTED—Engineer with twelve years' experience in Engineering and Forestry. Expert land surveyor, timber estimator, timberland R. R. location. Experienced in woods operation and good manager of men. Permanent position desired with Timber Company, Railroad Company or Private Estate. At present employed. Address Box 4, Care AMERICAN FORESTRY.

ASSISTANT FORESTER—\$1,500 to \$1,800 annum. Limited to residents of New Jersey if a sufficient number of qualified candidates; if not, open to citizens of the United States without regard to residence. Candidates will be permitted to submit replies and papers in this examination by mail.

All candidates must be Professional Foresters with good, practical experience. Experience in woodlot management, in small lumbering and in shade tree work is desired. Subjects of examination and relative weights:

Experience and Education.....	6
Personal qualifications, age, character, etc.....	2
Paper on some subject pertinent to forest conditions in New Jersey.....	2
TOTAL.....	10

Communicate with CIVIL SERVICE COMMISSION, State House, Trenton, N. J.

A GRADUATE of one of the leading Forestry Schools of the country, with some experience in State and private work, would like to secure a position in some Eastern or Central State. Address S. G. H., care AMERICAN FORESTRY.

FOREST ENGINEER seeks position with an estimating firm or with a lumber company. Best of references. Address Forest Engineer, Care AMERICAN FORESTRY.

SURVEYOR—For large tracts of land, roads and railroads; furnishes instrument; capable of taking charge of party; would like position in South that will last all winter. Address "T. B. W.," care AMERICAN FORESTRY.

GRADUATE FORESTER—Practical experience in cruising, mapping and scaling. Eager to go anywhere. References furnished. Address R. L., care of AMERICAN FORESTRY.

PRACTICAL FORESTER wants situation on private estate. Has practical experience of sowing, laying, planting out, pruning, thinning, firebelts, ditching, rotation planting, mixed planting and thorough knowledge of fencing and tree felling. Has had seven years experience on best managed forestry area in Scotland. Address, "Raith," Care AMERICAN FORESTRY.

PRACTICAL FORESTER wants position with city Park Commission. Understands fully nursery work, planting, trimming and tree surgery. Best references and practical experience. Address "L. M. E.," Care AMERICAN FORESTRY.

WANTED—A position as an inspector of ties, timbers and lumber, by a forest school graduate with experience in inspecting ties, timbers and lumber. Can furnish best of references. Address Inspector, Care AMERICAN FORESTRY.

Graduate of Forestry School, having studied forestry and lumbering operations in this country and Germany, with experience in the U. S. Forest Service, and also in state and private nursery work, would like position with forest engineering firm or lumber company. Best of references. Address XY, Care of AMERICAN FORESTRY.

WANTED—A job as fire ranger or guard by a strong, healthy young man twenty-one years of age. Address "3" care AMERICAN FORESTRY.

AMERICAN FORESTRY'S ADVERTISERS

WANTED—Position by a clean cut young man, with A-1 references, with a Forestry Expert or a surveying party, or any other business where a knowledge of the subject of forestry can be had. Address G. W. H., care AMERICAN FORESTRY.

POSITION WANTED—Am graduate of Biltmore Forest School, with good record in survey, estimate and estate management and want position where I will have a chance to learn more. Have done practical work outside of school and am considered good at timber. Willing to go anywhere and be generally useful. Hard worker, don't mind long hours. Age, twenty-six. Give me interview or let me send references. Address J. U., care AMERICAN FORESTRY.

FOREST ENGINEER with training in this country and abroad, will consider position as Secretary of Fire Protective, Forestry or Conservation Association. Thoroughly experienced in Forestry and publicity work, and competent to handle affairs of such organization. Well recommended. Address "SECRETARY". Care of AMERICAN FORESTRY, Washington, D. C.

YOUNG MAN—Four years' practical experience in reforestation, nursery work, improvement thinning, fire protection and tree surgery, wishes position on private estate or for state or municipal work. Experienced handling men. Best of references. Address R. A., care AMERICAN FORESTRY.

FOREST ENGINEER of ability and experience wishes the management of large timbered tract. Thoroughly experienced in Lumbering and Practical private Forestry, and capable of taking entire charge of game preserve, private estate, or other forested lands. Well recommended. Address "Woods Supt.," Care of AMERICAN FORESTRY, Washington, D. C.

WANTED.—A Position as Superintendent on Private Estate. Expert experience with 22 years' backing, on Forestry, Agriculture, Horticulture, Landscape Engineering. Graduate Civil Engineer, Practical Experience in all mentioned work. Will take full responsibility of any estate or construction of an estate and guarantee my work. Fair salary expected. Please state salary you are willing to offer with reply. I will not accept a position in "part." I will not accept position under three months' notice to my present Employer. Address "V. C. P.," Care AMERICAN FORESTRY.

YOUNG MAN, 29 years old, wishes position with forest owner or lumber mill concern, to take care of all waste timber. Have 12 years' experience in distilling and extracting by-products from forest wastes, etc. Address I, Care AMERICAN FORESTRY.

FORESTER wants position with Consulting Forestry firm, or with lumber company or private estate. Training from Michigan Agricultural College and Yale Forest School; four years' experience with U. S. Forest Service and two winters with lumber companies. Acquainted thoroughly with Montana, Idaho and California timber as cruiser. References on request. Address E., Care AMERICAN FORESTRY.

ENERGETIC Post Graduate Forester desires position as an assistant in park or city forestry work. Subordinate duties preferred. Best of references. Address M. M. J., care of AMERICAN FORESTRY.

FOREST ENGINEER with Forest Service training in Colorado, Wyoming, private work in California, and six years' experience in the lumber industry on the Pacific Coast, would like field work in any part of the United States. Estimating of timber lands and topographic surveying a specialty. Four years' technical training. Address, "D." Care AMERICAN FORESTRY.

WANTED—Position as City Forester or Park Superintendent. Willing to consider position as an assistant. University training; experience in forestry, nursery and landscape work. Twenty-seven years old and married. Best of references. Address "F. S." Care of AMERICAN FORESTRY, Washington, D. C.

SURVEYOR—Young man 23 years old, 2½ years experience as rodman and draftsman on preliminary, location and construction for western railroads, desires position of like nature where there is an opportunity for learning forestry. Location is immaterial. Address Box 5, Care of AMERICAN FORESTRY.

WANTED—Timber estimating by postgraduate forester with experience in Eastern Canada and Lake States. References. Address P. T. A., Care of AMERICAN FORESTRY, Washington, D. C.

GRADUATE FORESTER desires position; practical experience in timber estimating, nursery work, also especially qualified for shade tree work; have passed Civil Service examination for forest assistant. Address "D. B.," Care of AMERICAN FORESTRY.

FOR SALE—BULLETINS AND CIRCULARS

Almost complete series of Forestry Bulletins and Circulars Bulletins Nos. 5 to 127, except 17 of the earlier ones; Circulars Nos. 5 to 216 except 12. A valuable set. State offer in first letter. Address U. A., Care AMERICAN FORESTRY.

BILTMORE TEXT BOOKS

The text books of the Biltmore Forest School, written by Dr. C. A. Schenck, continue for sale at Biltmore. For particulars address BILTMORE FOREST BOOKS, Biltmore, N. C.

TIMBERLANDS FOR SALE

Hardwood, White and Yellow Pine Timber

Lands for sale by SAVAGE BROTHERS, Cornelia, Ga.
5-4

CANADIAN AND NEWFOUNDLAND PULPWOOD
BIRCH and PINE LIMITS, for sale. Write JOHN A. MOODY, London, Canada.

REAL TIMBER BARGAIN

50,000,000 feet seventy per cent. N. C. Pine, Poplar and Cypress, all original growth. On Southern Railroad in South Carolina. Liberal terms and low price.

J. P. MULHERIN (Owner), Augusta, Ga.

FOR QUICK SALE, 25,000 ACRES

of Virgin timber at war prices, includes land and timber, in fee simple. Titles good. Payments reasonable. Address Box 21, Care of AMERICAN FORESTRY.

INTERIOR TRIM PLANT FOR SALE

For quick sale, the best factory in the South for manufacture of furniture or interior trim. Special advantages in rates, taxes, labor, raw material both yellow pine and hardwoods. Plant is new, fireproof and insurance rate is 66 cents per \$100.00. Sale price is less than half the cost. Write for particulars and photographs.

J. P. MULHERIN, Trustee,
Augusta, Ga.

FOR SALE—STANDING TIMBER

Now is the time to buy timber. You will never again have an opportunity to buy good stumpage as low as at present. Owing to the burning of our lumber plant we offer for sale 100 million feet of pine and hardwoods, principally red gum, oak, cypress and pine. This timber is very large and of fine quality, and can be logged at any season of the year. It is located in South Carolina, with favorable rates to market, climate healthy, labor cheap and plentiful. Additional timber can be secured for as large an operation as desired. Address Box 20, Care AMERICAN FORESTRY MAGAZINE, Washington, D. C.

Hamilton Watch

"The Watch of Railroad Accuracy"

"I have been carrying a Hamilton for the past eight years

and in twenty years I have found no watch that gives the satisfaction that the Hamilton Watch does."
— Conductor C. Smith, Chicago & Alton R. R.

It is Accuracy and only Accuracy that in the long run can confer on a watch the distinction which the Hamilton enjoys.

There are thirty models of the Hamilton Watch. Every one has Hamilton quality and Hamilton accuracy. They range in price from \$12.25 for movement alone (in Canada \$12.50) up to the superb Hamilton masterpiece at \$150.00.

Your jeweler can show you the Hamilton you want, either in a cased watch or in a movement alone, to be fitted to any style case you select, or to your own watch case if you prefer.

Write for Hamilton Watch Book, "The Timekeeper"

It pictures and describes the various Hamilton models and gives interesting watch information.

Hamilton Watch Company, Dept. 00, Lancaster, Pennsylvania

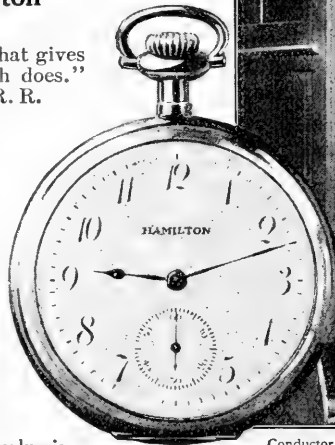

Conductor C. Smith of the Chicago & Alton train, "The Red Hummer"

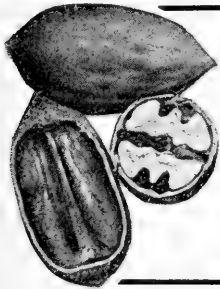

PECAN TREES FOR ZERO CLIMATES

Budded or Grafted

We are headquarters for hardy northern grown Pecan trees. We were the first to begin their propagation in this severe climate and to offer real papershell Pecan trees for planting in the North. We are still the most northern growers of hardy Pecan trees. Assurance of hardiness is well established by the 40,000 trees in various stages of growth to be seen at our nursery in Fairport, ten miles east of Rochester.

We make a specialty of Pecans, English Walnuts, Filberts, Hickories, Almonds and Sober Paragon Chestnuts

Our 1915 Catalog and Planting Guide, profusely illustrated, includes Nut Culture, Fruits, Roses, Shrubs, Evergreens, etc., mailed FREE.

GLEN BROS., Inc., Glenwood Nursery, Est. 1886, 1767 Main Street, ROCHESTER, N. Y.

Forestry Quarterly BACK VOLUMES SUPPLIED CHEAPLY

Address AMERICAN FORESTRY, 1410 H Street, Washington, D. C.

HILL'S SEEDLINGS and Also Tree Seeds TRANSPLANTS

FOR REFORESTING

BEST for over a half century. All leading hardy sorts, grown in immense quantities. Prices lowest. Quality highest. Forest Planter's Guide, also price lists are free. Write today and mention this magazine.

THE D. HILL NURSERY CO.
Evergreen Specialists
Largest Growers in America
BOX 501 DUNDEE, ILL.

EVERGREEN "We Raise Our Own Trees"



Seedlings Transplants

From our specialized collection of young conifers you will find what you want for every place and purpose. Our stock is hardy and field grown and admirably adapted for forest planting and lining out.

Your order will have personal attention and the price will be right.

Send for Catalogue and save money

The North-Eastern Forestry Co.
Tree Seeds, Nursery Stock. Box A, Cheshire, Conn.

Logging and Milling Opportunities in Idaho Yellow Pine

If you are looking for a new location for your milling and logging operations, the following tracts of accessible yellow pine in southern Idaho will interest you. The timber is of good quality, favorable millsites and local markets are available, and stumpage rates are equitable. For detailed information concerning these chances, write the District Forester, Ogden, Utah.

Boise and Payette National Forests.

South Fork of Payette River.

	<i>Bd. ft.</i>
Western yellow pine.....	252,950,000
Douglas fir.....	59,810,000

Total estimated cut..... 312,760,000

This chance comprises seven natural blocks which will be sold separately or in whole, to suit purchaser. The timber is all tributary to the best driving stream in southern Idaho. Logging conditions are very favorable.

Payette National Forest.

Middle Fork of the Payette River.

	<i>Bd. ft.</i>
Western yellow pine.....	318,177,000
Douglas fir.....	102,455,000
White fir and spruce.....	27,963,000

Total estimated cut..... 448,595,000

This timber is tributary to drivable stream. The chance is open to purchase in whole or by natural blocks, as desired by the buyer.

Weiser National Forest.

Weiser River.

	<i>Bd. ft.</i>
Western yellow pine.....	144,620,000
Douglas fir.....	82,665,000
Larch.....	30,605,000
Engelmann spruce.....	7,310,000
White fir and lodgepole pine....	22,300,000

Total estimated cut..... 287,500,000

This timber is tributary to the P. & I. N. Ry., running from Weiser to New Meadows, Idaho. It is a railroad proposition. The chance is divided into five natural blocks which will be sold separately or as a whole. Milling and logging conditions are very favorable.

Harvard University

SCHOOL OF FORESTRY

OFFERS specialized graduate training leading to the degree of Master of Forestry in the following fields:—Silviculture and Management, Wood Technology, Forest Entomology, Dendrology, and (in cooperation with the Graduate School of Business Administration) the Lumber Business

For further particulars address

RICHARD T. FISHER, Chairman
Cambridge, Massachusetts

GEORGIA

State Forest School

University of Georgia

COMPLETE four-year undergraduate course in theoretical and applied forestry leading to the degree:

Bachelor of Science in Forestry

¶ Wide range of specialization offered—

**Logging Engineering
Commercial Administration
Forest Management**

**City Forestry State Forestry
Dendropathology Research**

¶ Provision for four months field work—two following each of Freshman and Sophomore years—on McHatton Forest, a large forest estate in the Blue Ridge Mountains. Numerous excursions in Dendrology and Logging. Provision for practical work in specialization during Junior-Senior vacation

For announcement address

FOREST SCHOOL
Georgia State College of Agriculture
ATHENS, GEORGIA

"Oh that mine adversary had written a Book"

GEORGE H. MAXWELL

has written a Book

Our National Defense— The Patriotism of Peace

advocating the formation of a

Construction Corps of Citizen Soldiery

in which

All Foresters Would Be Enlisted as Reservists

and the work of the Forest Service extended to every State in the Union and the cost of planting and care of forests covered by an issue of Forestry Construction Bonds.

It is practically conceded that the Atlantic and Pacific Coasts of the United States are undefended.

*They cannot be defended by Coast Defenses
They cannot be defended by a Standing Army
They cannot be defended by a Larger Navy*

The only way they can be defended is squarely presented and demonstrated in OUR NATIONAL DEFENSE.

No Patriotic American Citizen who is interested in forestry can afford to be without the knowledge which can be gained from reading that book.

Copies will be mailed to any address in the United States on receipt of \$1.25 by the

RURAL SETTLEMENTS ASSOCIATION

Cotton Exchange Building

New Orleans, Louisiana

"COVERS PRACTICALLY THE ENTIRE FIELD OF FORESTRY"

Elements of Forestry

By FREDERICK FRANKLIN MOON, B. A., M. F., Professor of Forest Engineering, New York State College of Forestry, and Nelson Courtlandt Brown, B. A., M. F., Professor of Forest Utilization, New York State College of Forestry.

"This book covers practically the entire field of forestry, and contains general information on every phase of the subject . . . the chief object has been to gather data from sources not readily available, and to present them in a form easily grasped by the average student."

Forestry Quarterly, December, 1914.

The above extract gives an idea as to the scope of this book. The forester and the student will gather many helpful suggestions from a study of its pages, and will secure information which is not readily accessible in any other form.

If cash accompanies your order we will forward a copy of this book on ten days' approval. If found unsatisfactory, it can be returned and your money will be promptly refunded.

392 pages, 6 x 9, illustrated with half-tone plates, reproduced from original photographs and those obtained from the Forest Service.
Cloth, \$2.00 net.

JOHN WILEY & SONS, Inc., 432 Fourth Ave., New York
London: CHAPMAN & HALL, Ltd. Montreal, Canada: RENOUF PUB. CO.

HEAD FORESTER, GARDENER, GENERAL MANAGER

Expert at Forestry, Horticulture, and Agriculture
Thoroughly familiar with the *American, German, French and Hungarian* forest systems. Fire protection—forest nurseries—laying out new territory—bringing old ones under system—roads—telephones—fencing—game keeping, fish and fowl. Persian lambs a specialty. If you want to have a model estate to be proud of I have the experience gathered all over the globe connected with a thoroughly theoretical training. Expert on landscape gardening, green houses, and on everything *new, scientific, practical* in agriculture connected with the breeding of horses, cattle and in the erecting of buildings—draw my own plans. Would like to run very large model estate, with full power and responsibility. Wages *high but moderate*. At present in position. Please send full particulars. Personal interview by three days' notice—at liberty after two weeks' notice. *References*, genuine and stamped from authorities. There is no competition to scare me! Address, please, to the **American Forestry Association, Box 5, Wash., D. C.**

FO 1 RE 2 ST 3 RY 4

The **FOREST**
is three-fourths of
FORESTRY

Your opportunities are as unlimited as our forests if you study at

WYMAN'S SCHOOL OF THE WOODS
Incorporated Munising, Michigan

We make the
ENGRAVINGS

for the
**AMERICAN FORESTRY
MAGAZINE**

OUR SPECIALTY
is the "better" grade finish of
DESIGNS & ENGRAVINGS
in one or more colors
for Magazines, Catalogues,
Advertisements, etc.

HALF TONES	LINE PLATES
DULLO-TONES	COMBINATION LINE AND HALF TONES
COLOR PROCESS	MULTI-COLORS

Established 1889

GATCHEL & MANNING
SIXTH and CHESTNUT STREETS
Opposite Olde Independence Hall
PHILADELPHIA

Yale University Forest School

NEW HAVEN, CONN., U. S. A.

YALE University Forest School is a graduate department of Yale University. It is the oldest existing forest school in the United States and exceeds any other in the number of its alumni. A general two-year course leading to the degree of Master of Forestry is offered to graduates of universities, colleges and scientific institutions of high standing and, under exceptional conditions, to men who have had three years of collegiate training including certain prescribed subjects. Men who are not candidates for the degree may enter the School as special students, for work in any of the subjects offered in the regular course, by submitting evidence that will warrant their taking the work to their own advantage and that of the School. Those who have completed a general course in forestry are admitted for research and advanced work in Dendrology, Silviculture, Forest Management, Forest Technology, and Lumbering. The regular two-year course begins the first week in July at the School camp near Milford, Pennsylvania.

For further information address

JAMES W. TOUMEY, Director
NEW HAVEN, CONN.

Special Courses offered in

LUMBERING

and

WOOD UTILIZATION, PULP and PAPER MAKING

Other Special Courses in Forestry

Men with technical training along the lines of Lumbering and the various branches of Wood Utilization will be needed in the future.

Four and five year students in these courses will have constant access to the new Eastern Forest Products Laboratory.

The New York
State College of Forestry
At Syracuse University
Syracuse, N. Y.

In the National Forest Region

Colorado School of Forestry

A DEPARTMENT OF
COLORADO COLLEGE

THE course in theoretical and applied forestry leading to the degree of Forest Engineer covers a period of two years and is open to students who have completed two years of college work, including a sufficient amount of Botany, Geology and Surveying.

Graduate students may enter as candidates for the degree of Master of Forestry.

Fall and Spring Terms in the Manitou Forest, the College Reserve, 6,000 acres of pine and spruce timberland on the borders of the Pike National Forest. Winter Term at Colorado Springs.

For particulars address
Colorado School of Forestry
Colorado Springs, Colo.

DEPARTMENT OF FORESTRY

The Pennsylvania State College

A PROFESSIONAL course in Forestry, covering four years of college work, leading to the degree of Bachelor of Science in Forestry.

Thorough and practical training for government, state, municipal and private forestry.

Four months are spent in camp in the woods in forest work.

Graduates who wish to specialize along particular lines are admitted to the "graduate forest schools" as candidates for the degree of Master of Forestry on the successful completion of one year's work.

For further information address,

Department of Forestry
PENNSYLVANIA STATE COLLEGE
State College, Pa.

High-Grade Instruction by Correspondence

Established in 1892

Successful Graduates Practicing in all States

Four Courses: Regular College (three years), Post-Graduate (one year), Business Law (five months), and Bar Examination Review (three months). Classes begin on the first and third Mondays of each month.

Approved by Bench and Bar

Send for 64 page Catalog giving the Rules for Admission to the Bar and showing the Requirements in each State.

Chicago Correspondence School of Law
802 Reaper Block, Chicago

PATENTS that properly protect

Thirty years of experience enable me to assure clients an intelligent service in securing patents that afford fullest protection. Correspondence invited.

No attorney's fee until patent is allowed

Write for free copy of "Inventor's Guide" which gives valuable information about patent protection.

FRANKLIN H. HOUGH

Loan and Trust Building

WASHINGTON, D. C.

TIMBER ESTIMATES, FOREST
SURVEYS and MAPS

D. E. LAUDERBURN

Forest Engineer

6030 Metropolitan Building, New York City

→

TIMBER ESTIMATES
FIRE PROTECTION PLANS
MAPS. LOGGING REPORTS
EMPIRE STATE FORESTERS
156 FIFTH AVE. NEW YORK CITY

←

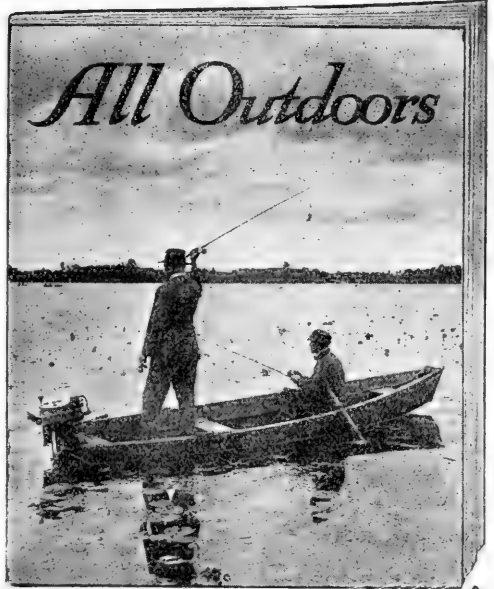

Spring Fever?

The April ALL OUTDOORS will be good for you. A special cruising number. Canoe or boat. Maps to aid you. Pictures to lead you.

Fishing?

Sure. Especially for trout. Tackle and equipment. How and where. Bully pictures and lots of them.

Out-of-doors in Spring

Is the keynote of April. If you do anything out-of-doors you will like ALL OUTDOORS.

Any newsdealer 15 cents but it will be better to use the coupon.

ALL OUTDOORS, Inc.

A. F.

145 West 36th St., New York.

Send me ALL OUTDOORS for six months on trial. 50 cents is enclosed. (\$1.00 for a year.)

Name

Address

Reducing the Cost of Upkeep—

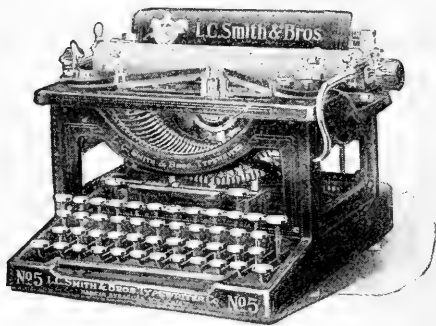

Ball Bearing; Long Wearing

THE INSTALLATION OF

L. C. Smith & Bros. Typewriters

is invariably followed by the discovery that the bills for ribbons are much less than before. A large corporation recently found that its ribbon expense was cut in two. This is not an accident. It is the result of the mechanical construction that makes the L. C. Smith & Bros. cheapest to maintain.

The ball bearings give light touch and eliminate pounding impact. The ribbon is actuated by the carriage, not the typebar. The ribbon mechanism is automatic, so that the ribbon reverses at the instant the end is reached and without added strain.

Low ribbon cost, low cost of maintenance and the highest efficiency—these are guaranteed to L. C. Smith & Bros. users.

Demonstration for the asking

L. C. Smith & Bro. Typewriter Company

Home Office and Factory, Syracuse, N. Y.

Branches in all Principal Cities

WASHINGTON OFFICE: 14th and H Streets, N. W.

ECONOMY

STRENGTH

DURABILITY

WORKABILITY

BEAUTY and

AMPLE SUPPLY

ALL COMBINED IN

Yellow Pine Lumber

The "Wood of a Thousand Uses"

If you want to know more about it
A CARD ADDRESSED TO US WILL BRING RESULTS

Our Own Mills Cut 275,000,000
Feet Annually

**MISSOURI LUMBER AND LAND
EXCHANGE COMPANY**

1111 Long Building :: KANSAS CITY, MO.

An Increasing

Population

An Increasing

Demand

A Decreasing

Supply

Emphasize current timber investment opportunities.

In a few years buyers will look back at the "good old days of 1915," when good timber could have been picked up at bargain prices. This **is** 1915.

Buy now and forestall future regrets.

We offer bargains in northern hemlock and hardwoods; southern hardwoods and southern pine, western pine, fir, spruce and cedar—also British Columbia timber.

Find out what they are and where they are.

James D. Lacey & Co.

Timber Land Factors

CHICAGO, ILL., 1750 McCormick Building
PORTLAND, ORE., 1313 Northwestern Bank Building
SEATTLE, WASH., 1009 White Building

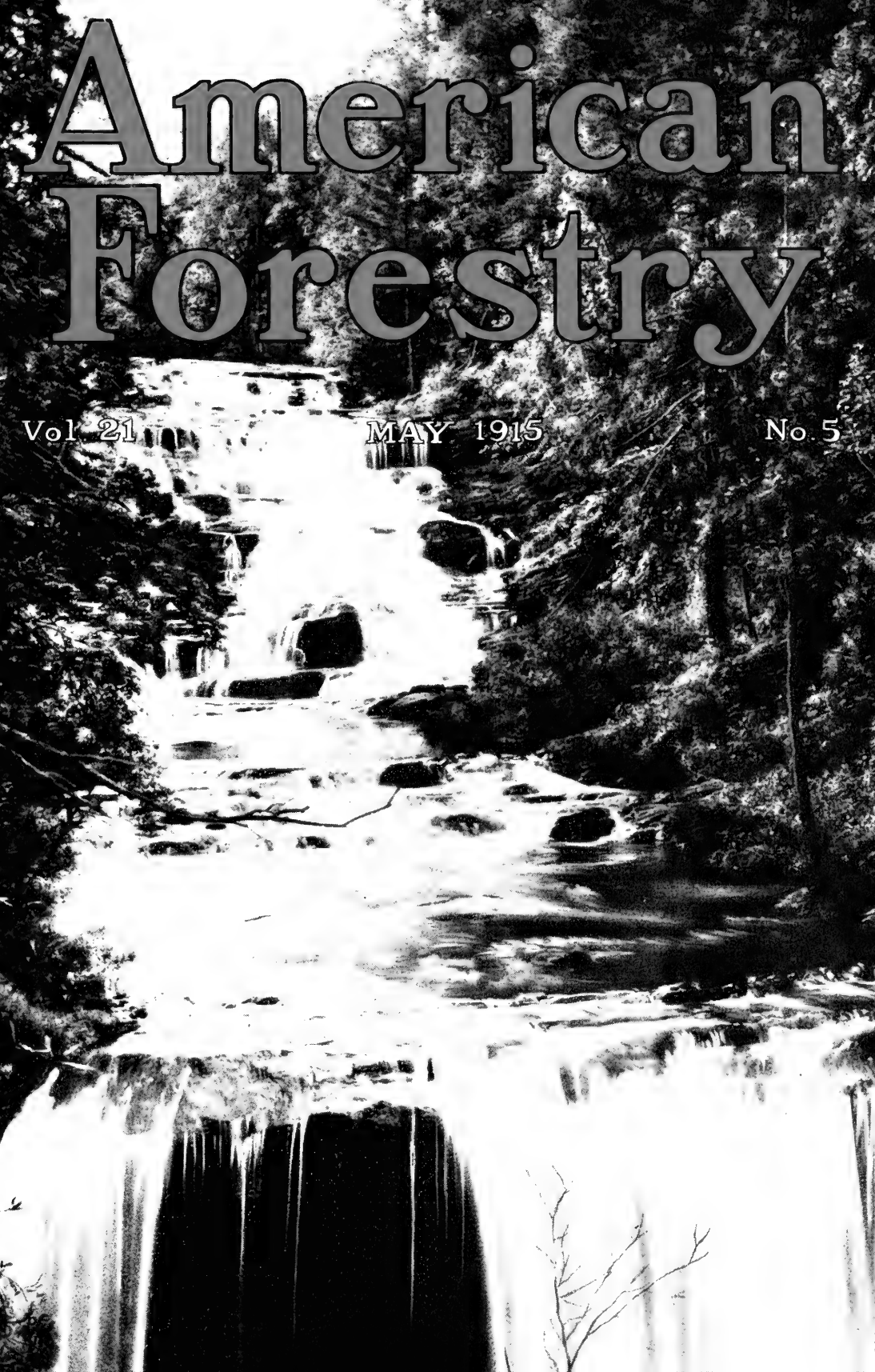

American Forestry

Vol. 21

MAY 1915

No. 5

BOOKS ON FORESTRY

AMERICAN FORESTRY will publish each month, for the benefit of those who wish books on forestry, a list of titles, authors and prices of such books. These may be ordered through the American Forestry Association, Washington, D. C. Prices are by mail or express prepaid.* :-: :-: :-: :-:

THE WOODS—Douglas Malloch	\$1.15
RESAWED FABLES—Douglas Malloch	1.15
THE TRAINING OF A FORESTER—Gifford Pinchot	1.12
LUMBER AND ITS USES—R. S. Kellogg	1.15
THE CARE OF TREES IN LAWN, STREET AND PARK—B. E. Fernow	2.17
NORTH AMERICAN TREES—N. L. Britton	7.30
KEY TO THE TREES—Collins and Preston	1.50
THE FARM WOODLOT—E. G. Cheyney and J. P. Wentling	1.70
AMERICAN FOREST TREES—Henry H. Gibson	6.00
IDENTIFICATION OF THE ECONOMIC WOODS OF THE UNITED STATES— Samuel J. Record	1.25
PLANE SURVEYING—John C. Tracy	3.00
FOREST MENSURATION—Henry Solon Graves	4.00
THE ECONOMICS OF FORESTRY—B. E. Fernow	1.61
FIRST BOOK OF FORESTRY—Filibert Roth	1.10
PRACTICAL FORESTRY—A. S. Fuller	1.50
PRINCIPLES OF AMERICAN FORESTRY—Samuel B. Green	1.50
SEASIDE PLANTING OF TREES AND SHRUBS—Alfred Gaut	1.75
FAMILIAR TREES—G. S. Boulger	1.50
MANUAL OF THE TREES OF NORTH AMERICA (exclusive of Mexico)—Charles Sprague Sargent	6.00
AMERICAN WOODS—Romeyn B. Hough	5.00
HANDBOOK OF THE TREES OF THE NORTHERN U. S. AND CANADA, EAST OF THE ROCKY MOUNTAINS—Romeyn B. Hough	6.00
GETTING ACQUAINTED WITH THE TREES—J. Horace McFarland	1.75
PRINCIPAL SPECIES OF WOOD: THEIR CHARACTERISTIC PROPERTIES— Charles Henry Snow	3.50
NORTH AMERICAN FORESTS AND FORESTRY—E. R. Bruncken	2.00
HANDBOOK OF TIMBER PRESERVATION—Samuel M. Rowe	4.00
TREES OF NEW ENGLAND—L. L. Dame and Henry Brooks	1.50
TREES AND SHRUBS—C. S. Sargent	5.00
TREES, SHRUBS AND VINES OF THE NORTHEASTERN UNITED STATES— H. E. Parkhurst	1.50
TREES—H. Marshall Ward	1.50
OUR NATIONAL PARKS—John Muir	1.91
THE LONGLEAF PINE IN VIRGIN FOREST—G. Frederick Schwarz75
LOGGING—Ralph C. Bryant	3.50
THE IMPORTANT TIMBER TREES OF THE UNITED STATES—S. B. Elliott	2.50
FORESTRY IN NEW ENGLAND—Ralph C. Hawley and Austin F. Hawes	3.50
THE PRINCIPLES OF HANDLING WOODLANDS—Henry Solon Graves	1.50
SHADE TREES IN TOWNS AND CITIES—William Solotaroff	3.00
THE TREE GUIDE—By Julia Ellen Rogers	1.00
FOREST PHYSIOGRAPHY—By Isaiah Bowman	5.00
MANUAL FOR NORTHERN WOODSMEN—Austin Cary	2.12
FARM FORESTRY—Alfred Akerman57
THE THEORY AND PRACTICE OF WORKING PLANS (in forest organization) A. B. Recknagel	2.10
ELEMENTS OF FORESTRY—F. F. Moon and N. C. Brown	2.20
MECHANICAL PROPERTIES OF WOOD—Samuel J. Record	1.75
STUDIES OF TREES—J. J. Levison	1.75
TREE PRUNING—A. Des Cars65
THE PRESERVATION OF STRUCTURAL TIMBER—Howard F. Weiss	3.00

* This, of course, is not a complete list, but we shall be glad to add to it any books on forestry or related subjects upon request.—Editor.

Plant Evergreens 3-25 Feet High and All Winter Planting Will Be Welcome

IF you need to screen unattractive surroundings, garage, stable, poultry house, laundry yard, or street.

IF you admire evergreens.

IF you need windbreaks to your house, garden, out door room or play ground.

IF you enjoy hunting big Cedars, Pines, Oaks, Maples, Dogwoods, Laurel, etc., and making your place look like an old place-right away.

IF you have evergreens, deciduous trees or shrubs to move to other parts of your grounds or give away or sell.

The Proof

Hicks Nurseries employed 100 men last winter, except 14 days. Half were digging trees. Our winter sales for the past four years were \$16,000.00.

In January the ground freezes six inches, but is easily worked if previously mulched to keep out frost.

On the mainland the frost is deeper and more continuous, but it is easy to dig through with pick or cold chisel.

If it costs a few cents additional to plant we will bear that to keep our staff all winter.

IF you wish to prevent winter unemployment. We can provide apparatus and men to cooperate with your men or we can attend to the entire operations.

IF you wish to take advantage of present reduced prices. Carload shipments or less from the nursery of pines, spruce, cedar, 3-25 feet high.

I. HICKS & SON

Westbury, L. I.,

New York

Thorburn's Tree Seeds

WE have, for many years, devoted a great deal of attention to tree seeds.

Even the rarest varieties are stocked by us, and you may be assured of prompt shipment of anything shown in our catalogue.

We should be glad to have you send us your lists for pricing. If you haven't a copy of our 1915 Catalogue one will be sent you on request.

J. M. Thorburn & Co.

53 Barclay Street through
to 54 Park Place
NEW YORK

Seeds for Forestry Purposes

WE offer a most complete list of both Deciduous and Evergreen Tree and Shrub seeds for forestry purposes.

Seeds that are of best germinating quality

Our catalogue contains a full list of the varieties we offer, which include the best and most rare species. Send for a copy, it will interest you.

THOMAS MEEHAN & SONS

Wholesale Nurserymen and Tree Seedmen
DRESHER, PENNA., U. S. A.

ORCHIDS

ORCHIDS

We are specialists in Orchids, we collect, import, grow, sell and export this class of plants exclusively.

Our illustrated and descriptive catalogue of Orchids may be had on application. Also special lists of freshly imported unestablished Orchids.

LAGER & HURRELL

SUMMIT, N. J.

Orchid Growers and Importers

Reducing the Cost of Upkeep—

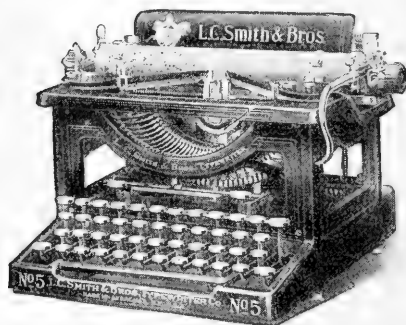

Ball Bearing; Long Wearing

THE INSTALLATION OF L. C. Smith & Bros. Typewriters

is invariably followed by the discovery that the bills for ribbons are much less than before. A large corporation recently found that its ribbon expense was cut in two. This is not an accident. It is the result of the mechanical construction that makes the L. C. Smith & Bros. cheapest to maintain.

The ball bearings give light touch and eliminate pounding impact. The ribbon is actuated by the carriage, not the typebar. The ribbon mechanism is automatic, so that the ribbon reverses at the instant the end is reached and without added strain.

Low ribbon cost, low cost of maintenance and the highest efficiency—these are guaranteed to L. C. Smith & Bros. users.

Demonstration for the asking

L. C. Smith & Bro. Typewriter Company

Home Office and Factory, Syracuse, N. Y.

Branches in all Principal Cities

WASHINGTON OFFICE: 14th and H Streets, N. W.

THE AMERICAN FORESTRY ASSOCIATION

OFFICERS FOR 1914

President

DR. HENRY STURGIS DRINKER, President, Lehigh University, South Bethlehem, Pa.

Vice-Presidents

JOSHUA L. BAILEY, Pennsylvania
THEODORE L. BRISTOL, Connecticut
Ex-President Connecticut Forestry Association
ANDREW CARNEGIE, New York
MRS. EMMONS CROCKER, Massachusetts
DR. CHARLES W. ELIOT, Massachusetts
President Emeritus Harvard University
DR. B. E. FERNOW, Canada
Dean of Forestry, University of Toronto
HON. WALTER L. FISHER, Chicago, Ill.
Ex-Secretary of the Interior
HENRY S. GRAVES, District of Columbia
Chief of the Forest Service
HON. CURTIS S. GUILD, Massachusetts
Ex-Ambassador to Russia
EVERITT G. GRIGGS, Washington
HON. DAVID HOUSTON
Secretary of Agriculture
HON. FRANKLIN K. LANE
Secretary of the Interior

HON. ASBURY F. LEVER, South Carolina
United States Representative
HON. THOMAS NELSON PAGE
Ambassador to Italy
HON. GEO. PARDEE, California
Ex-Governor California
GIPFORD PINCHOT, Philadelphia, Pa.
FILIBERT ROTH, Michigan
Dean of Forestry, University of Michigan
DR. J. T. ROTHROCK, Pennsylvania
HON. WM. H. TAFT, Connecticut
Ex-President United States
JOSEPH N. TEAL, Oregon
Chairman Oregon Conservation Commission
HON. JOHN WEEKS, Massachusetts
U. S. Senator
DR. ROBERT S. WOODWARD, Washington, D. C.
President, Carnegie Institution

Treasurer

JOHN E. JENKS, Washington, D. C.
Editor, Army and Navy Register

Executive Secretary

P. S. RIDSDALE, 1410 H Street N. W., Washington, D. C.

Directors

E. T. ALLEN, Oregon
Forester, Western For. and Conservation Asso.
HON. ROBERT P. BASS, New Hampshire
Ex-Governor of New Hampshire
WM. B. GREELEY, District of Columbia
Assistant U. S. Forester
W. R. BROWN, New Hampshire
Pres., New Hamp. Forestry Commission
HERMAN H. CHAPMAN, Connecticut
Professor of Forestry, Yale Forest School
DR. HENRY S. DRINKER, Pennsylvania
President, Lehigh University
ALFRED GASKILL
State Forester, New Jersey
JOHN E. JENKS, District of Columbia
Editor, Army and Navy Register

CHESTER W. LYMAN, New York
International Paper Company
CHARLES LATHROP PACK, New Jersey
Pres., Fifth National Conservation Congress
CHARLES F. QUINCY, New York
J. E. RHODES, Illinois
Secretary Southern Pine Association
ERNEST A. STERLING, Pennsylvania
Forest and Timber Engineer
JOHN L. WEAVER, District of Columbia
Real Estate Broker
J. B. WHITE, Missouri
Ex-President, National Conservation Congress

Auditors

E. A. STERLING, Pennsylvania

C. F. QUINCY, New York

Advisory Board, Representing Affiliated Organizations

National Wholesale Lumber Dealers' Association
ROBT. C. LIPPINCOTT, Philadelphia, Pa.
R. L. SISSON, Potsdam, N. Y.
JOHN M. WOODS, Boston, Mass.

Northern Pine Manufacturers' Association
C. A. SMITH, Minneapolis, Minn.
WILLIAM IRVINE, Chippewa Falls, Wis.
F. E. WEYERHAEUSER, St. Paul, Minn.

Massachusetts Forestry Association
NATHANIEL T. KIDDER, Milton, Mass.
FREDERIC J. CAULKINS, Boston, Mass.
HARRIS A. REYNOLDS, Cambridge, Mass.

Lumbermen's Exchange
J. RANDALL WILLIAMS, JR., Philadelphia, Pa.
FREDERICK S. UNDERHILL, Philadelphia, Pa.
ROBERT C. LIPPINCOTT, Philadelphia, Pa.

Camp Fire Club of America
WARREN H. MILLER, New York
O. H. VAN NORDEN, New York
FREDERICK K. VREELAND, New York

North Carolina Forestry Association
E. B. WRIGHT, Boardman, N. C.
ALSTON GRIMES, Grimesland, N. C.
J. C. SMOOT, North Wilkesboro, N. C.

National Association of Box Manufacturers
B. W. PORTER, Greenfield, Mass.
S. B. ANDERSON, Memphis, Tenn.
ROBT. A. JOHNSON, Minneapolis, Minn.

Carriage Builders' National Association
H. C. McLEAR, Wilmington, Del.
D. T. WILSON, New York
C. A. LANCASTER, South Bend, Ind.,

Boston Paper Trade Association
N. M. JONES, Lincoln, Maine
JOHN E. A. HUSSEY, Boston, Mass.
ARTHUR L. HOBSON, Boston, Mass.

Philadelphia Wholesale Lumber Dealers' Ass'n
ROBT. C. LIPPINCOTT, Philadelphia, Pa.
J. RANDALL WILLIAMS, JR., Philadelphia, Pa.
FRED'K S. UNDERHILL, Philadelphia, Pa.

New Hampshire Timberland Owners' Association
W. H. BUNDY, Boston, Mass.
EVERETT E. AMEY, Portland, Me.
F. H. BILLARD, Berlin, New Hampshire

Empire State Forest Products Association
FERRIS J. MEIGS, New York City
RUPUS L. SISSON, Potsdam, N. Y.
W. L. SYKES, Buffalo, N. Y.

California Forest Protective Association
MILES STANDISH, San Francisco, Cal.
GEO. X. WENDLING, San Francisco, Cal.
GEO. H. RHODES, San Francisco, Cal.

Minnesota Forestry Association
W. T. COX, St. Paul, Minn.
PROF. D. LANGE, St. Paul, Minn.
MRS. CARRIE BACKUS, St. Paul, Minn.

American Wood Preservers' Association
GEO. E. REX, Topeka, Ka.
CARL G. CRAWFORD, Louisville, Ky.
F. J. ANGIER, Baltimore, Md.

Southern Pine Association
J. B. WHITE, Kansas City, Mo.
J. E. RHODES, New Orleans, La.
E. A. STERLING, Philadelphia, Pa.

HUNTING AND CAMPING OUTFITS



I want to send our new illustrated catalogue to everyone who is interested in outdoor life. I call it a

SPORTSMAN'S HANDBOOK

for it not only describes the many things an outer-man or woman needs but tells of my personal experiences in the wilds when camping, exploring, fishing and hunting, with advice as to equipment and many "kinks" in wildcraft.

Please ask for Catalogue No. 162

Powhatan Robinson PRESIDENT
NEW YORK SPORTING GOODS CO.
15 and 17 Warren Street, New York

You can make any camping ground *good sleeping* ground if you carry along the

"PERFECTION" Pneumatic Mattress With Sleeping Bag

Rolls to a small, light bundle, when deflated. *Easily Inflated.* Never damp, hard or lumpy. Always evenly smooth and soft, conforming to your body. *Lasts indefinitely.*

Write for catalog today

PNEUMATIC MFG. COMPANY
552 17th St., Brooklyn, N. Y.



Barrett's Grade One LIQUID Creosote Oil

Cuts wood preserving bills in half—

For preserving telephone poles, telegraph poles, cross arms, railroad ties, fence posts, mine timbers, under-ground sills, sleepers, bridge timbers, planking, ice houses, wood tanks, shingles, poultry houses, silos, and structural timbers of all kinds.

Especially adapted for brush and open tank treatment.

Booklet on request.

BARRETT MANUFACTURING CO.

New York	Chicago	Philadelphia
Boston	St. Louis	Cleveland
Cincinnati	Pittsburgh	Detroit
Birmingham	Minneapolis	Seattle
Kansas City	Salt Lake City	



Jappo Makes Plants Grow

FREE

We will give you flower seeds free. Try them with Jappo and see how they grow.

FREE

Guaranteed To promote a vigorous growth in all plant life. Causes flowering plants to bloom in profusion. Stimulates growth of foliage.

NOTE OUR OFFERS

No. 1 With each 25 cent package of Jappo we will mail free 4 different packages flower seeds worth 20 cents.

No. 2 With each \$1.00 package of Jappo we will mail free 20 different packages flower seeds.

Send orders to

JAPPO PLANT FOOD

90 West Street

New York City

American Forestry

The Magazine of the American Forestry Association

PERCIVAL SHELDON RIDSDALE, Editor

EDITORIAL ADVISORY BOARD

HERMAN H. CHAPMAN
ERNEST A. STERLING
S. T. DANA

FREDERICK S. UNDERHILL
JOHN E. RHODES
S. N. SPRING

May	CONTENTS	1915
-----	----------	------

COVER PICTURE—Water-falls in Yosemite Park.		
THE GREAT WAR AND GERMAN FORESTS—By Poultney Bigelow.....	607	
With four illustrations.		
WAR NOTES FROM FRENCH FORESTS.....	612	
FLUSHING'S OLDEST TREE—By Everett P. Martin.....	614	
With one illustration.		
TEXAS FORESTRY LAW.....	615	
WOODLOT IMPROVEMENT.....	616	
TREE FRUITS AND FLOWERS—By Warren H. Miller.....	617	
With ten illustrations.		
JOSEPH N. TEAL.....	626	
DR. B. E. FERNOW.....	627	
LAKING—By W. R. Brown.....	628	
With eleven illustrations.		
GEORGIA STATE FOREST SCHOOL.....	636	
THE PINE-SHOOT MOTH.....	637	
With seven illustrations.		
WOMEN'S WORK IN CONSERVATION—By Mrs. John Dickinson Sherman.....	641	
With one illustration.		
IS THIS THE LARGEST ELM?.....	643	
With one illustration.		
DEVELOPING BRITISH COLUMBIA.....	644	
With one illustration.		
HON. CURTIS GUILD DEAD.....	645	
With one illustration.		
MAKING PRIVATE FORESTRY PAY—By James Upham.....	647	
A SLEDDING LOG HAULER.....	648	
With two illustrations.		
COLORADO SCHOOL OF FORESTRY.....	650	
With two illustrations.		
A CLERK'S WORK ON A NATIONAL FOREST—By Julia T. Shinn.....	653	
With two illustrations.		
THE FORESTRY ISSUES IN THE LAKE STATES—By H. H. Chapman.....	656	
BUILDING BIRD HOUSES—By Ned Dearborn.....	660	
With forty illustrations.		
EDITORIAL.....	670	
FOREST NOTES.....	672	
CANADIAN DEPARTMENT.....	674	
CURRENT LITERATURE.....	676	

AMERICAN FORESTRY is published monthly by the American Forestry Association
Subscription price, three dollars per year; single copies, twenty-five cents

Copyright 1915, by the American Forestry Association

Entered as second-class mail matter December 24, 1909, at the Post-office at Washington, under the
Act of March 3, 1879

THE IDEAL ROUTE

To or from the Fall Meeting
of the
**AMERICAN FORESTRY
ASSOCIATION**

San Francisco, October 20, 1915

N. Y.—San Francisco

Through the

PANAMA CANAL

Large Transatlantic Liners
Under the American Flag

“FINLAND” “KROONLAND”
22,000 Tons Displacement

Circular tickets one way by water, the
other way by rail

PANAMA PACIFIC LINE

9 Broadway, New York
319 Geary Street, San Francisco

Agents Everywhere

READY NOVEMBER 1, 1914

A New Booklet on Estimating
Southern Timber

Southern White Cedar
Shortleaf and Longleaf Pine
Southern Appalachian Timber

Postpaid, 20 cents

HOWARD R. KRINBILL

Forest Engineer

NEWBERN, N. C.

TIMBER ESTIMATES

We make accurate cruises of standing
timber, topographical maps, and advise
as to forest management for—

TIMBER OWNERS
BONDING HOUSES
MILL OPERATORS

MUNSON-WHITAKER CO.

Consulting Forest Engineers

NEW YORK, 676 Fourth Ave. CHICAGO, 516 Comm. Bk. Bldg.
BOSTON, 822 Tremont Bldg. PITTSBURG, 906 Arrott Bldg.

TIMBER ESTIMATES

Why not have your timber estimated by competent Forest
Engineers? Somebody will do it; why not the best?

IT WILL PAY AND SAVE IN BONDING,
SELLING OR OPERATING

We make preliminary examinations; complete forest surveys, including
logging maps; valuations; and planting and management reports.

Also Specialists on Preservative Treatment of Wood Against Decay

Write for information

CLARK, LYFORD & STERLING

1331-2 Real Estate Trust Building

PHILADELPHIA, PENNA.

Declaration of Principles and Policy

of the American Forestry Association

- IT IS A VOLUNTARY** organization for the inculcation and spread of a forest policy on a scale adequate for our economic needs, and any person is eligible for membership.
- IT IS INDEPENDENT**, has no official connection with any Federal or State department or policy, and is devoted to a public service conducive to national prosperity.
- IT ASSERTS THAT** forestry means the propagation and care of forests for the production of timber as a crop; protection of watersheds; utilization of non-agricultural soil; use of forests for public recreation.
- IT DECLARES THAT FORESTRY** is of immense importance to the people; that the census of 1913 shows our forests annually supply over one and a quarter billion dollars' worth of products; employ 735,000 people; pay \$367,000,000 in wages; cover 550,000,000 acres unsuited for agriculture; regulate the distribution of water; prevent erosion of lands; and are essential to the beauty of the country and the health of the nation.
- IT RECOGNIZES THAT** forestry is an industry limited by economic conditions; that private owners should be aided and encouraged by investigations, demonstrations, and educational work, since they cannot be expected to practice forestry at a financial loss; that Federal and State governments should undertake scientific forestry upon national and State forest reserves for the benefit of the public.
- IT WILL DEVOTE** its influence and educational facilities to the development of public thought and knowledge along these practical lines.

It Will Support These Policies

- FEDERAL ADMINISTRATION AND MANAGEMENT** of national forests; adequate appropriations for their care and management; Federal cooperation with the States, especially in forest fire protection.
- STATE ACTIVITY** by acquirement of forest lands; organization for fire protection; encouragement of forest planting by communal and private owners; non-political departmentally independent forest organization, with liberal appropriations for these purposes.
- FOREST FIRE PROTECTION** by Federal, State and fire protective agencies, and its encouragement and extension, individually and by cooperation; without adequate fire protection all other measures for forest crop production will fail.
- FOREST PLANTING** by Federal and State governments and long-lived corporations and acquirement of waste lands for this purpose; and also planting by private owners, where profitable, and encouragement of natural regeneration.
- FOREST TAXATION REFORMS** removing unjust burdens from owners of growing timber.
- CLOSER UTILIZATION** in logging and manufacturing without loss to owners; aid to lumbermen in achieving this.
- CUTTING OF MATURE TIMBER** where and as the domestic market demands it, except on areas maintained for park or scenic purposes, and compensation of forest owners for loss suffered through protection of watersheds, or on behalf of any public interest.
- EQUAL PROTECTION** to the lumber industry and to public interests in legislation affecting private timberland operations, recognizing that lumbering is as legitimate and necessary as the forests themselves.
- CLASSIFICATION** by experts of lands best suited for farming and those best suited for forestry; and liberal national and state appropriations for this work.

APPLICATION FOR MEMBERSHIP

Date.....

THE AMERICAN FORESTRY ASSOCIATION

1410 H Street, Washington, D. C.

Dear Sir: I hereby signify my desire to become of the AMERICAN FORESTRY ASSOCIATION, and enclose \$..... for dues.

Very truly yours,

Name.....

P. O. Address.....

- an Annual Member (\$1)
- a Subscribing Member (\$3)
- a Contributing Member (\$10)
- a Sustaining Member (\$25)
- a Life Member (\$100)
- a Patron (\$1,000)

American Forestry is sent to all except Annual (\$1) Members

RED OAK ACORNS

New crop—prime—fresh, excellent quality. Collected in Northern Illinois. Have between 40 to 50 bushels still on hand—price while they last \$2.00 per bushel (50 pounds), 10 bushels \$18.50. Also complete stock Evergreen Tree Seeds. Write for price-list.
THE D. HILL CO., Box No. 501, Dundee, Illinois

JAMES W. SEWALL
Timber Estimates

Topographic and Boundary Surveys, Planting, Logging Maps, Portable Mill Operations
Technical Training Thoroughness Experience
 CENTRE STREET OLD TOWN, MAINE

Evergreens for May Planting

You are not too late if you order at once
and our Special Prices still hold good

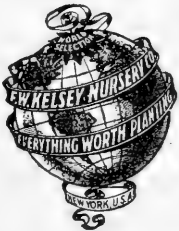

	1,000	10,000
NORWAY SPRUCE, 4 yr. Transplants.....	\$6.50	\$55.00
NORWAY SPRUCE, 3 yr. Seedlings.....	3.50	28.50
NORWAY SPRUCE, 2 yr. Seedlings.....	3.00	21.00
WHITE PINE, 3 yr. Seedlings.....	4.00	27.00
WHITE PINE, 2 yr. Seedlings.....	3.00	21.00

This stock is Extra Fine and grown in Vermont where the season is very backward and the plants admirable for May Planting

We also have a splendid assortment of the leading Varieties of Evergreens in larger stock. Your orders will receive prompt attention

F. W. KELSEY NURSERY CO. 150 Broadway
 NEW YORK

American Forestry

VOL. XXI

MAY, 1915

No. 5

THE GREAT WAR AND GERMAN FORESTS

By POULTNEY BIGELOW, M. A., F. R. G. S.

Late Lecturer on "National Expansion" in the Law Department of Boston University

[The noted author of this article said in a letter accompanying it:—"In general it's my private opinion that Belgium will not have wood enough left for toothpicks when the war is over; for it's no joke to warm a million men round the bivouac fire on successive cold nights; and as you know, soldiers in the enemy's country are apt to be careless! Even WE were such in the civil war!"—Editor.]

THE Editor of AMERICAN FORESTRY pays me the compliment of calling upon me for a contribution that shall include the

Great War and its effect on forests—

another way of saying that men and trees live for one another; and no tree can suffer without an injury to mankind.

Forests were the foundations of German greatness. Need I recall ele-



LARGE SILVER FIR AND REGENERATION OF SAME SPECIES

IN THIS FOREST ONLY THE CROOKED AND DEFECTIVE TREES HAVE BEEN CUT DOWN. THE PRESENT OVER STANDARDS WILL BE REMOVED IN TEN YEARS. BADENWEILER, SCHWARTZWALD—BADEN, GERMANY



PILES OF CORDWOOD AND FAGOTS
SHOWING HOW THE GERMANS UTILIZE WHAT IS USUALLY WASTED IN AMERICAN WOODS AND FORESTS. SCHWARTZ-
WALD, BADEN, GERMANY

mentary history to your minds? In 1806 Napoleon thrashed the Prussian army so thoroughly at Yena that it never ceased running until it ran into the arms of the Russian Alexander on the banks of the Memel. Out of deference to this Muscovite ally, the great Corsican refrained from incorporating Prussia as a province of France. He only took away the best half of her territory and compelled her miserable King (Frederick William III) to disband his army—leaving him but just enough to police his diminished acres and parade before him at Potsdam.

Incidentally be it noted that in 1806 Napoleon not only robbed Prussia of military stores and art treasures but his army pillaged every cash box and savings bank in the land and left the land of Queen Louise so poor that even

the Absolute King had to think twice before ordering a new suit of clothes.

In these straits God raised up the Grand old Stein. He was not a Prussian—few of Germany's great men have been Prussian; but he was a great political diagnostician and feared no man—either on or off the throne. The Prussian King cordially disliked this man of iron as he disliked all but those who flattered his many weaknesses. But there are times when a surgeon must be called—even a hated one. And as it was with Prussia in the darkest days of her history, the King needed money—and it is usually only when the Royal pockets are void that popular clamor gets a voice. The Courtiers who had helped Frederick William III to the disgrace of Jena could do nothing for him but wring their hands and curse



ROAD THROUGH GERMAN FOREST

ALL OF THE TREES ARE STRAIGHT AND STRONG AS THE WEAK AND OTHERWISE DEFECTIVE ONES HAVE BEEN REMOVED

Napoleon; but this did not pay salaries. At last the boldest ventured to beg their master to call in the famous Doctor Stein; and at last with a wry face the sour King consented and Stein came sternly to the Royal bed side.

Stein at once applied the proper remedies; money was raised—the King

also. Stein immediately thereafter was dismissed in disgrace, as are all such as tell the truth above a whisper.

But before this happened Stein had given to Prussia and the world a forest system which has not only enriched enormously the State primarily inter-

ested but has strengthened her very much for war purposes.

When Baron Stein sought to raise money for the King he looked about for something that he could pledge by way of security—he looked hopelessly until he came to the wilderness of forests lying between Hanover and the Russian border. These were of indefinite capacity and had been hitherto conducted in the reckless manner characteristic of latter-day forestation in this country. The wood was at the mercy of government officials who received salaries from the public purse but were of little more value than the so-called Fire Wardens of our New York State townships.

In parenthesis let me say that not long ago we had a fire on the eastern slopes of the Catskills that destroyed several hundred acres of valuable woods all within a few miles of farms and villages. The town supervisor knew nothing about the fire when I called him on the telephone—after the fire had been burning three days. Many farmers declined to come out and fight the flames because they had not been summoned to do so by the Supervisor who is also Fire Warden under the State law. Fortunately after five days, and without the assistance of the nominal Fire Warden, this fire was subdued, but only after serious injury to dozens of woodlots in this section.

The Prussian forests of 1806 were not quite so wastefully managed as are ours of 1914, but still left much to be desired from the standpoint of so thorough a man as Stein. He at once organized the schools which are today models for the world and in which the great army of Foresters and Game Keepers are trained for their high calling. And it is indeed a high calling, for it is not merely that of logging and fighting fires—serious as is that part of a forester's duties. The Herr Forester of Germany is the peer of any man in culture and social position, for his education has been long and thorough before he has been allowed to control so vital a part of the state as the forest! He must be not only familiar with the trees as a lumberman, he must also be a botanist, entomologist, zoologist, min-

erologist—indeed must be an all round student of what can injure or help a tree in every season.

For more than forty years I have been an almost annual tramp in the forest-clad mountains of Germany and Austria; sometimes diversified by canoe cruises through sylvan wildernesses no less carefully guarded by the highest human forethought.

As an American, the first thing to captivate my eye and understanding was the care taken to prevent fire. Every forest is divided into small squares with a clean broad lane on each side. Thus a forester can look for miles down these pine tree canyons and quickly note a fire—or a poacher. Moreover, so carefully are the forests mapped that by preconcerted signals the other foresters can be called to the exact spot without loss of time.

If the reader has ever had one experience in tramping through an American forest like those of the Adirondacks thirty years ago he will know what it means to have clean broad lanes at regular intervals instead of a tangle of fallen logs, brambles, wild grape vines and tough bushes.

The German forest is clean under foot; whereas with us the farmer who has cut some telephone poles or railway ties leaves the branches to feed the next fire which may be started by a careless match.

Baron Stein soon faced the King's creditors with something tangible—a scheme for treating all the Royal forests as part of the national treasure. The King made over this formerly private prerogative to the State and the State in turn now borrowed money from Holland on this security alone; I had almost said on that of Stein! It reads strangely today, yet our own history tells us of times when a private citizen had to endorse the notes of the United States before they could produce cash!

You will pardon me for not burdening this article with statistical figures—those interested can easily supply this deficiency and myself am eager to leave my desk and start once more for the woods—my most congenial sanctum.

But before closing let me record the conclusions to which a long life has

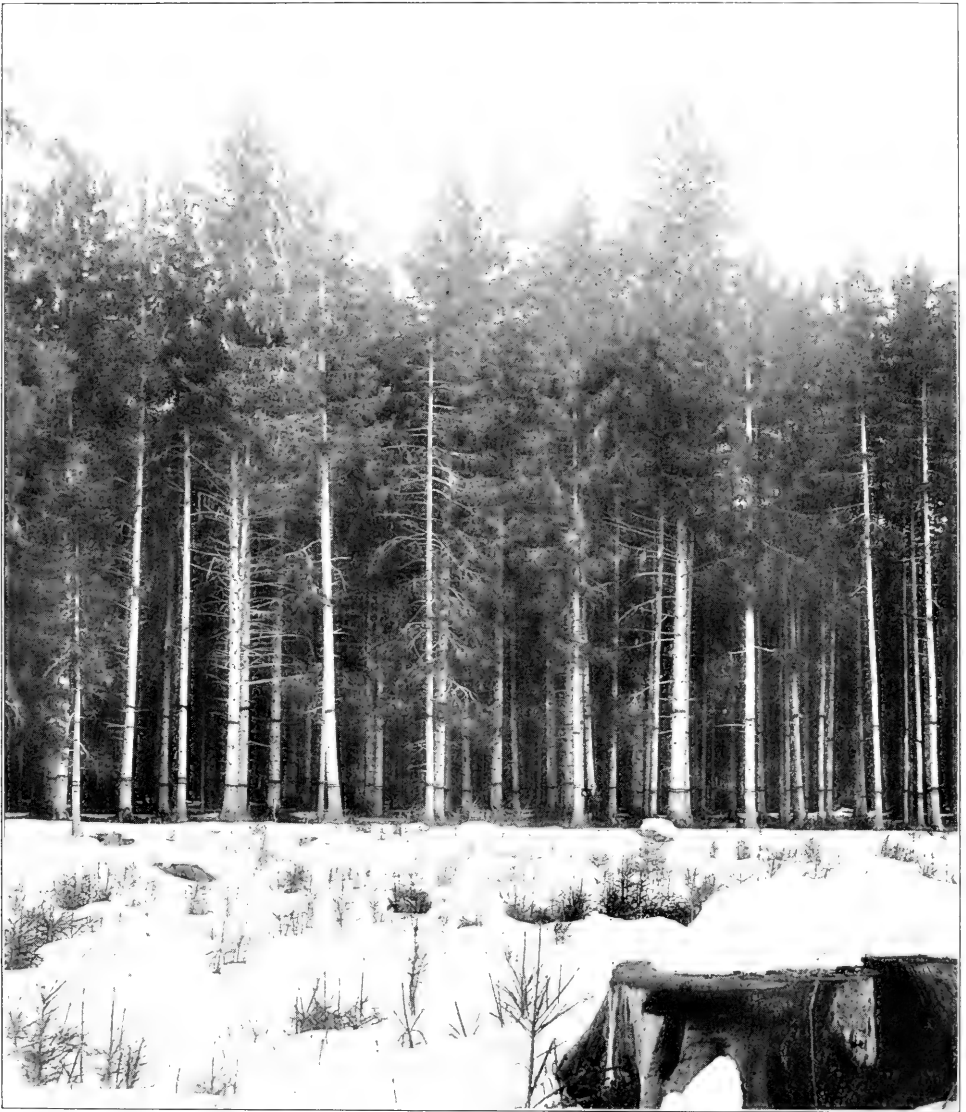

A STAND OF SPRUCE IN BAVARIA, GERMANY

brought me. The United States should treat our forests of every kind as a National Concern—not a private matter. Even the States are individually incompetent on account of the forests being frequently at the boundaries.

The normal value of wood lot land in the settled portions of the country is barbarously low in price because the farmer can have no protection from fires and not very much from depredation of other kinds. Today I am forced to cut down all my chestnuts because of a

blight which could never have done so much harm had a German Forest Administration existed.

We need National control of every patch of woods in this country and this control should be wholly free from political influence.

As a farmer I welcome such control, for I know that in Germany—after a test of more than 100 years—the individual German forest owner would no more revert to the crude methods of pre-Napoleonic times than would we

abolish National control of our navigable streams.

Maybe you will smile when I say that in spite of the immense increase in German population and the consequent increase in farm values, Germany today has more wealth in her forests and a more abundant supply of game than at any time since the days of Stein!

Today you can shoot more and better game in any part of Germany than in the most favored wildernesses of this country merely because the game laws in Germany are honestly administered whereas in New York State (at least) they are something of a popular joke.

Socialism does not frighten Germans as it does us, because Germans trust their rulers—and especially is this true in the matter of forest. The State can afford to wait half a century for a new tree and thus to spend millions in reclaiming land for forest purposes—but few farmers can let their capital

lie so long idle—and exposed to so many risks.

The German State feels responsible for the water-sheds, and acts on the principle that people who have good water to drink have scant excuse for quenching their thirst by other means. In New York State we have annual epidemics of typhoid in many of our country towns because the government has no adequate control of the water-sheds and our people drink more than they should from streams that flow through back yards where the latrine is a conspicuous ornament.

Germany does what private owners can rarely do—control the streams and forests in the interest of navigation no less than fish supply. In this State we have poisoned the noble Hudson no less than every other stream by permitting private owners first to cut off their timber without providing for reforestation; secondly by allowing sewers and factory waste to do their worst.

WAR NOTES FROM FRENCH FORESTS

[The following notes from "Revue des Eaux et Forêts, translated by Mrs. L. van Raucke from the January issue of that French forestry periodical are decidedly interesting—EDITOR.]

THE semesters of 1913-1914 of the National Forest School of Nancy, whose regular term in 1913 had been shortened, due to the fact that the military law of August 7, 1913, went into effect, had just closed at the moment when war was declared. Most of the higher officials of the school and experiment station immediately went into service as heads of battalions in the territorial army, while the adjutants and scouts were mobilized into the units of forest chasseurs.

"All the students have been incorporated into the active fighting troops and, as we hear from the lists published, many among them have already fallen as victims of the war. The Administration may well be proud of these young men, one of whom has already been decorated with the cross of the Legion of Honor.

"The school itself was converted into a hospital during the month of August; beds have been installed in the recitation rooms and gymnasium and even (for the summer only) in the storerooms. The lecture amphitheater No. 2 has been transformed into a linen room. The cabinet of one of the professors is used for dressing wounds. The students' dormitories are reserved as a rule for the officers and non-commissioned officers. Naturally, the garden is at every one's disposal. This temporary hospital constitutes an annex of one established in the neighborhood at the Jeanne d'Arc Lyceum, and forms a part of the sanitary stations established by the women of France.

"The soldiers who are slightly wounded, whose number has sometimes exceeded 150 men, officers who are ill, and convalescent privates have occupied the hospital and all have seemed to

carry away a grateful remembrance of their sojourn here. The school museum has been often visited and has been of much interest to troops of different nationalities who have been collected at the hospital and who at some later period may be able in their own countries to tell of the Forest School at Nancy.

"The school buildings fortunately were not damaged by the shells and bombardment of the night of September 9, nor by the bombs thrown by German aeroplanes September 4, October 13, and the latter part of December, 1914.

"All promotions of foresters have been suspended during the war. The promotions planned for 1914 will be valid for the year 1915, if hostilities cease."

* * *

A report of the army staff (Bureau No. 4) dated December 11, 1914, proposed the creation of a military commission of forests, similar to the military commission of navigation, with equal powers, for supplying wood to the army, and the following Decree was issued:

Article 1. A military forest commission is created to act in connection with the general staff of the army, under the same conditions as the military commission of navigation, with the additional duties of preparing by all means available the wood supplies of

the army. (Names of members of this commission are given.)

* * *

A decree forbidding the exportation of walnut timber declares that after December 4, 1914, the exportation, reexportation from warehouses, supplies in course of transit, or transhipment of walnut timber, round, square, or sawed, is prohibited. Exceptions to this decree may be accorded under conditions determined by the Minister of Finances.

* * *

An officer in an infantry battalion writes from the forest: "We have been on the frontier for two months and make reconnoiters every day in the dense forests which surround X. . . ., in order to surprise the patrols of the enemy, or to make sudden attacks which are often successful. The forest guards familiar with the country would make very useful guides in these forests which we generally traverse at night. Unfortunately, they have all been mobilized." It may well be asked, if it would not be better, instead of grouping the forest guards in companies which are not of very great assistance in the National defense, to place a certain number at the disposal of any regiments who are fighting near the district in which their duties lie in time of peace. They could render important service here in guiding troops on their night marches, organizing ambuscades, etc.

Meeting at Panama-Pacific Exposition.

Each member of the American Forestry Association is invited by the Board of Directors to attend the meeting of the Association at the Panama-Pacific Exposition at San Francisco on Wednesday, October 20.

The whole week of October 18 will be devoted to forestry, fire protection and lumbering and the allied subjects will attract, it is expected, a very large attendance.

The Society of American Foresters will meet on Monday, October 18; the Western Forestry and Conservation Association on Tuesday, October 19; the American Forestry Association on Wednesday, October 20; the Pacific Logging Congress on Thursday, October 21; and the two following days will be spent in visiting lumber camps in the magnificent red woods.

FLUSHING'S OLDEST TREE

By EVERETT P. MARTIN

FLUSHING, Long Island, is noted for its trees. The soil and climate are such that a great variety of trees and shrubs will grow there. One of the largest Cedar

of Lebanon in the country, 13 feet in circumference, 7 feet from the ground, 62 feet high, 75 feet in the spread is there. It has the largest weeping beech in the United States. An apple tree



FLUSHING'S OLDEST TREE

THIS IS A FINE WHITE OAK IN THE YARD OF ELLIS PARKER BUTLER, THE AUTHOR

160 years old, still bearing good apples. A cherry tree 10 feet in circumference, 5 feet from the ground, branched out like an oak, bearing yearly large crops of fine white cherries. Tulip trees that were good sized when the British soldiers camped under them. Besides these there are many other rare and beautiful specimens of trees and shrubs. But none is of more interest or more worthy of a visit than Flushing's oldest tree.

A sturdy white oak stands on a stretch of level land, that must have appealed to the early settler as an ideal claim. On this same flat, within the memory of the oldest inhabitant, there stood three other white oaks, all of the same general outline; large low trees with wide spreading branches. The oldest oak is 17 feet in circumference, 5 feet from the ground; 18 inches above the ground it is 19 feet around. Its spread is 90 feet. One branch is 53 feet 6 inches long, while the tree is only 54 feet high. Professor Asa Gray, the botanist, estimated that the last

surviving mate to the old oak, which stood on Parsons Avenue until 1895, was 600 years old, and this is probably as old.

It must have been a large tree probably two and one-half feet or more in diameter when the first white man saw it. When allowance is made for the curf in chopping, the butt cut would be two short even for a fence post. It was at that time as it is today practically good for nothing but fire-wood and that could be obtained more easily than by chopping down such a tree, and it is barely possible that its various owners, like the present one, Mr. Ellis Parker Butler, may have admired the tree.

The old monarch still stands in Mr. Butler's backyard on State Street. The good fortune that has been with it all these years has placed it where it does not interfere with electric wires and sewers, and gas pipes do not interfere with it. Barring accidents it ought to live for many years to come.

TEXAS FORESTRY LAW

TEXAS has awakened to a realization of the needs of protecting its forests and the legislature which recently adjourned passed a state forestry bill which the Governor signed. It has now become a law. The bill provides for the appointment of a State Board of Forestry of seven members, the Governor, Commissioner of the General Land Office, Commissioner of Agriculture, president of the University of Texas, president of the Agricultural and Mechanical College of Texas, and two citizens, to be chosen, so the bill expresses it "with reference to their knowledge of, and interest in, the planting and cultivation of trees in prairie regions, the preservation of natural forests, the foresting of denuded land, and the protection of stream flow."

The Board is to formulate plans for carrying on practical forestry, and to supervise all matters of forest policy.

A state forester with a maximum salary of \$3,000 a year is to be appointed by the Board of Directors of the Agricultural and Mechanical College.

The bill carried an appropriation of \$20,000, which was cut in half. The expectation is, however, that when it is seen from practical work just how important to the State is a forestry law, succeeding legislatures will provide ample revenue for the department.

The new law permits the Governor to accept for the State gifts of land for forest reserves and provides for purchases of similar lands; it also permits cooperation with the Government under the so-called Weeks law in the protection of the forests from fire.

The American Forestry Association did what it could to arouse sentiment throughout the State in favor of the passage of a forestry bill. A State Forestry Association was formed and did active work for it and the broadminded lumber-

men of the State also gave their aid. J. Girvin Peters of the United States Forest Service also visited Texas and reviewed the situation for the members of the legislature.

The passage of the bill has met with hearty approval throughout the entire State, for it is apparent that in about thirty years southern yellow pine in Texas will have practically ceased to be an important commercial resource, unless the cut over forest lands, valuable

chiefly for the growing of timber, are protected from fire and unrestricted grazing and managed in a way to insure continuous production. The importance to the State of the law cannot be over estimated. The next forward step in this direction which the State should make is to revise its method of taxing timber land to provide for the payment of taxes on such land under a system which will encourage private owners to grow timber as a crop.

WOODLOT IMPROVEMENT

EVERY farmer needs fuel; every farmer needs fertilizer; and every farm woodlot needs improvement. Why not kill all three birds with one stone? By judiciously planned thinnings the condition of the woodlot can be greatly improved; the material removed in the thinnings can be burned as firewood and the wood ashes left are so rich in potash as to make a valuable fertilizer.

The woodlot is, perhaps, the only farm crop to which the farmer has not considered it necessary to devote any care. His grains are sowed on carefully prepared soil; his vegetables are cultivated, and his fruit trees are pruned and sprayed; his forest trees alone are left to look out for themselves. This is the more remarkable when it is taken into consideration that any labor expended on the woodlot not only improves the final crop, but ordinarily pays for itself as well. No detailed technical knowledge is required for the work, all that is necessary is the exercise of common sense.

It is obvious that the trees in any woodlot are not all of equal value. Some are taller, straighter, thriftier, and of species which yield more valuable wood than others. It is also obvious that there is a constant struggle going on between the trees for light and growing space. The object of thinning is simply to give the best trees the advan-

tage in this struggle by removing the poorer ones which interfere with their development.

First of all defective trees should be removed. This includes trees attacked by insects or fungi (conks), trees with fire-scarred butts, with tops broken off by wind or lightning, and in general all trees which are unthrifty from any cause. Next come the trees of poor form, such as very crooked or very branchy ones, which are interfering with the growth of better formed neighbors. And finally are the trees of less valuable species, such as dogwood, ironwood, and hornbeam. These not only take up space that might better be occupied by such species as oak, hickory, and ash, but also, as a rule, produce seed more abundantly and so reproduce themselves at the expense of more desirable trees.

While the wood removed in these thinnings is frequently of no value for other purposes, it can practically always be used to advantage for fuel. In this way the work can be made to pay for itself, particularly when the future use of the wood ashes for fertilizer is borne in mind. The essential point to remember in making such thinnings is that the woodlot is a tree society, in which the best trees should be given every chance to attain the greatest possible development by the removal and utilization of the unfit.



THE SPANISH OAK.

THESE WILL BE FOUND FROM SOUTHERN NEW JERSEY TO FLORIDA AND THROUGH THE MIDDLE AND GULF STATES.

TREE FRUITS AND FLOWERS

By WARREN H. MILLER, M. F.

I COUNT it as one of the privileges of my life in the forest of Interlaken to have the joy of witnessing, each year, the grand process of the forest regeneration. For, there is something majestic, imperial, in the onward sweep of a whole forest of trees, from the first leaf buds of April, through the beautiful flowering period of May and June, through the full glory of ripening in July and August, to the gorgeous days of October when the ripe harvest falls in countless millions of nuts and seeds, Nature's one and eternal answer to the problem of the world's continuance. It is all on so grand a scale; comparable only to the mighty march of the constellations overhead, and, to live in it, and be in it and of it, is one of the delights of a forest dweller.

For they are all about me, thirty-seven species of American native trees, in countless individuals of their kind, and, each year, with the coming of the

first bluebirds and robins, I look for those red splotches in the forest that tell of the blossoms of the red maple, filling every vagrant zephyr of the spring air with their heavenly perfume; I look for the stream banks, yellow with the catkins of the black willows; the moist ravines white with the tender flowerets of the shad-bush, and, once in a while I encounter the pale maroon blooms of the burning bush and the Judas tree telling of a thicket containing these trees.

Then comes the great Twelfth of May, when the leaves are fully out, and with them the flowerets of the oaks, ashes, hickories, walnuts and gums, while the pink and white blossoms of the wild crab, wild plum, and cherry make every brook-side a flower paradise; and then, crowning glory of May, all through the forest the huge white bouquets of the flowering dogwood give to sweet Nature her ample bridal veil.

Then comes June, the period of reproduction, redolent with the odors of tulip tree, eastern cherry, linden and mountain ash; when the bees are busy and all nature is bathed in a mist of pollen, the inauguration of the busy ripening period to follow. Finally, the golden days of September and October, when the rich harvest of brown acorns, scarlet blue and purple berries, full-

just trees, and a lasting enthusiasm for their study, the tree fruits and flowers will furnish an inexhaustible storehouse of information and pleasure. There comes a time when all the wild flowers that do dwell in the forest are well known, familiar, less interesting because so well known; and then it is to the trees themselves that the forest lover will turn for further fields of exploration.

For, I hold that the tree flowers are more interesting than the prettiest plant flower that carpets the forest floor. Things are done on a much grander scale up there aloft in the tree crowns. In most cases Nature has found it necessary to divide the tree flowers in half, putting the stamens or pollen-producing element into one flower and the pistil or seed-producer into another, a rather incomprehensible phenomenon to the flower lover, who is used to the complete flower containing in itself both stamens and pistil, such as is found on most plants. But the plant has swarms of bees, flies and insects to transfer pollen from one flower to the next, so it need not bear a self-fertilizing flower, whereas in whole families of trees the individuals, by division of their own



THE CATALPA.

THIS TREE IS A WONDERFUL BLOOMER, BEING COVERED ANNUALLY LATE IN JUNE WITH A PERFECT SHEET OF FLOWERS NEARLY WHITE AND TINGED WITH PURPLE.

blown catkins and bursting cones gives to the world the sumptuous yield of Nature's labors; when the year's work is done and every living creature hunts and is hunted; when all the denizens of the forest are full to repletion with its bounty and are storing its rewards for the winter to come—the glorious Hunter's Moon; the season of happiness and thanksgiving since the beginning of the modern world.

To the lay mind but few trees outside of the dogwood and one or two others have any flowers at all, yet, if they only knew, what a field for enjoyable study and investigation lies right before their eyes! For the man who does not pretend to be a forester, but rather a forest lover, having an abiding love for

flowers, are able to set seed without requiring the pollen of another individual of the same species growing near it. This applies to all the oaks, hickories, willows, maples, walnuts; in general to all the tree flowers that do not depend upon flower display or fragrance to attract bees.

Let us examine together the flowers and fruits of some of our more common forest trees and see if they are not as interesting as any wild-flower that ever bloomed. We might divide them roughly into, the useful trees; the ones with handsome, showy flowers; and the conifers. May is the great month for tree flowers; set aside your study dates for going into the forest in that month, or you will be too late to see the great

majority of tree flowers. Leave June for the "wild-flowers," so called. Early in April all the maples will be in bloom, the flowers coming out and setting fruit before the leaves. If there is a red maple anywhere about, your nose will tell you of that fact. A wonderful perfume will be wafted through the forest; look for a dark red blotch in the tree tops; it is the crown of a flowering red maple. The flowers are small, red with yellow stamens, a pretty enough branch for house decoration anywhere. The sterile flowers are the most showy, the fertile ones being broader, with thin red calyx. All the other maples except the mountain maple flower early; our two old friends, the rock maple and silver maple, having small greenish-yellow flowers, much of the shape of the red maple ones. The latter and the silver maple set fruit early and by mid-May the pink samaras will come whirling down, so that the crop of young trees for that year will already be well under way by fall. The rock maple keys, on the contrary, do not come down until late fall.

Looking further for tree flowers in early spring, we would visit the stream banks on the lookout for the gray catkins of the pussy willow, often out in late March, and for the yellow pendants of the black willow. These are compound flowers, the despair of the museum flower preparation men, for each catkin consists of dozens of tiny flowerets, each complete in itself, and its interstices are well filled with silky hairs whose function appear to be to protect the pollen from being all blown away at once by the too-vigorous winds of early spring.

In the middle west, where the Judas tree is common, its early spring tree flower greets us while yet the violets have hardly opened out. It is a slender tree growing in the thickets and is profusely ornamented with the pale,

pink-maroon blossoms, reminding one somewhat of the bleeding heart of the home garden. Occasionally this tree is met in the East, so one should not despair of finding a specimen during the early spring rambles.

Carrying us on into great May is the service-berry bush, coming out late in April, and conspicuous with its sprays



THE CHESTNUT.

THERE IS NO MISTAKING THIS BLOSSOM WHICH IS TO BE SEEN LATE IN JUNE OR EARLY IN JULY.

of white blossoms, fragrant and beautiful. It fruits in June and July, yielding a reddish-purple sweet berry, and if there is any better jam than the "service berry" as made by the mountain men and backwoodsmen I have yet to taste it!

But now comes the glorious month of May, when the forest is loaded with flowers and one hardly knows where to turn first in describing them all. Most conspicuous of all is the flowering-dogwood, with its immense white-petalled

flowers, each with a purple spot at the base, the stamens forming a sort of green daisy center. In the fall both its leaves and its fruit are beautiful, the berries being brilliant scarlet in star-shaped clusters, and the leaves deep reds and purples. Its close cousin, the green osier or blue dogwood, also wants looking up in May, because, while its little yellowish-white racemes of flowerets do not come out until June, the leaves in May are highly ornamental,

They are much in evidence during that period when the leaves as yet are but scraggly ragged bunches of vegetation, just opening out from the winter buds. Most interesting of all are the future acorns, the fertile flowers, in general, for all the oaks, little scaly cups, with two or more reddish, hornshaped petals peeping out. Down in the center of these is the ovary, which will grow to an acorn when fertilized by the pollen from the sterile catkins growing in the

same tree, and the scaly cup later becomes the cup of the acorn. Nature is taking no chances with such an important tree as the oak, and any one of them can reproduce itself without any other individual of the species growing near it. Some of the acorns will not mature until the second season after setting, notably those of the white, black, pin, scrub and scarlet oaks; while the red, chestnut, swamp, white, and overcup oaks mature their acorns the first year. In all the species the acorns come down early enough in September to sprout a good many of them, while the rest hold over on the ground through the winter if not eaten and start early in the following spring. The bountiful crop of acorns formed one of the principal sources of flour for the eastern Indians; such acorns as those of the white oak requiring only boiling and leaching to equal the chestnut in flavor, and those with more tannin in them, such as the red, required



THE WHITE OAK.

THE PALE WHITE AND PINK LEAVES OF THE WHITE OAK ARE TO BE SEEN EARLY IN MAY.

being a pale white with purple spots. Look for it along stream banks and forest swamp borders.

And, early in May, do not fail to note the young leaves of the oaks, particularly the pale white-and-pink leaves of the white oak, truly as beautiful as any flower. At the same time examine the sterile and fertile flowers of all the oaks. The sterile ones are long, knotty, yellow-green pendants, reddish in the case of the black and scrub oaks.

drying, pulverizing and leaching through thin buckskin until the water running out no longer held a yellowish tinge. The flour was mixed in a batter, and paper bread made of it by spreading on a thin stone over the fire, the result being a crisp crust, like modern breakfast foods.

Most delicate and beautiful of the May tree flowers are those of the apple family. Look in some moist dell, tinkling with the fall of a tiny brook, for

the small bush of the wild crab, covered thick with the pink-white blossoms so like our own orchard blooms as to cause one to wonder if a stray apple seed has not fallen there. Its close cousin, the wild plum, has very much the same fragrant pinkish blossom, but it is to be looked for in a different location, preferably sandy soil, either dry or moist, it does not seem to matter to the wild plum; I have found it in the sand dune barrens of Barnegat and bordering salt marsh swamps along the seacoast with equal impartiality. Its fruit is a small red plum, rather resinous in taste, and apt to make one sick if indulged in too freely. The Indians dried these plums in quantities for winter fruit supply. What with the tree fruits—berries and nuts—to say nothing of edible plants such as the wild bean and the Indian potato, the Woodland Indians never lacked for plenty to substantiate their meat fare.

Among the nuts, both the hickories and the walnuts are out in May. In all the hickory species look for long trailing catkins, yellowish-green in all species but the mockernut which has reddish stamens. These constitute the sterile flowers, while the fertile ones are small embryo nut shells with no corolla or primitive petal at all. The walnuts make a better showing, with their sterile flowers long green strings of little knotty flowrets having purple anthers, while the fertile flower is a green, tubular forerunner of the nut, with two long, deep-pink lobes of corolla protruding. These are really the stigmas, or that part of the pistil which receives the pollen from the sterile flowers. The white walnut, or butternut, has even a prettier display, with deep rose stigmas on the fertile flowers and long, brown, drooping catkins for the sterile flowers.

A most handsome tree flower, coming out in late May, is the catalpa or Indian bean. Native to the central West, straggling specimens, either accidental plantings or stragglers from the van-



Photo by American Museum of Natural History.

THE WILD CRAB.

LOOK IN SOME MOIST DELL, TINKLING WITH THE FALL OF A TINY BROOK, FOR THE FRAGRANT BLOSSOMS OF THE WILD CRAB.

guard, are encountered here and there in the eastern woods. The flowers are abundant all over the tree, in big showy clusters, compound pyramids of forty or fifty bell-shaped white flowers with yellowish centers plentifully sprinkled

with small purple spots. Not a particularly pleasing odor, but a showy white display to view in the green forest.

Interesting because of its remote antiquity as the friend of man, is the ash family. Without ash spears and bows, ash arrows, tool handles, paddles and snowshoe rims, we would have been a long time fighting our way up from the level of the beasts. The history of the tree reeks with human gore, and more than one remote ancestor of our race has worshipped it as the tree which upheld the earth—which it *did* so far



THE LOCUST.

THESE BLOOM IN PROFUSION AND ARE A MOST ATTRACTIVE FLOWER.

as he was concerned! All the ash varieties flower in May, and all have deep blood-red bunches of flowerets, like blobs of blood, scattered along the branches. The fertile and sterile flowerets are not greatly different, the former having a long red stigma which superposes the ovary, and later gives way to the samara or key, similar to the maple key, but long and thin like a javelin. These keys ripen in the fall and persist until midwinter when the violent gales, sweeping through the bare trees,

tear them from the stems and drive them headlong through the forest, and thus Nature accomplishes the wide dissemination of the ash, for the tree uses so heavily of the soil that a grove of them would be an impossibility. Wolf of the forest though it is, and cousin of the peaceful olive though it is, give me one naughty, gory ash tree for all the olives in the world!

Another large family of trees flowering in May is the birch tribe. Not much to look at, but oh! what a debt mankind owes to the birch! so we will just give the green catkins of the family a look for curiosity's sake. Sterile and fertile, as is Nature's way with important trees; the sterile ones being showy catkins with tiny flowerets imbedded in a fuzz of green filaments, the fertile flowers, short stumpy catkins, made up of sheaves of what are later to be the wings of the tiny birch seeds. These will turn brown in autumn, the flower "blows," and the winged seeds fly far and wide on the October breezes.

Last of the May flowers to be examined, though many a lesser species must be passed by for lack of space, are the two gums and the beech tree. Liquidambar, the sweet gum, has a most peculiar flower, a sort of conglomerate of seed sacks, which starts in the early spring as a small, green, fuzzy button on a stem, and grows to a green, prickly sphere a little smaller than a golf ball. The sterile flower is an erect, compound bunch of flowerets which perish soon after the work of pollenization is done. Not so the other, which turns red-purple and then brown in the fall, and is finally blown off in the winter, so that any large clump of sweet gums is sure to have a grove of little ones surrounding it, the preponderance of them lying to the northeast because of the prevailing southwest breezes of autumn.

The tupelo, or sour gum, has an insignificant green flower scheme which

later develops into two green seeds on a long stem. These ripen to blue-black berries, sour in taste, but a tremendous delight to all song birds, for whom alone, not to speak of the

complete, puts forth in May huge quantities of little button balls of compound flowerets which are its sterile flowers; while, tucked in close to the twigs, are odd little growths resembling tiny green barnacles with a pair of tentacles extended. These grow into green burrs, turning brown in autumn, and bursting open to discharge two three-cornered seeds, sweet and edible, which are the beech nut, beloved of all forest dwellers.

Going over into June, the flower show in the forest is about over; but still perfumes greet your nostrils, and you may come upon the big showy yellow-and-red blooms of the tulip tree, whole clusters of tulips dotting the immense wall of the tree like Christmas candles. The simile is further carried out when the fruit develops, for each one is a tight green sheath of upright conical shape, composed of numerous winged seeds compactly assembled. These open and scatter in the fall,—a tiny seed, forsooth, for such a mighty giant of the forest as the liriiodendron.

When casting for black bass among the lily-pads in June, should your nostrils be assailed by a most heavenly perfume floating out over the water, look along the banks for a flowering wild cherry, of the black or choke like variety. It will be covered with the white spikes of compound cherry blossoms, fragrant, giving off billows of perfume and calling all the bees for miles around. I know of no sweeter odor in the forest, and, furthermore, have not the least objection to



Photo by American Museum of Natural History.

THE DOGWOOD.

ONE OF THE MOST CONSPICUOUS OF ALL THE FLOWERING TREES WHEN IN BLOOM IS THE DOGWOOD.

gorgeous coloration of the tupelo's autumn leaves, I will go to considerable pains to spare every sour gum on my place whose room is not urgently wanted.

The great beech, without which and plenty of him no eastern forest is

eating all I can reach of the red-dish-black cherries when they ripen in September. The wild red cherry, which behaves much as our cultivated varieties, with similar flower and fruit, budding in May and ripening fruit early in July, is sweeter but by no means as

abundant or as widely distributed as the black cherry.

Two old friends which flower in June are the holly and persimmon. The former bears small white blossoms, soon setting fruit and developing a green berry which turns the characteristic

sheen, it is good to look at in the fall, but not to eat until late in November when the frost has had a chance to mellow it. By that time the persimmon is almost black in color and is delicious in flavor. One of the delights of 'coonin'g of a moonlit night is not only the following hounds and the excitement of the chase but the fine harvest of persimmons certain to be gathered in any good 'coon country.

A final tree flowering in June is the mountain ash, occurring along river banks, swamp edges and mountain ravines all over the East and as far West as Minnesota. Its blossom is a large flat umbrella of white flowers, perfect, each one setting fruit to a berry which turns bright red and stays on until winter; a most ornamental little tree, a pleasure to meet in any forest any time from June until December.

Turning to the evergreens, you would be surprised to learn how beautiful and interesting are their flowers. I have lots of them, of many species about me in Interlaken, and never fail to watch them all closely during the flowering period. The pines flower late in May and early in June, the pitch pine leading off with handsome brushes of sterile flowers and spikes with lavender trimmings, which later develop into cones. The white pine puts out three or four brown pencils at each terminal bud which grow into the sterile flowers, while the embryo cones show soft pink-edged scales. When these are

young, with green scales and pink edges, they are as pretty an object as grows in the woods. The two cedars, white and red, start flowering early in May, the white being covered with little purple flowerets which develop into reddish-brown cones, and the red cedar with purple-red flowers replaced later with the characteristic blue berry,



Photo by American Museum of Natural History.

THE WILD PLUM.

THESE ARE CHARMING WHITE BLOSSOMS READILY DISTINGUISHED.

glossy scarlet late in the fall, and is, alas! too much sought after around Christmas time. The persimmon blossoms are yellow, both sterile and fertile, shaped like tiny urns. The fertile flowers are the solitary ones. The fruit is well known to every country boy who ever roamed the woods. Translucent orange in color, with a purplish

whitish underneath. The balsams, with their purple young cones and the yellow-red anthers of the sterile flowers, are always a welcome study in late April; and the hemlocks, flowering about the same time, with the crimson scales of the fertile flowers abundant all over the tree, make gay the springtime sunshine. The spruce tribe are out in May; in general, the flower scheme borders on purple for all the species; the red spruce shows reddish-purple sterile flowers with the scales of the fertile future cones a rose-purple. With the blue spruce, the same flower is a dark blue, tinged



THE BLACK CHERRY.

THIS WILL BE MOSTLY FOUND IN THE EASTERN HALF OF THE UNITED STATES. IT IS ALSO KNOWN AS THE WILD CHERRY.

Photo by American Museum of Natural History.

THE BLACK WALNUT.

THE FERTILE FLOWER IS A GREEN TUBULAR FORERUNNER OF THE NUT WITH TWO LONG DEEP PINK LOBES OF COROLLA PROTRUDING.



with purple; and in the white spruce the sterile flowers display red anthers, with pale red scales for the cone of the fertile flower.

The great extent and variety of the flowers of the deciduous species is apt to make one give one's whole available time to their study, but do not neglect a visit to the cool ravines where the hemlock blooms in early spring, and to the warm sunny hillsides where you will surely find the pines and the red cedar. If there are any evergreens about your place, find time in the spring to get acquainted with their flowers. It will be a memory worth treasuring.



MR. JOSEPH N. TEAL, PORTLAND, OREGON
A VICE PRESIDENT OF THE AMERICAN FORESTRY ASSOCIATION

The instant question of forest conservation and the one pressing for solution is that of *use*. That forests must be protected from destruction of all kinds, that a vast public interest is to be conserved by their protection is now generally accepted. Attention must now be directed to encouraging and securing the greatest possible *use* of this vast national resource. Governmental agencies should from now on exercise the same zeal in securing the distribution of the manufactured product as they have shown in the past in protecting the tree. Only through *use* will results be accomplished. If this great national asset is to be realized on, if it is to serve its purpose, foreign and domestic markets must be opened up on a basis that will place one of the greatest of our industries on a sound foundation. The commercial and industrial side of the question is as important as that of protecting the forest from physical harm. In other words, *use of the product* is a most important part of its conservation, and without use it is difficult to see the necessity for wasting time or money in protection. Make the forests of value and they will be taken care of. Without this incentive there is little inducement for their preservation. It has been said truthfully forest conservation is now 90 per cent salesmanship and 10 per cent forestry.

JOSEPH N. TEAL,
Vice President, American Forestry Association.



DR. B. E. FERNOW
DEAN OF THE FACULTY OF FORESTRY, UNIVERSITY OF TORONTO, AND VICE
PRESIDENT AMERICAN FORESTRY ASSOCIATION

For more than a third of a century it has been my privilege to be more or less directly engaged in advancing the movement for a more rational use of the forest resources in the United States and Canada,—this time covering pretty nearly the whole period from the beginning of such efforts on this continent. It is a long time, and, contemplating the output of energy by a continually growing number of persons on behalf of this reform, one might be apt to feel discouraged at what has been accomplished. Hasten slowly has certainly been the experience!

The reason is that under our democratic institutions education of the people at large is first needful before any action can be taken; and such education sinks through only slowly.

Forestry is a business for the long run, and hence not very interesting to private endeavor: it is *State business*. The idea that a State may properly engage in business has only slowly and lately come to be realized in the United States. It was, therefore, a great triumph when we succeeded in persuading the Federal Government to change its land policy, namely of disposing of the public domain, and to create permanent forest reservations. It was a great accomplishment to have these National Forests placed under a competent technical administration. It was a noteworthy victory to commit the Federal Government to the acquisition of National Forests in the Eastern States, extending its conservative influence over areas for which the States themselves were unable to care.

The most strenuous effort of the reformers should now be expended in persuading State after State that State-managed forests are a necessity, for, in my opinion, private forestry on a large scale, such as is needed, will, except under special conditions, for the present prove economically uninviting.

B. E. FERNOW, LL. D.
Vice President, American Forestry Association.

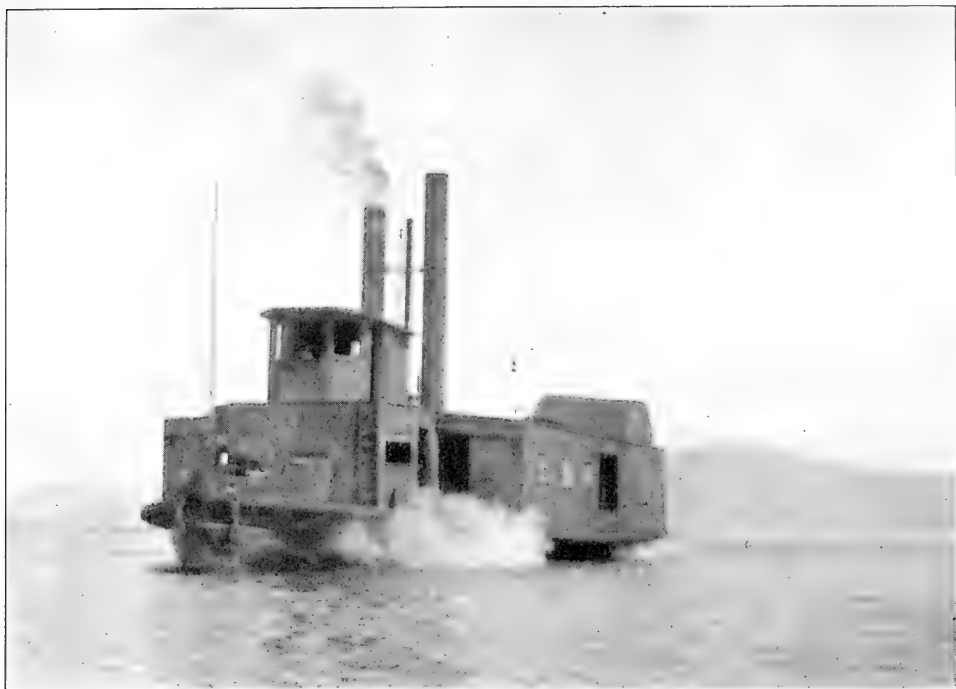

THE POWERFUL TOW BOAT USED IN THE OPERATION

LAKING

By W. R. BROWN

IT WAS the still hour just preceding dawn, a time of almost supernatural calm, broken only by the intermittent puff-puff of our smoke stacks, alternating with the chug-chug of paddle blades as they churned the water. A few clear stars reflected into the infinite lake that stretched mirror like to the shadowy shores, and at the stern of our great boxlike boat, lay a vast floating field of logs, at which it tugged unceasingly, and which extended, blacker than the black water to lose itself in the night. Above, a dim light in the pilot house, and below, an occasional glow from the ruddy furnaces, alone told of human vigilance. The Captain was nodding over his wheel, and the stoker had chosen this propitious moment for a comfortable doze in the warm corner of the boiler room, when somewhere in the vague distance came the sound made by the

splash of an oar, losing itself, and again becoming more and more regular and distinct.

Almost simultaneously with this definite punctuation of the night, arose the long, weird cry of the loon far up the lake, and at this peal of tremulous laughter the Captain shook himself from stupor, and with a characteristic tug at his hat, as if to assure himself of attention, went outside on the upper deck to determine the location of that mournful chuckle and read the potents of the dawn. Soon the cry of the wilderness arose again in the North, foretelling the wind that would surely come from that quarter with sunup, and, in the intenseness that followed the echo of those lonely notes, came again the regular creak of the oarlocks over the water.

As the Captain climbed down the short ladder from the pilot house into



A BATEAU

the furnace glow, we saw illuminated in half lights a man of short but stocky build, whose large square head was partially concealed by the broad brim of a felt hat pulled far down over one eye, leaving the upper features in shadow, through which sharp eyes shone with quick intelligence, and a firm square jaw framed in with the will of domination.

Over the bow, the dim outlines of a boat appeared in the mist, a line was

thrown and a friendly hand given over the side, and as the messenger climbed on deck, the emergency that had brought him many miles that night in the darkness was disclosed, as both Captain and messenger wended their way to the cook's galley for a tin of daylight coffee. It appeared that at the head of the lake where many logs were being turned out into a bagging boom at the mouth of a river, the supply of surrounding boom sticks had run



BATEAUX ON THE DRIVE

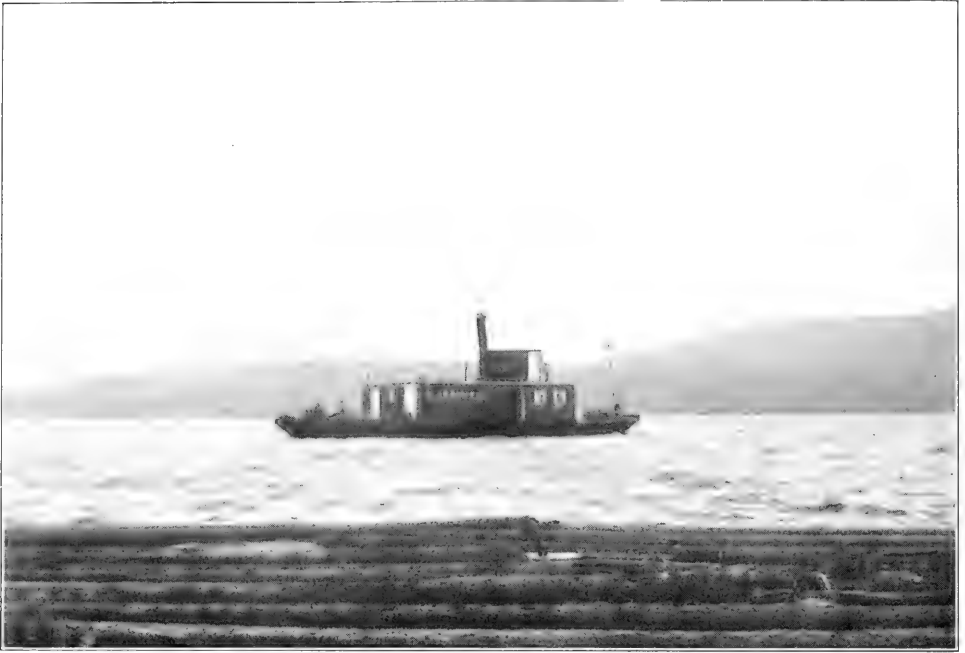

GETTING THE TOW OF LOGS ASHORE

short, and unless more were quickly brought, the rapid accumulation of logs threatened to break the boom and scatter before the wind the many thousand pieces enclosed. Such was the urgent request, and, it, coupled with the foreboding cry of the loon, determined the Captain to move quickly.

While the hungry emissary was routing out the fat cook to prepare a hasty breakfast of bacon and eggs, the Captain aroused the sleeping crew, and in a twinkling lanterns were moving about the decks and searchlights playing upon the white mists over the water. First of all the present tow of logs must be taken to the shore and securely fastened. So with much creaking, the port tow line was slipped around its post at the stern, and the great vessel pulling at the new angle slowly swung toward the shore. All was bustle; the boat's crew passed from one to another a long hitch line from the upper deck to a coil in the stern of their bateau, with cries of "snake her up;" the engineer blew steam from his engines, and the fireman furiously stirred the roaring grates. The stern

of the bateau, being now heavy with rope, and the vessel close to shore, the crew jumped into it and ran along the seats to their oars, and at the call from the bowman to "head boat" churned the water to foam, while the line unrolled into the still water, as with measured beat they disappeared from view. Quickly a few sturdy trunks were encircled with the rope by the crew, and back again swiftly the bateau glided to catch the steamboat as it swung away on its mission of rescue.

At the turning-out dam we found the required line of boom sticks resting along the shore like the far famed serpent of the sea, and, as we made fast to its drowsy head and pulled away, the long coil straightened as if alive, and spray hissed from every joint in an angry protest, as we pressed forward with every pound of steam up the lake. The speeding boom in our rear proved to be a stable path for the adventurous crew, who ran out new hitches upon it with great unconcern and jumped through the spray from one log to another.

While we watched the crew from the rear deck, there was recalled an exciting



SLICING LOGS THROUGH A DAM

incident resulting in four river drivers nearly passing in their checks. Ten sticks, held together by toggle chains, had been carefully worked around into the current above the dam by a boat's crew to be sluiced through for use below. This crew was rowing hard to straighten it, when the powerful suction at the gate seized upon the forward end, and commenced drawing the whole line through with ever increasing momentum. As it straightened out, the last log drew in upon the regular permanent side boom upon which four men were standing. Suddenly a stray branch of dead wood caught between the toggle

chains, twisted out of water and descended about knee high at lightening speed upon the men. Not a second was given for reflection; it meant death to be thrown into the whirling maelstrom that sucked through the gates. The first man saw the danger, gave a cry of warning, turned and hurdled the flying stick and came down cat-like in his place. Instinctively each of the others in succession did the same, no one losing his balance, but coming down right side up and unhurt. The next section sluiced, you may be sure, was extremely straight before it started.



BOOMING OUT AT A DAM



WINDING IN THE HEADWORKS

Our race up the lake to catch the escaping logs had been nearly completed and the Captain, to herald our coming, had wakened the slumbrous hills with a hoarse whistle, when the rising mists disclosed a sight that brought every man to the upper deck, to strain his

eyes across the waters. The blue surface was now ruffling with the rising breeze, and indistinct upon the horizon line could be seen dim specks of black rising and falling in clusters that seemed to concentrate around one point. Our rescue was too late, for the swollen



WINDING IN A BOOM BY HAND



TURNING OUT LOGS

boom pressed by the rising wind had parted the great cables link from link, and what we saw were the exultant logs, now running upon the flood spreading out fan shape in their new-found freedom.

It was a desperate emergency, and one chance alone remained, to pocket the oncoming mass in our surrounding boom, behind the nearest point of land. The Captain ran to his wheel, and with reversing engines made for the shore. The wind had grown until now, dancing white over the blue waves, the foam flew from crest to crest of long rolling billows and gathered in irregular streaks across the tumultuous water, and the oncoming logs leaped as if they were alive, and raced with the wind and their fellows down upon our slender barrier. We were not a moment too soon. With a celerity that eclipsed all their other efforts, the crew made a shore hitch of one end of our surrounding boom, around a few big trees, and the Captain threw both anchors. Strained and tense all hands gathered on deck to await the outcome, and speculate in doubtful tones the chances of our anchors holding; while in the boiler-room the stoker busily labored to feed the ravenous

furnaces, and the fat cook, indifferent to all the fortunes of war, methodically set his tables in the galley ahead for the noonday meal, for the hours had flown by unnoticed in the excitement, and the sun had risen high with the wind. The hemp hawser creaked and groaned over our stern post, and from time to time the Captain sighted across the pilot house to note any drag of the anchors. On shore the waving tops of two mighty trees showed where the strain bore heaviest, and the whole field before us churned restlessly in undulating waves.

As the irresponsible will of the elements were here opposed by the modern force of appliance and invention, a short account of the adaptation of modern methods to overcome ancient impossibilities may be of interest to the reader. For many years the older methods of winding in against an anchor by hand, on what was called headworks, had deterred all attempts to exploit the vast bodies of timber lying beyond these lakes, for time and again a heavy loss had followed upon almost inevitable disaster. The old method had been to construct a large raft called a headworks, equipped with



STARTING A BOOM OF LOGS THROUGH A DAM

a drum, spindle, rope and anchor; tow this to the length of the rope by bateau, drop the anchor and wind in the boom logs by hand. At the point where the anchor rope stretched across knee high, it was said the men, thoroughly exhausted by many hours of labor, and fast asleep between their rounds, with their breasts leaning on the reaches, would regularly step over the rope when they came around to it in unison with the rest. But when creeping from headland to headland a strong wind caught the raft away from the shore, the anchor would drag like a plow in the deep soft bottom, or the rope would part, and then back down the lake they would go and lose all the labor of the day and night. The adaptation of the tow boat, however, made successful the older methods by adding speed and power, and brought out a whole new field of experience and adventure. The lore of the pioneer of the old order of things was still most valuable. Their knowledge of conditions had been gained by a preparedness to take advantage of nature in her every mood, and to note with care the sweep of the wind from each valley,

and the protection furnished by each promontory or bay. The potents of the morning and the fulfillments of the day were their capital and long inheritance, and such lore was now reenforced by the careful weighing of figures and the scientific comparison of hulls, engines and textile strength.

Dinner had just been called by the cook in his usual drawling voice, and all hands had flocked to his long table to forget the excitement of the moment in the relish of beans and a huge bowl of custard, when a mighty lurch threw us all into a heterogeneous composite of legs, plates, fat cook and dessert. The scramble that ensued was full of flying arms and profanity, but having finally extricated ourselves and climbed to the deck, the cause of the commotion was seen. Two enormous spruce were bending slowly out over the water near the shore in response to the overpowering strain of the 2-inch hawsers which were slipping up their trunks in violent tugs, that snapped branches like pipe stems and drew tough roots from their long resting places. With a mighty lift and a last splash the far end of the boom swung clear carrying



LOGS GOING THROUGH A DAM

one of the trees with it down the shore.

"Up with the anchors and cut loose the line," shouted the Captain, now thoroughly aroused, and an ax glinted over the stern post and the hawser whipped the water like a bow string. By good luck another promontory jutted out below, the last point of contact between ourselves and the lake, and all hope now lay in our reserve sticks recovered from the mouth of the river. The anchors came up dripping black ooze, and we made for the point below. Here a diagonal line could be run outward from a jutting point, and wedge the impact of the logs against the shore itself. Not a moment's delay or the boom would be upon us,

and the Captain's orders were as vigorous as they were picturesque. Again, at the call of the boatswain, the men sprang to the oars and drove the bateau full up the shore in their eagerness and ran the lines into the woods. Anxious moments passed until the Captain saw with relief the boatswain wave his hands on the shore, and turning the wheel he rang the fast bell ahead and steered at full speed toward the oncoming mass, and swung the boat around the outer edge. Guided by the boom the moving field wedged closer and closer in on the shore, and our last try and hope hung in the balance. Slowly the logs settled in like a great ice pack, but the pressure this time was against the shore, and

as the hours passed and the wind slowly died down, we saw with growing relief our rescue had been successful although the mighty force of the on-coming logs was shown by the fringe of sticks driven high and dry upon the beach.

All the long afternoon we hung and held, and all the afternoon one by one the scattered logs drifted or were gathered in by our small convoy, until under the storm clouds the great red sun shone forth, and the warring elements in nature grew still at his completed course. Peacefully and warmly shone the last fire of the crimson West in spots of gold upon the mirrored surface between the logs, and at last the great boat let the hawser drop in the black water and made a

final circle around the logs with the boom; lanterns flitted along the shore like will-o'-the-wisps as the crew made fast, and as the last knot was tied, and the last man clambered on deck; bitterns croaked, the lone owl hooted, and the faint far away cry of the loon came over the lake. The laugh of the tired crew had a genuine ring of satisfaction in it as they assembled before the warm furnace to talk it all over and turn in, and another unrecorded incident that goes to make the character of the passing American woodsman was closed, as the stoker went back to the grateful heat of his corner in the boiler room, and the Captain muttering slowly dragged himself aloft into the cold pilot house.

GEORGIA STATE FOREST SCHOOL

THE Georgia State College of Agriculture, through its Forest School, offers a four year course in professional forestry leading to the degree of Bachelor of Science in Forestry. Forestry is introduced during the Freshman year and practical field work follows both the Freshman and Sophomore years. During the Junior and Senior years provision is made for specialization along one of half a dozen different lines of forest activity. To the man desiring city work there is offered a combination of forestry and landscape gardening, providing the preparation necessary to fill the position of city forester. In the same way provision is made for specialization in Logging Engineering, Business Administration, Dendro-pathology, Forest Management, State Forestry and Forest Research.

The Summer Camp of the Forest School is conducted as an additional term of the Freshman and Sophomore years of the forestry course. The work is of a practical nature so that the students may secure the more perfect correlation of class-room theory and the actual operations in the woods.

For the first time, it has been decided to extend the privileges of Summer

Camp to persons other than those matriculated in the University. It is the object of the School to reach and benefit in this way three other classes of nature students; first, those men who contemplate a course in forestry but prefer a summer of "woods" work in order to satisfy themselves that their decision is right; second, those teachers, and prospective teachers, of "nature study" who desire further preparation; and third, that great group of men and women who love nature and desire to learn more of her.

The State Forest School is in charge of Prof. J. B. Berry.

The forestry movement in the South has been rather slow but the fact that prominent men and women of the State are losing no opportunity to voice forestry sentiments in public is a good indication that thinking people are awaking to the dangers of deforestation. Needless to say the movement, once started, will sweep the state in the same way in which it has taken many Northern States. In fact, a movement is on foot to introduce a forestry bill at the coming session of the legislature and it is to be expected that provision will be made for machinery to enforce forest legislation.

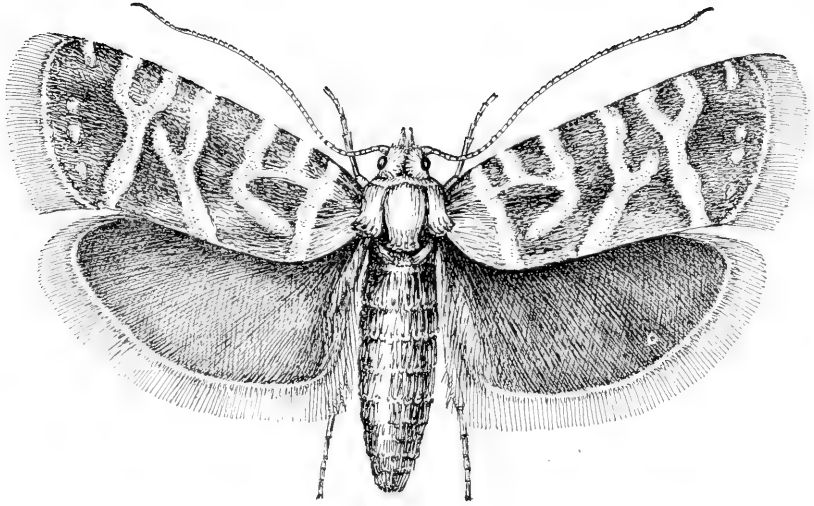

THE PINE-SHOOT MOTH—GREATLY ENLARGED

THE PINE-SHOOT MOTH

THE importation of pine trees from Europe after July 1, 1915, has been forbidden by the Department of Agriculture under a quarantine order. This action was taken to protect American pine trees from the pine-shoot moth which has done so much injury in Europe and which has been found in a few places in this country.

This pine-shoot moth is a small orange-red moth, the larvæ of which eats out the new buds and kills or deforms the young twigs of pine trees, so as seriously and permanently to lower their timber value. It has within very recent years been accidentally introduced into America on imported European pine seedlings and has unfortunately become established in several widely separated localities in the eastern and middle western States.

Early last summer, a correspondent of the Bureau of Entomology complained of a serious insect injury to European pines under his surveillance on Long Island, and sent examples of the injury and of the larvæ

causing it; the latter could not be identified as those of any of our known American pine pests, and August Busck, Entomological Assistant in Forest Insect Investigation of the Bureau of Entomology, was authorized to visit the affected localities to ascertain the extent of the injury and obtain sufficient live material for study and rearing. From this material a large number of moths emerged and these were at once recognized as the famous European pine-shoot moth.

Subsequent surveys, says Mr. Busck in his report, established the fact that the species has been repeatedly introduced on European nursery stock, and that it has become established in nurseries and parks in several localities scattered over nine States.

In view of the experience with other introduced European insects, and con-

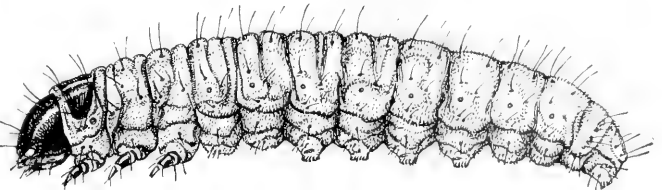

LARVÆ OF THE PINE-SHOOT MOTH—ENLARGED

sidering the very serious financial loss caused abroad annually by this insect, its introduction into this country gives just cause for alarm, because incalculable injury may result to the vast American forest interests if this insect is permitted to become generally established on native pines.

The species is a constant menace to pine forests in Europe and annually causes serious depredations, especially to young plantations of pine, in spite

tioned on the yellow pine, or Scotch pine in Europe, because this is pre-eminently the forest tree of importance there, it attacks all species indiscriminately, according to Ratzeburg and other authorities, and the American infestations have come in on European seedlings of the Austrian pine and on mughus pine quite as often as on Scotch pine.

According to Ratzeburg and Severin, it also attacks, and is equally injurious

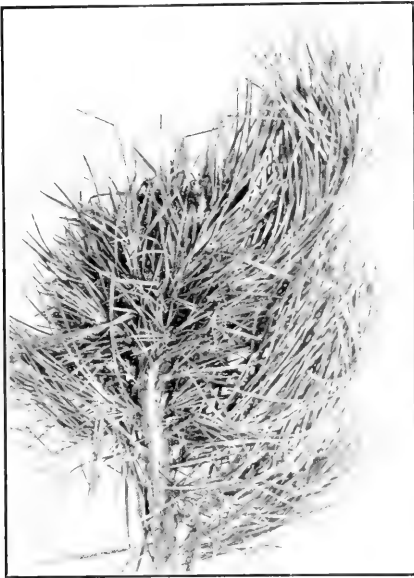

WORK OF EUROPEAN PINE-SHOOT MOTH
SHOWING THE MALFORMATIONS IN PINE RESULTING FROM INJURY BY THIS PEST

of continual preventive work against it. It has been the subject of much study and of an extensive literature from the time it was first described by Schiffermiller in 1776 to the present day. The species was named in honor of a Vienna entomologist, Baron Buol, who studied its injurious work during the latter part of the eighteenth century; since then numerous accounts have appeared of particularly severe outbreaks in many parts of Europe, from England to Russia, and from Scandinavia to southern France. It also occurs in Siberia.

The moth is confined to pine and does not attack other coniferous trees, as spruce or larch, even though these grow alongside of the infested pines. While the species is most often men-

tioned on the yellow pine, which is cultivated in Europe; and Mr. Carl Heinrich found the species on a small lot of another native American pine, which was growing immediately surrounded by infested European pine seedlings.

These latter records are particularly significant, as they prove beyond question that the pest will spread to our native American pines if not prevented.

The species attacks mainly young trees between 6 and 15 years of age, but it is often excessively destructive to younger plantings and seedlings and injurious also to older trees, though trees of 30 years or older are rarely seriously affected.

The larvæ of the European pine-moth is so effectively protected within the

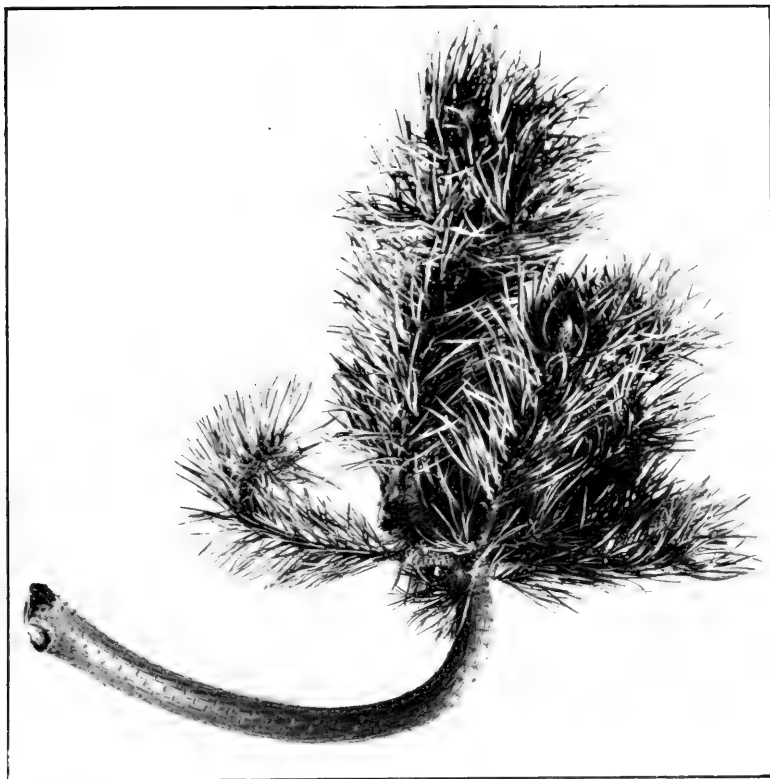

BRANCH INFESTED BY PINE-SHOOT MOTH

buds that it can not be reached by any insecticide, and the only method of combating it is that used in Europe for more than a hundred years, namely, the pruning and destruction of the infested buds and twigs together with the larvæ they contain. Such hand picking is practiced every year in the government-controlled forest reserves of Europe.

This pruning must be done while the insect is within the twigs, and while it may be done throughout the entire year, except during the midsummer months when the insect is in the adult stage, it can be most profitably done in the fall and winter months while the young larvæ are yet within the undeveloped buds, because the pruning at this time will enable the secondary set of buds to develop in the spring without delay. The only drawback to the collecting of the larvæ in the fall and winter is that the infested buds are then less noticeable than in the spring when the injury is further developed.

A little practice, however, soon enables instant recognition of the infested buds, even by an unskilled laborer; the slight exudation of pitch at the base of the bud covering the entrance hole of the larvæ is very characteristic and easily recognized when once known.

In the spring, when the buds develop into young shoots, the injury is very much more apparent, and anybody can then distinguish the infested twigs at a glance. For this reason it is advisable to have the trees gone over again in the spring, so as to remove any infestation which has been overlooked in the fall. In America the work of the larvæ in the fall has progressed far more and is much more easily discovered than is the case in Europe, where the larvæ have attained very small proportions and have attacked only one or two buds before the winter resting period intervenes.

The fact that this species is stationary during the greater part of the year, and



TWISTED GROWTH INDICATING PRESENCE OF PINE-SHOOT MOTH

only found within definite parts of certain kinds of trees, namely, in the next year's buds of pines, makes effective control work much easier than is the case with insect pests which are general feeders and which are not confined to definite parts of the food plant, as, for example, the gipsy moth or the brown-tail moth. While the European pine-shoot moth is confined to nurseries and private parks and has not spread to the native pines, it should

prove a comparatively easy task to eradicate the species absolutely within any limited area. At the present time it would even seem possible completely to stamp out this dangerous pest in America, and forestall the infestation of our native pine forests, provided that the danger of new infestation is removed. But when once the species has multiplied sufficiently to become generally distributed on the native pines the possibility of eradication will be past.

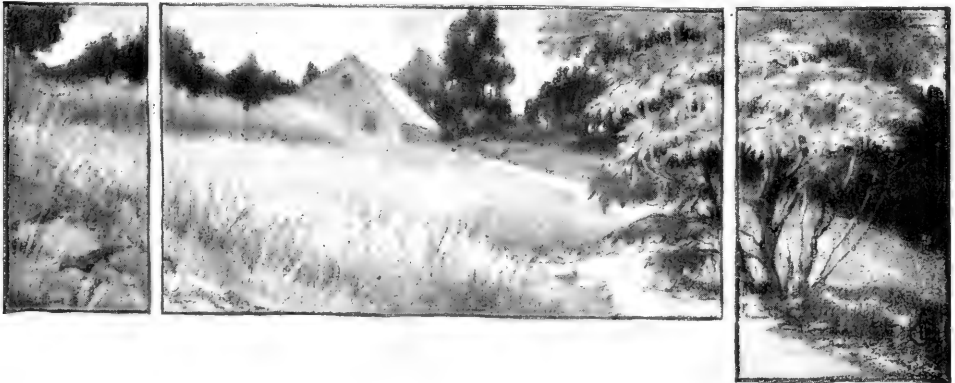

WOMEN'S WORK IN CONSERVATION

By MRS. JOHN DICKINSON SHERMAN

Chairman Conservation Department, General Federation of Women's Clubs

THROUGH the Conservation Department the General Federation has had a share in the work of acquiring the new Rocky Mountain National Park for the American people. This new park is

seventy-five miles northwest of Denver, in the Estes Park region. It contains approximately 350 square miles of the most picturesque part of the Colorado continental divide.

Mr. Robert B. Marshall, chief geog-



Copyright by Moffett, Chicago

MRS. JOHN DICKINSON SHERMAN

rapher of the United States Geological Survey, said in his report to the Department of the Interior:

"This region as a whole is as beautiful as any to be found in the United States or, indeed, in the whole world."

The Rocky Mountain National Park abounds in natural scenic attractions and in the things of interest in the outdoor world. There are forty mountain peaks rising over 12,000 feet above the level of the sea and ten peaks of over 13,000 feet, while Longs Peak, "King of the Rockies," towers above them all to the height of 14,255 feet. There are glaciers and snow fields, hundreds of mountain streams, waterfalls and cascades, 150 mountain lakes, forests, mountain meadows, canyons and gorges. One thousand five hundred varieties of wild flowers are to be found in this area and over 100 species of birds. There are many kinds of wild life, including mountain sheep, grizzly and black bears, elk, deer and beaver. Nowhere in the world today is there so great a mountain sheep range; nowhere are there more interesting colonies of beaver.

The new park, therefore, appeals to the tourist who is desirous of seeing scenery and is limited in time. It has even a stronger attraction for those who desire a longer stay and a more intimate acquaintance with its natural beauties. The climate is mild, the air invigorating and in summer there is no snow to make even the highest peaks inaccessible.

It seems especially fitting that this splendid scenic area should have been

created a national park. Practically all of the land within its boundaries was already a part of the public domain—the Arapahoe and Colorado National Forests. This land has little commercial value, but is fitted by nature to the needs of the people for a public recreation ground and as such will serve its highest purpose. Many of the attractions of the park are of a perishable nature and need the protection of a national park management. As a national park this area becomes sanctuary for wild animal life, of which enough is left to insure its perpetuation and increase under protection. Under national park management an adequate system of trails and roads will be built, thus affording easy access to the natural scenic beauties.

The accessibility of this new national park is one of its strongest merits. It is within easy reach of the people of the great Mississippi Valley and much nearer the center of population than any other scenic national park.

This region is already comparatively well known. For several years people have been visiting it from every part of the United States. Last summer alone there were more than 55,000 visitors and most of these were from outside the State of Colorado.

It was because of the nation-wide interest in this region and the especial fitness of the area for park purposes that the Conservation Department of the General Federation gave the measure its earnest support and we are highly gratified with our first work for the conservation of natural scenery.

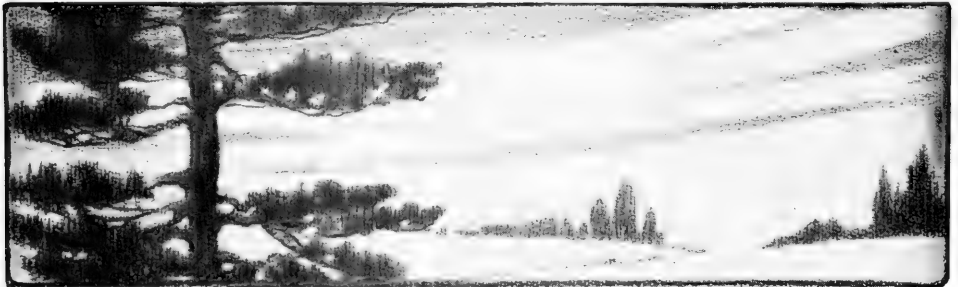

IS THIS THE LARGEST ELM?

MRS. Mary M. Williamson of Middletown, Conn., furnishes an addition to the several magnificent elms for which Connecticut is famous, in the Wethersfield Elm which she believes is the largest in the State.

This elm is at Wethersfield, Hartford County, Connecticut, and when it was measured in 1912 by Mrs. Williamson's husband its circumference was 27 feet

1 inch, its spread 142 feet 8½ inches and its age about 175 years. This is larger than either the Benedict Elm mentioned in AMERICAN FORESTRY for February or the Stirling Elm described in AMERICAN FORESTRY for April. Indeed it is so much larger than either of these two that there apparently is justice in the claim that it is the largest elm in the entire State.

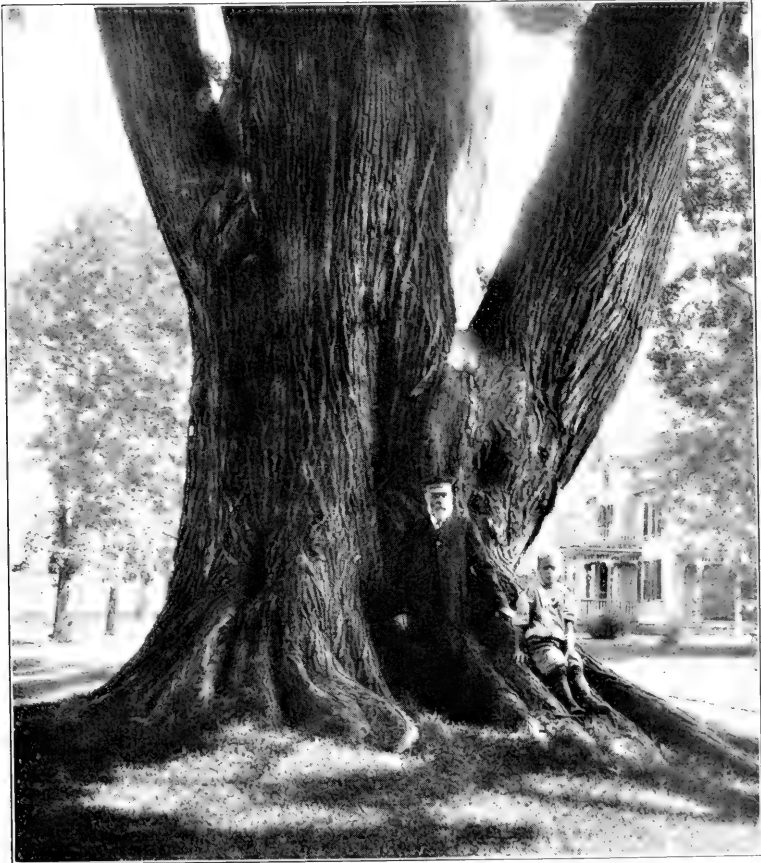

THE WETHERSFIELD, CONNECTICUT, ELM

IT IS CLAIMED THAT THIS IS THE LARGEST ELM IN CONNECTICUT AND THE DIMENSIONS EXCEED THOSE OF ANY OTHER SO FAR REPORTED TO AMERICAN FORESTRY

DEVELOPING BRITISH COLUMBIA

HON. W. R. Ross, Minister of Lands for British Columbia, who during the past three years has organized a business administration and protection of the forests of that Province, is now undertaking the systematic development of wider markets for British Columbia forest products. The importance of this work to the Province cannot be over estimated. The annual value of the forest products of British Columbia in 1913 was nearly \$34,000,000. The forests of the Province are so extensive as to support in perpetuity five times as great an industry, or one worth \$170,000,000. The markets of British Columbia lumber and other forest products must be found outside British Columbia. Mr. Ross has, therefore, been active in securing the appointment of the Chief Forester of the Province as a special Commissioner of the Dominion Government to investigate the possibility of shipping Canadian lumber to all the important foreign lumber markets of the world. He will visit in particular the United Kingdom, France, Italy, South Africa, Australia, New Zealand, India, China and Japan. The information gained from this investigation will form the basis of the steps to be taken by Mr. Ross in making it easier for British Columbia manufacturers to export to foreign markets. The Minister has also under consideration plans for cooperating with the timber industries of

the Province in creating a greater demand for provincial lumber products in the Canadian Prairie and Eastern Canada. The problem of increasing the British Columbia export trade in forest products is one which means millions of dollars to the people of the



HON. W. R. ROSS
MINISTER OF LANDS FOR BRITISH COLUMBIA

Province, and for this reason it is receiving careful consideration at the hands of the Government.

American Matchwood for Brazil

American manufacturers of matchwood may find a market for their product in Brazil, if a sample shipment now being arranged by the U. S. Forest Service proves suitable to the Brazilian match manufacturers whose ordinary supply of Russian aspen has been cut off by the European war.

HON. CURTIS GUILD DEAD

MEMBERS of the American Forestry Association mourn the loss of Hon. Curtis Guild, of Boston, who was elected president of the Association on January

13, 1909 and served until August 2, 1911. Since then he was a director and a vice-president of the Association. Mr. Guild died at his home in Boston on April 6, of pneumonia, after a few days illness.



HON. CURTIS GUILD, VICE PRESIDENT AMERICAN FORESTRY ASSOCIATION, WHO DIED AT BOSTON ON APRIL 6, 1915

The following telegram of condolence to Mrs. Guild expresses the sentiment of the members of this Association:

"I beg to express on behalf of the American Forestry Association, and of the many friends of forestry of Mr. Guild, deep regret at the termination of a life so distinguished for public service to his country and to its best interests. His services in the cause of American

the American Forestry Association of a president of distinguished public service, who brought to this office enthusiasm and a strong belief in the cause which had developed by official contact during six years of service as Lieutenant Governor and Governor of Massachusetts while that State was shaping a constructive forest policy."

Mr. Guild, three times elected Gover-

"I believe we all may take an honest pride in the object of our Association. The passing of the Appalachian Mountain Bill marks a new epoch in the preservation of the forests and especially in the preservation of forests on the watersheds upon which depends absolutely the existence, not to say the prosperity, of any people.

The wide tracts of wind-swept, rocky, sterile districts in Spain are an object lesson that cannot be too strongly brought home to every American citizen.

Without smoothly flowing rivers there is no permanency of fertility or even soil for agriculture. Without forests to restrain the Spring freshets and to conserve the slowly melting snows on the mountain slopes there can be no smoothly flowing rivers and without conservation there will surely be no forests.

It is all very well to restore by irrigation, though at terrific expense, as in Russia and our own alkali districts, naturally fertile soil. But if the soil is swept away there is no fertility to be restored.

Forest conservation is more backward in the United States than anywhere else in the world. It should be encouraged in every possible way for the sake of beauty, for the sake of shade as a barrier against the blizzard and the cyclone, as a promoter of fertility and through such promotion a promoter of a lower cost of living.

The Biblical story of the tree as a source of human knowledge and civilization, the Norsk legend that the whole earth rested on a tree, the prehistoric worship of the tree in places as far apart as Hindustan, Germany and England is a natural instinct and the surviving custom of celebrating victories by a green bough in the helmet are all evidences of the human instinct to look to the tree as a natural protector and promoter of human happiness.

Faithfully yours,

Curtis Guild

A few days before his last illness Mr. Guild sent the above expression of opinion on forest conservation to AMERICAN FORESTRY.

Forestry will ever be remembered with appreciation and gratitude by the friends of conservation in America.

H. S. DRINKER,

President, American Forestry Association."

Mr. Guild became a member of the American Forestry Association on November 18, 1908, and remained a member until his death. He did much to further forest conservation in this country and was a most valued official of the Association. The following from AMERICAN FORESTRY of September, 1911, was a tribute paid him when he resigned as president to become ambassador to Russia:

"The appointment as ambassador to Russia of the Hon. Curtis Guild deprived

nor of Massachusetts and Ambassador to Russia in the Taft Administration, was born in Boston on February 2, 1860. He was the son of Curtis and Sarah Crocker Cobb Guild. His father was the founder of the Boston *Commercial Bulletin*.

He graduated from Harvard with highest honors in 1881.

In 1884, after traveling in Europe, he was admitted to full partnership with his father and uncle in the ownership of the *Bulletin*. In 1902 he took sole charge of the paper. His political career began at the age of 21. In 1895 he was elected chairman of the Republican State convention. He was prominent as a speaker for McKinley in 1896

and 1900, and in 1902 he was elected Lieutenant-Governor of Massachusetts. After serving as Lieutenant-Governor until 1905 he was elected Governor, an honor which fell to him twice subsequently. April, 1911, he was appointed

to represent this country at the Russian capital. Col. Guild enlisted during the Spanish-American war as First Lieutenant and Adjutant of the Sixth Massachusetts, and was made Lieutenant-Colonel and Inspector-General.

MAKING PRIVATE FORESTRY PAY

By JAMES UPHAM

THERE is in Michigan a practical and successful lumberman of many years' experience. He believes in forestry. About thirty-five years ago he acquired about 1,400 acres of young growth maple, hemlock, oak, birch and cherry. At that time he was connected with a steamboat company using cordwood as fuel. He saw a time when local forests would be exhausted. He realized the future value of his tract and figured the time would come when its lumber would be such that it would pay to handle it by forestry methods and manufacture practically every particle of it that could be taken off. He resolved upon systematic forest management. Roads were built through the tract; its growth was studied; its manufacture considered—the birch going to the spool industry, the cherry and oak for veneers and other stuff for novelties so that everything was used down to the last piece. Today many of the trees are over 12 inches in diameter, breast high.

The management of the tract as planned by David Day is interesting. He began it as a business proposition. So we learn that his plan was to make it pay for the investors point of view. Mr. Day wants to keep this 1,400-acre tract right along, not despoiling its beauty by clean cutting. To do this he will have to divide the 1,400 acres into 25-acre blocks—numbering from one to fifty-six blocks. Each year one of these blocks is cut out. The next year another; and so on until all fifty-six blocks have once been cut over. Then number "one" block will be ready to cut again. Thus the forest is never cut with the "clean-sweep" policy.

Contiguous to the tract is a small sawmill. Mr. Day will saw his logs into lumber, spool blocks, veneers and novelty stock. Herein lie his annual dividends on the forestry investment. He cuts, removes, and utilizes *every possible portion of a tree* and protects young growth with a view to future returns from it.

Since Mr. Day is a lumberman of long experience, the question of a proper disposal of his forest products is readily answered by himself. The following are prices received by Mr. Day, f. o. b., Glen Haven, Michigan. The prices are for log run, that is, the full run of the log except No. 3 common.

Sugar maple, \$23 to \$24 per M.
 Beech, \$18 per M.
 Soft elm, \$29 per M.
 Basswood, \$27 per M.
 Rock elm, \$26 per M.
 Hemlock, \$15 to \$16 per M.
 Hemlock (mill cull), \$9 to \$10 per M.
 Sugar maple and beech slabs and edgings \$3.50 per cord.

The prices of oak and cherry are not given since they sell at very high prices anyway and this article shows only what forestry is doing for less valuable species. The lumber prices alone are given. In addition veneers and novelty stock will swell his profits.

This tract is attracting a great deal of attention both from the United States Government and the State and shows what anyone can do with at least 1,000 acres or upward when conservatively handled under forestry.

It is especially noteworthy because it is being handled by a practical business man who would not touch forestry if there was no profit in it for him.

A SLEDDING LOG HAULER

A CORRESPONDENT, impressed with the work of a steam log hauler at the Boyd & Harvey logging camp at Dead River Forks in the northern part of Maine, sends the following sketchy account of the work it does when conditions are right, which means snow from 6 inches to 3 feet deep.

The hauler pulls eight sled-loads of logs, each load including 10,000 feet of spruce logs, 80,000 feet in all.

The sleds weigh a half-ton each. The load on each sled weighs 5 tons. That's five and one-half tons to a sled, or a total of 45 tons that the hauler drags along.

This log-hauler at the Boyd & Harvey logging camp will travel through 3 feet of snow. It has to have snow, in fact, in order to do business, for its front wheels are not wheels at all, but big skids or runners.

The back wheels are as big as road roller wheels and are "slagged," with big steel shoes.

If the log-hauler is on a down grade they check it from running away by spreading hay in front of the skids. It wouldn't do to have the hauler take the bit in its teeth, so to speak, and gallop off with 80,000 feet of spruce. Something might "bust."

It takes four men to run this log-hauler, steersman, engineer, fireman and conductor. When the tall spruce trees, which furnish pulp for making news paper, are felled on the broad forest slopes, they are drawn by horses to the hauler, where they are loaded on sleds. After eight sleds have been loaded in line the hauler buckles on, gives a couple of puffs and away goes the whole outfit over to Dead River 5 miles from the Boyd & Harvey camp.



Photo by International News Service

THE SLEDDING LOG HAULER

IN ACTION AT THE LUMBER CAMP AT DEAD RIVER FORKS, MAINE. THE MACHINE HAULS FROM FOUR TO EIGHT SLEDS AT A SPEED OF SIX TO TEN MILES AN HOUR—EACH SLED WEIGHS ABOUT FIVE AND ONE-HALF TONS LOADED



Photo by International News Service

THE LOG HAULER HEAD ON

THE ENGINE HAS A CREW OF FOUR MEN AND WILL RUN ON SNOW FROM SIX INCHES TO THIRY-SIX INCHES DEEP

The cutting is done for this season and the hauling is practically completed because the snow is going. The lumberjacks are ready to get back to town, after their hard work in the woods.

This place is far enough out of the way. It is 40 miles from Moosehead

Lake and 8 miles from Lake Moxie station on the old Somerset branch of the Maine Central Railroad.

There have been forty lumberjacks at this camp, all under Boss Farley, with Mrs. Farley in charge of the cooking.



CAMP COLORADO IN THE MANITOU FOREST

COLORADO SCHOOL OF FORESTRY

THE Colorado School of Forestry was established as a department of Colorado College in 1905, when General W. J. Palmer and Dr. W. A. Bell gave to the College a tract of 9,500 acres known as Manitou Park, situated in a mountain valley about 25 miles Northwest of Colorado Springs. About 3,200 acres is agricultural land and has been devoted to that purpose, the proceeds being applied toward the endowment of the School. The remainder, now called the Manitou Forest, is timbered and is used for field instruction. The Manitou Forest itself is surrounded on three sides by the Pike National Forest, to which the students have access for the purpose of estimating timber and studying the various problems of forest management.

In addition to these natural advantages, the location of the School at Colorado Springs affords to the student the opportunity of studying other important branches of forestry that are being developed by the Forest Service. Eight miles west of the city,

on the slopes of Pikes Peak, is situated the Fremont Experiment Station, where extensive forest investigations are being conducted. The practical purpose underlying these investigations is to find out how best to reproduce, develop and manage the forests of the Rocky Mountain region. A few miles north is the Monument Nursery, where a million seedlings are grown each year to be set out on the denuded lands in the National Forests.

The United States Bureau of Entomology has recently established at Colorado Springs a forest insect station for the study of the insect problem in the Southern Rocky Mountains. An insectary will be maintained in connection with it for the breeding of the insect-enemies of the tree-killing species. The location of this station at Colorado Springs will be of great advantage to the forestry students in their study of forest entomology.

The forestry curriculum was thoroughly revised in 1912 and a larger amount of practical field work introduced. All the forestry courses proper were con-



STUDENTS EXTRACTING SEED

A PART OF THE WORK DONE BY THE STUDENTS AT THE COLORADO STATE SCHOOL OF FORESTRY

solidated into the junior and senior years, an arrangement which affords a stronger and more systematic presentation of the whole subject than was possible in the former curriculum in which the forestry subjects were intermingled with others throughout the four-year period. This arrangement also enables the Department of Forestry to make full use of its most valuable asset—the Manitou Forest. A forest laboratory is the prime requisite of a school of forestry. When the Manitou Forest was given to Colorado College for this purpose Mr. Gifford Pinchot, then Chief Forester of the United States, made the statement that the Colorado School of Forestry “has in Manitou Park the best out-of-door laboratory for forest experimentation in the country.” But under the old program it was impossible to make adequate use of this magnificent tract of woodland. This has now been provided for by dividing both the junior and senior years into three terms—fall, winter, and spring—and giving the entire work of the fall term and part of the spring term (in the junior year) in the Manitou Forest.

In the junior year the student enters the Forestry Department. During the

fall term, from early in September to the last of November, the headquarters of the School are at Camp Colorado in the Manitou Forest. The camp consists of a group of buildings and tents that provide ample and comfortable accommodations. Instruction is given by daily lectures, recitations and field work. The juniors spend the first half of the term studying forest mensuration. Sawmills in the vicinity provide the opportunity for practice in log-scaling and the making of mill tallies. Measurements are taken of felled and standing trees and the data worked up into volume, growth and yield tables.

The last half of the term is spent in forest surveying and timber estimating. After receiving a thorough drill on a number of sample “forties” the class goes on camping trips to different parts of the Pike National Forest, estimating and mapping large bodies of timber. An experienced mountaineer accompanies the party as cook and teaches each student the arts of camp cooking and packing.

The juniors also begin the study of dendrology in the fall term. By study in the field they become familiar with the different species and forest types of the region. They are also given suffi-

cient practice in timber operations—tree-felling, log-making, skidding, etc.—to make them proficient in the use of woodsmen's tools.

The senior class during the fall term study forest management and forest improvement work, or construction engineering. The field work in forest management involves the making of working plans for the Manitou Forest or adjacent tracts.

The course in Forest Improvement Work furnishes instruction in the building of forest roads, trails, bridges, fire-lines, telephone lines, lookout stations and ranger cabins. It is imperative that a forester acquire a thorough knowledge of these operations in order that he can lay out, estimate the cost of, and supervise such work. A large amount of construction engineering is always necessary on forests that are being put under scientific management and today forms one of the chief lines of work on our National Forests.

A few days of the fall term are spent in collecting the annual seed crop. At the proper time, just before the cones of the yellow pine and Douglas fir are ready to open, they are collected and spread out on canvas sheets to be opened by the sun. They are then thrashed out, cleaned and stored away to be used in the planting operations the following spring.

The winter term, from the first of December to April, is spent in Colorado

Springs, when library, laboratory and wood testing work is carried on in connection with the lectures and recitations in the various technical courses. The wood testing laboratory is well equipped for that purpose. Here is mounted a Riehle testing machine for making tension, compression, shearing and transverse tests. Students are required to make a series of tests upon the resisting properties of various species of commercial woods.

In the spring the work is again transferred to the field but the two classes separate. The juniors spend part of the term in the Manitou Forest and part at the Government Nursery at Monument. They return to the Forest for the field work in silviculture.

The seniors visit some large lumbering center in the South, where they study logging and milling operations on a large scale. They also estimate an extensive tract of timber and make a logging plan for it. The spring of 1913 was spent at Crossett, Arkansas, where the facilities for such work are unexcelled.

In addition to the prescribed course as here outlined, the students are expected to gain further experience by spending their summer vacations in some kind of practical forest work—either working for a lumber company or in the Forest Service. Most of them obtain employment on the National Forests.



A CLERK'S WORK ON A NATIONAL FOREST

By JULIA T. SHINN, *Clerk on the Sierra National Forest*

“WHO cares about it? Anybody but another clerk?” Which only goes to prove that you’ve never been a clerk in the field. There a clerk is a clerk and any number of other things—not a Pooh-Bah, for her duties are humble enough, but a sort of “crew of the Nancy Brig.”

Many a Forest office is at the end of a stage line where there is a small whirl of a center—hotel, store, blacksmith shop and saloon (or if the place be “dry,” a pool-hall) and possibly a chapel—to which the roads converge from the canyons and the passes. The clerk lives, perhaps, at the hotel; in summer the rendezvous of teamsters stockmen, millmen, “traveling men” and passing tourists intent on higher regions, but in winter without guests

save herself and the school-mistress. Or perhaps she lives in her own home on a hill farm within a mile of the Forest office.

In either case she is part of the little hill community; and just as the Deputy Supervisor runs the cinematograph for the Improvement League picture shows, so she and that Deputy’s wife help with the refreshments served thereafter, and count the door money taken in by one of the forest rangers. She plays the baby organ for the Sunday School in the little chapel which the aforesaid door money is to paint—and the Forest Supervisor is president of the organized congregation; the Forest Examiner teaches the Bible class.

When, therefore, on a morning, the Supervisor is dictating letters and the telephone bell rings, the clerk turns to



A FOREST SUPERVISOR'S OFFICE

THE UP TO DATE EQUIPMENT IS APPARENT AND THE OFFICE LOOKS AS IF IT IS USED FOR IMPORTANT AND PRACTICAL WORK, AS IT IS

the switch board only to hear: "Do I bring sandwiches or cream puffs?"

"Puffs," she answers, feeling her ears get hot as she senses the impatience of the Supervisor.

"Have you got a good recipe?"

"I'll call you up at noon."

Later, the dictation finished, she begins her typewriting. Again the telephone. This time it is: "Is there a doctor book in your Forest Library? Can you find out what's good for croup? I'm afraid Betty is going to have it, and I'm all alone here, you know; Jack's gone to the Chowchilla fire."

She works fast to make up for time lost looking up croup remedies, but before the letters are ready for the Supervisor, a district ranger calls in: "Can you tell me what was paid per foot last spring for those caves troughs put up on the office?"

Fortunately she remembers the name of the firm from whom the troughs were bought and can run through the accounts for last year and dig out the desired information.

"That much? Gee! Too rich for a ranger's blood. Thanks just the same."

Back to the typewriter, when a knock comes at the office back door. The Supervisor can see that door from his windows, and calls out: "It's old Piutey; I haven't time to waste on him. Will you interview him?"

Old Piutey proves to have a basket to sell. "Four dolla you. Dat Susie woman she say 'Nother woman, fi' dolla. Jane, she my fren'—four dolla he." Down falls the clerk before such subtle flattery, and four of her hard-earned dollars are transferred to the corner of Piutey's red bandanna, though she has a sneaking feeling that a good business woman would not have given more than three dollars for the basket. "Never mind," she says to herself, poor old Sue needs the money and this will make a good wedding gift for the Massachusetts cousin, anyhow."

Once more she tackles the letters, and this time they are finished, though not till noon.

After noon come accounts; for a field clerk, like the clerk of the country store or the country school teacher,

must be familiar with all phases of the work. Here is a voucher signed in the wrong space. A new one must be prepared and sent to the creditor of the Forest with more careful instructions. Here is a voucher amounting to over \$50 and no bids. Will the men never learn to heed that restriction! She goes to the telephone to call up the offending ranger.

"Mr. Smith, is this your forage voucher for two tons of hay delivered at the Mount Bullion Station?"

"Yes, marm."

"It's for sixty dollars!"

"Yes, marm."

"But there are no bids."

"No, marm. You can't get bids on hay, Miss Brown; no two lots of hay are alike and that there's the only first-class hay in this neighborhood."

"You might have bought it a ton at a time—sent it in on two vouchers of different dates."

"No marm—you see I got it cheaper all on one load," replies honest Smith.

Rebuked, the clerk says faintly "All right—goodbye." Then she racks her brain for an "exigency statement" that will obviate the necessity of bids. Finally on the ground that "no two lots of hay are alike" she types in "Only dealer within a reasonable distance from whom the article could be obtained," and prays her guardian angel that the voucher may pass the scrutiny of the Fiscal Agent safely.

Having worked through the vouchers and prepared them for signature, she turns to a bunch of "special use" reports. A number of them have been approved by the Supervisor and the permits are easily made out, the letters of transmittal quickly prepared. But here is one in which Ranger Grayson recommends the granting of a five-acre residence permit.

"The old man has a sick girl," writes Grayson, "and they like to camp there. He thinks he needs five acres. It's a cold canyon, anyhow, and no one else would want it, so I recommend that the use be granted. He is a poor man and can't really afford the five dollars, so I hope you can put it lower."

Now Grayson knows, as well as the clerk does, that regulations are regula-



FILING CASES INDICATE AMOUNT OF DETAIL

THERE ARE SO MANY THINGS TO TAKE THE ATTENTION OF THE FOREST SUPERVISOR THAT BUSINESS EFFICIENCY IS NECESSARY

tions and that \$5.00 is the minimum charge for a residence permit—three acres the maximum area. What is to do? Put it up to the Supervisor? What is a clerk for but to save the Supervisor such details and leave him time for more important things? Only those deplorable creatures “clerks that can’t think” do such things. So she formulates a letter to Ranger Grayson for the Supervisor’s signature, calling his attention to the proper page and line in the Manual, and suggesting that he see the man again and explain the regulations to him.

3.45—time to take the basket of letters, permits, vouchers, etc., to the Supervisor for signature. She takes it in to the private office, then returns to put her desk to rights, answer a few telephone calls, etc., until the mail shall be ready to put up.

A subdued chuckle comes from the Supervisor’s office. Then he calls: “Miss Brown, there’s no reason why this old man Andrews shouldn’t *camp* anywhere he pleases, provided he uses

tents and not a permanent building. As for the five acres in Cold Creek Canyon, I suppose he wants it for his horse and cow at his summer camp. He could have a \$2.00 pasture permit for that. Needn’t bother tonight, but fix him up in the morning.”

She takes back the letter—without meeting the Supervisor’s eye—and, properly chastened as to clerks who can’t think, shuts up shop for the night—resolved to try the next day to think with her head more than with her Manual.

Next morning, the weather data recorded, she turns to the pile of mail on her table, opens and stamps it with the dater and takes it to the Supervisor, holding out such routine items as need no attention until she shall have done her part. These are accounts to be vouchered, vouchers to be audited and entered on the accounts cards, approved applications for forest homesteads to be recorded and sent to the proper ranger for report, reports on special use

applications to be checked up, requests for grazing application blanks or rangers' requisitions for supplies.

By the time she has laid out her day's work, it is time to take dictation, and the round begins again. Thus

day follows day, each full of interesting details, each different from the last, and all worth while, because the clerk in a field office of the Forest Service feels herself to be a part of The Game, not just a cog in a machine.

THE FORESTRY ISSUE IN THE LAKE STATES

By H. H. CHAPMAN

NOWHERE in the Eastern States has there been greater interest displayed in forestry than in the States of Michigan, Wisconsin and Minnesota. The public consciousness has been keenly aware of the extensive denudations by lumbermen, transforming many forest areas into barren plains. Forest fires, sweeping over these level lands, have attained a speed and fierceness unknown in mountain regions, and on several occasions, notably at Hinckley, Minnesota, in 1894, and at Baudette, Minnesota, in 1910, have resulted in great loss of life as well as property.

The stimulus thus given to popular interest in fire protection and forestry would long ago have brought about an advanced state of development of public forest reserves, were it not for an insidious undertow constantly working to discredit the movement by misrepresentation and breaking out in open hostility at the least provocation. This opposition is directed against the use of lands for forest production. Its advocates include interests which deal in wild lands, and who on general principles oppose scientific land classification as tending to bring the agricultural possibilities of a region into disrepute. If the public accepts the statements of these land dealers they will be forced to believe that not an acre of non-agricultural land exists in the three Lake States, and that the moral right of land speculators to sell any land whatever to prospective settlers is unquestioned.

Such representations are eagerly accepted by townspeople and practically

all classes who depend for their own prosperity upon the upbuilding of a region through development of farming and may even be echoed by farmers and settlers in their desire to secure increased population and a more extensive distribution of the tax burden. Hence the strength of this fundamental opposition to State Forest reserves need occasion no surprise.

But if our civilization in America is to progress, or even maintain itself, the unregulated exploitation of the weak by the strong, the ignorant by the unscrupulous, must cease. An economic fact cannot be suppressed by merely denying it. Results speak for themselves. One of the deepest truths demonstrated by centuries, in the most densely populated nations of the Old World, is that there exists much land too poor to be successfully farmed. The one profitable use for such land is forest production. The result of efforts to farm non-agricultural soils is impoverishment, discouragement and actual pauperization, leading finally to the creation of a race which is wholly incompetent. Fortunately, the extreme results, in the Lake States, have not had time to manifest themselves or are prevented by the mobility of the population. Instead of being prevented from seeking other fields, as so often happened in absence of transportation in earlier ages, the unfortunate victims of land hunger, after exhausting their resources, abandon the farm and the mortgage, and drift elsewhere, perhaps to the slums of some city. If of superior stock, they may even profit by their experience and get a start on

better land, becoming eventually prosperous citizens.

These facts, so abundantly proved by even the most superficial investigation of individual cases in any county containing non-agricultural soil, are a bitter pill to swallow for the average American optimist. Ostrich-like, he seeks to deny the existence of economic facts by concealing his head in the sand. Economists who seek to secure a proper determination of the real value of lands, by scientific means, for the double purpose of devoting lands of true agricultural value to farming and of withholding worthless lands from such uses, are subjected to storms of abuse and vituperation and branded as enemies of prosperity and progress; while legislative and private means are used to discredit and misrepresent their efforts.

This situation calls for a patient and persistent effort to educate the public mind to recognize the great truths underlying land classification. It is the most fundamental and important of all efforts at true conservation of human energy. Since forestry presents a logical and profitable use for lands that are worthless for agriculture, land classification is inevitably linked with forestry, and non-agricultural lands must be placed in forest reserves under State or National control.

State forestry thus becomes the goal around which the struggle rages. The champions of untrammelled license bitterly attack the advocates of State forestry, accusing them of a desire to lock up whole sections of good farming lands in forest reserves. Such ideas are absolutely foreign to the whole scheme of State forestry and nowhere can instances be cited where foresters have advocated the use of agricultural lands for State forest reserves. The differences arise entirely over the definition of the term "agricultural" land, and the methods to be used in determining its classification.

Foresters are the first to urge that land classification should *not* be left to them, but should be entrusted to soil experts familiar with agricultural practice. Even this procedure is fought by the opposition to classification. It will be found on analysis that the

owners of large blocks of cut-over timberlands are opposed on general principles to any investigation of the character of lands in the vicinity of their holdings, for fear it will increase the difficulty of disposing of these lands at good prices to would-be farmers.

In Michigan the battle for land classification has raged for twenty years. Enormous areas, totalling at one time over a million acres, had reverted to the State for taxes. The State Forestry Board finally advocated the establishment of a Public Domain Commission which was to classify these State lands, set aside for forestry all lands of non-agricultural character, and sell the agricultural lands direct to settlers. A minimum of 200,000 acres of forest reservation was made mandatory by law, and the Commission reserved 235,194 acres, scattered in small bodies through fifty-four counties, in only four of which are there more than 10,000 acres of forest reserves. In reserving but a fraction more than the minimum fixed by law, and in following a policy of opening up and disposing of the remaining 750,000 acres of land which was once considered too poor to be worth the taxes, the Commission unquestionably reflected the wishes of the population of the counties affected, and acted in entire good faith for what they thought was the best interests of the State. But statements made by foresters in Michigan claim that much of this unreserved land was of doubtful agricultural value, and that the State has now lost a great opportunity to establish at a minimum of expense a system of State reserves sufficient to meet the future needs of the community. Apparently it may take another generation of effort and demonstration to awaken the Michigan public to the evils of promiscuous use of non-agricultural land for purposes for which it is not fitted. Michigan forest reserves may at some future period require considerable enlargement by purchase.

Wisconsin in 1903 and 1905 withdrew from sale all State lands north of Township Thirty-three and constituted therein a State Forest reserve. Power was given the State Forester to sell and exchange these lands in order to consol-

idate the areas, and to dispose of agricultural portions to settlers. Although the State pays taxes on these lands to the road and school funds, increasing opposition arose in the counties where the reserves were located, based on the argument that agricultural lands were being locked up and development thwarted. A Committee of the Legislature of 1914-15, after a thorough investigation which extended to Eastern States, reported:

“First.—That the general policy or idea of forestry is sound and a success commercially;

“Second.—It is not good policy to permit attempts to be made to induce settlers with a view to home-making to go on lands not suited to agriculture;

“Third.—There are thousands of acres of land in northern Wisconsin which, on account of poor character of the soil and its rough nature will not be used for farming either in this generation or several to come. This can be said without detracting from the agricultural possibilities of the section in which they are located. Agricultural writers say that 25 per cent of all lands in the northern half of the State are unsuitable for the growing of crops. This would give $3\frac{1}{4}$ million acres of possible forest lands.”

The report presents many other striking facts which abundantly prove the economic wisdom and conservatism of the State's policy of land reservation, and recommends the continuation of the system. Meanwhile, a suit brought against the State to test the constitutionality of the law of 1905 which empowered the State to sell and exchange State school lands, has been decided adversely and the adjustment of this matter will greatly hamper and retard the entire State policy. Previous to this agitation, Wisconsin had appropriated \$50,000 per year for five years to purchase additional lands for State Forest reserves. These purchases are now suspended. The determination of the entire future policy of Wisconsin is dependent on recognizing the fundamental necessity for scientific land classification, and a willingness on the part of the people of the State to support and abide by such classification.

In Minnesota, in spite of the progress made in State fire protection, following the Hinckley and Baudette fires, the interests hostile to land classification successfully thwarted all tentative efforts to secure State Forest reserves, although the State owns several million acres of land which should be examined and classified. Much of this land, in northeastern Minnesota is solid granite ledges, or is filled with boulders and never by the greatest stretch of the imagination could be called agricultural. Yet such is the fear of land speculators, lumbermen owning cut-over lands, and real estate men, of the principle of honest classification, that even the existence of these great bodies of granite rock is strenuously denied. The Minnesota Forestry Association succeeded in the last general election in arousing the public conscience to such an extent that a constitutional amendment was adopted, giving the Legislature permission to classify and reserve non-agricultural State lands. At once the opposing interests took alarm. The usual misrepresentations were repeated to the effect that the classification sought to tie up agricultural lands. In an effort to cripple the State Forest Service, inspired apparently by the idea that if this Service were crippled the movement for land classification would be nipped in the bud, the Senate Finance Committee cut the State appropriation for forest fire protection in two, thus seeking to revert to the conditions existing previous to the Baudette fire.

A bill appropriating \$25,000 for land classification was summarily rejected by the legislature, thus nullifying the expressed wishes of the people of the State.

American civilization has much to learn, and one of the most fundamental of these lessons is a recognition of existing economic conditions and the protection of her citizens against unbridled exploitation. If land is unfit for agriculture, no amount of misrepresentation will change its character, or aid the unfortunate settler who acquires it to make a decent living. But once such lands are devoted to the legitimate purpose of timber production, all true agricultural lands in the vicinity are benefited by the general uplift of

the economic status of the entire community. Foresters have realized this for two decades and have borne

the heat and odium of the fight for better civilization. How long must they continue to fight alone?

HOW OLD WAS IT?

MR. Paul R. Strain of Worthmore Farm near Wellsburg, West Virginia, writes *AMERICAN FORESTRY* that in blasting on the farm of E. C. Carter near his place, an ax mark was observed on the heart of a quarter section of an oak stump thrown out by the explosives. The stump had been cut long enough to be quite dead and was about 26 inches in diameter where cut off. The ax marks uncovered by the splitting of the stump from the blasting out had been overgrown with fully 8 inches of new wood. The young tree when chopped into must have been about 8 inches in diameter. An opposite section of the stump shows a sloping cut of good size but no ax marks are visible.

"The forest in which the stump was," writes Mr. Strain, "had been cleared less than ten years ago but the stump gave me the impression of having been dead much longer, and all through its interior it is what we call around here, 'badly dotted.' Nevertheless, I underestimated the soundness of it when I loaded only four sticks of dynamite

under it, the explosion leaving the shattered quarters in the ground and thus making possible the discovery of the ax marks.

"One very impressive thing is evidence of the very thin edge of the cutting tool which made the mark. Few axes nowadays are ground so thin as it must have been.

"There were few if any settlers in this part of Virginia in 1780, which is about the time of my great-grandfather taking up land here, so it is interesting to conjecture just when and by whom the marks were made. I do not believe it is possible to count the annual ring growth until the wood is dressed down smoother than the blast left it.

"Evan Hindman, who has cut a good deal of timber in this section of Brooke County, West Virginia, stated on viewing this specimen, that he had seen similar old ax marks on trees he had felled, even more deeply overgrown with new wood than this one, but he did not state what varieties of trees they were."

TO EACH MEMBER:

We wish to double the membership of the Association. Will you help? Will you get one friend to join? The additional revenue will enable us to do important work for forestry. (See Editorial on page 670.)

You should be proud to recommend the Association and *AMERICAN FORESTRY* to your friends. Get a new member NOW. We must increase our membership and we need your help.

Application blank opposite page 607.

AMERICAN FORESTRY ASSOCIATION.

BUILDING BIRD HOUSES*

By NED DEARBORN,
Assistant Biologist United States Biological Survey

THE birds which adapt themselves to living in bird houses, and the dimensions to be observed in constructing these houses are given in the following table. These dimensions should be carefully observed in erecting the houses.

Birds may be gathered about us in all seasons of the year with ease and certainty merely by offering what they desire. In winter they are often pushed for food, and if we supply this need they will report daily at the lunch counter and help

DIMENSIONS OF NESTINGS BOXES FOR VARIOUS SPECIES OF BIRDS.

Species.	Floor of cavity.	Depth of cavity.	Entrance above floor.	Diameter of entrance.	Height above ground.
	<i>Inches.</i>	<i>Inches.</i>	<i>Inches.</i>	<i>Inches.</i>	<i>Feet.</i>
Bluebird.....	5 by 5	8	6	1½	5 to 10
Robin.....	6 by 8	8	(¹)	(¹)	6 to 15
Chicadee.....	4 by 4	8 to 10	8	1⅞	6 to 15
Tufted titmouse.....	4 by 4	8 to 10	8	1¼	6 to 15
White-breasted nuthatch.....	4 by 4	8 to 10	8	1¼	12 to 20
House wren.....	4 by 4	6 to 8	1 to 6	⅞	6 to 10
Bewick wren.....	4 by 4	6 to 8	1 to 6	1	6 to 10
Carolina wren.....	4 by 4	6 to 8	1 to 6	1⅞	6 to 10
Dipper.....	6 by 6	6	1	3	1 to 3
Violet-green swallow.....	5 by 5	6	1 to 6	1½	10 to 15
Tree swallow.....	5 by 5	6	1 to 6	1½	10 to 15
Barn swallow.....	6 by 6	6	(¹)	(¹)	8 to 12
Martin.....	6 by 6	6	1	2½	15 to 20
Song sparrow.....	6 by 6	6	(²)	(²)	1 to 3
House finch.....	6 by 6	6	4	2	8 to 12
Phoebe.....	6 by 6	6	(¹)	(¹)	8 to 12
Crested flycatcher.....	6 by 6	8 to 10	8	2	8 to 20
Flicker.....	7 by 7	16 to 18	16	2½	6 to 20
Red-headed woodpecker.....	6 by 6	12 to 15	12	2	12 to 20
Golden-fronted woodpecker.....	6 by 6	12 to 15	12	2	12 to 20
Hairy woodpecker.....	6 by 6	12 to 15	12	1½	12 to 20
Downy woodpecker.....	4 by 4	8 to 10	8	1¼	6 to 20
Screech owl.....	8 by 8	12 to 15	12	3	10 to 30
Sparrow hawk.....	8 by 8	12 to 15	12	3	10 to 30
Saw-whet owl.....	6 by 6	10 to 12	10	2½	12 to 20
Barn owl.....	10 by 18	15 to 18	4	6	12 to 18
Wood duck.....	10 by 18	10 to 15	3	6	4 to 20

¹ One or more sides open.

² All sides open.

to relieve the tedium of our indoor life. In summer they care less for food provided by their human friends, and other means must be sought to attract them about the home. They appreciate fresh water for bathing and drinking. A shallow pool of varying depth, if only a foot across, becomes on hot days a center of attraction for all the birds in the vicinity, and it may be made with little effort and material; only a small amount of cement is required, or, if that be lacking, a pan with stones in it set in the ground will be equally serviceable. Trees, shrubs, and vines bearing fruit relished by birds are great attractions in their season.

Birds are desirable about premises not only on account of their beauty and song, but because of their economic worth. They are especially useful as insect destroyers during the breeding period, when they have to work early and late to obtain sufficient food for their nestlings, and their movements at this time are more

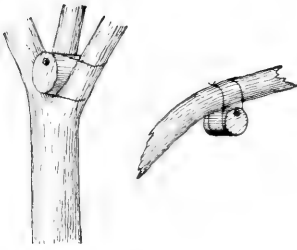

FIG. 1.—Tomato can with circular piece of board fitted in one end, to make house for bluebirds or wrens.

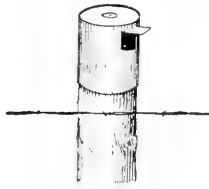

FIG. 2.—Tomato can, with one end removed, fastened to top of post. Hole cut in side for entrance. Suitable for bluebirds or wrens if put in shady place.

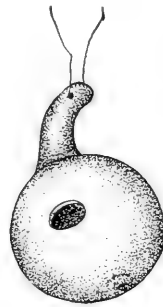

FIG. 3.—Gourd for martins.



FIG. 4.—Gourds arranged for martins.

interesting than during any other season. There is, therefore, a double purpose in offering them special nesting facilities. If mud is available, swallows, robins, and phœbes will found and wall their nests with it. If we put out feathers, bits of wool, or twine, a dozen different kinds of birds will make use of them. If we furnish safe retreats in which they can rear their young comfortably, most of them will be occupied. In fact no attraction for summer birds is more effectual than a series of houses suited to the needs and habits of the various kinds of house birds.

A few years ago only four species were commonly regarded as house birds—the house wren, the bluebird, the tree swallow, and the martin. Since the movement to protect birds and make neighbors of them began, however, their natures and needs have become better understood, and it is now known that many other species will avail themselves of houses constructed for them by their human friends. The practice of erecting bird houses in this country, while now nation-wide, is not so common and uniformly distributed as it should be, and more extended provisions of this nature can not fail to result in a largely increased number of house birds.

HOUSE BIRDS INCREASING IN NUMBER

The habit of nesting in birds houses has been adopted by individuals of many species which would not ordinarily be expected to make use of such homes, and this may be taken as indicating that it will become more general from year to year as facilities are afforded and as the number of birds hatched in houses increases.

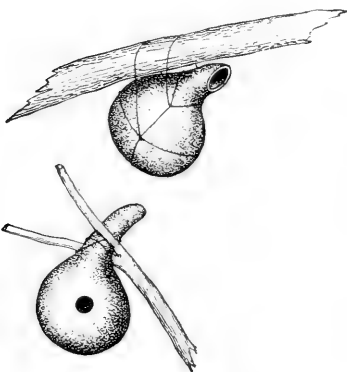

FIG. 5.—Gourds for wrens or bluebirds.

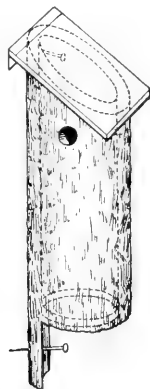
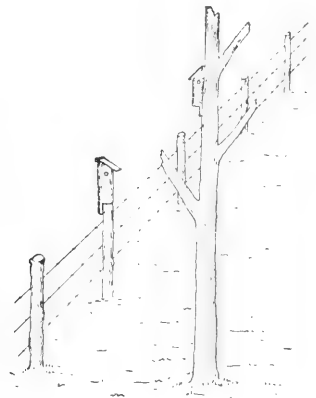

FIG. 6.—House made from hollow log.



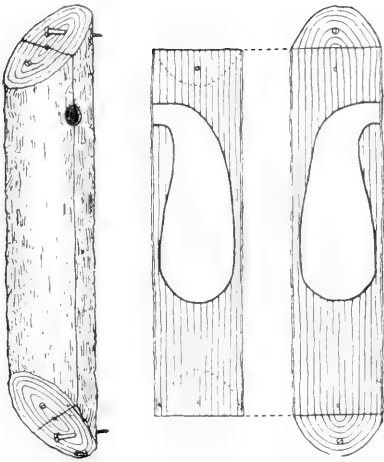

FIG. 7.—Log split and halves marked to be gouged out to form a cavity. Halves to be screwed together. Top should be covered with tin or zinc.

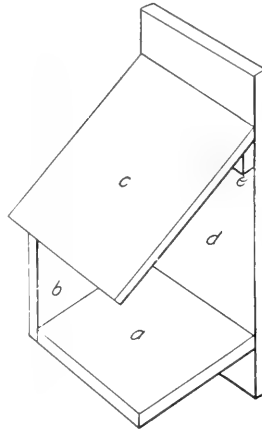

FIG. 8.—Outdoor nest shelf.

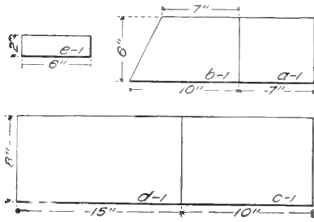
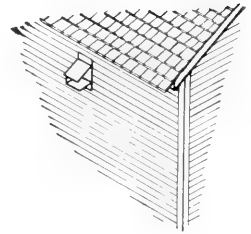

FIG. 9.—Diagrams for outdoor nest shelf shown in figure 8.

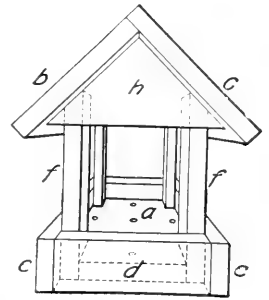
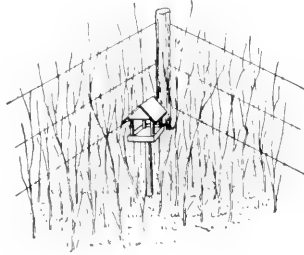

FIG. 10.—Nest shelter.

That western wrens and bluebirds should take as naturally to artificial shelters as did their eastern relatives was to be expected. On the other hand, the use of houses by birds which until recently had persistently ignored them is surprising, and must be considered a victory for those who have studiously attempted to enlarge their circle of feathered neighbors.

Woodpeckers, nuthatches, and titmice excavate their own houses, usually new ones each year, leaving the old homes to less capable architects. Builders of artificial houses generally go to the woodpecker for designs, and by varying styles to suit the tastes of different kinds of birds, have been rewarded

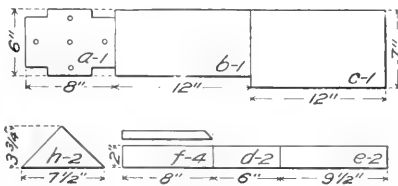

FIG. 11.—Lumber diagrams for nest shelter shown in figure 10. Thickness of boards $\frac{3}{4}$ inch.

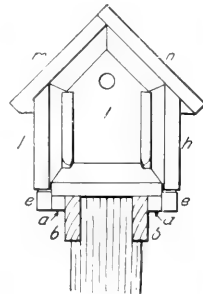

FIG. 12.—Cross section and interior view of front half of house for swallows and bluebirds.



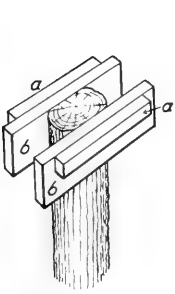

FIG. 13.—Foundation for house shown in figure 12.

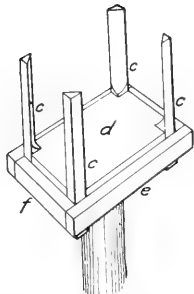

FIG. 14.—Floor and posts added to foundation shown in figure 13.

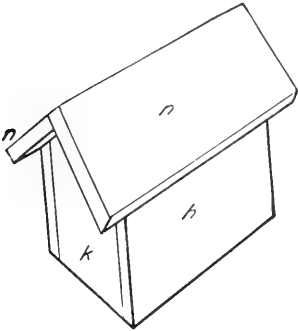

FIG. 15.—House ready to place over floor and posts as shown in figure 14.

known to use nesting boxes. Houses set close to streams in the western mountains will probably be occupied by ouzels or dippers. Florida grackles sometimes breed in flicker holes and may be expected to occupy houses now and then. In every locality having trees there is a group of birds ready to appropriate houses when they have the opportunity.

by such tenants as chickadees, tufted titmice, white-breasted nuthatches, Bewick and Carolina wrens, violet-green swallows, crested flycatchers, screech owls, sparrow hawks, and even some of the woodpeckers, the master builders themselves. Flickers readily accept houses built according to their standards. Red-headed and golden-fronted woodpeckers are willing occupants of artificial houses, and even the downy woodpecker, that sturdy little carpenter, has, in one instance, at least—this according to Jefferson Butler occurring on the Ford farm, near Detroit, where great pains have been taken to provide for birds—deemed

such a home a satisfactory abode in which to raise a family. Shelters having one or more sides open are used by birds which would never venture into dark houses suited to woodpeckers. They have been occupied by robins and brown thrashers, and, in one instance, by a song sparrow. This song sparrow record is another surprise from the Ford farm, announced by Mr. Butler, which is very encouraging to those experimenting with bird houses.

The number of house birds may be still further augmented as time goes on. All of the commoner woodpeckers are likely to be included, as are several of the small owls and wrens, and a few of the wild ducks, as the golden-eye. The wood duck is already

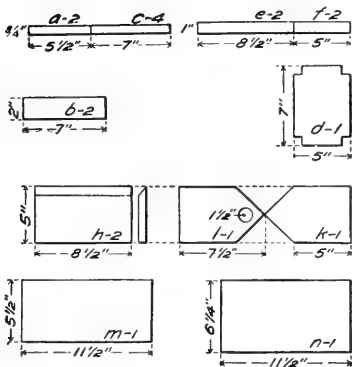

FIG. 16.—Lumber diagrams for building house shown in figures 12 to 15. Thickness of boards $\frac{3}{4}$ inch.

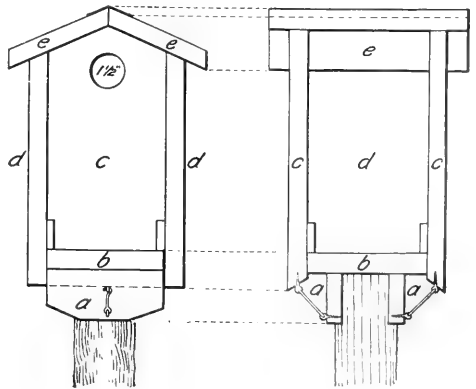

FIG. 17.—Diagrammatic drawings of bluebird house. This house can be removed from its floor by unfastening two wire hooks.

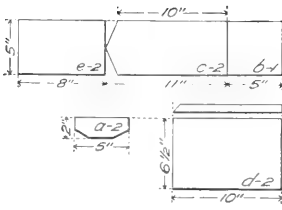

FIG. 18.—Lumber diagrams of house shown in figure 17. Thickness of boards $\frac{3}{4}$ inch

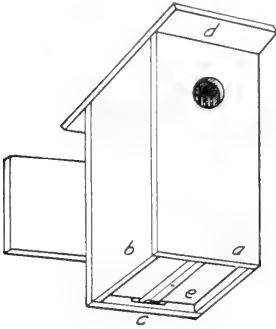

FIG. 19.—Style of house suitable for sparrow hawks, screech owls, bluebirds and wrens. Designed to be placed in trees. Bottom can be removed by turning button.

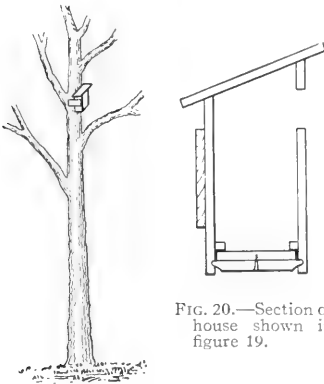

FIG. 20.—Section of house shown in figure 19.

SUGGESTIONS FOR CONSTRUCTING HOUSES

House birds differ decidedly in their requirements. For those which usually excavate homes for themselves, the diameter of the entrance and the depth and diameter of the cavity must be in accord with their specific standards. Some birds are satisfied with almost any sort of a lodging. Bluebirds and wrens, for example, are content to build in tomato cans, although chickadees and nuthatches disdain them. Wood is a better building material than metal or earthenware. Entrance holes should be countersunk from the outside to exclude rain. Heads of nails and screws should be set rather deeply and covered with putty. All houses should be easy to open for cleaning. A perch at the entrance is unnecessary and may even be an objection, as it is frequently used by English sparrows while they twitter exasperatingly to more desirable occupants. To provide for proper ventilation a row of small holes is sometimes bored just beneath the eaves, but there should never be a ventilating hole lower than the entrance, and joints should be made tight, as drafts of air are dangerous. In case there is danger that rain may be driven in through the door, a small drainage hole, which will be covered by the nest, may be made in the middle of the floor.

The appearance and durability of houses are improved by a coat of paint. A neutral shade of green or gray is suitable for houses mounted in trees, while those on poles, being conspicuously placed, lend themselves harmoniously to the landscape when painted white.

The dimensions of nesting boxes shown in Table 1 are taken from the experience of successful builders and from measurements of woodpecker holes.

HOUSE PLANS

Possibilities in the way of improvising bird houses with very little work are suggested in Figures 1 and 2. Ordinary tomato cans treated in either of the ways here indicated will be tenanted by wrens and bluebirds. The cans ought always to be

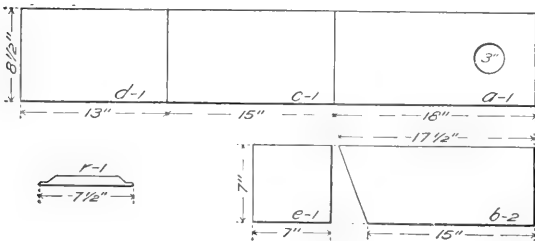

FIG. 21.—Diagrams of house shown in figure 19 for sparrow hawks and screech owls. Thickness of boards $\frac{3}{4}$ inch.

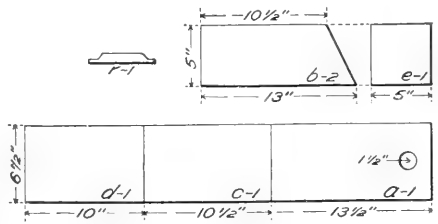

FIG. 22.—Diagrams of house shown in figure 19 for bluebirds. Thickness of boards $\frac{3}{4}$ inch.

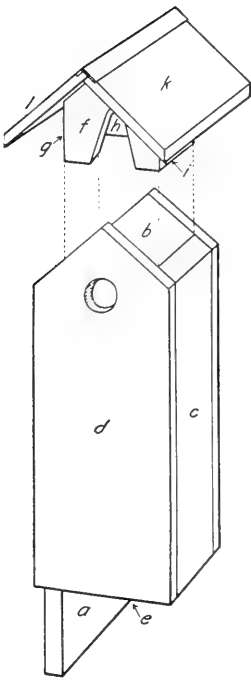

FIG. 23.—Flicker house to be mounted on post or stub of tree.

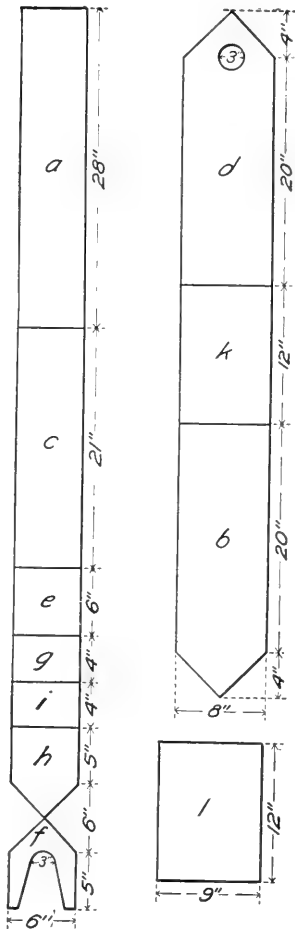

FIG. 24.—Lumber diagrams for flicker house shown in figure 23. Thickness of boards $\frac{3}{4}$ inch.

placed in shaded places as the metal becomes very hot in the sun.

Bird houses in the Southern States have long been made from gourds. The entrance is in the side and a drain hole in the bottom, as shown in Figure 3. A piece of wire through the neck for mounting it completes the house. A number of gourds thus prepared and strung on a pole seems to make a satisfactory tenement house for a colony of martins. Used singly they are equally well adapted to wrens and bluebirds. While gourds are not durable when exposed to the weather they are easily replaced.

Ordinary wooden boxes, if clean, can be made into bird houses by merely nailing on a cover and cutting out an entrance hole. Such makeshifts are rarely weatherproof and are never pleasing to the eye. Branches containing real woodpecker holes, when obtainable, are perhaps the best attraction that can be offered most house birds in the breeding season. By carefully fitting such a branch to a fruit or shade tree its foreign origin

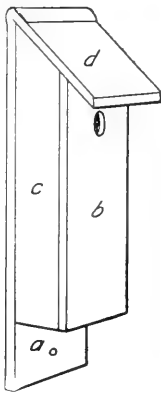
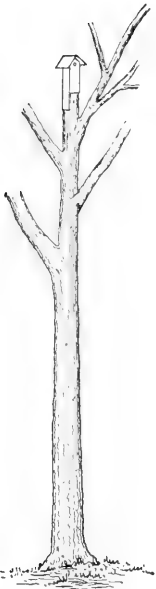

FIG. 25.—House to be placed in tree for woodpeckers, chickadees, nuthatches or titmice.

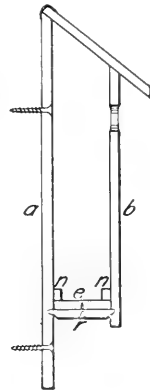

FIG. 26.—Section of house shown in figure 25.

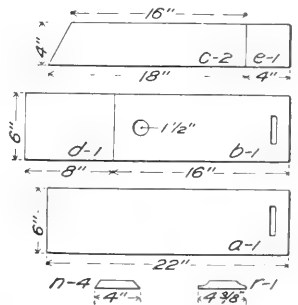

FIG. 27 Lumber diagrams of house shown in figure 25, suitable for downy woodpecker. By reducing size of entrance it becomes right for titmice and nuthatches. Thickness of boards $\frac{3}{4}$ inch.

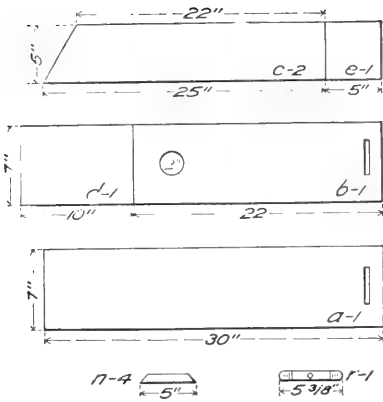

FIG. 28.—Lumber diagrams of house shown in figure 25, suitable for red-headed woodpecker. Thickness of boards $\frac{3}{4}$ inch.

will scarcely be noticed. The house shown in Figure 6 is suitable for use in trees. It is made from a log or large branch, hollowed by decay, and fitted with a top and bottom as illustrated in the figure. The cover is to go on after the log is fastened in place. Either the top or bottom should be removable. Methods of doing this are shown in Figures

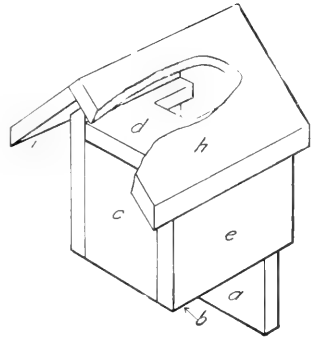

FIG. 29.—House for wrens and house finches. Roof broken to show interior.

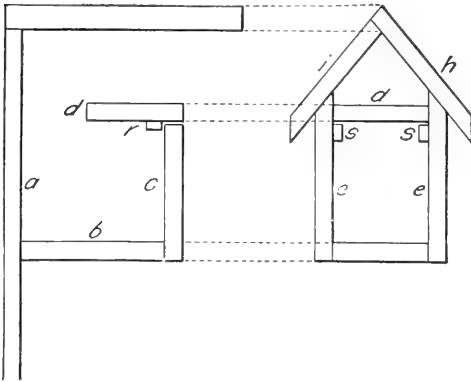

FIG. 30.—Sections of house shown in figure 29. Upper floor removable.

23 and 26. Another way of making a log house is to split a straight-grained log 2 feet or more in length through the middle and then cut out a cavity with a gouge. The excavations in the two halves can be made to match exactly by means of a pattern or template having the size and shape desired for the proposed cavity through the plane of cleavage. Figure 7 shows the appearance of such a house and how to place the template symmetrically on each half of the stick. The top of this house should be covered with tin or zinc to keep out moisture. The halves should be fastened together with screws to

allow the house to be taken apart and cleaned.

Phœbes like to nest about buildings, and a simple shelf under the roof of a porch or shed is all they require. If, however, it is desirable to have them stay outside,

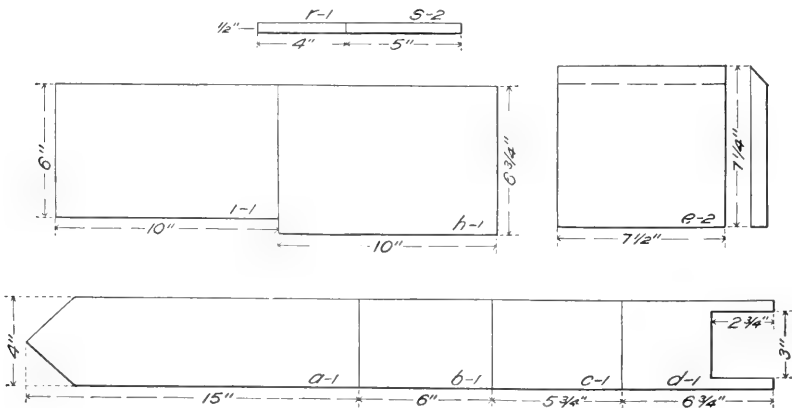

FIG. 31.—Lumber diagrams for house shown in figure 29. Thickness of boards $\frac{3}{4}$ inch.

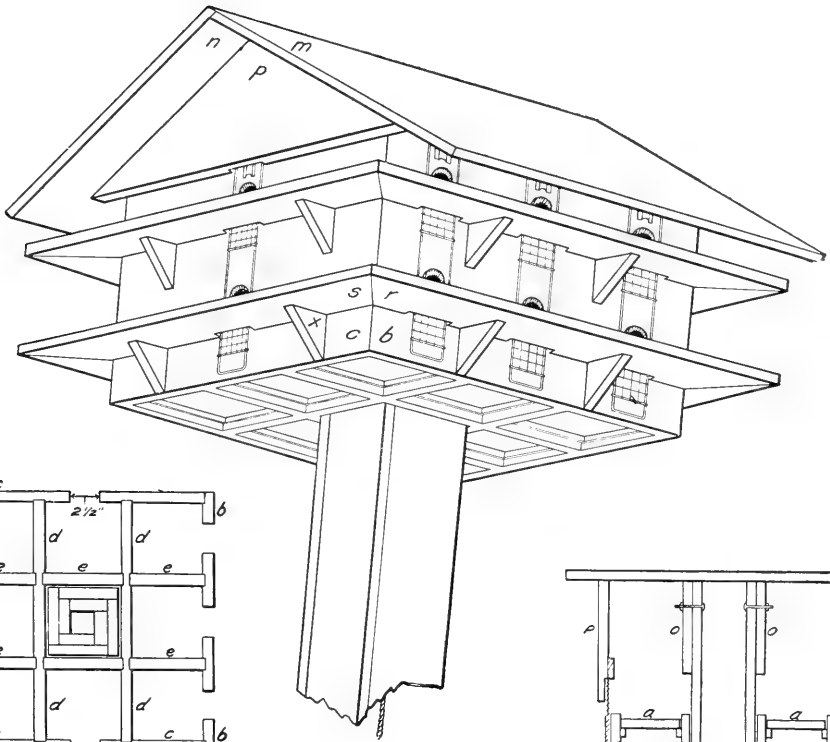

FIG. 32.—Martin house.

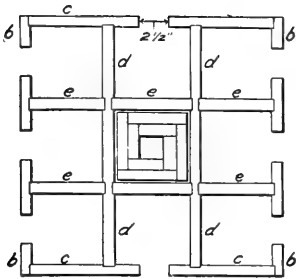

FIG. 33.—Horizontal section of martin house.

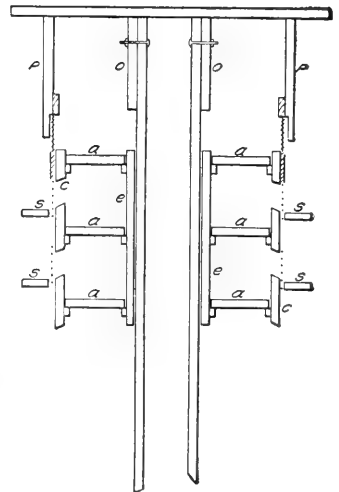

FIG. 35.—Longitudinal vertical section of martin house; lowered, and doors closed.

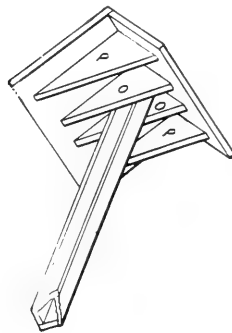

FIG. 36.—Roof of martin house attached solidly to pole.

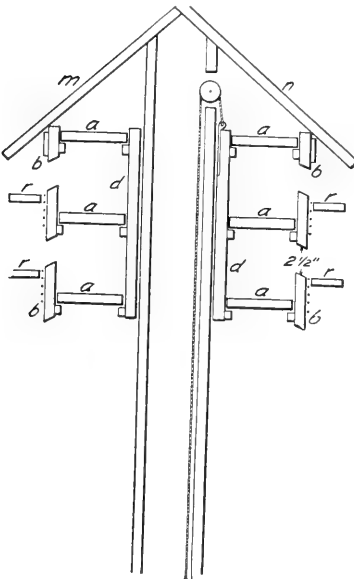

FIG. 34.—Cross vertical section of martin house; raised and doors open.

the shelf must be provided with a roof. Figure 8 shows a shelf shielded from the weather by one wall and a roof. This shelf if placed high under the eaves of a two-story building may attract barn swallows; phœbes and robins also are likely to build upon it if it is not less than 8 feet from the ground. In some cases it will be advisable to leave only one side open.

A nest shelter designed to be placed in shrubbery for catbirds, brown thrashers and song sparrows is shown in Figure 10. As it requires little lumber or labor, one may well be placed in

every patch of weeds or brush frequented by these birds. Fastened to a large horizontal branch or in a crotch of a tree it is likely to be used by robins.

The house shown in Figures 12 to 15 is designed to be set on a pole or a tree stub for the use of swallows especially. It can be cleaned by simply lifting the box from its base. Bluebirds and wrens, as well as swallows, nest in this style of house though they prefer a deeper cavity. Another pole house is shown in Figure 17. This is essentially after the woodpecker model and is suitable for bluebirds. By releasing the hooks which fasten the box to the base, cleaning is easy. Figure 19 illustrates a house to be attached to a tree. It can be opened for cleaning by turning a button and removing the bottom. This house is easy to build and if suitably proportioned is adapted to a great variety of birds. Plans are furnished for two sizes—one for bluebirds and the other for screech owls or sparrow hawks.

The flicker house shown in Figure 23 is designed to be placed on a post or the stub of a tree. The roof can be lifted in the same way that a stopper is removed from a bottle. A house suitable for members of the woodpecker family and also for nuthatches and titmice, including chickadees, is shown in Figure 25. It is attached to boles of trees.



FIG. 39.—Proper way to make first "hitch" of rope on hook of counterweight.

The bottom is removable, as appears in Figure 26.

Figure 29 shows a house designed for wrens and house finches. For wrens it may be placed on a tree or fence post. If attached near the eaves of a building, house finches or wrens will use it. The front gable is open, entrance to the room below being through the rear of the upper floor. This house can be opened for cleaning by lifting out the upper floor.

Martin houses are built on the apartment plan to satisfy the social instinct so marked in martins but so conspicuously lacking in most other birds. They usually contain not less than ten or twelve rooms and for this reason are relatively complicated, especially if they are minatures of elaborate buildings, as is often the case. Like the single room houses, they should be easy to inspect and clean from top to bottom and, if possible, should be made proof against the English sparrow. An attempt to combine these essentials in a plain house is illustrated in Figure 32. The body of this house slides upon its pole, to the top of which the roof is solidly attached (Figure 36). The pole is hollow and through it runs a cord by which the house is raised and lowered. The floors are all removable by lifting up. When the house is out of contact with the roof all of the entrances are closed by gates actuated by springs, the gates moving upward to close, and being kept down and open by pressure against the roof. By means of this device sparrows may be kept out of the house until martins are due to arrive, or if they get in when the house

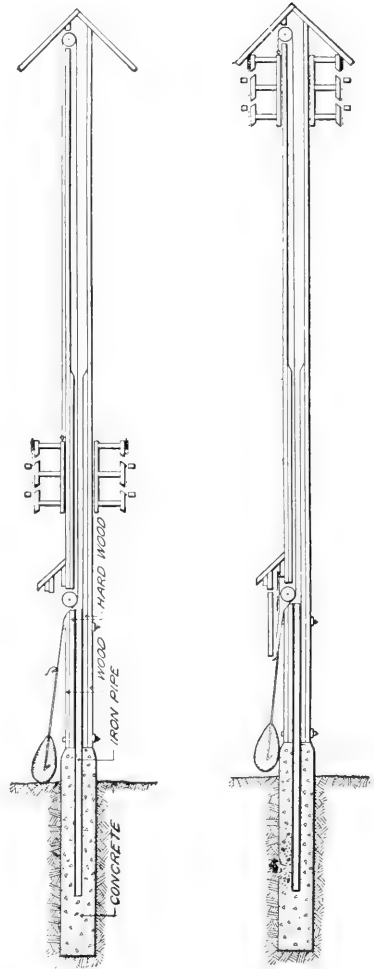

FIG. 37.—Martin house lowered; doors closed.

FIG. 38.—Martin house in place; doors open.

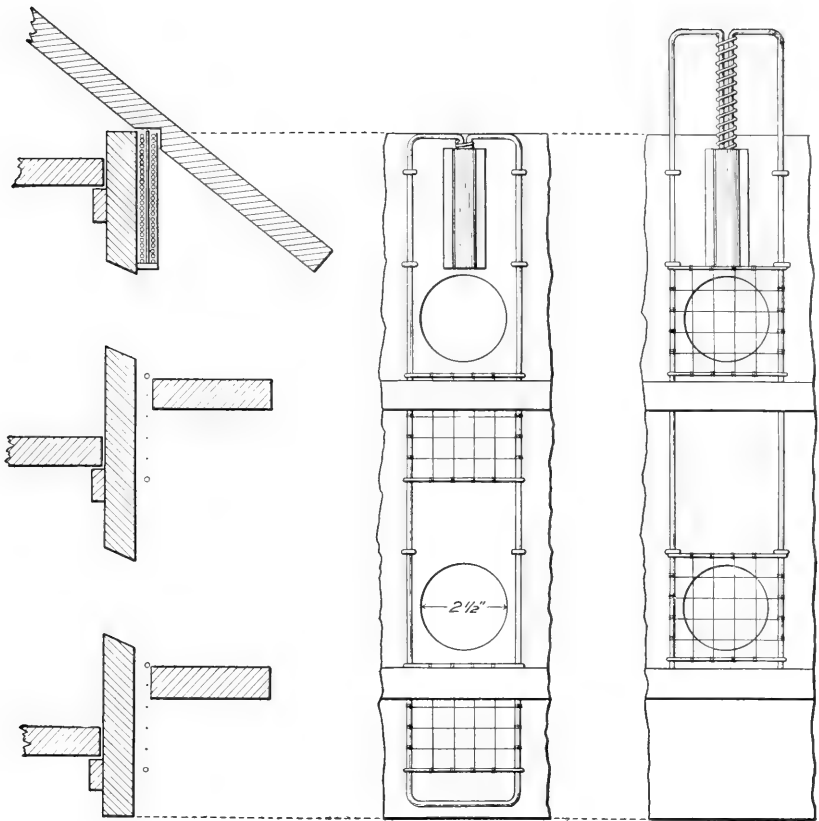

FIG. 40.—Details of construction and operation of gates.

is open they can be trapped by suddenly lowering it. The pole shown here is made from hardwood boards put together with screws. The concrete base has a core of 2-inch iron pipe which extends upward far enough to make a firm connection with the upper part on which the house slides. A heavy weight is employed to hold the house hard against the roof. By passing the cord around the hook of the weight exactly as shown in Figure 39 and pulling it upward until the weight is clear of the ground, it can easily be held without slipping while a more secure knot can be tied. A hook less wearing to the cord and fully as serviceable may be made from an acute natural crotch of oak or other hardwood instead of iron. Where this house is exposed to strong winds it may be advisable to attach guy wires to corners of the roof. The pole may be made of a single piece of 4-inch galvanized pipe, set in a concrete base. In this case the house should be a cylinder and the roof a cone.

*From a bulletin of the Biological Survey.

Campers More Careful

In northern Arizona, Utah, Nevada, southern Idaho, and western Wyoming, the fires on national forests set by campers have decreased in four years from nearly a third to approximately one-fifth. Lightning fires have increased from less than one-fourth to nearly one-half. The relatively larger proportion from lightning, however, is due partly to decrease in other causes.

EDITORIAL

\$10,000,000 NEEDED FOR FOREST RESERVES

THE next Congress will be asked to provide for an appropriation of \$10,000,000 for use at the rate of \$2,000,000 a year to continue the purchase of land in the Southern Appalachians and White Mountains as Federal Forest Reserves. It is most important that the money be set aside for this purpose. It means much to the future of the whole Atlantic seaboard to have several million acres of non-agricultural land from most of which all merchantable timber has been removed, held in reserve under Government ownership, protected from fire and disease and perpetuated as productive forest land. All through New England and along the Southern Appalachians there is a very strong sentiment in favor of continuing the purchase of these forest growing lands and it is certain that Congress will be urged from many quarters to provide for the appropriation with as little delay as possible.

The present appropriations for the purchase of lands in the Southern Appalachian and White Mountains will cease with the fiscal year, that is on June 30, 1915. There is now available for further purchases about \$1,000,000, which sum will be sufficient to carry the work to near the end of 1915. The area approved for purchase by the National Forest Reservation Commission, or already acquired, is 1,186,000 acres, the average cost of which has been slightly over \$5.00 per acre with an additional expense of approximately 60 cents per acre for appraisals, surveys, title examinations and supervision. It is estimated by officials of the Forest Service that with the remaining one million dollars enough additional lands can be purchased to bring the total to more than 1,400,000 acres, with an average price not exceeding \$6.00 per acre.

The work was started and has been carried on under the greatest difficul-

ties as to surveys and titles. No other part of the country is believed to have titles so involved or to present so many boundary complications as do the Southern Appalachian Mountains in which the bulk of this work has been done. This in part accounts for the low price of the land and the relatively high cost of examinations, surveys and title work.

The Secretary of Agriculture in a report to Congress in 1907 recommended the purchase of 5,000,000 acres in the Southern Appalachians and 600,000 acres in the White Mountains. The National Forest Reservation Commission in its last report to Congress strongly approves of that recommendation, in fact adopts it as its working program, and recommends that Congress extend the appropriations for purchases through a further period of five years at the rate of two million dollars per year.

The American Forestry Association for eleven years labored to secure the legislation embodied in the Weeks law. It has closely watched the execution of the law under the National Forest Reservation Commission and the Department of Agriculture and the results which have been accomplished demonstrate fully the wisdom of the program which has been undertaken. Furthermore great good is being accomplished by the Government in putting the purchased lands immediately under administration so that they can be protected from fire and fully utilized as National Forests.

In view of the achievements accomplished in the way of purchases and in the administration of acquired lands the American Forestry Association considers it appropriate to give full support to the National Forest Reservation Commission in its recommendation to Congress for appropriations at the rate of two million dollars per year for a

further period of five years. This program will be actively urged at the next session of Congress and it is hoped that other associations and organizations,

which so faithfully labored to start the movement for Federal purchases in the Appalachians, will give it active support now that it is well begun.

FORESTRY ON A FIRM BASIS IN NEW JERSEY

THROUGH a group of laws enacted by the legislature which has just adjourned, and after a State-wide discussion that has subjected the work of the Forest Commission to the closest scrutiny, the forest policy of New Jersey seems to be firmly established.

The most important act is that by which the Forest Commission, and its whole organization including the State Forester and State Firewarden, is consolidated with the Geological Survey, the Water Supply Commission and two park commissions in a Department of Conservation and Development. This new department is yet to be organized, but the intent of the statute is that forestry shall be advanced rather than retarded in any way.

The second act authorizes the Forest Commission (and its successor) to establish a patrol, at the cost of the responsible party, wherever an extraordinary fire hazard is created. The specific purpose of this is to guard the railroad exposure, which in parts of New Jersey is exceptionally serious.

The third measure is a complement to the second and authorizes the Forest Commission to require the disposal of brush and litter whenever it shall be accumulated in a way to be dangerous.

Neither of these control acts is rigid or mandatory but vests in the Forest Commission discretionary power to abate a nuisance.

For the present forestry in New Jersey is largely a question of fire control; behind that lie exceptional opportunities in management based upon the mild climate, warm soil, and unusual market conditions.

The modifications in the game laws which were desired, one of which was recommended by the Governor, have not been secured. The property owners of the State, therefore, continue to be exposed to the very serious hazard that is created every fall by the hunters.

A much-desired revision of the shade tree laws has also been secured. As New Jersey has been a leader in this direction the new act is likely to be of value outside the State as well as to its own municipalities.

Change in Address.

Members of the American Forestry Association are requested to send notification of any change in address so that the AMERICAN FORESTRY MAGAZINE and other mail will not be delayed in reaching them.

Such notices are desired before the 25th of each month so that the address may be changed for the monthly mailing of the magazine.

FOREST NOTES

The Pocono Protective Fire Association, of Monroe County, Pennsylvania, is following up its well tried methods to instruct the people of the community and to interest them in forest protection. It has repeated this year its offer of \$25.00 as prize money for competition in essay writing on topics relating to forestry by the scholars of the County. Last year forty-two responded; this year there are sixty-five.

There is a two-fold object behind these school contests. First, to set the young people of the County to thinking about the subjects on which the essays are written; and, second, by interesting these scholars to awaken interest in the same subjects in the adult members of their families. That which interests the children becomes the talk of the household and cannot fail to influence, in some degree at least, the grown-ups.

With a similar object in view the directors of the Association for two years have got the fire wardens of the County together in March for an informal conference and a dinner. This year the meeting was held at the Inn at Buck Hill Falls, on March 20th; and twenty-three wardens were present. Mr. C. N. Thompson, one of the directors of the Association, and manager at the Inn, was the host, and entertained the entire company. Besides the fire wardens and the directors, the State Department of Forestry was represented by District Forester J. L. Strobeck and Forest Inspector George H. Wirt.

Mr. Wirt made the principal address, having come from Harrisburg for the occasion. Mr. Strobeck gave the wardens their instructions for the coming fire season, and there were addresses from others, including some of the wardens.

The whole affair was eminently successful, and there is good reason to regard these annual meetings and dinners as permanent institutions in Monroe County. They bring the men together in a social way and at the same time serve to impress upon them a sense of united action, and a realization that they are part of an organized body working for the good of the community and the State.

The nation-wide study of the lumber industry, which is being made jointly by the Department of Agriculture and the Department of Commerce, and the other industrial and technical investigations and experiments which have been carried on by the Forest Service in the last two years was discussed at a conference of Forest Service officials at Madison, Wis., on April 14 to 17. The Forest Service Laboratory, the Washington Office of Industrial Investigations, and each of the seven National Forest Districts was represented at the conference by specialists. Among the subjects for discussion were Cooperation of the Forest Service with industries, lumber distribution in the United States, utilization of

low-grade lumber and mill waste, adaptation of manufacturing and grading to specific classes of consumers, unification and standardization of lumber grades, study and development of general markets for National Forest timber, mill scale studies, including technical methods, tallying, etc.; lumber depreciation, and the collection and compilation of lumber price data.

The information already collected by the Forest Service under some of these headings includes the most exhaustive data on the mechanical properties of wood ever collected by any agency in the world, and already has resulted in practical reforms and big savings to several of the important wood-using industries.

The American Sawmill Company has presented The New York State College of Forestry with a portable sawmill. This mill is to be set up at the College Experiment Station at Rockwell and it is expected that it will prove of considerable use in practical demonstration work for the students. Numerous small problems may be brought out in great detail with this equipment.

The State Ranger School at Wanakena of the College of Forestry at Syracuse opened its fourth successful year the first Tuesday in March with twenty men from all parts of the State who will take a year of practical training in the school, fitting themselves for such positions as forest guards, rangers, tree planting experts and forest estate managers. Mr. G. A. Gutches, formerly District Inspector of Forests of Saskatchewan, has just been brought in to take charge of the school and he will seek to make the school of especial service to the lumbermen and forest owners of the State. Mr. Gutches will be assisted by Professor E. F. McCarthy who will be in charge of the instructional work at the school. Both Director Gutches and Professor McCarthy are graduates of the Forest School of the University of Michigan and both have had wide experience in forest work for the United States Government in the West. Besides the experience with the United States Forest Service, Mr. Gutches has spent three years in charge of very important lines of forest work in Western Canada.

Receipts from grazing permits on the National Forests for the season of 1915 will contribute to the public revenues approximately \$1,200,000, or about \$200,000 more than last year, according to an estimate made from the allowances just authorized by the Secretary of Agriculture. The Forests this year will furnish forage for 1,983,775 cattle and horses, 8,747,025 sheep and goats, and 64,040 swine, the figures indicating a material increase of meat production on the government-regulated ranges.

The largest tract of California pine ever offered by the Government has been purchased by the Pelican Bay Lumber Company, of Klamath Falls. Its bid of \$3 a thousand for the first unit of 85,000,000 feet on Four Mile Creek and \$3.25 for the pine in the second unit of 297,000,000 on the Bear Creek water shed was found to be the highest when the bids were opened in Portland, Ore., April 10.

Arrangements have just been completed between the authorities of the public parks and public schools of the City of Binghamton, New York, and The New York State College of Forestry at Syracuse University for the making of a complete shade tree census of Binghamton. The work is outlined and the necessary material and instructions are furnished by The New York State College of Forestry in such a way as to make the field work of distinct educational value to the pupils in the public high schools. The information gathered will be used in the preparation of a shade tree map for Binghamton.

The State College of Forestry at Syracuse will cooperate during the coming spring with the State Education Department at Albany and the High Schools of the State in the

development of various school forests and a Forest Day. This cooperation was furthered by means of a bulletin entitled, "The Planting of Forest Trees by the Public Schools of the State," a copy of this bulletin was sent to each High School in the State. Arrangements have already been completed with fourteen High Schools in the State in the matter of starting a school forest during the coming spring and each one of these schools will plant from 1,000 to 5,000 trees.

Secretary Lane has approved the plan to open Yellowstone National Park to automobiles this summer under regulations which will later be prescribed, and has fixed August 1 as the date for their admission. This is the only national park which automobilists have not hitherto been allowed to use. In 1913 the Interior Department threw open Yosemite National Park to motorists, under careful regulations, and it has resulted in a very much wider use of that park.

Mr. James A. Conners, of the James W. Sewall office, has been appointed City Engineer of Old Town, Maine.

BOOK RECEIVED

THE LOG OF A TIMBER CRUISER, by William Pinkney Lawson, \$1.50. (Duffield & Co., New York.)

Mr. Lawson was formerly an Assistant Forest Ranger in the United States Forest Service and in this book, which has thirty-two pages of illustrations, he gives an accurate and vivid account of the field work of the United States Forest Service. He not only tells of the adventures of an actual cruising party in the Gila National Forest, but gives also an in-

tensely interesting description of Forest Service field work; and of what it means to be a forester—of his difficulties, triumphs, pleasure and satisfactions. The book is full of the best kind of out-of-door spirit, and the experiences of the cruising party are described with a humor and understanding that will make the book fascinating to those who now know the Forest Service only as a name, and at the same time it is an intimate record for all Forest Service men.

Chestnut Quarantine

The chestnut bark disease has become so serious that in the opinion of the United States Department of Agriculture it is desirable to quarantine New England, New York, New Jersey, Pennsylvania, Delaware, Maryland, Virginia, West Virginia, Ohio, North Carolina, Iowa, and Nebraska, or such portions thereof as may be found to be essential. A public hearing on this question will be held in Washington at 10 o'clock on May 18th. The proposed quarantine will restrict the movement from this territory of chestnut nursery stock and chestnut lumber with the bark on.

CANADIAN DEPARTMENT

By ELLWOOD WILSON

The most important happening of the month, from a forestry standpoint, is the announcement by the Hon. Frank Cochrane, Minister of Railways and Canals, that he has instructed the Management of the Intercolonial and other Dominion Government Railways, to put into force the fire protection regulations imposed on the other railways of Canada by the Dominion Railway Commission, thus removing a very curious and harmful anomaly. Mr. Cochrane is to be congratulated and his common sense and public spirit will receive the thanks of all those interested in the conservation of the forests of Eastern Canada and all timber owners in that section. This matter was first brought to Mr. Cochrane's notice by Sir Clifford Sifton, Chairman of the Conservation Commission, and he also deserves credit for this step forward.

If the National Transcontinental Railway is taken over and operated by the Government the Dominion Railway Commission's Fire Protection Regulations will be put in force. The Grand Trunk Pacific has practically refused to operate this line constructed by the Government and in order to keep the right-of-way from falling to pieces it must be operated.

In order to stimulate the revenues the British Columbia Government have again amended the Forest Act so as to permit of the reinstatement of any timber licenses that have lapsed since the thirty-first of December, 1906.

The Government has appointed Mr. H. R. MacMillan, its Chief Forester, special commissioner to proceed to Australia, to study market conditions for British Columbia timber and to arrange with the Australian Government for better terms and a broader market. He will also do everything possible to advertise British Columbia woods and explain their uses and advantages. No better man could possibly have been selected for such a mission and we wish Mr. MacMillan a pleasant and most successful trip.

The St. Maurice Lumber Company is preparing to construct several miles of telephone lines through their limits this spring.

Mr. J. M. Dalton, of the Gres Falls Pulp & Paper Company, has just returned from a trip to St. Jacques to see the working of a gasoline log hauler and returned much impressed with what he saw. One hauler was taking five large sleighs carrying about 7,000 board feet per trip and making three trips per ten-hour day on a 7 mile road. There was no trouble whatever in getting up even long steep hills

but some difficulty in going down as it was hard to keep the sleds used as trailers from getting across the roads and otherwise out of line. The machine would take the five loaded trailers up hills that a horse could not have hauled a bunk load on and in breaking out branch roads the machine would take its load through loose snow that would completely stall a horse drawing an empty sled. It was doing the work of twenty-five horses.

The spring work of the St. Maurice Forest Protective Association has commenced and every effort will be made to keep the fires down to a lower figure than ever this season. Plans are matured and everything is in readiness. A new departure will be made this spring in that a special ranger will be assigned to each log drive and it is hoped that this will cut out one of the commonest sources of fires. Several miles of new telephone will be built and one of the rangers working in a settled district will probably be supplied with a Ford automobile.

A meeting of the lumbermen on the Upper Ottawa river was held recently and the formation of the Upper Ottawa Forest Protective Association was discussed and most of the lumbermen were in favor of it. At a later meeting however it was decided to wait for another year. Evidently the limit holders on the Upper Ottawa, being further back in the woods are less progressive than their brethren lower down the river, who formed the Lower Ottawa Association last spring and were much pleased with its success during the past very dangerous season.

Mr. Robson Black has been appointed Secretary of the Canadian Forestry Association to take the place vacated by the resignation of Mr. James Lawler. Mr. Black is a graduate of Queen's University and was for seven years on the editorial staffs of the Montreal Herald, Montreal Star, Ottawa Citizen and Toronto News. Two years ago he went into magazine work and was Editor of the Financial Press Service of Canada. He was also publicity manager for the Conservative Party in Ontario. Mr. Black will have ample scope for his talents and energies and the Association is expecting much from him.

Mr. G. C. Boyd, of Bobcaygeon, Ont., who has large lumber interests spent a few days in Grand Mere, looking over the forestry work of the Laurentide Company.

Messrs. G. D. McKay and Arnold Hanssen have been elected active members and Mr. B. K. Ayers an associate member of the

Canadian Society of Forest Engineers. Mr. McKay was the first Chief Fire Warden of British Columbia and is now Chief Timber Inspector of that Province. Mr. Hanssen is a graduate of the Royal Fredriks University of Norway and of the Norwegian Government School of Forestry and has been with the Laurentide Company for three years. Mr. Ayers is Yale Forest School M. F. 1913 and worked for the Society for the Protection of The New Hampshire Forests and for the State of New Hampshire, and later for the Laurentide Company and is now with The Ansonia Forest Products Company at Ansonia, Conn.

The following are the officers of the Canadian Society of Forest Engineers, just elected to serve for three years: President, Clyde Leavitt of Ottawa, Forester to the Dominion Conservation Commission and Chief Fire Inspector for the Dominion Railway Commission; Vice-President, H. R. MacMillan, Chief Forester of British Columbia; Secretary-Treasurer, Ellwood Wilson, Forester to the Laurentide Company, Ltd.

Mr. B. M. Winegar, Forester to the Operating Department, Eastern Division of the Canadian Pacific Railway, will be married in June to Miss Dohan, of Montreal.

Mr. J. E. Rothery, of the firm of Vitale & Rothery, of New York, has been elected a Fellow of the Royal Geographical Society.

Mr. M. A. Grainger, of The British Columbia Forest Service, has written a most interesting book which should appeal to every lover of the outdoor life, called a "Woodsman of the West."

The Dominion Parks Branch is doing all in its power to make the parks and forest reserves of Canada known and to make them of use, interest and help to all the people. Four illustrated pamphlets have just been issued by the Superintendent, Mr. J. B. Harkin: "Just a Sprig of Mountain Heather," "Glaciers of the Rockies and Selkirks," "Classified Guide to Fish and their Habitat in the Rocky Mountains Park," and "The Nakimu Caves." These are very interesting reading and anyone who wants a delightful trip for the summer should send for them. There are six scenic and four animal parks already established in Canada, all of them well worth a visit and they are not surpassed by any European scenery. Many of the glaciers are easily accessible to tourists and every type of Alpine scenery can be found. Six varieties of game fish are found in the Rocky Mountains Park, the lake trout of Lake Minnewanka sometimes weigh up to 40 pounds and the brook trout planted have excellently adapted themselves. Ponies are used in going from lake to lake and the man who loves fishing can have a delightful trip. Caves are a feature of the Glacier Dominion Park and the Government is constantly making them more accessible to the public.

A novel type of fire poster is being introduced in these Parks, made of enameled sheet iron with a picture of a forest fire at the top. These are very striking and are durable.

Dr. C. Gordon Hewitt, Dominion Entomologist, says that the depredations of bark beetles in British Columbia have been very serious and further studies of these insects and ways to combat them will be made during the coming summer. Further studies of the parasites of the spruce bed worm will be made. This insect, which has been serious in Eastern Canada for the past five years seems to be dying out.

Forest Assistant L. C. Tilt has been appointed to the Manitoba Inspection Office at Winnipeg.

Mr. C. F. McFayden, who resigned his position with the British Columbia Forest Branch, has been appointed Forest Assistant under the Dominion Service and will probably be assigned to the Athabasca Division of the Rocky Mountain Forest Reserve.

Nineteen employes of the Dominion Forest Branch have enlisted for the war, among them Messrs. G. E. Bothwell, A. E. Parlow, J. B. Mitchell and F. McVickar, members of the Canadian Society of Forest Engineers.

The Forester's Club of Ottawa has been active lately and during the latter part of February had a very interesting meeting at which Mr. R. H. Campbell, Director of the Dominion Forest Branch told of his trip to Europe and of his discussion with Dr. Schlich on the Canadian Forests.

The Pulp and Paper Association, of Canada has formed a Technical Section which will collaborate with the Dominion Forest Products Laboratory.

The water of the River St. Lawrence is exceptionally low this spring and the gradual but steadily decreasing amount of water is said to be due to the denuding of the watersheds by cutting and fire. This is a very serious matter as it affects very materially the trade of Montreal and thus of the whole Dominion.

A very interesting decision has just been rendered by the Canadian courts which holds that a man employed in the woods is not a workman under the Workman's Compensation Act and if injured must seek compensation under the common law. He is classed with agricultural laborers. This seems logical as forestry is really a department of agriculture.

CURRENT LITERATURE

MONTHLY LIST FOR APRIL, 1915.

Forestry As A Whole

(Books and periodicals index in the library of the United States Forestry Service.)

New Jersey—Forest park reservation commission. Why New Jersey advocates forestry. 4 p. Trenton, N. J., 1915.

Proceedings and reports and associations, forest officers, etc.

California—State forester. Fifth biennial report, 1913-1914. 202 p. il., pl. Sacramento, Cal., 1914.

India—Burma—Forest department. Report on forest administration for the year 1912-13. 149 p. Rangoon, 1914.

India—Northwest frontier province—Forest department. Progress report on forest administration for 1913-14. 48 p. Peshawar, 1914.

Indiana—State board of forestry. Fourteenth annual report, 1914. 100 p. il. Indianapolis, 1915.

Montana—State forester. Biennial reports, 2d-3d, 1911-14. Map. Helena, Mont., 1912-14.

New York state college of forestry, Syracuse university. Empire forester, Jan. 1915, v. 1, no. 1. 88 p. il. Syracuse, 1915.

South Australia—Woods and forests dept. Annual progress report upon state forest administration for the year 1913-14. 11 p. pl. Adelaide, 1915.

Washington—State board of forest commissioners. Report of the state forester for the period ending Nov. 30, 1914. 29 p. Olympia, 1915.

Forest Aesthetics

Street and park trees

Buck, F. E. The planting and care of shade trees. 24 p. il. Ottawa, 1914. (Canada—Dept. of agriculture—Dominion experimental farms. Bulletin no. 19, 2d ser.)

Silveira, Alvaro Astolpho da. A arborização de Bello Horizonte. 14 p. pl. Bello Horizonte, Imprensa official do estado de minas geracs, 1914.

Forest Education

Arbor day

Kentucky—Department of education. Arbor and bird day, 1914-1915. 149 p. il., pl. Frankfort, 1915.

Forest schools

Briscoe, John M. Forestry summer camp course. 4 p. il. Orono, Me., 1915. (University of Maine—College of agriculture—Extension department. Timely hints for farmers, v. 8, no. 5.)

Georgia state forest school. Summer camp Georgia state forest school, June 21 to August 21. 8 p. il. Athens, Ga., 1915. (Georgia state college of agriculture. Bulletin, March 1915.)

India—Forest college, Dehra Dun. Progress report for the year 1913-14. 27 p. Calcutta, 1914.

New York state college of forestry, Syracuse university. Announcement of the Eastern forest products laboratory in state forestry building, Syracuse. 8 p. Syracuse, N. Y., 1914.

Forest Legislation

Montana—State board of forestry. State forest land laws enacted sessions 1909 and 1911. 13 p. Helena, Mont.

Silvics

Morozov, G. F. Biologhiya nashikh lyesnuikh porod (Biology of our forest species.) 110 p. il. S.—Peterburgh, 1914.

Forest Experiment Stations

Algeria—Service des forêts. Bulletin de la Station de recherches forestières du nord de l'Afrique, v. 1, no. 2. 42 p. pl. Alger, 1914.

Silviculture

Morozov, G. F. Konspekt lektzii po obshchemu lyesovodstvu. 3 kurs: Rubki vozobnovleniya i ukhoda (Conspectus of lectures on silviculture. 3d year: Regeneration cuttings and improvement cuttings.) 78 p. pl. S.—Peterburgh, 1914.

Forest Protection

Insects

High, M. M. The huisache girdler. 9 p. pl. Wash., D. C., 1915. (U. S.—Dept. of agriculture. Bulletin 184.)

Quaintance, A. L. The San Jose scale and its control. 27 p. il. Wash., D. C., 1913. (U. S.—Department of agriculture. Farmers' bulletin 650.)

Diseases

Beattie, Rolla Kent. Bibliography of the chestnut tree blight fungus. 32 p. pl. Harrisburg, Pa., Commission for the investigation and control of the chestnut tree blight disease in Pennsylvania, 1914.

Fire

Clearwater timber protective association. Eighth annual report, 1914. 29 p. Orofino, Idaho., 1914.

New York—Conservation commission—Division of lands and forests. Manual of instruction for the forest fire protective force, 1915. 30 p. Albany, N. Y., 1915.

Forest Management

House, Homer D. Certain features of German forestry. 30 p. pl. Albany, University of the state of New York, 1915.

Forest Mensuration

Winkenwerder, Hugo, and Clark, Elias Treat. A manual of exercises in forest mensuration. 146 p. Seattle, Wash., published by the authors, 1915.

Forest Administration

- Cameron, D. Roy. Dominion forest work in British Columbia. 8 p. Vancouver, B. C., 1914
- Whitford, H. N. Agricultural land in British Columbia and its relation to forest policy and forest administration. 4 p. Victoria, B. C., 1915.

Forest Utilization

- Ekman, Wilh. Skogsteknisk handbok. 286 p. il. Stockholm, C. E. Fritzes bokförlags aktiebolag, 1908.

Lumber industry

- Kellogg, Royal Shaw. Some troubles of the lumber industry. 12 p. Chicago, Ill., National lumber manufacturers' association, 1915.
- Lewis, R. G. Forest products of Canada, 1913: lumber, lath and shingles. 55 p. diagr. Ottawa, 1915. (Canada—Dept. of the interior—Forestry branch. Bulletin 48.)
- Northern hemlock and hardwood manufacturers association. Some lumber problems, being the minutes of the 6th annual meeting, 1915. 107 p. Wausau, Wis., 1915.
- Smith, Franklin H. Japanese markets for American lumber. 16 p. Wash., D. C., 1915. (U. S.—Department of commerce—Foreign and domestic commerce, Bureau of. Special agents series no. 94.)

Wood Preservation

- Gardner, Henry A. Fire retardant paints for shingles and other wood structures. 26 p. il. Wash., D. C., 1914. (Paint manufacturers' association of the U. S.—Educational bureau—Scientific section. Bulletin no. 42.)
- Weiss, Howard F., and Teesdale, C. H. Tests of wood preservatives. 20 p. il., pl. Wash., D. C., 1915. (U. S.—Dept. of agriculture. Bulletin 145.)

Periodical Articles*Miscellaneous periodicals*

- American review of reviews, April, 1915.—The national parks on a business basis, by Stephen Tyng Mather, p. 429-31.
- Botanical gazette, March, 1915.—Growth studies in forest trees; 2. Pinus strobus, by H. P. Brown, p. 197-241.
- Breeders' gazette, March 18, 1915.—The work of Dr. Bessey, by Will C. Barnes, p. 558; The duties of forest rangers, by Will C. Barnes, p. 588-9.
- Breeders' gazette, April 8, 1915.—Fighting predatory animals on the western ranges, by Will C. Barnes, p. 705-6.
- Conservation, April, 1915.—Smoke and fume nuisance, p. 14; Cooperative fire protection, p. 15.
- Country gentleman, March 13, 1915.—Facts about fence posts; the kind of wood to use and how to use it, by S. B. Detwiler, p. 521-2.
- Country gentleman, April 3, 1915.—Planting the place with large trees, by Samuel J. Record, p. 644-5.

- Country life in America, March, 1915.—John Muir, by Bailey Millard, p. 76-7.
- Gardeners' chronicle, March 20, 1915.—North American forest trees in Britain, by A. Henry, p. 145-6.
- In the open, March, 1915.—Western catalpa, by George H. Wirt, p. 39-41.
- National wool grower, March 1915.—Pastures and sheds in connection with range lambing grounds, by James T. Jardine, p. 17-21.
- Out West, January, 1915.—The conservator; a story of the U. S. Forest service, by Grant Goodale, p. 15-19.
- Phytopathology, February, 1915.—Storm and drouth injury to foliage of ornamental trees, by Carl Hartley and Theodore C. Merrill, p. 20-9.
- Reclamation record, April, 1915.—Tree planting lower Yellowstone and North Dakota pumping projects, p. 164.
- Recreation, February, 1915.—Why not federal protection of migratory elk, by Will C. Barnes, p. 78-80.
- Science, March 26, 1915.—Light and the rate of growth in plants, by D. T. MacDougal, p. 467.
- Scientific American supplement, January 30, 1915.—Fire resisting wood, p. 69.
- Scientific American supplement, February 6, 1915.—The canon ball tree of tropical America, p. 92.
- United States—Department of agriculture. Journal of agricultural research, March, 1915.—Air and wind dissemination of ascopores of the chestnut-blight fungus, by F. D. Heald and others, p. 493-526.
- United States—Department of agriculture—Office of Information. Weekly news letter to crop correspondents, April 7, 1915.—Grafting and budding the walnut, p. 2-4.
- Trade journals and consular reports*
- American lumberman, March 13, 1915.—Preservative treatment of wooden silos, by George M. Hunt, p. 28-9; Lumbering in eastern Brazil, by Joao Viterbo de Sampaio, p. 55.
- American lumberman, March 20, 1915.—The economical uses of lumber, p. 30-1; Advocates town forest to provide labor, by Harris A. Reynolds, p. 38.
- American lumberman, March 27, 1915.—Piling of lumber to prevent warping, by John W. Young, p. 25; Act as beasts of burden; resourceful Forest service employes accomplish difficult task when mules give out, p. 29; Computing strength of southern pine, by Fred J. Hoxie, p. 30-2; Some peculiarities of the European tie trade, p. 40-1; Forest products display in schools, p. 43; Incense cedar for pencil manufacture, p. 57; Lumber costs as association work; read before North Carolina pine association, Norfolk, Va., March 25, 1915, by R. B. Goodman, p. 34-5, 51.
- American lumberman, April 3, 1915.—The "cedars" and moth-proof chests and closets, p. 24; More about the kyanizing of wood, p. 25; Sane and practical fire

- prevention; address delivered before the Massachusetts wholesale lumber association, by F. J. Hoxie, p. 31.
- American lumberman, April 10, 1915.—The country's cut and shipments, February, 1915, by National lumber manufacturers' association, p. 29.
- Armour engineer, March, 1915.—Preservation of wood from decay, by C. H. Teesdale, p. 200-7.
- Canada lumberman, March 15, 1915.—Increasing use of logging railroads, by E. Lisherness, p. 35; St. Maurice forest protection work, p. 36.
- Engineering record, January 16, 1915.—Test pavement of creosoted blocks at Kansas city, p. 86.
- Engineering record, February 13, 1915.—Value of paving materials discolored by two years' service test in New York, by H. W. Durham, p. 203-4; Only creosote properly applied withstands teredo, by E. S. Christian, p. 209-10.
- Engineering record, March 20, 1915.—Economic considerations justify wood-stave pipe for water-power penstocks, by Robert E. Horton, p. 356-7.
- Hardwood record, March 25, 1915.—Wood and water, p. 22; Pipe stems of bird cherry, p. 24.
- Hardwood record, April 10, 1915.—What becomes of oak lumber, p. 17; A maple with roots in the crown, by S. J. Record, p. 26A.
- Lumber trade journal, March 15, 1915.—Wood-using industries of Georgia, p. 19-29; Logged off land problems, by Harry Thompson, p. 34, 36; New grading rules adopted, by the New Orleans contractors and dealers exchange, p. 47-8.
- Lumber trade journal, April 1, 1915.—Yellow pine blocks for floors requiring service, p. 15.
- Lumber world review, April 10, 1915.—The effect of different methods of drying on the strength of wood, by H. D. Tiemann, p. 19-20.
- Mississippi Valley lumberman, April 9, 1915.—The administration of the national forests; an address before the Western forestry and conservation association, by H. S. Graves, p. 35.
- Municipal journal, March 18, 1915.—School boyforesters, by Karl W. Detzer, p. 364.
- Paper, March 17, 1915.—Sulphate pulp prospects in Canada; using waste wood in the manufacture of pulp for kraft paper encourages forestry, by Einar Gelertsen, p. 15-16.
- Paper, March 31, 1915.—The chemist in the pulp and paper industry, by F. L. Moore, p. 11-12; A laboratory for wood cellulose research, by Carl G. Schwalbe, p. 13-18; Pulpwood and mill sites in Alaska, p. 22-4.
- Paper, April 7, 1915.—The Hall process for mechanical pulp, p. 15-16, 36.
- Paper trade journal, March 18, 1915.—Wood pulp from yellow pine waste, by Guyon Miller, p. 52.
- Pulp and paper magazine, March 15, 1915.—America's pulp and paper school, by J. Newell Stephenson, p. 167-71; The German paper industry, by Grosvenor M. Jones, p. 180-4.
- St. Louis lumberman, March 15, 1915.—Specifications for structural timber, by F. J. Hoxie, p. 25; Measuring moisture in green or dry lumber, by B. D. Curtis, p. 29-30; Address on conservation at Drury college, Springfield, Mo., by John B. White, p. 60-1. List of associations and officers, p. 72.
- St. Louis lumberman, April 1, 1915.—Porch work, p. 47-8; Uses for green ebony; tropical wood employed in making toilet articles and musical instruments, by Charles Davis, p. 51; Canadian timber trade, by James Lawler, p. 55; The cost of manufacture, by Austin Cary, p. 46-8.
- Southern lumber journal, March 15, 1915.—The mill cost of lumber production today, p. 26-7.
- Southern lumberman, April 3, 1915.—Wood block paving on trial, p. 19-20, 24; Rules of Southern log association, p. 28.
- Southern lumberman, April 10, 1915.—New use for southern woods, p. 21, 23; Cost of manufacturing gum lumber, by W. B. Burke, p. 27-8; Utilizing wood waste, by Arthur D. Little, p. 34.
- Timber trade journal, March 6, 1915.—Afforestation in Ireland, p. 365.
- Timberman, March, 1915.—Philippine wood exhibit, by G. F. Cornwall, p. 35; Logging in Borneo, by Fred McCurdy, p. 36.
- United States daily consular report, March 19, 1915.—Wooden sandals in Mexico, by L. B. Hoyt, p. 1117-18.
- United States daily consular report, March 27, 1915.—Hongkong lumber trade, by George E. Anderson, p. 1241; Camphor tree in Federated Malay states, by Caspar L. Dreier, p. 1243.
- United States daily consular report, April 5, 1915.—Canadian maple sugar season, by G. Russell Taggart, p. 66; Chemical pulp in Scandinavia, by Michael J. Hendrick, and Ernest L. Harris, p. 70-1.
- United States daily consular report, April 7, 1915.—Portable timber-felling machines for India, by Henry D. Baker, p. 111; Sale of turpentine and rosin in France, by John Ball Osborne, p. 112; Wooden ties for British railways, by Carl R. Loop, p. 127.
- United States daily consular report, April 9, 1915.—Lumber trade in Russia, by John H. Snodgrass, p. 153-5.
- United States daily consular report, April 10, 1915.—Lumber trade in the British Isles, by Lorin A. Lathrop, p. 181-9.
- United States daily consular reports, April 12, 1915.—Box and barrel shooks in Ceylon, by Walter A. Leonard, p. 202-3; Wattle-bark supplies of British colonies, by George H. Murphy, p. 206-7; Finnish paper and wood-pulp industry, by John H. Snodgrass, p. 207.

- United States daily consular report, April 14, 1915.—Lumber market in Spain, by Wilbur T. Gracey, p. 250-3.
- Veneers, April, 1915.—New veneered door construction, by J. Crow Taylor, p. 11-12.
- West Coast lumberman, March 15, 1915.—Scientific practices in timber utilization, by O. T. Swan, p. 20, 34; The logged land problem, by C. J. Zintheo, p. 42.
- Wood turning, February, 1915.—Sawing handle stock, by James F. Hobart, p. 11-12.
- Wood turning, April, 1915.—Toys consume much wood, p. 15; Evolution of the cedar pencil, p. 21.
- Forest journals*
- Boletín de bosques, pesca i caza, May, 1914.—Nuevos ensayos sobre preservacion de maderas, by Ramon A. Cabrera, p. 527-33; Los bosques de Chile, by F. Albert, p. 533-41; Casas de madera sin elaborar; indicaciones jenerales para su construccion, by A. Veloso, and Ramon A. Cabrera, p. 542-54.
- Boletín de bosques, pesca i caza, June, 1914.—Destruccion de bosques en Honduras, p. 607-8; Impregnacion electrica de la madera, p. 608-9; Las bosques en Palentina, p. 609-10.
- Canadian forestry journal, March, 1915.—The relation of forestry to the development of the country, by R. H. Campbell, p. 35-9.
- Forest leaves, April, 1915.—State forest improvements in 1914, by George H. Wirt, p. 19-20; Forest fires and their prevention, by S. B. Elliott, p. 21-3; Forest problems in Pennsylvania, by J. T. Rothrock, p. 24-5; Forest fires in Pennsylvania in 1914, p. 28.
- Forestry quarterly, March, 1915.—The point of view, by James W. Toumey, p. 1-3; A town forest in America, by Page S. Bunker, p. 4-7; A practical system of logging cost-accounting, Samuel B. Detwiler, p. 8-11; Tables for determining profits in forestry, by W. D. Sterrett and W. B. Barrows, p. 12-14; Reforestation of brush fields in northern California, by Richard H. Boerker, p. 15-24; Charcoal as a means of solving some nursery problems, by George A. Retan, p. 25-30; Some aspects of the northern plains forest region of Canada, by A. B. Connell, p. 31-4; The use of brands and other marks on livestock, by Carnot Valiton, p. 35-42; A method of yield regulation, by M. Muret, p. 43-6; Forests and forest industries of Quebec, p. 71-2.
- Indian forester, January, 1915.—Fungi and plant diseases, p. 1-2; The tali-pot palm (*Corypha umbraculifera*), by G. S. Butterworth, p. 3-6; One year's meteorological observations at Changa-Manga, by R. N. Parker, p. 6-13; Note on anwal (*Cassia auriculata*) barks form Marwar, by Puran Singh, p. 14-17; A further note on the best season for collecting myrabolans as tanning material, by Puran Singh, p. 17-21; What is forestry, p. 25-8; Sugar from sawdust, p. 28-30.
- Indian forester, February, 1915.—Two wire-ropeways, p. 35-40.
- Ohio forester, January, 1915.—The forestry work of the experiment station, by Edmund Secrest, p. 3-15.
- Ohio forester, April, 1915.—The evolution of American forestry, by F. W. Rane, p. 3-6; Hoop poles, by J. W. Calland, p. 6-7.
- Philippine agriculturist and forester, January, 1915.—Camphor in the Philippines, by Francisco A. Quisumbing, p. 190-2.
- Skogen, January, 1915.—Om Jämtlands skydds-skogar (Concerning Jemtland's protection forests), by Erik Geete, p. 1-26; Atgärder till förekommande av skadegörelse a ungskog (Measures for preventing damage in young forests), by R. Lübeck, p. 27-9.
- Skogsvårdsföreningens tidskrift, January, 1915.—Sagverksteknikens utveckling (Development of sawmill technique), by Otto Hellström, p. 73-84; Markflorans analys pa objektiv grund (An analysis of the living ground cover as a basis for determining types), by Torsten Lagerberg, p. 1-72.
- Skogsvårdsföreningens tidskrift, February, 1915.—Om skogseld, dess förebyggande och bekämpande (Concerning forest fires, their prevention and extinction), by Gustaf Lundberg, p. 113-56; Redögorelse för verksamheten vid statens skogsförsöksanstalt under år 1914 (Report of the activities of the state forest experiment station for the year 1914), by Gunar Schotte, and Hesselman, p. 157-64; Synpunkter rörande skötseln av enskildes skogar i lappmarken (Suggestions concerning the care of private forests in Lapland), by Th. Hermelin, p. 165-8; Svenska trävaruexportföreningen och Norrlandska skogsvårdskommitténs forslag (Reply to the forest administration's statement of November 14, 1914, by the Swedish wood export society), p. 169-71; Domänstyrelsens svar pa Svenska trävaruexportföreningens genmäle den 31 dec. 1914 (Answer to the Swedish wood export society's reply of December 31, 1914, by the forest administration), p. 172-4; De ecklesiastiska skogarnas förvaltning (The administration of the state forests), by Hugo Tigerschiöld, p. 175-8.
- Tidsskrift för skogbruk, March, 1915.—Litt om, havd man laerte om Sveriges skogbruk paa den baltiske utsilling 1914 (A little concerning what one learned regarding Swedish forestry at the Baltic exposition), by Henrik Jelstrup, p. 79-91; Skogtaksation og skogbruk (Forest valuation and forestry), by R. M. Aubert, p. 94-104; Litt fra "eventyrylandet" Nordmarken (A little from the fairy land of Nordmarken), by J. T., p. 105-6; Procentkurver for hugst (Percent curves for cutting), by G., p. 107-10; Margboreren (The pith borer), by K., p. 110-15; Plantningen i Valdres (The plantation in Valdres), by Edv. Bull, p. 115-16.
- Yale forest school news, April 1, 1915.—Public resources: the wrong and the right way to handle them, by Henry S. Graves, p. 15-18.

FORESTERS ATTENTION

AMERICAN FORESTRY will print free of charge in this column advertisements of foresters wanting positions, or of persons having employment to offer foresters

YOUNG MAN, expert in all branches of shade tree work and with forestry training, desires position as forester, arboriculturist or tree surgeon. References furnished. Address C. S., care AMERICAN FORESTRY.

FORESTER of technical training, six years' teaching and practical experience in different parts of the United States, wishes to better position. Best references from university and employers, and others. Address G. O. T., Care AMERICAN FORESTRY.

FORESTER with 15 years experience Estimating, Surveying, Mapping, and in the care of private holdings desires position. Perfectly reliable in every way, and with executive ability. Address "A," care AMERICAN FORESTRY.

WANTED—By Graduate Forester, position in forestry work in South, or Tropics. Slight knowledge of Spanish and German. Scientific or experimental work preferred. Address, "F. W. H." Care of AMERICAN FORESTRY.

WANTED—By young man intending to study forestry, position with lumber company, surveying party, or other position by which he can gain practical knowledge. Address L. L., Care AMERICAN FORESTRY.

YOUNG MAN, 27 years old, unmarried, university training, business experience and three years of practical experience in surveying and construction, including preliminary surveys, estimates, railroad and highway location surveys and construction, topographic surveys, mapping, etc. Capable of taking charge of party, desires position with forester or lumber firm. Best references from former employers. Address "T. B. C.," Care AMERICAN FORESTRY.

FORESTER, with seven years' practical experience, desires a position as Forester. Have had considerable experience in reforestation and management, also fire protection. Address "T. F. H." Care AMERICAN FORESTRY.

FOREST ENGINEER—Best of American and European training. Five years of practical work along lines of organization, administration, protection, cruising and appraising. Would like position with some large timber holding company, railroad, or municipal watershed. Best of references. Address "CRUISER," Care AMERICAN FORESTRY.

A forest school graduate with experience in U. S. Forest Service and with lumber company, also possessing thorough business training, will consider offer of good forestry position. Address M., care AMERICAN FORESTRY.

WANTED—Position by practical experienced man as tree surgeon. Am familiar with trees of all kinds. Special terms on orchard work. Terms reasonable. Small jobs will not be considered. Will send book upon request. Do not write for book out of idle curiosity. Address Box 6, care of AMERICAN FORESTRY.

MAN with practical experience in lumbering, timber estimating, mapping and compass work. Have had one year of college training and would like position where there is an opportunity to acquire further knowledge of forestry. Address Box 7, care of AMERICAN FORESTRY.

POSITION WANTED—Engineer with twelve years' experience in Engineering and Forestry. Expert land surveyor, timber estimator, timberland R. R. location. Experienced in woods operation and good manager of men. Permanent position desired with Timber Company, Railroad Company or Private Estate. At present employed. Address Box 4, Care AMERICAN FORESTRY.

ASSISTANT FORESTER—\$1,500 to \$1,800 annum. Limited to residents of New Jersey if a sufficient number of qualified candidates; if not, open to citizens of the United States without regard to residence. Candidates will be permitted to submit replies and papers in this examination by mail.

All candidates must be Professional Foresters with good, practical experience. Experience in woodlot management, in small lumbering and in shade tree work is desired. Subjects of examination and relative weights:

Experience and Education.....	6
Personal qualifications, age, character, etc.....	2
Paper on some subject pertinent to forest conditions in New Jersey.....	2

TOTAL.....10

Communicate with **CIVIL SERVICE COMMISSION**, State House, Trenton, N. J.

A GRADUATE of one of the leading Forestry Schools of the country, with some experience in State and private work, would like to secure a position in some Eastern or Central State. Address S. G. H., care AMERICAN FORESTRY.

FOREST ENGINEER seeks position with an estimating firm or with a lumber company. Best of references. Address Forest Engineer, Care AMERICAN FORESTRY.

GRADUATE FORESTER—Practical experience in cruising, mapping and scaling. Eager to go anywhere. References furnished. Address R. L., care of AMERICAN FORESTRY.

PRACTICAL FORESTER wants situation on private estate. Has practical experience of sowing, laying, planting out, pruning, thinning, firebelts, ditching, rotation planting, mixed planting and thorough knowledge of fencing and tree felling. Has had seven years experience on best managed forestry area in Scotland. Address, "Raith," Care AMERICAN FORESTRY.

PRACTICAL FORESTER wants position with city Park Commission. Understands fully nursery work, planting, trimming and tree surgery. Best references and practical experience. Address "L. M. E.," Care AMERICAN FORESTRY.

WANTED—A position as an inspector of ties, timbers and lumber, by a forest school graduate with experience in inspecting ties, timbers and lumber. Can furnish best of references. Address Inspector, Care AMERICAN FORESTRY.

Graduate of Forestry School, having studied forestry and lumbering operations in this country and Germany, with experience in the U. S. Forest Service, and also in state and private nursery work, would like position with forest engineering firm or lumber company. Best of references. Address XY, Care of AMERICAN FORESTRY.

WANTED—A job as fire ranger or guard by a strong, healthy young man twenty-one years of age. Address "3" care AMERICAN FORESTRY.

WANTED—Position by a clean cut young man, with A-1 references, with a Forestry Expert or a surveying party, or any other business where a knowledge of the subject of forestry can be had. Address G. W. H., care AMERICAN FORESTRY.

AMERICAN FORESTRY'S ADVERTISERS

POSITION WANTED—Am graduate of Biltmore Forest School, with good record in survey, estimate and estate management and want position where I will have a chance to learn more. Have done practical work outside of school and am considered good at timber. Willing to go anywhere and be generally useful. Hard worker, don't mind long hours. Age, twenty-six. Give me interview or let me send references. Address J. U., care AMERICAN FORESTRY.

FOREST ENGINEER with training in this country and abroad, will consider position as Secretary of Fire Protective, Forestry or Conservation Association. Thoroughly experienced in Forestry and publicity work, and competent to handle affairs of such organization. Well recommended. Address "SECRETARY". Care of AMERICAN FORESTRY, Washington, D. C.

YOUNG MAN—Four years' practical experience in reforestation, nursery work, improvement thinning, fire protection and tree surgery, wishes position on private estate or for state or municipal work. Experienced handling men. Best of references. Address R. A., care AMERICAN FORESTRY.

FOREST ENGINEER of ability and experience wishes the management of large timbered tract. Thoroughly experienced in Lumbering and Practical private Forestry, and capable of taking entire charge of game preserve, private estate, or other forested lands. Well recommended. Address "Woods Supt.," Care of AMERICAN FORESTRY, Washington, D. C.

WANTED.—A Position as Superintendent on Private Estate. Expert experience with 22 years' backing, on Forestry, Agriculture, Horticulture, Landscape Engineering. Graduate Civil Engineer, Practical Experience in all mentioned work. Will take full responsibility of any estate or construction of an estate and guarantee my work. Fair salary expected. Please state salary you are willing to offer with reply. I will not accept a position in "part." I will not accept position under three months' notice to my present Employer. Address "V. C. P." Care AMERICAN FORESTRY.

YOUNG MAN, 29 years old, wishes position with forest owner or lumber mill concern, to take care of all waste timber. Have 12 years' experience in distilling and extracting by-products from forest wastes, etc. Address 1, Care AMERICAN FORESTRY.

FORESTER wants position with Consulting Forestry firm, or with lumber company or private estate. Training from Michigan Agricultural College and Yale Forest School; four years' experience with U. S. Forest Service and two winters with lumber companies. Acquainted thoroughly with Montana, Idaho and California timber as cruiser. References on request. Address E., Care AMERICAN FORESTRY.

ENERGETIC Post Graduate Forester desires position as an assistant in park or city forestry work. Subordinate duties preferred. Best of references. Address M. M. J., Care of AMERICAN FORESTRY.

FOREST ENGINEER with Forest Service training in Colorado, Wyoming, private work in California, and six years' experience in the lumber industry on the Pacific Coast, would like field work in any part of the United States. Estimating of timber lands and topographic surveying a specialty. Four years' technical training. Address, "D." Care AMERICAN FORESTRY.

WANTED—Position as City Forester or Park Superintendent. Willing to consider position as an assistant. University training; experience in forestry, nursery and landscape work. Twenty-seven years old and married. Best of references. Address "F. S." Care of AMERICAN FORESTRY, Washington, D. C.

SURVEYOR—Young man 23 years old, 2½ years experience as rodman and draftsman on preliminary, location and construction for western railroads, desires position of like nature where there is an opportunity for learning forestry. Location is immaterial. Address Box 3, Care of AMERICAN FORESTRY.

FOREST SCHOOL GRADUATE with four years' experience in southern mountains, in lumbering and forestry work, would like position with Forest Engineering Firm or Lumber Company. Address XX., Care AMERICAN FORESTRY.

POSITION WANTED by Graduate Forester and Expert Nurseryman, now, in charge of large nursery. Best references. Address, "Nursery," Care of AMERICAN FORESTRY.

WANTED—A position for the summer by a student of Forestry. Experience in planing mills, steam and gasoline machinery, power boats, chaining and rodding for surveyor. Will do anything that requires work. Address Box 8, Care of AMERICAN FORESTRY.

SURVEYS AND MAPS for roads, drains and large tracts of lands. Would like work in the South during the winter months. Will consider offer of steady position. Forest work given special attention. W. B. TIMBRELL, 308 Realty Building, Elmira, N. Y.

WANTED—Timber estimating by postgraduate forester with experience in Eastern Canada and Lake States. References. Address P. T. A., Care of AMERICAN FORESTRY, Washington, D. C.

GRADUATE FORESTER desires position; practical experience in timber estimating, nursery work, also especially qualified for shade tree work; have passed Civil Service examination for forest assistant. Address "D. B.," Care of AMERICAN FORESTRY.

Wanted—Trained Forester

With TROPICAL Experience

for work for American interests in Dutch East Indies. State experience and salary expected and when services would be available.

Address Box 50, Care of AMERICAN FORESTRY

BILTMORE TEXT BOOKS

The text books of the Biltmore Forest School, written by Dr. C. A. Schenck, continue for sale at Biltmore. For particulars address BILTMORE FOREST BOOKS, Biltmore, N. C. tf

TIMBERLANDS FOR SALE

NEWFOUNDLAND LIMITS.

325,760 acres; ninety-nine year lease; has 304,640,000 feet Pine; 470,400,000 feet Birch; 890,880,000 feet Spruce for lumber; 3,120,600 cords Spruce Pulpwood; and seven (7) thousand horse water power; price \$1.25 acre; or three-fifth interest for 75 cents an acre, half cash. JOHN A. MOODY, London, Canada.

FOR QUICK SALE, 25,000 ACRES

of Virgin timber at war prices, includes land and timber, in fee simple. Titles good. Payments reasonable. Address Box 21, Care of AMERICAN FORESTRY.

INTERIOR TRIM PLANT FOR SALE

For quick sale, the best factory in the South for manufacture of furniture or interior trim. Special advantages in rates, taxes, labor, raw material both yellow pine and hardwoods. Plant is new, fireproof and insurance rate is 66 cents per \$100.00. Sale price is less than half the cost. Write for particulars and photographs.

J. P. MULHERIN, Trustee,
Augusta, Ga.

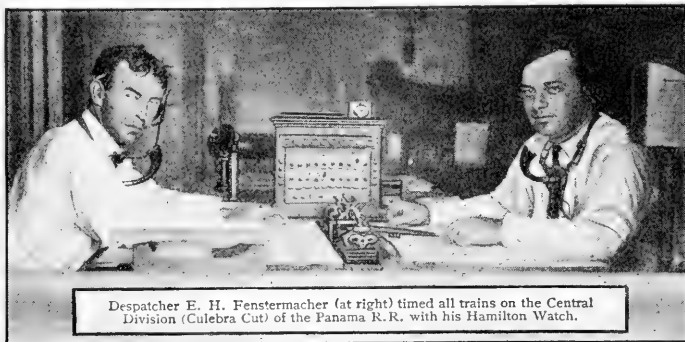

Despatcher E. H. Fenstermacher (at right) timed all trains on the Central Division (Culebra Cut) of the Panama R.R. with his Hamilton Watch.

The Hamilton Watch and the Panama Canal

Mr. Fenstermacher timed and supervised from 260 to 350 dirt train movements each day of eight hours to and from the canal prism on a *single track*. An absolutely reliable watch was necessary to avoid wrecks and tie-ups, and his *Hamilton* did the work.

Hamilton Watch

“The Watch of Railroad Accuracy”

There are thirty models of the Hamilton Watch. Every one has Hamilton quality and Hamilton accuracy. They range in price from \$12.25 for movement alone (in Canada \$12.50) up to the superb Hamilton masterpiece at \$150.00.

Your jeweler can show you the Hamilton you want, either in a cased watch or in a movement alone, to be fitted to any style case you select, or to your own watch case if you prefer.

Write for the Hamilton Watch Book—“THE TIMEKEEPER”

It pictures and describes the various Hamilton models and gives interesting watch information.

HAMILTON WATCH COMPANY

Dept. 00

Lancaster, Pennsylvania

EVERGREEN

“We Raise Our Own Trees”

Seedlings Transplants

From our specialized collection of young conifers you will find what you want for every place and purpose. Our stock is hardy and field grown and admirably adapted for forest planting and lining out.

Your order will have personal attention and the price will be right.

Send for Catalogue and save money

The North-Eastern Forestry Co.

Tree Seeds, Nursery Stock. Box A, Cheshire, Conn.



History of Forestry

By B. E. FERNOW
Dean of Forestry
University of Toronto

A book every student of Forestry should buy and without which no forest library is complete.

506 pages, 8vo
Price, \$2.50, postpaid

Address
American Forestry Association
Washington, D. C.

HILL'S SEEDLINGS and Also Tree Seeds TRANSPLANTS

FOR REFORESTING

BEST for over a half century. All leading hardy sorts, grown in immense quantities. Prices lowest. Quality highest. Forest Planter's Guide, also price lists are free. Write today and mention this magazine.

THE D. HILL NURSERY CO.

Evergreen Specialists
Largest Growers in America

BOX 501

DUNDEE, ILL.

CHANCES

for

Small Operations

in the

Sierra Nevadas

California

The Forest Service has a number of good logging and milling propositions in Eastern California along the Western Pacific R.R. Many are small and suitable for an operator with limited capital. Here are a few of them.

TAHOE NATIONAL FOREST

Mohawk Chance—1150 acres.

Jeffrey pine.....	7,011,000	feet B.M.
White fir.....	7,310,000	" "
Sugar pine.....	3,064,000	" "
Incense cedar.....	1,725,000	" "
Douglas fir.....	955,000	" "
Red fir.....	160,000	" "
	20,225,000	" "

Additional timber can be secured to extend the life of the operation if desired.

PLUMAS NATIONAL FOREST

Jackson Peak Area—925 acres

Yellow pine.....	9,959,000	feet B.M.
Sugar pine.....	410,000	" "
Douglas fir.....	3,202,000	" "
White fir.....	2,019,000	" "
Incense cedar.....	275,000	" "
	15,865,000	" "

Mill and all equipment necessary to handle this unit and place lumber f. o. b. Western Pacific would cost about \$25,000.

Taylor Creek Unit

Yellow pine.....	26,129,000	feet B.M.
Sugar pine.....	4,385,000	" "
Douglas fir.....	5,940,000	" "
White fir.....	950,000	" "
Incense cedar.....	5,947,000	" "
	43,351,000	" "

Full details in regard to these units and other bodies of National Forest timber in California may be obtained from the District Forester, San Francisco, Cal.

Harvard University

SCHOOL OF FORESTRY

OFFERS specialized graduate training leading to the degree of Master of Forestry in the following fields:—Silviculture and Management, Wood Technology, Forest Entomology, Dendrology, and (in cooperation with the Graduate School of Business Administration) the Lumber Business

For further particulars address

RICHARD T. FISHER, Chairman
Cambridge, Massachusetts

GEORGIA

State Forest School

University of Georgia

COMPLETE four-year undergraduate course in theoretical and applied forestry leading to the degree:

Bachelor of Science in Forestry

¶ Wide range of specialization offered—

Logging Engineering
Commercial Administration
Forest Management
City Forestry **State Forestry**
Dendropathology **Research**

¶ Provision for four months field work—two following each of Freshman and Sophomore years—on McHatten Forest, a large forest estate in the Blue Ridge Mountains. Numerous excursions in Dendrology and Logging. Provision for practical work in specialization during Junior-Senior vacation

For announcement address

FOREST SCHOOL
Georgia State College of Agriculture
ATHENS, GEORGIA

Yale University Forest School

NEW HAVEN, CONN., U. S. A.

YALE University Forest School is a graduate department of Yale University. It is the oldest existing forest school in the United States and exceeds any other in the number of its alumni. A general two-year course leading to the degree of Master of Forestry is offered to graduates of universities, colleges and scientific institutions of high standing and, under exceptional conditions, to men who have had three years of collegiate training, including certain prescribed subjects. Men who are not candidates for the degree may enter the School as special students, for work in any of the subjects offered in the regular course, by submitting evidence that will warrant their taking the work to their own advantage and that of the School. Those who have completed a general course in forestry are admitted for research and advanced work in Dendrology, Silviculture, Forest Management, Forest Technology, and Lumbering. The regular two-year course begins the first week in July at the School camp near Milford, Pennsylvania.

For further information address

JAMES W. TOUMEY, Director
NEW HAVEN, CONN.

In the National Forest Region

Colorado School of Forestry

A DEPARTMENT OF
COLORADO COLLEGE

THE course in theoretical and applied forestry leading to the degree of Forest Engineer covers a period of two years and is open to students who have completed two years of college work, including a sufficient amount of Botany, Geology and Surveying.

Graduate students may enter as candidates for the degree of Master of Forestry.

Fall and Spring Terms in the Manitou Forest, the College Reserve, 6,000 acres of pine and spruce timberland on the borders of the Pike National Forest. Winter Term at Colorado Springs.

For particulars address

Colorado School of Forestry
Colorado Springs, Colo.

Special Courses offered in

LUMBERING *and* WOOD UTILIZATION, PULP and PAPER MAKING

Other Special Courses in Forestry

Men with technical training along the lines of Lumbering and the various branches of Wood Utilization will be needed in the future.

Four and five year students in these courses will have constant access to the new Eastern Forest Products Laboratory.

**The New York
State College of Forestry**
At Syracuse University
Syracuse, N. Y.

DEPARTMENT OF FORESTRY

The Pennsylvania State College

A PROFESSIONAL course in Forestry, covering four years of college work, leading to the degree of Bachelor of Science in Forestry.

Thorough and practical training for government, state, municipal and private forestry.

Four months are spent in camp in the woods in forest work.

Graduates who wish to specialize along particular lines are admitted to the "graduate forest schools" as candidates for the degree of Master of Forestry on the successful completion of one year's work.

For further information address,

Department of Forestry
PENNSYLVANIA STATE COLLEGE
State College, Pa.

High-Grade Instruction by Correspondence

Established in 1892

Successful Graduates Practicing in all States

Four Courses: Regular College (three years), Post-Graduate (one year), Business Law (five months), and Bar Examination Review (three months). Classes begin on the first and third Mondays of each month.

Approved by Bench and Bar

Send for 64 page Catalog giving the Rules for Admission to the Bar and showing the Requirements in each State.

Chicago Correspondence School of Law
802 Reaper Block, Chicago

PATENTS that properly protect

Thirty years of experience enable me to assure clients an intelligent service in securing patents that afford fullest protection. Correspondence invited.

No attorney's fee until patent is allowed

Write for free copy of "Inventor's Guide" which gives valuable information about patent protection.

FRANKLIN H. HOUGH
Loan and Trust Building WASHINGTON, D. C.

TIMBER ESTIMATES, FOREST
SURVEYS and MAPS

D. E. LAUDERBURN
Forest Engineer

6030 Metropolitan Building, New York City

TIMBER ESTIMATES
FIRE PROTECTION PLANS
MAPS. LOGGING REPORTS
EMPIRE STATE FORESTERS
156 FIFTH AVE. NEW YORK CITY

←

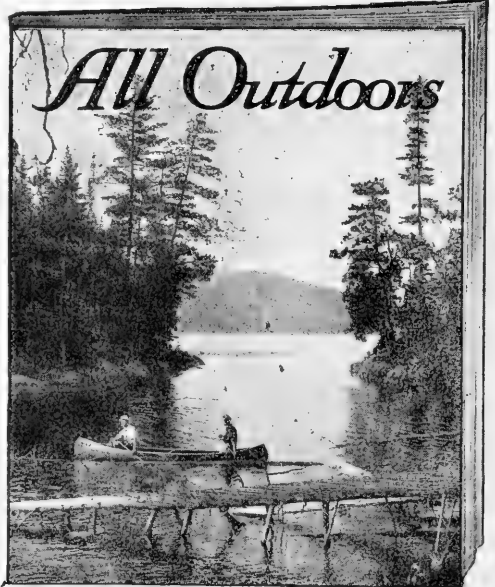

The Editor of ALL OUTDOORS
has two theories about you.

If you seek entertainment through stories of fishing, hunting, adventure, you want yarns that will give you the spirit of the real thing, not crude boastings of other men's doings.

If you wish to know how to fish, camp, shoot, canoe, feed dogs, you desire that information in the clearest, most condensed form.

Buy a copy of the May number at a newsstand for 15 cents and see how the editor has suited your needs. There are special pictures and articles for canoeists.

ALL OUTDOORS, Inc., 145 W. 36th St., N.Y.

Send me ALL OUTDOORS for six months on trial. 50 cents is enclosed. (\$1.00 for a year.)

Name

Address

AF5

ECONOMY

STRENGTH

DURABILITY

WORKABILITY

BEAUTY and

AMPLE SUPPLY

ALL COMBINED IN

Yellow Pine Lumber

The "Wood of a Thousand Uses"

If you want to know more about it
A CARD ADDRESSED TO US WILL BRING RESULTS

Our Own Mills Cut 275,000,000
Feet Annually

**MISSOURI LUMBER AND LAND
EXCHANGE COMPANY**

1111 Long Building :: KANSAS CITY, MO.

Within A Decade

Our forest resources will have been reduced to the extent of 450,000,000,000 to 500,000,000,000 feet.

That Quantity of timber will have disappeared from the market for all time.

Timber Buying Time Is Here

Today there is a market for the best of the timber. In the near tomorrow there will be a demand for all of it. In that near tomorrow timber will be good property to own—IF YOU BUY IT NOW.

James D. Lacey & Co. Timber Land Factors

CHICAGO, ILL., 1750 McCormick Building
PORTLAND, ORE., 1313 Northwestern Bank Building
SEATTLE, WASH., 1009 White Building

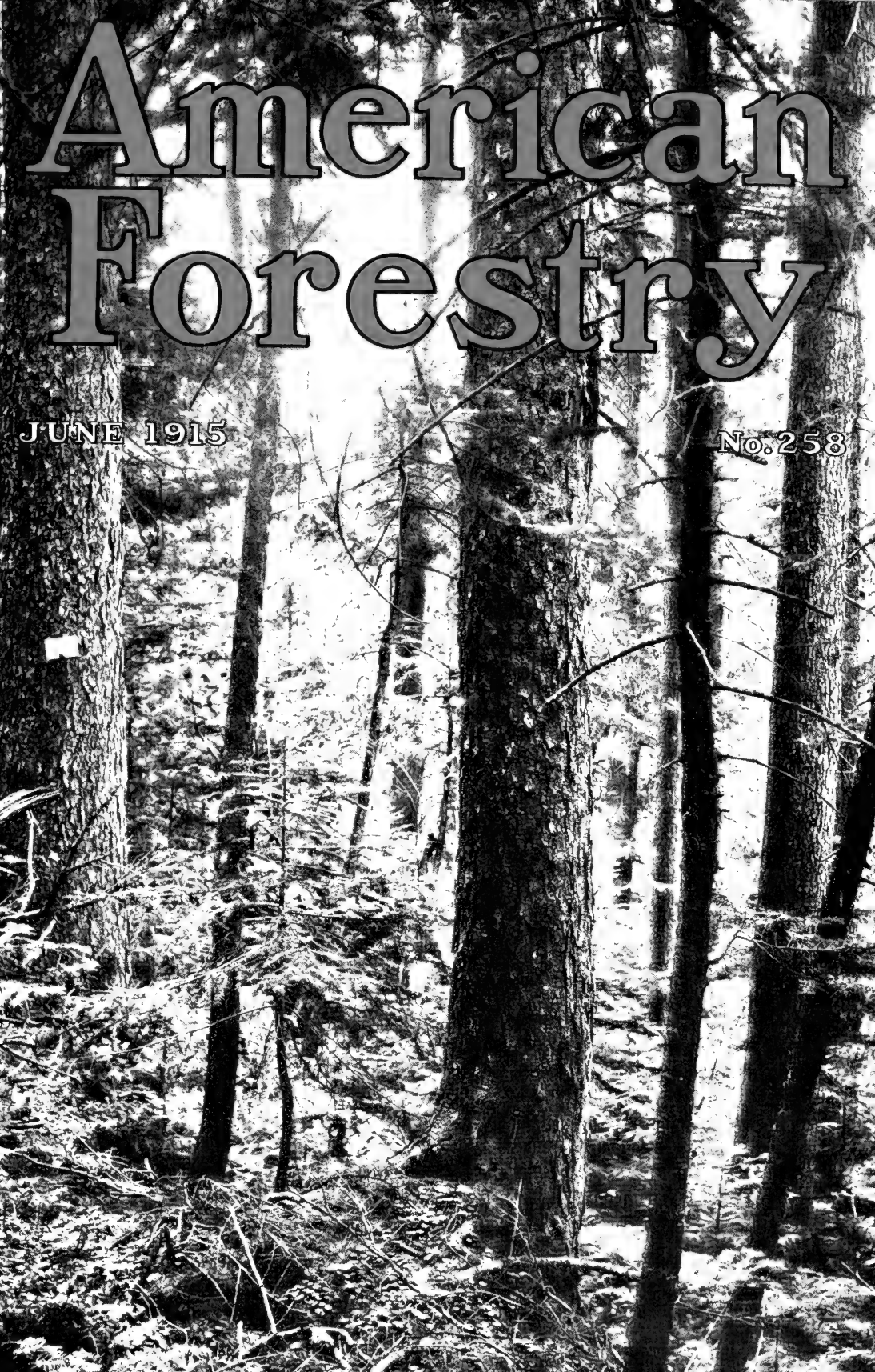

American Forestry

JUNE 1915

No. 258

BOOKS ON FORESTRY

AMERICAN FORESTRY will publish each month, for the benefit of those who wish books on forestry, a list of titles, authors and prices of such books. These may be ordered through the American Forestry Association, Washington, D. C. Prices are by mail or express prepaid.* :-: :-: :-: :-:

THE WOODS—Douglas Malloch	\$1.15
RESAWED FABLES—Douglas Malloch	1.15
THE TRAINING OF A FORESTER—Gifford Pinchot.....	1.12
LUMBER AND ITS USES—R. S. Kellogg	1.15
THE CARE OF TREES IN LAWN, STREET AND PARK—B. E. Fernow.....	2.17
NORTH AMERICAN TREES—N. L. Britton.....	7.30
KEY TO THE TREES—Collins and Preston.....	1.50
THE FARM WOODLOT—E. G. Cheyney and J. P. Wentling.....	1.70
AMERICAN FOREST TREES—Henry H. Gibson.....	6.00
IDENTIFICATION OF THE ECONOMIC WOODS OF THE UNITED STATES— Samuel J. Record.....	1.25
PLANE SURVEYING—John C. Tracy.....	3.00
FOREST MENSURATION—Henry Solon Graves.....	4.00
THE ECONOMICS OF FORESTRY—B. E. Fernow.....	1.61
FIRST BOOK OF FORESTRY—Filibert Roth.....	1.10
PRACTICAL FORESTRY—A. S. Fuller.....	1.50
PRINCIPLES OF AMERICAN FORESTRY—Samuel B. Green.....	1.50
SEASIDE PLANTING OF TREES AND SHRUBS—Alfred Gaut.....	1.75
FAMILIAR TREES—G. S. Boulger.....	1.50
MANUAL OF THE TREES OF NORTH AMERICA (exclusive of Mexico)—Charles Sprague Sargent.....	6.00
AMERICAN WOODS—Romeyn B. Hough.....	5.00
HANDBOOK OF THE TREES OF THE NORTHERN U. S. AND CANADA, EAST OF THE ROCKY MOUNTAINS—Romeyn B. Hough.....	6.00
GETTING ACQUAINTED WITH THE TREES—J. Horace McFarland.....	1.75
PRINCIPAL SPECIES OF WOOD: THEIR CHARACTERISTIC PROPERTIES— Charles Henry Snow.....	3.50
NORTH AMERICAN FORESTS AND FORESTRY—E. R. Bruncken.....	2.00
HANDBOOK OF TIMBER PRESERVATION—Samuel M. Rowe.....	4.00
TREES OF NEW ENGLAND—L. L. Dame and Henry Brooks.....	1.50
TREES AND SHRUBS—C. S. Sargent.....	5.00
TREES, SHRUBS AND VINES OF THE NORTHEASTERN UNITED STATES— H. E. Parkhurst.....	1.50
TREES—H. Marshall Ward.....	1.50
OUR NATIONAL PARKS—John Muir.....	1.91
THE LONGLEAF PINE IN VIRGIN FOREST—G. Frederick Schwarz.....	.75
LOGGING—Ralph C. Bryant.....	3.50
THE IMPORTANT TIMBER TREES OF THE UNITED STATES—S. B. Elliott..	2.50
FORESTRY IN NEW ENGLAND—Ralph C. Hawley and Austin F. Hawes.....	3.50
THE PRINCIPLES OF HANDLING WOODLANDS—Henry Solon Graves.....	1.50
SHADE TREES IN TOWNS AND CITIES—William Solotaroff.....	3.00
THE TREE GUIDE—By Julia Ellen Rogers.....	1.00
FOREST PHYSIOGRAPHY—By Isaiah Bowman.....	5.00
MANUAL FOR NORTHERN WOODSMEN—Austin Cary.....	2.12
FARM FORESTRY—Alfred Akerman.....	.57
THE THEORY AND PRACTICE OF WORKING PLANS (in forest organization) A. B. Recknagel.....	2.10
ELEMENTS OF FORESTRY—F. F. Moon and N. C. Brown.....	2.20
MECHANICAL PROPERTIES OF WOOD—Samuel J. Record.....	1.75
STUDIES OF TREES—J. J. Levison.....	1.75
TREE PRUNING—A. Des Cars.....	.65
THE PRESERVATION OF STRUCTURAL TIMBER—Howard F. Weiss.....	3.00
THE PRACTICAL LUMBERMAN—By Bernard Brereton (third edition).....	1.50

* This, of course, is not a complete list, but we shall be glad to add to it any books on forestry or related subjects upon request.—Editor.

Plant Evergreens 3-25 Feet High and All Winter Planting Will Be Welcome

IF you need to screen unattractive surroundings, garage, stable, poultry house, laundry yard, or street.

IF you admire evergreens.

IF you need windbreaks to your house, garden, out door room or play ground.

IF you enjoy hunting big Cedars, Pines, Oaks, Maples, Dogwoods, Laurel, etc., and making your place look like an old place right away.

IF you have evergreens, deciduous trees or shrubs to move to other parts of your grounds or give away or sell.

The Proof

Hicks Nurseries employed 100 men last winter except 14 days. Half were digging trees. Our winter sales for the past four years were \$16,000.00.

In January the ground freezes six inches, but is easily worked if previously mulched to keep out frost.

On the mainland the frost is deeper and more continuous, but it is easy to dig through with pick or cold chisel.

If it costs a few cents additional to plant we will bear that to keep our staff all winter.

IF you wish to prevent winter unemployment. We can provide apparatus and men to cooperate with your men or we can attend to the entire operations.

IF you wish to take advantage of present reduced prices. Carload shipments or less from the nursery of pines, spruce, cedar, 3-25 feet high.

I. HICKS & SON

Westbury, L. I.

New York

Thorburn's Tree Seeds

WE have, for many years, devoted a great deal of attention to tree seeds.

Even the rarest varieties are stocked by us, and you may be assured of prompt shipment of anything shown in our catalogue.

We should be glad to have you send us your lists for pricing. If you haven't a copy of our 1915 Catalogue one will be sent you on request.

J. M. Thorburn & Co.

53 Barclay Street through
to 54 Park Place
NEW YORK

Seeds for Forestry Purposes

WE offer a most complete list of both Deciduous and Evergreen Tree and shrub seeds for forestry purposes.

Seeds that are of best germinating quality

Our catalogue contains a full list of the varieties we offer, which include the best and most rare species. Send for a copy, it will interest you.

THOMAS MEEHAN & SONS

Wholesale Nurserymen and Tree Seedmen
DRESHER, PENNA., U. S. A.

ORCHIDS

ORCHIDS

We are specialists in Orchids, we collect, import, grow, sell and export this class of plants exclusively.

Our illustrated and descriptive catalogue of Orchids may be had on application. Also special lists of freshly imported unestablished Orchids.

LAGER & HURRELL

SUMMIT, N. J.

Orchid Growers and Importers

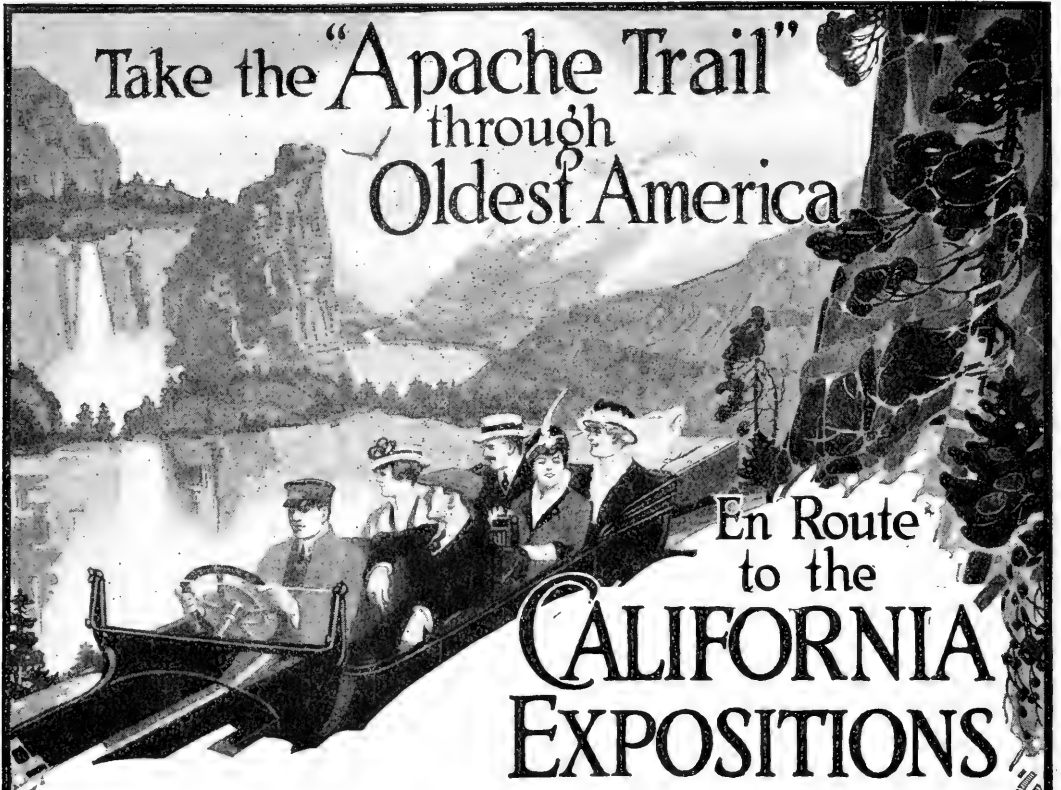

Take the "Apache Trail"
through
Oldest America

En Route
to the
**CALIFORNIA
EXPOSITIONS**

MAKE this marvelous side trip through Arizona's National Reserve — See the ancient Cliff Dwellings, famous Copper Camps, magnificent gorges and gigantic Roosevelt Dam. A journey that crowds into a few magic hours the thrill of the old Apache Trail, with the irresistible beauty and romance of the Oldest Highway in America. This is one of the many delights, if you take the

SUNSET LIMITED

(Every Day in the Year—No Extra Fare)

Southern Pacific — Sunset Route

The Exposition Line

New Orleans Los Angeles San Diego San Francisco

Automatic Electric Safety Signals. Oil burning Locomotives — no dust, no cinders.
Through Dining and Observation Cars.

Best Dining Car in America

Choice of Water or Rail Lines to New Orleans

Low Rates; Stop-overs on all one-way tickets at New Orleans, El Paso, Los Angeles and San Francisco or Oakland and at all points on round trip tickets.

Write for illustrated literature and other information

GENERAL OFFICES :

NEW YORK CITY
366 Broadway

NEW ORLEANS **HOUSTON**
Metropolitan Bank Bldg. Southern Pacific Bldg.

SAN FRANCISCO
Flood Building

Agencies all over the United States, Mexico, Cuba, Europe

THE AMERICAN FORESTRY ASSOCIATION

OFFICERS FOR 1914

President

DR. HENRY STURGIS DRINKER, President, Lehigh University, South Bethlehem, Pa.

Vice-Presidents

JOSHUA L. BAILEY, Pennsylvania
THEODORE L. BRISTOL, Connecticut
Ex-President Connecticut Forestry Association
ANDREW CARNEGIE, New York
MRS. EMMONS CROCKER, Massachusetts
DR. CHARLES W. ELIOT, Massachusetts
President Emeritus Harvard University
DR. B. E. FERNOW, Canada
Dean of Forestry, University of Toronto
HON. WALTER L. FISHER, Chicago, Ill.
Ex-Secretary of the Interior
HENRY S. GRAVES, District of Columbia
Chief of the Forest Service
EVERITT G. GRIGGS, Washington
HON. DAVID HUSTON
Secretary of Agriculture
HON. FRANKLIN K. LANE
Secretary of the Interior

HON. ASBURY F. LEVER, South Carolina
United States Representative
HON. THOMAS NELSON PAGE
Ambassador to Italy
HON. GEO. PARDEE, California
Ex-Governor of California
GIFORD PINCHOT, Philadelphia, Pa.
FILBERT ROTH, Michigan
Dean of Forestry, University of Michigan
DR. J. T. ROTHROCK, Pennsylvania
HON. WM. H. TAFT, Connecticut
Ex-President United States
JOSEPH N. TEAL, Oregon
Chairman Oregon Conservation Commission
HON. JOHN WEEKS, Massachusetts
U. S. Senator
DR. ROBERT S. WOODWARD, Washington, D. C.
President, Carnegie Institution

Treasurer

JOHN E. JENKS, Washington, D. C.
Editor, Army and Navy Register

Executive Secretary

P. S. RIDSDALE, 1410 H Street N. W., Washington, D. C.

Directors

E. T. ALLEN, Oregon
Forester, Western For. and Conservation Asso.
HON. ROBERT P. BASS, New Hampshire
Ex-Governor of New Hampshire
WM. B. GREELEY, District of Columbia
Assistant U. S. Forester
W. R. BROWN, New Hampshire
Pres., New Hamp. Forestry Commission
HERMAN H. CHAPMAN, Connecticut
Professor of Forestry, Yale Forest School
DR. HENRY S. DRINKER, Pennsylvania
President, Lehigh University
ALFRED GASKILL
State Forester, New Jersey

JOHN E. JENKS, District of Columbia
Editor, Army and Navy Register
CHESTER W. LYMAN, New York
International Paper Company
CHARLES LATHROP PACK, New Jersey
Pres., Fifth National Conservation Congress
CHARLES F. QUINCY, New York
J. E. RHODES, Illinois
Secretary Southern Pine Association
ERNEST A. STERLING, Pennsylvania
Forest and Timber Engineer
JOHN L. WEAVER, District of Columbia
Real Estate Broker
J. B. WHITE, Missouri
Ex-President, National Conservation Congress

Auditors

E. A. STERLING, Pennsylvania

C. F. QUINCY, New York

Advisory Board, Representing Affiliated Organizations

National Wholesale Lumber Dealers' Association

ROBT. C. LIPPINCOTT, Philadelphia, Pa.
R. L. SISSON, Potsdam, N. Y.
JOHN M. WOODS, Boston, Mass.

Northern Pine Manufacturers' Association

C. A. SMITH, Minneapolis, Minn.
WILLIAM IRVINE, Chippewa Falls, Wis.
F. E. WEYERHAEUSER, St. Paul, Minn.

Massachusetts Forestry Association

NATHANIEL T. KIDDER, Milton, Mass.
FREDERIC J. CAULKINS, Boston, Mass.
HARRIS A. REYNOLDS, Cambridge, Mass.

Lumbermen's Exchange

J. RANDALL WILLIAMS, JR., Philadelphia, Pa.
FREDERICK S. UNDERHILL, Philadelphia, Pa.
ROBERT C. LIPPINCOTT, Philadelphia, Pa.

Camp Fire Club of America

WARREN H. MILLER, New York
O. H. VAN NORDEN, New York
FREDERICK K. VREELAND, New York

North Carolina Forestry Association

E. B. WRIGHT, Boardman, N. C.
ALSTON GRIMES, Grimesland, N. C.
J. C. SMOOT, North Wilkesboro, N. C.

National Association of Box Manufacturers

B. W. PORTER, Greenfield, Mass.
S. B. ANDERSON, Memphis, Tenn.
ROBT. A. JOHNSON, Minneapolis, Minn.

Carriage Builders' National Association

H. C. McLEAR, Wilmington, Del.
D. T. WILSON, New York
C. A. LANCASTER, South Bend, Ind.

Boston Paper Trade Association

N. M. JONES, Lincoln, Maine
JOHN E. A. HUSSEY, Boston, Mass.
ARTHUR L. HOBSON, Boston, Mass.

Philadelphia Wholesale Lumber Dealers' Ass'n

ROBT. C. LIPPINCOTT, Philadelphia, Pa.
J. RANDALL WILLIAMS, JR., Philadelphia, Pa.
FRED'K S. UNDERHILL, Philadelphia, Pa.

New Hampshire Timberland Owners' Association

W. H. BUNDY, Boston, Mass.
EVERETT E. AMEY, Portland, Me.
F. H. BILLARD, Berlin, New Hampshire

Empire State Forest Products Association

FERRIS J. MEIGS, New York City
RUFUS L. SISSON, Potsdam, N. Y.
W. L. SYKES, Buffalo, N. Y.

California Forest Protective Association

MILES STANDISH, San Francisco, Cal.
GEO. X. WENDLING, San Francisco, Cal.
GEO. H. RHODES, San Francisco, Cal.

Minnesota Forestry Association

W. T. COX, St. Paul, Minn.
PROF. D. LANGE, St. Paul, Minn.
MRS. CARRIE BACKUS, St. Paul, Minn.

American Wood Preservers' Association

GEO. E. REX, Topeka, Kan.
CARL G. CRAWFORD, Louisville, Ky.
F. J. ANGIER, Baltimore, Md.

Southern Pine Association

J. B. WHITE, Kansas City, Mo.
J. E. RHODES, New Orleans, La.
E. A. STERLING, Philadelphia, Pa.

HUNTING AND CAMPING OUTFITS



I want to send you my new illustrated catalogue to everyone who is interested in outdoor life. I call it a

SPORTSMAN'S HANDBOOK

for it not only describes the many things an outer-man or woman needs but tells of my personal experiences in the wilds when camping, exploring, fishing and hunting, with advice as to equipment and many "kinks" in wildcraft.

Please ask for Catalogue No. 162

Rowland Robinson MANAGER
NEW YORK SPORTING GOODS Co.
 15 and 17 Warren Street, New York

You can make any camping ground *good* sleeping ground if you carry along the

"PERFECTION" Pneumatic Mattress With Sleeping Bag

Rolls to a small, light bundle, when deflated. *Easily Inflated.* Never damp, hard or lumpy. Always evenly smooth and soft, conforming to your body. *Lasts indefinitely.*

Write for catalog today

PNEUMATIC MFG. COMPANY
 552 17th St., Brooklyn, N. Y.



PATENTS that properly protect

Thirty years of experience enable me to assure clients an intelligent service in securing patents that afford fullest protection. Correspondence invited.

No attorney's fee until patent is allowed

Write for free copy of "Inventor's Guide" which gives valuable information about patent protection.

FRANKLIN H. HOUGH

Loan and Trust Building

WASHINGTON, D. C.

TIMBER ESTIMATES, FOREST SURVEYS and MAPS

D. E. LAUDERBURN

Forest Engineer

6030 Metropolitan Building, New York City

TIMBER ESTIMATES
FIRE PROTECTION PLANS
MAPS, LOGGING REPORTS
EMPIRE STATE FORESTERS
 156 FIFTH AVE., NEW YORK CITY

←

Barrett's

Grade One
 LIQUID
Creosote Oil

Cuts wood preserving bills in half—

For preserving telephone poles, telegraph poles, cross arms, railroad ties, fence posts, mine timbers, under-ground sills, sleepers, bridge timbers, planking, ice houses, wood tanks, shingles, poultry houses, silos, and structural timbers of all kinds.

Especially adapted for brush and open tank treatment.

Booklet on request.

BARRETT MANUFACTURING CO.

New York	Chicago	Philadelphia
Boston	St. Louis	Cleveland
Cincinnati	Pittsburgh	Detroit
Birmingham	Minneapolis	Seattle
Kansas City	Salt Lake City	



We make the ENGRAVINGS

for the
**AMERICAN FORESTRY
 MAGAZINE**

OUR SPECIALTY
 is the "better" grade finish of
DESIGNS & ENGRAVINGS
 in one or more colors

for Magazines, Catalogues,
 Advertisements, etc.

HALF TONES	LINE PLATES
DULLO-TONES	COMBINATION LINE AND HALF TONES
COLOR PROCESS	MULTI-COLORS

Established 1889

GATCHEL & MANNING

SIXTH and CHESTNUT STREETS
 Opposite Olde Independence Hall
PHILADELPHIA

American Forestry

The Magazine of the American Forestry Association

PERCIVAL SHELDON RIDSDALE, Editor

EDITORIAL ADVISORY BOARD

HERMAN H. CHAPMAN
 ERNEST A. STERLING
 S. T. DANA

FREDERICK S. UNDERHILL
 JOHN E. RHODES
 S. N. SPRING

June, 1915

CONTENTS

No. 258

COVER PICTURE—Scene in a White Mountain Forest	
BIRD ENEMIES OF FOREST INSECTS—By W. L. McAtee.....	681
With twelve illustrations.	
FORESTS OF JAPAN—By Nils B. Eckbo, M. F.	693
With eighteen illustrations.	
AMERICAN ACADEMY OF ARBORISTS.....	712
With seven illustrations.	
JOHN BIRKINBINE, DEAD	714
SHADE TREES AND SHRUBS—By J. J. Levison.....	715
With four illustrations.	
HICKORIES, ELMS AND ASH TREES—By Warren H. Miller, M. F.,	719
With seven illustrations.	
320 MILES OF SHADE TREES.....	729
E. T. ALLEN.....	730
One portrait.	
E. A. STERLING.....	731
One portrait.	
HARRISBURG'S MUNICIPAL FOREST—By Harry J. Mueller.....	732
With six illustrations	
A NEW CONSERVATION COMMISSIONER.....	736
With one portrait.	
FOREST HOMES.....	737
W. GOODRICH JONES OF TEXAS.....	738
With one portrait.	
OREGON FOREST STUDENTS.....	740
With four illustrations.	
FOREST FIRE "DON'TS".....	743
EDITORIAL.....	744
FOREST NOTES.....	746
CANADIAN DEPARTMENT.....	749
BRITISH COLUMBIA NOTES.....	750
CURRENT LITERATURE.....	751

AMERICAN FORESTRY is published monthly by the American Forestry Association
 Subscription price, three dollars per year; single copies, twenty-five cents

Copyright 1915, by the American Forestry Association

THE IDEAL ROUTE

To or from the Fall Meeting
of the
**AMERICAN FORESTRY
ASSOCIATION**

San Francisco, October 20, 1915

N. Y.—San Francisco

Through the

PANAMA CANAL

Large Transatlantic Liners
Under the American Flag

“FINLAND” “KROONLAND”
22,000 Tons Displacement

Circular tickets one way by water, the
other way by rail

PANAMA PACIFIC LINE

9 Broadway, New York
319 Geary Street, San Francisco

Agents Everywhere

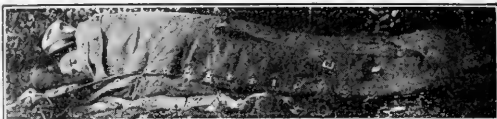

THE MILLER PACKSACK SLEEPING BAG

Made by

**The Forester Equipment Co.,
ASBURY PARK - NEW JERSEY**

The pictures tell the whole story—a Packsack that unhooks to make a Sleeping Bag. Weight with mattress bag 7½ lbs., made of the best water-proof Army drab haversacking, lined with wool batting and two detachable thicknesses of light-wove olive Army wool cloth warmer than any blankets. Bronze snap hooks fasten up sides of packsack and fasten it to browse bag.

Send for Illustrated Catalogue



Wren
House
No. 6

Do You Love Birds?

Encourage them to live in your Gardens. Use our successful bird houses for Wrens, Chickadees, Blue Birds and Purple Martins. Strongly made—well painted, to resist weather. Prices 35c to \$10.00. Design illustrated \$1.50. Our reliable, wire Sparrow Trap endorsed by U. S. Government \$3.00 F. O. B. Dubuque,

Write for free illustrated Folder No. 233A

**Farley & Loetscher Manufacturing Co.
Dubuque, Iowa**

Expert Service

*Is Demanded
by Modern
Business
Methods*

E. A. Sterling
FOREST ENGINEER

Commercial Trust Bldg.
PHILADELPHIA, PA.

Forest Engineering

is expert service in the application of scientific and economic engineering knowledge and experience to forests and their products. It is essential to modern timberland ownership and operation, and equally important to the distributor and consumer of wood.

The Field Covers

Technical Advice and Practical Service

in acquiring, estimating and mapping timber; in making valuations; in management; in selling either the stumpage or manufactured product; in selecting grades or kinds to meet your service requirements; and in preservative treatment to prevent decay.

Declaration of Principles and Policy

of the American Forestry Association

- IT IS A VOLUNTARY** organization for the inculcation and spread of a forest policy on a scale adequate for our economic needs, and any person is eligible for membership.
- IT IS INDEPENDENT**, has no official connection with any Federal or State department or policy, and is devoted to a public service conducive to national prosperity.
- IT ASSERTS THAT** forestry means the propagation and care of forests for the production of timber as a crop; protection of watersheds; utilization of non-agricultural soil; use of forests for public recreation.
- IT DECLARES THAT FORESTRY** is of immense importance to the people; that the census of 1913 shows our forests annually supply over one and a quarter billion dollars' worth of products; employ 735,000 people; pay \$367,000,000 in wages; cover 550,000,000 acres unsuited for agriculture; regulate the distribution of water; prevent erosion of lands; and are essential to the beauty of the country and the health of the nation.
- IT RECOGNIZES THAT** forestry is an industry limited by economic conditions; that private owners should be aided and encouraged by investigations, demonstrations, and educational work, since they cannot be expected to practice forestry at a financial loss; that Federal and State governments should undertake scientific forestry upon national and State forest reserves for the benefit of the public.
- IT WILL DEVOTE** its influence and educational facilities to the development of public thought and knowledge along these practical lines.

It Will Support These Policies

- FEDERAL ADMINISTRATION AND MANAGEMENT** of national forests; adequate appropriations for their care and management; Federal cooperation with the States, especially in forest fire protection.
- STATE ACTIVITY** by acquirement of forest lands; organization for fire protection; encouragement of forest planting by communal and private owners; non-political departmentally independent forest organization, with liberal appropriations for these purposes.
- FOREST FIRE PROTECTION** by Federal, State and fire protective agencies, and its encouragement and extension, individually and by cooperation; without adequate fire protection all other measures for forest crop production will fail.
- FOREST PLANTING** by Federal and State governments and long-lived corporations and acquirement of waste lands for this purpose; and also planting by private owners, where profitable, and encouragement of natural regeneration.
- FOREST TAXATION REFORMS** removing unjust burdens from owners of growing timber.
- CLOSER UTILIZATION** in logging and manufacturing without loss to owners; aid to lumbermen in achieving this.
- CUTTING OF MATURE TIMBER** where and as the domestic market demands it, except on areas maintained for park or scenic purposes, and compensation of forest owners for loss suffered through protection of watersheds, or on behalf of any public interest.
- EQUAL PROTECTION** to the lumber industry and to public interests in legislation affecting private timberland operations, recognizing that lumbering is as legitimate and necessary as the forests themselves.
- CLASSIFICATION** by experts of lands best suited for farming and those best suited for forestry; and liberal national and state appropriations for this work.

APPLICATION FOR MEMBERSHIP

Date.....

THE AMERICAN FORESTRY ASSOCIATION

1410 H Street, Washington, D. C.

Dear Sir: I hereby signify my desire to become
of the AMERICAN FORESTRY ASSOCIATION, and
enclose \$..... for dues.

- an Annual Member (\$1)
- a Subscribing Member (\$3)
- a Contributing Member (\$10)
- a Sustaining Member (\$25)
- a Life Member (\$100)
- a Patron (\$1,000)

Very truly yours,

Name.....

P. O. Address.....

American Forestry is sent to all except Annual (\$1) Members

RED OAK ACORNS

New crop—prime—fresh, excellent quality. Collected in Northern Illinois. Have between 40 to 50 bushels still on hand—price while they last \$2.00 per bushel (50 pounds), 10 bushels \$18.50. Also complete stock Evergreen Tree Seeds. Write for price-list.

THE D. HILL CO., Box No. 501, Dunder, Illinois

JAMES W. SEWALL

Timber Estimates

Topographic and Boundary Surveys, Planting, Logging Maps, Portable Mill Operations

Technical Training Thoroughness Experience

CENTRE STREET OLD TOWN, MAINE

Reducing the Cost of
Upkeep—

THE INSTALLATION of

L. C. Smith & Bros.
Typewriters

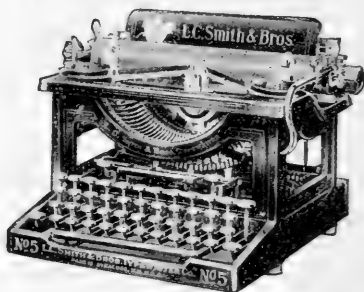

Ball Bearing; Long Wearing

is invariably followed by the discovery that the bills for ribbons are much less than before. A large corporation recently found that its ribbon expense was cut in two. This is not an accident. It is the result of the mechanical construction that makes the L. C. Smith & Bros. cheapest to maintain.

The ball bearings give light touch and eliminate

pounding impact. The ribbon is actuated by the carriage, not the typebar. The ribbon mechanism is automatic, so that the ribbon reverses at the instant the end is reached and without added strain.

Low ribbon cost, low cost of maintenance and the highest efficiency—these are guaranteed to L. C. Smith & Bros. users.

DEMONSTRATION FOR THE ASKING

L. C. SMITH & BROS. TYPEWRITER CO., Home Office and Factory, SYRACUSE, N. Y.
Branches in All Principal Cities 14th and H Streets, N. W., Washington, D. C.

American Forestry

VOL. XXI

JUNE, 1915

No. 6

BIRD ENEMIES OF FOREST INSECTS

By W. L. McATEE

Biological Survey, U. S. Department of Agriculture

BIRDS may be called health officers for our trees. Whenever unhealthy conditions prevail as a result of insect attacks, birds are sure to discover them and to do something toward improving the situation. As surgeons examine human bodies for evidences of disease and remove the cause, so birds tirelessly scan the trees from top to base, detecting insects and devouring them. As there are specialists among the surgeons, some paying particular attention to one part of the body and others to another, so with the birds in their relations to trees.

The ground feeding birds as the wild turkey, grouse, chewinks, wrens, and thrushes, search the leaf strewn forest floor and devour many insects injurious to the trees. The woodpeckers clamber about over the trunks and larger branches, detect their prey beneath the bark and dig it out. The creepers and nuthatches frequent the same parts of trees, closely inspecting crevices in the bark, which may yield some insect tidbits. The titmice, chickadees, and kinglets choose for their hunting grounds, the smaller branches, twigs and buds, where may be found the small insects and their eggs of which these little birds are so fond. The cuckoos, orioles, vireos and warblers closely examine the leaves, and prey upon the larvae and sucking insects so abundant there. The humming-birds, with some assistance from other small species, prey upon insects frequenting flowers. Moreover, the birds which feed upon or about trees are not the only ones that benefit them by devouring their insect foes. When these

insects take to flight, they are likely to be snapped up by the flycatchers, and when, as frequently happens, they form large migratory swarms, they are preyed upon voraciously by the night-hawks, swifts, and swallows.

A large number of birds participate in the destruction of forest insects, and it is fortunate that this is the case, for the insect foes of trees are legion. More than 500 different kinds of insects are known to live upon a single species of tree, and the number of individuals of these pests that are sometimes present is practically infinite. Bark infesting insects are among the most destructive enemies of the forest; they have been known to kill almost every tree of certain species over hundreds of square miles. Wood borers hasten the decay and disintegration of trees and are especially injurious to shade trees; leaf-feeding insects frequently strip trees or make them appear as if scorched by fire, and, in some cases, have threatened to destroy all of the trees upon which they feed over vast areas. The total damage to trees by insect pests is enormous, and several years ago was estimated to exceed \$110,000,000 annually. Not only is the damage extremely large, but the difficulties of directly combating insect pests in forests are so great that man is able to do comparatively little. The services of natural enemies of the destructive insects should therefore be highly appreciated. If they serve to reduce the damage by only a small percentage, the gain to the country is a very large sum. Among these enemies, birds are conspicuous. Their services are well known and have long been acknowl-

edged. No reasons have thus far developed for considering any other group of the natural enemies of forest insects in general, more important than birds.

Birds are known to destroy large numbers of bark beetles. These small beetles are among the most important pests of our forests. They feed just

A. D. Hopkins, of the U. S. Bureau of Entomology, who made a special study of this insect and its work, gives birds much credit for devouring it. He says "The principal enemy of the spruce destroying beetle, and other bark-infesting enemies of the spruce, consists of the woodpeckers, which destroy, it is believed, from 50 to 75 per cent of the

broods of the spruce beetle in many hundreds of trees each year." Mr. J. L. Webb, of the same Bureau, gives similar testimony regarding the western pine-destroying bark beetle, reporting that woodpeckers had evidently destroyed a large percentage of the insects in some of the trees." More than forty-five species of birds are known to feed upon bark beetles, and some of them occasionally eat large numbers of the insects. For instance, no fewer than twenty-three of one species of bark beetle were found in the stomach of so small a bird as the chimney swift, and in single stomachs of the hairy woodpecker, fifty have been found. The nighthawk and the chimney swift catch bark beetles while they are in flight, and usually no doubt when they are extending their ranges. No fewer



FIVE THOUSAND ANTS FOR ONE MEAL.

IT IS SEEMINGLY INCOMPREHENSIBLE BUT NEVERTHELESS TRUE THAT THE FLICKER, ONE OF THE LARGEST AND BEST KNOWN OF OUR WOODPECKERS, OFTEN EATS AS MANY AS 5,000 ANTS TO SATISFY ITS VORACIOUS APPETITE FOR ONE MEAL. IT ALSO EATS MANY OTHER INSECTS AND WAGES STEADY AND ENERGETIC WARFARE ON INSECTS WHICH ARE DESTRUCTIVE TO TREES

beneath the bark, forming tunnels which in many cases girdle and thus kill the trees. Few forest foes cause so great damage. The spruce-destroying bark beetle has been responsible for the loss of many billions of feet of timber in the northeastern United States. Dr.

than eighteen species of bark beetles have been taken from stomachs of the nighthawk and nineteen from the chimney swift.

Other beetles that are among the most destructive enemies of trees are the round-headed and flat-headed wood-

borers. Their work is similar to that of the bark-beetles in that their excavations under the bark frequently result in girdling the trees. The larvae of these beetles are the especial prey of woodpeckers; all kinds of woodpeckers eat them and usually as a regular article of diet. The three-toed woodpeckers, of which there are two species inhabiting the northern part of the country, are very fond of these larvae and make of them no less than three-fourths of their entire food. The hairy woodpecker also has a great relish for wood-boring larvae, and from a score to more than four score of the borers have been taken at a meal by single birds. The flat-headed apple tree borer, a pest in various parts of the United States, is eaten by the downy woodpecker. Prof. R. A. Cooley, of the Montana Agricultural Experiment Station, says of this bird: "Besides picking up miscellaneous pests, it locates the burrows of this borer and extracts them in considerable numbers. In the older orchards of Montana scarcely a tree can be found that does not bear the marks of woodpeckers, a large proportion of which are made by this species."

Certain kinds of caterpillars also bore timber, and one kind in particular, that of the leopard moth, is very destructive to shade trees. In various localities, it has been noted that this species is held in check by native birds. "No other explanation," says Dr. W. E. Britton, "can be given of the scarcity of the leopard moth in the country, adjacent to infested towns,

except the presence of insectivorous birds. *** Mr. James Walker, of Newark, N. J., states "that infested elms placed in a nursery outside the city limits of Newark were rid of the larvae by woodpeckers."

The work begun by the wood-borers is continued by ants. Trees that would otherwise have value, at least for firewood, are hollowed out by ants until they are mere fragile shells, ready to



RED HEADED WOODPECKER

THE UPPER IS THE ADULT BIRD, THE LOWER THE YOUNG BIRD. THE WOODPECKER FAMILY TAKES THE LEAD IN THE DESTRUCTION OF ENEMIES OF THE TREES

topple over at the first storm and of no value whatever. The ants that do this work in the United States are mostly the large black species, frequently known as carpenter-ants. They have a host of bird enemies. Fully fifty species of birds are now known to eat

them, and they sometimes take large numbers. About 600 of these large ants have been found in the stomach of single individuals of the red-shafted flicker and the pileated woodpecker, and about 1,000 in the stomach of a nighthawk. Woodpeckers are exceptionally fond of ants, certain species of this family in the United States making

expenditure of enormous sums of money annually in combating these insects, they remain pests of the first rank, and cause damage that can be reckoned only in millions of dollars.

Their natural enemies consequently are of great interest, and among them birds are by no means least. No fewer than forty-six kinds of birds are known

to feed upon the gypsy moth, in some of its stages, and thirty-one upon the brown-tail. Forty-three birds are numbered among the enemies of the orchard tent-caterpillar and thirty-two for the forest tent-caterpillar. In some cases the birds have been conspicuously successful in destroying these pests. Mr. E. H. Forbush, State Ornithologist of Massachusetts, says: "Instances were recorded during the first state campaign against the gypsy moth, from 1890 to 1895, where small isolated moth colonies appeared to have been suppressed and even annihilated by birds. A serious outbreak was discovered in Georgetown, Mass., in 1899. It had been in existence for a long time, but its spread had evidently been limited by the great number of birds that were feeding there on all forms of the moth. Several



THE BLUE JAY

THIS BIRD NOT ONLY EATS TREE INSECTS BUT PLAYS A VERY USEFUL ROLE AS A TREE PLANTER BY DISTRIBUTING QUANTITIES OF TREE SEEDS. JAYS INCLUDE IN THEIR INSECT MENU THE LARVAE OF THE DESTRUCTIVE GYPSY MOTH AND THE EGGS OF THE BROWNTAIL MOTH AND THE TENT CATERPILLAR

as high as 85 per cent of their food of ants and the whole group averaging nearly 30 per cent.

Various caterpillars must be ranked among the greatest pests of our trees. It requires no more than mention of a few species such as the tent caterpillar, the gypsy moth and the browntail to emphasize this fact. In spite of the

months later the state abandoned the work against the moth, and little hope was entertained that anything more than a severe check had been given the insect in Georgetown. Nevertheless, in the six years that have since elapsed comparatively few moths have been found in that locality. The most feasible explanation seems to be that

up to 1906 the birds have kept the numbers of the moths below the point where they can do appreciable injury."

How birds are able to accomplish such results may be better understood by considering the following observations of Messrs. Mosher and Kirkland, also reported by Mr. Forbush: A yellow warbler ate fifteen caterpillars of the gypsy moth in less than five minutes; a scarlet tanager ate upwards of thirty caterpillars within 5 minutes; two scarlet tanagers together ate small caterpillars at the rate of thirty-five a minute for 18 minutes; a crow blackbird ate forty caterpillars in a little over 3 minutes; a red-eyed vireo ate seventy-three in 40 minutes; a yellow-billed cuckoo ate eighty-one in 48 minutes. Before such enthusiastic appetites, the numbers of the most abundant insect pest must surely melt away.

Similar records for the forest tent-caterpillar are the following: A black-billed cuckoo was seen to eat thirty-six within 5 minutes; red-eyed vireos (probably a pair) took ninety-two forest tent-caterpillars from a tree within an hour; a male Baltimore oriole went into a tree infested by these caterpillars, where he stayed 4 minutes, killing eighteen caterpillars in that time, coming a little later he stayed 7 minutes and took twenty-six caterpillars.

At Ogdensburg, New York, Mary B. Sherman made the following observations on the warfare of birds against the

forest tent-caterpillar: "The town is full of birds, and they are doing good work. * * * The English sparrow has been eating the forest tent-caterpillars, and last summer they attacked the cocoons and fed on the moths. We have an unusual number of orioles

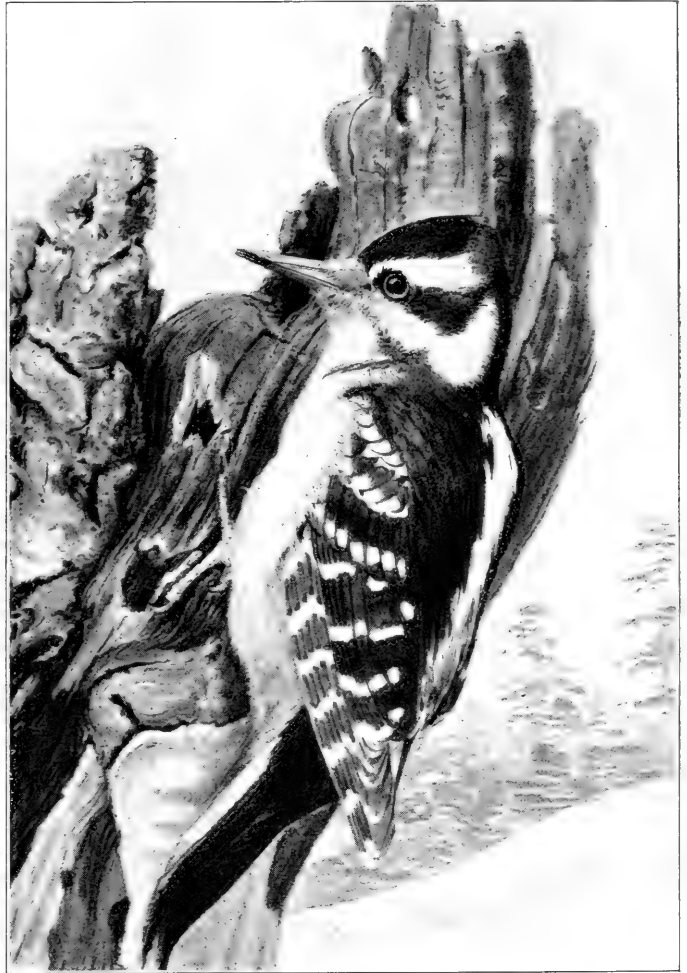

THE HAIRY WOODPECKER

THIS BIRD WITH ITS LONG SHARP BILL FOR DIGGING INSECTS, EGGS AND LARVAE FROM BENEATH THE BARK OF TREES FEEDS LARGELY ON WOOD BORING LARVAE. BARK BEETLES AND GYPSY MOTHS ARE ALSO DESTROYED BY IT

which I have seen feeding on the caterpillars. I have also seen the yellow and several other warblers, the yellow-billed cuckoo, the robin, the cedar waxwing, and I believe, the house wren feeding on the caterpillars. The maples in front of the house have been filled

with warblers, all of which were very busy with the trunks and branches. * * * We have practically no forest tent-caterpillars. * * * They hatched in large numbers, but the cold evidently killed many, and the birds appeared to have cared for the remainder."

caterpillars is recounted by America's foremost Ornithologist, Robert Ridgway.

"We first noticed the caterpillars something like two weeks ago, our attention being attracted to them by noticing several branches which had been stripped of their leaves. We then

discovered the caterpillars in clusters on the twigs and foliage and a little later a compact mass of them, about a foot long by 6 inches wide, on the bark of the trunk, a foot or so from the ground. Within a day or two of our first discovery of the pests, we saw a yellow-billed cuckoo in the tree, busily engaged in eating the caterpillars. Later this was joined by another (probably the mate) which, however, only made occasional visits to the tree, its time being doubtless mainly occupied with incubating or brooding. The other cuckoo practically *lived* in the tree, being very seldom absent, even for a short time, and was so persistent in his destruction of the caterpillars that whenever one fell to the ground he would immediately follow it and then dispatch and devour it; and later when few were left on the

tree we saw him carefully searching the ground beneath. The result of the work of these two cuckoos (principally one of them) was that within a week the colony of caterpillars was absolutely exterminated, and I have not been able to find one in the neighborhood." (July 30, 1906.)

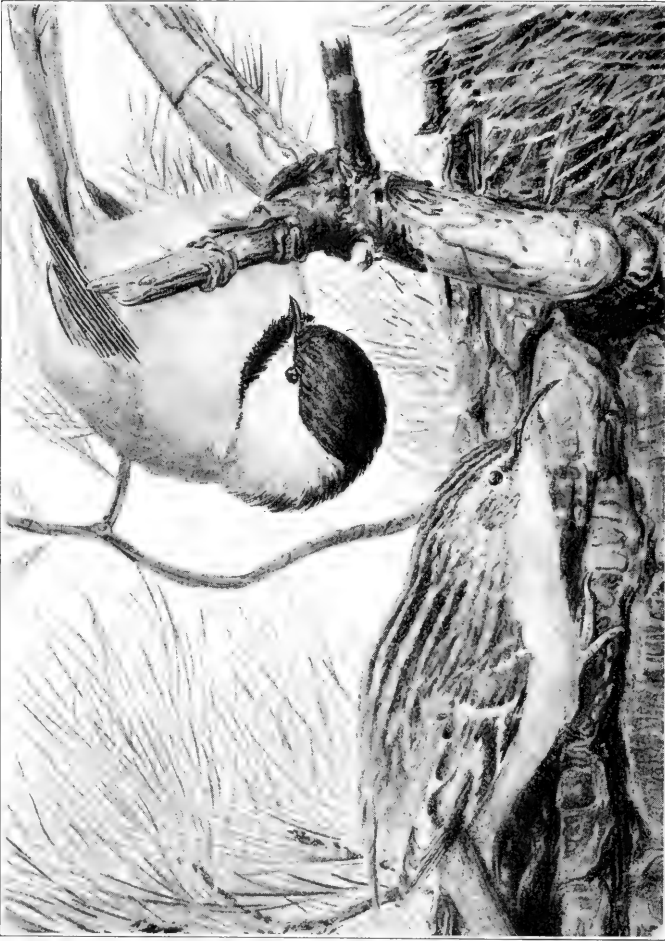

BLACK-CAPPED CHICKADEE AND BROWN CREEPER

THE CHICKADEE ON THE UPPER BRANCH AND THE CREEPER ON THE TRUNK OF THE TREE ARE AMONG THE MOST IMPORTANT OF THE INSECTIVOROUS BIRDS. THEY CLIMB OVER TRUNKS AND BRANCHES SCANNING EVERY INCH OF THE SURFACE FOR INSECTS THAT ARE CONCEALED IN THE BARK

All of the caterpillars mentioned above are hairy kinds, which, it is often asserted, are avoided by birds. The evidence makes it clear, however, that this is not always the case. Cuckoos in particular are fond of these hairy larvae. How a pair of cuckoos extirpated a colony of destructive walnut-

There is no doubt about the liking birds have for smooth caterpillars, and one of the most common and injurious groups of these larvae—canker worms—are known to be eaten by more than fifty species of birds. In California, the Brewer blackbird is a serious foe of canker worms and has been credited upon several occasions with clearing orchards of the pests. In Massachusetts, the Baltimore oriole has been observed to achieve the same desirable end. Orchardists should be grateful indeed when birds as beneficial as these make homes among their trees.

Another smooth caterpillar of almost historical importance is the larva of the snow-white linden moth. These larvae known as drop-



BLACKBURNIAN WARBLERS

THE WOOD WARBLERS ARE A LARGE FAMILY OF SMALL BIRDS FOUND NOWHERE OUTSIDE OF THE AMERICAS. THEY ARE FOND OF PLANT LICE, SCALE INSECTS AND OTHER SMALL BUT OFTEN DANGEROUS ENEMIES OF TREES



WHITE BREASTED NUT-HATCH

A BIRD WHICH DEVOTES ITSELF TO FINDING INSECTS, THEIR LARVAE AND EGGS WHICH ARE CONCEALED IN CREVICES IN THE BARK OF TREES

worms became excessively abundant in some of the larger eastern cities from 1850 to 1870 and were the subject of voluminous comment in the press. It is said that the English sparrow was introduced for the purpose of suppressing this insect, and as Prof. G. W. Herrick relates "so well did this bird do its work that for nearly a half century we have heard almost nothing about this insect as a shade-

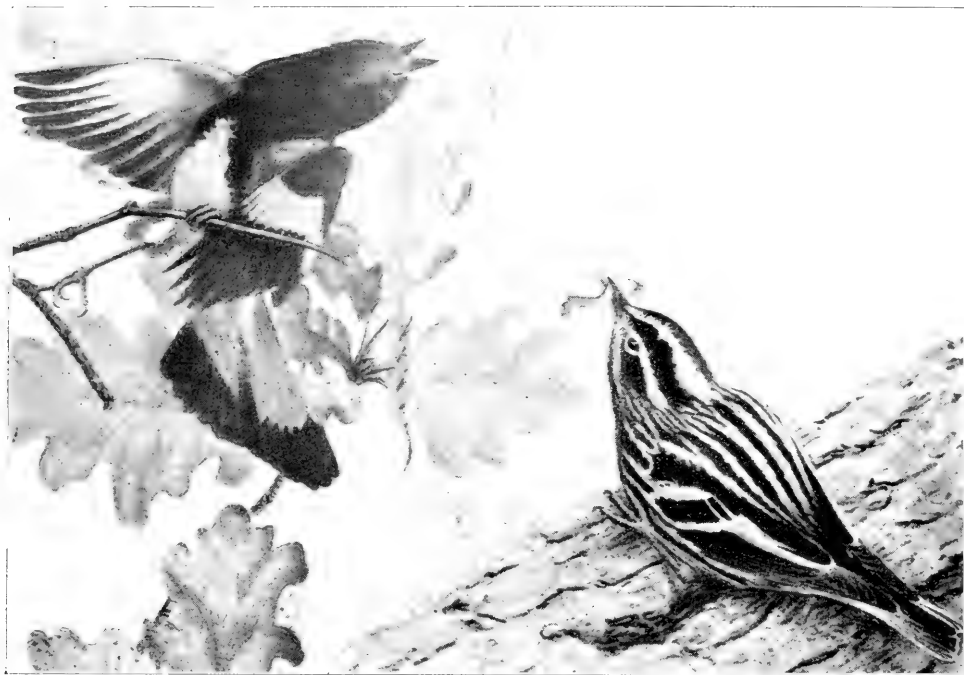

BLACK AND WHITE WARBLER AND AMERICAN REDSTART

THESE BIRDS ARE BOTH STRICTLY AMERICAN IN DISTRIBUTION AND WHILE THEY ARE NOTED FOR THEIR SWEETNESS OF SONG AND BRILLIANCY OF PLUMAGE THEY ALSO DO GOOD SERVICE IN TREE PROTECTION, SPECIALIZING ON SMALL INSECTS CONCEALED IN THE BUDS AND LEAVES



A PAIR OF YOUNG WHIP-POOR-WILLS

THESE BIRDS ARE CHARACTERISTIC OF ROCKY, WOODED LOCALITIES AT RATHER LOW ELEVATION. THE MATURE BIRDS FEED ON LARGE MOTHS AND BEETLES INCLUDING MANY LEAF-CHAFERS

tree pest. * * * One of the most remarkable phases of this pest were the flights of great swarms of the snow-white moths. * * * In New York City, the effect was compared to a snowstorm in mid-summer. Myriads of moths fluttered about the electric lights. Dr. John B. Smith says that on the evening of July 17, Newark, Elizabeth, and Paterson, N. J., had the same experience. On the morning after the flight, however, nothing remained except great numbers of snow-white wings without bodies, showing the work of the English sparrow. * * * The testimony regarding the activity of the English sparrow in exterminating this pest in cities seems to show rather conclusively that this much-disliked bird did actually bring about the destruction of this insect. Nearly every writer on the snow-white linden moth makes acknowledgment to the sparrow and declares that the cities owe their freedom from this insect to that bird."

The writer has seen English sparrows doing the same kind of work on the brown-tail moth, the whole pavement on blocks near electric lights, being littered with the wings of moths whose bodies had been eaten. We might continue to enumerate the bird enemies



YELLOW BILLED CUCKOO

THIS IS AN IMPORTANT INSECTIVOROUS BIRD. IT SPECIALIZES ON THE HAIRY CATERpillARS AND THESE CONSTITUTE ABOUT HALF ITS FOOD WHEN THEY CAN BE OBTAINED. FALL WEBWORMS, TUSSOCK, GYPSY AND BROWNTAIL MOTH LARVAE ALSO ARE OFTEN EATEN AND THE BIRD IS MOST VALUABLE AS A PROTECTOR OF TREES

of caterpillar pests, such as the fall web-worm, the tussock-moth, the cat-alpa sphinx and others, but must pass to some of the other enemies of trees. Plant-lice infest trees of almost all

kinds, sometimes in enormous numbers. They are preyed upon by most small birds, and particularly by the chipping sparrow, goldfinch, house finch, Audubon warbler, orange-crowned warbler,

attacks of birds, but now more than sixty species of birds are known to prey upon them. The beautiful rose-breasted grosbeak feeds upon a large number of destructive insects, among



HERMIT THRUSH AND WOOD THRUSH

BOTH OF THESE BIRDS DESERVE A HIGH PLACE AMONG THOSE WHO DESTROY INSECT ENEMIES OF TREES. THEY FEED LARGELY UPON THESE INSECTS AND ARE ALSO NOTED FOR THEIR FLUTE-LIKE TONES

downy woodpecker, Baltimore oriole, chickadees, bush-tits and kinglets.

Another group of small but nevertheless very destructive insects are the scale insects. These inconspicuous and far from edible-looking creatures were once thought to be free from the

them several species of scales. More than 100 scale insects have been found in a single stomach of this bird. Related grosbeaks, the cardinal, and the black headed grosbeak also are fond of scale insects. Eighteen per cent of the entire food of 120 black-headed grosbeaks consisted of black olive scales, pests which are exceedingly abundant and destructive in California. Twenty-nine species of birds are known to prey upon them. The little bush-tits depend upon scales for about a fifth of their whole subsistence.

Another insect which injures trees and which should not be passed unmentioned is the periodical cicada or seventeen-year locust. These insects deposit their eggs in twigs, which either die and drop off, or heal with large scars. The natural enemies of cicadas are legion, including practically all carnivorous animals. Among vertebrates, fishes and

tortoises, when they have opportunity, frogs, toads, lizards, squirrels, and a multitude of birds prey upon the cicadas. The English sparrow especially is a persistent foe of this insect, and in many cases it has been observed that where sparrows are plentiful, hardly

a cicada escapes them. The extermination of the insect in city parks is freely predicted because of the abundance of English sparrows in these reservations. The crow-blackbird or grackle is another bird that pursues cicadas so relentlessly that it sometimes destroys all of a brood in restricted areas.

protection and increase of birds in the state forests. Hundreds, yes thousands, of nest boxes have been erected for the birds; nesting sites have been carefully preserved for those birds that will not nest in boxes; and measures have been adopted to help the birds through the hardships of winter. In England the attraction of birds by supplying a large

number of nest boxes was adopted as a definite method of combating the larch sawfly.

The boxes were made of waste lumber—slab wood—at a low cost. "In the first year (1908,) sixty boxes were distributed and 31 per cent were occupied. The number of boxes was increased yearly until in 1911 there were 347 boxes of which 66 per cent were occupied." In 1913 about 75 per cent of the boxes had tenants. In addition to the provision of nesting boxes, feeding stations were erected for the purpose of holding the birds in the region during the winter. The result was a material increase in the number of birds resident in the forests attacked by the sawfly.

The method is considered entirely economical, because it is only through the natural enemies that the suppression of the pest can be expected, and if these enemies are increased in number, the outbreak will subside much sooner than otherwise, and the pecuniary loss will be correspondingly decreased.

In the case of most forest insects, direct suppression by man is impossible. This makes the work of natural enemies of the pests of paramount importance. Among these enemies birds are the most voracious, and rally the quickest to the scene of an outbreak.

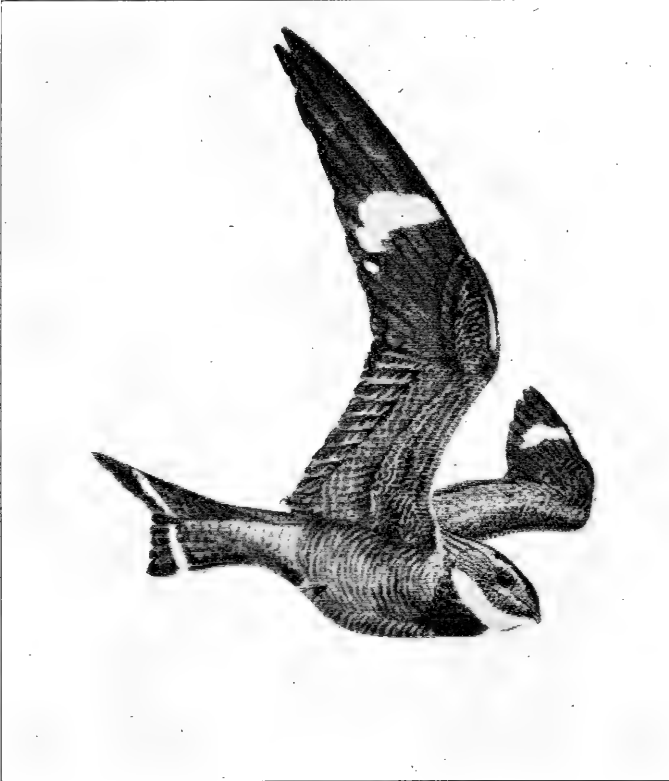

THE NIGHT HAWK

THIS BIRD PATROLS THE AIR FOR INSECTS IN THE LATE AFTERNOON AND NIGHT. IT DESTROYS MANY FOREST PESTS AND IS KNOWN TO FEED UPON EIGHTEEN DIFFERENT KINDS OF BARK BEETLES

We have mentioned by no means all of the tree pests that have important bird enemies, but enough has been recorded to indicate that birds are the most important natural enemies of certain of these pests, and that they are of some value in combating almost all of the forest insects. Their great value has by no means passed unrecognized. In European countries, the aid of birds has been widely invoked in controlling tree insects. In those countries where forestry has been highly developed one of its branches is the

PENNSYLVANIA'S FIRE LOSSES

UNUSUALLY severe forest fires in Pennsylvania during the spring did a great amount of damage. So many were the fires that it has not been possible so far to ascertain what the total loss is. The situation, in the opinion of State Forestry Commissioner Conklin is evidence of the great necessity of a larger appropriation for the State Forestry Department and also evidence of the short sighted policy of the last legislature in making the appropriation a small one and of ex-Governor Tener in further reducing it. Commissioner Conklin says:

"The Department of Forestry has always preached the doctrine that it is cheaper to prevent fires than to extinguish them. The cost is usually not much greater, and, in addition, the timber and all the other valuable things destroyed are saved.

"The forest fire law of 1909, in Section 18, provides a method for daily patrol, but this provision has been completely nullified since the passage of the law by the refusal of the Legislature to appropriate sufficient money to place men upon daily patrol. A patrol of the highly dangerous regions, which, in the experience of the department, results in the quenching of many fires in their incipiency, would cause careless users of fire in the woods to be more cautious, because of the fact that a patrol is kept. Five minutes work at a fire at its beginning is worth days of labor put in

after the fire has once obtained a great headway.

"All danger regions of the State are equipped with Forest Fire Wardens and Assistants, but they cannot go upon daily patrol for want of money to pay them. The appropriation which is allowed the department for this purpose must be skimmed out to the very end, and it takes all of it and sometimes more to pay the wages of the men who are actually employed to extinguish fires. The last two Legislatures had to be appealed to for deficiency appropriations.

"The Department is asking this year for a forest fire appropriation of \$150,000. Of course, what is not needed will not be expended, but we must have a fund with which to patrol danger points for the prevention of fire if we are ever to make any great headway against fire in the woods.

"A comparison of the appropriations which Pennsylvania has made for this purpose with that made by other States is instructive at this time. In Massachusetts and New York an annual appropriation of 1 cent per acre for forested land for protective purposes was made. At this rate, the 7,500,000 acres of similar Pennsylvania land would require \$150,000, or \$75,000 per year. Because of adequate protection Massachusetts was able to limit the average area of each fire to 11 acres, and New York to eighteen; but in the case of Pennsylvania the average mounts to 508 acres per fire."

A JULY FEATURE

"THE WAR'S EFFECT ON RUSSIAN FORESTS"

Will be graphically described in the July issue of *American Forestry* by Stanley Washburn, the famous war correspondent of the *London Times*, who is at the front with the Russian Army.

In the article is a thrilling word picture of a frightful battle in a dense forest.

FORESTS OF JAPAN

By NILS B. ECKBO, M. F.

[The statistics for this article were obtained through the courtesy of the Hon. M. Kamiyama, Director of the Forestry Bureau, Tokyo. Other information was gathered on a two months' tour through the various forest regions of the country, by the author and a friend. The article includes the substance of an address delivered by the author before the Society of American Foresters on March 4, 1915—EDITOR.]

THE itinerary of the tour of the forest regions of Japan, which was made by K. R. McGuffey and myself, was planned by the Director of the Forestry Bureau at Tokyo. It embraced visits to a number of the more important "Minor Forests," where it would be possible to obtain a good idea of the general administration and the various phases of forest activities. Japanese letters of introduction were provided to all forest officers concerned, and an interpreter was placed at our free disposal on the main island. The Governor of Hokkaido rendered the services of a forest expert in addition to an interpreter, while traveling in the

northern part of the country. The accommodations obtained away from the lines of beaten travel were intensely interesting. The country inns and farmhouses, where we had to stop, were all highly primitive and built of thin boards or straw; but they were all exceedingly cleanly, regardless of the limited circumstances of the owner. The sleeping quarters consisted usually of a mattress thrown on the floor, and the menu contained delicacies like laquer bowl soup, raw fish, bamboo sprouts and rice, etc., and if our luck was particularly good, we might relish chicken and eggs.



MEGURO EXPERIMENT STATION

THIS WELL DEVELOPED STATION IS NEAR TOKYO. ON THE LEFT IS THE DIRECTOR; THE INTERPRETER IS IN THE CENTER AND K. R. MCGUFFEY, WHO ACCOMPANIED THE WRITER, IS EXAMINING THE SEEDLINGS



SCHOOL OF FORESTRY, SAPPORO, HOKKAIDO, JAPAN

The local forest officers were always most courteous and conducted the excursions to our great benefit, and with credit to themselves.

Japan is mountainous with numerous volcanoes, the highest peak, Fujiyama, reaching an elevation of 12,370 feet. The mountains are swept by dry winds from the continent on one side and the moist air currents from the Pacific Ocean on the other. Owing to these

factors the country has a variety of climates varying from a tropical one in Formosa to a frigid climate in Hokkaido. As a natural consequence of the climatic conditions and the great amount of rainfall, Japan has as rich a flora as any country in the world. About 56,125,000 acres, or 59 per cent of Japan proper, is covered with forests and the country is said to have not less than 800 different forest trees. Of this number, however,



ROADWAY TO A TEMPLE

THIS IS IN SOUTHERN JAPAN. NOTE HOW THE ROADWAY IS LINED WITH TREES OF SEVERAL VARIETIES OF WHICH GREAT CARE IS TAKEN



NURSERY IN NORTHERN JAPAN

IN THE LEFT MIDDLE GROUND IS A STACK OF STRAW MATS. THESE ARE USED FOR SHIELDING THE YOUNG SEEDLINGS FROM THE HOT SUN AND ALSO IN INCLEMENT WEATHER

only twenty species are important from an economic point of view. In spite of this great percentage of forest land, Japan has not enough timber for its own supply and the exportation of valuable hardwoods is more than equalized by the cheaper grades imported.

The principal trees among the conifers are pine, fir, spruce, sugi, Hinoki and Hiba.

The principal trees among the broad-leaved species are birch, several varieties of oak, beech, chestnut, maple, cherry and ash.

The forests can be divided naturally into four zones; tropical, sub-tropical, temperate and frigid.

The forests are classified according to ownership as follows:

Crown Forests.....	1,775,000 acres
State Forests.....	10,850,000 acres
Public Forests.....	12,250,000 acres
Temple Forests.....	850,000 acres
Private Forests.....	30,400,000 acres
Total.....	56,125,000 acres

The forests of Hokkaido and Formosa are not included in the above classification, because they are managed entirely by the local governments.

The Crown Forests are subject to the control of the Department of Imperial Household.

The State Forests are under control of the Department of Agriculture and Commerce of which the Forestry Bureau is a branch. The administration is regulated by the Law of State Forests and Unused Land of 1899, but the Forestry Bureau itself was founded by virtue of an Imperial ordinance of 1886.

The forests belonging to public corporations, temples and private individuals are subject to the supervision of the Department of Agriculture and Commerce in accordance with the provisions of the Forestry Law. This law was passed in 1897 and provides rules regarding the management of timberland in general.

Regardless of ownership the forests of Japan are divided into two classes, Reserve Forests and Utilization Forests.

The Reserve Forests include timbered areas necessary for local demand, watershed protection, and the public welfare in general, and are subject to restrictions regarding cutting, in accordance with the provisions of the Forestry law. At the present time, the Reserve Forests cover about 2,200,000 acres.

The Utilization Forests consist of the remainder of the timberland, or about 53,925,000 acres. This area is subject to no restriction whatever, and is managed with the object of producing the greatest possible revenue for all times to come.

With the exception of the forests belonging to the Imperial Household and those in Hokkaido and Formosa, the forests of Japan are under jurisdiction of the Minister of the Department of Agriculture and Commerce.

The supervision of the forests belonging to public corporations, temples and private individuals is vested in Governors, Chief Magistrates, Municipal Councils, and Chief Officials of towns and villages by authority of the Minister, and they are responsible to him.

The administration of the state forests rests with the Minister of Agriculture and Commerce, but the execution rests with the Director of the Forestry Bureau.

The Forestry Bureau is located at Tokyo and all applicants are subject to a higher and lower Civil Service Exam-

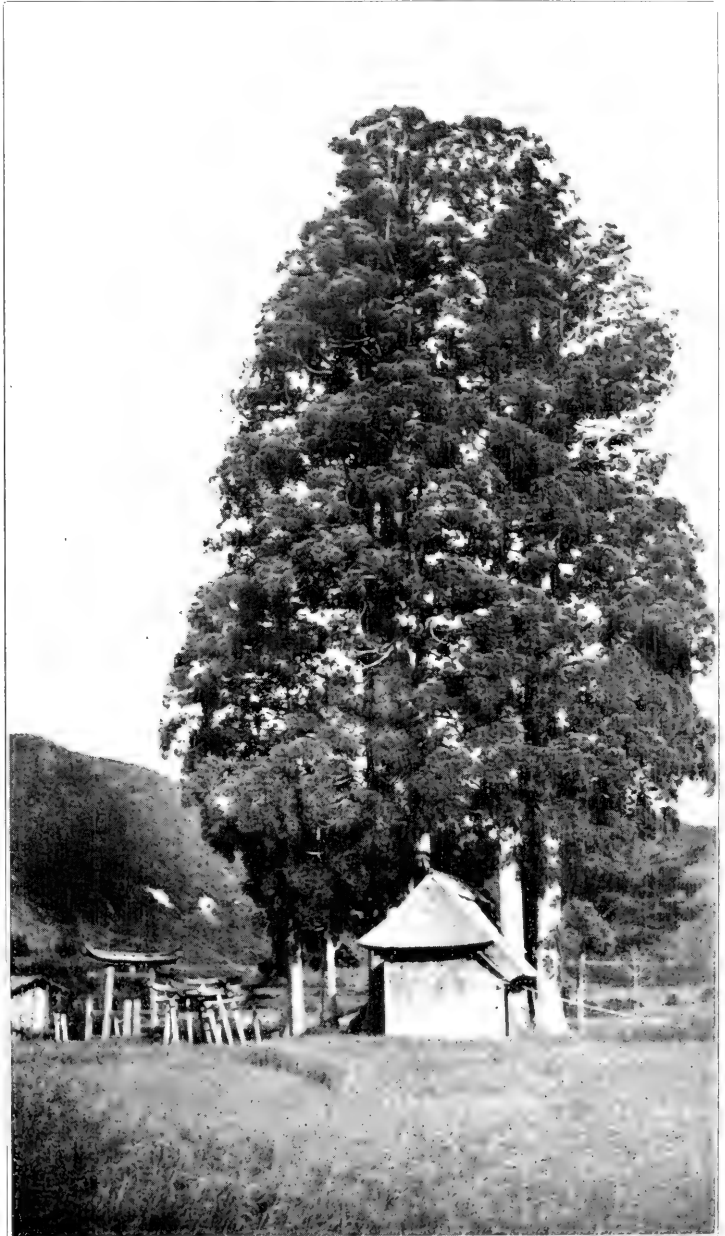

THE SACRED SUGI TREE AND HOUSE OF WORSHIP



A FOREST RANGER STATION

HOWEVER POOR THESE FOREST RANGER STATIONS MAY BE IT IS NECESSARY FOR ALL PERSONS TO REMOVE THEIR SHOES BEFORE ENTERING THEM

ination before entering the Forestry Bureau. The officials constituting the personnel of the Forestry Bureau and the field force consists of twenty Secretaries, twenty-three Assistant Secretaries, and eighty-two experts in the higher civil service; and 1,426 clerks and assistant experts, and 1,321 forest inspectors and rangers in the lower civil service. Of these 2,079 are under the Department for Ordinary Expenditures and 668 under that of Extraordinary Expenditures.

This makes a total of 2,272 permanent employes. Besides this number there are 354 foresters connected with prefectural governments. The 10,850,000 acres of State Forests are divided into ten Major Forest Districts containing on an average 1,085,000 acres. These districts are in turn divided into 211 Minor Forest Districts—National Forest—with an average of 51,420 acres. The Minor Forest Districts are sub-

divided into 1,314 Protection Districts—Ranger Districts—which will average 8,257 acres.

As stated previously, the area of the State forests comprises 10,850,000 acres. Part of this land is unfit for State Administration, and some areas are better suited for agricultural purposes than forestry. The total area of this land is 1,150,000 acres, and is set apart as "Unnecessary Land" and is sold to local corporations or individuals.

The remainder of the land, or 9,700,000 acres, is divided into 8,775,000 acres of land with trees and 925,000 acres of land without trees, rocky, etc.

On account of lack of transportation facilities some of the forests have not been exploited at the present time. To be more specific, 5,725,000 acres have been exploited and 3,050,000 acres are yet unexploited.



A GROUP OF "AINODES" OF NORTHERN JAPAN.
DESCENDANTS OF THE ORIGINAL INHABITANTS OF JAPAN. THEY ARE A POWERFULLY BUILT RACE, SPLENDIDLY ADAPTED TO WOODWORK.

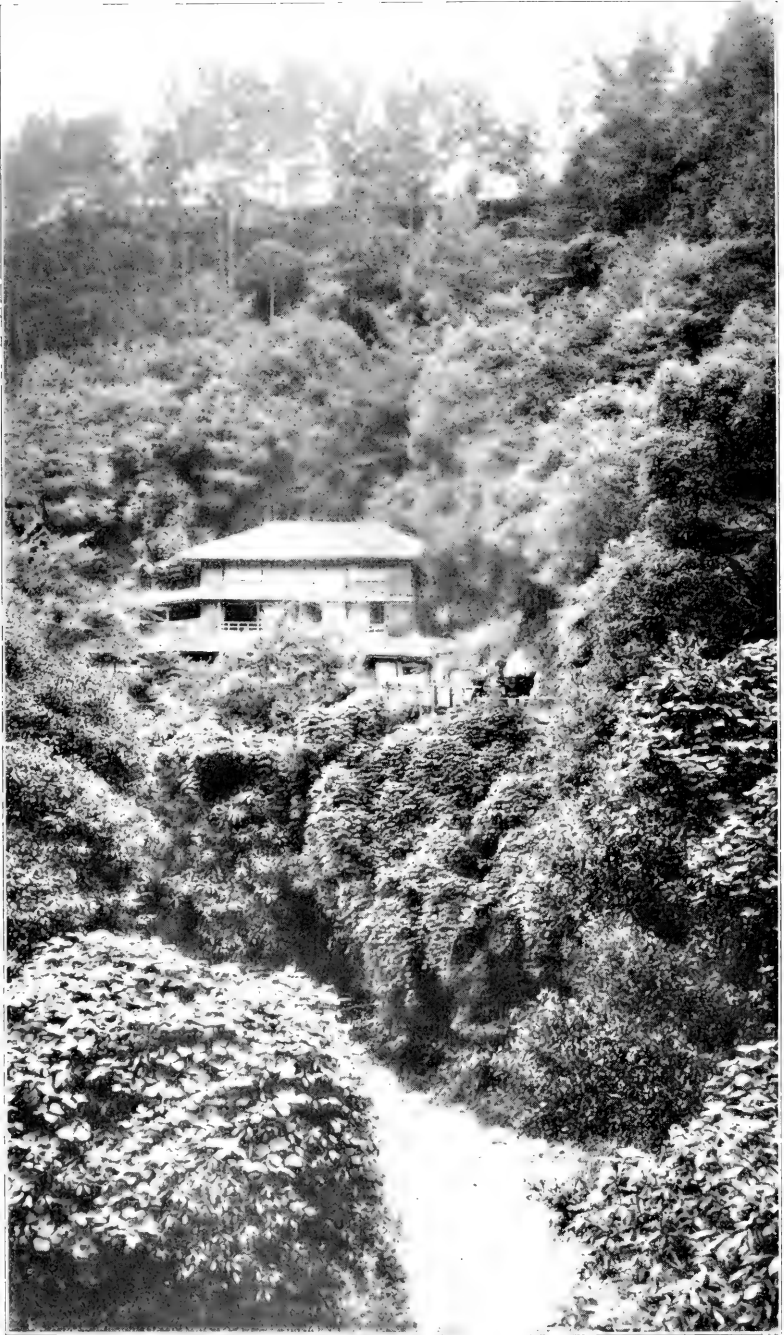

COUNTRY INN AND TEA HOUSE

ONE OF THE MANY FASCINATING PLACES TO BE FOUND ALONG THE LINES OF TRAVEL IN SOUTHERN JAPAN. HERE THE WAYFARER GETS EXCELLENT ACCOMMODATIONS

The administration of the State Forests is divided into two departments, Extraordinary Affairs and Ordinary Affairs.

By the means accruing from the sale of unnecessary land, the department of Extraordinary Affairs is practically limited to the unexploited areas, and does the following work:

Sale of Unnecessary Land:—The proceeds of the sales, which are estimated at \$11,500,000, are set aside as a "Forestry Fund."

Adjustment of boundary lines and surveying of forests belonging to the State:—The aim of this work is to distinguish definitely those forests which belong to the State and to determine the exact area.

Organization of Enterprises:—This section makes working plans for the most valuable forests.

Silvicultural Work:—This includes the improvement of land without trees, nursery work, planting and checking driftsand, etc.

Purchase of Land:—This section undertakes the purchase of land which is deemed necessary for the proper administration of the State Forests and their preservation.

The department of Ordinary Affairs undertakes the work in exploited forests and includes the local force. The main duties of the force are:

Exploitation by Felling:—There are two ways of disposing of the timber, namely, sale of the standing trees or the sale of logs when the logging is done by the Government. The standing trees sold in 1906–1907 totaled 48,792,000 board feet; and in 1907–1908, 42,696,000 board feet. The trees cut by the Government in 1906–1907 totaled 8,496,000 board feet and in 1907–1908, 18,444,000 board feet.

Silvicultural Work:—While planting on the treeless areas comes under Extraordinary Affairs, planting after felling and in the forests in general comes under Ordinary Affairs.

Forest Police:—All forest officers are to serve as police on the forests. The following is a table showing the "Ordinary Forest Revenue" and expenditure for three consecutive years:

	Yen Ordinary Revenue	Yen Ordinary Expendi- ture	Yen Ordinary Surplus
1906–1907	2,573,456	1,012,543	1,560,913
1907–1908	3,859,200	1,488,279	2,370,921
1908–1909	5,884,309	2,605,097	3,279,212



JAPANESE WOOD CHOPPER
THIS MAN IS AT WORK IN THE UTCHIMAPPU MINOR FOREST. NOTICE
THE SHORT SAW AND THE WEDGE SHAPED AXE

Of the most important forests visited can be mentioned the Owani, Utchimappu and Odate Minor Forests, besides the large areas under the Governor of Hokkaido. They are all located pretty well north and their most valuable trees are sugi and hiba on the main island and pine and fir on Hokkaido.

The forests are well covered by intensive working plans furnishing detailed maps and estimates, besides prescribing a fixed annual cut and so forth. The Owani Minor Forest, for



UNLOADING BABY CAR

THESE ARE MUCH USED IN LUMBERING OPERATIONS. THIS PHOTOGRAPH WAS TAKEN ON THE ODATE MINOR FOREST JAPAN

example, with an area of 26,215 acres and a total estimate of 600 million feet B.M., cuts annually, on a 100 to 120 year rotation, according to Commander C. Omikiyama, 7.2 million feet; which is twice the amount prescribed by the working plans, due to the economic conditions of the country at the time. This forest is divided into seven cutting districts and fifty different forest types, which are all shown on the map. A complete map and estimate had been prepared of the first division of the Utchimappu on an intensive scale. A total area of 8,011 acres had been covered, and each tree calipered at an aggregated cost of 40 cents per acre. On the second division of the same forest, the cost was reduced to 25 cents per acre, and on still another area it took twenty men ten months to survey 12,900 acres of timberland.

Reconnaissance on the National Forests in the United States usually covers less than 10 per cent of the area, an expense rarely exceeding 5 cents per

acre. While it is far from my intention to advocate similar 100 per cent work in this country, I think it is particularly interesting to note that the Japanese Government realizes the value of the work to such an extent, and feels justified in authorizing this large expenditure, where stumpage values are only twice as high as in this country.

All trees are marked prior to cutting. One of the marking tools has an embossed Japanese steel insignia on one end, and is heated so as to burn the brand into the wood.

The most accessible forests are reproduced artificially. This is the case on the Odate Minor Forest, where they cut clear, burn the area and plant; but both Utchimappu and Owani Forests as well as the forests on Hokkaido depend mainly on natural reproduction. They attempt to attain the latter through various systems of cutting and soil preparation. On the Utchimappu, where the forest consists principally of a pure stand of hiba, the Shelterwood



JAPANESE SAWDUST CONVEYOR

HERE IS THE ODATE GOVERNMENT SAW MILL. THE SAW DUST IS SWEEPED DOWN A HOLE IN THE FLOOR, WOMEN CATCH IT IN BAGS AND CARRY IT AWAY

Compartment System is applied successfully. On the Owani, where sugi and hiba predominate, good results were obtained under favorable circumstances, with two cuttings. In the first about 50 per cent would be cut and the rest left to seed up the ground, and when this had been accomplished the second half would be carefully removed. In more valuable timber a system is used with three cuttings:

Preparatory cutting, which is only a light thinning.

Seed cutting, which comes five years later and removes 50 per cent of the remaining stand.

Clear, or final cutting, which takes place fifteen years after the second cutting. Between the second and third cutting, it is sometimes necessary to make thinnings to aid natural reproduction, and all areas imperfectly reproduced after the third cutting are restocked artificially. On Hokkaido it had been found worth while to remove all cover in rows about 1 foot wide and 6 feet apart besides stirring the soil

thoroughly, in order to gain the desired result.

Before any sale of timber can take place, the tract must be carefully investigated by the Minor Forest Officer. Guided by the working plan, he recommends the trees to be sold on the stump, or possibly advocates the logging and manufacture by the Government, as the case may be. Dead or injured trees not to exceed a value of \$150 may be sold by him; but all larger sales must be approved by the Major Forest Officer.

An agreement is entered into with the operators providing perfect utilization, proper condition of cut-over area, and so forth. The material may be paid for according to estimate or by scale after cutting. The proceeds from sales are sent directly to Government banks, except in small sales of less than \$150, when a forest officer may receive the money.

The felling is accomplished by means of saw and axe. The saw is broad and simple toothed with a handle in one end, and is so short as to necessitate



ODATE GOVERNMENT SAWMILL

THE OUTPUT OF THIS MILL IS ABOUT 25,000 FEET OF MANUFACTURED TIMBER A DAY. IT IS SITUATED IN NORTHERN JAPAN



METHOD OF HAULING LOGS

THIS IS A WELL GRADED SKIDROAD ON THE ODATE MINOR FOREST, JAPAN AND THE THREE MEN WERE ABLE TO HUSBLE THE TWO BIG LOGS DOWN THE GRADE AT A LIVELY PACE

circling around the larger trees to get them down. The axe used for notching, limbing and felling is narrow and wedge shaped, while another broad axe is used for barking. To assist in rolling the logs the chopper uses a hook, somewhat similar to one side of a miner's pick.

Logs are usually cut 12 feet long, and the larger ones are often hewn square in the woods to make them lighter, and because they are most easily sold that

as possible, and $2\frac{1}{4}$ to $3\frac{1}{4}$ inches wide by 8 inches long. They are bundled in units of 400 shakes, and sold at 15 cents per unit. From a log 12 feet long and 1 foot square is made 10 to 12 units, which represent a gross value of \$1.50. When labor is deducted at the rate of 5 cents per unit, it leaves \$1.00 for the log, which is 40 cents more than the log would have sold for in the square. Sugi splits equally as well as hiba, and



STACKING PULP LOGS

BY MEANS OF TWO ROPES PULLED BY A SCORE OF MEN THESE LOGS ARE HAULED OUT OF THE RIVER AND STACKED IN LARGE PILES

way. This method is practiced on the Utchimappu, and the chips are bundled and sold for 1 cent per bundle in the woods or 4 cents in Aomori. The weight of the bundle is supposed to be one half the amount one man can carry. The trees are cut to 3 inches in the top, and the remainder of the tree is utilized for fuel or charcoal when close to settlements.

The bark of the sugi and hiba is used for tannin, and brings a price of 6 and 4 cents respectively per 6 square feet delivered at Aomori. Shakemaking is a common industry at Utchimappu, where the hiba is used for this purpose. The shakes are all split by hand as thin

is also used to a great extent in shake-making on other forests. A visit to a Japanese match factory and a pulp mill was very interesting.

Charcoal burning is a highly developed art in Japan and this is only natural because of the much greater use per capita of this product than in any other country.

In addition to the Japanese laborer, who is very efficient when trained, is used the Aino for common woodwork in the north. The Ainos possessed the islands prior to the Japanese invasion; but they have since gradually been driven back. They are naturally large and powerful, with a prolific growth of

hair, and are the very antithesis of the small Japanese inhabitants.

These people are the lineal descendants of the inhabitants of the wild forest regions, where they depended entirely on the capture of game for a livelihood. It is said of them that one of their favorite pastimes is to corner a bear and kill him by brute strength. The wages of a chopper vary from 25 to 50 cents per day, according to his ability, and a man with one horse gets from 60 to 75 cents per day.

A technically trained forester commences with less than \$10 per month and a Major Forest Officer receives a salary of \$1,000 to \$1,500 per annum.

The total force on the Utchimappu Minor Forest consists of thirteen men, and the monthly pay roll amounts to \$115.

Transportation is one of the most interesting phases of the work in the woods of Japan, a fact due partly to the almost total lack of horses. Man bears the burden of the beast in this country, and most of the hauling is accomplished through human strength. Well graded roads are ordinarily laid out through the forest to be logged, and are provided with skids or crossies a few feet apart. The logs are loaded on to small wooden sleds, which are made mobile by two coolies pulling in front and one pushing from behind. The loads slip along comparatively easily on the skidroad, and the logs are transported in this manner to the stream, railroads or saw-mill as the case may be. The sled is not so heavy but that it can be picked up and carried back into the woods by one man.

Baby railroads are constructed where long hauls have to be made, and where there is sufficient timber to justify the investment. One is being operated at Utchimappu as well as one of considerable length at Odate. The roadbed is

laid out on an even downhill grade so as to allow the cars to run entirely by gravity. The cars are small, but are able to carry surprisingly large loads. They are easily pushed by one coolie on account of the fine grading. The rail-



A WATER BALANCE

THE LOGS ARE RAISED UP THIS STEEP INCLINE BY FILLING THE DUMMY CAR AT THE TOP WITH WATER UNTIL IT OUTWEIGHS THE CAR CARRYING THE LOGS

road is built single track, with no sidings, and the car is light enough for one man to lift it off the track when it is met by a loaded car coming down. Efficient brakes are provided each car, which is very essential in order to avoid accidents.

River driving is carried on wherever possible, and the stream improvements, dams, and so forth are constructed in much the same way as in any other country. Watching the drive one day, the forest officer hailed an expert driver and told him to give us a little exhibition. The man rode down the stream nicely on one log, and I snapped his picture while he was rolling it. He took stage fright, however, fell in the

go to be emptied and loaded with logs again.

An aerial tram was also built at this point for transportation of logs and ore in cooperation with the Kosaki Mining Company.

There are at the present time about eleven sawmills operated by the Government, of which two were visited. They are primitive in construction with a conglomeration of foreign made ma-



A LOGGING RAILROAD
THESE CARS ON THE ODATE GOVERNMENT FOREST ARE RUN MAINLY BY GRAVITY

water, and had a hard time making it for shore.

A water balance was erected at Odate, where the logs had to be elevated about 100 feet from the river to the sawmill on the bank. This was accomplished by means of a short double track railroad on a steep incline provided with two cars fastened together so that one would be at the top, when the other was at the river. The cars were made water-wagon fashion, and while the one car was being loaded with logs at the river, the upper car was filled with water. When full it would outweigh the logs, and down it would

chinery. At one mill were found German, English, and American made parts in addition to machinery made in Japan. The mills are low powered and operating mainly gangsaws and circulars, using bandsaws to a small extent for re-saws. The average output was approximately 25 M. per day. Three men were necessary to roll the log onto the carriage, where it retained its place by its own weight. Above the circular saws could be seen punctured tin cans filled with water, which was steadily dripping down on the saw to keep it cool. The sawdust was swept through a hole in the floor into a basement,



AN EXPERT JAPANESE DRIVER

THESE MEN BECOME REMARKABLY CLEVER IN RIDING THE LOGS AND DELIGHT TO COMPETE WITH EACH OTHER IN ACROBATIC STUNTS ON THE LOGS, PARTICULARLY IN THE SWIFT CURRENTS



A LOG DRIVE
LOGS CUT ON THE UCHIMAPPU MINOR FOREST IN JAPAN AND PILED ON THE BANKS OF THE RIVER READY TO BE STARTED DOWN STREAM. THE CURRENT IS SWIFT
AND THERE ARE MANY SHALLOWS NECESSITATING CAREFUL DRIVING IN ORDER TO PREVENT JAMS

where women collected it in baskets and carried it off on their backs.

Planting has been carried on by the Japanese for probably a much greater period than 400 years, and it is this work that gives Japan credit for having practiced forestry before any other nation. As a matter of fact, however, the forests of Japan have been under real forest management less than thirty years.

Large and small nurseries are scattered throughout the islands, and are kept in excellent shape. In the nurseries visited sugi and hiba were the principal species. Sugi is the most important of the two and requires no shading. Hiba is shaded the first spring with straw screens or mats. The stock is grown 3 to 4 years old and transplanted once or twice. The usual spacing in the field is 4 by 6 feet, or 1,800 plants per acre. One man plants from 150 to 200 per day, and at a daily wage of 25 cents this work costs \$2.70 per acre. The cost of the plants amounts to 75 cents per 1,000, or \$1.35

per acre, giving a total cost of \$4.05 per acre for planting work.

Utchimappu Minor Forest alone plants annually 600,000 sugi and 400,000 hiba on nonrestocking cut-over land and on treeless areas.

Japan has three higher schools of forestry. One is connected with the Imperial University near Tokyo, one is at Morioka, and one at Sapporo, Hokkaido. The Imperial University offers a three years graduate course leading to a degree corresponding to "Bachelor of Forestry."

The school at Sapporo enrolls thirty students every year, of which about one-half enter the Government Forest Service of Hokkaido.

The forest experiment station at Moguro in the neighborhood of Tokyo, comprises 10 acres and is 20 years old. It offers an excellent exhibition of native and foreign species, model nursery, laboratory, and collections.

The Botanical Garden in Tokyo is also intensely interesting, and has odd specimens of Japanese and foreign species.

The Meeting at San Francisco

Great interest is manifested in the meeting of the American Forestry Association at the Panama-Pacific Exposition at San Francisco, Wednesday, October 20, in conjunction with the Western Forestry and Conservation Association.

Many members who have decided to visit the Exposition have timed their trip to be able to attend the meeting. The program for the day is now being arranged and will shortly be announced. It will deal chiefly with western forestry problems, and with the value of the Association and its work.

Members who wish to do so can arrange to join a party which will spend October 22 and 23 in the Redwood Lumber Camps. In this party will be a number of forest conservationists, lumbermen and loggers.

There is a wide variety of trees in California and many of them are along the general routes of tourist travel and may readily be seen. American Forestry will have an article in the July issue describing these and telling how best to reach them.

AMERICAN ACADEMY OF ARBORISTS

RECOGNIZING the need of an association for the future development of their profession a number of City Foresters, men interested in landscape forestry and others qualified for membership, have organized the American Academy of Arborists. Arborist is the term now being generally accepted to designate men proficient in city and landscape forestry. The Association will be conducted on a highly technical and professional basis, its aim being expressed in the constitution as being "to place and maintain the practical arboriculture and landscape forestry of the country on the highest professional basis." There are to be two classes of members. Fellows, who must be over 25 years of age, who are graduates from schools specializing in Arboriculture or the arts and sciences closely connected with Arboriculture, and Honorary Members who shall be persons of broadly acknowledged eminence in Arboriculture or landscape forestry.

The charter members of the organization are Herman W. Merkel, Chief Forester of the New York Zoological Park; William W. Colton, Forest Commissioner of West Newton, Mass.; Prof. J. W. Toumey, Director of the Yale Forest School; J. J. Levison arboriculturist of the Brooklyn, New York Park Department; Harold J. Neal, City Forester of Worcester, Mass.; R. B. Maxwell, City Forester, of Baltimore, Md.; George A. Cromie, City Forester of New Haven, Conn.; James H. Walker, City Forester, Newark, N. J.; H. B. Filer, City Forester, Buffalo, N. Y.; and A. T. Hastings, City Forester, Jersey City, N. J.

From these charter members the officers were selected. They are: President, Hermann W. Merkel; Secretary, J. J. Levison; Vice-Presidents, William W. Colton and R. B. Maxwell; Directors, James H. Walker, George A. Cromie and Harold J. Neal.

JOHN BIRKINBINE DEAD

THE many friends of forestry in Pennsylvania, and elsewhere, lost an ardent advocate of forest conservation, in the death, on May 14, of John Birkinbine of Philadelphia. Mr. Birkinbine was President of the Pennsylvania Forestry Association, an office he had held continuously from 1893, and to which he devoted much of his time and energy. He worked enthusiastically and steadily in the cause for the last thirty years and was active in the founding of the Pennsylvania Forestry Association in 1886, and in making it the successful

organization which it has been since its inception. He did not confine his efforts to further the cause of forest conservation to Pennsylvania, for he was always eager to aid in extending the agitation for the better use and protection of forest lands in any part of the country. His death removes from active participation in the cause of forestry a man who had achieved a place as one of the leaders in the movement. Besides his forestry interests Mr. Birkinbine had acquired an international reputation as a water power expert.



OFFICERS OF AMERICAN ACADEMY OF ARBORISTS

DIRECTOR, W. M. W. COLTON,
FOREST COMMISSIONER,
WEST NEWTON, MASS.

VICE-PRESIDENT, R. B. MAXWELL,
CITY FORESTER, BALTIMORE, MD.

SECRETARY, J. J. LEVISON,
ARBORICULTURIST,
BROOKLYN, N. Y., PARK DEPARTMENT

DIRECTOR, JAS. H. WALKER,
CITY FORESTER,
NEWARK, N. J.

PRESIDENT, HERMANN W. MERKEL,
CHIEF FORESTER,
NEW YORK ZOOLOGICAL PARK
DIRECTOR, GEO. A. CROMIE,
CITY FORESTER, NEW HAVEN, CONN.

DIRECTOR, HAROLD J. NEALE,
CITY FORESTER,
WORCESTER, MASS.

SHADE TREES AND SHRUBS

A DEPARTMENT FOR THE ADVICE AND INSTRUCTION OF MEMBERS
OF THE AMERICAN FORESTRY ASSOCIATION

EDITED BY J. J. LEVISON, B. A., M. F.

*Arboriculturist Brooklyn Park Department, Author of "Studies of Trees," and Lecturer
on Ornamental and Shade Trees, Yale University Forest School*

It is the aim of the American Forestry Association, in conducting this department in each issue of AMERICAN FORESTRY, to provide its members with expert advice upon the selection, care and cultivation of ornamental and shade trees and shrubs, for park, garden, lawn and street uses. Members are invited to make inquiries of this department, write their experiences and to ask for any such suggestions or advice as they may desire.—EDITOR.



PROPER CUTTING OF A LIMB

THE LIMB SHOULD BE CUT CLOSE TO THE TRUNK OF THE TREE
AS SHOWN IN THIS PHOTOGRAPH

FOR many years past, the landscape architect has championed his profession by establishing beautiful parks and country estates. The forester, too, has demonstrated the value of his calling by pointing out ruthless methods of cutting and showing how to protect and utilize the forest to the highest point of efficiency. Not so with the arborist. His work came in demand very recently; not until the great masterpieces of Olmsted, Vaux, Downing and many others began to show signs of decay and not until we saw the premature death of the stately elms of New England and of the thousands of other beautiful specimen trees upon which Nature itself—the greatest artist of all—has bestowed special favor. To save these trees and care for all others required highly specialized attention. The professional arborist had to be called in and now his position is as fixed as that of his co-workers. He has come to stay and is required to maintain what the others establish.

Ten years ago the arborist was unknown and not appreciated. Today he is sought by everyone who owns a

tree or a bush. In fact, his services have become so popular that a number of men have sprung up who presume to be expert arboriculturists and who really have no title to that trust. These men, unwittingly or otherwise, often do work of absolutely no importance to the vigor of the tree and neglect the fundamentals.

One aim of this new department will be to help these men in the business in which they are expected to be expert and to enlighten the employers of such men as to what is salient and what is not. Aside from these men, however, we have in this country many commercial firms and individuals who thoroughly understand their business and who can be absolutely relied upon. We have many city foresters, arboriculturists, tree wardens and superintendents of trees who are eminent in their profession. With these we expect to cooperate and by interchange of opinions mutually help each other. It was chiefly due to the honest work of these professional men that the interest in arboriculture has assumed such vast proportions. The cooperation of the landscape architects, foresters, superintendents of parks and private estates and gardeners was almost equally important because they all recognize that it is to their interest as well as to the interest of the owners to have some one work with them who by training and experience is able to give special attention to the numerous details of tree culture. Outside factors also helped to bring this about. Some of these are the rapid growth of cities and the consequent desire on the part of their inhabitants to maintain country homes; the enhanced interest in social welfare and park development and the increased number of insect and fungous pests.

The arborist's sphere is primarily to care for and to plant trees and shrubs in parks, woodlands and on streets. But the word care is a big word and includes a great many related subjects, each of which is almost a study in itself. It includes a knowledge of the habits of the injurious insect and fungous pests and methods of combating them; it includes methods of fertilizing, repair protection from unfavorable extraneous

agencies, such as gas and sewerage leaks, compact soils, overhead wires, root injury, etc. The word planting also takes in a bigger field than the mere planting of trees. The arborist very

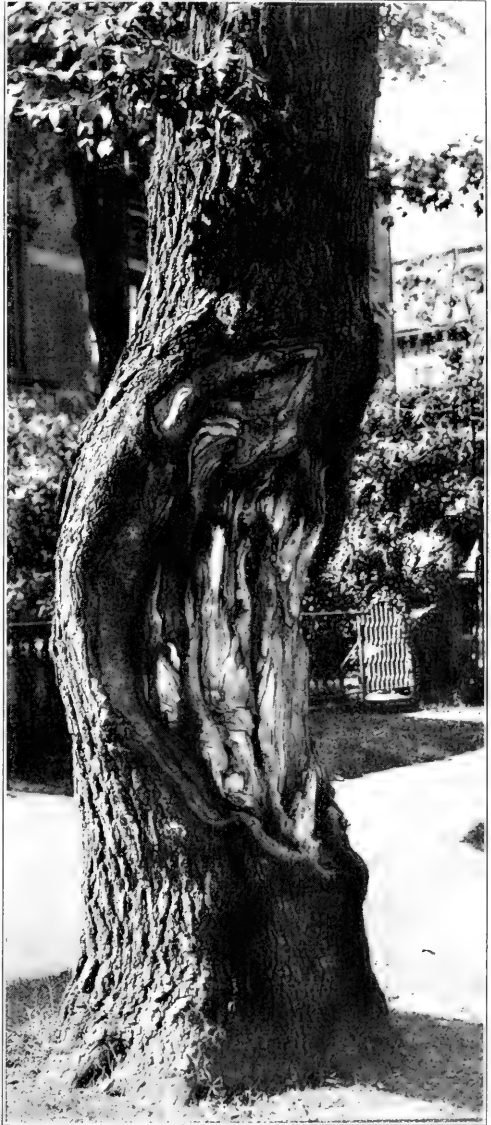

DAMAGED BY HORSES

RESULT OF NEGLECT IN PROPERLY CARING FOR A TREE WHICH HAS BEEN INJURED BY HORSES BITING IT

often has to plant shrubs, vines and wild flowers. He has to know whether certain plants will do well in certain locations and he has to know just how

to nourish the plants immediately after planting.

All this gives one the impression that the field is clearly defined and the knowledge and methods thoroughly exploited. This is not so. The field is full of new problems, new methods present themselves daily and the literature on the subject is only in its infancy. Many of these problems are details

only of special technical interest while others, of vast importance, are of more general interest. Such questions, as what particular brand of spraying material to use and how and when to combat some particular insect, are examples of the former, while such considerations as municipal control of shade trees, proper handling of woodlands in parks and on country estates,

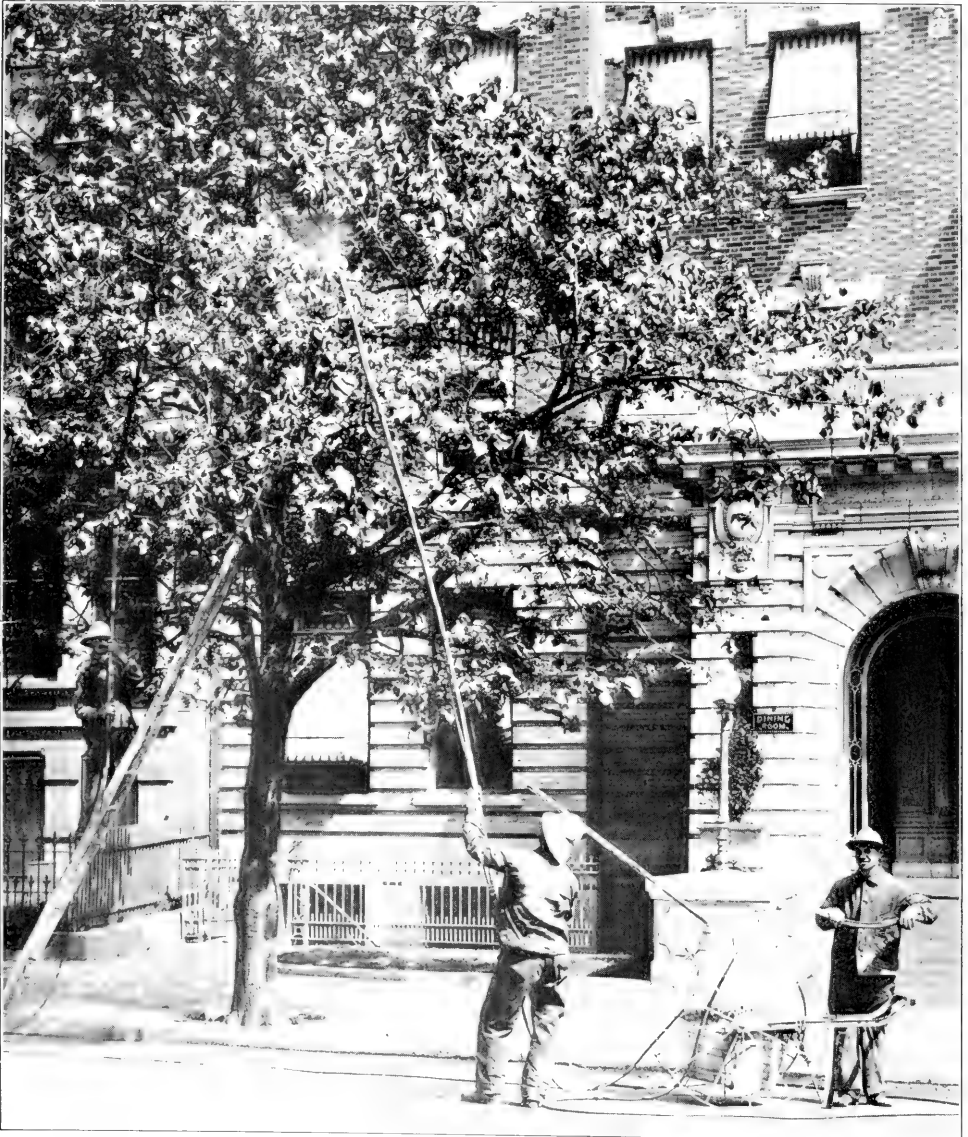

SPRAYING WITH A BARREL PUMP

THIS IS A HANDY AND SERVICEABLE METHOD MUCH USED IN BOTH PUBLIC AND PRIVATE WORK, ALTHOUGH FOR CITY SHADE TREE SPRAYING THE PUMPING APPARATUS ON A WAGON IS THE BETTER AND MORE ECONOMICAL



WORK OF THE HICKORY BARK BORER

SECTIONS CUT FROM DAMAGED TREES, SHOWING THE HOLES OUTSIDE THE BARK MADE BY THE BORER AND THE GALLERIES INSIDE THE BARK

establishment of municipal nurseries, city forests and state parks and the proper ground cover for slopes and woodlands are questions of the latter class.

To the one interested in the care of trees there may thus be offered hundreds of suggestions of innumerable practical value. The men at present engaged in

this work are still learning and exchange of experiences and discussions would therefore be of value to all. This is just what this department aims at. It will need the cooperation of all interested, welcoming both your questions as well as your findings and it in turn will aim to make its information as authoritative as it possibly can make it.

ADVICE FOR THE MONTH OF JUNE

Cultivate and water all young plants. It is quite essential that young plants, especially those recently set out should be watered and weeded during the summer months. No fixed amount of water can be prescribed; that will vary with the size and habits of the plant as well as with the local soil and climatic conditions. It is well to dig down occasionally and examine the moisture conditions of the soil around the roots, this will avoid the danger of overwatering.

Destroy the nests of the forest tent caterpillars so common at this time on wild cherries, mulberries, willows and other trees. Apply a burning rag or torch to the web or else squirt a little kerosene into the web. Where the webs can be readily reached, the latter is preferable because it prevents burning of the infested branch.

Spray for leaf-eating insects. The necessary apparatus and arsenate of lead, the standard material, should be held in readiness and the spraying should be done after due consideration of the habits of the particular insect in question. Information on the habits of any particular insect pest and definite instructions as to time and methods of spraying can be obtained from the local State Agricultural Experiment Station or from the United States Department of Agriculture.

Most leaf-eating insects commence defoliation at the end of May. The elm-leaf beetle, in the vicinity of New York City, starts feeding on about the fifteenth of May. In combating leaf-eating insects use arsenate of lead, of a recognized brand, at the rate of 1 pound to 10 gallons of water. Make the application to the under side of the leaves as soon as feeding begins or a few days before if that can be anticipated.

Hickory trees infested with the hickory bark borer should be removed and destroyed at once because the beetles emerge from the infested trees in early June and soon after proceed to other neighboring hickory trees where they deposit their eggs in the outer sapwood. In the vicinity of New York City, including all of Long Island, parts of New Jersey and Westchester County, nearly all the hickories are badly infested with this pest.

The presence of the insect can be detected by the small holes in the bark of the trees and the fine sawdust which is ejected from these holes, when the insects are active. It is important to emphasize the advisability of detecting the fine sawdust because that is the best indication of the actual operations of the hickory bark borer. These holes, however, will not be noticeable until the insect has completed its transformation. In summer, the infested trees show wilted leaves and many dead twigs. Holes in the base of the petioles of these leaves are also signs of the working of the insect. Since the insect works underneath the bark, it is inaccessible for treatment and all infested trees should be cut down and burned, or the bark removed and the insects destroyed. This should be done before the beetles emerge from the tree in June.

Spray for certain sucking insects. Such species of sucking insects as the oyster shell scale hatch their eggs at this time and can be most successfully combated when the young commence to crawl. There are several oil emulsions in the market suitable against these insects but their use is dangerous without specific instructions as to strength, time of application and the kind of tree to be applied on.

In almost every group of trees one will find a few that show at this season, a number of branches which have died off during the winter. These dead branches can be removed now as well as later. In removing these branches the cuts should be made close and the resulting wounds should be covered with coal tar.

[Requests for advice or information from this department should be addressed to Editor, AMERICAN FORESTRY, Washington, D. C. They will be given prompt attention.]

Change in Address.

Members of the American Forestry Association are requested to send notification of any change in address so that the AMERICAN FORESTRY MAGAZINE and other mail will not be delayed in reaching them.

Such notices are desired before the 25th of each month so that the address may be changed for the monthly mailing of the magazine.

HICKORIES, ELMS AND ASH TREES

By WARREN H. MILLER, M. F.

THIS group constitute a striking set of individuals which, next after the oaks, maples and birches are most frequently met with in the average hardwood forest. Our hickory is a most American tree, as typical of our Republic (before the present epoch of imperialism set in) as the wild turkey among our birds or the bison among our animals. They have nothing like the hickory in Europe; no tree that combines so many fine lumber qualities as well as producing a nut finer in flavor than any imported variety whatsoever.

It is one of those distinctively American things, unique in its excellence not to be matched elsewhere—a leaf of hickory ought to find its place on our national escutcheon! Like the turkey and the bison, the hickory has been little appreciated by us as a nation, and it has been allowed to go almost to the vanishing point. The hickory bark borer destroys hundreds of thousands of wild trees every year, now that the birds are so scarce; no young trees are coming up to take the place of those that we have; and no attempt is being made to raise hickories on a large scale, either in orchard or in forest. On the farm the hickory is appreciated to the point of leaving a fine one standing when clearing a field, partly as a shade tree for cows, partly because a good one can be depended upon for about two bushels of nuts every seed year.

The wood commands about twice the price of white pine, \$30 at the mill per M., and we use 350 million feet of it a year, a rate of cutting that plays havoc with the very existence of the tree in wild forests. The estate owner has a big field ahead of him in the study and growing of this tree (the shagbark being the one understood by the general term "hickory"), yet the only one actually orcharded on a large scale is the southern hickory or pecan. As the natural range of this nut is up the Mis-

issippi Valley as far north as Wisconsin, there is no reason why it cannot be grown anywhere throughout our area, in fact all the nurseries offer "hardy" pecans for northern growing, which are doubtless from wild stock growing in the northern part of its range. But there is no reason why shagbark hickory can not be grown, either in forest or in orchard, the former for lumber and nut crops, the latter for nuts only—either way it would be a paying proposition for one whose tastes lie in the realm of horticulture. But I take it that these articles interest chiefly the man who does not fancy the cares and labors of orcharding, but who does love to have plenty of wood about him and is not averse to bettering the quality of and beautifying within reasonable expense limits his own wild forest. For him the shagbark will be a tree to plant and encourage wherever a moist loamy bottom of granite, limestone or clay base exists. It does not do well in sand base soils. Nurseries seldom offer young hickories, as they are exceedingly difficult to transplant, and wild stock, gathered, no matter how young, is nearly certain to die. The way to set a tree in a given locality, then, is to plant one or two sound healthy nuts and save the vigorous seedling. Also, wherever nature has already started a young hickory, to clear away the overgrowth and give it all the encouragement possible.

We have a number of species of hickories, but four of them will be enough to know and identify. The shagbark is known at once by its long, hard, whitish gray bark scales, warping off at both top and bottom from the trunk. Young specimens are not so easy to be sure of, but look for a large five-leaved leaf with the center leaflet very large, two nearly-as-large on each side of it, and two little ones behind that, and your identification is reasonably certain. Occasionally they have a

seven leaflet leaf, but as a rule this number belongs to its cousin the mockernut. The shagbark is an exceedingly imposing and stately tree in any forest and one can hardly have too many of them. They cannot be grown in pure stand, however, for the drain they make on the vitality of the soil is very great, almost as great as with the ash tree.

In the autumn the shagbark leaf goes right to a russet brown and is soon down, so that it cannot be depended upon much in the autumn color scheme. The wood, like that of all the hickories, is tough, strong, springy and heavy; salable at high prices for all sorts of tool handles and carriage work; not durable in the ground. The nuts bring \$2 a bushel in the open market, so that the biannual yield from each tree runs over \$12.

Higher up on the ridges and uplands you will find that smooth-barked cousin of the shagbark, the mockernut hickory, so named by the country boy because of its thick shelled nut with the small sweet kernel, which looks so very like a shagbark nut, but which, after several stones have been smashed in breaking it, yields only a tiny reward for the great labors involved. This tree will grow in sand base soils as well as in all the others, and is blessed with a glorious, pale yellow leaf coloration in autumn, so that, when prospecting for nuts in the fall you come upon one of these shafts of flaming yellow looming up through the trees you may be sure that it is *not* a shagbark—and get out your sledge-hammer forthwith!

The wood is equally as valuable as the shagbark, but more pliant. Woodsmen use it to make rope of,



Photo by Romeyn B. Hough, Lowville, N. Y. Author of "Trees of America."

THE SHAGBARK HICKORY

THE NATIONAL TREE OF AMERICA. NOTE THE CHARACTERISTIC, TALL OBLONG CROWN EVEN IN FIELD GROWTH



Photo by Romeyn B. Hough, Lowville, N. Y. Author of "Trees of America."

THE MOCKERNUT HICKORY

THIS TREE IS BROADER AND DARKER BARKED THAN THE SHAGBARK, AND IS ALSO LACKING IN THE SCALY BARK. WITHE'S AND BASKETS ARE MADE OF THE TOUGH FLEXIBLE BARK AND SHOOTS

usually by peeling off the bark and plaiting it into a rope, kept smooth and pliant by rubbing with deer fat. To show what can be done with it the writer once took a small sapling of the mockernut hickory, peeled off the bark like stripping a glove from the finger, split three strips of it a yard long and one-eighth inch wide, tied them in a double knot at one end and plaited the three into a braided rope; and in five minutes' work with the hands alone had a rope that three men could not break. Not only that, but he then tied this rope to a bow made of the sapling itself, at both ends with a clove hitch knot, put it around a cedar fire drill and made two fires with it before the rope wore out! Up to the time that I tried that experiment I was very skeptical that any thong could be made of vegetable fibre strong enough yet flexible enough to withstand the terrific wear and tear of fire making with the rubbing stick; but, given a sharp flint stone, a dead cedar or balsam and a young mockernut hickory, I will make you a fire any time with my bare hands in half an hour's time, and I hold a medal of honor for that feat!

Growing in still poorer soils if need be, but on rocky ledges and hillsides by preference, is the pignut hickory, a rather small member of the family, but very handsome, especially when it paints blobs of sheer orange on your hillside in autumn. The nut is very variable, some specimens giving a small thin-shelled bitter nut and other ones with thick shells, occasionally sweet. It is a sort of degenerate shagbark, with the same five to seven leaflets but smaller and pale underneath; bark, gray but close-adhering. This tree is well worth saving, even though its nuts are not edible, as it is always handsome in appearance, even stately when growing in generous soils (reaches 120 feet high and three feet diameter in the Ohio basin) and its lumber commands high prices for wagon and tool work, so that you are blessed if your hillside has a fair sprinkling of them. Planted from seed, not to be transplanted, like all the other hickories.

The last of the group is the swamp hickory or bitternut. It will get a foothold of its own accord on the edge of your pond or lake, and, as it there gets plenty of sun, will have a lot of long branches and therefore be worthless as lumber. However, both it and the pignut yield grand firelogs for the open fire, in the library of a winter's night, so that any surplus of them growing in your swampy spots should be encouraged for future stores in the wood pile. It has eleven leaflets, small and narrow; and a small, bitter nut, but at that, the tree affords a refuge and a granary for your red squirrels and chickarees. As a landscape feature on a pond border it makes a most graceful and attractive hickory, with orange leaves in autumn. It grows readily from seed and can be transplanted, with care, taking up while dormant and following the roots out far enough to get a reasonable amount of feeders. Transplant in the spring well before the sap starts up the tree.

All the hickories have two kinds of flowers, the sterile green catkins, which furnish the pollen, and the fertile flowrets, which later develop into nuts. The tree is thus able to set its own fruit, and the seed years are from two to three years apart.

Of the elm group but two are at all common, the white and rock elms. The white elm occurs over our whole range, but has its best growth in the north, and never does well in close forest as the heavier-leaved trees soon crowd it down and kill it. But, favored with sun and clearness, it makes a stately growth, the joy of the landscape architect, with its characteristic sweep and droop of the many branches. The wood is of high value for tough usages like wagon wheel hubs, pulleys, etc., but is an indifferent dangerous firewood as it sparks almost as badly as hemlock. It contributes nothing to the autumn coloration for its leaves go quickly to brown and are soon down, but all summer long it more than compensates. Also the dead leaves soon perish, making it a good lawn tree. Prefers moist granite or limestone soils, but will succeed in clays and to a certain extent in



THE WHITE ELM

ONE OF THE GREATEST FAVORITES AMONG AMERICAN TREES. NOTE THE WHITE OAK GROWING BENEATH IT, AND PROBABLY OF THE SAME AGE

sand bases. Usually crooked and spindly in forest, so see that it has clearance on a hillside or other location where there is plenty of sunlight.

The other elm, the rock elm, is very scarce in the east and fast growing so in the west, almost as rare in fact as the nearly extinct slippery elm, once fairly common all over our area. About

ten years ago, when the writer was engineer for a large western car works, almost the first work I undertook for them was the design of an all-steel hand car because the end of the rock elm was already in plain sight! This company then had all the available rock elm located and a lien on it for future use, but at that, they were preparing

for the last of it by replacing their rock elm car sills and walking beam frames with pressed steel. For combined toughness and strength, no other wood begins to approach the rock elm, even longleaf yellow pine being a poor second, while the oaks were not to be thought of. Anyone who has worked this wood with carpenter's tools will appreciate this, and as it is not to be replaced with any material except pressed steel, if I were growing elm at all as a forest proposition, the rock elm would be my choice. The characteristic feature of this valuable tree is the corky ridge formation on its twigs. It is a small and more compact tree than the white elm, easily propagated from seed in nursery beds, and readily transplanted, as are all the elms, but it is not

offered by nurserymen who usually confine themselves to the more ornamental white and weeping elms, both costing about one dollar for 8 to 10 foot specimens. They all require rich moist soil, the red or slippery elm never straying far from a river bottom, and the rock elm taking the drier soils. The leaves of all of them are much alike, with characteristic parallel leaf veins, the red and rock elms having longer and thinner leaves than the white. The last two are much less vulnerable to insect attack, foreign insects in particular being a veritable scourge to the white elm.

Perhaps the most interesting of all the trees in this group are the ash trees. That poet who wrote the line "The warlike ash, reeking with human



ANOTHER ELM

NOTE THE GREAT SPREAD OF THE BRANCHES WHICH MAKES IT PARTICULARLY DESIRABLE AS A SHADE TREE

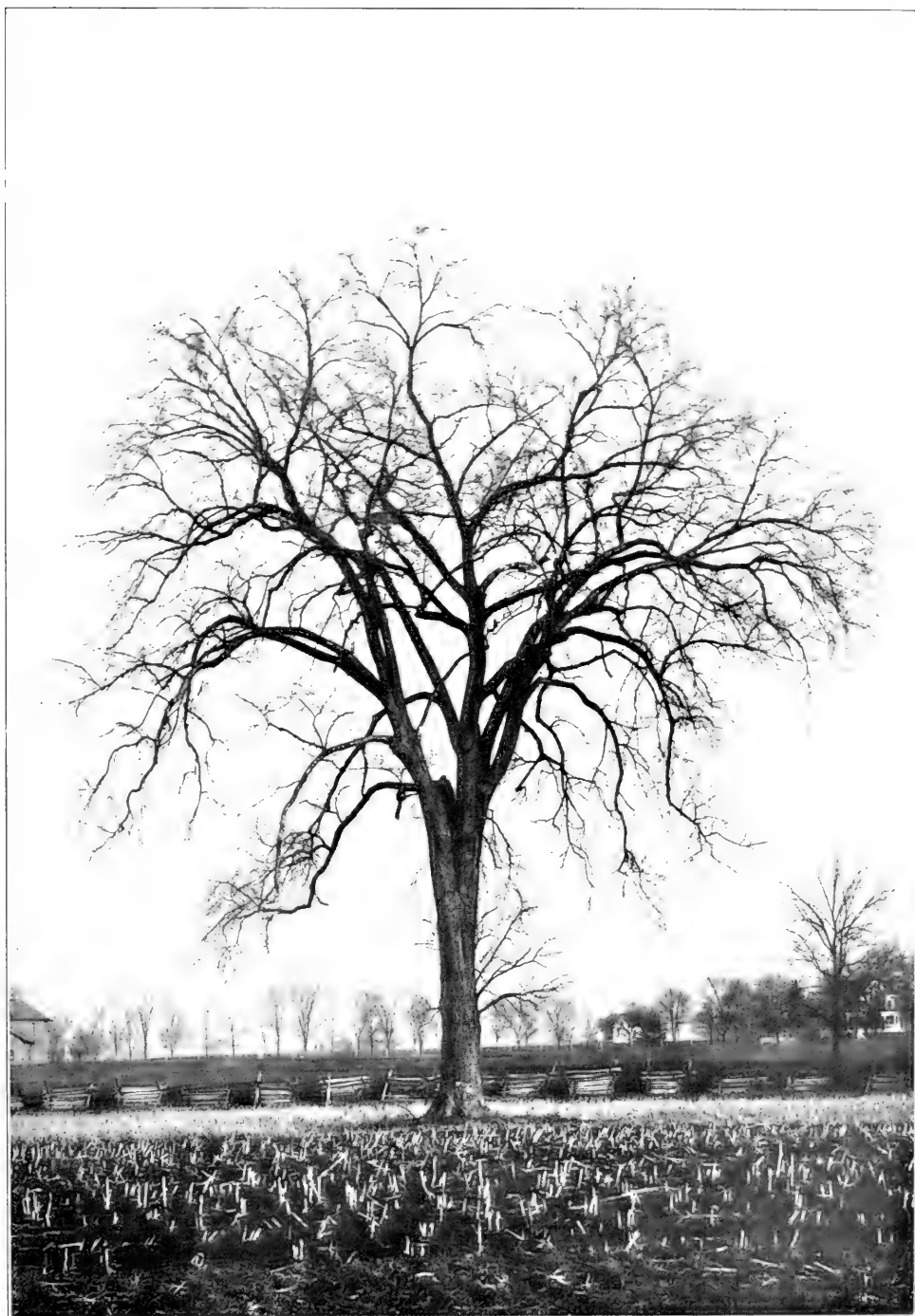

ELM TYPE COMMON IN OHIO

THESE WHITE ELMS ARE PROLIFIC IN CENTRAL OHIO AND ARE AS POPULAR THERE AS IN OTHER SECTIONS OF THE UNITED STATES

blood" hit the keynote of ash characteristics, for the tree has been most intimately our strength since the earliest stone ages. In fact, the Edda, the Sacred Tree, whose crown upheld the heavens, and under whose roots burnt the hells, of the most ancient mythology of the human race, was the ash, and, with its blood-red flowrets, like drops of human blood along the twigs, the tree well bears out the poet's simile. Since the world began man has made his bows and his spear shafts, and has split out his arrows from the ash, and, though it belongs to the same family as the olive, the symbol of peace, we as a race would cheerfully give all the olives in the world for one stark, heathen ash tree! Aside from its warlike qualities the ash is the queen of the forest for beauty, and the wolf of the forest for soil consumption. When an ash tree is through it takes a whole revolution of beech to restore the exhausted soil, and, to insure that no other tree shall share the soil with it, the rain drippings from its leaves kill every other sapling that tries to make a start. Even its own young cannot live under it, and, to insure that they get a fair start, Nature provides a seed like a small winged javelin that will fly to a considerable distance and then strikes deep into the soil, point first. And, to insure high winds to carry them far, these samaras have so tough a stem as to hang on until late in the winter when only an unusual gale can tear them loose.

With its seven to nine leaflets on the leaf stalk, the ash is like to be mistaken for a hickory, but an inspection of the fruit or flowers will decide at once. The deep red flowrets in small bunches, sessile on the twigs, are nothing like anything on a hickory tree and, later, the bunches of long, winged samara, like maple keys, in no way resemble a hickory nut! Both American white ash and European *F. Excelsior* are easily obtained from nurseries, at prices ranging from 75 cents to \$2 for specimens from 10 feet to 2½ inches diameter and 25 feet high; or they can be propagated from seed by collecting from the trees in the fall, putting in heaps in compost piles (which rids them of their wings) and planting in

nursery beds in the spring. Readily transplanted to forest sites in the second year provided that the tap root is cut and the seedling transplanted in the autumn of the first year.

For soil preference the white ash likes a rich moist loam, any base except sand, anywhere not too dry, and it needs lots of sun. The black ash wants a more swampy location, and both of them give a handsome crown of leaves with many branches, the leaves turning to copper and purple-green in the autumn. In the forest the ash has a tall columnar trunk with no side branches until it reaches the crown of the forest, when it branches out with a round heavy crown. In Europe the thrifty French grow it in oak forests in the proportion of about one ash to four oaks, and also use it as shade over coppice growth. I have seen whole forests of it forming a light shade over young coppice shooting up from old oak stumps, the ash trees being spaced about forty feet. Over there its principal enemy is the cantharides or Spanish fly; indeed, in the south of France it is grown to attract these insects, which are then collected in great numbers for medicinal purposes. Our own white ash is immune from Spanish fly attacks, so it also is now being largely introduced in the clay base forests of the Seine basin, in both oak standard forests and oak coppice.

We have four principal species of ash trees, the white, black, green and blue. The wood of the first is strong, light, elastic and, beyond a certain point, brittle. The name ash comes down to us unchanged from the Saxon word *aesc*, a pike, and the latin *fraxinus* from its sudden snap off short when over strained. The white ash is known from the black by its bark, which is ridgy with the striations crossing at a long slant, giving innumerable lozenges of bark, and by the short stems of its leaflets, for the black ash has sessile leaflets and a soft gray bark without lozenges. The wood of the latter is more pliant and darker in color, but it, too, snaps off short like a biscuit when the limit of its endurance is reached. Often called the "hoop" ash because in the backwoods, hoops and baskets are

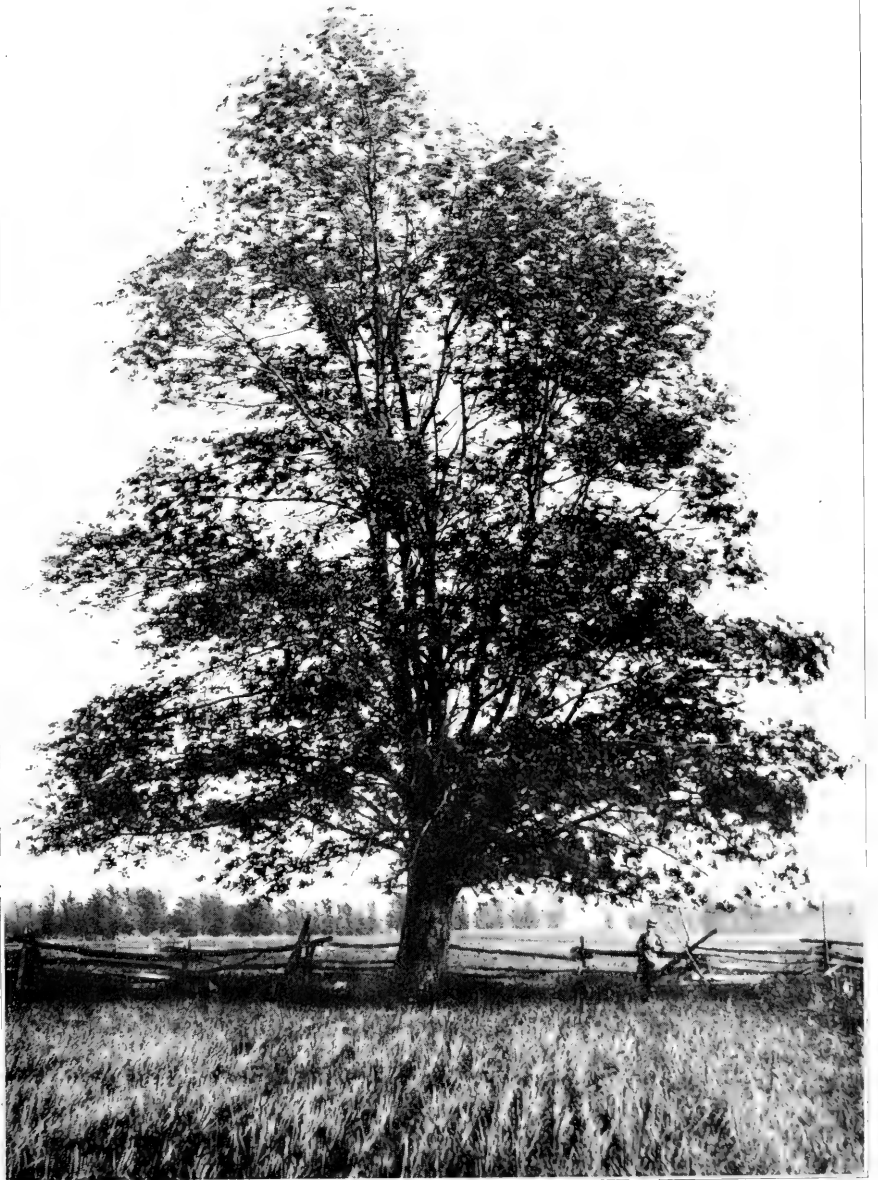

Photo by Romeyn B. Hough, Lowville, N. Y. Author of "Trees of America."

THE WHITE ASH

THE WHITE ASH, THE EDDA OR SACRED TREE OF THE WHITE RACE, WHOSE CROWN UPHOLDS THE HEAVENS
THE HISTORY OF THE WORLD COULD BE WRITTEN AROUND THIS TREE

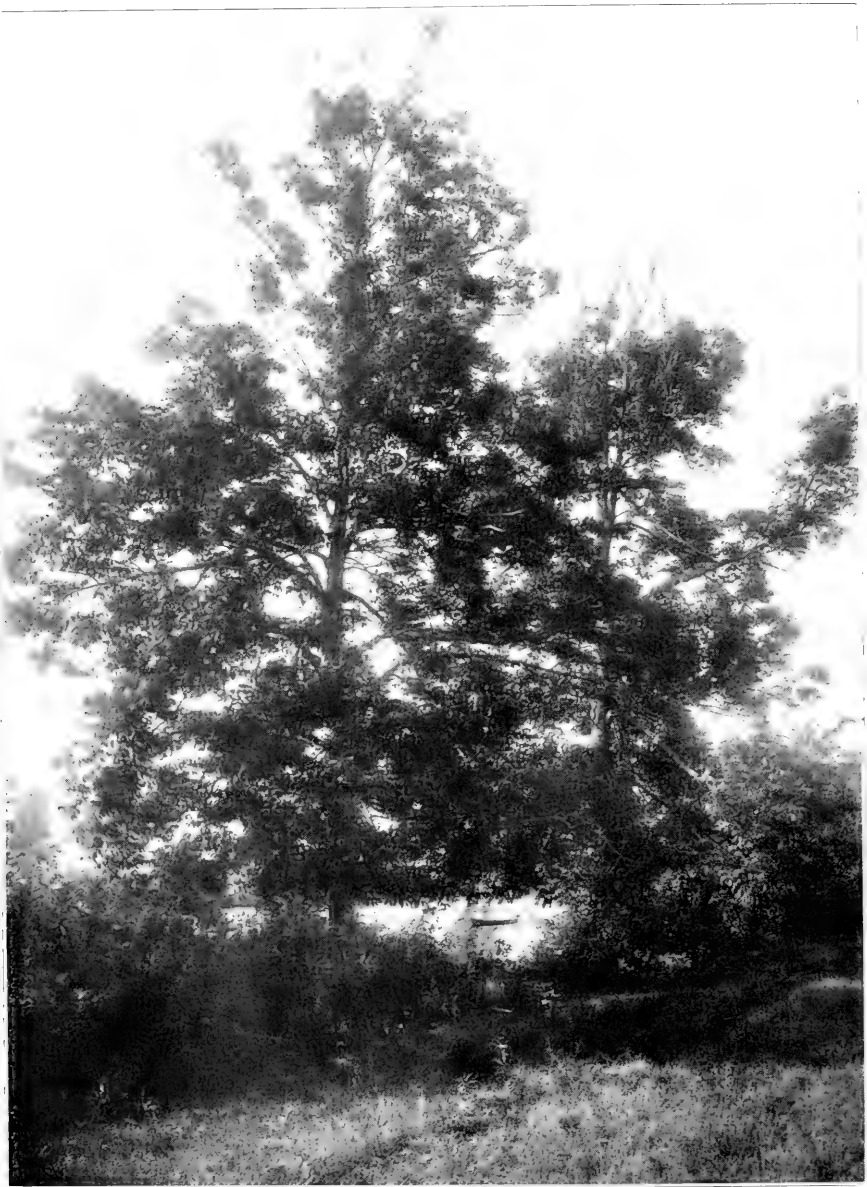

Photo by Romeyn B. Hough, Lowville, N. Y. Author of "Trees of America"

THE BLACK ASH

THE SNOWSHOE AND HOOP ASH OF THE REDMEN. THE WOOD IS EXCEEDINGLY FLEXIBLE AND STRONG, ITS SAP RINGS ARE SO FORMED THAT SOAKING AND POUNDING SEPARATES THEM INTO FLAT STRIPS

made from it by sawing off a section of green branch, free from knots, beating it soundly to separate out the annual rings and then splitting the stick as wide as the hoops are wanted, say two inches. The annual rings then separate by hand and give as many strips as there are annual rings in the billet.

Of the other two ashes, the red (or green), both varieties of the same species, is a small and infrequent tree, hard to tell from the white ash, preferring stream sides and low locations in company with red maples and gums. Its samaras, grown on a little fishpole of a stem, distinguish it from the white

ash, and, like the others, it makes a very handsome shade and ornamental tree. A clump of four of them that I know personally are growing in Riverside Park up a hundred feet above the Hudson in New York City and are doing very well, though the location is drier than Nature would select.

The blue ash, *F. Quadrangulata*, is rare east of the Ohio basin, but easily grown here. A very pretty small tree.

with bluish bark from which the Indians used to make their blue dye by boiling the inner bark. Its twigs are mint shaped, that is, four-sided, whence its specific name, and it is the only one of the ashes which does not split easily. Because of its toughness lumbermen use it for raft and car side poles. On the forest estate it would be more an interesting curiosity than a subject for planting.

320 MILES OF SHADE TREES

FIFTY-SEVEN cities and towns in Massachusetts have determined to cooperate in a wholesale planting campaign. This movement was started by the Massachusetts Forestry Association and local interest was aroused in each place situated on a Circuit consisting of State Highways and of city and town streets. This Circuit begins at Boston and passes through the cities of Worcester and Springfield on to Pittsfield and North Adams near the New York State line. From North Adams, the trunk line of the State Highway is followed through the northern half of the State connecting Greenfield, Fitchburg and the historic towns of Concord and Lexington. From Lexington, Massachusetts Avenue closes the Circuit passing through old Cambridge to the starting point on Commonwealth Avenue, Boston. This circuit is approximately 320 miles in length and is one of the most delightful drives in the Commonwealth.

Nearly 100 miles of the line wind through the Berkshire Hills. In passing over it one encounters Jacob's Ladder a few miles west of Springfield. This Ladder is an interesting piece of highway and consists of a series of rising and descending gradients in passing over the height of land. Almost immediately after leaving the Ladder one finds himself among the beautiful old estates of Lenox and Pittsfield. Facing eastward at North Adams, the famous Mohawk Trail is seen winding its way to the top of Florida Mountain in the Hoosac Range, the highest point on the State Highways. To reach this

height requires a constant climb for $3\frac{1}{2}$ miles. When this point is past the traveler coasts, if in an automobile, for several miles through the wild rugged canyon of Cold River. This is one of the most picturesque bits of scenery in the state.

On the whole this Circuit is already one of the most popular drives in the state. Improved roads all the way make it very attractive to tourists and thousands of these visitors cross the state each year in automobiles by this route. While this highway is already very attractive and comfortable to the traveler, it is proposed to make it more so by planting shade trees and ornamental shrubbery along all the sections where they do not now exist. There are many places especially in the Berkshire Hills where nature has already done more than man could do to make this highway beautiful and these sections will not be touched. There are cuts and embankments to be sure which of course will be given attention and will be planted to vines, shrubbery, or trees as the individual case demands.

After the idea had been given due publicity a Conference of official delegates from the cities and towns traversed by this Circuit was called by the Association. This Conference was held in Worcester, May 8th, and ways and means were discussed by which the task could be accomplished. A Circuit Tree Planting Committee was elected by the Conference and clothed with power to make surveys, plans and estimates and to execute the work in cooperation with all of the cities and towns on the Circuit.



Forest conservation has passed the inspirational stage. It calls for concrete measures; founded on justice, workable in practice.

Growing new forests is an enterprise governed by business considerations. So is conservation handling of existing forests. Speculation is mostly over. Timber-owning from now on is nothing but the expensive carrying of raw material until it can be manufactured profitably.

To perpetuate forest resources demands that forest industry be guaranteed prosperous and stable footing. It must have safety from ignorant prejudice, also a lively constant use of wood at a price paying for protection and production by proper methods.

We lack this today. Paradoxical as it may seem, forest conservation's most urgent need is for a better lumber market. The reverse means sacrifice, waste, and consequent early extinction. What has no value, we do not save.

Successful measures affecting forest affairs must be based on intimate knowledge of the business they involve. Citizens, states, and congresses now deal too much with forest problems in an ignorance no man of them would tolerate if it affected his own business.

The remedy lies in education; not so much in the importance or technique of forest production as in its business necessities. When we have this, and not before, will we have an American forest policy that coordinates Federal, State and private effort.

To further such education is the chief duty of every sincere forest agency, private and governmental.

E. T. ALLEN,
Director American Forestry Association.



Conservation strictly speaking means protecting against loss or injury. As applied to natural resources in the propaganda of the past ten years it first meant forest preservation by "wise use." Its present day application includes not only all natural resources, both commercial and scenic, but human life and energy. The result is a somewhat indefinite promulgation of theories and policies, which lose force by variance from the original conception of conservation, and by the distribution of the educational effort over too many fields and subjects.

Forest conservation never meant "preservation" in the sense of not using the forests, although this interpretation is still given. Proper forest conservation means using the mature forests and producing other forest crops on the land. This makes forest conservation a purely economic problem. The end desired cannot be attained unless it is profitable, and up to the present, with a few minor exceptions, it has not been possible to make capital yield a reasonable return from conservative forestry. Mature forests are still available at much less than the cost of production, prices for forest products are too low, close utilization is not possible, and carrying charges are too high and too uncertain. With the mere ownership of mature reserve timber threatening the solvency of timberland owners, it is useless to talk about investing capital in forest production from the seedling or volunteer young growth stage.

One unfortunate result of the forest conservation agitation of the past decade is that it inspired speculative buying of timber, with the expectation of large returns because of the dwindling supplies. The phantom of timber famine has never been very real, and its use as a bugaboo or club has been a boomerang. Another result of the talk of timber scarcity is that it has given an excuse for an unjustified use of substitutes, and created a wide spread feeling that it is a public duty to use building material other than wood. The reduced sales of lumber cause lower prices, and put the possibilities of conservation farther away than ever. Conservation that does not pay will not conserve. The country needs economic, not sentimental forest conservation.

E. A. STERLING,
Director American Forestry Association.

HARRISBURG'S MUNICIPAL FOREST

By HARRY J. MUELLER

APRIL 23rd last, was a "red letter" day for Harrisburg, Pa. Thousands of school children set out about 5,000 white pine seedlings, as a nucleus the city's municipal forest. There have been many Arbor

Day proclamations and many exercises on a small scale in the State, but never was there a planting in which so many school children participated carried out so successfully. Can you imagine two thousand children marching from



TWO THOUSAND HARRISBURG, PA., CHILDREN ON THEIR WAY TO PLANT FIVE THOUSAND WHITE PINE SEEDLINGS IN THE FIRST MUNICIPAL FOREST IN PENNSYLVANIA



EACH CHILD MADE A HOLE IN WHICH TO PLACE A WHITE PINE SEEDLING

their school through green woods to do their part in setting out little pine trees? Nature was all dressed up for the occasion; the showy flowers of the dogwood and Judas tree dotted against the pale green background of the bursting leaf buds of the elm, sassafras, maple and oaks, made a glorious picture. The floor of the woods was beautifully carpeted with young shoots of grass and myriads of wild flowers.

Gathering the children into a large circle in an open place, the exercises were opened by singing "Pennsylvania." Miss Mira L. Dock, of the American Forestry Association and Chairman of the Forestry Committee of the General Federation of Women's Clubs, addressed the children. Being formerly a Harrisburger, she told of her joy in being back again to help with what she termed, "the realization of her fondest dream—restoring Wildwood to its natural beauty." In appreciation of her remarks the children sang "Planting a Tree."



FORESTER MUELLER DISTRIBUTING TREES TO THE CHILDREN

Deputy Commissioner of Forestry of the State of Pennsylvania, I. C. Williams, then told the children that

"the preservation of the beautiful park depends upon you, and unless you plant trees each year to replace the old ones that die, this will soon become a barren waste."

J. Horace McFarland, President of the American Civic Association, added a few remarks on the taking care of our trees. He asked the children, "Did

avoided any confusion, and the roots of the plants did not dry out.

"Mister, I have a hole."

"Mister, give me a tree."

"How do you plant it?"

"Mister, is this right?"

These were the questions heard from all sides. It truly was a wonderful sight to see these kiddies spread out over a couple of acres patiently waiting for their trees. Their faces rivaled the wild flowers in the tall grass. And such care—no dolly was ever more tenderly handled than were these little trees, as they were placed in their last resting place.

Everyone was alive with interest. After the planting came the marking of



LITTLE GIRL PLANTING A SEEDLING IN A HOLE SHE HAS DUG



READY TO PLANT THE SEEDLING. EACH OF THE 5,000 PLANTED WAS ABOUT THIS SIZE

you ever cut down a tree," then followed with "Did you ever grow one? You could perhaps cut down in two hours any of these forest giants which took two or three hundred years to build."

After a short instruction on the history of the white pine tree from the seed until it is ready to set out, and how to "plant a tree" the children formed a line and began singing "America," as the column moved slowly toward the plantation. As each child took his place beside a hole, already prepared to receive the tree, a corp of men distributed the trees which had been previously puddled, but only to children that stood at the holes. This

their trees. Rows of stones, fences of broken sticks, most every plan that a child's mind could devise was in evidence. The plot resembled an Indian burying ground after they left.

It was rather remarkable how well the work was done. Only a few of the trees had to be planted over. As a whole, the little girls did better work

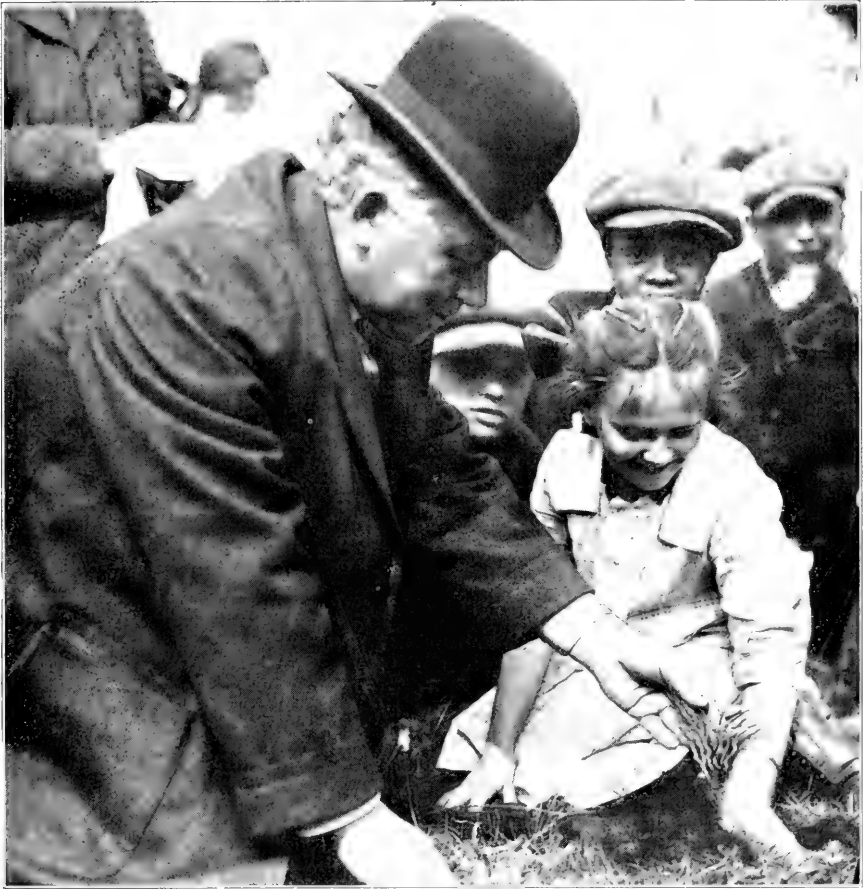

I. C. WILLIAMS, DEPUTY STATE FORESTRY COMMISSIONER, SHOWING A LITTLE GIRL HOW TO PLANT ONE OF THE WHITE PINE SEEDLINGS

than the boys. As the planting was limited to one of the largest schools of the city, a certain sense of rivalry was displayed by the ones not included in the exercise. Pupils from other schools passing by were invited to join in, but they said, "We'll show you we can plant ours better than you when our turn comes."

It is the plan to mark each schools' work and carry these plantings every fall and spring Arbor Day until all the

waste places now given over to growing weed trees like Aspen, Maple, Alders and Birches will be reclaimed to more desirable species, and a forest primeval is again established.

Considering the proposition from a commercial point of view, under systematic management, the annual returns from the sale of timber from this park should more than pay the expenses of maintenance.

A NEW CONSERVATION COMMISSIONER

MR. George D. Pratt, of Brooklyn, N. Y., has been appointed by Governor Whitman as head of the reorganized Conservation Commission of New York State. In making his selection for the office, Governor Whitman has chosen an active and prominent conservationist, for Mr. Pratt has for many years been closely identified with many phases of the movement.

The appointment was received with general satisfaction throughout the State and especially by members of the Camp Fire Club of America of which organization Mr. Pratt is the President. The work will undoubtedly be most congenial to him, as he has given much study to it for several years and his practical experience derived as an officer and member of several associations devoted to conservation will be of great value to him in his new work. He has recently been the recipient of thousands of messages of congratulation and encouragement following the announcement of his appointment.

The appended memorandum of

Mr. Pratt's activities and connections indicates how closely he has given his attention to conservation matters:

President, Camp-Fire Club of America; Member, Boone and Crocket Club, Aero Club, American Bison Society,



GEORGE D. PRATT

RECENTLY APPOINTED BY GOVERNOR WHITMAN AS HEAD OF THE REORGANIZED CONSERVATION COMMISSION OF NEW YORK STATE. MR. PRATT IS ONE OF THE LEADING CONSERVATIONISTS OF THE COUNTRY

American Museum of Natural History, Century Club, New York Zoological Society, National Sculpture Society, New York Yacht Club, Piping Rock Club, Seawanahka-Corinthian Yacht Club, Wild Life Protective Fund; Member Committee on Admissions, University Club, New York; Chairman, Physical Department Committee, International Y. M. C. A.; Chairman, Central Branch (Brooklyn) Y. M. C. A.; Treasurer, Boy Scouts of America; President, Brooklyn Council, Boy Scouts of America; Member, Public Recreation Commission, City of New York; Vice-President, Brooklyn Institute of Arts and Sciences; Member, National Society for the Promotion of Industrial Education, American Association for Labor Legislation, National Conservation As-

sociation, National Association of Audubon Societies, Society of Sanitary and Moral Prophylaxis; Treasurer, Pratt Institute, Brooklyn, N. Y.

Commissioner Pratt has announced the appointments of Llewellyn Legge as Chief Protector in charge of the Division of Fish and Game, Clifford R. Pettis as Superintendent of Forests, William C. Howard as Assistant Superintendent of Forests, and A. S. Houghton, of New York, City as Secretary to the Commission.

Commissioner Pratt at the same time announced the appointment of eighty-six forest and district rangers and mountain watchman. Marshall McLean of New York has been designated by the Attorney General as counsel for the Commission.

FOREST HOMES

SECRETARY of Agriculture Houston has promulgated a set of regulations for administering the new law which provides that National Forest land may be leased for summer home sites and other recreational purposes in tracts of 5 acres or less for periods not to exceed thirty years. This law supplements the revocable permit system under which recreational use of the forests already had developed considerably. Many users have been unwilling to make substantial improvements because of the uncertainty of tenure involved in the old form of permit, which, however, is still expected to meet the requirements of persons who are not likely to occupy the land for more than a few years, or to make elaborate improvements.

The primary object of the "term permits," as the leases are called, is not to obtain revenue but to promote the use of National Forest land for recreational purposes, say the regulations. At the same time, since permittees receive special benefits, it is regarded as only fair that they should reimburse the government for the expenditure incurred in administering the Forests.

The rates range from \$5 a year up, in accordance with the location of the land, the demand for it, and the use to which it will be put. The District Foresters are authorized to grant permits to applicants who intend to make improvements costing less than \$1,000 and to use the land for a period not longer than fifteen years. All other permits will be approved by the Forester at Washington.

Applications must be filed with the Supervisor of the forest affected, designating the location of the land desired, the use to be made of it, and the approximate cost of contemplated improvements. Examination and survey of the land will be made by the Forest Service free of charge. An application for a hotel or summer resort site must be accompanied by plans and specifications of proposed structures and a statement as to their probable cost. The law stipulates 5 acres as the maximum, and it is believed that much less than this will suffice for most persons, but permittees will not be placed close together except when it is necessitated by heavy demand for land in a particular locality.

W. GOODRICH JONES OF TEXAS

ON JUNE 1 the new State Forestry law in Texas went into effect, and in a short time, following the selection of a State Forester and the organization of his department, the State will begin to make the progress which always follows good forest management.

The passage of this forestry bill was largely due to the efforts of W. Goodrich Jones, of Temple, Texas, who has been elected president of the newly organized Texas State Forestry Association in recognition of his interest and his labors in the cause of forestry. Mr. Jones as a youth spent two years at school in Dresden, Germany, and there he became imbued with the German love of forestry. Later he visited most of the forests and forest schools in Germany and Austria, and also spent much time in the forests in the west and north-west in this country. His love of the woods has led

him to build a summer home in the Pecos National Forest at Cowles, New Mexico, some 8,000 feet above sea level.

He has been a member of the American Forestry Association ever since its organization and at one time was one of its vice-presidents, representing Texas at the Governor's Conference called by President Roosevelt. Twenty years ago Mr. Jones was instrumental

in having Texas pass an Arbor Day bill. Fifteen years ago he was commissioned by the United States Forest Service to make a report on the standing timber in Eastern Texas and how long it was likely to last, and he has never



W. GOODRICH JONES OF TEXAS

ELECTED PRESIDENT OF THE RECENTLY ORGANIZED TEXAS STATE FORESTRY ASSOCIATION, AND AN ENTHUSIASTIC ADVOCATE OF FOREST CONSERVATION

relaxed his interest in forestry not only in his own State but throughout the entire country.

So, when it became apparent that Texas must protect her forest resources by the creation of a State Forestry Department and the passage of a State forestry law, Mr. Jones was the logical man to lead the movement. He secured the assistance of Senator Morris Shep-

pard and through Senator Sheppard, Mr. J. G. Peters of the Forest Service was sent to Texas to outline the need of a forestry law and submit the draft of a forestry bill to Governor-elect Ferguson, the legislative committee and others who were interested. Dean, E. J. Kyle of the State Agricultural and Mechanical College; J. C. Dionne of the Gulf Coast Lumberman of Houston; Dr. W. B. Phillips, State Geologist, and Richard F. Burgess of El Paso all gave their assistance, while the American Forestry Association aided by means of a publicity campaign in arousing a demand for a State Forestry law. It was not an easy matter to get the bill passed. The House Committee favored it by the scant majority of one; and

while the bill passed the House by a good majority, it got through the Senate by only one vote. Then Governor Ferguson hesitated about signing it, and for a time it looked as if he would not. Mr. Jones at once notified all who had worked for the bill, and the Governor received messages urging him to sign, while a committee consisting of Mr. Jones, President Bissell of the A. & M. College and Dr. Wm. B. Phillips called personally to impress upon the Governor the necessity of a forestry law, and finally he signed it.

Later the Texas Forestry Association was permanently organized, and Mr. Jones was elected its first president, a position he is certain to fill with credit to himself and to the association.

A LARGER AMERICAN FORESTRY

STARTING with the August number, AMERICAN FORESTRY will be enlarged from its present size, $6\frac{3}{4}$ by 10 inches, to 9 by 12 inches, thereby giving a much larger page, making it easier to handle and read, and permitting better illustrative work, which is so necessary and desirable in presenting to our readers the best that can be given in photographic reproduction of all the many phases of forest and tree conditions.

That the continued improvement of the magazine during the last several months is being appreciated by the readers of the magazine is apparent. Its increased value as a medium of education in all that pertains to trees and forests is indicated by the steadily growing demand for it, not only by individuals but also by schools and colleges.

With the August issue, still further improvement will be made and a still greater educational value will be given by the inauguration of a series of thoroughly well written and illustrated articles, each relating to one variety of tree and telling all about it, from the simplest way to identify it to all its varied commercial uses.

The cover of the enlarged magazine will be a picture in color of a tree together with its bark, leaf and bud, a different tree being pictured each month.

These improvements will make the magazine more instructive and valuable, and it will become a necessity to anyone interested in trees, woodlands and forests, and desiring the best articles and information about them.

OREGON FOREST STUDENTS

SINCE the organization of the Oregon Forest School in 1909, it has been the practice of those in charge to take the students, each spring, for a field trip of about two weeks, into the forests of the Cascade Mountains. Special trips by classes in management, mensuration, logging and silviculture are of course made during the year, but it has been found that taking the whole crowd to the woods tends to produce an esprit de corps which can be created in no other way. The effect of having all the men joined on one piece of work unites them in a very wholesome way. The free-masonry engendered by the camp fire, the cook shanty and the last sack of tobacco is well known to all woodsmen.

In past years field work has been in the nature of practice work, of value only to the fellow who did it. This year a cooperative arrangement was entered into with the Federal Forest Service to the end that the energies of the seventy embryo foresters and logging engineers who made the trip should produce something of permanent value. Supervisor Brundage of the Santiam National Forest had a reconnaissance project which, through lack of funds, had not been completed. Mr. Brundage had work to do and the Forest School had the men to do the work. With these very simple fundamentals a working agreement was made which produced eminently satisfactory results.

The Forest School men went by train to the little logging town of Detroit, and from there packed their blankets 12 miles by a rough mountain trail to the camp site on the Breitenbush River. The Breitenbush,

which rolls "white water" nearly its entire course, is a picturesque mountain torrent. With the stately Douglas firs, towering 200 feet and more above them, and with a dozen sulphur hot springs gushing boiling water near them, the foresters had an ideal location for their headquarters camp.

The area which was to be cruised had never been surveyed, so the Forest Service officials have run control lines



OUR WOODS PILOT



THE OREGON FOREST STUDENTS IN THE WOODS



A CREW READY TO HIT THE TRAIL



AN ESTIMATING CREW
STUDENTS OF THE OREGON FOREST SCHOOL. THESE CREWS, USUALLY OF FIVE MEN EACH, ARE IN CHARGE OF THE
UPPER CLASSMEN

with transit and stadia along the principal ridges and streams. Between these meandered lines the cruise lines were run, due north and south or east and west, as conditions required. A 10 per cent cruise was made, using the familiar Forest Service gridiron method. Distances between control lines were chained except where, in a few cases, men were experienced enough to pace. Pacing, in this country, was no easy task, since the ground was pretty thickly strewn with down timber and since, on nearly every line, there was a difference in elevation of one to four thousand feet. Elevations were taken with aneroid barometers, checked by an instrument read every half hour in camp.

The estimating crews, usually consisting of five men each, were in charge of upper classmen, who, in addition to acting as straw bosses, did the topographic work. Another man ran compass and carried the head end of a chain or paced, another tallied, while two rooks, armed with Biltmore sticks, took diameters and threw them into the tallyman. Five Forest Service men

and three Forest School professors acted as inspectors of the whole job. None of the inspectors got lost, but occasionally a crew was lost by the inspector.

To the forestry student of the Eastern United States, this cruising expedition would sure have been some experience. Imagine estimating trees up to 8 feet in diameter and 225 feet high, and fancy areas of this stuff going better than 150,000 board feet to the acre. Besides, the little area of 10,000 acres cruised out, was a veritable arboretum. Douglas fir, western hemlock and western red cedar were the principal species. But shot in among them, here and there, were mountain hemlock, Engleman spruce, incense cedar, noble fir, lovely fir, western grand fir, white pine, lodgepole pine, whitebark pine, yellow cypress, western yellow pine and western yew, with alder, and Oregon maple along the streams. To add interest to the work, an occasional deer was sighted, and fresh elk tracks were seen, while one crew got great amusement for a half hour, watching a black bear eat grass in an open glade.

FOREST FIRE "DON'TS"

TO OBTAIN the cooperation of the public in preventing forest fires which are doing a great deal of damage in the East this spring, the United States Forest Service has prepared ten "DON'TS" to be observed in the woods. It is hoped that these rules may have a beneficial effect during the fire season of the Southern Appalachians, which is not yet over, and that of the north woods, which is just beginning and which, from present indications, promises to be unusually severe.

Many thousands of acres of forest and suburban woodland from Maine to

Florida, and from the Atlantic coast as far West as Arkansas, have been burned over already this spring by fires which started for the most part from preventable causes. On the National Forest purchase areas alone, forty-nine fires occurred in March, burning over more than 6,500 acres, while forty-four fires starting on private land near or within government boundaries damaged nearly 5,500 acres. Fires in April were even more numerous and severe, but rains in the latter part of the month helped the situation somewhat. Fire statistics for April are not yet available.

THE "DON'TS"

1. Don't throw your match away until you are sure it is out.
2. Don't drop cigarette or cigar butts until the glow is extinguished.
3. Don't knock out your pipe ashes while hot or where they will fall into dry leaves or other inflammable material.
4. Don't build a camp fire any larger than is absolutely necessary.
5. Don't build a fire against a tree, a log, or a stump, or anywhere but on bare soil.
6. Don't leave a fire until you are sure it is out; if necessary smother it with earth or water.
7. Don't burn brush or refuse in or near the woods if there is any chance that the fire may spread beyond your control, or that the wind may carry sparks where they would start a new fire.
8. Don't be any more careless with fire in the woods than you are with fire in your own home.
9. Don't be idle when you discover a fire in the woods; if you can't put it out yourself, get help. Where a Forest Guard, Ranger, or State Fire Warden can be reached, call him up on the nearest telephone you can find.
10. Don't forget that human thoughtlessness and negligence are the causes of more than half of the forest fires in this country, and that the smallest spark may start a conflagration that will result in loss of life and destruction of timber and young growth valuable not only for lumber but for their influence in helping to prevent flood, erosion, and drought.

EDITORIAL

MORE EASTERN FOREST RESERVES

A NUMBER of the leading organizations of New England and of the South Atlantic States will be asked to join the American Forestry Association in the effort to secure the passage by the next Congress of an act providing for an appropriation of \$2,000,000 a year, for a period of five years, to be used in the purchase of forest land in New England and the Southern Appalachians as forest reserves.

By the end of this year, when the present appropriation will be exhausted, about 1,200,000 acres of this land will have been secured. A total of some 5,000,000 acres is needed. That is the amount of acreage recommended by Secretary of Agriculture Houston. The National Forest Reservation Commission endorsed the recommendation. Every thinking citizen who can judge by present conditions in deforested countries what the future holds for New England and the Southern Appalachian territory if the forest land is not preserved also heartily approves the plan to increase and extend the forest reserves in these districts.

AMERICAN FORESTRY asked Governor Locke Craig of North Carolina his opinion and Governor Craig said: "The Appalachian Mountains are covered with forests nowhere excelled. The luxuriance of the vast wooded areas contribute largely to the grandeur of the scenery. The views from mountain peaks are magnificent beyond description and are restful and pleasing on account of the richness and beauty of the foliage. These forests are about to be destroyed. They are very valuable for lumber. The individuals and corporations who own them have, as the law now exists, the right to cut them down. They are mowing them down as a field of wheat is mowed. The debris left upon the ground soon becomes very dry and there is a great deal of it. It is impossible to prevent fires

in this inflammable material. After these mountains have been cut over terrific conflagrations sweep the whole country, destroying every living thing. Instead of mountain peak and ridge and slope, covered with a wealth of primeval forest, there is vast desolation. I have seen this myself.

"The Appalachian Mountains constitute the source of our rivers that water the plains and turn the wheels of industry. When the forests on the mountains are destroyed the water supply is no longer conserved. When the rains come the torrents rush down and wash away the fertile lands and destroy the efficiency of the streams.

"The Government can render a lasting and invaluable service to the country by the protection of these forests."

Governor Craig hits the nail on the head in his last sentence. Furthermore it is the duty of the Government to provide for the future welfare of the people and it can perform no more valuable service than by providing for the protection of these forests lands—such protection indeed is vitally important, and should not be delayed.

Governor Rolland H. Spaulding of New Hampshire not only approves of what purchases have been made in his State but advocates further purchases without delay. He says to American Forestry:

"I am glad to accede to your request for an expression of opinion, personal and official, as to the necessity for acquiring more Federal Forest Reserves in the White Mountains.

"The importance of protecting the forest covering at the sources, in the New England region, of our chief New England rivers, is daily becoming more evident and more widely appreciated. Purchases of land already made for Federal Forest Reserves in this territory have been wise and timely, but insufficient. For the sake of economy in

the purchases and for the sake of doing the remedial work as rapidly as possible, now is the time to act."

Now is the time to act, as Governor Spaulding says. The work has been well started and it should be continued. It is safe to say that the citizens of

every New England and every Southern Appalachian State wish it continued and will petition their Senators and Congressmen to vote in favor of providing the \$10,000,000 desired for the increase in these forest reserves during the next five years.

LUMBER WASTE IN THE WOODS

COMMENTING upon a photograph of piles of cordwood and fagots in a German forest, published in the May issue of AMERICAN FORESTRY, Mr. Frank A. Cutting of Boston, Mass., a lumberman, voices the feeling of practically all lumbermen in his remarks. The photograph called attention to the fact that the cordwood and fagots so well utilized by the Germans are usually wasted in American woods and forests.

Mr. Cutting expresses the situation thoroughly well when he says in his letter: "All lumbermen in the United States would be glad to utilize their waste if it could be done, but the fact is that the American people have been taught to burn coal, use gas and electricity, and there are only few localities, populated by foreigners, who will use wood at all, and they are able to pick up waste materials in cities to quite an extent. The railways are not interested in having waste products from their woods utilized as fuel; they wish to sell the coal that is in the mines they own, and they encourage use of coal and discourage the use of wood. Freight rates are high on wood waste for fuel and it is impossible to use it to any extent.

"I am operating a tract of land in the Adirondacks and I would be glad

to give any one all the waste material they wanted at 25 cents per cord of 128 cubic feet, if they would take it away, and there is some of the waste material I would be pleased to give them for nothing if they would move it. All lumbermen would give away their defective trees if they could get anyone to cut them down and take them away. It is not the lumberman who is to blame because waste material is left in the woods; he would be very glad to have this waste material removed and utilized."

Mr. Cutting is quite right, it is not the lumberman who is to blame for waste material in the woods. If he could get it out at even a very little profit the lumberman would do so. But he cannot. It would be better for the forest if he could, for thus one forest fire danger would be removed. Perhaps some day when utilization of wood waste has reached the point where value is secured from every portion of the tree the present condition will be overcome.

One hesitates to think of what suffering would be saved the very poor in big cities during the winter if the hundreds of thousands of cords of waste wood now annually left to rot in the forests could by some means be made available for their use.

FOREST NOTES

Beginning June 7, the department of forestry at Cornell will offer instruction during a full summer term, in addition to the regular winter terms heretofore conducted. The first six weeks of the term, it is announced, will be spent at Ithaca, and the remainder of the time, up to September 22, will be in camp on a large forest tract in the Adirondack mountains. The courses offered form a regular part of the specified work for professional students of forestry in the college, though the courses will be open also to those who have had three years instruction at Cornell, or its equivalent. The subjects include timber utilization and measurement, silviculture, forest management, and advanced research into various other forest problems. Because of the advantages of summer work, especially in a fully timbered area such as the Adirondacks, certain of the courses offered will be given hereafter during the summer term only.

In addition to the summer work in the woods the students are required to spend the ensuing fall in getting practical experience in the logging woods, returning to Ithaca to finish their college course in the spring. Those who take graduate training for the degree of master in forestry, must have an additional summer term in the camp in the woods, and then one more term at Cornell, to be graduated in February in time for the examinations for the Federal Forest Service, or for the beginning of spring activities in state or private employ. The alternation of class room and laboratory study with practical work in the field during the final years at the University is believed by those in charge of the course to offer a desirable arrangement not only from the standpoint of thorough instruction in forestry, but also it is said to appeal to men seeking thorough technical training.

Secretary of Agriculture Houston has completed an extensive tour of the National Forests to find out for himself to what extent their timber, forage, water power, recreational and agricultural resources are being developed for the public under present methods and to make a study of the administrative problems of the Forest Service. During May he visited the forests in several of the Western States, spending almost the entire time of his trip in the wilds, seeking first-hand impressions of the conditions under which the Forest Service works.

Conditions on the National Forests during the summer are likely to be unusually arduous, according to Forest Service officials, in that a dangerous fire season is indicated for many of the forests by the abnormally slight precipitation of the winter. Unless the deficiency is made up, the forests will be dry and inflammable earlier in the season than usual and the water supply of many extensive regions

will be low. Numerous irrigation, reservoir, and power projects are wholly or in part dependent on National Forest protection of watersheds, and it is beginning to be generally understood that, aside from actual farming on National Forest land, the agricultural interests of the West are much concerned in the conservation of water supplies accomplished by the Forest Service through lessened fire damage and regulated grazing. In Southern California the interest in maintaining a forest cover on the mountains from which local water supplies are derived is so keen that for a number of years local funds have been raised and paid over to the Department of Agriculture in order to provide for more intensive protection than the federal appropriations make possible.

Under the methods employed in handling the livestock grazing business of the National Forests, agricultural development is benefited not only through the prevention of injury to watersheds but also through the opportunities opened for ranch development. As new settlers locate near the forests room is made for their stock by cutting down, if necessary, the number of stock allowed the larger permittees. More than 16,000,000 cattle, sheep, and hogs, including young stock, will find forage this year on the National Forests. The revenue from this source is expected to exceed \$1,200,000 in 1915.

One of the difficult administrative problems, now being rapidly worked out on the National Forests is that of agricultural development of land more valuable for farm than for forest purposes. Extensive land classification has been made possible by a special appropriation of Congress for this purpose, renewed each year since 1912. Up to date, about 16,000 agricultural homesteads have been listed within the National Forests, opening to agricultural development nearly 1,700,000 acres of forest land. In addition, a certain amount of agricultural development is provided for under special use permits, where for any special reason listing does not afford a practicable means of meeting settlers' needs.

More than 37,000 special use permits of all kinds have been issued to the public since 1905, granting free, or for a reasonable charge, permission to conduct all sorts of enterprises on National Forest land. They include apiaries, barns, boat houses, botanical gardens, cemeteries, churches, cottages, golf links, hotels, mines, mineral springs, observatories, orchards, quarries, railroads, ranches, residences, restaurants, rifle ranges, roads, sanitariums, sawmills, slaughter houses, telegraph and telephone lines, tennis courts, tramways, tunnels, water power plants, wells, weirs, and

wharves. The total income from special use permits in 1914 was over \$131,000.

Farmers, prospectors, and local settlers of all classes, who needed timber for their own use in the construction of houses, barns, fences, and the like, were given free more than 120,000,000 feet of National Forest timber during 1914, while about 14,000,000 feet was sold to settlers, ranchers, and others at cost prices. The timber sale business of the National Forests amounts to about \$1,250,000 annually, more than 1,500,000,000 board feet of stumpage having been sold to lumber operators last year.

The National Forests contain most of the picturesque wilderness in the country, and their recreational resources are practically unlimited. More than 2,000 cottages have been built on the forests by summer residents under the permit system, which has been supplemented by a law providing that tracts of 5 acres or less may be leased for periods not to exceed thirty years. This law, under which leasing regulations have just been promulgated by the Secretary of Agriculture, is expected to stimulate recreational development of the forests. Already a large number of applications to lease National Forest land for summer residence sites have been received, and even communities are beginning to take advantage of the forests situated near them by obtaining tracts for use as picnic, camping, and playgrounds.

The State-owned lands in the Adirondacks and Catskills must eventually become a very productive forest area giving large returns to the State not alone from the products of the forest but as a tremendous reservoir for water storage and as a recreation place for all the people of the State. For a number of years the question of how to handle safely and effectively these State-owned forests has been before the people in one form or another. During the past year the Faculty of The College of Forestry at Syracuse, made up of fourteen graduate Foresters, has been giving this whole question careful study and there have been regular discussions held every week or two taking up every possible phase of the question. From these discussions there has come gradually the idea that the only safe way in which to treat the forest lands of the Adirondacks and Catskills as a great State resource is to place them under a Constitutional Conservation Commission.

New York leads all the other States in the Union in lumber consumption, with a total annual bill for timber of all kinds of over \$100,000,000. Enough wood is used annually in the industries of the State to make a board walk 1,000 feet wide and 1 inch thick from Syracuse along the New York Central to New York City and part way back.

In the United States as a whole four-fifths of the standing timber is privately owned, and one-fifth is owned by various States and the

Federal Government. New York owns one-fifth of the forest land of the State and one-fourth of the standing timber. Owing to a clause in the Constitution this timber can not be cut even though it is dying or dead and a menace to healthy timber about it.

H. S. Betts has been appointed Chief of the Office of Industrial Research of the Forest Service and reported in Washington early in May. He takes the place of O. T. Swan, who recently resigned. Mr. Betts had been connected with the Forest Service Laboratory at Madison, Wis.

Out of a total of 142 forest fires this spring in eighteen counties in Kentucky where there are Forest Wardens, seventy-eight were caused by burning brush; by hunters, ten; railroads, eight; saw mills, four; incendiary five; and thirty-four were of unknown origin. There were ten more fires during the spring up to April 30, than during the whole of 1914. While the fires in the aggregate did immense damage to younger growth, their discovery by the wardens prevented widespread destruction.

Thomas B. Wyman, Secretary-Forester of the Northern Protective Association at Munising, Mich., has devised a novel method of keeping before the eyes of men who go into the woods the necessity of taking precautions against forest fires. On the backs of playing cards which are distributed in packs by the Association, he sounds a warning, and on the faces of the cards each heart, spade, club and diamond, bears a brief but pointed sentence urging better care of the forests.

Chief Forester Henry S. Graves, who was on a tour of western forests with Secretary of Agriculture Houston, was called East early in May by the serious illness of his father Prof. W. B. Graves, of Andover, Mass. Mr. Graves fortunately was able to reach his father in time to be with him when he died.

The College of Forestry of the University of Washington was given the unanimous decision of the Judges as having the best exhibit at the Engineers' Open House, given on the campus at the University recently. The Judges were H. C. Gill, Mayor of Seattle; President Henry Landes, of the University of Washington; Kenneth C. Beaton, of the staff of the Seattle Post Intelligencer, and Almon H. Fuller, Dean of the College of Engineering.

Mayor Gill based his decision on the difficulty of bringing the great out-doors within the compass of a small room; President Landes complimented the Foresters on the amount of work accomplished in so short a time; Mr. Beaton gave the Foresters his vote because their exhibit was the most original; while Dean Fuller thought that the utilization of the material at hand was most clever.

United States Forester Coert Dubois, with headquarters at San Francisco, has decided to present badges to the Boy Scouts of Cali-

fornia who qualify this summer as National Forest Aids. To become eligible to receive a badge, the Scout is required to spend at least ten days in a National Forest performing useful service during the fire season under the direction of Federal Forest Officers. At the end of this period he has to pass an examination in elementary forestry.

The first Scout to receive the badge was a Mill Valley boy who worked in the Tahoe Forest last summer under Forest Supervisor R. L. P. Bigelow. He performed with credit the duties assigned to him, being specially complimented by Bigelow for his conduct at the Crystal Peak fire, and passed the examinations with a fair rating.

The badge is of bronze with the Forest Service pine tree in relief encircled by the words "National Forest Aide." The District Forester expects that a number of them will be earned by the Boy Scouts next season.

Each forest user on the Apache National Forest has been provided with a circular calling his attention to the danger of forest fires during the hot summer season and asking him to lend a helping hand to the Forest Service in the endeavor to prevent fires. He is asked to observe the following simple rules:

Dig a pit or clear trash from your camp fire and be sure it is out before you leave it.

Be sure your match is out before you throw it away.

Throw your cigarette or cigar stubs or knock out your pipe ashes where they cannot start a fire.

A little care is worth days of fire fighting. If you discover a fire and cannot go yourself and put it out, will you please notify the nearest Forest Officer?

State Forester Chapin Jones, of Virginia, recently appointed, is inaugurating a campaign against fires in the woods, in which all citizens are asked to join. The first step is to get warning notices into the hands of people who have timberland to protect or who wish to put them up for the good of the cause. These are now being distributed and may be had by addressing the State Forester at Charlottesville, Va.

These notices are of three different kinds, and are printed in large letters on heavy cardboard, for posting indoors in stores, post-offices, blacksmithshops, etc., and on cloth for posting outdoors, along the roads and paths in the woods, etc., where anyone traveling through the woods would see them. They explain the State laws, which are strict, and call upon all citizens to be careful not to start a fire and to put out, if possible any that they may find burning.

The Conservation Committee of the New York Constitutional Convention held its first public hearing upon proposed amendments

relating to the forests, fish, game, waters and other natural resources of the State at Albany, on May 18. The members of the committee are Charles H. Dow of Jamestown, Chairman; Edward M. Angell of Glen Falls, H. LeRoy Austin of Catskill, George A. Blauvelt of Monsey, George Clinton, Sr., of Buffalo, W. Barlow Dunlap of Amsterdam, Olin H. Landreth of Schenectady, Ferris J. Meigs of Tupper Lake, Rush Rhees of Rochester, Edward M. Smith of Watertown, James S. Whipple of Salamanca, and Arthur J. Baldwin, William P. Bannister, Timothy A. Leary, Louis Marshall, Morgan J. O'Brien, and John G. Saxe, of New York.

The war tax of 1 cent on each letter and post card mailed in Canada and the tax of 2 cents on each check and bill of exchange has been cheerfully met and everyone is anxious to help in every way possible.

Last summer the New Brunswick Railway Company removed all inflammable material from a narrow strip bordering the right-of-way of the Transcontinental and Intercolonial Railways through their wild lands. Largely as a consequence of this, in spite of a dry summer, fires were confined to an area of less than 100 acres and only very few acres destroyed were burned by fires originating on the railroads. The method employed was to pile the debris on the right-of-way and burn it there. Care was taken to avoid scorching trees standing along the border of the woods.

In the speech from the Throne at the opening of the New Brunswick Legislature, announcement was made that a new act to provide for a complete and scientific survey of the seven million acres of Crown Lands at a cost of \$400,000 would be introduced. It was announced that the survey would probably take three or four years to complete and would lead to a re-classification of the Crown Lands.

The Committee appointed by timber limit holders in the Upper Ottawa Valley to consider the formation of a cooperative fire protective association like those in the lower Ottawa and St. Maurice Valleys decided that they were too late to take action this year. Let us hope that Providence will forgive their procrastination and care for them and protect their timber this summer.

The Grand Trunk Pacific Railway has announced that contracts have been let and other arrangements made for the installation of crude oil burners on passenger locomotives on the section between Prince Rupert, B. C., and Jasper, Alta., a distance of 718 miles. It is expected that this installation will be complete by next June. Freight engines will continue to burn coal for the present.

CANADIAN DEPARTMENT

By ELLWOOD WILSON

His Royal Highness, the Duke of Connaught, has consented to act as Patron of the Canadian Forestry Association for the year 1915.

The Minister of Railways and Canals, the Hon. Frank Cochrane, is negotiating with the Provincial Governments of New Brunswick, Quebec and Ontario for the establishment of motor speeder patrols on the National Transcontinental and Intercolonial Railways. This will be a great step in advance and should go far to prevent forest fires being set by the railways. It is to be hoped that the good work will be continued and that the efficiency of Government owned railways will approach that of those privately owned. Mr. McNeillie, late with the C. P. R. has joined the staff of the Intercolonial with headquarters at Moncton.

The work on the big hydroelectric plant of the Laurentide Company, Ltd., which was temporarily suspended last fall has started up again and will be rapidly pushed to completion. The dam is 1,700 feet long with a maximum height of 90 feet and when completed will have six 20,000 horse power units. The St. Maurice River will be backed up for nearly 20 miles, and will be navigable for steamboats for 72 miles above Grand' Mère. This company is establishing a timber reserve by planting up lands bought for the flowage rights, 150,000 trees, mostly Norway Spruce, were planted in 1914 and have wintered exceptionally well. Two hundred thousand more will be planted this month and two to three hundred thousand this fall and as soon as possible 1,000,000 trees per annum will be planted which is the Company's present annual cut. An extension of one and one half acres is being made to the Company's nursery in which some experiments in tree raising will be carried out.

The reindeer imported by the Laurentide Company last summer have wintered well, but as they were travelling just before the rutting season no young were born. Two bucks were trained last winter and worked nicely in harness.

The students of the Quebec Forestry School are in their spring camp at Burrill's Siding on the Estate of Mr. G. C. Piché, Chief Forester of Quebec. Mr. Piché is also building a house for the use of the students at the Government Nursery at Berthierville, which will be a model of its kind. There has been a large demand for trees for private planting from this nursery and its entire output will soon be called for.

The Canadian Northern Ontario Railway is arranging to install an efficient fire protective

system along its new line from North Bay to Port Arthur, in accordance with the requirements of the Dominion Railway Commission. There will be twenty-three special patrolmen with track velocipedes, and two head patrolmen with power speeders, covering portions of the line where the fire hazard is greatest. Where the situation will permit, the section men and other regular employees will perform such patrol work and fire fighting as may be necessary.

Davis W. Lusk, Jr., Yale Forest School, 1912, is at Calgary, Alberta, investigating fire damage for the Dominion Government.

Last season the Laurentide Company, Ltd., made some experiments with the Jenson Tree Planter and found it so satisfactory that ten more planters were ordered this year and will be used in the planting operations. They were found faster than setting the trees by hand in holes made with a mattock or dibble and it was found that the mortality among the trees set with the planter was considerably less than among those planted in the old way. Comparative costs of the two methods will be published later.

Mr. R. R. Bradley, Forester of the New Brunswick Railway Company reports that several students who worked for him last season have enlisted. Among them is Mr. R. K. Shives, who has gone to Toronto to join the aviation corps. He was the first applicant.

The damage done by the spruce bud worm last summer was very serious throughout New Brunswick, much more so than during the previous summer. Spruce hillsides seen from a distance took on the same brown tinge that a severe scorching would give them. Over large sections of the St. John River and Miramichi valleys practically all the new growth was destroyed. It seems that the chief danger in the work of the insect lies in the weakening of the trees which must render them liable to attacks by more deadly insects, such as the bark beetle.

There is another disease attacking the fir and cedar and to some extent the pine in New Brunswick. The effect is to dry out and kill the twigs and branches and in some cases whole trees of these species. The branch instead of losing its needles, as when attacked by the spruce bud worm, will die, and turn a brilliant red until the needles fall off. This blight does not seem to affect the spruce.

Mr. R. H. Campbell, Director of the Dominion Forestry Branch, is taking another step in line with his progressive and creative policy for forestry work in Canada. He proposes, in order to bring together the organizations that are interested in forest research in Canada, and to systematize and develop it, to form in connection with the Dominion Forestry Branch, an Advisory Committee, which would include most of the leading men directly interested in forest research. The work of the Committee will be to suggest problems for investigation and methods of carrying out such projects; to pass upon all projects of scientific investigation planned and to revise for publication the results of such investigations. It is not proposed that any remuneration should be given for services on the Advisory Committee, nor that the Committee should meet as a whole at any time, but they should be consulted by correspondence. There may be a small executive committee of the Advisory Committee which will consider plans and proposed projects more in detail and have them put into proper form for transmission to the various authorities to whom the investigation would be suggested. As soon as it can be arranged a special officer of the Forestry Branch will take charge of the arranging and recording of the investigations that may be undertaken. The following have been invited to become members:

Dr. B. E. Fernow, Dean, University of Toronto Forestry School; to represent forest management and silvicultural aspect of forest research.

Clyde Leavitt, Forester; to represent Conservation Commission and forest protection researches.

W. N. Millar, Assistant Professor of Forestry University of Toronto Forest School; to represent Forest mensuration and engineering aspects of forest research.

R. B. Miller, Dean, University of New Brunswick Forest School; to represent Maritime Provinces.

Ellwood Wilson, Forester Laurentide Company; to represent Quebec private timber owners.

G. C. Piché, Forester Province of Quebec; to represent Quebec Provincial Government.

E. J. Zavitz, Forester, Province of Ontario; to represent Ontario Provincial Government.

H. R. MacMillan, Forester, British Columbia; to represent British Columbia Provincial Government.

L. M. Ellis, Forester, Canadian Pacific Railway; to represent Canadian Railways.

Dr. Judson F. Clark, Clark & Lyford, Consulting Foresters; to represent Private Foresters, both east and west.

F. W. Broderick, Professor Horticulture and Forestry, Manitoba Agricultural College; to represent farm forestry in prairie provinces.

J. H. White, Instructor, University of Toronto Forest School; to represent technological and botanical aspects of forest research.

Dr. C. D. Howe, Associate Professor, University of Toronto Forest School; to represent silvical aspects of forest research.

BRITISH COLUMBIA NOTES

Cooperation in fire protection along the International Boundary is being arranged between the U. S. Forest Service and the British Columbia Forest Branch. The plan includes on the United States side the Washington, Okanogan, and Colville Forests in District 6; the Kaniksu, Pend d'Oreille, Kootenai, and Blackfoot Forests in District 1; and in British Columbia the Vancouver, Vernon, Nelson and Cranbrook Forest Districts.

In the educational campaign for fire prevention this year the distribution of pocket whetstones to woodsmen of all kinds, and of sets of lantern slides to moving picture theatres will be continued. Their use last year was much appreciated and gave excellent results. About 20,000 of the whetstones and several hundred slides will be distributed. The whetstones bear an attractive inscription requesting care with fire in the woods. The design is copyrighted by the Western Forestry and Conservation Association, through whose courtesy its use is allowed.

A Ranger Station and launch depot is being built at Thurston Bay on Sonora Island. This is one of the many islands lying between Vancouver Island and the mainland, and is about the centre of the region where most of the logging on the coast has so far been done.

Transportation in this part of the Province is practically all by water, and the work of protection and administration requires the use of a good many launches, large and small, by the Forest Branch. The launch depot is fitted up with ways, machine shop, storage sheds, etc., for looking after the launches, and its establishment will greatly facilitate Government work.

Some of the largest and best bodies of timber in British Columbia are situated around Cowichan Lake on Vancouver Island. A telephone line to facilitate fire protection will be built there in the near future by the timber holders and the Forest Branch in cooperation.

During the winter a number of the District Foresters have given special instruction and practice in cruising, surveying and scaling to their rangers. Such Ranger Schools, as they are called, are held in the field, camps being established in a locality offering opportunities for instruction in all the various lines of work.

The chance to improve their qualifications for forest work given by these "Ranger Schools" has been appreciated by the Rangers and other officers attending them. A number of Forest Guards were, on their urgent request, allowed to attend.

These Ranger Schools will hereafter be held every winter in each Forest District.

CURRENT LITERATURE

MONTHLY LIST FOR MAY, 1915

(Books and periodicals indexed in the Library of the United States Forest Service.)

Forestry As a Whole

Proceedings and reports of associations, state forest officers, etc.

Deutsche dendrologische gesellschaft. Mitteilungen no. 23. 399 p. il. Teltow, 1914.

India—Bihar and Orissa—Forest department. Annual progress report on forest administration for the year 1913-1914. 63 p. Patna, 1914.

Massachusetts—State forest commission. Report, 1914. 10 p. pl. map. Boston, Mass., 1915.

Massachusetts—State forester. Eleventh annual report, 1914. 111 p. pl., map. Boston, Mass., 1915.

Sweden—Forstliche versuchsanstalt. Mitteilungen, heft 11. 200 p. Stockholm, 1914.

Forest Aesthetics

Street and park trees

Fitchburg, Mass.—Park commissioners. Annual report, 1914. 49 p. pl. Fitchburg, 1915.

Forest Education

Forest schools

Idaho, University of—School of forestry. Announcements, 1914-1915. 16 p. il. Moscow, Idaho, 1914.

Forest Legislation

Massachusetts—State forester. The new Massachusetts forest taxation law explained and printed in full. 35 p. pl. Boston, Mass., 1914.

Peyton, Jeannie S., comp. Forest fire laws of Virginia. 9 p. Charlottesville, Va., 1915. (Virginia—State forester. Forestry leaflet No. 2.)

Peyton, Jeannie S. Forestry laws of Virginia. 12 p. Charlottesville, Va., 1915. (Virginia—State forester. Forestry leaflet No. 1.)

Forest Description

North Carolina—Geological and economic survey. Timber resources of Franklin county. 4 p. Chapel Hill, N. C., 1915. (Press bulletin 143.)

Forest Botany

Trees: classification and description

Bean, William Joseph. Trees and shrubs hardy in the British Isles. v. 1-2. il., pl. London, J. Murray, 1914.

Shaw, Norman. Chinese forest trees and timber supply. 351 p. pl., map. London, T. Fisher Unwin, 1914.

Wight, W. F. Native American species of *Prunus*. 75 p. pl. Wash., D. C., 1915. (U. S. Dept. of agriculture, Bulletin 179.)

Silvics

Studies of species

Zon, Raphael. Seed production of western white pine. 15 p. Wash., D. C., 1915. (U. S. Dept. of agriculture. Bulletin 210.)

Silvical characteristics of trees

Ponset de Sandon, B. B. Rol svyeta v lyesu i egho znachenie v lyesovodstvye (Role of light in the forest and its significance in silviculture.) 164 p. il. Righa, 1914.

Silviculture

Planting

Allen, R. W. Windbreaks, hedges, and ornamentals for irrigated sandy soils of eastern Oregon. 24 p. il. Corvallis, Ore., 1915. (Oregon—Agricultural experiment station. Bulletin 125.)

Henry, Augustine. Profitable trees. 12 p. Dublin, Dept. of agriculture and technical instruction for Ireland, 1913.

Idaho, University of, Department of forestry. Announcements concerning forest and shade trees and basket willows recommended for planting in Idaho. 4 p. Moscow, Idaho, 1915. (University of Idaho. Publication, v. 10, No. 1.)

New York state college of forestry, Syracuse University. Planting forest trees on idle lands in New York. 15 p. il. Syracuse, N. Y., 1913. (Bulletin, Sept., 1913, ser. 13, No. 2 C.)

Robinson, R. G. Forest-tree growing in the South Island. 30 p. pl. Wellington, N. Z., Dept. of lands and survey, 1914.

Saskatchewan—Dept. of education. Tree planting for the schools of Saskatchewan. 27 p. map. Regina, 1914.

Forest Protection

Diseases

Associated factory mutual fire insurance companies. Dry rot in factory timbers. 2d ed. 107 p. il. Boston, Mass., 1915.

Hole, R. S. *Trametes pini*, Fries, in India. pl. 26 p. Calcutta, Supt. govt. printing, 1915. (Indian forest records, v. 5, pt. 5.)

Fire

North Carolina—Geological and economic survey. Our forest fire record. 2 p. Chapel Hill, N. C., 1914. (Press bulletin No. 137.)

Shapiro, D. F. Strakhovanie lyesnuikh imushchestv ot oghnya (Insurance of forest property against fire.) 41 p. S. Peterburgh, 1914.

United States—Dept. of agriculture. Forest service. April field program, 1915. 29 p. Wash., D. C., 1915.

National and state forests

United States—Dept. of agriculture—Forest service. The national forests of New Mexico. 20 p. Albuquerque, N. M., 1915.

Forest Utilization*Lumber industry and trade*

Cary, Austin. Informal talk given Forest club, Victoria, B. C., Dec. 28th, 1914. 4 p. Victoria, B. C., 1914.

Faas, V. V. Lysea i ekspornaya lyesnaya torg-hovlya yughozaladnagho kraya (Forests and export lumber trade of southwestern region.) 34 p. S.—Peterburgh, 1913.

Faas, V. V. Lyesa i lyesnaya torghovlya Finlyandii (Forests and lumber trade of Finland.) 339 p. pl., diagr., map. S.—Peterburgh, 1914.

Faas, V. V. Lyesnaya torghovlya i torghovue doghovori s inostrannuimi ghosudarstvami (Lumber trade and trade treaties from foreign countries.) 120 p. S.—Peterburgh, 1914.

Findlay, Richardson & Co., ltd. Philippine lumber. 13 p. il. Manila, P. I.

Schneider, Edwin Emil. Felling, sawing and seasoning timber. 18 p. il. Manila, P. I., 1913.

Seliber, B. I. Sovremennoe sostoyanie nashei lyesoobrabatuvayushchei promyshlennosti (Present condition of our wood manufacturing industry.) 42 p. S.—Peterburgh, 1914.

Wood-using industries

Zinn, W. D. The wooden hoop silo. 4 p. il. Morgantown, 1914. (W. Va.—Agricultural experiment station. Circular 8.)

Forest by-products

Crockett, Walter H. How Vermont maple sugar is made. 48 p. il. St. Albans, Vt., 1915. (Vt.—Dept. of agriculture. Bulletin no. 21.)

Wood technology

Schneider, Edwin Emil. Methods of identification of Philippine woods. 21 p. il. Manila, P. I., 1912.

Wood preservation

West Coast Lumber Manufacturers' Associaton, and Association of Creosoting Companies of the Pacific Coast. Creosoted Douglas fir paving blocks; the modern pavement for roads, streets, bridges and crossings. 32 p., tables. Seattle, Wash., 1915.

Auxiliary Subjects*Botany*

Gatin, C. L. Les fleurs des bois. 73-115 p. il. Paris, P. Lechevalier, 1913.

National parks

Glacier national park. Report of the supervisor, 1914. 22 p. map. Wash., D. C., 1914.

Mount Rainier national park. Report of the superintendent, 1914. 21 p. map. Wash., D. C., 1914.

Sequoia and General Grant national parks. Report of the superintendent, 1914. 22 p. map. Wash., D. C., 1914.

Wind Cave national park. Report of the acting superintendent, 1914. 13 p. map. Wash., D. C., 1914.

Yosemite national park. Report of the acting superintendent, 1914. 36 p. map. Wash., D. C., 1914.

Erosion

Davis, R. O. E. Soil erosion in the south. 23 p. il., pl. Wash., D. C., 1915. (U. S.—Dept. of agriculture. Bulletin 180.)

Dyes and dyeing

Little, Arthur D. The dyestuff situation and its lesson. 10 p. Boston. A. D. Little Inc., 1915.

Periodical Articles*Miscellaneous periodicals*

Botanical gazette, April, 1915.—The alpine and subalpine vegetation of the Lake Tahoe region, by F. J. Smiley, p. 265-86; On the male gametophyte of *Picea canadensis*, by A. H. Hutchinson, p. 287-300.

Breeders' gazette, April 29, 1915.—National forest products laboratory, by E. N. Wentworth, p. 847-8.

Colliery engineer, Jan. 1915.—Preservative treatment of timber, by J. M. Goldman p. 314-17.

Country gentleman, May 1, 1915.—More meat from the ranges, by L. H. Douglas, p. 805, 824.

Garden magazine, April, 1915.—Planting and shaping young trees, by J. C. Whitten, p. 160-1.

Gardeners' chronicle, April 17, 1915.—*Cupressus lusitanica*, by A. Bruce Jackson, p. 206-7.

International institute of argiculture. Monthly bulletin of agricultural intelligence and plant diseases, Jan., 1915.—The trees of the Alföld in Hungary, by Jenő Bernátsky, p. 88-92.

Journal of botany, April, 1915.—"Witches' brooms" on British willows, by Miller Christy, p. 97-103.

Journal of the Washington academy of science, April 19, 1915.—*Tribroma*, a new genus of tropical trees related to *Theobroma*, by O. F. Cook, p. 287-9.

National wool grower, April, 1915.—Possibility of producing more and better sheep by improvement in methods of handling on the range, by James T. Jardine, p. 15-18.

Plant world, April, 1915.—The flora of the Williams division of the Tusayan national forest, Arizona, by Arthur D. Read, p. 112-23.

Railroad red book, Jan., 1915.—National irrigation in Colorado, by C. J. Blanchard, p. 17-22; Our national forests, by Smith Riley, p. 32-3; National forest resources of Utah and Nevada, by A. C. McCain, p. 125-7.

Reclamation record, May, 1915.—Tree planting in the plains region of Colorado, Wyoming and Nebraska (North Platte), p. 220.

Recreation, May, 1915.—The national forests and wild life, by Henry S. Graves, p. 230, 236-9.

Resources of Tennessee, April, 1915.—Care and protection of forests, by R. S. Maddox, p. 65-73.

Science, April 23, 1915.—Charles E. Bessey, by John M. Coulter, p. 599-600.

Scientific American, April 3, 1915.—Teak wood, p. 311.

- Sierra club bulletin, Jan., 1915.—The forest fire season of 1914 in California, by Coert Du Bois, p. 322-5.
- United States—Department of agriculture. Journal of agricultural research, April, 1915.—Observations in *Rhizina inflata*, by James R. Weir, p. 93-6.
- United States—Department of agriculture. Weekly news letter, April 21, 1915.—Trees and shrubs; varieties of ornamental plants recommended for private grounds and schools in different sections, p. 1.
- Trade journals and consular reports*
- American lumberman, April 17, 1915.—Preservative treatment of wood, by E. W. Peters, p. 38, 49; A wood paving experiment; blocks are laid without sand cushion, p. 38 A; Suggestions for the utilization of yellow pine, by Harry T. Kendall, p. 38 D-40; Tests fireproof paint, p. 45; Raps taxation system, by B. F. Bonner, p. 47.
- American lumberman, April 24, 1915.—Forest service officials confer; discuss progress of investigation of the lumber industry in meeting at Madison, Wisconsin, p. 26-7; Grading rules of yellow pine structural timber discussed, by H. S. Betts, p. 28-30.
- American lumberman, May 1, 1915.—A testimonial of wood's durability; quaint old windmill stout and strong after century of exposure to elements, p. 30; Taxation of forest and timberland, by Thos. E. Lyons, p. 33, 52; How to safeguard the timber bond business, by John C. Spry, p. 34; Lumbermen visit Forest products laboratory, p. 41-2.
- American lumberman, May 8, 1915.—Will utilize wood waste; Wisconsin enterprise to make shoes with hardwood soles, p. 28; Treats ties with crude oil, p. 28; New type of creosoting plant, p. 31; Tests woods for egg case use, p. 41.
- Canada lumberman, May 1, 1915.—Montreal engineers discuss dry rot, p. 30-31.
- Engineering and mining journal, April 10, 1915.—Wood as a fuel for mine plants, by E. A. Holbrook, p. 645-7.
- Engineering news, Jan. 28, 1915.—The Broad Street wood block pavement, Newark, N. J., p. 153; Test of long-submerged hemlock timber, by T. R. Lawson, p. 159.
- Engineering news, Feb. 11, 1915.—Dry sand and cement mixture vs. mortar bed for wood block pavements, by Theodor S. Oxholm, p. 217; Lugs or spacers to prevent expansion failures in wood-block pavements, by Frank W. Cherrington, p. 275-6.
- Hardwood record, April 25, 1915.—Vehicle making in the United States, p. 18.
- Lumber trade journal, May 1, 1915.—New grading rules for yellow pine timbers and export lumber, by Southern pine association, p. 15; Explosives in land clearing and the burning of stumps discussed, by Harry Thompson, p. 46.
- Lumber world review, April 25, 1915.—Modern uses of wood, by Hermann von Schrenk, p. 21-3; The value of cypress and its better utilization, by Frank N. Snell, p. 27-8; Suggestions for the utilization of yellow pine, by Harry T. Kendall, p. 29-32.
- Lumber world review, May 10, 1915.—National lumber manufacturers' association March report of production and movement of lumber, p. 40.
- Mississippi Valley lumberman, April 16, 1915.—Wood block paving, p. 34; What the government can do for the industry, by E. G. Griggs, p. 39-40.
- Mississippi Valley lumberman, April 23, 1915.—Timber utilization, by O. T. Swan, p. 38-40.
- Mississippi Valley lumberman, May 7, 1915.—The taxation of forest land in Wisconsin, p. 26.
- Municipal journal, May 6, 1915.—Experiments with wood paving blocks, by Clyde H. Teesdale, p. 623-6.
- New York Lumber trade journal, May 1, 1915.—Honduran lumber trade, by Walter F. Boyle, p. 46, 48.
- Paper, April 14, 1915.—Fibers and their formation, p. 16-17.
- Paper, April 21, 1915.—Forestry and paper-making, by Thomas J. Keenan, p. 13-15.
- Paper, April 28, 1915.—Measuring the moisture in cellulose, by Otto Nordström, p. 13-15.
- Paper, May 5, 1915.—Plants available for papermaking, p. 17-18.
- Paper, May 12, 1915.—Some notable paper-making fibers, by James Scott, p. 14-15.
- Paper trade journal, April 15, 1915.—Esparto grass for manufacture of paper, by R. S. Geare, p. 44-6.
- Pioneer western lumberman, April 15, 1915.—Developing a market for Philippine hardwood, by J. D. Miller, p. 20-1; Composite statement of the cost of manufacturing lumber, embodying the figures of 20 miles in Washington and Oregon for 1913, by J. G. McIntosh, p. 21.
- Pioneer western lumberman, May 1, 1915.—Wood block paving in Minneapolis, p. 6; Philippine hardwoods at the exposition, p. 24.
- Safety engineering, April, 1915.—Protecting the national forests from fire, by Allen S. Peck, p. 293-8.
- St. Louis lumberman, May, 1, 1915.—Old water pipe in New York, p. 16; Creosote oil, by Horace C. Porter, p. 17.
- Southern industrial and lumber review, April, 1915.—Texas forestry, by W. Goodrich Jones, p. 12.
- Southern lumberman, April 24, 1915.—Forest service experts demonstrating new method of turpentine production, p. 26.
- Southern lumberman, May 1, 1915.—Improved practice in the production of naval stores, by A. W. Schorger, p. 37-8; Stump pullers and methods of using them, by Earl D. Strait, p. 40.
- Timber trade journal, April 3, 1915.—The forests of Washington state, p. 485; Pollard oaks, p. 486.
- Timber trade journal, April 10, 1915.—The manufacture of charcoal, p. 522-3.

- Timber trade journal, April 17, 1915.—British Guiana and its greenheart timber, p. 647-52; Review of the timber trade of 1914, p. 661-761.
- Timber trade journal, April 24, 1915.—British Columbia and Oregon pine sleepers; methods of creosoting, p. 826.
- Timberman, April, 1915.—Creosoted wood blocks proven by experience ideal paving material, p. 29-30; An economical method of wood preservation, by W. D. Clark, p. 30-2; Cradle for rough water towage, p. 46-7; Increasing the efficiency of modern dry kilns, p. 48.
- United States daily consular report, April 15, 1915.—Lumber industry in British Columbia, by R. M. Newcomb and others, p. 266-8; Brazilian jatoba gum, by Richard P. Momsen, p. 269.
- United States daily consular report, April 17, 1915.—Timber trade of United Kingdom and London, by Carl R. Loop, p. 303-7.
- United States daily consular report, April 21, 1915.—Wooden-block pavements in Norway, by Michael J. Hendrick, p. 367.
- United States daily consular report, April 27, 1915.—Greek market for shooks and lumber, by A. B. Cooke, p. 462-3.
- United States daily consular report, May 6, 1915.—Osiers and basket making in Ireland, by Wesley Frost, p. 612-14.
- United States daily consular report, May 10, 1915.—Market for American shooks in Sicily, by Samuel H. Shank, p. 686.
- United States daily consular report, May 11, 1915.—Extending British Columbia lumber exports, by R. E. Mansfield, p. 700-1; A remarkable flagstaff, by R. E. Mansfield, p. 701; Ash wood for Swedish matches, by Ernest E. Harris, p. 703.
- United States daily consular report, May 12, 1915.—Rattan in China, by Franklin H. Smith, p. 715-17.
- Veneers, May, 1915.—Golden oak finish on quartered oak, by A. Ashmun Kelley, p. 13-14.
- West Coast lumberman, April 15, 1915.—Creosoted fir blocks will pave the way to West Coast prosperity, by O. P. M. Goss, p. 24-5; Creosoting of silo staves, p. 30.
- West Coast lumberman, May 1, 1915.—Creosoted wood block paving in Seattle, p. 26-7; Lumber industry of the Philippines, p. 44.
- Forest journals*
- Allgemeine forst-und jagd-seitung, Feb., 1915.—Ueber technik und methode der aufnahme von mischbeständen, by L. Wappes, p. 33-9; Kapital oder aufgespeicherte, naturalnutzung, by H. Hausrath, p. 39-41; Erhebungen über die grösse des rindenanteiles beim eichenstammholz, by Gutfleisch, p. 52-6; Karl Fricke, p. 56.
- Bulletin of the New York state forestry association, April, 1915.—Federal and state co-operation in fire protection, by J. G. Peters, p. 5-7; A timberland owners' fire protective association for the Adirondacks, by Walter C. Witherbee, p. 8-9; Forest protective work in the Pacific northwest, by E. T. Allen, p. 11-12; Connecticut's fire warden system, by W. O. Filley, p. 13-15; Results of cooperative fire protection in New Hampshire, by Edgar C. Hirst, p. 16-19; School boy forest scouts in Michigan, by James Hale McGillivray, p. 28-29; The forestry problem in the Adirondacks, by E. S. Bruce, p. 30-5; Forest fire protection along Canadian railways, by Cly Leavitt, p. 36-8; Forest fire prevention in Vermont, by A. F. Hawes, p. 39-40; State-wide protection from forest fires, by F. W. Besley, p. 41-2; Forest fire system in Pennsylvania, by George H. Wirt, p. 43-4; Development of forest fire protection in New York state, by Wm. G. Howard p. 45-6.
- Canadian forestry journal, April, 1915.—Reconnaissance forest surveys, by H. Claughton Wallin, p. 51-2; Successful tree planting in Ontario, by N. Silverthorn, p. 53; A woman's plea for trees, by E. Bowers, p. 59-60.
- Forstwissenschaftliches centralblatt, Jan., 1915.—Dr. Hermann von Fürst, by Max Endres, p. 3-5; Die russische forst wirtschaft, by Max Endres, p. 10-19; Verbesserung der viertelmethode durch konstruktion der ersten pfeilhöhe, by Elsner, p. 19-22; Über nachhaltige massenentnahmen ohne flächenverrechnung, by Hemmann, p. 23-6; Die bedeutung des rotwildschälenschadens in kiefernbeständen einst und jetzt, by Voss, p. 27-30; Ueber das forstliche schulwesen in den Vereinigten Staaten von Nordamerika mit besonderer berücksichtigung der Yale forest school, by Friedrich Moll, p. 30-4; Die fixierung von aquarellfarben auf karten, by M. Öehmcke, p. 35-6.
- Indian forester, March, 1915.—Notes on the twisted fibre in chir pine, by E. A. Smythies, p. 69-75; On some forest matters, by C. E. C. Fischer, p. 75-8; Some notes on the regeneration of "in" and "kanyin" in an upper Burma division, by H. R. Blanford, p. 78-81; Mixed impregnation with oils; note on the treatment of Terminalia tomentosa broad gauge sleepers, by R. S. Pearson, p. 81-8; Forests, stream-flow and rainfall, p. 100-1.
- North woods, April, 1915.—Arbor and bird day, p. 3-7.
- Proceedings of the Society of American foresters, April, 1915.—Charles Edward Bessey, p. 113-14; Present condition of applied forestry in Canada, by H. R. MacMillan, p. 115-29; Forest administration in the southern Appalachians, by K. W. Woodward, p. 130-40; A study of Douglas fir seed, by C. P. Willis and J. V. Hafmann, p. 141-64; The beginnings in the development of a private forest estate in New England, by George H. Meyers, p. 165-74; Game on the national forests, by Smith Riley, p. 175-82; The entomological aspect of slash disposal, by Ralph Hopping, p. 183-5; Douglas fir and fire, by C. S. Judd, p. 186-91; The management of Engelmänn spruce—al-

AMERICAN FORESTRY'S ADVERTISERS

pine fir stands, by John W. Spencer, p. 192-8; A possible measure of light requirements of trees, by W. W. Ashe, p. 199-200. The clinometer on fire lookouts, by Donald Bruce, p. 201-6.

Quarterly journal of forestry, April, 1915.—Forestry in the British empire, by Wm. Schlich, p. 95-112; Present problems in American forestry, by W. B. Greeley, p. 112-27; Visit to the state school and forest of Vallombrosa, p. 127-33; The pitwood trade in the Midlands, by A. Slater, p. 134-7.

Revue des eaux et forêts, March 1, 1915.—La question forestière en Algérie, by Laporte, p. 553-63; Les forêts et la guerre, p. 573-4.

Tree talk, May, 1915.—A pest of shade trees; the whitemarked tussock moth, by W. E. Britton, p. 6-7; Cavity treatment, by F. A. Bartlett, p. 9-11; Reforestation of Long Island, by Henry H. Tryon, p. 13-17.

FORESTERS ATTENTION

AMERICAN FORESTRY will print free of charge in this column advertisements of foresters wanting positions, or of persons having employment to offer foresters

YOUNG MAN, expert in all branches of shade tree work and with forestry training, desires position as forester, arboriculturist or tree surgeon. References furnished. Address C. S., care AMERICAN FORESTRY.

FORESTER of technical training, six years' teaching and practical experience in different parts of the United States, wishes to better position. Best references from university and employers, and others. Address G. O. T., Care AMERICAN FORESTRY.

FORESTER with 15 years experience Estimating, Surveying, Mapping, and in the care of private holdings desires position. Perfectly reliable in every way, and with executive ability. Address "A," care AMERICAN FORESTRY.

WANTED—By Graduate Forester, position in forestry work in South, or Tropics. Slight knowledge of Spanish and German. Scientific or experimental work preferred. Address, "F. W. H." Care of AMERICAN FORESTRY.

A forest school graduate with experience in U. S. Forest Service and with lumber company, also possessing thorough business training, will consider offer of good forestry position. Address M., Care AMERICAN FORESTRY.

WANTED—Position by practical experienced man as tree surgeon. Am familiar with trees of all kinds. Special terms on orchard work. Terms reasonable. Small jobs will not be considered. Will send book upon request. Do not write for book out of idle curiosity. Address Box 6, care of AMERICAN FORESTRY.

POSITION WANTED—Engineer with twelve years' experience in Engineering and Forestry. Expert land surveyor, timber estimator, timberland R. R. location. Experienced in woods operation and good manager of men. Permanent position desired with Timber Company, Railroad Company or Private Estate. At present employed. Address Box 4, Care AMERICAN FORESTRY.

MAN with practical experience in lumbering, timber estimating, mapping and compass work. Have had one year of college training and would like position where there is an opportunity to acquire further knowledge of forestry. Address Box 7, care of AMERICAN FORESTRY.

ASSISTANT FORESTER—\$1,500 to \$1,800 annum. Limited to residents of New Jersey if a sufficient number of qualified candidates; if not, open to citizens of the United States without regard to residence. Candidates will be permitted to submit replies and papers in this examination by mail.

All candidates must be Professional Foresters with good, practical experience. Experience in woodlot management, in small lumbering and in shade tree work is desired. Subjects of examination and relative weights:

Experience and Education..... 6
Personal qualifications, age, character, etc..... 2
Paper on some subject pertinent to forest conditions in New Jersey..... 2

TOTAL.....10

Communicate with **CIVIL SERVICE COMMISSION**, State House, Trenton, N. J.

A **GRADUATE** of one of the leading Forestry Schools of the country, with some experience in State and private work, would like to secure a position in some Eastern or Central State. Address S. G. H., care AMERICAN FORESTRY.

FOREST ENGINEER seeks position with an estimating firm or with a lumber company. Best of references. Address Forest Engineer, Care AMERICAN FORESTRY.

GRADUATE FORESTER—Practical experience in cruising, mapping and scaling. Eager to go anywhere. References furnished. Address R. L., care of AMERICAN FORESTRY.

PRACTICAL FORESTER wants situation on private estate. Has practical experience of sowing, laying, planting out, pruning, thinning, firebelts, ditching, rotation planting, mixed planting and thorough knowledge of fencing and tree felling. Has had seven years experience on best managed forestry area in Scotland. Address, "Raith," Care AMERICAN FORESTRY.

PRACTICAL FORESTER wants position with city Park Commission. Understands fully nursery work, planting, trimming and tree surgery. Best references and practical experience. Address "L. M. E.," Care AMERICAN FORESTRY.

WANTED—A position as an inspector of ties, timbers and lumber, by a forest school graduate with experience in inspecting ties, timbers and lumber. Can furnish best of references. Address Inspector, Care AMERICAN FORESTRY.

Graduate of Forestry School, having studied forestry and lumbering operations in this country and Germany, with experience in the U. S. Forest Service, and also in state and private nursery work, would like position with forest engineering firm or lumber company. Best of references. Address XY, Care of AMERICAN FORESTRY.

WANTED—A job as fire ranger or guard by a strong, healthy young man twenty-one years of age. Address "3" care AMERICAN FORESTRY.

WANTED—Position by a clean cut young man, with A-1 references, with a Forestry Expert or a surveying party, or any other business where a knowledge of the subject of forestry can be had. Address G. W. H., care AMERICAN FORESTRY.

WANTED—Position as City Forester or Park Superintendent. Willing to consider position as an assistant. University training; experience in forestry, nursery and landscape work. Twenty-seven years old and married. Best of references. Address "F. S." Care of AMERICAN FORESTRY, Washington, D. C.

SURVEYOR—Young man 23 years old, 2½ years experience as rodman and draftsman on preliminary, location and construction for western railroads, desires position of like nature where there is an opportunity for learning forestry. Location is immaterial. Address Box 5, Care of AMERICAN FORESTRY.

AMERICAN FORESTRY'S ADVERTISERS

POSITION WANTED—Am graduate of Biltmore Forest School, with good record in survey, estimate and estate management and want position where I will have a chance to learn more. Have done practical work outside of school and am considered good at timber. Willing to go anywhere and be generally useful. Hard worker, don't mind long hours. Age, twenty-six. Give me interview or let me send references. Address J. U., care AMERICAN FORESTRY.

YOUNG MAN—Four years' practical experience in reforestation, nursery work, improvement thinning, fire protection and tree surgery, wishes position on private estate or for state or municipal work. Experienced handling men. Best of references. Address R. A., care AMERICAN FORESTRY.

WANTED.—A Position as Superintendent on Private Estate. Expert experience with 22 years' backing, on Forestry, Agriculture, Horticulture, Landscape Engineering. Graduate Civil Engineer, Practical Experience in all mentioned work. Will take full responsibility of any estate or construction of an estate and guarantee my work. Fair salary expected. Please state salary you are willing to offer with reply. I will not accept a position in "part." I will not accept position under three months' notice to my present Employer. Address "V. C. P." Care AMERICAN FORESTRY.

YOUNG MAN, 29 years old, wishes position with forest owner or lumber mill concern, to take care of all waste timber. Have 12 years' experience in distilling and extracting by-products from forest wastes, etc. Address I, Care AMERICAN FORESTRY.

FORESTER wants position with Consulting Forestry firm, or with lumber company or private estate. Training from Michigan Agricultural College and Yale Forest School; four years' experience with U. S. Forest Service and two winters with lumber companies. Acquainted thoroughly with Montana, Idaho and California timber as cruiser. References on request. Address E., Care AMERICAN FORESTRY.

ENERGETIC Post Graduate Forester desires position as an assistant in park or city forestry work. Subordinate duties preferred. Best of references. Address M. M. J., Care of AMERICAN FORESTRY.

FOREST ENGINEER with Forest Service training in Colorado, Wyoming, private work in California, and six years' experience in the lumber industry on the Pacific Coast, would like field work in any part of the United States. Estimating of timber lands and topographic surveying a specialty. Four years' technical training. Address, "D." Care AMERICAN FORESTRY.

FOREST SCHOOL GRADUATE with four years' experience in southern mountains, in lumbering and forestry work, would like position with Forest Engineering Firm or Lumber Company. Address XX., Care AMERICAN FORESTRY.

POSITION WANTED by Graduate Forester and Expert Nurseryman, now in charge of large nursery. Best references. Address, "Nursery," Care of AMERICAN FORESTRY.

WANTED—A position for the summer by a student of Forestry. Experience in planing mills, steam and gasoline machinery, power boats, chaining and rodding for surveyor. Will do anything that requires work. Address Box 8, Care of AMERICAN FORESTRY.

SURVEYS AND MAPS for roads, drains and large tracts of lands. Would like work in the South during the winter months. Will consider offer of steady position. Forest work given special attention. W. B. TIMBRELL, 308 Realty Building, Elmira, N. Y.

WANTED—Timber estimating by postgraduate forester with experience in Eastern Canada and Lake States. References. Address P. T. A., Care of AMERICAN FORESTRY, Washington, D. C.

GRADUATE FORESTER desires position; practical experience in timber estimating, nursery work, also especially qualified for shade tree work; have passed Civil Service examination for forest assistant. Address "D. B.," Care of AMERICAN FORESTRY.

FOREST ENGINEER with training in this country and abroad, will consider position as Secretary of Fire Protective, Forestry or Conservation Association. Thoroughly experienced in Forestry and publicity work, and competent to handle affairs of such organization. Well recommended. Address "SECRETARY". Care of AMERICAN FORESTRY, Washington, D. C.

WANTED—Employment with timber or lumber company in the West by young man of 27, with college education, commercial training and some teaching and business experience, who has spent five seasons—totaling twenty-one months—as Assistant Forest Ranger in the U. S. Forest Service, in the Pacific Northwest. Address 12, Care American Forestry.

WANTED—A job as Fire Guard or anything pertaining to forestry by a young man 19 years old. I am inexperienced but willing to work and learn. Address Box 14, Care of AMERICAN FORESTRY.

Wanted—Trained Forester With TROPICAL Experience

for work for American interests in Dutch East Indies. State experience and salary expected and when services would be available. Address Box 50, Care of AMERICAN FORESTRY

BILTMORE TEXT BOOKS

The text books of the Biltmore Forest School, written by Dr. C. A. Schenck, continue for sale at Biltmore. For particulars address BILTMORE FOREST BOOKS, Biltmore, N. C. tf

TIMBERLANDS FOR SALE

30,000 selected WHITE and CHESTNUT OAK trees
15,000 Selected ASH trees, on 5,000 acres in the State of Virginia, estimated to cut more than 30 MILLION FEET. Balance of timber on this land can be bought cheap. Price of the selected trees, \$2.50 each. This is the greatest bargain we have ever heard of.
6-11 GEORGE J. PHILP, Oil City, Penna.

BARGAIN IN CAROLINA TIMBER

50,000,000 feet original growth timber; 35,000,000 feet North Carolina Pine, Yellow Poplar and Cypress; 15,000,000 feet Red and White Gum, Oak and Ash. Located on Southern Railway. Write for particulars, prices and terms.

J. P. MULHERIN, Augusta, Ga.

NEFOUNDLAND LIMITS.

325,760 acres; ninety-nine year lease; has 304,640,000 feet Pine; 470,400,000 feet Birch; 890,880,000 feet Spruce for lumber; 3,420,600 cords Spruce Pulpwood; and seven (7) thousand horse water power; price \$1.25 acre; or three-fifth interest for 75 cents an acre, half cash. JOHN A. MOODY, London, Canada.

FOR QUICK SALE, 25,000 ACRES

of Virgin timber at war prices, includes land and timber, in fee simple. Titles good. Payments reasonable. Address Box 21, Care of AMERICAN FORESTRY.

INTERIOR TRIM PLANT FOR SALE

For quick sale, the best factory in the South for manufacture of furniture or interior trim. Special advantages in rates, taxes, labor, raw material both yellow pine and hardwoods. Plant is new, fireproof and insurance rate is 66 cents per \$100.00. Sale price is less than half the cost. Write for particulars and photographs.

J. P. MULHERIN, Trustee, Augusta, Ga.

Hamilton Watch

"The Watch of Railroad Accuracy"

Begin to talk accuracy to your jeweler and he'll begin to talk Hamilton to you.

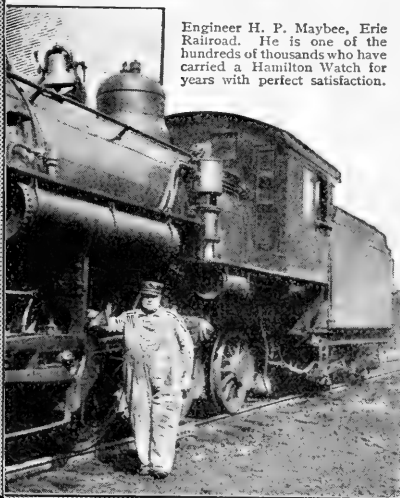

Engineer H. P. Maybee, Erie Railroad. He is one of the hundreds of thousands who have carried a Hamilton Watch for years with perfect satisfaction.

There are thirty models of the Hamilton Watch. Every one has Hamilton quality and Hamilton accuracy. They range in price from \$12.25 for movement alone (in Canada \$12.50) up to the superb Hamilton masterpiece at \$150.00.

Your jeweler can show you the Hamilton you want, either in a cased watch or in a movement alone, to be fitted to any style case you select, or to your own watch case if you prefer.

**Write for the Hamilton Watch Book—
"The Timekeeper"**

It pictures and describes the various Hamilton models and gives interesting watch information.

**Hamilton Watch Company
Dept. 00, Lancaster, Pennsylvania**



EVERGREEN

"We Raise Our Own Trees"

Seedlings Transplants



From our specialized collection of young conifers you will find what you want for every place and purpose. Our stock is hardy and field grown and admirably adapted for forest planting and lining out.

Your order will have personal attention and the price will be right.

Send for Catalog and save money

The North-Eastern Forestry Co.

Tree Seeds, Nursery Stock. Box A, Cheshire, Conn.

History of Forestry

By **B. E. FERNOW**
*Dean of Forestry
University of Toronto*

A book every student of Forestry should buy and without which no forest library is complete.

506 pages, 8vo
Price, \$2.50, postpaid

Address
American Forestry Association
Washington, D. C.

HILL'S SEEDLINGS and Also Tree Seeds TRANSPLANTS

FOR REFORESTING

BEST for over a half century. All leading hardy sorts, grown in immense quantities. Prices lowest. Quality highest. Forest Planter's Guide, also price lists are free. Write today and mention this magazine.

THE D. HILL NURSERY CO.

*Evergreen Specialists
Largest Growers in America*

BOX 501

DUNDEE, ILL.

200,000,000 Ft.

National Forest Timber For Sale

On or before September 1, the Forest Service will advertise for sale 200,000,000 feet B. M. of timber within the Apache National Forest, Arizona, at which time the terms of sale will be announced.

AMOUNT AND KINDS—Approximately 140,000,000 feet western yellow pine, 34,000,000 feet Douglas fir, 16,000,000 feet white fir, 6,000,000 feet spruce, 4,000,000 feet Mexican white pine and cork bark fir.

LOCATION—In the Blue Range, Apache National Forest, Arizona, in approximately Township 3 N., Ranges 28, 29 and 30 E.; Township 3½ N., Ranges 28, 29 and 30 E.; and Township 4 N., Ranges 28, 29 and 30 E., mostly unsurveyed land. The timber is tributary to the Clifton-Morenci mining market of Southeastern Arizona.

While further field work is necessary prior to the announcement of specific terms, attention is at this time called to the chance in order that persons interested may secure from the District Forester, Albuquerque, New Mexico, complete information as it becomes available or examine the tract during the favorable season, which begins June 1.

Harvard University

SCHOOL OF FORESTRY

OFFERS specialized graduate training leading to the degree of Master of Forestry in the following fields:—Silviculture and Management, Wood Technology, Forest Entomology, Dendrology, and (in cooperation with the Graduate School of Business Administration) the Lumber Business

For further particulars address

RICHARD T. FISHER, Chairman
Cambridge, Massachusetts

GEORGIA

State Forest School University of Georgia

COMPLETE four-year undergraduate course in theoretical and applied forestry leading to the degree:

Bachelor of Science in Forestry

¶ Wide range of specialization offered—

Logging Engineering
Commercial Administration
Forest Management

City Forestry State Forestry
Dendropathology Research

¶ Provision for four months field work—two following each of Freshman and Sophomore years—on McHatton Forest, a large forest estate in the Blue Ridge Mountains. Numerous excursions in Dendrology and Logging. Provision for practical work in specialization during Junior-Senior vacation

For announcement address

FOREST SCHOOL
Georgia State College of Agriculture
ATHENS, GEORGIA

Forest Working Plans

By A. B. RECKNAGEL, A. B., M. F.,
Professor of Forestry, Cornell University.

In preparing this book the author constantly kept in mind the experience which he gained while doing active work for the Forest Service in various parts of the United States.

Every one interested in forestry will appreciate the valuable information contained in this book.

230 pages, 6 x 9, illustrated.
Cloth, \$2.00 net.

Logging

The Principles and General Methods of Operations in the United States

By RALPH CLEMENT BRYANT, F. E., M. A.,
Manufacturers' Association Professor of Lumbering, Yale University.

The more important features of operation are covered in this book. Discusses at length the chief facilities and methods for the movement of timber from the stump to manufacturing plant, especially logging railroads.

590 pages, 6 x 9, 133 figures.
Cloth, \$3.50 net.

FREE EXAMINATION If you have an account with us or can supply a reference, our books will be sent for ten days free examination, no cash in advance. At the end of this time their price is to be remitted or the books returned, postpaid.

If cash accompanies the order, you have the privilege of returning the books within ten days after their receipt, when your money will be refunded.

JOHN WILEY & SONS, Inc., 432-4th Ave., New York
London: CHAPMAN & HALL, Ltd. Montreal, Canada: RENOUF PUB. CO.

FO 1 RE 2 ST 3 RY 4

The FOREST is three-fourths of FORESTRY

Your opportunities are as unlimited as our forests if you study at

WYMAN'S SCHOOL OF THE WOODS
Incorporated Munising, Michigan

READY NOVEMBER 1, 1914

A New Booklet on Estimating Southern Timber

Southern White Cedar
Shortleaf and Longleaf Pine
Southern Appalachian Timber

Postpaid, 20 cents

HOWARD R. KRINBILL
Forest Engineer NEWBERN, N. C.

ENGRAVINGS

made by

National Engraving Co.

506-508 Fourteenth St. N. W.
WASHINGTON, D. C.

Engravers to the Government

Pan American Union
Smithsonian Institution
Agricultural Department
U. S. Geological Survey
Patent Gazette
Experimental Stations and
State Institutions

HALF-TONES

LINE CUTS

THREE-COLOR PROCESS PLATES

ELECTROTYPES

Printers Demand Our CUTS

Yale University Forest School

NEW HAVEN, CONN., U. S. A.

YALE University Forest School is a graduate department of Yale University. It is the oldest existing forest school in the United States and exceeds any other in the number of its alumni. A general two-year course leading to the degree of Master of Forestry is offered to graduates of universities, colleges and scientific institutions of high standing and, under exceptional conditions, to men who have had three years of collegiate training, including certain prescribed subjects. Men who are not candidates for the degree may enter the School as special students, for work in any of the subjects offered in the regular course, by submitting evidence that will warrant their taking the work to their own advantage and that of the School. Those who have completed a general course in forestry are admitted for research and advanced work in Dendrology, Silviculture, Forest Management, Forest Technology, and Lumbering. The regular two-year course begins the first week in July at the School camp near Milford, Pennsylvania.

For further information address

JAMES W. TOUMEY, Director
NEW HAVEN, CONN.

Special Courses offered in **LUMBERING** *and* **WOOD UTILIZATION, PULP and PAPER MAKING**

Other Special Courses in Forestry

Men with technical training along the lines of Lumbering and the various branches of Wood Utilization will be needed in the future.

Four and five year students in these courses will have constant access to the new Eastern Forest Products Laboratory.

**The New York
State College of Forestry**
At Syracuse University
Syracuse, N. Y.

In the National Forest Region

Colorado School of Forestry

A DEPARTMENT OF
COLORADO COLLEGE

THE course in theoretical and applied forestry leading to the degree of Forest Engineer covers a period of two years and is open to students who have completed two years of college work, including a sufficient amount of Botany, Geology and Surveying.

Graduate students may enter as candidates for the degree of Master of Forestry.

Fall and Spring Terms in the Manitou Forest, the College Reserve, 6,000 acres of pine and spruce timberland on the borders of the Pike National Forest. Winter Term at Colorado Springs.

For particulars address

Colorado School of Forestry
Colorado Springs, Colo.

DEPARTMENT OF FORESTRY

The Pennsylvania State College

A PROFESSIONAL course in Forestry, covering four years of college work, leading to the degree of Bachelor of Science in Forestry.

Thorough and practical training for government, state, municipal and private forestry.

Four months are spent in camp in the woods in forest work.

Graduates who wish to specialize along particular lines are admitted to the "graduate forest schools" as candidates for the degree of Master of Forestry on the successful completion of one year's work.

For further information address,

Department of Forestry
PENNSYLVANIA STATE COLLEGE
State College, Pa.

ECONOMY

STRENGTH

DURABILITY

WORKABILITY

BEAUTY and

AMPLE SUPPLY

ALL COMBINED IN

Yellow Pine Lumber

The "Wood of a Thousand Uses"

If you want to know more about it
A CARD ADDRESSED TO US WILL BRING RESULTS

Our Own Mills Cut 275,000,000
Feet Annually

**MISSOURI LUMBER AND LAND
EXCHANGE COMPANY**

1111 Long Building :: KANSAS CITY, MO.

At Your Command

When you feel the need of information regarding timber on which you can rely with absolute certainty, write us.

We have in our files data relating to the timber resources of the western hemisphere, particularly North America.

Our organization and exceptional facilities equip us to serve you, to your profit, in matters of small as well as affairs of great moment.

James D. Lacey & Co. **Timber Land Factors**

CHICAGO, ILL., 1750 McCormick Building
PORTLAND, ORE., 1313 Northwestern Bank Building
SEATTLE, WASH., 1009 White Building

American Forestry



JULY 1915

No. 259

BOOKS ON FORESTRY

AMERICAN FORESTRY will publish each month, for the benefit of those who wish books on forestry, a list of titles, authors and prices of such books. These may be ordered through the American Forestry Association, Washington, D. C. Prices are by mail or express prepaid.* :-: :-: :-: :-:

THE WOODS—Douglas Malloch	\$1.15
RESAWED FABLES—Douglas Malloch	1.15
THE TRAINING OF A FORESTER—Gifford Pinchot	1.12
LUMBER AND ITS USES—R. S. Kellogg	1.15
THE CARE OF TREES IN LAWN, STREET AND PARK—B. E. Fernow	2.17
NORTH AMERICAN TREES—N. L. Britton	7.30
KEY TO THE TREES—Collins and Preston	1.50
THE FARM WOODLOT—E. G. Cheney and J. P. Wentling	1.70
AMERICAN FOREST TREES—Henry H. Gibson	6.00
IDENTIFICATION OF THE ECONOMIC WOODS OF THE UNITED STATES— Samuel J. Record	1.25
PLANE SURVEYING—John C. Tracy	3.00
FOREST MENSURATION—Henry Solon Graves	4.00
THE ECONOMICS OF FORESTRY—B. E. Fernow	1.61
FIRST BOOK OF FORESTRY—Filibert Roth	1.10
PRACTICAL FORESTRY—A. S. Fuller	1.50
PRINCIPLES OF AMERICAN FORESTRY—Samuel B. Green	1.50
SEASIDE PLANTING OF TREES AND SHRUBS—Alfred Gaut	1.75
FAMILIAR TREES—G. S. Boulger	1.50
MANUAL OF THE TREES OF NORTH AMERICA (exclusive of Mexico)—Charles Sprague Sargent	6.00
AMERICAN WOODS—Romeyn B. Hough	5.00
HANDBOOK OF THE TREES OF THE NORTHERN U. S. AND CANADA, EAST OF THE ROCKY MOUNTAINS—Romeyn B. Hough	6.00
GETTING ACQUAINTED WITH THE TREES—J. Horace McFarland	1.75
PRINCIPAL SPECIES OF WOOD: THEIR CHARACTERISTIC PROPERTIES— Charles Henry Snow	3.50
NORTH AMERICAN FORESTS AND FORESTRY—E. R. Bruncken	2.00
HANDBOOK OF TIMBER PRESERVATION—Samuel M. Rowe	4.00
TREES OF NEW ENGLAND—L. L. Dame and Henry Brooks	1.50
TREES AND SHRUBS—C. S. Sargent	5.00
TREES, SHRUBS AND VINES OF THE NORTHEASTERN UNITED STATES— H. E. Parkhurst	1.50
TREES—H. Marshall Ward	1.50
OUR NATIONAL PARKS—John Muir	1.91
THE LONGLEAF PINE IN VIRGIN FOREST—G. Frederick Schwarz75
LOGGING—Ralph C. Bryant	3.50
THE IMPORTANT TIMBER TREES OF THE UNITED STATES—S. B. Elliott	2.50
FORESTRY IN NEW ENGLAND—Ralph C. Hawley and Austin F. Hawes	3.50
THE PRINCIPLES OF HANDLING WOODLANDS—Henry Solon Graves	1.50
SHADE TREES IN TOWNS AND CITIES—William Solotaroff	3.00
THE TREE GUIDE—By Julia Ellen Rogers	1.00
FOREST PHYSIOGRAPHY—By Isaiah Bowman	5.00
MANUAL FOR NORTHERN WOODSMEN—Austin Cary	2.12
FARM FORESTRY—Alfred Akerman57
THE THEORY AND PRACTICE OF WORKING PLANS (in forest organization) A. B. Recknagel	2.10
ELEMENTS OF FORESTRY—F. F. Moon and N. C. Brown	2.20
MECHANICAL PROPERTIES OF WOOD—Samuel J. Record	1.75
STUDIES OF TREES—J. J. Levison	1.75
TREE PRUNING—A. Des Cars65
THE PRESERVATION OF STRUCTURAL TIMBER—Howard F. Weiss	3.00
THE PRACTICAL LUMBERMAN—By Bernard Brereton (third edition)	1.50

* This, of course, is not a complete list, but we shall be glad to add to it any books on forestry or related subjects upon request.—Editor.

Big Pines for August-September Planting

TREES 6 to 20 feet high. Trees that save you five to ten years or more. Guaranteed to grow satisfactorily or replaced. They have been skillfully grown in the nursery, frequently rootpruned and transplanted. This results in a compact system of small feeding roots contained in a big ball of earth. We have invented canvasses and platforms for securely holding this ball of earth. They will ship a thousand miles.

How Can I Use Them?

Evergreens from the nursery are usually considered little bright spots to look down upon and wait for. These big Pines serve a purpose corresponding to the side walls of a house. Are you annoyed by the dust and noise of the street? Are you disturbed by the constant passing? Are you wishing you had a larger country place where the public did not intrude? To get such a place would cost more money and perhaps necessitate traveling further out of town.

These Pines will make a dense screen immediately. You can have them planted in a few days and enjoy them immediately. Send for Hicks Evergreens for August-September Planting. It suggests several beautiful ways of arranging Pines with Laurel, Birch and Oak.

There are thousands of other large evergreens growing in squares 6 to 15 feet apart—Austrian, Scotch, Pitch and Jack Pine; Hemlock, White and Nordmann's Fir,

Blue and Douglas Spruce. Let us send you 5 free samples of White Spruce 3 to 5 feet high, hardy, dense, blue-green. Excellent for the seashore or mountains.

Living Off The Country

Are there beautiful big Pines or Cedars 5 to 30 feet high? Do you wish the fun of selecting and grouping them in your home landscape? We will send apparatus, foreman and a few expert men to work with local men and teams. July is the time to start. Do you want big Elms or Sugar Maples? Now is the time to pick them out. The same crew can move them in September or October.

Do you wish some shrubs and flowers to plant right away? We have them in boxes and pots, permitting planting where the places are closed in April.

Isaac Hicks & Son
Westbury, Nassau County, N. Y.

Thorburn's

*Tree Seeds are Produced
by Scientific Forestry*

OUR experts have devoted much time to tree seeds. We recognize the immense importance of the work.

Our stock includes rare species and covers double the assortment of any other seed house—American or Foreign.

Ask for a copy of our extensive list.

J. M. Thorburn & Co.
SINCE 1802

53 Barclay Street through
to 54 Park Place
NEW YORK

Seeds for Forestry Purposes

WE offer a most complete list of both Deciduous and Evergreen Tree and shrub seeds for forestry purposes.

Seeds that are of best germinating quality

Our catalogue contains a full list of the varieties we offer, which include the best and most rare species. Send for a copy, it will interest you.

THOMAS MEEHAN & SONS
Wholesale Nurserymen and Tree Seedmen
DRESHER, PENNA., U. S. A.

ORCHIDS ORCHIDS

We are specialists in Orchids, we collect, import, grow, sell and export this class of plants exclusively.

Our illustrated and descriptive catalogue of Orchids may be had on application. Also special lists of freshly imported unestablished Orchids.

LAGER & HURRELL
SUMMIT, N. J.
Orchid Growers and Importers

THE AMERICAN FORESTRY ASSOCIATION

OFFICERS FOR 1915

President

DR. HENRY STURGIS DRINKER, President, Lehigh University, South Bethlehem, Pa.

Vice-Presidents

JOSHUA L. BAILEY, Pennsylvania
THEODORE L. BRISTOL, Connecticut
Ex-President Connecticut Forestry Association
ANDREW CARNEGIE, New York
MRS. EMMONS CROCKER, Massachusetts
DR. CHARLES W. ELIOT, Massachusetts
President Emeritus Harvard University
DR. B. E. FERNOW, Canada
Dean of Forestry, University of Toronto
HON. WALTER L. FISHER, Chicago, Ill.
Ex-Secretary of the Interior
HENRY S. GRAVES, District of Columbia
Chief of the Forest Service
EVERITT G. GRIGGS, Washington
HON. DAVID HOUSTON
Secretary of Agriculture
HON. FRANKLIN K. LANE
Secretary of the Interior

HON. ASBURY F. LEVER, South Carolina
United States Representative
HON. THOMAS NELSON PAGE
Ambassador to Italy
HON. GEO. PARDEE, California
Ex-Governor of California
GIFFORD PINCHOT, Philadelphia, Pa.
FILIBERT ROTH, Michigan
Dean of Forestry, University of Michigan
DR. J. T. ROTHROCK, Pennsylvania
HON. WM. H. TAFT, Connecticut
Ex-President United States
JOSEPH N. TEAL, Oregon
Chairman Oregon Conservation Commission
HON. JOHN WEEKS, Massachusetts
U. S. Senator
DR. ROBERT S. WOODWARD, Washington, D. C.
President, Carnegie Institution

Treasurer

JOHN E. JENKS, Washington, D. C.
Editor, Army and Navy Register

Executive Secretary

P. S. RIDSDALE, 1410 H Street N. W., Washington, D. C.

Directors

E. T. ALLEN, Oregon
Forester, Western For. and Conservation Asso.
HON. ROBERT P. BASS, New Hampshire
Ex-Governor of New Hampshire
WM. B. GREELEY, District of Columbia
Assistant U. S. Forester
W. R. BROWN, New Hampshire
Pres., New Hamp. Forestry Commission
HERMAN H. CHAPMAN, Connecticut
Professor of Forestry, Yale Forest School
DR. HENRY S. DRINKER, Pennsylvania
President, Lehigh University
ALFRED GASKILL
State Forester, New Jersey

JOHN E. JENKS, District of Columbia
Editor, Army and Navy Register
CHESTER W. LYMAN, New York
International Paper Company
CHARLES LATHROP PACK, New Jersey
Pres., Fifth National Conservation Congress
CHARLES F. QUINCY, New York
J. E. RHODES, Illinois
Secretary Southern Pine Association
ERNEST A. STERLING, Pennsylvania
Forest and Timber Engineer
JOHN L. WEAVER, District of Columbia
Real Estate Broker
J. B. WHITE, Missouri
Ex-President, National Conservation Congress

Auditors

E. A. STERLING, Pennsylvania

C. F. QUINCY, New York

Advisory Board, Representing Affiliated Organizations

National Wholesale Lumber Dealers' Association
ROBT. C. LIPPINCOTT, Philadelphia, Pa.
R. L. SISSON, Potsdam, N. Y.
JOHN M. WOODS, Boston, Mass.

Northern Pine Manufacturers' Association
C. A. SMITH, Minneapolis, Minn.
WILLIAM IRVINE, Chippewa Falls, Wis.
F. E. WEYERHAEUSER, St. Paul, Minn.

Massachusetts Forestry Association
NATHANIEL T. KIDDER, Milton, Mass.
FREDERIC J. CAULKINS, Boston, Mass.
HARRIS A. REYNOLDS, Cambridge, Mass.

Lumbermen's Exchange
J. RANDALL WILLIAMS, JR., Philadelphia, Pa.
FREDERICK S. UNDERHILL, Philadelphia, Pa.
ROBERT C. LIPPINCOTT, Philadelphia, Pa.

Camp Fire Club of America
WARREN H. MILLER, New York
O. H. VAN NORDEN, New York
FREDERICK K. VREELAND, New York

North Carolina Forestry Association
E. B. WRIGHT, Boardman, N. C.
ALSTON GRIMES, Grimesland, N. C.
J. C. SMOOT, North Wilkesboro, N. C.

National Association of Box Manufacturers
B. W. PORTER, Greenfield, Mass.
S. B. ANDERSON, Memphis, Tenn.
ROBT. A. JOHNSON, Minneapolis, Minn.

Carriage Builders' National Association
H. C. McLEAR, Wilmington, Del.
D. T. WILSON, New York
C. A. LANCASTER, South Bend, Ind.

Boston Paper Trade Association
N. M. JONES, Lincoln, Maine
JOHN E. A. HUSSEY, Boston, Mass.
ARTHUR L. HOBSON, Boston, Mass.

Philadelphia Wholesale Lumber Dealers' Ass'n
ROBT. C. LIPPINCOTT, Philadelphia, Pa.
J. RANDALL WILLIAMS, JR., Philadelphia, Pa.
FRED'K S. UNDERHILL, Philadelphia, Pa.

New Hampshire Timberland Owners' Association
W. H. BUNDY, Boston, Mass.
EVERETT E. AMEY, Portland, Me.
F. H. BILLARD, Berlin, New Hampshire

Empire State Forest Products Association
FERRIS J. MEIGS, New York City
RUFUS L. SISSON, Potsdam, N. Y.
W. L. SYKES, Buffalo, N. Y.

California Forest Protective Association
MILES STANDISH, San Francisco, Cal.
GEO. X. WENDLING, San Francisco, Cal.
GEO. H. RHODES, San Francisco, Cal.

Minnesota Forestry Association
W. T. COX, St. Paul, Minn.
PROF. D. LANGE, St. Paul, Minn.
MRS. CARRIE BACKUS, St. Paul, Minn.

American Wood Preservers' Association
GEO. E. REX, Topeka, Kan.
CARL G. CRAWFORD, Louisville, Ky.
F. J. ANGLIER, Baltimore, Md.

Southern Pine Association
J. B. WHITE, Kansas City, Mo.
J. E. RHODES, New Orleans, La.
E. A. STERLING, Philadelphia, Pa.

Declaration of Principles and Policy

of the American Forestry Association

- IT IS A VOLUNTARY** organization for the inculcation and spread of a forest policy on a scale adequate for our economic needs, and any person is eligible for membership.
- IT IS INDEPENDENT**, has no official connection with any Federal or State department or policy, and is devoted to a public service conducive to national prosperity.
- IT ASSERTS THAT** forestry means the propagation and care of forests for the production of timber as a crop; protection of watersheds; utilization of non-agricultural soil; use of forests for public recreation.
- IT DECLARES THAT FORESTRY** is of immense importance to the people; that the census of 1913 shows our forests annually supply over one and a quarter billion dollars' worth of products; employ 735,000 people; pay \$367,000,000 in wages; cover 550,000,000 acres unsuited for agriculture; regulate the distribution of water; prevent erosion of lands; and are essential to the beauty of the country and the health of the nation.
- IT RECOGNIZES THAT** forestry is an industry limited by economic conditions; that private owners should be aided and encouraged by investigations, demonstrations, and educational work, since they cannot be expected to practice forestry at a financial loss; that Federal and State governments should undertake scientific forestry upon national and State forest reserves for the benefit of the public.
- IT WILL DEVOTE** its influence and educational facilities to the development of public thought and knowledge along these practical lines.

It Will Support These Policies

- FEDERAL ADMINISTRATION AND MANAGEMENT** of national forests; adequate appropriations for their care and management; Federal cooperation with the States, especially in forest fire protection.
- STATE ACTIVITY** by acquirement of forest lands; organization for fire protection; encouragement of forest planting by communal and private owners; non-political departmentally independent forest organization, with liberal appropriations for these purposes.
- FOREST FIRE PROTECTION** by Federal, State and fire protective agencies, and its encouragement and extension, individually and by cooperation; without adequate fire protection all other measures for forest crop production will fail.
- FOREST PLANTING** by Federal and State governments and long-lived corporations and acquirement of waste lands for this purpose; and also planting by private owners, where profitable, and encouragement of natural regeneration.
- FOREST TAXATION REFORMS** removing unjust burdens from owners of growing timber.
- CLOSER UTILIZATION** in logging and manufacturing without loss to owners; aid to lumbermen in achieving this.
- CUTTING OF MATURE TIMBER** where and as the domestic market demands it, except on areas maintained for park or scenic purposes, and compensation of forest owners for loss suffered through protection of watersheds, or on behalf of any public interest.
- EQUAL PROTECTION** to the lumber industry and to public interests in legislation affecting private timberland operations, recognizing that lumbering is as legitimate and necessary as the forests themselves.
- CLASSIFICATION** by experts of lands best suited for farming and those best suited for forestry; and liberal national and state appropriations for this work.

HUNTING AND CAMPING OUTFITS



I want to send our new illustrated catalogue to everyone who is interested in outdoor life. I call it a

SPORTSMAN'S HANDBOOK

for it not only describes the many things an outer-man or woman needs but tells of my personal experiences in the wilds when camping, exploring, fishing and hunting, with advice as to equipment and many "kinks" in wildcraft.

Please ask for Catalogue No. 162

Powhatan Robinson President
NEW YORK SPORTING GOODS Co.
15 and 17 Warren Street, New York

For the best of sleeps, anywhere and in any weather, depend on a

"PERFECTION" Pneumatic Mattress With Sleeping Bag

Rolls to a small, light bundle, when deflated. Easily Inflated. Never damp, hard or lumpy. Always evenly smooth and soft, conforming to your body. Lasts indefinitely.

Write for catalog today

PNEUMATIC MFG. COMPANY
552 17th St., Brooklyn, N. Y.

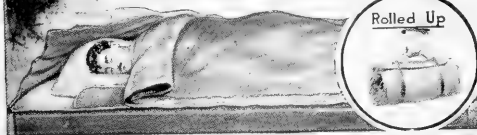

EVERGREEN

"We Raise
Our Own
Trees"

Seedlings Transplants

From our specialized collection of young conifers you will find what you want for every place and purpose. Our stock is hardy and field grown and admirably adapted for forest planting and lining out.

Your order will have personal attention and the price will be right.

Send for Catalog and save money

The North-Eastern Forestry Co.

Tree Seeds, Nursery Stock. Box A, Cheshire, Conn.

HILL'S SEEDLINGS and Also Tree Seeds TRANSPLANTS

FOR REFORESTING

BEST for over a half century. All leading hardy sorts, grown in immense quantities. Prices lowest. Quality highest. Forest Planter's Guide, also price lists are free. Write today and mention this magazine.

THE D. HILL NURSERY CO.

Evergreen Specialists
Largest Growers in America

BOX 501 DUNDEE, ILL.

Barrett's Grade One LIQUID Creosote Oil

Cuts wood preserving bills in half—

For preserving telephone poles, telegraph poles, cross arms, railroad ties, fence posts, mine timbers, under-ground sills, sleepers, bridge timbers, planking, ice houses, wood tanks, shingles, poultry houses, silos, boat timbers or any exposed woodwork.

Especially adapted for brush and open tank treatment of structural timbers of all kinds.

Booklet on request.

BARRETT MANUFACTURING CO.

New York Chicago Philadelphia
Boston St. Louis Cleveland
Cincinnati Pittsburgh Detroit
Birmingham Minneapolis Seattle
Kansas City Salt Lake City



We make the ENGRAVINGS

for the
**AMERICAN FORESTRY
MAGAZINE**

OUR SPECIALTY
is the "better" grade finish of
DESIGNS & ENGRAVINGS
in one or more colors

for Magazines, Catalogues,
Advertisements, etc.

HALF TONES LINE PLATES
DULLO-TONES COMBINATION LINE
AND HALF TONES
COLOR PROCESS MULTI-COLORS

Established 1889

GATCHEL & MANNING

SIXTH and CHESTNUT STRBETS
Opposite Olde Independence Hall
PHILADELPHIA

American Forestry

The Magazine of the American Forestry Association

PERCIVAL SHELDON RIDSDALE, Editor

EDITORIAL ADVISORY BOARD

HERMAN H. CHAPMAN
ERNEST A. STERLING
S. T. DANA

FREDERICK S. UNDERHILL
JOHN E. RHODES
S. N. SPRING

July, 1915. Vol. 21

CONTENTS

No. 259

COVER PICTURE—Hungry Horse Creek, Flathead National Forest, Montana	
FORESTS IN THE RUSSIAN WAR ZONE—By Stanley Washburn.....	755
With eleven illustrations.	
CALIFORNIA TREE NOVELTIES—By E. A. Sterling—Part I.....	768
With ten illustrations.	
HARDWOODS ON THE COUNTRY ESTATE—By Warren H. Miller, M. F.....	780
With nine illustrations.	
FOREST CONFERENCE IN THE WHITE MOUNTAINS.....	791
BROOKLINE PROTECTS BIRDS—By Charles B. Floyd.....	792
With two illustrations.	
ORNAMENTAL AND SHADE TREES—HICKORY TREES THREATENED WITH DESTRUCTION—By J. J. Levison.....	797
With six illustrations.	
NEW ENGLAND'S FEDERAL FOREST RESERVE—By Philip W. Ayres.....	803
With seven illustrations.	
H. H. CHAPMAN.....	813
With one portrait.	
JAPANESE FOREST SCHOOL.....	814
With one illustration.	
THE BLACK HAWK TREE—By Jens Jensen.....	815
ESTABROOKS PARK.....	816
With two illustrations.	
OLD AX MARKS IN TREES—By Avern Pardoe.....	817
A WORK ON THE CONSERVATION OF WATER BY STORAGE—By Dr. George Fillmore Swain, Reviewed by Henry Sturgis Drinker.....	818
EDITORIAL.....	821
FOREST NOTES.....	823
CANADIAN DEPARTMENT—By Ellwood Wilson.....	824
BRITISH COLUMBIA NOTES.....	826
CURRENT LITERATURE.....	827

AMERICAN FORESTRY is published monthly by the American Forestry Association
Subscription price, three dollars per year; single copies, twenty-five cents
Copyright 1915, by the American Forestry Association

Entered as second-class mail matter December 24, 1909, at the Post-office at Washington, under the
Act of March 3, 1879

APPLICATION FOR MEMBERSHIP

Date.....

THE AMERICAN FORESTRY ASSOCIATION
1410 H Street, Washington, D. C.

Dear Sir: I hereby signify my desire to become
of the AMERICAN FORESTRY ASSOCIATION, and
enclose \$..... for dues.

Very truly yours,

an Annual Member (\$1)
a Subscribing Member (\$3)
a Contributing Member (\$10)
a Sustaining Member (\$25)
a Life Member (\$100)
a Patron (\$1,000)

Name.....

P. O. Address.....

American Forestry is sent to all except Annual (\$1) Members

RED OAK ACORNS

New crop—prime—fresh, excellent quality. Collected in Northern Illinois. Have between 40 to 50 bushels still on hand—price while they last \$2.00 per bushel (50 pounds), 10 bushels \$18.50. Also complete stock Evergreen Tree Seeds. Write for price-list.

THE D. HILL CO., Box No. 501, Dundee, Illinois

JAMES W. SEWALL

Timber Estimates

Topographic and Boundary Surveys, Planting, Logging Maps, Portable Mill Operations

Technical Training Thoroughness Experience
CENTRE STREET OLD TOWN, MAINE

Reducing the Cost of Upkeep—

THE INSTALLATION of

**L. C. Smith & Bros.
Typewriters**

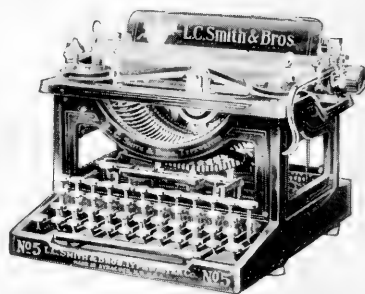

Ball Bearing; Long Wearing

is invariably followed by the discovery that the bills for ribbons are much less than before. A large corporation recently found that its ribbon expense was cut in two. This is not an accident. It is the result of the mechanical construction that makes the L. C. Smith & Bros. cheapest to maintain.

The ball bearings give light touch and eliminate

pounding impact. The ribbon is actuated by the carriage, not the typebar. The ribbon mechanism is automatic, so that the ribbon reverses at the instant the end is reached and without added strain.

Low ribbon cost, low cost of maintenance and the highest efficiency—these are guaranteed to L. C. Smith & Bros. users.

DEMONSTRATION FOR THE ASKING

L. C. SMITH & BROS. TYPEWRITER CO., Home Office and Factory, SYRACUSE, N. Y.
Branches in All Principal Cities 14th and H Streets, N. W., Washington, D. C.

American Forestry

VOL. XXI

JULY, 1915

No. 7

FORESTS IN THE RUSSIAN WAR ZONE

BY STANLEY WASHBURN

Chief War Correspondent of the London Times in Russia

[Mr. Washburn wrote this article for AMERICAN FORESTRY at the request of Mr. Charles Lathrop Pack, a director of the American Forestry Association and a close friend of the famous writer. Mr. Washburn's opinion is that the damage to forests in the war zone is not serious and that the number of trees destroyed by shell fire, cut down for trenches and otherwise used is but a small percentage of the standing timber.—EDITOR'S NOTE.]

IN THE first place it is difficult for me to write of forest conditions in a way that can be of any value to the readers of a forestry magazine, as I have none of the knowledge of a forester. The use of the forests has appealed to me only from its military side, and I am afraid that I can give but meagre information as to the nature of the growth in Poland and none at all of that in East Prussia.

"From what I have seen over here I am not of the opinion that the forests as a whole have suffered very severely save in isolated patches.

"The one thing, however, that has grieved me to see has been the destruction of beautiful avenues of trees in many different quarters. Poland as well as parts of Galicia has a fair number of main arteries of travel in the shape of roads. Nearly all of these are flanked by beautiful trees. I do not know exactly what they are but to me they resemble poplars. Some of them are 2 feet and better in diameter at the butt and from 60 to 75 feet in height. Some of these avenues strike one as almost as impressive as the avenue of cryptomeria at Nikko, Japan (the Nikaido). They look as though they had been standing for centuries. In many places where fighting has taken place these beautiful trees have been cut out at the very butt to give a

field of fire. The main road running from Warsaw to Sochaczew and Lowicz is such as I describe. I passed up and down this unusual highway many times in the early days of the Great War and never failed to admire its beauty.

"When the second invasion of Poland took place and the Blonie line was being fortified these lovely trees all came down for miles to clear the field of fire for both artillery, machine-gun and rifle fire. But when one considers that all huts and dwellings within the zone of fire must as a military necessity be leveled, of course the trees are accepted as a loss which must follow as a matter of course. The roads running through Brody toward Lwow, or as it is known in America, Lemburg, were similarly flanked with trees, whose huge columns now lie in the ditches along side the way.

"Poland, as you know, is well patched with timber, mostly spruce and fir. I should say though, with my duties as a War Correspondent ever uppermost, I have always been preoccupied to such an extent that I have never looked at the woods from any point of view than that of estimating its value as cover. The groves that flank, sometimes on both sides, the Bazura-Rawka position west of Warsaw have been of excellent service to us. Where possible

trenches have been dug on the military crests at the fringe of these patches, and traverses have been run up from the rear where the reserve trenches are completely out of sight of the enemy, and it is possible for soup kitchens, supplies and reinforcements to come into the approaches without being visible to the enemy. This of course gives a greater degree of safety to the men going forward and enables the first line troops to be relieved at intervals more frequent than when there are no approaches masked by trees.

"Incidentally trenches in or at the edge of timber can be covered over with timber roofing so there is the least possible difficulty in transporting material to the men. I have always observed the best trenches in the timber, barring the Blonic line, and where possible and the terrain permitting trenches are over here on the Russian western operations often constructed in the shadow of or near patches of timber. This is often impossible where the strategic points in the terrain happen

to fall in open places as is frequently the case.

"Personally I believe that the portion of the forests actually used for the construction of military works is too small to seriously affect the total supply.

"Neither do I think that the destruction by shell fire is worth mentioning. I have observed in a dozen places this effect and the damage is surprisingly small, all things considered. The effect of shrapnel fire on forests is a mere flea bite. A shell bursting above the forest has no effect at all save where the shell case strikes and often that only lops off branches or dents the trunks, especially if the growth be a heavy one. A shell bursting in timber will, of course, destroy a number of trees in the immediate vicinity but as a matter of fact such bursts are rare, nearly all shrapnel bursting on time fuses above the tree tops. The few that burst on contact are almost certain to explode in the upper branches where their damage is small, usually resulting in only breaking off a few tops.



Photo by Underwood & Underwood, New York

RUSSIAN CAVALRY SCOUTS

SHOWING THE NATURE OF MUCH OF THE COUNTRY ON WHICH THERE HAS BEEN SEVERE FIGHTING. MANY OF THESE GREAT DOGS ARE USED BY THE SCOUTS



Photo by International News Service

RUSSIAN METHOD OF USING LOG FORTIFICATIONS

DURING THE WINTER CAMPAIGN IN GALICIA THE RUSSIANS FOUND THE GROUND FROZEN SO HARD IT WAS IMPRACTICAL TO DIG TRENCHES, SO TREES WERE FELLED BY THE HUNDREDS AND USED TO MAKE LOG PROTECTIONS SIMILAR TO THE ONE SHOWN IN THE PICTURE. IN THIS TEMPORARY FORT A RUSSIAN OFFICER IS STATIONED WITH A LOOKOUT APPARATUS



Photo by International News Service

RUSSIANS IN THE TRENCHES IN POLAND

THOUSANDS UPON THOUSANDS OF TREES HAVE BEEN FELLED ALONG THE RUSSIAN FRONTS FOR THE BUILDING OF DEFENSIVE WORKS AS ON MOST OF THE TERRITORY ON WHICH THE CZAR'S TROOPS HAVE FOUGHT THERE IS MUCH FORESTED LAND

"As a general proposition in shell fire I am not of the opinion that any of it is very destructive without resistance. Even the heavy calibres bursting in mud or soft ground do an astonishingly small amount of damage, while in the air their destructiveness is due mostly to the sheaf of shrapnel or the flying fragments, the energy of which is rapidly lost and, while perhaps annoying to men, cannot be construed, I believe, to have a very vital effect on standing timber. The shells of the heavier calibres, from the 15 centimetre field howitzers up, do, of course, more damage in timber, but even this is trifling in general, the reason for this being that it is difficult to get observation that will give the range of troops in woods, and hence dropping shells is largely a waste of ammunition. There are of course a

few places where fire has been concentrated where the forests have been utterly destroyed, but these patches are nothing but clearings of a few square kilometers and cannot be considered as having any bearing on the entire situation. There is one such spot on the Bzura front, unnecessary to locate more specifically, where the Germans in their February attacks are said to have concentrated over a short front 600 guns. This patch of timber has been reduced to kindling wood but it is almost a unique exception.

"The woods in Poland have given the very best possible cover, in my opinion, for the operations of artillery. I have, myself, been in a number of 15 centimetre howitzer batteries beautifully masked in timber. These are invariably using indirect fire with panorama sights

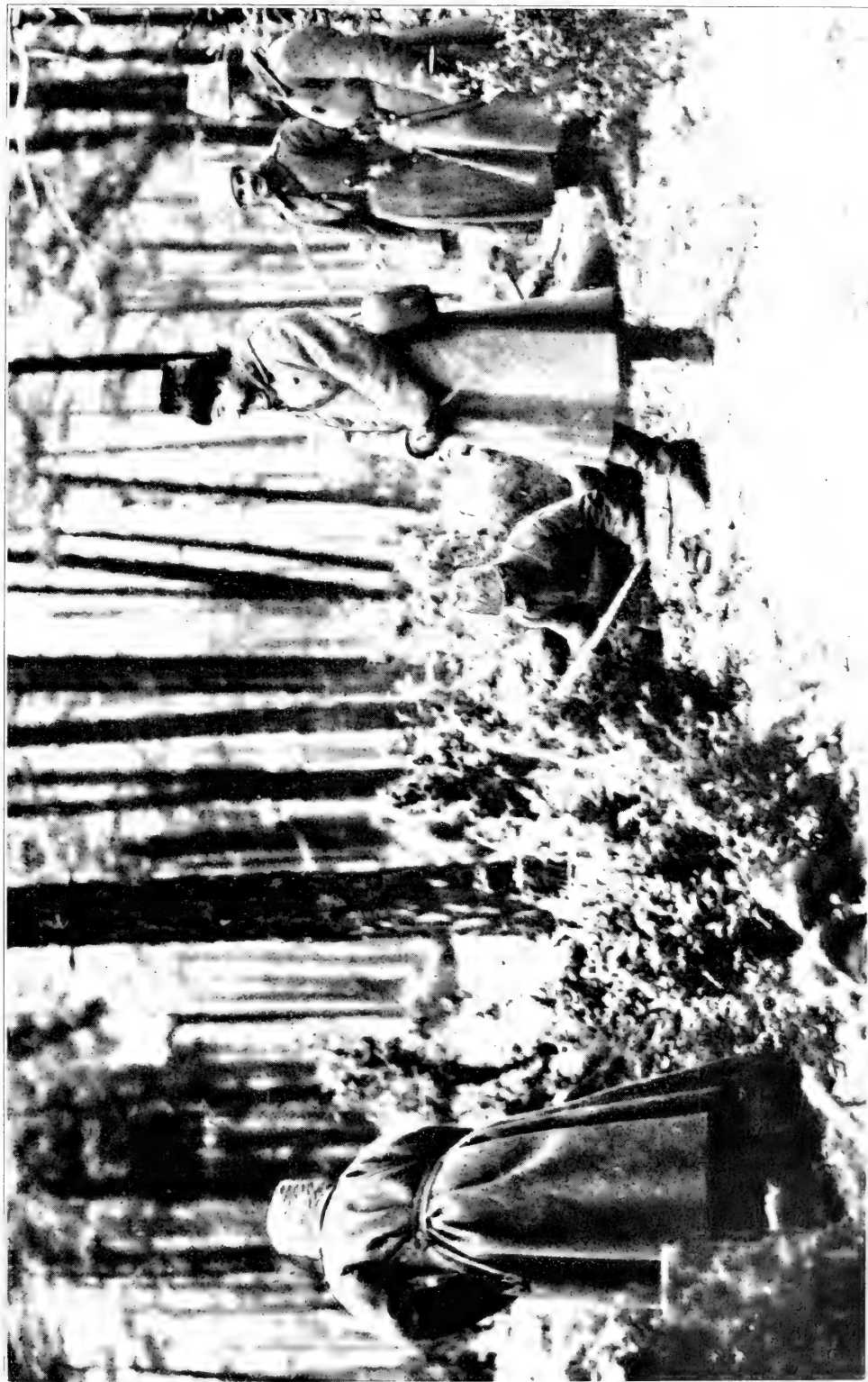

Photo International News Service

RUSSIAN TROOPS IN THE CARPATHIAN MOUNTAINS

HERE, COUNTRY SIMILAR TO THAT FOUND IN GALICIA AIDED THE TROOPS IN DEFENSIVE OPERATIONS AND TRENCHES MILES IN LENGTH WERE DUG IN THE FOREST. IT WAS DIFFICULT FOR ARTILLERY TO OPERATE IN THE FORESTS AND INFANTRY OPERATIONS WERE THEREFORE ALL THE MORE EFFECTIVE

turned to an aiming point in rear or flank with point of observation miles away, with telephone connections to check the effect of fire. It is possible that much of the forest may have been felled for works but I have personally seen no evidence of it.

"The most intense forest fighting has probably been in the vicinity of Suwalki on the East Prussian front where the tide of war has carried both armies back and forth for many months. I have not been on that front and so can express no opinion of the fighting there.

The Russians followed them in at the point of the bayonet and for nine days the battle raged in this belt. I think there is nothing since our battle of the Wilderness to compare to it."

Mr. Washburn's description of this battle, which also appears in his book, "Field Notes From the Russian Front" is thrilling in the extreme and graphically tells of the kind of fighting which occurs in heavily wooded country. He says:

"The Russian soldier is to me the most philosophical individual in the



Photo by International News Service

GERMANS GETTING TIMBER FOR TRENCHES

IN POLAND THE GERMANS FREELY UTILIZED THE TIMBER FROM THE HEAVY FORESTS TO BUILD AND PROTECT THEIR TRENCHES AND THOUSANDS OF TREES WERE USED FOR THIS PURPOSE

The worst place where I have seen the evidence of forest fighting was in the patch of woods lying between Konstienze, near the Vistula, and Radom. All of this is blocked under the head of the Battle Around Ivangrod. This was the Austro-German advance on Warsaw and Ivangrod. The enemy never got beyond the Vistula. One of our Caucasian Corps crossed the river, took the Austrians in the flank and drove the whole enemy forces back into this patch of wood which is perhaps 10 kilometers wide and 30 kilometers long and composed of really dense timber, fir and spruce, I should say.

world. I have seen him in the hospitals with arms and legs gone, head smashed in, ghastly wounds of all sorts, and if he has the strength to speak at all, he whispers 'Nichivo,' the equivalent of which in English is 'What difference does it make, anyway?' After a glimpse of the men and the munitions that permeate the life behind the army, one is not surprised at the feats that these same men, backed by their organization and transport, are performing every day on the actual field of battle. While it is true that many of the recent actions have been rearguard affairs, where it has been perfectly

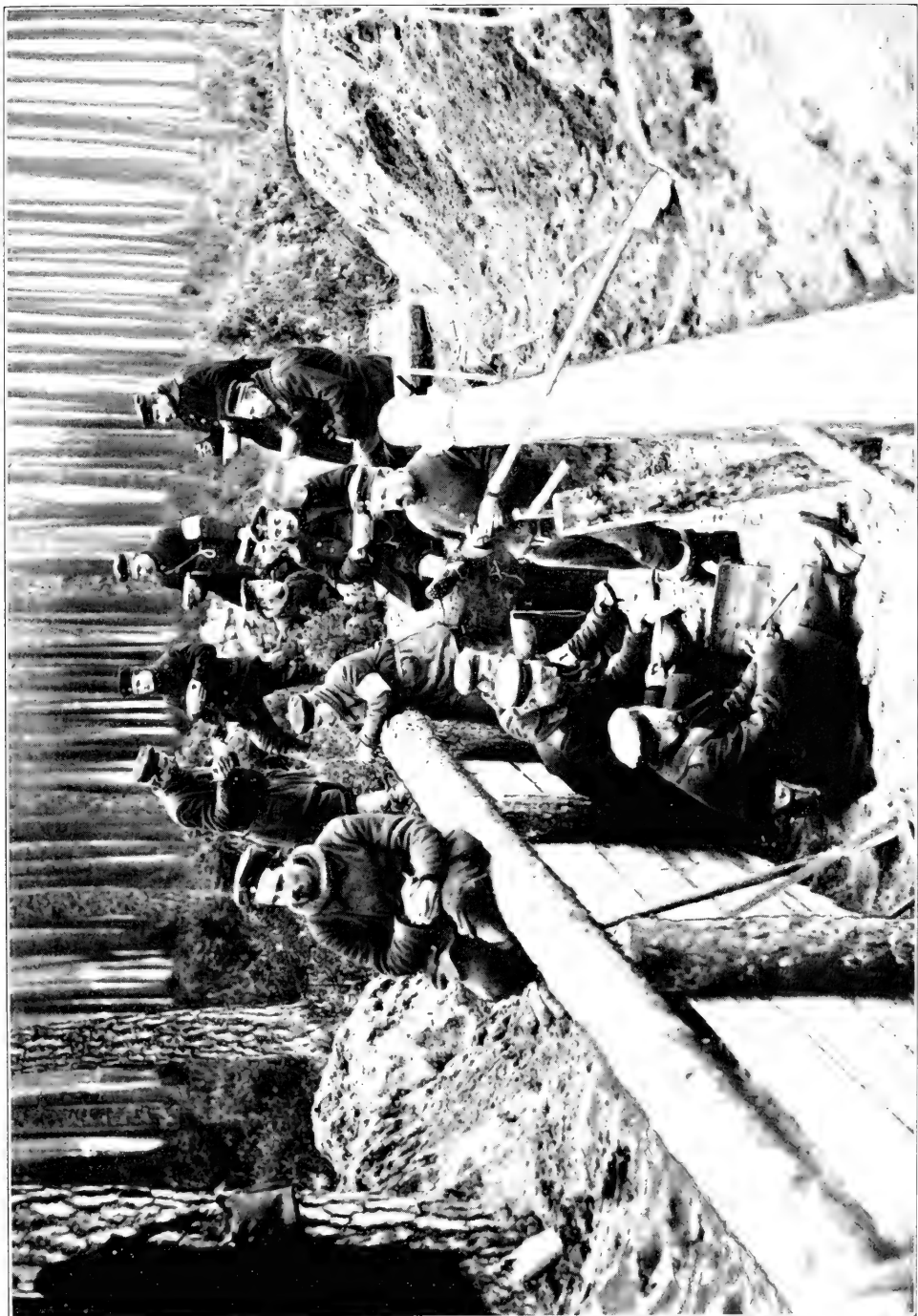

Photo by International News Service

TIMBER USED FOR TRENCHES

A FOREST ALONG THE LINE OF THE GERMAN ADVANCE THROUGH POLAND SHOWING THE HEAVY GROWTH AND HOW THE SOLDIERS TAKE ADVANTAGE OF THE SHELTER OF THE FOREST TO ENTRENCH THEMSELVES. SUCH TRENCHES EXTEND FOR MILES.



TYPICAL BATTLE GROUND IN GALICIA

COUNTRY LIKE THIS PROTECTED BY WIRE ENTANGLEMENTS MADE THE ADVANCE OF ONE SIDE OR THE OTHER SLOW AND DIFFICULT AND THOUSANDS OF RUSSIANS, GERMANS AND AUSTRIANS HAVE MET DEATH IN SANGUINARY BATTLES IN THE HEAVY WOODS

obvious that the enemy was making a stand only long enough to permit him to get out his impedimenta at his leisure, it is equally true that there have been other actions where he had not the slightest idea in the world of leaving unless he was forced.

"The best illustration of this is the battle which seems to be known in a vague way as the battle of Ivangrod. I have asked many people in the last few days what they knew of this action. All seemed to be aware in a general way that it was an important Russian victory. Some said it was a German-Austrian rearguard action; but few seemed to know any of the details of the contest which, in any other war that this world has ever seen, would have filled books with its details of fierce hand-to-hand fighting. As far as I know there is nothing in the history of war, with the possible exception of the American battle of the Wilderness, that can touch this event I speak of; and the Virginia campaign, as regards

losses, duration, and men engaged, was a mere skirmish compared with this. Yet here a few weeks afterwards, beyond the mere fact of it having taken place and having been won by the Russians, practically nothing is known about it.

"I shall not attempt to describe the military or strategic aspects of this desperate spot, because if one begins on historical relation of battles in this war there is absolutely no ending. I shall, however, sketch just a little of it, to indicate the nature of the work that the Russian soldiers did here. For in no battle of the whole war, on any front, has the fibre, determination and courage of troops been put more severely to the test than in this one. The German programme, as has been pointed out, contemplated taking both Warsaw and Ivangrod and the holding for the winter of the line formed by the Vistula between the two. The Russians took the offensive from Ivangrod, crossed the river and, after hideous fighting



A RUSSIAN HEAVY BATTERY IN A FOREST NEAR WARSAW

DUE TO THE HEAVY GROWTH OF TREES FURNISHED AN EFFECTIVE SCREEN FOR THE BIG GUNS. FOR SOME HOURS, FINALLY AUSTRO-GERMAN ARTILLERY LOCATED THE RUSSIAN GUNS AND THE AUSTRO-GERMAN BOMBARDMENT OF THE WOODS, DURING WHICH NUMEROUS TREES WERE DESTROYED OR DAMAGED, FOLLOWED



Photo by International News Service

RUSSIAN OUTPOST IN GALICIA

TREES ARE CUT DOWN AND POSTS MADE FROM THEM FOR THE PURPOSE OF ERECTING THE WIRE ENTANGLEMENTS WITH WHICH ALL THE CONTENDING ARMIES PROTECT THEMSELVES AGAINST INFANTRY ATTACKS

fairly drove Austrians and Germans from positions of great strength around the quaint little Polish town of Koziénice. From this place, for perhaps 10 miles west, and I know not how far north and south, there is a belt of forest of fir and spruce. I say forest, but perhaps jungle is a better term for it, for it is so dense with trees and underbrush that one can hardly see 50 feet away. Near Koziénice the Russian infantry, attacking in flank and front, fairly wrested the enemy's position and drove him back into this jungle. The front was itself bristling with guns, and I counted in about a mile position, forty-two guns. The taking of this line was in itself a test of the mettle of the Russian peasant soldier.

"But this was only the beginning. Once in the wood, the Russian artillery was limited in its effect upon the enemy; and in any event, the few roads through

the forest and the absence of open places made its use almost impossible. The enemy retired a little way into this wilderness and fortified. The Russians simply sent their troops in after them. The fight was now over a front of perhaps 20 kilometers. There was no strategy.

"It was all very simple. In this belt were Germans and Austrians. They were to be driven out, if it took a month. The carnage began.

"Day after day the Russians poured troops in on their side of the wood. These entered, were seen for a few minutes, then disappeared in the labyrinth of trees and were lost. Companies, regiments, battalions, and even brigades were absolutely cut off from each other. None knew what was going on anywhere but a few feet in front. All knew that the only thing required of them was to keep advancing. This they did,



AUSTRIANS IN AN ENTRENCHED POSITION

OWING TO THE HEAVILY WOODED CHARACTER OF THE COUNTRY IT IS DIFFICULT TO DETECT THESE DEFENSES AT A DISTANCE. THEY SHIELD THE DEFENDERS FROM INFANTRY AND ARTILLERY FIRE. HEAVY LOGS COVERED WITH EARTH ARE USED FOR THE ROOFING AND THIS IS SO SOLID AND WELL CONSTRUCTED THAT IT WILL RESIST SHRAPNEL FIRE

foot by foot and day after day; fighting each other hand to hand; taking, losing and retaking position after position. In all of this 10 kilometers of forest I dare venture to say there is hardly an acre without its trenches, rifle pits and graves.

"Here one sees where a dozen men had a little fort of their own and fought furiously with the enemy a few feet away in a similar position. Day after day it went on, and day after day troops were poured into the Russian side of the wood; and day and night the continuous crack of rifle fire and the roar of artillery hurling shells into the wood, could be heard for miles. But the artillery played a lesser role, for the denseness of the forest made it impossible to get an effective range. Yet they kept at it, and the forest for miles looks as though a hurricane had swept through. Trees staggering from

their shattered trunks, and limbs hanging everywhere, show where the shrapnel shells have been bursting. Yard by yard the ranks and lines of the enemy were driven back, but the nearer their retreat brought them to the open country west of the wood, the hotter the contest became; for each man in his own mind must have known how they would fare when, once driven from the protecting forest, they attempted to retreat through the open country without shelter.

"The state of the last two kilometers of the woody belt is hard to describe. There seems scarcely an acre that is not sown like the scene of a paper-chase, only the trail here is bloody bandages and bits of uniform. Here also there was small use for the artillery, and the rifle and the bayonet played the leading role. Men, fighting hand to hand with clubbed muskets and



Photo by International News Service

A TRENCH IN A GALICIAN FOREST

MUCH OF THE GROUND OVER WHICH THE CONTENDING FORCES IN THE EAST HAVE FOUGHT IS SIMILAR TO THIS SHOWN IN THE PICTURE. HERE THE TRENCH AND THE FOREST COMBINE TO PROTECT THE DEFENDERS AND MAKE THE ATTACK DIFFICULT

bayonets, fought from tree to tree and ditch to ditch. Systematically, patiently, stoically, the Russians sent in fresh troops at their side of the wood.

"The end was of course inevitable. The troops of the Dual Alliance could not, I suppose, fill their losses, and the Russians could. Their army was under way, and they would have taken that belt of wood if the entire peasant population of Russia had been necessary to feed the maw of that ghastly monster of carnage in the forest. But at last the day came when the dirty, grimy, bloody soldiers of the Czar pushed their antagonists out of the far side of the belt of woodland. What a scene there must have been in this lovely bit of open country, with the quaint little village of Augustow at the cross-roads.

"Once out in the open, the hungry guns of the Russians, that had for so long yapped ineffectively and sightlessly into blind forest, got their chance. Down every road through the wood, came the six-horse teams with the guns jumping and jingling behind, with their accompanying caissons heavy with shrapnel. The moment the enemy were in the clear, these batteries, eight guns to a unit, were unlimbered on the fringe of the wood and were pouring out their death and destruction on the wretched enemy now retreating hastily across the open.

"The place where the Russians first turned loose on the retreat is a place to remember—or to forget, if one can. Dead horses, bits of men, blue uniforms,

shattered transport, overturned gun carriages, bones, broken skulls, and grisly bits of humanity strew every acre of the ground. A Russian officer, who seemed to be in authority on this gruesome spot, volunteered the information that already they had buried at Kozienice in the wood and in the open 16,000 dead; and as far as I could make out the job was still a long way from being completed. Those who had fallen in the open, and along the road, had been decently interred, as the forests of crosses for 10 miles along that bloody way clearly indicated; but back in the woods themselves, there were hundreds and hundreds of bodies lying as they had fallen. Sixteen thousand dead means at least 70,000 casualties all told, or 35,000 on a side if losses were equally distributed. This is figured on the basis of the 16,000 dead which were already buried, without allowing for the numbers of the fallen that still lie about in the woods. And yet this is a battle the name of which is, I dare venture to say, hardly more than known either in England or the United States, and in which the losses on both sides probably amount to more than the entire army that Meade commanded at the battle of Gettysburg." If one wants to get an idea of what war is under these conditions, it is only necessary to stroll back among the trees and wander about among the maze of rifle pits and trenches thrown up by the desperate soldiers as they fought their way forward or defended their retreat."

AN EXPLANATION

A POEM "A Tale of the Trail" appearing in AMERICAN FORESTRY for April was by error credited to Matt Daly a preacher-poet who is working among the lumberjacks of the north. It was written by Mr. James W. Foley of Oakland, Cal., and was published in

a volume of his writings. Mr. Daly saw the poem reproduced in a Minnesota paper, typed it and sent it to a friend who, thinking it was Mr. Daly's own, sent it to AMERICAN FORESTRY for publication. This explanation is made in justice to Mr. Foley and in response to a letter from him.

CALIFORNIA TREE NOVELTIES

PART I

By E. A. STERLING

[The information contained in this article, and in the one to follow in August, will be most desirable to the visitor, who, going to California this summer or fall, will take time to see some of the natural wonders of the State, among which are the magnificent trees and forests. Mr. Sterling tells what trees may be seen along the regular tourist routes, and he knows, as he has ridden over a considerable portion of the State's forested area.—EDITOR.]

CALIFORNIA announces its faith in itself and in the nation, by the simultaneous presentation of two great expositions at a time when the world is staging the most tremendous events in history. Such confidence deserves well of the visitors who seek her hospitality. Yet only a small part of what the Pacific coast has to offer is found among the artistic and commercial features so wonderfully assembled at the Panama-California and Panama-Pacific Expositions.

California can offer unparalleled natural attractions which are her very own, and every one interested in the unique and beautiful in the way of mountains and forests, will find much that is fascinating and inspiring on or near the established tourist routes in this great out door playground of the West. From the low wooded mountains in sight of the grounds of the Panama-California Exposition at San Diego, northward along the Sierra Madre, Sierra Nevada and coast ranges, past the ocean slopes which look down on the golden city by the western gate to Mount Shasta and the Siskiyou Mountains on the northern boundary is an enormous forest region more diversified in character and with more wonderful trees than are found in any other spot or region on earth. In kind, in size, in beauty, and in abundance, California forests are absolutely unexcelled.

John Muir, who knew California mountains and forests as no other man knew them says in his book "The Mountains of California:" "The distribution of the general forest in belts is readily perceived. These extend in

regular order from one extremity of the range to the other; and, however dense and somber they may appear in general views, neither on the rocky heights nor down in the leafiest hollows will you find anything to remind you of the dank, malarial selvas of the Amazon and Orinoco, with their 'boundless contiguity of shade,' the monotonous uniformity of the Deodar Forests of the Himalaya, the Black Forest of Europe, or the dense dark woods of Douglas Spruce where rolls the Oregon. The giant pines, and firs, and Sequoias hold their arms open to the sunlight, rising above one another on the mountain benches, marshaled in glorious array, giving forth the utmost expression of grand beauty with inexhaustible variety and harmony.

"The inviting openness of the Sierra woods is one of their most distinguishing characteristics. The trees of all the species stand more or less apart in groves, or in small, irregular groups, enabling one to find a way nearly everywhere, along sunny colonnades and through openings that have a smooth, parklike surface, strewn with brown needles and burs. Now you cross a wild garden, now a meadow, now a ferny, willowy stream; and ever and anon you emerge from all the groves and flowers upon some granite pavement or high, bare ridge commanding superb views above the waving sea of evergreens far and near. * * *

* * * "Crossing the treeless plains of the Sacramento and San Joaquin from the west and reaching the Sierra foot-hills, you enter the lower fringe of the forest, composed of small oaks and pines, growing so far apart that not one-twentieth of the surface of the

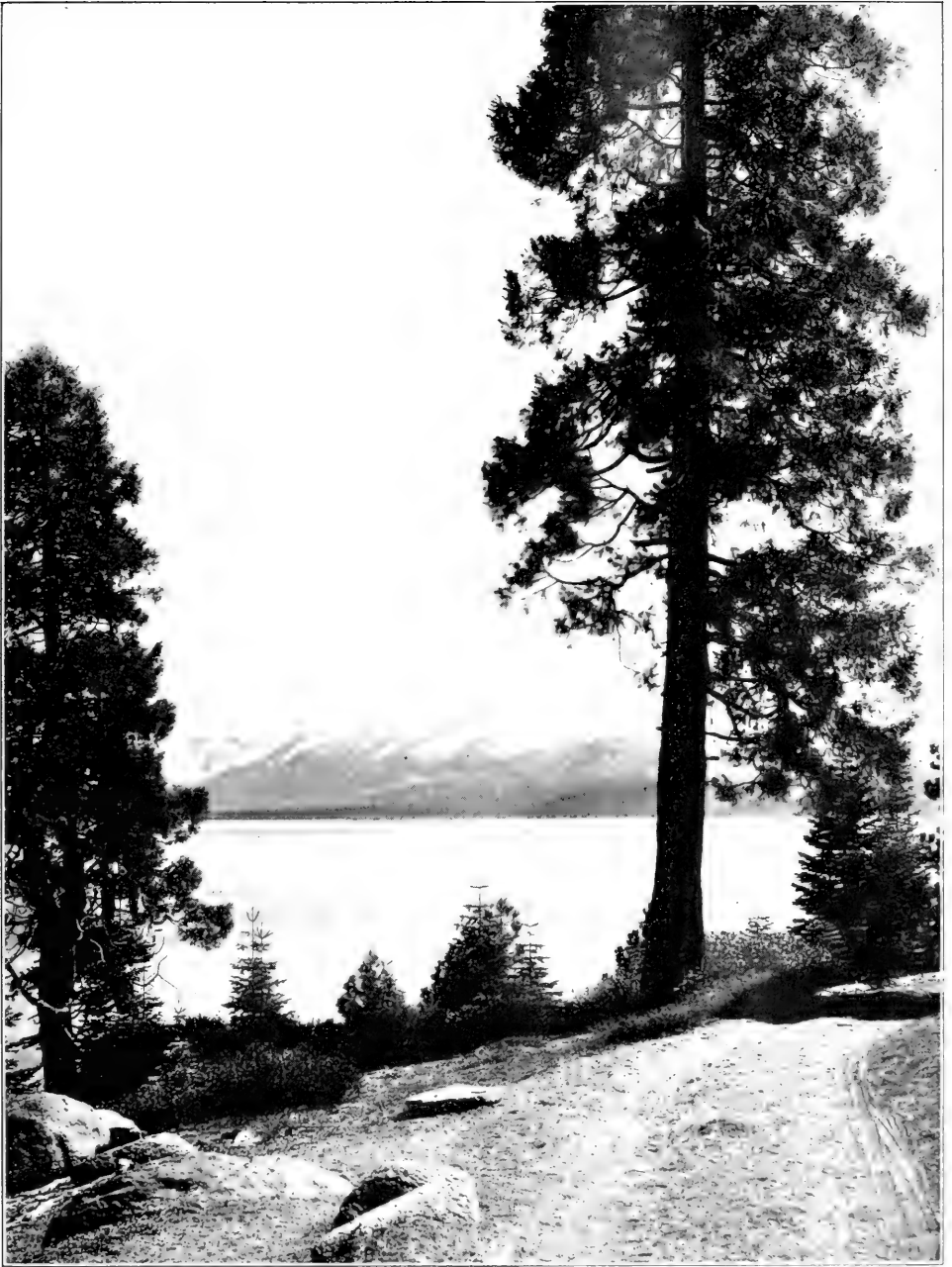

AT BEAUTIFUL LAKE TAHOE

A TYPICAL ROAD, LAKE AND MOUNTAIN SCENE IN THE LAKE TAHOE COUNTRY. INCENSE CEDAR ON LEFT FOREGROUND, FIR ON RIGHT, WITH YOUNG FIR AND YELLOW PINE ON THE EDGE OF THE LAKE



DEEP SNOW COVERS MUCH OF THESE TREES

GENERAL VIEW SHOWING SCANTY FOREST COVER AT HIGH ELEVATION IN VICINITY OF GLEN ALPINE, SILVER PINE, LODGEPOLE PINE, BLACK HEMLOCK IN FOREGROUND, EL DORADO NATIONAL FOREST, CALIFORNIA. THE SNOW IS BETWEEN 20 AND 30 FEET DEEP IN PLACES ALONG HERE

ground is in shade at clear noonday. After advancing 15 or 20 miles, and making an ascent of from 2,000 to 3,000 feet, you reach the lower margin of the main pine belt, composed of the gigantic Sugar Pine, Yellow Pine, Incense Cedar and Sequoia. Next you come to the magnificent Silver Fir belt, and lastly to the upper pine belt, which sweeps up the rocky acclivities of the summit peaks in a dwarfed, wavering fringe to a height of from 10,000 to 12,000 feet."

Under a wide diversity of altitude, climate and soil, the greatest possible extremes in tree growth are produced. To see and appreciate to the full what the Pacific coast has to offer in the way of trees would take years. Even the casual visitor, however, will have ample

opportunity to see examples of the extreme conditions and of the best which lies in between. One cannot reach San Diego without seeing from the car windows, the stunted pinon pines and diminutive oaks of the foot hills, with a touch of desert flora thrown in. A little more effort will be required to see the optimum of tree growth in the giant Sequoias of the Sierras, or the magnificent redwoods of the northern coast country. Under the influence of heavy rains and the dense fogs which roll in from the Pacific, there has been produced a redwood forest so dense and so dark and composed of such large individual trees, that they seem more like vegetation of long past geological ages. Even larger trees, but

in less dense forests, are found on the west slopes of the Sierras, where the Sequoias have been left grouped on restricted areas, which were untouched by the flood of glacial ice, which in ages past broke through to the coastal plains.

Of these redwoods, John Muir well says: "The redwood is the glory of the Coast Range. It extends along the western slope, in a nearly continuous belt about 10 miles wide, from beyond the Oregon boundary to the south of Santa Cruz, a distance of nearly 400 miles, and in massive, sustained grandeur and closeness of growth surpasses all the other timber woods of the world. Trees from 10 to 15 feet in diameter and 300 feet high are not uncommon, and a few attain a height of 350 feet or even 400, with a diameter at the base of 15 to 20 feet or more, while the ground beneath them is a garden of fresh, exuberant ferns, lilies, gaultheria, and rhododendron. This grand tree, *Sequoia sempervirens*, is surpassed in size only by its near relative, *Sequoia gigantea*, or Big Tree, of the Sierra Nevada, if, indeed, it is

surpassed. The *sempervirens* is certainly the taller of the two. The *gigantea* attains a greater girth, and is heavier, more noble in part, and more sublimely beautiful. These two Sequoias are all that are known to exist in the world, though in former geological times the genus was common and had many species. The redwood is restricted to the Coast Range, and the Big Tree to the Sierra. As timber the redwood is too good to live. The largest sawmills ever built are busy along its seaward border, 'with all the modern improvements,' but so immense is the yield per acre it will be long ere the supply is exhausted. The Big Tree is also, to some extent, being made into lumber. It is far less abundant than the redwood, and is, fortunately, less accessible, extending along the western flank of the Sierra in a partially interrupted belt, about 250 miles long, at a height of from 4 to 8,000 feet above the sea. The enormous logs, too heavy to handle, are blasted into manageable dimensions with gunpowder. A large portion of the best timber is thus shattered and destroyed, and, with the



COULTER PINE, SAN GABRIEL MOUNTAINS, CAL.

SCATTERED COULTER PINE GROWING IN THE SPARSE CHAPARRAL ON THE LOWER SLOPES AND ALONG THE DRY STREAM BEDS IN THE SAN GABRIEL MOUNTAINS, SOUTHERN CALIFORNIA. BOTH FIRE AND ARIDITY ARE RESPONSIBLE FOR THE SCANTY VEGETABLE GROWTH, AND THE REFORESTATION OF SUCH SITES IS VERY DIFFICULT. THE WHITE STALKS SEEN SCATTERED THROUGHOUT THE PICTURE ARE THE FLOWER STEMS OF THE LOW GROWING YUCCA KNOWN AS SPANISH BAYONET, WHICH ARE VERY BEAUTIFUL WHEN IN BLOSSOM



SOME WASHINGTON PALMS

A GROUP OF WASHINGTON PALMS IN PALM CANYON ON THE ANGELES NATIONAL FOREST. THE ABSENCE OF OTHER TREE GROWTH AND THE SCANTY CHARACTER OF THE CHAPARRAL INDICATES THE EXTREME HARDINESS OF THESE TREES, AND THEIR ABILITY TO SURVIVE UNDER EXTREME CONDITIONS OF DROUGHT, FROM WHICH THEY ALSO DERIVE THE NAME OF DESERT PALM. EVEN UNDER THESE UNFAVORABLE CONDITIONS THEY ARE THE LARGEST NATIVE PALMS GROWING WITHIN THE BORDERS OF THE UNITED STATES

huge, knotty tops, is left in ruins for tremendous fires that kill every tree within their range, great and small. Still, the species is not in danger of extinction. It has been planted and is flourishing over a great part of Europe, and magnificent sections of the aboriginal forests have been reserved as National and State Parks—the Mariposa Sequoia Grove, near Yosemite, managed by the State of California, and the General Grant and Sequoia National Parks on the Kings, Kaweah, and Tule Rivers, efficiently guarded by a small troop of United States Cavalry under the direction of the Secretary of the Interior. But there is not a single specimen of the redwood in any National Park. Only by gift or purchase, so far as I know, can the Government get

back into its possession a single acre of this wonderful forest.”

These historic and notable trees have been described and pictured until familiar to everyone. Within a few hours horseback ride of some of the Sequoias, is found another extreme in the timber-line trees at the higher altitudes in the Sierras. Several species which attain commercial size on the intermediate and lower slopes, become small and stunted as the higher altitudes are reached. Others, notably the white bark pine, have their natural habitat on the upper slopes at altitudes of 6,000 to 8,000 feet; while still higher up towards the zone of perpetual snow or barren rock are other trees which exist only in the harsh environment to which the endless struggle for existence has



KNOBONE PINE AND COULTER PINE IN CHAPARRAL, SAN BERNARDINO MOUNTAINS, ANGELES NATIONAL FOREST, CALIFORNIA

THE NON-COMMERCIAL TREE GROWTH OF THE FOOTHILLS AND INTERMEDIATE SLOPES ON THE SAN BERNARDINO MOUNTAINS, CHAPARRAL COVERS THE GROUND BETWEEN THE TREES, AND WHILE A DENSE FOREST ON THE DRY SLOPES CAN NEVER BE EXPECTED, THE TREES WOULD RECLAIM MUCH OF THE AREA NOT CHECKED BY FIRE. THE DEAD TRUNKS ON THE RIGHT OF THE PICTURE ARE PROBABLY FIRE KILLED. AT THE TOP OF THE DEAD TREE WHICH IS OUTLINED AGAINST THE SKY ON THE LEFT OF THE PICTURE, CAN BE SEEN THE PERSISTENT CONES OF THE KNOBONE PINE, WHILE THE TREE OCCUPYING THE SAME RELATIVE POSITION ON THE RIGHT SIDE IS A COULTER PINE, ONE OF THE LARGE CONES BEING PLAINLY VISIBLE IN THE TOP



CHAPARRAL, SPRUCE, BULL PINE AND SUGAR PINE

FOREST DISTRIBUTION AS INFLUENCED BY SLOPE AND EXPOSURE IN THE SIERRA MADRE RANGE IN SOUTHERN CALIFORNIA. CHAPARRAL ON THE DRY SOUTH SLOPES, BULL PINE, SUGAR PINE AND SPRUCE ON THE WEST SLOPES, RIDGES AND COOL RAVINES. THE ABRUPT TRANSITION FROM FOREST TO CHAPARRAL ON THE RIDGE SUMMITS IS SEEN FROM MANY ROADS AND TRAILS RUNNING UP INTO THE MOUNTAINS FROM SAN BERNARDINO AND PASADENA

driven them and made them fitted. On some of the flattened Sierra ridge summits or rocky slopes scanty tree growth is maintained on almost bare rock, the disintegrated granite or rock crevices giving support to foxtail, lodgepole and even yellow pine. Only trees of great hardiness can withstand these conditions of extreme temperatures, drought and lack of soil. From the stage road along the Merced in the lower end of Yosemite Valley look for the large tree on a narrow ledge high up on the rocky face of El Capitan. Also see the smaller trees growing out of apparently solid rock on the granite knobs near Prospect Point and Mirror Lake. The limber pine is the high Alpine climber, its high inaccessible range being from 8,000 to 12,000 feet on the higher slopes and lower peaks of the Sierras, where it exists as the advance guard at the upper timber line. The growth is very slow, the limbs are often larger than the trunk

which remains stunted, and trees only a few feet high may be over 200 years old. It is a distorted, dwarfed and pathetic specimen, often hardly shoulder high, and found clinging in situations where vegetable life of any kind seems impossible.

The desert regions produce other forms of tree growth which are unique and unusual because of the long struggle which has adapted them to existence with a minimum of moisture. There are regions in California where the annual rainfall is less than 10 inches, which by comparison with other portions of the State which have a precipitation of 6 or 8 feet, produce a striking parallel. There is a natural relation between rainfall and temperature with the consequent extremes between heat and cold, which also have their effect upon tree growth. Then in between lie all the gradations and overlapping conditions which produce the



THE AUTHOR AND A SEQUOIA

BASE OF SEQUOIA TOP LEFT BY LUMBERMEN. FIVE 16-FOOT LOGS WERE TAKEN OUT. THE HOLE WAS BURNED BY FIRE WHICH RAN THROUGH SLASH SEVEN YEARS AGO. TULARE COUNTY, SEQUOIA NATIONAL FOREST, CAL.

wealth and variety of forests for which California is famous.

The large, inspiring and beautiful in the way of tree growth is confined to the regions of moderate or heavy precipitation. Under desert conditions, the flora is stunted, scanty and weird. The tree yuccas contribute strikingly to the desert flora. Seen from the Santa Fe trains on the Mohave desert these are easily the "most wild-looking denizens of desert hills and plains," but to ride and live among them completes the sense of weirdness which they produce. To see the Joshua tree or Mohave yucca by moonlight, or as sometimes happens, under a fall of snow, leads one to question his sanity,

or his existence on a well ordered conventional earth. The most beautiful member of the desert flora is the Washington palm, or "desert palm," of which the only species found in the United States inhabits the Colorado desert and arid canyons of Southern California. It is the largest of our native palms, growing to an extreme height of 60 to 70 feet with great leaves 4 feet wide and stems 5 to 6 feet long. The best known grove is in Palm Canyon in the San Jacinto Mountains, near Agua Caliente, 10 miles south of the Southern Pacific Railroad at Seven Palms.

Many visitors to the Panama Expositions will make the side trip to



YELLOW PINE AND FIR REPRODUCTION

THE STRUGGLE BETWEEN THE FOREST AND THE CHAPARRAL AT THE FOOT OF MOUNT SHASTA. FIRE IS THE ALLY OF THE CHAPARRAL. WITHOUT IT THE PINES, FIR AND CEDAR WOULD WIN BACK THE LOST GROUND. THIS VIEW AND MANY LIKE IT CAN BE SEEN FROM THE TRAIN JUST NORTH OF SISSON ON THE SHASTA ROUTE OF THE SOUTHERN PACIFIC

Yosemite. By either route the transition from the chaparral and foot hills to the Sierra Forests of Douglas fir, cedar and pine will be seen. In the foot hills the live oaks and digger pine will be the prominent features of the landscape and an open non-commercial forest carpeted with low growing chaparral species will be traversed. The digger pine is the most ghostly of all pines, its grayish green and scanty foliage bringing into prominent relief the trunk and limbs of skeleton shape and aspect, with the peculiar U-shaped forks. Studded among the oaks of the foot hills, with the chaparral as a background, is the red barked manzanite lending a touch of color, by which a forest condition of unusual artistic charm is created. As the higher slopes are reached, but where the arid conditions of the valley are still felt, yellow pine and fir will begin to appear in the sheltered moist ravines and on

north slopes. Finally the true forests of the intermediate slopes of the Sierras will be found under a variety of groupings and mixtures dependent on local conditions of soil, moisture and exposure.

The Sierra commercial forests are not seen at their best on any of the usual scenic routes. The sugar and yellow pines, fir, cedar and spruce, which contribute to the importance of California as a lumber producing State, have been largely cut out near the railroads and are not up to standard where the travel booklets tell one to go. To see these forests one must go into the lumber camps off the established routes of travel, although glimpses may be had from the highways and byways over which the hurried visitor travels. The Lake Tahoe country, for example, gives some idea of what these forests were before fire and commercial necessity took their toll. On the slope



WHERE THERE IS A HARD STRUGGLE FOR EXISTENCE
 WHITEBARK PINE AT UPPER LIMIT OF TREE GROWTH ON PYRAMID PEAK, EL DORADO NATIONAL FOREST, CAL.

above the lake the struggle between chaparral and the forests is keenly waged with the forest winning back its ground where fire is absent for a few years. Mark Twain in "Roughing It" describes the Tahoe Forests of fifty years ago and gives a wonderful description of a forest fire. South of Lake Tahoe is a wonderful sub-Alpine Lake country, where one may fish through the ice in May and near timberline see mountain hemlock 30 to 50 feet high buried almost to their tips in snow. Comparatively short trips from Weed, Sisson or McCloud in the Mount Shasta region, take one into the forests of sugar and yellow pine; while from various points such as Chico and Madera in the Sacramento and San Joaquin Valleys the lumber camps can be reached by stage or logging railroad. The sugar pine is perhaps at its best on the American River east of Sacramento; while the railroad trip to

Angels Camp, in Calaveras County, made famous by Bret Harte and Mark Twain, is a revelation of forest scenes.

The species comprising the typical Sierra Forest do not possess unique or surprising features. It is simply the wonderful abundance and the high quality of the timber which creates the effect that mature forests always do, of impressiveness and a desire to abandon care and pitch a tent where the best trees are. The individual trees, under normal conditions are tall, with clear and straight trunks, many being 6 to 8 feet in diameter, although the average is less; but the eastern visitor loses the sense of size because of the absence of comparative standards. The eastern forests of 5 to 10,000 feet per acre with individual trees running up to 2 or 3 feet, are dwarfed by these western forests, where the stand may run 30, 50 or even a 100,000 feet per acre. There is too, in some regions, an



A BROKEN CONIFEROUS FOREST

THIS IS IN THE VICINITY OF MOUNT SHASTA IN THE SHASTA NATIONAL FOREST, SISKIYOU COUNTY, CALIFORNIA, AND THIS TYPE OF FOREST MAY BE SEEN FROM THE SOUTHERN PACIFIC RAILROAD LINE WHICH PASSES MOUNT SHASTA

apparent scantiness to the forest, yellow pine, for example, often growing in open parklike stands which permit

grass or chaparral to grow densely underneath.

(To be continued in August.)

AMERICAN WILLOW INDUSTRY

BECAUSE the European supply of willow rods has been largely cut off several American manufacturers of willow furniture and baskets have asked the Department of Agriculture for the addresses of persons in this country who have taken up willow growing. For some years the Department has distributed willow cuttings of imported varieties with a view to developing the production of high-grade willow rods in the United States. The usual imports of willows come chiefly from England, Belgium, Holland, France and Germany,

but these sources have been practically closed for several months.

One manufacturer reports that Japanese osiers are taking the market formerly supplied by Germany, at a slightly higher price. Finished willow baskets from Japan have come in where split bamboo was the only Japanese basketware on sale before the war. As a consequence of the shortage of imported osiers, it is said, the price of American willows has increased and growers here are meeting with a heavy demand for their product.

THE IMPROVED American Forestry Magazine

Tree identification and tree knowledge articles will be a feature each month of the enlarged and greatly improved issues of American Forestry Magazine starting with the August issue.

THE TULIP OR YELLOW POPLAR TREE will be the first one featured.

The cover of the magazine will be a strikingly attractive picture in four colors of a typical Tulip or Yellow Poplar tree, its bark, its leaves and its buds and these will be of the greatest value in identifying the tree readily.

In addition there will be an illustrated article upon the characteristics and the history of the tree by a recognized expert, an article which will instruct our readers so that they may have comprehensive information about it.

COMMERCIAL USES OF TULIP OR YELLOW POPLAR will be another profusely illustrated article, telling in detail for which articles of commerce it is most used and most serviceable. This will be of unusual value.

ORNAMENTAL AND SHADE TREES will be given a special department. This, conducted by Mr. J. J. Levison, will be a monthly feature which will give much needed information to our members having ornamental and shade trees and desiring to know how to take care of them.

CHILDREN'S KNOWLEDGE OF FORESTRY will be another department which will be devoted to educating children in tree knowledge and forestry, giving them such information that they will grow to love and to know trees and their value. This will be conducted by Mr. Bristow Adams of Cornell University.

WOOD PRESERVATION which has a decided practical value in forest conservation will be a monthly department conducted by Mr. E. A. Sterling, former president of the American Wood Preservers Association. As treated woods are now in use by farmers and housebuilders, the need of a department giving the best advice about the subject is evident.

BIRDS AND THE NEED OF THEM will be another subject given a special department. The conservation of birds is vitally necessary to the preservation of human life. So few people realize this that American Forestry will make a special effort to promote proper protection and care of birds.

PRIVATE FORESTRY AND WOODLOT FORESTRY, both important, will be written about by experts whose advice will be found of great assistance.

NATIONAL, STATE AND MUNICIPAL FORESTRY will receive attention in a number of articles by able writers, as will the great variety of subjects pertaining to the forests not only in this country but abroad.

A WORD TO MEMBERS

If you are pleased with your magazine will you not ask your friends to become members. We need more. One new member secured by each present member would **DOUBLE** the association's educational value.

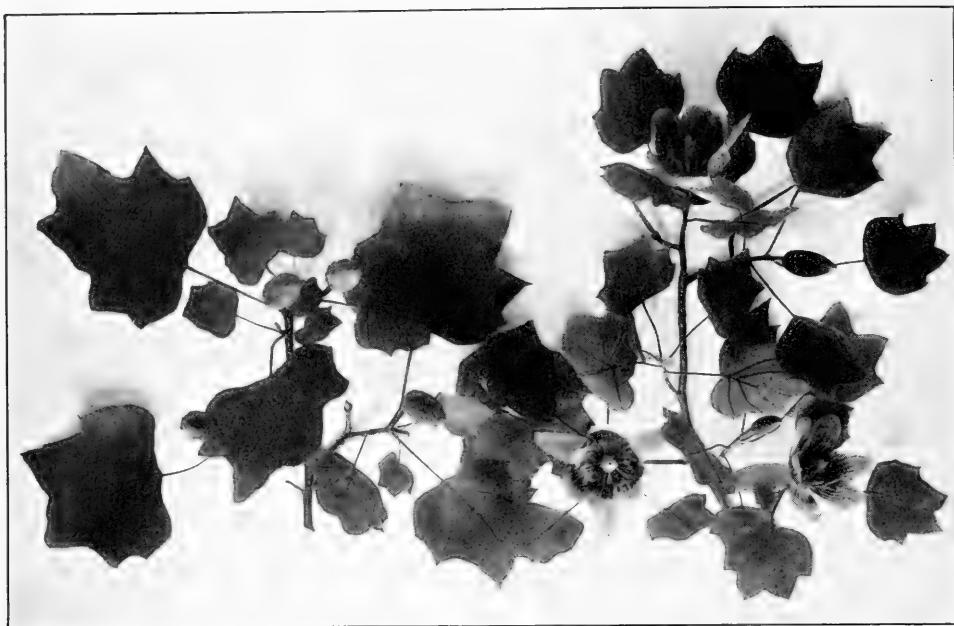

SPRAYS OF THE TULIP TREE

HARDWOODS ON THE COUNTRY ESTATE

By WARREN H. MILLER, M. F.

IT IS with much pleasurable anticipation that I start in upon this introduction to my favorites among what may be called the isolated tree species among the broad leaves. For many of these do not occur in large families as do the oaks and maples and hickories, but rather a single representative, or two at most, is accorded us here in America, large as the family may be elsewhere on the globe. Yet these trees represent some of the most beautiful and the most stately of all our forest denizens, and without them we would feel that many beloved old favorites would be wanting. I refer to the tulip tree, the linden, the sweet and sour gums, the two dogwoods, the two willows, the wild cherries, the two walnuts, the chestnuts, and that noble gray gaint, the beech. Can you conceive of a forest without these trees? And could you forgive the lack

of variety that would ensue from their total omission? Commercially, for the sake of selling large blocks of lumber all of a grade and kind, we might tolerate the European system of pure forests, all oaks, or all hornbeam, or all beech; but to the country estate owner, while he may have his stands of pure oak and his sugar bush, his forest as a whole will not satisfy unless it presents a landscape bordered at least with a fair representation of the amazing diversity of our native tree species.

The liriodendron or tulip tree is one of these satisfactory old favorites, growing rapidly to a huge column of tree, a veritable factory chimney in bark, rising sheer without a limb to a fork 50 feet from the ground. And then its noble head, solid and mighty, bedecked with gay tulip flowers in June, a grand shaft of orange yellow leaves in October, and all through the

winter lifting its pointed seed shafts into the blue heavens for all the birds in the world to feed upon (and it's seldom that there aren't a few of them twittering about up there during the winter, too). No need to plant in fresh liriiodendrons, —if there is a big one about he will people the earth with tulip trees, seeding mostly a few hundreds of yards to the northeast of himself due to the prevailing southwest winds of autumn. Young forest-grown ones are hard to transplant, so that if you need one to decorate some conspicuous vantage point where there is little likelihood of a seed being blown, either seed it yourself or get a young nursery specimen, a 12-foot tree costing you \$1.50. Identification of this tree is easy even when young. Look for a large blunt-ended leaf something like a maple leaf with the point cut off. In young trees these leaves are huge, reaching 14 inches in length, and they are often of irregular shape so that they are apt to be taken for a sassafras except that the aromatic sassafras odor is lacking. The flower is a large, yellow and orange tulip, and fruit a long green cone which turns brown during the fall and is composed of a sheaf of winged orange seeds, blown far and wide during the winter. You will find that nature has been kind in the matter of tulip trees for they grow on any base soil not too dry and there will surely be several giants to look at besides not a few young ones in any forest of over 10 acres anywhere in our area except the northern border. Not hardy in the land of the spruce, however, its northern limit being about southern Vermont. Liriiodendron belongs to the magnolia family and is our sole northern representative.

The linden is another lone representative of a large and distinguished family, but our American species is one of the finest. Judging by its scarcity we do not begin to appreciate it, for, with its fine proportions, its abundant, white, fragrant blossoms and odd fruit, it is a most fascinating tree to have about. And, as a bee tree it is unexcelled. With a few of them in your forest go ahead and set out your hives; the bees will never lack for honey flowers until your lindens are through.

Leaves are of the characteristic linden, heart—shape with notched edges, going direct to brown in the fall, coming out late and dropping early. Fruit a small pea on the end of a stalk sticking out at an angle from a wing which grows sessile on the twig and enables the pea to float for some distance in the air, at least clear of the parent tree when falling. The European linden has been planted much among us but is quite vulnerable to insect attack while ours is immune. Both can be bought from nursery or transplanted from wild stock. Grows best in granite, limestone and clay base soils, in moist localities—anywhere that is favorable to hemlock, sugar maple, and white ash. The one I know best lived on my father's place, the soil base being red limestone clay, and the tree thrived mightily, having a diameter of about 2 feet and a height of fifty-five.

The two gum trees are represented in nearly every forest, but are at their finest in sand base soils with a hardpan underneath keeping the soil wet and ferny. Both the sweet gum and sour gum, or tupelo, are striking trees, unique in every respect. The sweet gum grows straight as a lance in the forest, with a fine broad crown at the general height of the growth surrounding it; in the open it puts forth a multitude of side branches so that the columnar trunk is lost sight of, but the beauty of these branches more than repays. I would be chary, however, of clearing away too much around a forest sweet gum, for it at once puts forth a multitude of side buds up and down the trunk and the beautiful column is soon lost to view in a fuzzy coat of short branches. In the autumn the sweet gum is in its glory, for its characteristic star-shaped leaves go into the most gorgeous shades of deep red and purple, making it a plume of pure color that is a joy to look upon. For this reason young saplings transplanted from the nursery on the woodland borders of meadows and glades will be a good investment as they grow their side branches at the same time that they put on height and the result is a handsome broad tree always strikingly beautiful and positively gor-

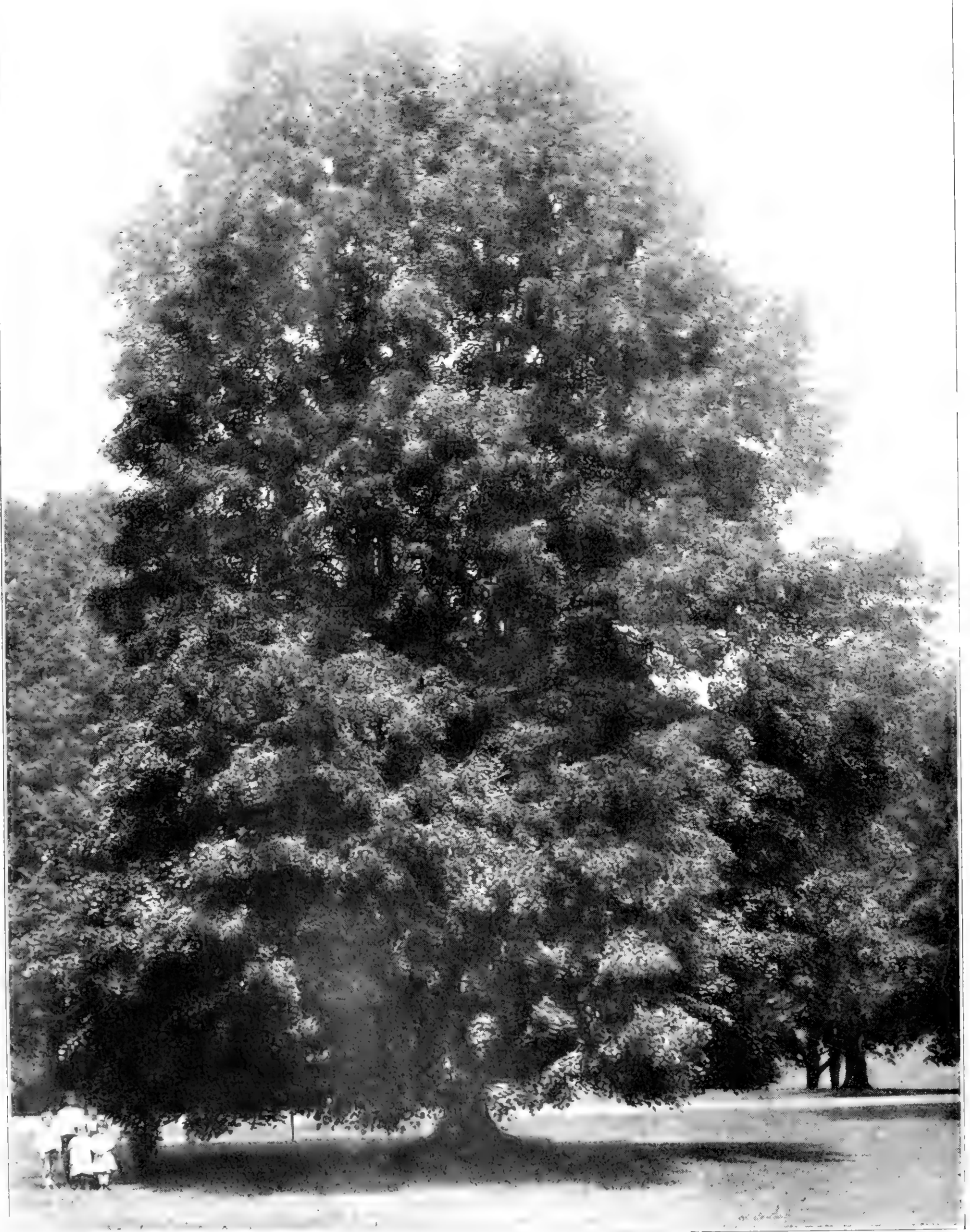

AN EUROPEAN LINDEN

THIS IS ONE OF THE HANDSOME TREES FOR COUNTRY ESTATES OR PARKS, HAVING A HEAVY GROWTH AND GIVING AMPLE SHADE AS WELL AS ADDING GREATLY TO THE CHARM OF THE LANDSCAPE OF WHICH IT IS SO FITTINGLY A PART

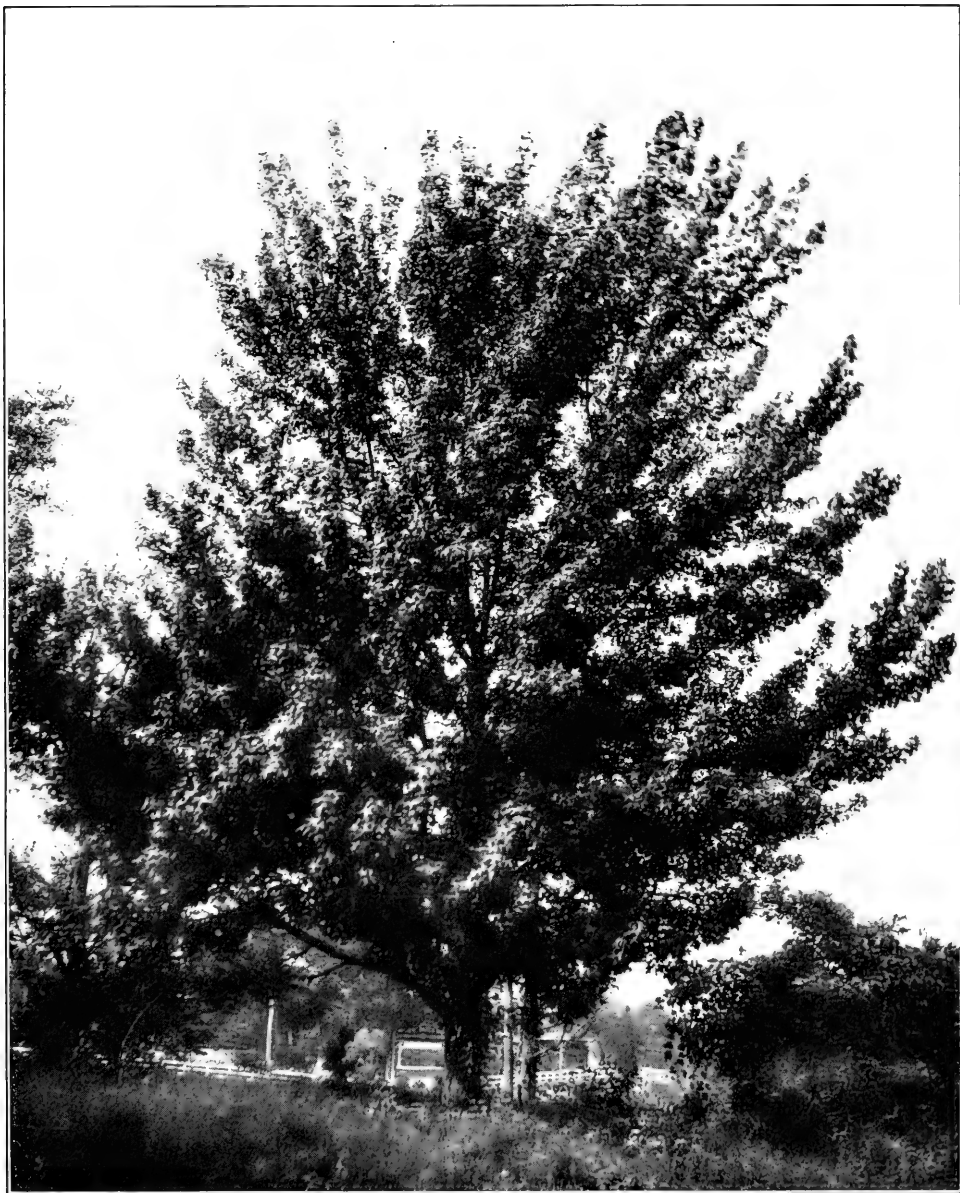

THE SWEET GUM OR LIQUIDAMBAR

IN THE FOREST THIS TREE SENDS UP A PERFECTLY STRAIGHT COLUMNAR TRUNK, BRANCHLESS TO THE CROWN. IN FIELDS IT SPREADS AS SHOWN. THE HANDSOME FALL COLORATION, DARK PURPLE-RED, ADORNS ITS STAR-SHAPED LEAVES

geous in the fall. A very hard tree to move from its wild location in the forest but easily grown from seed, in fact if you own a field to the east of one or two sweet gums it will be a continuous fight to keep them from peopling your field with a thicket of their young, for

the prickly balls which form the seeds are blown for several hundred yards from the parent tree and it seems that nearly all germinate. The reason is, of course, that this burr is but the receptacle containing several true seeds, at least one of which is sure to be

fertile. These burrs hang on as ornaments nearly all winter and will attract many a wandering troup of winter goldfinches and other hungry feathered citizens. The wood of the sweet gum is disappointing. It seems like such a perfect pole or post, and it peels as smooth as if finely sandpapered, but after a month or so it has warped and checked with so many deep cracks in it as to be entirely untrustworthy for any purpose whatsoever. Nature has been so lavish with this tree as an ornament that she evidently intended it strictly to remain so.

The sour gum is an odd, curious denizen of our forests, growing on any base soil provided that it is wet enough; prefers sand or clay base for its best developments. With us it reaches astounding proportions, 15 and 20 inches thick, generally hollow inside and much prized by gray squirrels as a rainproof and shot-proof home. Even when a mere sapling the sour gum shows its growth characteristics, which are to put up a reasonably straight trunk and then twist the top into a sort of flat umbrella with all the other branches drooping at their tips to match. One of the first signs of spring is the red leaf buds of the sour gum which are so numerous and noticeable as to make a red patch on the landscape wherever there is one of these trees. Its leaves are out early, and soon after come the flowers, green and insignificant, followed by the double berry of the fruit. In the fall this tree is a show. Its leaves turn a brilliant crimson, then spots of dark blue and blotches of purple appear, later the whole leaf gets a darker and more magnificent purple-black; finally a deep black, and then it falls to the ground, the whole process taking the month of October and part of November. Meanwhile its multitude of deep blue-black berries have attracted every robin in the fall flights and there they feast from morn till night. It is a hard tree to transplant and the nurseries do not offer it, but it is no trouble at all to get fine seedling on any site desired, not too dry, by planting a seed spot and saving the finest specimen resulting. They endure shade well, in fact we have millions of young ones under the parent

trees in the Interlaken forest and the older trees manage to get a growth in spite of competition from the white oaks, red maples and sweet gums which abound, finally fighting their way up to a niche in the general forest cover. The wood is tough, white and strong, and is used a good deal in wood turning. Poor stuff as a fire wood; makes good backlogs.

Belonging to the same family as the sour gum are the two dogwoods, both interesting, and one of them, the flowering dogwood, one of the most beautiful objects in the forest. If Nature has not given you all the dogwoods you want, by all means plant in some as they will grow in any base soil not too dry, in fact I cannot recall a forest south of the spruce belt that has not its dogwoods. In the region of deep snows and intense cold it is sure to be winter-killed; anywhere that 10° below zero is an unusual occurrence go ahead and plant in where wanted. Perhaps its most distinguishing characteristic, which it shares with the beech, is its ability to grow in the deepest shade, all its life, however, whereas the beech has to get out to sunlight sooner or later if it is going to make a tree. You can plant in dogwoods where you know well that they never may hope to have a patch of sunlight all to themselves, yet year after year the lovely white crown of huge flowers will greet you every May, and the handsome scarlet berries resulting will feed the robins every fall. The converse of this proposition does not follow, for the dogwood thrives equally well in the broiling sun. I am acquainted with two such, which are the only trees their owner boasts, yet his have a fine thrifty crown and an abundance of flowers. Not only that, but for variegated reds, purples and yellows in the autumn, commend me to the leaves of the dogwood bush. It takes an air brush in the museum laboratories to reproduce the shadings and mottlings of the autumn color of these dogwood leaves. The museum artists color the white wax imitation of the leaf a fine yellow, next they stipple on blue spots, and then sprinkle in some of red, and finally tip the leaf with purple, and at that will be somewhat

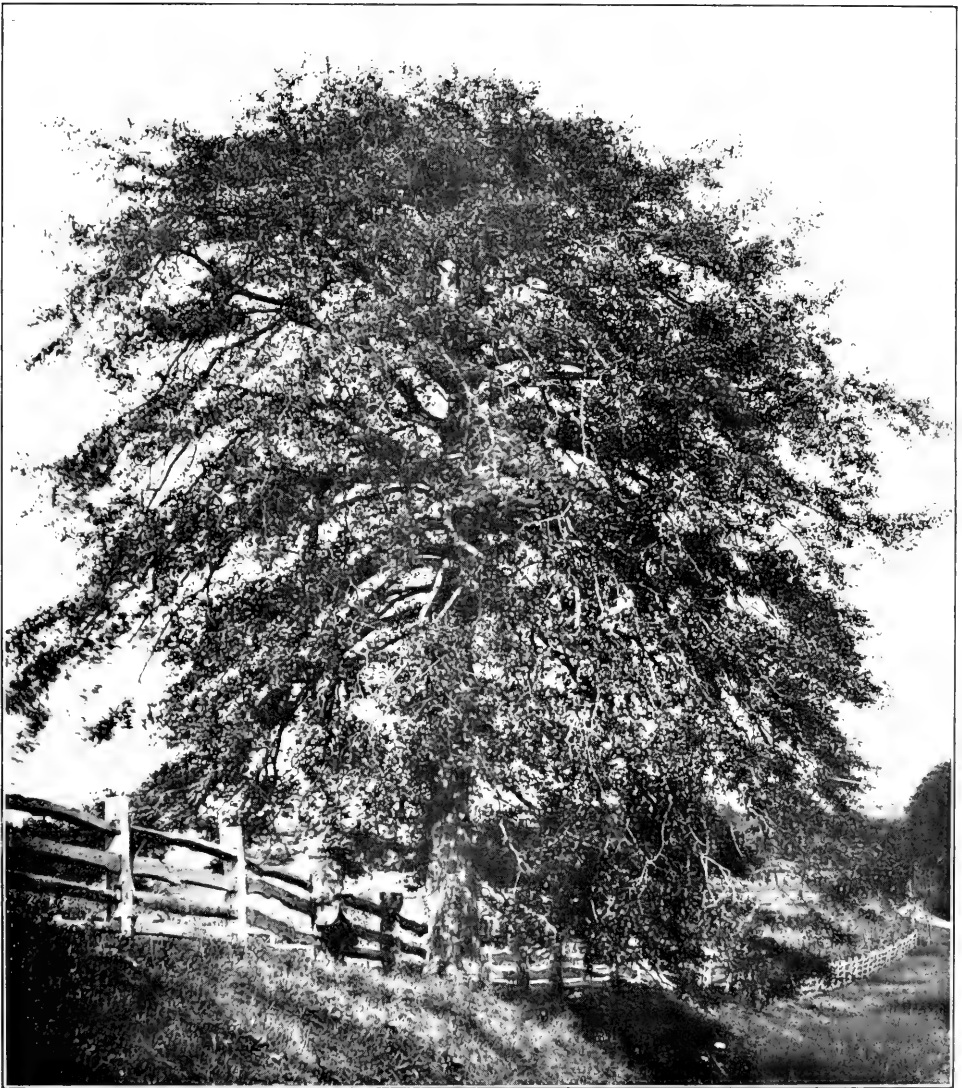

THE SOUR GUM OR TUPELO

NOTE ITS CHARACTERISTIC HABIT OF GROWTH, WITH FLAT-TOPPED CONTORTED CROWN AND DROOPING SIDE BRANCHES. IN THE AUTUMN ITS DEEP RED LEAVES MAKE IT A STRIKINGLY DECORATIVE FEATURE IN ANY FOREST LANDSCAPE

behind the gaudy natural leaf. Young dogwoods can be transplanted wild in late autumn, or a 5-foot nursery bush will cost you 50 cents; also easily grown from seed. Your dead dogwoods make excellent fire wood, also salable for fine wood work as it is very hard and pure white, the bark makes as good a febrifuge in medicine as the chinchona, and can be substituted for galls in making ink, while our Indians used to get a fine

scarlet dye from the more fibrous roots of the young trees.

The "other dogwood" *cornus alternifolia*, has a leaf so like the flowering variety that you are sure it is a dogwood anyhow, but its flower is a cyme of small white flowerets, sometimes pale yellow, and the fruit is of blueblack upright berries on small reddish stems, altogether a different plant from the flowering dogwood. It is called the "green osier" in the country, and it

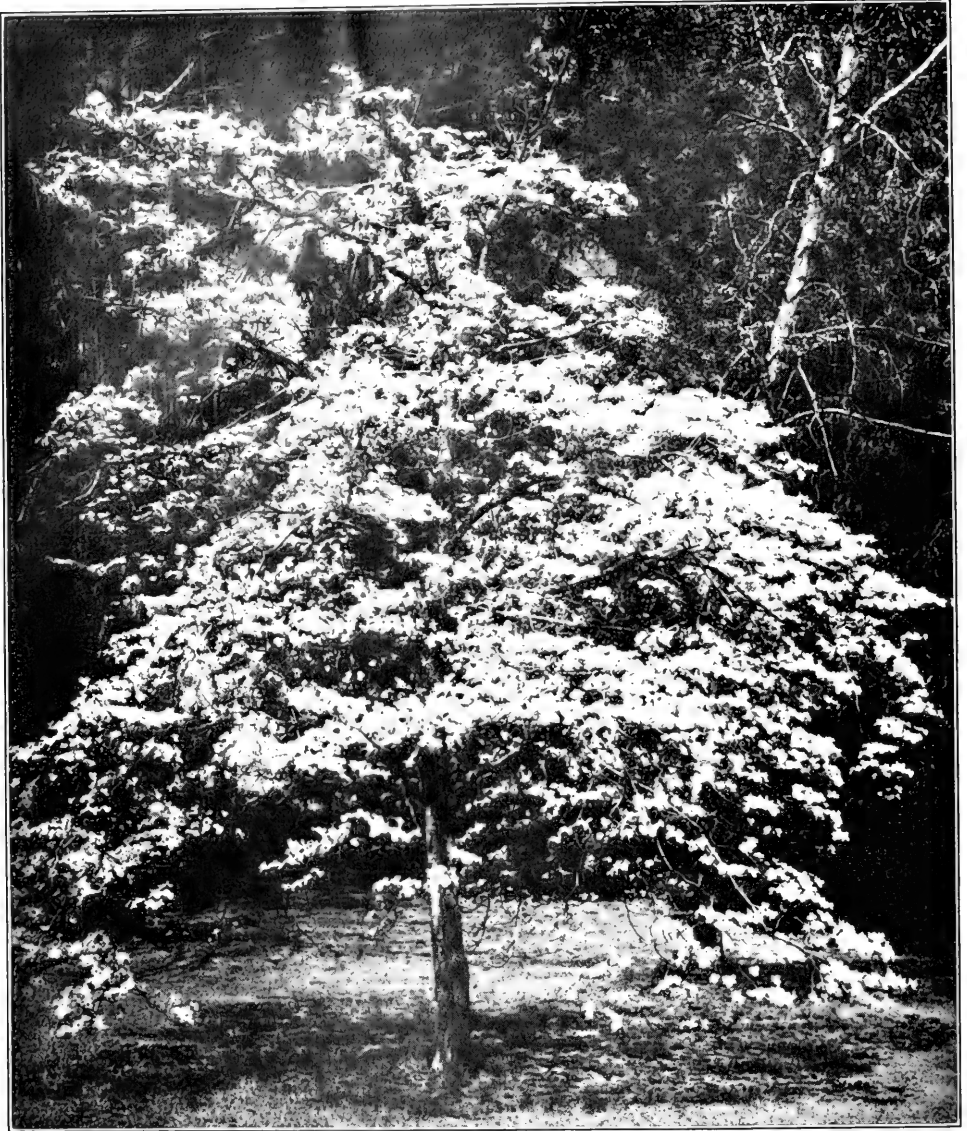

THE DOGWOOD

THIS TREE WITH ITS PROFUSE WHITE BLOSSOMS IS ONE OF THE MOST ATTRACTIVE IN THE SPRING AND THE EARLY SUMMER AND IS A GREAT FAVORITE WITH THOSE WHO LOVE THE FLOWERING TREES

loves to get its roots into a brook, in company with alders and other wet footed bushes. Though sometimes offered by nurseries it is subject to blight and is best left to nature, that is, if she has but one in your brook give thanks and spare the ax, otherwise it is hardly worth importing.

While we are on watery subjects let's get acquainted with our various willows,

though only two of them will bear extensive mention here. Owing to several useful varieties, notably the golden osier and the weeping willow, having been brought to America by the early colonists the tree tyro is apt to become very much confused in attempting to identify the species encountered on his own property. The golden osier, *S. vitellina*, is the dam willow, noted for

its quick and vigorous growth from live stakes cut from growing trees. One of the first leaves to appear in the spring (as are also the black and pussy willows), turning yellow in the fall, usually very late, among the last down. Identified by the light yellow branches noticeable in the spring by a yellow blotch along the stream side, before any leaf is out and the first sign that the forest is waking up. The weeping willow, *S. Babylonica*, is a familiar exotic, now at large in this country growing wild. Known by its long drooping twigs, 10 and 12 feet long.

Among our native indigenous willows, the black willow is most common, seen everywhere along stream sides and in swamps and ponds, noted by its dark, almost black bark and narrow leaf with the rounded base; also by its habit of growing in clumps. Out west we have a willow called the "anglers misery," or sand-bar willow which grows wherever there are trout and aids materially in keeping up the trout supply by making it impossible to land one without going overboard through the willow stems which crowd the stream bank. Not common in the east. For the owner of an estate the weeping, osier, black and pussy willow are enough to work with, and surely there is no finer water decoration than these same trees. Seton tells of the golden osiers on the dam at Wyndygoul which eight years ago were mere twigs and are now fine vigorous trees. I have seen and admired them and as I recall it they are now about 6 inches through and some 25 feet high. In his new place, The Finchery, he has been able to get splendid island effects from an erstwhile marsh by piling the dredgings about clumps of black willows of venerable age and now glorious in their island setting of lake

water. *S. Babylonica* does best on stream and lake banks where it can festoon its long plumes over the still waters beneath and charm every beholder with the reflected beauties of its foliage. All the willows spread themselves about the country by dropping their twigs into the stream, whence they are carried on down until they find a lodgment in some mud bank and take root forthwith. The seeds ripen in July in tiny capsules replacing the flowers in the catkins and are blown far by the wind. Nature's way of spreading the species when a willow grows, as



THE FLOWERING DOGWOOD BLOSSOM

it often does, in a wet burr grass meadow with no actual water anywhere in sight. Nursery specimens of *Babylonica*, 8 to 10 feet high, cost about 75 cents and of golden osier, 4 to 5 feet, 35 cents.

Our two wild cherries next claim attention. No forest is without them, as the poorer the soil the more wild cherries on it. Any base soil, especially for *serotina* though it does its proudest on sand base. With us it makes a tree about 40 feet high and a foot through, though I have seen it in Maryland and Delaware much larger. In May the fragrance of its blossoms is one of the olefactory delights of the woods; a whiff of breeze just off a wild cherry tree in full bloom is a thing to make you stop and go back to get more of it, no matter how pressing the busi-

ness in hand. The two cherries, *Pennsylvanica* and *serotina* are easily identified because the first has two small cherries on long stems exactly like our cultivated cherry, and the second has a raceme of berries something like a grape cluster. The nurseries do not offer any but flowering exotics, but either cherry grows easily from seed. Collect and pile the pits in sand, proportion of one to four, during the winter and plant in the spring. Be careful not to let them sprout, for the cherry sends down its root and puts up its cotyledons simultaneously so that it must keep on growing where it sprouted, for to sow a seed that has already put out its root is to kill the cotyledons or first leaf growths and so kill the plant. Some fanciers take the risk of planting in nursery beds in the fall, but they are quite apt to be eaten by mice or dug up by the birds. If kept in sand through the winter, first being cleaned of the

outer fruit envelope, they will sprout at once when sown in the spring. In both of the cherries the wood is very valuable for furniture making, and the bark is handsome to look at when the tree is alive, leaves turn a fine yellow in autumn and the berries feed all the migratory birds that pass your way. In location *serotina* prefers a moister soil than *Pennsylvanica* and occurs over our whole area, while the latter takes the high ground and is only found wild in the northern part of our range. Its principal enemy is the tent caterpillar, which will seek out and kill every wild cherry in a whole county if not checked. As these creatures live in big colonies in their tent and go out all together in droves to feed, it is not a hard matter to observe when they come home and then burn up the whole colony in their tent with the asbestos torch.

Two more trees, and then we must leave all the others, regretfully enough,

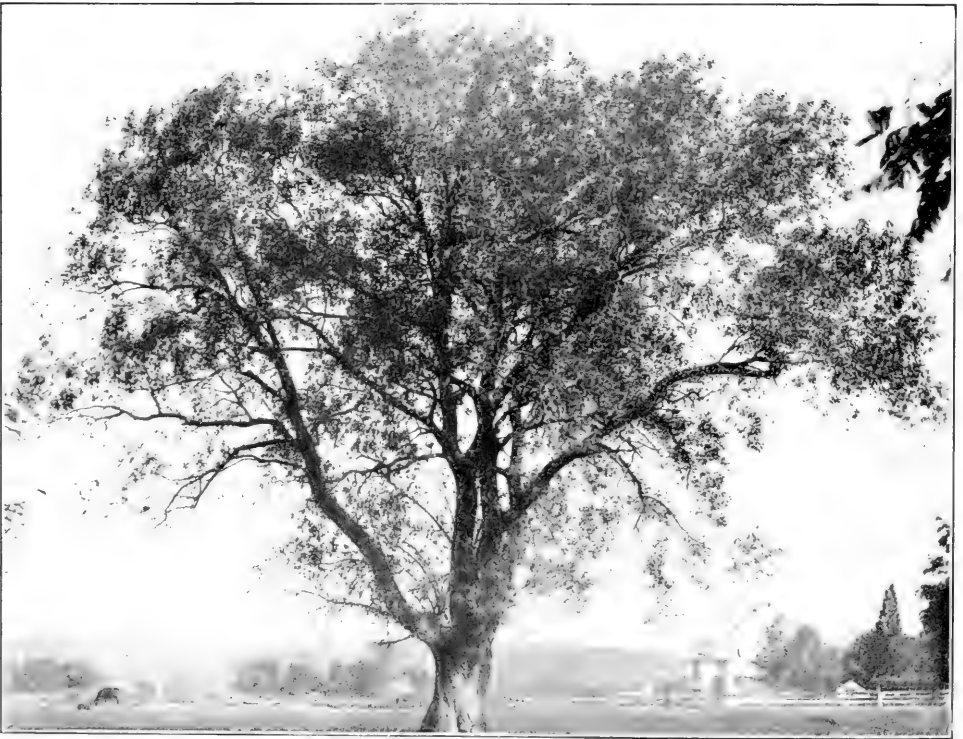

THE YELLOW WILLOW

INTRODUCED FROM EUROPE, NOW INDIGENOUS ALL OVER THE COUNTRY. THE OSIER FOR POND DAMS. ORNAMENTAL IN BRANCHES AND LEAVES THROUGHOUT THE YEAR. WILL GROW EASILY AND QUICKLY FROM SHOOTS WHEREVER IT CAN FIND WATER

but a book of twenty volumes could be written about our American wild trees and then there would still be a lot to discover about them—and we have a whole chapter of the more important evergreens awaiting us. Our fine American chestnut must have a mention. Restricted in range to the Ohio basin and the Atlantic States, it is fast being exterminated in the latter by the famous (or infamous) blight which has swept over the country in the last four years. There seems to be no cure as yet discovered, though I have heard ordinary Bordeaux mixture well spoken of by those who have experimented with various remedies. Most of the experimenters are looking for something that will do for wild forest

conditions, and reject Bordeaux on the score of expense. On an estate however, the expense of spraying all the trunk of a big chestnut with Bordeaux would not amount to very much, not over 80 cents a tree including labor and material, and if it will work let us try it. The blight has not struck us yet in the Interlaken Forest, but it has been three years since we have had a decent fall of chestnuts, and in 1911 the whole crop was wormy. The next generation will probably have chestnuts again, for the fungus blight will have spent itself, as such things do, and the bird conditions ought to be better so that every chestnut is not stung and ruined by some damned fly or other, with no kingbirds or great crested flycatchers



THE COMMON BLACK WILLOW

ONE OF THE FIRST OUT IN THE SPRING. NATIVE ALONG STREAM BANKS AND ORNAMENTAL THROUGHOUT THE YEAR.
NO GOOD FOR WHISTLES

perched in the tree tops to nab him in the act. All our soils, granite, limestone, clay and sand seem to suit the chestnut equally well, as I believe that no section can show any larger or finer trees than any other. Just why it will not grow in Southern Michigan, for instance is a little puzzling but out there as eastern chestnut is a rarity, while further west it is unknown. I believe it is purely a matter of the distribution of so heavy-seeded a tree as the chestnut, and if planted it would succeed.

Last tree of all, the head of the family, the beech. Grows over our whole area extending to just west of the Mississippi. The seed, a three-cornered nut

about half the size of a chestnut. The tree, one of the most magnificent giants of our forests, a great, smoothbarked fellow, with a huge round crown of small green leaves, turning yellow in the fall and then staying on all winter in russet brown where they give a fine note of color against the white snow. When young, beech will endure shade to an enormous extent, and it forms one of the principal saplings in the undergrowth. Luckily they must have sun later or perish, or else soon all our forests would be pure beech,—which God forbid. However, the yearly leaf fall from these young trees helps the soil humus even though the roots of these same trees rob the larger ones of



THE AMERICAN BEECH

ONE OF THE GRANDEST TREES IN OUR FORESTS. WITH SMOOTH GRAY TRUNK AND PERSISTENT YELLOW LEAVES IT IS ALWAYS AN ORNAMENT IN EVERY WINTER FOREST LANDSCAPE

their rightful moisture, so that in Europe the standard way to enrich the soil of a forest is to grow pure beech on it for a revolution—100 years. We have not reached that stage yet so I am not in favor of allowing the forest to be cluttered up with a tangle of worthless young beech saplings, preferring to extend the available moisture upon the older trees, since we are well off in the matter of humus. But, as a landscape feature, particularly on lake banks and ravine slopes, let us encourage the large beeches and the thrifty half-grown ones, because of their picturesque beauty. And that exotic cousin of our beech, the copper or purple beech, is now offered so cheaply by nurserymen and grows so quickly into an object of striking beauty, that any forest will be enriched by the planting of a few of

them at salient points. As to soils, both beeches take any base and any locality you choose to offer them. Huge specimens can be found in rich ravine slopes, in swampy fern bottoms, on high dry ridges, in clay, granite, limestone and sand soils, so it seems to matter not at all to the beech where you put it so that the soil is not arid, such as is used by pitch pines and gray birches. In wet soils young beeches will do well in full sunlight, otherwise they need older trees overhead as they will not stand being dried out. A full grown beech, one of the big kind with a 3-foot trunk, exhales 10 tons of water daily through its leaves, and all this must come up through the myriads of feeder roots down in the soil—giving you some idea of the amount of water actually handled by trees.

FOREST CONFERENCE IN THE WHITE MOUNTAINS.

THE Annual Forestry Conference in the White Mountains, under the auspices of the Society for Protection of New Hampshire Forests, and of the State Forestry Commission, will take a broader scope this year, and bring together the agricultural interests and the forestry interests, as far as possible, of all of the New England States, together with officers of the American Forestry Association who will ask the cooperation of New England organizations in their association's effort to secure the passage by the next Congress of an appropriation of \$10,000,000 for the purchase of forest reserves in New England and the Southern Appalachians.

The chief topic will be the problems of small woodlands and the farmer's woodlot. There will be discussions on planting, thinning, marketing small bodies of timber, and taxation of the woodlot, together with demonstrations

by experts of planting, thinning, felling and skidding trees. The meetings will take place at the Profile House in Franconia Notch beginning on the evening of September 1, and continuing through the second and third. This hotel and neighboring hotels and boarding houses make special rates.

To a meeting of this scope the Boston Chamber of Commerce, through its agricultural committee, and the Western New England Chamber of Commerce, are lending active cooperation. Mr. Henry S. Graves, Chief of the Forest Service, and Professor J. W. Toumey, Director of the Yale Forest School, are among those who will speak for the foresters. President Kenyon L. Butterfield of the Massachusetts Agricultural College, and Dr. Edward T. Fairchild, President of the New Hampshire State College, are among those who will speak for the agriculturists.

BROOKLINE PROTECTS BIRDS

By CHARLES B. FLOYD, *Vice-President the Brookline, Mass., Bird Club.*

[Mr. Floyd here tells how necessary is the encouragement of bird life in order that they may battle against the insects which every year destroy many millions of dollars worth of trees, shrubs and plants. He also describes how carefully Brookline, Mass., protects its birds and the success it has had in so doing.—EDITOR'S NOTE.]

THE study of birds among old and young has increased all over this country at a marvelous rate since the various State Audubon Societies began their efforts to arouse the people to the enormous losses caused by the ravages of insects. These pests have multiplied in numbers until they have become overwhelming; owing to the fact that the birds which would ordinarily hold them in check have been slaughtered to such an extent that the balance of nature has been upset.

The public is slowly beginning to know that man needs and must have the birds to protect his fields, orchards and shade trees, night and day, or they will be destroyed. All the devices and inventions yet produced are unable to cope with the outbreaks of insects which occur continually in all parts of this country; for the insect literally dominates the earth.

Instances can be cited where large flocks of birds have destroyed huge swarms of insects and saved men from ruin and possible starvation. When one is reminded of the fact that there are over 300,000 "vegetation eaters" known to scientists, and probably twice that number still unknown, that these pests feed on practically all varieties of plants, and that with their reproductive powers a single pair like the gipsy moth can produce enough young in eight years to destroy all the foliage in the United States, it is not over estimating the situation when I repeat that the insect dominates the earth.

Their destructiveness is due to the amount of vegetation they ruin for they actually eat their way through their short life. A gipsy moth whose length of life is twenty to thirty days will devour three-quarters of a pound of leaves. If this seems a small amount

try weighing a pound. As this hairy destroyer consumes the leaves of a tree the tree's means of breathing and taking in nourishment are removed. The tree becomes weakened, month after month, and finally dies from attacks of borers and bark beetles. Some insects in the larvæ stage are able to bore into the hardest wood. Not all insects, however, live on vegetation, some eat only the dead. The latter do no harm. The foliage is not subject to the attacks of a few varieties of insects, such as the gipsy, brown tail and leopard moths but new species are constantly appearing that injure trees and crops. Over 400 known varieties of insects prey on the oaks, 176 attack the apple tree, and about the same number live on the plum, peach, pear and cherry trees. One-tenth of the value of the crops of the farmers, market gardeners, and orchardists are lost each year. As the forests are cleared away the natural plant food of the insects grows less and less so they turn to the crops, gardens and fruit trees for sustenance and cause an increasing loss each season. In certain places in Massachusetts the devastation by insects has been so large that the State has been unable to check it, and after abandoning the attempt, the birds have not only stopped but wiped out the scourge. When such out-breaks occur the birds quickly gather to feed upon the insects, for their food is then plentiful and easy to obtain.

The career of the gipsy moth in Massachusetts will illustrate how quickly one of these plagues can gain a foothold and increase with terrible results. In 1868 or 1869 this moth was introduced into Medford, Mass. Twenty years later it had grown to such numbers that it was alarming the community. By 1890 the legislature was asked for

assistance in eradicating it and \$50,000.00 was voted for that purpose. During the next ten years \$1,000,000 was spent in the fight by the State and much more by private individuals. The year 1905 saw the brown-tail moth, which had lately been planted in Somerville, also overrunning the country and \$300,000.00 was appropriated to exterminate the two. By this time the gipsy moth had spread into Rhode Island, New Hampshire and Connecti-

cut and the brown-tails were following. Much money is still being spent to destroy them.

The insects which have been imported grew much more rapidly here than in their native country; for their natural enemies are left behind, our birds have to learn to eat them; and everything that grows is food for them. The yearly loss to the farmers is very great. As long ago as 1868 it was estimated that the country suffered to the extent



STUFFED SPECIMENS OF LAND AND WATER BIRDS

SHOWN AT THE BROOKLINE, MASS., EXHIBIT. THERE ARE ALSO PORTIONS OF TREES SHOWING NESTS OF THE TENI CATERPILLAR, GYPSY AND BROWNTAIL MOTHS, LEOPARD MOTH AND WOODLICE AND SAMPLES OF THE BENEFICIAL WORK OF WOODPECKERS AND FLICKERS

of two billion and a half. In 1890 the loss had increased one billion dollars. The year 1901 witnessed a loss of over three millions of dollars in Massachusetts alone.

The insect, its eggs and young are the natural food of many birds, and the amount they and their young consume is astonishing. The young eat as much in proportion to their size as their parents do. A young robin has been known to eat one-half its weight in meat a day in captivity, and from fifty to seventy cut worms and earth worms a day. The stomachs of two flickers that were examined were found to contain 3,000 and 5,000 ants respectively. One night hawk had eaten 500 mosquitoes. A yellow billed cuckoo, eighty-two caterpillars, another eighty-six caterpillars. Two scarlet tanagers ate thirty-five gipsy moths per minute for 18 minutes. It is estimated that 21,000 tons of insects are eaten each season in Massachusetts.

Birds are able to consume large quantities because their digestive organs are particularly large and powerful. After the stomach is full the gullet can be filled and anything not readily digested ejected from the mouth. Their strong bills crush the shells of the harder insects and as the process of digestion is rapid, and their appetite insatiable, it is not surprising that they consume almost incredible numbers of the leaf eaters. At all seasons, day and night, the birds are searching the trunks, branches and twigs of the trees for eggs, larvae and the insects themselves. Under the trees, on the ground among the leaves and in the grass, towhees, sparrows and thrushes search for the pests. In holes in the trunk and bark the woodpeckers, nuthatches, creepers and flickers hunt and drill. Along the limbs and out on the twigs kinglets and chickadees explore eagerly. Warblers and vireos search the trees from top to bottom, and flycatchers dart from their perches to seize the insects in the air. All these work from dawn until dark and at night-fall, when the swallows have left the upper air, the night-hawks and whip-poor-wills carry on the relentless pursuit.

It will be seen from the foregoing that the birds are among man's greatest benefactors. Laws have been made by both State and Federal Legislators for their protection. This, however, is not enough. The Forestry Department of the town of Brookline, Mass., has recognized the place the birds fill in the care of trees, shrubs, plants and foliage of all kinds, and steps have been taken to protect, encourage and care for all that live within the town limits.

Brookline has been as hard hit by the work of the gipsy, brown-tail, leopard moths and elm beetle as any of her neighbors. In 1908 the town was the worst gipsy moth infested district in New England. Today the gipsys are well under control and due recognition of the work of the birds is made. The task of destroying the winged pests has been carried on in several ways. The department was thoroughly re-organized and equipped. It built its own spraying machines which are the largest of their kind in the United States. Where once the apparatus then in use took the entire season to spray the trees on a street like Beacon Street, the work now can be done in 2 hours. Besides this treatment the men of the department cut out all dead limbs, examine and prune the trees where needful. Electric and telephone wires and horses are not allowed to mar this tree property of the town any more than its fine public buildings.

When the foresters go through the town removing dead limbs and trees they take away the natural resting places of many of the most useful birds, such as the flickers, woodpeckers, chickadees and nuthatches. Proper resting suites then had to be furnished to keep the birds about the town, and accordingly 300 nesting boxes were placed in suitable locations for them. Each box was numbered on the bottom so that it could be easily seen from below, and its number recorded on a map in the office of the Forestry Department. Records were thus kept of the number of homes occupied and the species using them. The results have been satisfactory.



BROOKLINE, MASS., BIRD EXHIBIT IN THE PUBLIC LIBRARY

HERE ARE DISPLAYED NESTING BOXES, BATHS, NESTS, EGGS, PICTURES, CHARTS, BOOKS AND PAMPHLETS AND PRACTICALLY EVERYTHING ON THE SUBJECT OF APPLIED ORNITHOLOGY. THE EXHIBIT WAS VIEWED BY SEVERAL THOUSAND MEN, WOMEN AND CHILDREN

The question of food is one which governs the habits and actions of all birds. As the town has grown and its open places have been built upon the birds have been forced to seek new feeding grounds. Of course most birds migrate twice each year but some remain here all winter that in the natural order of things would go south. To keep the birds about during the cold months, 150 feeding stations were selected and after every snow storm or rain storm, when a sudden freeze has covered the trees and ground with ice, grain and suet are placed at these stations. Thus the birds are provided for until a thaw releases their natural food. The man whose duty it is to place the grain and suet states that during the heavy snow the pheasants came out of the woods when he called to them and crows actually followed his sleigh from station to station.

Superintendent Lacy, his men, and members of the Brookline Bird Club all report a noticeable increase in bird life throughout the town. More birds have wintered there that generally go south than have for many years. Large flocks of juncos, white-throated and song sparrows have passed the winter in good health, and even hermit thrushes, a brown thrasher and grackle have been seen all during the cold days. Through the efforts of the town's bird warden, Brookline is now a bird sanctuary. The holders of large estates, among them those owned by Messrs. Sherman Whipple, Louis and Walter Cabot, Ernest B. Dane, Franklin Huntress and Alfred Douglas have agreed to prohibit all shooting upon their property and have posted notices to that effect. When the hunting season opens the woodlands of the town and the private

estates will be policed and patrolled by men of the Forestry Department to guard against gunners and all pot hunters as well as fire.

To stimulate interest throughout the town in this important and necessary work an exhibit of everything connected with the subject of applied ornithology was recently arranged at the Public Library. Stuffed specimens of land and water birds from private and state collections were displayed. Nesting boxes, baths, feeding boxes, nests, eggs, pictures, charts, books and pamphlets of illustrations, cases of injurious insects, grain and seeds that the birds feed on, and samples of the bird work done in the elementary schools were arranged. Portions of trees showing nests of the tent caterpillar, gipsy and brown-tail moths, limbs with evidence of the work of the leopard moth and wood lice, and samples of the beneficial work of the woodpeckers and flickers were shown. Portions of fifty varieties of berry-bearing shrubs were placed on the walls against a back ground of green paper and nearby were lists of vines and bushes to plant to attract the birds. This interesting display was viewed by several thousand adults and many children.

The National Association of Audubon Societies has established a Department of Applied Ornithology under the direction of Mr. Herbert K. Job, former State Ornithologist of Connecticut, because of so many inquiries for information pertaining to work, such as has been outlined.

It is to be hoped that other towns will soon follow the lead of Brookline in their forestry work and give the birds the protection and care which is their due.

ORNAMENTAL AND SHADE TREES

A Department for the Advice and Instruction of Members of the American Forestry Association.

EDITED BY J. J. LEVISON, B. A., M. F.

Arborcultivist Brooklyn Park Department, Author of "Studies of Trees," and Lecturer on Ornamental and Shade Trees, Yale University Forest School.

HICKORY TREES THREATENED WITH DESTRUCTION

ARE we to lose our hickory trees in much the same fashion as we have already lost our chestnut trees? Unless municipalities and the owners of woodland property will do something in a concerted way to protect the hickory trees, we shall lose them soon. Thousands of hickory trees are already dead all over Long Island and for hundreds of miles north and northwest of New York City.

The enemy is the hickory bark borer, officially known as "*Scolytus quadripinosus*" which is a small black beetle that bores in the inner bark of the tree and then girdles the tree with a series of galleries preventing the flow of sap. The insect works at a comparatively fast speed and often trees die in the same year they are attacked by the borer.

From October to early May the borer is a grub located in small galleries in the bark. Through the winter it gradually enlarges these galleries until it has completely encircled the tree. This period of the insect's life is the best time to check the spread of the trouble. Working underneath the bark, the insect is naturally inaccessible for treatment except by cutting the infested trees down and burning the bark. If the infested part of the tree or the whole tree is burned at this time, the colony of borers will be destroyed before they have a chance to enter other trees and begin work on them. It is by working against the insect during this period that we have been successful in saving the hickory trees in Prospect Park, Brooklyn—while every other method has

failed and the hickory trees all around on the outside of the park have died.

From early May through June the grub emerges in the form of a beetle. Then it feeds upon the stems and bases of the young leaves of the tree. The writer has tried to spray the hickory

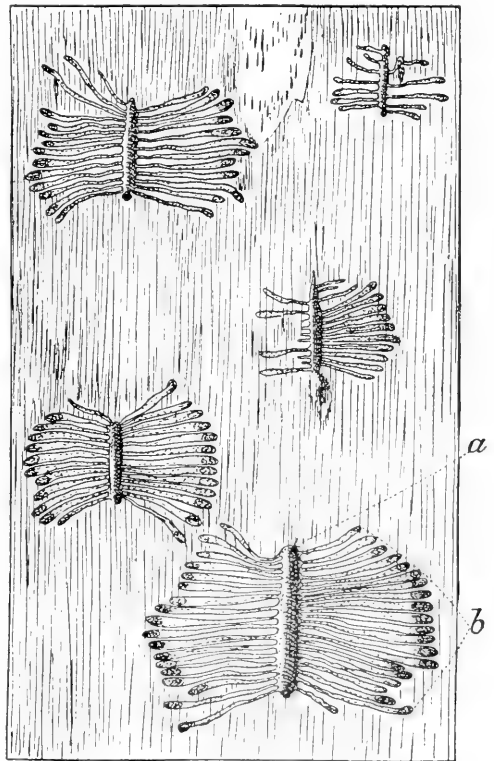

WORK OF THE HICKORY BARK BEETLE

THIS IS THE SURFACE OF THE WOOD BENEATH THE BARK SHOWING (A) THE PRIMARY GALLERY AND (B) THE LARVAE MINES

trees at this period with arsenate of lead at the rate of 1 pound to 10 gallons of water in order to poison the beetles in their process of feeding. This method has probably been of some service but can be little depended on and the salvation of the hickory trees really lies in the rapid, timely and absolute destruction of all infested bark.



INSIDE THE BARK

INNER SIDE OF HICKORY TREE BARK SHOWING PARENTAL AND LARVAL GALLERIES AS DIAGRAMED IN THE FIRST ILLUSTRATION IN THIS ARTICLE

After the period of feeding, the beetle bores small holes into the trees in which it deposits its eggs. These eggs hatch out into grubs and the life cycle of the insect is repeated. The presence of the insect can be detected by the small holes in the bark of the tree and the fine sawdust which is ejected from these holes when the insects are active. These holes, however, will not be

noticeable until the insect has completed its transformation. In summer, the infested trees show wilted leaves and many dead twigs. Holes in the base of the petioles of these leaves are also sure signs of the workings of the insect. At the present time the mature beetles are emerging from the infested trees and soon it will be time for those

interested to select the hopelessly infested trees, mark them for removal and cut them down in winter. The hickory wood is heavy, hard and strong and that of the removed trees sufficiently suitable for agricultural implements, carriages and wagons, for fuel, telephone poles, ties and posts.

The hickory bark borer is an old enemy in this country but has never before been serious enough to cause special comment. Now it is serious enough, in the vicinity of New York, at least to cause alarm. It was observed as early as 1867 and has since then been studied by entomologists in many parts of the country. In 1903 a serious infestation occurred at Belle Isle Park in Detroit, Michigan. All the hickory trees there were threatened with destruction and only a timely cutting down of the infested ones saved the rest. The felled trees were sold and covered the expense of the cutting.

The writer first observed its presence on Long Island at Prospect Park in 1906. He then obtained the personal assistance of Dr. A. D. Hopkins, Chief of the Division of Forest Insects in the United States Bureau of Entomology and of Dr. E. P. Felt, State Entomologist of New York. We then experimented with numerous methods of eradicating the borer and finally came to the conclusion that the most practical way was to remove and burn the infested trees before the month of May. Accordingly we cut out and burned all the badly damaged

trees and limbs from Prospect Park and kept up the examination and elimination until we reached the point several years ago where we had no dead hickory trees in the park. Previous to that time there were from two to three hundred hickory trees dead annually in the park. Today we have some splendid specimens of hickory trees in the park, not at all infested, while all around us thousands of hickory trees are either dead or dying.

QUESTIONS AND ANSWERS

[AMERICAN FORESTRY invites its readers to send any questions they desire to this department and they will be gladly answered and without delay.—EDITOR.]

Q.—I enclose picture of a fine oak to which horses are constantly tied, but which I hope to protect with wire. Would like to know if we can cure the diseased spots already affected. The spots in the center of the picture, just above the horse's nose, are the worst places, and I have seen bugs or ants coming out in numbers. Could a novice do anything at tree surgery through advice by correspondence? Could any acid treatment be applied to arrest decay? I am quite anxious our town should have a Tree Club but so far efforts have failed. The tree shown in the illustration is in the center of a side street where it makes a welcome shade, as shown by use.—J. A. T., Asheboro, N. C.

A.—For ants or grubs, inject carbon bisulphid with a syringe or squirt can and immediately after the injection is made clog up the holes with soap in order to retain the deadly fumes generated by the carbon bisulphid within cavities. Then cover the wound with coal tar and place around the tree a guard made of wire netting of $\frac{1}{2}$ -inch mesh. The work can be done by an amateur as well as by an expert.

When you are ready to start a tree club, consult this Department. We are ready to tell the results of experiences along these lines in Brooklyn, Newark, and other cities and we can furnish you with suitable literature on the subject.

Q.—I have a big oak tree on my property here in Hoboken, and the tree, while a great ornament to my place, shows of late signs of sickness, the top branches seeming to die out, and I wish to find out what can be done to save it, if possible. Shall be glad to have you advise me.—C. M. B., Hoboken, N. J.

A.—Dead branches in an old oak tree may be the result of various causes of deterioration. The tree may be suffering from a fungus disease on the



EXIT HOLES IN HICKORY BARK

THE HICKORY BARK BORERS, WHICH HAVE DEVELOPED UNDER THE BARK BORE THEIR WAY OUT THROUGH SUCH HOLES AS ARE HERE SHOWN

trunk, from a root disease, from mechanical injury to roots or bark, from old age, neglected wounds or a foreign element in the soil. A personal examination, or a much closer description would be required to make this advice more specific. The remedy would vary with the cause.



THIS SHOULD NOT BE DONE

WHEN A HORSE IS HITCHED TO A TREE IT IS ALMOST CERTAIN THAT THE TREE WILL BE INJURED AS IS THE ONE IN THE ILLUSTRATION. THIS REQUIRES SURGICAL TREATMENT TO SAVE IT FROM DISEASE AND FROM ROTTING

Q.—Am sending you small pieces of pine for examination. They appear to have small drops of sap upon them, but when this sap is opened you will find from one to four small red bugs. I have ordered the tree cut and burned, but am afraid it is something that might spread to the other trees. What can be done to combat this evil?—D. C., Brooklyn, N. Y.

A.—The specimens of pine branches sent showing masses of pitch containing small yellowish insects have been examined. This is commonly met with at this time of the year on scrub and other pines. It is due to the pitch

maggots which are the larvae of small gnats belonging to the family *Cecidomyiidae*. The insects only occur for a short period and as a rule do no damage to the trees. You are not justified in cutting down trees on account of the presence of this insect, or going to the expense of any other treatment.

Discussion of the following questions is requested by the readers of AMERICAN FORESTRY, and expressions of opinion, addressed to the Editor of this Department, will be appreciated.

1. How shall we determine what sections of a city should be included in the "Treeless Zone?" To what extent should business houses and commercial traffic across footways influence this?

2. What can be said for and against the following practically untried trees for street and highway purposes?

- (a) Kentucky Coffee Tree (*Glym-nocladus dioicus*).
 - (b) Willow Oak (*Quercus phellos*).
 - (c) Hackberry (*Celtis occidentalis*).
 - (d) Yellow Wood (*Cladrastus lutea*).
 - (e) White Ash (*Fraxinus Americana*).
- Consideration of these species is invited with special reference to use in latitudes between New York and Richmond.

Q.—We have here 20 acres of woods, containing pine, chestnut, maple, birch, oaks, etc. Many of these are fine large trees, but the woods have been neglected for many years. We are anxious to improve and beautify them. The sun has not reached the ground in these woods for a generation and I wish you would send me your advice as to clearing them for beauty, not for commercial uses, citing the best article or book for the care of such a small, valuable wood.—R. G. D., Whitinsville, Mass.

A.—To care for the woodlot in order to promote its greatest aesthetic value, we would suggest the following treatment:

Mark all the dead and diseased trees in the fall before the leaves drop and remove them in winter. See that the ground is free from brush and logs, but do not disturb the young growth and leaf mold on the ground. Remove the poor specimen trees that absolutely

interfere with the proper development of the better ones, but in doing this bear in mind that it is better to have the woodland a bit overcrowded than too open. The ground in a woodland should always be well covered with trees and shrubs in order to prevent drying out of the soil, in order to conserve the moisture in the ground and in order to hasten the decomposition of the leaf mold. Where there are big open gaps, you should plant little trees—white pine, red oak and beech. You can get these from the State Forestry Department or from a forest nursery at a very small cost. There should be numerous paths, about 6 feet wide, passing through the woodland in all directions. These would serve to make the woods accessible and would provide suitable barriers (fire lanes) in case of fire. For detailed information on this subject, see the chapter on "The Care of Woodlands" in a book known as "Studies of Trees" published by John Wiley & Sons, New York City.

Q.—Would you kindly give me information regarding the tree troubles represented on the enclosed leaves:

The sugar maple from which this leaf was taken is a lawn tree 35 years old. Has shown no signs of blight previous to this year; its neighboring trees of same variety are O. K. This tree is badly affected in the lower half of its top and on the inner branches.

The Norway Maple leaf was handed to me for my advice, I did not see the tree but the galls do not appear serious, but the party wished further information.—M. S. B., Y. M. C. A., Wilmington, Del.

A.—The leaf of the sugar maple shows evidence of drouth. This may not be due directly to the lack of water but may often be due to some root trouble or similar incapacity to take in sufficient water. Frequent watering and cultivation during the summer and a heavy mulch of well decomposed manure in late Fall would help to prevent a recurrence of this difficulty. Most of the sugar maples on Long Island suffer from drouth.

The galls on the Norway maple leaf are of practically no consequence and may never again re-appear.

NOTES

We are very much in need of tree men, and desire to get in touch with men who are able to handle this sort of work. They will be employed for

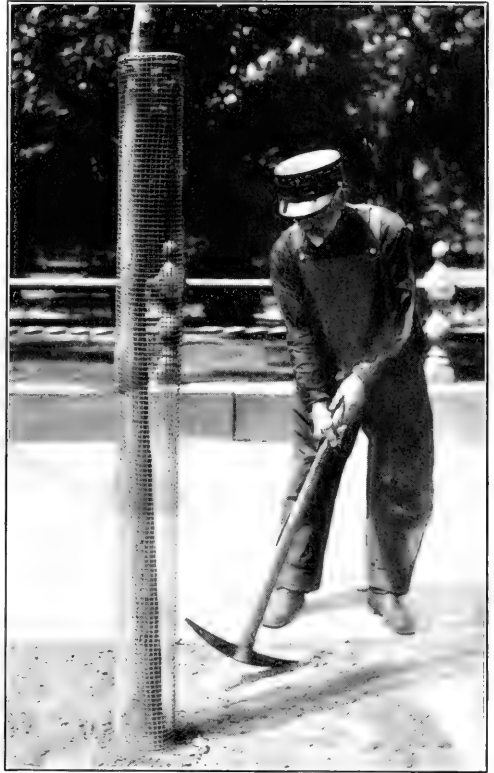

WIRE TREE GUARD

TYPE OF TREE GUARD WHICH IS NOT ONLY INEXPENSIVE BUT IS ATTRACTIVE AND IS QUITE EFFICIENT IN PROTECTING THE TREE. IT MAY BE EASILY PLACED AND READILY REMOVED

permanent work on monthly pay-roll with wages from \$50 to \$250 a month. Please address immediately William H. Forman, Forman's Forestry Company, Commercial National Bank Building, Washington, D. C.

City Forester, R. Brooke Maxwell, of Baltimore, writes: "There has been a considerable amount of speculation recently among foresters and others interested in trees regarding the possibility of growing the Pecan (*Hickoria Pecan*) in this part of Maryland or as far up the Atlantic coast as Baltimore. The Division of Forestry of this

city has just completed the removing of what I consider to be the largest Pecan tree in the State. The tree measured 32 inches D. B. H. and was approximately 85 feet tall. The tree was between 90 and 100 years of age. It was found growing in a back yard in one of the oldest sections of the city. I could not get any information regarding the fruiting of this tree, but as

far as growth is concerned better results could not have been asked for. Other information regarding the Pecan in Maryland would be interesting."

Mrs. J. M. Clark of Cohasset, Mass., writes: "We are on the firing line of the gypsy moth, and we have destroyed 500 tent caterpillar nests this season, so far. The fight has been on since the last of April."

ADVICE FOR THE MONTH OF JULY;

1. Cultivate and water all plants set out last spring.
2. Spray for leaf-eating insects. Use arsenate of lead of standard brand at the rate of about 1 pound to 10 gallons of water.
3. Spray for plant lice on beech, maples, etc., with whale oil soap at the rate of 1 pound to 5 gallons of water.
4. Remove all broken branches and dead branches of larger size. Cover the wound with coal tar.

The San Francisco Meeting

That a large number of members of the American Forestry Association will attend the meeting at the Panama-Pacific Exposition in San Francisco on Wednesday, October 20th, is evident. Not only will there be the members from California, Washington, Oregon and other Western States, but a number of members in the east will so time their intended trip to the Exposition that they will be enabled to attend the Association's meeting.

The whole week of October 18th will be devoted to Forestry and Lumbering and the program, owing to the great importance of the lumber industry on the Pacific coast, should attract wide attention.

The week's program will be:

Monday, October 18—Meeting of the Society of American Foresters.

Tuesday, October 19—Meeting of the Western Forestry and Conservation Association.

Wednesday, October 20—Meeting of the American Forestry Association.

Thursday, October 21—Meeting of the Pacific Logging Congress.

Friday and Saturday, October 22 and 23—Members will visit by special train the famous redwood logging camps near Eureka, returning to San Francisco Saturday night.

Members of the American Forestry Association who expect to be in San Francisco for the meeting will kindly notify the Secretary so that additional particulars may be sent to them.

The program will be announced shortly.

NEW ENGLAND'S FEDERAL FOREST RESERVE

By PHILIP W. AYRES

[The American Forestry Association, with a number of influential organizations in New England and the Southern Appalachians cooperating, will earnestly advocate the passage by Congress of a bill providing an appropriation, under the Weeks Law, of \$10,000,000 to continue the purchase of Federal Forest Reserves in New England and the Southern Appalachians. Delegates representing the associations will confer with Secretary of Agriculture Houston on the subject in Washington on Wednesday September 22 at 10 a. m.—EDITOR'S NOTE.]

THE Weeks Act, for the purchase of forest land at the head waters of navigable streams, is one of the great measures in the country's history. It is like the irrigation act that is making fertile fields from the desert land, or the Smith-Lever Act that brings agricultural instruction to the farmer's door, or the Morrill Act that fifty years ago established the State Universities. This measure if adequately carried out will in large measure safeguard the navigable stream from disastrous erosion and provide a timber supply to replace our vanishing material for houses, furniture, tools, etc. It accomplishes this through the purchase of forest lands by the Federal Government. General in its terms, it applies to all parts of the country, but is limited in action to those States that pass enabling acts inviting the Federal Government to acquire land within their boundaries. Maine and New Hampshire at the North, and eight States at the South have enacted the necessary laws.

Because the West is fairly well supplied with National Forests, the officers of the Government have applied the first appropriation under the Weeks Act exclusively to the eastern or Appalachian Mountains. The wisdom of this decision becomes apparent when it is realized how great are the timber resources of the West and how depleted are those of the East.

Population is increasing at an unprecedented rate. One million new souls are added to our country every twelve months. Our timber resources, taking the country as a whole, are consumed far more rapidly than they grow.

It is not difficult to see the end of this process. The timber scarcity is already evident in the increased prices of everything made of wood. A house, a wagon, or even a rolling pin, costs twice as much as a few years ago. The need for action on a large scale is fully apparent.

The Weeks Act, signed by President Taft in March, 1911, carried an appropriation of \$11,000,000, of which only \$8,000,000 became available. Three-million dollars of this appropriation have never been taken from the Federal Treasury. The reason for this is that by the terms of the measure itself three separate departments of Government must exercise supervision over each purchase, and before any tract is finally taken it must be approved by the National Forest Reservation Commission. Before these several departments could be coordinated into a working force and the new board organized, the time specified for the use of the first part of the appropriation had gone by. Indeed, the time for using the first million dollars expired before the measure had gone through all of the weary acid tests of Congressional committee opposition. Meantime plans had been made for the larger expenditure, which plans now await the further action of Congress.

By the terms of the Act the appropriation covered a period of five years, and terminated by limitation on June 30, 1915. This was an experiment. It has been worked out successfully. Shall it be renewed? To carry out its beneficent purpose the operation of the law should be made continuous, until the great body of wild mountain land throughout the country has been placed

beyond the ruinous reach of private exploitation. With more far reaching vision than most of us, Dr. Edward Everett Hale used to say that the entire Appalachian Mountain System, from Maine to Georgia, must be taken by the Government. Timber grows very slowly. Most trees require from eighty

cannot be met and overcome by private interests. The public interest and private interest in the control of these lands are in sharp contrast. In a country of 100,000,000 people with the lack of control that has characterized our American use of natural resources, a continuous appropriation of \$2,000,000

a year, until the renewed forests become sufficiently productive, will prove none too much. It will steady the country, not only against extraordinary fluctuations in prices, but also against monopolistic control that is always likely to take advantage either of fluctuation or scarcity.

A great and creditable work has been accomplished with the money available under the Weeks Act, in the purchase of Federal Forest Reserves in New England and the Southern Appalachians during the last four years.

One and one-quarter million acres in the least accessible parts of these regions have been examined and purchased. Anyone who has had experience in buying land, particularly tracts of forest land, will realize the force and tact necessary to

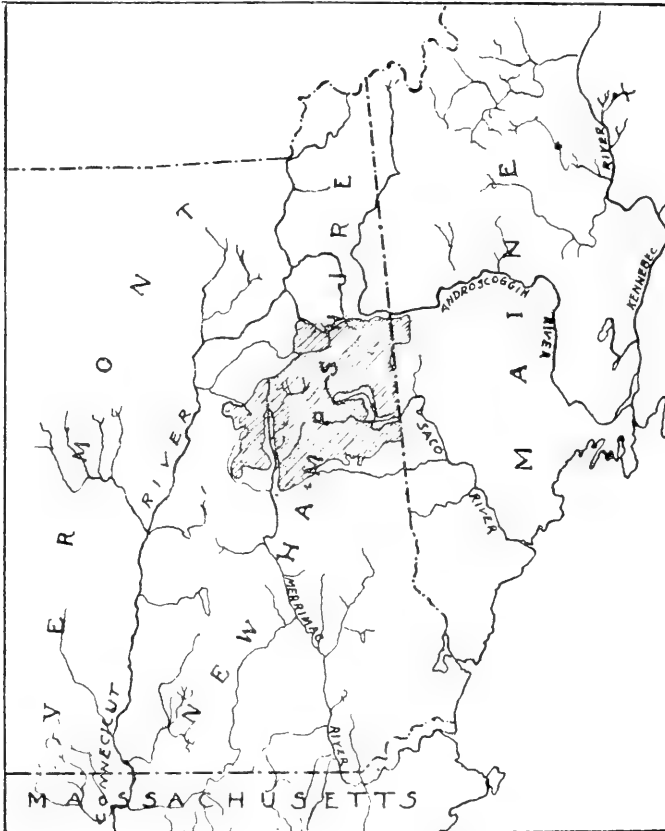

PURCHASE AREA AND WATERSHEDS

MAP OF NORTHERN NEW ENGLAND SHOWING THE RISE OF THE IMPORTANT RIVERS IN NEW ENGLAND IN THE WHITE MOUNTAIN REGION. IT SHOWS THE PRESENT PURCHASE AREA THAT SHOULD BE EXTENDED TO INCLUDE AT LEAST THE HEAD WATERS OF THE CONNECTICUT

to one hundred years to reach maturity. This crop cannot be handled advantageously by private owners. Even rich corporations cannot afford to wait so long for returns, and should not be asked to do so. The best of them leave the high slopes skinned of timber, covered with debris, and in a condition to invite fire from a camper's match. The inflammable nature of mountain soils and the tremendous power of erosion incessantly at work in all mountain regions,

make such extensive purchases successfully without encountering severe criticism. The great task has been honestly and skillfully done.

In the White Mountains 265,000 acres have been acquired; in the Southern Appalachian Mountains a little more than 1,000,000 acres. To friends of the White Mountains this is disappointing and appears a disproportionate division, especially to those who realize the close relationship between



Plate 6. L. D. Felt Co., United States Forestry Service.

SOUTH SLOPES OF THE PRESIDENTIAL RANGE

THESE SLOPES ARE PART OF THE UNITED STATES FEDERAL FOREST RESERVES IN THE WHITE MOUNTAINS ACQUIRED BY THE PURCHASE IN SEPTEMBER, 1914, AND ARE TYPICAL OF MUCH OF THE LAND WHICH IT IS HOPED MAY BE ADDED TO THESE RESERVES DURING THE NEXT FIVE YEARS.

the mountain forests and the extensive water-powers upon which New England's industry largely depends. To be sure, the Act as passed was not intended to protect industry, but only, under the Constitution, to protect navigation. While all of New England's rivers are navigable for short distances, and the Connecticut River for a distance of 50 miles, with a fleet of thirty-five vessels between Hartford and New York, we have not the navigation interests that are found in other parts of the country. The bill provides, however, for the purchase of forest lands at the head waters not only of navigable streams, but also of streams that may become navigable. In view of the efforts on the part of important commercial organizations in Massachusetts and Connecticut to extend navigation on the Connecticut River from Hartford to Springfield and Holyoke, and of the efforts by State Commissions, both in Massachusetts and New Hampshire to extend navigation on the Merrimac River to Lawrence and Lowell, and even to Manchester, the purely navigation interests on New England Rivers assume an importance that cannot be overlooked, and that warrant an ample and more generous policy of forest protection. This is a piece of work that New England cannot legally accomplish for itself. This is a task that only the Federal Government can accomplish. The disproportion mentioned above is still further apparent in the purchase areas that have been designated. An area at the North has been set apart to include, unwisely we believe, only a little more than 600,000 acres, as against 5,000,000 acres that have been set aside for purchase at the South.

In the White Mountains a large proportion of the land that has been purchased is cut-over land. Many persons believe that to have acquired a larger proportion of the standing timber that still remains in broken patches upon the high slopes of the White Mountains, would have more fully carried out the purpose and intention of the Weeks Act. These forests at high elevations are composed almost exclusively of spruce and fir, because these

shallow-rooted species can spread out in thin soils, and find subsistence where other trees fail. The mountain soils, composed largely of vegetable mould, and their products, the forest, are both inflammable. Forest fires seriously cripple these soils and not infrequently reduce considerable areas to bare rock, from which flood waters only can descend. The ordinary method of lumbering on these high slopes is that of clean cutting, for the reason that whatever the lumbermen leave the wind destroys. It is a dead loss to the operator to leave anything. Following this method fire and erosion do their worst, and if they do not render the soil permanently barren, a condition far more frequent than the casual observer would believe, they so cripple it that two or three centuries are necessary, in our cold northern mountains, to reproduce a commercial forest. It was to prevent this Chinese treatment of our American mountains that the Weeks Act was passed.

The method of logging pursued by the Federal Government on the National Forests provides for removing the mature trees, clearing up the debris, protection from fire, and preservation of the crown-cover of the forest so that the sun does not beat upon and dry out the soil, protection of the forest trees from wind, insects, and fungous diseases, regard for water flow, for reforestation, and last but not least, for the beauty of trails and roadsides in much traveled places.

All who know and love the White Mountains, in whatever part of the country, will be glad to learn what land has been acquired. The ten year's struggle to secure the Act at the hands of Congress has resulted in keen interest in each individual purchase. Of the 265,000 acres acquired, the first purchase that was made included the spruce forests on the north slopes of the Presidential Range. By good fortune, but not by design, these woods were the favorite haunts of the Appalachian Mountain Club, and contained their most numerous trails. Unfortunately this tract was not acquired until after heavy operations by the old lumbering methods had robbed many of its ridges



Photo by B. R. Jones of the B. & M. R. R.

MOUNT ADAMS AND MOUNT MADISON IN NEW ENGLAND

THESE TWO MOUNTAINS HAVE RECENTLY BEEN ACQUIRED AS PART OF THE WHITE MOUNTAIN NATIONAL FOREST. THERE IS CONSIDERABLE PRIMEVAL TIMBER ON THE MOUNTAIN SLOPES. IT IS EXPECTED THAT MANY PEOPLE WILL TAKE ADVANTAGE OF THE OPPORTUNITY OFFERED BY THE GOVERNMENT FOR ESTABLISHING SUMMER HOMES AND RECREATIONAL RESORTS IN THESE WHITE MOUNTAIN RESERVES



NATIONAL FOREST IN THE WHITE MOUNTAINS

MAP OF THE PRESENT PURCHASE AREA IN NEW HAMPSHIRE AND MAINE, SHOWING IN HATCHED LINES THE TRACTS ALREADY PURCHASED, OR APPROVED FOR PURCHASE

and valleys of primeval forest. Much valuable timber, however, remains. On these moist north slopes fire has not followed, making of these woods an unusual exception. In many places young spruce trees are seeding in abundantly. The fire danger has not passed, however, and everyone who traverses the paths should be cautious.

The southern slopes of the Presidential Range have been acquired also. These include two adjoining valleys striking in their differences of condition. One of them, the Rocky Branch, was heavily cut and burned over before its acquisition by the Government. The angel of death appears to have found no passover sign, and to have ravaged this valley with complete desolation. Seed trees and seedlings are gone. Where the soil is not burned away, small bird cherry trees, the seeds long

dormant, cracked by fire, are springing in by the million. These have no value and will occupy the soil from fifty to eighty years. It takes half a century after a fierce fire for little spruces to seed in again, and another half century at this elevation for them to become 6 inches in diameter. The summers, under the summit of Mt. Washington, are short and cold. It requires another half century for the trees to acquire small saw logs. From the human point of view, a two century set-back is not a light matter.

The adjoining valley is the Great Gulf that projects its wide space into the east side of Mt. Washington. Here the primeval spruce timber is standing. It ranges in small sizes to be sure. How could a wind-swept valley at high elevation produce other than small timber? Yet, taking the valley as a



Photo by Guy L. Shorey, Corham, N. H.

SLOPES OF MOUNT WASHINGTON

THIS WELLKNOWN MOUNTAIN IS NOW A PART OF THE WHITE MOUNTAIN NATIONAL FOREST. THE VALLEY CONTAINS A GREAT AMOUNT OF TIMBER THAT CAN BE HANDLED BY THE GOVERNMENT AT A PROFIT AND THERE IS NOT MUCH DANGER OF FIRE

whole there are very large values. If later the larger trees are removed, when the advance in prices shall enable the Government to take them out at a profit, a second cutting and perhaps a

third can be taken out from this uncrippled soil, before the burned over area in the neighboring valley will be fit for use. What is more wickedly unmindful of the future than reckless

destruction of soil capacity? What can be more favorable to those floods that the Weeks Act seeks to prevent? Nothing is more important in the White Mountains than for the Government to acquire the remaining timber, before it is forever too late.

Probably some will raise the question, often asked when the Weeks Act was first up for consideration, "Why does not New Hampshire save the White Mountains?" The answer is simple

Since the Weeks Act was passed logging operations have unfortunately been permitted in a steep valley that forms a part of Franconia Notch. In this valley a destructive fire swept over one of the ridges before any logging operations were undertaken there, making the ridge permanently barren. We have now the debris where seven million feet of spruce timber have been recently logged off clean. The present prospects of this steep valley are not promising.



THE NEW STONE HUT OF THE APPALACHIAN MOUNTAIN CLUB AT THE LAKE OF THE CLOUDS, NEAR THE SUMMIT OF MOUNT WASHINGTON

and plain. But one of the very many large manufacturing enterprises, and none of the navigation interests, that are affected by the protection of the forests in the White Mountains, are located within the borders of New Hampshire; they are all in other States. New Hampshire has a total population of less than 450,000 persons. These are farming people and small manufacturers, almost wholly without men or families of large means. It is clearly not the duty of these few people to bear the burden of a National Forest. New Hampshire has purchased the Crawford Notch at the cost of \$100,000.

New growth on this thin soil will be very slow, even if a fire does not set it back for several hundred years.

A purchase comprising 35,000 acres has been made on the eastern side of the Carter-Moriah Range in the valley of the Wild River, a beautiful country not much known hitherto because of its comparative inaccessibility. The new roads and trails constructed by the Government for fire protective purposes, are also opening up this region for visitors of the hardy type. Though severely burned in places, the tract contains much valuable timber that will be taken off later by the Government and thus render a partial return at least upon the original outlay.



BURNED OVER LAND ON THE WHITE MOUNTAINS

THIS MOUNTAIN HAS BEEN REPEATEDLY BURNED OVER BY FOREST FIRES. WHEN THE ROOTS OF THE TREES, WHICH HELD THE GROUND IN PLACE WERE FINALLY CONSUMED A LANDSLIDE OCCURRED AND A FREIGHT TRAIN WAS WRECKED AT THE FOOT OF THE MOUNTAIN

Large portions of the Pinkham Notch have come into possession of the Government, excepting the steep slopes of the Carter-Moriah Range on the east side of the valley. In this beautiful Notch the Glen Ellis Falls are located, and farther north one gets the wonderful view of Mt. Washington.

Both the north and south slopes of the Tamworth Range have been taken, including the whole of Mt. Chocorua. A portion of this purchase is on terms that permit the timber to be removed later by the lumber company, but this must be done, under rules by the department of agriculture. Before this tract

was recently acquired parts of it had been logged over. It was therefore covered with debris. A destructive fire broke out on the twelfth of May, 1915, and again after two rain storms on the twenty-seventh of May, and in spite of all efforts is still burning on the fourteenth of June. This shows how difficult it is to put out a mountain fire on cutover land, and how needful to acquire it before it is cut. Unless the remaining timber on the high slopes is acquired before it is cut over, there will be grave danger of other such fires after the Government has acquired the land. Lumber operations are active in parts of the White Mountains.

Considerable tracts of land have been acquired in Bethlehem and Franconia, including the northern slopes of Mt. Lafayette and Mt. Garfield. A new trail constructed by the Government for making this forest accessible in case of fire, opens up also to visitors for the first time the summit of Mt. Garfield and the beautiful falls on the north side of the mountain.

Two tracts have been taken in the Pemegewasset Valley in the towns of Woodstock and Thornton; one of these tracts covers the eastern foothills of Mt. Moosilauke and extends up to the height of land that forms the Connecticut and Merrimac watersheds. Here is the Lost River, a series of glacial caverns and giant potholes made by the receding ice-sheet many thousands of years ago. This small tract has been purchased by the Society for Protection of New Hampshire Forests.

Not the least of the Government purchases lies on the southern slopes of Mt. Moosilauke; a tract of about 7,000 acres. This purchase includes the most timber per acre and the highest value per acre on the average, of any land thus far acquired in the White Mountains. Here much mature spruce timber is standing. Here the Government has located the first of its felling operations. Over a considerable area that has been partially cut over in years past, and where the young growth is springing up in excellent condition, a body of mature trees is obstructing the development of young trees. No better place could be selected for beginning the

work of logging under the Government method. The mature timber needs to be saved. Young growth needs more light and relief from competition; the brush will be disposed of so that no danger of fire will remain. The form of contract requires that a strip of timber shall be left on either side of the highway.

And now the question arises, shall the Weeks Act be renewed? The experiment has been successful, and shall the country embark upon this permanent policy? New England answers, Yes, and will work for the measure; but New England wants a larger and more sympathetic view of her needs in the administration of the new Act. A glance at the map of northern New England will show that in laying out the present limit in which purchases are made, no attempt is shown to cover the head waters of the Androscoggin River, the Kennebec River or the Connecticut River. The Androscoggin and the Kennebec have extensive natural lake storage, and, too, perhaps the protection of their flow is less a matter of immediate necessity. The Connecticut River, however, has no natural lake storage. Its flow is directly dependent upon the forest cover. This river affects directly the well-being of a very large population estimated at more than 2,000,000 people, located in four States. It bears an extensive commerce, and a strong movement is on foot to extend navigation upon it for many miles. Surely this river, if any in the country, deserves adequate attention at the hands of federal authorities, to whom the administration of the Weeks Act is entrusted. There is a considerable body of wild mountainous land in northern New Hampshire that should be included in the Government purchase in order to protect this river. The original source of the Connecticut is in New Hampshire. There is a large body of land in Vermont that is equally important to its even flow. Vermont has not yet passed the enabling act, but is considering it, and will probably do so at the next session of its legislature. We ask particularly for a larger consideration of the needs of the Connecticut River.



To my mind the American Forestry Association exists for the purpose of getting things done which ought to be done. Achievement in American forestry depends directly on the twin forces of progressive legislation and efficient public administration. To secure the latter we must have technical foresters in charge of the executive machinery, and a complete freedom from political or partisan control of the National and State Forest Service. Only in this way can we hope to secure impartial administration of forest laws. The present and growing tendency on the part of politicians to endeavor to secure control of the appointments and appropriations of State forestry organizations by means of consolidation with fish and game administration and other devices must be resisted by a campaign of education. Similar attacks on the policy of National forestry through the arguments for States rights, must be fought with equal vigor.

The ideals aimed at and secured by foresters in public service constitute a new standard for our American civilization, of unselfish devotion to common good, the harmonizing of conflicting interests for the best prosperity of all, and the guarding of our future welfare without neglecting the still more important needs of the present.

The American Forestry Association represents the popular demand which created this public service and it is through our association that the public can best secure its continuance and protection from political attack.

Whatever else we may do, is secondary in importance to the maintenance of a high standard of efficiency in State and National Forest Service. If efforts to degrade and debase public forest administration to the level of party politics are successful, American forestry will utterly fail to establish itself and the preliminary achievements which so far have merely laid the foundations, will be of no avail.

HERMAN H. CHAPMAN.

Director American Forestry Association.



JAPANESE FORESTRY STUDENTS

THESE YOUNG MEN ARE IN CHARGE OF PROFESSOR KITAO MOROTO OF THE FORESTRY SCHOOL OF THE TOKYO IMPERIAL UNIVERSITY OF JAPAN

JAPANESE FOREST SCHOOL

EXCELLENT work is being done in training foresters at the Forestry School of the Tokyo Imperial University in Japan, which is in charge of Professor Dr. Kitao Moroto.

"The forests attached to the college are eight in number," says Dr. Moroto in a letter to *AMERICAN FORESTRY*, "two in Tokio-Fu, one in Chiba Prefecture, one in Hokkaido, one in Formosa, two in Corea, and one in Sachalen. The sum of the area of these forests is about three hundred thousand acres (300,000). The college forest in Chiba Prefecture covers an area of about 5,358 acres and is divided into the Kiosumi and the Okuzan forests by the boundary line of the Provinces of Awa and Kazusa. This forest is intended for use in practical instruction in forestry and for the investigations undertaken by the professors and students in the Forestry Department of the College. It is hoped

that it may also serve as a model of scientific forest management in this country.

The Kiyosumi forest attached to the college occupies the southern slopes of Mount Myoken in Awa, where stands the famous temple of Serchoji. The forest, comprising an area of over 831 acres, is situated about 3 miles north of Amatsu-cho, on the southern coast of the Province, its highest point having an elevation of about 1,000 feet above the sea level. The Forest zone belongs to that of broad leaved evergreen trees, and the most important forest trees here to be found are *sugi* (*cryptomeria japonica*) Bon and Momi (*abornis firma*). The former are the result of planting and extend over about 490 acres. The latter being natural occurs as a pure wood, or as the over-wood of coppice woods with standards. Most of the remaining portion of the forests consists of coppice woods which are composed

of over seventy species of forest trees, both evergreen and deciduous. Since this forest has come under the control of the college, a systematic method of management has been introduced to provide a model forest for practical work, and at the same time to serve the purposes of investigation and instruction, as well as to make the public acquainted with the systematic management of forests. With these objects in view, roads have been projected through the districts and the necessary surveys

have been carried out. The whole district has been so laid out as to make possible systematic working; and the annual cutting and other forestry operations will be regulated according to a working plan.

Also a lot of woodland in the forest with an area of about 60 acres, where no cutting has ever been done, is protected against the ax in order to preserve a fine specimen of primeval forest and to afford some illustrative aids to silvicultural study."

THE BLACK HAWK TREE

By JENS JENSEN.

AMONG a great many trees of historic value in Illinois the old Black Hawk Tree was the foremost of all. This giant cotton-wood that stood like a sentinel over the prairies just a little west of the village of Wilmette, one of Chicago's suburbs, reached the good old age of over 600 years. It was destroyed by a malicious act, and at the time of its death did not show a single dry limb or any deterioration in its noble form. This giant towered over the prairies 130 feet and its diameter measured a little over 12 feet near the ground. It was hollow at the base with an opening of 5 feet by 9 feet. The hollow was large enough to hold a man on horseback, and an early owner of the tree used it for a pigpen.

During the great fire of 1832 this was the only tree left unharmed in this region. The Indians supposed it to be under the protection of a great spirit, and it became a gathering place for the Medicine men from the various tribes that roamed about this section. Pieces of the bark were used as love charms by the Indian maidens.

During the Black Hawk war the Sax drew upon themselves the wrath of the Foxes and the Pattowatamies by

selling their land to the Government. About this time a young Sax warrior fell in love with a beautiful daughter of the Pattowatamies, but fearing the wrath of their people they met at the tree, believing the sacred ground around it would protect them from molestations. This romance was suddenly interrupted by a party of Sax, killing the young warrior and burying him beside the tree. The Indian girl made her escape but soon after returned to the tree and killed herself upon her lovers grave. It is said that her spirit still haunts the place.

Black Hawk himself often assembled the chiefs of his confederates around the tree, and many of the campaigns against the white were planned beneath its shadow. The early pioneer recognized it as a land mark, and this it was until its death a few years ago. Strong and sturdy as it was it might have lived for additional centuries, passing its early associations from generation to generation. There are other trees of equal importance over the country that should be protected from harm and vandalism. Proper foresight would have preserved this old tree for coming generations.

There are or have been numerous trees of great historical interest in the United States and Canada. American Forestry invites from its readers brief descriptions of any such trees of which they know.—Editor's Note.]

ESTABROOK PARK

AN experiment in private forestry which should encourage others who have similar opportunities is told for *AMERICAN FORESTRY* by Mr. J. A. Estabrooks of Boston. He writes:

"On retiring from business in 1889 at the age of 36, I went for a holiday to Tryon, N. C., among the Blue Ridge Mountains, 40 miles south of Asheville and 2 miles from the South Carolina border. Things in 1889 were very primitive at Tryon. Continuing to visit that region, in the winter of 1894 I bought 36 acres of forest land at a low price. It was the usual unsightly collection of uncared for trees.

"I applied the treatment of improvement cutting and bonfires of the debris for several winters, until at last even a native mountaineer called my place 'the best stand of trees in Polk

County.' In 1894 hardly anyone knew what forestry meant. The usual opposition argument was 'Why! it takes 100 years to grow a tree.'

"In 1914 I sold the 36 acres at an excellent profit, partly owing to the popularity of Tryon as a resort, and obtained the guarantee of a continuous stand of trees under forestry treatment. A condition was kindly attached by the purchaser, Mr. J. L. Washburn of Duluth, Minnesota, that the woods should be named as a park after me. There is a great variety of trees on the Park, the Tulip tree being especially in evidence."

The accompanying pictures show views of Mr. Estabrooks land taken some years ago. The condition of the trees on it has been greatly improved since then and now the stand is a most attractive one.



ESTABROOKS PARK FROM TRYON, N. C.

A VIEW OF THE PARK IN THE LEFT MIDDLE GROUND FROM ONE EDGE OF THE TOWN. THE APPROACH OF THE TOWN TO IT ADDED SOMEWHAT TO THE INCREASE IN ITS VALUE



ESTABROOKS PARK, NEAR TRYON, N. C.

THIS TRACT OF LAND, BOUGHT BY J. A. ESTABROOKS OF BOSTON IN 1894, AND SUBJECT TO IMPROVEMENT CUTTING ON FORESTRY PRINCIPLES WAS SOLD TWENTY YEARS LATER AT A HANDSOME PROFIT. MR. ESTABROOKS' EXPERIENCE SHOULD BE AN INSPIRATION TO OTHERS

Tyron County, where this park is located, has a most effective forest fire protective association, organized about a year ago, and described in a recent issue of *AMERICAN FORESTRY*. There is much

cut over land on which second growth is well established and which, with efficient fire protection, will some day be of considerable value.

OLD AX MARKS IN TREES

By AVERN PARDOE

MR. STRAIN'S letter in *AMERICAN FORESTRY* for May, p. 659, reminds me of a discovery I made a few years ago. I was cutting a large white pine, about 3 feet in diameter and 150 feet high, when about a third of the way through the ax went into what I thought was rot. The remainder of the cut was made with the saw. We then found the supposed unsoundness was in reality a cup cut into the tree when it was young and subsequently overgrown

with new wood. There were over eighty rings of new wood outside the cup and about seventy rings had been formed before the cup was made. It was undoubtedly Indian work as eighty years ago there were no white people in the district. The purpose of the cut must have been to gather gum for the making and mending of canoes, etc. The place was the shore of an island in Lake Joseph in the Mishoka District, Ontario, Canada.

A WORK ON THE CONSERVATION OF WATER BY STORAGE

By GEORGE FILLMORE SWAIN, LL. D.

Reviewed by HENRY STURGIS DRINKER,

President of Lehigh University and President of the American Forestry Association.

THE CONSERVATION OF WATER BY STORAGE, by George Fillmore Swain, LL. D., Gordon McKay Professor of Civil Engineering in Harvard University; Past President American Society of Civil Engineers; Yale University Press, New Haven, Connecticut, 384pp. price, \$3.00

THIS very valuable work is made up of a collection of studies fitting one into another, so as to present a harmonious whole, being addresses delivered in the Chester S. Lyman Lecture Series, in 1914, before the Senior Class of the Sheffield Scientific School of Yale University.

It is the most masterly, comprehensive and authoritative deliverance on the general subject of the Conservation of Water by Storage that has ever appeared, and the chapters particularly devoted to the water power question, in which the author is a recognized leading expert, are most timely in view of the large amount of irrelevant talk and political bias that has characterized much of the public discussion of this important economic question, not only in the National Congress but also in the National Conservation Congress.

Dr. Swain's opening chapter on "Conservation in General" is an illuminating summary highly instructive and suggestive to those who have already studied the subject and of the greatest value to the man or woman who is seeking light on this great national question.

This general discussion is followed in Chapter II with a discussion of the Conservation of Water and its relation to the Conservation of other Resources. What could be better or more succinct than the following:

"It is clear that there are three kinds of natural resources, in the Conservation of which we are concerned—
1. Those resources which are not renewable, and in which utilization, even though without waste, necessarily des-

troys the store available for future generations. Such are coal, oil, gas, phosphates, and other mineral deposits. Every particle of these resources which is utilized diminishes by so much what is left for our successors.

2. "Those resources which are self-renewing, though at a comparatively slow rate, requiring considerable time for a complete renewal. In this class are included the forests, which may be entirely cut down, but which will ordinarily reproduce themselves in time. In case of these resources, as in the case of those in the first class, any utilization diminishes the store available for our immediate successors, although distant future generations may be able to replace the loss of those resources which fall in the second class.

3. "Water power falls in a different class from either of the above, and seems to occupy a place by itself, having several peculiar characteristics. In the first place, while resources of the first two kinds, if not utilized, are in general stored and *preserved* for the use of future generations, water power, if not utilized, is *constantly wasting with no good results to anybody*. Nevertheless the water flows day by day and year by year, and, speaking generally, the power is perpetual. It is like a free gift offered by the Creator to man, which flows by him in a continuous stream and may be had for the asking. Water power, however, presents a second peculiar characteristic in that its conservation is a double conservation. The utilization of water power for a purpose for which steam power, or some other form requiring the use of

fuel, would be employed, is not only the utilization of a freely given resource which would otherwise be wasted, but it involves the saving of a corresponding amount of one of the non-renewable or slowly renewable resources. The use of water power to furnish motive power for street or steam railways, or for lighting, saves an equivalent amount of coal. The conservation of water power, therefore, is a double conservation, and it would seem, therefore, inasmuch as it involves the conservation of a non-renewable resource of a strictly limited supply, that its conservation is of greater importance than that of any other of our material resources."

This is followed by a masterly discussion and exposition, from an engineering standpoint, of water power utilization, with a study of Riparian Rights and of the powers of the Government over Navigable Streams, and in Chapters III and IV by a study of questions surrounding the problems of Water Power at Government Dams, and of Water Power at Private Dams. The engineering, riparian and other legal questions involved are exhaustively discussed, yet succinctly and without prolixity or unnecessary expansion.

The author luminously weighs the important questions surrounding governmental control and well says: "Indeed the conservation movement in the past, particularly as regards water powers, has been too much dominated by the idea of enforcing the arbitrary powers of the Federal and State Governments, and extending regulation and restriction to their utmost limits." And Dr. Swain here quotes the remark of a well-known Senator who said, "That is the trouble with the present craze for restriction and regulation of private investment in these enterprises. You regulate and restrict to the extent that you have nothing to regulate."

Dr. Swain further wisely says, "It is from a point of view of pure conservation that the development of water power is most important. When we consider also that the development of water power not only conserves fuel, but directly serves to promote the navigability of rivers, we should be very careful how we discourage this

triple conservation in order to secure other results which we may consider desirable. If we do discourage it, we may be antimonopolists, or something else, but we are certainly not conservationists. The conservation movement, originating in a wise demand for the economical use of our natural (not national) resources, has too much deteriorated into a demand that those resources be retained by the National Government and not permitted to be developed by private capital except under restrictive burdens."

What a broad statesmanlike and wise conclusion is given in the following summary of Dr. Swain's admirable discussion in Chapter IV of the questions surrounding the matter of monopoly in Water Power Development:

"Finally, in considering this entire water power discussion, it is very important to avoid the attitude of mind taken by so many in these days, which assumes that average business morality is less than average public morality. In times of old, it was a popular adage that 'the king can do no wrong,' though perhaps, rather than popular, it was a belief entertained mainly by kings themselves. Today there is a similar popular impression that the Government can do no wrong. Where the people are sovereign, they are very apt to imitate other sovereigns in assuming themselves incapable of error. It was a maxim of Robespierre's, which dictated his entire infamous career, and which led to his brief period of power and his ultimate ruin, that 'The people are never wrong.'

"Both impressions are equally erroneous. Government bureaus and officials in a democracy may be guilty of just as flagrant abuses of justice as kings or individuals."

Chapter V on "Water Power on the Public Domain" is a timely discussion of a great question which occupied much attention in the last National Congress, and which presents facts and engineering conclusions which should be of weight in the final determination of the Government policy. To show the serious economic question presented by the Government's continued ownership of lands, in Western States, Dr.

Swain quotes from the testimony given in the recent 63rd Congress the following table showing approximately the "Percentage of the Area of far Western States owned by the Federal Government:"

State.	Total Acreage owned by United States.	Percentage of Total.
Arizona.....	67,097,293	92.00
California.....	53,276,547	52.58
Colorado.....	37,702,033	56.67
Idaho.....	45,218,919	83.80
Montana.....	61,049,263	65.80
Nevada.....	62,219,423	87.82
New Mexico.....	49,315,409	62.83
Oregon.....	32,229,745	51.90
Utah.....	43,564,645	80.18
Washington.....	17,684,198	40.00
Wyoming.....	42,613,499	68.00

This large retention by the Government of lands originally embraced in the public domain and contained in the boundaries of the several states when given statehood rights involves complicated questions of control and ownership by the Government in such lands, and of exemption from State taxation, wholly different from any presented in the Eastern and Middle States. Dr. Swain shows that "one of the most serious obstacles to the development of water powers on the public lands is that the Government permit which must be obtained is now, by law, revocable at any time at the will of the Department by which it is granted, and is also subject to such conditions as that Department may impose not only when the permit is granted, but subsequent thereto."

This evil was sought to be corrected by legislation considered, but not passed in the last Congress, and which will doubtless be revived in the next Congress, when Dr. Swain's masterly technical discussion of the whole question from a purely impartial technical engineering standpoint will be of great practical value in reaching a sane business conclusion. In concluding his discussion of this matter Dr. Swain says, "The onerous restrictions which have been criticised in this chapter will not, of course, entirely prevent water-power development, although, in the opinion of the writer and of many other engineers, they are quite sufficient to do

so if they were thoroughly understood by investors. Undoubtedly, however, they do hinder development, increase the cost of financing and render necessary a higher rate of interest than would otherwise be requisite. They therefore discourage true conservation in the sense of use."

Chapter VI discusses "Technical Aspects of Conservation by Storage" beginning with the five related problems of (1) the use of water as a source of power; (2) the use of water as a source of water supply for communities; (3) the use of water for irrigation; (4) the promotion of river navigation; and (5) the prevention of damage due to floods, and this chapter gives a masterly exposition of the steps to be taken to make the flow of a stream more regular by preventing the run off from being discharged immediately or rapidly into the streams and by promoting a gradual discharge

1. By the construction of surface reservoirs.

2. By so treating the surface of the ground that rapid discharge will be prevented, by preserving and increasing the forested areas, especially on steep slopes, or by breaking up the ground on flat areas, for cultivation.

The construction of storage reservoirs is thoroughly gone into, with many examples and illustrations of existing dams both completed and while in course of construction. In summarizing the relative advantages and disadvantages of steam and water power plants the author again emphasizes from the wealth of his experience, the need of fair liberal treatment, if water power plants are to be made financially successful saying, "Once safely financed and in operation, with a good market and fair treatment, water power developments are very attractive on account of the greater convenience, the small operating expense, the small amount of labor employed, the consequent absence of labor troubles, independence of fuel supply, smaller depreciation, and the comparatively small amount of working capital needed. These advantages, however, may be more than off-set if the permit is not

definite, or if it is revocable, or if burdensome regulations and restrictions are likely to be imposed. If water power is to be developed, inducements must be offered to investors, including a reasonable assurance of fair treatment from the public authorities."

Chapter VII on "Forests and Stream Flow" is intensely interesting to both the engineer and the forester, with its discussion of sub-surface storage, and the application of inductive and deductive reasoning in studying the relation between forests and the flow of streams.

Chapter VIII is devoted to "Floods." The author expresses the opinion that "There seems little doubt that, speaking generally, river floods, and the damage which they cause, are increasing in the United States." He groups the causes of river floods under the following heads:

1. "The fact that the rain-fall is unequally distributed, and that large quantities fall during storms in a comparatively short period of time.

2. "The fact that the rain falling upon the ground is not held back, but flows rapidly from the surface into the streams, or that the melting snows are carried off in the same manner, and

discharged into the streams in a comparatively short time.

3. "The fact that the stream channels are not large enough or smooth enough, or do not have slope enough; in other words, that the stream channels have not the capacity to carry off the maximum amount of water delivered to them without rising above their banks."

Following this Dr. Swain discusses the remedies available or proposed to prevent floods, by building surface reservoirs, by forestation and cultivation (as noted also in Chapter VII), by increasing the capacity of river channels and by constructing cut-off channels.

In the various numbers of the Appendix Dr. Swain has presented copies of a number of official documents and Acts of Congress of interest in connection with the general subjects treated in his work.

Dr. Swain's work will be of value and interest to engineers and foresters and to all students of conservation for it is the product of a master mind, versed in the great subjects treated and endowed with the faculty of presenting them to experts and to the inexpert with impressive yet pleasing and convincing insistence.

EDITORIAL

NEW YORK'S FOREST PROBLEM

IN AN effort to modify the present rigid requirements of New York's Constitution, which now prohibits all cutting of timber in the State reserves, the Constitutional Convention is considering the adoption of an amendment which would allow the sale and removal of dead or down timber, while retaining the clause which prevents the cutting down of green or live trees.

In the decade of 1890-1900 a law exactly similar to the proposed statute was passed by Congress to permit the logging of dead and down timber on Indian reservations in Minnesota, in which the green timber could not be

sold at that time, pending the completion of estimates and other formalities. This law became the cloak for extensive operations, under which green timber was cut right and left. Suits brought by the Government to recover the value of the timber and prevent further trespass resulted in a remarkable decision by a Federal judge, to the effect that a "dead" tree was a tree which had "ceased to increase in value." This loophole made it impossible to distinguish "dead" from "live" trees. The entire administration of the law was accompanied by so much scandal that it was repealed in 1902.

An honest and able administration of such a law in New York at present, if it escapes such legal garbling, would successfully prevent the cutting of classes of timber not intended by the Constitution.

But the greatest difficulty remains. Fire killed timber, if it stands in large enough areas, can be profitably logged. Large conflagrations create such conditions. Every few years there will occur periods of drought which will create a fire hazard in the Adirondacks that will tax the utmost resources of the best production system to cope with. There are many irresponsible persons in such regions who would probably be tempted to set fire to the woods at such times, since the result would be to stimulate industry and provide them with openings for employment during the following winter. Deliberate incendiaryism occurring in thinly populated regions is a difficult problem to cope with. The incendiary is usually able to escape detection. Here again, a vigilant and thorough protection force might prevent such results.

But in adopting this provision the State of New York would be deliberately creating an extra moral fire hazard which more than offsets the possible advantage of salvaging dead timber. If the Constitutional Convention believes that it cannot trust the State forest administration to properly control the cutting of green timber to prevent damage to the forest, it would be unwise to burden the same administration with the heavy responsibility of a

"dead and down" timber clause. The Convention should either permit regulated cutting of both live and dead timber or prevent it altogether.

The prejudice against permitting cutting of green timber is deeply ingrained in the minds of New York citizens, due to distrust of her politicians. The situation demands the complete elimination of politics from the management of the State forest lands. Should the convention be able to accomplish this, they need no longer hesitate to permit cutting. On the Minnesota National Forest, the timber around the shores of the lakes and other points accessible to the public is preserved and protected although the Forest Service has the technical right to cut and remove it. Areas of especial value can be so classified, and preserved in their primitive condition. The remaining areas, unaccessible to the public, can be logged by methods which preserve the forest cover, secure reproduction and prevent waste from decay. These methods have been fully demonstrated on the National Forests. Must New York, through timidity, close her eyes to progress, and either lock up her forest resources, or imperil them with ill considered half measures? Now is the time for the State to establish a sane and orderly administration which will bring the Adirondack forests to a plane equal to that of the wonderful Black Forest of Germany, which, while serving as the recreation ground for the entire region, supports hundreds of villages and thousands of persons dependent entirely on the forest industries for their existence.

\$10,000,000 MORE FOR FOREST RESERVES

ON WEDNESDAY, September 22, members of the American Forestry Association and delegates of various Forestry Societies, Boards of Trade, Chambers of Commerce and other organizations of the New England and Southern Appalachian States will appear before Secretary of Agriculture Houston at

Washington in conference. They will ask the Secretary to recommend to Congress the passage of a bill providing for an appropriation of \$10,000,000 to be expended at the rate of \$2,000,000 a year for five years in the purchase, under the Weeks Act, of more Forest Reserves in New England and in the Southern Appalachians.

FOREST NOTES

On May 27 occurred the wedding of Mr. William Robinson Brown of Berlin, N. H., and Miss Hildreth Burton Smith of Atlanta, Ga., at the residence of Mr. and Mrs. Orton B. Brown at Berlin, N. H. Mr. Brown is a director and member of the Executive Board of the American Forestry Association, a member of the New Hampshire Forestry Commission and of other forestry and forest fire protective organizations. He is part owner and assistant treasurer of the Berlin Mills Pulp and Paper Company. The bride is the granddaughter of Gen. John B. Gordon, the famous Confederate leader and the daughter of Mr. and Mrs. Burton Smith of Atlanta.

The University of Washington *Forest Club Annual* for 1915, being Vol. 3 of the series is now being distributed. It is an admirable publication, well printed, well illustrated and with a considerable variety of well written articles on forestry. The *Annual* is dedicated to Edmond S. Meany, the first man to foster and teach forestry at the University of Washington. The contributors are Fred Madigan, Burt P. Kirkland, Prof. Hugo Winkenwerder, Joseph Morgan, Donald H. Clark, Edward J. Hanzlik, Elias S. Clark, and Dan McNeil. The committee having in charge the production of the *Annual* comprised Harold A. Browning, Arthur Bevan, Willis Corbitt, and Donald Clark.

The Seniors of the Penn State Department of Forestry have just returned from their spring camp in Breathett Co., Ky. The work was largely carried out on the tracts of The Mowbray & Robinson Co., specialists in hardwoods.

The Sophomores of the Department of Forestry at Penn State, previous to the opening of the regular summer camp in the Seven Mountains, MacAlevy's Fort, Penn., are with the Central Pennsylvania Lumber Co., at Laquin, Pa.

The work consists of a general introduction to logging, bark peeling, and milling and about a week's work in mill scale studies.

Interesting side trips have been made to the Barclay Chemical Company plant, The Penn Stave Company's mill and Schroder Wood Company's kindling wood factory. En route to Laquin the Paper Mills of the New York & Pennsylvania Paper Company were visited, also the J. K. Rishel furniture factory and the big C. P. S. Company's mills at Williamsport.

Active steps are now being taken by the Bureaus of Public Works and Forestry in Manila to cooperate in a tree-planting scheme for planting trees along the public roads throughout the Islands. Several conferences have been held between the representatives of the two bureaus concerned and it is hoped

that a beginning on the work may be made in the very near future.

The Bureau of Forestry of the Philippine Islands is taking up, as one of the most vigorous lines of work for the present year, the inauguration of an active campaign to more intimately acquaint the great body of people throughout the Islands with the possibilities and methods of forest conservation, the benefits which they will receive from such work and the harm which will inevitably occur if these resources are neglected or destroyed.

A review of the State work undertaken and carried out by the Maryland Board of Forestry for the spring of 1915 shows that the supply of planting stock at the Forest Nursery established one year ago was practically exhausted in sales made to residents of Maryland, and the size of the nursery proper increased 65 per cent through plans made for supplying standard varieties of forest trees at cost a year hence; that a total of 4 miles of State highway in as many different counties was planted up with attractive and appropriate roadside trees furnished free from the Nursery to abutting property owners, and the work of supervision likewise given at no cost to them; while in addition to the foregoing a considerable amount of planting was done under direct supervision of the State Forester and his assistants for afforestation of waste and abandoned farm lands, ornamental and protective planting.

The State Forest Service during the coming season will continue to further the improvement of Maryland's highways through the restrictive and careful cutting and pruning of all publicly owned trees, and will also sum up and complete several phases of its work which have been undertaken in seasons past, paying particular attention to the cooperative handling of privately held timber lands for purposes of demonstrating the possibilities of good forestry.

That jack pine is admirably suited for re-foresting many of the dry, sandy regions of the North Central States is the conclusion of a new publication of the Department of Agriculture, Bulletin No. 212, "Observations on the Pathology of the Jack Pine." This tree, it is said, suffers only occasionally from winter injury, stands drought well, and is comparatively free from a number of diseases which are commonly found on other coniferous trees. The pine is, however, sensitive to heat. The most important fungous disease from which the jack pine suffers is done by the *Peridermium cerebrum*, which in many localities presents a somewhat serious problem. The fungus attacks trees of all ages, frequently killing the young ones and seriously interfering with the development of those which survive. The removal of infected branches from young

growth is recommended as a means of saving many trees from this disease.

The Forest Annual, Vol. 6, of the University of Nebraska has recently been issued and dedicated to Dr. Charles Edwin Bessey, the originator and promoter of the Forestry Department of the University. The new issue maintains the degree of excellence established by previous ones, and has a number of particularly good articles on Forestry, the contributors being Arthur W. Sampson, Arthur T. Upson, George N. Lamb, Clarence F. Korstian, L. H. Douglas, J. S. Boyce, Prof. E. F. Schramm, C. R. Tillotson, Prof. Wm. W. Morris, Albert H. Miller and E. W. Nelson. It is well illustrated and is altogether a valuable and desirable publication.

"Professor Nelson C. Brown of the New York State College of Forestry at Syracuse, N. Y., has started on a three months' trip through the West to gather data on lumbering methods and utilization. In addition to a considerable number of the large western operations, Professor Brown's itinerary includes the various district offices of the Forest Service."

"Students from the Ranger School and from the Summer Camp of the New York State College of Forestry rendered valuable service in fighting the recent fires in the Adirondacks. Nineteen men from the Ranger School and forty men from the Summer Camp were rushed to the front at Star Lake. District Warden O'Brien, Warden Yerder, and Ranger Ferris gave the students high praise, while the cottagers about the lake ascribed the saving of their homes to the work of the young foresters."

A. W. Thompson, who operates a sawmill in Saulsbury's Woods, on the Cherry Hill Farm, Maryland, says it is not necessary to go to California to see big trees. He recently cut an oak tree that sawed 1,964 feet of lumber.

He also cut a gum tree that measured 44 inches across the stump, making four logs

18 feet long, one log 14 feet, one log 7 feet, the smallest log being 14 inches across the small end.

He cut an oak that contained a swarm of bees, an old squirrel in her nest and a snake 4 feet long. The bees, squirrel and snake were not 6 feet apart in the hollow.

The total forest area of the South is estimated at 259,000,000 acres. That of Germany is about 35,000,000. In 1913 the whole United States cut 38,000,000,000 feet of lumber, of which the South cut more than 22,000,000,000, including fifteen billion feet of yellow pine. One Louisiana sawmill cuts 1,000,000 feet of this wood a day. Eight years ago the site selected for this mill was in a stretch of virgin forest. Today it stands upon the outskirts of the thriving and unusually attractive little city of Bogalusa with more than 10,000 inhabitants and stores, residences and public buildings which would be the pride of many an older community of much greater size.

A prize of \$25 has been offered by the Manufacturers Association of Seattle to the discoverer of the tallest tree in the world. When found it will be bought and converted into a flagpole in a prominent location in Seattle as a monument to Washington's lumber industry.

Arrangements have been made by the Lighthouse Service with the Forest Service for the reforestation of certain lighthouse reservations in the eleventh lighthouse district, where conditions are favorable for this purpose. In the spring of 1916 about 20 acres will be planted under the direction of a Forest Service officer, and beginning with 1917 the planting will be carried on at the rate of 100 acres a year, the annual cost being estimated at \$1,500.

The object of this plan is to perpetuate the supply of timber on lighthouse reservations for use in making spar buoys and for other purposes.

CANADIAN DEPARTMENT

By ELLWOOD WILSON

The Montreal *Gazette* under date of eighth of June prints the following despatch which shows the necessity of the railways under the control of the Dominion Government handling their fire protection under the same regulations which have been so successful on privately owned railways.

"Cochrane, Ont., June 8. Heavy losses have been sustained along the line of the National Transcontinental Railway during the past week by forest fires. The fires raged for a distance of fully 70 miles along the railway between here and Kapuskasing. At the latter place, where several hundred prisoners of war are detained, fire for a time seriously threatened the camp. The prisoners were

orderly and no trouble ensued, they themselves joining in the fire fighting. The Provincial Government farm buildings at Ground Hog River were destroyed. At Jacksonboro, the headquarters of the Ontario Colonization Company, many cottages were burned, but the new large mill escaped." This section is in one of the heaviest timbered sections traversed by the National Transcontinental and such a fire is without excuse and due to the lack of the most elementary precautions.

In direct contrast to the above might be mentioned an incident which occurred recently on the Canadian Pacific Railway in Quebec. A spark from an engine set fire to

grass at the side of the right-of-way and this spread to a small piece of timber and was extinguished by the fire-ranger of the Laurentide Company after burning about 3 acres. The next day the defective engine was taken out of service, a special patrolman put on with a track velocipede to follow all trains, the section foreman was severely reprimanded, the master mechanic was hauled over the coals and within four days the Forest Inspector appeared on the scene and appraised the damage and the matter is now before the Claims Department for immediate settlement. The Canadian Pacific Railway has determined to stop forest fires and rid itself of the pest of fire claims. All strength to its arm.

The Quebec Government is taking another step forward, a notice has been sent to all limit holders in the Province saying that the Government wishes to pass an Order-in-Council making it obligatory on all persons lumbering along the right-of-way of any railroad to clear away and burn all tops and debris within 100 feet of the right-of-way. This measure should have the strongest support of everyone interested in the protection of the forests from fire. It is quite time too that this should go a step farther and all persons, lumbermen, settlers and farmers cutting trees should be compelled to burn their debris and slash. The cost would not be large and being made compulsory for all would only place the increase on the consumer. In the long run, an insurance against fires, by making logging easier and travel in the woods more convenient and by promoting reproduction and preventing diseases such a measure would give added profit instead of added cost.

Experiments conducted by the Laurentide Company with the Jensen tree planter this spring, where twelve of these machines were in use, show that in average country, open fields and poplar and birch following fire and averaging about 20 feet in height, that a man and boy with a machine will plant 1,000 to 1,200 trees per ten-hour day, while a man and two boys, the man making holes with a mattock and the boys planting, will only plant 1,000 trees per ten-hour day. Besides, the trees planted with the machine are more firmly set, and the ground is less disturbed than with the mattock. This is of value where there is a thick layer of duff. The mortality among trees planted with the machine is somewhat less than those planted with the mattock, especially in open fields.

A very interesting bulletin was issued by the Commission of Conservation recently. The National Domain in Canada and its Proper Conservation, by Frank D. Adams, Ph. D., D. Sc. This deals in a general way with Agriculture, Forest Products, Water Powers, Mines and Minerals, Fisheries and the Fur Trade and is well illustrated and contains interesting charts and tables, and maps. This calls attention to the rapidly diminishing timber supply and the necessity of prompt and energetic measures for its protection and conservation.

Chief Forester MacMillan, of British Columbia, who is making a trip to South Africa, Australia, New Zealand, India, China, Japan and South America, in an effort to interest these countries in British Columbia Timber, reached England in the latter part of April and is busy on the transportation problem, since the lack of shipping is proving a serious handicap. While in Europe Mr. MacMillan will investigate the lumber markets in France, Italy and Spain.

In Quebec the dry weather has brought its usual crop of forest fires but they are less serious than usual. Quite a commentary on the necessity of cooperative associations is shown by the fact that the largest fires this spring are on the limits of firms who have refused to become members and who said that their own men could handle the situation. It has now been proved that men who have had experience in fire ranging and fire fighting are the only men competent for such work, and the longer their term of service and the greater their experience the more valuable they become. The idea that any loafer around a town can be picked up in time of emergency and that he will make a competent fire ranger put forward by many self styled practical men has been thoroughly disproved.

The June number of the *Canada Lumberman and Wood-Worker*, is an "Export Number" and contains much material of value to the man or firm looking for export business. Information about foreign measures, monies, export regulations, markets, packing, customs, etc., is given very fully and completely and reflects much credit on the editor.

Messrs. E. G. McDougall, C. S. Cowan and L. R. Andrews have volunteered for the front. They are all members of the British Columbia Forest Service and Messrs. McDougall and Andrews are members of the Canadian Society of Forest Engineers. Mr. Ellwood Wilson has been elected a member of the Society of American Foresters.

Mr. G. C. Piché, Chief Forester of Quebec has planted a number of thousand trees on his estate at Burrill's Siding, thus setting a good example to people in the Province.

Mr. G. A. Gutches, the Head of the New York State Ranger School at Wanakena spent three days at Grand Mere inspecting the nursery work and plantations of the Laurentide Company. Mr. Gutches is a firm believer in the disposal of logging debris by burning and the Laurentide Company will give his ideas a trial in their experimental logging operations.

The British Columbia Government has issued a circular letter to settlers and farmers, embodying the regulations concerning fire permits, giving rules for guidance when burning slash or brush in land clearing operations and information as to what should be done when fire breaks out. It also appeals to all citizens to help eliminate the fire menace and

should certainly be a great help in educating the public along proper lines, and education is the only means which will serve the purpose.

The Technical School started a few years ago by the Shawenegan Water & Power Company in cooperation with other industrial companies in the district held its first commence-

ment exercises on June 10. This school has done excellent work and is destined to be of great service to the region.

The Canadian Pacific Railway is experimenting with a small light motor, costing about \$55 which can be attached without difficulty to any track velocipede. If successful this should prove very useful.

BRITISH COLUMBIA NOTES

The fire season in British Columbia opened early under ominous conditions, there being a period of three weeks or more between the last of the snow and the growth of the new vegetation, when the hazard was very great in the northern interior. While a number of serious fires occurred the advent of continuously heavy rains in the first week of May, and the wet weather since, have effectually checked all fires and fostered a healthy growth of vegetation. The conditions recorded above, together with the short winter, did, in one respect, however, materially help to diminish the fire hazard, many thousands of acres of logging and farmers' slash having been dealt with, at the suggestion of or in cooperation with the Forest Branch. In this way many dangerous fire traps were cleaned up, and as a result of the attention paid to disposal of slash by the road and telephone authorities, satisfactory headway has been attained. The number of Forest Guards already appointed and assigned to districts amounts to about 150, in addition to the permanent staff of thirty-eight Rangers. As the season advances it is expected that thirty more Guards and probably fifty or sixty patrolmen will be added.

Mr. H. R. Christie, Assistant Chief of Operation, is making an extended trip of Inspection in the northern Forest Districts conferring with District Foresters Murray, Bonney, Marvin, Allen and Irwin. He reports that while there was a short spring fire season heavy rains have made the north country safe for the present.

During Chief Forester MacMillan's absence on a tour of the world in the interests of trade extension as Special Trade Commissioner, Mr. M. A. Grainger is the Acting Chief Forester of the B. C. Forest Service.

The British Admiralty has been buying large quantities of timber for war purposes of late and the Hastings Mills of British Columbia at Vancouver recently secured an order from them for ten million (10,000,000)

feet of Douglas Fir. This will go forward in June and July in tonnage supplied by the British Admiralty.

Mr. Wyngard C. Gladwin, an Inspector of the British Columbia Forest Branch, died after a long illness on April 13.

Mr. Gladwin was a pioneer in fire protection matters in British Columbia, having had charge of the Provincial Fire Wardens from the inception of protection work. Formerly a member of the Northwest Mounted Police, he brought to the work a wide knowledge of men, and the principle of organization and discipline. Mr. Gladwin had succeeded in placing the fire protection work on a sound basis by the time the Forest Branch was established in 1912, and the present system is simply the natural growth of his work. From 1912 until his death he had charge of the railway fire protection work of the whole Province, acting as Inspector both for the Board of Railway Commissioners and the Provincial Forest Branch. Loyal and honorable as an officer, and generous and sympathetic as a friend, Mr. Gladwin's death is deeply felt by his associates.

An interesting departure has been made under the direction of the Hon. W. R. Ross to make our people realize the great importance of the lumber industry and the necessity of protecting the forest resources of British Columbia from damage by fire.

Moving pictures have nowadays an educational power only second to that of the press itself. Hence last year a number of the motion-picture theatres in the Province were supplied with a set of slides to be used in the intervals between the ordinary films. The slides were sent out under instructions from the Minister of Lands with a letter explaining the need for the cooperation of the theatre proprietors in order to reach a large body of the public inaccessible by any other means. The result was entirely satisfactory, both theatres and patrons expressing their appreciation. This year many more were sent out.

CURRENT LITERATURE

MONTHLY LIST FOR JUNE, 1915.

(Books and periodicals indexed in the Library of the United States Forest Service.)

Forestry as a Whole.

Proceedings and reports of associations, forest officers, etc.

Congrès forestier international, Paris, 1913. Congrès forestier international tenu à Paris du 16 au 20 juin 1913. 961 p. Paris, Touring-club de France, 1913.

Hawaii—Board of commissioners of agriculture and forestry. Report for the biennial period ending December 31, 1914. 244 p. pl. Honolulu, 1915.

India—Jammu and Kashmir—Forest dept. Progress report of forest administration for the year 1913-1914. 80 p. Lahore, 1914.

India—Punjab—Forest dept. Progress report of forest administration for the year 1913-1914. 135 p. Lahore, 1914.

India—United Provinces—Forest dept. Annual progress report on forest administration, 1913-14. 154 p. Allahabad, 1914.

Louisiana forestry association. Addresses and proceedings, 5th annual meeting. 59 p. il. Bogalusa, La., 1914.

Michigan—Game, fish and forestry department. Biennial report, 1913-14. 81 p. Lansing, Mich., 1914.

New Brunswick—Crown land dept. Fifty-fourth annual report, for the year ended 31st October, 1914. 81 p. pl. Fredericton, N. B., 1915.

Ontario—Dept. of lands, forests and mines. Report for the year ending 31st October, 1914. 157 p. il. Toronto, 1915.

Pennsylvania—Dept. of forestry. Report for the years 1912-1913. 494 p. pl. Harrisburg, Pa., 1915.

Quebec—Dept. of lands and forests. Report for the 12 months ended 30th June, 1914. 97 p. tables. Quebec, 1914.

Switzerland—Département de l'intérieur—Inspection des forêts, chasse et pêche. Rapport sur sa gestion en 1914. 17 p. tables. Bern, 1915.

Switzerland—Dept. des innern—Inspection für forstwesen, jagd und fischerei. Verzeichnis der wissenschaftlich gebildeten forstbeamten der Schweiz, 1915. 21 p. Bern, 1915.

Forest Education

Forest Schools

Michigan, University of—Dept. of literature, science, and the arts. Announcement of the course in forestry, 1914-1915. 33 p. Ann Arbor, 1914.

Washington, University of—College of forestry. Catalogue, 1915-1916. 31 p. Seattle, Wash., 1915.

Forest Botany

Maiden, J. H. A critical revision of the genus *Eucalyptus*, pt. 22. 22p. pl. Sydney, Govt. printer, 1914.

Maiden, J. H. The forest flora of New South Wales, pt. 55. 33p. pl. Sydney, N. S. W., Govt. printer, 1914.

Silvics

Forest influences

Waters, Byron. Practical forestry in the San Bernardino Mts. 14 p. Riverside, Cal., Tri-counties reforestation committee, 1911.

Silviculture

Planting

Switzerland—L'inspection fédérale des forêts. Ausgerichtete bundesbeiträge an ausgeführte aufforstungs- und verbauungsarbeiten im jahr 1914. 7 p. Bern, 1915.

Forest Protection

Insects

Britton, W. E. The gypsy moth. 24 p. il. New Haven, 1915. (Conn.—Agricultural experiment station. Bulletin 186.)

Burgess, A. F. Report on the gypsy moth work in New England. 32 p. il, pl, maps. Wash., D. C., 1915. (U. S.—Dept. of agriculture. Bulletin 204.)

Essig, E. O. Injurious and beneficial insects of California. 2d ed. 541 p. Sacramento, California state commission of horticulture, 1915.

Diseases

Davey institute of tree surgery. Instruction books 13-14. il. Kent, O., 1914-15.

Weir, James R. Observations on the pathology of the jack pine. 10 p. il, pl. Wash., D. C., 1915. (U. S.—Dept. of agriculture. Bulletin 212.)

Fire

Tri-counties reforestation committee. Forest fires on San Bernardino range; review of conflagration of summer of 1911, its cause and plans to meet similar emergencies. 23 p. Riverside, 1911.

Forest Economics

Campbell, R. H. The relation of forestry to the development of the country. 7 p. il. Ottawa, 1915. (Canada—Department of the interior—Forestry branch. Circular no. 11.)

Rothrock, J. T. Areas of desolation in Pennsylvania. 30 p. pl. Phila., Herbert Welsh, 1915.

Statistics

France—Ministère de l'agriculture—Direction des eaux et forêts. Statistique et atlas des forêts de France. v. 1-2. maps. Paris, 1912.

Forest Administration

National and state forests

Pettis, C. R. Resources of the forest preserve. 41 p. pl. Albany, N. Y., 1915. (N. Y.—Conservation commission.—Division of lands and forests. Bulletin 12.)

Forest Utilization*Lumber industry*

Pratt, Merritt B. The deterioration of lumber; a preliminary study. 20 p. il. Berkeley, Cal., 1915. (California—Agricultural experiment station. Bulletin 252.)

Wood-using industries

Massachusetts—Bureau of statistics. Wages and hours of labor in the paper and wood pulp industry in Massachusetts. 157 p. Boston, 1915. (Labor bulletin no. 103.)

Mitchell, W. G. Treated wood-block paving. 40 p. il. Ottawa, 1915. (Canada—Dept. of the interior. Forestry branch. Bulletin 49.)

Teesdale, Clyde H. Experiments with wood paving blocks. 4 p. il. N. Y., 1915.

Wood preservation

American wood preservers' association. Proceedings of the 11th annual meeting, 1915., 527 p. pl., tables. Baltimore, Md., 1915.

Gould, Clark W. Quantity of wood preservatives consumed and amount of wood treated in the United States in 1914. 18 p. il. Baltimore, Md., American wood preservers' association, 1915.

Auxiliary Subjects*Conservation and natural resources*

Adams, Frank D. The national domain in Canada and its proper conservation. 48 p. pl., maps. Ottawa, Canada, Commission of conservation, 1915.

Governors' conference. Proceedings of the 7th meeting. 306 p. Madison, Wis., 1914.

Hutton, George H. Water conservation by spreading on gravels. 11 p. Riverside, Cal., Tri-counties reforestation committee, 1914.

Pedley, W. E. Conservation of water by spreading on gravels. 11 p. il. Huntington Beach, Cal., Tri-counties reforestation committee, 1914.

Botany

Wilcox, E. Mead. A handbook of Nebraska grasses. 120 p. il. Lincoln, 1915. (Nebraska—Agricultural experiment station. Bulletin 148.)

Soils

Jones, J. S. & Colver, C. W. Soils of the cut-and-burned-over areas of north Idaho. 20 p. il. Moscow, Id., 1915. (Idaho—Agricultural experiment station. Bulletin 81.)

Irrigation

United States—Reclamation service. Oregon cooperative work; Deschutes project, by the cooperating officers of the state of Oregon and the Reclamation service office at Portland, Oreg. 147 p. pl., diagr., maps. Portland, Oreg., 1914.

Grazing

Wooton, E. O. Factors affecting range management in New Mexico. 39 p. pl. Wash., D. C., 1915. (U. S.—Dept. of agriculture. Bulletin 211.)

Periodical Articles*Miscellaneous periodicals*

American journal of botany, Jan. 1915.—The temperature of leaves of *Pinus* in winter, by John H. Ehlers, p. 32-70.

American journal of botany, April, 1915.—The persistence of viable pycnospores of the chestnut blight fungus on normal bark below lesions, by R. A. Studhalter and F. D. Heald, p. 162-8.

Biltmorian, June, 1915.—Using the unemployed in forestry work, by Frank L. Haynes, p. 13-16; Volume tables for southern white cedar, by Howard R. Krinbill, p. 16-19; Creosoted wood paving block, by Hammond Robertson, p. 20-1.

Botanical gazette, May, 1915.—The medullary rays of *cedrus*, by M. A. Chrysler, p. 387-96.

Country life in America, June, 1915.—Junipers of the Sierras; photographers, by Charles T. Mott, p. 50-1.

Farm and fireside, May 22, 1915.—To make woodlots pay, by Edmund Secrest, p. 14.

Fire prevention news. May 1915.—Factors, of safety in wood construction, by James P. Whiskeman, p. 1-2; Lumbermen and fire prevention, by Frank H. Lathrop, p. 3; Fallacies of forest fire fighting, by Page S. Bunker, p. 3-4.

Gardeners' chronicle, May 1, 1915.—The vegetation of the coniferous wood, by George Brown, p. 229-30; Our trees, by W. Botting Hensley, p. 238.

Gardeners' chronicle, May 15, 1915.—*Cupressus lusitanica* var. *benthamii*, by A. Bruce Jackson, p. 259.

Harper's magazine, June 1915.—The last stand of the red-woods, Henry Seidel Canby, p. 46-58.

In the open, April, 1915.—The white pine; what it is, how to plant it, facts about its life and growth, by George H. Wirt, p. 25-9; The league fights forest fires, p. 33-5.

In the open, May, 1915.—White ash, by George H. Wirt, p. 26-9.

Journal of the Association of engineering societies, March, 1915.—Creosoting of cross ties as practiced by American rail roads, by A. C. Steinmayer, p. 110-20.

Journal of the New York botanic garden, March, 1915.—Dwarf evergreens, by George V. Nash, p. 47-61.

Journal of the Washington academy of science, May 19, 1915.—New or imperfectly known species of bull-horn acacias, by Wm. Edwin Safford, p. 355-60.

National wool grower, May, 1915.—"Blanket" system of handling sheep on the Madison national forest, by C. E. Fleming, p. 7-10; Forest and sheep, by D. Howe, p. 39-40.

Reclamation record, June, 1915.—Tree planting, Truckee-Carson project, p. 262-3.

Scientific American supplement, April 24, 1915.—Hour angle observation of polaris by daylight, by Robert V. R. Reynolds, p. 263.

United States.—Department of agriculture. Journal of agricultural research, May 15, 1915.—Wilt of gipsy-moth caterpillars, by R. W. Glaser, p. 101-28.

United States.—Dept. of agriculture. Weekly news letter, May 19, 1915.—Moth injures pine trees, p. 8.

- United States—Dept. of agriculture. Weekly news letter, June 9, 1915.—Seventeen year locusts; brood 6 periodical cicada to appear in eastern states in May and June, p. 1-2.
- United States—Dept. of agriculture. Year book, 1914.—The national forests and the farmer, by Henry S. Graves, p. 65-88; The farm woodlot problem, by Herbert A. Smith, p. 439-56.
- United States—Weather bureau. Monthly weather review, March, 1915.—The influence of a western yellow pine forest on the accumulation and melting of snow, by Alexander J. Jaenicke, p. 115-26.
- Wood preserving, April-June, 1915.—The Galesburg tie plant, p. 19-20; Development of demand for wood blocks, by R.S. Manley, p. 21-2; Piling and marking ties on the Pennsylvania R. R., p. 27-8; Wood block floor in the foundry, p. 31-2.
- Trade journals and consular reports*
- American lumberman, May 15, 1915.—Damage from pin worms and the remedy, p. 22; Wood block's popularity expanding, p. 29; Uniform accounting for lumber producers, by John G. McIntosh, p. 47; Osage orange a good dyewood, p. 52; Starts ranger course; Georgia college will prepare men to be woods' bosses, p. 54.
- American lumberman, May 22, 1915.—Engineer disagrees with new density rule, by Fred J. Hoxie, p. 25; Household uses of wood, by Joseph B. Knapp, p. 47-8.
- American lumberman, May 29, 1915.—Correct way to tax lumber; Seattle concern claims plan will overcome many evils if properly used, p. 45; Increasing the exportation of Douglas fir, p. 52-3; Boosting creosoted wood flooring and paving, p. 55.
- American lumberman, June 5, 1915.—Kiln drying common lumber, by C. C. Bronson, p. 45; Use of electricity in logging and lumbering, by W. E. Herring, p. 48.
- Canada lumberman, May 15, 1915.—The lumber industry of central British Columbia, by F. S. Wright, p. 36-8.
- Canada lumberman, June 1, 1915.—The export trade of Canada in wood goods, by Edward Harper Wade and others, p. 86-7, 100-10, 116-24; European markets and trade customs, by A. E. Trotman, p. 96-8; Great Britain's consumption of timber, p. 112-14.
- Electric railway journal, April 3, 1915.—Tie treating on the Boston and Worcester street railway, p. 678-9.
- Electrical record, March, 1915.—Some uses for wood in the electrical industry, p. 55-7.
- Engineering record, March 6, 1915.—Wood block replaces plank as steel bridge flooring, by Edward Stingel, p. 300.
- Engineering record, March 20, 1915.—Economic considerations justify wood-stave pipe for water-power penstocks, by Robert E. Horton, p. 356-8.
- Engineering record, April 24, 1915.—Forest service suspension bridges in Pacific northwest, p. 529.
- Hardwood record, May 25, 1915.—Man and nature as tree planters, p. 15; An efficient spark arrester, p. 30; Tree dyes of the United States, p. 22.
- Lumber world review, May 25, 1915.—What is the matter with the lumber industry, p. 24-7.
- Lumber world review, June 10, 1915.—What is the matter with the lumber industry, by Carleton H. Parker, p. 23-5; Service is what the lumber consumer wants, by E. A. Sterling, p. 26-7; Portable timber-felling machines for India, by Henry D. Baker, p. 27.
- Mississippi Valley lumberman, May 28, 1915.—The government study of the forest industry, by Austin Cary, p. 39-40.
- Mississippi Valley lumberman, June 4, 1915.—A Canadian view of the future of lumbering, by H. R. MacMillan, p. 37-8.
- Municipal journal, June 3, 1915.—Absorption test for wood blocks, by George W. Tillson, p. 776-7; Sand cushion vs. mortar bed for wood block pavements, by Theodor S. Oxholm, p. 777.
- Pacific builder and engineer, May 15, 1915.—Creosoted and untreated piling on Pacific Coast, by H. E. Horrocks, p. 207-8.
- Paper, May 19, 1915.—New steam-soda process for wood, p. 14-15.
- Paper, May 26, 1915.—Causes of defects in sulphite cellulose, by R. R. Oliver, p. 11; Industrial resources of the south, by Arthur D. Little, p. 12-16, 38.
- Paper, June 2, 1915.—Great Britain's resources in paper material, p. 13-14.
- Paper, June 9, 1915.—Canada's woodpulp production p. 11-13.
- Paper trade journal, May 20, 1915.—Ontario's forest resources, by Julius D. Dreher, p. 38.
- Paper trade journal, June 3, 1915.—National homemaking, by C. J. Blanchard, p. 46-52.
- Pioneer western lumberman, May 15, 1915.—Lumber supply of the United States; comparison of competitive and non-competitive Pacific Coast species, p. 3-4; Some specific information about yellow pine, by G. A. Buell, p. 25; Approved method for laying wood block paving, p. 28.
- Pioneer western lumberman, June 1, 1915.—Wood block paving for bridges, p. 6; Greenheart an unusual wood, p. 7.
- Pulp and paper magazine, May 1, 1915.—Forestry and paper making, by Thos. J. Keenan, p. 267-9.
- Pulp and paper magazine, May 15, 1915.—Measuring the moisture in cellulose, by Otto Nordstrom, p. 290-2; Courses of instruction in paper making in British technological institute, p. 293-7; Manufacture of aniline colors in the United States, by I. F. Stone, p. 298-300.
- St. Louis lumberman, June 1, 1915.—Address delivered before the 6th annual meeting of the Louisiana forestry association, May 7, 1915, by Henry E. Hardtner, p. 66-7.
- Savannah naval stores review, May 15, 1915.—Could the pine tree stand the bleeding strain? p. 3-4.

- Timber trade journal, May 15, 1915.—The forests of Russia, p. 967.
- Timber trade journal, May 22, 1915.—Incense cedar for pencil manufacture, p. 998.
- Timberman, May, 1915.—Efficiency in logging, by W. W. Peed, p. 25-6; Uses for sugar and white pine, by George X. Wendling, p. 27-8; Wood block pavement, by N. E. Ayer, p. 40; Valuable qualities of Montana larch, by A. G. Naundorf, p. 42; Idaho logging flume, p. 48 B-C.
- United States daily consular report, May 19, 1915.—Canadian lumber for United States, by R. M. Newcomb, p. 810.
- United States daily consular report, May 22, 1915.—Wood dishes in Uruguay, by Herman L. Spahr, p. 859.
- United States daily consular report, May 27, 1915.—Market for box shooks in Andalusia, by Wilbur T. Gracey, p. 924-5.
- United States daily consular report, May 28, 1915.—Substitutes for Swedish pine in Brazil, by R. E. Simmons, p. 938-9.
- United States daily consular report, June 12, 1915.—Reforestation of lighthouse reservations, p. 1153; Foreign markets for artificial limbs, by Albert Halstead and others, p. 1154-58.
- United States daily consular report, June 14, 1915.—Forestry and timber in Ireland, by Wesley Frost, p. 1192-6.
- Veneers, June, 1915.—Some information about mahogany, by H. W. M., p. 13-14.
- West Coast lumberman, May 15, 1915.—Logged-off land, by Harry Thompson, p. 33.
- West Coast lumberman, June 1, 1915.—Use of engines in land clearing, by Harry Thompson, p. 39; Exporting North Borneo timber, p. 44.
- Wood turning, June, 1915.—Turning balls and knobs, by Jas. F. Hobart, p. 5-6; Utilization in handle making, p. 11.
- Forest journals*
- Allgemeine forst- und jagd-zeitung, Dec. 1914.—Neuere erfahrungen auf dem gebiete der erforschung und bekämpfung der nonne, by Baader, p. 361-9; Ueber zusammenlegungen und forsteinrichtung, by Hemmann, p. 369-73.
- Canadian forestry journal, May, 1915.—How Switzerland cuts the tax-rate by forest harvesting, by Marie Widmer, p. 66; What Newfoundland does to safeguard her forests, by P. T. McGrath, p. 67.
- Forest and farm, May, 1915.—The farmer's wood lot, by S. T. Dana, p. 71-3; Teaching forestry in the woods, by Charles A. Whittle, p. 73-4.
- Forest leaves, June, 1915.—Value of forests in reducing floods, by C. P. Birkinbine, p. 38-9; A unique pine and spruce planting by James F. Walker, p. 39-40; Jamaica views, by J. T. Rothrock, p. 40; Pennsylvania forestry legislation, p. 43-4; Some tree insect pests, p. 45-6.
- Forestry quarterly, June, 1915.—The forestry situation in Great Britain, by B. E. Fernow, p. 149-53; Normal forest and actual forest; normal growing stock and actual growing stock; normal stand and actual stand, by Filibert Roth, p. 154-62; Further notes on the effect of exposure on white pine seedlings, by E. A. Ziegler, p. 163-70; The management of lodgepole pine, by D. T. Mason, p. 171-82; The subdivision of forests, by J. S. Illick, p. 183-98; Small sale costs on the Apache forest, by Clifford W. McKibbin, p. 199-207; The woodlot problem, by Bristow Adams, p. 208-14; John Muir; and appreciation, by J. D. Guthrie, p. 215-17.
- Forstwissenschaftliches centralblatt, March, 1915.—Das verhalten des holzes gegen eisen, by P. Rohland, p. 109-12; Ueber die bekämpfung des grossen braunen rüsselkäfers, by Franz Scheidter, p. 113-25; Stickstoffdüngungsversuche mit 2 und 4 jährigen fichten und deren wachstumsergebnisse nach der verpflanzung ins freie, by Siefert and Helbig, p. 126-39.
- Forstwissenschaftliches centralblatt, April, 1915.—Schafzucht und waldwirtschaft, by H. Hausrath, p. 152-60; Zur reform der deutschen forstentomologie, by K. Escherrich, p. 161-71; Ueber holzmassenschätzung für zwecke der waldtragsregelung, by Schubert, p. 171-6; Ueber die bedeutung der kameralistischen und der doppelten buchführung in der forstlichen verrechnung, by K. Katzer, p. 176-87.
- Indian forester, April, 1915.—The uniform system in Burma, by H. C. Walker, p. 105-11; Twisted fibres in chir pine, by F. Canning, p. 112-16; A further note on the oil-value of some sandal-woods from Madras, by Puran Singh, p. 123-31.
- Naturwissenschaftliche zeitschrift für forst- und land-wirtschaft, Jan. 1915.—Die eichenmehltau, *Microsphaera alni*, var. *quercina*, by F. W. Neger, p. 1-30; Eine epiphyllische Ulothrix, by A. Eckley Lechmere, p. 30-41; Ueber die keimung einiger baum- und gehölzsaamen, by Wilhelm Kinzel, p. 129-59.
- Naturwissenschaftliche zeitschrift für forst- und land-wirtschaft, April-May, 1915.—Untersuchungen über verzögerte keimung, by Puchner, p. 159-78; Holzerstörende krebse, by Friedrich Moll, p. 178-207.
- Revue des eaux et forêts, April 1, 1915.—L'age des bois et le traitement des forêts, p. 582-96.
- Schweizerische zeitschrift für forstwesen, Dec. 1914.—Weisserle und Tessinkorrektion, by F. Aubert, p. 307-14; Verbau einer rüfe im Jura, p. 314-19; Forstliche studienreise nach Thüringen im Juni 1913, by E. Meyer, p. 320-24; Eidgenössisches forst- und landwirtschaftliches institut, p. 325-6; Der Alpwald, by Merz, p. 327-36.
- Schweizerische zeitschrift für forstwesen, Jan.-Feb., 1915.—Die förderung des plenterwaldes, p. 4-9; Exkursion in die waldungen des Spessart, 12. Juni 1913, by M. Conrad, p. 9-13; Beitrag zu den fragen der ertragsregelung mit besonderer berücksichtigung des schlagweisen hochwaldbetriebes, by F. Gascard, p. 13-24; Sturmschaden in den waldungen der gemeinde Grabs, by R. Rietmann, p. 24-6.

- Schweizerische zeitschrift für forstwesen, Mar.-April, 1915.—Einiges über forsteinrichtung, by Neuhaus, p. 41-4; Nochmals "Die forderung des plenterwaldes, by F. Fankhauser, p. 44-9; Rückblick auf die entwicklung des schweizerischen forstwesens, p. 50-3; Die witterung des jahres 1914 in der Schweiz, by R. Billwiller, p. 57-67.
- Skogen, Feb. 1915.—Barkning av massaved; en fråga av nationalekonomisk betydelse (The barking of pulpwood; a question of national economic importance), by Isaac Ljunqvist, p. 33-42; Om renens användning i skogsbrukets tjänst (Regarding the use of elk in lumbering), by Einar J. Berggren, p. 43-9; 1914 års travarumarknad (Pulp market in 1914), p. 50-4.
- Skogen, March, 1915.—Nagra ord om virkets försäkring, hyvling ock lagring (A few words concerning the sawing, planing and storage of lumber), by Magnus Nordquist, p. 57-71; Nagot om fröträd (Concerning seed trees), by Ake Joachimsson, p. 72-3.
- Skogen, April, 1915.—Skötsel av plantskolor (The care of tree nurseries), by Th. Grinnald, p. 81-104; Om utbuskning av vägar (Marking roads by means of bushes), by Ake Joachimsson, p. 105-7; Om granens s. k. skottfällning och orsaken härtill (Regarding the falling of pine-spruce cones and its causes), by Edvard Wibeck, p. 108-11.
- Skogen, May, 1915.—Tallskytte och snöskytte (Pine fungus and snow fungus), by Torsten Lagerberg, p. 117-26; Blixtens förhållande till olika trädslag (The relation of lightning to various tree species), by Henrik Hesselman, p. 127-35; Flottningskanalen vid Mora (The driving canal at Mora), by Erik Geete, p. 136-40; De insektätande faglarnas betydelse för skogshushållningen (The importance of insect eating birds in relation to forest management), by Ivar Trägårdh, p. 140-8.
- Skogsvårdsföreningens tidskrift, March, 1915.—Taxeringen av Värmlands läns skogar och förslaget till en texering av landets samtliga skogar (Estimate of Värmlands county forests, and suggestions for an estimate of all the country's forests), by Henrik Hesselman, p. 193-232; Lappmarkens utsyningslag (Some observations on Lapland's surveying law), by Einar Hammarstrand, p. 233-42; Barrträdskvalstret, *Paratetranychus ununguis* (The coniferous insect, *Paratetranychus ununguis*), by Ivar Trägårdh, p. 243-6; Skogsbrandsfrågan (The forest fire question), by Otto Hellström, p. 246-8.
- Skogsvårdsföreningens tidskrift, April, 1915.—Några tankar med anledning av domänstyrelsens utlåtande rörande statsrevisörernas uttalanden om hushållningen å statens skogar (A few thoughts with reference to the forest administration's utterances concerning the statements of the commissioners of audit regarding the care of the state forests), by Nils G. Ringstrand, p. 329-51; Synpunkter rörande Lappmarkens utsyningslag (Observations concerning Lapland's surveying law), by Frans Kempe, p. 352-5; Försäkringsinspektionens förslag till obligatorisk skogsbrandförsäkring i statsanstalt (Suggestion of the insurance inspection commission regarding compulsory forest fire insurance for state property), p. 356-67; Norskt skogsbruk sådant det framträdde å jubileumsutställningen 1914 (Norwegian forestry as exhibited at the Centenary exposition, 1914), by Erik Hedemann-Gade, p. 368-90.
- Tidsskrift för skogbruk, April 1915.—Statens skogjop (Purchase of forests by the state) by Ägnar Barth, p. 125-35; Snaasen Grong og Lierne (Conditions in Snaasen, Grong og Lierne), p. 137-9; Om vort lands skogdannende former av alm gran (*Picea excelsa*) og disses større og mindre værdi som skogstraer (Concerning our country's forest forms of Norway spruce and their value as forest trees), by B. Hansteen Cranner, p. 140-58; Produktion av skogfrø (Extraction of forest seed), by O. P. Moe, p. 159-65; Nordlandsloven (The Nordland law), by Henrik Jelstrup, p. 165-7.
- Zeitschrift für forst- und jagdwesen, Jan, 1915.—Karl Fricke, by Alfred Möller, p. 1-8; zur bekämpfung des kienzopfes, by Schultz, p. 8-29; Aufforstung von ödlandereien, by Krause, p. 29-46.

Hamilton Watch

"The Watch of Railroad Accuracy"

Begin to talk accuracy to your jeweler and he'll begin to talk Hamilton to you.

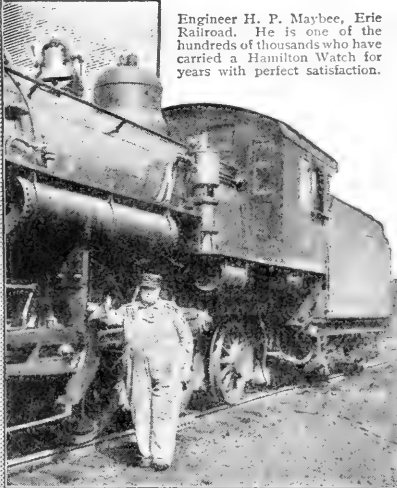

Engineer H. P. Maybec, Erie Railroad. He is one of the hundreds of thousands who have carried a Hamilton Watch for years with perfect satisfaction.

There are thirty models of the Hamilton Watch. Every one has Hamilton quality and Hamilton accuracy. They range in price from \$12.25 for movement alone (in Canada \$12.50) up to the superb Hamilton masterpiece at \$150.00.

Your jeweler can show you the Hamilton you want, either in a cased watch or in a movement alone, to be fitted to any style case you select, or to your own watch case if you prefer.

Write for the Hamilton Watch Book—*"The Timekeeper"*

It pictures and describes the various Hamilton models and gives interesting watch information.

Hamilton Watch Company
Dept. 33, Lancaster, Pennsylvania



TIMBERLANDS FOR SALE

30,000 selected WHITE and CHESTNUT OAK trees
15,000 Selected ASH trees, on 5,000 acres in the State of Virginia, estimated to cut more than 30 MILLION FEET. Balance of timber on this land can be bought cheap. Price of the selected trees, \$2.50 each. This is the greatest bargain we have ever heard of.
6-11 GEORGE J. PHILP, Oil City, Penna.

BARGAIN IN CAROLINA TIMBER

50,000,000 feet original growth timber; 35,000,000 feet North Carolina Pine, Yellow Poplar and Cypress; 15,000,000 feet Red and White Gum, Oak and Ash. Located on Southern Railway. Write for particulars, prices and terms.

J. P. MULHERIN, Augusta, Ga.

NEW RAILROAD VIRGIN TIMBER

We can introduce actual buyers to actual owners of 5,000 to 20,000 acre tracts of excellent Hardwoods (no commissions). Address TRAFFIC DEPARTMENT, Oneida & Western R. R. Co., Second National Bank Building, Cincinnati, Ohio.

FOR QUICK SALE, 25,000 ACRES

of Virgin timber at war prices, includes land and timber, in fee simple. Titles good. Payments reasonable
Address Box 21, Care of AMERICAN FORESTRY.

NEWFOUNDLAND LIMITS.

325,760 acres; ninety-nine year lease; has 304,640,000 feet Pine; 470,400,000 feet Birch; 890,880,000 feet Spruce for lumber; 3,120,600 cords Spruce Pulpwood; and seven (7) thousand horse water power; price \$1.25 cash; or three-fifth interest for 75 cents an acre, half cash.
JOHN A. MOODY, London, Canada.

INTERIOR TRIM PLANT FOR SALE

For quick sale, the best factory in the South for manufacture of furniture or interior trim. Special advantages in rates, taxes, labor, raw material both yellow pine and hardwoods. Plant is new, fireproof and insurance rate is 66 cents per \$100.00. Sale price is less than half the cost. Write for particulars and photographs.

J. P. MULHERIN, Trustee, Augusta, Ga.

TIMBER ESTIMATES

FIRE PROTECTION PLANS

MAPS, LOGGING REPORTS

EMPIRE STATE FORESTERS

156 FIFTH AVE., NEW YORK CITY

Wanted—Trained Forester

With TROPICAL Experience

for work for American interests in Dutch East Indies. State experience and salary expected and when services would be available.

Address Box 50, Care of AMERICAN FORESTRY

BILTMORE TEXT BOOKS

The text books of the Biltmore Forest School, written by Dr. C. A. Schenck, continue for sale at Biltmore. For particulars address BILTMORE FOREST BOOKS, Biltmore, N. C.

SAVE
YOUR
TREE

The New Scientific Discovery
DEXTRO - GERM

Cures and helps the growth of fruit, nut bearing and shade trees.

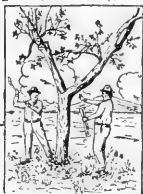

Not a Spray or Fertilizer. A *live bacteria*. A REAL CURE for sick plant life—non-poisonous—easily applied. **Dextro-Germ Kit Complete sent prepaid for \$3.00. Treatment for one large Tree.** Highly endorsed. A real arboreal boon, which means better, bigger, healthier trees and fruit.

FREE Our illustrated booklet "F" on Dextro-Germ and how to save the tree, sent on request.

Dextrogermoform Propagating Company
52 Nassau Street, New York City.

Laboratories, Plymouth, Mass.
Local salesmen wanted.
References required.

DEXTRO
-GERM
DOES IT

The Jacobs Bird-House
Company

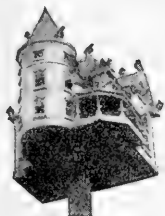

Our Indorsement

The first American enterprise for the manufacture of Bird-Houses and Bird Feeding Devices. Over thirty-two year's experience by the President-Manager.

Eleven beautiful designs for the Purple Martin, \$6.50 up.

The best single room nest-boxes for Bluebirds, Wrens, Tree Swallows, Chickadees, Flickers, Tufted Tits, etc., \$1.00 each, \$9.00 and \$10.00 per dozen.

Sheltered Feeding Devices for Winter Birds, \$1.00 to \$12.00.

Sheltered Suet Baskets, two for \$1.00.
Genuine Government Sparrow Trap, \$4.00 each.
Cement Bird-Baths and Drinking Fountains, four designs.

All direct from our factory to the user. Best products at lowest possible prices. All prices f. o. b., Waynesburg, Pa. Send 10 cents for our latest Bird-House Booklet.

JACOBS BIRD-HOUSE COMPANY

404 South Washington Street, Waynesburg, Pa.

HANDBOOK of TREES

Photo-descriptive and will enable you to identify the trees without a knowledge of botany

AMERICAN WOODS

A publication illustrated by actual specimens

Mounts of Woods for
Lantern

Mounts of Woods for
Microscope

Views of Typical Trees

Showing Habits of Growth, Leaves, Flowers, Fruits, Barks, etc., both as lantern slides and photographs

If you are interested in trees or woods send for full information and free samples

Address

ROMEYN B. HOUGH CO.

BOX 1, LOWVILLE, N. Y.

See Exhibit San Francisco Exposition
Mezzanine Floor of Palace of Education

Do You Love Birds?



Wren House No. 6

Encourage them to live in your Gardens. Use our successful bird houses for Wrens, Chickadees, Blue Birds and Purple Martins. Strongly made—well painted, to resist weather. Prices 35c to \$10.00. Design illustrated \$1.50. Our reliable, wire Sparrow Trap endorsed by U. S. Government \$3.00 F. O. B. Dubuque.

Write for free illustrated Folder No. 233A

Farley & Loetscher Manufacturing Co.
Dubuque, Iowa

Expert Service

*Is Demanded
by Modern
Business
Methods*

E. A. Sterling

FOREST ENGINEER

Commercial Trust Bldg.
PHILADELPHIA, PA.

Forest Engineering

is expert service in the application of scientific and economic engineering knowledge and experience to forests and their products. It is essential to modern timberland ownership and operation, and equally important to the distributor and consumer of wood.

The Field Covers

Technical Advice and Practical Service

in acquiring, estimating and mapping timber; in making valuations; in management; in selling either the stumpage or manufactured product; in selecting grades or kinds to meet your service requirements; and in preservative treatment to prevent decay.

FO 1 RE 2 ST 3 RY 4

The **FOREST** is three-fourths of **FORESTRY**

Your opportunities are as unlimited as our forests if you study at

WYMAN'S SCHOOL OF THE WOODS
Incorporated Munising, Michigan

Timber Cruising Booklets

BILTMORE TIMBER TABLES

Including solution of problems in forest finance.

SOUTHERN TIMBER TABLES

How to estimate Southern Pine, Southern White Cedar, and Southern Appalachian Timber—Spruce pulpwood, Hemlock bark, Chestnut oak bark, Chestnut tannic acid wood.

Postpaid, 25 cents each

HOWARD R. KRINBILL
Forest Engineer Newburn, N. C.

HIGHEST QUALITY LOWEST PRICES QUICK SERVICE

Submit your Engraving propositions to us for suggestions and prices if you want to **SAVE TIME and MONEY**

NATIONAL ENG. CO. INC.
DESIGNERS-ENGRAVERS
506 14TH STREET N W
WASHINGTON, D. C.

**WRITE
CALL
TELEPHONE
MAIN 8274**

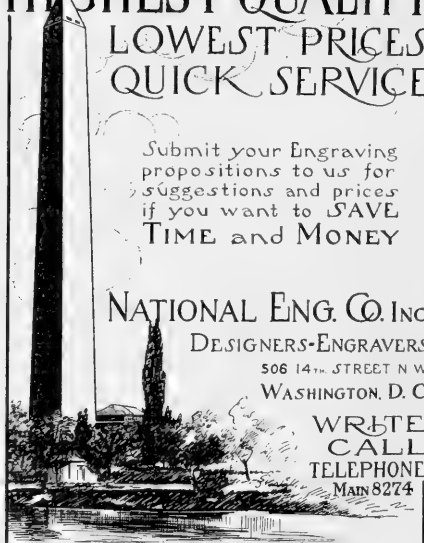

49,000,000 Ft.

National

Forest Timber

For Sale

AMOUNT AND KINDS—49,000,000 feet B. M., more or less, in two separate areas, Cliffs area containing 26,000,000 feet B. M., more or less, of western yellow pine, and Bonita Park area 23,000,000 feet B. M., more or less, of western yellow pine, Douglas fir and white fir timber.

LOCATION—Within the Coconino National Forest, Arizona, Cliffs area in approximately Section 36, T. 21 N., R. 7 E., and Sections 9, 14, 16, 17, 19, 21, 29, 31, 32 and 33, T. 21 N., R. 8 E., G. & S. R. M. and Bonita Park area in approximately Sections 12, 13, 24 and 25, T. 23 N., R. 7 E., and Sections 10, 15, 16, 17, 18, 19, 20, 21, 22, 26, 27, 28, 29, 30, 31, 32 and 33, T. 23 N., R. 8 E., G. & S. R. M.

STUMPAGE PRICES—Lowest rates considered for Cliffs timber \$3.75 per M., and for Bonita Park timber \$2.00 per M. Rates to be readjusted every three years.

DEPOSIT—With bid \$5,000.00, to apply on purchase price if bid is accepted, or refunded if bid is rejected. Ten per cent may be retained as forfeit if the contract and bond are not executed within the required time.

FINAL DATE FOR BIDS—Sealed bids will be received by the District Forester, Albuquerque, N. Mex., for either or both areas, up to and including July 20, 1915.

The right to reject any and all bids is reserved. Before bids are submitted full information concerning the character of the timber, conditions of sale, deposits and the submission of bids should be obtained from the District Forester, Albuquerque, New Mexico, or the Forest Supervisor, Flagstaff, Arizona.

Harvard University

SCHOOL OF FORESTRY

OFFERS specialized graduate training leading to the degree of Master of Forestry in the following fields:—Silviculture and Management, Wood Technology, Forest Entomology, Dendrology, and (in cooperation with the Graduate School of Business Administration) the Lumber Business

For further particulars address

RICHARD T. FISHER, Chairman
Cambridge, Massachusetts

GEORGIA

State Forest School

University of Georgia

COMplete four-year undergraduate course in theoretical and applied forestry leading to the degree:

Bachelor of Science in Forestry

¶ Wide range of specialization offered—

Logging Engineering
Commercial Administration
Forest Management

City Forestry **State Forestry**
Dendrology **Research**

¶ Provision for four months field work—two following each of Freshman and Sophomore years—on McHatton Forest, a large forest estate in the Blue Ridge Mountains. Numerous excursions in Dendrology and Logging. Provision for practical work in specialization during Junior-Senior vacation

For announcement address

FOREST SCHOOL
Georgia State College of Agriculture
ATHENS, GEORGIA

Yale University Forest School

NEW HAVEN, CONN., U. S. A.

YALE University Forest School is a graduate department of Yale University. It is the oldest existing forest school in the United States and exceeds any other in the number of its alumni. A general two-year course leading to the degree of Master of Forestry is offered to graduates of universities, colleges and scientific institutions of high standing and, under exceptional conditions, to men who have had three years of collegiate training, including certain prescribed subjects. Men who are not candidates for the degree may enter the School as special students, for work in any of the subjects offered in the regular course, by submitting evidence that will warrant their taking the work to their own advantage and that of the School. Those who have completed a general course in forestry are admitted for research and advanced work in Dendrology, Silviculture, Forest Management, Forest Technology, and Lumbering. The regular two-year course begins the first week in July at the School camp near Milford, Pennsylvania.

For further information address

JAMES W. TOUMEY, Director
NEW HAVEN, CONN.

In the National Forest Region

Colorado School of Forestry

A DEPARTMENT OF
COLORADO COLLEGE

THE course in theoretical and applied forestry leading to the degree of Forest Engineer covers a period of two years and is open to students who have completed two years of college work, including a sufficient amount of Botany, Geology and Surveying.

Graduate students may enter as candidates for the degree of Master of Forestry.

Fall and Spring Terms in the Manitou Forest, the College Reserve, 6,000 acres of pine and spruce timberland on the borders of the Pike National Forest. Winter Term at Colorado Springs.

For particulars address
Colorado School of Forestry
Colorado Springs, Colo.

Special Courses offered in

LUMBERING *and* WOOD UTILIZATION, PULP and PAPER MAKING

Other Special Courses in Forestry

Men with technical training along the lines of Lumbering and the various branches of Wood Utilization will be needed in the future.

Four and five year students in these courses will have constant access to the new Eastern Forest Products Laboratory.

**The New York
State College of Forestry**
At Syracuse University
Syracuse, N. Y.

DEPARTMENT OF FORESTRY

The Pennsylvania State College

A PROFESSIONAL course in Forestry, covering four years of college work, leading to the degree of Bachelor of Science in Forestry.

Thorough and practical training for government, state, municipal and private forestry.

Four months are spent in camp in the woods in forest work.

Graduates who wish to specialize along particular lines are admitted to the "graduate forest schools" as candidates for the degree of Master of Forestry on the successful completion of one year's work.

For further information address,

Department of Forestry
PENNSYLVANIA STATE COLLEGE
State College, Pa.

ECONOMY

STRENGTH

DURABILITY

WORKABILITY

BEAUTY and

AMPLE SUPPLY

ALL COMBINED IN

Yellow Pine Lumber

The "Wood of a Thousand Uses"

If you want to know more about it
A CARD ADDRESSED TO US WILL BRING RESULTS

Our Own Mills Cut 275,000,000
Feet Annually

**MISSOURI LUMBER AND LAND
EXCHANGE COMPANY**

1111 Long Building :: KANSAS CITY, MO.

“The only time I ever lost money on a timber investment was when I did not make the investment,” said a lumberman who owned billions of feet of choice stumpage.

An excellent way for you to lose money is not to buy timber NOW.

A few choice tracts of timber of excellent quality, blocked up by men who expected to cut it themselves, are on the market.

There are not many of them, but the offerings are sufficiently attractive to make investigation worth while.

Write us about your needs.

James D. Lacey & Company **Timberland Factors**

CHICAGO, ILL., 1750 McCormick Building

PORTLAND, ORE., 1313 Northwestern Bank Building

SEATTLE, WASH., 1009 White Building

A
Cc
—

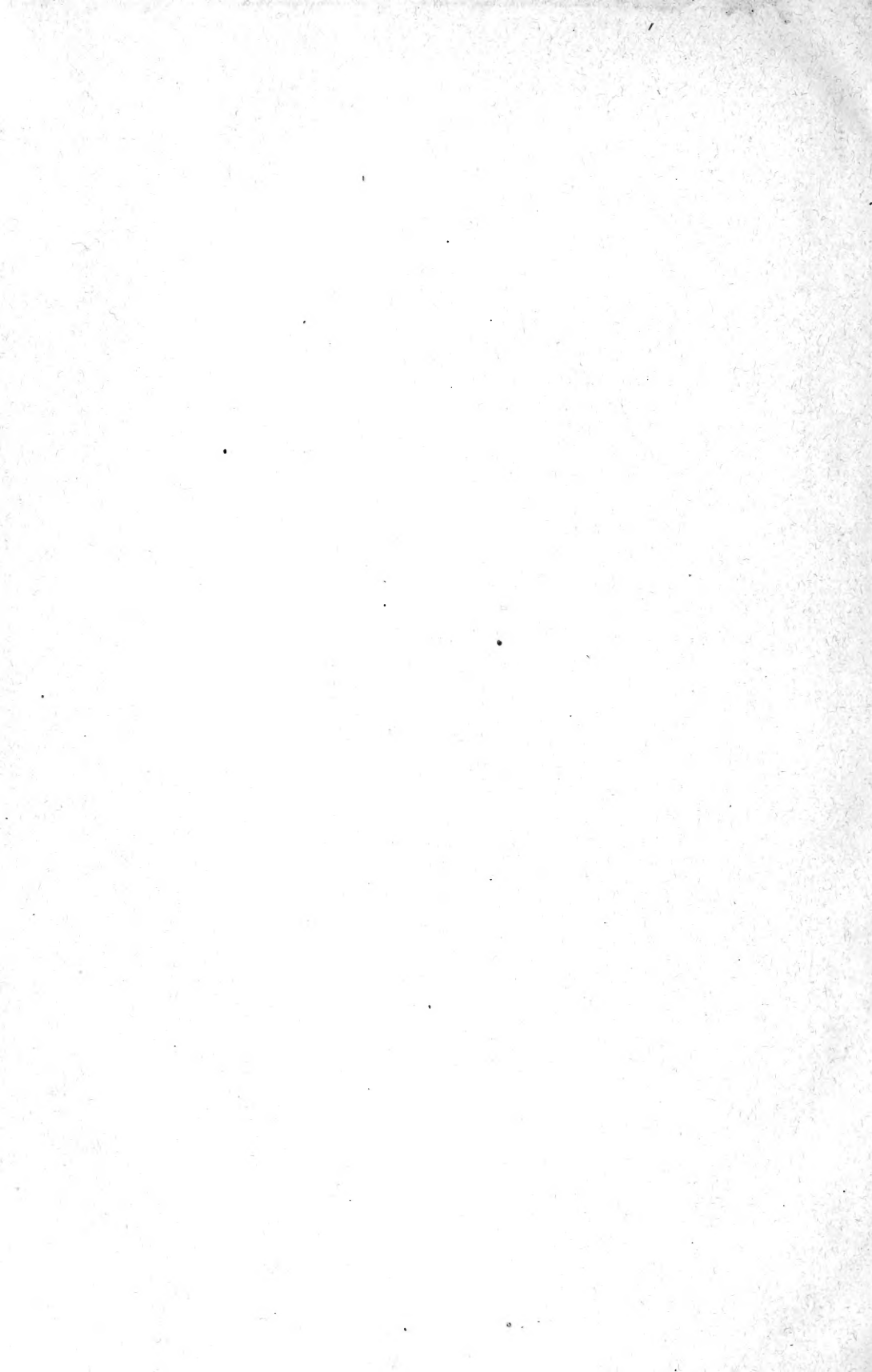



3 5185 00258 19

