



29

1

789

THE AMERICAN JOURNAL
OF
PHYSIOLOGY

EDITED FOR

The American Physiological Society

THE
AMERICAN JOURNAL
OF
PHYSIOLOGY

VOLUME XXXII

1327.5
—
16 | 5-14

BOSTON, U. S. A.

1913

QP
1
A5
v.32
cop.2

COPYRIGHT, 1913
BY THE PLIMPTON PRESS

THE PLIMPTON PRESS
NORWOOD MASS U.S.A

CONTENTS

NO. I, MAY 1, 1913

	PAGE
THE RELATION OF OSMOTIC PRESSURE TO ABSORPTION PHENOMENA IN THE DOG FISH. <i>By G. G. Scott and W. Denis</i>	1
A DEFINITE PHYSICO-CHEMICAL HYPOTHESIS TO EXPLAIN VISUAL RESPONSE <i>By Leonard T. Troland</i>	8
THE UNIFORM RATE OF THE DESTRUCTION OF PEPSIN BY THE PASSAGE OF THE DIRECT ELECTRIC CURRENT. <i>By W. E. Burge</i>	41
THE EFFECT OF ADRENAL SECRETION ON MUSCULAR FATIGUE. <i>By W. B. Cannon and L. B. Nice</i>	44
THE RECEPTIVE RELAXATION OF THE COLON. <i>By Henry Lyman.</i>	61
REMARKS ON THE ORIGIN OF THE PHRENIC NERVE IN THE RABBIT, CAT, AND DOG. <i>By Abby H. Turner</i>	65
ON THE RELATION OF PULSE PRESSURE TO RENAL SECRETION. <i>By Robert A. Gesell</i>	70

NO. II, JUNE 2, 1913

DIRECT AND CROSSED RESPIRATION UPON STIMULATION OF THE PHRENIC, THE SCIATIC, AND THE BRACHIAL NERVES. <i>By W. T. Porter and Abby H. Turner</i>	95
CARBON DIOXIDE PRODUCTION FROM NERVE FIBRES WHEN RESTING AND WHEN STIMULATED; A CONTRIBUTION TO THE CHEMICAL BASIS OF IRRITABILITY. <i>By Shiro Tashiro</i>	107
A NEW METHOD AND APPARATUS FOR THE ESTIMATION OF EXCEEDINGLY MINUTE QUANTITIES OF CARBON DIOXIDE. <i>By Shiro Tashiro.</i>	137
STUDIES ON THE PHYSICAL PROPERTIES OF PROTOPLASM. I. THE PHYSICAL PROPERTIES OF THE PROTOPLASM OF CERTAIN ANIMAL AND PLANT CELLS. <i>By G. L. Kite</i>	146

NO. III, JULY 1, 1913

ON THE RELATION OF THE BLOOD SALTS TO CARDIAC CONTRACTION. <i>By E. G. Martin</i>	165
---	-----

	PAGE
THE SUGAR CONSUMPTION IN NORMAL AND DIABETIC (DEPANCREATED) DOGS AFTER EVISCERATION. <i>By J. J. R. Macleod and R. G. Pearce</i>	184
ON THE FORMATION OF FAT FROM CARBOHYDRATES. <i>By Sergius Morgulis and Joseph H. Pratt</i>	200
THE ACTION OF THROMBOPLASTIC SUBSTANCE IN THE CLOTTING OF BLOOD. <i>By F. W. MacRae, Jr., and A. G. Schnack</i>	211

No. IV, AUGUST 1, 1913

STUDIES IN FATIGUE. I. FATIGUE AS AFFECTED BY CHANGES OF ARTERIAL PRESSURE. <i>By Charles M. Gruber</i>	221
ON CERTAIN DISTINCTIONS BETWEEN TASTE AND SMELL. <i>By George Howard Parker and Eleanor Merritt Stabler</i>	230

No. V, SEPTEMBER 2, 1913

IS THE PRESSOR EFFECT OF PITUITRIN DUE TO ADRENAL STIMULATION. <i>By R. G. Hoskins and Clayton McPeck</i>	241
CONTRIBUTIONS TO THE PHYSIOLOGY OF THE STOMACH. V. THE INFLUENCE OF STIMULATION OF THE GASTRIC MUCOSA ON THE CONTRACTIONS OF THE EMPTY STOMACH (HUNGER CONTRACTIONS) IN MAN. <i>By A. J. Carlson</i>	245
RAPID METHOD OF PREPARING THROMBIN. <i>By W. H. Howell</i>	264
THE RELATION OF METATHROMBIN TO THROMBIN. <i>By F. W. Weymouth</i>	266
ON THE ABSORPTION OF WATER BY THE SKIN OF THE FROG. <i>By S. S. Maxwell</i>	286

No. VI, OCTOBER 1, 1913

PHYSIOLOGICAL OBSERVATIONS FOLLOWING DESCENT FROM PIKE'S PEAK TO COLORADO SPRINGS. <i>By Edward C. Schneider</i>	295
THE EFFECT OF WATER INGESTION ON THE FATTY CHANGES OF THE LIVER IN FASTING RABBITS. <i>By M. R. Smirnow</i>	309
ON THE INFLUENCE OF MUSCULAR EXERCISE ON THE ACTIVITY OF BULBAR CENTRES. <i>By E. G. Martin and C. M. Gruber</i>	315

No. VII, NOVEMBER 1, 1913

	PAGE
ELECTROMYOGRAM STUDIES:	
I. ON SOME TECHNICAL PROCEDURES IN THE USE OF THE EINTHOVEN GALVANOMETER. <i>By Charles D. Snyder</i>	329
II. ON THE TIME RELATIONS AND FORM OF THE ELECTRIC RESPONSE OF MUSCLE IN THE SINGLE TWITCH. <i>By Charles D. Snyder</i>	336
THE ENDURANCE OF ANEMIA BY NERVE CELLS IN THE MYENTERIC PLEXUS. <i>By W. B. Cannon and I. R. Burket</i>	347
EVIDENCE OF FAT ABSORPTION BY THE MUCOSA OF THE MAMMALIAN STOMACH. <i>By Charles W. Greene and William F. Skaer</i>	358
CONTRIBUTIONS TO THE PHYSIOLOGY OF THE STOMACH:	
VI. A STUDY OF THE MECHANISMS OF THE HUNGER CONTRACTIONS OF THE EMPTY STOMACH BY EXPERIMENTS ON DOGS. <i>By A. J. Carlson</i>	369
VII. THE INHIBITORY REFLEXES FROM THE GASTRIC MUCOSA. <i>By A. J. Carlson</i>	389
THE TONUS AND HUNGER CONTRACTIONS OF THE EMPTY STOMACH DURING PARATHYROID TETANY. <i>By A. J. Carlson</i>	398
THE EFFECT OF PITUITARY EXTRACT UPON RENAL ACTIVITY. <i>By C. E. King and O. O. Stoland</i>	405

No. VIII, DECEMBER 1, 1913

A METHOD OF EXCLUDING BILE FROM THE INTESTINE WITHOUT EXTERNAL FISTULA. <i>By Richard M. Pearce and A. B. Eisenbrey</i>	417
A COMPARISON OF THE AUSCULTATORY BLOOD PRESSURE PHENOMENON IN MAN WITH THE TRACING OF THE ERLANGER SPHYGMOMANOMETER. <i>By Arthur W. Weyssse and Brenton R. Lutz</i>	427
STUDIES IN FATIGUE: II. THE THRESHOLD STIMULUS AS AFFECTED BY FATIGUE AND SUBSEQUENT REST. <i>By Charles M. Gruber</i>	438

INDEX	451

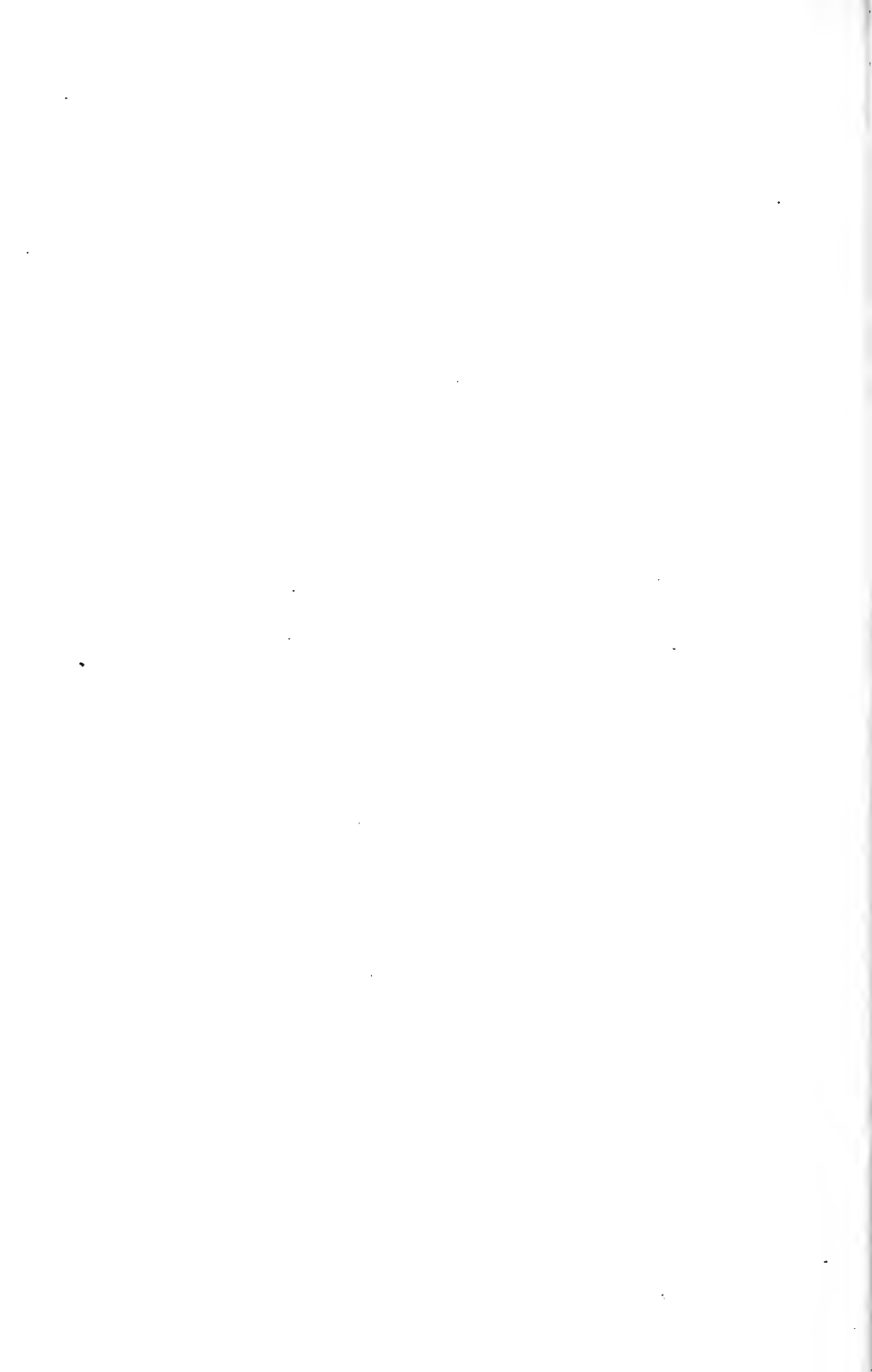

THE
American Journal of Physiology

VOL. XXXII

MAY 1, 1913

NO. I

THE RELATION OF OSMOTIC PRESSURE TO ABSORPTION PHENOMENA IN THE DOG FISH

BY G. G. SCOTT AND W. DENIS

[From the Laboratory of the U. S. Bureau of Fisheries, Woods Hole, Mass.]

ALTHOUGH much work has been done on problems relating to the absorption of inorganic salts, dye stuffs etc. by the skin and mucous membranes of mammals, and the excretion of the same in the urine, but little attention has been directed to this function in marine animals. In connection with the work of one of us (Scott) regarding the behavior of the Elasmobranchs when placed in diluted and concentrated sea water, it occurred to us that it might be of interest to see whether foreign materials such as salts etc. dissolved in the sea water would follow the same laws as apparently apply to the absorption of water. As it has been shown by Botazzi '06 and others that the blood of Elasmobranchs is about equal in its osmotic pressure to that of the sea water in which they live, and as it is known that fish of this group will survive, for a time at least, considerable changes in the concentration of this medium, the problem of the absorption is simpler in such a case than in that of the Teleosts.

The smooth dog fish "*Mustelus canis*" was used in all our experiments, care being taken in every case to use animals in good condition showing no trace of any abrasion of the skin or mucous membranes.

Throughout our work the following procedure was employed: First, in all animals the spinal cord was destroyed to about the level of the anterior dorsal fin. The fish was then made to swallow a large

bolus of absorbent cotton saturated with olive oil; to this bolus a long thread was attached so that after the former had passed into the stomach, gentle tractions on the thread would serve to bring the bolus into the viscus. By this device it was possible as was proved by numerous tests to prevent the entrance of any fluid into the stomach. The fish after being subjected to the above treatment was then placed tail up in a tall narrow glass jar of about five litres capacity containing three litres of water and inclined at an angle of about forty degrees. A current of air kept continually bubbling through the water in the jar prevented asphyxiation of the animal. The fish when placed in the jar in the manner described above could be maintained for hours in such a position that only the head was under water. If some nontoxic substance for the qualitative detection of which a delicate method is available be now mixed with the sea water in the jar it is possible to measure the absorption of this body from the water under various experimental conditions. Under the experimental conditions outlined above three membranes are exposed to the substance whose absorption is to be observed, viz., the skin of the head, the mucous membrane of the mouth and pharynx, and the gill membranes. As will be shown later on we feel we can surely exclude the skin of the dog fish from any participation in the absorption phenomena taken up in this paper. Regarding the relative importance on the one hand of the buccal mucous membrane and on the other of the gill membranes as paths of absorption we can only say that the evidence presented by Bert '71, Mosso '90, Sumner '06 indicate the gill membranes to be the seat of osmotic exchange. In a paper to be published soon,¹ one of us (Scott) will cite experiments which show that *Mustelus* with its œsophagus ligated, and the head as far back as the fifth gill slit immersed in fresh water, exhibits as great a change in the osmotic pressure of the blood as when the entire fish is immersed in the experimental solution. In the latter case the skin of the body, the intestinal tract, the gill membranes are freely exposed to the experimental medium. In the former case it is the gill membranes which are the chief membranes exposed. Since as great a change occurs in the latter case, the author (Scott) taking into account all the other evidence offered, feels that the only conclusion to be drawn is that the gill membranes constitute by far

¹ Annals N. Y. Academy of Sciences.

the chief passageways through which the substances in the present instance pass into the blood. We however, do not entirely disregard the possibility that the mucous membrane of the mouth and the pharynx, which like the gill membrane is continually bathed in the medium, may in part at least be responsible for absorption phenomena, but are satisfied that these membranes at the most are concerned only to a nominal degree. In our first experiments we sought to learn whether foreign substances introduced into the sea water but prevented from reaching the stomach could be detected in the body fluids, more especially the coelomic fluid, blood and urine, and the influence if any produced on such absorption by changes in the concentration of the sea water. The urine was collected by means of a canula tied into the urinary papilla. The method of obtaining urine was outlined by Denis '12. Samples of blood were obtained from the caudal artery.

ABSORPTION OF METHYLENE BLUE

Experiment I. — Fish 4, length 83.5 cm.; weight 2009 gm. After pithing the animal, tying a canula in the urinary papilla and causing the animal to swallow a bolus of absorbent cotton, the fish was placed in a jar containing three litres of sea water and 90 mg. of methylene blue. After nine hours the animal while apparently still in good condition was killed. The volume of urine collected during this period amounted to 4 c.c. only and contained no trace of methylene blue.

Experiment II. — Fish 2, length 71 cm.; weight 1047 gm. This animal was placed for four hours in a mixture of one and one half litres of sea water and one and one half litres of distilled water to which had been added 90 mg. of methylene blue. At the end of this time the urine was of a distinct green tinge showing that some of the dye stuff had undoubtedly been absorbed.

ABSORPTION OF BORIC ACID

Experiment III. — Fish 42, length 76 cm.; weight 1641 gm. This animal was placed for four hours and fifteen minutes in sea water to which had been added 0.3 gm. boric acid per litre. The volume of urine collected amounted to about 1 c.c. Urine, blood, coelomic fluid and stomach contents all gave negative results when tested for the presence

of boric acid by means of turmeric paper. This test was carried out directly in all the fluids with the exception of the blood; in this case precipitation of the greater part of the coagulable protein was secured by allowing the blood to flow into about three times its volume of 95 per cent alcohol. After standing for about an hour the coagulum was filtered off and the filtrate after evaporation almost to dryness on the water bath was tested for boric acid as described above.

Experiment IV. — Fish 43, length 68 cm.; weight, 1188 gm. This animal was placed for four hours and fifteen minutes in a mixture of one volume of distilled water to which had been added 0.3 gm. boric acid per litre. The volume of urine collected amounted to 5 c.c. Boric acid was found to be present in the urine and blood, but could not be detected either in the stomach or in the coelomic fluid.

ABSORPTION OF POTASSIUM IODIDE

Experiment V. — Fish 22, length, 88.5 cm.; weight, 1358 gm. This animal was placed for four and one half hours in sea water to which had been added potassium iodide in a concentration of 1 gm. per litre. At the end of the experiment the presence of potassium iodide could be demonstrated in the blood but not in the urine (volume about 1 c.c.), coelomic fluid or stomach contents. The test used for the detection of potassium iodide was the familiar starch paste reaction, the fluid under examination being first treated with a few drops of a concentrated solution of potassium nitrate and a little concentrated hydrochloric acid. Before applying the test to blood the latter was first coagulated with alcohol as described above.

Experiment VI. — Fish 15, length, 78 cm.; weight, 1670 gm. This animal was placed for two hours and twenty minutes in a mixture of one volume sea water and one volume distilled water to which had been added 1 gm. of potassium iodide per litre. At the end of the experiment the animal was still alive and in good condition; this experiment was continued for a shorter time than the preceding one in which undiluted sea water was used, as experience had taught us that if the dog fish be allowed to remain too long in diluted sea water, bleeding at the gills may at times ensue. The urine (volume 5 c.c.), blood and coelomic fluid of this animal all showed the presence of potassium iodide. None was found in the stomach.

Experiment VII. — Fish 7, length, 78 cm.; weight, 2773 gm. This animal was placed for three hours and fifty minutes in sea water which had been concentrated by evaporation until it had obtained a specific

gravity of 1.035, and to which had been added potassium iodide in a concentration of 1 gm. per litre. At the end of this time no potassium iodide could be detected in the urine (volume about 1 c.c.); coelomic fluid or stomach contents; the blood gave a positive test.

All of the experiments described above have been repeated several times but as in every case results practically identical with those reported have been obtained it seems useless to take up further space to report them in detail.

As the absorption phenomena described in this paper occur largely by way of the gill membranes, in order to prove definitely that the skin of the dog fish does not in any way act as a path of absorption for salts etc., we have performed the following experiments.

Experiment VIII. — Fish 62, length, 73 cm.; weight 1075 gm. The cord of this animal was destroyed up to the level of the dorsal fin, the opening in the skin made by the pithing was carefully covered with a collodion dressing, and the fish then placed tail down in a tall narrow jar containing a 0.1 per cent solution of potassium iodide in sea water. A piece of rubber sheeting with an opening in the centre was then placed around the animal just below the gills, the edges of the rubber being tightly bound to the jar and the whole immersed in a large tank of sea water. By means of this device the epidermis covering two thirds of the body, and the mucous membrane of the cloaca are bathed in a solution of potassium iodide while the gills and mucous membranes of the mouth and pharynx are prevented from coming in contact with the salt. After thirty-five minutes blood drawn from the dorsal aorta gave no test for potassium iodide.

In another fish treated in the same way, in which the sea water was diluted with an equal volume of distilled water, a similar negative result was obtained.

It has been found by Scott that if the dog fish be placed in diluted sea water, water is absorbed by the animal, the osmotic pressure, the nitrogen and salt content of the blood decreases; by our results it would seem that at the same time salts and-so-forth might be absorbed, and absorbed with greater ease when the animal is surrounded by a medium of less osmotic pressure than its own blood. To further elucidate this point it has seemed worth while to make a few observa-

tions regarding the actual rapidity of absorption of potassium iodide by the dog fish under various osmotic conditions of the external medium. All experiments on this subject were carried out under the conditions described above except that no attempt was made to collect the urine.

It was our object in this series of experiments to determine as nearly as possible the actual time required by a fish immersed in a sea water solution of potassium iodide to absorb a sufficient quantity of this salt to enable it to be detected in the systemic blood. After pithing, the tail of the animal was therefore removed and the caudal artery closed by means of a small plug in such a way that the latter could be easily withdrawn when it was desired to collect samples of blood. The amount of blood taken for each test was five cubic centimetres which was allowed to flow into three times its volume of 95 per cent alcohol. The method used for the detection of the iodide has already been described. Taking in each case the average of several determinations it was found that when the head of the dog fish is immersed in sea water containing one gram of potassium iodide per litre this salt can be detected in the blood within four to five minutes. If, as the external medium, we use sea water diluted with its own volume of distilled water, absorption can be demonstrated in two minutes, while if the medium consists of sea water concentrated to a specific gravity of 1.035 (the specific gravity of sea water being 1.025) no potassium iodide can be detected in the blood until the expiration of nine to ten minutes. In all of these experiments the stomach was tested for the presence of potassium iodide but invariably with negative results.

Certain theoretical considerations seem to be of interest here. It has been said that the gill membranes are by all means the chief structures concerned in these absorption phenomena. In the experiments showing the relation of the time of absorption to the concentration of the external medium it would appear that the physical laws of diffusion suffice to explain the results. On the inner side of the gill membranes is the blood which contains no potassium iodide. Outside the membranes the potassium iodide is in solution along with other solutes. In every case the osmotic pressure of potassium iodide in the blood is zero while outside the gill membranes its osmotic pressure is considerably above zero. So that in every solution in

which it is dissolved, namely sea water, hypotonic sea water and hypertonic sea water, the potassium iodide will pass into the blood. Its action is independent of the other solutes in the external medium. But in the case of the potassium iodide dissolved in the diluted sea water there is simultaneously a rapid movement of water into the blood through the gill membranes and this will accelerate the movement of the salt. In the hypertonic solution there is a rapid movement outward of water and this outward going stream will retard the inward movement of the potassium iodide.

PAPERS CITED

- BERT, P.: *Comptes rendus de l'académie des sciences*, 1871, lxxiii, p. 382.
BOTTAZZI, F.: *Archivio fisiologia*, 1906, iii, p. 416.
DENIS, W.: *Journal of biological chemistry*, xiii, 1912-1913, p. 225.
MOSSO, A.: *Biologisches Centralblatt*, 1890, x, p. 570.
SUMNER, F. B.: *Bulletin of the United States Bureau of Fisheries*, 1905, xxv, p. 53.

A DEFINITE PHYSICO-CHEMICAL HYPOTHESIS TO EXPLAIN VISUAL RESPONSE

BY LEONARD T. TROLAND

[From the Biological Laboratories, Massachusetts Institute of Technology.]

I. THE PRESENT-DAY SITUATION IN VISUAL PHYSIOLOGY

Although Essential, an Adequate Theory of Visual Response Does Not Exist. — The progress of modern physics has conclusively proven that there is but one way in which we can develop a systematic account of the phenomena natural to a particular field of scientific investigation: we must advance structural hypotheses of such a character as to provide us with a basis for the deduction of these phenomena in accordance with known dynamical laws. The field of visual physiology is one which embraces a large variety of closely interconnected and very definitely observable processes, and it is one in which — it would seem — the speculative method could be applied with great advantage; but the fact remains that in spite of the repeated efforts which have been made in the direction of an hypothesis to explain the phenomena of visual response, there is extant to-day no system which is capable of doing this. As a result visual physiology is in a state which may not unfairly be characterized as chaotic; chaotic in the lack of organization among its constituent and varied facts, and chaotic in the disagreements of its special authorities.

Necessity of a Physical Viewpoint. — It is the belief of the present writer that most of the extant theories of visual response — e.g., those of Hering, Donders, Mrs. Ladd-Franklin, etc. — err in a quantitative rather than in a qualitative way; they are on the right track, but have failed in progressiveness. It seems inconceivable that we should be able to develop a satisfactory theory of the nature of visual response, if we neglect to consider the properties of radiant energy and the mechanism of its interaction with matter in general,

as these are revealed by modern researches. It is also incredible that we should obtain such a theory without close attention to the fundamental laws of chemistry as these are exemplified or are exemplifiable in the physiological processes of the retina. And yet, so far as the writer has been able to discover, the extant hypotheses of visual response involve only very vaguely, or not at all, the salient concepts and principles of modern theoretical physics and chemistry. Hence it is the purpose of the present paper to indicate — of course, very schematically — the possible fruitfulness of the application of these concepts and principles to the speculative field in question. It is perhaps impossible to overemphasize the importance of the physical viewpoint in respect to the attainment of any finally satisfactory notion of the mechanism of visual — or, in fact, of any other physiological — processes; if we believe, as we profess, that life is an organic complex of physical and chemical reactions, we must surely be intellectually blind if, in the theoretical study of these reactions — or of life — we overlook the fundamentals of the electrical and molecular conception of matter and of energy.

The Extant Hypotheses. — The extant hypotheses concerning the mechanism underlying visual sensation may be divided into three classes: the mechanical, the chemical and the electrical. Among the mechanical hypotheses we may count the original proposals of Young,¹ the views of Charpentier,² G. Stanley Hall,³ William Patten,⁴ Antoine Pizon,⁵ H. M. Bernard,⁶ Adolph Stöhr,⁷ and others. In each of these hypotheses it is supposed that molar masses of matter — of microscopic size —, fibrillae, granules, etc., are set into vibration by the action of the light waves which impinge upon the retina,

¹ YOUNG, THOMAS: *Lectures on Natural Philosophy*, 1807, London.

² CHARPENTIER, AUGUSTIN: *La lumière et les couleurs*, 1888, chap. xii, pp. 265-294.

³ HALL, G. STANLEY: *Proceedings of the American Academy of Arts and Sciences*, 1878, xiii, p. 402.

⁴ PATTEN, WILLIAM: *American Naturalist*, 1898, xxxii, pp. 832-857.

⁵ PIZON, ANTOINE: *Comptes rendus, Académie des sciences*, 1901, cxxxiii, pp. 835-837.

⁶ BERNARD, H. M.: *Annals and Magazine of Natural History*, 1896, xvii, pp. 162-167.

⁷ STÖHR, ADOLPH: *Zur Hypothese der Sehstoffe und Grundfarben*, 1898, Leipzig. Cf. LADD-FRANKLIN, C.: *Psychological Review*, 1900, vii, p. 415.

these vibrations forming the essence of the response. Much more closely in line with the probabilities of the case are the chemical theories, the most important of which are the Young-Helmholtz,⁸ Hering,⁹ and Ladd-Franklin¹⁰ hypotheses. Derivatives of these are to be found in the suppositions made by A. König,¹¹ H. Ebbinghaus,¹² G. E. Müller,¹³ F. C. Donders,¹⁴ Schenck,¹⁵ Wundt¹⁶ and J. von Kries.¹⁷ Chemical hypotheses have also been advanced by F. W. Edridge-Green,¹⁸ E. R. Oppolzer,¹⁹ and W. Preyer.²⁰ While differing with respect to details, these theories all agree in supposing that the light rays act upon molecular, rather than upon molar units of matter. Framed more with reference to electro-physiological phenomena than with respect to the electro-magnetic character of light are the electrical hypotheses of Edridge-Green,²¹ Preyer,²² William

⁸ HELMHOLTZ, H. VON: Handbuch der physiologischen Optik, 3rd edition, 1911, ii, pp. 119 ff.

⁹ HERING, EWALD: Grundzüge der Lehre vom Lichtsinn, 1905 and 1907, Leipzig. Also: Lehre vom Lichtsinne, 1878, Vienna.

¹⁰ LADD-FRANKLIN, CHRISTINE: Zeitschrift für Psychologie und Physiologie der Sinnesorgane, iv, pp. 211-221.

¹¹ KÖNIG, A. and DIETERICI, C.: Zeitschrift für Psychologie und Physiologie der Sinnesorgane, 1893, iv, pp. 241-348. Also in: Sitzungsbericht, Akademie der Wissenschaften, Berlin, 1886, pp. 805-830.

¹² EBBINGHAUS, H.: Zeitschrift für Psychologie und Physiologie der Sinnesorgane, 1893, v, pp. 145-238.

¹³ MÜLLER, G. E.: Zeitschrift für Psychologie und Physiologie der Sinnesorgane, 1896-1897, x, pp. 1 and 321; xiv, pp. 1 and 161.

¹⁴ DONDERS, F. C.: Graefe's Archiv für Ophthalmologie, 1881, xxvii, 1, p. 55.

¹⁵ SCHENCK, F.: Archiv für die gesammte Physiologie, 1907, cxviii, pp. 129-181.

¹⁶ WUNDT, W.: Physiologische Psychologie, 1893, i, p. 535.

¹⁷ KRIES, J. VON: Zeitschrift für Psychologie und Physiologie der Sinnesorgane, 1899, xix, pp. 175-191. See also: *ibid.*, ix, p. 81.

¹⁸ EDRIDGE-GREEN, F. W.: The Hunterian Lectures on Colour-vision and Colour-blindness, delivered before the Royal College of Surgeons of England, Feb. 1 and 3, 1911; 1911, London.

¹⁹ OPPOLZER, E. R. VON: Zeitschrift für Psychologie und Physiologie der Sinnesorgane, 1902, xxix, pp. 183-203.

²⁰ PREYER, W.: Archiv für die gesammte Physiologie, 1881, xxv, p. 31.

²¹ See reference 18, *supra*.

²² PREYER, W.: Zeitschrift für Psychologie und Physiologie der Sinnesorgane, 1894, vii, p. 241.

Peddie,²³ G. G. Stokes²⁴ and William Nicati.²⁵ In addition to these there exist two theories based upon purely optical considerations; these have been published by Göller²⁶ and G. Darzens.²⁷ The most important of the above mentioned hypotheses are adequately presented in current text-books of physiology, and hence even if space permitted it would be supererogatory for us to review them here.

Weaknesses of Extant Visual Hypotheses. — The most general criticism which can legitimately be made of the above listed theories is that of inexactness and superficiality. In the present paper we shall pass by as unworthy of notice all attempts to justify hypotheses upon a purely pragmatic basis; the view that scientific hypotheses are *merely* aids in the systematization of phenomena may to-day be regarded as irrelevant, if not antique. If any hypothetical account of the mechanism of visual response is to be seriously considered it must employ the definite structural and quantitative concepts of theoretical physics and chemistry, and the dynamical interactions which are involved must not only lead deductively to results which explain the psycho-physical phenomena, but they must be consistent with the other logical contents of the "universe of discourse" which they are forced to enter. Now none of the extant visual theories fulfill these requirements. Most of them are not only vaguely formulated, and contain no distinct reference to general physics and chemistry — to say nothing of the special physical chemistry of light and of nervous response — but they often flatly contradict both physical and physiological principles. The physical conception of *resonance* lies at the bottom of practically all of the hypothetical accounts which have been given of the process of visual stimulation; but it requires only a very simple calculation to show that if any microscopically

²³ PEDDIE, W.: Proceedings of the Royal Society of Edinburgh, 1903, xxiv, pp. 448-449.

²⁴ STOKES, G. G.: Nature, 1895, liii, pp. 66-68.

²⁵ NICATI, W.: La psychologie naturelle, 1898, Paris. Also: Archives d'ophthalmologie, 1895, xv, pp. 1-44.

²⁶ GÖLLER: Du Bois-Reymond's Archiv, 1888.

²⁷ DARZENS, G.: Comptes rendus, Académie des sciences, 1895, cxxi, pp. 133-135. Reference should here also be made to the recent electro-optical hypothesis of MEISLING, A. A.: Zeitschrift für Sinnesphysiologie, 1907, xlii, pp. 229-240; especially as interpreted by E. B. Holt, in "The New Realism," 1912, New York, pp. 312 ff. The present writer has not seen Meisling's article.

observable structure is to resonate in tune with even the longest light waves the material substance involved must possess a modulus of elasticity two hundred million times greater than that of hard-drawn steel.²⁸ This is a *reductio ad absurdum* of all theories of mechanical visual stimulation which depend upon resonance, and as yet there has appeared but one theory of any sort (the theory of Darzens, *supra*) which does not employ this latter principle, either explicitly or implicitly. A second and conclusive objection to all purely mechanical hypotheses is to be found in the certainty that light can act directly only upon electrical, and not upon neutral mechanical, structures. Accordingly, we are led from molar to molecular systems, from mechanical to chemical hypotheses, and there can be little doubt that here we have entered the appropriate field of investigation. Light is known to originate in processes of chemical change, and even if we had no empirical evidence of photo-chemical resonance, we should be amply justified in the supposition that molecular systems are of the right magnitude to make possible such a selective response. Moreover, at the present time, we have every reason for believing that the forces of chemical affinity are actually electrical in nature, so that the electrical forces of the light ray may be expected to bring about the chemical decomposition of the sensitive molecules. Now nearly any one of the thirteen distinctively chemical hypotheses of visual response which we have mentioned above may be accepted as providing us with a satisfactory general schema of the actual process of the response. But at this point their excellence is apt to end; none of them follows out in detail the obvious implications of the electro-chemical viewpoint, and only a few of them appear to have been construed in their particulars with careful and comprehensive reference to the actual phenomena of visual sensitivity, whether these phenomena be psychological or physiological. In explanatory value the hypothesis of Hering is undoubtedly superior to any other extant theory, but in its (pseudo-)chemical, physiological and psychological aspects

²⁸ The formula used in this calculation was:

$$Y = \frac{4\pi^2 k^2 ML}{\lambda^2 a}$$

the force on the vibrating particle being $-Mkx$, where x is its displacement. L and a are the dimensions of the elastic structure. For a wave-length of $750 \mu\mu$, Y (Young's modulus) = 17×10^{21} .

it is guilty of all manner of offense against fact and reason. The scientific value of the more consistent Young-Helmholtz hypothesis, on the other hand, is at the present time almost negligible; it explains only the most rudimentary of the phenomena of visual sensation. That the ultimately successful doctrine as to the nature of the visual mechanism must involve the concept of electricity is made obvious by the fact that light is an electro-magnetic process, and consequently can react only with electrical or magnetic systems, as well as by the facts of retinal and general nerve physiology, which all point to electrical factors in stimulation. Never-the-less the extant theories which make use of electrical conceptions are perhaps the most unsatisfactory and vaguest of all, quite failing to take into consideration the established nature of electricity and its relationship with matter. Therefore, in view of the tremendous strides which have been made during the past twenty years in our knowledge of the general physics of light, chemical action, and physiological response, it seems advisable that something be attempted in the way of a rectification of that chaos of visual theory which has arisen in so unpredictable manner from the epoch-making work of Helmholtz. The present paper purports to be modest in its attitude, if not in its intentions.

II. THE PSYCHOLOGICAL ANALYSIS AND PSYCHO-PHYSICS OF VISUAL SENSATION

The Elementary Visual Sensation and its Attributes.—The problem of the theory of visual response is complicated by the fact that the latter includes within its field that greatest of all philosophical enigmas, the psycho-physical relation. However physiological in its intent, no hypothesis of visual response can neglect to consider the facts of visual psychology, for it is towards the explanation of these facts that the theory ultimately turns. If we assume the subjective standpoint of introspective psychology, we find that the concrete subject-matter with which we have to deal is the individual *visual field*, with its qualitative and quantitative modifications, and we may, for convenience, describe the abstract content of any *point* in this field as the *elementary visual sensation*, S. Now the exact character of S may vary both quantitatively and qualitatively, and

by studying these variations introspectively we find that they involve six distinct qualities: red, R; green, G; blue, B; yellow, Y; black, B; and white, W; not all of which, however, can be present simultaneously. Let us denominate these six qualities, the *fundamental attributes* of S, and as they may exist in varying intensities, their *degrees* may be symbolized by the letters: r, g, b, y, b and w, respectively. These quantitative terms will be spoken of as *redness*, *greenness*, etc. It is the opinion of the writer that these are the basic factors of the psychology of visual sensation, and that no others are involved; the "brightness" of Hering's theory is merely a whiteness conceptually modified to meet the demands of the hypothesis, or else it is a perceptual element, misplaced.²⁹

The Schematic Relations of the Attributes.—A study of the modes of occurrence of the fundamental attributes of S reveals the following correlations: (1) if $g > 0$, $r = 0$; (2) if $y > 0$, $b = 0$; and, conversely: (3) if $r > 0$, $g = 0$, and (4) if $b > 0$, $y = 0$. In other words, the *hues*: R and G, and Y and B, are mutually exclusive, or "antagonistic."

The hues can be arranged in the cyclic order: $\begin{matrix} \diagup B \diagdown \\ R \quad G \\ \diagdown Y \diagup \end{matrix}$ in which

adjacent qualities will fuse, while opposite ones exclude, or cancel each other. The attributes W and B seem to lie outside of the cycle above represented, and in such a way that W may be added to any possible combination of hues, while B is present in strict proportion to the absence of R, G, B, Y, and W, so that we may write: $b = k - (r + g + b + y + w)$ where k is a constant. These relations are geometrically schematized in the well-known "color pyramid," and they are derived from a purely subjective, or non-physical, examination of the elementary sensation.

General Explanation of the Psycho-physical Situation.—The problem now arises as to the manner in which we shall conceive the relationship which exists between S and the physical processes of response. Corresponding with any specified elementary visual sensa-

²⁹ The exact manner in which the six "attributes" of the visual sensation may be discriminated from each other has been elaborately discussed by the author in his Massachusetts Institute of Technology (Boston) bachelor's thesis: "Studies in the Theory of Visual Response," 1912, section IX. This work is not published, but is on file in the Biological Library of the Institute.

tion, there exists what we may describe as an elementary visual response, V , which can be analyzed into five parts, succeeding each other in time, as follows: (1) the stimulus, P ; (2) the stimulation, or retinal process, R ; (3) the afferent nerve impulse, I ; (4) the central brain process, C ; and (5) an efferent impulse, M . Now in the ordinary theory of psycho-physical parallelism it is asserted that S , although not a part of V , occurs simultaneously with, and as a constant function of C . From the modern panpsychic or "psychical-monistic" standpoint, however, it appears more likely that in any actual case of observation, C would lag slightly behind S in time, since the entire series, V , is regarded as being merely a perceptual or conceptual representation, in the consciousness of the physiological observer, of an objective, non-physical, process of which S is an integral part.³⁰ This objective series of events, which may be called Q , corresponds, point for point, with V , and in such a manner that S , the elementary visual sensation, finds its physical representation in C , the elementary visual cerebration. The postulates of psychical monism, like those of a non-critical parallelism, permit us to write: $C=f(S)$, since the essence of the panpsychic doctrine lies in the supposition that the observable physical world is causally conditioned by the objective or parapsychical world.

Specific Psycho-physics of Visual Sensation. — Since it has been found that the elementary visual sensation, S , may exhibit six distinct attributes, it follows from the relation, $C=f(S)$, that C , also, has a six-fold attributive character. Let us designate the factors in question as follows: $C_r, C_g, C_b, C_y, C_o, C_w$. These terms must evidently be related with R, G, B, Y, O, W , in the following manner: (1) $c_r=f(r)$, (2) $c_g=f(g)$, (3) $c_b=f(b)$, (4) $c_y=f(y)$, (5) $c_o=f(o)$ and (6) $c_w=f(w)$, the lower-case letters being employed to indicate the quantitative expression for the qualities, entities or processes which are qualitatively symbolized by the corresponding upper-case letters. For simplicity's sake, we shall assume in the following discussion that all of the functional relations above represented may be regarded as proportionalities of such a sort that, $c_g=g$, etc. Any error involved

³⁰ An adequate idea of the philosophical position of "psychical monism" can be obtained from Wm. MacDougall's recent book: "Mind and Body," chapter on "automaton theories." A more elaborate discussion appears in C. A. Strong's "Why the Mind has a Body" (N. Y., 1903).

by this assumption will be such as to not materially affect the general validity of our argument; moreover it is, for several reasons, the most probable hypothesis.

III. OUTLINE OF A DEFINITE PHYSICO-CHEMICAL THEORY OF VISUAL RESPONSE

Argument from the Physical Nature of Light. — We found that the principal objections which can be raised against a mechanical hypothesis of visual response lie in the fact that mechanical systems are not of the right order of magnitude to resonate in tune with light, and that, as a rule, molar masses of matter do not bear the free electrical charges which are essential in order that the forces of the light ray should grip them. In the molecule, however, we find both of the above indicated requirements quite perfectly fulfilled (*cf.* page 12 *supra*); we have good reason for declaring that many, if not all, chemical molecules are electrical dyads made up of positively and negatively charged atoms or radicles which can be separated from each other by the action of electrical forces. Suppose that we consider a certain molecule, M , which is composed of the positive and negative parts: I_+ and I_- , respectively. Then since the system is not a rigid one, I_+ and I_- will be capable of vibrating with respect to each other with a certain natural frequency, n . Now if n is also the frequency of some light ray which impinges upon M , the molecule will resonate with respect to this ray, so that under the proper conditions, the constantly increasing amplitude of vibration will result in a final disruption of the molecule. I_+ and I_- , in the free state, are ions, and the process initiated by the light is, accordingly, one of *ionization*.

Mechanism of Visual Stimulation. — The above argument of course contains nothing of novelty from the general physical point of view, but if we apply it to the physiological case of visual response we arrive at the conclusion that in all probability *the immediate effect produced by light upon the retina consists in an increase in the ionization of certain specific chemical substances there present*. Now in harmony with what we know concerning the probable localization of the light sensitivity in the retinal elements, let us suppose that these substances, which may be designated in general by M , are enclosed in

the terminal segments of the rod and cone cells.³¹ Now the most recent, and thus far the most successful hypothesis to explain the nerve impulse is that of W. Nernst,³² especially as elaborated by A. V. Hill³³ and R. S. Lillie,³⁴ and in accordance with this hypothesis, the stimulation of nervous tissue is conditioned by an increase in the ionic concentration of its native dissolved substances, or by some equivalent process. It appears, then, that besides corresponding in a general way with the recognized physiological phenomena of electrical variation in the stimulated retina,³⁵ our deductions with reference to the intimate nature of the retinal response are quite in harmony with what now appears to be the correct view concerning the fundamental nature of protoplasmic stimulation and conduction. Certain substances contained in the terminal segments of the rods and cones suffer increased ionization under the influence of light, and this increased ionization, *via* the mechanism of the Nernst hypothesis (*vide infra*), initiates the visual impulse in the contiguous nerve fibres.

Exact Mechanism of the Visual Impulse. — Previous to becoming acquainted with the Nernst hypothesis, the present writer was led, on purely speculative grounds,³⁶ to make the following definite assumptions concerning the mechanism of the visual impulse. (1) The visual impulse consists in an actual propagation of the positive ion, I_+ , from the rod and cone cells along the optic nerve and tract, to the cerebrum (especially to the neurons of the cuneus in the cerebral cortex). (2) This propagation takes place with the speed of the visual impulse, and occurs within the neuro-fibrils, which are “to be thought of as *molecular tubes*, specialized protoplasmic structures within which it is possible for even single ions to travel without encountering great

³¹ The author has discussed the problem of the localization of the sensitive structures in the retina, in the work above referred to, section XVIII. A large number of independent considerations make it impossible to deny that the rods and cones contain the immediately stimuable elements of the retina.

³² See: NERNST, W.: *Archiv für die gesammte Physiologie*, 1908, cxxii, pp. 275-315.

³³ HILL, A. V.: *Journal of Physiology*, 1910, xl, pp. 190-224.

³⁴ LILLIE, R. S.: *This Journal*, 1911, xxviii, pp. 197-223.

³⁵ The original memoir in this field is that of JAMES DEWAR and J. G. MCKEN-DRICK: *Transactions of the Royal Society of Edinburgh*, 1873, xxvii, p. 141.

³⁶ The writer's “Thesis,” already cited, section XXI.

resistance. (3) The manner in which an individual ion or a group of ions may be imagined to be propagated . . . will be described as follows. The non-fibrillar portion of the nerve fibre is made up of a mixture of substances certain of which are ionized, and others of which are capable of constituting an osmotic membrane which normally is equally permeable to the positive and to the negative ions. However, when a positive ion comes into contact with one of the neuro-fibrils the surrounding neural substance acquires a slight differential permeability, so that the negative ions are capable of moving within it more readily than are the positive ions. This being the case, the loss of negative ions into the surrounding tissues — say into the myelin sheath, when this is present — results in the development of a positive charge within the core itself. The original positive ion thus finds itself placed within the influence of a positive electrical field. Since this is a state of disequilibrium, if the ion is free to move — and if, as will be the case, its charge is much smaller than that produced in the nerve — it will travel in one direction or the other along the neuro-fibril. If we suppose the ion to have had an original impetus in the afferent direction, it will move in this sense. The resulting process is obvious. As soon as the ion has moved into a new region of the nerve fibril the permeability of the neural substances about it for negative ions will be altered as before, a new state of disequilibrium will be produced and the process will be repeated, the ion moving continuously in one direction within the fibril.” The mechanism above described may be aptly characterized as an *electrical peristalsis*, and is capable of being historically regarded as return to the view of Descartes³⁷ with reference to the functioning of the motor nerves. At first sight it appears very improbable that any such bodily transfer of the ions as is above imagined should occur; it is well known that the average velocity of ions moving in solutions is about one centimetre per hour (with a potential gradient of a volt per centimetre), whereas the nerve impulse in man travels 125 metres per second, or about 800,000 times as fast. On the other hand, the negative ions of a Crookes tube or from radium have a velocity often 30,000 times that of the nerve impulse. If we suppose nervous tissue to be specially organized for conduction purposes, no general objection can be raised

³⁷ In his essay entitled, “L’homme.” Cf. HOWELL, W. H.: A Text-book of Physiology, 1909, p. 111.

to the rapid motion of chemical ions within it, for no cause appears why special structures may not reduce the resistance encountered, to practically the zero point. As we shall see, the hypothesis as it stands, possesses great explanatory power, and hence should be retained as long as it proves consistent with known physical and biological principles.³⁸ The electro-peristaltic hypothesis makes use of the essential mechanism of the Nernst theory, viz., the presence and action in irritable structures of osmotic membranes endowed with variable differential permeability with respect to the positive and negative constituents of the native electrolytes of the tissues, and the dependence of the selective permeability of such membranes upon their state of polarization, i.e., upon the relative concentration of positive or negative ions in their vicinity. The hypothesis as above stated (quoted from the writer's Massachusetts Institute of Technology thesis, 1912) does not coincide in every respect with the mechanism described by Lillie³⁴ as that characteristic of general cell irritability and conductivity; it is, however, strictly analogous with the latter; and at the present stage of development of the theory it is gratuitous to suppose that the reactions of all tissues are strictly identical, although the general relationships involved are probably universal. The detailed analysis of the structures and processes implied by the electro-peristaltic hypothesis of the visual — and other — impulses shows that the mechanism in question will insure continuous afferent conduction, corresponding at each instant with the intensity of the force acting uniformly upon the sense-organ; the Nernst theory, alone — like the artificial stimulation of nerve fibres under laboratory conditions — gives conduction only when *changes*

³⁸ The electro-peristaltic hypothesis when applied to other departments of sense and neurology proves equally fruitful in explanations. Consider, for example, its bearing upon the singular fact that the only sensory nerves, the olfactory, whose ends are unprotected, yield a different sense quality for every specific stimulus; our interpretation would obviously be that the stimulating molecules (ions) are transported bodily to the brain. The excitation of muscular tissue, on the other hand, can be attributed, on the basis of this hypothesis, to the transmission of small quantities of oxidases or similar enzymes along the motor fibres. The hypothesis also provides a simple explanation for sleep, memory, the delay of the impulse at the synapses, the psycho-physics of affective states, the "Ritter-Valli law," and other psycho-physiological facts.

³⁴ LILLIE, R. S.: This Journal, 1911, xxviii, pp. 197-223.

in the nature of the stimulus take place. The laboratory results, however, are also entirely consistent with our hypothesis.

Nature and Relations of the Visual Cerebrosis. — The general nature of the visual cerebrosis, C , follows at once from our account of the mechanism of the impulse. The *cerebral state corresponding with any condition of retinal stimulation consists simply in the presence in the cerebral cells of the specific ions which are liberated in the retina by the action of the light.* The physics of this correlation is made so obvious by our hypothesis concerning the nature of the visual impulse that it requires no expository comment. In the preceding section of this paper we have given reasons for supposing that the visual cerebrosis possesses six more or less independent aspects, which we have symbolized as $C_r, C_g, C_b, C_y, C_b,$ and $C_w,$ respectively. We have already stated the hypothetical psycho-physics of these terms, and at present it only remains to indicate their physiological connections. The character of these connections is perhaps obvious. It is clearly implied by the fundamentals of our theory that for each of these components there must be a corresponding — and materially identical — component in the visual impulse, so that the constitution of the latter may be represented as: $I = I_r + I_g + I_b + I_y + I_b + I_w.$ Moreover, it is further implied that the retinal process, R , has a similar division. Now with one reservation, this may be taken to mean that there are contained in the external segments of the rods and cones, specific ionizable chemical substances corresponding with each of the components of the visual cerebrosis. The one exception is the case of C_b , which in view of our psychological equation: $b = k - (r + g + b + y + w)$ (*cf.* page 14) may be taken to represent the *absence of ionic charge* in the appropriate cerebral elements. Thus we arrive at the conclusion that there exist in the retina five distinct visual substances: $M_r, M_g, M_b, M_y,$ and $M_w;$ these the writer has denominated *molecular resonators*, because they are selectively ionized by lights of specific and differing wave-length, or frequency, and their intrinsic positive ions, $I_{r+}, I_{g+}, I_{b+}, I_{y+},$ and $I_{w+},$ are the exact psycho-physical correlatives of the fundamental visual qualities, $R, G, B, Y,$ and $W,$ respectively.

The Mechanism of Complementation. — In order to take in account the “antagonistic” relations which exist between the hues (*cf.* page 14), it is necessary to make the following additional hypothe-

sis, which is independent of those already stated, but which can be justified upon developmental grounds.³⁹ Within the large "ganglion" cells of the inner stratum of the retina there must be supposed to exist a certain substance which we may call the complementation substance. The component molecules of this complementation substance are made up of a nucleus and two side-chains; each of these side-chains is a potential negative ion, the nucleus itself being a doubly charged positive ion. Of these molecules there are two varieties. The first is so constructed chemically that its two negatively charged ionic side-chains are capable of combining simultaneously, but not separately, with the two positive ions of the visual impulse: I_{r+} and I_{g+} . The second reacts in a similar way with the visual ions: I_{y+} and I_{b+} . The result is that in each case the positively charged nuclei of the molecules are set free and become a part of the impulse, as it is passing through the ganglion cells. We may speak of the two substances above described as the R-G-complementation substance and the Y-B-complementation substance, respectively. If the R-G-complementation molecule, M_{crg} , has the constitution $M_{crg} = I'_{r-}(I_{w++}) I'_{g-}$, the *complementation reaction* for the ions, I_{r+} and I_{g+} may be written as follows:

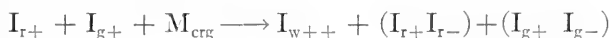

only I_{w++} , of course, entering the impulse. As indicated by its subscript, $I_{w++} = 2I_{w+}$.

Mathematical and Other Special Properties of the Molecular Resonators.—We shall assume that the five specific molecular resonators, whose presence in the retinal end-cells has been postu-

³⁹ There is reason for believing that color-vision is a secondary sexual character. (Consider, for example, the fact that color-blindness is forty times more common in males than in females.) We must suppose that the complementary colors once represented antagonistic motor tendencies of approach and retreat (love and repulsion), and that the purpose of the complementation reaction is to eliminate the conflict which would thus otherwise arise between two opposed reflexes when, as in white light, both "colors" are physically present at once. On this basis, of course, we must assign to the mechanism a very ancient lineage. Let us note in passing that the "complementation molecule" has all of the properties of an Ehrlich amboceptor, and hence may be thought of as a common type of physiological molecule.

lated, are so distributed that under normal conditions each of the *cones* contains M_r , M_g , M_b and M_y in equivalent concentrations, while M_w is contained only and alone, in the *rods*. M_w we shall suppose to be identical with the familiar *visual purple*. Now since under the action of the light — and even, as we shall see, apart from this — the molecular resonators are constantly being destroyed, there must exist corresponding anabolic reactions which continually build them up. Like all specific organic reactions, these must be under the control of appropriate *enzymes*, which we shall designate as *aesthesogenases*, the substrates⁴⁰ upon which these enzymes operate being called *aesthesogens*. Each molecular resonator must be conceived to possess a characteristic set of properties and auxiliaries. Perhaps the most important conception which we must apply is that of specific *concentration*, which may be expressed in terms of molecules per retinal element (rod or cone), the concentration of M_n being symbolized by m_n . Under the action of light, or even in its absence, M_n will be decomposing at a definite rate, which may be written as $dm_n/dt = \dot{m}_n$; this has the abstract significance common in chemical kinetics.⁴¹ Another characteristic of each resonator must be its *light sensitivity*, q_n , which is the equivalent of dm_n/de , where e is the intensity of the light falling upon the molecule. This constant is related with the specific *resonance function*, which is of the type: $\dot{m}_n = f_{n\lambda}(\lambda)$, and shows how the number of molecules broken down per second varies with the wave-length of the impinging light. The general form of resonance functions (as determined by dynamical reasoning) is illustrated in the separate curves of Fig. 4. The decomposition: $M_n \longrightarrow I_{n+} + I_{n-}$ may be regarded as the analytic aspect of what we shall call a *resonance reaction*. This reaction, like all of its species, is reversible, and under equilibrium conditions, the reverse change must at any instant be equal to the forward one, so that the position of the equilibrium point will obviously determine the *percentage ionization* of the resonator at that instant. We have every reason for supposing that this will not be zero even in the absence of light and consequently

⁴⁰ *I.e.*, the specific substances whose reaction velocities are accelerated by the presence of the enzyme.

⁴¹ *Cf.* Encyclopaedia Britannica, 11th ed., vi, p. 27, for a discussion of the theory involved.

we are forced to define for each molecular resonator a specific *normal ionization*; the effect of the introduction of a light ray into this chemical system is merely to *increase the reaction constant of the disintegrative or ionizing reaction*. We have already spoken of the aesthesogens and these must be supposed to enter into a synthetic reaction which produces the molecular resonators, as follows:

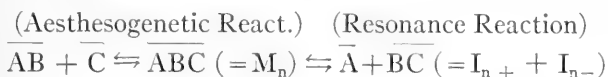

\overline{AB} and \overline{C} being the aesthesogens which are specific for M_n . The aesthesogenetic reaction, conformably with our symbolism, need not be ionic.

Mathematical Properties of the Visual Impulse. — It is only reasonable to suppose that the number of ions leaving a retinal element, *via* the neuro-fibrillae, per second is proportional to the number present, or to the concentration, and it is obvious that what may be designated as the *intensity* of the impulse, or the number of ions passing through any cross-section of the nerve fibre per unit of time, will depend upon the number leaving the retinal element and the number *lost* in the process of conduction. If we symbolize a component of impulse intensity by ι_n , we may write: $\iota_{nr} = k_n i_{n+}$, where ι_{nr} is the impulse intensity *at the retina*, and i_{n+} is the concentration of positive ions of the species I_{n+} in the same region, and k_{nr} is a constant. The generalized impulse intensity, ι , will, of course, have five components: $\iota = \iota_r, \iota_g, \iota_b, \iota_y,$ and ι_w . Another quantitative conception involved in the notion of visual conduction is that of *impulse loss*; we must suppose that at the synapses, and possibly at other places, some of the traveling ions are permanently lost from the neuro-fibrils. The specific rate of loss at any point in the path of conduction may be symbolized by η_n . The visual cerebrosis, as we have stated, is merely a concentration of the impulse and hence must depend for its intensity, c , — the number of ions per cortical element — upon the intensity of the visual impulse *at the cortex*. If we make the only probable assumption, that the rate of diffusion of ions from the cortical element is proportional at any time to the number present, we get for equilibrium conditions the following relation: $c_n = \iota_{nc}/k_{nc}$, where c_n is a component of cerebrosis inten-

sity, ι_{nc} the corresponding impulse intensity at the cortex and k_{nc} a constant.⁴²

IV. THE EXPLANATION OF CERTAIN VISUAL PHENOMENA

The Problem of the Explanation of Visual Phenomena. — The purpose of an hypothesis concerning the intimate mechanism of the visual response is simply to enable us to *explain* the manifold phenomena of that response, that is, to permit us to deduce from the hypothesis, as combined with general principles of science and of thought, certain conclusions which coincide with the facts of the particular field which the hypothesis enters. The presumption is that an hypothesis which is completely successful as a basis for explanation can only be one which describes or represents the “real” unseen mechanism. The present section of our paper will be devoted to a very cursory presentation of some of the many theoretical consequences to be drawn from the definite physico-chemical theory of vision outlined on the preceding pages.

The Electrical Phenomena in the Stimulated and Unstimulated Eye. — We have supposed that the rods and cones of the retina are the seats of the production of an equal number of positive and negative ions, and that, of these ions, the former are propagated along the optic nerve in the form of the visual impulse. It follows that the negative ions remain unneutralized in the bacillary layer. Since the state of ionization at the retina is not quantitatively zero even in the absence of all light stimulus, it follows that if we examine a fresh and even unstimulated eye we should find the cut surface of the optic nerve to be positive with respect to the layer of rods and cones, the latter being negative. Experiment shows this to be the case.⁴³ The fact that the inner layers of the retina are normally positive with respect to the cut surface of the optic nerve may be explained by supposing that there is a large *impulse loss* (of the positive ions) in

⁴² The first proportionality takes the form: $\psi^n = k_{nc}c$, where ψ_n is the rate of diffusion referred to. But at equilibrium the income of the cortical element must equal its outgo, or the impulse intensity at the cortex, $\iota_{nc} = \psi_n$, from whence the given relation is obtained.

⁴³ An excellent brief account of the electrical phenomena of the eye is given by RIVERS, W. H. R.: *A Text-book of Physiology*, edited by E. A. Schaefer, 1900, Edinburgh and London, ii, pp. 1050 ff.

the synapses of these layers (*cf.* page 23). This corollary also accounts for the negativity of the outer as compared with the inner strata, and of the nerve as compared with the ocular media and cornea. When light falls upon the retina, our postulates demand an immediate increase in the ionization of the molecular resonators in the rod and cone layer, the consequence of which is an increase in the impulse intensity, an increased impulse loss in the synaptic strata, and an increased positivity of the optic nerve endings. If the entire retina is illuminated, the first electrical effect will be an increase in the negativity of the bacillary layer, owing to the departure of a larger number of positive ions per element of time. The second electrical effect will be an augmented positivity of the synaptic layers, owing to the discharge of the above mentioned positive ions into this region. These ions will in part be picked up by the fibrils of the optic nerve fibres, with the result that an increased positivity of the cut surface of this nerve will ensue. Coincident with this, however, there will be a still greater enhancement of the positivity of the ocular media, and hence of the cornea, by virtue of the increased impulse loss. We expect, therefore, that the incidence of light at the retina will result in a positive variation of the current normally established between the cornea of the eye and the cut surface of the nerve, and that with an injured retina this will be immediately followed by a negative variation. Both of these expectations are fulfilled by experimental data.⁴⁴ When the stimulus is removed the flow of positive ions along the nerve will immediately decrease, but on account of its relatively great mass the charge of the ocular media will be only slowly lost; consequently the removal of the stimulus will effect a second "positive variation," as shown by experiment. Lack of space, alone, forbids a more detailed study of the electrical phenomena of the stimulated and unstimulated eye on the basis of our hypotheses.

The Physiology of Visual Thresholds. — The explanation of many important factors in visual physiology involves the conception of *threshold differences*; these are physical quantities which are capable of inducing a specified *just perceptible* sensory change. We may suppose that the perception or "discrimination" of such change is paralleled psycho-physically by the automatic reaction of a certain cortical element, Z_{cd} , which takes place whenever there occurs a

⁴⁴ RIVERS: *loc. cit.*, p. 1051.

change in a specific component of the cerebrosis intensity, equal to Δc_n . On the basis of our postulates it can be shown that the corresponding change, Δt_{nr} in the impulse intensity at the retina, will be proportional to Δc_n , but the concomitant liminal alteration, Δm_n , in the rate of ionization of the molecular resonators in the cones will be proportional, as we shall shortly see, to some complex function: $f_n^a(c_n + \Delta c_n) - f_n^a(c_n)$. It is clear that *thresholds for light intensity*, Δe , will depend, other factors constant, upon the light sensitivity, q_n , (*cf.* page 22) of the corresponding molecular resonators, M_n , so that $\Delta e = \Delta \dot{m}_n / q_n$. Thresholds for changes in *wave-length* must be conditioned by the form of the resonance function in such a way that: $\Delta \lambda = \Delta \dot{m}_n / f'_{n\lambda}(\lambda)$, for a specific limited range of wave-lengths, $f'_{n\lambda}$ being the first derivative of the resonance function (*cf.* page 22). By the use of our conception of impulse loss in the synaptic regions of the retina, and of the brain, and an application of the general principles of diffusion it is possible to show that a correlation should exist between the retinal *area* stimulated and the intensity of light required to just produce sensation. These deductions with reference to area thresholds are in accordance with the empirical determinations of Abney⁴⁵ and others; lack of space prevents their exposition here. By similar means we may explain with exactness the relation which exists between the intensity threshold for a given region and the state of stimulation of outlying regions of the retina. It is obvious that the concentration of the molecular resonators, m_n , must be involved in the determination of all of the visual thresholds. The psycho-physics of the thresholds is made too obvious by our postulates to require discussion ($\Delta n = \Delta c_n$, *cf.* pages 15-16).

The Explanation of Certain Temporal Relationships of Stimulus and Sensation. — It is well known that in order that a given light stimulus should produce visible effects it must act upon the retina for a certain minimum period, the magnitude of which is partly determined by the intensity of the light. For the production of a sensible change our theory demands merely that the per cent ionization of the molecular resonators in the rods or cones should be increased by a certain definite amount, and it is obvious that the increase brought

⁴⁵ ABNEY, W. DE W.: Proceedings of the Royal Society, London, 1897, lxi, p. 330.

about by a given stimulus will be strictly dependent upon the *quantity of energy* absorbed by the rod or cone, so that it becomes possible to write the following expression for an *energy threshold*: $\Delta(tae)$, where a is the cross-section of the light ray passing through the rod or cone, t the duration of the stimulus, and e its intensity. This applies, of course, only to stimuli of relatively short duration, and explains the correlations observed by Charpentier.⁴⁶ The fact that the basis of visual response is chemical is very

clearly indicated by the phenomenon of energy threshold. Exner and others⁴⁷ have made exhaustive studies upon the curve of excitation and de-excitation of the retina. According to our hypotheses the phenomena of inertia and persistence of vision may be both retinal and cerebral in origin, since the process of excitation and de-excitation is essentially the same in either place. If, owing to the establishment of a

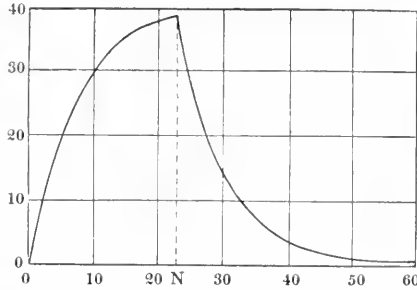

FIG. 1. To illustrate the character of the excitation-de-excitation curve necessitated by our postulates. The abscissae give units of time elapsed; the ordinates give the impulse intensity.

A light stimulus of constant intensity was applied at 0, and removed at N. These curves were obtained by substituting arbitrary concrete values in the equations given below.

constant state of stimulation at the retina, the impulse intensity at the cortex assumes a constant value ι_c , it follows that if the rate of diffusion of the ions from the cortical element is proportional to their concentration, we may write: $dc = (\iota_c - k_c c)dt$, where k_c is the appropriate constant (cf. page 23, bottom). By integration this equation becomes: $-\frac{1}{k_c} \log (\iota_c - k_c c) = t$, which represents an excitation curve of the same general form as that empirically found by Exner. Similarly, when the stimulus is withdrawn, we have: $dc/dt = -k_c c$, or $\log c = -k_c t$, t in each case being the time after the alteration of the stimulus. The theoretical and experimental curves are compared in Figs. 1 and 2. An extension of this argument

⁴⁶ CHARPENTIER, A.: Archives d'ophtalmologie, 1890, x, p. 108. Cf. RIVERS: *loc. cit.*, pp. 1067-1068.

⁴⁷ EXNER, SIGMUND: Sitzungsbericht, Königliche Akademie der Wissenschaften zu Wien, 1868, lviii, p. 601. Cf. RIVERS: *loc. cit.*, p. 1066.

enables us to account quite perfectly for the phenomena observed in "flicker photometry."⁴⁸

The Explanation of Fechner's Law. — By an application of the principle of chemical mass action to the double reaction schematized on page 23 (*supra*), it is possible to deduce an equation which has the form of the Weber-Fechner law connecting the intensity of the stimulating light, e , and the intensity of the corresponding sensation, s . Translated into physiological terms Fechner's law has the approximate form: $c_n = k \log e$, and since, as we have seen (page 23) the cerebrosis intensity must be proportional to the impulse intensity at the retina, we may also write: $i_{rn} = k \log e$, k being any constant.

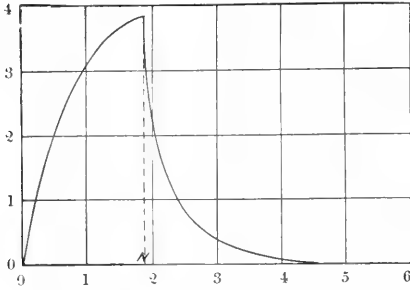

FIG. 2. An empirical curve obtained by Exner, showing the state of excitation of the visual apparatus as a function of the time following the application of a stimulus. The abscissae give the relative time elapsed; the ordinates give the sensory intensity.

NOTE. — Exner's curve is an excitation curve only; the curve of de-excitation is interpolated from data by FICK. See TIGERSTEDT, ROBERT: A Text-book of Human Physiology, trans. by J. R. Murlin, 1906, N. Y., pp. 540 and 539.

The mechanism underlying Fechner's law must, accordingly, be retinal, and that this is actually the case is evidenced by measurements upon the action currents of the frog's eye.⁴⁹ The chemical equations to which we have just alluded form the basis of the two following equations: (1) $\dot{m}_a = (k_1 + eq)m - k_2 i_+ i_-$, for any definite set of ions, where m_a is the apparent or average rate of change of the ionization; and (2) $\dot{m}_a = k_3 ab \bar{c} - k_4 m$; ab and c represent the concentrations of the two aesthesogens. Solving these equations simultaneously, we get an expression of the form: (3) $m = \sqrt{ke/k + ke} = kt, = kc$, k being

⁴⁸ The cortical dissipation, ψ , (see note 42 above) = $k_c c = -dc/dt$, so that the time, t_f , which can elapse between one pulse of afferent visual ions and the next — dependent upon the frequency of the stimulus — must be $t_f = \Delta c/k_c$, if flicker is to be exactly upon the verge of disappearance. Hence the stimulus frequency, $\phi = 1/t_f = k_c c/\Delta c = \text{constant} \times c$, or the frequency requisite to just abolish flicker is proportional to the cerebrosis intensity, and hence to the intensity of the sensation. By Fechner's law, $\phi = (\text{approx.}) \text{constant} \times \log e$, which is the result found by: GRÜNBAUM, O.: Journal of Physiology, 1898, xxii, p. 433.

⁴⁹ See RIVERS: *loc. cit.*, pp. 1050 ff.

a different constant in each place. As shown in Fig. 3, equation (3) has the same general form as that of empirically determined curves representing Fechner's law. The argument, although complicated, is straight-forward.⁵⁰

Explaining the Phenomena of Color Vision. — Most of those who have theorized concerning the visual mechanism have devoted themselves quite exclusively to the phenomena of color vision. While the above discussion of some of the general correlations exhibited in the visual process is of necessity very schematic, it will, perhaps, suffice to convince the reader of the possibility of making a single physical hypothesis cover with even quantitative precision the general, as well as special, aspects of the field. It now remains to be seen whether our electro-chemical theory will prove equally fruitful with reference to the even more complex phenomena of color. It must be understood, of course, that our purpose is more that of the reviewer than of the expositor; a

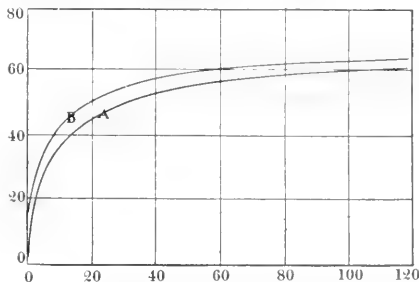

FIG. 3. Curves illustrative of the explanation of the Weber-Fechner law deduced from our hypotheses. The abscissae give the light intensity; the ordinates give the impulse intensity.

Curve A is a plot of the expression $t_f = 6\sqrt{400e/(80+3e)}$

Curve B is a plot of the expression $t_f = 6\sqrt{400e/(50+3e)}$

full, or even an adequate, discussion of the simplest of the problems involved would require in itself a volume of no small size. The theoretical situation in visual response is tremendously intricate, — but there is nothing which is intricate which is not, *ipso facto*, capable of being analyzed, provided one has sufficient time and patience. In the first place, although the relationships concerned are not simple it is perhaps obvious in what way the characteristics of a light ray which falls upon the retina are able to determine the attributive constitution of the corresponding sensation. In Fig. 4 we have drawn five curves which represent the manner in which the five specific molecular resonators are broken down by light

⁵⁰ The argument is presented in detail in the author's "Thesis," already several times referred to.

rays of varying wave-frequency. These theoretical curves have the same symmetrical form as curves of resonance in mechanics⁵¹ and they represent what we have called the *resonance functions* of the specific substances, M_r , M_g , M_b , M_y , and M_w , but it is important to notice that, while the general distribution of relative sensitivity remains constant, the exact shape of these areas must vary widely with alterations in the concentration of the resonators, in the intensity of the light, etc. For stimuli of high intensity these curves will all

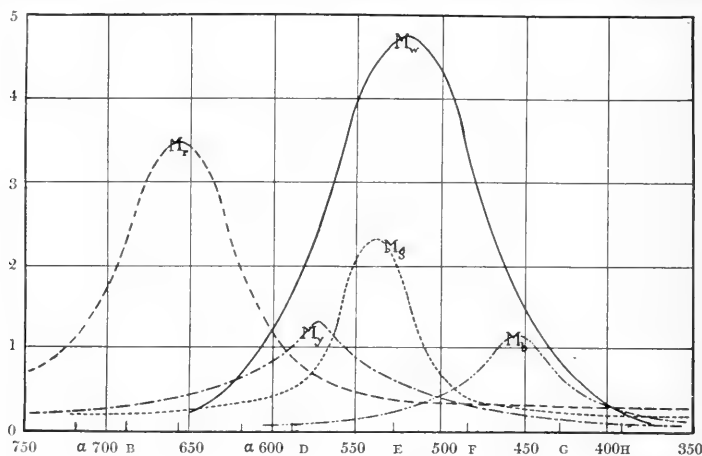

FIG. 4. Graphical representation of the approximate nature of the resonance functions of M_r , M_g , M_y , M_b , and M_w .

The ordinates represent the relative number of molecules decomposed per second per unit light intensity, the concentration of the molecular resonators also being constant and standard. The abscissae give the wave-length of the stimulating light in 10^{-7} cmss, uniform energy and normal spectrum.

be markedly flatted owing to the concomitant influence of the forces expressed in Fechner's law.

Complementation and Some of its Corollaries.—On pages (20-21), we have described a chemical mechanism by the operation of which specific pairs of visual ions would be able to mutually exclude each other from the visual impulse. The law governing the change produced in the constitution of the visual impulse due to the action of the complementation molecules may be exemplified as follows. If the impulse before passing through the "ganglion cells" has the constitution: $\iota_r + \iota_g$, where $\iota_r > \iota_g$, the constitution after passing these cells will be: $(\iota_r - \iota_g)$ of I_{r+} + $2 \iota_g$ of I_{w+} . The corresponding sensa-

⁵¹ See, e.g., LAMB, HORACE: *The Dynamical Theory of Sound*, 1910, London, p. 33.

tion, S, then, will be a pink, not a greenish red. An entirely analogous relationship must hold between the impulse components, ι_y and ι_b , and it is obvious that when $\iota_r = \iota_g$ and $\iota_y = \iota_b$ the only impulse component reaching the cortex will be ι_w ; these, then, are the conditions for complete *complementation*; the positions of complementary lights in the spectrum are determined by the retinal and neural conditions underlying and limiting this result, — they find an approximate implicit representation in the curves of Fig. 4. All of the familiar effects of “color mixture” are similarly represented in this diagram. Suppose, for example, that we stimulate the same cone with lights of $\lambda = 650$ and $\lambda = 550$; with appropriate intensities the two elements ι_r and ι_g will cancel each other leaving only the ι_y (and ι_w) which is also introduced by both lights, as necessitated by the form of our curves. The constitution of the resulting sensation will obviously be $S = Y + W$, although, as we say, “red” and “green” lights have been mixed. Examination of our diagram will show that it explains very perfectly the fact established by J. J. Müller and von Kries⁵² that when a heterogeneous light stimulus is made up of two (or more) lights having wave-lengths falling between the limits $\lambda = 760$ to 567 , or $\lambda = 390$ to 492 the *chroma* of the induced sensation does not differ from that of a sensation induced by a homogeneous wave yielding the same hue. It also explains the location of the points of least chroma and greatest luminosity, in the visible spectrum, at $\lambda = 575$ (approx.) and $\lambda = 500$; at these points the M_r and M_g , and M_y and M_b curves, respectively, intersect, and hence with these lights the complementation reaction finds its maxima. Fig. 4 is also consonant with the fact that the physical complementary of “green” is necessarily heterogeneous, for a light exciting M_g also strongly excites M_y , so that to produce perfect complementation it is requisite that an increment of ι_b , as well as of ι_r be introduced into the impulse at the retina. The relations which the curves bear to each other are such that all other lights can find homogeneous complementaries. Another important phenomenon which our general theory permits us to readily account for, is the disappearance of hue with increasing light intensity. Every light stimulus, we suppose, acts upon every molecular resonator, but at low intensities a light

⁵² See: GREENWOOD, M., JR.: Studies in Special Sense Physiology, in: Further Advances in Physiology, 1909, New York.

of wave-length $\lambda = 655$ (say) acts very strongly upon M_r and only weakly upon M_g , M_y and M_b . But as the intensity is increased the increase in the several components of ι (at the retina) follows Fechner's law (*q.v.*) — as we have interpreted it — and for this reason each of these components approaches a definite maximum; the nearer any component is to the maximum natural to it, the less will any change in the light intensity affect it. The result is that, no matter what the wave-length of a light may be, its effect upon the several resonators at very high intensities is the same. The relative light sensitivities indicated by the maxima of the curves in Fig. 4 are such as to be in harmony with the results of the quantitative study of this phenomenon for different sets of lights.⁵³ Another interesting point with reference to our diagram is the manner in which it accounts for the repetition of the hue R in the (violet) short-wave end of the spectrum. The relationship figured between the resonance functions of M_r and M_g is justified by four or five independent considerations, which, however, cannot be enumerated here.⁵⁴ Our explanation of the peculiar hue relations sustained by the short wave-lengths is in complete accord with the mutations of spectral violet with increasing light intensity, fatigue, etc.⁵⁵ Extant visual hypotheses — excepting Hering's — are to be adversely criticized for their inability to explain the repetition of the hue R in two widely separated parts of the spectrum.

Further Notes on the Psycho-physics of the Hues.—The forms of the resonance functions which we have suggested in our figure are such as to make it necessary to suppose that the limits of the visible spectrum are imposed by the selective absorption of the ocular media or of the inner strata of the retina. However, chemical resonance curves are seldom symmetrical and consequently it would be quite legitimate to modify our functions to suit the demands which may be made upon them in this respect. Contrary to the assump-

⁵³ See: ROOD, O. N.: *Modern Chromatics*, 1875, New York, p. 181.

⁵⁴ Among these may be counted the phenomena of selective adaptation, the change of hues with increasing light intensity, and the position of M_r in the optical and the evolutionary scales. M_r , we must suppose, has the greatest light sensitivity of any of the chromatic resonators; is a peculiarly unstable compound.

⁵⁵ See, *e.g.*: HESS, CARL: *Ueber die Tonänderung der Spectralfärbung durch Ermüdung der Netzhaut*, 1890, Leipzig.

tions of König and Dieterici⁵⁶ but in harmony with general chemical analogy we have assumed that any light ray — within the limits of the visible spectrum — can appreciably increase the ionization of each molecular resonator. This factor in our hypothesis not only permits us to satisfactorily account for the phenomena of color mixture but it also provides an explanation for the exact nature of the shift occurring in the positions of complementary lights with increasing intensities, both in peripheral and foveal vision,⁵⁷ as well as for many interesting fatigue phenomena.⁵⁸ In this connection it should be noted that, owing to the excitability of each of the resonators by every visible light, the induction of W by “daylight” depends not only upon the principles of exact complementation, but also upon the action of Fechner’s law, for the effective intensity of “daylight” is proportional to the *energy integral* over the entire spectrum. Another psycho-physical relation which is readily taken into account by our hypothesis is the fact that the highest difference sensibility occurs in those parts of the spectrum possessing the highest luminosity and least chroma. A glance at our resonance function diagram (Fig. 4) will show that it is in just these regions—about $\lambda = 580$ and $\lambda = 490$ —that the greatest shifting in the composition of the visual impulse should occur, and consequently — in accordance with our interpretation of visual thresholds (pages 25-26) — the greatest number of discriminations should be made for a given change in wavelength.

The Problem of Sensory Luminosity. — In terms of our theory, sensory luminosity, or “Helligkeit” is identical with the attribute, W, of the visual sensation, and the extent in which this attribute appears is always proportional to ι_w . This, in turn, is determined by two factors, the complementation reaction, and the excitation of M_w . The “specific luminosity” of the spectral colors obviously depends upon the manner of superposition of complementary resonance functions for the light involved, and the ground of the distribution of these “specific luminosities” we have already indicated. The fact that in the prismatic spectrum the maximum luminosity is in

⁵⁶ See reference given in note II, *supra*.

⁵⁷ Cf. NICATI, W.: La psychologie naturelle, 1898, Paris, pp. 63-65.

⁵⁸ E.g., those observed by: BURCH, G. J.: Journal of Physiology, 1897, xxi, p. xxvii.

the yellow must be assigned to the combination of the curve of dispersion of the refracting substance with the M_r and M_y curves of our diagram, rather than to any purely physiological cause. The shift in the location of this maximum which occurs with decreasing illumination is, of course, due to the rise of the M_w or "twilight" excitation; this constitutes the familiar and somewhat over-emphasized Purkinje phenomenon, which has been completely explained by the researches of von Kries and others into the properties of the visual purple. The present writer accepts von Kries' theory and, as already stated, identifies M_w with the substance peculiar to the retinal rods. The measurement of luminosity by the method of "flicker photometry" may be explained upon our hypothesis if it is supposed that the *cortical discrimination limen*, Δc_w , is smaller than that characteristic of the chromatic components; this supposition is, in fact, necessitated by the results of König.⁵⁹

The Explanation of Simultaneous Contrast. — In the original statement of our hypothesis concerning visual stimulation we asserted that, in accordance with general chemical analogies, the ionization of the molecular resonators should not be zero even in the absence of optical stimulus (normal ionization). On this basis it follows that the visual impulse is never null, and so we are at once provided with an explanation of the so-called "proper light of the retina." Since in the absence of stimulus, one "sees gray," it becomes necessary to account for the fact that one is ever able to "see black." The mechanism by which the elementary visual impulses corresponding to certain retinal cells may suffer a *decrease* through the stimulation of adjacent cells is that underlying *simultaneous contrast*, and may be briefly described as follows. We will first take notice of the retinal *rods* alone, and consider that the only molecular resonator present is M_w . Let S_d denote the visual sensation situated at a point in the visual field corresponding with R_d , a stimulated portion of the retina, while S_o , an immediately outlying sensation element, corresponds with R_o , an outlying retinal activity. Now suppose that the light L_d , stimulating R_d , has a finite intensity e_d , while the outlying light L_o has zero intensity, so that we may write: $m_{wd} > m_{wo}$; hence, $\iota_{wd} > \iota_{wo}$. This means that the rate at which the I_{w+} ions are leaving the stimulated

⁵⁹ KÖNIG, A.: Zeitschrift für Psychologie und Physiologie der Sinnesorgane, 1895, viii, pp. 375-381.

region is greater than that at which they are leaving the unstimulated area; but since, in the reaction: $M_w \rightarrow I_{w+} + I_{w-}$, I_{w-} ions are produced in number equal to that of I_{w+} , when equilibrium is established, the rate of dissipation of the negative ions through the retinal bacillary layer from the position of R_d must be greater than that taking place in the opposite direction. If this is the case, the concentration of I_{w-} ions in the region of R_o must have increased over the concentration of the same ions which existed previously to the stimulation of the adjoining region, R_d . But the state of ionization of the molecular resonator, M_w , in any region depends upon the concentration of each of the ions, I_{w+} and I_{w-} , in such a way that: $(k_1 + k_s)m_w = k_2 i_{w+} i_{w-}$. It is obvious then that an increase in i_{w-} must be accompanied by a decrease in i_{w+} , and consequently ϵ_{w_o} must fall below that normal to the unstimulated retina, so that the corresponding sensation will be "darker" — contain less W, than the "proper light of the retina." This is the mechanism of *simple achromatic contrast*. Since the "proper light" is normally gray, we must suppose that in the unstimulated retina, the complementary ions, I_{r+} and I_{g+} , and I_{y+} and I_{b+} are exactly balanced in number. *Complex achromatic contrast* must then depend upon a process entirely similar to that above described, in which, however, four different species of ions are involved. The physical mechanism of *chromatic contrast* may be argued from the above. Suppose that R_d is stimulated by a homogeneous light. In this case there will be a spread of *specific* negative chromatic ions from the stimulated point, the disturbance of the normal ionization of *specific* chromatic resonators, a failure of the — unstimulated — complementation equilibrium, and the consequent induction of a sensory hue in the region of the visual field which is occupied by S_o which is complementary with respect to the — stimulated — sensory hue of S_d . Owing to the fact that the transfer of ions between adjacent retinal elements under the conditions above studied is not a diffusion process but is due primarily to the differences of electrical potential existing between the elements, there must be a motion of positive ions from R_o into R_d , as well as of negative ions in the opposite direction. The quantitative measurements of the distribution and correlations of contrast are quite in harmony with the above explanation, which is a natural consequence of the form of our original hypotheses.

The Explanation of Adaptation. — In the deduction of Fechner's law (*cf.* page 28) one develops, as an intermediate step, the equation:

$$m = \frac{k + k \overline{ab} \overline{c}}{k + ke}$$

in which \overline{ab} and \overline{c} are the concentrations of the aesthesogens (*cf.* page 22) AB and C, respectively, and m is the concentration of the *corresponding* molecular resonator. Since the rate of dissociation, m_n , of the resonator is relatively proportional to m , and since the intensity of the corresponding component of the visual cerebrosis, C, is similarly proportional to m_n , it follows that any change occurring in \overline{ab} and \overline{c} , will be reflected by a similar change in c . We should expect to find a diminution of \overline{ab} and \overline{c} after long continued stimulation, during which the process has been moving constantly in the sense of left to right in the double chemical equation given on page 23. It appears then, that stimulation with "white" light should result in an after-image containing less W than the retinal proper light, whereas stimulation with a homogeneous light should be followed by an after-image complementary in hue to the original, owing to the subtraction of a specific component of the impulse, the normally balancing complementary of which is then left free. The data obtained in the special qualitative and quantitative study of adaptation phenomena prove to be strictly in harmony with the demands of our Fig. 4.⁶⁰ Our hypothesis also has the advantage of being able to account for the high luminosity of certain after-images, for as noted in the last paragraph, the effect of local stimulation is to cause a general migration of positive ions into that region, so that those molecular resonators in the stimulated area which are not intensively concerned in the response will increase rather than diminish in concentration during the specialized fatigue process.⁶¹ The positive after-image may be attributed to an over-charging of the cortical element with ions of a specific character, and other details of adaptation, such as the func-

⁶⁰ See notes 54 and 55, above. Several cases are discussed in detail in the author's "Thesis," chapter 21.

⁶¹ The necessity of accounting for the great luminosity of the negative after-image has been emphasized by Hering and by Mrs. Ladd-Franklin. See, *e.g.*, LADD-FRANKLIN, C.: *Psychological Review*, 1894, i, pp. 396-399.

toning of the M_w or twilight substance, may be accounted for in a way entirely consistent with our postulates.

The Problem of Color-blindness. -- The majority of theories of visual response find their impetus in the phenomena of color-blindness, and yet none of the extant hypotheses is capable of satisfactorily account for the well-known abnormal types of color-vision. These types are the "red-blind" or *scoterythrous*, which is characterized by a low stimulus value for lights of low frequency; the "green-blind" or *photerythrous*, for which the limits of the spectrum are the same as for a normal observer, although only two hues can be discriminated; and the so-called yellow-blue-blind, in which red and green can be discriminated, but not yellow and blue. Both the Young-Helmholtz and the Hering hypotheses, which were specially designed to account for these types of color-blindness, are now acknowledged—at least in the most important cases—to be incapable of doing this.⁶²

Mrs. Ladd-Franklin's theory is hardly more successful. The explanation of color-blindness is a complex matter, and one which cannot be accomplished apart from genetic and pathological investigations. It is to be noted, however, that the arrangement of the curves of Fig. 4 is such as to account perfectly for the established facts concerning dichromatic response if it is supposed that in the photerythrous type there is absent a special cortical mechanism, which we may call the *R-G-cortical-chromatic element*, the presence of which is essential in order that the I_r+ and I_g+ ions of the impulse should be received in the visual cerebration; while the scoterythrous type may be explained by supposing the concomitant absence of the M_r resonator. The positions of "gray bands," maxima of luminosity, etc., as observed

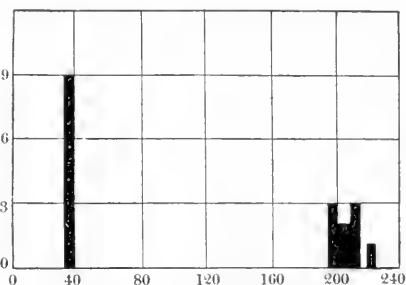

FIG. 5. Biometric plot showing the distribution of twenty cases of "dichromatic" visual response.

ORDINATES: Class frequency.

ABSCISSAE: Intensity of light from the lithium line required to match a given intensity of light from the sodium (D) line. Arbitrary units.

Data from: KRIFES, JOHANNES, von: *Zeitschrift für Psychologie und Physiologie der Sinnesorgane*, 1897, xiii. p. 259.

⁶² For a frank confession of the failure of Hering's hypothesis in this connection, see: TSCHERMAK: *Ergebnisse der Physiologie*, 1902, i, 2, p. 795.

for these two types are in harmony with the resonance functions represented in our diagram. The blue-yellow-blind, moreover, can be classed with equal success as cases of the absence of a Y-B-cortical-chromatic element. Total color-blindness may be due to the absence of both of the cortical elements, or of all of the chromatic molecular resonators, or to other conceivable effective combinations of losses. Obviously the explanatory scheme which is suggested is a very flexible one.⁶³ The phases of color-blindness exhibited in the normal peripheral retina may be satisfactorily accounted for in the same terms.

Scope of the Above Discussion. — It must not be supposed that the writer regards the above exposition of the consequences of what may be appropriately denominated the *photo-ionic theory of visual response*, to be sufficient to establish the validity of the hypotheses which he has advanced. On the contrary, the entire paper must be looked upon simply as an abstract of a much more elaborate, but still exceedingly imperfect discussion of the deductions and points of view made possible by the notion that the mechanism of visual response is ionic in character. It is hoped, however, that the paper will at least suffice to dimly suggest, if not to demonstrate, the importance of looking upon these, and other, physiological problems in the light of modern theoretical physics and chemistry.

V. SUMMARY

At the outset we saw that extant hypotheses to explain visual phenomena not only fail to keep step with the progress of physics and chemistry, but are unduly vague in statement and, in many cases, are inconsistent with the sciences the concepts and laws of which they are bound to employ. Consequently it seemed advisable to formulate a renovated, if not a new, chemical hypothesis to deal with

⁶³ The explanation here offered of the two distinct types of dichromatic visual response has the appearance of artificiality, largely on account of the fact that, for purposes of abbreviation, the *cortical chromatic elements* were not presented as integral parts of our hypothesis. In the explanation of color-blindness, one cannot legitimately expect any primitive simplicity. A simple explanation of these phenomena, even if it were obtainable, would be inconsistent with the general tendency of the field of nature involved. There can be no reasonable

these phenomena, in a manner more consonant with the viewpoint and methods of modern physics and chemistry.

From the nature of the stimulus we argued that the physical process of excitation in the retina must be one of *ionization*, and since we know that the nerve impulse is ionic in its mechanism, it was easy to connect this excitation in a definite way with the visual nerve current and thence with the cerebral and psychical processes. Our assumptions were perhaps over-simple, but they were quantitative in character, wherever possible, and the conclusions drawn from them later appeared to be quite consonant with the facts. We were led to postulate five specific visual substances, or *molecular resonators*, corresponding with the psychological qualities, red, green, blue, yellow, and white, respectively. By the introduction of a special and clearly defined chemical mechanism which would remove "complementary components" of the visual impulse in pairs and substitute a "white component" we laid a foundation for the explanation of the phenomena of complementary colors. In every case we sought to make the definition of our hypotheses as sharp as possible.

Arriving at the practical problem of applying our assumptions to the facts of visual physiology and psychology, we found, in the first place, that the ionic viewpoint permitted at least a schematic explanation of the electrical phenomena exhibited by the stimulated and unstimulated eye. A brief discussion of certain important "visual thresholds" showed again that we were on the right track, and provided a foundation for further argument. Certain calculations based immediately upon our original postulates yielded a theoretical curve for the rise and decay of the visual excitation, coinciding with that experimentally established. Furthermore, we discovered that an application of the law of chemical mass action to the ionization process in the retina provided us with a direct explanation of the well-known Weber-Fechner law.

doubt, in view of the ascertained facts, that color-blindness may depend upon either or both retinal or (and) cerebral abnormalities. Neither, in view of such measurements as those represented in the distribution areas of Fig. 5, can it be doubted that there exist distinct visual types, which can only be accounted for upon some presence-absence hypothesis, and not on the basis of a continuous variability of properties such as Hering's explanation of the inconstancy of "red-green blindness" (as due to fluctuations in the color of the lens or ocular media) demands.

In the field of "color vision" our hypotheses proved equally fruitful, their consequences harmonizing even quantitatively not only with the familiar phenomena of "color mixture" and adaptation, which are more or less adequately accounted for by extant theories, but also giving us an insight into certain of the finer details of the mechanism of color. Among the latter were the mutations and final disappearance of the hues with increasing light intensity, the distribution of brightness and chroma in the spectrum, and in spectrum hues produced by mixture, the fact that "green" lacks a homogeneous complementary, the repetition of "redness" in the "violet end" of the spectrum, the distribution of "sensibility to differences" with respect to change in wave-length, the shift in the relative positions of complementary colors with changes in light intensity, etc. The problem of sensory luminosity, or "*Helligkeit*" was then discussed in connection with our assumptions, which deal with the phenomena in question more simply than does the theory of Hering. We saw that the ionic hypothesis provides a direct electro-chemical basis for the explanation of simultaneous and successive contrast, and one which avoids the difficulties which have been raised by Hering and others with respect to the relative luminosity of the after-image. In the discussion of these phenomena the physico-chemical viewpoint was maintained, and proved enlightening.

In conclusion, it appeared that an additional assumption with reference to the cerebral connections of the different hues, would permit our hypothesis to account quantitatively for the most familiar types of color-blindness, by means of a doctrine — seemingly necessitated by the facts — of the absence of unit characters.

THE UNIFORM RATE OF THE DESTRUCTION OF PEPSIN BY THE PASSAGE OF THE DIRECT ELECTRIC CURRENT

By W. E. BURGE

[From the Physiological Laboratory of the University of Illinois.]

IT has been shown that the activity of pepsin and of ptyalin is destroyed by the passage of a direct electric current and that the rate of this destruction in the case of ptyalin is uniform per coulomb. The present investigation was begun to determine whether the rate of decrease in peptic activity is also uniform per coulomb.

The solution of pepsin used was prepared by dissolving one gram of a commercial preparation of pepsin in 100 c.c. of distilled water. The digestive activity of equal portions of the solution before and after electrolysis was determined by the amount of digestion in Mett's tubes in forty-eight hours. The egg-white in these tubes was cooked in boiling water for one minute.

The electrolyzing cylinder, a description of which has already been published,¹ was charged with 5 c.c. of the pepsin solution and placed across the electrodes of a direct electric circuit in series with a potential reducer and a milliammeter. The cylinder was then placed in a shaking machine and shaken at the rate of five hundred single shakes per minute in order to prevent polarization. Portions of the normal solution had already been shaken at this rate for several hours and it was found that this rate of shaking of itself had no effect upon the activity of the enzyme. Twenty-five milliamperes of current were passed through the 5 c.c. of solution for twenty minutes while it was being shaken at the above named rate. At the end of this time the electrolyzed solution was removed from the cylinder, 5 c.c. of fresh solution were introduced, the cylinder was replaced in the shaking machine, and twenty-five milliamperes were passed for forty minutes. At the end of this period the solution was removed and the

¹ BURGE: This journal, 1913, xxxi, p. 328.

cylinder was recharged. Electrolyses were continued in this manner until solutions were obtained through which the current had passed for twenty, forty, sixty, eighty, one hundred, one hundred twenty and one hundred forty minutes respectively. When the series were complete 3 c.c. of .5 per cent hydrochloric acid were added to 3 c.c. of each of the electrolyzed pepsin solutions and to 3 c.c. of the non-electrolyzed solution which served for comparison. Into each test tube containing the .25 per cent hydrochloric acid pepsin solution a Mett's tube 3 cm. in length was introduced and these test tubes were placed in a thermostat at 38° C. for forty-eight hours. At the end of this time the Mett's tubes were removed from the solutions and the amount of digestion was measured. A photograph of a typical experiment is reproduced here showing Mett's tubes twice the actual size (Fig. 1). The dark portion represents the amount of undigested egg-white and the light portion the empty tube from which the egg had been digested. The results of the experiments are indicated also in the accompanying table.

TABLE I

	Tube	Coulombs passed	Mm. of egg digested	Decrease in mm. of egg digested	Decrease in mm. per Q.
Non-electrolyzed solutions	I	0	8.0		
Electrolyzed solutions	II	30	6.5	1.5	.050
“ “	III	60	5.5	2.5	.041
“ “	IV	90	4.5	3.5	.039
“ “	V	120	3.5	4.5	.038
“ “	VI	150	2.5	5.5	.037
“ “	VII	180	1.5	6.5	.036
“ “	VIII	210	0.5	7.5	.036
				Average	.04

As will be seen from the table the amount of egg-white digested was decreased in proportion to the number of coulombs that were allowed to pass. The decrease in digestive power as between Tube I

and Tube II is expressed as a difference of 1.5 mm. in the column of egg-white. As this difference was caused by the passage of 30 coulombs, the quotient of $\frac{1.5}{30}$ or .05 mm. expresses the decrease in digestive power per coulomb. The quotients obtained in a similar

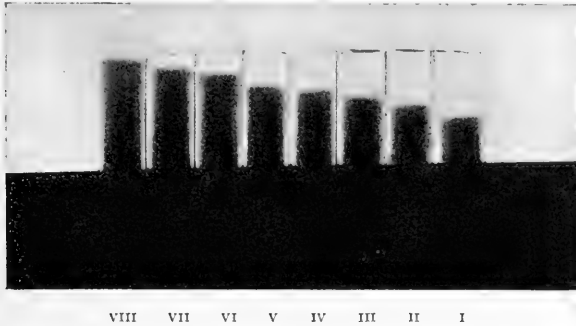

FIGURE 1.— Photograph of Mett's tubes magnified twice. The dark portion represents the undigested egg white, the light portion the extent of digestion.

way for the other tubes, in comparison with Tube I, are given in the last column of the Table. The average obtained from these figures indicates a diminution in digestive power of 0.04 mm. per coulomb.

The agreement among these figures is sufficiently close to justify the conclusion that the digestive activity of a solution of pepsin is decreased by the passage of a direct electric current at a uniform rate per unit of current.

THE EFFECT OF ADRENAL SECRETION ON MUSCULAR FATIGUE¹

BY W. B. CANNON AND L. B. NICE

[From the Laboratory of Physiology in the Harvard Medical School]

IN the older literature on the adrenal glands the effect of their absence, or of injected extracts, on skeletal muscle was not unfrequently noted. As evidence accumulated, however, tending to prove that adrenal secretion has important relations with the sympathetic nervous system, its relations with skeletal muscle began to receive less consideration.

The muscular weakness of persons suffering from Addison's disease was well recognized before experimental work on the adrenals was begun. Experiments on rabbits were reported in 1892 by Albanese who showed that muscles stimulated after removal of the adrenal capsules, were much more exhausted than when stimulated the same length of time in the same animal before decapsulation.² Similarly Boinet reported that rats recently decapsulated were much more quickly exhausted in a revolving cage than were normal animals.³

More direct evidence of the effect of adrenal extract on skeletal muscle was brought forward by Oliver and Schäfer. After injecting the extract subcutaneously into a frog they found that the excised gastrocnemius muscle registered a curve of contraction about 33 per cent higher and about 66 per cent longer than the corresponding muscle not exposed to the action of the extract. Similar prolongation of the muscle curve was observed after injecting the extract intravenously into a dog.⁴ A beneficial effect of adrenal extract on

¹ A preliminary report of this research was given at the meeting of the American Physiological Society, December, 1911. See Proceedings, this Journal, 1912, xxix, p. xxiv.

² ALBANESE: Archives italiennes de biologie, 1892, xvii, p. 243.

³ BOINET: Comptes rendus, Société de Biologie, 1895, xlvi, pp. 273, 498.

⁴ OLIVER and SCHÄFER: Journal of physiology, 1895, xviii, p. 263. See also RADWÁNSKA, Anzeiger der Akademie, Krakau, 1910, pp. 728-736. Reviewed in Zentralblatt für Biochemie und Biophysik, 1911, xi, p. 467.

fatigued muscle, even when applied to the solution in which the isolated muscle was contracting, was claimed by Dessy and Grandis, who studied the phenomenon in a salamander.⁵ Further evidence to the same conclusion was offered in a discriminating paper by Panella. He found that in heterothermic animals the active principle of the adrenal glands notably reinforced striated muscle, prolonging its ability to do work, and improving its contraction when fatigued. In homothermic animals the same effects were observed, but only after experimental procedures (anaesthesia, section of the bulb) had changed them to a condition resembling the heterothermic.⁶

The foregoing evidence indicates that decapsulation has a debilitating effect on muscular power, and that injection of extracts of the capsules has an invigorating effect. It seemed possible, therefore, that increased secretion of the adrenal glands, whether from direct stimulation of the splanchnic nerves or as a reflex result of pain or the major emotions, might act as a dynamogenic factor in the performance of muscular work. With this possibility the present investigation was concerned.

THE METHOD

The general plan of the investigation consisted primarily in observing the effect of stimulating the splanchnic nerves, isolated from the spinal cord, on the contraction of a muscle whose nerve, also isolated from the spinal cord, was rhythmically and uniformly excited with break induction shocks. Thus only a blood connection existed between the splanchnic region and the muscle. Cats were used for most experiments, but results obtained with cats were confirmed on rabbits and dogs. To produce anaesthesia, in the cats and rabbits, and at the same time to avoid the fluctuating effects of ether, urethane (2 gm. per kilo body-weight) was given by a stomach-tube. The animals were fastened back-downward, over an electric warming pad, to an animal holder. Care was taken to maintain the body temperature at its normal level throughout each experiment.

The nerve-muscle preparation. — The muscle selected for record was usually the right *tibialis anticus*, though at times the right *extensor*

⁵ DESSY and GRANDIS: Archives italiennes de biologie, 1904, xli, p. 231.

⁶ PANELLA: Archives italiennes de biologie, 1907, xlviii, p. 462.

communis of the digits was employed. The anterior tibial nerve was bared for about two centimetres, severed proximally, and set in a Sherrington shielded electrode around which the skin was fastened by spring clips. By a small slit in the skin the tendon of the muscle was uncovered, and after being tightly ligatured with strong thread, was separated from its insertion. Thus a nerve-muscle preparation was made which was still connected with its proper blood supply. The preparation was firmly fixed to the animal holder by thongs looped around the hock and the foot, i.e., on either side of the slit through which the tendon emerged.

The ligature tied to the tendon was passed over a pulley and down to a pivoted steel bar which bore a writing point. Both the pulley and this steel writing lever were supported in a rigid tripod. In the earliest experiments the contracting muscle was made to lift weights (125 to 175 gm.), and was sometimes "loaded" with these weights; but in all the later observations the muscle pulled against a spring. In most instances the muscle was afterloaded, but by raising the muscle clamp the tension developed in the muscle at rest was made nearly equal to the pull of the spring at its shortest length. The "support," therefore, was little more than a constant base for relaxation. The pull of the spring as the muscle began to lift the lever away from the support was in most of the experiments 110 gm., with an increase of 10 gm. as the writing point was raised 4.5 mm. The magnification of the lever was 3.8.

The stimuli delivered to the anterior tibial nerve were, in most experiments, single break shocks of a value barely maximal when applied to the fresh preparation. The rate of stimulation varied between 60 and 300 per minute, but was uniform in any single observation. A rate which was found generally serviceable was 180 per minute. In a few experiments a regularly repeated tetanizing current was used.

Since the anterior tibial nerve contains fibres affecting blood-vessels, as well as motor fibres for skeletal muscle, the possibility had to be considered that stimuli applied to it might disturb the blood supply of the nerve-muscle preparation. Vasoconstriction would be likely to produce the most serious disturbance. The observations of Bowditch and Warren, that vasodilator rather than vasoconstrictor effects are produced by single induction shocks repeated at intervals

of not more than five per second,⁷ reassured us as to the danger of diminishing the blood supply, for the rate of stimulation in our experiments never exceeded five per second and was usually two or three. Furthermore in using these different rates we have never noted any result which could reasonably be attributed to a diminished circulation.

The splanchnic preparation. — The splanchnic nerves were stimulated in various ways. At first only the left splanchnics in the abdomen were prepared. The nerves, separated from the spinal cord, were drawn into a Sherrington shielded electrode, which was attached by threads to the body wall. A rubber tube connected the electrode with the exterior of the body, and separated the wires from the abdominal viscera. The placing of this electrode, however, required so much time and, in spite of great care, was so likely to result in harmful pulling on the nerves, that some other device became necessary.

The form of electrode which was found most satisfactory was that

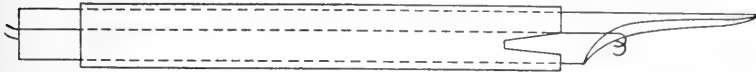

FIGURE 1. The shielded electrode used in splanchnic stimulation. For description see text.

illustrated in Fig. 1. It was made of a round rod of hard wood, beveled to a point at one end, and grooved on the two sides. Into the grooves were pressed insulated wires ending in platinum hooks, which projected beyond the bevelled surface. Around the rod was placed a rubber tube which was cut out so as to leave the hooks uncovered when the tube was slipped downward.

In applying the electrode the left splanchnic nerves were first freed from their surroundings and tightly ligatured as central as possible. By means of strong compression the conductivity of the nerves was destroyed proximal to the ligature. The electrode was now fixed in place by thrusting the sharp end into the muscles of the back. This was so done as to bring the platinum hooks a few millimetres above the nerves. With a small seeker the nerves were next gently lifted over the hooks, and then the rubber tube was slipped downward until it came in contact with the body wall. Absorbent

⁷ BOWDITCH and WARREN: *Journal of physiology*, 1886, vii, p. 438.

cotton was packed about the lower end of the electrode, to take up any fluid that might appear; and finally the belly wall was closed with spring clips. The rubber tube served to keep the platinum hooks from contact with the muscles of the back and the movable viscera, while still permitting access to the nerves which were to be stimulated. This stimulating apparatus could be quickly applied, and, once in place, needed no further attention.

In some of the latest experiments both splanchnic nerves were stimulated in the thorax. The rubber-covered electrode proved quite as serviceable there as in the abdomen.

The current delivered to the splanchnic nerves was a tetanizing current of such strength that no effects of spreading were noticeable.

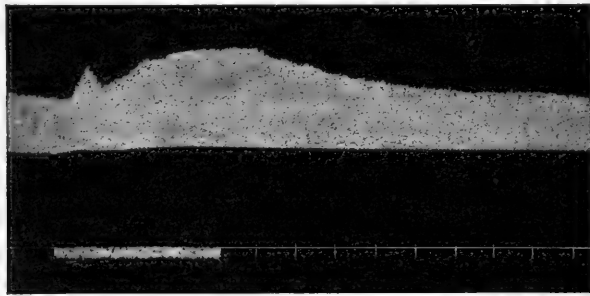

FIGURE 2. Upper record, contraction of the *tibialis anticus*, 80 times a minute, lifting a weight of 125 gm. Lower record, stimulation of the left splanchnic nerves, two minutes. Time, half minutes.

That splanchnic stimulation causes secretion of the adrenal glands has been proved in many different ways which need not be recounted here. On this assumption the present investigation was undertaken.

THE EFFECTS OF STIMULATING THE SPLANCHNIC NERVES

The effect on contraction of fatigued muscle, which can often be obtained by stimulating the left splanchnic nerves, is shown in Fig. 2. In this instance the muscle was afterloaded, and while contracting lifted a weight of 125 gm. The rate of stimulation was 80 per minute.

The muscle record shows a brief initial rise, followed by a drop, and that in turn by another prolonged rise. The maximum height

of the record is 13.5 mm., an increase of 6 mm. over the height recorded before splanchnic stimulation. Thus the muscle was performing for a short period 80 per cent more work than before splanchnic stimulation, and for a considerably longer period exhibited an intermediate betterment of its efficiency.

1. The first rise in the muscle record.—

The brief first elevation in the muscle record when registered simultaneously with blood pressure, is observed to occur at the same time with the sharp initial rise in the blood-pressure curve (see Fig. 3). The first sharp rise in blood pressure is due to contraction of the vessels in the splanchnic area, for it does not appear if the alimentary canal is removed, or if the coeliac axis

and the superior and inferior mesenteric arteries are ligatured. The betterment of the muscular contraction is probably due directly to

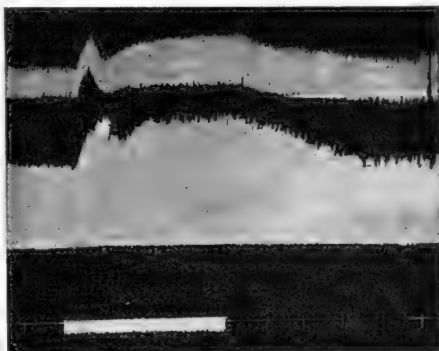

FIGURE 3. Top record, blood pressure with membrane manometer. Middle record, contractions of *tibialis anticus* loaded with 125 gm. and stimulated 80 times a minute. Bottom record, splanchnic stimulation (two minutes). Time, half minutes.

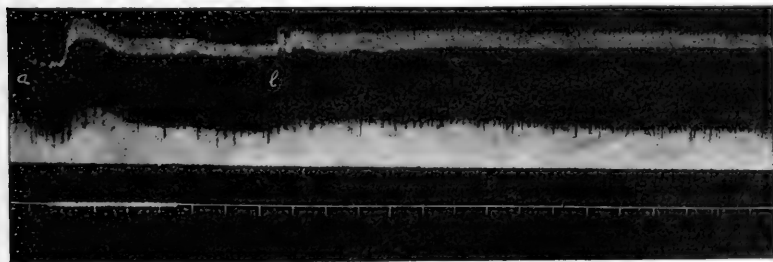

FIGURE 4. (Four-fifths the original size.) Top record, blood pressure with membrane manometer. Middle record, contractions of *tibialis anticus* against a spring. Bottom record, stimulation of left splanchnics. At *a* both adrenal veins were clipped, at *b* the clips were removed.

the better blood supply resulting from the increased pressure, for if the adrenal veins are clipped, and the splanchnic nerves are stimulated, the blood pressure rises as before and at the same time there may be registered a higher contraction of the muscle (see Fig. 4).

2. **The prolonged rise of the muscle record.** — As Fig. 3 shows, the initial quick uplift in the blood-pressure record is quickly checked by a drop. This rapid drop does not appear in Fig. 4, a record made when the adrenal veins were obstructed. The difference between Figs. 3 and 4 in this respect agrees with Elliott's observation of a similar difference in blood-pressure records before and after excision of the adrenal glands. And as Elliott,⁸ and as Cannon and Lyman⁹ have shown, this sharp drop after the first rise, and also the subsequent elevation of blood pressure, are the consequences of liberation of adrenal secretion into the circulation. Fig. 3 demonstrates that the prolonged rise of the muscle record begins soon after this characteristic drop in blood pressure.

In Fig. 4 removal of the clips from the adrenal veins after the splanchnics had been stimulated occasioned a slight, but distinct improvement in the muscular contraction. As in the experiments of Young and Lehmann, in which the adrenal veins were tied for a time and then released, the release of the blood which had been pent in these veins was quickly followed by a rise of blood pressure.¹⁰ The volume of blood thus restored to circulation was too slight to account for the rise of pressure. In conjunction with the evidence that splanchnic stimulation calls forth adrenal secretion,¹¹ the rise may reasonably be attributed to that secretion. The fact should be noted, however, that in this instance the prolonged improvement in muscular contraction did not appear until the adrenal secretion had been admitted to the general circulation.

Figs. 2 and 3, and Fig. 4 illustrate two types of improvement in the activity of fatigued muscle in response to adrenal secretion. Many variations on these types were noted in the course of the investigation. The improvement varied in degree as indicated by increased height of the record. In some instances the height of contraction was doubled — a betterment by 100 per cent; in other instances the contraction after splanchnic stimulation was only a small fraction higher than that preceding the stimulation; and in still other instances there

⁸ ELLIOTT: *Journal of physiology*, 1912, xlv, p. 403.

⁹ CANNON and LYMAN: *this Journal*, 1913, xxxi, p. 376.

¹⁰ YOUNG and LEHMANN: *Journal of physiology*, 1908, xxxvii, p. liv.

¹¹ See ASHER: *Zeitschrift für Biologie*, 1912, lviii, p. 303; ELLIOTT: *Journal of physiology*, *Loc. cit.*, p. 399.

was no betterment whatever. Never in our experience, were the augmented contractions equal to the original contractions of the fresh muscle.

The improvement also varied in degree as indicated by persistence of effect. In some instances the muscle returned to its former working level within four or five minutes after splanchnic stimulation ceased (see Fig. 2); in other cases the muscle continued working with greater efficiency for fifteen or twenty minutes after the stimulation.¹²

The question now arises, does the adrenalin liberated by splanchnic stimulation act itself, specifically, to improve the muscular contraction, or does it produce the improvement by increasing the blood pressure and thereby increasing the blood flow through the laboring muscle?¹³ And further, since splanchnic stimulation results in an augmentation of the sugar content of the blood,¹⁴ might not the greater ability of the muscle be due to a greater supply of this source of muscular energy? And in the cases in which no improvement occurred what was the reason for the failure? All these questions must be considered.

THE CAUSE OF THE PROLONGED RISE IN THE MUSCLE RECORD

The association of the first rise in the muscle record with an increase of blood pressure shows that the factor of blood supply is capable in itself of restoring to some degree the efficiency of a fatigued muscle.

¹² "Tonus waves," similar to those described by Storey (this Journal, 1904, xii, p. 83), have been repeatedly observed by us. They had interesting relations to the discharge of adrenalin into the blood. If the waves were not present, splanchnic stimulation would often cause an augmented contraction in which the waves were present. Or if the waves were already present, splanchnic stimulation would commonly result in their being more rapid (see Fig. 6, *A* and *B*, also Fig. 7).

¹³ It is assumed in this enquiry that vessels supplying active muscles would be actively dilated (See KAUFMANN: Archives de physiologie, 1892, xxiv, p. 283), and would, therefore, in case of a general increase of blood pressure, deliver a larger volume of blood to the area they supply.

¹⁴ MACLEOD: this Journal, 1907, xix, p. 405, also for other references to the literature.

In order to differentiate between a possible specific action of adrenal secretion as an antidote to fatigue, and the effect which the secretion would have by increasing blood pressure, various methods were employed to keep the blood pressure constant during stimulation of the splanchnic nerves. Bayliss's compensator¹⁵ proved too slow to be effective. The pressure was maintained at a uniform level in some



FIGURE 5. Top record, blood pressure with mercury manometer; between the arrows the pressure was kept from rising by compression of heart. Middle record, contractions of *tibialis anticus*, 180 per minute, against a spring. Bottom record (zero of blood pressure) shows stimulation of left splanchnics. Time, half minutes.

instances, however, by compression of the heart through the walls of the thorax. In other instances a loop of strong thread was passed through a small opening in the belly wall and around the abdominal aorta just before its forking into the iliacs. By more or less tension on the thread the pressure in the arteries of the legs could be regulated at will. This pressure was registered by means of a manometer attached to the left femoral artery. As soon as the pressure showed a

¹⁵ See BAYLISS: Handbuch der physiologischen Methodik, 1911, ii, Abtheilung iv, p. 372.

tendency to rise the loop was pulled upon, and the inflow to the arteries of the leg thereby kept from increasing; as a tendency to fall manifested itself the pull on the loop was lessened.

The rôle of increased blood pressure when adrenal secretion is liberated. — In Fig. 5 is presented the record (from a decerebrate cat) of a fatigued muscle contracting 180 times per minute, and reduced to a very low degree of activity when splanchnic stimulation was started. The stimulation was continued for two minutes. During the first minute blood pressure was prevented from rising by compression of the heart, and in that time no betterment of the contraction appeared. As soon as compression of the heart ceased, however, the blood pressure promptly rose from approximately 48 mm. of mercury to 110 mm., and simultaneously the height of the muscular contraction increased about six-fold.

It is noteworthy that although the blood pressure gradually fell to its former level the muscle did not return to its former inefficiency. Merely because the blood supply *had been* better, probably because depressive metabolites had been thus washed away more effectively, and possibly because fresh sources of energy had been brought to the muscle in larger amount, the muscle continued to show a greater ability.

When the blood pressure was restored to its former level, the splanchnic nerves were again stimulated — this time for one minute. The blood pressure was kept down in this instance for one and three-fourths minutes by compression of the heart. Only slight tendency to higher contractions was manifested by the muscle during this period. And again only when the heart was permitted to fill and empty in a normal manner, and the pressure consequently rose, was there a considerable betterment of the contraction.

In these instances splanchnic stimulation undoubtedly liberated adrenalin, for the blood pressure remained elevated for fully seven minutes after the first stimulation ceased — a much longer time than is required for the adjustment of the circulation after compression of the thorax, but a time corresponding to the duration of effects of adrenal secretion. In spite of this the height of the muscle record failed to increase in any remarkable degree so long as the blood pressure was prevented from rising. The adrenal secretion, if it improves the contraction of fatigued muscle in a specific manner,

seems to have in that respect an influence much less important than that which it exercises in bettering the blood supply.

Does adrenalin have any specific effect on muscular fatigue?—Although in the instance represented in Fig. 5, and in some other instances when blood pressure was prevented from rising, no clear evidence of remarkable recovery from fatigue was noted after splanchnic stimulation, we have been unable to prove that adrenalin is without any specific effect on fatigued muscle.

In Fig. 6 *A*, for example, a fatigue record of uniform height was changed to a rhythm of higher contractions when the splanchnics

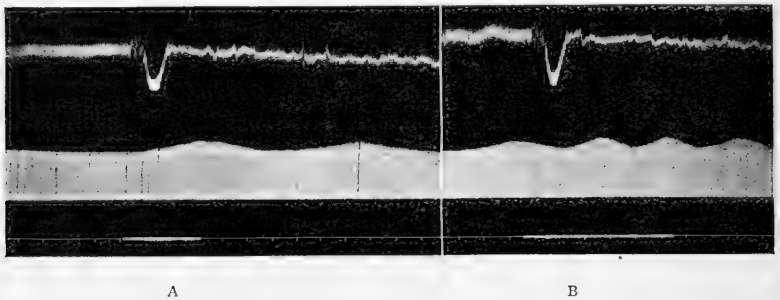

FIGURE 6. (Two-thirds the original size.) *A*, top record, blood pressure in left femoral artery with mercury manometer. Middle record, contractions of the *extensor communis* against a spring. Bottom record, stimulation of left splanchnics, and time in half minutes. *B*, the same, five minutes after *A*. From the beginning of splanchnic stimulation to the end of the record in *A* and *B*, rise of blood pressure prevented by pull on the aorta.

were stimulated and the blood pressure in the legs prevented from rising by a pull on the aorta. And in Fig. 6 *B*, taken five minutes after *A*, the slow rhythm of *A* was changed by stimulation of the splanchnics to a more rapid rhythm of slightly higher contractions. That adrenalin was secreted in these cases is shown by the fall of blood pressure shortly after stimulation of the splanchnics was begun. It is noteworthy that the first oscillation in *A* does not start with the beginning of stimulation, but is coincident with the first indication of the fall of pressure.

Similar results are obtained if, instead of arousing adrenal secretion, adrenalin is injected. In Fig. 7, 2 c.c. of adrenalin (1:100,000) were injected intravenously during the period indicated on the time line. The blood pressure was prevented from rising by pulling on

the thread looped round the aorta. There was a typical fall of pressure after the injection. Accompanying it was a distinct increase in the height of the muscular contractions. Changes in blood pressure in the legs almost exactly the same as those following the injection of adrenalin could be produced by pulling on the aorta, but there resulted no alteration in the height of the fatigue record. The rise in that record shown in Fig. 7, therefore, is not due to diminished blood supply.¹⁶ Also it is not due, therefore, to the introduction of sodium bicarbonate from the manometer connection into the circulation.

The drop in blood pressure following injection of adrenalin, or as a consequence of adrenal secretion, is due to vasodilation.¹⁷ It might be supposed that, because of vasodilation, and in spite of a general fall of pressure, the blood supply to the muscle would be improved; and therefore, even in the case represented in Figs. 6 and 7, the higher contraction should be ascribed to better circulation. Against this supposition is the observation that when the arteries are deprived of their central innervation, as was the case with the arteries supplying the contracting muscle, adrenalin causes not a dilation but a constriction of the vessels.¹⁸ And even if adrenalin did not cause vasoconstriction in this region, it could hardly produce much further dilation, for, as already noted, the vascular nerves had been cut and furthermore

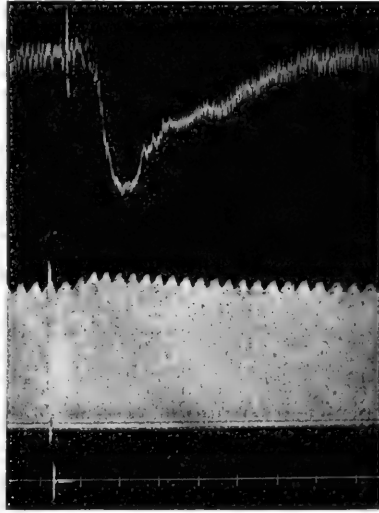

FIGURE 7. Top record, blood pressure, mercury manometer. Middle record, contractions of *tibialis anticus*, 180 times per minute, against a spring. Bottom record, injection of 2 c.c. adrenalin (1: 100,000), and time in half minutes. Rise of blood pressure prevented by pull on the aorta.

¹⁶ LEE's suggestion (this Journal, 1907, xviii, p. 272) that increase of carbon dioxide increases the height of muscular contraction makes the effect of lessened blood supply worthy of consideration.

¹⁷ See CANNON and LYMAN: *Loc. cit.*, p. 384.

¹⁸ See CANNON and LYMAN: *Loc. cit.*, p. 387.

were being stimulated at a rate favorable to relaxation (see p. 47). It seems probable, therefore, that adrenalin can itself act specifically in a manner not yet explained, to improve the contraction of fatigued muscle. This conclusion is in harmony with the observation of Dessy and Grandis, previously cited, that adrenal extract betters contraction when added to a solution in which the muscle is submerged.¹⁹

Consideration of the cases in which no improvement was observed.— Comparison of the records reproduced in Fig. 5 and in Fig. 7 shows that in all probability the part played by adrenalin itself in directly augmenting the power of fatigued muscle is much less than the part which it plays by improving the blood supply. The astonishing increase in the power of the muscle shown in Fig. 5, however, occurred in an animal with a blood pressure of only 48 mm. of mercury, a pressure which was more than doubled by splanchnic stimulation.

In the early experiments of this investigation the sole object of recording blood pressure was to note the relations between changes of pressure and the variations in muscular contraction, or the results on muscular contraction when the adrenals were stimulated and the pressure kept under control. In these early experiments, unfortunately, because of the reasons just given, the actual height of the blood pressure was not recorded.

The marked improvement of muscular contraction in some instances and the slight improvement or lack of improvement in others (*cf.* Figs. 2 and 7) in which the conditions seemed the same, led to an enquiry regarding the occasion for the difference. The fact soon appeared that although the slight improvement which we have attributed to adrenalin directly (see Fig. 7) can be manifested even if the blood pressure is as high as 140 or 150 mm. of mercury, such improvement as is shown in Figs. 3 and 5 does not appear unless there is a low blood pressure. And if the pressure is down as low as 50 mm. of mercury, splanchnic stimulation or injection of a small dose of adrenalin will cause the pressure to increase greatly, and a striking betterment of muscular work results.²⁰ The effects of adrenal

¹⁹ We have been unable to confirm this observation by similar use of frog muscles.

²⁰ The exact relations between variations of blood pressure and muscular efficiency are now being investigated in this laboratory by Mr. C. M. GRUBER.

secretion, therefore, seem to be of two sorts; (1) a direct specific effect which benefits a fatigued muscle even when blood pressure is high, and (2) an indirect effect due to better circulation, and (within limits which are as yet undetermined) more striking the lower the blood pressure.

Elimination of hyperglycaemia as a cause of the higher contraction. — In the course of these experiments we repeatedly found sugar in the urine—a result probably due to hyperglycaemia from splanchnic stimulation. Recently Wilenko²¹ has declared that the ability of the organism to burn sugar is lessened by adrenalin. It may be, however, that because of the artificial conditions of his experiments, their pertinence, when applied to the natural hyperglycaemia and adrenalinaemia of splanchnic origin, is questionable. Whether the adrenal secretion liberated with sugar when the splanchnics are stimulated does or does not similarly check the utilization of the sugar, data are at hand to prove that the hyperglycaemia is not essential to improved muscular contraction as described above. The sugar which makes the hyperglycaemia following splanchnic stimulation comes from the liver. The liver can be almost wholly removed, without disturbing the blood flow in the inferior vena cava, and yet splanchnic stimulation causes the typical rise in the muscle curve.

DISCUSSION OF RESULTS

It is noteworthy that the best results of adrenalin on fatigued muscle reported by previous observers were obtained from studies on cold-blooded animals. In these animals the circulation is maintained normally by an arterial pressure about one-third that of warm-blooded animals. Injection of adrenalin in an amount which would not shut off the blood supply would, by greatly raising the arterial pressure, markedly increase the circulation of blood in the active muscle. In short the conditions in cold-blooded animals are quite like those in the pithed mammal with an arterial pressure of about 50 mm. of mercury (see Fig. 5). Under these conditions the improved circulation causes a striking recovery from fatigue. That marked results

²¹ WILENKO: *Biochemische Zeitschrift*, 1912, xlii, p. 49; *Zentralblatt für Physiologie*, 1913, xxvi, p. 1059.

of adrenalin on fatigue are observed in warm-blooded animals only when they are deeply anaesthetized or are deprived of the medulla, was claimed by Panella. He apparently believed that in normal mammalian conditions adrenalin has little effect because quickly destroyed, whereas in the cold-blooded animals, and in mammals whose respiratory, circulatory and thermogenic states are made similar to the cold-blooded by anaesthesia or pithing, the contrary is true.²² In accordance with our observations on the effects of blood pressure on fatigued muscle, we would explain Panella's results not as he has done but as due to two factors. First, the efficiency of the muscle, when blood pressure is low, follows the ups and downs of the pressure much more directly than when the pressure is high (see p. 56). And second, a given dose of adrenalin raises a low blood pressure in atonic vessels, whereas it may lower the pressure or fail to cause a marked rise in vessels tonically contracted. The improvement of circulation is capable of explaining, therefore, the main results obtained in cold-blooded animals and in pithed mammals.

Oliver and Schäfer reported more effective contractions in muscles removed from the body after adrenal extract had been injected. As shown in Fig. 5, however, the fact that the circulation *had been* improved results in continued greater efficiency of the contracting muscle. Oliver and Schäfer's observation may reasonably be accounted for on this basis.

How the improvement in muscular contraction, after adrenal secretion is evoked or after adrenalin is injected, can be explained, is not clear. The results above reported show that the improvement, though not great, is distinct, and that it apparently does not result from better circulation. According to Panella²³ adrenalin has an effect antidotal to curare, and, injected either mixed with or following curare, is capable of preventing the complete immobility which the curare alone would produce. This experiment points to an action of adrenalin in the region of transfer of influence from the nerve to the muscle. Radwńska²⁴ also reported finding that adrenalin has a more favorable action on fatigued muscle if the muscle is being stimulated through its nerve than if stimulated directly, and

²² PANELLA: *Loc. cit.*, p. 462.

²³ PANELLA: *Archives italiennes de biologie*, 1907, xlvii, p. 30.

²⁴ RADWŃSKA: *Loc. cit.*

he drew the inference that its beneficial effect is on the nerve endings. It seems quite possible therefore that the improved contraction of fatigued muscle after splanchnic stimulation, when rise of arterial pressure is prevented, is the consequence of a facilitation of the passage of impulses into the fatigued muscle.

The original purpose of this investigation was to learn whether the increased adrenal secretion accompanying major emotional states and pain²⁵ might act as a dynamogenic factor in the performance of muscular work. Apart from the increase of arterial pressure in conditions of low pressure, the change wrought by adrenal secretion on the efficiency of muscle is too slight to account for the feats of strength which are performed in times of great excitement. The main source of power under these conditions is probably to be found in an immensely augmented activity of the nervous system. The observations here recorded, however, indicate that adrenalin may operate favorably in making more effective the nervous impulses delivered to fatigued muscles.

SUMMARY

If the *tibialis anticus* muscle, stimulated through its isolated nerve, is writing a fatigue curve, excitation of the left splanchnic nerves, also isolated, usually produces an increased height of contraction in the muscle record. (See Figs. 2 and 3.) Since splanchnic stimulation discharges adrenal secretion, the question is raised as to the effect of adrenal secretion on skeletal muscle.

The betterment of action of the fatigued muscle is mainly due to the increased blood flow resulting from splanchnic stimulation, and is more marked the lower the blood pressure when the splanchnics are excited. (See Fig. 5.) The betterment of the muscular contraction may long outlast the change in the circulation. Probably most previously reported effects of adrenalin on skeletal muscle (observed in cold-blooded animals with low blood pressure) should be attributed to the change in circulation and not to a specific action of adrenalin.

If, by pull on the aorta or by compression of the thorax, blood

²⁵ See CANNON and DE LA PAZ: this Journal, 1911, xxviii, p. 64; CANNON and HOSKINS: this Journal, 1911, xxix, p. 274.

pressure in the hind legs is prevented from rising, splanchnic stimulation still causes a slight but distinct rise in the height of contraction of the fatigued muscle. This betterment may appear in rhythm or altered rhythm. (See Fig. 6.) Its initial appearance coincides with evidence of adrenal secretion. It is produced also when adrenalin in weak solution (1:100,000) is given intravenously. (See Fig. 7.)

The improvement of muscular contraction which apparently results from adrenal secretion (when the blood pressure is controlled) is too slight to account for the increased muscular power observed during excitement. Fatigued muscles may, however, be thus prepared, by secretion of the adrenal glands, for better response to the demands of powerful nervous discharges.

THE RECEPTIVE RELAXATION OF THE COLON

By HENRY LYMAN

[From the Laboratory of Physiology in the Harvard Medical School]

THAT the cardiac sphincter is relaxed as food is started toward it in the oesophagus was shown by Kronecker and Meltzer in 1883.¹ In 1911, Cannon and Lieb found that if the stomach is tonically contracted when food is swallowed, the tonus is momentarily abolished by vagus impulses, at a time when the swallowed bolus would be delivered by the oesophagus.² Thus muscles which would otherwise be opposed in action are made to cooperate reciprocally. A similar relation was proved by Joseph and Meltzer to exist between the stomach and intestine, — inhibition of contractions of the duodenum in the rabbit occur coincident with peristalsis of the pyloric portion of the stomach.³ Might not the same mutual relation be present between the ileum and proximal colon? Cannon noted in his first observations of the movements of the intestines that “as food is nearing the ileocolic valve the large intestine is usually quiet and relaxed,” and that contraction near the valve disappears “just previous to the entrance of the food.”⁴ Since the characteristic activity of the proximal colon is anastalsis, large and small intestine would be set in direct opposition if that activity continued while the small intestine discharged material through the ileocolic valve. The relation between these neighboring parts of the alimentary canal seemed worthy of further study.

In the present study the intestines were observed directly. The animal (cat) was anaesthetized with urethane (2 gm. per kilo body-weight), and in occasional instances when the corneal reflex returned ether was used in addition. After a tracheal cannula was intro-

¹ KRONECKER and MELTZER: *Archiv für Physiologie*, 1883, Supplement Band, p. 358.

² CANNON and LIEB: *this Journal*, 1911, xxvii, p. xiii.

³ JOSEPH and MELTZER: *this Journal*, 1911, xxvii, p. xxxi.

⁴ CANNON: *this Journal*, 1902, vi, p. 267.

duced, the spinal cord was pithed from the sacrum to the lower thoracic region (to remove the inhibitory effect of splanchnic influences), and the opening in the skin closed with sutures. Eserine salicylate (gr. $\frac{1}{60}$) was given subcutaneously, and, if necessary, the dose was repeated in two hours. Half an hour after the lower cord was pithed the abdomen was opened, bleeding points were clamped or tied off, and the animal then placed in a bath of physiological salt solution at 38° C. A glass tube with a lumen of 8 mm. was tied into the rectum so that defecation might occur without spoiling the bath.

To excite movements of the small intestine when food was not present in it warm starch paste, colored with methylene blue and rendered more stimulating by the addition of yellow soap, was injected through the wall by means of a large hollow needle. If natural digestion was in process the gut reacted well to the presence of the paste-soap mixture, but if the tract was empty the injected material was quite without effect.⁵ The mixture was not introduced through the wall of the colon because injury to this part of the tract seemed to affect unfavorably its motions.

If digestion was not in process when the abdomen was opened, 15 c.c. $\frac{n}{10}$ HCl was poured into the stomach through a tube in the oesophagus, and this was followed by 100 c.c. of warm milk. Natural gastric peristalsis would then begin, the contents would be discharged, and the course of the food along the intestinal canal could be clearly observed. From two and a half to three hours were usually taken for material to reach the ileocolic junction. In one case, however (a cat with diarrhoea), the entire process was complete, and the whole tract, including the colon, was empty in an hour and twenty-four minutes.⁶

Observations on the relations of activity in the ileum and in the colon were as follows:

⁵ Cf. MAGNUS: *Archiv für die gesammte Physiologie*, 1904, cii, p. 130.

⁶ Activity of the upper part of the gastro-intestinal canal, when the abdomen is opened, stimulates the large gut to empty itself. In this process the first change is the drawing down of the distal part of the large gut into the pelvis. Then a strong katastaltic wave, starting in the caecum and usually traversing only the proximal third of the colon pushes material into the distal two thirds where katastalsis is the usual activity. After one or two such waves from the caecum defecation occurs if that is possible. Cf. CANNON: *The mechanical factors of digestion*. London and New York, 1911, p. 161.

When material was being driven through the ileocolic sphincter by peristalsis in the ileum, the colon, which a moment before had been in tonic contraction and exhibiting anastalsis, became motionless and quite relaxed. As soon as the process was finished and the ileum was again quiet, anastaltic waves again appeared in the colon (see Fig. 1, A, B and C). In fourteen cats which were studied in this manner this reciprocal relation between the activities of ileum and colon was repeatedly noted.⁷

In one case only was there an exception; the activities of the colon in this instance consisted in strong contractions directed towards

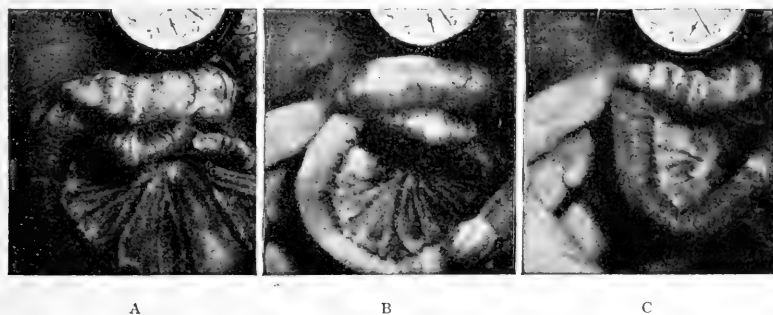

FIGURE 1. Photographs of the intestines, taken with flash-light.

- A. Anastalsis on the colon at 12: 22: 27. Ileum relaxed. Time recorded by submerged watch.
- B. At 12: 25: 28 colonic anastalsis stopped as a peristaltic wave in the ileum is pushing material into the colon. Note the pallor of the ileum.
- C. At 12: 26: 35. Strong anastalsis on the colon again, and inactivity of ileum.

defecation, alternating with vigorous anastalsis, and no material was pushed onward from the ileum. The rectal tube was afterwards found to be plugged. When the contents of the colon were gaseous, and when the colon had very little solid or semisolid material in it, receptive relaxation did not always occur.

The colon was not inhibited by mere presence of food in the lower ileum, for segmentation was often noted in the small gut close to the

⁷ Destruction of the spinal cord did not abolish the tone of the ileocolic sphincter in the animals observed in this investigation, for the anastaltic waves never forced material from the colon into the ileum. This result does not agree with Elliott's observations on the rat (*Journal of physiology*, 1904, xxvi, p. 166), but his animals were examined several days after the lower cord had been destroyed.

sphincter while active anastalsis continued in the colon. Moreover, when the small gut was clamped next the sphincter with rubber-tipped forceps, and the lower ileum distended with starch paste, anastaltic waves kept running over the proximal part of the large gut without interruption. And when a cotton swab, coated with vaseline, was pushed up to the sphincter no inhibition of the activities of the colon resulted; but when the swab was forced through the sphincter the colon at once relaxed to become active again as soon as the swab was withdrawn. This effect could be repeated several times.

Since the receptive relaxation of the colon occurred in the absence of nervous connections with the spinal cord, the mechanism controlling it is local, probably as the relation of the pyloric part of the stomach to the duodenum is local. It is another instance of the reciprocal innervation of opposed muscles.

REMARKS ON THE ORIGIN OF THE PHRENIC NERVE IN THE RABBIT, CAT, AND DOG

By ABBY H. TURNER

[From the Laboratory of Comparative Physiology in the Harvard Medical School]

IN an experimental study¹ of crossed respiration it was necessary to sever and to stimulate the phrenic nerve in the neck of the rabbit, cat, and dog. Complete section and adequate stimulation present some difficulty because variations in the origin of the nerve leave the observer sometimes in doubt whether he is dealing with the whole nerve or only part of it. Systematic dissections were therefore made at Dr. Porter's suggestion, to learn the frequency and character of these variations and to determine the best place for cutting the nerve and for stimulating its central end.

THE RABBIT

In making the dissection from the ventral side of the rabbit's neck the ventral rami of the fourth, fifth, and sixth cervical nerves are found beneath the external jugular vein and the sterno-mastoid muscle. The ventral rami of the seventh and eighth cervical and the first thoracic nerves appear well beneath the pectoral muscles and the union of the external jugular, cephalic, transverse-scapular, and axillary veins. Since the purpose of the dissection was physiological the points of origin of the phrenic roots and the site of their union to form the main phrenic stem will be mentioned as they would appear were the dissection made in the living animal without injury to the nerves, not as they might be found to be after a final separation of all the minute connective tissue strands.

Different individuals and the two sides of a single animal may vary in the number of phrenic roots and in their place of union.

¹ PORTER, W. T., and ABBY H. TURNER: To be published in the next issue of this Journal, June 1, 1913.

There are usually three roots (Fig. 1), one each from the fourth, fifth, and sixth cervical nerves, but there may be two or four. When only two roots were found they were from the fourth and the fifth cervical nerves. *The root from the fourth nerve* is slender and leaves the ventral ramus at or before its appearance from the deep neck muscles.

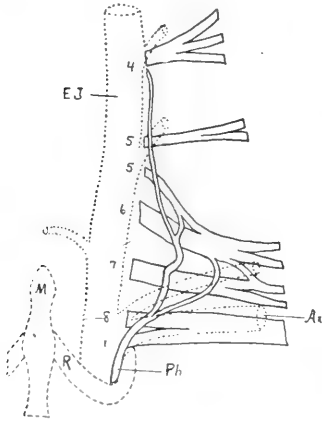

FIGURE 1. The right phrenic nerve in a rabbit with fourth, fifth, and "long" sixth root. The central ends of five cervical nerves are marked 4, 5, 6, 7, and 8, respectively; (1) marks the first thoracic nerve. The subdivisions of the nerves are incompletely indicated. *Ph*, phrenic nerve; *Ax*, axillary vein; *EJ*, external jugular vein; *M*, manubrium; *R*, cartilage of first rib.

It passes backward over the fifth nerve and may go as far as the eighth before being joined by other roots, although it usually unites with the fifth root between the fifth and sixth nerves. *The fifth phrenic root* leaves the fifth nerve with the ansa uniting the fifth and sixth nerves, from which it is wont to separate to join the fourth root nearer the sixth than the fifth nerve. This fifth root is often though not always the largest phrenic component. *The sixth phrenic root* presents the greatest variation as it may be single or double, long or short.

When it leaves the sixth cervical near the latter's place of appearance between the muscles it will be called "short" because in that case it typically unites at once with the other roots. When it leaves the sixth cervical a centimetre or more farther out it will be called "long" because in that case its course is usually a loop, laterally

extended, across the seventh nerve, and its union with the other phrenic roots is as far or farther back than the seventh nerve. In some cases both short and long roots were found. Any union of the phrenic roots further back than the sixth cervical presents difficulty to the operator because of the large overlying veins. The variation in origin and course of the roots makes it essential that all roots be carefully identified to insure complete section or stimulation. In all cases, except in the few instances where only two roots occur, the length of nerve between the final union of phrenic roots and the nerve's entrance into the thorax is short, rarely if ever more

than 1.5 cm. and frequently only a few millimetres. In stimulating the nerve, therefore, the danger of escape of current to the nearby brachial plexus is obvious and a pure phrenic effect is rendered less sure. As a result of these dissections it seems advisable to use the nerve in the thorax rather than in the neck whenever possible. If opening the thorax is undesirable, the safest place to identify the phrenic is under the axillary vein as close as possible to the entrance of the nerve into the thorax. Tables I and II afford a survey of the variations in the rabbit.

TABLE I
ORIGIN OF PHRENIC NERVES IN THIRTY-THREE RABBITS

Cervical nerves from which nerve originates	Right	Left
4th, 5th, 6th (short root)	11	9
4th, 5th, 6th (long root)	15	11 (+ 1?)
4th, 5th, 6th (both short and long roots) . .	2	4 (+ 1?)
4th, 5th	5	5
4th, 6th (5th ?)	1
4th, 5th, 6th (two long roots)	1

THE CAT

Seven dissections of the origin of the phrenic in the cat were made. In all except one case the origin was from the fifth and sixth cervical nerves. In the one exception, a left nerve showed also a small root from the fourth cervical. In ten of the fourteen nerves the roots united at about the seventh cervical nerve, somewhat beneath the large veins, but furnished a piece of nerve anterior to the thorax long enough for safe stimulation after it was carefully freed from the neighboring brachial plexus. In one case the two roots united well down inside the thorax opposite the second rib, and in another case opposite the third rib, but in both these instances the roots were parallel and adjacent. In two cases however, the fifth root ran

TABLE II
PLACES OF UNION OF ROOTS OF PHRENIC NERVES IN THIRTY-THREE RABBITS

	Right	Left
4th root joins 5th between 5th and 6th cervical	2
4th root joins 5th at or near 6th cervical	20	16 (+ 1?)
4th root joins 5th between 7th and 8th cervical	2
4th root joins 5th and 6th roots at 6th cervical or anterior to 7th cervical	6	8
4th root joins 5th and 6th roots at 7th cervical or beyond	6	2
4th and 5th roots join 6th root at 6th cervical or anterior to 7th cervical	2	4
4th and 5th roots join 6th root at 7th cervical or beyond	13 (+ 1?)	15 (+ 1?)
4th, 5th, and 6th roots unite at 6th cervical	1	..
4th, 5th, and 6th roots unite at 7th cervical	1	..
4th, 5th, and 6th roots unite at 8th cervical	1
5th root joins 6th root at or near 6th cervical	10	10
5th root joins 6th root at 7th cervical	1?	1
5th and short 6th roots join 4th and long 6th roots at 7th cervical	1

Full face figures call attention to instances where a union of roots occurs at or posterior to the 7th cervical nerve. Total, 42 (+ 3?).

dorsal to the subclavian vein as usual while the sixth root was ventral to it, a modification unexpected and difficult for the operator. The union of the two roots was within the thorax in these cases.

THE DOG

Two dissections only were made. All four nerves took their origin from the fifth, sixth, and seventh cervical nerves. The place of final union varied from the level of the seventh nerve to that of the first

rib within the thorax, and in all cases careful exploration beneath the large veins in the neck would have been necessary to insure the use of all roots of the nerve anterior to the thorax.

CONCLUSION

As a result of these dissections it is advised that the phrenic nerve whenever possible be severed or stimulated in the thorax rather than in the neck.

ON THE RELATION OF PULSE PRESSURE TO RENAL SECRETION

BY ROBERT A. GESELL

[*From the Physiological Laboratory of the Washington University*]

OBSERVATIONS concerning the relation of blood pressure to the activity of the kidneys are numerous, but the relation of pulse pressure to renal secretion has but rarely been noted. Erlanger and Hooker¹ in their observation of blood pressure in man noted a relation which was as follows:

1. As a rule the amount of urine secreted varied directly with the magnitude of the pulse pressure.
2. In a case of orthostatic albuminuria the amount of albumin in the urine varied inversely with the magnitude of the pulse pressure.
3. The amounts of urea, chlorides and phosphates secreted in the urine varied directly with the magnitude of the pulse pressure.

More recently Hooker² has again investigated this problem. By means of a specially devised pump he studied the effects of variation of the magnitude of the pulse pressure upon the perfused, isolated kidney of the dog. He obtained the following results:

1. With a constant mean perfusion pressure the amount of urinary filtrate varied directly as the magnitude of the pulse pressure.
2. With a constant mean perfusion pressure the amount of protein in the urinary filtrate varied inversely as the magnitude of the pulse pressure.
3. With a constant mean perfusion pressure the rate of blood flow through the organs varied directly as the magnitude of the pulse pressure.

¹ ERLANGER and HOOKER: Johns Hopkins Hospital reports, 1904, xii, p. 346.

² HOOKER: This journal, 1910, xxvii, p. 24; HOOKER: Archives of internal medicine, 1910, v, p. 491; HOOKER, HEGEMAN and ZARTMAN: This journal, 1909, xxiii, p. xi.

Unfortunately the conditions in man, owing to the difficulty of controlling the pulse pressure and of obtaining at the same time accurate data concerning mean blood pressure and volume flow through the kidneys, do not allow of a finer study of the relation of pulse pressure to renal activity.

The method employed by Hooker offers rather great technical difficulties, subjects the kidneys to abnormal conditions, and introduces two variable factors at one time,—the rate of blood flow through the kidneys varying directly with the magnitude of the pulse pressure.

A method by which the pulse pressure can be altered at will in the animal is of course the ideal method. Such a method was used in the present research. The principle of air compression was employed. An air chamber under mean blood pressure was connected indirectly with one or both renal arteries and the magnitude of the pulse pressure controlled by varying the size of the air chamber. Various modifications of this general procedure were employed. Each will be considered in detail in its proper place.

Dogs were used in all the experiments. They were anaesthetized with morphine and ether. The kidneys were left intact and were not manipulated.

THE EFFECTS OF THE AIR CHAMBER UPON PULSE PRESSURE

The pulse curve represents a series of pressure changes lying between diastolic and systolic pressure occurring during each cardiac cycle and may be altered in three ways by the method used for diminution of the pulse pressure. There may be alterations in the time relations of pressure changes, diminution of the suddenness of pressure changes, and diminution of the magnitude of pressure changes. In this research we are studying then the effects of changing three variable factors at one time. It is of interest to determine the relative importance of these factors, if possible, and therefore attention is called to them at this point. Evidence will be brought out to show that probably the magnitude and suddenness of pressure changes are of importance and therefore when future reference is made to the effects of diminution or change of pulse pressure the suddenness of pressure changes should always be kept in mind.

THE RELATION OF PULSE PRESSURE TO MEAN BLOOD PRESSURE
AND VOLUME FLOW OF BLOOD

Numerous investigators³ have noted the beneficial effect of an intermittent perfusion pressure upon isolated organs not only for the maintenance of the normal condition of the tissues but also for the rate of perfusion through the tissue.

Since the normal condition of tissues and volume flow of blood as well as the mean blood pressure are important factors in secretion, the relation of altered pulse pressure to these factors was studied in a few preliminary experiments.

A dog was prepared on a warm table. Its temperature was maintained at the normal level throughout the experiment. A means of injecting blood at a constant pressure was arranged. The abdomen was opened and the gastro-intestinal tract removed in order to gain free access to the renal arteries and veins. By an arrangement shown in Fig. 1 the pulse pressure was eliminated in one kidney without altering the

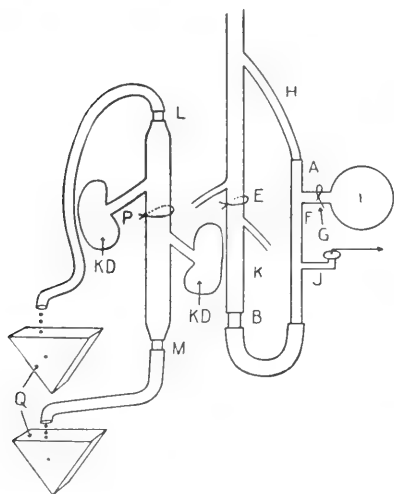

FIG. 1.

pulse pressure in the other. Cannula *A* was connected with the inferior mesenteric artery *H*, cannula *B* with the lower end of the abdominal aorta *K*, and *A* and *B* connected by a tube with two side branches *F* and *J*. Branch *F* was connected with the air chamber *I*, and communication between the two broken or established by pinch cock *G*. A manometer to record the blood pressure in the left renal artery was connected to the tube *J*. The whole system was filled with Ringer's solution to the exclusion of all air bubbles. The tension of the air in *I* was increased to mean blood pressure. Ligature

³ HOOKER: *Loc. cit.*; SOLLMANN: This journal, 1905, xiii, p. 241; BRODIE: *Journal of physiology*, 1903, xxix, p. 267; HAMEL: *Zeitschrift für Biologie*, 1889, xxv, p. 274; HOFFMANN: *Archiv. für die gesammte Physiologie*, 1903, C, p. 242.

E, which lies on the aorta between the left and right renal arteries, was tied, thereby shunting the blood for the left renal artery out of its normal course, through the inferior mesenteric artery, through the tubes up the abdominal aorta to the left renal artery. The blood for the right kidney followed its normal course. By this arrangement it was possible to eliminate the pulse pressure in the left kidney without altering blood pressure conditions in the right kidney. The volume flow of blood from the right and left kidneys was measured directly by means of two tipping buckets. The arrangement of cannulae is shown in Fig. 1. One cannula *L* was connected with the inferior

TABLE I

Period no.	Right or left kidney	Mean blood pressure in mm. Hg.		Volume flow of blood in c.c. per minute	
		P.P.+	P.P.—	P.P.+	P.P.—
1	L.K.	70	70	100	100
1	R.K.	70	70	88	85
2	L.K.	70	70	108	108
2	R.K.	70	70	94	92
3	L.K.	76	76	120	120
3	R.K.	76	76	120	120

vena cava directly above and another cannula directly below the renal veins. Ligature *P*, which lies on the inferior vena cava between the renal veins was tied and the blood from each kidney was led into separate tipping buckets *Q*. In this procedure the circulation of the kidneys was not interrupted for a moment on inserting either the arterial or venous cannulae. The blood was collected from the tipping buckets, defibrinated, and continually replaced by other defibrinated blood, through the external jugular vein. The mean blood pressure was maintained at any desired level by regulating the rate of inflow of blood. The magnitude of the pulse pressure was perfectly controlled by regulating the size of chamber *I*.

Figs. 3, 5, and 6 show effects which the air chamber exerted on

the pulse pressure. The difference in effect is due largely to the size of the air chamber employed.

Returning to the relation of pulse pressure to mean blood pressure and volume flow of blood; it was found with the arrangement shown in Fig. 1 that it was possible to diminish the pulse pressure in the left renal artery without diminishing the pulse pressure in the right renal artery. When this was done the mean blood pressure remained practically constant. The volume flow of blood from each renal vein

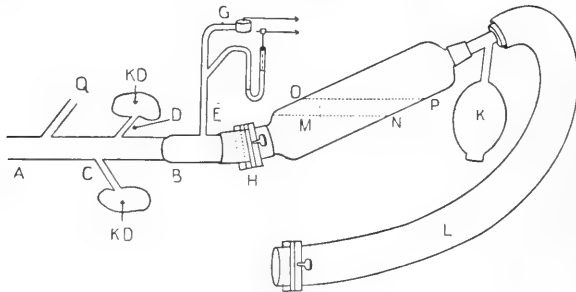

FIG. 2.

showed practically no change. Some of the data obtained are tabulated on page 73.

These results seem to be opposed to the results of numerous investigators, but the fact that the data so far collected were obtained from perfusion of isolated organs and tissues under more or less abnormal conditions probably accounts for the difference in findings. With the kidneys intact, diminution of pulse pressure over long periods of time had, in the present experiments, very little effect upon the kidneys. In some experiments no change was noted.

THE RELATION OF ALTERED PULSE PRESSURE TO RENAL SECRETION AND FURTHER DATA CONCERNING MEAN BLOOD PRESSURE AND VOLUME FLOW OF BLOOD

With the above important data at hand the additional study of the relation of pulse pressure to renal secretion was attempted by a simplified method. The pulse pressure was altered simultaneously in both kidneys and the outflow of blood from both kidneys measured by one tipping bucket.

The dogs were prepared as previously described, but a new arrange-

ment shown in Fig. 2 for varying the magnitude of the pulse pressure was employed. A large cannula *B* was inserted into the abdominal aorta directly below the renal arteries. Blood pressure was recorded by one or both manometers *G* from side tube *E*. *B* was connected to a large air chamber which consists of a glass tube *J* and a rubber tube *L* one inch in diameter and six feet long. The pressure in this chamber was raised to mean blood pressure by means of a rubber bulb *K*. The amount of diminution of the pulse pressure was regulated by adjusting the size of the chamber. The blood pulsates between the dotted lines *MN* and *OP*, and there the pulse pressure

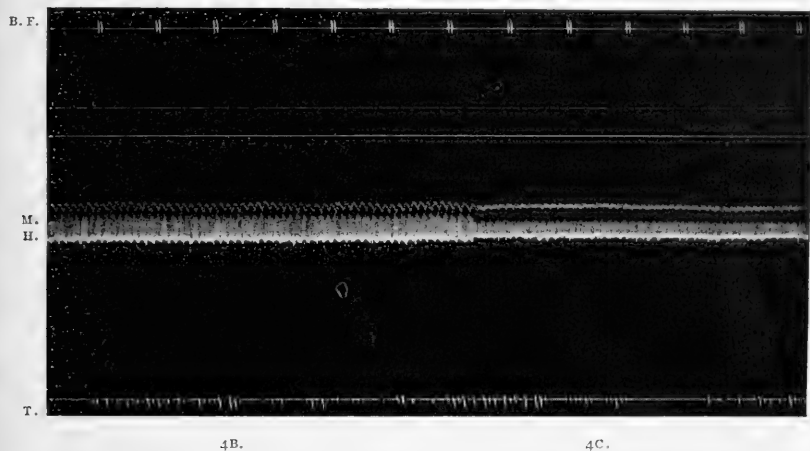

FIGURE 3. About one half the original size. *4b*. Period of normal pulse pressure. *4c*. Period of diminished pulse pressure. *B. F.* Volume flow of blood from both kidneys recorded, by tipping buckets. 125 cc. per minute in periods *4b* and *4c*. *M.* Mean blood pressure recorded by mercury manometer connected with tube *E*. 97 mm. Hg during periods *4b* and *4c*. *H.* Pulse pressure recorded by Hürthle manometer connected with tube *E*. *T.* Time in seconds.

is diminished. By recording blood pressures from *E*, *D*, and *Q* respectively it was found that the degree of elimination of pulse pressure in a rough way varied inversely with the distance from the point of elimination. The changes of magnitude of pulse pressure occurring in the renal arteries amount to about half those recorded by the Hürthle manometer *G*. The blood pressure records are therefore used only as an index of the altered condition of pulse pressure in the renal arteries.

As in the preliminary experiments important data were obtained

concerning the relation of the pulse pressure to mean blood pressure and volume flow of blood through the kidneys.

Fig. 3 shows that the volume flow of blood and the mean blood pressure were not changed by a diminution of pulse pressure by the method employed. The mean blood pressure was recorded with a mercury manometer and the magnitude of the pulse pressure by a Hürthle manometer—both connected at *E*. On decreasing the magnitude of pulse pressure the volume flow of blood (125 c.c. per minute) and the mean blood pressure (97 mm. Hg) remained absolutely constant. Similar results were repeatedly obtained and are tabulated in Table II which is of interest in that it shows that a fall of mean blood pressure occurring with a diminution of pulse pressure may be accompanied by a slight increase in volume flow of blood.

TABLE II

Period no.	Mean blood pressure in mm. Hg		Volume flow of blood from both renal veins in c.c. per minute	
	P.P.+	P.P.—	P.P.+	P.P.—
1	100	98	126	132
2	97	96	128	131
3	97	97	125	125
4	97	96	180	185
5	99	96	176	185
6	108	108	232	228
7	111	109	232	228

The uniformity of results leaves no doubt concerning the relation of altered pulse pressure to mean blood pressure and volume flow of blood. Therefore if a change in renal secretion accompanies altered blood pressure that change must be ascribed to some specific effect of pulse pressure itself, whatever that may be.

Fig. 4 shows a diminution of urine flow accompanying a diminution of pulse pressure, even though the mean blood pressure and the volume flow of blood remain unchanged. Unfortunately the blood pressure was recorded from the carotid artery by a mercury manome-

ter and consequently does not show any pulse pressure changes. But previous experiments warrant us in assuming that the pulse pressure diminished on connecting the air chamber at the point indicated by the arrow head. The mean blood pressure remained at 122 mm. Hg throughout. The volume flow of blood (156 c.c. per minute) was unchanged by decreased pulse pressure. The urine flow was markedly decreased. This decrease must have been caused by the influence of pulse pressure itself.

FURTHER DATA FROM SIMPLIFIED METHOD CONCERNING THE RELATION OF ALTERED PULSE PRESSURE TO THE RATE OF RENAL SECRETION

It was desirable to obtain for analysis samples of urine over long periods of varying conditions of pulse pressure. This seemed impossi-

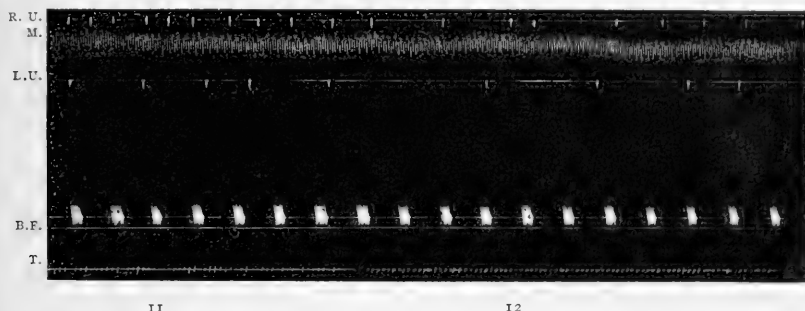

FIGURE 4. About one half the original size. 11. Period of normal pulse pressure. 12. Period of diminished pulse pressure. *R. U.* Urine flow in drops from right kidney. *L. U.* Urine flow in drops from left kidney. *M.* Blood pressure in carotid artery registered by a mercury manometer. 122 mm. Hg during periods 11 and 12. *B. F.* Volume flow of blood recorded by tipping buckets. 156 cc. per minute during periods 11 and 12.

ble because of the difficulties in the preceding method in maintaining constant vascular conditions. The procedure was therefore simplified still more by leaving the gastro-intestinal tract intact. The blood was no longer defibrinated but the glass portion of the air chamber partially filled with a dilute solution of hirudin. Since all the findings of the previous methods concerning the relation of pulse pressure to volume flow of blood and to mean blood pressure were constant it seemed justifiable to omit direct measurement of volume flow. But to be doubly assured that the same relations would hold

under the new conditions the velocity flow of blood was measured in the inferior vena cava and used as an index to the volume flow through the kidneys. A thermo-electric method devised by Dr. Erlanger was employed. A delicate thermo-electric junction in circuit with a d'Arsonval galvanometer was placed in the inferior vena cava at the base of the heart. Equal quantities of Ringer's solution at room temperature were injected into the inferior vena cava directly below the renal veins and the time between the injection and the deflection of the galvanometer was used as an index to the velocity flow of blood. Numerous observations were made upon three dogs but no appreciable change in rate of blood flow was found under vary-

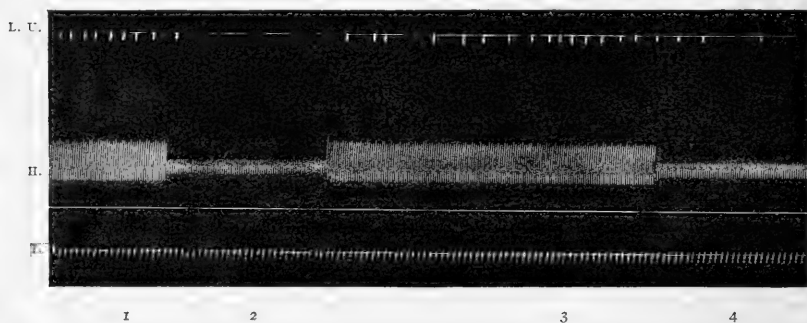

FIGURE 5. Four sevenths the original size. *L. U.* Urine flow in drops from left kidney. (The right kidney was not secreting). *H.* Blood pressure recorded by Hürthle manometer connected with tube *E*, showing effects of connecting the air chamber to the aorta. 1 and 3 normal pulse pressure of 60 mm. Hg. 2 and 3 diminished pulse pressure of 25 mm. Hg indicating a pulse pressure of 45 mm. Hg in the renal arteries. *T.* Time in seconds.

ing conditions of pulse pressure. Therefore in the future experiments no determinations of blood flow were made, on the assumption that if velocity changes accompanied altered conditions of pulse pressure, they were too small to obscure effects of pulse pressure itself upon renal secretion.

To produce diuresis a mixture of one part of 4 per cent sodium sulphate and three parts of Ringer's solution was slowly injected at a constant pressure throughout the experiment.

Figs. 5-8 show in general that the secretion of urine was stopped or diminished by a decreased pulse pressure; that with normal pulse pressure there was a subsequent recovery. But the suddenness and the amount of diminution and the rate of recovery varied with different animals and with the same animal at different times.

A copious flow of urine may be abruptly stopped by a diminution of pulse pressure, as shown in Fig. 5. There was a mean blood pressure of 70 mm. Hg. A normal pulse pressure of 60 mm. Hg was reduced to 25 mm. Hg at tube *E*, which indicates a pulse pressure of approximately 45 mm. Hg in the renal arteries. This relatively small change in pulse pressure was sufficient to quickly stop the urine flow and hold it in check until the kidneys were again subjected to normal pulse pressure. Then recovery was prompt.

The secretion of urine may only gradually be decreased by a diminution of pulse pressure as shown in Fig. 6. In this case we have a slightly different state of affairs. There was a relatively higher mean

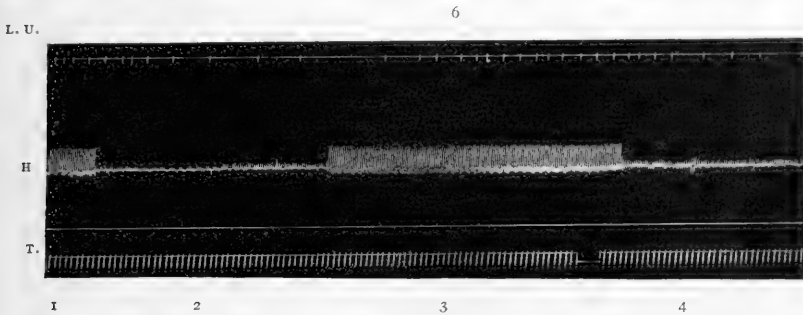
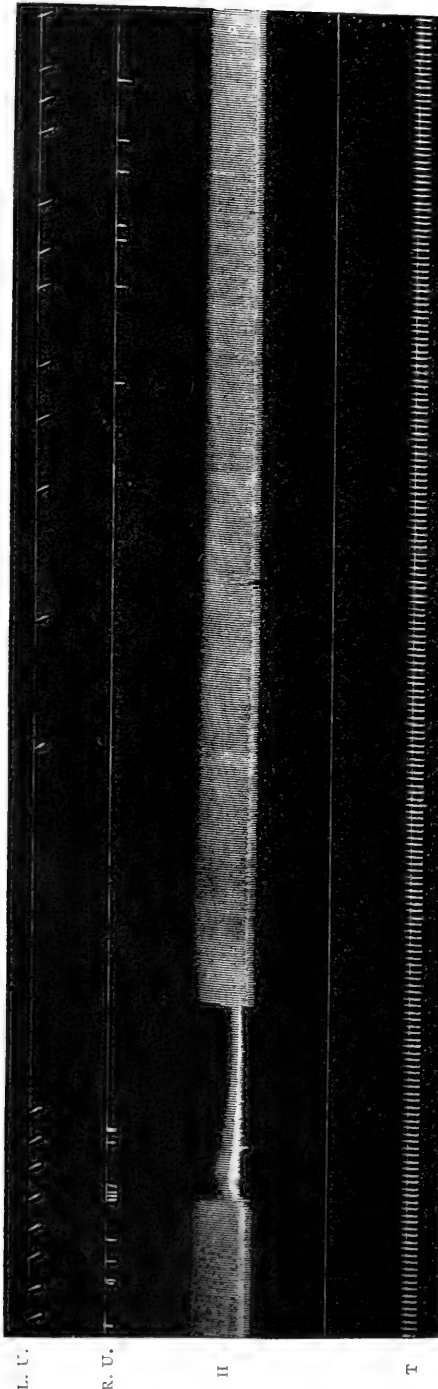

FIGURE 6. About four sevenths the original size. *L. U.* Urine flow in drops from left kidney. (The right kidney was not secreting). *H.* Blood pressure recorded by Hürthle manometer connected with tube *E*, showing effects of connecting the air chamber to the aorta. 1 and 3 normal pulse pressure. 2 and 4 diminished pulse pressure. *T.* Time in seconds.

pressure and a relatively greater decrease in pulse pressure. The secretion was only gradually diminished, not stopped by a diminution of pulse pressure. There was a rapid recovery with normal pulse pressure.

Fig. 7 shows the prolonged effect on secretion of a short period of diminished pulse pressure. An abundant flow of urine was stopped completely in twelve seconds. Recovery was very gradual and was not complete at the end of two and a half minutes. In other cases a short period of diminished pulse pressure stopped the secretion as long as an hour. This is of theoretical importance. It points out the deleterious effect of a constant pressure as well as the beneficial effects of a pulsatile pressure.

The influence of pulse pressure upon renal secretion may be masked by conditions tending to increase the rate of secretion. For



II. Blood pressure recorded by Hürthle manometer connected with tube *E*. 1 and 3. Periods of normal pulse pressure. 2. Period of diminished pulse pressure. *T*. Time in seconds.

instance in one experiment the rate of secretion at the beginning of the experiment was 16 and 18 drops respectively from the right and left kidney. Two hours later the rate was 41 and 24 drops respectively. During the gradually increased rate a diminution of pulse pressure had no noticeable effect upon renal secretion. Later on, however, when the flow of urine had become constant the effect of decreased pressure, although slight, was demonstrable.

In general, as shown in Figs. 4-7, the rate of secretion varied directly with the magnitude of the pulse pressure. In marked contrast to this are the results shown in Fig. 8, which indicate that in addition to magnitude of pulse pressure the suddenness of pressure changes may be a very important factor in renal secretion.

It was found in certain instances that on connecting the air chamber with the aorta, the magnitude of the pulse pressure was unchanged, slightly diminished or even increased

FIGURE 7. *R. U.* Urine flow in drops from right kidney. *L. U.* Urine flow in drops from left kidney.

and yet in every case a copious secretion was abruptly stopped, and held in check until the kidneys were again subjected to normal pulse pressure.

In a specific instance: During normal pulse pressure there was a rapid flow of urine. Connecting the air chamber probably reduced the pulse pressure 1 or 2 mm. Hg in the renal arteries, but raised the mean pressure a few millimetres. The secretion of urine was stopped by some influence of the air chamber. It was held in check for over three minutes. Recovery of normal secretion was prompt on subjecting the kidneys to normal pulse pressure.

Of still greater interest are the results shown in Fig. 8, in which the magnitude of the pulse pressure was increased 15 mm. Hg

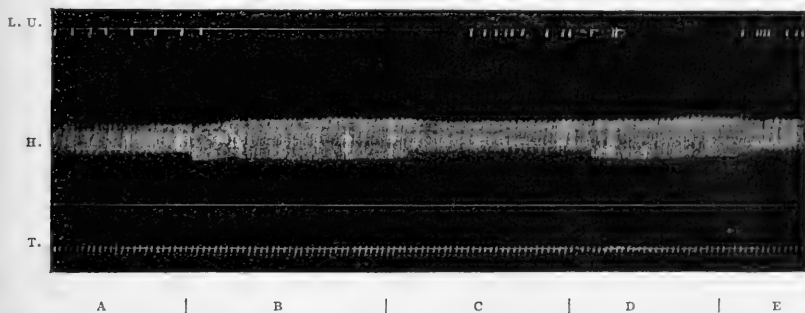

FIGURE 8. Four sevenths the original size. *L. U.* Urine flow in drops from left kidney. *H.* Blood pressure recorded by Hürthle manometer connected with *E.* *a, c, e.* Periods of normal pulse pressure. *b, d.* Periods of altered (increased) magnitude of pulse pressure produced by connecting the air chamber with the aorta.

on connecting the air chamber to the aorta. Whenever this occurred a rapid flow of urine was suddenly stopped and held in check until normal pulse pressure was again allowed to act upon the kidneys. It will be noted that although the magnitude of the pulse pressure may be unchanged, the form of the pulse curve is materially altered. The normal pulse curve is composed of sudden pressure changes. There is a sudden rise of pressure followed by a sudden fall in pressure which is abruptly checked and momentarily held in check at the dirotic notch, there-giving way to another sudden fall. Compare this with the pulse curve obtained by the Hürthle manometer when the air chamber is connected with the aorta. The most marked differences are the relatively gradual rise and fall of the limbs, the rounded apex and especially the absence of the dirotic notch. In other words,

compared with the abrupt and rugged normal pulse it is a smooth and swinging pulse. The shape of the pulse curve, the suddenness of pressure changes, — vascular shocks may be very important factors in secretion. Their significance will be considered farther on.

THE RELATION OF PULSE PRESSURE TO QUALITATIVE CHANGES IN THE URINE

Urine for analysis was collected in four experiments during which no appreciable changes of mean blood pressure accompanied manipulation of the pulse pressure. The urine was collected during ten-minute periods; a period of normal pulse pressure alternating with a period of altered pulse pressure. The amounts of chlorides, total nitrogen, urea nitrogen, and albumin eliminated were determined. For determination of chlorides the Harvey⁴ modification of the Volhard method was used; for total and urea nitrogen Folin's⁵ microchemical method; for albumin the heat and acid test, using the amount of precipitate as an index to the amount of albumin present. Tables III, IV, and V give data obtained from analyses of urine from the four experiments mentioned.

In Table III A the rate of flow of urine was not registered by a drop recorder. The urine was caught in test tubes. The flow during period 2 (normal pulse pressure) was found to be 15 per cent faster than during periods 1 and 3 (altered pulse pressure). The amount of urea nitrogen eliminated per cubic centimeter of urine was practically the same in all the periods. But on account of the greater elimination of urine during period 2, the absolute amount of urea nitrogen eliminated during the period of normal pulse pressure was greater than during the periods of diminished pulse pressure. The amount of chlorides eliminated during the period of normal pressure was both relatively and absolutely greater than during the periods of diminished pulse pressure. The amounts of albumin eliminated during periods 1 and 3 appeared to be in excess to that eliminated in period 2.

Table III B shows analyses of urine gathered in 4 ten minute periods in another experiment. Unfortunately the amount of urea

⁴ EMERSON: Clinical diagnosis, 3rd edition, 1911, p. 137.

⁵ FOLIN: Journal of biological chemistry, 1912, xi.

and total nitrogen eliminated per cubic centimeter of urine gradually diminished as the experiment progressed. This may illustrate the deleterious effect of diminished pulse pressure upon renal epithelium, but was disconcerting in interpreting the results, in that it obscured the momentary effects of pulse pressure changes. Table III B therefore shows no perceptible relation between pulse pressure and

TABLE III

III A						
Number	Pulse pressure	Urea N. in G. per c.c. of urine	Percentage decrease of urea N.	Chlorides in G. per 5 c.c. of urine	Percentage decrease or increase of chloride	Albumin
1	—	0.017	?	0.0144	?	trace +
2	+	0.017	0	0.0185	>28.5	trace
2	—	0.016	5.9%	0.014	<21.3	trace +
III B						
1	+	0.0166	?	0.027	?	trace
2	—	0.0035	70.8	0.019	<30%	trace +
3	+	0.002	43	0.05	>64.5%	trace
4	—	0.0016	20	0.045	<10%	trace +

the elimination of urea. In contradistinction to the progressive decreased elimination of urea, the chlorides show a progressive increased elimination. Yet the effects of diminished pulse pressure during periods 2 and 4 change this progressive tendency of increased elimination to actual decreased elimination amounting to 30 and 10 per cent respectively. Compare this with period 3 (normal pulse pressure) during which there was a percentage increase of chloride elimination amounting to 64.5 per cent. Albumin was eliminated during all periods but to a slightly greater extent during periods of diminished pulse pressure (2 and 4).

Table IV shows analyses of 8 samples of urine from another experiment. Samples 4, 5, 6 and 7 were collected during the first part of the experiment and samples 18, 19, 20 and 21 two hours later. Again as in the preceding experiment, the elimination of nitrogen progressively diminished, the greatest percentage decrease occurring at the beginning of the experiment. The momentary effects of varied pulse pressure on nitrogen elimination therefore were again masked.

TABLE IV

No.	Pulse pressure in mm. Hg	Mean pressure in mm. Hg	Rate of urine flow from R. & L. kidney	Total N. in G. per c.c. of urine	Percentage decrease of total N.	Chlorides in G. per c.c. urine	Percentage increase in chlorides	Albumin
4	70	120	{ R. 16 L. 7	0.0247	18.2	0.000	0	0
5	45	120	{ R. 16 L. 7.6	0.0202	9.4	0.000	0	0
6	60	118	{ R. 16.7 L. 7.3	0.0185	7.6	0.0015	0	0
7	35	118	{ R. 14 L. 5.6	0.0169		0.0015	0	0
18	70	125	{ R. 34.8 L. 23.2	0.0060		0.0025	?	0
19	50	125	{ R. 36.4 L. 23.2	0.0024		0.0025	0	0
20	70	120	{ R. 22.8 L. 13			0.006	140%	0
21	40	120	{ R. 33.3 L. 20.6			0.006	0	0

As in Table III B the chlorides showed a tendency of progressive increased elimination, marked during periods of normal pulse pressure. The elimination of chlorides increased only during periods of normal pulse pressure. During periods of diminished pulse pressure it remained the same as in the preceding period of normal pulse pressure.

TABLE V

Minute number	(3) P.P.	Average number of drops per minute	(4) P.P.	Average number of drops per minute	(5) P.P.	Average number of drops per minute	(6) P.P.	Average number of drops per minute	(7) P.P.	Average number of drops per minute
1	19	16	4	...	14	...	15	...
2	15	20	9	...	16	...	15	...
3	35	19	8	...	17	...	17	...
4	21	15	9	...	16	...	12	...
5	17	19.88	19	14.37	9	9.4	15	...	15	12.6
6	19	19	12	...	18	16.8	12	...
7	19	7	12	...	16	12
8	17	0	10	...	16	9
9	17	12	...	19	7
10	10	...	20
11	16	...	18
12	6	...	17
13	6
14	11	13.3
15	17
16	17
17	17
18	19
19	14
20

Although the experiment shows no actual decrease of chlorides in the urine eliminated during the periods of diminished pulse pressure, it shows that a gradual tendency to increased elimination of chlorides can be effectually checked by subjecting the kidneys to diminished pulse pressure.

Tables V and VI give data from the last successful experiment. The urine was collected over 5 periods — 4 periods of diminished pulse pressure and 1 period of normal pulse pressure. The pulse pressure was diminished slightly and to the same extent in periods 3 and 4, was normal during period 5 and again diminished to the same extent during periods 6 and 7.

Table V gives the number of drops of urine secreted per minute throughout the experiment. It shows very beautifully the gradual development of a deleterious action of diminished pulse pressure during periods 3 and 4, and 6 and 7, also the gradual recovery from this effect during period 5 — of normal pulse pressure.

Table VI gives the chemical analyses of the samples of urine collected during the five periods. In this experiment the tendency to progressive decreased elimination of nitrogen was not so marked as in the two preceding experiments. The relation of pulse pressure to elimination of nitrogen is therefore very clearly shown. The percentage decrease of elimination of urea nitrogen during period 3 is unknown, but judging from data of other experiments it probably was larger than the following decrease during period 4. The same blood pressure conditions prevailed during periods 3 and 4. The

TABLE VI

No. P.P.	Urea N. in G. per c.c. urine	Percentage decrease urea N.	Total N. in G. per c.c. urine	Percentage Percentage decrease of total N.	Chlorides	Albumin
3	0.0398	?	0.0558	?	0	0
4	0.036	9.5	0.0393	29	0	0
5	0.033	8.3	0.0351	10.7	0	0
6	0.0227	31.2	0.0287	20	0	0
7	0.0218	3.8	0.028	1	0	0

percentage decrease of urea nitrogen elimination during period 4 was 9.57. During period 5 the pulse pressure was normal. The percentage decrease of urea nitrogen elimination was only 8.3. Had the urine been collected only during the latter half of period 5 the decrease probably would have been much less. During the following period (6) of diminished pulse pressure there was a very marked decrease of elimination of urea amounting to 31.2 per cent. In the following period (7) during which the same blood pressure condition prevailed, there was a decrease of only 3.8 per cent. The marked changes in elimination of urea occurred during periods in which the pulse pressure was altered. The relation of elimination of total nitrogen to pulse pressure as the table shows was in general similar to that observed for urea nitrogen. In this experiment the urine was free from chlorides and albumin. This total absence or diminution of chlorides has been noticed by others^{6, 7, 8, 9, 10} especially when sodium sulphate was used as a diuretic.

THEORETICAL CONSIDERATIONS AND DISCUSSION OF RESULTS

The nutrition of an organ is of utmost significance for its proper functioning. The metabolism and gaseous exchange in the kidney is very great and for that reason the volume flow of blood through the kidneys must be considered as an important factor in secretion of urine. Preliminary experiments, however, showed no change in volume flow of blood accompanying pulse pressure changes as affected by the methods herein described. But the mere fact that the volume flow of blood is not changed does not necessarily rule out a deleterious nutritive effect of diminished pulse pressure.

The gaseous exchange in the kidneys may be diminished by a diminished pulse pressure as indicated by the works of Fleishel v. Marxow.¹¹ He showed by experiment that the state of a gas in

⁶ BRODIE: Harvey lecture on renal activity, 1909-1910.

⁷ SOLLMANN: This journal, 1902, viii, p. 155.

⁸ MAGNUS: Archiv für experimentelle Pathologie und Pharmakologie, 1900, xlv, p. 68.

⁹ CUSHNY: Journal of physiology, 1902, xxvii, p. 429.

¹⁰ THOMPSON: Journal of physiology, 1900, xxv, p. 487.

¹¹ FLEISHEL v. MARXOW: Beiträge zur Physiologie, zu Ludwig gewidmet, 1887, p. 29. Quoted by Erlanger and Hooker, *loc. cit.* p. 368.

solution is markedly changed by shaking; that gas after agitation in a solvent is more readily given up than if agitation were omitted. He thinks that the gas is no longer in true solution, but in a state of suspension and therefore more readily given up by the solvent. He thinks that the shocks to which the blood is subjected plays an important part in exchange of gases.

The massaging action of the pulse should also have a beneficial effect on promoting a freer flow of lymph and an increased streaming of protoplasm.

Such massage as results from pulse pressure may be beneficial in still another way. Kahlenberg¹² has shown the importance in dialysis of stirring the solution in contact with the osmotic membrane. Only by stirring can the maximum osmotic pressure be obtained; but more important, the process of osmosis is materially hastened by bringing fresh solution of stronger concentration in contact with the membrane. It seemed, therefore, that massage might be of considerable importance, not only in bringing fresh solution in contact with the renal cells but also in promoting diffusion of the solute through the cell itself. If osmosis is simply a matter of solubility and diffusion of the solute, and provided the renal cellular protoplasm has no marked activity of its own a pulsatile pressure would be of great theoretical importance. The massaging action produced by a smooth swinging pulse as described in Fig. 8 does not seem to be the fundamental factor producing changes in secretion accompanying alterations of pulse pressure. Whether the massage is not active enough to assist in promoting diffusion or whether the lack of sudden pressure changes brings about conditions which might counteract the beneficial effects of massage is a question. This will be discussed later on under filtration and molecular aggregates.

Brodie¹³ emphasizes the importance of the glomerulus as an organ of propulsion, assisting in overcoming the resistance of passage of urine through the tubules. The present experiments give no direct evidence against or for that theory. In some cases complete obliteration of the pulse pressure had barely any effect upon the rate of urine flow, while in other cases increasing the magnitude of the pulse pres-

¹² KAHLBERG: *Journal of physical chemistry*, 1906, x, no. 3.

¹³ BRODIE: *Loc. cit.*

sure stopped the flow. While propulsion of the urine may be of importance over long periods of time, these experiments indicate that we must look elsewhere for the marked specific action of pulsation on the activity of the kidneys.

The glomerulus has always been looked upon as a favorable site for filtration, and since filtration is nothing more than the mechanical process by which molecules or particles of matter are forced through the interspaces of other molecules or particles of matter it seems very likely that the normal pulsatile pressure might be more efficient than a constant pressure; not only because the pulsatile pressure reaches a higher level, but also on account of the relative behavior of small and large particles to sharp light taps. The larger tend to remain stationary, the smaller to take on the velocity of the impact. Take for example a vessel, the bottom of which is porous enough to allow the passage of fine grains of sand, and fill that vessel with a mixture of fine and coarse grains of sand. Exerting a constant pressure on this vessel above will have no effect on the passage of sand through the pores, but if constant pressure is replaced by sharp, light taps the results are entirely different. Not only are the finer granules at the membrane assisted by agitation in their passage through the membrane, but all the granules are rearranged—the finer granules lying near the membrane and the coarser near the surface. The finer granules, by means of a greater relative velocity imparted to them than to the heavier granules possessing relatively greater inertia make their way to the bottom of the jar; while the coarser granules remain in position or are forced upwards by the smaller granules.

A similar process may occur within the cell in which the organized cellular structure represents the coarser granules with greater inertia and the urinary constituents (water, salts, urea, etc.) not directly combined with the cellular structure represent the finer granules. If this process occurs it can readily be seen that the magnitude of the pulse pressure is not the important factor in filtration, but rather the abruptness of pressure changes—slight sudden vascular shocks—may be of greater significance. Some records seem to support this view. For instance the experiments in which the magnitude of pulse pressure was increased when the air chamber was connected with the abdominal aorta. In these cases the flow of urine was

copious during the period in which the pulse pressure was normal, but stopped abruptly when the pulse pressure was increased.

Attention has been called to the form of the pulse curve at this time, the lack of any secondary waves, and the relative slowness of pressure changes. In these cases of increased pulse pressure the air chamber worked perfectly in taking up all sudden impacts, and transforming them into a smooth swinging pulse. In some of the experiments the air chamber did not work as perfectly in these respects. Even though the pulse pressure was successfully reduced to a relatively small magnitude the dicrotic notch was always in evidence. In these cases, diminution of pulse pressure was not as effective in slowing secretion as in other cases where the dicrotic notch was more successfully eliminated.

The effects of mechanical shock upon living cells have received considerable attention from Meltzer.¹⁴ He considers mechanical shock as a fundamental factor in the activity of living protoplasm and that every kind of protoplasm or cell has an agitation of optimum intensity for its growth. Of interest is Shacklee's and Meltzer's¹⁵ work on the destructive action of shaking upon proteolytic enzymes $S_{\frac{1}{m}}$ in which they find that pepsin, rennin and trypsin are completely destroyed by shaking. Even the churning action of the stomach on pepsin enclosed in rubber cots is sufficient to destroy the efficiency of pepsin 40 per cent. Abderhalden and Guggenheim¹⁶ have shown the destructive action of shaking upon tyrosinase.

Mathews¹⁷ found that the most careful transfer of starfish eggs produced sufficient mechanical shock to cause parthenogenesis.

Mrs. Andrews¹⁸ working on the choana flagellata found that agitation produced distinct changes in the viscosity of the protoplasm. That the slightest tap on the cover slip, covering the organisms under observation, caused a distinct rigidity of the collar.

That mechanical shock is an important factor in the activity of

¹⁴ MELTZER: *Zeitschrift für Biologie*, 1894, xii, p. 464. Johns Hopkins Hospital reports, 1900, ix, p. 135. This journal, 1903, ix, p. 245.

¹⁵ SHAKLEE and MELTZER: This journal, 1910, xxv, p. 81.

¹⁶ ABDERHALDEN and GUGGENHEIM: *Zeitschrift für physiologische Chemie*, 1908, liv, p. 352.

¹⁷ MATHEWS: This journal, 1901, vi, p. 142.

¹⁸ MRS. ANDREWS: *Journal of morphology* (supplement 1897), xii, pp. 492-498.

protoplasm has been sufficiently demonstrated; but the question arises what is the specific effect of mechanical shock? Is it a general effect upon the whole protoplasm of the cell favoring or retarding metabolic processes, or is it due to some phenomenon favoring or retarding a free exchange of material between the cell and bathing medium as indicated by these experiments?

The relation of pulse pressure to renal secretion must be considered from two points of view: the beneficial effect of a pulsatile pressure and the deleterious effect of a non-pulsatile pressure. In some cases when the kidneys were subjected to diminished pulse pressure for only a short time the secretion was stopped for an hour. The question arises — is this prolonged after-effect due to a deleterious action on the renal protoplasm itself or to a clogging of protoplasmic interspaces hindering the normal passage of urinary constituents through the cells?

The work of Ramsden and Winkelbach seems to be of significance in this connection. Ramsden¹⁹ has shown the effect of shaking upon a solution of egg albumin. A clear solution becomes turbid with the production of fine coagulated strands of albumin which are no longer soluble in the medium. More recently²⁰ he has extended his experiments to other solutions and suspensions. He found "that quite apart from evaporation solid highly viscous coatings are spontaneously and more or less rapidly formed upon the free surfaces of all proteid solutions; that similar coatings of solid or highly viscous matter occurs on the free surfaces of a large number of non-proteid colloid solutions and fine suspensions, and of a few apparently crystalloid solutions, and that they are formed also at the interfaces of solutions which without being of high viscosity are capable of persistent emulsion."

Ramsden found that "by simple mechanical means adapted to produce heaping up of surface membranes, large masses of solids (mechanical surface aggregates) can be separated out from all proteid solutions and from a large number of colloid solutions and suspensions."

Winkelbach²¹ demonstrated the formation of molecular aggre-

¹⁹ RAMSDEN: Mann's Chemistry of protein, p. 273.

²⁰ RAMSDEN: Proceedings of the Royal Society of London, 1904, lxxii.

²¹ WINKELBACH: Zeitschrift für angewandte Chemie, 1906, p. 1953. Quoted from Freundlich: Kapillarchemie, p. 444.

gates on shaking a solution of gelatine, egg albumin, and other solutes with benzene or benzin.

If under diminished pulse pressure a thick viscous layer can form at the interfaces of the renal cells and the bathing medium, as it does at the interfaces of certain solutions, secretion might be markedly varied by subjecting the cells to a pulsatile or constant pressure. By the shaking action of the normal pulse the albumin in the viscous layer might be heaped up into mechanical surface aggregates and kept in coarse enough suspension to prevent its passage through the cells, and at the same time continually break up the viscous layer and allow a freer entrance of urinary constituents into the cells.

On the contrary by allowing the formation of a viscous layer by diminishing the pulse pressure the albumin might be kept in fine enough suspension to enter and pass through the cells into the tubules — finally clogging the protoplasmic interspaces, thereby preventing filtration. The rate of recovery of urine flow after a period of decreased pulse pressure may depend on the rate of resolution of albumin which has bodily entered the cell.

Ramsden points out that the failure of proteids and other colloids in solution to pass through a fine filter without considerable loss is largely due to the formation of surface membranes and mechanical coagule upon the air, grease, and other suitable surfaces in the pores of the filter. With the formation of these membranes the rate of flow through the filter is decreased. Why if this phenomenon occurs in a simple filter might it not be still more pronounced in living cells, especially designed to prevent the passage of highly organized substances such as albumin, from the blood?

From the foregoing it would seem that the relation of pulse pressure to the elimination of urine has a practical therapeutic bearing. Drugs which increase the pulse pressure without markedly lowering the blood pressure or producing undue constriction of the renal vessels theoretically should be good diuretics. Among such drugs are *strophanthus* and *digitalis*. Their marked diuretic effect has long been noted. Concerning their mode of action various suggestions have been made. But the effects of pulse pressure itself, which is altered by the administration of these drugs, apparently has not been taken into account. Judging from the marked changes in secretion produced experimentally by altering the pulse pressure it

would seem that the increased pulse pressure *per se* produced by digitalis and strophanthus may account largely for the diuresis produced.

SUMMARY

1. A method has been described by which the pulse pressure in the intact animal can be altered without materially changing the mean blood pressure or volume flow of blood through the kidneys.

2. Employing this method pulse pressure has proved to have a specific effect of its own upon renal secretion.

3. It was found that normal pulse pressure exerted a beneficial effect upon secretion of urine.

4. Constant or diminished pulse pressure produced by the method described had a deleterious effect upon the activity of the kidneys.

5. The amount of urine eliminated, as a rule, varied directly with the magnitude of the pulse pressure.

6. A few exceptions were noted which suggest that in addition to magnitude of pulse pressure, the suddenness of pressure changes, vascular shocks, may be an important factor in the secretion of urine.

7. The amounts of chlorides, urea, and total nitrogen eliminated, as a rule varied directly with the magnitude of the pulse pressure.

8. In two experiments in which albumin occurred in the urine, the amount eliminated varied inversely with the magnitude of pulse pressure.

9. Various theories concerning the specific action of pulse pressure on renal activity are discussed.

10. The practical therapeutic bearing of this problem relative to the diuretic action of such substances as digitalis and strophanthin are pointed out.

It is my pleasure to acknowledge here the suggestions and assistance Doctor Erlanger rendered me in this work. I also wish to thank Doctor Shaffer for the use of his laboratory for making chemical analyses.



THE

American Journal of Physiology

VOL. XXXII

JUNE 2, 1913

NO. II

DIRECT AND CROSSED RESPIRATION UPON STIMULATION OF THE PHRENIC, THE SCIATIC, AND THE BRACHIAL NERVES¹

BY W. T. PORTER AND ABBY H. TURNER

[From the Department of Comparative Physiology in the Harvard Medical School]

IN 1895 it was discovered that the respiratory impulse descends from the bulb to the phrenic nuclei in the lateral column of the spinal cord.² At the level of the phrenic cells, the path divides. The greater part of the respiratory fibres remain on the side of their origin; the lesser part cross to the phrenic cells of the opposite side. When the lateral column is severed between the bulb and the phrenic nuclei, the diaphragm ceases to contract on the side of the hemisection. The arrest of that half of the diaphragm is not momentary, but permanent, for the diaphragm has been found passive in rabbits kept alive for twenty-four days after the operation.³ Yet the phrenic cells are not inhibited by the hemisection, for if the phrenic nerve upon the opposite or active side be severed, the diaphragm on the passive side (the side of the hemisection) at once begins to contract. From these observations it was concluded that the crossed path carried impulses which ordinarily did not rise to the threshold value

¹ An account of this research was given to the American Physiological Society, December 28, 1911. This Journal, 1912, xxix, p. xxxi.

² W. T. PORTER: The Journal of physiology, 1895, xvii, p. 455.

³ W. T. PORTER and W. MUHLBERG: this Journal, 1900, iv, p. 334.

necessary to discharge a motor impulse from the phrenic cells of that crossed side. But when the phrenic nerve on the direct side was cut, the impulses taking the crossed path to the opposite side were increased and crossed respiration became possible.

This conclusion has recently been called in question⁴ on the ground that the stimulation of the central end of the phrenic nerve in the cat causes reflex contraction of both sides of the diaphragm, from which it is argued that the phenomenon described above is due to the mechanical stimulation of the phrenic nerve by its section. The afferent impulse thus set up might pass to the phrenic cells of the passive (the hemisected) side and there call forth an efferent impulse which would descend the phrenic nerve of the passive side and cause that half of the diaphragm to contract. In this event, crossed respiration would be due to a bulbar or purely spinal reflex, and the evidence for a division of the bulbo-spinal respiratory tract into a direct and a crossing portion would be destroyed.

We purpose in this communication to show (1) that in the rabbit, the animal used by Dr. Porter, but upon which Messrs. Deason and Robb made no observations, the stimulation of the central end of the phrenic nerve calls forth no respiratory reflex whatever; and (2) that in the cat, whose phrenic nerve has long been known to carry afferent fibres, the freezing of the phrenic nerve upon the crossed (uninjured) side causes the diaphragm on the direct (the hemisected) side to resume its contractions, as in the rabbit, although the interruption of the physiological continuity of a nerve by freezing does not stimulate the nerve

We shall also present observations upon the alleged frequency of bilateral contractions of the diaphragm after hemisection.

* METHOD

In these experiments rabbits and cats were used. The animals were etherized and tracheotomized and preparations were then made to record the contractions of the diaphragm. It is here that the unwary observer may come to grief. It may be stated positively that accurate observation in this field requires special precautions

⁴ DEASON and ROBB: this Journal, 1911, xxviii, p. 57.

for the section and stimulation of the phrenic nerve and demands the direct inspection of the diaphragm.

The Section and Stimulation of the Phrenic Nerve. — The section of the phrenic nerve in the neck is frequently fallacious because the nerve often receives a branch from the brachial nerves posterior to the point of section. It was for this reason that Porter advocated grasping the nerve near the first rib and pulling it out of the chest.⁵ By this procedure it is reasonably but not absolutely certain that the lowest root of the phrenic nerve will be torn across. The following protocol is instructive.

Experiment May 12, 1911. In an anaesthetized rabbit the spinal cord was hemisected. The diaphragm of that side ceased to contract. Pulling out the phrenic nerve of the opposite side near the sixth nerve was followed by bilateral contractions of the diaphragm. When the nerve was found under the subclavian vein and pulled out there, the ordinary one-sided crossed breathing at once appeared.

Pulling out the nerve from the neck is safe only when followed by a positive — not a negative — observation; e.g., if after this supposed destruction of the nerve only the opposite side of the diaphragm contract, the phrenic has been torn across distal to its lowest component; but if both sides of the diaphragm contract, this last component has escaped and both sides of the muscle are still connected with the spinal cord. The truth of these remarks will be acknowledged on reading Miss Turner's study in the preceding number of this journal.⁶

In view of these dangers we have in this investigation severed the phrenic nerve within the thorax.

It is even more necessary to use the intrathoracic rather than the cervical portion of the phrenic nerve for electrical stimulation. A glance at Fig. 1 in Miss Turner's paper⁷ will show how very short is the portion of the nerve accessible to stimulation in the neck; at

⁵ W. T. PORTER: *The Journal of physiology*, 1895, xvii, p. 466, and especially Experiment LXVIII, pp. 478-479.

⁶ ABBY H. TURNER: *this Journal*, 1913, xxxii, p. 66.

⁷ ABBY H. TURNER: *loc. cit.*, p. 66.

this point it is impossible to make sure that current has not escaped to the brachial nerves.

The Observation of the Diaphragm. — The contractions of the two halves of the diaphragm cannot be determined accurately by recording the intrathoracic pressure. Respiration may be carried on by the muscles of the neck alone,⁸ or by the intercostal muscles, or by the abdominal muscles. The part played by the intercostal and abdominal muscles is seen in the following experiment.

Experiment April 20, 1911. In an adult cat anaesthetized with ether, the left half of the spinal cord was severed at the third cervical vertebra. The left half of the diaphragm at once ceased to contract. Artificial respiration was begun and the diaphragm was divided into two parts by a median incision extending from the sternum to the vena cava. The left half was connected to a recording lever. The right phrenic nerve was severed within the thorax. Crossed respiration immediately followed. The respiratory contractions of the intercostal muscles on the right side continued unimpaired. The artificial respiration was so regulated that the action of the diaphragm was uniform; there was no dyspnoea. On stimulation of the central end of the divided right phrenic nerve, and of the divided sciatic nerve, vigorous reflexes were obtained from the intercostal and the abdominal muscles.

In another cat, traction upon the phrenic nerve within the thorax caused strong contractions of the intercostal muscles.

It cannot be doubted that changes in the intrathoracic pressure caused by such contractions of the intercostal and the abdominal muscles may be attributed to the diaphragm when the observer depends merely upon a tambour connected with the trachea or the pleura. Nor can such errors be avoided by the inspection of the unopened thorax. It is frequently impossible to say whether a diminished excursion of the body wall upon one side is due to that side being dragged passively by contractions of the opposite side or is the result of a contraction feeble on one side and, by compensation, strong upon the other. Even when the abdomen is open and the under surface of the diaphragm viewed directly, experience is needed to avoid self-deception, so closely do passive movements simulate contractions.

⁸ W. T. PORTER: *Journal of physiology*, 1895, xvii, p. 457.

Only when the artery which encircles the central tendon is seen to approach the wall of the thorax may the spectator be certain that the diaphragm on the suspected side actually does contract.⁹

For these reasons we have always observed the exposed diaphragm. In some cases, the contractions were recorded by Head's method, in which the diaphragm is reached through an opening in the linea alba, the median end of the ventral muscular slip fastened to the thoracic wall, the xiphoid cartilage severed from the sternum, and the contractions of the isolated portion of the diaphragm carried to a recording lever by a thread passed through a hook in the split cartilage. In other cases, the xiphoid cartilage and the contiguous part of the sternum were cut away and the diaphragm divided in the middle line back to the vena cava. The movements of either half could then be recorded through a lever connected by a thread to the central tendon. The abdominal organs were kept from interfering by broad, smooth, metal plates suitably curved and carefully fixed in place. This method has the advantage of using the main part of the diaphragm rather than the less vigorous ventral slip. Both methods are open to criticism in that the record is influenced by the movement of muscles other than the diaphragm, particularly by general body reflexes. These are apt to cause a change of level in the sensitive recording lever, due to altered tensions in the thread connecting it to the diaphragm. It is usually easy, however, to distinguish in the record such alterations from those due to changes in the frequency and extent of the contractions of the diaphragm itself.

THE STIMULATION OF THE CENTRAL END OF THE PHRENIC NERVE IN THE RABBIT

During Normal, Direct or Uncrossed, Respiration. — In three rabbits the central end of the cut phrenic nerve of one side was stimulated with spinal cord and medulla intact, while a record was taken of the movements of the diaphragm of the opposite side. No reflex change in the rhythm or amplitude of the diaphragm's contractions was found. A typical protocol follows.

⁹ Additional precautions are given by Porter and Muhlberg, *loc. cit.*, p. 338.

Experiment March 29, 1911. A rabbit was etherized and tracheotomized.

The contractions of the left half of the diaphragm were recorded by a lever attached to the central tendon. The right phrenic nerve was cut anterior to the diaphragm and the central end stimulated. The secondary coil of the Harvard inductorium was at 4 cm. (a strong stimulus; with the secondary coil at 12 cm. the current was still perceptible to the tongue). No reflex was observed. To show the sufficient irritability of the animal the right sciatic nerve was prepared and the central end stimulated with the secondary coil at 13 cm. A strong reflex contraction of the diaphragm was observed.

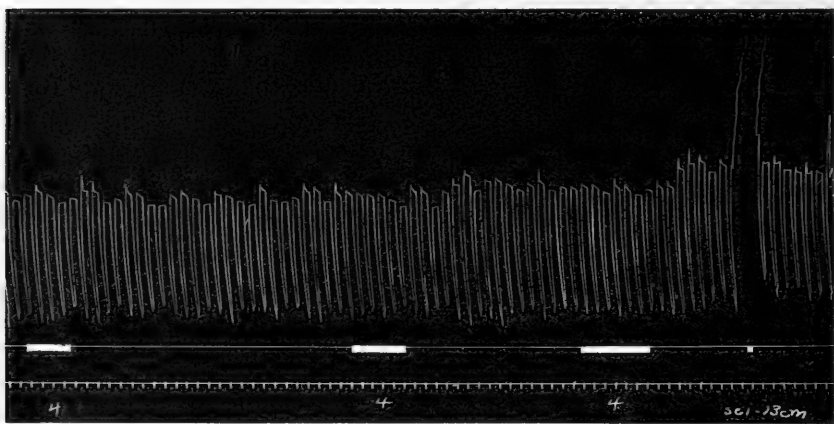

FIGURE 1. Two thirds the original size. From the experiment of March 29, 1911. The contractions of the left half of the diaphragm of a rabbit recorded by a lever attached to the central tendon. The rabbit had received $\frac{1}{100}$ grain of strychnine in the external jugular vein. The electro-magnetic signal (second line) records three successive stimulations of the central end of the phrenic nerve with a very strong current (the secondary coil at 4 cm. There is no reflex.) But a very brief stimulation of the central end of the sciatic nerve with an exceedingly weak current (13 cm.) caused violent reflex contractions. The lowest curve marks two second intervals.

As no reflex contraction of the diaphragm was obtained by stimulation of the central end of the phrenic nerve under normal experimental conditions, it was determined to increase the activity of the respiratory centre by dyspnoea.

Experiment March 23, 1911. In an animal prepared as in the preceding experiment, the artificial respiration was stopped and the central end of the phrenic nerve stimulated during the progressive asphyctic increase of the contractions of the diaphragm. The progressive

change in respiration in the dyspnoeic animal was not influenced by the phrenic stimulation.

The phrenic nerve was stimulated also in a rabbit whose irritability had been heightened by strychnine, as follows.

Experiment March 29, 1911. As noted above, the contractions of the left half of the diaphragm of a rabbit were recorded by a lever attached to the central tendon of the diaphragm. One hundredth grain of strychnine in sodium chloride solution was given by the external jugular vein. Apparently spontaneous spasms occurred at intervals and the increase in the irritability of the centres was also shown by the response to sciatic stimulation. But the stimulation of the phrenic nerve caused no reflex (Fig. 1).

These experiments support the conclusion that in normal (direct) respiration, the stimulation of the phrenic nerve does not cause a reflex contraction of the diaphragm.

Phrenic stimulation during crossed respiration should now be examined.

During Crossed Respiration. — In nine rabbits the spinal cord was hemisected between the calamus scriptorius and the phrenic nuclei

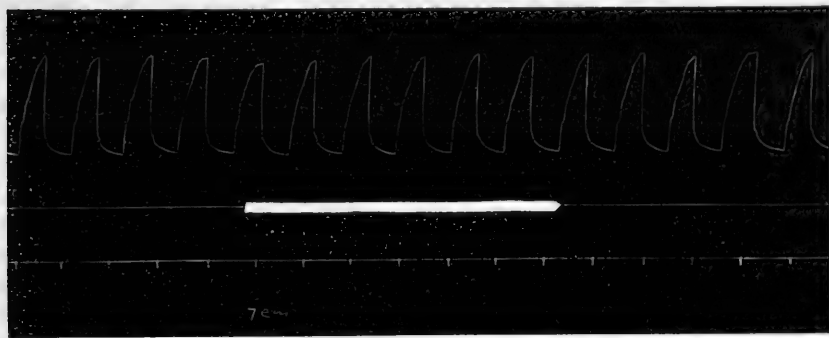

FIGURE 2. Two thirds the original size. From the experiment of March 21, 1911. The contractions of the left ventral slip of the diaphragm (Head's method) in a rabbit with the spinal cord hemisected on the left side at the third vertebra. Prolonged stimulation of the central end of the right phrenic nerve with a strong induction current (7 cm.) produced no change in the contractions of the diaphragm. The lowest line marks two second intervals.

and paralysis of the diaphragm on the operated side observed to exist. The phrenic nerve of the opposite side was then severed and

crossed respiration resulted. The contractions of the diaphragm were recorded by Head's method or by a lever attached to the central tendon. No reflex change in the rhythm or amplitude of the contractions of the diaphragm took place on phrenic stimulation. Typical protocols follow.

Experiment March 21, 1911. An etherized rabbit was tracheotomized and the left half of the cord was severed at the third vertebra. After section of the right phrenic nerve the contractions of the left ventral slip of the diaphragm were recorded by Head's method. Stimulation of the central end of the right phrenic nerve cut within the thorax caused no change in the contractions of the diaphragm.

Experiment March 25, 1911. The left half of the spinal cord in a rabbit anaesthetized with ether was severed about the third vertebra. After section of the right phrenic nerve, the contractions of the left half of the diaphragm were recorded by a lever attached to the central tendon. The strong stimulation of the central end of the right phrenic nerve cut near the diaphragm produced no reflex action but the very weak stimulation of the right brachial nerves caused strong reflexes.

Experiment March 27, 1911. In an etherized rabbit the cord was hemisected on the left side at the third vertebra and the right phrenic nerve was cut just anterior to the diaphragm. A lever was attached to the central tendon on the left side of the diaphragm. The right crural nerve was now cut and the central end weakly stimulated. The crossed respiration of the left half of the diaphragm was for some moments greatly increased, and during this excitement the central end of the right phrenic nerve was strongly stimulated, but without effect on the diaphragm.

Experiment March 30, 1911. In an etherized rabbit whose irritability had been increased by strychnine, the abdomen was opened and the diaphragm observed directly while the central end of the right phrenic nerve was strongly stimulated. The crossed respiration due to the left hemisection of the spinal cord was not affected by this stimulation.

In none of our experiments on crossed respiration in the rabbit did the preparation of the phrenic nerve in the thorax or traction there by pulling the nerve over a smooth glass hook cause bilateral diaphragmatic contractions.

There is therefore no evidence of afferent fibres in the phrenic nerve of the rabbit, the stimulation of which affects the movements

of the diaphragm. Nor were reflexes in answer to phrenic stimulation observed in any other part of the animal. The phrenic nerve in the rabbit is apparently a purely motor nerve.

THE STIMULATION OF THE CENTRAL END OF THE PHRENIC NERVE IN THE CAT

Three experiments were made on cats to demonstrate again the existence of afferent fibres in the phrenic nerve of this animal. A protocol follows.

Experiment April 20, 1911. In an adult cat, anaesthetized with ether, the spinal cord was hemisected on the left side at the third vertebra, and a lever attached to the left half of the diaphragm, which had been separated from the right half as far as the vena cava. Cutting the right phrenic nerve in the thorax was followed by crossed respiration. The artificial respiration was so regulated that the contractions of the left half of the diaphragm were uniform; there was no dyspnoea. On stimulating the central end of the right phrenic nerve, the frequency and force of the contractions of the opposite half of the diaphragm were clearly altered. A similar reflex action on the diaphragm followed the stimulation of the central end of the sciatic nerve. The threshold value for the sciatic reflex was much lower than that for the phrenic reflex.

The fact that the stimulus required for reflexes through the phrenic nerve is so much stronger than that for the sciatic or brachial nerves is in itself evidence that crossed respiration can hardly be due to the much weaker stimulus of section; but this possibility may be completely excluded by severing the phrenic nerve physiologically by a method that cannot stimulate the nerve.

CROSSED RESPIRATION IN THE CAT FOLLOWING THE FREEZING OF THE PHRENIC NERVE

In December, 1911, the spinal cord of an anaesthetized cat was hemisected on the left side at the third vertebra and the thorax opened. Only the right side of the diaphragm contracted. The right phrenic nerve was carefully freed from underlying tissues in its course through

the thorax and placed upon a small metal tube connected with a reservoir of liquid carbon dioxide. On admitting the carbon dioxide, frost formed on the tube and the nerve was frozen at the point of contact. The right half of the diaphragm ceased to contract, while on the left, or hemisected side, the diaphragm contracted vigorously.

Crossed respiration therefore cannot be due to the mechanical stimulation of the phrenic nerve by section.

THE ALLEGED FREQUENCY OF BILATERAL CONTRACTIONS OF THE DIAPHRAGM AFTER HEMISECTION OF THE SPINAL CORD

The earlier students in this field noted many instances¹⁰ in which hemisection of the spinal cord between the bulb and the phrenic nuclei was followed apparently by contractions of both sides of the diaphragm. It is probable that almost all these observations were erroneous. The difficulty of determining whether both halves of the diaphragm are actually contracting is not generally appreciated. Moreover, no one would believe without much experience how difficult it is to sever completely one half the spinal cord. It is never absolutely safe to trust to an ordinary cross-section, for the respiratory fibres are found in the lateral column which lies so far within the arch of the vertebrae that it is very difficult to reach all the fibres with a knife. The use of a wire or other blunt instrument raises always the doubt whether the fibres were sufficiently crushed. Under these conditions, the only safe method is to hemisect the spinal cord by making two incisions about three mm. apart and removing the piece between. If this piece with its lateral column intact can be laid upon the table all doubt is at an end.

When these precautions are observed, it will be found that the adult animals in which both halves of the diaphragm contract after hemisection are so few in number that they may be classed reasonably as anomalies.

Thus in twenty-nine rabbits and dogs W. T. Porter noted only two with bilateral respiration; in thirteen rabbits and two cats hemi-

¹⁰ This literature is cited by W. T. Porter in the *Journal of physiology*, 1895, xvii, p. 462.

sected by Porter and Muhlberg there was not a single instance of bilateral contractions; nor have we observed one case in the present series of thirteen rabbits and three cats. Crossed respiration was indeed apparently present in two animals. In one of these (March 24, 1911) the lateral column of the cord was found to be only partly severed, so that the normal uncrossed pathway may not have been interrupted. In the second case (May 12) on pulling out the phrenic nerve near the sixth nerve bilateral breathing appeared after hemisection. When the nerve was found under the subclavian vein and pulled out there, the ordinary one-sided crossed breathing at once appeared. In this instance it seems possible in view of the variety in the phrenic nerve that the first section was incomplete and that sufficient stimulus was given to the adjacent *brachials* to cause the bilateral breathing. In no case did the preparation of the phrenic nerve in the thorax or traction there by pulling the nerve over a smooth glass hook cause bilateral diaphragmatic respiration, though strong contractions of the expiratory muscles were noted on stimulating the parietal peritoneum and pleura.

In an animal in which the cord was hemisected and which was poisoned by strychnine, it was noted that the strong contractions of the diaphragm in the strychnine spasms involved only one-half the muscle, the paralyzed side remaining passive throughout. The phrenics here were untouched.

In two cats on which observations were made, neither dyspnoea nor the stimulation of the central end of either sciatic resulted in bilateral breathing after hemisection of the cord and consequent unilateral paralysis of the diaphragm. The preparation of the opposite phrenic nerve in the thorax was also without effect as was traction on the prepared nerve in the thorax. The reflex to the sciatic stimulus was in general strong and while the paralyzed side of the diaphragm was inactive, the active side changed its rhythm in response to phrenic traction. On cutting the prepared phrenic nerve, crossed respiration occurred at once in one case, and after slight sciatic stimulation in the other. The good condition of the latter animal was indicated by the continuance of crossed respiration unimpaired for three hours.

All our data, therefore, point unmistakably to the conclusion that hemisection of the cord arrests the contractions of the homo-

lateral half of the diaphragm, with exceptions so infrequent as to be anomalous.

SUMMARY

1. In the study of crossed respiration, the section and stimulation of the phrenic nerve within the chest and the direct inspection of the diaphragm are of great advantage.

2. The accurate stimulation of the central end of the phrenic nerve in the rabbit does not cause contraction of the diaphragm or other reflex movements.

3. In the cat, reflex contractions of the diaphragm may follow the stimulation of the phrenic nerve.

4. In the cat, a strong stimulus is required to call forth a reflex with the phrenic nerve, while in the same individual a very weak stimulus to the sciatic or the brachial nerves will cause reflex contractions of the diaphragm.

5. Hemisection of the spinal cord between the bulb and the phrenic nuclei stops the contractions of the diaphragm on the same side, but these contractions are at once resumed when the opposite phrenic nerve is severed by freezing. A mechanical stimulus therefore cannot be the cause of the crossed respiration.

CARBON DIOXIDE PRODUCTION FROM NERVE FIBRES WHEN RESTING AND WHEN STIMULATED; A CONTRIBUTION TO THE CHEMICAL BASIS OF IRRITABILITY.¹

BY SHIRO TASHIRO

[From the Department of Biochemistry and Pharmacology, the University of Chicago, and the
Marine Biological Laboratory, Woods Hole, Mass.]

INTRODUCTION

THERE have been two theories of the nature of conduction — one upheld among others by Hermann, that it was a propagated chemical change; the other, at present the dominant view, that it is a propagated physical change.

In 1901 Professor Mathews suggested² that it was in the nature of a coagulative wave propagated along the fibre; this coagulation of the nerve colloids leading either directly or indirectly to the electrical disturbance accompanying the impulse. At the time, there was no evidence of chemical change in the nerve fibre, and its indefatigability seemed to point to an absence of metabolism. Certain facts were known, however, which were difficult to reconcile with this physical theory. Darwin had observed that in *Drosera*,³ conduction occurred only if the protoplasm had oxygen; and Mathews⁴ observed that salts would not stimulate a nerve, or, at any rate, their power of stimulation was much reduced if the nerve remained in the body for a time after death, or if the nerve were brought into the salt solution in an atmosphere of hydrogen. This clearly indicated a dependence of the irritability on oxygen.

¹ The preliminary report of these investigations was given in part in Biochemical section of Eighth International Congress for applied chemistry, September, 1912. See original communications, Eighth International Congress of applied chemistry, xxvi, p. 163. See also this Journal 1913, xxxi, p. xxii.

² Mathews Century Magazine, 1902, pp. 783-792; Science, 1902, xl, p. 492.

³ Insectivorous Plants, p. 57.

⁴ Unpublished observations.

This fact lead to a search for evidence of the chemical nature of irritability and in a number of papers ⁵ it was clearly pointed out that the anaesthetics were probably acting directly in a chemical manner instead of indirectly, by affecting permeability, and that probably the anaesthetics acted by uniting with the protoplasm where O₂ usually took hold. This view was strengthened by the temperature coefficient of conduction, which is nearly that of a chemical reaction; by the importance of O₂ for artificial parthenogenesis; and by many other facts some of which have recently been collected by Haberlandt, Buijtendijk and others.

Although it has been established by repeated demonstrations, that the nerve does not fatigue under ordinary conditions, as measured by the method used in muscular studies, yet Fröhlich ⁶ observed that the nerve undergoes certain changes by long activity. Gotch and Burch discovered ⁷ in 1889 that if two stimuli are successively set up within $\frac{1}{500}$ of a second, only one negative variation is produced. This critical interval, or refractory period, is found to be altered by temperature changes, by drugs, asphyxiation, and anaesthetics.⁸ Thus by prolonging the refractory period by partial anaesthesia, Fröhlich easily demonstrated that with a frequency of stimulation less than this normal refractory period, stimulation of the attached muscle no longer occurred. He interprets this as a phenomenon of fatigability of the nerve. Thöner's ⁹ observation seems to lead to a similar interpretation, for he found recently that fatigability is less effective when the refractory period is shortened by high temperature. There seems, then, to be fatigue in the nerve, but it cannot be measured by an ordinary scale.

After the complete failure of the chemical detection of CO₂ and

⁵ A. P. MATHEWS: Biological bulletin, 1904-5, viii, p. 333; this Journal, 1904, xl, p. 455; *ibid.*, 1905, xiv, p. 203; Biological Studies by the pupils of William Sedgwick, 1906, p. 81; Journal of pharmacology and experimental therapeutics, 1911, ii, p. 234.

⁶ FRÖHLICH: Zeitschrift für allgemeine Physiologie, 1903-4, iii, p. 445. *Ibid.*, p. 75.

⁷ GOTCH and BURCH: Journal of physiology, 1899, xxiv, p. 410.

⁸ See TAIT and GUNN, Quarterly journal of experimental physiology, 1908, i, p. 191; TAIT, *ibid.*, 1909, ii, p. 157.

⁹ THÖNER: Zeitschrift für allgemeine Physiologie, 1908, viii, p. 530; *ibid.*, 1912, xiii, pp. 247, 267, 530.

acids in the excited nerve, Waller still believes that it must give off CO_2 when stimulated. In 1896, he showed, with an electro-physiological method, that among other reagents, CO_2 , in minute quantities, increased the excitability of the isolated nerve of the frog, and that the normal nerve, when excited, also increased its activity.¹⁰ From this he ingeniously formed the hypothesis that every activity in the nerve fibre must be associated with CO_2 production.

That there may be CO_2 production in the nerve, but too small to be measured by ordinary methods, is shown by the following calculations: A frog (*Rana temporaria*) gives off 0.355 gram of CO_2 per kilogram per hour at 19 – 20° C.¹¹ A small piece of the nerve fibre of the same animal, say 1 cm. in length, will weigh in the neighborhood of 10 milligrams. Now, if the mass of the nerve respire at the rate of the whole animal, it would give off about 0.000007 grams of CO_2 during ten minutes. This calculation at once suggested that the lack of positive evidence of metabolism in the nerve fibre was not at all conclusive that such metabolism did not occur, in view of the limitation of the methods for the estimation of CO_2 . It was evidently necessary to devise methods for the detection of very minute quantities of CO_2 . Thus at Professor Mathews' suggestion a new method for CO_2 analysis was first devised, and then, under his direction, I have undertaken to go back once more to the question of CO_2 production in the nerve fibre during the passage of a nerve impulse.

To study the nature of metabolism involved in a tissue, one should at least determine the oxygen consumption and the carbon dioxide production. Inasmuch, as the present problem, however, is concerned only with direct evidence for the existence of metabolism in the nerve fibre, I have attempted to measure CO_2 production only, for it is true that the lack of oxygen consumption may not necessarily indicate the absence of chemical changes, while the production of CO_2 will surely prove the presence of metabolism. Furthermore, as CO_2 production is the only sure universal expression of the respiratory activity in anaerobic and aerobic plant and animal tissue in normal condition, the inquiry of CO_2 production in an excited nerve will not only concern the problem of the nature of the nerve impulse

¹⁰ WALLER: Croonian lecture, Philosophical transactions, London, 1896.

¹¹ Taken from Pott's figures. See figures in Table ix, p. 129.

itself, but may, also, aid in forming a fundamental conception of the tissue respiratory mechanism. In this way, if the protoplasmic irritability has a direct connection with the cellular respiration, then our idea of the general nature of the pharmacodynamics of many reagents on a living tissue may be essentially modified.

METHODS AND MATERIALS

Two new apparati were constructed which will detect CO_2 in as small quantities as one ten-millionth of a gram and estimate it with quantitative accuracy. The detailed method has been described in a separate article.¹²

Preliminary experiments with these new apparati showed that the sciatic nerves of dogs gave too large quantities of CO_2 for my method so that I was compelled to use a smaller nerve of a cold-blooded animal for quantitative estimation. For exact measurements of CO_2 production, I have used only two kinds of nerve, although I have used a large variety of nerves in qualitative experiments. For a non-medullated nerve fibre, Prof. G. H. Parker¹³ was so kind as to suggest to me that I use the nerve trunk of the claws of the spider crab (*Labinia Caniliculata*) which is a bundle of mixed sensory and motor fibres. The frog, whose sciatic was used as a representative for medullated nerve, was exclusively *Rana pipiens*, obtained from Indiana.

As my apparati in the present form cannot be used for a muscle nerve preparation nor for the normal nerve in situ, the use of an isolated nerve could not be avoided. Experimental factors thus introduced should be carefully considered before we interpret the observation as a normal metabolism. This serious objection, however, can be overlooked, as far as our fundamental question of different metabolic activities before and after a stimulation is concerned, for Waller¹⁴ has demonstrated that the presence of excitability in an isolated nerve persists as long as nineteen hours provided that the electrical changes correctly represent the state of excitability. Although

¹² See pp. 137-145.

¹³ For this and other suggestions, I am under great obligation to Dr. Parker.

¹⁴ WALLER: 1896, *Brain*, xix, p. 53.

Herzen claims that under certain conditions of local narcosis the nerve fibre may give an action current without any muscular contraction (Wedenshi and Boruttau both deny this), and Ellinson¹⁵ recently demonstrated by the use of cinchonamine hydrochloride the absence of negative variations without abolishing the excitability of the nerve, yet evidences are now abundant to indicate that the action current is a normal physiological phenomenon in uninjured tissue expressing the simultaneous activity resulting in a corresponding change in the peripheral organ.¹⁶ These facts, therefore, must be taken as showing that as long as a negative variation remains, the nerve is probably excitable; and that the phenomena observed in the isolated nerve could be regarded as identical with that of a normal nerve as far as the passage of a nerve impulse in an isolated nerve fibre is concerned.

CO₂ PRODUCTION FROM RESTING NERVE

In this study of the metabolism of the resting nerve, particular care was taken to select those fibres which were free from nerve cells. The work of several investigators¹⁷ seems to indicate that tissue oxidation is primarily concerned with the cell nucleus. Inasmuch as the respiration in the central nervous system is certain¹⁸ and the blood supply to fibres is seemingly scanty, the notion persists among certain biologists that a nerve fibre should not respire since it has no nucleus. In order to test the correctness of such an idea, I have studied quantitatively the output of CO₂ from various lengths of nerve which are known to be free from nerve cells.¹⁹ Here is the result:

¹⁵ ELLINSON: *Journal of physiology*, 1911, xlii, p. i.

¹⁶ For further details, see: GOTCH and HORSLEY: *Philosophical transactions of the Royal Society*, 1891, clxxii, p. 514; BERNSTEIN: *Archiv für die gesammte Physiologie*, 1898, lxxiii, p. 376; REID and McDONALD: *Journal of physiology*, 1898-9, xxiii, p. 100; LEWANDOWSKY: *Archiv für die gesammte Physiologie*, 1898, lxxiii, p. 288; ALCOCK and SEEMANN, *ibid.*, 1905, cviii, p. 426.

¹⁷ See SPITZER: *Archiv für die gesammte Physiologie*, 1897, lxvii, p. 615; M. NUSSBAUN: *Archiv für mikroskopische Anatomie*, 1886, xxvi, p. 485; R. S. LILLIE: *This Journal*, 1902, vii, p. 412.

¹⁸ L. HILL: Quoted from Hulliburton's *Chemistry of nerve and muscle*, p. 79.

¹⁹ In this connection, I wish to express my indebtedness to Prof. H. H. Donaldson for his kind advice.

Non-Medullated Nerve Fibre. — (The nerve of the spider crab, and apparatus 2 for the qualitative, and apparatus 1, for the quantitative, estimations were used.) When I place the nerve of a spider crab in the right chamber and no nerve in the left, and watch for the deposit of barium carbonate, the drop on the right will soon be coated with the white precipitate, but no precipitate whatever is visible with a lens in the left. CO_2 is thus shown to be produced by this resting nerve. Now, by interchanging the nerve from the right to the left, no nerve being in the right, we can convince ourselves of the correctness of this conclusion, by eliminating any technical error which might produce the different results in different chambers. The rate at which the precipitate appears and the quantity of the precipitate, depends on the size of the nerve. In fact, CO_2 production from the resting nerve of the spider crab is found to be proportional to its weight, other things being equal, and is constant: For 10 milligrams per ten minutes it gives 6.7×10^{-7} grams at $15 - 16^\circ\text{C}$.

The quantitative determination of this amount is made in the following manner:

The claws of the crab are carefully removed, and, by gently cracking them, the long fibre of the nerve trunk is easily isolated. After removing the last drops of the water by a filter paper, the nerve, with the aid of glass chop sticks, is carefully placed on the glass plate,²⁰ and quickly weighed. The glass plate with the nerve is now hung on the platinum hooks in the respiratory chamber A, and then the chamber sealed with mercury. The analytic chamber is now filled with mercury in the manner described elsewhere,²¹ and then the apparatus is washed by CO_2 free air as usual. The time when the barium hydroxide is introduced to the cup in chamber B is recorded, and the stop-cock between the two chambers is closed. When at the end of ten minutes the drop at cut F is perfectly clear, having not a single granule of the precipitate visible to a lens, thus insuring that the air is absolutely free from CO_2 then a known portion of the gas from the respiratory chamber is introduced into the chamber below in which the clear drop of barium hydroxide has been exposed, and it is determined whether or not the amount of the gas taken contains

²⁰ The weight of this plate is known so that the weight of the nerve can be determined very quickly. See p. 120.

²¹ See pp. 138-139.

enough CO_2 to give the precipitate in ten minutes. If it does, a fresh nerve is prepared and a less volume of the gas is withdrawn; if it does not, a larger volume should be taken till the precipitate appears within ten minutes. (See footnote, page 140.)

In this way, by repeated experiments with several fresh nerves, a minimum volume of the gas for a known weight of the nerve which gives a precipitate is determined. This minimum volume should contain exactly a definite quantity of CO_2 — namely 1.0×10^{-7} gram.²²

In this way, since we know the original volume of the respiratory chamber from which this minimum volume is withdrawn, and since we know the quantity of CO_2 contained in this volume, it is easily calculated, how much CO_2 is produced by the nerve during the known period. It should be understood that in determining the minimum volume of gas taken from the respiratory chamber, a series of experiments were conducted in order to calculate both the minimum volume which just gives the precipitate and the maximum volume which does not give the the precipitate for a known weight of the nerve for a known period of respiration. In the tables following, columns 8 and 9 refer to these volumes calculated from experiments.

Table I, gives the result for a non-medullated nerve.

Medullated Nerve Fibre. — For the quantitative estimation of CO_2 production from the medullated nerve I have taken a frog's sciatic, using apparatus 2. The results given in Table II, obtained by similar methods, show that each ten milligrams of the frog's sciatic nerve gives off 5.5×10^{-7} grams for the first ten minutes.

A large quantity of nerves were tested and it was determined whether or not all resting nerves give off CO_2 . As a result, I found no exception in any of them. The following varieties of nerves were examined:

1. MOTOR NERVE: Occulo-motor nerve of the skate. (*Raia Ocellata*.)
2. SENSORY NERVE: Olfactory nerve of the same. (*Raia Ocellata*.)
3. MEDULLATED NERVE: Sciatic nerve of the dog, frog, turtle, mouse; optic nerve of the skate. (*Both Raia Ocellata and Raia Erinecia*.)
4. NON-MEDULLATED NERVES: Nerves of the spider crab; olfactory nerve of the skate. (*Raia Ocellata*.)
5. NERVE OF INVERTEBRATE: Spider crab's nerves.

²² See p. 140.

TABLE I
 CO₂ PRODUCTION FROM RESTING NERVE OF SPIDER CRAB, *LABIDIA CANILICULATA* (NON-MEDULLATED)

Column 1	2	3	4	5	6	7	8	9	10
Date	Temperature of room	Weight of nerve in milligrams	Stimulation	Duration of respiration in minutes	Amount of gas taken from respiratory chamber	Precipitation of BaCO ₃ after ten minutes	No. of c.c. of gas which gives precipitate, calculated for 10 mg. nerve, ten minutes ¹	No. of c.c. of gas which does not give ppt. calculated for 10 mg. nerve, ten minutes ¹	Original volume of respiratory chamber
Oct. 13	15.8	40	no	30	2 c.c.	+	24 c.c.	9.5 c.c.
"	18	20	"	30	1 c.c.	+	6 c.c.	"
Nov. 3	16.8	20	"	10	1 c.c.	+	2 c.c.	"
"	"	20	"	10	.5 c.c.	+	1.0 c.c.	"
"	25	"	10	.5 c.c.	+	1.25 c.c.	"
"	same nerve	"	10	.5 c.c.	+	1.25	"
"	16	"	10	1 c.c.	+	1.25	"
"	15	20	"	10	.5 c.c.	+	1.0	"
"	14.8	16	"	16	.5 c.c.	+	"
"	16	16	"	10	1 c.c.	+	1.0 c.c.	"
"	16	16	"	10	1 c.c.	+	1.6 c.c.	"
"	17.5	15	"	12	.55 c.c.	+99 c.c.	"
"	17	8	"	10	.5 c.c.	-	4 c.c.	"
"	17	12	"	10	.6 c.c.	-72 c.c.	"
"	16	18	"	10	.6 c.c.	-	1.08 c.c.	"
"	14.8	8	"	10	1.5 c.c.	-	1.2 c.c.	"
"	"	11	"	10	1 c.c.	-	1.1 c.c.	"
"	16	12	"	10	.7 c.c.	-85 c.c.	"

¹ From these experiments, it is obvious that 1.25 c.c. out of respiratory chamber is minimum volume which gives the first precipitate. Since the original volume of respiratory chamber was 9.5 c.c. and 1.25 c.c. out of it contains the definite CO₂ to precipitate BaCO₃ which corresponds to 1.0×10^{-7} g., total CO₂ production from 10 mg. of this nerve for ten minutes is calculated as follows:

$$1.0 \times 10^{-7} \times \frac{1.25}{9.5} \times 6.7 \times 10^7 \text{ g. CO}_2 \text{ at } 15^\circ - 16^\circ$$

² This abnormal result is interesting, for this nerve was found hanging down from the glass plate, touching on the mercury at one end. Whether this high production of CO₂ was due to this or not was not determined.

TABLE II
CO₂ PRODUCTION FROM RESTING SCIATIC NERVE OF FROG, RANA PIPIENS (MEDULLATED)

1	2	3	4	5	6	7	8	9	10
Date	Temperature of room	Weight of nerve in milligrams	Stimulation	Duration respiration	c.c. of gas taken from respiratory chamber	↓ of BaCO ₃ after ten minutes	No. of c.c. which gives ↓, calculated for ten minutes ¹	No. of c.c. which does not give ↓, calculated for 10 mg. ten minutes ¹	Original volume of respiratory chamber
March 26	19°	10	no	10 min.	1 c.c.	—	4	1 c.c.	15 c.c.
" "	"	same nerve	"	20 "	2 c.c.	+	"	"	"
" 27	"	11½	"	15 "	1.1 c.c.	—	"	2.47 c.c.	"
" "	21	11	"	10 "	1 c.c.	—	"	1.1 c.c.	"
" "	28	6	"	10 "	2 c.c.	—	"	1.2 c.c.	"
" 31	20	13½	"	15 "	1 c.c.	—	"	2.02 c.c.	"
" "	20	14	"	15 "	1 c.c.	—	"	2.10 c.c.	"
April 1	19.5	9	"	15 "	2 c.c.	+	2.70	"	"
" "	20	9	"	15 "	2 c.c.	+	2.70	"	"
" "	19	16½	"	10 "	2 c.c.	+	3.30	"	"
" "	22	14	"	10 "	2 c.c.	+	2.8	"	"
" 2	21	11½	"	15 "	2 c.c.	+	2.65	"	"
" "	25	12	"	20 "	1 c.c.	+	2.4 ²	"	"
" "	24	10½	"	10 "	2.4 c.c.	+	"	2.5 c.c.	"
" "	23	13	"	10 "	2 c.c.	+	2.6	"	"
" 3	13	20½	"	10 "	1.2 c.c.	—	"	2.46 c.c.	"
" "	20	20½	"	10 "	1.2 c.c.	—	"	2.46 c.c.	"
" "	27	20	"	10 "	1.2 c.c.	+	2.40 ²	"	"
" "	29	26	"	10 "	1 c.c.	—	"	2.6 c.c.	"
" "	25	25½	"	10 "	1 c.c.	—	"	2.55 c.c.	"
" "	18	22	"	11 "	1 c.c.	—	"	2.2 c.c.	"

¹By glancing at the columns 8 and 9 it is clear that 2.70 c.c. is the minimum volume, for 2.6 c.c. is maximum volume which does not give the precipitate. Since original volume of respiratory chamber is 15 c.c. we have

$$1.0 \times 10^{-7} \text{ g.} \times \frac{1.5}{2.7} = 5.5 \times 10^{-7} \text{ g. CO}_2 \text{ at } 19^\circ - 20^\circ$$

² Little high result in these cases is no doubt due to high temperature.

6. NERVE OF VERTEBRATE: Nerves of frog, dog, mouse, squiteague (*cynoscion Regalis*), and skate. (*Both Raia Ocallata and Raia Erinecia.*)
7. NERVE OF WARM-BLOODED ANIMALS: Those of dog, mouse and rabbits.
8. NERVE OF COLD-BLOODED ANIMALS: Frog, squiteague (*cynoscion Regalis*) and skate. (*Both Raia Ocallata and Raia Erinecia.*)

From this I have concluded that isolated nerves of all animals give off CO₂. It remains, now, to consider whether this CO₂ is the product of normal respiratory activity or due to disintegration of the dead tissue.

IS THE CO₂ GIVEN OFF PRODUCED BY LIVING PROCESSES?

Comparison of Dead and Living Nerves. — In the first place, it was thought that if CO₂ was due to normal metabolism of a living nerve, its production should be diminished when the nerve was killed. The following result (Table III) is self explanatory.

TABLE III
COMPARISON BETWEEN NORMAL AND KILLED (BY STEAM) NERVES OF SPIDER CRAB

1	2	3	4	5	6	7
Date	Tempera- ture of room	Weight of nerve in mg.	Stimula- tion	c.c. of gas taken from respiratory chamber	Duration of respiration: minutes	Ppt. of Ba(CO ₃) after ten minutes
Nov. 4	13°	40 (killed)	no	.5	10	—
“ “	..	40 (killed)	st'n	.5	10	—
“ 5	..	16 (normal)	no	1.	10	+
“ 6	15	16 (killed)	no	1.	12	—
“ 7	16	16 (normal)	no	1.	10	+

Comparison of Anaesthetized and Non-Anaesthetized Nerves. — It is naturally feared, however, that the killing experiment itself may not prove that CO₂ production is necessarily due to the living mechanism, for high temperature may drive off CO₂ produced already by the process of tissue disintegration, just as the CO₂ diffused out from a wet thread saturated with the gas, the rate of diffusion being a function of temperature. Thus anaesthesia was tried, although we should

expect at the outset that if ether had no direct affect on the respiratory process, as some physiologists believe, then the negative results would not at all interfere with my contention. The fact is, however, that either an isolated nerve directly treated with ether vapor or urathane, or the nerve isolated from a deeply anaesthetized frog gave a much less quantity of CO_2 than the normal nerve isolated from a normal frog whose heart has been cut away for a period of time equal to that of etherization. Anaesthetics, then, diminish CO_2 production from an isolated nerve fibre. These experiments are being continued quantitatively.

CO_2 Production of Isolated Nerve at Successive Time Intervals.

— It was also thought that if CO_2 production was due to bacterial decomposition, although it is highly improbable for such a fresh tissue, we may expect that either killing by steam or treating with

TABLE IV
SHOWING DECREASED CO_2 PRODUCTION BY LONG-STANDING (FROG'S SCIATIC)

1	2	3	4
Temperature of room	Time elapsed after isolation	Minimum c.c. necessary to give ↓ calculated for 10 mgs. 10 minutes	Total CO_2 produced from nerve of 10 mg. for 10 minutes
24°	immediately	2.7 c.c.	5.5×10^{-7} g. CO_2
25	1 hour	7.08 c.c.	2.1×10^{-7} g. CO_2
24	2 hours	10.8 c.c.	1.4×10^{-7} g. CO_2
24	5.5 hours	12.8 c.c.	1.1×10^{-7} g. CO_2
23.5	7 hours	15.3 c.c.	$.9 \times 10^{-7}$ g. CO_2
23.5	10.5 hours	21.0 c.c.	$.6 \times 10^{-7}$ g. CO_2
24	26 hours	9. c.c. ¹	1.6×10^{-7} g. CO_2
24	27.4 hours	1.8. c.c	8.1×10^{-7} g. CO_2

¹ The gradual increase at this point should be noted (after 26 hours, it is clear that bacterial decomposition sets in).

ether would check the CO_2 production, and that the results observed above may not necessarily prove that CO_2 production from the isolated nerve fibre is due to a respiratory process. Hence a number of the nerves were isolated from several frogs of the same size and sex, and

were left in Ringer's solution, and then the rate of the gas production is determined with the different nerves removed at successive intervals of time from the Ringer's solution for twenty-five hours. The interesting results given in Table IV not only show that CO_2 from the fresh nerve is not due to bacterial decomposition, but it also indicates that when such abnormal decomposition sets in, the output of gas takes a sudden jump. This Table further shows that the vital process by which CO_2 is produced gradually slows up as the tissue approaches death, indicating that the decrease of CO_2 production is parallel to the decrease of irritability of the nerve.

Increase of CO_2 on Stimulation. — The most convincing evidence of all that CO_2 is formed by a vital process is the fact that a stimulated nerve gives off more CO_2 (Part II) indicating the presence of normal metabolism in the living nerve which is accelerated when the nerve is stimulated. Thus we may safely conclude here that like any other tissue or organs, the nerve, too, respire whether it has a nucleus or not, and that the rate of CO_2 production is proportionate to its weight, other things being equal.

CO_2 PRODUCTION FROM STIMULATED NERVE

We have now come to our main inquiry, namely, is there any chemical basis for irritability? Just what relation exists between nervous activity and chemical changes is the question that a biologist should consider before he attempts to build any conception of the real dynamics of living matter. For it is the phenomena of excitability in the nerve fibre that has stood so long in the path of understanding protoplasmic irritability in general. As for the brain, it is now established that certain chemical changes are involved during stimulation and that definite chemical changes are associated with pathological cases either in its chemical composition²³ or in the formation of abnormal metabolites.²⁴ Aside from the confused facts concerning histological changes in the ganglion cells of fatigued animals, Hill has observed, using Ehrlich's method of methylene blue

²³ KOCH and MANN: *Archiv of neurology and psychiatry*, 1909, iv, p. 44.

²⁴ DIXSON: *Journal of physiology*, 1899-1900, xxv, p. 63; CROFTAN: *American journal of the medical sciences*, 1902, p. 150.

for the determination of the rate of oxidation, that a spot of cerebral surface, if stimulated, loses its blue color owing to the using up of the oxygen.²⁵ In case of the nerve fibre, however, we have already seen that no direct evidence has ever been presented to show any chemical changes connected with its activity, although there has been some indirect evidence. As considered before, the failure of the direct detection of CO₂ from the stimulated nerve must be due to the lack of a delicate method. Thus using the new method we have already demonstrated that a resting nerve gives off CO₂, and will now attempt to prove that nerves give off more CO₂ when stimulated.²⁶

Electrical Stimulation of non-Medullated Nerve.—Owing to the scope of delicacy of the new method, which is sensitive to as small a quantity as 1.0×10^{-7} gram (an amount corresponding to the CO₂ contained in $\frac{1}{6}$ cc. of pure air), the utmost caution must be taken to prevent any complication which may result in formation or absorption of minute quantities of CO₂. After I had found by experiment that there is no appreciable increase of CO₂ due to the direct electrical decomposition in the nerve when stimulated by a weak induction current and that several other forms of stimulation qualitatively confirmed the results obtained by the electrical stimulation, I have naturally employed the induction current as a stimulant in all my experiments on the quantitative estimation of CO₂ production from the stimulated nerve.²⁷

As Table V shows, the stimulated non-medullated nerve fibre of the spider crab gives off $16. \times 10^{-7}$ grams of CO₂ for 10 milligrams of

²⁵ HILL: *loc. cit.*

²⁶ Professor Carlson has very kindly called my attention to a recent publication from the Physiologisch Laboratorium der Utrechtsche Hoogeschool, in which Buijtendijk reports that certain head nerves of fishes take up more O₂ when electrically stimulated. He could not, however, find any increase of O₂ consumption in the sciatic of the frog. Also see: Koninklijk Akademie van Wetenschappen, Amsterdam, afd. xix, pp. 615-621.

Haberlandt also recently reports (Archiv für Physiologie, 1911, p. 419) that the resting nerve takes up of O₂, 41.7 - 33.4 cmm. at 19° - 24° per gram per hour. When this nerve is excited, intake of O₂ is increased. Since the respiratory quotient of the stimulated nerve is equal to that of the resting, he concludes that when the nerve is excited, it must give off more CO₂. He does not, however, indicate how much CO₂ is produced by stimulation.

²⁷ Use of non-polarizable electrodes was impossible for my apparatus, for the presence of foreign liquid in the chamber interferes with CO₂ estimation. As

nerve for ten minutes, while a fresh resting nerve gave only 6.7 by 10^{-7} grams for the same units. The details of the methods are as follows:

The nerve of the claw of the spider crab is isolated as before. A comparative estimation was made first. Two pieces of the nerve of equal weights and length were placed separately on the two glass plates, each nerve being laid across the electrodes of the plate, in the manner shown in Figure 1. In this way either nerve can be stimulated at will. These glass plates are hung by their wires upon the platinum wires fused into the side of the apparatus, these wires being connected in turn with the induction coil. Under this condition, when both nerves are not stimulated, the amounts of the precipitate are equal in both chambers. However, when one of the nerves is elec-

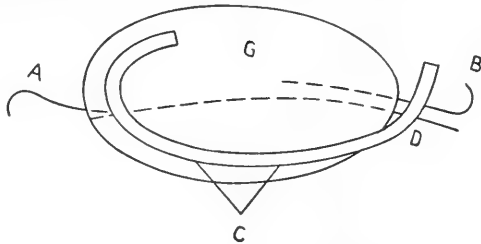

FIGURE 1. Glass weighing plate. A. B. Platinum wire fused in the rear of the glass plate, with hooks. C. The nerve which is stimulated at D. G. The plate proper.

I have the other piece of the same glass out of which this plate is made. This piece of glass is weighed exactly equal to this weighing plate, so that any wet tissue can be weighed very quickly. In order to make results more accurate, no attempt was made to weigh closer than $\frac{1}{2}$ milligram.

trically stimulated (the distance between the primary and secondary coils was always more than 10 cm. using a red dry battery, the current being barely perceptible on the tongue), not only does the precipitate appear sooner in the chamber in which the excited nerve is placed, but also the quantity of the carbonate is much greater.

To test whether the increase of CO_2 production from the stimulated nerve is due to the direct decomposing influence of the current, or to the increase of metabolism produced by the passage of a nerve long as we are not concerned with the electrical changes in the nerve, the use of platinum electrodes instead, is not a great objection, provided that the current is weak enough not to decompose the tissue directly, and that the duration of stimulation is not very long.

impulse, the following experiments were performed. If we assume that the condition under which an electrical decomposition takes place is the same both in the living and the dead nerve, then if the increased CO_2 is due to the current itself, we should expect that when a killed nerve is stimulated by a current, it ought to increase CO_2 production just as much. When I placed two nerves killed by steam in each chamber, and stimulated only one of them, the stimulated nerve did not give any more CO_2 than the unstimulated, using the same strength of current employed in the other experiments. In the next place, it was thought that if the increase of CO_2 is due to direct electrical decomposition, not limited to the point of contact with the electrodes, we ought to get a proportional increase of CO_2 by altering the distances through which the current directly passes. The fact was, however, that we could produce an increase of CO_2 production by stimulating with electrodes 2 mm. apart as well as by 15 mm. apart. Increase of CO_2 , therefore, is due to nervous excitation and not to the direct influence of the electric current itself.

With this consideration, I have proceeded to make a quantitative estimation of CO_2 from the stimulated nerve in the manner described before. The results are shown in Table V.

Electrical Stimulation of Medullated Nerve. — With apparatus 2, the output of CO_2 from the excited sciatic nerve of the frog has been quantitatively estimated. As shown below, 10 mgs. of the sciatic nerve gives off 14.2×10^{-7} grams of CO_2 during ten minutes stimulation while the resting nerve of the same animal gave off 5.5×10^{-7} grams for the same units.

Mechanical Stimulation. — We have now established the fact that when a nerve is stimulated by an electrical stimulus, it gives off more CO_2 . In order to prove more conclusively that this CO_2 production is due to the passage of a nerve impulse, I have employed several other means which are known to have definite influence on excitability of the nerve. So far, the use of these methods has been confined to qualitative experiments, but the results are a sufficient confirmation of the observations made by electrical stimulation. I cite them here as a preliminary report.

Since the ordinary method for mechanical stimulation cannot be applied directly to the nerve in my apparatus in its present form, I used a different method, namely, crushing the nerve. That, when a

TABLE V
 CO₂ PRODUCTION FROM STIMULATED NERVE OF SPIDER CRAB (NON-MEDULLATED)

1	2	3	4	5	6	7	8	9	10
Date	Temperature of room	Weights of nerve in milligrams	Stimulation	Duration of stimulation	c. c. taken from respiratory chamber	Ppt. of BaCO ₃ after ten minutes	No. of c. c. of gas which gives ppt. calculated for 10 mg., ten minutes ²	No. of c. c. of gas which does not give ↓, calculated for 20 mg., ten minutes ²	Original volume of respiratory chamber
Nov. 3	16.8°	20	Stimulated	10 min.	.5	+	1 c.c.	...	9.5
" 3	14	12	"	10 "	.5	+	.6 c.c.	...	"
" 4	14	40	"	10 "	.5	- ¹	...	2.0 ¹	"
" 6	14.8	20	"	10 "	.5	+	1 c.c.	...	"
" 7	16.8	8	"	10 "	.5	+	.4 c.c.	...	"
" "	16.5	8	"	10 "	.5	-4	"
" "	17	16	"	10 "	.5	+	.8 c.c.	...	"
" "	17.4	16	"	10 "	.5	+	.8 c.c.	...	"
" "	17.5	8	"	10 "	.5	-4	"
" "	17	8	"	10 "	1.0	+	.8 c.c.	...	"
" 8	15	11	"	10 "	1.0	+	1.1 c.c.	...	"
" "	16	10	"	10 "	1.0	+	1 c.c.	...	"

¹ Killed by steam.

² From this we see minimum precipitating volume is .6 c.c., since .4 c.c. is maximum non-precipitating volume:

... Total CO₂ output from 10 mg., ten minutes is

$1.0 \times 10^{-7} \times \frac{9.5}{.6} \text{ g.} = 16 \times 10^{-7} \text{ g. CO}_2 \text{ at } 14^\circ - 16^\circ$ Compare with Table I

TABLE VI
CO₂ PRODUCTION FROM STIMULATED SCIATIC NERVE OF FROG (MEDULLATED)

1	2	3	4	5	6	7	8	9	10
Date	Temperature of room	Weight of nerve in milligrams	Stimulation	Duration of stimulation	c.c. taken from respiratory chamber	Precipitation of BaCO ₃ after ten minutes	No. of c.c. of gas which gives ↓, calculated for 10 mg, ten minutes ¹	No. of c.c. of gas which does not give ↓, calculated for 10 mg, ten minutes ¹	Original volume of respiratory chamber
March 27	24°	14	Stimulated	10 min.	2	—8 c.c.	15 c.c.
" "	24	13	"	10 "	1	+	1.3	"	"
" "	24	11.5	"	10 "	1	+	1.15	"	"
" 28	18	13	"	10 "	1.8	+	2.34	"	"
" "	19	8	"	20 "	1	+	1.6	"	"
" "	20	9.5	"	20 "	1	+	1.9	"	"
" "	20	15	"	10 "	1	+	1.5	"	"
" 30	25	14.5	"	10 "	1	+	1.45	"	"
" "	24	9	"	11 "	1	—99 c.c.	"
" "	21	9	"	10 "	1.5	+	1.35	"	"
April 3	18	22	"	10 "	.9	+	1.98	"	"
" 4	21	17	"	10 "	1	+	1.7	"	"
" "	22	10.5	"	10 "	1	+	1.05	"	"
" "	25	16.5	"	10 "	1	+	1.65	"	"
" "	23	1.6	"	10 "	1	+	1.6	"	"
" "	21	1.7	"	10 "	1	+	1.7	"	"
" 5	25	9.7	"	10 "	1	—97 c.c.	"
" "	26	14	"	10 "	1	+	1.4	"	"

¹ Since minimum precipitating volume is 1.05 c.c. and maximum non-precipitating volume is .99, it is obvious that 1.05 c.c. is minimum: . . . $1.0 \times 10^{-7} \times \frac{1.5}{10.5} \text{ g.} = 14.2 \times 10^{-7} \text{ g. CO}_2 (20^\circ - 22^\circ)$

protoplasm is smashed, there occurs vigorous chemical changes, is shown by several investigators. Fletcher²⁸ reports that injured muscle gives off more CO₂ than the normal.

Later he and Hopkins²⁹ discovered that muscle, under a similar condition, is richer in lactic acid.

Dr. Mathews has observed a similar activity in crushed eggs of *Arbacia*. Quite accidentally, I have discovered that a fresh nerve, too, when crushed with the rough edge of a glass rod gives off more CO₂. This increase of gas production from the injured nerve, I take to be due to mechanical stimulation. To test this hypothesis, I rendered the nerve unexcitable by means of ether and 0.2 m. solution of KCl, which is known to abolish excitability of a nerve.³⁰

Under these conditions, I observed no increase of gas production when the nerve is crushed. Therefore, the metabolism existing in the living nerve must be accelerated by this stimulation when it is injured.

This interpretation, however, is not accordant with that of Fletcher and Hopkins, on muscle. In studies of lactic acid formation in muscle, they found that lactic acid is spontaneously developed, under anaerobic condition, in excised muscle, and that fatigue due to contractions of excised muscle is accompanied by an increase of lactic acid. In an atmosphere of O₂, there is no survival development of lactic acid for long periods after excision. From a fatigued muscle, placed in O₂, there is a disappearance of lactic acid already formed. But this disappearance of lactic acid, due to oxygen, does not occur, or is masked, at supraphysiological temperature (e. g., at 30°). Now traumatic injury to an irritable muscle too produces a rapid development of acid. Since, however, in this case the disappearance of lactic acid due to O₂ does not occur, they conclude that one essential condition for this effect of oxygen appears to be the maintenance of the normal architecture of the muscle. Thus they contend that the increase of the lactic acid by mechanical injury is not due to stimulation, but must be due to tissue destruction.

They, however, did not determine, as far as I know, how much the output of CO₂ is affected by treating the injured tissue with O₂.

²⁸ FLETCHER: *Journal of physiology*, 1898-9, xxiii, p. 37.

²⁹ FLETCHER and HOPKINS: *ibid.*, 1906-7, xxxv, pp. 261, 288.

³⁰ MATHEWS: *This Journal*, 1904, xi, p. 463.

Unless it is proven that CO_2 production from the injured muscle is quantitatively equivalent to lactic acid formed, their interpretation cannot be applied to the injured nerve, for in the case of the "plateau" of the survival muscle respiration, when in complete loss of irritability, the lactic acid yield remains stationary, Hill calculated that the CO_2 production corresponds to the amount liberated from the carbonate of the tissue by the lactic acid formed.³¹

Furthermore, if their interpretation is applied to the nerve, the fact that etherized nerves or nerves rendered unexcitable by KCl do not increase CO_2 output when crushed, cannot be explained. The fact that only excitable nerves when injured increase their CO_2 production, is a sufficient proof that some sort of stimulation is applied to the nerve when crushed, the tissue destruction, no doubt, following afterward. The increase of CO_2 production on crushing the living nerve and its absence on crushing the anaesthetized nerve is the point that I want to emphasize here in order to confirm my results obtained by electrical stimulation. I may add here that a perfectly parallel increase of CO_2 by crushing has been observed in dry seeds, including wheat, wild oats, Lincoln oats, Swedish select oats, leaves of Japanese ivy, and spinal cords of rabbit.³²

Chemical Stimulation. — The study of the nature of chemical stimulation has been so thoroughly made³³ that at first it was thought that chemical reagents would be ideal as stimuli.

It was soon discovered, however, that the presence of minute quantities of a foreign liquid is such a disturbing factor that stimulation by salt solutions could not be used for quantitative experiments. With a qualitative analysis, however, I found a variety of evidences which show that the nerve stimulated chemically gives off more CO_2 , and that the nerve rendered less excitable by reagents decreases CO_2 production.

When each sciatic nerve of a frog is isolated and one is left in the normal saline in one case, and in the body of the frog in the other, for the same length of time, and then transferred to the two chambers of the apparatus, if the quantities of the precipitate are compared, it is found that the nerve which has been in normal saline gives more CO_2 .

³¹ HILL: *Journal of physiology*, 1912, xliv, p. 481.

³² Fuller discussion of these will appear in a subsequent paper.

³³ MATHEWS: *This Journal*, 1904, xl, p. 455; 1905, xiv, p. 203.

It is known that normal saline stimulates frog's sciatic nerves. The different rates at which CO_2 is produced from the different nerves treated by various concentrations of KCl is equally instructive. It is known that when a nerve is placed in a molecular solution of KCl, a stimulation takes place for a considerable time. Then it finally becomes unexcitable,³⁴ whereas, .2 m. KCl solution abolishes nervous excitability in a short time without primary stimulation. The CO_2 production follows exactly analogous to this. The nerve treated with the stronger solution gives more CO_2 than that of a weaker solution. This was true even after both nerves became unexcitable, showing that the nerve must be giving off more CO_2 while being stimulated by the stronger solution. Although my quantitative data are not complete at this stage, this preliminary statement is sufficient to show that the nerve chemically stimulated gives off more CO_2 . It may be added in passing that the different solubility of CO_2 in the different concentrations of these salts solutions cannot explain these results solely by a physical interpretation, for there is not enough difference in the solubility of CO_2 in dilute equimolecular solutions of KCl, and NaCl, whose effect on CO_2 production is so divergent, the former salt diminishing, the latter increasing it.

Heat Stimulation. — It may be recalled in Table I that high temperature increases the output of CO_2 from the resting nerve. A respiratory process should increase proportionally to the temperature. Raising of temperature, however, not only increases the rate of respiration, but also (particularly by sudden changes of it) stimulates the nerve. A very interesting fact is observed in connection with the killing of the nerve. When the nerve is killed gradually by a slow increase of temperature, it gives off more CO_2 than when killed suddenly, the determination being made after both are killed. CO_2 production from the dead nerve under this condition must be due to the diffusion of the gas which was formed previously, just as Fletcher's dead muscle is charged with CO_2 gas. The different outputs of CO_2 between slowly killed and suddenly killed nerves cannot be accounted for unless we assume that in one case, CO_2 is produced more while being killed than in the other. Whether such increase of CO_2 production, however, was due to the acceleration of normal respiration by the slowly increasing temperature, or due to direct stimulation caused

³⁴ MATHEWS: *loc. cit.*

by heat, or due to both, cannot be decided here unless we consider the relation between excitation and tissue respiration.³⁵

It is hoped that we may have a better understanding of this matter when we study the temperature coefficient of normal respiration of the nerve. At present, we are satisfied to state only that there is a strong evidence to support the conclusion that heat, too, increases CO₂ production from the nerve.

DISCUSSION OF THE RESULTS

Comparison of Metabolism of Non-Medullated and Medullated Nerve. — Although it appears ridiculous to attach any significance to the marked similarity in the magnitudes of CO₂ production from non-medullated and medullated nerves, the temptation is irresistible to comment on the high output of CO₂ from the non-medullated nerve fibre. Let us study the Table following (Table VIII), in which a summarized comparison is given.

TABLE VIII

Nerve	CO ₂ from resting nerve	CO ₂ from stimulated nerve	Rate of increase of CO ₂
Non-medullated (spider crab)	6.7×10^{-7} g. (15° - 16°)	$16. \times 10^{-7}$ g. (14° - 16°)	2.4 times
Medullated (frog)	5.5×10^{-7} g. (19° - 20°)	14.2×10^{-7} g. (20° - 22°)	2.6 "

Since I have found that injury increases the CO₂ production from the nerve, the values I have obtained from cut, or isolated, fresh resting nerves, such as I had to use, may be somewhat greater than the output of normal uninjured nerves would be. But since Alcock³⁶ has shown that a non-medullated nerve gives a higher electrical response, both in the negative variation and the injury current, the CO₂ increase due to the cut alone will probably be greater in case of the non-medullated nerve than in that of the medullated one. That means that the value of the CO₂ production for the resting uninjured,

³⁵ See p. 134.

³⁶ ALCOCK: Proceedings of the Royal Society, 1904, lxxiii, p. 166.

non-medullated nerve should be reduced more from the figures found for the isolated nerve, than that of the medullated one. In other words, by lowering 6.7×10^{-7} gram which is the value for resting, non-medullated, isolated nerves, the rate of increase of CO_2 by stimulation in the uninjured nerve would become higher than 2.4 times, and probably higher than 2.6 times, which is the rate for the medullated nerve. This greater effect in the non-medullated nerve is what we should expect if our present conception that conduction is in the axis cylinder only, is correct. Before any accurate comparison of the increase of CO_2 production on stimulation of non-medullated and medullated nerves can be made it will be necessary, however, to determine how much of the CO_2 from the resting nerve is due to injury alone. Before we consider this point seriously, also, we should determine the metabolic activities of greater numbers of nerves of different animals. Such an investigation is at present useless until we determine more quantitatively the relation between CO_2 production and the various strengths of stimulation and the degree of excitability. If any uniformity of CO_2 output in respect to anatomical variations is discovered, light may be thrown on the function of the medullary sheath and other differentiations.

However insignificant these results may be as far as the similar rates of the gas production of these two nerves is concerned, it should be strongly emphasized that technical error plays no part in these determinations. Inasmuch, as we are dealing with such an extremely small amount of the gas, it is quite natural for those who are not familiar with my apparatus to suspect, by a hasty inspection of my results, that the small differences I found under different metabolic conditions may be due to mere experimental variations. For this reason, particular attention is called to a detailed description of the quantitative method I used, especially the footnote on page 144, where I have cited a series of determinations of unknown quantities of CO_2 in testing my apparatus. I may repeat here that my experiments with the spider crab and the winter skate were done at Woods Hole³⁷ during the summer of 1911, while those with the frog were done in Chicago during the winter of 1912. Under these different conditions, I have not only used the different sizes of nerves, but also

³⁷ I take great pleasure in acknowledging my indebtedness for the kind accommodation offered me by Drs. Lillie and Drew at Woods Hole.

experimented with two different apparatus, the respiratory chambers of which have had entirely different capacities.³⁸

Comparison between the Metabolism of Resting Nerves and that of Other Tissues. — To compare the rate of metabolism of the nerve with that of other tissues is a matter of no great physiological value on account of great variations which do not affect equally the rate of CO₂ production. Simply to give a better picture of the scope of nervous metabolism, however, let us make the following comparison: Since there is no exact determinations made on either the other organs, or the whole animal, in the case of the spider crab, I have quoted those of the nearest crustacea of which data are available. (Table IX).

TABLE IX

Animals	CO ₂ per Kg. per hour	Temperature	Determined by ¹
Crustacea (whole animal)			Jolyet and Regnaut
Cray fish (<i>Astacus</i>)	37.7 c.c.	12°.5	" " "
Crab (<i>Cancer pagurus</i>)	89.9 c.c.	16	" " "
Lobster (<i>Homarus vulgaris</i>)	54.4 c.c.	15	" " "
Nerve of spider crab (<i>Labinia canaliculata</i>)	212 c.c.	15° — 16°	Tashiro
Frog:			
(<i>Rana esculenta</i>) (whole animal) .	.082 gms.	17	Schultz
(<i>Rana temporaria</i>) (whole animal)	.355 "	19° — 20°	Pott
(<i>Rana pipiens</i>) (sciatic nerve) .	.33 "	15	Tashiro
(<i>Rana temporaria</i> ²) (isolated muscle)18 "	21	Fletcher
Dog	1.325 "	...	Regnaut and Reiset
Man at rest41 "	...	Pettenkoffer and Voit
" " "61 "	...	" " "
" " "37 "	...	Speck

¹ All the figures are quoted from Schäfer's Text Book of Physiology i, pp. 702, 707 and 708, except that of the isolated muscle which I calculated from Fletcher (*loc. cit.*). Fletcher fails to state the weight of a leg, but gives the value .2 c.c. for one-half hour. Hill believes that if we take each leg 6 g. in average, the value will not be far from the truth.

² Fletcher fails to state the species of the frog, but it is inferred from Hill's paper.

³⁸ See the last columns of Table I and Table II.

Active Nerves.—That the nerve increases its CO₂ production approximately 2.5 times when stimulated, is in accordance with our conception of the metabolism of other acting organs. Just how much increase of CO₂ takes place during functional activity of an organ or organisms depends on conditions as well as on habits of different organs and animals. Pettenkofer and Voit³⁹ report that a man (weighing 70 kgs.) gives off when working 0.76 grams per kg. per hour, while resting only .56 gram. Barcroft⁴⁰ found that the submaxillary gland when stimulated by the chorda tympani gives off 3–7 times more CO₂ than the resting gland. In the case of contracting muscle, the results are very contradictory. Hermann⁴¹ found that the contracting muscle gave off 9.3 per cent of CO₂ (by volume) while the resting one, only 1.4 per cent. Tissot⁴² and other workers also found a similar increase of CO₂ from contracting muscle. Minot,⁴³ working with Ludwig, maintains that there is no relation whatever between CO₂ production and muscle tetanus. L. Hill⁴⁴ and Fletcher⁴⁵ both confirmed Minot's work by finding no increase of CO₂ production from muscular tetanus. According to Fletcher, the increase he found in CO₂ production from a contracting muscle in a closed vessel is due to the rigor. Under this condition, he believes, increased formation of lactic acid is responsible for liberating CO₂ already produced. In either case, it is understood that functional activity in the muscle is accompanied by an increase of metabolic activity. It is difficult to compare this increase of metabolic activity of the muscle with that of the nerve unless we determine how much and what kind of metabolism takes place in contracting muscle.

Respiration Quotient of the Nerve Fibre.—As quoted before Haberlandt found that a resting nerve consumes 41.7 to 83.4 cmm. O₂ for 1 gm. for an hour at 19° – 24°. Although he has not determined chemically the production of CO₂ he could easily read the respiration quotient by means of the index fluid. Thus he found

³⁹ PETTENKOFER and VOIT: *loc. cit.*

⁴⁰ BARCROFT: *Ergebnisse der Physiologie*, 1908, vii, p. 735.

⁴¹ HERMANN: *Stoffwechsel der Muskeln*, Hirschwald, Berlin, 1867.

⁴² TISSOT: *Archives de physiologie*, 1894–5, (5) vii. p. 469.

⁴³ MINOT: *Arbeiten aus der physiologischen Anstalt zu Leipzig*, 1868, p. 1.

⁴⁴ L. HILL: See Schäfer's *Text Book of Physiology*, 1898, i, p. 911.

⁴⁵ FLETCHER: *Journal of physiology*, 1898–9, xxiii, p. 68.

that the respiratory quotient of the resting and acting nerve is nearly unity. Since he found that O_2 consumption is increased when stimulated, and since the respiration quotient remains constant before and after the stimulation, he concluded that it must give off more CO_2 when stimulated. It is very interesting to compare the O_2 consumption in this experiment with the CO_2 production of mine.⁴⁶

Taking his lowest figure, because he worked in $19^\circ - 24^\circ$ and I in $19^\circ - 20^\circ$, 41.7 cmm. of O_2 amount to .00007 cc. for 10 milligrams for ten minutes. My figure of 5.5×10^{-7} grams for the same units may be translated to .00027 cc. of CO_2 (ignoring temperature and pressure correction). Therefore $\frac{CO_2}{O_2} = \frac{00027}{00007} = 3.8$, the respiratory quotient.

As I have not determined O_2 consumption of the nerve of *Rana pipiens*, this figure has no particular value, but the fact that the CO_2 production is comparatively higher than O_2 consumption is a matter of considerable interest.

One of the most important observations made by A. V. Hill⁴⁷ is the fact that he could not detect any rise of temperature in a frog's nerve as measured by an apparatus which is sensitive to a change of one-millionth of a degree. From this, according to his calculation, he concludes that not more than one single oxygen molecule in every cube of nerve of dimension of 3.7μ can be used up by a single propagated nerve impulse. Therefore, he suggested that an impulse is not of irreversible chemical nature but a purely physical change.

Although, I confess, my ignorance makes it impossible to interpret his valuable results from my observations, I may add that these two apparently irreconcilable facts may throw light on the true nature of nervous metabolism. Dr. Mathews has suggested that metabolism in the nerve may be something of the order of alcoholic fermentation, which is not a direct oxidation, and where heat production cannot be so large as CO_2 production, since the energy content of glucose is only a trifle higher than that of the alcohol produced. The comparatively little heat production in the case of working glands is a matter of interest in this connection. At any rate we should not forget the

⁴⁶ He used *Rana esculenta*, which, by the way, gives for the whole animal .082 g. CO_2 per kg. per hour at 17° according to Schultz. My frog was *Rana pipiens*.

⁴⁷ HILL: *Journal of physiology*, 1912, xliii, p. 433.

anatomical as well as the chemical differences between muscle and nerve. In this respect the ratio between CO_2 production and O_2 consumption from the nerve is suggestive.

The extremely small intake of O_2 has another point of interest in relation to the general nature of irritability. It has been repeatedly reported that a nerve can remain excitable several hours in an oxygen-free atmosphere, although there is no doubt its excitability diminishes, yet there is a considerable amount of evidence to show that oxygen is very closely associated with the state of excitability. To harmonize these two facts, the oxygen-storage hypothesis has been suggested, by which the exhaustion is attributed to complete consumption of the stored oxygen and that excitability is restored when atmospheric oxygen is readmitted. Without committing ourselves to this hypothesis, I may add that according to Haberlandt's figure, the resting nerve of 10 milligrams will consume only .0042 cc. O_2 in ten hours. If we take our figure and assume that one volume of oxygen was necessary to produce one volume of CO_2 (this assumption is made without any significance except to give a liberal estimate), the CO_2 production would require about .015 cc. of O_2 for ten hours. And if we assume again that activity will increase O_2 consumption in proportion of CO_2 production, then it means that the nerve when stimulated takes up only .03 cc. of O_2 during ten hours stimulation. I am not aware, at present, of the existence of any method which will surely remove O_2 as completely as this from a large vessel; and this is a very liberal estimate. My experiences in rendering the air free from CO_2 encourages me to raise the question, How can one remove every trace of O_2 from a nerve fibre? Without having a correct criterion for an oxygen-free medium we cannot at present consider definitely any question of the relation of O_2 to irritability.

CONCLUSION

In spite of all the negative evidence against the presence of metabolism in the nerve fibre, we have established three important facts: namely, (1) A resting nerve gives off a definite quantity of carbon dioxide; (2) stimulation increases CO_2 production; and (3) CO_2 production from the resting nerve proportionally decreases as irri-

tability diminishes. These facts prove directly that the nerve continuously undergoes chemical changes, and that nervous excitability is directly connected with a chemical phenomenon. There is still another question left, namely, Is there any direct relation between excitability and tissue respiration? To put this question more directly, we may ask: Does excitability depend on the respiratory process in the protoplasm? To answer these questions we must refer to two facts; namely the direct relation between the rate of respiratory activity and the decrease of excitability; secondly, the influence of reagents on CO₂ production and their effects on the state of excitability.

By the studies of CO₂ production by Fletcher⁴⁸ lactic acid formation by Fletcher and Hopkins,⁴⁹ and heat evolution by A. V. Hill,⁵⁰ it has been established that in isolated muscle, respiratory processes decrease when irritability diminishes. In the case of the nerve, as shown in Table 3, CO₂ production reaches this minimum when excitability approaches zero. These relations, however, do not show conclusively that the protoplasmic irritability depends on respiratory activity, for it is quite probable that the dying nerve may alter its physical condition as well, which according to the physical school, may consequently alter the state of excitability.

That irritability is independent of the respiratory processes has been hitherto successfully contended in the case of the dry seed. The works of Horace Brown, Thiselton-Dyer⁵¹ and others indicate that the dry seed can be kept alive at the conditions where no ordinary gaseous exchanges are possible. It is argued, therefore, that life is possible without any metabolic activity.⁵² While a definite potentiality for irritability may exist without any metabolic activity, yet that the irritability can persist without respiratory activity, or vice versa, is a matter by no means settled. In the case of ordinary air-dry seed, Waller could demonstrate the response of electrical changes when stimulated although the detection of CO₂ was impossi-

⁴⁸ FLETCHER: *loc. cit.*

⁴⁹ FLETCHER and HOPKINS: *loc. cit.*

⁵⁰ A. V. HILL: *loc. cit.*

⁵¹ THISELTON-DYER: Proceedings of the Royal Society, 1897, lxii, p. 160; *ibid.*, lxxv, p. 361.

⁵² I am indebted to Professor Crocker for his kind suggestion as to botanical literature.

sible. This failure, however, as he himself expected, was due to the lack of delicacy of the chemical methods for detecting CO_2 . I observed, with my apparatus that even a single kernel of a dry seed gives off a definite quantity of CO_2 as long as it is alive. In ordinary condition not only a living dry seed gives off more CO_2 than the dead one, but also like the nerve, it always gives off more CO_2 when stimulated by mechanical injury. In the normal condition, therefore, we may safely conclude, there is always metabolic activity as long as the seed is irritable, and that in the different states of irritability, the respiratory activity is proportionately different. At present, therefore, we have no decided evidence which will prevent us from considering excitability as a function of respiration under ordinary conditions. This relation is more directly studied by the use of anaesthetics.

I have already demonstrated that an etherized nerve gives off considerably less CO_2 than the normal. Such an etherized nerve will not give more CO_2 when it is crushed. This may be interpreted by some to mean that the etherized nerve may be already dead. This, however, is not the case. This objection, also, I have considered by studying the nerve treated with KCl.

When the nerve is treated with .2 m KCl and then crushed, it does not give an increase of CO_2 production. Mathews has shown that while a .2 m. KCl solution renders the nerve unexcitable, yet it will recover its excitability by being replaced into $n/8\text{NaCl}$. These two facts, therefore, support the idea that any agents that suppress excitability of the nerves also decrease the CO_2 production and that CO_2 production by crushing the nerve must be largely due to stimulation. This hypothesis is strikingly supported by similar observations on the dry seed. Etherized seeds give much less CO_2 and cannot be stimulated to give more CO_2 by crushing, while under normal conditions, crushing a seed always increases its CO_2 production. Quantitative experiments in this direction will be given in another paper.

These facts directly support Mathews' hypothesis that substances which suppress irritability must act on the tissue respiration primarily. If such an hypothesis is correct, we can easily picture what is happening in the nerve fibre. Vernon⁵³ considers that a tissue contains certain substances which can absorb oxygen from their sur-

⁵³ VERNON: *Journal of physiology*, 1909-10, xxxix, p. 182.

roundings to form an organic peroxide, and by the help of a peroxidase can transfer this to amino acid and carbohydrate molecules bound up in the tissue, just as H_2O_2 ⁵⁴ can oxidize, with the help of an activator, an acid of formula $R \cdot CHNH_2 \cdot COOH$ to CO_2 , NH_3 and an aldehyde $RCHO$, and then oxidize this aldehyde to $RCOOH$ and ultimately to CO_2 and H_2O . Poisons such as HNC , $NaHSO_3$ and NaF , which he found to decrease CO_2 production, temporarily paralyzed respiration, he thought, by uniting with aldehyde groups, while formaldehyde, acid and alkali temporarily paralyze CO_2 forming power of the tissue by destroying the peroxidase. The organic peroxide, though it can still affect some oxidation, cannot of itself carry it to the final CO_2 stage. Recovery of CO_2 forming power is due to the regeneration of the peroxidase.

Although I doubt that such a process occurs in nervous respiration, the idea of two similar metabolic phenomena involved in the nervous metabolism is very helpful to understand the behavior of the nerve during continued activity. Most recently Tait discovered that a refractory period has two phases, absolute and relative.⁵⁵ When he treated the sciatic nerve of a frog with yohimbine, the relative phase is greatly prolonged, while the absolute one is little affected, a result quite different from other common anaesthetics. Waller⁵⁶ has already observed that protoveratrin slows up the positive variation of the nerve, while the negative variation is little influenced. Waller contends that this drug does not alter catabolic change, but retards anabolic activity to a considerable degree. Since pharmacological action on animals of protoveratrin and yohimbine are very similar, Tait concludes that these drugs must attack the nerve in similar manner, and that a refractory period, too, must consist of two phases corresponding to the catabolic and anabolic processes which Waller observed in the case of protoveratrinized nerves. Thus, he considers that his "absolute phase" of the refractory period corresponds to negative variation or catabolic process of the nerve, and the "relative" to the positive return or anabolic. Yohimbine, in other words, retards anabolic processes considerably, thus prolonging the refractory period, or increasing nerve

⁵⁴ DAKIN: *Journal of biological chemistry*, 1908, iv, pp. 63, 77, 81, 227.

⁵⁵ TAIT: *Journal of physiology*, 1912, xl, p. xxxviii.

⁵⁶ WALLER: *Brain*, 1900, xxiii, p. 21.

fatigue easily. These considerations suggest very strongly that the absence of fatigability in the nerve as measured by the ordinary methods, is not a question of absence of metabolism, but merely the speed by which these two processes come to an equilibrium.

Although we have an infinite number of facts still unexplainable, by our present knowledge of nerve physiology, we have established a few new facts around which we may build up some idea concerning this most essential phenomena of living matter, — i.e., irritability. As to the true nature of the nerve impulse, I can only confess my ignorance.

SUMMARY

1. All nerve fibres give off CO_2 . The resting, isolated nerve of the spider crab produces 6.7×10^{-7} gram per 10 milligrams per ten minutes. The frog's sciatic 5.5×10^{-7} grams.

2. When nerves are stimulated they give off more CO_2 . The nerve of the spider crab claw produces $16. \times 10^{-7}$ gram when stimulated, the frog nerve 14.2×10^{-7} grams. The rate of increase of CO_2 by stimulation amounts to about 2.5 times.

3. The CO_2 output of resting nerve is due to a vital active process.

4. Anaesthetics greatly reduce the carbon dioxide output of nerves and dry seeds.

5. Mechanical, thermal and chemical stimulation also increases the carbon dioxide output of nerves.

6. Single dry living seeds (oat, wheat, etc.) react in most particulars similar to nerves as regards their irritability, relation to anaesthetics, mechanical stimulation and carbon dioxide outputs.

7. The general conclusion is drawn that irritability is directly dependent upon and connected with tissue respiration and is primarily a chemical process. These results strongly support the conception that conduction is of the nature of a propagated chemical change.

To Prof. A. P. Mathews, under whose direction I have carried on these experiments, I express my appreciation and gratitude. For many suggestions, I am under obligation to Dr. F. C. Koch.

A NEW METHOD AND APPARATUS FOR THE ESTIMATION OF EXCEEDINGLY MINUTE QUANTITIES OF CARBON DIOXIDE¹

By SHIRO TASHIRO

[From the Department of Biochemistry and Pharmacology, the University of Chicago, and the Marine Biological Laboratory, Woods Hole, Mass.]

IN connection with the study of the metabolism of the nerve fibre, I undertook, at the suggestion of Prof. A. P. Mathews, to work out a method for the detection of exceedingly minute quantities of carbon dioxide. Following a suggestion made by Dr. H. N. McCoy, a very simple method was devised, which I reported first to the Chicago Section of the American Chemical Society;² later in conjunction with Dr. McCoy, its further details were reported to the Analytic Section,³ of the Eighth International Congress of Applied Chemistry. The principle of the new method is as follows:

1. Exceedingly minute quantities of carbon dioxide can be precipitated as barium carbonate on the surface of a small drop of barium hydroxide solution.

2. When a drop of barium hydroxide is exposed to any sample of gas free from carbon dioxide, it remains perfectly clear, but when more than a quite definite minimum amount of carbon dioxide is introduced, a precipitate of carbonate appears, detectable with a lens.

3. By determining, therefore, the minimum volume of any given sample of a gas necessary to give the first visible formation of the precipitate, its carbon dioxide content can be estimated accurately, since this volume must contain just the known detectable amount of carbon dioxide.

¹ One of these apparatus was described at the biochemical section, Eighth International Congress of applied chemistry, September, 1912; see also, *Journal of biochemistry*, 1913, xiv, p. xli.

² May 18, 1912.

³ Original Communication: Eighth International Congress of applied chemistry, 1912, i, p. 361.

I have constructed two apparatusi, based on this principle, which are especially adapted for the estimation of the output of carbon dioxide for very small biological specimens. With these apparatusi, one cannot only detect easily a very small amount of gas, given off by a small dry seed, or a small piece of a frog's sciatic nerve, but can also estimate it with considerable accuracy.

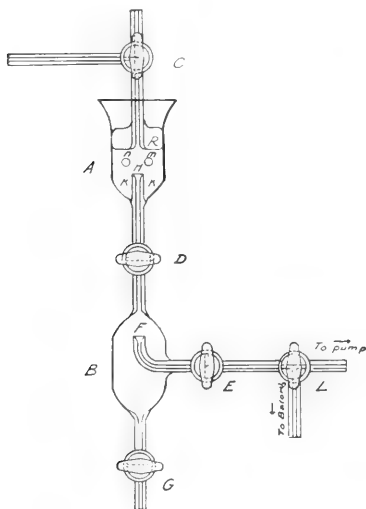

FIGURE 1
One-third the actual size.

The apparatus shown in Fig. 1 consists of two glass bulbs. The upper bulb A, is a respiratory chamber, having a capacity of about 15 c.c., which can be diminished to 9 c.c. by means of mercury. The lower bulb B is an analytic chamber with a volume of 25 c.c., which can be made to 5 c.c. by filling up with mercury. These two bulbs are connected with a capillary stop-cock D. The respiratory chamber is fitted with a tight glass stopper, R, which is connected to a three-way capillary stop-cock C. This glass stopper is so arranged that the chamber can be sealed by putting mercury above the stopper.

The tubes are thick walled capillaries of about 1 mm. internal diameter, excepting upturned tubes inside the bulbs, which should be rather thin walled, especially at F and H, where it is widened to an internal diameter of about 2 mm. It is important that the glass of which these tubes are made should be of a quality not readily attacked by barium hydroxide.

The details of the method of procedure are as follows:

The apparatus is first cleaned and dried.⁴ The specimen is

⁴ The apparatus is made in such a way that it can be cleaned and dried in ten minutes without being taken apart. For this, the stop-cock D is closed and E and L are opened. The arm at L is connected to the suction pump. Then a little acidulated water is introduced through G. By closing E, and opening D and G, the excess of water is drained off. Then the process is repeated with distilled water, alcohol, and alcohol ether. The last drying is completed by passing a current of air through G while D is closed.

placed on a glass plate⁵ and weighed. The glass plate is hung on n and m, which are electrodes fused into the side of the respiratory chamber A. The chamber is now closed with the stopper R and sealed with mercury. Through L, a connection is made with a pump⁶ and about 20 c.c. of mercury is introduced through G. Not too much mercury should be used; its surface should not be within 5 mm. of the cup F. Then wash the whole apparatus with carbon dioxide-free air,⁷ which is introduced through C, by successive evacuations. After the evacuation and washing out with pure air, which is repeated three or four times, the pressure inside of the bulbs is made equal to the atmospheric pressure by adjusting it at the nitrometer in the usual fashion. Stop-cock E is then closed, and the space between E and L is evacuated so that the barium hydroxide can rush in, a process which is very advantageous to obtain a clear barium hydroxide solution. Then clear barium hydroxide solution is run in through L. By opening E very slowly and carefully, the solution is now introduced into the chamber so that a small drop stands up upon the upturned end of the capillary at F. Then the connection between the two chambers is closed by D. It is imperative that this drop of the solution should be perfectly clear at the start. If no deposit of barium carbonate forms on the surface of the drop within ten minutes,⁸ a portion of the sample gas is drawn into B by withdrawing mercury through G and opening the stop-cock D. The volume of mercury withdrawn, which may be readily determined by volume, or more accurately by weight, gives the volume of the sample

⁵ The kind of glass plate used in connection with the nerve and small animals like *Planaria* is shown on p. 120, Fig. 1. (The first paper.)

⁶ The pump should be capable of giving a vacuum of at least 25 or 30 mm. of mercury.

⁷ Air cannot be freed completely from carbon dioxide by passing it through wash bottles. In my work, carbon dioxide-free air is prepared by shaking air with twenty per cent solution of sodium hydroxide in a tightly-stoppered carboy, fitted with suitable tubes. When this is to be used, it is driven into a nitrometer which is filled with less concentrated alkaline solution (a weak solution is used so that the chamber may not be too dry) by displacing it by running in a solution of sodium hydroxide. After each evacuation, this air is introduced from the nitrometer into the chamber A through stop-cock C.

⁸ If no precipitate appears within ten minutes, it is a sure control that the apparatus is free from carbon dioxide.

gas taken from the respiratory chamber, since the pressure in A and B is kept equal to the atmospheric during the transfer.

One now watches the surface of the drop at F with a lens to see whether any formation of barium carbonate occurs within ten minutes. With this apparatus, I have repeatedly introduced accurately known quantities of carbon dioxide of very high dilution into B in the manner just described and as a result have found, with remarkable regularity, that 1.0×10^{-7} gram of carbon dioxide is the minimum amount which will cause a formation of barium carbonate within a period of ten minutes. Smaller amounts of carbon dioxide give no visible results; while larger amounts give a deposit more rapidly, and appear in larger quantities. This minimum detectable amount 1.0×10^{-7} gram is about the amount which is contained in $\frac{1}{8}$ c.c. of natural air, in which we assume 3.0 parts of carbon dioxide in 10,000 by volume.⁹

In order to determine the concentration of carbon dioxide in the respiratory chamber, one must first find, for the apparatus used, the minimum detectable amount of carbon dioxide. Then one finds, by trial,¹⁰ the minimum volume of gas necessary to give the first visible formation of barium carbonate. This volume must, therefore, contain the known minimum detectable amount of carbon dioxide. From the ratio between this volume and the original volume of the respiratory chamber, out of which this amount is withdrawn, the absolute

⁹ LETTS and BLAKE: Proceedings of the Royal Dublin Society, 1899-03, ix, p. 107.

¹⁰ In the case of biological problems, when the specimen gives off carbon dioxide continuously, and sometimes at different rates, varying with the time, it is much simpler not to attempt to determine the minimum volume by a continuous trial with the same sample; but instead to repeat the experiments with a series of samples of known weights for a known time, and determine the minimum volumes which give the precipitates, and the maximum volumes which do not give the precipitates. In this way, it can easily be calculated what is the minimum volume which gives the precipitate for the given weight of the specimen for a given time. Table I on page 114 will illustrate this more clearly.

Another upturned cup H provided in the respiratory chamber A is used in case only the qualitative detection of CO_2 is wanted. In such a case, the perfectly clear barium hydroxide solution is introduced, after the necessary cleaning and washing, to the respiratory chamber, forming the usual drop at H instead of F. It should be noted that in case a smaller capacity is necessary for the respiratory chamber, the mercury is introduced by a pipette to the bottom of the chamber at K.

quantity of carbon dioxide, given by the specimen, may be computed.

At the suggestion of Dr. F. C. Koch, another apparatus was constructed, which provides a control drop of the barium hydroxide solution, side by side with the other. The apparatus (Biometer) shown in Fig. 2, although it appears complex, is nothing more than apparatus 1, inclined 90° , but each of its chambers is provided with a barium hydroxide cup d and f. It is made of glass consisting of two respiratory chambers, serving also as analytic chambers, connected by a three-way stop-cock L, the other arm of which is connected to one arm of another three-way stop-cock K. Each of the other two arms of stop-cock K is connected to a nitrometer W and X. The nitro-

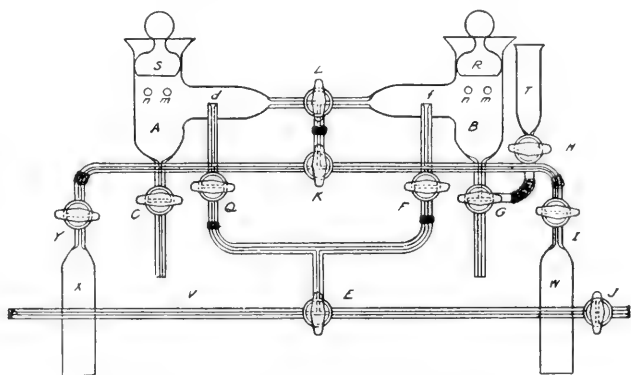

FIGURE 2. Biometer, one-third actual size.

The shaded portions of the apparatus indicate the rubber connection which is first coated by shellac, and then sealed with a special sealing wax. Some parts are also sealed with mercury.

meter on the right, is connected to a carboy with air free of CO_2 ; and the other, on the left, to a similar reservoir with air free of CO_2 plus any gas which is desired as a medium for conducting the experiment. Chamber A is drawn to a capillary stop-cock C; chamber B is drawn to the three-way stop-cock G, one arm of which is connected with a mercury burette T, which is used for adjusting the pressure. Both of the chambers have a capacity of 20 to 25 c.c. and are provided with a pair of platinum electrodes n and m, and also with the glass stoppers S and R, which can be sealed as usual with mercury. The pump is connected through J, and the barium

hydroxide solution is introduced through V to d and f, where drops are formed as before.

As stated above, this apparatus can be used for the combined purposes of qualitative detection, quantitative estimation, and comparative determination of the output of CO_2 from the various biological specimens. It has a decided advantage over the other in the fact that we have a control drop, side by side, under exactly the same conditions, and that the comparative estimation of CO_2 produced by different specimens can be made very easily and accurately. The detailed method of procedure is described under three different headings:

(a) **For the Qualitative Detection of Carbon Dioxide.** — After the apparatus is cleaned and dried,¹¹ a weighed tissue is placed on the glass plate and hung on n and m of the chamber A, and no tissue in the other chamber. After both chambers are closed with the stoppers S and R and sealed with mercury, they are so filled with mercury that the remaining volumes in both chambers are now exactly the same. The chambers are now evacuated and washed with pure air. When evacuation and washing with pure air is complete, the pressure is made atmospheric, by adjusting with the nitrometer the connection between A and B is then closed with stopcock L. If any CO_2 is given off by the tissue, the deposit of carbonate will soon appear on d, while in the control chamber the drop on f remains perfectly clear. In order to avoid any possible error of a technical nature this experiment is repeated by exchanging the chambers, now using chamber B for the respiratory chamber and the other A as a control.

(b) **For Comparative Estimation of CO_2 from Two Different Samples.** — By repeated quantitative experiments, it was found that the speed with which the first precipitate appears and the sizes of the deposits on the drops at d and f represent corresponding quantities of carbon dioxide. Thus with remarkably simple means, we can determine simultaneously the comparative outputs of the gas from two different tissues or from the same tissues under different conditions. The method of procedure is best illustrated by the following example. Two pieces of the sciatic nerve are isolated from the same frog and exactly weighed. One piece is laid on one glass plate, and the other

¹¹ This, too, can be cleaned and dried without being taken apart. See footnote on p. 138.

on the other plate in such a way that one part of the nerve lies across the electrodes of the glass plates as shown in Fig. 1, page 120. In this way, when the plates are hung on the electrodes *n* and *m*, any desired nerve can be stimulated with the induction current. These plates are now hung on the electrodes in each chamber, and the usual procedure is followed for the cleaning and the washing of the apparatus to make it CO_2 free. After the connection between the two chambers is closed by means of stop-cock *L*, the nerve in chamber *A* is stimulated by the current. Then if one can watch over the surfaces of the drops carefully from the start, he finds the first deposit of the carbonate on cup *d* of chamber *A* in which the stimulated nerve is placed. Later, the total amount of the precipitates grows much larger in the case of this cup. This increased output of the carbon dioxide from the stimulated nerve, thus observed, can be duplicated by repeating the similar experiment, after exchanging the chambers, as usual. This comparative estimation can be more accurately made by exact quantitative measurement, the method for which the following will illustrate.

(c) **For Quantitative Measurement of Gas.**—The detailed method is exactly analogous to that of apparatus 1. Here we use chamber *B* as the respiratory chamber and *A* as the analytic chamber. Barium hydroxide should be introduced into chamber *A* only at *d*, and the stop-cock *F* is always closed except at the time of washing. The pressure should be adjusted by mercury burette *T*, or by the potash bulb of the nitrometer. In case the mercury burette is used, the remaining volume in the respiratory chamber should be recorded.¹² The introduction of a known amount of gas from the respiratory chamber *B* to the analytic chamber *A* is accomplished by withdrawing the mercury from *C* into a very narrow graduated cylinder, while the stop-cocks *L*, *G* and *H* are opened. After a quick adjustment of the mercury burette to equalize the pressure, the stop-cock *L* is closed and the presence of carbonate is looked for exactly in the same manner as described in connection with the other apparatus, determining the minimum volume that gives the precipitate for the known mass of tissue for a known time.

¹² The bulbs are marked at the point where their capacity became 15 c. c. by introducing mercury. The variation of capacity can easily be read by noting the mercury burette.

In summarizing, I may emphasize the following points:

1. Particular care must be taken to test the air-tightness of the apparatus.
2. Purifying the air must be done with greatest care, as this is essential.
3. The apparatus must be perfectly dry.
4. A weak suction pump cannot be compensated by frequency of washing.
5. As long as the ratio between the c.c. taken from the chamber and the original volume of the chamber is needed, it is most important to have the pressure in A and B equal to the atmospheric. If this is accomplished we can neglect any caution against pressure and temperature variations — a correction which is always necessary for ordinary methods of analysis of exceedingly minute quantities of any gas.

In devising this method and in constructing this apparatus, I am under great obligation to Professors McCoy and A. P. Mathews and to Dr. F. C. Koch.

In order to test the accuracy with which an estimate of concentration of carbon dioxide could be made, many determinations were carried out with samples of air which contained accurately known concentrations of carbon dioxide prepared by Dr. F. C. Koch. The experimenter did not learn the concentrations of the samples until after the analysis had been completed. In making up the test samples, pure carbon dioxide, made by heating sodium bicarbonate was diluted with the carbon dioxide free air several times in succession, as illustrated by the following example: 5.5 c.c. of pure carbon dioxide was diluted to 52.0 c.c. over mercury and thoroughly mixed; 5.5 c.c. of the first mixture was diluted to 52.0 c.c.; 1.1 c.c. of the second was diluted to 50.7 c.c.; of this third mixture 5.6 c.c. was received from Dr. Koch. I diluted this a fourth time to 255.6 c.c. to form a mixture to be analyzed. The following observations were made: 0.5 c.c. was introduced into the apparatus and produced no precipitate in ten minutes; 0.5 c.c. more of the same sample, gave no precipitation in another interval of ten minutes; 0.5 c.c. more, a total of 1.5 c.c., was run into the bulb. In six minutes the first evidence of a precipitate appeared on the surface of the drop at d of apparatus 2 and in eight minutes was well developed. Since

the amount of carbon dioxide required to give the precipitate is 1.0×10^{-7} grams, this amount is contained in 1.5 c.c. of the sample or 1 c.c. contained 6.7×10^{-8} grams of carbon dioxide. The amount of carbon dioxide actually contained in the sample was

$$\frac{5.5 \times 5.5 \times 7.1 \times 5.6}{52 \times 52 \times 50.7 \times 255.6} \text{ c.c.} = 6.2 \times 10^{-8} \text{ grams.}$$

In six such determinations, all made with samples the concentration of which were unknown to the experimenter at the time of the analysis, the results given in the following table were obtained:

Volume of sample required to give a precipitate	Weight of carbon dioxide in one c.c.	
	Found	Taken
1.0 c.c.	1.0×10^{-7} g.	0.92×10^{-7} g.
.5 c.c.	$2. \times 10^{-7}$ g.	2.3×10^{-7} g.
.55 c.c.	1.82×10^{-7} g.	1.83×10^{-7} g.
1.5 c.c.	$.67 \times 10^{-7}$ g.	0.62×10^{-7} g.
2.25 c.c.	$.45 \times 10^{-7}$ g.	0.45×10^{-7} g.

STUDIES ON THE PHYSICAL PROPERTIES OF PROTOPLASM

I. THE PHYSICAL PROPERTIES OF THE PROTOPLASM OF CERTAIN ANIMAL AND PLANT CELLS

By G. L. KITE

[From the Hull Laboratories of Biochemistry and Pharmacology, University of Chicago]

INTRODUCTION

ALTHOUGH the living substance of animal and plant cells was correctly interpreted by Dujardin and von Mohl in the second quarter of the nineteenth century, almost nothing is definitely known of the physical state of protoplasm. Properties described by such adjectives as glutinous, slimy and hyaline were recognized by the early microscopists, who were forced to study living cells and tissues.

During the last fifty years an extensive literature has grown up on the subject of the structure of protoplasm. For the purposes of this paper, these investigations may be divided into two groups. The first group comprises those studies on the structure of protoplasm, made with the aid of fixatives. A large part of our knowledge of the morphology of the cells and tissues of animals and plants is the direct result of the development of fixing methods.

The errors involved in the attempts to determine the true molar structure of protoplasm by the use of fixing reagents have been pointed out particularly by Flemming,¹ Berthold,² Schwarz,³ Fischer,⁴ and Hardy.⁵ In this connection, it will suffice to state that Hardy's conclusion that fixing reagents always cause structural changes in pro-

¹ FLEMMING: *Zellsubstanz, Kern und Zelltheilung*, 1882, Leipzig.

² BERTHOLD: *Studien über Protoplasmamechanik*, 1886, Leipzig.

³ SCHWARZ: *Cohn's Beiträge zur Biologie der Pflanzen*, 1887, v, p. 1.

⁴ FISCHER: *Archiv für Entwicklungsmechanik*, 1901, xiii, p. 1.

⁵ HARDY: *Journal of physiology*, 1899, xxiv, p. 158.

toplasm that are frequently very different from the normal living substance, has never been refuted. Hence, at least, it does not seem that more than an approximation of the actual structure of protoplasm can be attained by the use of fixatives. Besides, this method is worthless as a means of investigating the physics of protoplasm.

The papers that fall in the second group deal with the study of living cells. Strassburger,⁶ Wilson,⁷ Foot and Strobell,⁸ Lundegardh⁹ and others have shown that many of the structural elements of the mitotic figure can be seen in living animal and plant cells. Numerous investigators have pointed out the presence of granules, vacuoles, and fibrils in various types of unfixed cells; but for the most part, the studies on living cells have been made for the purpose of decreasing the error due to the use of fixing reagents.

All such investigations are open to several sources of error. Hardy¹⁰ writes that the process of dying produces structural changes in the cell substance, since coagulation appears to occur in all dying cells. Many cells are certainly quickly asphyxiated when mounted for microscopical examination in the usual manner. I have been able to overcome, largely, this source of error, by the use of an open-end moist chamber, that does not appear to interfere with normal respiration.

A second source of error is due to the nature of the optical principles involved in microscopical vision. Many years since Abbé¹¹ demonstrated that the optical image is a diffraction pattern produced by the object and that under certain conditions the image may be quite different from the object. More recently, Porter,¹² experimenting under ordinary working conditions, has described a number of interesting examples of this sort. Porter¹² says, "Images were formed which were utterly false in their smaller details, and other images were profoundly modified by the presence of structure lying

⁶ STRASSBURGER: *Zellbildung und Zelltheilung*, Jena, 1880, iii. Auflage.

⁷ WILSON: *Journal of morphology*, 1899, xv, Suppl.

⁸ FOOT and STROBELL: *American journal of anatomy*, iv, p. 199.

⁹ LUNDEGARDH: *Jahrbücher für wissenschaftliche Botanik*, li, p. 236.

¹⁰ HARDY: *Journal of physiology*, 1899, xxiv, p. 158.

¹¹ ABBÉ: *Archiv für mikroskopische Anatomie*, 1874, ix, p. 413; *Gesammelte Abhandlungen*, 1904, i, p. 45.

¹² PORTER: *Philosophical magazine*, 1906, ii, p. 154.

entirely beyond the focal plane." Such facts should serve to make it evident that one can easily fall into error in interpreting the optical image of a living cell. Porter¹² recommends "a working knowledge of the phenomena and laws of diffraction," as a safeguard against this form of error.

The third and by far the most important source of error is due to the peculiar and little known optical properties of living matter. The phenomena of reflection, refraction, absorption, dispersion, interference, diffraction¹³ and a scattering action on light¹⁴ are all exhibited by this substance, with the result that a correct interpretation of the image of a living cell is frequently impossible. Furthermore, many cells are so opaque and turbid that the interior is not visible. Cloudiness or turbidity is almost a universal property of protoplasm and appears to be due chiefly to dispersion, refraction, diffraction, and the scattering action on light of the colloidal particles which may be considered as the real structural units of all protoplasm.

Globules, granules and cell walls frequently show diffraction halos that are difficult to interpret in undissected cells.

The aim of this investigation is to determine the physical state and the molar structure of protoplasm. The methods are radically different from those heretofore used, and are believed to be adequate for this purpose. Dissection and vital staining are used to determine the truthfulness of the optical image and the actual structure of cells. Unfortunately, the amount of the error involved in the employment of these methods depends entirely on the skill of the experimenter; but it is believed that the error becomes quite small with complete mastery of the methods.

The structural changes that cells may undergo during the time

¹³ Excellent expositions of the principles of physical optics are given by: WOOD, R. W: 1911, *Physical Optics*; DRUDE, P.: 1912, *Lehrbuch der Optik*; PRESTON: 1901, *Theory of Light*.

¹⁴ Lord Rayleigh (*Philosophical magazine*, xli, p. 107) has pointed out that reflection and refraction have no application unless the surface of the disturbing body is larger than many square wave-lengths. The turbidity of protoplasmic sols, then, is due entirely to the scattering action on light of the minute aggregates of the disperse phase, while reflection, refraction, diffraction, dispersion and a scattering action on light are all seemingly involved in the production of turbidity by gels.

required for their dissection is a possible source of error that may appear, at first sight, to be very difficult to control. Certainly many biologists hold the view that cells rapidly undergo important morphological changes following mechanical injury. With few exceptions it has not been found difficult to follow the structural changes that occur in cells that are being dissected; but the really remarkable fact is the marked slowness of such death changes as granulation, fragmentation and general coagulation, following mechanical injury.

It seems best to limit this introductory paper to a description of selected types of widely different cells and in future publications to treat systematically, selected types of the principal phyla of animals and the chief groups of plants.

The special literature bearing on this investigation will be discussed in subsequent papers.

A review of such well-known theories as those of Bütschli, Flemming and Altmann lies outside the province of this paper.

METHODS AND MATERIAL

The development of a really adequate method for the dissection of living cells, under the highest powers of the microscope, has made possible this study. The principles of this method are simple. The dissecting instrument is a glass needle that may measure less than one micron in diameter and is drawn on the end of a piece of special Jena glass tubing about 200 mm. long and 4 mm. in diameter. The needle is held in a three-movement Barber pipette holder. The cell chosen for dissection is mounted in a hanging drop in an open-end moist chamber and held in place by water-glass surface tension, which can be varied at will.

Both diffuse sunlight and artificial light are used as sources of illumination. For the latter a Nernst Glower has been found satisfactory, but all the light waves outside of 450 and 670 $\mu\mu$ are cut out by the use of appropriate ray screens. The same means is used to remove enough of the orange and red rays to make the transmitted light perfectly white. Such light is composed of the waves that are least injurious to living cells. A special condenser¹⁵ of a focal dis-

¹⁵ The condenser was made by E. Leitz & Co., Wetzlar.

stance of about 20 mm., a 2 mm. apochromatic objective, compensating oculars, and a number of vital stains, are necessary additions.

An open-end moist chamber 25 x 60 x 15 mm. has been found satisfactory. The bottom is separated into three compartments by very small glass rods and water is placed in the end compartments. If water be put in the middle compartment it may decrease the efficiency of the condenser. The chamber is held in a mechanical stage and most of the dissections are made by quick movements of the chamber and therefore of the cell being dissected, the needle remaining fixed.

The use of acetylene which can be burned in a glass micro-burner has greatly simplified the making of extremely fine needles. An acetylene flame that is so small that it is invisible in a well-lighted room can be kept alive.

The more important of the vital stains used include methylene blue, new methylene blue N (Cassella Color Co.), new methylene blue GG (Cassella Color Co.), new methylene blue R (Cassella Color Co.), janus green (Metz & Co.), pyronin (Grübler), vusuvín (Grübler), toluidin blue (Grübler), neutral red (Grübler).

The chief structural components of a cell can usually be quickly brought out by using a large enough number of vital stains, thus effecting a great economy of time, when the dissection of the unstained cell is made.

Barber's¹⁶ isolation and intracellular injection methods, variously modified, are frequently employed to supplement and control the data obtained by dissection.

Nomenclature Employed. — The current nomenclature of descriptive physics, physical optics and colloidal chemistry will be employed. Such physical properties as solidity, tenacity, elasticity, hardness and viscosity have been determined for the cells, so far studied. In general, the term viscosity will be used to designate the degree of rigidity of protoplasmic structures, but such a structure as a vitelline membrane may be comparatively soft and yet have what must be considered as a high internal friction or viscosity. Elasticity is determined by transfixing a selected piece of a cell and stretching it and observing the power of resumption of the original form. Dis-

¹⁶ BARBER: University of Kansas Science Bulletin, 1907, iv, p. 3; Journal of infectious diseases, 1911, viii, p. 248; *ibid.*, 1911, ix, p. 117.

section is the method employed for determining such properties as solidity, hardness and tenacity or cohesiveness. All physical properties that have been enumerated are relative and it is hoped at a later time to increase the accuracy of description by the selection of arbitrary standards. The usage of the terms employed in this paper is based on the dissection of many widely different types of animal and plant cells.

Living matter occupies an intermediate position between true solids and true liquids and has many of the properties of both as well as properties peculiar to itself. It belongs to the class of colloids known as emulsoids and exists in either a gel (hydrogel) or a sol (hydrosol) state.¹⁷ The term gel will be used to designate the amorphous semi-solid state and sol the apparently homogeneous liquid state, of living substance. Protoplasmic sols usually appear as hazy homogeneous liquids on account of the very minute size of the protein aggregates that compose the solid phase. On the other hand protoplasmic gels are characterized by the large size of the particles of the solid phase which set to form the gel. Hence, living gels may exhibit either a homogeneous or heterogeneous molar structure.

It should now be clear that the term homogeneous is used in a relative sense to describe the optical image and refers only to the molar structure that can be brought out by the usual microscopical powers and further that heterogeneity is the universal distinguishing characteristic of colloidal sols and gels. In this connection it may be noted that Pauli¹⁸ states that the "unfixed" gel of gelatine is not structured in the sense of being composed of threads, networks, granules and vacuoles; it has the molar structure of a one-phase system, which is precisely what is meant by the term homogeneous as used in this paper; the molecular structure is unknown. The present unsettled state of the problem of phase relations of colloidal

¹⁷ For discussion of the classification of colloids see: NOYES, A: 1905, *Journal of the American Chemical Society*, 1905, xxvii, p. 85; OSTWALD, WO.: 1907, *Zeitschrift für Chemie und Industrie der Kolloide*, 1907, i, p. 291; PERRIN, J.: 1905, *Journal de la chimie physique*, iii, p. 50; FREUNDLICH and NEUMANN, 1908, *Kolloid Zeitschrift* iii, p. 80; VON WEIMARN, P. P.: *ibid.*, 1908, iii, p. 26.

¹⁸ PAULI: *Der Kolloidale Zustand und die Vorgänge in der lebendigen Substanz*, Braunschweig, 1902.

solutions has been ably discussed in a recent paper by Hardy.¹⁹ It is usual to regard colloidal systems as consisting of two phases, a solid and a liquid, which have been termed by Wo. Ostwald²⁰ the disperse phase and the dispersion medium, respectively.

For convenience of description arbitrary meanings will be given the terms microsome and globule; the former will be restricted to minute dense masses of gel, the latter to suspensions in protoplasm that show many of the physical properties of oil droplets and besides are usually free of protoplasm when dissected out of a cell. Most of the suspensions so far found in cells fall into one or the other of these groups, but intermediate forms have been observed.

THE EGG OF ASTERIAS

The egg of *Asterias* is surrounded by a mass of either transparent or translucent jelly which is soft and somewhat elastic and glutinous; but it can be cut and torn to pieces and removed from the egg with little difficulty. Thirty-four and six-tenths microns is the average thickness of this jelly. This structure has a low viscosity for a gel and is therefore extremely dilute. On many eggs, the jelly has become turbid and undergone a change in refractive power and as a result is visible in the usual microscopical examination. The inner surface of the jelly envelope is closely applied to the outer surface of the vitelline membrane which is invisible except in eggs that have matured. The vitelline membrane of the immature starfish egg is a transparent and invisible solid of about two microns in thickness. The physical properties of this structure are very definite since it exhibits extraordinarily high viscosity, elasticity and tenacity. A small piece can be drawn out into a mere thread and when freed the thread contracts to a more or less rounded mass. During maturation the vitelline membrane swells to two and three times its original thickness, undergoes a change in refractive index, and becomes quite cloudy and hence visible. In this state it is softer, more glutinous and less rigid. The inner surface of this

¹⁹ HARDY: Proceedings of the Royal Society, Series A, 1912, lxxxvi, p. 601.

²⁰ OSTWALD: Zeitschrift für chemie und Industrie der Kolloide, 1907, i, p. 291.

membrane is tightly glued to the surface of the cytoplasm, from which it can be dissected only with considerable difficulty.

The misleading optical phenomena that are involved in a study of the cytoplasm are of great interest.

It is usual for cytologists to consider the echinoderm egg a classical example of the alveolar structure of protoplasm. No one can question the fact that beautiful round spaces with hazy, protoplasmic walls in which are embedded minute granules, can be seen in such eggs. Bütschli supposed these spaces to be filled with a watery fluid.

What is the true structure of the cytoplasm of the egg of *Asterias*? Careful dissections give a clear-cut answer to this question.

The cytoplasm is a quiet translucent gel of comparatively high viscosity; it can be drawn out into large strands, but is not cohesive and elastic enough to form small threads. It can be cut into small pieces with comparative ease. Fragments usually become spherical, though in some cases water is slowly taken up and the mass changes into the sol state. Minute granules measuring little more than one micron are scattered plentifully throughout the cytoplasmic gel. It has been found impossible to free these structures completely from the gel in which they are embedded. They are optically more dense and have a different refractive index from the surrounding living substance. A part of the total mass of cytoplasm is composed of what appears to be alveoli or spaces; but a careful dissection of such an alveolus reveals the presence of a globule that has many of the optical properties of an oil drop. Such a globule, freed from cytoplasm, does not dissolve in sea water and in a light of low intensity exhibits the usual diffraction halo. The invisibility of liquid droplets of rather high viscosity when embedded in the cytoplasm might at first sight appear difficult to explain. This invisibility is due to the fact that the refractive index and dispersive power of the globules is very near that of sea water; also, the optical density of the cytoplasm is evidently higher than that of the globule. No diffraction rings could be seen surrounding the globules when they were imbedded in cytoplasm. Centrifugal force dislodges the globules, proving them to be merely suspended in a living gel. The minute granules respond much less readily to centrifugal force. Besides they show optical properties — their index of refraction is certainly higher than that of the surrounding gel — that ally them to highly concentrated particles

of the cytoplasmic gel. Yet it seems likely that all such structures as granules and globules must be considered as having separated out of the disperse phase and to be therefore of the nature of suspensions. The living cytoplasm, then, is an apparently homogeneous and very viscous gel in which microsomes and globules are suspended.

If the nucleus of the immature starfish egg be dissected out in sea water it undergoes no appreciable change. Dissection of the highly-translucent nuclear membrane shows this structure to be a very tough viscous solid, and, in fact, closely allied physically to the vitelline membrane and not at all the delicate structure of the conventional descriptions. With the exception of the nucleolus, the nuclear substance is all in the sol state. The nuclear sol is apparently a homogeneous liquid. The nucleolus is a small mass of quite rigid and cohesive granular gel that is suspended in the nuclear sol.

The polar body is a granular, elastic and highly viscous gel.

In order to make it possible to observe the structural components of the starfish egg and of the eggs of other common marine invertebrates, without having to use my tedious methods, vital staining was resorted to. The jelly envelope can be stained a beautiful light blue with dimethyl-safranin-azo-dimethyl-anilin; the vitelline membrane a very dark blue with isamin blue; the globules or droplets from yellow to orange with vusuvin; and the extremely small granules a slate blue with diethyl-safranin-azo-dimethyl-anilin.

The dead or dying asterias egg shows remarkable morphological changes. The whole egg becomes almost opaque. The cytoplasm separates into a large number of more or less rounded masses which still adhere to each other. Such masses vary greatly in size, some being as small as five microns in diameter. If the formation of such small masses be observed, one is easily misled into believing that fusion of the globules is occurring. Dissection of such a mass frees the original globules. The dead gel does not stick to a glass needle and can no longer be drawn out into strands; it has lost much of its viscosity and cohesiveness. The nuclear fluid has set and the resulting gel is more voluminous than was the nuclear fluid in the living egg. The nuclear membrane shows little change in its physical properties, while the nuclear gel is elastic and quite viscous and granular. The physical properties of the dead nuclear gel are very similar to those

exhibited by the living cytoplasm. Small fragments of the dead nuclear gel do not go into solution when dissected out in sea water.

AMEBA PROTEUS

Small pieces of ectoplasm of proteus can be cut off in distilled water and show no change. This living substance has a moderately high viscosity and cohesiveness; it does not stick to glass needles very readily and little difficulty is experienced in cutting it into pieces as small as the limit of microscopical visibility. Pieces of all sizes appear perfectly homogeneous. The cloudiness of the ectoplasmic gel is a well-known property. The inner three or four microns of the hyaline ectoplasm and particularly the interior of the outer end of small pseudopods, contain varying numbers of minute granules and globules that may measure as much as four or five microns. If these granules and globules are dissected out they do not go into solution. The globules show confusing diffraction rings; but, both globules and granules can be brought out by light staining with diethyl-safranin-azo-dimethyl-anilin. The endoplasm contains a large contractile vacuole in which the presence of protein has not been demonstrated, as yet, and numerous food vacuoles which contain either liquid or liquid and food masses. The same kind of granules and globules are found in the endoplasm as are found in the ectoplasm and the number of these structures varies in different animals. The substance forming the walls of the vacuoles is of much higher viscosity and cohesiveness. The living endoplasmic substance is a very dilute and apparently homogeneous gel that possesses a remarkable affinity for water. The ectoplasm of ameba then is a quite concentrated gel while the interior is quite dilute and is continuously changing its water-holding power in different regions. New methylene blue R and trypan blue are of great value in bringing out the globules, granules and vacuoles.

The nuclear membrane is an extremely thin and moderately tough solid substance. It shows some elasticity and is quite viscous.

The whole of the nuclear substance is a highly rigid and granular gel, the minutest pieces of which show no appreciable change when dissected out in distilled water. A slight elasticity and a definite

glutinicities are exhibited by this substance. There are variations in concentration of the nuclear gel that produce a characteristic but misleading optical image. The nucleus appears to contain an irregular network with granules imbedded in it. The interstices of the network are very small luminous spots which have been misinterpreted to be vacuoles. Many dissections have shown that the granules are very concentrated masses of gel; the network irregularly disposed masses of a diluter gel; and the interstices or light spots the most dilute gel in the nucleus. The so-called network is a part of the nuclear gel that forms a concentration gradient; the interstices and granules may be considered constants connected by the grading network. It should be clearly understood that the network is not made up of definite threads of fibres but of irregular masses of hydrogel that are very dense immediately surrounding the granules, from which they grade into the dilute gel of the interstices. No free liquid was found in the nuclear substance.

When the granules are in focus they appear gray and cloudy or opalescent; when out of focus as dark spots. They measure from less than one to about two microns in diameter.

It seems that a part of the luminosity of the interstices of the network is due to diffraction and not simply to slight absorption of light by this portion of the nuclear substance.

The structural details of the nucleus can be brought out with considerable vividness by staining with janus green (diethyl-safran—in azo-dimethyl-anilin).

Slight cuts in the surface of proteus quickly close. Extensive cuts frequently cause an ameba to explode—in as short a time as two seconds nothing but the nucleus may remain. If the contractile vacuole be cut and its liquid content caused to mix with the cytoplasm the Ameba is immediately destroyed with explosive violence. A relatively large dose of distilled water and even $\frac{1}{2}$ to 1 molar cane sugar solution or one molar sodium chloride or potassium nitrate give a like result. It is not usually possible to produce more than a temporary vacuole with two molar cane sugar; a large dose of sugar of this concentration usually causes the appearance of granules, globules, fibrils and a hyaline appearance in any portion of the endoplasm into which the injection is made. The doses that were injected varied from about 270 cubic microns to 30,000 cubic microns.

A large number of indicators have been injected into the interior of proteus with the idea of determining a possible relation between an excess of H^+ or OH^- ions and the extraordinary water-holding-power of the endoplasm. Azolitmin, sodium alizarin sulphonate, tropeolin 000 No. 1, methyl orange and congo red, dissolved in from $\frac{1}{2}$ to $\frac{3}{4}$ molar cane sugar have been so far employed. A neutral to slightly alkaline reaction is shown by all the indicators. It seems probable then that the concomitant variation in water-holding-power of different regions of the cytoplasm is the mechanism by which *Ameba proteus* moves and is associated with an excess of OH^- ions.

A number of operations were performed on the ectoplasm of *Ameba proteus* for the purpose of determining the relation between movement and surface tension changes. The results of shallow and deep cuts in the ectoplasm have already been given. The outer 5 to 7 microns of the pseudopods were cut away in some animals, and in others small doses of distilled water were injected into the ectoplasm. The removal of the outer end of a pseudopod was usually followed by rapid closure of the incision. The injection of distilled water into the ectoplasm had no noticeable effect on the formation of pseudopods. By means of such operations the rigid ectoplasm was either removed, for a short time, from a given area of the surface or at least greatly weakened; yet, no tendency to the formation of pseudopods was ever observed, in such weakened surface areas. These facts seem to justify the conclusion that surface-tension changes play a negligible rôle in the movement of *Ameba proteus*. Furthermore, it may be recalled, that the outer surface of *Ameba proteus* is a semi-rigid solid of from 5 to 12 or more microns in thickness, and it has still to be shown, that the changes, in the tension of the surface film, that are commonly assumed to occur, can appreciably affect the underlying semi-rigid ectoplasm.

The nutrient solution in which the amebae were grown was slightly alkaline in reaction.

Proteus usually recovers from the large doses of neutral salts and sugar in much less than an hour, almost certainly by throwing them off.

PARAMECIUM

The living substance of Paramecium is a soft, elastic and somewhat glutinous gel which can be drawn out into strands. It is filled with a large number of vacuoles of various sizes the walls of which are more dense than the surrounding gel. The surface layer is more viscous and cohesive than the interior. Small cuts usually close quickly, extensive deep cuts are either followed by a loss of cytoplasm or a rapid change of the whole cytoplasm into the sol state with almost explosive violence. If the fluid in the contractile vacuole be caused to mix with the cytoplasm a rapid change of this substance into the sol state results. Suspended in the living and apparently homogeneous and rather dilute gel are varying numbers of extremely small granules and small globules. Many of the granules are recently ingested bacteria. Neither the granules nor globules go into solution when dissected free from the cytoplasm. The food masses are granular gels of rather high viscosity.

The optical properties of the meganucleus render its study extremely tedious. It is almost transparent and invisible. Therefore its refractive index and its dispersion are very close to those of water. Dissection has proved the meganucleus to be a gel of higher viscosity than the cytoplasm and to be slightly glutinous and elastic. The meganuclear gel has areas, more dense than the surrounding substance, that may be considered granules.

A complete study of the micronucleus has not been made.

NECTURUS

The Striped Muscle Cell. — The living substance of the striped muscle cell of Necturus is the most viscous, elastic and cohesive of the living gels we have so far considered. The muscle substance sticks to a glass needle and can be drawn out into extraordinarily long threads which when released almost regain their previous shape. The absorptive power and turbidity of this substance are comparatively high.

When the whole or a piece of a muscle cell is stretched the striations become faint or disappear — only to reappear when the tension

is removed. Beautiful but misleading diffraction phenomena are to be observed when a piece of muscle cell is stretched. If the point of a very minute needle be pushed into a muscle cell, it can be moved in one direction about as easily as another.

The optical image of striped muscle is very misleading. Dissections have shown that the dark bands seen in living muscle are produced by concentrated areas of muscle substance which absorb enough transmitted light of low intensity to appear as dark bands in the optical image. I have been unable to dissect out definite fibrils. The substance lying between the concentrated regions and appearing as light bands is a highly viscous, elastic gel and has no physical properties that serve to distinguish it from the surrounding sarco-plasmic gel. By cutting the dark band to pieces, small masses of highly concentrated muscle substance, frequently less than one micron in diameter, are partially freed from the dilute enveloping gel and in light of low intensity show well-defined diffraction halos. The appearance of dark bands in the optical image, then, is produced by absorption of light waves by the concentrated muscle substance; the light bands, by the low absorptive power of the diluter intermediate gel, and the diffraction of the light waves by the edges of the concentrated substance. Striking changes in the optical image that are well known can be produced by increasing the intensity of illumination. The dark band becomes cloudy and more or less opalescent and the light band may show an intersecting dark line or well-defined diffraction fringes just outside the geometrical shadow of the concentrated substance. Hence, absorption, diffraction, refraction and dispersion are involved in the formation of the optical image of striped muscle and the former two particularly when the illumination is of a relatively high intensity.

The nuclear substance is a gel that is for the most part comparatively dilute but contains more concentrated areas in the form of granules and an imperfect network. The appearance of a network in the optical image is due not to definite fibrils but to more concentrated parts of the gel that grade into the diluter nuclear substance.

On the outer surface of the muscle cell is found a highly translucent membrane, the sarcolemma, which is extremely elastic and measures about one micron in thickness. It is stuck to the whole outer surface of the muscle cell and is viscous and cohesive enough

to offer an appreciable resistance to a glass needle a micron or less in diameter. The disagreement among investigators concerning the presence of a sarcolemma is due to the fact that it is transparent and that its refractive and dispersive powers are so nearly the same as those of water. Instead of being the delicate structure of the conventional descriptions, the sarcolemma of the striped muscle cell of *Necturus* exhibit physical properties that are very similar to those of the vitelline membrane of an echinoderm egg.

If a concentrated solution of isamin blue made by boiling in distilled water or .8 per cent sodium chloride be added to freshly teased muscle cells, blue staining of the sarcolemma occurs in ten to fifteen minutes.

An Epidermal Cell.—The epidermal cells are embedded in an intercellular gel of extremely high viscosity and considerable elasticity. The substance is tough but softer than many nuclear membranes and shows a relatively high absorptive power. It is also quite turbid. A few globules and granules, varying in size from about one to four microns, that can be easily stained with diethyl-safranin-azo-dimethyl-anilin are to be seen scattered through the intercellular gel.

The whole cell substance is a gel of even higher rigidity than the muscle substance of the same animal. Small pieces cut out of the nucleus or cytoplasm, in distilled water or .8 per cent sodium chloride, show no appreciable change.

The cytoplasm exhibits a high absorptive power and a definite elasticity. Very small granules that seem to be denser cytoplasmic areas are to be seen scattered throughout the turbid cytoplasm. Many cells show radially arranged fibrils, in the outer part of the cytoplasm, which can be partially freed from the surrounding gel by dissection. Such a fibril is physically and optically more dense than the remainder of the cytoplasm.

The nuclear membrane is thin, clear, and quite cohesive and elastic, and has a different index of refraction from the cytoplasm and nucleus.

The nuclear gel is of a higher viscosity than the cytoplasm. The appearance of a network in the optical image of the nucleus is due to concentrated areas in the form of granules and imperfect threads which are not sharply separated from, but grade into, the surrounding diluter

gel. The whole nuclear substance is quite glutinous. No trace of free liquid could be found in the nucleus.

SPIROGYRA

The cellulose wall of Spirogyra is enormously cohesive; it is cut or punctured with extremely fine Jena glass needles with considerable difficulty. The outer surface is covered by an almost invisible soft gel, that frequently measures five or more microns in thickness and can be stained red with sodium alizarin sulphonate in a neutral or slightly alkaline solution. A layer of dilute granular gel covers the inner surface of the cellulose wall and is connected by a number of strands of an elastic gel to a central mass of living substance, in which a small nucleus is imbedded. The central mass of gel contains a few granules and is of a higher viscosity and cohesiveness than the surface cytoplasm. This mass also has a higher refractive index and higher absorptive power than the surface cytoplasm. The anchoring strands of gel decrease in viscosity from within outwards. Much of the surface layer of cytoplasm is usually invisible. Hence, it is quite translucent and has refractive and dispersive powers very close to those of water. If the cell wall is cut across the surface cytoplasm shrinks. The chloroplasts either shrink or separate into rounded masses. The chloroplasts have a higher viscosity and elasticity than the gel in which they are imbedded.

The pyrenoid is a complex structure. Dissection shows the presence of an optically dense but fragile wall which, when broken, frees a globule that is of considerable interest. This globule shows many of the optical properties of an oil droplet but has too high a viscosity to round up under the influence of surface tension; therefore it seems to be a true gel.

None of the cytoplasm goes into solution very readily even when cut into very minute pieces.

The nucleus of Spirogyra is a gel that has higher viscosity and refractive and absorptive powers than the cytoplasm. It is also more cloudy than the cytoplasm. There are denser areas in the nuclear substance in the form of granules and threads that form a sort of network. Small pieces dissected from all parts of the nucleus

into water, not only do not go into the sol state but remain too rigid to show surface tension effects. Pieces of broken glass needles stick firmly to the nuclear gel when imbedded in it. The image of the nucleus is false in important details. The denser areas, when in the focal plane, appear as grayish or slightly opalescent granules and threads and when above or below the focal plane as dark spots and lines. Besides, if the intensity of the illumination be increased the network appears much finer. Very small dense masses of gel could be partly freed from the remaining nuclear substance. It seems proper to term such structures granules. On the other hand, the dense masses that produce the appearance of a network in the image are not actual threads that are sharply separated from the surrounding gel but irregularly shaped dense areas that grade into the immediately contiguous diluter gel. The light spots that change their position at different focal planes seem to be due chiefly to two factors, viz., a relatively low absorptive power of the gel occupying the interstices of the network and diffraction by the edges of the denser areas.

It seems certain that the vacuolar fluid of *Spirogyra* contains protein and must be considered a hydrosol. Much evidence has been adduced in support of this statement. A number of injections of Millon's fluid into the vacuole were made with positive results. Extremely small solid particles appeared in the cell sap after the injection of such precipitating agents for proteins, as saturated sublimate, 40 per cent formaldehyde, saturated picric acid and saturated phosphotungstic acid containing 5 per cent sulphuric acid.

The vacuolar fluid is cloudy. This is positive proof of the presence of ultramicroscopic particles which would ordinarily be considered protein even in the absence of a positive color test for protein.

The cell sap of *Chara* seems to be richer in protein than that of *Spirogyra*. This conclusion is based on the fact that a comparatively heavy precipitate results from the intravacuolar injection of saturated sublimate or 40 per cent formaldehyde. Hence, it is probable that cell sap containing protein is very common in plants.

Mucor, *Saprolegnia*, *Hydrodictyon*, *Chara* and the parenchymatous cells of the leaves of *Tradescantia* have been dissected for comparison with animal cells. In general, it may be stated that the cellulose walls of plants are extremely cohesive and are cut and punctured

with considerable difficulty. The protoplasm of plant cells is much more dilute or less rigid than that of animal cells.

RESTING AND DIVIDING MALE GERM CELLS OF THE SQUASH
BUG (*ANASA*). GRASSHOPPERS AND CRICKETS

A brief note has been published on this subject.²¹

The whole cell substance of resting and dividing spermatogonia and spermatocytes is a moderately viscous gel. Cutting away pieces of the cytoplasm and nucleus in Ringer's fluid shows that these structures are far too rigid to flow or change shape under such experimental treatment. The appearance of a network is due to denser masses of nuclear gel that grade into the diluter surrounding substance. No definite threads or fibrils could be dissected out of resting nuclei. Some of the optical principles involved in a study of the living nuclei of spermatogonia and spermatocytes were discussed in connection with the nucleus of proteus.

Very definite statements can be made about the physical properties of chromosomes and spindle fibres. The chromosome has been found to be the most highly concentrated and rigid part of the nuclear gel. Such a mass of gel is less translucent and has a higher refractive index and absorptive power than the diluter homogeneous gel in which it is imbedded. A chromosome when dissected out shows no affinity for water and does not disintegrate readily. Pieces of it stick to the glass dissecting needle but when drawn out show no marked elasticity. The spindle fibre is an elastic concentrated thread of nuclear gel and its absorptive power and refractive index are also different from those of the diluter gel in which the spindle fibre is imbedded and from which it cannot be entirely freed. Metaphase spindle fibres that were dissected out with great care seemed continuous with the ends of the chromosomes. The homogeneous gel in which a telophase spindle is imbedded is so rigid, that all the surrounding cytoplasm can be cut away and the spindle and chromosomes show no appreciable change; metaphase, anaphase and telophase spindles can be cut to pieces in Ringer's fluid and the pieces are so rigid that they undergo no change in shape.

²¹ KITE and CHAMBERS: 1912, *Science*, N. S., xxxvi, p. 639.

Many of the physical and chemical changes of cell-division are reversible. Pressure on the cell plate of spermatocytes in telophase has caused rapid fusion of the daughter cells and extensive swelling and loss in rigidity of the protoplasmic gel in which the spindle fibres are imbedded. If the displaced spindle fibres and chromosomes are dissected out, after such a partial reversal, they are found to have undergone no appreciable change in rigidity.

From a preliminary study of mitosis, a few conclusions, that are probably general, can be drawn. It seems that cell-division results primarily from concomitant shrinking and swelling or change in water-holding power of different portions of the cell protoplasm. Many of the structural elements of the mitotic figure separate out of the protoplasm and change in rigidity according to their water-content. During the prophase, the nuclear substance becomes so soft that movement of the components of the nucleus is affected by flowing of the nuclear gel. The mechanism at the basis of this flowing seems to be a change in water-holding power of the nuclear components.

I wish here to thank Dr. A. P. Mathews for the very helpful interest that he has shown in this investigation.

125

THE
American Journal of Physiology

VOL. XXXII

JULY 1, 1913

NO. III

ON THE RELATION OF THE BLOOD SALTS TO
CARDIAC CONTRACTION

By E. G. MARTIN

[From the Laboratory of Physiology in the Harvard Medical School]

THE importance of the salts of the blood in maintaining the beat of the heart is established beyond question. The precise relation of individual salts in the series of reactions making up a heart-beat is still the subject of study. The problem of the action of salts cannot be attacked directly; too many factors are involved. Conclusions must be drawn, therefore, through comparison of data obtained from numerous more or less indirect experiments. The difficulties of interpretation under these conditions are necessarily very great, and workers have been led to form very diverse opinions from quite similar data.

Consider, for example, the question of the "inner stimulus," the actual excitant to the cardiac contraction. At least three distinct views as to its nature are at present before physiologists. Lingle,¹ correlating heart tissue with skeletal muscle tissue, adopts Loeb's view that sodium ions constitute the excitant. Langendorff² looks upon the metabolic products of the heart's own activity as the means

¹ LINGLE: this Journal, 1900, iv, p. 265.

² LANGENDORFF: Archiv für Anatomie und Physiologie, physiologische Abtheilung (Suppl. Band), 1884, p. 1.

of stimulation. Howell³ suggests that the origination of the beat is not dependent on any specific stimulus, but results from the spontaneous break down of the highly unstable substance whose decomposition yields the energy manifested in the contraction.

With regard to the rôle of individual salts there is a like difference of opinion. Thus, in respect to calcium, Lingle⁴ believes that this salt exerts its beneficial effect by antagonizing the poisonous action of sodium. S. R. Benedict⁵ attributes the improved beat which follows its use to the rise in tone which it brings about. Howell⁶ pictures the rôle of calcium in connection with the conversion of energy-liberating substance from a stable into an unstable, easily dissociable compound. From a study of the relation of the tissue to its oxygen supply I was led⁷ formerly to believe that calcium might have something to do with the oxidative activities of the heart substance.

Purpose of this Study. — My intention, in presenting the views herein contained, is not to advance any new theory of salt action, but to suggest a means whereby the divergent theories already current can be harmonized in a fashion that will offer satisfactory explanations of the various salt-phenomena thus far described, so, perhaps, simplifying the situation.

In studies of the action of salts on the heart the chief consideration hitherto has been the presence or absence of spontaneous rhythmicity. Solutions have been classified according as they favor or interfere with contraction. Series of beats have been examined to see whether the media used cause exhaustion or recovery. A somewhat different, and perhaps instructive point of view can be gained if attention is directed to the character of the individual contractions. The operation of the "all or none" law of cardiac activity makes the height of any contraction the index of the amount of energy-liberating material available for performing it. By observing the effect of various solutions on the height of contraction, therefore, conclusions

³ HOWELL: The Harvey Lecture. Journal of the American Medical Association, 1906, xlvi, No. 23.

⁴ LINGLE: *Loc. cit.*

⁵ BENEDICT: this Journal, 1905, xiii, p. 199.

⁶ HOWELL: *Loc. cit.*

⁷ MARTIN: this Journal, 1906, xvi, p. 214.

may be drawn as to the influence of the solutions on the elaboration of dissociable energy-yielding material within the tissue.⁸

Schultz⁹ has described another means of gaining information as to the effect of salts on heart tissue, namely by determining their influence on the time required after contraction for the excitability to electric stimuli to return to normal.

By the use of this criterion of Schultz and the one I suggest above, in connection with the older criteria, which are concerned primarily with the efficiency of media in causing beats, we should be able to differentiate, if there be any difference, between agencies concerned with the actual production of contractions and those having to do rather with the preliminary process of preparing dissociable material.

Is there a Specific, Inner Stimulus? — That the immediate process of contraction depends upon a definite inner stimulus, in mammalian hearts, at least, seems to be pretty clearly established by some recent observations of Cushny¹⁰. This author stimulated a spontaneously beating ventricle at a rate faster than its own, forcing it into an abnormally rapid rhythm. At the cessation of the artificial stimulation the ventricle showed a period of stand-still before resuming spontaneous activity. The significant observation of Cushny was that during this period of stand-still the heart was as sensitive as at other times to artificial stimulation. The stand-still was not due, therefore, to a loss of irritability, but to a failure of the inner stimulus; and the experiment demonstrates the existence of an inner stimulus quite independent of any particular condition of irritability. Hering¹¹ has also argued in favor of a specific inner stimulus. He cites various experiments in support of his view, but considers two observations particularly conclusive. The first of these is the reversal of rhythm sometimes seen in perfused mammalian hearts, whereby the auricles,

⁸ If the height of contraction is to be interpreted in this manner care must be used that the tissue under examination is contracting as a whole, and not in part only. The tendency of heart tissue under experimental conditions to show partial contractions is pointed out by Schultz. (*This Journal*, 1908, xxii, p. 134.) I have observed the same repeatedly. There is, however, little difficulty in distinguishing partial from complete contractions if one is on the lookout for them.

⁹ SCHULTZ: *this Journal*, 1908, xxii, p. 133.

¹⁰ CUSHNY: *Heart*, 1912, iii, p. 257.

¹¹ HERING: *Archiv für die gesammte Physiologie*, 1911, cxliii, p. 370, and 1912, cxlviii, p. 608.

instead of setting the pace, beat in response to stimuli from the spontaneously-beating ventricles. This, according to Hering, is an example of auricular irritability maintained in the absence of spontaneous activity. Hering's second significant observation is that in the dying heart the various parts become inactive, not together, but one after the other. This is interpreted as signifying that in this case loss of irritability precedes failure of the inner stimulus.

Although the existence of a definite inner stimulus seems, from Cushny's observations, to be satisfactorily established, the experiments of Hering do not appear particularly conclusive in support of it. The failure of the auricles in the perfused heart to beat spontaneously can be as reasonably explained by assuming a partial loss of irritability, sufficient to prevent spontaneous activity, but not to abolish response to stimuli from the beating ventricle, as by assuming an unimpaired irritability made ineffective through the disappearance of the inner stimulus. In the observation on the dying heart the successive failure of region after region shows, it is true, a progressive loss of irritability, but to stimuli proceeding from the regions still active; there is nothing in the experiment to prove that there is an inner stimulus exerting its influence ineffectively in the inactive regions. Hering¹² has pointed out a possible fallacy in such experiments as that of Cushny, in that in them the criterion of cardiac irritability is responsiveness to artificial stimulation, a criterion which may not be valid when applied to the irritability of the heart for its normal stimulus. To settle the question finally, therefore, either responsiveness to artificial stimulation must be shown to be a valid criterion of cardiac irritability, or some other undoubted index of irritability must be established.

Various considerations incline me to the view that cardiac irritability depends upon the amount of available energy-liberating material, per unit of substance, present in the tissue. It is universally assumed that in the rhythmically beating heart at the end of systole the available source of energy is exhausted, and that during the succeeding diastole there is an accumulation of the special material required for yielding the energy of the next systole. That during this accumulation there is also a steady increase of irritability until the beginning of the next systole is also generally assumed.

¹² HERING: *Loc. cit.*, 1911, cxliii, p. 376.

If we grant that in the rhythmically active heart the diastolic accumulation of energy-yielding material is accompanied by increasing irritability, must we not admit the probability, at least, that the presence of abundant available material in the quiescent heart signifies high irritability there as well?

The index to the amount of energy-liberating material available for any contraction is, as stated earlier, the height of the contraction. If the increase in irritability goes hand in hand with the accumulation of this material, we can judge the degree of irritability by the same criterion. As indicating that this suggested relationship between contraction height and irritability actually holds, certain experimental results are interesting, even though they are based on the

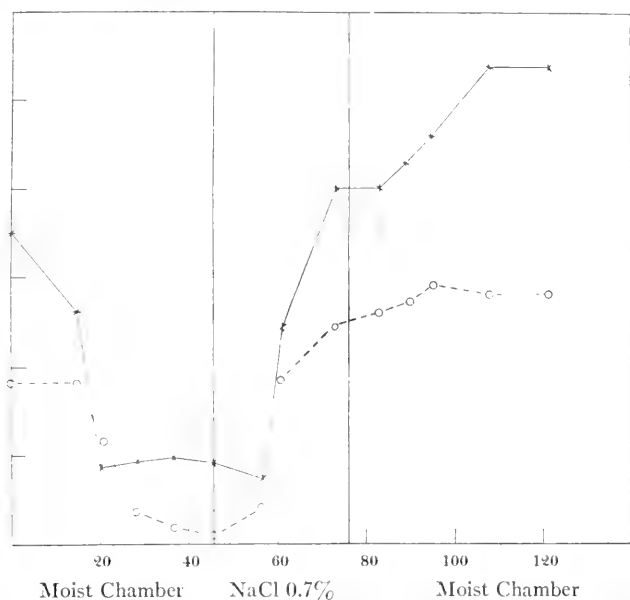

FIGURE 1. Curves showing that height of contraction and excitability to induction shocks vary in parallel fashion in freshly excised ventricle strips. The continuous line is the curve of irritability; the broken line is the curve of contraction height.

results of artificial stimulation, and cannot, on that account, according to Hering, be accepted as wholly convincing.

Schultz reports¹³ that freshly-cut heart strips immersed in Ringer's solution give, for some time after immersion, progressively higher

¹³ SCHULTZ: *Loc. cit.*, p. 143.

contractions when stimulated, and during this same period show, according to his criterion, mentioned above (p. 167), progressively increasing irritability. By a method recently developed¹⁴ I have made accurate determinations of the threshold of response to induction shocks of freshly-cut heart strips, and find that there is a remarkable parallelism between the curve of irritability and of contraction height. This parallelism is shown graphically in Fig. 1, which is the record of the course of the irritability and the height of contraction of a strip during the first two hours after excision.

Schultz reports, and I confirm his statement, that in heart tissue several hours after removal from the body, the agreement between excitability to electric stimuli and height of contraction seems not to hold so strictly. Even though there is thus some opposing evidence, the preponderance favors the idea that height of contraction is on the whole a fairly good index to the excitability of the tissue, and we are

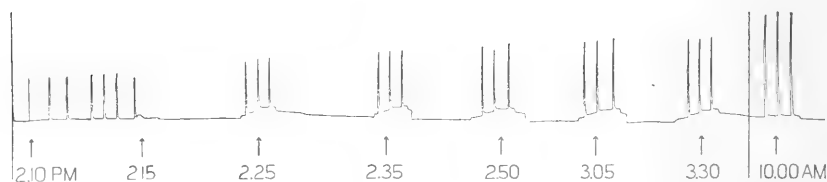

FIGURE 2. Tracing showing that a heart strip which is not spontaneously active may give under artificial stimulation, contractions which are much higher than previous spontaneous contractions of the same strip.

justified, therefore, in basing tentative judgments as to irritability on observations of contraction height.

Let us now apply this criterion of irritability to the problem of the inner stimulus: Can we show that strips which are spontaneously active with a certain degree of irritability may lose their spontaneity and yet develop even greater irritability? Fig. 2 is a tracing obtained from an apex strip of ventricle from *Chrysemys marginata*. The tracing was taken Nov. 21 and 22, 1911. The fresh strip was immersed in 0.7 per cent sodium chloride solution till beats began. The latent period was one hour and ten minutes. Five minutes after the onset of spontaneous rhythmicity the sodium chloride solution was replaced (2.15) by 50 c.c. Ringer's solution (NaCl 0.7%,

¹⁴ MARTIN: this Journal, 1908, xxii, p. 116. Also the Measurement of Induction Shocks, New York, 1912.

CaCl₂ 0.026%, KCl 0.04%), to which 2 c.c. 0.9 per cent potassium chloride had been added. Spontaneous activity immediately ceased. At intervals, as indicated on the tracing (2.25, 2.35, 2.50, 3.05, 3.30 P.M and 10 A.M), series of three minimal induction shocks were sent through the strip. The liquid was drawn off just long enough in each case for the stimulations to be sent in. The record shows a progressive increase in the height of contraction from series to series, continuing for twenty hours after the first activity of the tissue. The first contractions under artificial stimulation were higher than the highest spontaneous contractions, and the last contractions under artificial stimulation were twice as high as the spontaneous contractions. This experiment, which I have performed repeatedly with similar results, proves that a procedure which prevents spontaneous activity completely may have no influence on the development of irritability, and to that extent justifies Cushny's use of artificial stimuli in judging the irritability of the quiescent mammalian heart in his experiment, cited above. Another experiment, described below, seems to me to give positive indication that spontaneous beats, when they do occur, are the result of the operation of a definite "inner stimulus." In this experiment I was determining the threshold of irritability of ventricle strips to single induction shocks, measuring the stimuli by the method I have recently described.¹⁵ A strip had been immersed in 0.7 per cent sodium chloride solution till spontaneous beats began, and was then removed to moist air. Spontaneous activity ceased in about five minutes, without any indication of the onset of "sodium chloride exhaustion." After fifteen hours in the moist air the threshold stimulus for the strip was 720 Z units.¹⁶ The contractions following this stimulation were very vigorous. Seven minutes after determining the threshold the strip was immersed in 0.7 per cent sodium chloride. It contracted spontaneously in less than one minute; the sodium chloride was then withdrawn. One more spontaneous beat occurred, and then the strip remained quiet. Three minutes later the threshold was 660 Z units. Five minutes later still the threshold had fallen to 528. Five minutes after this last stimulus the strip was again immersed in 0.7 per cent sodium chloride solution. Strong spontaneous contractions began within

¹⁵ MARTIN: *Loc. cit.*

¹⁶ MARTIN: this Journal, 1910, xxvii, p. 228.

ten seconds. These continued for fifteen minutes, although the sodium chloride solution was withdrawn after one minute. Eight minutes after the strip had ceased spontaneous activity the threshold was still 528. It began to decline soon after, however, and within a half hour threshold values as low as 317 were obtained, without any reappearance of spontaneous beats. During the hour in which the observations just cited were made, a ventricular strip had a declining threshold of irritability, virtually throughout the period. It showed spontaneous activity twice; each time immediately after the application of a sodium chloride solution; and each time upon a different plane of irritability. To one watching a strip behaving as this one did, the impression is overwhelmingly of a definite stimulus thrown into operation with each immersion in the sodium chloride solution.

The Characteristic Features of Ventricular Activity in Pure Sodium Chloride Solution. — Careful study of a large number of experiments in which ventricle strips have been placed in pure sodium chloride solutions after various sorts of preliminary treatment, has impressed me with certain features of sodium chloride action which seem to be general, and which I would summarize as follows: (1) *For ventricle tissue to be active in sodium chloride solution, it must come from a medium favorable to the production of dissociable substance.* (2) *The onset of activity is prompter the greater the irritability in the preceding medium.* (3) *The first spontaneous contractions in sodium chloride equal in height the last contractions in the preceding medium.*

Leaving out of account, for the moment, the effects of sodium chloride on freshly-excised strips, the conditions favorable for the manifestation of the sodium chloride effects outlined above are: long continued immersion in Ringer's solution; prolonged suspension in moist air following immersion in sodium chloride solution; sometimes treatment with sugar solution after sodium chloride exhaustion.¹⁷

The usual termination of spontaneous activity in these preparatory media is through a period of lessening frequency of beat, without much decline in height of contraction, indicating a diminished spontaneity, but not a decrease in the production of dissociable substance. The effect of immersion in pure sodium chloride solution is in every one of these cases prompt resumption of rhythmic activity — after

¹⁷ For detailed description of the behavior of strips in the media named, see MARTIN: this Journal, 1904, xi, p. 123 *et. seq.*

Ringer's solution activity is usually resumed with striking suddenness, and in every case the first beats are the highest of the series and are about the same height as the last beats in the preceding medium.

Frequently strips in moist air, particularly when placed therein after brief treatment with sodium chloride¹⁸ give a rather long series of beats with continuously declining vigor of contraction. Immersion in sodium chloride solution at the end of such a period sometimes brings about a series in which there is gradual increase of vigor for some time, as long as fifteen minutes in my experiments. This result is significant in that it forms the only exception I have seen to the general observation that the first beats in sodium chloride solution are maximal or nearly so.

One of the very familiar phenomena attending the use of sodium chloride on heart strips is the rather long latent period which precedes activity, when the strips are immersed in the solution immediately after removal from the animal. The various explanations of this latent period that have been offered need not be reviewed here. I wish, however, to report certain facts about the condition of heart tissue immediately after separation from the animal, including the latent period in sodium chloride. Schultz¹⁹ reports that heart strips cut while in Ringer's solution and suspended in moist air are inexcitable to induction shocks for a half hour or longer. I have studied the excitability of similar strips, the only difference between my procedure and that of Schultz being that I invariably omitted any rinsing solution; the strips were always cut directly from the heart, through which blood was being pumped. Such strips, placed for a moment on a glass plate, are very irritable to mechanical stimulation and in responding to the stimuli unavoidable in handling them, pump themselves quite free of blood. My observations differ from those reported by Schultz in that they show that the freshly isolated strips, when first placed in moist air, are fairly excitable to induction shocks. I have records of threshold stimuli ranging from 290 to 850 Z units. In my experience the irritability declines steadily. In an experiment in which the initial threshold was 290 it had increased in twenty minutes to 1100. In an experiment with a high initial threshold, 850 Z units,

¹⁸ See MARTIN: *Loc. cit.*, p. 124.

¹⁹ SCHULTZ: *Loc. cit.*, p. 134.

no contractions were given after twenty minutes by stimuli of 8000 units.

I have demonstrated also, by means of an experiment described in my first paper on this subject,²⁰ the steady decline in irritability in moist air of freshly isolated apex strips. In this experiment the entire heart is removed from the body and suspended in moist air and the apex is partially severed from the base. Records of the contractions of the apex are taken. This procedure gives an apex strip, virtually isolated so far as salt relationships are concerned, but subject to rhythmic stimulation from the active venous portion of the heart. Such strips invariably show a steady decline in height of contraction, corresponding, we must believe, with a steady diminution in production of dissociable material, and with steady decline in irritability. The onset of complete "exhaustion" usually requires about two hours.

However we may interpret these observations they demonstrate the fact that ventricular tissue upon separation from its normal environment loses its excitability more or less rapidly. When a strip is immersed in sodium chloride solution it has first to overcome this tendency to declining irritability before it becomes able to execute spontaneous contractions.

Schultz (*loc. cit.*) states that the return of excitability of excised strips is promoted by immersing them in a saline bath. I have made observations of the threshold stimulus, at intervals during the latent period, of fresh strips in 0.7 per cent sodium chloride, the solution being withdrawn only long enough in each case to allow stimulation. I find that the threshold a few minutes after immersion is usually several times higher than at the moment of separation from the body. Thus in one experiment, the threshold of the freshly isolated strip was 400 Z units. Five minutes after immersion in 0.7 per cent sodium chloride the threshold was 1224. In seven minutes more the threshold had fallen to 576; eight minutes later it was 343; and three minutes after this reading, and just before spontaneous contractions began, the threshold was 300. Similar variations, although with a more rapid secondary increase in irritability, I have observed in fresh strips immersed in Ringer's solution. Such results show that removal from the body to any medium whatever involves in the course of the readjustment of the tissue to its environment a lowering

²⁰ MARTIN: this Journal, 1904, xi, p. 105.

of excitability, which must be overcome before activity is resumed. I believe the necessity for this readjustment explains, at least, in part, the long latent period of fresh strips in sodium chloride solution, as well as the various means of shortening the period that have been described. Further discussion of this point is reserved for a later portion of the paper.

The Characteristic Features of Ventricular Activity under Treatment with Calcium-Containing Solutions. — Apex strips respond to treatment with solutions containing calcium in a manner perfectly characteristic, and often very striking. The effect of such solutions, when positive, is always to bring about a marked increase in the *height of contraction*, which is prompt in showing itself. I have seen the effect follow the addition of calcium-containing solutions to sodium chloride solutions surrounding strips in all stages of the typical sodium chloride series. Strips beating in moist air show marked increase of vigor after the application of calcium-containing solutions. Fresh strips immersed in Ringer's solution show only occasional spontaneous contractions, but such as occur are always very vigorous indeed.

That this effect of calcium extends to mammalian heart tissue is shown by Langendorff and Hueck²¹ and by Gross,²² who report that a permanent increase in the calcium content of the circulating blood causes a permanent increase in the force and amplitude of the heart beat.

DISCUSSION

I have emphasized the characteristic effects of sodium and of calcium on ventricular tissue to bring out what I assume, tentatively, to be their respective functions with reference to cardiac activity. The effect of sodium is always such as to suggest the action of a direct stimulus, and this I assume to be its function so far as the heart is concerned. In adopting this view I am abandoning my former position²³ of support for the Langendorff theory of stimulation by metabolic products, in favor of Lingle's theory that sodium ions consti-

²¹ LANGENDORFF and HUECK: Pflüger's Archiv, 1903, xcvi, pp. 473-485.

²² GROSS, E.: *Ibid.*, 1903, xcix, pp. 264-322.

²³ MARTIN: this Journal, 1906, xvi, p. 201.

tute the "inner stimulus"; but only to the extent of granting to sodium ions a positive stimulating effect. I still believe that the evidence formerly adduced by me²⁴ indicates that metabolic products may also stimulate heart tissue. I see no reason why we must confine stimulating properties to single substances, excluding all others. Indeed an experiment reported by Benedict,²⁵ in which galactose solution caused beats in a freshly isolated apex strip, and the commonly observed revival after sodium chloride exhaustion by sugar solutions, can be explained more satisfactorily by granting to these substances certain stimulating powers than in any other way.

An objection which may be urged against this theory, so far as it assumes for sodium a direct stimulating function, is that in such an experiment as that cited on p. 171. in which immersion in sodium chloride is followed promptly by beats, the tissue must be saturated with sodium chloride at the time of immersion, and the application of more sodium to a tissue already saturated with it would scarcely be expected to exert a very positive influence.

To my mind the best answer to this objection is the experiment itself. The tissue, saturated with sodium chloride, is quiescent; when immersed in more sodium chloride it beats. Obviously there is some difference of condition before and after immersion. The equilibrium existing in the tissue saturated with sodium chloride is instantly upset when it is immersed in more sodium chloride.

We have no positive knowledge as to the ionic conditions obtaining in the equilibrium of the quiescent tissue. Various hypotheses to account for the equilibrium and its upset by sodium chloride might be offered. A suggestive fact is that equilibrium with quiescence cannot prevail in heart tissue *immersed* in sodium chloride solution, after the initial latent period is over, so long as dissociable material is available, and provided activity is not prevented by the presence of an inhibitory substance, such as potassium. Moreover, after prolonged immersion in sodium chloride solution, strips removed to moist air are nearly always active for many hours. In view of these facts the occasional stand-still shown by strips, after a rather brief immersion in sodium chloride solution, suggests that a true satura-

²⁴ MARTIN: *Loc. cit.*, pp. 203 and 205.

²⁵ BENEDICT: this Journal, 1908, xxii, p. 22.

tion may not have occurred under these conditions, and lessens the force of the objection I have mentioned.

The effect of calcium seems clearly to be that suggested by Howell,²⁶ namely to promote the production of dissociable energy-liberating material. If the height of contraction is a reliable index to the amount of dissociable substance available, as we must believe it to be, all the reported facts about the effects of calcium point directly to this conclusion, for the one striking feature of the calcium effect wherever it appears is improvement in the vigor of beat.

The dependence of the calcium effect upon the oxygen supply, which, as I have previously shown,²⁷ is very marked, I formerly interpreted²⁸ as indicating a rôle for calcium in connection with the oxidative processes in the tissue. That the facts can be interpreted as satisfactorily in terms of my present view I shall show in a later paragraph.

The theory of the action of sodium and calcium on heart tissue presented in this paper may be summarized in a brief statement. Sodium and calcium ions are not antagonistic, but act positively upon different phases of the contractile process. Calcium promotes the conversion of stable material into unstable, energy-liberation material; sodium promotes the dissociation process whereby energy is actually liberated. In other words, calcium makes material available, sodium causes this material to liberate its energy. In neither of these functions are the salts exclusive agents; the production of dissociable material may depend on other factors than calcium; the dissociation process may be affected by other substances than sodium.

The notion that sodium and calcium ions are antagonistic in their influence on vital processes has prevailed since the work of Ringer²⁹ and of Loeb³⁰ on the interaction of these and other ions. The greater part of the evidence offered in favor of such antagonism has been derived from experiments on tissues other than heart, chiefly skeletal muscle, *Fundulus*, and *Gonionemus*. Loeb has recently presented

²⁶ HOWELL: *Journal of the American Medical Association*, 1906, xlvi, No. 23.

²⁷ MARTIN: *this Journal*, 1906, xv, p. 309.

²⁸ MARTIN: *Ibid.*, p. 316.

²⁹ RINGER: *Journal of physiology*, 1886, vii, p. 302; also, xviii, 1895, p. 428.

³⁰ LOEB: *this Journal*, 1900, iii, p. 337; also, *Archiv für die gesammte Physiologie*, lxxx, 1900, p. 229.

his ideas on salt antagonism,³¹ taking the position that the antagonism is not a true one in the sense that one salt acts in direct opposition to another, but rather that there is a cooperative action of the salts upon the tissue, of such a sort as to interfere with the manifestation of the peculiar effect of either one. The experimental basis for Loeb's view is chiefly a series of studies on the effects of salts on developing eggs of *Fundulus*. Osterhout³² has demonstrated by two distinct methods that in plant cells "the antagonistic action of salts is largely or entirely due to the fact that they hinder or prevent one another from entering the protoplasm."

Joseph and Meltzer,³³ on the other hand, have described experiments on skeletal muscle, which furnish indication that in this particular tissue there may be a direct salt antagonism.

All these observations and opinions serve to show clearly that the conclusion reached depends often on the tissue studied. To assume, then, an antagonistic action in heart tissue between sodium and calcium ions, on the ground of observations made on very different tissues, is surely unwarranted.

When I reviewed the literature of the causation of the heart beat, after eliminating from my mind the idea that sodium and calcium are antagonistic, I wondered that the idea could persist so strongly with such meagre evidence in its favor. The observations upon which the belief is based, with reference to heart strips, are the recovery from sodium chloride "exhaustion" which follows the use of calcium, and the better beat in sodium-calcium mixtures as compared with pure sodium chloride solution,³⁴ and the observation of Howell³⁵ that sodium tends to relaxation, while calcium tends to tonic shortening. With reference to the improvement in beat caused by calcium, I have shown above that this is apparently a direct calcium effect, and there is abundant evidence that it may be quite independent of a previous injurious influence of sodium. Thus strips which have been vigorously active for hours in moist air often show marked

³¹ LOEB: The Carpenter Lecture, *Science*, N.S., xxxiv, 1911, p. 653.

³² OSTERHOUT: *Science*, N.S., xxxiv, 1911, p. 187; and *Ibid.*, N.S., xxxv, 1912, p. 112.

³³ JOSEPH and MELTZER: this *Journal*, 1911, xxix, p. 1.

³⁴ LINGLE: *Loc. cit.*, p. 277.

³⁵ HOWELL: this *Journal*, 1901, vi, pp. 184 and 199.

increase in amplitude following the application of calcium-containing solutions, a result which can scarcely be due to an antagonizing of sodium by the calcium.

Howell's correlation of the antagonism between sodium and calcium in the causation of the beat with their antagonism in relation to tone loses its force if the salts are shown not to be antagonistic in their effects on tone. In a recent paper³⁶ I have analyzed the relations of salts to cardiac tonus and have advanced evidence which seems to me to cast grave doubt on the view that sodium and calcium as present in the blood are definitely antagonistic in their influence on tone.

If there is truth in the idea herein advanced that sodium and calcium ions are not antagonistic in their effects on heart tissue, but act positively on different phases of cardiac activity, the various previous observations on the behavior of heart substance when treated by these ions must be explicable in terms of this idea. I purpose, as briefly as possible, to discuss the recorded observations on this basis so as to show the applicability to them of my hypothesis.

Ventricular tissue of the turtle in its normal relation to the blood supply we know to be highly responsive to stimuli from the venous end of the heart, but, as the immediate stand-still following excision shows, not capable of spontaneous activity. We have in this situation a high degree of excitability in the absence of an effective inner stimulus.

When ventricular tissue is removed from the blood supply, but not otherwise treated, its excitability, both to artificial stimulation and to the normal stimulus from the active venous region, diminishes steadily. This decline in excitability can be explained as due to a disturbance of equilibrium whereby the ions present in the tissue enter other than their normal combinations. A similar change for the ions of shed blood I have already suggested.³⁷ That the disturbance in ionic relationships is a permanent one is shown by the complete failure of excised ventricle to recover excitability unless treated with certain suitable solutions.

Freshly cut ventricle strips immersed in 0.7 per cent sodium chloride solution show a latent period in which there is at first a decline

³⁶ MARTIN: this Journal, 1912, xxx, p. 182.

³⁷ MARTIN: this Journal, 1904, xi, p. 117.

in excitability to induction shocks. This is succeeded by a period of increasing excitability, and this in turn by spontaneous activity.

Methods of shortening the latent period are by treatment with calcium-containing solutions or carbon dioxide (Martin) or sodium oxalate or galactose (Benedict). On the justifiable assumption that spontaneous beats begin as soon as the intensity of the inner stimulus meets the threshold we may look for shortening of the latent period either by agencies which intensify the inner stimulus or by those that increase the excitability. According to the theory proposed by Howell and supported in this paper the shortening of the latent period by calcium is due to the action of this substance in increasing the excitability. Inasmuch as the immediate onset of beats after sodium oxalate is said by Benedict ordinarily to require the use of Ringer's solution rather than pure saline, we may interpret the effect of the oxalate as due to the precipitation of the calcium of the tissue, thereby preparing the way for immediate influence to be exerted by the calcium of the Ringer's solution. The effects of carbon dioxide and of galactose are best to be explained, I believe, by attributing to them direct stimulating properties.

The ultimate onset of spontaneous activity of strips in pure sodium chloride solution, following a period of increasing excitability, can be explained by supposing that the tendency of the ions contained in the tissue to enter combinations unfavorable to excitability is overcome by the presence of the sodium. This possibility I have previously pointed out.³⁸

The declining series of beats terminating in "sodium chloride exhaustion" signifies a continuous decline in the conversion of energy-liberating material from inactive into active form. This decline is probably due, as I have suggested elsewhere,³⁹ primarily to insufficient oxidation, whereby unoxidized waste products accumulate to an extent which interferes with the production of energy-liberating material. The evidence for this view is the excellent recovery which follows treatment with abundant oxygen. Since calcium salts also induce recovery from this exhaustion we must believe that under the stimulation of calcium the production of dissociable material goes on in spite of the clogging effect of the unoxidized waste products,

³⁸ MARTIN: this Journal, 1906, xvi, p. 203.

³⁹ MARTIN: *Ibid.*, 1906, xv, p. 319.

although, as I have shown,⁴⁰ the calcium effect cannot manifest itself in the complete absence of oxygen.

Sodium carbonate and sugar are other substances that bring about recovery from sodium chloride exhaustion. That induced by sodium carbonate is probably akin to the improvement which follows treatment with oxygen, at least in that it operates by getting rid of waste products, although in this case the method is neutralization and not oxidation. The beneficial effects of sugar solution may be either through influence on the conversion of material into available form, or, as seems to me equally likely, through a combination of this effect with a powerful reinforcement of the inner stimulus.

The Rôle of Potassium. — That potassium is inhibitory to cardiac activity has long been definitely established. The precise mechanism of its action is, however, unknown. I am inclined to believe that potassium in moderate concentrations acts in opposition to the inner stimulus rather than in antagonism to the elaboration of energy-liberating material, but in higher concentrations opposes both processes. Some observations that bear out this view are reported by Howell⁴¹ in connection with studies of the relation of the potassium content of the circulating medium to vagus inhibition. Howell states that if the concentration of potassium chloride in the medium is gradually increased a point is reached (0.1 per cent) above which there is a definite effect upon the force of the beat, as well as upon its rate. In this diminution of force we have definite evidence of an effect of potassium on the production of dissociable material in the ventricle. The effects of potassium on rate are irrelevant in this connection, since the ventricular rate is established by the venous part of the heart.

That concentrations of potassium insufficient to affect unfavorably the production of energy-liberating material may, by opposing the inner stimulus, prevent the manifestation of spontaneous activity in the ventricle is shown by the experiment of which a tracing is given in Fig. 2, p. 170. In this experiment spontaneous rhythmicity developed as the result of immersion in 0.7 per cent sodium chloride solution, and after becoming well established was abolished by transferring the tissue to Ringer's solution containing a small excess of

⁴⁰ MARTIN: *Loc. cit.*, p. 316.

⁴¹ HOWELL: this Journal, 1906, xv, p. 283.

potassium chloride. That the suspension of activity was not due to interference with the production of dissociable material was shown when artificial stimuli were applied. The responses to these stimuli were progressively greater and greater, a result which can be explained only by supposing that the presence of potassium in small concentration is no bar to the conversion of substance into energy-liberating form, although it does suffice to overcome the action of the inner stimulus.

According to the view of the action of sodium and calcium set forth above, we may look upon potassium as antagonistic to both sodium and calcium, but to sodium more markedly than to calcium, a much higher concentration of potassium being required to counteract the influence of calcium on the process of preparing energy-liberating material than to counteract the directly stimulating influence of sodium.

SUMMARY

1. Various means of studying the influence of salts on the heart-beat are considered. The conclusion is drawn that by virtue of the "all or none" law the height of contraction is an index to the amount of available energy-liberating material present at the beginning of the contraction, and as such offers a fruitful means of attacking the problem of salt action.

2. Evidence is presented indicating that to a considerable degree the irritability of heart tissue depends on the amount of dissociable substance per unit of mass present within it, so that the height of contraction may serve to some extent as a criterion of irritability.

3. An experiment is described which may be interpreted as confirming Cushny's demonstration of the existence of a specific inner stimulus.

4. The characteristic features of ventricular activity in pure sodium chloride solutions are stated as follows: (1) for ventricle tissue to be active in sodium chloride solution the tissue must come from a medium favorable to the production of dissociable substance; (2) the onset of activity is prompter the greater the irritability in the preceding medium; (3) the first spontaneous contractions in sodium chloride equal in height the last in the preceding medium.

5. Freshly excised ventricle tissue is shown to undergo a steady decline in irritability which can be overcome only by treatment with suitable solutions. The decline occurs during the first few minutes of immersion in sodium chloride solution or Ringer's solution, but is presently succeeded in these solutions by steadily increasing irritability. The initial decline is interpreted as an inevitable effect of cutting the tissue off from its usual environment. Its occurrence explains the latent period in sodium chloride.

6. The characteristic effects of calcium-containing solutions on heart tissue are shown to be always in the direction of increased vigor of beat.

7. To interpret the characteristic effects of sodium and calcium the notion that they are antagonistic in their action on heart tissue is rejected. To each is assigned a positive function on a definite phase of the heart's activity. For calcium is assumed the function proposed for it by Howell of acting to promote the conversion of stable into unstable energy-yielding material; and for sodium the function proposed by Lingle of serving as the immediate stimulus to bring about the actual dissociation, and so to initiate the beat. To account for various observations the further assumption is made that neither sodium nor calcium is an exclusive agent; the preparation of dissociable substance is hampered to a great degree by accumulating waste products, and is therefore aided by abundant supplies of oxygen or by sodium carbonate; carbon dioxide in moderate concentration, and perhaps sugar, act to stimulate heart tissue directly, much as sodium does.

THE SUGAR CONSUMPTION IN NORMAL AND
DIABETIC (DEPANCREATED) DOGS AFTER
EVISCERATION¹

By J. J. R. MACLEOD AND R. G. PEARCE

[From the Physiological Department, Western Reserve University, Cleveland, O.]

IN connection with the physiology of the carbohydrates no problem more urgently requires solution at the present day than that of the relationship which the pancreas holds to the utilization of sugar in the animal body. The hyperglycaemia which supervenes with such remarkable rapidity after complete pancreatectomy and the subsequent inability of the animal to metabolize any form of carbohydrates indicate that in the normal animal this relationship must be of the very greatest importance. When we attempt to explain the manner in which the pancreas exercises this function, however, great difficulties present themselves. We are, for example, not yet certain whether the pancreatic function is a local one or one effected in other parts of the body by an internal secretion (hormone) which the gland discharges into the blood.

By a local function is meant one by which some toxic substance, present in the blood and produced in the course of body metabolism, is acted on by the pancreatic cells in such a way as to neutralize it. When this substance is not thus acted on by the pancreas its accumulation in the blood paralyzes the power of the tissues to utilize sugar. Although there is no known fact which absolutely disproves this view there is likewise no direct evidence which would encourage us to entertain it, so that the tendency at present is to consider the pancreatic influence as being exercised by means of an internal secretion. Even if we accept this view, however, there is no agreement as to the *modus operandi* of the hormone. Some believe that the hormone is necessary for the utilization of dextrose in the tissues, others, that

¹ A preliminary communication of many of the observations included in this article appeared in the *Zentralblatt für Physiologie*, 1913 (March), p. 1311.

it participates in the control of the mobilization of dextrose from the liver. According to this latter view the disturbance which removal of the pancreas creates is one in which the liver not only loses the power of retaining absorbed dextrose as glycogen but in which it also develops in an exaggerated degree the power of producing sugar out of proteins and certain fats (gluconeogenesis). The sugar which thus passes the liver without having gone through a glycogen stage, and the new sugar which has been produced, accumulate in the blood more quickly than the tissues can utilize them, even although the tissues are not believed to show any less than their normal glycolytic powers.

A third view, which is really a compromise between the other two, supposes that the tissues cannot utilize dextrose until after it has undergone a preliminary transformation, one stage of which involves the production of glycogen for which the pancreatic hormone is necessary.

It has proved itself to be a most difficult matter to devise experiments which offer decisive evidence for or against any one of these hypotheses. Thus, the observations of Forschbach,² that the removal of the pancreas from one of two animals that had been previously united by sewing skin, muscles and peritoneum together (parabiosis) did not cause the usual degree of glycosuria, is unconvincing. Even if the observations themselves were free of criticism — which they are not — the immunity to diabetes of the depancreated animal might just as well be explained by local action of the pancreas of the anastomosed animal as by the presence of an internal secretion. The same criticism can be made of the observations of Carlson and Drennan³ that pancreatectomy in pregnant dogs near full term is not followed by the usual degree of glycosuria. One of these authors (Drennan⁴) has furnished another type of evidence which if correct would certainly favor the "hormone" hypothesis. He found that the amount of sugar excreted by a depancreated dog in twenty-four hours became less when blood from a normal animal was intravenously injected. Unfortunately, however, the urine alone was examined;

² FORSCHBACH: *Deutsches medicinische wochenschrift*, 1908, xxxiv, p. 910; also *Archiv für experimentelle Pathologie und Pharmacologie*, 1908, ix, p. 131.

³ CARLSON and DRENNAN: *this Journal*, 1911, xxviii, p. 391.

⁴ *Ibid*, p. 396.

the evidence would be much more convincing if the behavior of the blood-sugar had also been ascertained.

Seemingly incontrovertible evidence in favor of the "hormone" hypothesis has recently been furnished by Knowlton and Starling.⁵ These authors have studied the rate of dextrose consumption in blood perfused through the heart and lungs of normal and depancreated dogs. They found that the normal heart in an hour consumed about 4 mg. of dextrose for every gram of heart muscle, whereas the diabetic heart in four cases did not consume any dextrose in this time. They also found that the rate of disappearance, although low at first, gradually became greater when blood from a normal animal was perfused through a diabetic heart, and conversely, that the perfusion of blood from a diabetic animal through a normal heart was followed by a practically normal rate of dextrose consumption for the first hour but that this diminished subsequently. The interpretation which Knowlton and Starling put on these results is that the normal blood and tissues contain some substance which is necessary for the utilization of sugar in the organism, and they further offer, as evidence that the "hormone" is derived from the pancreas, the observation that the addition of a decoction of the pancreas, made with faintly acid Ringer's solution and subsequently neutralized with sodium carbonate, caused the diabetic blood to reacquire its normal glycolytic power, when perfused through the diabetic heart.

Confirmatory evidence for these remarkable observations has been furnished by Maclean and Smedley⁶ who found that there was very much less consumption of dextrose from oxygenated Locke's solution when this was perfused through the heart of a depancreated animal than when it was perfused through a normal heart. These authors were however unable entirely to confirm Knowlton and Starling's statement that the addition of pancreatic extract restores the sugar-consuming power. They point out that the extracts may not have been prepared under exactly the same conditions.

Although the conclusions which are drawn, at least in so far as

⁵ KNOWLTON and STARLING: *Zentralblatt für Physiologie*, 1912, xxvi, p. 169; *Proceedings of the Royal Society*, 1912, lxxxv, p. 218; *The Journal of physiology*, 1912, xlv, p. 146.

⁶ MACLEAN and SMEDLEY: *The Journal of physiology*, 1913, xlv, p. 470.

they refer to utilization of sugar by the heart, do seem to be justified by the published results, there are, nevertheless, several technical details in connection with the experiments which demand attention.

In the first place, it is unfortunate that an untried method was employed by Knowlton and Starling for estimating the amount of sugar in the blood mixture that was used for perfusion. This method consisted in precipitating the proteins in the blood or serum with copper sulphate and subsequently removing the excess of copper in the protein-free filtrate with sodium hydrate. We have found, by comparison of results obtained on the same blood by this and the well-tried method of Rona and Michaelis, that considerable discrepancy is likely to occur unless very great care is taken to add just exactly the amount of sodium hydrate that is necessary to neutralize the cupric sulphate. Even with these precautions, we have been unable to obtain the same close agreement between the duplicates that is observed when the Rona-Michaelis method is employed, nor have we found that the results obtained by the two methods always agree with one another. These facts are shown in the following table:

TABLE I
SUGAR IN BLOOD OR SERUM AFTER REMOVAL OF THE PROTEIN BY COPPER
SULPHATE OR COLLOIDAL IRON

Fluid employed	Reducing Substance in per cent after precipitation by:	
	CuSO ₄	Colloidal iron
I. Dog blood	0.098 0.127	0.122 0.122
Dog serum	0.153 0.145	0.161 0.161
II. Dog serum and 0.2 ¹ per cent dextrose	0.326 0.338	0.336 0.334
Dog serum and 0.4 ¹ per cent dextrose	0.416 0.519	0.537 0.517
III. Ox blood and 0.4 ¹ per cent dextrose .	0.623 0.631	0.611 0.626
Serum of above	0.967	0.999

¹ These percentages are approximate.

We were never able to obtain accurate agreement between the duplicates by the copper method whereas this is usually the case when the colloidal method is employed. We have probably omitted some precaution which Knowlton and Starling adopted, but of which they do not warn us in their published papers. We can only add that we have been most careful to follow their directions. These authors themselves obtained much more satisfactory results; for example, out of eleven duplicate analyses there was absolute agreement in six, a difference of less than 2 per cent in three. In two cases, however, the error was more than 5 per cent.

It is stated by Knowlton and Starling that the amount of glycolysis in the blood under the conditions of their experiments could not have exceeded 0.01 per cent dextrose per hour. This is without doubt too low a figure. It is at least very much less than that found by one of us (J. J. R. M.) to apply in the case of defibrinated or "hirudin" blood of the dog incubated under strictly sterile conditions at body temperature;⁷ thus, in defibrinated blood the following percentile glycolysis was observed:—40 (2 hrs. 15 min.), 55 (2 hrs. 50 min.), 34 (2 hrs. 30 min.), 27 (1½ hrs.); and in Hirudin blood these values were: 70 (2 hrs. 30 min.) and 37 (2 hrs. 30 min.). It should be pointed out, however, that in the experiments referred to no dextrose was added to the blood whereas in those of Knowlton and Starling a considerable quantity of dextrose was usually added. This was especially the case in those bloods which exhibited a very slight degree of glycolysis (*cf.* Table I of Knowlton and Starling). The importance of this observation will be discussed in a subsequent paper; meanwhile it is significant to note that the sugar content of the blood used for perfusing the heart of the diabetic dogs was very high in the three cases recorded in which no sugar disappeared, (Nos. 12, 17, and 18, Table III), possibly because dextrose had been added in excess of the amount usually present, even in diabetic blood.

Edelmann,⁸ working with oxalate blood (of the dog) found that after two hours incubation from 11.26 to 24.24 per cent of sugar disappeared and Loeb,⁹ using defibrinated blood, found in ninety minutes

⁷ Unpublished experiments. The sterility of the blood was tested by bacteriological examination.

⁸ EDELMANN: *Biochemische Zeitschrift*, 1912, xl, p. 314.

⁹ LOEB, A.: *Ibid.*, 1913, xlix, p. 413.

that from 48 to 62 per cent disappeared. The former author also found that a certain amount of glycolysis likewise occurs in diabetic blood and this was also observed to be the case by Knowlton and Starling.¹⁰ It is somewhat difficult to harmonize this fact with the statement that in blood perfused through the diabetic heart there should sometimes be no glycolysis whatsoever.

Although, as computed from Knowlton and Starling's tables, it is the case that the general average for sugar consumption by the normal hearts was about 4 mg. per gram heart muscle per hour yet there were very great deviations from this average; thus, leaving out of account cases in which the anaesthetic was left on by mistake, or in which the blood was very venous, the variations ran from 2.84 to 6.29 mg. per gram muscle per hour. In three of the seven hearts of diabetic animals the consumption varied from 1.8 mg. to 4.9 mg. per gram per hour, but this almost normal consumption is explained by the authors as probably due in part, at least, to bacterial growth; in the remaining four observations of this series extra precautions against bacterial growth were taken and no dextrose was used. In five diabetic dogs of another series of observations the consumption was much less than normal.

It is stated by Knowlton and Starling that the diabetic heart beat was very slow but that it increased in rate whenever pancreatic extract was added to the perfusion fluid. This and the accompanying partial restoration in sugar consuming power may have depended on the fact that the extract was neutralized with sodium carbonate, the presence of which in Locke's solution as Neukirch and Rona¹¹ have shown materially augments the beat and increases the sugar consuming power of the heart. Knowlton and Starling also observed slight quickening of a perfused diabetic heart when some sodium bicarbonate was added to the perfusion fluid.

In making these criticisms we do not desire to be understood as denying the possibility that less sugar may be used by the diabetic as compared with the normal heart. We believe however that the observations so far recorded do not unmistakably prove this fact.

¹⁰ KNOWLTON and STARLING: *Cf.* Proceedings of the Royal Society, 1912, B., lxxxv, p. 221.

¹¹ NEUKIRCH and RONA: *Archiv für die gesammte Physiologie*, 1912, cxlviii, p. 285.

But even if the diabetic heart should consume less sugar it is not justifiable to conclude that removal of the pancreas brings about the disappearance from the blood of some substance which is necessary for the utilization of carbohydrates in the other tissues of the body. It is necessary before drawing such a conclusion to compare the sugar utilization in the skeletal muscles of normal and diabetic animals. Theoretically, this could most simply be done by ascertaining the rate of sugar consumption in the artificially perfused hind limbs. Since such experiments always involve a certain risk of bacterial contamination, and since there are other technical difficulties and sources of inaccuracy connected with them, we have put the question to the test by observing the behavior of the sugar in the blood of dogs from which all the abdominal viscera were removed. Following such evisceration, as Bock and Hofmann, Pavy, and one of ourselves¹² have shown, the percentage of sugar in the blood steadily falls because the utilization of sugar in the tissues cannot be compensated by an increased discharge of sugar from the liver. Such preparations may really be considered as perfusions of the muscles with blood pumped by the heart and arterialized by the lungs. In them the conditions are certainly more nearly normal than is the case when an artificial pump and *in vitro* arterIALIZATION of the blood are employed. There are however two difficulties which present themselves in the use of such preparations. The first of these is that anaesthetic must continue to be administered, the presence of which in the blood might, as Knowlton and Starling imply, depress the glycolytic power. To control this, in about one half of our experiments, we have tied the innominate and left subclavian arteries just after their origin from the aorta, thus removing the higher nerve centres from the circulation and rendering the administration of anaesthetic unnecessary. As can be seen from the tables of results, however, this did not measurably affect the rate with which sugar disappeared. The other difficulty was with regard to the arterial blood pressure. Although this invariably rose considerably, as an immediate result of the ligation of the coeliac axis, it subsequently fell, as a rule, until, in some cases, it came to be no higher than about 40 mm. Hg; indeed, especi-

¹² BOCK and HOFMANN: *Experimental Studien über Diabetes*, Berlin; PAVY and SLAU: *The Journal of physiology*, 1903, xxix, p. 375; MACLEOD: *this Journal*, 1909, xxiii, p. 278.

ally in our earlier observations, the blood pressure might steadily decline to zero within a period of about half an hour after ligation of the abdominal vessels.

The cause for the fall of pressure in these earlier experiments was probably hæmorrhage into some untied small branch of the aorta, for the viscera were not actually removed after ligation of the vessels. This bleeding may have been through vessels coming to the stomach from the oesophagus or on to the rectum from the inferior hæmorrhoidal arteries. In the subsequent experiments, where actual evisceration was practiced, these vessels were necessarily tied.¹³ But even when every precaution was taken to avoid any such leakage of blood into untied splanchnic vessels, the blood pressure usually fell, so that within an hour after the evisceration it was no more than 60 mm. Hg. Such a fall was not experienced by Pavy. Since we have found from experience that irregular results in the amount of sugar in the blood are likely to be obtained when the blood pressure is much below 40 mm. Hg., we have, in the later experiments of the present research, kept it at a higher level than this by intravenous injections of adrenalin. The amount of adrenalin injected was always adjusted so as to keep the pressure as constant as possible. The preparation used was 1-1000 adrenalin chloride (Parke Davis); in some cases it was injected undiluted, in others it was diluted five times with Locke's solution. The amounts required were never large and even in the cases where the dilute solution was employed were never sufficient to bring about any material dilution of the blood. It can be seen, by comparing the results obtained in cases with and without adrenalin, that the injection did not in any way influence the rate of sugar disappearance. In certain of the experiments the animals died from cardiac failure in spite of all we could do to prevent it and we were compelled to take the blood for analysis from the heart chambers after death. We have found, however, that the amount of sugar in such blood is practically always considerably in excess of that present in blood removed even a few minutes previously from the renal vein or carotid artery.

The sugar was estimated in the blood by Bertrand's method after

¹³ On account of Pavy's observation that even after ligation of the portal vein there may be some sugar discharged by way of the hepatic veins, we have in all experiments applied mass ligatures to the back portions of the liver lobes.

removal of the proteins of means of colloidal iron. In as many cases as possible duplicate analyses were made.

CONSIDERATION OF RESULTS

In order that we might have some standard with which to compare the rate of glycolysis following pancreatectomy, a series of observations were made on samples of blood removed at varying intervals after evisceration in normal dogs. It was hoped that it would be possible so to control the conditions of the experiments, that a constant rate of sugar disappearance for different animals could be determined. The results actually obtained in a series of eleven such observations are given in Table II from which it will be seen that no such constancy was attained. The values set down in the fourth column of the table most clearly demonstrate the rate of glycolysis. They represent the milligrams of dextrose which disappeared from 100 gm. of blood during one minute.

TABLE II
GLYCOLYSIS IN THE BLOOD OF EVISCERATED NON-DIABETIC DOGS

No.	Time after evisceration (minutes)	Dextrose in blood (per cent)	Amount of dextrose disappearing from 100 gm. blood per minute (milligrams)	Remarks
1	15	0.112	0.83 0.33	Ether anaesthesia. B. P. fell from 120 to 40 mm. Hg.
	33	0.097		
	60	0.088		
2	15	0.244	2.4	Morphine and urethane. B. P. fell from 70 to 10 mm. Hg. * Dead.
	30	0.208		
	45	0.190*		
3	15	0.185 0.164	1.4	Cerebral vessels tied. B. P. fell from 50 to 10 mm. Hg.
4	15	0.113 0.100	0.86	Ether anaesthesia. B. P. 50 mm. Hg. falling to zero.

Abdominal vessels ligated (no adrenalin)

TABLE II (Continued)

No.	Time after evisceration (minutes)	Dextrose in blood (per cent)	Amount of dextrose disappearing from 100 gm. blood per minute (milligrams)	Remarks
5	30	0.178	1.46 0.93	Ether and urethane.
	45	0.156		
	60	0.142		
6	0†	0.287	2.66	Morphine and urethane. B. P. 90-40 mm. Hg. * Heart-blood. † 10 min. after operations.
	24	0.223		
	39	0.162*		
7	0†	0.195	1.53 0.46	Ether and urethane. B. P. 120-20 mm. Hg. * B. P. practically zero. † 15 mm. after operations.
	30	0.172		
	45	0.165		
	60	0.175*		
8	0	0.229	4.46 0.97	Morphine and urethane. B. P. 80-20 mm. Hg.
	15	0.162		
	45	0.133		
9	0	0.341	2.8 1.46 1.80	Ether anaesthesia. B. P. 160-60 mm. Hg. (viscera not removed), 1-5000 adrenalin.
	15	0.299		
	30	0.272		
	45	0.245		
10	15	0.113	1.10 1.40	Cerebral vessels ligated, 75 c.c. 1-5000 adrenalin. B. P. 80-40 mm. Hg. Starved animal.
	30	0.096		
	45	0.073		
11	0	0.085	1.16	Hemorrhage during operations, only 1 c.c. 1-1000 adrenalin used. B. P. 60 mm. Hg.
	30	(0.082)		
	60	0.057		

Abdominal vessels ligated and defibrinated blood plus dextrose then injected. (No adrenalin)

Abdominal vessels ligated and viscera removed in two experiments. Adrenalin injected.

In the first four experiments no special precautions were taken to prevent the fall of blood pressure ensuing upon evisceration; and if we leave out of account those determinations which were made on blood samples removed when the blood pressure was near zero,

TABLE III
GLYCOLYSIS IN THE BLOOD OF EVISCERATED DIABETIC DOGS

No.	D. N. ratio	Time after evisceration (minutes)	Dextrose in blood (per cent)	Amount of dex- trose disappear- ing from 100 gm. blood per minute (milligrams)	Days after pancreat- ectomy	Remarks
3	4.6	0	0.231	2.86 2.10	3	Cerebral vessels ligated; 40 c.c. 1-1000 adrenalin injected. B. P. 80-40 mm. Hg.
		30 45	0.145 0.113			
4	2.8 3.3 (starvation)	0	0.305	4.60	5	Ether anaesthesia. No adrenalin. Liver lobes not ligated. Viscera not removed. B. P. 80-40 mm. Hg. Dog almost moribund before experi- ment started.
		15	0.235			
8	3.3	15	0.311	4.3 2.2	3	Cerebral vessels ligated; 30 c.c. 1-5000 adrenalin. B. P. 120-80 mm. Hg. During experiment cardiac failure with resuscitation.
		45	0.180			
		60	0.147 } 0.147 }			
9	2.8	0	0.425	2.0	4	Cerebral vessels ligated 75 c.c. 1-5000 adrenalin.
		20	0.385			
		35	(0.164)			
10	4. 4.4 (some milk allowed)	0	0.303	0.5 0.6 0.7	5	Ether anaesthesia. B. P. remained above 60 mm. Hg. up to 90 mm., after which 1-5000 adrenalin in- jected to maintain B. P. One kidney not removed.
		30	0.288			
		60	0.273 }			
		90	0.268 } 0.249			

				0.232 0.210 } 0.213 } 0.160 } 0.172 }	0.56 1.66		* Normal blood plus dextrose injected. B. P. now averaged 140 mm. Hg.
11	3.9 (starvation)	0 30 60 90	0.292 0.270 0.224 } * 0.202 } 0.193 }	*0.73 1.53 0.91	6		Ether anaesthesia. Both kidneys ligated; after 60 min. 2 c.c. 1-1000 adrenalin injected slowly. B. P. 90-60 mm. Hg. * Heart blood.
12	3.8 (starvation)	0 40 53	0.331 0.222 0.144*	2.72	6		Ether anaesthesia; 100 c.c. 1-5000 adrenalin injected. Both kidneys ligated. B. P. 80-40 mm. Hg. * Heart blood.
13	— (haematuria)	0 30 45	0.277 } 0.264 } 0.157 } 0.130 }	3.7 1.8	7		Ether anaesthesia. Both kidneys ligated; 35 c.c. 1-5000 adrenalin injected. B. P. 60-20 mm.
14	1.8	0 30 38	0.269 0.226 0.341*	1.43	4		Cerebral vessels ligated; less than 5 c.c. 1-1000 adrenalin. Both kidneys ligated. B. P. 120 mm. gradually falling. * Collected from heart after death.
15	3.57	0 30 60 90	0.265 0.220 0.138 0.136*	1.50 2.73	5		Cerebral vessels ligated. Both kidneys ligated; 40 c.c. 1-5000 adrenalin mostly after 60 min. B. P. 80 mm. Hg. until after 60 min., when it began to fall. * Animal just dead.

it will be seen the dextrose consumption varied between 0.83 to 2.4 mg. In the next four experiments (Nos. 5 to 8 inclusive) it was attempted to maintain the blood pressure in the eviscerated animals by removing usually about 150 c.c. of blood from the animal at the start of the experiment and after defibrination and the addition of an equal volume of Locke's solution, containing 1 per cent dextrose, reinjecting it into the animal immediately after the evisceration. This was done in order to leave as small a quantity of blood as possible in the tied-off splanchnic vessels. The procedure did not materially prevent the rapid fall of blood pressure. The glycolysis was naturally somewhat quicker immediately after the injection (in one case rising to 4.46 mg.) but after some time it fell to between 0.46 and 0.97 mg. dextrose per minute.

In the last three experiments of the table, adrenalin (1-1000 or 1-5000 in Locke's solution) was injected at constant pressure into the renal vein at such a rate as to keep the blood pressure at least above 60 mm.; the dextrose consumption varied between 1.13 and 2.8 mg. per minute, thus indicating, when compared with the previous figures, that the adrenalin had no material influence on the rate of glycolysis.

Under the conditions of these experiments there is therefore a considerable variation in the glycolysis of different normal animals and it is not possible to co-relate the variations either with the mean arterial blood pressure or with the tying off of the head arteries which of course also involves opening the thorax and applying artificial respiration.

Turning now to the results obtained on diabetic animals, which are given in Table III, it is to be noted that in a much larger proportion of the experiments the fall of blood pressure produced by evisceration was compensated by injections of adrenalin. These experiments, being on very valuable material, were naturally not undertaken until after the experience gained by work on normal animals had been obtained, the outcome of which as we have seen was to indicate adrenalin injections as the most satisfactory means of keeping up the blood pressure. That such injections did not bear any relationship to the rate of glycolysis in diabetic animals was demonstrated in one or two cases in which the drug did not require to be given until the latter part of the experiment, in one case (No. 10) the rate of glycolysis was the same before and after the injection,

in another (No. 11) it was less and in a third (No. 15) it was greater. Nor was ligation of the vessels proceeding to the head and fore limbs associated with any demonstrable variation in the glycolysis. Thus, in the cases in which these vessels were untied (Nos. 10, 11, 12, 13 and 14), and the anaesthesia consequently maintained the rate of glycolysis varied between 0.5 (No. 10) and 4.6 (No. 4) mg. per minute, whereas in those in which the vessels were tied (Nos. 3, 8, 9, 14 and 15), it varied between 1.5 and 4.3 mg. per minute.

When we compare the results obtained on diabetic with those obtained on normal dogs it is plain that no difference can be made out. For some reason which we cannot explain, the results in both cases are extremely variable and it, therefore, becomes impossible to give any average which would be at all reliable for either series of observations. However, some comparisons may be of interest. The average dextrose consumption for the 11 normal dogs (17 observations) is 1.63 mg. per minute and for the 10 diabetic animals (19 observations) it is 1.86 mg. per minute.

The maximum and minimum rates for the non-diabetic animals (including those in which dextrose was injected) are 2.4 and 0.83 mg. per minute respectively, and for those that were diabetic, 3.7 and 0.50.

In one experiment on a diabetic animal (No. 10) there does appear to be distinctly less glycolysis than in any other case, either normal or diabetic. This was an unusually resistant, although markedly diabetic, animal, the blood pressure remaining above 60 mm. for more than an hour after the evisceration so that no adrenalin had to be injected until after ninety minutes. The dextrose consumption meanwhile ranged between 0.5 and 0.7 mg. per cent per minute. Unfortunately in this experiment the kidney on the right side was not tied off so that the comparatively small decrease in dextrose which did occur might be accounted for, in part at least, by excretion into the urine. In five other experiments, however, the vessels of both kidneys were ligated and in those the glycolysis was very marked. The injection of 250 c.c. defibrinated blood containing 5 per cent dextrose into this dog was followed by more marked glycolysis which might be attributed to the influence of pancreatic hormone. We are not prepared to give any other explanation at present, only we would point out the remarkable rate in the experiments on normal dogs, in which dextrose was injected, at which it disappeared. Perhaps the dextrose

introduced in this way finds some depôt other than the liver in which it is converted to glycogen. The possibility of its being retained in the lymph must also be borne in mind.

We cannot draw any conclusions from our results regarding the comparative rates of sugar utilization by the normal and the diabetic heart, but we believe that there is no difference in this regard in so far as the skeletal muscles are concerned. It is possible that the difference observed by Knowlton and Starling in sugar consumption between normal and diabetic hearts might have existed under the conditions of our experiments and yet have been insufficient to make an impression on the blood of the eviscerated animal. The conditions which influence the rate of sugar disappearance are so variable in different animals, and even in the same animal at different periods of the same observation, that it has proved impossible to obtain an average figure for sugar utilization by the use of which we could decide whether this was more marked in the one group than in the other. As already pointed out we can offer no explanation for these variations. We are certain, however, that they do not depend on any error in the blood-sugar estimations.

As a criterion of the degree of diabetes in the depancreated animals we have as usual taken the D. N. ratio. In one instance this could not be obtained because of an unaccountable and severe haematuria. Most of the animals received a pint of milk for the day or two following the pancreatectomy and meat on the succeeding days. In one or two instances they were starved for the day immediately preceding the evisceration experiment. It will be seen from the second column that all of the dogs were diabetic to the full degree. Although the operations were performed with every aseptic precaution possible and were kept afterwards in thoroughly clean cages there was always some suppuration of the wound, a condition which we have very rarely experienced in operations on non-diabetic animals. For example, in the experiments numbered three and four in the table the pancreatectomy was performed in two stages; in the first one the gland was removed except for the free vertical portion (*processus uncinatus*) which was grafted, with its blood vessels intact, in the subcutaneous tissues of the abdominal wall. After this operation there was no suppuration. The graft was then removed (without opening the abdomen) and the wound suppurred.

In conclusion we may point out that even if the isolated heart of the diabetic animal should be unable to utilize dextrose, this need not necessarily imply that it is because of the absence of some hormone which is necessary for utilization of dextrose by the heart muscle. It may be because of the presence in diabetic blood of toxic substances which may interfere with sugar utilization by the heart, under the conditions of the perfusion experiments. The fact that addition of pancreatic extract to the diabetic blood brings about a restoration of the glycolytic power — a fact which is not, we believe, supported by a sufficient amount of evidence (see p. 186) — would certainly offer stronger support to the hormone hypothesis but it would not necessarily render the “toxic” hypothesis untenable, for such an extract might contain antitoxin.

ON THE FORMATION OF FAT FROM CARBOHYDRATES

BY SERGIUS MORGULIS AND JOSEPH H. PRATT

[*From the Nutrition Laboratory of the Carnegie Institution of Washington, Boston, Mass., and the Laboratory of the Theory and Practice of Physic of Harvard University.*]

THE experiments described in this paper have all been performed on a dog belonging to one of us (J. H. P.), which showed certain peculiarities in the metabolic activity due to pancreatic achylia.

On March 29, nearly eight months before our experiments were begun, the corpus pancreatis of the dog was removed, leaving the processus lienalis and the processus uncinatus in situ. A detailed description of the operation and subsequent history of this dog "Flora" is given in another paper.¹

At the time of the operation the dog was very fat and weighed 13.8 kg. There was a steady loss of weight from the time of the exclusion of the pancreatic juice from the intestine to the end of June, when it had fallen to 6.5 kg. From this time to the middle of September the weight was fairly constant. Diabetes did not develop. The administration of pigs' pancreas, which was begun in September, was followed by a gain in weight. When the feeding of pancreas was discontinued on October 21 the dog weighed 8.35 kg.

An absorption experiment was begun on November 12 and continued for four days. During this period the dog ate 3000 gm. of meat. 42.23 per cent of the nitrogen of the food was lost in the feces and 72.73 per cent of the fat. The animal was in nitrogenous equilibrium, losing only .02 gm. of body nitrogen during the four days.

The experiments were performed at the Nutrition Laboratory with the dog apparatus constructed on the principle of the closed circuit, and essentially like that described by Prof. F. G. Benedict

¹ BENEDICT, F. G., and PRATT, J. H.: *Journal of biological chemistry*, July, 1913.

in an earlier paper² but modified by him for direct determinations of oxygen. It would be superfluous to give here a detailed description of the apparatus; it will suffice to mention that the animal's muscular activity has been carefully controlled by means of a pneumograph attached to the cage in which the animal is kept, and communicating with a Marey tambour. The cage being suspended by a spring at one end and resting on two knife edges at the opposite end is sensitive to the slightest movement on the part of the animal, and the movements are recorded on a kymograph by means of a pointer resting on the tambour. The carbon dioxide, absorbed in soda lime bottles, is ascertained by the difference in weight of the bottles at the beginning and end of each experiment. As there are two sets of soda lime absorbers attached to the apparatus, either one or the other may be brought into operation by a shift of a three-way valve. By this arrangement it was possible to determine the carbon-dioxide production during successive half-hour periods without interrupting the course of the experiment. The oxygen was admitted into the system from a small cylinder, which was likewise weighed before and after each period. The amount of oxygen thus determined by weight was also checked by readings of a Bohr meter through which the oxygen passed before entering into the system. The relative humidity of the air of the respiration chamber was measured by a psychrometer; samples of the air at the end of the experiment or at the end of each successive period have been analyzed for carbon dioxide with the Sondén apparatus.

Knowing the empirical volume of the entire system (including the chamber and accessories) we were able to compute the quantitative composition of the residual air at the end of each period by making use of the data obtained from readings of the psychrometer, barometer, thermometer, and the per cent of carbon dioxide in the air. The difference in the residuals enabled us to make corrections for the consumption of oxygen and the production of carbon dioxide as determined directly by weight.

The efficiency and accuracy of the respiration apparatus have been frequently tested, and we did not run regular experiments before complete satisfaction as to its perfection in this regard could be

² BENEDICT, F. G., and HOMANS, J.: this Journal, 1911, xxviii, p. 29; Journal of medical research, 1912, xxv, p. 409.

obtained. The system was tested for tightness and blank experiments showed no changes in the weight of the soda-lime absorbers. Furthermore, check experiments were performed from time to time by burning ethyl alcohol in the respiration chamber. Almost invariably the quotients obtained were in complete agreement with the theoretical expectation for the combustion of alcohol, thus giving positive proof of the accuracy of our apparatus.

There is nothing essentially novel in the fact that within the organism of an animal one substance may be chemically transformed into another substance. The formation of carbohydrates from fat or protein, and the formation of fat from carbohydrates have been maintained by physiologists on different occasions, and in the majority of cases with sufficient justification. The transformation of fat into carbohydrates, for instance, figured greatly in metabolism studies with hibernating animals where it was thought that this transformation furnished the *raison-d'être* for the extremely low respiratory quotients observed by several investigators. This hypothesis, however, has serious objections against it, and recently it has been severely criticized by Nagai,³ who showed that with accurate and well-controlled methods one does not find quotients with hibernating animals as low as were hitherto claimed. The fact of the transformation of carbohydrates into fat, on the contrary, has been receiving more and more confirmation ever since Liebig supposed that such a change may occur, and it may be said that today this is fairly beyond questioning. It was corroborated by the experience of breeders and agriculturists that rich carbohydrate food is conducive to the fattening of the stock. Henneberg (1881),⁴ Chaniewski (1884),⁵ Munk (1885),⁶ Meissl (1886)⁷ and others⁸ experimenting with various animals, such as sheep, geese, dogs, pigs, found that in striking the balance of the intake and output, and comparing it with the actual acquisi-

³ NAGAI, H.: *Zeitschrift für allgemeine Physiologie*, 1909, ix, pp. 243-367.

⁴ HENNEBERG, W.: *Zeitschrift für Biologie*, 1881, xvii, pp. 295-350.

⁵ CHANIEWSKI, T.: *Zeitschrift für Biologie*, 1884, xx, pp. 178-192.

⁶ MUNK, J.: *Virchows Archiv für Pathologische Anatomie*, 1885, cx, pp. 91-134.

⁷ MEISSL, E.: *Zeitschrift für Biologie*, 1886, xxii, pp. 63-160.

⁸ LEHMANN, K. B., and VOIT, E. *Zeitschrift für Biologie*, 1901, xlii, pp. 619-671.

⁹ RUBNER, MAX: *Zeitschrift für Biologie*, 1886, xxii, pp. 272-280.

tions of the body they could not evade the conclusion that the carbohydrates had contributed to the deposit of fat. These experiments dealt with the assimilation of protein, fat and carbohydrate unassisted by a parallel investigation of the respiratory exchange of the animals under observation. Yet, if the transformation of carbohydrate into fat is an actuality, it should be reasonable to expect some clue as to its occurrence in the gaseous metabolism, since a substance rich in oxygen is thereby changed into one poor in oxygen. In other words this process should become revealed in the respiratory quotient which is the ratio between the carbon dioxide produced and the oxygen consumed during any length of time.

When this paper was already written we found an interesting paper in Russian, in which the metabolism of both dogs and rabbits fed only on sugar was discussed. The author of this article apparently did not realize the significance of the respiratory quotient, as throughout his voluminous tables and text he makes no mention of it. He determined, however, the carbon dioxide production and oxygen consumption of his subjects, and we were thus able to work out the respiratory quotients from his data. The experiments were per-

TABLE I

Original data				Computed		
Dog	Days	CO ₂	O	CO ₂	O	Respiratory Quotient
		Average in grams per day		Average in litres per day		
Damka	9 fasting	265.1	224.7	134.96	157.29	.858
	9 sugar diet	389.2	223.4	198.14	156.38	1.267
	29 sugar diet	1094.8	747.6	557.36	523.32	1.065
Bijka	9 fasting	330.7	325.5	168.36	227.85	.739
	9 sugar diet	368.5	267.2	187.60	187.04	1.003

formed in the following way: An animal was first subjected to a fast lasting several days, with water, and the urine was analyzed for nitrogen and the various inorganic constituents. Then the animal, after it had recuperated from the fast and attained the initial weight again, was put on a diet of sugar either in the form of solid lumps or in the form of a solution which was given through the stomach tube. The urines were also collected and analyzed as in the preliminary period. In a few instances the gaseous exchange was likewise determined, and we used these data in compiling Table I.

We may observe that in either case with an exclusive sugar diet the dog had a respiratory quotient of over one. In the case of the dog "Damka" the average quotient for the first nine days of the sugar feeding was 1.267, and for the entire experimental period of twenty-nine days, 1.065. The other dog "Bijka" shows only a slight rise of the respiratory quotient over one, but the respiratory quotient of the first dog is likewise a great deal higher when fasting. It is possible that the method for measuring the gaseous exchange employed by Protasov⁹ was not unimpeachable, as it is very improbable for an animal fasting nine days to have a respiratory quotient of .858, and it may be that the figures for the oxygen are lower than the actual consumption.

We believe that Pflüger first realized the importance of the gaseous exchange and of the respiratory quotient in the transformation of carbohydrate into fat when he instructed his student Bleibtreu¹⁰ to carry out a study of the gaseous metabolism. Bleibtreu employed young geese which he fed superabundantly upon rye meal and found large deposits of fat in their bodies when they had been killed at the close of the experiment. He performed also several respiration experiments with the result, as was to be expected on theoretical grounds, that in each case the respiratory quotients rose above one, ranging from 1.117 to 1.38, thus furnishing new proof for the origin of fat from carbohydrates. While Bleibtreu's experiments are extremely interesting, and undoubtedly conclusive, yet owing to deficiencies of

⁹ PROTASOV, I. I.: Metabolism of matter under condition of exclusive feeding with sugar, Dissertation, Imperial Military Medical Academy in St. Petersburg, 1895, p. 67. (In Russian.)

¹⁰ BLEIBTREU, M.: Archiv für die gesammte Physiologie, 1901, lxxxv, pp. 345-400.

his apparatus they leave room for criticism, and it seems to us not unlikely that with methods more properly controlled one would not find quotients as high as 1.38. However this may be, his results are true in the main and the quotients of over one may be taken as a direct proof of the phenomenon which has been recognized and postulated long ago.

Although the point may be considered well established, we do not hesitate to contribute to this subject as the conditions under which the transformation of carbohydrates into fat took place are rather singular. Besides, our experiments present practically the first series of determinations of oxygen and carbon dioxide coincident with this transformation (certainly in the case of the dog) which have been made with a well-controlled and critical method. Our dog was in a very emaciated state and since, as was stated above, she could utilize but a fraction of the protein and fat in the ingested meat, most of it (40 and 70 per cent respectively) being excreted in the form of large bulky stools, she was fed on glucose besides, and on one occasion we observed that the respiratory quotient increased above one. Suspecting that our dog was forming fat, we decided to follow up this matter.

We proceeded to feed the dog large quantities of glucose, expecting by thus over-feeding her with carbohydrates to find a state resembling somewhat that observed by Bleibtreu. The dog was given daily at least 120 gm. of glucose with some meat, and on the days on which respiration experiments were performed she got as much as 200 to 225 gm., with a relatively small admixture of chopped meat. It is interesting to note that in spite of such an abundance of nourishment her body weight remained practically unchanged throughout the experimental period of nearly three weeks.

Having given the dog glucose in the food for two preceding days, she was brought into the respiration chamber on November 18, two hours after eating 100 gm. of glucose and 300 gm. of meat. The dog remained in the chamber for two hours and during that time she produced per hour 4.12 litres of carbon dioxide and consumed 3.90 litres of oxygen. A week later the dog was fed 300 gm. of meat and 125 gm. of glucose and about three hours later a similar amount of meat and 100 gm. of glucose, after which she was placed in the respiration apparatus for two hours. This time she produced per hour 4.96

litres of carbon dioxide and consumed 4.78 litres of oxygen. The same thing was repeated next day. The animal received 50 gm. of meat and 100 gm. of glucose in the morning, then three hours later another portion of 50 gm. of meat and 125 gm. of glucose, and went directly into the respiration chamber. The dog produced per hour 5.40 litres of carbon dioxide and consumed 5.19 litres of oxygen. On November 26, the dog was again given 50 gm. of meat and 125 gm. of glucose, and a respiration experiment lasting nearly two hours was immediately begun. Then she received another 100 gm. of meat and 100 gm. of glucose and the interrupted experiment was continued for another two hours. During these two successive experiments the animal produced per hour 4.20 and 4.50 litres of carbon dioxide and consumed 3.92 and 4.22 litres of oxygen respectively, but the respiratory quotients in both experiments were practically the same. The last experiment of the series was performed a week later during which time the dog was fed on meat and glucose. On the day of the experiment she received 50 gm. of meat and 125 gm. of glucose, but could not be induced to eat any more, and vomited at the mere sight of food. Under these circumstances we were obliged to resort to injecting the glucose subcutaneously, and we thus introduced into the body 240 c.c. of a 20 per cent aqueous solution of glucose, making a total of 48 gm. of glucose. The dog was put directly into the respiration chamber and this time the highest respiratory quotient of practically 1.1 was obtained. The respiratory quotients obtained in this series of experiments range from 1.038 to 1.099 and the data are presented in tabular form in Table II.

Since the respiratory quotient is the ratio between the carbon dioxide production and the oxygen consumption, the high quotient contingent upon the formation of fat from carbohydrate may be either due to an increase of the numerator, or to a decrease of the denominator; the numerical outcome in both events remains the same. The latter course is in agreement with Liebig's conception of this transformation process. Pflüger's idea of an intramolecular migration of the oxygen atoms resulting in a formation of carbon chains of which the fat molecule is afterwards reconstructed, is probably the more correct one. The postulate that the transformation is accompanied by an increased output of carbon dioxide which is to be expected on this assumption, finds corroboration at least in some of our experi-

ments. Thus we observed a gradual rise in the carbon dioxide production in successive periods of thirty minutes each while the oxygen consumption remained practically constant. In one of the experiments the dog having been placed in the respiration chamber two

TABLE II

Date	Body weight in kilograms	Diet	Carbon dioxide production	Oxygen consumption	Respiratory quotient
			per hour		
Nov. 18	6.08	9.30 A.M. 300 gm. Meat + 100 gm. Glucose	4.12	3.90	1.055
Nov. 25	6.50	11.30 A.M. 300 gm. Meat + 125 gm. Glucose
Nov. 26	6.60	3.00 P.M. 300 gm. Meat + 100 gm. Glucose	4.96	4.78	1.038
		11.00 A.M. 50 gm. Meat + 100 gm. Glucose
Nov. 27	6.68	2.00 P.M. 50 gm. Meat + 125 gm. Glucose	5.40	5.19	1.040
		9.00 A.M. 50 gm. Meat + 125 gm. Glucose	4.20	3.92	1.073
Dec. 3		11.00 A.M. 50 gm. Meat + 100 gm. Glucose	4.50	4.22	1.058
		9.45 A.M. 50 gm. Meat + 125 gm. Glucose
		3.00 P.M. Injected subcutaneously 240 c.c. of a 20 per cent solution of Glucose	5.51	5.01	1.099
		Average	4.78	4.50	1.062

hours after a meal of meat and glucose the carbon dioxide output was continually increasing from 1.88 to 2.21 litres for thirty minutes. In another experiment tabulated below, the carbon dioxide output was gradually increasing from 2.25 to 2.65 litres in successive thirty-minute periods, but the oxygen consumption, if we take into consideration that the amounts for the second and third periods probably

compensate for each other, remains practically 2.39 in each period. Although in the early part of the fourth period there was some muscular activity, the dog has been very quiet in the second and third periods, as can be seen on the kymograph records, while she was less quiet in the first period. This must be taken as good evidence that the increasing output of carbon dioxide has not been caused by an increased muscular activity of the subject.

TABLE III

Date	Carbon dioxide	Oxygen	Respiratory quotient	Diet
	per hour			
Nov. 25, 1912				
3.30 — 4.00 P.M.	2.25 l.	2.39 l.	.941	11.30 A.M., 300 gm. Meat +
4.00 — 4.30 P.M.	2.41 l.	2.19	1.100	125 gm. Glucose
4.30 — 5.00 P.M.	2.61 l.	2.58	1.012	3.00 P.M., 300 gm. Meat + 100
5.00 — 5.30 P.M.	2.65 l.	2.40 l.	1.104	gm. Glucose
Total for 2 hours	9.92 l.	9.56 l.	1.038	

It would be an extremely difficult task to figure out with some degree of accuracy the amount of fat which is formed from carbohydrates during the experimental period. Furthermore, as we did not analyze the urine excreted during a sufficient number of the respiration experiments, we lack the most important data for this purpose. Without pretending to estimate with any degree of precision the quantity thus formed, we may attempt to compute that amount approximately by making the justifiable assumption that the animal has been burning carbohydrates for its maintenance during the experiment. Following this line of reasoning, we should expect the carbon dioxide output to be equal to the oxygen intake during the same experiment. The excess of carbon dioxide set free in the chemical process of transformation of carbohydrates into fat is not a measure of the metabolic activity of the organism, nor is it connected with the production of heat. It is an extra quantity superimposed upon

the carbon dioxide that results from the maintenance combustion of the metabolism. Theoretically, we know that 2.7 gm. of glucose may give 1 gm. of fat with the liberation of .55 gm. of water, and 1.16 gm. of carbon dioxide. Hence it follows that for every gram of fat originating from carbohydrates there should be set free 1.16 gm. or .59 litre of carbon dioxide above the amount resulting from the combustion of the body materials. If we avail ourselves of Hanriot's formula for the transformation of carbohydrates into fat, where a hypothetic substance (stearo-oleo-palmitin) is imagined to be formed by satisfying the three valencies of a glycerid with the fatty acid radicles of the three chief representatives of animal fatty acids (stearic, palmitic, oleic acids), we would expect instead .60 litre of carbon dioxide. On the line of reasoning suggested above this extra amount of carbon dioxide resulting from the formation of fat can be computed by subtracting from the ascertained quantity of carbon dioxide an amount equal to that of consumed oxygen, which on the above supposition must have been directly produced in the process of combustion of carbohydrates. For the sake of convenience, we may make use of the average figures given in Table II which may serve as representative for the entire set of experiments recorded therein. We will observe that there were 4.78 litres of carbon dioxide produced and 4.50 litres of oxygen consumed per hour, and that the average respiratory quotient was 1.062. If carbohydrates alone had been burned for maintenance during that time 4.50 litres of carbon dioxide would have been derived from that source. The excess of .28 litre (4.78-4.50) of carbon dioxide is what on this view has been set free in the transformatory process which was going on simultaneously with the other. The theoretical expectation of the liberation of about .60 litre of carbon dioxide when one gram of fat is newly formed from glucose, is equivalent to a rise in the respiratory quotient by .131 when the animal's consumption of oxygen per hour is 4.50 litres, as may be gotten by dividing .60 by 4.50. The average respiratory quotient observed in our experiments is .062 above one, or roughly one-half of the theoretically expected rise of the quotient, when one gram of fat is newly formed. In other words, we may assume that in the course of one hour .5 gm. of fat are being formed from carbohydrates on the average in such an extreme case as when carbohydrates alone are being burned for maintenance. As a matter of fact, how-

ever, the experiments with our dog have shown that on a mixed diet, though the respiratory quotient was very high, it never reached unity, but was usually about 0.940. We may, therefore, assume further that under the experimental conditions and the condition of the dog described here, the animal deposited on an average a gram of fat per hour.

In concluding we wish once more to emphasize the fact that a weak and emaciated dog with severe disturbance in the absorption of fat and protein was still able to form fat from carbohydrates. Apart from the additional proof which our investigation brings to the theory of the transformation of carbohydrates into fat, it also shows that the transformation may and actually does take place even in the carnivorous dog.

THE ACTION OF THROMBOPLASTIC SUBSTANCE IN THE CLOTTING OF BLOOD

BY F. W. MACRAE, JR. AND A. G. SCHNACK

[From the Physiological Laboratory of the Johns Hopkins University]

IN the theory of the coagulation of the blood which we owe to Morawitz it is assumed that the prothrombin is converted to active thrombin by the combined influence of calcium and thrombokinase, the latter element being furnished by the tissue cells, including the blood corpuscles. Howell in several papers has contended that thrombokinase, or the thromboplastic substance of the tissues, is not concerned in the activation of the prothrombin, but exerts its favoring influence upon coagulation by neutralizing the antithrombin present in blood. This latter author¹ has shown, moreover, that the active constituent of thromboplastic substance is one of the lecithans or phosphatids; not the one designated as lecithin, but a related substance which in its solubilities coincides rather with the fraction known as kephalin. A somewhat similar conclusion in regard to the nature of the thromboplastic substance has been reached independently by Zak.²

In order to determine whether or not the thromboplastic substance (kephalin) acts as a kinase, it would be desirable to isolate prothrombin and determine directly whether calcium alone suffices to convert it to thrombin, or whether the action of thromboplastic substance is needed in addition. Unfortunately no method of isolating prothrombin has been devised, so that this direct mode of approaching the problem is not feasible at present. An indirect method of attack is suggested by the fact, emphasized by Morawitz,³ that the favoring influence of thromboplastic extracts upon the coagulation of blood is not exhibited when the blood is deprived of its calcium

¹ HOWELL: This Journal, 1912, xxxi, p. 1.

² ZAK: Archiv für experimentelle Pathologie und Pharmakologie, 1912, lxx, p. 27.

³ MORAWITZ: Handbuch der Biochemie, 1909, ii, pt. 2, p. 51.

by the addition of oxalate solutions. Thromboplastic substances (tissue extracts) have a very remarkable influence in hastening the coagulation of peptone-bloods. It is upon such bloods in which, owing to an excess of antithrombin, spontaneous clotting is greatly delayed or entirely prevented, that the effect of thromboplastic extracts is shown most clearly, and it is a matter of interest to know whether in peptone-blood the presence of calcium is absolutely necessary for this action of thromboplastic substance. At Dr. Howell's request we undertook to study this point. We began our experiments with the idea that a peptonized blood which was oxalated as soon as it was drawn from the animal might behave differently from one which, after removal from the animal, was allowed to stand for a certain time, thirty minutes to an hour, before being oxalated, since in the latter there would be an opportunity for the conversion of some of the prothrombin to thrombin. To test this idea a dog was peptonized by the injection of peptone in amounts equal to 0.4 gm. per kilogram of animal. The blood, after twenty minutes, was withdrawn in two lots. The first lot was drawn at once into a solution of sodium oxalate in the proportion of nine parts of blood to one part of oxalate (one per cent sodium oxalate made up in 0.9 per cent solution of sodium chloride). The second lot was allowed to stand for thirty minutes to one hour and was then mixed with sodium oxalate in the same proportions as in the first lot. Both lots were then centrifugalized to obtain a clear plasma. It was believed that the second lot, because of standing for a time before its decalcification, would have enough thrombin formed so that kephalin solutions added to it might be able to cause clotting in the absence of calcium. The experiments carried out in accordance with this plan failed to demonstrate the point. Neither the plasma of lot one nor that of lot two would clot upon the addition of solutions of kephalin alone. Addition of calcium chloride alone caused prompt clotting, when the plasma was first diluted with an equal volume of water, and calcium solutions together with kephalin solutions were even more effective. A single example (see opposite page) will suffice to illustrate this point.

Similar results were obtained from other experiments in which the calcium was removed by the addition of sodium metaphosphate, sodium citrate, or sodium fluoride.

An interesting although inexplicable result which came out of

these experiments may be referred to briefly although it has no direct bearing upon the main problem which we were investigating. In a successful peptone plasma which does not clot spontaneously, even upon the addition of an equal volume of water, the addition of solutions of calcium chloride alone does not produce clotting while solutions of kephalin alone cause clotting in a few minutes. If this same

LOT I. PEPTONIZED DOG BLED AT ONCE INTO OXALATE SOLUTION

Peptone plasma	Water	CaCl ₂ (1%)	Kephalin solution	
1. 10 drops	10 drops	6 drops	10 drops	Clot in 2.5 min.
2. 10 drops	10 drops	0	10 drops	No clot in 24 hr.
3. 10 drops	20 drops	6 drops	0	Clot in 11 min.
4. 10 drops	20 drops	0	0	No clot in 24 hr.

LOT II. PEPTONIZED BLOOD KEPT THIRTY MINUTES BEFORE OXALATING

Peptone plasma	Water	CaCl ₂ (1%)	Kephalin solution	
1. 10 drops	10 drops	6 drops	10 drops	Clot in 2 min.
2. 10 drops	10 drops	0	10 drops	No decisive clot in 24 hr. Slight membrane formation
3. 10 drops	20 drops	6 drops	0	Clot in 8 min.
4. 10 drops	20 drops	0	0	No clot in 24 hr.

plasma is decalcified by the use of oxalate solutions addition of calcium chloride in quantity sufficient to overcome the excess of oxalate now causes clotting, while solutions of kephalin alone are without effect. It should be added that the promptness with which calcium causes clotting under these circumstances varied with the condition of the plasma, for example, with the amount of contained antithrombin, or with the dilution. If calcium is added to the undiluted plasma clotting may occur very slowly, whereas if the plasma is diluted once or twice with water clotting takes place promptly. As is well known, dilution weakens the effect of antithrombin. Several hypotheses may be suggested to explain this result, but as they are entirely speculative it is scarcely worth while to enumerate them. This result, however, together with other known facts regarding the action of solutions of kephalin, suggested that possibly the assumed effect of kephalin upon the antithrombin in the peptone plasmas was interfered with by the presence of an excess of the oxalate. The experi-

ments were modified, therefore, by providing for the removal of this excess of oxalate. For this purpose the oxalated peptone plasma was dialyzed in collodion tubes against large volumes of solutions of sodium chloride, 0.9 per cent, the outside solution being renewed once or twice. The results obtained from this series of experiments differed somewhat in details, for reasons which were not clear, but which depended probably upon certain variations in conditions that could not be controlled, such, for example, as the varying amounts of fibrin factors in the several bloods used, the character of the dialyzing membranes, etc. The important fact is that by this means we have been able to show that solutions of kephalin alone can cause clotting in peptone plasmas free from calcium. The following experimental results may be quoted in proof of this point.

Experiment.—Fasting dog. Eight per cent solution of Witte's peptone injected under pressure into the femoral artery in amount to give 0.4 gm. per kilogram of animal. Blood withdrawn after 20 minutes. One lot oxalated at once (9 pts. blood to 1 pt. solution of sodium oxalate made up in solution of sodium chloride 0.9 per cent) and one lot oxalated after standing 30 minutes. Each lot was centrifugalized to get a clear oxalated peptone plasma. Each lot was then dialyzed over night (15 hrs.) against a solution of sodium chloride, 0.9 per cent. The plasmas, free from oxalate and calcium, were then tested as follows:

LOT I				
Peptone plasma	Water	Kephalin solution	CaCl ₂ (1%)	
10 drops	20 drops	0	0	No clot in 24 hr.
10 drops	10 drops	10 drops	0	Clot in 45 to 50 min.
10 drops	0	20 drops	0	Clot in 1 hr.
10 drops	20 drops	0	1 drop	Clot in 15 min. — feeble

LOT II				
Peptone plasma	Water	Kephalin solution	CaCl ₂ (1%)	
10 drops	20 drops	0	0	No clot in 24 hr.
10 drops	10 drops	10 drops	0	Clot in 5 min.
10 drops	0	20 drops	0	Clot in 15 to 20 min.
10 drops	20 drops	0	1 drop	Clot in 15 min.

The kephalin solution used in these experiments was calcium free as was demonstrated by incinerating a large amount of the kephalin used and dissolving the ash in dilute hydrochloric acid. This solution gave no precipitate on the addition of ammonia and ammonium oxalate. It is not possible, therefore, to explain the clotting obtained with the solutions of kephalin on the hypothesis that the kephalin acted as a thrombokinas in conjunction with calcium as demanded by Morawitz's theory. Nor is it possible to assume that the kephalin acted as a kinase to activate alone the prothrombin present in the plasma. Other experiments, made with oxalated normal (non-peptonized) plasma, subsequently dialyzed for twenty-four hours to remove excess of oxalate, showed that the kephalin has no such action. Such plasmas clot readily on the addition of thrombin or of calcium solutions, but are entirely unaffected by solutions of kephalin.

The only hypothesis that explains satisfactorily the result obtained is that the kephalin by neutralizing the antithrombin contained in the peptone plasma allowed the thrombin present to react with the fibrinogen. The specimen — lot II—allowed to stand before oxalating clotted more readily than the other specimen — lot I— because more thrombin had formed. Some subsequent experiments carried out in a manner similar to the one described above gave a different result in that the solutions of kephalin did not cause clotting in the dialyzed plasma. Investigation showed that one difficulty lay in the length of time that the oxalated plasma was submitted to dialysis. As is well known thrombin is easily adsorbed and it is, therefore, probable that in plasma in which little thrombin is present this substance may be removed partially or completely either as a result of dialyzing off or because of adsorption by the substance of the dialyzing tube. If such an action takes place kephalin of course can no longer induce coagulation, if its action is limited to neutralizing the antithrombin. In later experiments, therefore, the plasma was examined from time to time during the dialysis to determine whether oxalate was still present and whether kephalin solutions caused coagulation. While each specimen of peptoneplasma used gave somewhat different results when treated by this method, it was possible in all cases to demonstrate that for a certain time after dialysis had proceeded the plasma when treated with kephalin alone gave a clot. Before the dialysis the kephalin had been ineffective and usually

when the dialysis had gone over a certain period the kephalin was again without effect, probably, as suggested above, because the ready-formed thrombin in the plasma had been destroyed or removed. Two examples may suffice to indicate the variations exhibited by different plasmas. In each experiment the dog was peptonized as described above and the withdrawn blood after standing was oxalated and centrifugalized to obtain a clear plasma. It was shown first that this oxalated plasma was not clotted by solutions of kephalin and it was then submitted to dialysis and tested from time to time.

Period of dialysis	Peptone plasma	I		
		Water	Kephalin solution	
15 min.	10 drops	10 drops	10 drops	Clot in 26 min.
30 min.	10 drops	10 drops	10 drops	Clot in 41 min.
60 min.	10 drops	10 drops	10 drops	Clot in 37 min.
120 min.	10 drops	10 drops	10 drops	No clot

At each interval a control, consisting of 10 drops of plasma and 20 drops of water, was prepared. Each remained unclotted for twenty-four hours.

Period of dialysis	Peptone plasma	II		
		Water	Kephalin solution	
15 min.	10 drops	10 drops	10 drops	No clot
30 min.	10 drops	10 drops	10 drops	No clot
45 min.	10 drops	10 drops	10 drops	Feeble clot over night
60 min.	10 drops	10 drops	10 drops	Feeble clot over night
90 min.	10 drops	10 drops	10 drops	Firm clot over night.
120 min.	10 drops	10 drops	10 drops	No clot but precipitate

Controls with water alone (peptone plasma 10 drops, water 20 drops) tried throughout the experiment gave a negative result in each case.

These dialyzed plasmas after dilution were tested also by the addition of solutions of calcium chloride. As would be expected this reagent caused clotting in most cases within a few minutes owing to its effect in activating the prothrombin present in the plasma. Since in most cases this reaction was obtained even after prolonged dialysis

lasting over several days it is evident that prothrombin unlike the thrombin is relatively stable. In one case, however, for reasons which were not apparent, the reaction with calcium was slower and slower as the dialysis proceeded and disappeared entirely after two hours.

In the above-described experiments it is assumed that the kephalin alone causes clotting of a calcium free plasma because by antagonizing or neutralizing the antithrombin it permits whatever ready-formed thrombin may be present to exert its action. On this view it is evident that if thrombin is added to the peptone plasma, in amounts insufficient to neutralize the antithrombin, the effect of the kephalin in causing clotting should be shown more clearly. Experiments demonstrated that this inference is correct. For example:

Experiment.—Dog weighing $7\frac{1}{2}$ kg. Injected into the femoral artery 3 gm. of Witte's peptone. After twenty minutes the blood was drawn from the carotid into an oxalate solution (9 parts of blood to 1 part of oxalate 1 per cent). The oxalated blood was centrifugalized at 3000 for thirty minutes. The clear plasma was drawn off and was dialyzed in a collodion tube against a solution of sodium chloride 0.9 per cent until the oxalate was completely removed. With this plasma the following experiments were performed in duplicate.

Peptone plasma	Water	Solution of thrombin	Solution of kephalin	Time of clotting
10 drops	15 drops	15 drops	5 drops	4½ min.
10 drops	10 drops	15 drops	10 drops	• 5½ min.
10 drops	20 drops	15 drops	0	Clot between 8 and 16 hr.
10 drops	25 drops	0	10 drops	No clot in 24 hr.
10 drops	35 drops	0	0	No clot in 24 hr.

It will be seen from this experiment that while the amount of thrombin added, 15 drops, caused clotting only after eight hours, the same amount of thrombin together with 5 or 10 drops of the kephalin caused prompt clotting in four to five minutes. In this plasma, owing to the promptness with which it was oxalated and centrifugalized, none of the prothrombin apparently was converted to thrombin or if so the latter was removed in the dialysis, since kephalin alone caused no clotting.

A word may be added in regard to the action of the oxalate in retarding the normal reaction of kephalin. This retarding influence

is indicated clearly enough by the experiments described above, but other observations have shown that even in the presence of an excess of oxalate the effect of kephalin in neutralizing antithrombin may be demonstrated, provided sufficient active thrombin is present in the mixture. In one series of experiments, for example, a peptone plasma was oxalated and was then divided into two portions. To one of them was added an equal volume of water, to the other an equal volume of a solution of kephalin and to these two portions a thrombin solution was added in increasing amounts to determine for each the minimal amount of thrombin requisite to cause clotting. In all cases the solution containing the kephalin clotted with the fewer drops of thrombin indicating that in spite of the oxalate the kephalin continued to exert some favoring influence. Under the conditions of the experiment the nature of this favoring influence can hardly be interpreted otherwise than on the hypothesis that it exerted a neutralizing effect of some kind upon the antithrombin.

SUMMARY

Calcium-free (oxalated) peptone plasma may be made to clot by the addition of calcium-free solutions of thromboplastic substance (kephalin), provided the excess of oxalate is removed by dialysis, properly controlled.

This action of the kephalin is demonstrated more easily if some thrombin is added previously to the dialyzed oxalated plasma in an amount insufficient in itself to overcome the effect of the antithrombin.

This result is opposed to the theory (Morawitz) that the thromboplastic substance acts as a kinase in conjunction with calcium, but is in accord with the view (Howell) that thromboplastic substance (kephalin) facilitates clotting by neutralizing the action of antithrombin.

ERRATA

in June number of the American Journal of Physiology (Vol. XXXII., No. II).

Substitute "*apparatus*" for "*apparati*" in the following places:

page 110, lines 7, 11, 23.

page 129, line 1.

page 137, line 28.

page 138, lines 1, 3.

page 144, line 6.

Substitute "*7.I c.c.*" for "*I.I c.c.*" on page 144, line 29.

In figure 1, page 120, correct as indicated the following drawing:

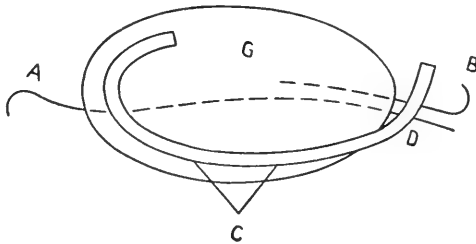

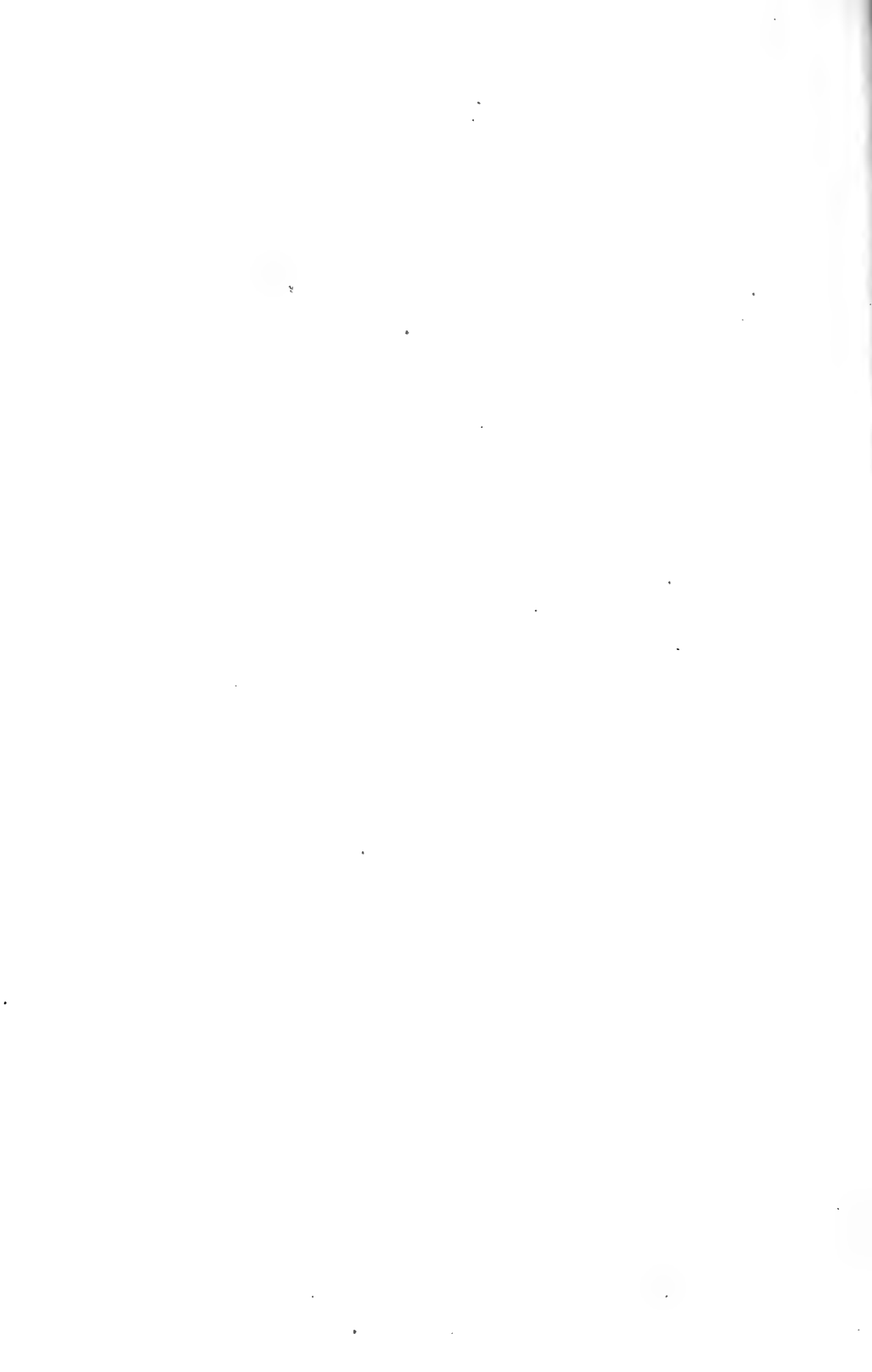

THE
American Journal of Physiology

VOL. XXXII

AUGUST 1, 1913

NO. IV

STUDIES IN FATIGUE

I. FATIGUE AS AFFECTED BY CHANGES OF ARTERIAL PRESSURE

BY CHARLES M. GRUBER

[From the Laboratory of Physiology in the Harvard Medical School.]

THAT increased muscular effort causes an increased arterial pressure has long been known. The reverse of this relation — the effect of arterial pressure on muscular efficiency — seems not to have attracted much attention. After carefully searching through the literature I have been unable to find any references to observations on the effects of changes of arterial pressure, either increase or decrease, on neuro-muscular fatigue. In a recent paper¹ Cannon and Nice have called attention to the need of more exact study of the relation between the circulation and muscular ability, and the work here reported was undertaken with the purpose of making clearer these relations.

THE METHOD

Cats, anaesthetized with urethane (2 gm. per kilo, by stomach) were used in the experiments. By making a small slit through the skin on the outer side of the left thigh, the sciatic nerve was isolated, cut, and its distal end fastened in a Sherrington shielded electrode. The electrode was then held in place by fastening around it, with paper clips, the two flaps of skin.

¹ CANNON and NICE: this Journal, 1913, xxxii, p. 80.

Through another small slit in the skin the tendon of the left *tibialis anticus* muscle was isolated from its insertion. The tendon was then fastened to a muscle lever by a string passing about a series of pulleys. These pulleys were arranged so that the muscle pulled in its normal direction. One leather loop about the hock and another around the foot just below the fastening of the tendon bound the leg to the board and made a very satisfactory nerve muscle preparation. This preparation had its normal blood supply, unaltered except by the cutting of the sciatic nerve.

The stimulating current in every case was a break induction shock, obtained from a Martin vulcanite knife-blade key² operated by an electro-magnet as follows. A soft iron bar was pivoted near its centre to an upright board. Below one end of the bar was an electro-magnet, working in opposition to a flat steel spring attached to the other end of the bar. An upright iron rod, fastened near the centre of the bar, was connected at the other end (by a wire link) to the inverted brass triangle of the Martin key. Thus as the upright rod was moved to and fro it moved the knife blade making and breaking the circuit through the mercury in the key. A motor running at a uniform rate was used to revolve a metallic cylinder provided with projecting points, which made and broke the current in the electro-magnet circuit, usually 160 times per minute. In a few experiments lower rates were used. This rate was slow enough to produce not vasoconstriction but vasodilation³ in the vessels of the stimulated muscle. The secondary of the inductorium was connected with the shielded electrode on the sciatic nerve.

The muscle lever consisted of a piece of light straw 20 cm. in length from the axis to the writing point. The tendon was attached 4.5 cm. from the axis and at the moment of contraction began to pull against the tension developed in a spring which was attached at the same position on the lever. This spring, in the majority of cases, had a tension of 120 gm. the moment the muscle began to contract, but in a few cases it had an initial tension of as much as 250 gm. For each 2.5 cm. excursion of the muscle lever on the drum the spring increased 15 gm. above the original 120.

² MARTIN: this Journal, 1910, xxvi, p. 181.

³ BOWDITCH and WARREN: Journal of physiology, 1886, vii, p. 416; BRADFORD: *Ibid.*, 1889, x, p. 390.

The blood pressure was registered from the right carotid or femoral artery by means of a mercury manometer. A time marker which indicated intervals of thirty seconds was placed at the atmospheric pressure line of the manometer. Thus, at any given muscular contraction, the height of blood pressure was simultaneously recorded.

The blood-pressure style, muscle lever and time marker were all placed in a vertical line on the kymograph surface. The rate of the drum was always slow and the muscle contractions were recorded close together.

Several methods were used to vary the blood pressure. Those employed to raise it were: (1) stimulation of the spinal cord in the cervical region with platinum electrodes, and (2) stimulation of the left splanchnic nerves with the adrenal glands tied off. The electrode used on the splanchnic nerves was similar to that used by Cannon and Nice.⁴ The methods employed to lower the pressure were: (1) simple compression of the thorax; (2) pulling on a loop placed around the aorta just above its iliac branches, and (3) injection of very small doses of adrenalin⁵ through a cannula in the left external jugular vein.

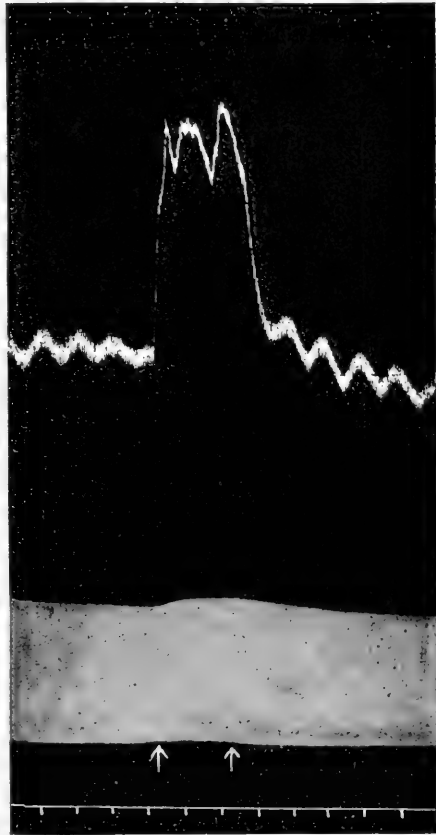

FIGURE 1. In this and all following records, the upper curve indicates the blood pressure the middle line muscular contraction, and the lower line the time in 30 seconds (also zero blood pressure). Between the arrows the exposed cervical spinal cord was stimulated.

⁴ See CANNON and NICE: *Loc. cit.*, p. 71.

⁵ See CANNON and LYMAN: this Journal, 1913, xxxi, p. 376.

THE EFFECTS OF INCREASED ARTERIAL PRESSURE

In taking up the results of variations of arterial pressure on fatigue, it is convenient to consider first, the effect of rise of pressure. This rise was brought about in the experiment represented in Fig. 1, by stimulation of the cervical spinal cord, and in Figs. 2 and 3 by stimu-

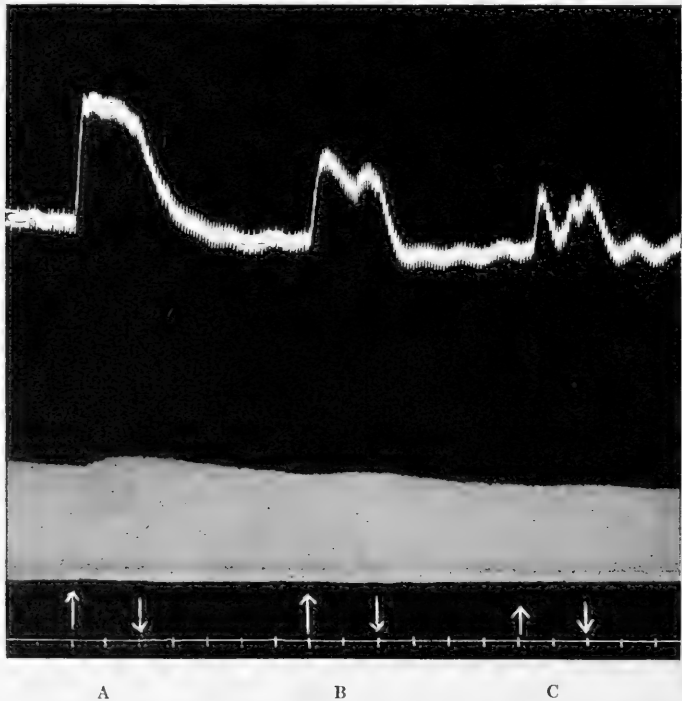

FIGURE 2. Stimulation of the left splanchnic nerves (left adrenal gland tied off) during the period indicated by the arrows.

lation of the left splanchnic nerves after the left adrenal gland was tied off. The original blood pressure in Fig. 1 was 120 mm. of mercury. This was increased 62 mm. with an increase of only 8.4 per cent in the height of muscle contraction. In Fig. 2 the original pressure was 100 mm. of mercury. By increasing this pressure 32 mm. there resulted a synchronous betterment of 9.8 per cent in the height of muscular contraction. In Fig. 2B the arterial pressure was raised 26 mm. and the height of contraction increased correspondingly 7 per cent. In Fig. 2C no appreciable betterment can be seen although the blood

pressure rose 18 mm. In Fig. 3 the original blood pressure was very low — 68 mm. of mercury. This was increased in Fig. 3A 18 mm. with an increase in the height of contraction of 20 per cent; in Fig. 3B 24 mm. with a corresponding increase of 90 per cent and in Fig. 3C 30 mm. with a betterment of 125 per cent.

That this increase in the height of contraction is due to the increase in blood pressure seems almost beyond dispute. It is evident from

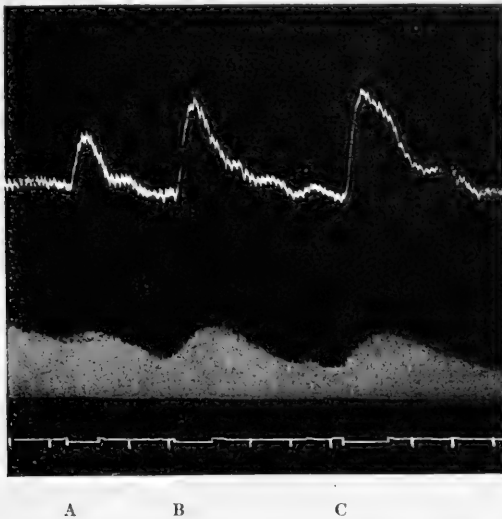

FIGURE 3. During the period indicated in the time line the left splanchnic nerves were stimulated. The vessels of the left adrenal gland were tied off.

these observations that when the blood pressure is low a small rise has many times the effect that it has when the pressure is high. There is abundant evidence that fatigue products accumulate in a muscle doing work.⁶ As the pressure rises, thus bettering the circulation through the active muscle, these products are carried away more rapidly. Moreover, since the stimulation of the sciatic nerve used

⁶ DuBois, REYMOND: *Archiv für Anatomie*, 1859, p. 849; RANKE: *Archiv für Anatomie*, 1863, pp. 422-450; MOLESCHOTT and BATTISTINI: *Archives italiennes de biologie*, 1887, viii, pp. 90-124; GLEISS: *Archiv für die gesammte Physiologie*, 1887, xl, pp. 69-75; LANDSBERGER: *Archiv für die gesammte Physiologie*, 1891, l, pp. 339-363; FLETCHER and HOPKINS: *Journal of physiology*, 1906-07, xxxv, p. 247; LEE: *this Journal*, 1907, xviii, p. 267.

in these experiments was too slow to cause vasoconstriction, but instead caused vasodilation the opportunity for the blood to pass readily in large volume through the vessels and thus to carry away a large per cent of the accumulated waste products of fatigue, is obvious. Ranke⁷ found that if a muscle is deprived of its circulation and fatigued to a standstill, and then the circulation restored, it again contracts for a short time due to the neutralization of the waste-products by the blood.

THE EFFECT OF MECHANICAL DECREASE OF ARTERIAL PRESSURE

If an increase in blood pressure produces an increase in the height of muscle contraction it is natural to suppose that a decrease in

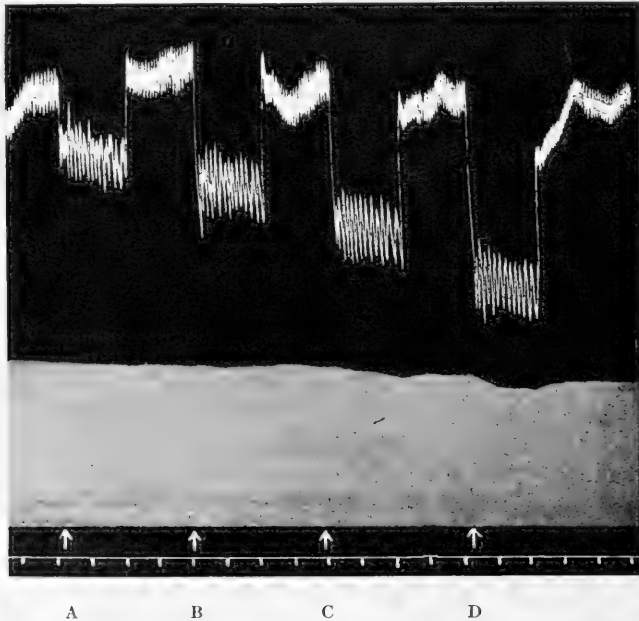

FIGURE 4. The arrows indicate the point at which the thorax began to be compressed.

blood pressure would have the opposite effect. Such is the case only when the blood pressure falls below the region of 90 to 100 mm. of mercury. Thus, if the arterial pressure is 150 mm. of mercury it

⁷ RANKE: *Archiv für Anatomie*, 1863, p. 446.

has to fall approximately 55 to 65 mm. before it produces a decreased effect in the height of contraction. Fig. 4 is a record in which the blood pressure was decreased by compressing the thorax. The record shows that, when the pressure dropped from 120 to 100 mm. of mercury there was no appreciable decrease in the height of contraction; when to 90 mm. of mercury there resulted a decrease of 2.4 per cent; when to 80 mm. of mercury a 7 per cent decrease and when to 70 mm. a 17.3 per cent decrease.

Thus about 90 to 100 mm. of mercury may be called the critical region at which the decrease in blood pressure is accompanied by a concurrent decrease in the height of muscular contraction. It is near that point that the blood flow is in danger of being insufficient.

Results similar to those represented in Fig. 4 were obtained by pulling on a string looped about the aorta just above the iliac branches.



FIGURE 5. During the period indicated in the time line 0.3 c.c. of a 1:100,000 solution of adrenalin was injected into the left external jugular vein.

THE EFFECT OF DECREASING THE ARTERIAL PRESSURE BY ADRENALIN

In the third series of experiments adrenalin was used to lower the blood pressure. Cannon and Lyman found that adrenalin injected in small doses — 0.1 to 0.2 c.c. of 1: 100,000 solution — produces a fall in blood pressure until a critical region was reached. Below this region the same amount injected produces a rise.⁸

In Fig. 5, 0.3 c.c. of 1: 100,000 solution of adrenalin was injected slowly into the right external jugular vein. The blood pressure dropped from 120 mm. to 96 mm. of mercury. With this decrease in arterial pressure there was a resultant betterment of 14.3 per cent

⁸ *Loc. cit.*, p. 389.

in the height of muscular contraction. Since this fall of pressure is within the critical zone a uniform contraction or a decrease would be expected. A similar drop in arterial pressure is shown in Fig. 4B.

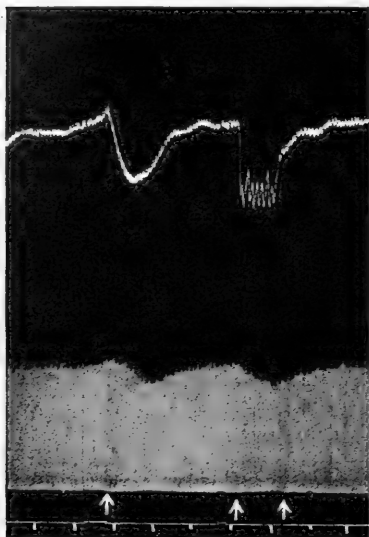

FIGURE 6. In A, at the point indicated by an arrow, 0.3 c.c. of a 1:100,000 solution of adrenalin was injected intravenously. In B, the arrows indicate the period during which the thorax was compressed.

This was brought about mechanically and there resulted a decrease of 2.4 per cent in the height of contraction. When at 100 mm. no change resulted. This betterment may be accounted for by the effect of adrenalin.⁹

A quite different effect is shown in Fig. 6A. The same amount of adrenalin — 0.3 c.c. 1: 100,000 solution — was injected as in the case represented in Fig. 5. In this case, however, the blood pressure fell from a low region to a region below the critical region — 108 to 90 mm. of mercury. Instead of a betterment in the height of contraction, as in the preceding experiment, there was a decrease of 18.7 per cent. The same result followed when the pressure was lowered by compressing the thorax. In Fig. 6B an almost equal fall of blood pressure was thus produced and a fall of 17.7 per cent in the height of contraction resulted.

Fig. 7 confirms Fig. 6 very well. In Fig. 7A, as in Fig. 6A, 0.3 c.c. of 1: 100,000 solution of adrenalin was injected. There was a fall in blood pressure from 102 to 80 mm. of mercury and a corresponding fall of 17.7 per cent in the height of contraction. In Fig. 7B the same quantity of adrenalin was injected but here the blood pressure was maintained above the critical point by stimulating the left splanchnic nerves (with the left adrenalin vessels tied) at the points indicated by arrows. No fall in the height of muscular contraction resulted. This seems to indicate that, in these cases, the muscular contraction is

⁹ See CANNON and NICE: *Loc. cit.*, p. 74.

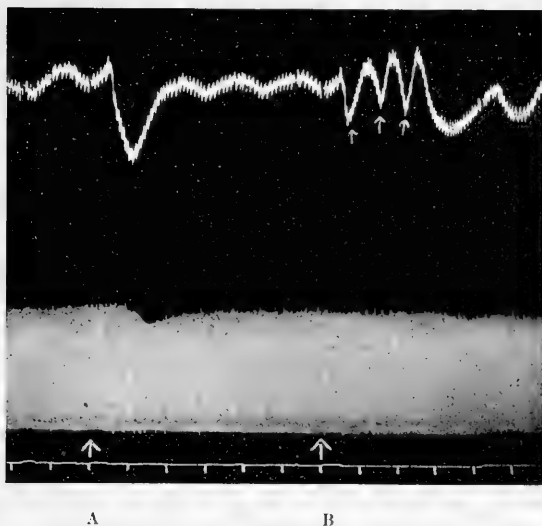

FIGURE 7. In A, the arrow indicates the point at which 0.3 c.c. of a 1:100,000 solution of adrenalin was injected. In B, the lower arrow indicates the point at which the same quantity of adrenalin was injected. The upper three arrows indicate the points at which the left splanchnic nerves were stimulated. The left adrenal gland was tied off.

dependent upon the blood flow rather than upon the action of adrenalin.

SUMMARY

1. Increasing the arterial pressure, thus bettering the circulation, increases the height of muscular contraction 100 to 125 per cent when the blood pressure is below 90 to 100 mm. of mercury but only 5 to 25 per cent when the pressure is above this region.

2. As the blood pressure or the circulation is decreased, the height of muscular contraction is lowered, but this takes place only when the arterial pressure falls below 90 to 100 mm. of mercury.

3. Small doses of adrenalin — 0.1 to 0.3 c.c. of a 1:100,000 solution — slowly injected intravenously, cause a fall of arterial pressure. When this fall is not below the critical region — about 90 to 100 mm. of mercury — a betterment in the height of contraction results; when below this zone the result is the opposite.

I wish to express my thanks to Dr. W. B. Cannon for valuable suggestions offered me during these experiments.

CONTRIBUTIONS FROM THE ZOÖLOGICAL LABORATORY OF
THE MUSEUM OF COMPARATIVE ZOÖLOGY AT
HARVARD COLLEGE, No. 238

ON CERTAIN DISTINCTIONS BETWEEN TASTE AND
SMELL

BY GEORGE HOWARD PARKER AND ELEANOR MERRITT STABLER

INTRODUCTION

PERHAPS the most widely accepted distinction between taste and smell is that taste is excited by materials in the state of solution and smell is called forth by substances in a vaporous or gaseous condition. This distinction is based upon an experiment on sensory stimulation published by E. H. Weber in 1847 in which he showed that a dilute solution of eau de cologne, though highly odorous when sniffed, produced no sensation of smell when poured into the nose. Nagel, many years later (1894), was so fully persuaded of the correctness of this view that he went so far as to deny a sense of smell to water-inhabiting vertebrates, such as the fishes, etc., maintaining that solutions were inodorous and that the so-called olfactory organs of fishes and other water-inhabiting animals were more in the nature of organs of taste than organs of smell.

Meanwhile, Aronsohn (1884), who had repeated Weber's experiment, declared that substances in solution when poured into the nose, could be smelled, provided they were dissolved in a physiological salt solution that was kept warmed to about the temperature of the human body. This conclusion was confirmed by Vaschide (1901), and by Veress (1903), though the latter showed that the solutions tested were rather in the nature of heterologous than homologous stimuli. Thus, notwithstanding the opinion of Zwaardemaker (1895), Haycraft (1900), and others, it seems to us that solutions must be admitted to

be stimuli for the olfactory surfaces, a conclusion in agreement with the belief expressed many years ago by Müller (1837, p. 484) and reiterated recently by von Frey (1904, p. 334) and even by Nagel (1904, p. 600), that in normal olfaction in man the odorous particles are caught on the moist olfactory surfaces and dissolved there before they can act on the nerve terminals. The belief that solutions are stimuli for the olfactory surface is also favorable to the view that fishes and water-inhabiting amphibians may have as true an olfactory organ as air-inhabiting vertebrates do, a conclusion suggested by the observations of Aronsohn (1884, p. 164) on goldfish, and of Baglioni (1909a, p. 719) on *Balistes*, and proven by the experiments of Parker (1910, 1911) on *Ameiurus* and *Fundulus*, of Sheldon (1911) on *Mustelus*, and of Copeland (1912) on *Spheroides*. It must, therefore, be admitted that in both air-inhabiting and water-inhabiting vertebrates the stimulus for the olfactory organs is in reality a solution and, since this is also true for the sense of taste, the problem naturally presents itself of the real difference between smell and taste.

In attacking this question it seemed well to select as a stimulus a substance that was relatively simple chemically, that was easily obtainable in pure form, and that was at once a stimulus for both smell and taste. Such a substance was found in ethyl alcohol. This well-known reagent has a characteristic odor and a well-marked sweetish taste. Our preliminary tests were carried out with a high-grade laboratory product, but our final tests were made with Kahlbaum's alcohol of the highest obtainable purity and guaranteed to contain not over 0.2 per cent water. The alcohol was received in sealed tin containers and was kept by us in glass-stoppered bottles. In carrying out our tests we endeavored to determine the lowest dilutions at which the sweet taste and the characteristic smell could be excited as well as that which would call forth the first signs of sting from those surfaces of the mouth that are unprovided with gustatory organs. In order that the various concentrations of alcohol used as stimuli for the several sense organs might be compared, we have made all dilutions on the basis of the relative number of molecules and expressed them in terms of molecular solutions or corresponding gas dilutions and not in per cents as has been done heretofore by many investigators.

TASTE FROM ETHYL ALCOHOL

So far as the taste of ethyl alcohol was concerned, it was our object to ascertain the weakest dilution at which the sweet taste could be distinguished. We therefore prepared a 10 mol. solution of the purest alcohol and this we used as a stock from which weaker solutions were made as they were needed. In each test the subject was required to close the eyes, close the nose by pinching it between thumb and finger, and receive on the extended tongue near the tip two drops of the fluid to be tested. The glass dropping apparatus that we used delivered 297 drops of dilute alcohol per 5 c.c. The two drops generally employed in these experiments represent, therefore, about 0.017 c.c. The fluids used in these tests were dilute alcohol and, as a check, distilled water. After the fluid had been on the tongue a short time and before the nose was released, the subject was required to state whether the fluid was distilled water or dilute alcohol. Preliminary tests showed that a fold of filter paper wet with dilute alcohol and held in the cavity of the mouth, but not in contact with its walls, could not be distinguished from a similar fold wet with distilled water. Hence there was no reason to suppose that the determinations were influenced by any diffusion of alcoholic vapor from behind into the nasal chambers. It is believed that the determinations depended absolutely on the action of the materials on the surface of the tongue. The subjects of the tests were the authors of the paper, one experimenting on the other. After each test the subject washed out the mouth with tepid tap water and rested for a period of about five minutes before another test was made.

To a solution of alcohol of 5 mol. strength both subjects responded with perfect accuracy and, on repeated trials, they always distinguished the dilute alcohol from the distilled water. At a dilution of 3 mol. the sweet taste of the alcohol was very faint. In ten tests nine were correct and one a failure. On applying the two drops of dilute alcohol to the tongue, both subjects regularly experienced a slight indescribable sensation before the characteristic sweet taste of the alcohol appeared. This preliminary sensation was quickly and completely obliterated by the sweet taste that followed. At a dilution of 2 mol. the subjects failed five times in ten trials and we there-

fore conclude that the weakest solution that can call forth the sweet sensation with certainty is of about 3 mol. strength.

A comparison of the sweet taste of cane sugar with that of ethyl alcohol showed the former to be much the more effective stimulus. While it was possible to distinguish with certainty a solution of ethyl alcohol of not less than 3 mol. concentration, a solution of cane sugar of only $\frac{1}{20}$ mol. concentration was easily recognized and, judging from the results of Lemberger (1908, p. 303), still more dilute solutions can be easily distinguished. Ethyl alcohol is to be regarded, therefore, as a not very efficient stimulus for the sweet taste.

IRRITATION FROM ETHYL ALCOHOL

Distilled water and solutions of alcohol were applied to certain non-gustatory surfaces of the mouth in the same manner as to the tongue, with the intention of determining the weakest dilution that would call forth the slight stinging and warming effect of alcohol on such surfaces. Three regions were selected for these tests: first, the region on the floor of the mouth between the lower incisors and the root of the tongue; secondly, the space between the lower lip and the lower incisors; and thirdly, the inner face of the cheek.

In the region between the lower incisors and the root of the tongue, the results were most uniform. At a concentration of 10 mol. ten correct determinations were made in ten trials. At 5 mol., however, there were six failures in ten trials.

In the region between the lower lip and the incisors the results were less uniform than on the floor of the mouth proper. One subject (E. M. S.) distinguished with certainty the 5 mol. solution of alcohol but failed generally on the 3 mol. solution; and the other subject (G. H. P.) distinguished the 10 mol. solution but failed on the 5 mol. solution.

The records of the tests on the inner surfaces of the cheeks show a somewhat similar difference. A 10 mol. solution of alcohol was always distinguished with certainty from distilled water by one subject (E. M. S.) and poorly distinguished by the other (G. H. P.). At a dilution of 5 mol. both subjects failed to distinguish between the water and the distilled alcohol. In this, as in the preceding trials, one subject (E. M. S.) proved to be somewhat more sensitive than the

other (G. H. P.), a condition probably dependent upon the greater youthfulness of the former.

The sensations produced in these tests were described in a variety of ways, such as faintly warming, warmish sting, slightly stinging, prickling, etc., but they all partook in general of the nature of slight irritations. They probably result from the stimulation of sense organs which have recently been designated as those of the common chemical sense (Parker, 1912), and which probably pervade many of the peripheral mucous surfaces of the body.

THE SMELL FROM ETHYL ALCOHOL

In determining the weakest dilution at which the characteristic smell of alcohol could be detected, a method of procedure different from that used for taste had to be employed. This was in essentials the method that had been used by Valentin (1850), Fischer und Penzoldt (1886), and others. Our own procedure was as follows: Two glass battery jars of equal capacity, 1340 c.c., were cleaned till they gave the least possible odor. It was found impossible to free such jars entirely from smell. A careful examination always disclosed a faint clay-like odor, which, from its constancy, we were led to believe was due to the glass itself. When the two jars were indistinguishable in this respect, a drop of distilled water was put in one and a drop of dilute alcohol in the other. Both jars were covered and the fluids allowed to evaporate completely, a process which was facilitated by the introduction of a small electric fan, through the cover of the jar. After the complete evaporation of the fluids, the jars were tested in sequence by the subject, who, with eyes closed, was allowed a full breath through the nose from first one and then the other jar. The subject was then required to state in which jar the alcohol had been evaporated. The jars were then carefully washed and, after having been dried, were tested for their own smell and prepared for another trial.

The results obtained from these tests were remarkably uniform and constant for the two subjects. Both subjects distinguished with invariable correctness the jar in which a drop of a 10 mol. solution of alcohol had been evaporated from the one in which an equal amount of distilled water had been vaporized. When a drop of dilute alcohol

of 5 mol. concentration was evaporated in the jar, six failures in ten were made. Taking into account the dilution due to the evaporation into the known volume of air in the jar, the results may be stated as follows: both subjects detected the alcohol in an aerial dilution of $\frac{1}{7960}$ mol., but failed to detect it at $\frac{1}{15,920}$ mol. In other words the most considerable dilution at which the alcohol could be detected by the olfactory apparatus was about $\frac{1}{8000}$ mol.

This determination was obtained by the use of Kahlbaum's purest grade of alcohol. The preliminary trials made with the high-grade laboratory alcohol gave a very different result. The jar in which the laboratory alcohol had been evaporated could be distinguished when the contents were at a dilution of $\frac{1}{200,000}$ or even $\frac{1}{400,000}$ mol. The odor noted at these dilutions, however, had a sharp and penetrating quality quite unlike that of alcohol and was without question due to some impurity. In the test with the Kahlbaum alcohol, the odor remained constantly alcoholic to the weakest dilution that could be smelled. We therefore believe that the limit of dilution, $\frac{1}{8000}$ mol., found by us for the odor of ethyl alcohol is a reliable determination uninfluenced by impurities.

The only previous record of such a determination that we have been able to find is that given by Passy (1892^b, p. 1140), who states that 0.250 mg. of ethyl alcohol in a litre of air is the least concentration at which alcohol can be detected by its odor.¹ This is equivalent to a dilution of $\frac{1}{184,000}$ mol., which is so near that of the least perceptible dilution of our laboratory stock that we suspect that this determination, like that for our laboratory stock, was influenced by an impurity and does not represent the real limit for pure alcohol.

DISCUSSION

It appears to us that the evidence is sufficient to justify the conclusion that in vertebrates the stimulus for smell is a substance dissolved in the fluids that bathe the olfactory surface and that in this respect smell and taste are similar. The difficulty in imitating a normal stimulation of the olfactory organs by solutions experimentally

¹ Passy (1892,^a p. 307) elsewhere states that $\frac{1}{200}$ gm. of ethyl alcohol in a litre of air is only slightly perceptible. This concentration is twenty times that referred to by Passy as the lowest concentration that can be smelled.

introduced into the nose of air-inhabiting animals is due in our opinion to the inability of the investigator to reproduce the olfactory solvent. This material, the slimy covering of the olfactory surface, is very different from water or even warmed physiological salt solution. Hence, it is not surprising that odorous substances dissolved in these media should not act as normal stimuli for the olfactory surfaces of air-inhabiting vertebrates. Were it possible to imitate closely the olfactory solvent, we believe that there would be no difficulty in stimulating the olfactory organs with solutions made up in this solvent. The fact, known even to Weber (1847, p. 351), that water introduced into the human nose will cause a temporary loss of the power of smell, is enough to show the extreme sensitiveness of the olfactory organ and to suggest that any fluid, except that which is normal to it, may be physiologically disturbing to its surface. Hence, we put at naught those experiments that have thus far yielded negative results on introducing odorous solutions into the nose and believe that these results are dependent upon the disturbing effect of the solvent rather than on the inability of the olfactory organs to be stimulated by dissolved materials. In fishes the olfactory surfaces are apparently undisturbed by the water that bathes them, but in air-inhabiting vertebrates these surfaces seem to have become adapted to a well-developed slimy covering and thus to have lost their ability to respond normally to simple aqueous solutions. It is this loss of responsiveness that has led, in our opinion, to the degeneration of the olfactory apparatus in such mammals as the whales, whose aquatic habits, in comparison with those of fishes, have been secondarily acquired. We therefore definitely abandon the idea that taste and smell differ on the basis of the physical condition of the stimulus, a state of solution for taste, a gaseous or vaporous condition for smell, and maintain that both senses are stimulated by solutions, though in smell, at least for air-inhabiting vertebrates, the solvent is of a very special kind.

If the senses of taste and smell are stimulated by solutions, the probability that they are both chemical senses, as maintained long ago by Nagel (1894), is thereby greatly increased, and from this standpoint a partial distinction between them may be drawn on the basis of the solutes. Most substances that we smell have no taste, and most substances that we taste are without smell. Thus the olfactory sense is attuned to one set of substances and the gustatory

to another. But this distinction has numerous exceptions, for not a few organic substances, like alcohol for example, have both taste and smell, and, judging from the work of Veress (1903), there are inorganic salts with smells as well as tastes. Nevertheless the distinction pointed out seems to us to have some value.

But the difference between taste and smell that we believe to be of a still more general character is a quantitative one; we smell very dilute solutions, we taste only relatively strong ones. This difference appears most clearly when we deal with the dilution of the stimulus as expressed in terms of molecular solutions rather than in per cent, for this method allows us to compare mixtures of gaseous materials with solutions. If, from this standpoint, we compare the stimuli for some of the most penetrating odors with those of the strongest tastes, the contrast becomes very striking. One of the strongest tastes is the bitter taste of quinine hydrochloride and this can be excited by a solution as dilute as $\frac{1}{25,000}$ mol. One of the strongest smells known is that of mercaptan of which, according to Fischer und Penzoldt (1886, p. 8), 0.01 mg. evaporated in 230 c.c. of air gives a perceptible odor. Assuming the substance used to have been *methyl* mercaptan and stating the matter in terms of a molecular solution, this substance can be smelled at a dilution of $\frac{1}{1,104,000,000,000,000}$ mol. Thus it appears that when we compare the most powerful tastes with the most powerful smells, we find that the olfactory organ of man is responsive to a dilution over 44,000,000 times greater than that to which the sense of taste responds. But this comparison is obviously inexact since the stimuli for the two senses are different substances. Hence, the importance of making this comparison with a substance that is a stimulus for both smell and taste. Ethyl alcohol, as recorded in this paper, can barely be recognized by taste at a concentration of 3 mol., but it is discernible by smell at a dilution of about $\frac{1}{8000}$ mol. This comparison, then, like that between mercaptan and quinine, shows that the olfactory organs of man are much more sensitive to ethyl alcohol than are his gustatory organs, the ratio of the stimuli being about 1 to 24,000.

Although we believe that the distinction between taste and smell as presented in the preceding paragraph is a valid one, we are perfectly aware that the measurements upon which this opinion is based are not measurements of the real stimuli. They show the relative

concentration of molecules in the materials supplied to the tongue and to the moist olfactory surfaces; they do not show the molecular concentrations in contact with the actual end-organs. It is probable, however, that in both smell and taste the concentration of stimulating material at the end-organ is not far from that in the adjacent source, the air in the olfactory organ or the solution on the surface of the tongue. We therefore believe that we are correct in concluding that we smell enormously attenuated solutions and taste only relatively strong ones. In this respect the two senses may be said to differ from each other more or less as ordinary scales do from a chemical balance; taste is used in determining the presence of relatively large amounts of substance, smell for only the most minute quantities. Hence, taste is inoperative except when the source is very near at hand, usually in the mouth, whereas smell may be active when the source is far distant, the dilution suffered by the stimulating substance in its spread not having been sufficient to have brought it below the concentration necessary for stimulation.

SUMMARY

1. The weakest aqueous solution of ethyl alcohol that could be tasted was of about 3 mol. concentration.

2. The weakest aqueous solutions of ethyl alcohol that just stimulated the non-gustatory surfaces of the mouth were as follows: for the region between the lower incisors and the root of the tongue, 10 mol.; for the region between the lower lip and the incisors, from 5 to 10 mol.; and for the inner surface of the cheek, 10 mol.

3. The weakest aerial dilution of ethyl alcohol that could be smelled was about $\frac{1}{8000}$ mol.

4. Ordinary grades of ethyl alcohol may excite smell at dilutions as low as $\frac{1}{400,000}$ mol., but this is probably due to impurities.

5. Both smell and taste are stimulated by solutions. In air-inhabiting vertebrates the olfactory solvent is a slimy fluid of organic origin and not easily imitated. Hence the olfactory organs of these animals are not appropriately stimulated by ordinary aqueous solutions.

6. Beside the different chemical nature of the stimuli, that for the sense of taste is a relatively strong solution, that for smell a rela-

tively weak solution. The dilutions of ethyl alcohol as minimum stimuli for smell and taste are as 1 to 24,000.

BIBLIOGRAPHY

- ARONSOHN, E.: 1884. Beiträge zur Physiologie des Geruchs. Arch. für Anat. u. Physiol., physiol. Abt., Jahrg., 1884, pp. 163-167.
- BAGLIONI, S.: 1909a. Zur Physiologie des Geruchsinnens und des Tastsinnes der Seetiere. Zentralbl. für Physiol., Bd. 22, pp. 719-723.
- BAGLIONI, S.: 1909b. Contributions expérimentales à la physiologie du sens olfactif et du sens tactile des animaux marins ("Octopus" et quelques poisson). Arch. Ital. Biol., tome 52, pp. 225-230.
- COPELAND, M.: 1912. The Olfactory Reactions of the Puffer or Swell-fish, *Spheroides maculatus* (Bloch and Schneider). Journ. Exper. Zoöl., xii, pp. 363-368.
- FISCHER, E. UND F. PENZOLDT: 1886. Ueber die Empfindlichkeit des Geruchsinnens. Sitzungsber. phys.-med. Soc., Erlangen, Heft 18, pp. 7-10.
- FREY, M. VON: 1904. Vorlesungen über Physiologie. Berlin, 8vo, x + 392 pages.
- HAYCRAFT, J. B.: 1900. The Sense of Smell. In E. A. Schäfer, Text-book of Physiology, ii, pp. 1247-1258.
- LARGUIER DES BANCELS, L.: 1912. Le Gout et l'Odorat. Paris, 8vo, x + 94 pages.
- LEMBERGER, F.: 1908. Psychophysische Untersuchungen über den Geschmack von Zucker und Saccharin (Saccharose und Krystallose). Arch. für ges. Physiol., Bd. 123, pp. 293-311.
- MÜLLER, J.: 1837. Handbuch der Physiologie der Menschen. Band 2. Coblenz, 8vo, 780 pages.
- NAGEL, W.: 1894. Vergleichend-physiologische und anatomische Untersuchungen über den Geruchs- und Geschmackssinn und ihre Organe. Bibl. Zool., Heft 18, viii + 207 pages, 7 Taf.
- NAGEL, W.: 1904. Handbuch der Physiologie des Menschen. Band 3. Erste Hälfte. Braunschweig, 8vo, xvii + 806 pages.
- PARKER, G. H.: 1910. Olfactory Reactions in Fishes. Journ. Exper. Zoöl., viii, pp. 537-542.
- PARKER, G. H.: 1911. The Olfactory Reactions of the Common Killifish, *Fundulus heteroclitus* (Linn.). Journ. Exper. Zoöl., x, pp. 1-5.
- PARKER, G. H.: 1912. The Relation of Smell, Taste, and the Common Chemical Sense in Vertebrates. Journ. Acad. Nat. Sci., Philadelphia, xv, pp. 219-234.

- PARKER, G. H., AND R. E. SHELDON: 1913. The Sense of Smell in Fishes. Bull. United States Bureau Fisheries, xxxii, pp. 33-46.
- PARKER, G. H., and E. M. STABLER: 1913. Taste, Smell and Allied Senses. Science, N. S., xxxvii, p. 269.
- PASSY, J.: 1892a. Sur les minimums perceptibles de quelques odeurs. Compt. Rend. Acad. Sci., Paris, tome 114, pp. 306-308.
- PASSY, J.: 1892b. Les propriétés odorantes des alcools de la série grasse. Compt. Rend. Acad. Sci., Paris, tome 114, pp. 1140-1143.
- SHELDON, R. E.: 1911. The Sense of Smell in Selachians. Journ. Exper. Zool., x, pp. 51-62.
- VALENTIN, G.: 1850. Grundriss der Physiologie der Menschen. Dritte Auflage. Braunschweig, 8vo., vii + 733 pages, 5 Taf.
- VASCHIDE, N.: 1901. L'expérience de Weber et l'olfaction en milieu liquide. Compt. Rend. Soc. Biol., Paris, ann. 53, pp. 165-167.
- VERESS, E.: 1903. Ueber die Reizung des Riechorgans durch directe Einwirkung riechende Flüssigkeiten. Arch. ges. Physiol., Bd. 95, pp. 368-408.
- WEBER, E. H.: 1847. Ueber den Einfluss der Erwärmung und Erkältung der Nerven auf ihr Leitungsvermögen. Arch. Anat. Physiol. und wissenschaftl. Med., Jahrg., 1847, pp. 342-356.
- ZWAARDEMAKER, H.: 1895. Die Physiologie des Geruchs. Leipzig, 8vo, vi + 324 pages.

THE
American Journal of Physiology

VOL. XXXII

SEPTEMBER 2, 1913

NO. V

IS THE PRESSOR EFFECT OF PITUITRIN DUE TO
ADRENAL STIMULATION

By R. G. HOSKINS AND CLAYTON McPEEK

[From the Laboratory of Physiology of the Starling-Ohio Medical College]

OUR first experiments were made upon dogs under ether-urethane anaesthesia. In most cases the experiments were begun under ether, then urethane (two grams per kilo) was immediately introduced into the stomach and the ether gradually discontinued as the urethane became effective. In some instances, however, a slight amount of ether had to be continued throughout the experiment in order to maintain satisfactory anaesthesia. Cannulas were introduced into the carotid artery for the registration of blood pressure and into the femoral vein for the administration of the drug under investigation. The belly was opened in the median line and, while the viscera were protected by warm towels, needles were thrust through the body wall at each side of the hilus of each adrenal gland. By means of these needles double ligatures were drawn through so that they could be pulled tight from outside the body and occlude adrenal circulation. The ligatures were carefully placed to avoid including any considerable number of splanchnic nerve fibres, the blocking of which would introduce an extraneous factor. The ligatures were used double to permit removal with a minimal laceration of tissues; they were looped together and so adjusted that the junction came at the hilus of the gland. Then when either member of either loop was cut, a slight traction on its fellow-member released both loops. The ligatures

having been adjusted, the abdominal cavity was closed and the experiment begun. This technique has previously been used by several investigators.¹

Blood pressure was recorded by means of an ordinary mercury manometer and float. Having established the normal pressure for a given animal, a standard dose of pituitrin (Parke, Davis and Co.) was introduced into the femoral vein. In order to avoid a diminution of effect when the dose was repeated, small quantities only were used, — from 0.6 to 10 c.c. of a 1:10 solution. It was found, as a matter of fact, that such dosage could be repeated at intervals of 10 to 15 minutes without significant decrease in pressor effects. Having recorded the results following a given standard dose, the adrenals were ligated by traction upon the previously arranged ligatures. After a brief fluctuation blood pressure immediately returned to its previous level. Then the same dose was repeated and the effects again observed. When this effect had worn off, the ligatures were released. Again there was a brief fluctuation of pressure, which, however, soon returned to normal, permitting another repetition of the standard dose. Allowing for a slight progressive diminution in the sensitiveness to the drug, there was no appreciable difference between the effects when the adrenals were intact and when their circulation was occluded. Our results confirm the observations of Young and Lehmann and of Hoskins and McClure² that adrenal ligation in the dog has no immediate influence upon blood pressure.

An obvious source of error in such results is a possible exhaustion of the adrenal glands as a result of the anaesthetic and of the sensory stimulation necessarily involved in the preparation of the animal. In carrying out another research we obtained evidence which indicates that in the dog such exhaustion actually does occur.³ Cannon and Nice⁴ have shown, however, that there is still dischargable epinephrin in the adrenals of cats even after evisceration. We decided, therefore, to repeat the observations on this animal. Three such experiments

¹ YOUNG and LEHMANN: *The Journal of physiology*, 1908, xxxvii, p. liv.
HOSKINS and MCCLURE: *Archives of internal medicine*, 1912, x, p. 343.

² *Loc. cit.*

³ HOSKINS and MCPeCK: *The Journal of the American Medical Association*, 1913, lv, p. 1777.

⁴ CANNON and RICE: *This Journal*, 1913, xxxii, p. 49.

were made, using correspondingly smaller doses. — about 0.5 c.c. Ether alone was used for anaesthesia. The results in each case, however, confirmed our previous findings. One experiment was particularly convincing. The cat was in a late stage of pregnancy and the adrenals therefore supposedly hypertrophied. That they were actually secreting during the experiment was shown by the fact that the blood pressure was lowered during the time they were ligated off and, after a characteristic epinephrin wave, was re-established at the original level after their release. Pituitrin was injected before, during, and after adrenal ligation; the rise in blood pressure was closely similar in each case.

The presence of accessory chromaffin tissue can scarcely be considered a source of error. If the adrenal glands contain by far the greater portion of such tissue and if the removal of these is without effect, the intact supply can safely be ignored.

The foregoing observations are not without interest in their bearing upon the general problem of the interrelations of the endosecretory organs. Our findings have been offered for publication because in the present state of this subject definite negative observations are nearly as much to be welcomed as further positive results. So far as a relationship between the adrenals and the pituitary is concerned, there is to be found in the literature little evidence. The fact that both adrenal and pituitary extracts raise blood pressure and cause hyperglycemia⁵ suggests that one organ might stimulate the other. There are on record observations by Hallion and Alquier⁶ and by Rénon and Delille⁷ that the prolonged use of extracts of the posterior lobe of the pituitary causes a hyperplasia of the adrenal cortex. In our present ignorance of the physiology of the adrenal *cortex*, however, the significance of such observations is obscure. On the whole, it now seems probable that there is no direct dependence of the adrenals upon pituitary functioning.

⁵ WEED, CUSHING, and JACOBSON: Johns Hopkins Hospital bulletin, 1913, xxiv, p. 40.

⁶ HALLION and ALQUIER: Comptes rendus de la Société de biologie, 1908, lxxv, p. 5.

⁷ RÉNON and DELILLE: *ibid.*, p. 499.

SUMMARY

1. Intravenous injections of pituitrin in small dosage can be repeated at intervals of ten or fifteen minutes without significant failure of their pressor effect.
2. The adrenal glands of the dog can be ligated off without affecting general blood pressure; in the pregnant cat, however, such ligation has been observed to cause fall of blood pressure with subsequent rise when the ligatures were released.
3. In either animal occlusion of the adrenal circulation does not diminish the pressor effect of a standard dose of pituitrin.
4. There is probably, therefore, no direct dependence of adrenal functioning upon pituitary secretion.

CONTRIBUTIONS TO THE PHYSIOLOGY OF THE STOMACH

V. THE INFLUENCE OF STIMULATION OF THE GASTRIC MUCOSA ON THE CONTRACTIONS OF THE EMPTY STOMACH (HUNGER CONTRACTIONS) IN MAN

BY A. J. CARLSON

[From the Hull Physiological Laboratory of the University of Chicago]

ANALYSIS OF THE PROBLEM

THE character of the periodic and continuous motor activity of the empty stomach in man has been reported. It has also been shown that the contractions of the empty stomach give rise to the sensation of hunger, or the "hunger pangs" by stimulation of afferent nerves endings in the walls of the stomach, and not by stimulation of nerve endings in the gastric mucosa. The hunger contractions of the stomach are inhibited, reflexly, by all stimuli acting on the end organs of taste and general sensation in the mouth cavity, so that in the case of chewing palatable food when in hunger we have the so-called psychic secretion of gastric juice preceded and paralleled by a psychic inhibition of gastric motility and tonus. The fact that the hunger contractions of the stomach lead to increased excitability of the central nervous system and to vase-motor changes has also been placed on record.¹ In the present paper an attempt is made to determine more specifically the cause of the hunger contractions themselves, so far as this is possible in man. The contractions of the empty stomach may be due to:

(1) **The Condition or the Stimulation of the Gastric Mucosa.** — The absence of food means absence of mechanical stimuli, and cessation or diminution of the secretion of gastric juice, and hence a diminished acidity. Carbon dioxide may be secreted into the empty stomach and may act as the primary stimulus. Carbon dioxide and

¹ CARLSON: This journal, 1912-13, xxxi, pp. 151, 175, 212, 318.

other gases may enter the stomach from the intestines, and act as stimuli. Succus entericus, pancreatic juice, and bile may enter the stomach and act as the primary stimulus through alkalinity or by means of specific substances such as the bile acids. The reader will recall that a number of workers maintain that bile facilitates the intestinal movements.

(2) **The Condition of the Blood**, such as the relative concentration of nutrient substances, tissue metabolites, and hormones. It is possible that the neuro-muscular apparatus of the stomach is specially sensitized to slight variations in these substances. While we recognize the condition of the blood as a possible factor, it does not seem a probable one; in the first place, because the composition of the blood is on the whole more constant than the composition of the tissues, and because in young and vigorous individuals the hunger contractions of the stomach begin as soon as the stomach is empty, and while digestion and absorption is still in progress in the intestines, so that there can be no lack of nutrient substances in the blood. In view of the relative constancy of the composition of the blood as shown by all past work on the serum, the existence of a periodic fluctuation in the concentration of any one substance in the blood parallel with the periodicity of the hunger contractions seems improbable.

(3) **The Nervous Impulses Through the Vagi.**—It is well known that the tonus of the stomach depends, in part, on impulses from the vagi, and that the stimulation of the peripheral end of the vagi induces strong contractions in the stomach whether empty or filled with food. It is also known that the stomach is capable of carrying out the *movements of digestion* to a fair degree of efficiency after section of both the vagi and the splanchnic nerves. In other words, the neuro-muscular apparatus of the stomach seems to be primarily automatic, as regards the genesis of the movements of digestion.

The experiment of sectioning the vagi does not prove this point, however. The experiment does prove the *plasticity* of the gastric motor mechanism. One would expect that the extrinsic gastric nerves bear the same relation to the movements of the filled and of the empty stomach. This phase of the problem cannot be studied on man. If it should develop that the periodic hunger contractions

of the empty stomach are caused by periodic discharges through the vagi, the ultimate question of the cause of hunger would again become a problem of physiology of the central nervous system.

(4) **A Primary Automaticity of the Local Neuro-Muscular Mechanism of the Stomach.** — This can be established only by exclusion of the three other possibilities outlined above. A primarily automatic mechanism might still be influenced by the blood, by the extrinsic nerves, and by local reflexes from the gastric mucosa. The periodicity of the automatic activity might be due, not to a parallel periodicity in any essential stimulus, but to some peculiarity in the metabolism of the stomach developed as a special adaptation, similar to periodicities in other organs. The absence of the hunger contractions during digestion, or possibly the modifications of the hunger contractions into the movements of digestion, must, in this case, be due to specific inhibitory or regulatory impulses from the gastric mucosa.

Mr. V. is admirably adapted for determining the relation of stimulation of the gastric mucosa to the hunger movements, as the fistula is large enough to permit the balloon and connecting tube, and a tube for the introduction of liquids and gases, to be placed in the stomach simultaneously. The liquids and gases can be introduced with or without the man's knowledge. Furthermore, the contents of the stomach (fluid and gas) can be withdrawn for analysis at any stage of the hunger movements and without any material disturbance.

RESULTS

(1) **The Action of Water.** — Water, at body temperature or nearly ice cold, inhibits the tonus and the hunger contractions of the stomach. The inhibition following the introduction of a glass of water (100–200 cc.) directly into the stomach lasts on the whole only three to five minutes, and is never followed by any augmentation of the tonus or the hunger contractions. The cold water causes greater inhibition than the water at body temperature. If the water is introduced into the stomach during very intense hunger contractions (“hunger tetanus”) there may be no perceptible inhibition. In other words, the degree of inhibition by water in the stomach is inversely proportional to the intensity of the hunger contractions

present at the time the water is introduced. Water, warm or cold, introduced directly into the stomach during a period of relative relaxation and quiescence does not increase tonus or initiate a contraction period. A typical tracing showing this temporary inhibition by water is reproduced in Fig. 1.

The statement that cold water causes on the whole greater inhibition than water at body temperature requires the following qualification. The record of the stomach movements were taken by means of an air-inflated balloon in the stomach cavity. Now, when cold water is introduced the water surrounds the balloon, at least partly, and cools the air in the balloon. This itself will lower the tension somewhat, until the temperature of the air is restored to that of the body by the warming of the water or by the passing of the water into the intestine. I do not think that this is a serious source of error, for this reason. A few experiments were made with water at 50°C. This causes greater inhibition than the water at 38°C. Water at 50°C. will, of course, increase the air tension in the balloon, yet the inhibition of the stomach tonus and movements is sufficiently marked to mask the effect of slight warming of the air.

How does water in the stomach produce this temporary inhibition? It goes without saying that in these experiments the water was not introduced fast enough to cause contractions by distension of the stomach walls, although this occurred unavoidably in a few instances. The only possible ways that water at body temperature can stimulate the nerve endings in the mucosa seem to be (1) by mechanical pressure, or (2) by osmosis. Cessation of the inhibition probably marks the passing of the water out of the stomach into the intestine, or the addition of sufficient salts to prevent stimulation by hypotonicity. The greater inhibitory action by cold water and by water above the body temperature is evidently due to stimulation of the protopathic temperature nerve endings in addition to those acted on by pressure and osmosis.

It is clear that the action of water on the stomach mucosa is in the direction of inhibition of the hunger contraction. How can this be reconciled with the view that a glass of cold water induces or augments hunger? It is to be remembered that in these experiments the water had no chance to act on the nerve endings in the mouth and the œsophagus. The alleged action of a cold drink on hunger

and appetite is probably reflex effects (cold) from the mouth and œsophagus. In the writer's own case a glass of ice water causes increased muscular tonus, sometimes even to the point of shivering and formication. This increased kinesthetic sense probably acts in the way of "bahnung" for the hunger sensation, if it is not actually a part of the hunger complex. Cannon and Washburn² suggest that the effect of a cold drink on the hunger sensation is due to "the power of cold to induce contraction in smooth muscle." Although their meaning is not clear I take it that they have in mind primarily the contraction of the stomach musculature. This could not come about by the cold acting on the stomach musculature directly. The reflex effects of cold water from the mouth and œsophagus are very complicated as regards the stomach, while cold water acting on the gastric mucosa directly causes inhibition.

(2) **The Action of Acids.**—All acids, or liquids containing acids, including normal human gastric juice, cause inhibition of the movements and the tonus of the empty stomach when introduced directly into the stomach cavity. No acid has been tested in stronger concentration than 0.5 per cent. The duration of the inhibition is on the whole directly proportional to the concentration and the total quantity of acid introduced. 200 c.c. of 0.5 per cent HCl may cause complete inhibition of the contractions and a relaxation of the tonus for 40–60 minutes, while 200 c.c. of 0.25 per cent HCl will usually inhibit for a period of 25–30 minutes only.

This inhibition by acids can be made evident during all stages of activity of the empty stomach. If the acid is introduced during relative quiescence of the stomach the appearance of the next period of hunger contractions is delayed; if introduced during the active contractions these are abolished or depressed.

The duration of the acid inhibition is probably determined by three factors, namely, (1) passing of the acid into the duodenum, (2) fixation and neutralization of the acid of the mucous gastric secretion, (3) neutralization by bile and intestinal juice which at times pass into the stomach through the dilated pylorus.

While it is a striking fact that gastric juice of full normal acidity (0.48–0.53 per cent) and other acid solutions inhibit the hunger contractions, it does not follow that a neutral or alkaline reaction in the

² CANNON AND WASHBURN: *This journal*, 1912, xxix, p. 452.

gastric cavity is a prerequisite for these contractions. During the strong contractions the stomach secretes a juice rich in mucin and combined HCl, but usually containing some free HCl. After the introduction of acids the contractions reappear before all the acid has passed out of the stomach or has been completely neutralized. And in case Mr. V. chews palatable food during a strong hunger period, the hunger contractions reappear before there is complete cessation of the psychic secretion of gastric juice. In other words, the hunger contractions are not inhibited by weak concentrations of acids in the stomach. A neutral or alkaline reaction of the mucosa is not necessary for these contractions.

A typical tracing showing the inhibition of the hunger contractions by V.'s own gastric juice is reproduced in Fig. 2. When V. chews palatable food during a hunger period two inhibitory factors come into play, namely the reflex inhibition from the mouth, and the acid inhibition from the stomach. If the food is sufficiently palatable and the mastication is continued long enough the inhibition produced reflexly from the mouth fuses with the acid inhibition from the stomach. If the food is not especially palatable or the mastication period brief, the contractions may resume on cessation of the chewing and then again be inhibited for a time during the period of most rapid secretion of the gastric juice.

The degree of inhibition produced by normal gastric juice is the same as that caused by an equal quantity of hydrochloric acid of a concentration equal to the free acidity of the gastric juice. It would thus seem that the hydrochloric acid in the gastric juice constitutes the stimulus that leads to the inhibition.

This acid inhibition of the hunger contractions is of peculiar interest in connection with the neuro-muscular mechanisms of these hunger movements and the gastric movements in normal digestion. The movements of the stomach in digestion are not inhibited by acids in the stomach, that is, at least not by acids in concentrations equal to that of the gastric juice. The fact that the intensity of movements of the antrum increases as the gastric digestion advances may even indicate that a certain degree of free acidity facilitates the movements of digestion. At first it occurred to me that since acid in the stomach inhibits the *hunger contractions*, but not the *digestion contractions*, the mechanisms involved in these two types of gastric

activity are different, at least as regards the character of the afferent impulses from the gastric mucosa. But on further reflection it became apparent that this is not necessarily the case. For the digestive movements involve primarily the pyloric end, while the hunger movements (as studied by our method) involve the fundus of the stomach. It is possible that acid stimulation of the nerve endings in the gastric mucosa leads, reflexly, to inhibition of the fundus, and peristalsis of the pyloric region of the stomach. This hypothesis is, of course, capable of experimental verification or refutation.

(3) **The Action of Alkalies.** — The tests were made with sodium carbonate in concentrations varying from 0.2–1.0 per cent, and in varying quantities. In concentrations of 0.2 per cent or less the sodium carbonate solution appears to have the same influence on the hunger contractions as equal quantities of water, that is a slight temporary inhibition. This inhibition is evidently due, not to the *alkalinity* but to the *bulk* of the solution. In concentrations from 0.2 per cent to 1.0 per cent the degree of inhibition produced is on the whole directly proportional to the concentration and the quantity of the solution put into the stomach. 200 c.c. of one per cent sodium carbonate causes about the same degree of inhibition as 200 c.c. one-half per cent hydrochloric acid. It is thus clear that alkalinity has the same effect as acidity, only to a less degree; both acids and alkalies causing inhibition without any after effect of the nature of augmentation.

The fact that 0.2 per cent sodium carbonate has no more effect on the hunger movements than equal quantities of water seems to show that a slight alkalinity of the gastric mucosa is compatible with the hunger contractions of the empty stomach. It makes it also evident that the entrance of bile or intestinal juice into the stomach will have little or no effect on these movements, while any concentration that influences these movements produce inhibition.

(4) **The Action of Local Anaesthetics.** — Solutions of some local anaesthetics were tested with the view of determining whether the sensory nerves in the gastric mucosa plays only an inhibitory rôle in the processes of gastric hunger contractions. Phenol, chloreton, orthoform, quinine-urea-hydrochloride, and adrenalin chloride were used in quantities and concentrations compatible with *absolute*

safety to Mr. V. It was not considered advisable to use cocaine. The solutions of the drugs were introduced in quantities of 100 and 200 c.c.

In the concentrations employed no specific action of any of the above substances could be demonstrated. For example, 100 c.c. of phenol (dilution 1-10,000) has the same effect as 100 c.c. of water, that is, a slight temporary inhibition. The same applies to the other drugs. No appreciable anaesthesia of the gastric mucosa was produced by any of the drugs. It seems probable that the solutions of these drugs pass out of the stomach just as rapidly as equal quantities of water, and hence do not remain long enough in the stomach to produce local anaesthesia. Because of the danger attending the use of local anaesthetics in strong concentrations, further work on V. was deferred until complete orientation was at hand from work on dogs. It seemed, however, that adrenalin chloride introduced into the stomach even in considerable quantities could not be particularly injurious. But even in large quantities (100 c.c. of a dilution of 1-10,000) the adrenalin acting in the gastric cavity has no other effect on the hunger movements than equal quantities of water.

(5) **The Action of Alcoholic Beverages.**—Tests were made with sour and sweet wines, beer, brandy, and pure alcohol. The taking of alcoholic beverages with the meals is a habit with many people. It is claimed by many people that a glass of wine, beer, or some mixture of alcohol taken before meals increases the appetite (and possibly the hunger). The writer is neither a total abstainer nor a habitual user of alcoholic beverages. But it is his experience that a glass of beer or brandy taken at meal time *seems* to awaken or increase appetite. This effect is rather immediate and therefore not due to the absorption of the alcohol. Powlow has recorded an instance from his own experience where a drink of wine seemed to initiate the sensation of hunger (?) the very minute the wine reached the stomach. From enquiries as extensive as opportunities have permitted, I am inclined to believe that this apparent augmentation of the appetite by alcoholic beverages is rather a common experience. In view of this fact I expected to find that these alcoholic beverages increased the tonus and the contractions of the empty stomach, since it is the tonus and the contractions of the empty stomach that give rise to the hunger sensation. To my surprise the results proved to

be the very opposite. *Wine, beer, brandy, and pure alcohol introduced directly into the stomach inhibit the hunger contractions and the tonus of the empty stomach instead of increasing them.* This is true whether these fluids are cold or at body temperature. If these alcoholic beverages are greatly diluted with water, a degree of dilution can be reached which has the same action on the stomach as equal quantities of water, although the specific beverage is readily detected when the mixture is placed in the mouth. In no instance have I been able to make out any undoubted augmentation of the stomach tonus and hunger contractions after the inhibition period. In other words, alcoholic beverages when introduced directly into the empty stomach in quantities and concentrations that directly affect the tonus and the contractions of the stomach cause inhibition, and inhibition *only*.

The pure alcohol was never used in stronger concentrations than 10 per cent. The brandy was usually diluted one half with water, while the beer and wines were put into the stomach undiluted.

We have seen that acids in the stomach cause inhibition of the hunger contractions. Pure alcohol also causes inhibition. It is therefore evident that the alcohol and acids are primarily responsible for the inhibition following the introduction of alcoholic beverages into the empty stomach. But for the sake of brevity we may designate it "the alcohol inhibition."

The duration of the alcohol inhibition varies directly with the quantity and concentration of the beverage introduced in the stomach. Thus 50-100 c.c. of 10 per cent alcohol may inhibit the hunger contractions for one to two hours; or if introduced during a period of relative quiescence it delays correspondingly the onset of the next hunger period. 200 c.c. of beer causes inhibition for 30-60 minutes. The sour wines on the whole cause greater inhibition than the sweet wines, probably through their acids. A typical record of the alcohol brandy inhibition of the hunger contractions is reproduced in Fig. 3. This tracing is from a series of experiments on the author himself.

It must be stated that these alcoholic beverages were put into the stomach of Mr. V. with his consent and without any protest, resentment, fear, or disgust on his part, which might account for the stomach inhibition. Mr. V. takes wine and beer occasionally. At times I had him bring his own choice of wine and beer, and occasionally I had him, himself, introduce into the stomach the desired



FIGURE 1. About two thirds the original size. Record of contractions of the empty stomach of Mr. V. At \times 100 c.c. cold water introduced directly into the stomach. Showing the temporary inhibition.³



FIGURE 2. About one half the original size. Record of contractions of the empty stomach of Mr. V. At \times 25 c.c. of human gastric juice (V's own gastric juice, psychic secretion, secured two hours previously) introduced into the stomach. Showing the acid inhibition.

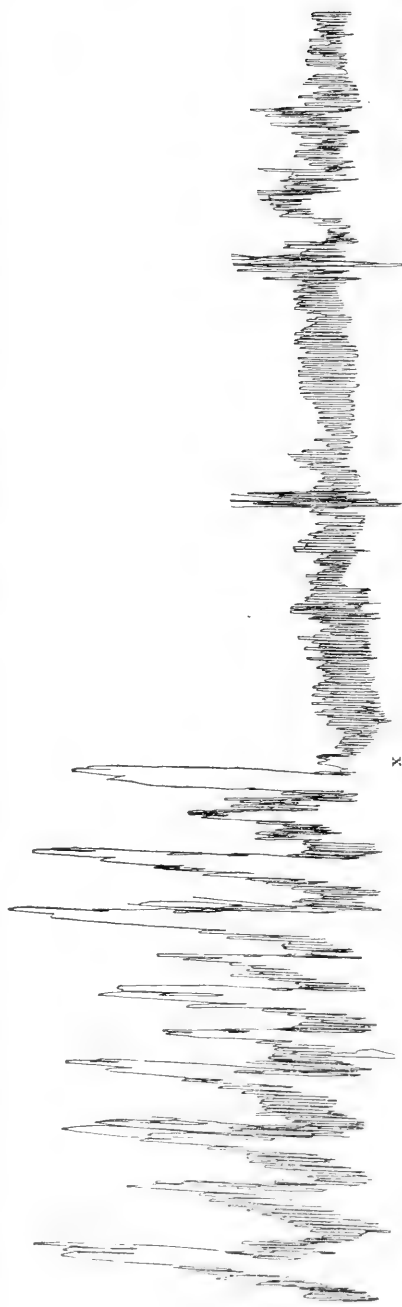

FIGURE 3. Records from the empty stomach of A. J. C. At \times introduction of 15 c.c. brandy in 25 c.c. warm water directly into the stomach. Showing the alcohol inhibition of the hunger contractions.

³ All the tracings reproduced in this paper were taken by means of a bromoform manometer.



FIGURE 4. One half the original size. Record from the empty stomach of Mr. V. during part of a period of strong hunger movements. At T 200 c.c. of beer introduced directly into the stomach. Showing immediate and long lasting inhibition of the hunger contractions.

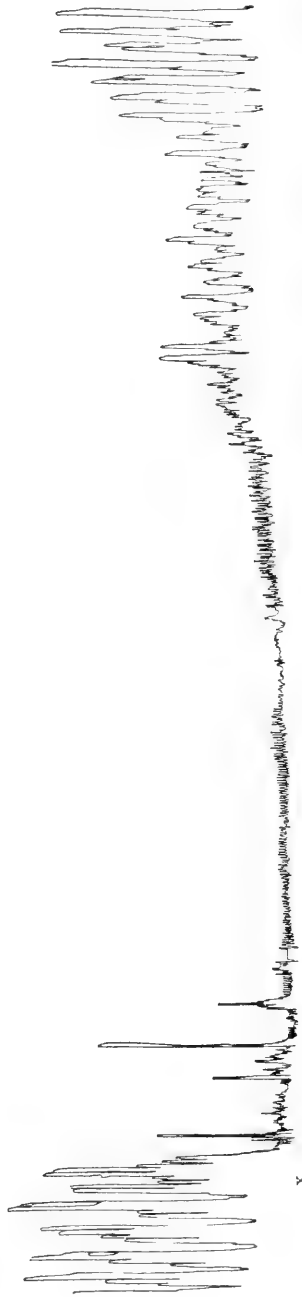

FIGURE 5. About one half the original size. Record from the empty stomach of dog with gastric fistula. At X 25 c.c. of 0.5 per cent HCl (warm) introduced directly into stomach. Showing the prolonged acid inhibition, with gradual recovery. Total time of the part of the tracing reproduced, 30 minutes.

quantities. The effect on the hunger contractions was always the same. I am therefore confident that we are here dealing with a characteristic alcohol and acid inhibition, and not with a masked "psychic" inhibition.

How are these results to be harmonized with the seeming stimulation of the appetite by alcoholic beverages taken by the mouth? In the first place the local inhibitory action of alcoholic beverages in the gastric cavity is so marked and so invariable, that I feel confident that this is always the gastric effect of these beverages, whether taken normally by the mouth, or introduced into the empty stomach without coming in contact with the mouth and œsophagus. *Alcoholic beverages can therefore not initiate or increase hunger*, since hunger is caused by the stomach contractions, and these are inhibited by the alcohol. Since most alcoholic beverages stimulate the end organs of taste and smell as well as those of general sensibility in the mouth cavity and in the œsophagus it is possible that this stimulation in some way augments or initiates *appetite* for food. If this is the case we have the singular condition of alcoholic beverages augmenting appetite and inhibiting hunger at the same time. There can be little doubt that cerebral states as modified by training and habit are also a factor in this apparent action of alcoholic beverages on appetite. It is certain that the individual's first taste of alcohol, beer, or sour wines does not focus his attention on food and eating.

If alcoholic beverages in the stomach caused as marked inhibition of the stomach movements in digestion as they do in the case of the stomach movements in hunger even moderate drinking with meals would lead at once to acute indigestion. As this is not the case, it is evident that alcoholic beverages affect the mechanisms of these two types of movements differently.

(6) **The Action of Carbon Dioxide and Air.**—The action of carbon dioxide in the cavity of the empty stomach was studied in two ways: (1) by introduction of water charged with CO_2 , (2) by introduction of CO_2 gas. It is well known that an excess of carbon dioxide in the blood of the abdominal vessels initiates and augments the tonus and movements of the digestive tract. An excess of CO_2 is sometimes found in the gaseous contents of the empty or partly filled stomach. It is known, furthermore, that carbon dioxide in sufficient concentration acts as a powerful stimulus to the nerve endings in

such membranes as those of the mouth and nose, and of the cornea and conjunctiva.

Carbon dioxide in the cavity of the empty stomach was at first considered a possible stimulus to the gastric hunger contractions, but this hypothesis proved entirely erroneous. In so far as the carbon dioxide in the stomach cavity affects the hunger movements the influence is in the direction of inhibition.

Water saturated with CO_2 under pressure has practically no more effect than similar quantities of pure water. It produces the same degree of temporary inhibition without any after effect in the way of augmentation. As such carbonated water stimulates the nerve endings in the mouth in the characteristic way, it follows that the nerve endings in the stomach are less affected by CO_2 than are the nerve endings in the mouth.

When the CO_2 is forced into the stomach in the form of gas and under pressure, the results are complicated by the mechanical action of the gas in forcibly distending the walls of the stomach and raising the intragastric pressure, and hence increasing the pressure in the balloon in the fundus. A sudden and forcible distension of the stomach no matter how produced leads to a few strong contractions. This factor can be fairly well controlled by introducing the gas slowly. When this precaution is taken the empty stomach can be considerably distended with CO_2 gas, without any marked effect either on the tonus or on the hunger contractions. But the chemical effect of CO_2 so far as it is demonstrable at all, is in the direction of inhibition.

It will undoubtedly occur to the reader that this slight inhibition by the CO_2 may be an instance of "psychic" inhibition from the distress of an overdistended stomach. This possibility has been guarded against. In the first place the stomach was not distended to the point of painfulness by the carbon dioxide. Furthermore, the stomach cavity was irrigated, so to speak, with the gas without raising the intragastric pressure perceptibly, by introducing the inlet tube to the cardiac end and allowing the gas to escape freely by the fistula. The reader will recall that the œsophagus is completely closed, so that the gas cannot escape by way of the mouth. Under these conditions the same slight inhibitory effects were recorded without signs of primary or secondary augmentation. It is thus clear that in so far as carbon dioxide in the gastric cavity affects the gastric

tonus and hunger contractions at all, the action is in the direction of inhibition. This is probably due to the acid stimulation of the nerve endings in the mucosa.

The introduction of air into the empty stomach has no effect whatever on the tonus and the hunger contractions, provided the stomach is not overdistended by the air, or the air introduced rapidly and under such pressure as to cause sudden and forcible distension of the stomach walls. This leads to a few contractions. But the same thing is produced by sudden inflation of the balloon in the fundus. It is therefore purely mechanical. Oxygen in greater concentrations than that of the air has not been tried. But it is evident that the 20 per cent oxygen of the air acts neither favorably nor unfavorably on the hunger movements.

(7) **Confirmatory Observations on Dogs.**—The results of the foregoing observations on Mr. V. are new, and, to the writer's mind at least, unexpected, on the basis of what is known of the motor activities of the stomach. That the same conditions which favor or permit the gastric movements of digestion should invariably inhibit the gastric hunger movements could not have been predicted. The fact that any and all kinds of stimulation of the nerve endings in the gastric mucosa cause inhibition, and only inhibition, of the gastric hunger movements is not to be accepted without rigid scrutiny of the evidence. The observations on Mr. V. were completed in August and September, 1912. They were repeated and confirmed, point for point, in April and May of this year. I am satisfied as to the facts. Is there any error in the interpretation? One possible error in the interpretation of fundamental importance has been referred to once or twice in the previous discussion. It is of sufficient importance to be taken up now, and disposed of as best we may. The fact that nothing but inhibition is produced by substances acting on the gastric mucosa, suggests that this may be in every case a "psychic" inhibition masking any weak action that may be of a positive or augmentation type. The very consciousness of Mr. V. that these substances were introduced into the stomach for experimental purposes might be the primary element in this possible psychic inhibition. That cerebral states may inhibit the gastric hunger movements is certain, from results both on Mr. V. and on dogs. In one instance when preparing to introduce 200 c.c. of 0.5 per cent acidic acid into the

stomach in the midst of the period of powerful hunger contractions Mr. V. somehow thought that I intended to introduce that much concentrated acid (or vinegar). As I was going about with the preparation I noticed that the stomach contractions suddenly became very feeble. Mr. V. looked worried. I inquired if he did not feel right, and he asked if I intended to put all that vinegar into the stomach. "It will surely hurt me," he said. To assure him, I drank half of the acid myself, and then asked him to take a mouthful of it. Then he laughed and said, "Oh, I thought it was pure vinegar." In two minutes after the mental stress and anxiety was over the hunger concentrations returned to their normal rate and amplitude.

The following facts speak against the possibility of the results being due to psychic inhibition.

(1) There was no evidence that Mr. V. was in any way afraid, displeased, disgusted, or impatient with the experiments. This applies particularly to the repetition of the tests in April and May this year. Mr. V. is now usually much interested in all the tests, and he has full confidence in the writer.

(2) The direct proportion between the quantity and concentration of the substance introduced into the stomach and the degree of inhibition produced is contrary to the hypothesis of a psychic inhibition. The displeasure or disgust ought to have been practically the same on introduction of 0.1 per cent and of 0.5 per cent HCl , of 1 per cent and 0.10 per cent alcohol, as in most cases Mr. V. did not know the strength of the material used, and he did not care, being satisfied with my assurance that it was harmless.

(3) In many cases I purposely deceived him as to the nature of the material, exchanging water for acids and *vice versa*. The stomach reaction was invariably in accordance with the substance actually introduced.

Hence I feel fairly satisfied even on the basis of the tests on Mr. V. that psychic inhibition plays no rôle in these results. But to meet the possibility once and for all, I have now repeated and confirmed all of the above tests on dogs.⁴ The parallel on the two series on man and dog is complete. The details of these results on dogs will

⁴ A series of experiments on myself also confirm the general results as stated above.

be reported later. But one typical tracing may be submitted now (Fig. 5). Well, may not psychic inhibition play a rôle in the tests on dogs? It does not, and for the following reasons:

(1) The dogs could not have known either the difference between the substances introduced into the stomach or the different concentrations of the same substance.

(2) Tests were made during sleep and without the animal waking up. The results were the same.

(3) Psychic inhibition of the gastric hunger movements in dogs is invariably of much shorter duration than the inhibition caused by acids, alkalies, and alcoholic beverages.

It is therefore clear that results on Mr. V. reported above are fundamental facts in the physiology of the stomach and not primarily dependent on afferent impulses that enter consciousness.

(8) **The Influence of the Inhibitions from the Gastric Mucosa on the Fundamental Rhythm of the Gastric Hunger Contractions.** — During the progress of this work it soon became apparent that these temporary inhibitions described above do not cut short a hunger period, but simply delay its culmination. The contractions that appear as the inhibition ceases are the continuation of the period temporarily checked by the inhibition. They are not the beginning of a new period. This is particularly true when the inhibitions are induced during the first half or two thirds of the hunger period. When the tetanus stage of the hunger period is reached a stimulation of the gastric mucosa sufficiently strong to cause prompt cessation of the contractions seems to actually terminate the period, for when the contractions reappear they are not the incomplete tetanus or strong and rapid contractions of the culmination of the period, but the feeble and slow movements characteristic of the beginning of a period. By careful adjustment of the quantity and strength of the material introduced into the stomach during the first part of the hunger period and by renewing the inhibition on reappearance of the rhythm it is possible to lengthen a 30-40 min. period into a 90-120 min. period. In other words, the motor mechanisms of the hunger contractions may be compared to the spring of a watch. When the spring is wound up it will run the watch for a certain number of hours, and it makes no difference whether or not these hours are consecutive.

It seems to me that this fact has an important bearing on the

question of the primary stimulus to the hunger movements. It seems to point to a primary automatism, peripheral or central, or both, relatively independent of the condition of the blood as well as of afferent nervous impulses. The fact speaks particularly strongly against the hypothesis that the primary stimulus is to be sought in the condition of the blood. For example, if the primary stimulus is in some condition of the blood, this condition must be present and to a gradually increasing degree from 12:30 to 1 p.m. to parallel a hunger period beginning at 12:30 p.m. and ending at 1 p.m. And this condition of the blood must be absent from 1 p.m. to 1:45 p.m. as the stomach is relatively quiescent during that time. The hypothesis seems to be rendered untenable by the fact that by manipulations which do not, at least in some cases, involve any change in this hypothetical condition of the blood the culmination of the hunger period may be delayed till 1:30 or 1:45 p.m., so that the strongest hunger contractions fall in the time when the blood does not stimulate the gastric mechanism in a way to cause the hunger movements.

(9) **Discussion of the Results.** — I do not see how the further analysis of the mechanisms of these inhibitions is possible by experiments on man. Whether the reflex is, in whole or in part, through the vagi and the splanchnic nerves or local through the mesenteric plexus can only be determined by lesion of the extrinsic nerves. This phase of the work is not yet completed.

But what is the significance of this inhibition in the normal work of the stomach? The inhibition of the hunger contractions by mechanical and chemical stimulation of the gastric mucosa prevents the appearance of these contractions during the period of gastric digestion. This negative control of the hunger movements from the stomach cavity is obviously a useful coördination. The primary or actual stimulus to the hunger contractions is therefore to be sought in the vagus tonus, in some condition of the blood, or in a primary automatism of the gastric neuro-muscular mechanism. I have some evidence that the latter is the essential factor and that extrinsic nerves and the condition of the blood only modify the primary automatism. If this is the case the hunger contractions ought to appear as soon as the stomach is empty of food or other substances capable of stimulating the nerve endings in the mucosa. We would also

expect these contractions to be more or less continuous as long as the stomach is empty, at least in young and vigorous individuals, and when the condition of the individual as a whole does not lead to increased activity of the extrinsic inhibitory nerves (splanchnics). On this hypothesis the gradual tonus contraction of the gastric fundus *pari passu* with the progress of the gastric digestion represents the algebraic sum of the inherent automatism and the inhibitory effects from the gastric cavity. A gradual fatigue of the inhibitory mechanisms is probably also a factor, as I have abundant evidence (man and dog) of such "escape" of the stomach from inhibitory nervous processes.

We should probably look for the closest parallelism between the gastric hunger contractions and the absence of stimulation of the gastric mucosa in infants and young children, that is, before cerebral (and possibly gastric) habits relative to feeding have been established. During the last five months I have made a close study of a healthy (bottle-fed) infant touching this point. It is well known that, other things being equal, the more food put into the stomach the longer time required for the completion of gastric digestion. If this infant (now five months old) is given only four ounces of food he calls for more after about two hours. If he is given seven to eight ounces of the same food the call for more food is delayed for three to four hours. If he is given five ounces of the food at 6 p.m. he nearly always wakes up and calls for more at 12-1 o'clock; while if he is given as much food as he will take ($7\frac{1}{2}$ to $8\frac{1}{2}$ ounces) at 6 p.m. he rarely wakes up and calls for food until 3-5 o'clock the following morning. There is evidently a close parallel between the time of the emptying of the stomach and the appearance of the hunger contractions. The more frequent calls for food during the day are obviously due to the fact that the gastric hunger contractions must reach a certain degree of intensity before they cause the soundly sleeping infant to wake up. This is certainly true in the case of dogs. A dog may sleep on peacefully and quietly during gastric hunger contractions of moderate intensity. When these contractions become very intense the dog moves or moans in his sleep and sometimes wakes up.

While I have made no observations on the action of acids, alkalis and alcoholic beverages on the gastric movements of digestion, it is quite clear that these substances do not inhibit these movements

at least to the extent that they inhibit the hunger contractions. The movements of digestion are primarily concerned with the pyloric region, while the hunger contractions involve the cardiac and fundus region. Either these two regions of the stomach react differently to local stimulation of the gastric mucosa, or else the nervous mechanisms concerned in the hunger contractions and the digestion contractions are to a certain extent different.

In view of the fact that acids as well as normal gastric juice inhibit the gastric hunger contractions I expect that persons having gastric hypersecretion or actual hyperchlorhydria experience little or no true hunger sensations or pangs of gastric origin. At the same time we must consider in cases of prolonged hypersecretion, the possibility of a readjustment of such a character that the acid stimulation of the mucosa causes less inhibition than is the case in the normal stomach. The degree of plasticity inherent in these gastric mechanisms is virtually unknown.

RAPID METHOD OF PREPARING THROMBIN

By W. H. HOWELL

[From the Physiological Laboratory of the John Hopkins University]

A FEW years ago the author described a method of preparing pure or approximately pure thrombin. Beginning with a solution of fresh fibrin in strong solutions of sodium chloride the other proteins were removed gradually by repeated shaking of the solution with chloroform. The method is effective, but it is very tedious, requiring usually two months or more when the solution is shaken twice a day. I have modified the method recently so that an equally good, in some respects a better preparation of thrombin may be obtained in three or four days. This method, in detail, is as follows. A large amount of (pig's) fibrin is obtained from the butcher and is washed thoroughly in running water until the hemoglobin is removed. The washing must be done by hand, picking apart the strands that are deeply colored. When sufficiently washed the mass of fibrin is squeezed free from water and is then minced and well covered with an 8 per cent solution of sodium chloride. The preparation is allowed to stand for forty-eight to seventy-two hours in the cold and is then filtered. The filtrate contains thrombin together with other proteins. The filtrate is treated with an equal volume of acetone. A bulky precipitate is thrown down including the thrombin, while a large amount of the other proteins remains in solution. The precipitate is filtered off rapidly through a number of small filters, each containing from 25 to 50 c.c. As soon as the filtrate has run through, each filter is opened upon a pad of filter paper and the precipitate is spread as thin as possible by means of a spatula. Each filter paper, then, with its layer of precipitate is dried rapidly in a current of cold air.

For this purpose I make use of a box with wire trays and an electric fan. When perfectly dry the portion of the filter paper holding the dried precipitate is cut up with scissors into a bulk of water, using an amount of water equal to about two-thirds of the original saline

filtrate. After standing, with occasional stirring, for one-half hour, this solution is filtered. The filtrate contains the thrombin with traces of salt and of a protein coagulable on heating. To remove this latter protein the solution may be shaken with chloroform (10 or 15 c.c. to 100 c.c. of solution). After shaking, the chloroform settles, on standing, as a thick emulsion. This is filtered off and a specimen of the filtrate is tested by boiling. If the specimen shows any opalescence it indicates the presence still of some coagulable protein, and the process of shaking with chloroform must be repeated once or twice until a specimen of the filtrate remains entirely clear on heating. Care must be taken; however, not to continue shaking with the chloroform after the removal of the coagulable protein, as the thrombin also will come down eventually with the chloroform. This result seems to happen much more easily in these solutions practically free from salt than in the strong salt solutions of my first method. To preserve the thrombin finally obtained my method is to evaporate it to dryness in watch crystals, 2 c.c. to a crystal, using the current of air from an electric fan. When thus evaporated the thrombin shows a characteristic snow-flake crystallization together with a few crystals of sodium chloride. The dried thrombin may be kept indefinitely in a desiccator. It is easily and completely soluble in water and shows the reactions described in my previous paper.

To test the action of thrombin it is very convenient to keep on hand specimens of dried oxalated and dialyzed plasma. Dog's blood is oxalated and centrifugalized. The clear plasma is removed and dialyzed in collodion tubes against 0.9 per cent solutions of sodium chloride for twelve to twenty-four hours to remove the oxalate. The plasma is then evaporated in watch crystals, 2 to 5 c.c. to a crystal, in a current of cold air. When dry the plasma may be preserved indefinitely in a desiccator. For use the contents of each crystal are dissolved in 0.9 per cent salt solution, using double the volume of the original plasma. When properly made the dried material dissolves completely, giving a clear solution in which the fibrinogen is in a more normal condition than when obtained by the usual method of repeated fractional precipitation with sodium chloride.

THE RELATION OF METATHROMBIN TO THROMBIN

BY F. W. WEYMOUTH

[From the Physiological Laboratory of the Johns Hopkins University]

MORAWITZ showed in 1904 that part of the confusion surrounding the question of thrombin has arisen from the fact that there are two inactive forms both of which have been considered as precursors of the ferment. To one of these, found in oxalated plasma and activated by calcium salts, the prothrombin of Pekelharing, he gave the name α -proferment. The second, found in serum subsequent to clotting and not activated by calcium salts but by acids and alkalies in the entire absence of calcium, he called β -proferment; this was identical with the metazym of Fuld.¹ Later² he proposed the term metathrombin, a more suitable name in view of the fact that its absence from oxalate plasma and presence in serum only subsequent to thrombin formation shows it to be a modification and not a forerunner of the latter.

Unfortunately all writers have not adhered to this original conception. Mellanby, for instance,³ after referring to Morawitz's β -proferment uses the term metathrombin for the *active agent* liberated in serum by the action of acids and alkalies, an entirely unwarranted use of the term so clearly defined by Morawitz.

The present paper presents the results of some experimental work, undertaken at the suggestion of Dr. W. H. Howell, with the hope of throwing some light on the relation of metathrombin to thrombin, which according to Morawitz is entirely unknown.

A brief account will first be given of the technic employed, after which the experiments, dealing with serum, thrombin, and metathrombin, respectively, will be considered. The clotting power of thrombin or serum was tested on plasma solutions which were pre-

¹ Hofmeister's Beiträge, 1904, iv, p. 401.

² Ergebnisse der Physiologie, 1905, iv, p. 367.

³ Journal of Physiology, 1909, xxxviii, p. 92.

pared as follows. A dog (or cat) was bled directly into centrifuge tubes containing enough sodium oxalate to give a concentration 0.1 per cent to the mixture. The tubes were at once thoroughly mixed and centrifuged, the plasma drawn off and dialyzed for twenty-four or more hours against a large amount of 0.9 per cent NaCl to remove the oxalate. The plasma was then measured out in watch crystals (usually 3 c.c. to a crystal) and dried rapidly in a current of air at room temperature. Such crystals were kept in a desiccator until used when they were rubbed up in twice their original volume of 0.9 per cent NaCl (6 c.c.) and filtered. This procedure gives clear solutions which clot promptly and firmly upon addition of fresh serum or thrombin and are of very uniform strength. To avoid errors in comparison a particular experiment was always carried out on a single lot of plasma.

In obtaining the specimens of serum the blood was allowed to flow directly into centrifuge tubes and when clotting had taken place the clots were loosened and the whole centrifuged. The clear serum was then drawn off and set aside to be used as needed.

The tests for clotting time were carried out as follows. Varying small amounts of serum (usually 3, 4, and 5 drops) were placed in a series of homeopathic vials and ten drops of a freshly prepared plasma solution added. This was observed usually at five-minute intervals by tilting the vial until the formation of a clot was noted. This method, though it does not give accurate results for times less than two or three minutes, proved very satisfactory in work of the present nature, as there is little trouble from evaporation and the solutions may be observed over periods of twenty-four or more hours.

NON-STERILE SERA

The first three experiments were carried out on what may be termed *non-sterile sera*, the serum being collected without aseptic precautions and allowed to stand in uncorked test tubes at room temperature throughout the experiment. Chart No. 1 shows the variations in clotting power of these specimens, the abscissae representing the time in days after the drawing of the blood, and the ordinates the clotting time in hours. The solid lines represent the clotting time in five drops of serum added to ten drops of plasma, and though

similar and consistent data are at hand for three and four drops they have been omitted for clearness. The broken lines represent tests for metathrombin to be considered presently.

The serum in the three experiments shows great variation yet essential agreement in certain features which may be summarized as follows.

1. A period of loss of clotting power, becoming more rapid as the process continues.

The clotting time of the serum of Experiment No. 1 increased from fifteen minutes to three hours in three days (its further course was not followed). No. 3 when tested at three days gave no clot although the solutions stood for six days. The curve of No. 2 shows a rise almost as rapid though its start is delayed. This is apparently due to the fact that the serum was kept on ice for part of the time between its drawing and the first test. At five days its clotting time had also exceeded three hours. It would appear from this that dog's serum when freely exposed at room temperature (18° to 27° C.) for three to four days has its clotting power so greatly reduced as to escape detection by many of the methods employed; in fact for practical purposes the clotting power may be said to have been lost. The most active serum observed at this time caused clotting in nine times its original period.

2. A second period of marked variations in clotting power. This extended over five days in No. 3 and eighteen days in No. 2; the two experiments show few points of resemblance in this period. Infection is present in this period; it will be convenient to return to this point later.
3. A practically complete return of clotting power. In No. 3 this extended over eight days and reached a point where clotting took place in twenty minutes as against fifteen minutes in the first test. In No. 2 it lasted five days, reaching a clotting time of fifteen minutes as compared with ten minutes in the beginning.
4. A final period of complete loss of clotting power, occurring in eighteen to twenty-nine days.

Although tests were made over a period of thirty-four days in No. 2, and forty-eight days in No. 3, no clots were obtained though the solutions stood twenty-four to forty-eight hours.

Morawitz, who studied the diminution of ferment content in

horse serum, states that, though it varies considerably in different samples, the loss is practically complete in five to six days, the loss at first being more rapid. This corresponds well with the initial period of loss here shown, though to be exact there is clear evidence of thrombic power in samples of dog serum at the end of six days and for a long time afterwards. I am not aware that the serum has been carefully followed over long periods by any previous worker.

REACTIVATION

Parallel with the tests on the clotting power of these specimens of serum the content of metathrombin was studied and the results are shown by the broken curves in Chart No. 1. The method used was that which Morawitz found most efficient, treatment with an equal volume of $\frac{n}{10}$ NaOH and subsequent neutralization with $\frac{n}{10}$ HCl. The period of incubation was usually twelve minutes. As this process diluted the serum to approximately three times its original volume, a larger amount of the mixture was used, though not enough to offset the dilution. The curve given is based on the clotting time of 6 drops of a mixture of 10 drops serum, 10 drops $\frac{n}{10}$ NaOH and about 10 drops $\frac{n}{10}$ HCl. The process of reactivation does not always give uniform results and has at times failed, due apparently to changes taking place in the solutions of acids and alkalies on standing, yet on the whole the results are consistent and give valuable information.

A more serious question is that of the effect of the alkali on the free thrombin, as the interpretation of the curve depends upon what part of the clotting power of the reactivated samples is due to the persistence of the free thrombin and what to the thrombin liberated from the metathrombin. Morawitz states⁴ that the prolonged action of alkalies destroys the liberated thrombin; for instance, the action of $\frac{n}{10}$ NaOH for three hours at 35° C. completely destroyed the clotting power of a solution which if neutralized in less time proved very active. Strong solutions of the thrombin used in later experiments were tested for this point and it was found that even short treatment with $\frac{n}{10}$ NaOH greatly injured the thrombic power and

⁴ Hofmeister's Beiträge, 1903, iv, p. 404.

though the results were not always uniform it appears that the amount of thrombin undestroyed by the usual incubation of twelve minutes must be slight.

The features in common shown by the curves representing meta-thrombin content are: first, an initial loss much slower, however, than that of the serum, and second, a final complete loss corresponding to that of the thrombin. The intervening oscillations are neither consistent in the two experiments nor clearly related to the curves of the serum in the same experiments, sometimes following these and sometimes going in the opposite direction.

STERILE SERA

It was noted in the preceding experiment that during the period of greatest variation patent signs of putrefaction appeared. (See Fig. 1.) This suggested that more uniform and satisfactory results could be obtained by preventing infection. Accordingly a second series of experiments was carried out in a manner similar to that already described except that sterile cannulae and tubes were used and that the specimens of serum were kept stoppered with cotton except when samples were removed with a sterile pipette. During part of the time cultures were taken to determine the success of these precautions.

Figure 2 represents curves constructed as in the previous case from the results of two experiments. The most striking fact shown is that as long as the solutions are sterile there is no spontaneous return of power either of the thrombin or the metathrombin. The curves which were so variable in the previous experiments have become remarkably uniform. The only exception is shown by the serum of No. 5, which exhibits an increase of power just before its final loss. That this uniformity is due to the sterile condition is clearly demonstrated by the fact that a sample of the serum removed in No. 5 and exposed to the air, became infected and at once showed an increase of clotting power, diverging sharply from the behavior of the still sterile serum.

An equally important fact is that the initial loss is greatly delayed. Up to seven days in No. 6 and to fourteen days in No. 5 the sera

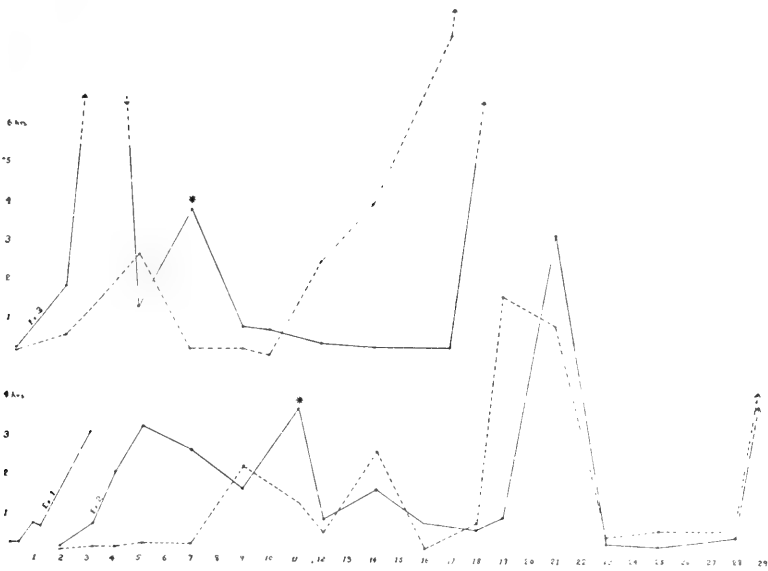

FIGURE 1. Curves from three experiments representing the relative amounts of thrombin and metathrombin in dog's serum (non-sterile) kept for a number of days.

The solid lines give the curves for thrombin, the broken lines the curves for metathrombin. The figures along the abscissa represent days, those along the ordinate give the time in hours for the clotting caused by five drops of serum added to ten drops of the fibrinogen solution (oxalated and dialysed plasma). * Infected.

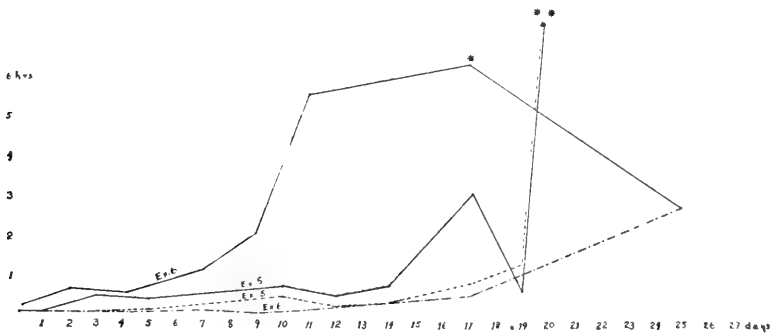

FIGURE 2. Curve of two experiments representing the relative amounts of thrombin and metathrombin in a sterile serum kept for a number of days. * Infected.

** Clotted in seventeen hours on twenty-first day; did not clot again.

are still very active, clotting in seventy and fifty-five minutes respectively. This is even more strikingly the case with the metathrombin, which retained most of its power up to seventeen days in both experiments. Infection, therefore, hastens the initial loss of clotting power, which, however, occurs in its absence, and causes most if not all of the apparently spontaneous returns of thrombic power observed in ordinary serum.

Morawitz mentions various factors which hasten the loss of clotting power.⁵ Temperature is important, specimens kept at 35° C. lost power in two and a half days, while those in an ice chest showed power after twelve days. Free exposure to the air also hastened the loss. Since sterile serum in the present work retained its clotting power at a room temperature of 18° to 27° C. for as long a time as that just cited for the serum kept in an ice chest, it is plain that the temperature in itself had little to do with the inactivation. It is clear that the influence of high temperatures and free access of air is to promote infection and bacterial growth rather than directly to affect the serum. Morawitz also states that power is retained longer in a neutral than in an alkaline medium. The present work throws no light upon this fact.

It is interesting to note in connection with the question of loss of thrombic power that suggestively analogous behavior has been found in the case of inorganic ferments. For instance, McIntosh⁶ states that on standing, colloidal silver loses some of its power to decompose hydrogen peroxide, due apparently to the fact that on standing the silver precipitates out. The silver solutions were also "reactivated" by alkalis. In reacting some of the silver passes into the hydroxide, which is broken up, liberating free silver. Here both "inactivation" and "reactivation" depend upon definite reactions the counterparts of which we do not yet know for thrombin.

Reduced to their simplest terms and freed from the complication of putrefaction these experiments show that there is a gradual and progressive loss of clotting power in serum so that in the course of one or two weeks the clotting time has increased about fivefold and by another week the serum is completely inactive. Metathrombin runs a similar course though its loss is much less rapid. Though ap-

⁵ Hofmeister's Beiträge, 1904, iv, p. 395.

⁶ Journal of physical chemistry, 1902, vi, p. 15.

parently a more stable body it does not seem to survive the thrombin for any appreciable time.

The fate of thrombin and metathrombin is not shown by their behavior in serum. According to the method of reactivation, already discussed, metathrombin is present from the outset and in greater amount than at any subsequent time. If the thrombin is transformed into metathrombin during the period of its rapid loss, the amount is too small or its subsequent destruction too rapid to cause an increase in the latter. These experiments, therefore, can throw no light on the origin of metathrombin. The return of clotting power after infection may be due to transformations of one of these substances into the other, but the factors are too complex to be easily analyzed and offer small inducement to investigation in this direction.

KEPHALINE

Several experiments were carried out in which the effect of adding kephaline solutions⁷ to serum was tried. Experiment 15 will serve as an example of the results. Six mixtures were made as follows.

Serum	Kephaline	Water
A 2.5 c.c.	0	1.5
B 2.5 c.c.	0.1	1.4
C 2.5 c.c.	0.25	1.25
D 2.5 c.c.	0.5	1.
E 2.5 c.c.	1.	0.5
F 2.5 c.c.	1.5	0.

After an incubation of fifteen minutes none of the mixtures containing kephaline required more than ten minutes to clot, while *A* clotted only after seventeen hours. About eighteen hours later

⁷ These solutions were prepared according to the method described by Howell. *This Journal*, 1912, xxxi, p. 1.

the mixtures were all less active, showing a very close correspondence to the amount of kephaline added, as indicated by the following table.

Amount of kephaline	Clotting time of 5 drops	Calculated amount of thrombin present on basis of $F = 5$ d. (Enzyme \times clotting time = constant)	Amount of kephaline \div calculated amount of thrombin
A 0.	24 hrs.	—	—
B 0.1	155 min.	0.44	0.204
C 0.25	50 min.	1.5	0.167
D 0.5	30 min.	2.5	0.2
E 1.	20 min.	3.75	0.267
F 1.5	15 min.	5.	0.3

At this time, however, the test for metathrombin gave a clotting time of ten minutes for all. On standing all the solutions lost power both in thrombin and metathrombin, though these two maintained about the relation shown in the detailed test just cited. At the end of eight days none of the mixtures clotted under twenty-four hours except *F*, the clotting time of which had reached thirty minutes. In general the other experiments gave similar results.

The following points seem to be shown. The addition of kephaline has no appreciable effect on the amount or rate of disappearance of metathrombin. This would agree with the idea that the metathrombin is formed for the greater part at the time of clotting. The free thrombin present corresponded to the amount of kephaline present, thus agreeing with Howell's conception of its action in neutralizing the antithrombin and so releasing the thrombin. Though it greatly retarded the loss of free thrombin it did not prevent it, even when present in large amounts. This is true of all the experiments tried. This might indicate that the antithrombin-kephaline compound is unstable and slowly breaks up, releasing the antithrombin, or that the thrombin was inactivated by some other substance beside antithrombin.

THROMBIN

The greater number of experiments in the present work were carried out with specimens of thrombin which was made by Howell's chloroform method.⁸ At that time he stated (p. 459) that "aqueous solutions of thrombin protected from putrefaction slowly lose their efficiency." The lot from which the solutions here used were made gave very uniform results and these solutions retained their thrombic power for remarkably long times. In all of the experiments controls of thrombin diluted with water were used and in no case under observation was there any loss of power though some of the periods were as great as eighteen days. The power of these thrombin solutions to cause clotting in two and a half to five minutes after standing for two weeks is in marked contrast to that of serum, which under the most favorable conditions will not cause clotting under an hour after similar periods. Some at least of the factors causing loss of power have been removed in preparing the thrombin solutions.

That the thrombin in these solutions is not more stable than that in serum is easily proved, for if some serum is mixed with a thrombin solution the clotting power of the latter is rapidly and completely lost. A considerable number of experiments were carried out in this manner to test the effect upon thrombin of serum treated in various ways. The following may serve as examples of these. It should be remembered that heating plasma to 60° C. coagulates the fibrinogen and destroys the thrombin so that these preparations carry no thrombin into the mixture.

EXPERIMENT 9:

2 c.c. thrombin + 2 c.c. serum heated to 60° C. for 5 minutes

(In this and all other experiments there was a control of thrombin and water which clotted in 2½ or 5 minutes)

Test	Period of incubation	3, 4 and 5 drops + 10 drops plasma sol.	
1	20 min.	4d. weak clot at 70 min.	
2	3 hrs.	5d. clotted in 25 min.	3 and 4d. in 24 hrs.
3	20 hrs.	5d. clotted in 40 min.	4d. in 70, 3 trace in 24 hrs.
4	44 hrs.	5d. clotted in 45 min.	4d. in 6 hrs., 3 no clot in 24 hrs.

⁸ This Journal, 1910, xxvi, p. 453.

EXPERIMENT 17:

		Thrombin	Plasma	Water
	C	1. c.c.	.2 c.c.	.8 c.c.
	D	1. c.c.	.1 c.c.	.9 c.c.
Test	Incubation			
1	20 min.	C clotted at 10 min. D 5d. in 2½ min., 3d. in 10		
2	16 hrs.	C no clot in 24 hrs. D very weak clot in 24 hrs.		
3	66 hrs.	C and D no clot in 24 hrs.		
4	162 hrs.	C and D no clot		

EXPERIMENT 18:

C 2 c.c. thrombin + 1 c.c. serum heated to 60° + 1 c.c. H₂O

Test		
1	4½ hrs.	Faint clot in 5½ hrs.
2	41 hrs.	Faint clot in 24 hrs.
3	89 hrs.	No clot
5	7 days	No clot

EXPERIMENT 20:

C 2 c.c. thrombin — 1 c.c. serum heated to 60° — 1 c.c. water

Test		
1	16 min.	Clotted in 10 min.
2	1 hr. 40 min.	Clotted in 115 min.
3	18 hrs.	No clot

From this it appears that serum heated to 60° C. will inactivate twice its volume of an active solution of thrombin in twenty-four hours. In five experiments only two showed a trace of clotting power after standing twenty-four hours. In Experiment 17 the serum inactivated five times its volume in sixteen hours, so that while the control clotted in two and a half minutes the serum-thrombin mixture did not clot in twenty-four hours.

It is not necessary to examine in detail the evidence for all the temperatures tried. Specimens heated to 62° C. show similar behavior though less rapid action. The inactivating agent even survived a temperature of 62° C. for over an hour, and 65° C. weakened but still left it very active. When heated to 70° C. (cat's serum) the mixture after standing eleven days still clotted as promptly as the

control. Pig's serum heated to 80° C. also showed no inactivating power. Unheated serum, as we have seen, has an even more rapid inactivating action than heated sera.

Therefore there exists in fresh serum or oxalated plasma a thermolabile body which acts rapidly upon thrombin converting it to an inactive form. The similarity of action of this body to antithrombin is, of course, obvious. Since this substance even though considerably diluted works so rapidly on a solution of thrombin more active than fresh serum it seems peculiar that serum should, under ordinary circumstances, hold its clotting power for several days. In fact a specimen of serum to which thrombin is added, loses its power more rapidly than it otherwise would. It is difficult to see an explanation for this behavior.

An effort was made to locate the inactivating body by salting out the proteins of the serum. It was found that the first filtrate after half saturation with ammonium sulfate (freed of this salt by dialysis) caused loss of power. This filtrate was further completely saturated to see if the body was an albumin or went out with the albumins. The protein-free filtrate had no inactivating effect but the albumin was unfortunately denatured in the treatment and could not be tested. A second preparation of serum albumin as well as egg and lactalbumin did not show the inactivating agent. Later experiments showed that the body was greatly weakened and finally removed by dialysis, thus explaining the failure to locate it among the proteins.

CALCIUM

Since the inactivating body is destroyed by heat it cannot be an inorganic salt. Calcium was, however, tried for possible effects. Solutions of CaCl_2 of varying strengths, some of them approximating that of the blood, were added to thrombin solutions, but produced no more sign of inactivation during the eleven days of the experiment than did the controls containing distilled water. A second possibility was tested by oxalating serum and dialysing it free of the added oxalate. This calcium-free serum when mixed with thrombin caused as rapid inactivation as ordinary serum. Evidently the presence of calcium does not produce, nor its absence prevent, inactivation.

HIRUDIN

Since the behavior of the inactivating body toward heat, dialysis, kephaline and other factors clearly identify it with the antithrombin of the blood, hirudin was tested for its effect on thrombin. Much difficulty was experienced in balancing the strengths of the hirudin and the thrombin, and though repeatedly tried it was not found possible to get a mixture in which the original retardation of thrombic power was slight, but which showed on standing the progressive action characteristic of serum. The thrombin was either completely and rapidly inactivated or, if, the initial action was small, this decreased rather than increased:

KEPHALINE

As kephaline acts only on antithrombin it was not tested on thrombin direct but in conjunction with serum or hirudin. In these cases it retarded the inactivating effect but did not completely prevent it; agreeing thus with the results already given of its action in serum.

METATHROMBIN

Having considered the fate of thrombin and methrombin in serum and the factors causing inactivation of thrombin solutions, we come to the main purpose of the present work, a study of the characteristics and mode of origin of metathrombin. Morawitz gives the following as characteristic properties of metathrombin.⁹ It is not found in oxalate or fluoride plasmas but in all sera whether fresh or old and inactive. It is more resistant toward the factors destroying thrombin, since it is found in as great amount in five-day-old serum as in fresh serum. If treated with acids and alkalies the active thrombin freed rapidly disappears. Apparently all is not freed by the first activation, since it may be reactivated twice, but the freed thrombin does not return to metathrombin as it may not be activated a third time. It is thermolabile, being destroyed (as are thrombin and prothrombin) by half an hour's heating to 60° or 62° C. It is not removed by dialysis and is precipitated out with the globulins by

⁹ Hofmeister's Beiträge, 1904, iv, p. 402 et seq.

addition of 30 to 50 per cent ammonium sulfate. It is activated by alcohol as well as acids and alkalies, but prolonged action of the latter destroys it. It is not found in Schmidt's thrombin.

I can confirm many of these points and have little to add. Metathrombin is present in five-day serum in considerable amount but never in the full strength shown at first. It is absent from very old serum. Thrombin prepared by Howell's method shows no metathrombin.

One prevalent misconception must be here corrected. It is stated, for instance,¹⁰ that "the thrombin [destroyed by the action of serum] may be recovered, in part at least, by proper alkali or acid activation." Serum shows metathrombin directly after clotting and it is not necessary to wait until the inactivation of the patent thrombin before attempting activation. In the present work many of the experiments gave misleading results because at first this was not realized. That thrombin is continually going over into metathrombin is quite probable, but if so the amount is too small to affect the much greater initial mass of metathrombin, and even the rapid loss of clotting power of serum in the first three or four days causes *no increase* of metathrombin.

Morawitz¹¹ considers that since metathrombin is not present in oxalate plasma but is present in great amount after clotting, its origin must be connected with the process of clotting. To determine this point as well as the possible rôle of calcium, he clotted oxalate plasma with Schmidt's thrombin containing oxalate. The serum obtained was inactive because of the great dilution of the thrombin and its absorption by the fibrin. It also contained no *metathrombin*. He therefore concludes that metathrombin is not formed in the process of clotting but arises through the action of calcium on prothrombin as does thrombin. Later¹² he modifies this view slightly, stating that the thrombin for the greater part goes over into metathrombin very quickly after clotting. That metathrombin represents a thrombin-antithrombin compound he considers disproved by the fact that in serum which has lost its antithrombin there is still much metathrombin. On the other hand, since the free thrombin of the serum persists

¹⁰ Rettger, This Journal, xxiv, 1909, p. 430.

¹¹ Hofmeister's Beiträge, 1904, iv, pp. 405, 411.

¹² Ergebnisse der Physiologie, 1905, iv, p. 371.

so much longer than what is apparently the same thrombin liberated from metathrombin by activation, he concludes that part of the former is bound to antithrombin and is only slowly liberated to disappear almost at once.

In regard to the experiment of clotting oxalate plasma with thrombin, the only point established is that the formation of fibrin from fibrinogen and thrombin does not produce metathrombin. Work of a different character, soon to be detailed, confirms this, and, in fact, such an origin was hardly to be expected. That metathrombin arises from prothrombin through calcium action is not proved, since other hypotheses, for instance the theory here proposed of a thrombin-antithrombin origin, meet equally well the logical requirements which are merely the absence of both thrombin and metathrombin from oxalate plasma and their presence soon after normal clotting, or to be more exact, the opportunity for interaction between prothrombin and calcium in the presence of the other components of the blood. Experiments on this point will be given.

As to the presence of metathrombin in solution from which the antithrombin has disappeared: this, instead of militating against a thrombin-antithrombin compound, is rather what would be expected, since if the antithrombin were bound in any such union it would hardly manifest itself in the ordinary manner.

It has already been stated that thrombin solutions (which contain no metathrombin) are rapidly inactivated by serum. Such solutions were tested not only for thrombin but for metathrombin. Somewhat detailed results of one such experiment may be given.

EXPERIMENT 20:

Five mixtures were made as follows:

	Thrombin	Water	Unheated	Serum		
				Heated		
				60°	65°	70°
A	2 c.c.	2	—	—	—	—
B	2 c.c.	1	1	—	—	—
C	2 c.c.	1	—	1	—	—
D	2 c.c.	1	—	—	1	—
E	2 c.c.	1	—	—	—	1

TEST 1. After 15 minutes' incubation,

5 drops clotted plasma in

A	5 min.
B	20 min.
C	10 min.
D	5 min.
E	2½ min.

TEST 2. After 1 hour and 4 minutes.

5 drops clotted plasma in		6 drops activated clotted in
A	5 min.	—
B	280 min.	10 min.
C	115 min.	115 min.
D	5 min.	115 min.
E	2½ min.	45 (weak)

TEST 3. After 18 hours and 20 minutes.

A	5 min.	65 (weak)
B	24 hrs.	15 (weak)
C	No clot in 24 hrs.	90 (weak)
D	490 min.	No clot in 24 hrs.
E	5 min.	65 min.

TEST 4. After 66 hours.

A	5 min.	20 min.
B	24 hrs.	35 min.
C	No clot in 24 hrs.	160 min.
D	24 hrs.	460 min.
E	10 min.	160 min.

This experiment clearly shows a point already referred to — the destruction of the inactivating body at a temperature between 65° and 70° C. — as *A* and *E* are the only mixtures which retained their thrombic power. The matter which now concerns us, however, is

the presence of metathrombin. In *B*, the first mixture to show loss of power, test 2 reveals a large amount of metathrombin. After this time both thrombin and metathrombin decline in this specimen. In *C*, in which the inactivation is less rapid, the metathrombin appears correspondingly later (test 3). In *A* and *E* there is at no time evidence of any considerable amount of metathrombin, and the readings are due in part at least to incomplete destruction of the large amount of thrombin present by the process of reactivation.

This experiment seems to me to offer in the related loss of thrombin and appearance of metathrombin proof of the transformation of thrombin into metathrombin by an inactivating agent in the serum which we have every reason to identify with antithrombin.

As previously stated, the action of hirudin upon thrombin was studied, but in this case no metathrombin was detected though it was repeatedly sought for. Whether this failure arose from the difficulty of balancing the action of the thrombin and the hirudin—it will be noted that in the experiment just given the whole course of events was far more rapid than in serum, and conceivably thrombin and hirudin may act even more quickly—or from an essential difference between hirudin and the antithrombin of the blood, I cannot say.

If metathrombin arises from the union of thrombin and antithrombin it ought to be possible to obtain a serum free from metathrombin if clotting took place in plasma deprived of its antithrombin. This was attempted by adding kephaline to oxalate plasma and then clotting with CaCl_2 , but the antithrombin could not be completely removed by this method, and metathrombin, though in reduced amount, was still present. On standing, the antithrombin content of both plasma and serum diminishes, but this did not prove a more satisfactory method. It was found, however, that dialysis removed the antithrombin, and though it weakened the prothrombin so that it was impossible to obtain an absolutely antithrombin-free plasma that would clot on addition of calcium, the antithrombin was very greatly reduced.

In Experiment 27 it was found that after forty-two hours' dialysis, one drop of the plasma (heated to 60°C . to remove the fibrinogen) added to two drops thrombin caused a fibrinogen solution to clot in five minutes, while a similar solution of thrombin and water caused

clotting in two and a half minutes. With fresh plasma the clotting may be retarded from twenty minutes to an hour. Ten c.c. of this plasma were removed and 0.2 c.c. of 2 per cent CaCl_2 added, producing clotting in twenty-three minutes. This clot was removed with a stirring rod and the serum tested at once for thrombin and metathrombin. Five drops of the serum caused clotting in five minutes; six drops of a reactivated sample caused no clot in twenty-four hours. A second test, half an hour later, gave similar results except that the reactivated mixture caused a weak clot in five hours which did not become firm on standing over night. Two hours later the metathrombin was increased, though not more than might have been expected from the small amount of antithrombin present. It should be borne in mind that under ordinary circumstances a sample of serum taken half an hour to two hours after clotting will cause clotting in five or ten minutes. Calcium was of course present, but this failed to produce metathrombin, so that Morawitz' conception of an origin from prothrombin and calcium is hardly tenable.

In view of the facts that metathrombin may be produced from a thrombin solution by the addition of antithrombin, and that the absence of antithrombin from an otherwise normal process of clotting prevents the appearance of metathrombin, there can be little doubt that metathrombin is a compound of thrombin and antithrombin. It apparently arises wholly or in great part very soon after clotting from the union of the newly formed thrombin and the antithrombin present in the blood, and then disappears, as does the unchanged thrombin, though much less rapidly.

SUMMARY

The present paper deals with the thrombin content of serum as determined by its clotting power on fibrinogen solutions and the metathrombin content as indicated by the clotting power after "activating" by the addition of weak alkalis and subsequent neutralization with acids. The effect of various substances upon thrombin and on serum was studied in an attempt to find the relation between thrombin and metathrombin.

1. The clotting power of serum (dog) is rapidly lost under ordinary conditions, becoming practically negligible in three or four days.

Following this there is a considerable period (five to eighteen days) of great variation ending with an almost complete return of power and finally after eighteen to twenty-nine days an absolute and lasting loss.

2. What has been said of thrombin is also true of the metathrombin content except that the initial loss is markedly less rapid.

3. If the serum is kept sterile the loss of power is much slower, the solution remaining quite active up to one or two weeks and requiring another week to become entirely inactive. The loss of metathrombin is even slower and in neither is there evidence of spontaneous reactivation. We may conclude that infection hastens the loss of both thrombin and metathrombin and is the cause of the apparently spontaneous return of power observed. Most of the factors which are stated to hasten inactivation act by hastening infection and bacterial growth.

4. Thrombin prepared by the chloroform method of Howell will retain its clotting power absolutely unimpaired for considerable periods (at least eighteen days).

5. The clotting power of this thrombin is rapidly destroyed by a body present in oxalate plasma and in serum. This inactivating body is considered identical with antithrombin from the following characters:

(a) It is thermolabile, surviving a temperature of 65° but being destroyed by 70° C.

(b) It is weakened and finally destroyed by prolonged dialysis.

(c) Its action is retarded by the presence of kephaline.

(d) The amount of antithrombin present in serum as indicated by the ordinary test of its retarding effect on a mixture of thrombin and fibrinogen always corresponds to the amount of the inactivating body present.

6. The presence of metathrombin in solutions of thrombin after the inactivation of the latter by antithrombin has been demonstrated at least in certain cases. This seems to make highly probable that metathrombin arises from the interaction of thrombin and antithrombin.

7. The practical absence of metathrombin arising from the clotting of oxalate plasma deprived as far as possible of its antithrombin by dialysis, greatly strengthens the probability that metathrombin is, as indicated above, a thrombin-antithrombin compound.

To recapitulate: it seems highly probable from the present experiments that metathrombin (β -proferment) is a thrombin antithrombin compound, which arises normally in greater part at the time of clotting by union of the newly formed thrombin with the antithrombin present in the blood. It exists parallel with the thrombin, but on account of its greater resistance to destroying influences and probable greater initial amount it persists in greater strength and for a longer time, but finally disappears entirely. Its rôle in ordinary clotting would appear to be negligible; it represents part of the excess of thrombin produced. The theoretical possibility of its origin from protective neutralization of thrombin in circulating blood is not supported by experimental proof, as it has not been found in oxalate or fluoride plasmas.

ON THE ABSORPTION OF WATER BY THE SKIN OF THE FROG

BY S. S. MAXWELL

[From the *Rudolph Spreckels Physiological Laboratory of the University of California*]

I. INTRODUCTION

THE process of secretion plays so large a rôle among the activities of the animal organism that an understanding of its underlying mechanism would go far to the elucidation of some of the most fundamental problems of physiology. For this reason it would be desirable to examine it in that form which presents the fewest variables. The experiments of Reid¹ and the observations of Overton² seemed to indicate that the skin of the frog is able to pass water through itself in opposition to osmotic pressure. If this could be clearly and satisfactorily demonstrated the frog skin could be used for a more thoroughgoing analysis of the process. On first view the results obtained by Reid appear to be convincing, and they seem to have been accepted without question by many physiologists. He experimented by using frog skins as the membranes of osmometers, and compared the rate at which liquid passed through when the outer side was exposed to the lower osmotic pressure with the rate when the inner side was so placed. He found that in healthy living skin the transfer of liquid took place most readily from without inwards, but that this result could be reversed by subjecting the skin to the action of chloroform or by allowing it to become stale. The latter fact, however, the fact that when the skin becomes stale, water passed more readily from within outward, would appear to prove too much. By the use of his very ingenious differential osmometer Reid

¹ REID: *Journal of physiology*, 1890, Vol. ii, p. 312.

² OVERTON: *Verhandlungen der physikalisch-medicinische Gesellschaft Zu Würzburg*, 1904, xxvi, p. 277.

found on comparing the rate of passage of water through the skin three periods:

1. A period in which the quantity of water passing from without inwards is in excess of that passing from within outwards.
2. A period in which the two amounts are practically equal.
3. A period in which the quantity of fluid passing from within outwards is in excess of the quantity passing from without inwards; and the number representing this excess increases with the lapse of time post mortem.

The existence of the first period was taken to prove a vital activity on the part of the cells of the epithelium. The water was supposed to be moved from without inward by a process of secretion on the part of the living skin. By the same logic, however, the existence of the third period proves that the dead skin is also possessed of a secretory power but in the opposite direction, an inference which for obvious reasons no one has ever drawn.

A second set of experiments more to the point was reported by Reid³ wherein the same liquid was placed in both sides of the osmometer and it was then found that liquid was transferred in the direction from without inward. The liquid used was "normal saline" supposedly isosmotic with the tissues. The concentration is not stated, but at that time normal salt was commonly taken to mean 0.6 to 0.65 per cent NaCl. As we shall see later the concentration is a matter of the utmost importance.

Very extensive experiments on the osmotic transfer of water through the skin of the frog were made by Overton.⁴ When the frog was submerged in water large quantities of liquid were taken up, and accumulated in the body in case the discharge of urine was prevented. Even in 0.65 per cent NaCl solution, supposedly isotonic with the tissues, some liquid was still taken up.

Snyder⁵ reported experiments on the temperature coefficient of absorption made in the following way: Frog skins were removed without tearing and were tied so as to form little sacs. These sacs were filled with Ringer's fluid, placed in Ringer's fluid and kept at constant temperatures. From the change in quantity of contents the inference was drawn that the process of absorption is a chemical

³ REID: British medical journal, 1892 (Feb. 13.)

⁴ *Loc. cit.*

⁵ SNYDER: Zentralblatt für Physiologie, 1908, xxii, p. 236.

one. As Snyder does not state the concentration it is to be presumed that he used the original solution of Ringer.

II. EXPERIMENTS

My first experiments were made to determine approximately the magnitude of the water absorption by the detached skin. It is well known that if a frog's leg is ligatured so tightly as to prevent fluid exchange with the rest of the body a relatively enormous quantity of water is taken up by the leg. While some of this water is later absorbed by the muscles and other tissues and produces pathological changes in them, a large part of the excess of liquid remains free in the interstices and lymph spaces of the limb. Does the detached skin take up water in a similar way? The following experiments will answer.

The skin of the leg was removed with as little violence as possible, any adherent blood gently wiped off, the skin turned right side out and ligatured at both ends. The closed sac, thus formed was dipped into distilled water, immediately withdrawn and gently pressed between folds of bibulous paper and weighed. It was then placed in distilled water, and, after twenty-four or forty-eight hours, it was weighed again in a similar manner.

Table I is typical as to range of magnitudes and variability:

TABLE I
INCREASE OF WEIGHT OF EMPTY SKIN OF FROG'S LEG IN DISTILLED WATER

Experiment	Weight in Grams			Per cent gain	
	At Beginning	24 hrs.	48 hrs.	After 24 hrs.	After 48 hrs.
1	0.72	1.56		116	
2	0.31	0.79		155	
3	0.68	1.70		150	
4	0.34		1.07		185
5	0.28	0.59	0.78	110	178
6	0.43	1.08	1.43	140	232

It is apparent that a relatively enormous quantity of water passes through a frog skin immersed in water. Is this liquid free or is it in part held in some kind of colloidal solution in the tissues of the skin?

The results in Table II were obtained in the same way as in Table I, but at the close of the experiment the sac was cut open, the liquid emptied out, the empty skin pressed gently between folds of bibulous paper and weighed.

TABLE II

Experiment	Weight			Empty Skin	
	Beginning	48 hrs.	Per cent gain	Weight after 48 hrs.	Per cent gain
1	0.62	1.25	100	0.68	10
2	0.74	1.49	101	0.84	13
3	1.07	2.40	124	1.33	24
4	1.09	2.45	125	1.17	7

The actual swelling of the skin is thus seen to have about the same order of magnitude as that of other tissues immersed in distilled water, while the great proportion of the gain in weight is due to free liquid lying within the sac. The free liquid was always found to be more or less tinged with blood when the sac was opened at the end of twenty-four or forty-eight hours. This was true even when the inside surface of the skin had been carefully washed with water or $\frac{m}{8}$ NaCl at the beginning of the experiment. A not negligible amount of blood had been contained in the cutaneous vessels and affected the result. On this account a few experiments were made of the kind illustrated in Table III. The inner surfaces were washed with water and 2 c.c. of distilled water were placed in each sac before it was tied. The skins were then weighed and placed in salt solutions of varying concentration. So long as these concentrations were low their effect upon the total quantity of liquid absorbed was little different from that of distilled water, but even a small amount of salt tended to inhibit the injurious action on the skin.

TABLE III
SKINS RINSED INSIDE AND 2 C.C. DISTILLED WATER PLACED IN EACH

Experiment	Solution bathing Skin	Weight			Empty Skin	
		Beginning	48 hrs.	Per cent gain	Weight after 48 hrs.	Per cent gain
1	Distilled H ₂ O	* 5.15	7.38	* 71	3.41	8.
2	M/100 NaCl	5.01	7.23	70	3.03	0.7
3	M/50 NaCl	4.70	6.62	71	2.70	0.
4	N/25 NaCl	4.80	6.71	68	2.78	- 0.7

* Note that the calculations of per cent gain assume that the 2 c.c. of water placed inside weighed 2 grams. The error in this assumption does not exceed the necessary experimental error and may properly be neglected.

In the experiments thus far described the skin was immersed in distilled water, and the presence of any of the tissue fluids in the inner layer of the skin would tend by simple osmotic processes to carry water through. Some experiments were then arranged by means of which the liquids in the sac of skin would be diluted while the liquid outside would have a considerable osmotic pressure. The direction and amount of transfer of liquid was noted and this was compared with the osmotic pressure as inferred from the electrical resistance of the liquid without and within the skin at the end of the experiment. The order of magnitudes is illustrated in the Table IV.

TABLE IV

Experiment	Liquid bathing the skin	Liquid placed inside sac	Weight			Specific Conductivity in reciprocal ohms	
			Beginning	After 48 hrs.	Per cent gain	Of bathing solution	Of liquid in sac
1	Tap water	None	0.97	2.14	120	1.45×10^{-3}	2.14×10^{-3}
2	M/25 NaCl	5 c.c. H ₂ O	11.56	16.07	70	5.19×10^{-3}	5.96×10^{-3}
3	M/15 NaCl	5 c.c. H ₂ O	7.71	7.42	- 10	10.26×10^{-3}	9.19×10^{-3}
4	M/10 NaCl	5 c.c. H ₂ O	7.68	6.50	- 40	13.33×10^{-3}	12.90×10^{-3}

NOTE: In experiments 2, 3 and 4 the per cent gain is calculated after deducting 5 gm. as the weight of the water added.

A comparison of the results in Table IV shows as would be expected that the movement of water is in the direction of the lower electrical resistance, that is towards the higher osmotic pressure. It would have been better to have made determinations of the freezing point of the liquids, but the apparatus at hand was not suited to the small amounts of liquids obtainable in some of the experiments. It is perfectly evident, however, that any error due to the presence of non-electrolytes, suspended colloids and the like, would be in the sense of increased resistance, and hence would give appearances favoring the idea of vital activity as opposed to osmotic transfer.

A few experiments were arranged with skins filled with the same liquid as that in which they were immersed. The liquid used was Loeb's solution composed of $\frac{m}{8}$ NaCl 100 parts, $\frac{m}{8}$ CaCl₂ 2 parts, $\frac{m}{8}$ KCl, 2 parts. Ten cubic centimetres of the solution were placed in each skin and the skin was immersed in fifty cubic centimetres of the same solution. It should be pointed out that these experiments are far from being so crucial as they would seem. Notwithstanding the fact that the skins were rinsed inside and out in the solution, before they were filled and tied, they nevertheless carried with them a considerable quantity of water in the mucous layer on the one side, and of blood and lymph on the other. The attempt to meet this objection by turning some of the skins wrong side out was not wholly satisfactory and it is planned to continue this part of the work in a new form. The sample experiments shown in Table V will, however, give some idea of the conditions observed:

TABLE V
SKINS IN LOEB'S SOLUTION; 10 C.C. OF THE SAME SOLUTION INSIDE EACH SKIN

Experiment	Side out	Weight			Specific Conductivity	
		Beginning	After 24 hrs.	Per cent gain	Of bathing solution	Of liquid in sac
1	Right	13.59	14.01	3.1	13.50×10^{-3}	13.82×10^{-3}
	Wrong	13.81	13.45	- 2.6	13.46×10^{-3}	12.57×10^{-3}
2	Right	12.93	13.09	1.2	12.62×10^{-3}	12.24×10^{-3}
	Wrong	11.52	11.10	- 3.6		
3	Right	14.75	14.93	1.2	12.57×10^{-3}	12.57×10^{-3}
	Wrong	12.84	12.66	- 2.6		

It is probable that a careful removal of excess of liquid from the skins used in experiments 2 and 3 of Table V would have changed the result of the conductivity experiments considerably, but it is a question how much of this can be done without injury to the skin. Experiment 3 would seem to indicate that transfer of liquid can take place without difference of osmotic pressure; but it is possible that such a difference had existed and that in this case equilibrium was established within twenty-four hours.

III. DISCUSSION OF RESULTS

It will be seen that while the above experiments show an enormous tendency of the frog skin to transport water by osmosis, the skin appears to be highly impermeable to inorganic salts. Some of the experiments, however, seem to show an ability to transfer water from one side to the other when the same osmotic pressure exists on both sides. The amount of such transfer is strikingly small as compared with that obviously due to osmotic pressure, and also as compared to the work done by secreting organs like the kidneys or the salivary glands. This difference raises the question whether the inference is justified that any transfer of water taking place through the skin is due to vital activity of the living cells. The experiments of Reid⁶ commonly cited in support of such a view are not very convincing. He found, for example, that the osmotic effect of a 5 per cent solution of glucose in normal saline in one side of the osmometer, against a normal saline solution on the other, was more effective when the inner side of the skin was turned towards the glucose than when in the reverse position. In the clearest set of experiments reported by him⁷ the amount of liquid passed through in twenty-four hours in the one direction was 174.093 cubic millimetres in the other 79.035 cubic millimetres. The difference of the two is 95 cubic millimetres. According to the secretion theory this difference is due to an acceleration in the one direction and a retardation in the other and is brought about by the vital activity of the cells. The actual secretion would then be approximately equal to one half the difference or 47.5 cubic millimetres. The area

⁶ *Loc. cit.*

⁷ *Loc. cit.*, p. 326.

of skin exposed in the osmometer used by Reid was 95 square millimetres and the total effect was equal to the transfer of a layer of liquid one half a millimetre deep over the entire surface of the skin, an amount which could be very well due to the physical differences of the two sides of the skin. On the one side is a layer of tissues infiltrated with blood and lymph; on the other an adherent layer of watery mucous secretion. This arrangement would favor movement of water by osmosis from the outer to the inner side of the skin. When liquids of equal osmotic pressure were placed on the two sides of the skin, movement of water from outside to inside would proceed until the salt concentration of the mucous layer became equal to that of the surrounding liquid. The irreciprocity of permeability to sodium ions described by Bayliss⁸ is harder to understand but may be accounted for on analogous grounds. Moreover, Starling⁹ has given theoretical considerations to prove that under certain conditions substances may actually pass through a membrane against osmotic pressure without the interference of vital activity. It is highly desirable that the conditions which he assumes should be worked out experimentally.

It has also been shown by Reid that the rate of transfer of water through the frog skin is affected by the addition of chloroform and of alcohol to the liquids in the osmometer, and the inference has been drawn that this is due to an effect of these agents upon the protoplasmic activities of the epithelial cells. In view of the slender evidence for the apparently slight amount of secretion by the skin, it would seem much more reasonable to suppose that these agents bring about some change in the physical state of the epithelium itself or in the adherent layers of material.

It has been pointed out already in the introductory part of this article that a difference in rate according to direction of transfer of liquid through the skin does not of itself prove a vital activity as the cause of the difference, for such a difference exists also in dead skin. In the latter the direction of easier transfer is from within outwards. The differences dealt with are differences in *rate* of transfer. It is noteworthy that the emphasis in most of the work on osmosis has been laid upon *equilibrium* rather than on *rate*, while

⁸ Bayliss, *Zeitschrift für Biochemie*, 1908, xi, p. 226.

⁹ STARLING: *The fluids of the body*, London, 1909.

diffusion has been studied from the standpoint of movement. When we have an adequate knowledge of the dynamics as well as of the statics of osmosis it will be easier to understand the apparent anomalies of the movement of water through the frog's skin without invoking vital activity as a means of explanation.

SUMMARY

1. It has been shown that an empty frog skin immersed in water takes up a relatively enormous quantity of water.

2. The taking up of large quantities of water depends upon the permeability of the frog skin to water and its relative impermeability to inorganic salts.

3. A skin exposed to liquids of equal osmotic pressure on both sides may still transfer water through itself from without inwards, but the amount is relatively small and is probably due to physical differences of the layers of liquid carried by the skin on and within its opposite surfaces.

4. The assumption of a vital activity on the part of the frog skin in transferring water through itself is shown to be unnecessary.

THE
American Journal of Physiology

VOL. XXXII

OCTOBER 1, 1913

NO. VI

PHYSIOLOGICAL OBSERVATIONS FOLLOWING DESCENT
FROM PIKE'S PEAK TO COLORADO SPRINGS

By EDWARD C. SCHNEIDER

[From the Department of Biology of Colorado College, Colorado Springs, Colorado]

AMONG the numerous physiological observations on the influence of high altitudes upon man, only a few have dealt with the changes following the descent to the lower level, and these have been on men who have resided at the high altitude from a few days to five weeks. It has been interesting, therefore, to follow the changes in the blood, circulation, and respiration of a man who has lived long on the summit of Pike's Peak, altitude 14,109 feet.

Mr. Howard H. Robison,¹ the resident manager of the Summit House on Pike's Peak, very kindly consented to serve as the subject for this study. He has resided on the summit six months—from early in May to November—for seventeen consecutive years. He first went up when a young man in his early twenties. He is a man of athletic physique, excellent habits, and leads a very active life. He holds the record for the most rapid ascent ever made of the Peak, walking from Manitou to the summit, up the "Cog" railway track, a distance of 8.9 miles and a rise of 7485 feet, in 2 hours 31 minutes.

¹ The writer wishes here to express his sincere thanks to Mr. Robison for so kindly serving as subject for this study, and to Mr. Leon C. Havens for help with blood-counts and air analyses.

In 1912 he went to the summit the morning of May 8 and came down the evening of November 12. During this period of over six months he had been down only once and then for only one night. The first observations on him were made on the summit of the Peak October 12, 13, and 14. The first study in Colorado Springs, altitude 6000 feet, was on the morning following his descent.

An attempt was made to have the examination made at the same hour each day so that daily rhythms need not be considered. Observations were made at frequent intervals throughout a period of ten weeks, and to these have been added a few isolated examinations made at other times. Changes were followed carefully for the first six days after the descent. Mr. Robison then went on a hunting trip for two weeks to Lamar, altitude 5765 feet, and was available again for the investigation several times during the next ten days. December 12 to January 25 he spent at San Antonio, Texas, near sea-level, after which he subjected himself to further observations.

THE CHANGES IN THE BLOOD

The changes in the percentage of haemoglobin, number of red corpuscles, total oxygen capacity, total volume of the blood, and specific gravity of the blood have been followed. The results appear in Table I. The total oxygen capacity and blood volume were determined by the carbon monoxide method of Haldane and Lorrain Smith.² Care was taken to allow at least twenty minutes to elapse, while the subject still continued to breathe into the confined space of the apparatus, after having received the carbon monoxide, so that the gas would distribute itself evenly throughout the body. The blood samples then taken were titrated in duplicate, and sometimes in triplicate, with a standardised carmine solution against a north light. The percentage of haemoglobin was determined by the Haldane-Gower's haemoglobinometer and the blood-counts were made with a Thoma-Zeiss haemocytometer. For the specific gravity a series of wide-mouthed bottles containing mixtures of glycerine and water of different densities was used.

² HALDANE and LORRAIN SMITH: *Journal of physiology*, 1900, xxv, p. 331.

The changes that followed Robison's descent from the summit of Pike's Peak to Colorado Springs agree in general character with

TABLE I
OBSERVATIONS ON THE BLOOD OF MR. ROBISON

Date	Time of observation	Percentage of haemoglobin	Total oxygen capacity in c.c.	Percentage oxygen capacity	Total volume of blood in c.c.	Specific gravity	Red corpuscles per cu. mm. in millions	
Oct. 12, 1912	3 p.m.	148	—	27.4	—	—	(7.7) ¹	Summit of Pike's Peak
13	8.45 a.m.	150	—	27.8	—	—	(7.5)	
14	7.55 "	148	1101	27.4	4018	—	—	
Nov. 13	7.35 "	144	1062	26.6	3992	1.073	—	Colorado Springs
14	10.40 "	142	1085	26.3	4125	—	—	
15	7.45 "	145	—	26.8	—	1.073	—	
16	7.25 "	144	1088	26.6	4090	1.073	7.6	
17	7.20 "	147	—	27.2	—	—	—	
18	7.15 "	143	1125	26.5	4245	1.072	7.7	
Dec. 3	8.15 "	134	1050	24.8	4234	1.071	7.4	
5	8. "	134	—	24.8	—	1.071	7.6	
12	7.45 "	132	1054	24.4	4320	1.070	7.5	
Jan. 26, 1913	10. "	122	—	22.6	—	1.068	7.2	After return from sea-level
28	7.30 "	121	965	22.4	4308	1.068	7.2	
30	8.20 "	122	973	22.6	4305	—	—	
May 1	7.25 "	122	—	22.6	—	1.067	7.0	In Manitou three months, altitude 6620 feet

¹ Counts made in July and August, 1911.

those observed by Douglas, Haldane, Henderson, and Schneider³ in the English-American Pike's Peak Expedition of 1911. They observed on themselves following their return to Colorado Springs that there was an *immediate* reduction in the percentage of haemoglobin, which fell in a day or two to about 110 per cent, which is near the normal for the altitude of 6000 feet. Simultaneously in them there was a distinct decrease in the total oxygen capacity of the blood, but this was not so marked as the change in the haemoglobin percentage. In each man, except one, the blood volume increased for thirteen days following descent, after which it returned to the normal for the lower altitude.

In Robison the blood changes delayed in appearing and then took place at a very slow rate. The percentage of haemoglobin did not clearly alter during the first six days. At the end of three weeks it had fallen from 148 to 134 or about 9.4 per cent. Nine days later it had only reached 132, so in one month it had not nearly approached the average for the altitude. Sometime during the next six weeks while Robison was near sea-level the haemoglobin fell to 122, the level to be maintained throughout the remainder of the stay at the foot of Pike's Peak. The previous winter Robison's percentage of haemoglobin fell from 145 on Pike's Peak to 116 at Manitou. This also is high, the average being 110 in men at 6000 feet. In 1912-13 the entire fall in the haemoglobin percentage was 17.6 per cent.

The destruction of haemoglobin and alteration in blood volume followed a somewhat different course than that observed in the English-American Pike's Peak Expedition. Two determinations of Robison's total blood volume and total oxygen capacity were made on Pike's Peak; unfortunately the figures, which were on a loose sheet of paper, for the titration in the experiment made October 13 were lost. An approximate estimate made at the time showed the results to agree well with the data of the 14th. Unlike the immediate change observed in Douglas, Haldane, and Schneider there was in Robison no destruction of haemoglobin during the first six days after his descent. However, while the total oxygen capacity remained stationary there was some diluting of the blood on the

³ DOUGLAS, HALDANE, HENDERSON, and SCHNEIDER: Philosophical Transactions of the Royal Society of London, 1913, Series B, CIII, pp. 271-298.

sixth day which gave an increase of 5.4 per cent in the total blood volume. During the next three weeks the total oxygen capacity diminished 4.3 per cent; while on the other hand, the blood reached its maximum volume. This was 7.5 per cent greater than the volume on Pike's Peak. While Robison was at sea-level the blood volume does not appear to have increased. There was, nevertheless, during this period a marked destruction of haemoglobin; the total oxygen capacity of the blood the last of January was 11.9 per cent less than it had been on the summit of the mountain. Applying Hüfner's value that the amount of oxygen which combines with one gram of haemoglobin is 1.34 c.c. there were 822 grams of haemoglobin in the subject's blood on Pike's Peak. Sometime within the ten weeks he destroyed a surplus of 98 grams of haemoglobin.

The reductions in the number of red corpuscles and in the specific gravity of the blood are roughly parallel with the other blood changes.

OBSERVATIONS ON THE ARTERIAL PRESSURE AND PULSE-RATE

For six years at widely separated periods arterial pressure and pulse observations have been made on Robison, and these indicate that long residence at an extremely high altitude has in no way altered the efficiency of his heart action and circulation. The arterial pressure determinations were always made on the subject while resting in the sitting posture. They have been found to range as follows:—

	Systolic pressure	Diastolic pressure	Pulse pressure
On Pike's Peak	106 to 122 mm.	75 to 86 mm.	26 to 38 mm.
In Colorado Springs	114 to 126 "	80 to 90 "	28 to 39 "

A uniform difference in the pressures at the two altitudes has not been found. On the whole, however, the data agree with the observations of Schneider and Hedblom.⁴ They found in a series of eighteen observations on Robison, in 1907, that his systolic and diastolic pressures averaged somewhat less on the summit of Pike's Peak.

⁴ SCHNEIDER and HEDBLOM: This journal, 1908, xxiii, p. 101.

Robison's resting heart-rate on Pike's Peak during the three days October 12, 13, and 14 varied between 80 and 92 beats per minute. The normal tempo on Pike's Peak per minute as shown by frequent observations was about 82. The slowest rate yet noted in him at this high altitude was 68, recorded by Schneider and Hedblom in 1907.

A very marked slowing of the pulse-rate, such as was observed by Durig and Kolmer,⁵ occurred following Robison's descent to Colorado Springs. During the first five days the rate remained constantly at 60 but on the sixth morning it had increased to 64. After the trip to Lamar the resting pulse had accelerated to 72 and throughout the remaining period of study it never returned to the slow tempo of the early days, but varied between 68 and 78. This increase in the pulse-rate does not appear to be definitely associated with the blood changes although the haemoglobin percentage had fallen ten points at the time the rate increased and the total oxygen capacity of the blood was slightly lowered. Very likely the explanation is to be found in the fact that the alveolar oxygen pressure in the lungs had fallen almost to the normal for the lower altitude.

Benedict and Higgins⁶ have shown that the pulse-rate at sea-level in normal individuals breathing oxygen-rich mixtures is less than when breathing ordinary air. Parkinson⁷ confirmed their observations and suggests in that the blood is capable of taking up more oxygen, when an excess is present, the heart muscle is better supplied with oxygen and thus works to better advantage, supplying the tissues by fewer beats. It is evident that the reaction of the organism to high altitudes is in large measure due to deficiency of oxygen and, therefore, we may expect the heart to benefit when oxygen is administered. This was found to be the case. Robison was set to breathing oxygen through the apparatus employed for administering carbon monoxide and oxygen in the blood volume studies. In each of two experiments on the summit of Pike's Peak there was almost an immediate slowing of the heart. Thus in the first experiment in two minutes after beginning to breathe the pure

⁵ DURIG: *Physiologische Ergebnisse der im Jahre 1906 durchgeführten Monte Rosa Expedition*, p. 48.

⁶ BENEDICT and HIGGINS: *This journal*, 1911, xxviii, p. 25.

⁷ PARKINSON: *Journal of physiology*, 1912, xlv, p. 54.

oxygen his pulse-rate was reduced from 80 to 72 and at the end of seven minutes had fallen to 64. The second experiment a day later was briefer but again the pulse-rate after having remained at 82 for some minutes was reduced in two minutes to 72 and a minute later was down to 70.

During the first month after the descent to Colorado Springs repeated attempts were made to reduce the cardiac-rate with oxygen but without success. It should here be remarked that the normal individual at an altitude of 6000 feet will respond to the breathing of oxygen-rich mixtures by a slowing of the pulse-rate. In our laboratories we have often confirmed the earlier observations on healthy young men. For example, one subject after sitting quietly for ten minutes had a pulse-rate of 71; this was lowered to 62 during ten minutes breathing of pure oxygen and four minutes after return to air it had again accelerated to 70 per minute. In a majority of the men studied, the character of the pulse while breathing the oxygen changes, becoming fainter and softer. With Robison this change could not at first be noted with certainty. However, on January 28 and 30 after he returned from sea-level the character of the pulse while he breathed the oxygen, although the rate was still unaltered, was found by several observers to be softer.

A definite slowing of this subject's cardiac-rate was obtained in an experiment on May 1, five and one half months after the descent. For ten minutes his pulse remained constant at 68 per minute; he was then given oxygen for ten minutes and during this interval the rate varied between 64 and 62. After the return to air the rate slowly increased and within nine minutes it had returned to 68.

The observations indicate that the accelerated heart-rate observed in the majority of persons during residence at very high altitudes is one of the several adaptive responses to the influence of the shortage of oxygen. They furthermore may possibly offer a confirmation of Parkinson's explanation that an excessive supply of oxygen in the blood favors the heart muscle. That there was less oxygen available for oxidative processes in the blood at 14,000 feet was indicated by the decidedly dark color of the blood when it was drawn for examination; while in Colorado Springs the color

was always a good arterial red. In addition, the partial pressure of oxygen in the arterial blood was less at the high altitude. Thus Douglas, Haldane, Henderson, and Schneider⁸ found the mean partial pressure of oxygen in the arterial blood on Pike's Peak to be 88.3 mm. while Douglas and Haldane⁹ have shown the mean at Oxford to be 99.1 mm. Miss FitzGerald¹⁰ has pointed out that the symptoms of oxygen deficiency at high altitudes are due not to the amount of oxygen in the arterial blood but to the partial pressure of this gas in the blood. When Robison came down to Colorado Springs there must have been, because of his deep breathing (this is discussed later) and of the high content of haemoglobin in the blood, much more oxygen rendered available by the rise in the partial pressure of the arterial oxygen. This excess of oxygen may have acted by destroying easily oxidizable substances which are very abundant in the blood at very high altitudes and even to some extent at sea-level.¹¹ The withdrawal of the stimulating action of these metabolites which may act through their hydrogen ion-concentration,¹² or the excess of oxygen alone,¹³ reduced the heart-rate of Robison below his normal for the lower altitude; and inhalation of pure oxygen, therefore, failed to further slow the heart. Later the breathing was shallower and the total oxygen capacity of the blood less, hence the supply of oxygen in the blood was not sufficient to completely destroy these oxidizable metabolites, or to permit the heart to work as economically as during the early days after the descent. It was, therefore, then possible to show the heart-rate when oxygen was administered.

THE RESPIRATION

Lung Ventilation. — The ventilation of the lungs for those dwelling at high altitudes is greater than that of mankind living

⁸ DOUGLAS, HALDANE, HENDERSON, and SCHNEIDER: *loc. cit.*, pp. 197-98.

⁹ DOUGLAS and HALDANE: *Journal of physiology*, 1912, xliv, p. 331.

¹⁰ FITZGERALD: *Philosophical Transactions of the Royal Society of London*, 1913, Series B, CIII, p. 361.

¹¹ DOUGLAS, HALDANE, HENDERSON, and SCHNEIDER: *loc. cit.*, p. 300.

¹² See FELDMAN and HILL: *Journal of physiology*, 1911, xlii, p. 439.

¹³ Mathison — *Heart*, 1911, II, p. 60 — finds in his study of the heart-block that the cardiac tissues are sensitive to want of oxygen.

at sea-level. It has been known since the researches by Haldane and pupils¹⁴ that the volume of fresh air taken into the lungs per minute during rest is so regulated as to keep the partial pressure of carbon dioxide in the alveolar air practically constant for the individual. The carbon dioxide content of the alveolar air is, therefore, taken as an index of lung ventilation. A diminution of the alveolar carbon dioxide pressure indicates an increase in the lung ventilation, while an increase in carbon dioxide means a reduction in the alveolar oxygen pressure. A number of workers¹⁵ have demonstrated that the alveolar carbon dioxide pressure falls, and as a consequence the volume of air breathed increases, with a diminution of atmospheric pressure. According to Douglas, Haldane, Henderson, and Schneider the alveolar carbon dioxide pressure required to excite the respiratory centre of man on Pike's Peak falls to about two-thirds that of the normal value at sea-level. This causes the breathing of 30 per cent more air per minute and an increase of 50 per cent in the alveolar ventilation.

The partial pressure of carbon dioxide in the alveolar air on Pike's Peak is about 27 mm. as compared with 40 mm. at sea-level.

A series of observations on Robison's alveolar air under resting conditions were made while he was on the Peak and at intervals for a period of five and a half months after his descent. Haldane's¹⁶ gas apparatus was used for the analyses and the samples of alveolar air were obtained by the direct method of Haldane and Priestley.¹⁷ Table II contains the results of this study. The figures as given are with two exceptions the average of the analyses of two samples.

The content of alveolar carbon dioxide and oxygen on Pike's Peak agreed closely with that obtained on the members of the

¹⁴ HALDANE and PRIESTLEY: *Journal of physiology*, 1905, xxxii, p. 225, and DOUGLAS and HALDANE: *ibid.*, 1909, xxxviii, p. 420.

¹⁵ See BOYCOTT and HALDANE: *Journal of physiology*, 1908, xxxvii, p. 25; WARD: *ibid.*, p. 378; DOUGLAS: *ibid.*, 1910, xl, p. 472; ZUNTZ, LOEWY, MÜLLER, and CASPARI: *Höhenklima und Bergwanderungen*, 1905, p. 428; DURIG: *Über das Verhalten der Atemmechanik und der Alveolartension*, 1910, p. 61; and DOUGLAS, HALDANE, HENDERSON, and SCHNEIDER: *loc. cit.*, pp. 206-220.

¹⁶ HALDANE: *Methods of Air Analysis*, 1912, p. 47.

¹⁷ HALDANE and PRIESTLEY: *loc. cit.*, p. 228.

TABLE II

Date	Barometer in mm. Hg.	Percentage of gases in dry alveolar air		Partial pressure of gases in mm. Hg. in alveolar air at 37° saturated with moisture		
		CO ₂	O ₂	CO ₂	O ₂	
Oct. 12, 1912	458	6.96	12.42	28.6	51.0	Pike's Peak
12	458	6.72	12.91	27.6	53.1	
13	457	7.16	12.34	29.4	50.6	
14	457	6.27	12.59	25.7	51.6	
Nov. 13	616	4.77	15.59	27.1	88.7	Colorado Springs
14	612	5.19	15.62	29.3	88.3	
15	613	5.44	14.90	30.8	84.3	
16	623	5.52	15.51	31.8	89.3	
17	620	5.46	15.37	31.3	88.1	
18	616	5.95	14.62	33.9	83.2	
Dec. 3	608	6.28	14.74	35.2	82.7	After return from Lamar
5	609	6.42	13.27	36.1	74.6	
12	615	6.93	13.26	39.4	75.3	
Jan. 26, 1913	613	6.98	12.39	39.5	70.1	After return from near sea-level
28	612	6.67	12.29	37.7	69.4	
30	614	6.89	12.65	39.1	71.7	
May 1	607	6.64	13.70	37.2	76.7	In Manitou three months

English-American Pike's Peak Expedition after they had been two weeks on the summit. The first sample of alveolar air which was taken from Robison fourteen hours, or the next morning, after his descent showed no change whatever in the carbon dioxide partial pressure. Hence he still continued to ventilate his lungs as much as on the summit of the Peak, which resulted in an alveolar oxygen pressure at least 35 mm. greater than he had on the summit and at least 10 mm. above that found in men acclimatised to the altitude of Colorado Springs. During the first six days following the descent the alveolar carbon dioxide pressure very gradually increased and as it did the ventilation decreased. However, on the sixth day the alveolar oxygen pressure was still more than 5 mm. above the normal for the altitude of 6000 feet.

The next two weeks while the subject was hunting near Lamar the decrease in lung ventilation must have greatly retarded, for on December 3, three weeks after the descent, the alveolar carbon dioxide content was 35.2 mm., which was still below normal; his normal for the altitude of Colorado Springs being about 37 mm.

Sometime between December 3 and 12 the carbon dioxide pressure reached normal and may have passed above if the reading 39.4 mm. may be regarded as correct and it is the result of several analyses. It was impossible to study this condition further because the subject left that day for the journey to near sea-level.

The observations made in January, immediately after the return from this journey, indicate that at sea-level he adapted his breathing so that the ventilation of the lungs was similar to that of the normal man at that level.

It appears that Robison readjusted his breathing on returning to the altitude of Colorado Springs after a residence of six months at 14,109 feet far more slowly than men who have sojourned only a few weeks at a high altitude. Thus Ward¹⁸ after a residence of six days at Capanna Regina Margherita on Monte Rosa, altitude 14,965 feet, and Douglas, Haldane, Henderson, and Schneider after their sojourn of five weeks on Pike's Peak, on descending found an *immediate* response, by an increase in carbon dioxide pressure and lessened lung ventilation, to the rise in the barometric pressure. The time required for complete adjustment in the mem-

¹⁸ WARD: Journal of physiology, 1908, xxxvii, p. 383.

bers of the English-American Expedition at 6000 feet was not determined because they later went down to sea-level. Here, however, they observed that the change became complete within two weeks of the day of leaving the summit of Pike's Peak.

This slow change in Robison's respiration suggests that some condition affecting the respiratory centre and due to the altitude stimulus, want of oxygen, becomes more permanently fixed by longer residence at the high altitude. This acquired condition or habit is then very slowly readjusted on return to a low level.

It has been suggested by Douglas, Haldane, Henderson, and Schneider¹⁹ that the fall in alveolar carbon dioxide pressure at high altitude is due to diminished alkalinity of the blood. They deem it probable that the diminished alkalinity is not due merely to an excessive production of lactic acid, as is the case after muscular activity, but to some adaptive alteration in the regulation of blood alkalinity; this regulative function they attribute to the kidneys. "A slight and gradual adaptive alteration in what one may call the exciting threshold of alkalinity for the kidneys would explain the reduced fixed alkalinity of the blood in acclimatised persons."

Power to hold the Breath. — Mosso²⁰ found on Monte Rosa that the power to hold the breath voluntarily was less than in Turin. The subject of this report was able to hold his breath on Pike's Peak for not longer than 25 to 28 seconds but in Colorado Springs he was able to hold it 46 to 56 seconds. No change in the power to hold the breath occurred during the winter.

Vital Capacity. — It is a popular belief, also held by numerous medical men, that the chest is greatly enlarged by residence at high altitudes. Humboldt²¹ claimed to find an increase in the capacity of the thorax among the inhabitants of the Andes, and Williams²² reports an increase in the size of the chest as a result of a residence in high mountain resorts. With these exceptions

¹⁹ DOUGLAS, HALDANE, HENDERSON, and SCHNEIDER: *loc. cit.*, p. 301.

²⁰ MOSSO: *Life of Man on the High Alps*, 1899, p. 201.

²¹ HUMBOLDT: *Voyage aux régions équinoxiales du nouveau continent*, fait en 1799-1804, Paris, 1814.

²² See STRAUCH: *American Journal of the Medical Sciences*, 1911, cxlii, p. 115.

all observers agree that for the majority of persons the vital capacity actually diminishes at high altitudes. Mosso²³ showed the members of his expedition had on Monte Rosa a vital capacity that was less than in Turin. Zuntz and his co-workers,²⁴ Durig,²⁵ and Fuchs²⁶ have confirmed Mosso's report.

The morning after Robison came down to Colorado Springs and frequently throughout the period of study his vital capacity was determined. The records of the first day taken at intervals of five minutes are 4000, 3975, 4120, and 4070 c.c. The second day shows 4225 c.c. The difference undoubtedly should be attributed to lack of experience with the spirometer and not to a change in the thorax. After his return from sea-level there was no change in the capacity.

Robison's endurance and strength as a mountain climber are certainly not to be explained by chest development as the following comparison with Born's²⁷ statistics of Yale men well shows:

	Robison	Track Athlete	Average Student
Height	68.3 in.	68.7 in.	67.8 in.
Weight	145.0 lbs.	143.5 lbs.	137.0 lbs.
Girth of Chest (normal)	34.2 in.	36.3 in.	34.4 in.
Girth of Chest (inflated)	35.8 in.	38.1 in.	36.0 in.
Vital capacity	4225. c.c.	4753. c.c.	3934. c.c.

Even though Robison is an active man and has lived at an altitude of 14,109 feet for six months during each of the last seventeen years his chest measurements, considering his height, compare not with the athlete but with the average student at sea-level.

The two keepers²⁸ of the Regina Margherita hut on Monte Rosa who remained from the beginning of July until the end of

²³ MOSSO: *loc. cit.*, p. 342.

²⁴ ZUNTZ, LOEWY, MÜLLER, and CASPERI: *loc. cit.*, p. 335.

²⁵ DURIG: *loc. cit.*, pp. 54-60.

²⁶ FUCHS: Sitzungsberichten der Physikalisch-Medizinischen Sozietät in Erlangen, 1908, xl, p. 240.

²⁷ BORN: Yale Alumni Weekly, April 1, 1908, pp. 1-5.

²⁸ MOSSO: *loc. cit.*, p. 154.

September at an altitude of 14,965 feet and continually ascended and descended for provisions showed a similar chest development. Francioli with a height of 68.5 inches and weight 169.8 lbs. had a vital capacity of 4017 c.c.; while Quaretta, height 64.6 in., weight 154.4 lbs., had a vital capacity of only 3790 c.c.

SUMMARY

1. The percentage of haemoglobin in the blood decreased very slowly after the descent from Pike's Peak, falling from 148 to 132 in 30 days and to 122 during the following six weeks.
2. The number of red corpuscles decreased from 7.7 to 7.0 millions; the specific gravity of the blood from 1.073 to 1.067.
3. The total volume of the blood showed an increase of 5.4 per cent on the sixth day and a maximum, 7.5 per cent, on the 30th day.
4. The total oxygen capacity of the blood did not alter the first six days. At the end of the third week it had decreased 4.3 per cent and at the end of 10 weeks had diminished 11.9 per cent.
5. During a period of six years the arterial pressure has remained normal.
6. The pulse-rate on Pike's Peak was about 82. The first days after descent it remained at 60 and later accelerated to 70.
7. The breathing of an oxygen-rich mixture slowed the heart-rate from 82 to 64 per minute on the Peak, but after the descent did not alter the rate the first ten weeks. Later at the lower altitude a slight reduction in the pulse-rate was obtained with oxygen.
8. The alveolar carbon dioxide pressure required to excite the respiratory centre did not alter immediately. After 24 hours it began to rise and increased slowly for 30 days, at which time it was above the normal for Colorado Springs. It later returned to the normal. For more than three weeks the amount of lung ventilation was excessive for the altitude of 6000 feet.
9. The power to hold the breath on Pike's Peak was one-half of that in Colorado Springs.
10. The vital capacity and chest measurements are not greater than those of men of similar physique at sea-level.

THE EFFECT OF WATER INGESTION ON THE FATTY CHANGES OF THE LIVER IN FASTING RABBITS ¹

BY M. R. SMIRNOW

[Instructor in Pathology and Bacteriology, Med. Dept. Yale Univ., New Haven, Conn.]

IN a paper entitled "Hydropic Changes in the Liver Cells of Rabbits," soon to be published by Dr. C. J. Bartlett and myself, mention is made that the peculiar picture described is not seen in fasting rabbits. It was to establish this point and to emphasize the fact, that the "hydropic" changes were probably due to hyperfunctional activity, that the work here outlined was undertaken.

Five rabbits were taken for experimentation, and emphatic instructions were given to the attendant not to feed them; but no instructions were given concerning water. Our rabbits are at all times given plenty of green stuffs, so the attendant as a rule finds no need of watering them, and it was this fact that caused him to neglect to water the rabbits placed under observation. The first and second rabbits were killed on the fourth and fifth day respectively, but showed nothing abnormal in gross. The third was killed on the seventh day, and showed a moderate degree of fatty change in liver. The liver was enlarged, quite yellow, softer than normal and tore easily. It was this unexpected condition coupled with the lack of water ingestion that resulted in the work here to be reported.

Twenty-seven normal rabbits were used. Of these, eleven were fasted from four to ten days, no water being given, and are here designated as "Group A." A second group of nine rabbits were fasted from four to fourteen days, but were given ordinary tap water, and are here called: "Group B." The last, a group of seven rabbits, were fasted five to eleven days, were given distilled water, and are here designated: "Group C."

¹ Read before the American Ass'n of Pathologists and Bacteriologists, in Washington, D.C., May, 1913.

The rabbits were separated into groups of three to five, and placed in clean cages, which allowed ample room for them to move about; but not room for excessive exercise. Water was placed in dishes for the animals that were to receive it. Most of the rabbits were weighed at the beginning and at the end of the experiment, and showed an average loss of two fifths their original weight, varying from between 250 to 600 grams. This average was the same for both the watered and unwatered animals.

The livers were examined in the fresh state with Sudan III in all cases. Frozen sections were also made and stained with Sudan III, haematoxylin and eosin, and tissue was fixed in Zenker's fluid and formalin for inbedding.

Eight of the first group of eleven rabbits showed a moderate or advanced fatty infiltration. These animals were fasted, with no water given, from five to ten days, were then killed, and autopsied immediately. The livers of these animals were quite yellow, flabby, almost semi-fluid in consistency, tore readily, and left considerable fat on the knife in cutting. Scrapings stained with Sudan III showed numerous small and large fat globules. Osmic acid gave positive test for fat where tried. Microscopically, with haematoxylin-eosin stain, the typical picture of fatty infiltration was seen, the more numerous fat vacuoles nearest the central veins. One animal of this group was killed at the end of four days. The liver showed nothing in gross, but gave a few fat globules when stained with Sudan III. Microscopically, the cells were somewhat smaller, coarsely granular, and showed here and there a few small vacuoles, which might have been interpreted as fat. The remaining two were animals that fasted seven and nine days respectively. These animals died. The livers showed a marked degree of coccidiosis and were quite congested. Scrapings stained with Sudan III and microscopical examination were negative.

Of the second group of nine normal rabbits deprived of food from four to nine days, water being allowed, only one showed a fair degree of fatty infiltration of the liver, and gave the Sudan III test. The livers of five others showed very slight vacuolations in the cells, microscopically with the use of the oil immersion. The cells were smaller and more granular and the nuclei

stained well. The livers did not give the Sudan III test in the fresh state, but microscopically the vacuoles mentioned might have been interpreted as fat. The remaining three animals of this group showed only a slight increase in size of the cells and a more granular cytoplasm than normal.

Of the seven that make up the third group of fasting animals, and which received distilled water, only one, an eleven-day rabbit, gave a positive Sudan III test, and was found to have a fair amount of fat microscopically. The others showed a slight vacuolation of the cells with the oil immersion, but did not give the Sudan III test. Of these rabbits, the one that showed the distinct fatty change, and one of those that showed vacuolations, were killed, all the others died. Most of the animals of this group showed a marked coccidiosis, which might have contributed to their deaths; but apparently did not favor fatty change.

Summing up the results obtained as shown in the accompanying charts, we find that nine of the eleven hungered and unwatered rabbits gave both the Sudan III test and the microscopic picture of fatty infiltration. This is in striking contrast to the findings in the rabbits fasting under the same conditions, but receiving water, wherein only two of the sixteen animals showed a fair amount of fat, evidenced both with Sudan III and the microscope; seven showed slight microscopic vacuolations, but gave no Sudan III test; and seven were entirely negative. Whether or not a greater percentage of watered fasting rabbits would show the fatty change, if more time were given them, is questionable. Offhand it would appear that it is not only a matter of time, in-as-much as six of the seven animals that were negative both to Sudan III and microscopical examination were kept under observation until death. It is worthy of mention in this connection that all of the last mentioned animals suffered from extreme coccidiosis, which must have at least hastened their deaths before fatty changes could develop.

The literature on this subject is very scant and conflicting. Statkewitch² and Nikolaides³ and others have shown fatty changes in the livers of fasting dogs, cats, rabbits and guinea pigs; but

² MOTTRAM: *Journal of physiology*, 1909, vol. 38, page 281.

³ GILBERT AND JANNIER: Quoted by Mottram.

regard a decided fatty change taking place only after prolonged hunger, and consider these changes to be degenerative in character. Water was given the animals during their fast.

On the other hand, Gilbert's and Jannier's⁴ experiments show that only a very mild degree of fatty change is seen in rabbits fasting for one to eight and one half days. These investigators do not regard the change as degenerative.

GROUP A

No.	Days	Killed or Died	Macroscopic	Sud.	III.	Microscopic	F. or V.*
1	4	Killed	Normal		Sl. +	cells swollen, granular, few show vacuolation	F.
2	5	"	"		+	definite fatty vacuoles in cells	F.
3	7	"	Soft, friable; yellow color		+	definite, fatty infiltration	F.
4	9	"	Soft, friable, flabby, yellow color, coccidia		+	Moderate fatty infiltration	F.
5	9	"	Soft, friable, flabby		+	Good amount of fatty infiltration	F.
6	10	"	Soft, friable, mushy		+	Good amount of fatty infiltration	F.
7	10	"	Soft, friable, flabby		+	Good amount of fatty infiltration	F.
8	10	"	" " mushy		+	Moderate amount of fatty infiltration	F.
9	7	Died	Congestion and coccidiosis		-	Natural cell structure	-
10	8	"	" " yellow mottling		+	Moderately fatty	F.
11	9	"	Congestion and coccidiosis		-	Normal cell structure	-

* F = Fatty V = Vacuoles - = Negative

⁴ MIKALAIDES: Archiv für Physiologie, 1899, page 518.

Mottram⁵ claims that a marked degree of fatty infiltration is evident in fasting and watered rabbits, and guinea pigs in from twenty-four to forty-eight hours. He states that this change is

GROUP B

No.	Days	Killed or Died	Macroscopic	Sud.	III.	Microscopic	F. or V.*
1	4	Killed	Pale, otherwise normal		-	Cells slightly swollen, more granular	F.
2	5	"	Normal		-	Slight vacuolation, with $\frac{1}{2}$ " objective	V.
3	6	"	"		-	Fair vacuolation	V.
4	11	"	"		Sl. +	Cells quite vacuolated for fat globules	F.
5	12	"	Congested, otherwise normal		-	Cells granular, moderately vacuolated	V.
6	14	"	Very pale		-	Cells granular, moderately vacuolated	V.
7	14	"	Normal		-	Cells granular, slightly vacuolated	V.
8	11	"	Congested, coccidiosis		-	Congestion coccidiosis, cells normal	—
9	10	Died	"	"	-	Congestion, coccidiosis, cells normal	—

microscopically visible, and uses the oil immersion for its demonstration.

In conclusion the following suggestions may be offered:

1. Fasting, unwatered rabbits, from four days and upwards, show a decided fatty infiltration of the liver, apparent in gross and microscopically.

2. Fasting, watered rabbits, from ten days and upwards, may

⁵ STATKEWITCH: Archiv für experimentelle Pathologie, 1894, page xxxiii.

show similar changes in the liver, but the percentage of incidence is very low, as compared with that of the unwatered animals.

3. In half the number of the fasting, watered rabbits under observation, microscopic vacuolation was observed. This vacuolation may be interpreted as a fatty change, but the picture is by no means comparable to that seen in the non-watered animals.

GROUP C

No.	Died	Killed or Died	Macroscopic	Sud.	III.	Microscopic	F. or V.*
1	5	Died	Congested, extreme coccidiosis		—	Cells normal, congestion	—
2	8	"	Congested, extreme coccidiosis		—	" " "	—
3	7	"	Congested, extreme coccidiosis		—	" " "	—
4	6	"	Congested, extreme coccidiosis		—	" " "	—
5	7	"	Congested, extreme coccidiosis		—	Cells smaller, more granular, occasional vacuole	V.
6	11	Killed	Pale color, otherwise normal		Sl. +	Moderate fatty infiltration	F.
7	11	"	Normal		—	Cells swollen and granular, slight vacuolation	V.

ON THE INFLUENCE OF MUSCULAR EXERCISE ON THE ACTIVITY OF BULBAR CENTRES

BY E. G. MARTIN AND C. M. GRUBER

[From the Laboratory of Physiology in the Harvard Medical School]

MUSCULAR exercise is accompanied by certain very definite adaptive changes in the circulation and in respiration. That there is an increased heart rate is a matter of common experience. The increase has been studied in detail by Hering,¹ Bowen,² Cook and Pembrey,³ and others.⁴ An increase in arterial pressure has been demonstrated by Zuntz and Tangl⁵ on dogs working in a tread-mill, and by MacCurdy, Bowen, Cook and Pembrey, and others on men.⁶ An increase in the rate and depth of respiration is a familiar accompaniment of muscular exertion. This has been studied in great detail by Geppert and Zuntz.⁷

The mechanism of these adaptations remains obscure. Various factors may be involved in bringing them about, and the task of determining which of the several possible factors are actually responsible is by no means easy. In each of the adaptations we have to do with a bodily function governed by bulbar centres. These centres have been shown to be susceptible to influences reaching them either by way of the blood stream or over afferent nerves. Our first task is to decide, if possible, for each of the

¹ HERING: *Archiv für die gesammte Physiologie*, 1895, lx, p. 483.

² BOWEN: *Contributions to Medical Research*, Ann Harbor, 1903, p. 462.

³ COOK and PEMBREY: *Journal of physiology*, xlv, p. 1.

⁴ LOWSLEY: *This journal*, 1911, xxvii, p. 446.

⁵ ZUNTZ and TANGL: *Archiv für die gesammte Physiologie*, 1898, lxx, p. 544.

⁶ For references see Lowsley: *loc. cit.*, p. 446.

⁷ GEPPERT and ZUNTZ: *Archiv für die gesammte Physiologie*, 1888, xlii, p. 189.

adaptive changes, the relative importance of the two great channels of influence. Hering,⁸ Hunt,⁹ and Bowen¹⁰ have concluded that so far as cardiac acceleration is concerned the adaptation is mediated chiefly through the nervous system. Johannson¹¹ agrees with their view as to the mechanism of immediate acceleration, but offers evidence that the persistent increase in heart rate following exercise depends on stimuli conveyed to the bulb by the blood. Johannson's view has recently been supported by Mansfield,¹² to the extent of making the blood an important agent in the persistent acceleration of exercise, although the latter author differs from Johannson as to the details of the mechanism.

When arterial pressure is considered we deal with a function depending only in part upon the activity of special bulbar centres, changes in heart rate and mechanical effects of muscular movement tending likewise to modify it. We cannot, therefore, draw direct conclusions as to the influence of exercise upon these centres from simple observations of blood-pressure changes. Bowen,¹³ in fact, interprets the rise of blood pressure accompanying exercise on a basis wholly exclusive of vasomotor influences. Evidence that the vasoconstrictor centre is affected positively by exercise seems to be lacking, although Hooker¹⁴ postulates a compensatory splanchnic vasoconstriction in accounting for the rise of venous pressure observed by him. There is, moreover, direct evidence of vasodilation within the active muscles,¹⁵ perhaps dependent on activity of the vasodilator centre; and of cutaneous vasodilation in the later stages of prolonged exercise,¹⁶ indicating a depression of the constrictor centre. Whether the mechanism for bringing about vasodilation in active muscles operates through nervous influences upon the vasodilator centre, or in some other way, has

⁸ HERING: *loc. cit.*, p. 483.

⁹ HUNT: This journal, 1899, ii, p. 464.

¹⁰ BOWEN: *loc. cit.*, p. 462.

¹¹ JOHANNSON: *Skandinavische Archiv für Physiologie*, 1895, v, p. 20.

¹² MANSFIELD: *Archiv für die gesammte Physiologie*, 1910, cxxxiv, p. 598.

¹³ BOWEN: This journal, 1904, xi, p. 60.

¹⁴ HOOKER: This journal, 1911, xxviii, p. 235.

¹⁵ KAUFMANN and CHAUVEAU: *Archives de physiologie normale et pathologique*, 1892, p. 283.

¹⁶ BOWEN: *loc. cit.*, p. 69.

not yet been demonstrated. Masing¹⁷ has shown that the cutaneous vasodilation occurring in prolonged exercise appears only when there is sweat secretion, suggesting a common, perhaps non-nervous, cause for the two phenomena.

The increased activity of the respiratory centre in exercise would seem, from the work of Geppert and Zuntz,¹⁸ to be wholly explicable upon a non-nervous basis, as due to the presence of metabolites in the circulating blood.

Recapitulating the evidence thus far cited we note that the bulbar centres controlling the heart rate are influenced nervously during exercise so as to cause acceleration; that direct evidence for *nervous action* upon the vasoconstrictor and vasodilator centres is wanting, and the indirect evidence indicates no very striking influence; and that the respiratory centre is apparently unaffected during exercise by nervous influences.

So meagre a play of nerve impulses upon the medulla as here indicated seems strange when we consider on the one hand the demonstrated great susceptibility of the bulbar centres to afferent impulses in general, and on the other the great volume of nervous activity called into play during muscular exercise.

Such nervous influence upon the medulla as does accompany muscular exercise may possibly be of two sorts, associated innervation from the motor cortex, or reflex from excitation of organs of muscle sense in the active muscles. The possibility of associated innervation of the bulb during exercise seems to have been considered thus far chiefly with reference to cardiac acceleration. Johannson¹⁹ believed that the immediate acceleration accompanying exercise is due chiefly to associated innervation. He based his view on the observation that experimental animals showed much more marked acceleration during voluntary struggling than during vigorous passive moments.

Athanasiu and Carvallo,²⁰ on the other hand, concluded from experiments on human beings suffering from paraplegia, in whom powerful but ineffective efforts toward movement brought about

¹⁷ MASING: *Deutsches Archiv für klinische Medicin*, 1903, lxxiv, p. 253.

¹⁸ GEPPERT and ZUNTZ: *loc. cit.*, p. 189.

¹⁹ JOHANNSON: *loc. cit.*, p. 20.

²⁰ ATHANASIU and CARVALLO: *Archives de physiologie*, 1898, xxx, p. 553.

no acceleration, that muscular exercise acts only reflexly in its effect upon the cardiac centres. They cite in support of their view the observation of Asp²¹ that stimulation of the central end of nerves from skeletal muscles causes cardio-acceleration. Hering²² considered both possibilities without arriving at any conclusion in favor of one over the other. Bowen²³ concluded that the increased pulse rate is partly cortical in origin and partly reflex.

We have undertaken the present investigation in the hope of throwing additional light upon the general problem of the reaction of the bulbar centres to muscular exercise and particularly in the attempt to determine whether or not the influence of muscular exercise is uniform in its effect upon the different centres.

The suggestion which we wish to offer as the result of our work may be stated in brief as follows: The immediate effect upon the bulbar centres of muscular exercise is due in the main to associated innervation from the motor cortex. This innervation acts to depress the cardio-inhibitory centre, the vasoconstrictor centre, and the respiratory centre.

The Depression of the Cardio-inhibitory Centre by Associated Innervation. — That the acceleration of the heart in exercise is due to depression of the inhibitory centre, rather than to stimulation of the augmentor centre, was well established by Hunt²⁴ on the basis of the short latent period of the acceleration as compared with the long latent period shown when the accelerator nerves are stimulated directly. Hering's earlier observation that the acceleration fails when the accelerator nerves are cut²⁵ is satisfactorily explained by Hunt²⁶ as showing the necessity for constant tonic activity of the augmentor centre to make depression of the inhibitory centre effective.

In the attempt to decide whether this depression of the inhibitory centre is cortical or reflex we have to consider the conflicting

²¹ ASP: Ludwig's Arbeiten, 1867, p. 182.

²² HERING: *loc. cit.*, p. 483.

²³ BOWEN: Contributions to Medical Research, Ann Arbor, 1903, p. 462.

²⁴ HUNT: *loc. cit.*, p. 464.

²⁵ HERING: *loc. cit.*, p. 483.

²⁶ HUNT: *loc. cit.*, p. 464.

evidence of Johansson and of Athanasiu and Carvallo already cited. The position taken by these latter investigators seems to us to be not justified by their evidence. Powerful efforts toward movement on the part of paraplegic individuals do not necessarily result in a flow of impulses as far as the bulb, and in the absence of positive proof that impulses do reach the bulb, the experiment does not invalidate positive evidence on the other side.

We have attacked the problem of associated innervation vs. muscle reflexes, as accounting for the cardio-acceleration of exercise, in three different ways. Our first experiment was a repetition of Johansson's²⁷ observation on the influence of passive movements on heart rate. To avoid possible complications from the cortex we performed the experiment on a decerebrate cat. The form of exercise used was vigorous passive flexion and extension of both hind limbs, continued for about thirty seconds. We obtained acceleration of the heart in four of eight periods of exercise. The acceleration did not exceed 14 per cent in any case, and did not appear until after the exercise had been in progress at least five seconds. This latter observation we consider significant in view of the great promptness with which acceleration occurs in ordinary voluntary activity.²⁸

Although passive movements of the joints give rise, undoubtedly, to considerable streams of afferent impulses, the objection may be offered that the impulses generated by passive movements are not necessarily equivalent to those aroused in the muscles during active contraction. Our second series of experiments was designed to overcome this possible objection. In these experiments we obtained vigorous active movements in two decerebrate cats by the use of strychnine. Our strychninized cats showed a rapid heart rate, ranging between 35 and 40 beats in ten seconds, but not by any means a maximal rate for the cat's heart; we have repeated observations of rates exceeding 44 beats in ten seconds. In twelve observations of the effect of strychnine convulsions on the heart rate we got acceleration in only three cases; not exceeding in any of them 9 per cent, and coming on more than ten seconds after the beginning of the convulsions.

²⁷ JOHANSSON: *loc. cit.*, p. 20.

²⁸ See BOWEN: *loc. cit.*, p. 462.

Our third series of experiments was a repetition of Johansson's original ones, except that we used human beings as subjects. The procedure was as follows: The subject lay flat on his back with legs extended. At intervals of one minute the pulse was counted for twenty seconds with a stop-watch. The subjects in these tests had been having their pulse counted regularly for several weeks, and were, therefore, presumably free from disturbing psychic reactions. After four or five minutes of preliminary pulse-counting the subject flexed his legs forcibly at the hips a designated number of times, leaving them extended again at the end of the exercise. The pulse was counted for twenty seconds beginning within two seconds after the body came to rest, and at minute intervals thereafter. For the passive exercise the subject's feet were grasped by an assistant and the legs alternately flexed and extended as vigorously as possible. The results obtained were as follows: Subject G. had for five minutes a pulse rate not exceeding 24 beats in twenty seconds. He flexed his legs four times; in the succeeding twenty seconds there were 26.5 beats. Three minutes later the rate was 23.5; two leg movements raised it to 26. Two minutes later, with the rate at 22, a single flexion of the leg brought about a rate of 25 in twenty seconds. Four minutes after this last reading the rate was 23.5; the legs were flexed passively one hundred times; the rate immediately afterward was 22.5. Two minutes later, with the heart rate at 22, the passive movements were repeated. The rate rose to 23. Two minutes after this last reading the rate had fallen to 21.5. A single active flexion of one leg raised the rate to 24. A second subject, M., showed precisely similar results. Prolonged passive exercise brought about no significant increase in heart rate, while one to four active leg flexions increased the rate three to four beats in twenty seconds.

The striking features of these experiments on human subjects were the marked acceleration resulting from very moderate amounts of active exercise, and the total failure of acceleration from vigorous passive exercise. Unless we deny absolutely the possibility that effective afferent impulses may be generated by passive movements, we must admit that these experiments point strongly toward associated innervation as the chief, if not the only, cause for the immediate acceleration of exercise. Our observa-

tions on decerebrate animals seem to us to point the same way, since neither vigorous passive movements nor the violent convulsions of strychnine brought about increases in rate at all comparable, either in amount, in promptitude, or in uniformity of occurrence, with the increases observed by Johannson and by ourselves in consciously active organisms.

An argument apparently in favor of the reflex source of the acceleration is that afforded by the well-known effect of posture on the heart rate, the erect posture being accompanied by a more rapid heart than is the recumbent. That this change of rate is not dependent on the increased muscular effort involved in maintaining the erect posture, but is due to the increased flow of blood to the lower parts of the body under gravity, was shown by Erlanger and Hooker.²⁹ In corroboration of their conclusion we can report the observation that even so marked a heightening of postural tonus as appears in decerebrate rigidity is without marked effect on heart rate. In two experiments on cats in which we compared the heart rate before decerebration with the rate after decerebration we had average rates of 18 and 15 beats in five seconds before, and of 16 and 15 in five seconds after the operation, and after rigidity had manifested itself.

The Response of the Vasoconstrictor Centre to Muscular Exercise. — The rise in blood pressure which accompanies muscular exercise is to be explained, as already noted, as due to mechanical effects of the exercise, together with the augmented heart beat. Whether direct nervous or chemical influences dependent upon muscular activity exert any effect upon the vasomotor centre has not been certainly determined. A fact noted by Lowsley³⁰ suggests that the metabolites poured out into the blood during exercise may depress the vasoconstrictor centre, as they were supposed by Johannson to depress the cardio-inhibitory centre. Lowsley observed that shortly after the cessation of activity blood pressure falls to a point lower than that obtaining before the exercise began. Since this lowered blood pressure cannot be referred to a diminished heart beat it signifies depression of vasomotor tone. The explana-

²⁹ ERLANGER and HOOKER: Johns Hopkins Hospital Reports, 1904, xii, p. 332.

³⁰ LOWSLEY: *loc. cit.*, p. 451.

tion proposed by Lowsley,³¹ that this lowered blood pressure is due to fatigue of the centre following its great activity during the period of exercise, does not commend itself, in view of the probability that there is, as a matter of fact, little such activity. The observation of Bowen, already cited,³² of cutaneous vasodilation during later stages of prolonged exertion, counts against the notion that the vasomotor centre is active during exercise, and may be looked upon, perhaps, as additional evidence pointing toward a depressor function for fatigue products.

While we have in metabolites carried by the blood a probably adequate mechanism for the vasomotor effects which follow exercise, these are too slow in operation to explain any reactions of the vasomotor centre that may occur at the outset of activity. If any such are normal accompaniments of exercise they are due to the operation of one or both the nervous mechanisms already noted as possible agents in bringing about bulbar responses, namely associated innervation, and muscle-sense reflexes.

A procedure which might be indicative of the existence of nervous influences affecting the vasoconstrictor centre during exercise would be stimulation of the motor cortex. Vasomotor responses to such stimulation might be supposed to represent the normal results of associated innervation during voluntary muscular activity. The earlier investigators who studied the effects of cortical stimulation on blood pressure obtained contradictory results.³³ Usually vasoconstriction with rise of blood pressure was observed, but in a number of cases a fall of pressure occurred instead. These observations were made upon curarized animals. Howell and Austin,³⁴ repeating the experiment, found that the effect varied with the anesthetic used. They obtained with dogs rise of pressure uniformly when morphia and curare were used, and fall of pressure when morphia and ether were used. We stimulated the motor cortex in several cats, using ether and morphia, and ether alone, and obtained uniformly a fall of carotid pressure.

³¹ LOWSLEY: *loc. cit.*, p. 465.

³² BOWEN: This journal, 1904, xi, p. 69.

³³ For early literature see TIGERSTEDT: *Physiologie des Kreislaufes*, Leipzig, 1893, p. 536.

³⁴ HOWELL and AUSTIN: This journal, 1900, p. xx.

The percentage drop varied from 16.7 to 35, averaging in fourteen observations 23.7. That this drop was due to vasodilation and not to diminished heart action is shown by the fact that in all but two of more than twenty-five observations the heart was slightly accelerated during the period of falling pressure. To determine whether the dilation was the result of depression of the constrictor centre or stimulation of the dilator mechanism we clamped the abdominal aorta, below the renal arteries, and also both axillary arteries, thus shutting the extremities out of the circulation. Repetition of the cortical stimulation gave a fall of carotid pressure as before, and the percentage change equalled that of our previous experiments. In another cat, whose splanchnic nerves had been cut sometime previously, in connection with another research, we stimulated the motor cortex repeatedly, recording blood pressure throughout. A slight drop in pressure accompanied each stimulation, not exceeding in any case eleven per cent, whereas in animals with intact splanchnics the least drop observed exceeded sixteen per cent, and the average was above twenty-three per cent. Since these procedures show the splanchnic area to be predominant as the seat of pressure changes, and since dilators to the splanchnic area have not been conclusively demonstrated, the evidence for splanchnic vasodilators depending at present solely on the observations of Dale,³⁵ we interpret our results as indicating an associated innervation from the motor cortex, depressor to the vasomotor centre. A criticism which might be urged against this conclusion is that we have accepted the results of cortical stimulation with ether anesthesia, and rejected contrary results obtained with curare-morphia anesthesia, because the former fit our theory and the latter do not. In reply to such a criticism we would state that our laboratory experience with ether and with curare, together with some observations to be published in due time, indicate that in ether anesthesia the behavior of reflex mechanisms corresponds in kind, although not in degree, with their behavior in decerebrate unanesthetized animals, whereas under curare the responses are often different in kind as well as in degree. The very fact that diametrically opposite results are obtained from cortical stimulation under these two drugs shows that one or both of them brings

³⁵ DALE: *Journal of physiology*, 1913, xlvi, p. 291.

about profound modifications in the nervous mechanisms involved. In our opinion curare probably has this effect, and for that reason we are inclined to question the soundness of many observations on vasomotor reactions in which curare was employed.



FIGURE 1. Blood pressure curve during a strychnine convulsion. The upper signal line shows the period of the convulsion. The lower line indicates time—5 second intervals.

As a means of determining whether a definite immediate effect of exercise on the vasomotor system can be demonstrated in animals in which cortical influences have been excluded, we made a number of observations on decerebrate cats. One method of inducing vigorous activity in these animals was by the use of strychnine. Decerebrate cats dosed with strychnine (.3 mg. in 3 c.c. saline) show typical convulsions. The blood-pressure changes observed during these convulsions were in some of our experiments such as to suggest more than mere mechanical effects from the strongly contracted muscles. A typical curve is presented in Fig. 1. During the convulsion there was a sharp rise in pressure followed immediately by a rapid and extensive fall. Had these been purely mechanical effects there should have been, with cessation

of the spasm, a rapid return of pressure to normal, such as occurs, for example, after a lowering of pressure by squeezing the thorax. Instead of such a rapid return, the pressure rose gradually, requiring thirty seconds to reach normal, and suggesting recovery from depressor stimulation. Pressure changes similar to those shown in Fig. 1 occurred in two of our strychninized decerebrate cats. In a third cat, dosed with excessive amounts of strychnine (3 mg.), each spasm was accompanied by a marked rise of pressure, ap-

parently mechanical, with a prompt return to normal after the spasm, and without a secondary fall. In still another cat, given the usual strychnine dose (0.3 mg.), no marked blood-pressure changes occurred, although the convulsions appeared to be of as great intensity as in our other experiments.

While these observations point to a possible reflex depression of the vasoconstrictor centre during the muscular spasms induced by strychnine, they were not constant enough to establish such an effect definitely, nor do they yield much information concerning the response of the normal animal, since the strychnine poisoning may well have brought about profound variations from the normal functioning of the nerve centres.

Another method of initiating from the muscles reflexes which might affect the vasoconstrictor centre was by the use of passive movements of the limbs. These we tried also upon decerebrate cats. In four trials we observed very slight lowering of pressure with gradual recovery, and in three other tests no pressure change whatever.

So far as our observations on blood pressure suggest anything they point to associated innervation as a more important influence than muscle-sense reflexes, and indicate depression of the vasoconstrictor centre as the effect produced. Physiologically such an effect might be of value as a protection against the excessive arterial pressure which would normally follow the augmented heart and the mechanical influences of exercise.

The Effect of Exercise on the Respiratory Centre. — We have already cited the conclusion reached by Geppert and Zuntz that the heightened activity of the respiratory centre during and after exercise is mediated through the blood rather than through nervous influences. In connection with our studies of muscular exercise we have made some observations on the immediate respiratory changes which accompany it. These, on account of the promptness of their onset, can scarcely be due to influences exerted through the blood stream. One form of exercise selected for this study was the lifting and sustaining of heavy weights, in some cases by flexing the arm at the elbow, in others by lifting with both arms a bar on which weights were hung. We adopted this form because it involves intense voluntary innervation of the active muscles without

calling into play so large a bulk of muscle tissue as to flood the system immediately with metabolic products. Respiration was recorded by means of a Fitz pneumograph about the chest, communicating with a recording tambour. Our subjects, except two, were ignorant of the meaning of the experiment, and of the significance of the apparatus used. They were chosen thus to avoid, as far as possible, the modifications in breathing which are apt to occur when the subject gives attention, voluntarily or involuntarily, to the act.

In sixteen observations, with weights ranging from 4 to 10 kilos, lifted with the left arm, there was a slowing of respiration in ten cases, an increase of rate in five, and no change in one. All the cases of increased rate, save one, occurred in experiments upon subjects who were aware of the nature of the procedure, and interested in the outcome.

When the subjects lifted heavy weights (25-50 kilos) with both arms the respiratory behavior was uniformly as follows: at the signal for beginning the effort a deep inspiration was taken; then with the glottis closed and the abdominal muscles tense the weight was lifted and held. During several seconds no respiratory activity was manifested. When, after this period of cessation, breathing was resumed, it proceeded at the normal rate, but the individual breaths were abruptly drawn and shallow and the chest was held throughout the period of effort more or less in the inspiratory position through the sustained contraction of the abdominal muscles.

Further evidence as to the respiratory behavior during intense muscular effort was had by questioning athletes with reference to their practice during the vigorous running competition known as the short dash. A common feature of indoor games is a forty-yard dash. So far as we could learn, the invariable habit of participants in this event is to refrain from breathing throughout its progress, except for a quick inspiration taken sometimes at the instant of starting. In the hundred-yard dash there is usually cessation of breathing during the first forty yards or so of the distance, then two, or sometimes three, hurried breaths are caught in rapid succession, and during the final rush for the goal the breath is held again. An interesting bit of incidental testimony is

that the closer the contest, and therefore the more intense the struggle, the more tendency is there for the breath to be held.

The observations we have cited seem to us to show clearly that during intense muscular effort there is a tendency toward inhibition of the respiratory centre. There is, to be sure, in nearly every case a preliminary drawing of breath, but this, so far as we can judge, is primarily of importance as a means of fixing the trunk muscles in the position most favorable for the effort, and only secondarily of respiratory significance. These respiratory modifications are obviously not voluntary in the ordinary sense, since they may occur without the conscious knowledge of the subject, and while his mind is engrossed with the muscular effort he is making, and since they become more marked the more complete is the engrossment in the effort. On the other hand, if one observes his breathing during the performance of intense exercise the impression is strong that the effort of holding the breath is part of the general effort involved. The inhibition of the respiratory centre through associated innervation, postulated by us in the opening paragraphs of this paper to account for the change of breathing occurring at the outset of exercise, seems to us to offer a reasonably satisfactory device for being about the effect observed. Associated cortical innervation acting upon a system of ordinary motor nerves and skeletal muscles such as is the respiratory mechanism might be expected to give the impression in consciousness of voluntary effort when attention is directed to it, and to operate unconsciously under ordinary circumstances.

From the standpoint of respiration an inhibition of the centre during intense muscular effort is obviously not adaptive. From the standpoint of the exercise, however, the fixation of the trunk in the inspiratory position may well be advantageous. There is no danger that the body will suffer from the suspension of breathing, for the rapid accumulation of metabolic products presently overcomes the cortical inhibition of the centre, with resumption of breathing and hyperpnea.

SUMMARY

1. The view of Johansson that the immediate cardio-acceleration of exercise is due to associated innervation from the motor cortex is supported, and additional evidence in favor of it is presented. This evidence consists of experiments on decerebrate cats in which vigorous passive movements or activity induced by strychnine produced no noteworthy change in heart rate; and on men, in which passive movements, producing no change in heart rate, were contrasted with moderate voluntary movements, which resulted in marked cardio-acceleration. On the basis of observations of Hunt and Bowen this acceleration is interpreted as due to depression of the cardio-inhibitory centre.

2. The assumption is made that the vasoconstrictor centre is depressed by associated cortical innervation during muscular activity. In support of this assumption the fall of pressure accompanying stimulation of the motor cortex is cited, and evidence is presented showing that this is due to depression of the vasoconstrictor centre and not to active vasodilation.

3. On the basis of observations of breathing during weight-lifting and during sharp running we conclude that there may be a cortical inhibition of respiratory activity during periods of intense motor innervation, not voluntary in the ordinary sense, but rather the result of associated innervation.

4. The conclusions cited in the above paragraphs are grouped into the general assumption that during muscular exercise there is associated innervation to the bulb, depressor to the cardio-inhibitory, the vasoconstrictor, and the respiratory centres.

THE
American Journal of Physiology

VOL. XXXII

NOVEMBER 1, 1913

NO. VII

ELECTROMYOGRAM STUDIES

I. ON SOME TECHNICAL PROCEDURES IN THE USE OF THE
EINTHOVEN GALVANOMETER

BY CHARLES D. SNYDER

[From the Laboratory of Physiology, The Johns Hopkins University]

IN outfitting for a new instrument it is often desirable, if for no other reason than that of economy, to make use so far as is possible of apparatus already at hand. Outfitting for the thread galvanometer admits of this practice to such an extent that it is thought worth while to report, among other things, a few of the devices that have been made use of in this laboratory.

THE MAIN SWITCH-BOARD

So complicated does the wiring become in setting up the apparatus for the thread galvanometer that instrument makers have found it profitable apparently to place the keys, metres, resistances, etc., with their proper connections, upon a table in a fixed position and offer the arrangement for sale as a single piece of apparatus.

The part of this, which we may call the main switch-board, as assembled in this laboratory, consists of the accessories necessary for the projection lantern, the storage of the electric bat-

teries and the current necessary to maintain and control the magnetic field in the galvanometer.

The accompanying diagram, Figure 1, shows the connections on this switch-board.

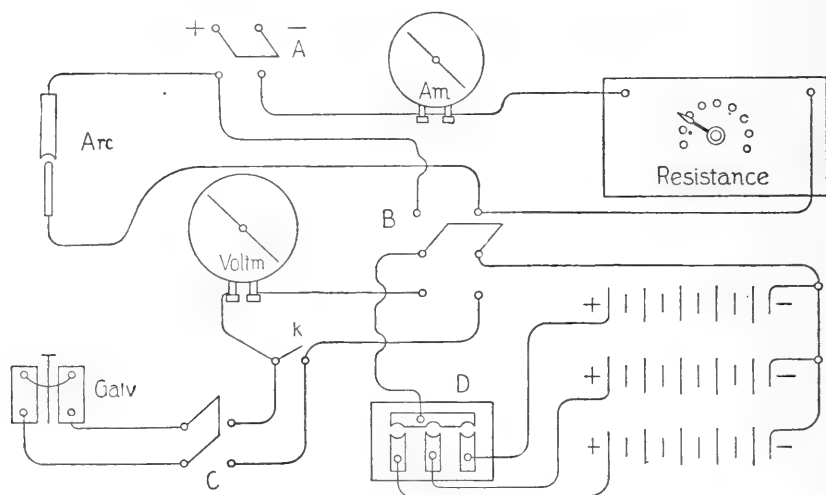

FIGURE 1

Of course the conditions of each laboratory will determine the exact disposition of the parts, many of which could be placed upon a board hung vertically upon the wall; other parts, such as the storage batteries, could be kept in some distant room.

In this particular case nearly all the parts shown in the diagram happen to be close together upon a table top and a shelf beneath. One end of the table abuts against the wall upon which are fixed the main key, A, and the ammeter. The storage cells of three batteries (five cells each) are placed upon the shelf under the table. The resistance box, capacity ranging from 0 to 50 amperes, must be near at hand on account of the need of constant adjustment. Upon the table top itself are placed the projection lantern, thread galvanometer, voltmeter, all the keys except A, and the wiring as shown.

Keys A, B, and C are double keys of the knife-edge type to be had of electrical supply houses, key B being a two-way key, and *k* a single key.

Key B may be regarded as the master key of the board. When closed in the upward position it admits of the charging of the storage cells. In this event the carbons of the lantern ("arc" in the diagram) are not in contact with each other and the resistance ("resistance" in the diagram) is set to supply a suitable amperage.

When key B is closed in the downward position the storage cells are available for the electro-magnet coils of the galvanometer.

By the wiring it will be noted that in no event can the main current supplied by A be put into communication with the galvanometer, and that key C, in a way, is superfluous. Its use (open) while charging the storage cells, however, is obvious.

Key D, a three-way plug key, admits of connecting any one of the three batteries of storage cells either with the main current for storing, or with the galvanometer for making the magnetic field.

The single key *k* by way of the voltmeter enables one to test the voltage of any one set of the storage cells at any time and independently of the galvanometer, that is, with C open.

The main key A may be supplied from the city's direct current, 110 or 220 volts. In case only an alternating current is available the lighting company may be induced to install a transformer at its own expense. In the latter event a rheostat interposed (also by the company) between the AC supply and the transformer enables one to adjust the voltage of the generating direct current within wide limits, say from 40 to 120 volts, a condition which is highly desirable in the many exigencies of experimentation.

The advantages of the adjustable coiled (dark) resistance, in the direct circuit after leaving A, are obvious when one remembers that one is working under the conditions demanded by photography. It is often desirable to "load" the batteries and the camera at the same time. This a lamp resistance would not easily allow.

THE PHOTOGRAPHIC REGISTRATION APPARATUS

The photographic registration apparatus so far supplied by the makers is apt to have the disadvantages of either a too narrow speed limit, or an unreliable, jerky movement. Both of these defects are particularly true of Edelmann's "Trommel-registrier Apparät." This apparatus, which I shall call the camera-drum in this paper, has been made very serviceable however by discarding the spring-motor supplied by the makers, and substituting, for the slower speed-ranges, the driving mechanism of a Baltzar kymographion.

A set of pulley wheels calculated to give several different speeds may be fixed to the axle of the kymographion. The pulley wheel on the friction disk of the camera-drum is too small and should be replaced by one of greater diameter, say 60 mm. One can thus obtain easily a half dozen steady speeds, of say 20, 30, 40, 60, 90 and 120 seconds per revolution of camera-drum.

For the rapid speeds which one finds necessary for graphic records of muscle-nerve latencies, for example, the Baltzar drum motor is not serviceable. But without any other change than that involved in changing pulley belts another device is employed. In this device a falling weight is used as follows.

A clutch of two pulley wheels as shown in the photograph, Figure 2, was constructed. One of the wheels carries the weights and rotates upon its axle at a fixed point; the other wheel revolves upon the same axle, and, when clutched to the first, transmits the motion by pulley belt to the camera-drum. But to facilitate the reversal of the weight-wheel and the setting of the camera-drum at its starting point, the transmission-wheel is movable along the axle so that it may be released from the weight-wheel at will. This latter movement is effected by means of a lever and ratchet device (shown in the photograph). When the lever is pulled down the transmission-wheel is drawn away from the weight-wheel against a strong spring which is wound spirally around the axle. The two wheels then are free to move independently of each other.

When the lever is released the spiral spring throws the transmission-wheel over against the weight-wheel, whereupon the two become locked by the clutches on their faces and must so rotate together as one wheel.

By varying the load of the weights, there being friction to overcome, one may obtain a variety of speeds. The fast speeds used so far in this work have been varied from one-half to two metres per second.

The demands of experimentation are such that a simpler driving mechanism cannot well be employed. For it is not only high speed one wants but the high speed must be developed

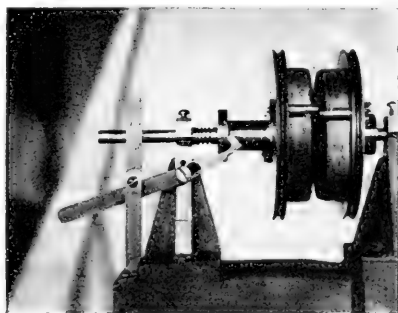

FIGURE 2. Photograph of clutch-device used for rapid speeds. (About one eighth actual size.) The transmission-wheel is held away from the weight-wheel by the lever, preparatory to reversing the weight-wheel and setting the camera-drum at its starting point. The wheels are then facing each other so that the clutch pegs fit into each other whenever the lever is released. The pulley belts and weights are not shown.

within one revolution of the camera-drum, — before the camera shutter opens and before the automatic stimulation signal-key (to be described directly) is thrown into action.

The "Fallapparat" of Prof. Max Cremer¹ is an ideal apparatus for rapid speeds, but the size of sensitized plate is limited to 15 or 20 cm. and for slow speeds one must again turn to another apparatus.

By using the devices here described one is able to employ the camera-drum for both slow and fast speeds by simply changing

¹ See Garten's article on photographic registration in Tigerstedt's *Handbuch der physiologischen Methodik*, p. 120.

a pulley belt. At the same time one retains the advantage of being able to use a sensitive surface 50 cm. long if needed. The power is also sufficient to operate simultaneously the spoke-wheel device of Garten for automatic ruling of the negatives.

AN AUTOMATIC STIMULATION AND SIGNAL KEY

In muscle and nerve work, or in any work where a rapidly moving sensitized surface is required, it is obviously essential to have the stimulation key (whenever one is required) operated automatically by the revolving mechanism itself. By extending a lever arm from the stimulation key and allowing its end to fall in front of the camera shutter one may record photographically the exact point in time when the stimulation occurred.

In other words one has a stimulating key whose action can be controlled exactly as regards the time relations of the moving camera-drum, and at the same time a signal key that makes a record of this action with no greater latency than that of a beam of light travelling only a few millimetres.

The photo-signal key has been used before. The object here is only to describe the method of its application in the present series of experiments.

To the edge of the shutter of the camera-drum a specially shaped metal bar is fastened at about its middle point. The bar is free to move at this point and may be regarded as a lever of two arms. One arm extends a few millimetres over and in front of the slit of the shutter. Its end is flattened in the vertical plane and the edges shaped to give the sharpest image possible. We shall call this arm of the lever the signal arm.

The other arm of the lever extends beyond the edge of the camera-drum and is then bent at right angles backwards. Its end is flattened in the horizontal plane.

When the lever is set in nearly horizontal position this arm makes contact with the flattened end of a small rod extending downward in a fixed position. The two contact surfaces are of platinum and when actually in contact may complete an

electric circuit. We shall call this arm of the lever, therefore, the contact arm.

The contact arm is made to extend somewhat beyond the point of contact so that a stout finger fixed on the edge of the friction disk of the drum when in motion may strike it and thus break the contact automatically.

Since both arms are of one and the same metal bar and have the same fulcrum, a movement that strikes the contact arm down simultaneously strikes the signal arm up.

If, at the same time, a beam of light is falling upon the signal arm, and the camera shutter is open, the movement of the arm may then be photographed. The instant that the electric current is broken is thus recorded with as great accuracy and constancy as can be desired.

SUMMARY

Certain technical devices and procedures are described for the equipment and operation of a thread-galvanometer in the usual physiological laboratory.

1. A description is given of a simple and perfectly safe disposition of the parts and wiring of an inexpensive main switch-board.

2. Certain modifications of Edelmann's photo-registration drum are briefly described which enable one to use it for both slow and fast speeds. The velocity of the camera-drum may thus be varied at will from 4 mm. to 2 metres per second.

3. A combined automatic breaking key and photo-stimulation signal is described which may be attached to the photo-registration drum.

The above devices have been used successfully, and thus at comparatively small expense, with the small electro-magnet thread galvanometer, Edelmann construction.

ELECTROMYOGRAM STUDIES

II. ON THE TIME RELATIONS AND FORM OF THE ELECTRIC RESPONSE OF MUSCLE IN THE SINGLE TWITCH

BY CHARLES D. SNYDER

[From the Laboratory of Physiology, The Johns Hopkins University]

THE QUESTION

THE electric response of muscle to stimulation may have a significance for us in any one, or all, of its three essential features, namely, (1) its magnitude as measured in terms of electrical units, (2) its duration, as measured in units of time, and (3) its form by which we shall designate variations in potential and electrical sign which occur while the response continues.

The significance of any one, or all, of these features of the electric response, needless to say, is bound up with the general problem of the nature of muscular contraction. For a long time it has been generally conceded that the phenomenon is an expression of the excitatory process and its propagation in living tissue. Whether the act of contraction, in case of muscle, is itself in any way the direct result of the electrical change, has not been seriously considered by physiologists.

Furthermore the question as to whether the mechanical changes involved in the act of contraction give rise to, or are accompanied by, any one part of the electrical change also has apparently received little or no serious consideration.

And rightly. For the evidence favoring such views is both meagre and conflicting. Furthermore (it may be stated at the outset) no evidence has been obtained in the present investigation (when all the evidence is once rightly understood) which will support such views.

The evidence in the literature will be reviewed as briefly as one may and then compared with the results of the present investigation.

HISTORICAL

According to early observers the electrical response in muscle began with,¹ and culminated in the middle of,² the latent period, or at least preceded the contraction wave.³

Bernstein⁴ by the use of his differential rheotome obtained results from which he could conclude that the negative phase of the electrical response was completed before the beginning of mechanical change (shortening).

Lee⁵ using the capillary electrometer as early as 1887 observed that the duration of the change of potential may continue for the whole of the contraction period. Burdon-Sanderson⁶ using the same instrument succeeded in photographing simultaneously both electrical and mechanical changes. He found that "the beginning of change of form in muscle and the culmination of the electrical change at the seat of origin may be synchronous." From his tabulated results it appears further that the electrical disturbance may continue at least during a part of the contraction.

Engelmann⁷ did not believe that the electrical response had any direct relation to the mechanical process of contraction. In defence of his position he arrays a large number of facts and finally expostulates, "if the capillary electrometer shows the beginning of the electrical change to be later than, or syn-

¹ V. BEZOLD, A.: Monatsberichte der königlichen Akademie zu Berlin, 1861, pp. 1023, 1862.

² HELMHOLTZ, H.: The same, 1854, p. 329.

³ V. KÖLLICKER UND H. MÜLLER: Verhandlungen der medizinischen Gesellschaft in Würzburg, 1856, vi, p. 528.

⁴ BERNSTEIN, J.: Untersuchungen über den Erregungsvorgang in Muskel- und Nervensystem. Heidelberg, 1871, p. 60.

⁵ LEE, FREDERIC S.: Archiv für Physiologie, 1887, p. 204.

⁶ BURDON-SANDERSON, SIR J.: Journal of physiology, 1895, xviii, p. 148.

⁷ ENGELMANN, TH. W.: "Über den Ursprung der Muskelkraft." Leipzig, 1895, p. 45.

chronous with, the change of form, then it shows it too late and thereby demonstrates its uselessness for the determination of such short time intervals." The chief objection lay in the experiments of Biedermann⁸ who showed that muscle in certain stages of narcosis, when no longer able to show any trace of mechanical response, still gave well-marked electrical response to stimulation.

Samojloff⁹ again uses the capillary electrometer and with most beautiful technique photographs both electrical and mechanical responses.

He shows "that the greatest part of the electric process falls within the latent period of the muscle contraction. The rest of the curve is for the most part like that described by other authors." If one examines Samojloff's curves (Figure 2, Plate I) one finds evidence that the electric disturbance continues after the beginning of contraction and even on into the relaxation phase.

After Einthoven introduced his thread galvanometer into physiology it was a natural wish to know what evidence this instrument could yield us in this field. Paul Hoffmann¹⁰ made a study of the question and while he made no simultaneous records of mechanical and electrical changes, he states that the electrical disturbance in no case lasted longer than 0.08 second. "With good material the diphasic curve is all over in 0.01 second"; but, "in other cases, especially using smaller frogs, I found a great lengthening of the second phase."

Using the red and white muscles of mammals Arnt Kohlrausch¹¹ obtained practically the same results, the whole time of the electrical response being 0.03 and 0.015 seconds for the red and white varieties respectively.

Judin¹² had already published a photograph purporting to be the simultaneous record of both the movement of the galva-

⁸ BIEDERMANN, W.: Sitzungsberichte der Wiener Akademie, 1888, xcvi, pt. iii, p. 101.

⁹ SAMOJLOFF, A.: Archiv für Physiologie, Suppl. Bd., 1908, p. 1.

¹⁰ HOFMANN, P.: Archiv für Physiologie, 1909, p. 489.

¹¹ KOHLRAUSCH, A.: The same, 1912, p. 283.

¹² JUDIN: Zentralblatt für Physiologie, 1908, xxii, p. 365.

nometer thread and the muscle lever in response to a single stimulus. In this photograph the chief electrical change appears to have occurred during the latent period but a considerable disturbance still seems to continue on into the period of contraction. Another remarkable thing about the curve is that it is complex, reminding one more of the curve described by Lee. If one ignores minor details the curve could be classed as being triphasic.

While there exists a great diversity of results concerning the duration of the electric response, the evidence concerning the form, with exception of that just noted, is much more unanimous.

When lead off from longitudinal and uninjured surface at certain points the form of the curve obtained is said to be generally, as Hermann¹³ long ago described it, diphasic.

If one examines the photographic records however one finds the evidence not to be so unanimous as are opinions on this point. The capillary electrometer records for the most part show evidences of a third phase and Hoffmann speaks of a monophasic deflection occurring in uninjured frog's gastrocnemius, if the leading off electrodes are placed in certain positions on the muscle.

Hoffmann's work was especially directed toward clearing up the conflicting mass of evidence in this problem, and one may only regret that he did not include the mechanical changes in his records. From the line reproductions which are exhibited in the text, however, one may see that the galvanometer thread has not yet come to rest at what may be taken as the end of the second phase. The curves are not always pure monophasic and diphasic curves or even combinations of these.

To sum up then one may say:

1. While the electric response in muscle takes place for the most part during the latent period of the muscle contraction yet there is often a continuation of a slighter electrical disturbance after the muscle begins to contract. This may even be noted to persist during a part or all of the relaxation of the muscle.

¹³ HERMANN, L.: *Archiv für die gesammte Physiologie*, 1878, xvi, p. 235.

2. When the muscle is led off from uninjured points the curve of the electric response is in the main diphasic. But often the return from the positive deflection (second phase) does not end at the null point but may pass beyond into a second negative phase, of small electromotive force, thus giving rise to an apparently triphasic response.

Are these irregularities which one finds so often in the records all due to experimental errors, to extraneous causes, and not at all to actual electrical changes arising within the muscle itself? The present investigation is an attempt to answer this question.

EXPERIMENTAL

The frog's gastrocnemius was used, since it has been the object of study in so many of the preceding investigations and also on account of its convenience. The muscle was stimulated by break induction shocks both directly and indirectly.

Both isotonic and isometric contractions were studied, special muscle levers having been constructed for the work. The isometric lever was carefully calibrated. While it was not perfectly isometric for the muscle yet at a tension of 500 gm. its writing point made an excursion of only 0.33 mm.

The small electromagnet model of Einthoven's galvanometer (Edelmann's construction) was used throughout.

The photographic apparatus and the special stimulation and signal key used are described in Part I of this series of studies.¹⁴

RESULTS

The records being all photographs were carefully marked, corresponding notes were kept, and the analyses of the records tabulated. The features of these analyses bearing upon the problem of this paper are presented in the following protocols.

May, 1912.—The records of this month show the duration of the second phase (time from culmination of first phase to culmina-

¹⁴ SNYDER, C. D.: This journal, 1913, xxxii, p. 329.

tion of second phase) to vary from 7 to 68 thousandths of a second. In one set of experiments a third phase (negative) appears which comes to a culminating point at the end of about 100 thousandths of a second, or sigmata.

January, 1913. — The second phase requires from 7 to 42 sigmata to reach the culmination point. A slow third phase is likewise present in a few records.

February, 1913. — Time to culmination of second phase, 60 to 135 sigmata. No third phase remarked.

ANALYSIS OF PHOTO-RECORDS FROM THE EXPERIMENT OF JULY 19

Number of record	Mechanical Response				Electrical Response				
	Latent period	Shortening period	Relaxation period	Total time	Latent period	First phase	Second phase	Total time	
<i>Isotonic</i>	3								
<i>Contractions:</i>	8	7.5 8.0	65 68	52 50	125 126	3.84 4.2	3.84 2.9	4.8 4.3	12.48 11.4
	9	9.7	62	42	114	4.87	2.58	3.3	10.8
Average		8.4	65	48	122	4.3	3.1	4.1	11.5
<i>Isometric</i>									
<i>Contractions:</i>	4	15.0	46	31	92	3.81	2.72	4.5	11.03
	5	14.9	47	30	91.9	3.33	3.3	4.4	11.03
	6	12.7	48	32	92.7	4.11	2.62	4.67	11.4
Average		14.2	47	31	92.2	3.7	2.9	4.5	11.1

July, 1913. — Selected records of these experiments are here tabulated. They are typically diphasic. The thread used was of platinum with about 5200 ohms resistance, and a sensitivity of about 2.5×10^{-7} amperes for 10 mm. deflection at 75 cm. projection, a magnification of about 200 times, and a tension equal to that used in the experiments.

The deflections of the thread in the electric response of the muscles varied, for the first phase, from 2.0 to 8.3 mm.; for the second phase, from 2.2 to 13. mm.

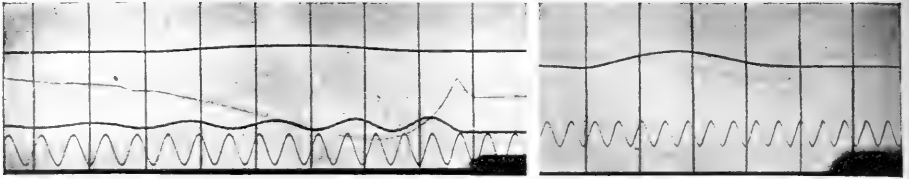

FIGURE 1. January 16, photograph No. 1. The second phase here, it will be noted, culminates only after the muscle begins to shorten. A third phase also appears culminating only after the contraction wave is passed. The muscle exerts a tension of about 100 gm. Leads from muscle, *a-c*.

FIGURE 2. April 2, photo. No. 3. The thread used has a resistance of about 7200 ohms. Stretch of nerve, 24 mm. Isometric lever. Leads, *b-c*. Resting current of about 4 mm. not compensated. Tension exerted by muscle, 200 gm.; actual shortening of muscle, about 0.13 mm.

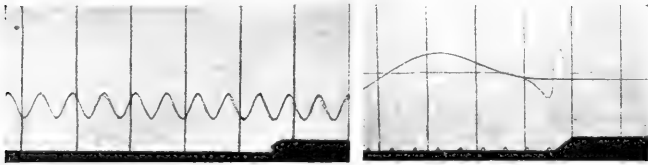

FIGURE 3. To show lag of thread upon break of direct current. Same thread at same tension as in Figure 2. Strength of current passing was about 0.01 milliampere. Lag, 0.09 seconds. Deflection 13.5 mm.

FIGURE 4. July 13, photo. No. 1. Isometric lever. Tension produced by muscle, 350 gm. Thread used has resistance of about 5200 ohms. It will be noted that the second phase reaches culminating point at the moment the muscle lever begins to leave base-line.

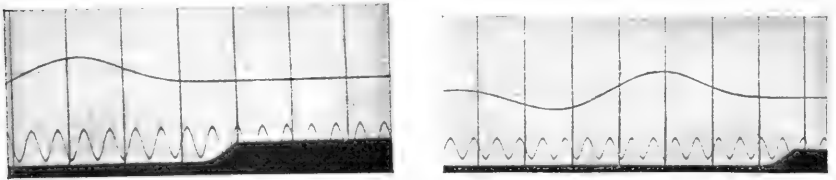

FIGURE 5. July 19, photo. No. 4. Same as in Figure 4 only the muscle lever rises a little later than the culminating point of the second phase of the electric response. The first slight deviation of the thread is due to a small amount of the stimulating current in the muscle-galvanometer circuit. This deflection coincides with the photo-stimulation signal below. Room temperature was about 28° C.

FIGURE 6. July 19, photo. No. 5. Same muscle as in Figure 5; same conditions. The lag in the thread is less in both Figures 5 and 6 than in Figure 4. This is due to difference in tension of thread.

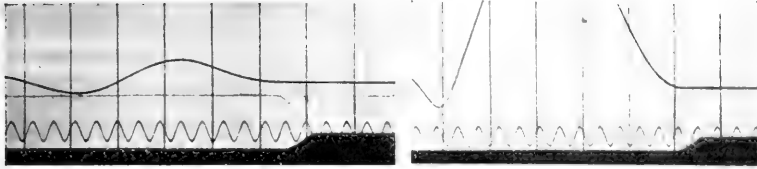

FIGURE 7. July 19, photo. No. 7. Same muscle and conditions as in Figure 6, save the direction of the stimulating current is reversed, which fact is shown in the record. The initial slight deviation of the thread is now downward instead of upward as in the other records. This proves it to be no part of the muscle response. The whole of the electric response is complete in the latent period!

FIGURE 8. July 19, photo. No. 3. Same muscle and conditions as in Figures 5, 6, and 7, save instead of the *isometric* an *isotonic* lever is attached to the muscle. The lever was loaded with a 40 gm. weight. The culmination of the second phase again falls synchronously with beginning of rise of lever. The muscle is changed in length freely; the deflection of thread at end of relaxation must be due to some movement of the leading off thread as also the slight irregularities at the beginning of shortening.

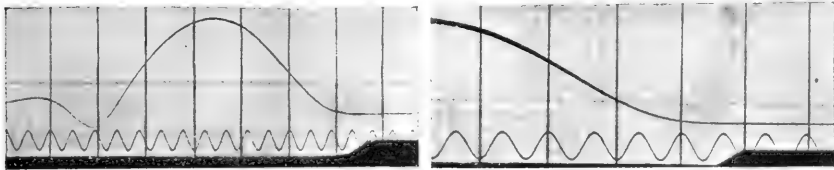

FIGURE 9. July 23, photo. No. 4. Same conditions as in Figure 8. Isotonic lever used. The hesitation of thread to return to null point at close of second phase and the slight deflection at end of relaxation must be due to slight displacement of the leading-off thread as in Figure 8.

FIGURE 10. July 23, photo. No. 1. Same muscle and lever as in Figure 9. The speed of the photographic film was greater than in the other photographs. In this record no stimulating current appears in the galvanometer circuit (see thread record).

The leads from the muscle were all from the *b-c* position, that is, from the belly of the muscle at the neural equator and a point midway from that to the (achilles) tendinous end.

The length of nerve intervening between stimulating electrodes and muscle was nearly 40 mm. The preparation was at room temperature, which was about 28° C. The numbers in the table express thousandths of a second.

All the photo-records here reproduced except number 3 show simultaneous records of the galvanometer thread, the muscle lever, the vibrations of tuning fork (100 D. V.'s per second) and the stimulation signal. The latter is a lever key falling, upon opening the circuit, in the beam of light. The image of the thread is the dimmer line, that of the muscle lever the heavier, in the middle of the photographs. All records read from right to left. The leads from the muscle to the galvanometer are (unless otherwise indicated) the leads *b-c*. The figures are one half the original size.

The photo-records of experiments of July 12, 13, 16, and 23 all show data similar to that tabulated for July 19.

It is of interest to compare the figures of July 19 with those of Burdon-Sanderson¹⁵ for frog's muscle stimulated indirectly with stretch of nerve of 12 mm., isotonic contraction. The times given are the actual times of each event:

Latency of response		Time to culmination	
mechanical	electrical	of electrical response	
		1st phase	2d phase
8	4	5	4

The two methods of procedure which produced in the July experiments such different results from those obtained in the previous spring and winter are, (1) the use of a much tighter thread, and (2) the horizontal instead of the vertical suspension of the muscle.

DISCUSSION AND CONCLUSION

From the foregoing it appears that the electric change in muscle in response to single stimulus is, as generally accepted, purely diphasic in character. A third phase or any other deviation from the diphasic wave finds explanation either in uncontrolled stray currents, or in displacement of the leading off electrodes caused by the changing form of the muscle during contraction. If the muscle hangs vertically it is difficult to prevent the leading off thread from slipping (experiments in

¹⁵ BURDON-SANDERSON, SIR J.: *loc. cit.*, p. 148.

May, January, and February). Even where the muscle is suspended horizontally and every precaution is taken to keep the threads in position evidence of their displacement is still at hand in the isotonic twitch. (Figures 8 and 9.)

Of the pure diphasic curves we have two types, those which are completed within the latent period and those which are greatly prolonged into the contraction period. Of the latter variety whatever the conditions of the muscle or the position of the leads they are all stamped with a common character. The first phase is apparently of small E.M.F. and of short duration, the second phase is of relatively greater E.M.F. and of greater duration. Indeed the prolonged character of the response is due to the great duration of this second phase. The explanation of this kind of electric response is to be found in the system of the galvanometer used. If the swing of the galvanometer is too slow in giving expression to the full amount of current flowing such a curve may obtain. For if the system (in our case the thread) has not yet measured the full value of the first phase before the "negative charge" has reached the second electrode then it will be cut short in its deflection in the negative direction. Reversal of current has set in and it now swings in the positive direction. There being no more reversals of direction the system has time to take the full measure of the second or positive phase of the response. It is thus that we have curves of electric response in muscle with greatly prolonged second phases (see Figures 1 and 2).

Furthermore a loose thread after no current flows in it will lag in its return to the null position. (See Figure 3.) This is also a part of the "continued electrical disturbances" found in such curves as shown in Figures 1 and 2. The greatly prolonged curves obtained in the experiments of May, January, and February thus also find an explanation. The thread used at that time was much looser than in the later experiments.

Doubtless this fact will also account for the observations of others of a greatly prolonged second phase (Hoffmann's and Judin's for example).

The manner in which the leading off threads are slung around the muscle would also affect the character of the electric re-

sponse. If one thread lay along an exact cross-section, the other longitudinally for some distance or even diagonally, it is quite apparent how one phase would be of a greater duration than the other. Indeed three threads laid on the muscle, the middle one connected to one pole of the galvanometer, the other outer two to the other pole, would give a triphasic curve.

It is well known that the temperature coefficient of the velocity of the excitation wave in muscle is positive for a greater range of temperature than the temperature coefficient of the contraction time, and that that of the latent period of the mechanical response is greater than that of the latency of the electrical response.

Experiments made at different temperatures, therefore, would doubtlessly show some difference in the time relations of mechanical and electrical responses. But compared to the causes pointed out above this factor would be of slight value.

THE ENDURANCE OF ANEMIA BY NERVE CELLS IN THE MYENTERIC PLEXUS

BY W. B. CANNON AND I. R. BURKET

[From the Laboratory of Physiology in the Harvard Medical School]

RESULTS obtained by various investigators have shown that nerve cells of different classes and positions in warm-blooded animals show differences in sensitiveness to anemia.

The nerve cells of the cerebellum and cerebrum are most sensitive. Mayer stated that from 10 to 15 minutes was the limit of cerebral anemia, beyond which resuscitation is not practicable.¹ Batelli stopped the heart by the induced current and started it again after varying intervals; he found that the functions of cerebral cells were re-established if the blood supply was absent for only 10 minutes, but that after 15 minutes the restoration was no longer constant, and after 20 minutes it was impossible.² Results similar to these were reported by Stewart, Guthrie, Burns, and Pike.³ Gomez and Pike, on examining the effects in detail, observed that the small pyramidal cells of the cortex were most sensitive — 8 minutes of anemia killed many of them; and that the Purkinje cells were next in order — 13 minutes producing in them diffuse chromatolysis.⁴

The cells of the medulla are more resistant. Gomez and Pike report that anemia for 8 to 13 minutes produces in them only slight lesions or no changes at all, and that anemia should last for 20 to 30 minutes in order to produce alterations incompatible with complete recovery. Stewart, Guthrie, Burns, and Pike describe one animal in which respiration returned

¹ MAYER: *Medicinisches Centralblatt*, 1878, xvi, p. 579.

² BATELLI: *Journal de physiologie et de pathologie générale*, 1900, ii, p. 456.

³ STEWART, GUTHRIE, BURNS and PIKE: *Journal of experimental medicine*, 1906, viii, p. 316.

⁴ GOMEZ and PIKE: *Journal of experimental medicine*, 1909, xi, p. 262.

after ligation of the innominate and left subclavian arteries for an hour, but in this instance there may have been a partial supply from below.

The cells of the spinal cord apparently withstand anemia for a somewhat longer period than those of the bulb. Ehrlich and Brieger produced permanent paralysis of the hind limbs, bladder, and rectum by clamping the aorta of the rabbit just behind the renal arteries from 45 to 60 minutes.⁵ Spronck⁶ and later Sarbó⁷ demonstrated that anemia of the cord for an hour causes necrosis of all the nervous elements. Considerable variation in the effects of anemia was noted by Spronck; in one animal all symptoms of injury disappeared after the ligation had been applied for a half hour; and in another, recovery was incomplete when the blood supply was restored after 10 minutes. Sarbó states that the paraplegia disappeared in his experiments if the ligation remained for less than an hour.

The cells of the spinal ganglia are also resistant to lack of blood supply. Gomez and Pike found no sign of a pathological change in these cells when made anemic for 30 minutes.

Still more resistant are the cells of the sympathetic ganglia. Tuckett was struck by the very slight change in the nerve cells of the superior cervical ganglion when long deprived of their blood supply, but still surrounded with lymph.⁸ Schröder applied more exacting conditions. He killed cats by narcosis and after varying intervals perfused the neck vessels from the carotid and tested the functioning of the cells of the ganglion by stimulating the cervical sympathetic trunk for its effect on the pupil.⁹ Thus he succeeded in demonstrating a restoration of function when 60 minutes had intervened between the last breath and the beginning of perfusion. These, therefore, are the most stable nerve cells in the absence of blood supply that have thus far been described.

⁵ EHRlich and BRIEGER: *Zeitschrift für klinische Medicin*, 1884, vii, Supplement, p. 155.

⁶ SPRONCK: *Archives de physiologie*, 1888, xx, p. 17.

⁷ SARBÓ: *Neurologisches Centralblatt*, 1895, xiv, p. 664.

⁸ TUCKETT: *Journal of physiology*, 1905, xxxiii, p. 79.

⁹ SCHRÖDER: *Archiv für die gesammte Physiologie*, 1907, cxvi, p. 603.

OBJECTS OF THIS INVESTIGATION

Magnus has furnished evidence that rhythmic contractions of the alimentary canal do not occur if the myenteric plexus is removed.¹⁰ And yet, as Mall has observed, a piece of small intestine may be removed from the body, kept on ice 24 hours, and on being perfused in a warm bath, will contract rhythmically.¹¹ If Magnus's evidence is correct the cells of the plexus must have continued living in the cold temperature for 12 hours or more after removal from their blood supply. This circumstantial evidence indicates that the cells of the plexus are exceptionally resistant to anemia, though of course the resistance could not reasonably be expected to endure as long in the warm body as in an ice-cold chamber. The hardiness of the intrinsic neurones of the alimentary canal, compared with those in other parts of the body, was the prime object of interest.

Lewandowsky has argued that Magnus's experimental procedure was faulty in that the plexus was removed by tearing the two muscular coats apart.¹² If by anemia the nerve cells are destroyed, a variation of the procedure is offered, and results thus obtained have an interesting bearing on the question of the neurogenic or myogenic origin of gastrointestinal contractions.

Learning the limits of endurance of anemia in these nerve cells is of interest also in relation to the possibility of continued functioning after the loss of blood supply in surgical states — as in hernia and intussusception.

For these different reasons the present enquiry was undertaken.

¹⁰ MAGNUS: *Archiv für die gesammte Physiologie*, 1904, cii, p. 362.

¹¹ See MALL: *Johns Hopkins Hospital Reports*, 1896, i, p. 54. We have observed similar restoration of rhythmic activity when the intestines, kept ice-cold over night, was warmed in oxygenated Ringer's solution.

¹² LEWANDOWSKY: *Die Functionen des Zentral-Nervensystems*. Jena, 1907, p. 92.

METHODS

Two methods were used to produce anemia, — by ligature, and by compression.

The Ligature Method. — This method is illustrated diagrammatically in Fig. 1. The vessels supplying a zone in the stomach, and zones in the small and large intestines were tied, and the zones then shut off from neighboring parts by tape tied tightly about the canal. Zones thus isolated soon became purplish in color. By cutting the injected vessels on the surface of the canal it was possible to prove whether the blood supply had been completely excluded. Usually when the vessels of the colon and small intestine were cut no bleeding ensued. The blood supply to the stomach, however, was much more difficult to control by this means; and since gastric katastalsis is the most persistently rhythmic activity of the muscles of the

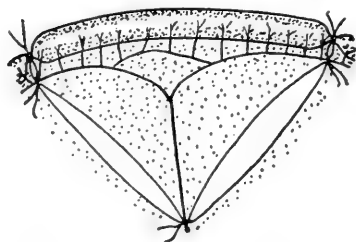

FIGURE 1. Diagram representing the method of isolating a segment of the alimentary canal by tying vessels and the canal itself. The mesentery is cut between the ligatures.

alimentary canal, and the stomach, therefore, is an excellent indicator of the effects of anemia on contractions, the use of a more reliable method was desirable.

The Compression Method. — In producing anemia by compression the stomach or intestine was fixed tightly between two glass plates, with rounded edges and sufficiently long to project on either side of the flattened portion of the canal. The plates were pressed together either

by rubber bands wound around the projecting ends of the plates or by screw clamps (see Fig. 2). The transparent glass permitted observation of the blood supply of the compressed parts and the pressure applied was always sufficient to render the tissues milky white. Perfect anemia was thus produced. A cut through the serosa and external muscular coat on either side of the glass plates, at the end of the period of anemia, left a mark which showed clearly the limits of the area which had been kept bloodless.

The periods of anemia lasted from 1 to 7 hours. During these periods the exposed parts were enclosed in a sheet of sterile rubber and kept warm. The operation was performed with careful asepsis. When the glass plates were removed a return of the circulation was in all cases ascertained by inspection. The animals (cats) were thoroughly anesthetized from the beginning of the operation until the abdomen was finally closed.

The Physiological Examination.—After a varying number of days following the operation the animal was examined for movements of the anemic part. On the pyloric end of the stomach or on the proximal colon, where continuously moving katastaltic or anastaltic waves can be observed with the X rays, activity was looked for by this means after food mixed with bismuth subcarbonate had been fed. Failure of the waves to pass over the part which had been anemic would prove, of course, that the anemia had disturbed or destroyed the functioning of that part; whereas the uninterrupted progress of the waves would prove that it had had no effect.

On the small intestine the X ray method could not be employed satisfactorily; in order to test the activities of the gut after anemia, the animal was fed a few hours before being killed, and when anesthetized and on its way to death, the abdomen was opened and the intestine examined under normal salt solution at body temperature. Segmenting movements can be induced by tying the gut below any region of particular interest and permitting the contents to accumulate until there is increased internal pressure. This procedure was utilized to call forth activity in the anemic region of the gut. At the same time observations were made on the movements of the stomach and colon.

The Histological Examination.—After observations had been made to determine the presence or absence of activity in the parts which had been anemic, the animal was killed and these parts were excised and fixed in Bouin's or Zenker's fluid, or in acetic acid. They were then embedded in paraffine, sectioned serially, and stained with eosine and methylene blue. The microscopic examination was made with a Leitz ocular No. 3,

and with objectives 7 and $\frac{1}{12}$. Each cell studied was examined through the series in order to get the three-dimensional appearance.

RESULTS

Physiological Examination.—In the earlier experiments in which anemia was produced by tying the vessels and the digestive tube, physiological tests soon showed that contraction was not destroyed within time limits far beyond the 60 minutes of anemia which nerve cells of the sympathetic ganglia will endure. In one of the first experiments four parts of the small intestine

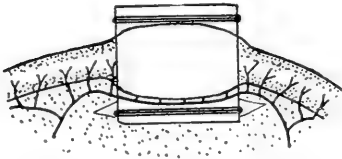

FIGURE 2. Diagram showing the method of producing anemia of a segment of the alimentary canal by including it between glass plates pressed together by rubber bands or screw clamps.

were isolated as shown in Fig. 1. In each place the main vascular trunks were tied with a linen ligature, and the anastomosis and the intestine itself tied tightly with tape. The procedure was carried out under ether anesthesia and with care for asepsis. At the end of a half hour all four isolated portions were purple and swollen, there was no pulsation in the vessels, the veins were full of dark blood, and yet there were some spontaneous movements of the gut. Removal of the ligatures of one portion at the end of a half hour resulted in prompt disappearance of the purple color, which was replaced by pink. The only difference from normal appearance was slight swelling of the region and minute subserous ecchymoses. As the blood reentered the region strong contractions occurred. The same changes occurred when the blood was readmitted to two other portions at the end of an hour. When circulation was restored in the fourth portion at the end of one and a half hours there were no spontaneous movements.

The absence of activity immediately after restoration of the blood supply in the last of the foregoing experiments does not mean that parts lose their functions by one and a half hours of such treatment. In Figs. 3 and 4 are shown waves passing over

the stomach and the colon; these parts had been tied off for two hours and at the end of that period were quite purple.

In another instance ligatures were placed on the stomach and proximal colon for *seven* hours. At the end of the period both parts were purple, but the stomach not so unnatural as the colon. Seventeen days later the movements of the canal

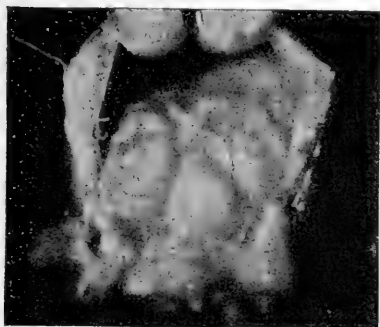

FIGURE 3. A photograph of katastatic waves passing over the pyloric end of the stomach where the vessels had been tied for two hours.



FIGURE 4. A photograph of anastalsis in a part of the colon (between the threads) where the vessels had been tied for two hours.

were observed under salt solution. The stomach exhibited perfect katastalsis. The colon had ruptured and had been mended by the growth of other tissues about it, but the lumen was thus so much constricted that material could hardly be passed through.¹³ In all probability the stomach in this case, in spite of its purple color at the end of 7 hours of "anemia," was not wholly deprived of blood supply. The results obtained under the more rigorous conditions of anemia produced by pressure indicate, indeed, that continuance of activity in this stomach

¹³ In this instance the entire lower half of the small intestine was enlarged and thin-walled. Rhythmically-repeated waves of katastalsis, similar to those of the stomach, appeared here and there. A tonus ring made by applying a 5 per cent solution of barium chloride became a source of these waves; at times it caused no waves to pass downwards, but several to move upwards (anastalsis) for a distance varying from 2 to 4 cm. Thus the small intestine in the presence of obstruction had taken on some of the characteristics of the colon. (Cf. CANNON: American journal of physiology, 1912, xxx, p. 114.)

was possible only because some slight blood flow persisted, or because the presence of blood in the vessels, even though stagnant, keeps the tissues normal longer than they can be so kept in a wholly bloodless state. The limits of the endurance of this sort of anemia (after ligation) by the nerve cells of the myenteric plexus were not determined.

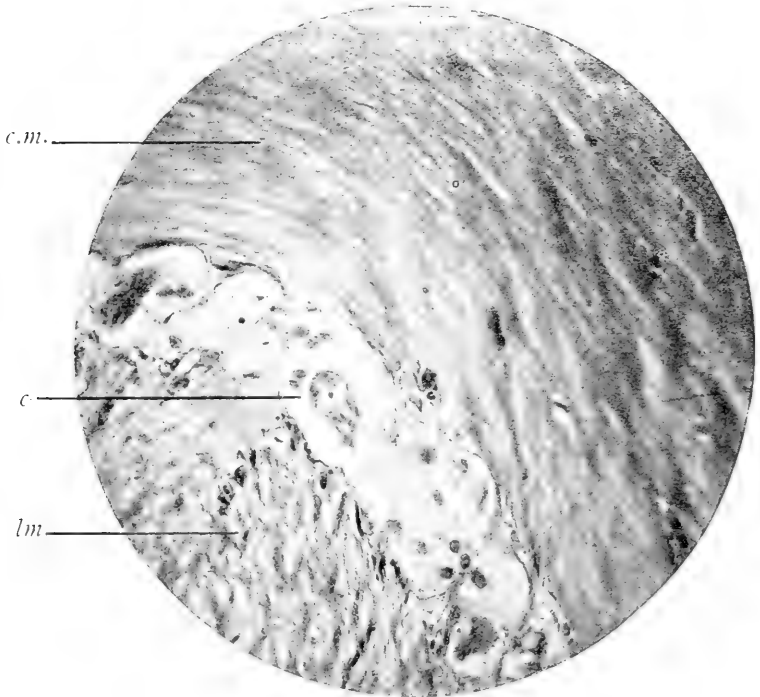

FIGURE 5. Section of a normal duodenum: *c*, nerve cell showing cytoplasmic granules; *cm*, circular muscle layer; *lm*, longitudinal muscle layer.

When complete anemia was caused by pressure between glass plates for any period up to 3 hours, and the gastric and intestinal contractions were examined later by the X rays or by inspection under salt solution, normal movements were invariably seen. In one instance perfect gastric katastalsis and occasional spontaneous constrictions of the proximal colon were seen, in regions which had been compressed for *four* hours. This result, however, was unusual. In all other instances compres-

sion for $3\frac{1}{2}$ hours was followed by failure of activity in the compressed region; and in three instances in which compression was applied for 4 or $4\frac{1}{2}$ hours perforation occurred and caused peritonitis. Complete anemia, with blood pressed from the vessels, can persist, therefore, at body temperature for about 3 hours, without destroying the ability of the alimentary canal to contract normally.

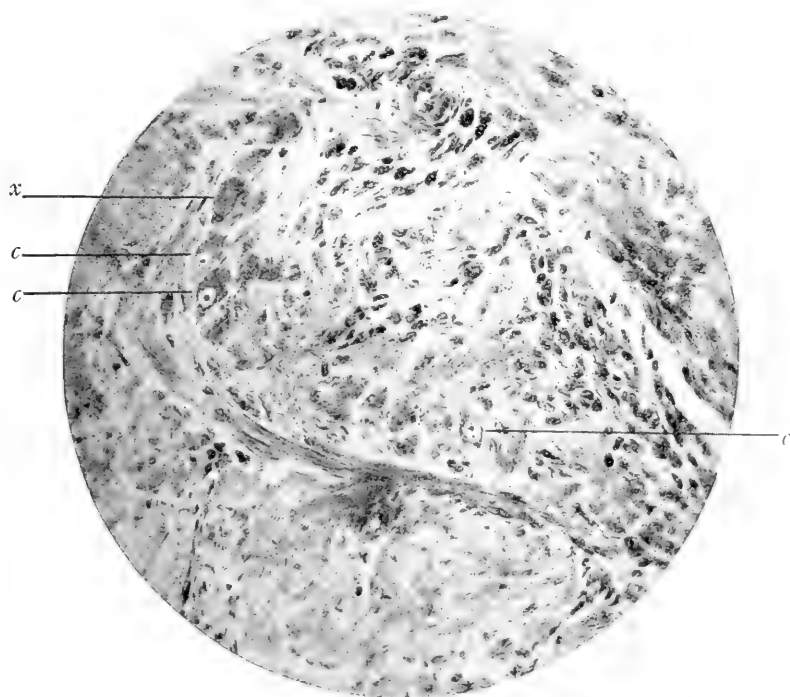

FIGURE 6. Section of a part of the canal which had been compressed for three hours, showing a nest of nerve cells with moderate connective tissue proliferation. *C, c, c,* nerve cells cut through different levels; *x,* section of a nerve cell passing only through cytoplasm.

Histological Examination.— In the tissues rendered anemic by tying vessels no degeneration of nerve cells was observed even when the anemia had lasted for as long as 6 hours. As already stated, however, there was some question as to whether the anemia in these cases was complete. These results, therefore, are chiefly valuable in showing that the nerve cells may

remain normal even if they are in a part of the stomach or intestines which has been for many hours deprived of its normal circulation, and is edematous, and purple with stagnant blood.

In tissues compressed till white for 1, 2 and 3 hours the nerve cells in the compressed region usually appeared quite normal.

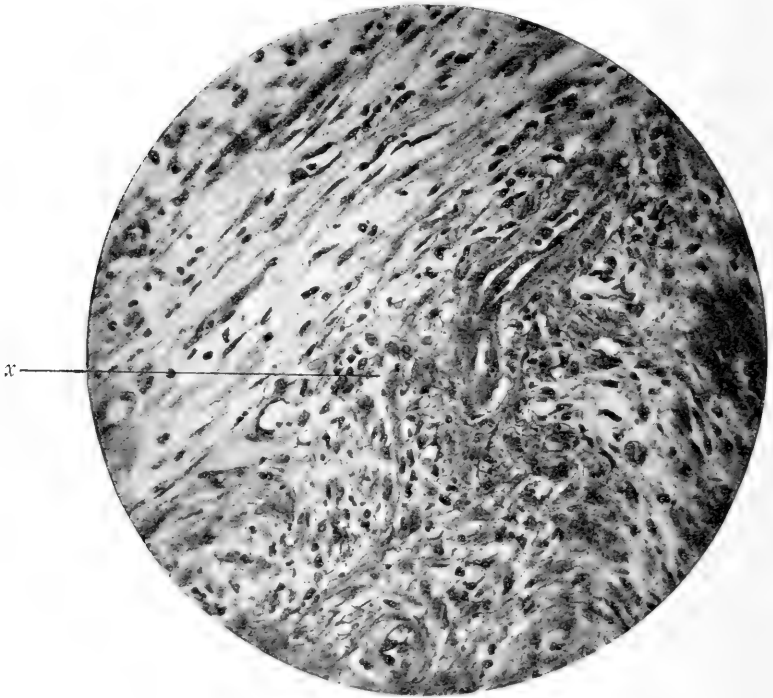

FIGURE 7. Section of a part of the duodenum which had been compressed three and a half hours. Specimen taken sixteen days afterwards. Muscle tissue partly degenerated, infiltrated with round cells, and to some degree replaced by connective tissue. *X*, original site of myenteric plexus between the muscular layers; nerve cells absent.

Comparison of the appearance of the cell bodies of the myenteric plexus in a normal intestine (see Fig. 5) and in a region under pressure for 3 hours (see Fig. 6) shows that when changes occur they consist in a disappearance of the cytoplasmic granules, a diffuse staining of the cytoplasm, and a moderate connective tissue proliferation. The nuclei become somewhat eccentric.

In the majority of cells anemic for 3 hours changes were not observed.

As a rule, in parts of the alimentary canal compressed $3\frac{1}{2}$ hours or longer practically all nerve cells disappear from between the two muscular layers (see Fig. 7); only occasionally can degenerated remnants be found. The muscular tissue also undergoes marked changes, — becoming infiltrated with round cells and in part replaced by connective tissue.

SUMMARY AND CONCLUSIONS

If the vessels supplying parts of the alimentary canal are tied and the parts themselves limited by ligatures, the tissues become edematous and purple, but may not be completely anemic. After the condition has persisted for 6 or 7 hours such regions may recover normal activities and on being examined histologically show nerve cells with normal appearance.

If complete anemia of parts of the alimentary canal is produced by compression between glass plates, the condition may last for as long as 3 hours without loss of normal motility or of nerve cells in the compressed regions. If the compression-anemia lasts for $3\frac{1}{2}$ hours or longer, it almost invariably results in loss of function and disappearance of nerve cells in the compressed parts.

The concomitance of persistence or loss of function with persistence or destruction of nerve cells in these experiments supports Magnus's contention that the spontaneous contractions of the alimentary canal are of nervous origin.

The continued existence of the cells of the myenteric plexus after 3 hours of complete anemia — 2 hours longer than the cells of sympathetic ganglia — reveals them as the most hardy nerve cells thus far found in the body.

EVIDENCE OF FAT ABSORPTION BY THE MUCOSA OF THE MAMMALIAN STOMACH

BY CHARLES W. GREENE AND WILLIAM F. SKAER

[From the Department of Physiology and Pharmacology, Laboratory of Physiology, University of Missouri]

VON KÖLLIKER discovered evidence of the absorption of fat from the gastric mucosa in mammals in 1857.¹ He said, "I have never failed to find fat in the gastric epithelium of young cats, dogs, and mice." "The content of the cells varies greatly from the finest fatty granules scarcely perceptible to the condition of the cells in which they were strutting with the engorged fat." This discovery together with the discovery of the fat splitting enzyme lipase by Claude Bernard in 1856,² and the discovery of the cleavage of fat in the gastric cavity by Marcet in 1858³ marks the historical beginning of the small and scattered literature on the subject of gastric fat absorption. That fat is absorbed through the intestinal mucosa was shown by Weber in 1847.⁴

The newer methods for the histological identification of fat lead us to take up a re-study of this important problem with the hope of settling some of the questions which have arisen in the last few years concerning the gastric absorption of fats.

METHOD IN OUTLINE

Our method of observation rests on the determination of the microscopic variation in the quantity of fat in the gastric tissues in relation to fat feeding. In brief it is as follows: we fed ani-

¹ KÖLLIKER, A. VON: *Verhandlungen der physicalisch-medicinischen Gesellschaft*, 1857, vii, pp. 174-193.

² BERNARD, CLAUDE: *Leçons de physiologie expérimentale*, 1856, ii, p. 178.

³ MARCET, W.: *Medical Times*, 1858, xvii, p. 209.

⁴ WEBER, E. H.: *Archiv für Anatomie, Physiologie, und wissenschaftliche Medizin*, 1847, vi, pp. 400-402.

mals with a constant diet to secure relative stability of conditions, then withheld food for a definite time, usually 24 hours. After this time a meal rich in fat and of the desired character was given. Very rich cream was used in the later experiments for testing the absorption of fat. For the rats olive oil was mixed with fresh ground meat. Young animals were allowed to suck the mother's milk where possible, but occasionally were fed artificially. As a rule several animals have been run in parallel, each group selected of the same litter or as nearly the same age as possible. Animals were chosen of different ages from those that had never taken food to adults. The animals were killed by anesthetics at varying times following digestion and absorption. The stomach was opened and its undigested content carefully removed and the mucosa rinsed with luke warm physiological saline. Selected tissues were fixed in 10 per cent formalin for about two hours, then sectioned by Bardeen's freezing microtome, stained with saturated alcoholic-alkaline scarlet red, counterstained lightly with haematoxylin, mounted in glycerine, and sealed. We find these preparations keep very well for a few weeks, depending largely upon the care with which traces of alkali are removed after the staining with scarlet red.

RESULTS OF OBSERVATIONS

Our observations may be divided into two groups, namely,

1. The evidences of fat absorption by the gastric superficial epithelium.
2. The variation in fat content of the mammalian gastric glands.

1. The Evidences of Fat Absorption by the Gastric Superficial Epithelium

The study of frozen sections cut vertical to the free surface chosen from the two principal regions of the stomach, namely, the cardiac and the pyloric, reveals a rich absorption of fat by the superficial epithelium. In both regions the quantity of fat and its distribution in the cells bears a definite relation to the

time that has elapsed since fat feeding. The assumption that the fat observed is a true absorption fat rests upon the constancy of this cycle in its relation to fat feeding. This cycle was shown long ago for the intestinal epithelium by Eimer.⁵ Eimer observed that in the small intestine and in the upper part of the large intestine the epithelial cells of the mucosa were filled with fat droplets first in the outer, i.e., superficial, zone, and that later the basal portion of the cell filled with fat.

The normal comparison for such a series of experiments would seem to be a fat free epithelium. As a matter of observation, however, it is extremely difficult to secure an absolutely fat free epithelium, a fact that was also observed on the intestinal epithelium by Eimer. The most favorable condition for comparison is that represented by the fasting stage of from 20 to 24 hours. At this time the gastric epithelium still contains a few fat droplets usually at the deeper, i.e., basal, ends of the cells. For our purposes this condition was taken as a standard.

After a fat meal is given to a series of 24-hour fasted animals and these are killed at successive periods of time extending through a range of, say, 3, 6, 10, 15, and 20 hours, it is noted that the superficial epithelial cells load with fat droplets to a maximum in from 6 to 15 hours. The loading is first in the free ends of the cells, i.e., the surface bordering on the lumen. The fat droplets gradually increase in number and size until they occupy all the space between the free surface and the nucleus. At the most superficial margin of the cell the fat droplets are always extremely small, usually a fraction of a micron. In the zone surrounding the nucleus the droplets are always larger. In both regions of the gastric epithelium the appearance gives one the impression that the fat droplets are growing larger by accretions as they pass from the marginal zone toward the nucleus. At this stage in very young animals the contrast is not so sharp as regards the size of the droplets as in older animals. As time progresses the fat droplets appear in ever increasing numbers in the basal end of the cell, i.e., between the nucleus and the basement membrane. At this period the entire epithelial

⁵ EIMER, TH.: *Virchow's Archiv für pathologische Anatomie*, 1867, xxxviii, p. 428.

cell is often engorged with fat, the droplets varying in size from a fraction of a micron to as much as 5 or 6 micra in diameter. The total mass of fat that may appear in an epithelial cell in that maximal stage of fat absorption seems to vary according to two factors. The first and most important of these is the factor of the age of the animal. The younger the animal apparently the greater the mass of fat that will be crowded into the cells at this stage of the cycle. The second factor is that of the quantity of fat that is being digested. We are convinced that the greater the mass of fat present in the lumen of the stomach in an active stage of digestion the greater the quantity in the cells at the maximum of the absorption cycle. In relation to intestinal absorption various men have called attention to the fact that the passage of fat is a progressive one, that, while fat is being absorbed into the free surface of the cell it is being lost or discharged from the basal end of the cell. Evidently this is also true for the gastric mucosa, so that a balance at any given instant must exist as between the quantitative amount of dissociated fat in the lumen, and consequently in the absorbing cell itself, and the quantity of synthesized fat appearing in droplets within the cell.

As absorption ceases the free ends of the cells begin to lose fat until very little is present between the free surface and the nucleus. This disappearance of fat is indicated by two microscopic factors, namely, a diminution in the absolute size of the fat drops and a decrease in the number present. Cells in which the free margins are relatively low in fat content as a rule show only small sized fat droplets. This stage is still characterized by a heavy loading of fat droplets in the bases of the cells, i.e., between the nuclei and the basement membrane. As a final stage, 24 hours or more, the basal portion of the cells lose the fat droplets until only liposomes are left in the extreme basal ends of the cells, the condition which was taken as the normal.

There is one slight variation in the above cycle, namely, the fact that at the very beginning of fat digestion and at the time just before the appearance of fat droplets in the superficial ends of the epithelial cells the normal remnant of fat in the bases of

the cells tends to disappear. In other words, there is a distinct but slight drop in the fat content curve just at the beginning of fat digestion. This drop, which we found very difficult to interpret at the beginning of our series of experiments, proved to be easily explained on the assumption of an increased quantity of lipase which is undoubtedly secreted at this time. The increase in lipase is sufficient to hydrolyze the fat remnant, thus sending it into solution, in which condition we of course could not find it by our fat staining methods.

Comparison of Cardiac and Pyloric Absorption.—The evidence of fat absorption is strong in both the cardiac and pyloric regions. A comparison of the two regions in one and the same animal generally shows a slight contrast in the relative quantity of fat in the most superficial cells. One must remember here that the crypts of the cardiac end of the stomach of most mammals are small and insignificant in comparison with the wide open funnel-like crypts of the pyloric mucosa. It is probably for this reason that the epithelial cells that load with fat in the cardiac end are only those representing the areas between the crypts. Unless absorption is very rapid and voluminous the cells in the mouths of the cardiac crypts rarely contain more than traces of absorption fat. On the other hand, the most superficial mucosa of the pyloric region is always in relatively intimate contact with the semi-fluid digesting mass. These cells are the ones that are so often engorged with fat. The size of the droplets is somewhat larger than in other portions of the stomach and occasional areas are observed in which the cells seem actually to be distended from the excess of internal pressure. In the pyloric region the cells lining the crypts, especially near the mouth, show a considerable loading with fat. Traces of fat are found even down relatively deep in the cells of the crypts.

The cycle of variation in fat quantity and in its distribution in the cell is the same whether one considers the cardiac or the pyloric mucosa.

Comparison of Gastric Fat Absorption in Different Animals.—As previously stated, we have used rats, cats, and dogs as experimental animals in this study. Of the last two species we have examined animals of various ages from birth to the adult.

In the cats we have made comparisons between the young just before taking nourishment and after the first sucking. In each of these classes fat absorption occurs in the gastric regions. The stomach of the rat near the esophageal opening is lined with stratified epithelium. This area was not shown to absorb fat. Our examinations were limited to two adult animals, a number entirely insufficient to determine the point. Both the cardiac epithelium and the pyloric were loaded with fat in the rats we examined. These rats were fed olive oil mixed with ground meat and cooked in small sausages. The control rats showed only the normal small quantities of fat at the bases of the epithelial cells.

In dogs, especially in the young puppies, the fat fed animals present an unusually heavy loading of fat in the epithelial cells. The fat droplets were of relatively large size and in quantity sufficient to engorge the most superficial regions.

In cats the mucosa is composed of smaller cells than in dogs. However, the loading of fat during absorption runs a close parallel with that in dogs. Our series of animals of different ages was run on cats. Just born kittens which have taken no nourishment show extremely fine liposomes in practically all the gastric tissues—the mucosa, gland cells, muscle coat, etc. The liposomes have a characteristic fine granular, evenly distributed appearance, but were not excessive in amount in any of our material. Kittens from the same litter that were allowed one meal gave a beautiful picture of fat loading in the gastric superficial epithelium. The picture is so characteristic and so readily obtained that this one experiment is sufficient to dispel any doubt as to the source of the fat. Adult cats reveal fat absorption by the gastric mucosa. Other things being equal, the quantity of fat is much less in the adult than in the very young. However, we must take exception to Weiss' statement⁶ that the power of fat absorption is lost by the gastric mucosa at an early age.

Considering the series of animals studied it seems that the power of fat absorption by the gastric mucosa is greater in the

⁶ WEISS, OTTO: *Archiv für die gesammte Physiologie*, 1912, cxliv, pp. 540-543.

young than in the adults, a factor which has been discussed by Schilling.⁷

2. *The Variation in the Fat Content of the Mammalian Gastric Glands in Relation to Fat Absorption by the Stomach*

An important observation running through this series of experiments is found in the fact that the amount of fat in the gastric glands increases through a definite cycle following a fatty meal. In some cases the gland cells are so filled with fat as to practically obscure the histological structure. The fat is generally distributed throughout the protoplasm of the cell, always exclusive of the nucleus. In the peptic glands fat granules appear first and most strikingly in the parietal cells, later in the chief cells. In the pyloric glands the fat appears first and in greatest quantity in the cells at the bottom of the glands. In cats and in dogs the pyloric glands are often convoluted at their bases not unlike though less marked than in the sweat glands. The fat in the cells of these convolutions when stained with the scarlet red brings the glandular areas into sharp contrast with the supporting tissues.

After a meal the fat is loaded into the gland cells relatively slowly, and in like manner is extremely slow to disappear. The maximum amount of fat in the gland after a fatty meal does not occur so soon after fat feeding as in the case of the superficial epithelium. In some cases this maximum appears as late as 20 to 24 hours. During fasting the fat in the cells disappears even more slowly, often taking several days to reach a stage which one would consider as comparatively free of fat. Taking it all in all, the cycle of variation in the fat content of the glands runs its course much more slowly and does not show such extremes of fat content as in the case of the epithelium. However, the variation is definite and quite adequate to be easy of identification. The length of time involved seems to us to be the factor which has led certain observers, notably Nikolaides⁸ to consider fat in the glands of the body as degeneration fat. However, we are con-

⁷ SCHILLING, F.: *Allgemeine Wiener medicinische Zeitung*, 1901, xlvi, pp. 279, 291, 301, 313.

⁸ NIKOLAIDES, R.: *Archiv für Physiologie*, 1899, pp. 519-524.

vinced that the condition that we have had under consideration is one definitely and directly dependent upon the amount of fat passing through the walls of the alimentary tract during absorption. There is no evidence of protoplasmic degeneration.

Last April Schickele⁹ published a paper in which he uses the term "Wanderfett" to designate the fat that accumulates in the tissue organs such as the liver, sweat glands, etc., during certain conditions. This term might well be applied to the case of excessive fat in the gastric glands observed in our work.

The fat content of the glands, like that of the epithelium, also undergoes a drop at the beginning of the digestion period. We have come to the conclusion that this depression of fat in the glands is directly related to physiological change occurring in the early stages of fat digestion, a fact which is readily explained on the view of the reversible reaction of lipase given us by Kastel and Loevenhart¹⁰ and by Loevenhart¹¹ himself.

When food reaches the stomach there is a great increase in the gastric secretions, owing to the usual normal reflexes. This must now, in light of the work of Marcet, Volhard,¹² Laqueur,¹³ and others, be accepted as a time of great increase in lipase produced by the activity of the gastric glands. The effect is that there is an increase in the normal lipase content not only of the gastric gland cells, but of the other adjacent structures of the mucosa also. The net result is that the normal fat of the gland cell is suddenly surrounded with an increase in the lipase. This disturbs the balance of the fat remnants in the gastric glands and in the mucosa as well, which, according to the Shütz-Borissow law, should lead to a further dissociation and disappearance of

⁹ SCHICKELE: Verhandlungen der deutschen pathologischen Gesellschaft, 15th session, 1912, pp. 451-454.

¹⁰ KASTEL and LOEVENHART: American chemical journal, 1900, xxiv, p. 491.

¹¹ LOEVENHART, A. S.: This journal, 1901, p. 331.

¹² VOLHARD, FRANZ: Münchener medizinische Wochenschrift, 1900, pp. 141, 194.

Ibid.: Zeitschrift für klinische Medizin, 1901, xlii, p. 414.

Ibid.: Zeitschrift für klinische Medizin, 1901, xliii, p. 397.

¹³ LAQUEUR, ERNST: Beiträge zu chemischen Physiologie und Pathologie, 1906, viii, pp. 281-284.

these fat remnants. The very process, therefore, of the production of lipase for the digestion of the fat content of the canal leads to a local disturbance of fat equilibrium in the gastric glands, a disturbance which involves also the gastric epithelium.

With the beginning of absorption of the digested fat there is first a loading of the fat into the columnar epithelial cells, later a diffusion of this fat into the membrana propria, lymphatics, gland cells, etc., with a final reconcentration of the fat into the gland cells. It is obvious, therefore, that the increase in content of fat in the gastric gland cells takes place somewhat later in the cycle of fat absorption than the increase noted in the columnar epithelial cells.

3. The Variation in Absorption Fat in Relation to Lipase Action

Throughout our work we have accepted Pflüger's hypothesis that fat digestion and absorption is a lipolytic process. By this theory lipase dissociates the fat in the canal and the dissociation products can pass the surface boundaries of the epithelial cells. Kastel and Loevenhart's demonstration of the reversibility of lipolytic action is adequate to account for the reappearance of stainable fat in the tissue cells. The quantitative amount of fat is an expression of the balance as between fatty acid and lipase, a proposition which may also be stated in the reverse way. This hypothesis adequately explains the histological picture of fat variation observed in our experiments. If one applies here the Shütz-Borissow law, according to which the quantity of the cleavage fat is proportional to the fourth power of the cleavage agency, it is obvious that we have a working hypothesis into which fit very nicely the observed facts not only as to the relative quantity of fat, but also the gross quantity in both the absorbing epithelium and in the glands.

In establishing our normals we studied a series of fastings of various durations. In occasional animals of medium to late fasting duration we found an unexpected quantity of fat in the various gastric glands. Such cases would be ordinarily judged as fatty degeneration, but the character and arrangement of the fat in the cells and the otherwise normal appearance of the tissues was not that of the typical and unquestioned pathological de-

generation. It seems rather to be a normal condition. We soon came to the conclusion that we were dealing with a disturbance as between lipase production and fat mobilization, i.e., a case of Schickele's "Wanderfett." In the early stages of fasting the labile substances, namely, the carbohydrates, are quickly used for the production of energy. A little later the fats of the adipose tissues and other more fixed substances are drawn upon. In this later stage the lipase producing tissues are doubtless strongly stimulated to increased activity for the accomplishment of the transportation of fats. Lipase was proven by Loevenhart to be a normal content of a large number of tissues of which certain glandular tissues are particularly mentioned by him. To these tissues ought to be added the gastric glands which are lipase producers. If one assumes that an excessive production of lipase takes place in these glands at the time during fasting when the fats are being dissolved from the storage tissues and are present in a relatively high per cent in the circulating fluids, it follows that there will be an increased synthesis of fats in the lipase producing tissues themselves. We believe from our evidence that the gastric glands are of this class. This hypothesis more adequately explains the histological picture shown in our second case than does the hypothesis of fat production from degeneration of the cell protein.

In conclusion, let us emphasize the main contribution in our paper, that *there is a definite cycle of variation in quantity of fat in the gastric mucosa and in the different gastric glands in relation to the time following a meal rich in fats.*

SUMMARY

In a series of experiments based on the study of the amount of fat in the superficial gastric epithelium and in the gastric glands at different times in relation to feeding and fasting we have come to the following general conclusions:

1. In puppies and kittens before the young have fed, the young gastric tissues show minute stainable granules which have the histological characteristics of fat. These granules are extremely small and are characteristic in their distribution.

2. The gastric epithelium of rats, cats, and dogs shows a definite cycle of variation in fat content following the taking of a meal rich in fat.

3. The gastric epithelium in a moderately fasting condition contains traces of fat in the bases of the cells. This condition has to be taken as the normal in fat absorption experiments.

4. The epithelial fat content following a meal of fat is expressed by a curve which at first shows a slight drop, then a rapid rise of the amount of fat in the cells, followed by a more gradual and slow decline to the normal.

5. The gastric epithelium and gastric glands of puppies and kittens both peptic and pyloric show a marked increase in the stainable fat after the taking of the first meal. Under ordinary conditions this fat is never reduced to the quantity and characteristic arrangement of that in the embryo.

6. The amount of fat in the gastric glands runs a definite and characteristic cycle of variation in relation to the taking of fatty foods. This cycle is marked by an initial slight drop with a slow and prolonged rise to a maximal and fall to the normal. The extremes of the fat content of the glands vary much less than in the epithelium.

7. More fat is found in the pyloric than in the peptic glands and the contrasts are more pronounced in the pyloric glands.

8. It is difficult to cause the entire disappearance of fat from the mammalian gastric gland cells by prolonged fasting.

9. In medium to late fasting there is occasionally an increased quantity of fat in the gastric gland cells. This has no relation to absorption fat but is explained as due to mobilization of body fats.

WILLIAM FREDERICK SKAER died June 16, 1913. His loss is deeply felt by his associates, who saw in him the promise of a most useful life.

CONTRIBUTIONS TO THE PHYSIOLOGY OF THE STOMACH

VI. A STUDY OF THE MECHANISMS OF THE HUNGER CONTRACTIONS OF THE EMPTY STOMACH BY EXPERIMENTS ON DOGS

BY A. J. CARLSON

[From the Hull Physiological Laboratory of the University of Chicago]

I. EXPERIMENTAL PROCEDURE

THE contractions of the empty stomach in dogs were recorded by means of a bromoform manometer connected with a delicate rubber balloon in the stomach. The balloon was introduced into the stomach either through a gastric fistula or through the esophagus. We were surprised to learn the ease with which a small rubber balloon and rubber tube attachment can be passed through the esophagus into the stomach in dogs. If gentle dogs are selected for the work and the dogs are handled gently, they make little or no resistance after the first two or three experiments. I have never observed vomiting or gagging in dogs as a result of the introduction or the presence of the stomach tube in the esophagus. On the contrary, the dog with the rubber tube and balloon in the stomach and esophagus will lie quietly for hours in the lap of an attendant, while the tonus and movements of the empty stomach are being registered on the kymograph. Frequently the dog will go to sleep during the experiments. This is especially the case if the dog is covered up with a coat or a comforter. The tube in the esophagus does not cause distress or inhibition of the stomach movements.

Most of the observations were made on dogs with a fistula in the fundus of the stomach. In our first dog we made use of

the classical silver cannula. In all the other dogs we discarded the metal cannula and adopted the method followed in human gastric fistula cases. The incision (3-4 cm. in length) is made 3 cm. below the last rib and 5-6 cm. to the left of the linea alba. The oblique and transverse muscles are carefully separated without cutting them. The desired region of the gastric fundus is pulled out through this opening. The peritoneum is sutured to the fundus pouch. The abdominal muscles are similarly sutured to the pouch. In making these sutures care is taken not to penetrate deeper than the muscle layers of the pouch. The apex of the fundus pouch is then slit open, and the edges sutured to the edges of the skin. A closed rubber tube of 1 cm. in diameter is passed through the opening into the stomach and kept in place for four days. Then the tube and dressing are removed. It is found that the abdominal muscles compress this narrow pouch to such an extent that there is virtually no leakage from the stomach, much less leakage in fact than even in the most successful fistula using the metal cannula. There is no trouble in way of closing up of the fistula as long as the animal is being used two or three times a week. The dog takes care of the slight leakage, so there is no corrosion of the skin. We have dogs now in the laboratory with such fistula of six months' standing, and the dogs are in the best of condition. In fact, it is obvious that this fistula leaves the stomach much more normal than does the silver cannula method. We have obtained normal hunger contractions of the empty stomach thirty-six to forty-eight hours after making the fistula. Nothing like normal hunger contractions is seen in the stomach for six to ten days after making the fistula by means of the metal tube.

The splanchnic nerves were sectioned through an incision in the linea alba. The splanchnic nerves on both sides were therefore cut in one operation.

The vagi nerves were sectioned in the chest. We found the following method most serviceable. The incision (5 cm. in length) is made on the left side between the eighth and ninth ribs and well toward the back. The intercostal muscles are cut midway between the two ribs leaving the pleura exposed for a

distance of 5 cm. All this can be done with practically no bleeding. The pleura is then sectioned, the esophagus with the adjoining vagi hooked up by an aneurism needle, pulled up to the chest opening, and the vagi sectioned 3-5 cm. above the diaphragm. This can be done and the chest closed in less than three minutes, so that artificial respiration (by means of a tracheal tube) is not necessary. It is best to use artificial respiration, however, as that diminishes the pneumo-thorax and in some cases there may be some delay in picking out the vagi. The animals make rapid and uneventful recovery.

In the beginning of this work the animals were kept suspended in comfortable hammocks during the observations on the gastric hunger movements. It soon became apparent, however, that any kind of mechanical restraint on a young, vigorous and very hungry dog causes restlessness and evident distress, especially when continued for hours. Training will overcome this in part, but not completely. Distress and restlessness will obviously interfere with the stomach movements. We therefore tried the expedient of having an attendant keep the dog snugly in his lap during the observation period. This proved very satisfactory, except for the attendant. It is irksome, to say the least, to sit still for two to eight hours at a stretch. We can appreciate the reason for the dog's restlessness when restrained mechanically in a hammock or on a couch for that length of time. When the attendant knows how to handle dogs even a very hungry dog will lie in his lap quietly for hours, and will usually cuddle up and go to sleep. After a few experiments most dogs seek the research room by preference, and jump into the attendant's lap voluntarily. Two dogs became so well trained that they would lie quietly on a pillow for two or three hours at a time without any restraint whatever. It is obvious that mental stress and restlessness interferes with the stomach contractions not only in the way of direct inhibition but also by the varying tonus and irregular contractions of the abdominal muscles.

The animals used in these experiments were mostly young and vigorous females.

II. RESULTS

1. *The character of the motor activities of the empty stomach*

The contractions of the empty stomach, as registered by means of a delicate balloon in the fundus, fall into three types according to the degree of tonus of the stomach.

Type I. — When the stomach shows feeble tonus the hunger contractions show an average duration of about thirty seconds,

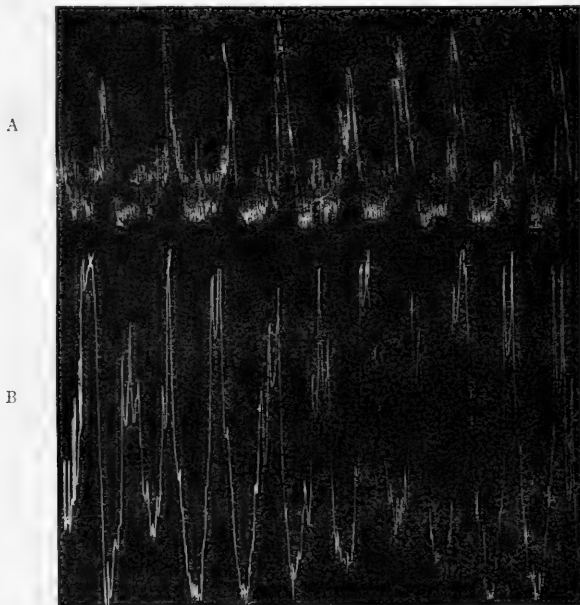

FIGURE 1. (One half the original size.) Tracings from the empty stomach (fundus) of dogs. Bromoform manometer. *A*, slow and feeble hunger contractions of Type I; *B*, rapid and vigorous hunger contractions of Type II.

and the intervals between the contractions vary from half a minute to three or four minutes. This type of contractions usually falls into groups, separated by intervals of relative quiescence. The duration of the groups vary from half an hour to three hours, and the number of contractions in each group varies correspondingly. It is very rare that a contrac-

tion group of Type I ends in the tetanus so frequently observed in man (Mr. V.). The group usually begins with feeble contractions but of longer than average duration and relatively far apart, and the contractions become gradually stronger and the intervals shorter. The end of the group is usually characterized by contractions of gradually decreasing strength. A typical tracing illustrating this type of the hunger contractions is reproduced in Fig. 1A.

Type II. — When the stomach is in relatively strong tonus the hunger contractions follow one another in rapid succession,

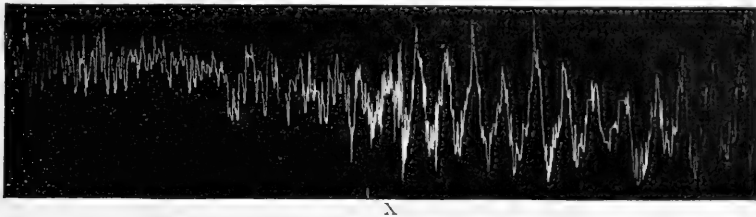

FIGURE 2. (One half the original size.) Record of hunger contractions of the empty stomach of dog. At X the gastric contractions change from Type III (incomplete tetanus or strong tonus) to Type II.

that is, without any intervening pause. The duration of the contractions varies between twenty and thirty seconds. These contractions are frequently interrupted by periods of incomplete tetanus lasting from one to five minutes. These periods of tetanus are practically identical with those previously described in man. The contractions of this type do not fall into distinct groups. They may vary to some extent in amplitude and rate, but otherwise may be continuous for an observation period lasting from two to six hours. If the animal becomes restless during the observation period the hunger contractions become irregular and may cease altogether, but this is probably due to splanchnic inhibition, and cannot be regarded as a spontaneous cessation of the hunger contractions.

This type of hunger contractions seems to be present only in young and vigorous individuals in excellent physical condition. Similar contractions were observed in our man, but less frequently than in our young and vigorous dogs. From obser-

vations on Mr. V. it is certain that the hunger sensation is practically continuous during these contractions. A tracing illustrating this type of the hunger contractions is reproduced in Fig. 1B.

Type III. — The hunger contractions designated as Type III constitute virtually an incomplete tetanus of the stomach. This tetanus is characterized by periods of strong and relatively persistent tonus on which are superimposed a series of rapid contractions. The duration of these rapid contractions averages twelve to fifteen seconds. These contractions are evidently analogous to the twenty seconds rhythm in man (Mr. V.). These tetanus periods vary in length from one minute to ten minutes. In prolonged starvation they may last much longer. In moderate hunger they are interspersed between groups of the Type II rhythm as shown in Fig. 3.

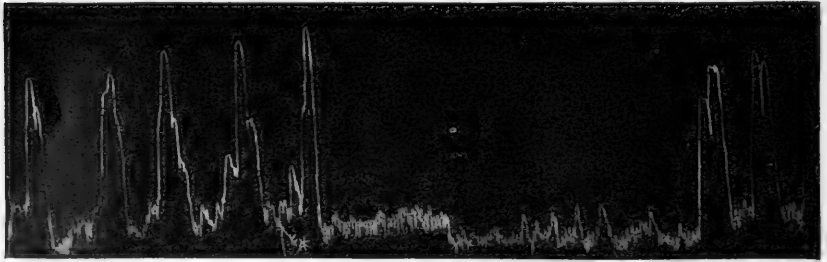

FIGURE 3. (Four fifths the original size.) Record of hunger contractions of the empty stomach of dog. At x dog allowed to see and smell meat. Showing inhibition of the hunger contractions through the splanchnic nerves.

This description of the gastric hunger contractions in dogs is based on observations on twenty-four individuals. The shortest observation period on each animal was two weeks, the longest five months with records taken, on the whole, every third day. The data should therefore be typical. The three types of contractions may be observed in the same dog on different days, or Type I may obtain for a few days, and then be superseded by Type II, etc. As a general rule Type I predominated in some of the dogs, and Types II and III in others. Some of the tracings also disclose what may be termed *transition stages*. Thus, near the end of a contraction period of

Type I the rapidity of the contraction may approach that of Type II, and occasionally the individual contractions of Type II will for short periods slow up to such an extent that they parallel Type I. This is to be expected, since the types of the hunger contractions seem to vary with the degree of gastric tonus, and this tonus may vary considerably during a single observation period. It is also to be noted that the hunger contractions may occasionally be feeble, irregular or practically absent for at least two to four hours at a time in dogs that are *seemingly* in good condition. And this is always the case if the dogs are in poor condition from any cause. One of the dogs developed pneumonia (fatal), and three of the dogs serious nose and eye infections. The dog in pneumonia showed an hypotonic stomach and complete absence of the hunger contractions. The dogs with the nose and eye infections showed very feeble and irregular hunger contractions during the period of infection.

The credit of discovery of the rhythmical contractions of the empty stomach in dogs belongs to Boldireff, but Boldireff's account of this rhythm is incomplete and partly misleading. According to Boldireff the contractions always come in groups of twenty to thirty minutes duration, and during the one and one half to two and one half hours intervals between these groups the stomach is completely quiescent. The contractions observed by Boldireff were evidently short and feeble periods of the Type I contractions, but the duration of the interval between the contractions given by Boldireff is on the whole much greater than that shown in my series. Boldireff evidently never obtained the Types II and III rhythm in his animals. The difference in the results of Boldireff and our own are probably due to (1) the condition of the animals, (2) the method of handling the animals, and (3) the method of registering the stomach contractions. Boldireff used the classical silver cannula for the gastric fistula. This depresses the stomach. All of his dogs had in addition to the gastric fistula (fundus) also duodenal, pyloric, pancreatic or hepatic fistulae. His dogs were therefore subjected to much greater disturbance of digestion and metabolism than is the case of a simple fistula of the fundus as prepared by me. The dogs not being in the best of

condition, it is not surprising that they showed only feeble rhythm of Type I. But it seems likely that forcing the dogs by mechanical means to lie or stand in one position for six to twelve hours at a time is also partly responsible for the brevity of the contraction periods and the length of the intervening periods of quiescence. It is my experience when dogs thus treated become restless, and restlessness always is accompanied by gastric inhibition, probably through the splanchnics. When the dog is allowed to make himself comfortable in the lap of an attendant he lies quietly and usually without any restraint. This condition is certainly more nearly normal.

The tracings published by Boldireff do not show the respiratory intragastric pressures, nor do they indicate the slightest variations of the gastric tonus during the observation periods. His method of registration was therefore not delicate enough to detect small variations in the intragastric pressure. It would seem, however, that his method ought to have recorded the Type II contractions, if they had been present in his dogs.

2. *Reflex or Psychic Inhibition of the Hunger Contractions*

Anything which interests, annoys, frightens, or angers the dog causes temporary inhibition of the hunger contractions (Fig. 4B). Cerebral processes of pleasant character such as the entrance of a friend (animal keeper) into the room cause almost as marked inhibition as fear or anger. Pain seems to cause the most pronounced and lasting inhibition, but the *hunger pain* itself is an exception.

Particular attention was given to the influence on the hunger contractions of seeing and smelling palatable foods. It was noted in a previous communication that seeing and smelling palatable foods when hungry did not seem to affect the gastric hunger contractions in our man V. Neither did the sight or smell of food induce contractions in the quiescent stomach. *In dogs the sight and smell of food leads to temporary inhibition of the hunger contractions, and the inhibition is directly proportional to the degree of interest taken in the food.* This is a true reflex or psychic inhibition, because it appears too quickly and is too

temporary to be an acid inhibition (psychic secretion of gastric juice) from the stomach mucosa. The inhibition from the sight and smell of food is most marked during the first few tests in each dog. Most dogs soon learn that they are not to be allowed to eat the food. Dogs thus "sophisticated" pay little or no attention to the food shown them, no matter how intense the hunger contractions, and when this is the case the sight and smell of food does not influence the hunger contractions. This particular inhibition is therefore of the type of "conditioned"

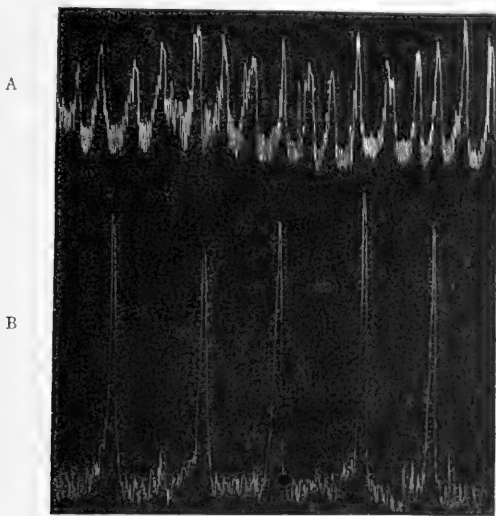

FIGURE 4. (One half the original size.) Typical records of the gastric hunger contractions of dogs with section of the splanchnic nerves (*A*) and the vagi nerves (*B*).

reflexes (Pawlow) similar to the "psychic" secretion of gastric juice on seeing and smelling palatable food. These reflexes not only require the presence of hunger and appetite processes, but also a certain fixation of the attention on the foods, and this is apparently not possible when the dog knows that he is merely being teased with the food.

In a few instances the sight and smell of food seemed to induce a few contractions in the quiescent stomach. This is, indeed, the reaction that I expected to find to the sight and smell of food. Some such cases have also been observed in our

man V. It seems that we have the nervous mechanism for such a reaction in the motor or tonus fibres of the vagi. But since this motor effect on the stomach is so rare and transitory I hesitate to conclude that the motor neurones to the stomach via the vagi can be stimulated by the sight and smell of palatable foods. I am rather inclined to think that the few exceptions to the usual inhibitory reflex are coincidences. Few irregular contractions are frequently seen during the period of relative quiescence of the stomach. In the dogs another source of error appears in the sniffing, the altered respiration, and the altered tension on the abdominal muscles, when food is smelled or seen. All these changes affect the intragastric pressure. In our man V. a few forced respiratory movements induces a strong contraction even in the quiescent stomach, probably through associated tonus innervation via the vagi.

The mechanism of the reflex or psychic inhibition of the hunger contractions described above have now been partly determined. When the splanchnic nerves are cut on both sides, these inhibitions are greatly diminished and frequently absent. The main efferent path is therefore via these nerves, either through inhibitory fibres to the stomach wall or through the secretory fibres to the adrenal glands causing hypersecretion of adrenalin. The inhibition appears too quickly to be initiated by adrenalin, but the latter may be a contributory factor. The slight degree of inhibition that may be obtained after section of the splanchnic nerves must come about either through impulses through the few inhibitory fibres in the vagi acting on the stomach wall, or (more likely) through inhibition of the vagus tonus; that is, a central inhibition.

When this phase of the work was outlined the possibility was recognized that section of the splanchnics may change the above inhibition to stimulation, by eliminating the bulk of the inhibitory nerve fibres to the stomach. I anticipated that after the section of the splanchnics the sight and smell of food would initiate or augment the gastric hunger contractions by increasing the vagus tonus. But I failed completely to substantiate this hypothesis. The gastric tonus mechanism via the vagi is there and unimpeded by inhibition via the splanchnic

nerves, but the quality and quantity of the afferent nervous impulse so far tested seem to act on this tonus mechanism only in the way of inhibition.

It has been shown in our man V. that the stimulation of nerve endings of taste and general sensibility to the mouth cavity causes temporary inhibition of the gastric hunger contractions. Even the chewing of palatable food inhibits the contractions. While the experiments on Mr. V. are conclusive for man, I attempted to repeat the tests on dogs, as I surmise that these inhibitions from the mouth cavity are characteristic for the whole vertebrate series. This phase of the work on dogs did not yield satisfactory results. To be sure, stimulation of nerve endings in the mouth by gustatory substances and the chewing of palatable food leads to temporary inhibition of the hunger contractions of the stomach in our dogs. But these measures also cause salivation, swallowing movements, restlessness, and struggling. We have seen that the mere sight and smell of food suffices to cause inhibition. Swallowing causes temporary inhibition, and this is invariably the case with restlessness and struggling caused by discomfort, displeasure, or anger, or anything of unusual interest. All these factors are easily controlled in man, but they cannot be controlled in dogs.

3. The Influence of Sleep on the Gastric Hunger Contractions

It was hoped that the gastric hunger contractions during sleep would shed some light on the question of central innervation (via the vagi) of these contractions, as the condition of sleep seems to involve diminished activity of the cerebrospinal system. Lombard showed that even the light sleep of few minutes duration in the middle of the day depressed or abolished the knee reflex. I have studied the gastric hunger movements during similar short periods of light sleep in our man V., the man going to sleep in the course of an experiment while reclining in an easy chair or lying on a couch. In no case did I observe any effect of these periods of sleep on the intensity or rate of the hunger contractions. These contractions invariably continued as if not influenced by the change in the

central nervous system accompanying sleep. These short periods of sleep so far studied probably never reached the degree of central depression that is characteristic of the normal and uninterrupted sleep during the night. I have not yet succeeded in observing the hunger contractions in Mr. V. during a normal night sleep, for the reason that the substitution of the rubber balloon for the six o'clock dinner does not seem to be conducive to sleep, in his case.

When a dog is lying comfortably in the lap of an attendant, and is covered up with a gown or a comforter, he frequently goes to sleep for periods varying from a few minutes to an hour or more, provided the hunger contractions are not too intense, and the room is kept fairly quiet. These periods of sleep are characterized by the usual change in respiration, pulse, and muscular tonus, and not infrequently by snoring. During these periods of sleep the gastric hunger movements persist unchanged both as regards rate and intensity. In case the dogs are restless or disturbed in some way before going to sleep the hunger contractions usually become stronger and more regular during the sleep. This is obviously due, not to an increased tonus innervation through the vagi, but to the cessation of inhibition processes through the splanchnics. If very strong hunger contractions appear during the sleep the dogs invariably become restless, even to the point of "moaning" in their sleep, and usually wake up. The waking up always causes a temporary inhibition of the hunger contractions. On waking up during a period of relative quiescence of the empty stomach the action of stretching and the increased tonus of the skeletal muscles is frequently accompanied by what appears to be a temporary increase in the gastric tonus, and sometimes even a few hunger contractions. This may be an instance of associated tonus innervation through the vagi, but the mechanical effects on the stomach of the increased tonus of the abdominal muscles must also be taken into account, and eliminated through section of the vagi. It may be noted in this connection that our man V. never has gone to sleep during the experiment at the period when the hunger contractions were moderately strong or very intense.

It is admitted that the above observations on man and dogs probably do not include the state of deepest possible normal sleep. But the results show that light sleep has no effect on the rate and intensity of the gastric hunger contractions, except in the way of removal of extrinsic inhibitory influences via the splanchnic nerves. If the gastric hunger contractions are initiated or augmented by tonus impulses through the vagi this central tonus mechanism is not materially influenced by the change involved in light sleep.

On the other hand, the gastric hunger contractions of the empty stomach do affect the sleep. It is a common experience that the healthy individual experiences difficulty in going to sleep and sleeps less soundly on an empty stomach, provided he is not extremely fatigued, when we probably have to do with a direct depression of the stomach by fatigue substances in the blood. The dog is actually aroused from his sleep by the intense hunger contractions of the stomach. It is highly probable that this also occurs in man, especially in infants and in young and vigorous individuals. This is due to action on the vaso-motor centres and on the reflex centres in general by the afferent impulses from the walls of the contracting stomach. Whether or not an individual is awakened from his sleep by the gastric hunger contractions is simply a matter of the algebraic sum of the intensity of the hunger contractions and the intensity of the sleep.

The origin of the afferent impulses that cause the hunger sensation has been demonstrated to be in the walls of the stomach. But in case any person should want additional proofs, it may be pointed out that the above observations furnish additional evidence that the sensation or consciousness of hunger does not originate the gastric hunger contractions, since these contractions go on unchanged during sleep. This conclusion may be objected to on the ground that our man V. as well as our dogs might have been *dreaming* of hunger, food, etc., during these periods of sleep. In the case of Mr. V. there were no such dreams, at least none that he could recall when questioned immediately after he woke up. And as for the dogs, we have as yet no means of finding out, except by sectioning

the vagi. The gastric hunger contractions do persist after isolation of the stomach from the central nervous system. But it is not unlikely that a person awakened from his sleep by strong hunger contractions of the stomach will dream of hunger, food, etc., during the process of regaining full consciousness.

4. *The Influence on the Gastric Hunger Contractions of Isolation of Stomach from the Central Nervous System*

(1) **Complete Section of the Splanchnic Nerves.** — Observations have been made on five dogs with complete section of the splanchnic nerves on both sides. The longest period of observation after the splanchnic section was two months. Observations were in some cases begun two hours after the operation. When the records of these five dogs are viewed as a whole, it is clear that the *complete section of the splanchnic nerves in dogs increases the gastric tonus and augments the gastric hunger contractions* (Fig. 5A). The hunger contractions become more rapid and more continuous, that is, there is less evidence of the periodic groups with intervening periods of relative quiescence. It is not uncommon to observe contractions at the rate of about two per minute during an entire observation period of two to four hours. The section of the splanchnic nerves does not abolish the periodicity completely, however. It seems to be a question of relative degree of gastric tonus. If for any reason the tonus of the empty stomach is relatively low on any day, the hunger contractions are less frequent, and there is greater evidence of periods of relative quiescence. We desire to emphasize the fact that the above conclusion is based on the observations as a whole. Even the dogs with the splanchnic nerves sectioned showed on some days no greater tonus of the empty stomach or greater rate and persistence of the gastric hunger contractions than does the dog with these nerves intact. And occasionally a dog with the splanchnic nerves intact exhibits as great a degree of gastric tonus and rate and persistence of the gastric hunger contractions as the maximum observed in dogs with the splanchnic nerves cut. This is to be expected, as by section of these nerves one eliminates only one (and in

the normal animal probably one of the least important) of the factors in the motor activity of the empty stomach. The conditions that effect the stomach through the blood, and through the vagi are still subject to the same variations as in the animal with the splanchnic nerves intact.

After complete section of the splanchnic nerves the psychic or reflex inhibition of the gastric hunger contractions already described is greatly diminished. The stimuli that cause anger,

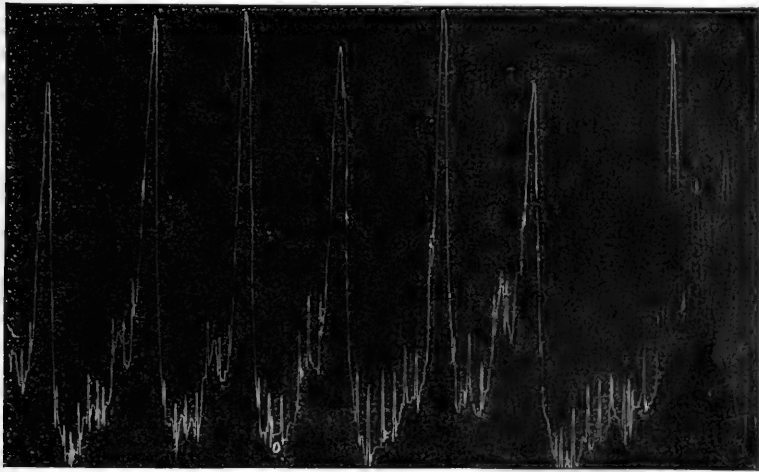

FIGURE 5. (Two thirds the original size.) Record of exceptionally vigorous hunger contractions of the empty stomach of dog thirty days after complete section of the vagi and the splanchnic nerves (isolation of the stomach from the central nervous system). This record was taken on the fifth day of starvation.

fear, pain, joy, or pleasure no longer lead to complete cessation of the hunger contractions. The maximum effect is a slight and transitory weakening of the contractions. It is therefore evident that the inhibitory fibres in the splanchnic nerves (and possibly also the secretory fibres to the adrenals) constitute the main efferent path in this type of inhibition. The slight degree of inhibition usually in evidence after section of the splanchnic nerves must be due to central inhibition of the vagus tonus or to action of the few inhibitory fibres in the vagi.

Particular attention was given to the effect of seeing and smelling food on the hunger contractions in these dogs with

section of the splanchnic nerves, in order to determine whether these stimuli augment the tonus of the vagi and thus increase the hunger contractions. The results were negative. Even with the greater part of the extrinsic inhibitory fibres to the stomach eliminated, the sight, smell, and taste of food not only fails to initiate or augment the gastric hunger contractions, but so far as these stimuli affect the stomach at all it is in the direction of inhibition of the hunger movements. The apparent increase in the intensity of the hunger pangs in man on seeing or smelling palatable food must therefore be essentially a central phenomenon of facilitation or *Bahnung*.

(2) **The Section of the Vagi.** — Section of both vagi in the chest was made in three dogs, and after this operation observations on the gastric hunger contractions were continued for from two weeks to three months. Observations were in some cases made two hours after the vagi section.

Section of the vagi leaves the empty stomach on the whole permanently hypotonic, that is, at least for a period of up to three months after the operation. The tonus of the empty stomach in these dogs varies somewhat from day to day, and occasionally the tonus may approach that of a dog with the vagi intact, but on the whole the tonus is permanently much lower than normal. This is evident not only from the observations by means of the balloon in the gastric cavity, but also on direct inspection and by palpation (introducing the finger through the fistula).

The hunger contractions of the empty stomach are changed mainly in rate and regularity. The duration of each individual contraction is about normal, or on the whole less than normal. The long-drawn-out contractions or tetanus are rarely seen. But the intervals between the contractions vary on the whole from two to five minutes or even up to eight minutes. The strength or rather the amplitude of the individual contractions may appear greater than normal, evidently because the contractions start rather suddenly and without any marked preliminary increase in tonus, and the maximal contractions are evidently so complete that all the air is forced out of the balloon. These contractions may continue of fairly uniform

amplitude and rate for two to three hours, that is, during a whole observation period. (Fig. 5.) The contractions vary in strength and rate from day to day, and on some days they may be completely absent during the entire observation period (two to four hours).

The periodicity of the hunger rhythm is, on the whole, obscured, except on the days when the gastric tonus approaches that in normal dogs. On such days the contractions appear at shorter intervals, and tend to fall into groups similar to those in normal dogs. Periods of gastric hunger contractions of normal rate and intensity have been observed as early as twelve hours after the complete section of the vagi in the chest. The period of most powerful hunger contractions so far observed in any dog was recorded in one dog twenty-four hours after the vagi section. This dog had during the four weeks preceding the vagi section showed almost invariably the Type II rhythm. It was therefore a dog with unusual intense gastric motor activity. The complete section of the vagi causes on the whole less depression in dogs that exhibit great hunger contractions while the vagi are intact. The variations in the rate and intensity of the gastric hunger contractions in different dogs is therefore primarily due to individual variations in the condition of the stomach rather than to variations in the central innervation or the central inhibition.

In the dogs with the vagi sectioned, but the splanchnic nerves intact, the "psychic" or reflex inhibition of the gastric hunger contractions is still in evidence, but the inhibition appears not to be so marked as when the vagi are intact. Accurate comparisons are, however, difficult to make because of the lowered tonus, and the usual long intervals between the hunger contractions after section of the vagi. I had expected an augmentation of the inhibition through the splanchnics after the vagi section. Instead of finding this to be the case there actually appeared a *gradual diminution in the influence of the splanchnic nerves on the empty stomach in the dog observed for three months after section of the vagi*. It was not due to the regeneration of the vagi fibres, and consequent restoration of the vagus tonus. If further work should establish this as a

fact, we would have a significant instance of physiological readjustment — either an actual diminution in the inhibitory impulses through the splanchnics in consequence of a dynamic readjustment in the central nervous system, or else an increased resistance (“tolerance”) to the splanchnic impulses on the part of gastric motor mechanism.

5. *Section of both Splanchnic and both Vagi Nerves*

Complete section of the splanchnic and the vagi nerves were made on four dogs, and observations made on the gastric hunger contractions for thirty to sixty days after the observation. The section of the splanchnic nerves were made seven days after the section of the vagi. After this complete isolation of the dogs' stomach from the central nervous system, there is practically a permanent hypotonus of the stomach except under conditions of prolonged starvation. The gastric hunger contractions are much the same as when the vagi alone are severed. The contractions are usually of great amplitude, but the intervals between the contractions are frequently longer than in normal dogs. The grouping of the contractions into periods is usually in evidence. These contractions of the isolated and empty stomach are present ten to twenty hours after the vagi section, and there is some improvement in the rhythm or an approach towards the normal tonus and contraction rate during the thirty to sixty days of observation. On the whole the hunger contractions of the isolated stomach conforms to Type I. The Type II is rare except during prolonged starvation. Short periods (two to three minutes) of incomplete tetanus are frequently seen especially during prolonged starvation, and during the first half of the hunger period. It is therefore clear that *all the essential characteristics of the hunger contractions of the empty stomach are determined by the local gastric motor mechanisms* rather than by the character of the central innervation or the central inhibition.

Cannon¹ has reported observations on the effects of vagi and splanchnic section on the gastric movements of digestion

¹ CANNON: This journal, 1906, xvii, p. 429.

in cats. Section of the splanchnic nerves did not affect the movements of digestion; section of the vagi caused slowing and weakening of the peristalsis of digestion, but the normal rate of peristalsis was practically restored in a few days. Combined vagi and splanchnic section left the digestion movements of the stomach practically normal even shortly after the operation. It seems that section of the vagi or complete section of the vagi and the splanchnic nerves in dogs cause on the whole a greater change in the movements of the empty stomach than does the same lesion in cats in case of the movements of the

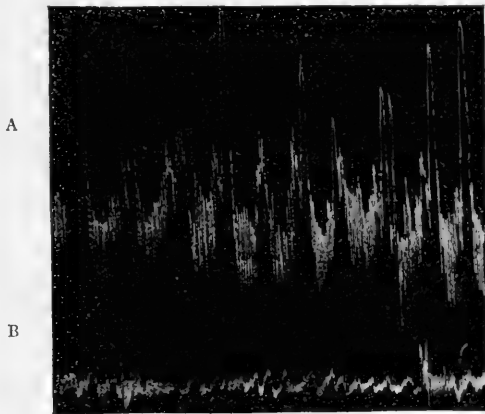

FIGURE 6. (One half the original size.) Tracings from the empty stomach of dog *A*, dog normal and showing normal hunger contractions; *B*, after dog developed pneumonia, showing complete absence of the hunger contractions.

filled stomach. This probably means that the tonus of the vagi plays a greater rôle in the movements of the empty than in the movements of the filled stomach. For it is not likely that there is such marked difference in the relative importance of the vagi in cats and dogs.

The changes in the character of the gastric hunger contractions after isolation of the stomach from the central nervous system seem primarily due to the persistent hypotonus. This is indicated by the fact that on days when the stomach of a normal dog shows relatively slight tonus, the hunger contractions approach the type shown by the isolated stomach, and

on days when the isolated stomach exhibits tonus approaching that in normal dogs the hunger contractions tend to assume the normal type. Occasionally records are obtained from the empty and isolated stomach that practically demonstrate the above point. During a period of relatively slow hunger rhythm the tonus for some unknown reason may increase markedly for periods of varying length *and during these periods the hunger contractions are identical in rate and character with those of the intact stomach in normal (strong) tonus.* In one of the dogs with the vagi and splanchnic nerves sectioned, six days fasting led to the appearance of periods of very great gastric tonus and during these periods (virtually periods of incomplete tetanus) the gastric contractions assumed the form of Type III.

However, the details of the changes in the hunger rhythm after isolation of the stomach from the central nervous system seem of minor importance in this connection. The essential point is that *since the empty stomach completely isolated from the central nervous system does exhibit the typical hunger contractions, the primary stimulus to these contractions is not to be sought in the extrinsic nerves.* This type of activity is characteristic of the empty stomach and primarily independent of the central nervous system. We do not mean to deny that under certain conditions the tonus fibres in the vagi may inaugurate or intensify the gastric hunger movements. But it seems likely that *under normal conditions the essential rôle of the vagi and the splanchnic nerves in connection with the gastric hunger contractions is that of modifying or regulating a primarily automatic mechanism in the stomach wall.* Further analysis of the hunger mechanism must be directed primarily to the intrinsic neuromuscular apparatus of the stomach, and secondarily to the factors that control the vagus tonus.

CONTRIBUTIONS TO THE PHYSIOLOGY OF THE STOMACH

VII. THE INHIBITORY REFLEXES FROM THE GASTRIC MUCOSA

BY A. J. CARLSON

[From the Hull Physiological Laboratory of the University of Chicago]

I. THE PROBLEM

IT has been shown by experiments on man (Mr. V.) that weak acids (including normal gastric juice) and alkalis, alcoholic beverages (wines, brandy, beer), coffee, tea, and even water acting on the gastric mucosa inhibit the gastric tonus and the gastric hunger contractions.¹ This inhibition is initiated by stimulation of nerve endings in the gastric mucosa, and not by mechanical tension or pressure on the stomach wall. The work on man led to the conclusion that any substance capable of stimulating the nerve endings in the gastric mucosa causes inhibition of the tonus and the hunger contractions, and inhibition only, as there was no evidence of any increase in the gastric tonus or hunger contractions following the primary inhibition.

The possibility that these inhibitory phenomena in man are in reality psychic inhibitions (consciousness of being subjected to experimentation) and hence not initiated by the stimulation of nerves in the gastric mucosa was considered. The following facts seemed to speak against the hypothesis of central or psychic inhibition. (1) The inhibition is proportional to the quantity and concentration of the material introduced into the stomach, and frequently Mr. V. did not know either the nature or the amount of the substance introduced. (2) The inhibition appears even when Mr. V. himself puts the wine or beer of his own

¹ CARLSON: This journal, 1913, xxxii, p. 245.

choice into the stomach. (3) Mr. V. was at no time impatient or displeased with the experiments so far as I could determine. (4) These substances produce identical inhibitions when put directly into the stomach of dogs (awake or asleep). (5) The inhibitions are in evidence after isolation of the stomach from the central nervous system by section of the vagi and the splanchnic nerves. The present paper deals with the character of this inhibition in dogs and the modification of the inhibition following section of the splanchnic and the vagi nerves. For an account of the special technique and experimental procedure in this work the reader is referred to the previous reports.² It will suffice to state that liquids were introduced into the stomach through the fistula by means of a soft rubber tube so that swallowing acts, and the stimulation of nerve endings in the mouth, the pharynx, and the esophagus were completely eliminated. These tests on dogs are thus parallel to those on Mr. V.

II. THE ACTION OF WATER, ACIDS, ALKALIES, AND ALCOHOLIC BEVERAGES

The observations were made on six dogs with all the extrinsic gastric nerves intact, on six dogs with the splanchnic nerves cut; and on four dogs with complete section both of the vagi and the splanchnic nerves. The results on the normal dogs are practically identical with those on Mr. V. already reported. Gastric juice (human, canine), weak acids and alkalies, brandy, wines, and beer introduced directly into the empty stomach during hunger contractions produce immediate inhibition of the gastric tonus and contractions. The duration of the inhibition depends upon the quantity of the material introduced into the stomach and on the degree of the hunger contractions. Thus the same quantity of gastric juice or wine seems to cause more prolonged inhibition in dogs showing the "type I" than in the dogs showing "type III" hunger rhythms. The duration of these inhibitions can best be studied in the dogs showing the type II and III hunger contractions, as these two forms are practically con-

² CARLSON: This journal, xxxii, p. 369.

tinuous, so that the errors from spontaneous periods of relative quiescence are eliminated. In normal dogs showing type II and III contractions, 25 cc. gastric juice or 0.5% HCl usually causes complete inhibition for 20 to 30 minutes. The return of the hunger contractions is always gradual. 25 cc. of beer will inhibit for 15 to 25 minutes. In one case 50 cc. of beer caused complete inhibition for one hour.

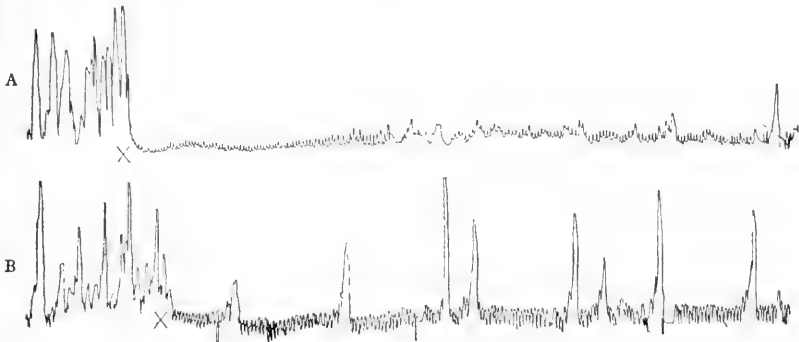

FIGURE 1. (One third the original size.) Tracings from empty stomach of dogs. *A*, normal dog; *B*, dog with both splanchnic nerves cut; *X*, introduction of 25 cc. 0.5% HCl into the stomach. Showing less complete inhibition of the hunger contractions by acid in the stomach after section of the splanchnic nerves.

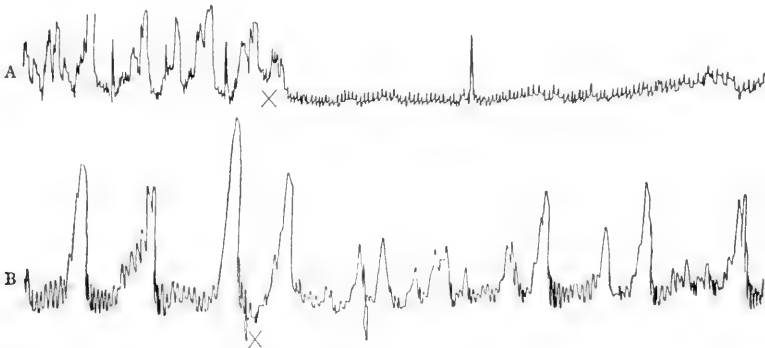

FIGURE 2. (One half the original size.) Tracings from the empty stomach of dogs. *A*, normal dog; *B*, dog with section of the vagi and the splanchnic nerves; *X*, introduction of 12 cc. of brandy + 12 cc. water into the stomach. Showing less complete inhibition by alcohol in the case of the stomach isolated from the central nervous system.

If these substances are introduced into the stomach of dogs during a period of relative quiescence and tonus relaxation the

only effect appears to be a still greater tonus relaxation and prolongation of the quiescent period. In some cases one or two hunger contractions follow immediately on introducing the material into the stomach. I am inclined to attribute these contractions to the mechanical distension of the stomach wall rather than to stimulation of nerve endings in the mucosa. This phenomenon was never observed when the stomach was in strong tonus and hunger contractions.

Typical tracings illustrating this inhibition of the gastric hunger contractions in normal dogs by acids, brandy, and beer are reproduced in Figs. 1(A) and 2(A).

III. THE ACTION OF CARBON DIOXIDE

The influence on the hunger contractions of CO_2 in the stomach cavity is the same in man and dog. The experiments on dogs were made with water saturated with CO_2 and with CO_2 gas. When the gas was employed, at times enough of it was passed into the stomach via the fistula to cause escape of the gas through the esophagus. The water saturated with CO_2 has practically the same action as ordinary water, that is a slight temporary inhibition without any after effect of the nature of increased tonus or contractions. This is true whether the carbonated water is introduced during active hunger contractions or during relative quiescence. The CO_2 gas usually initiates some contractions if introduced into the stomach during a period of quiescence. This is evidently due to mechanical distension of the stomach walls and not to chemical stimulation of nerve endings in the mucosa. If the empty stomach is in vigorous tonus and hunger contractions the CO_2 gas causes a slight temporary inhibition without any stimulating after effect. This temporary inhibition is in all probability due to a weak acid stimulation of the nerve endings in the mucosa.

IV. THE EFFECTS OF COMPLETE SECTION OF THE SPLANCHNIC NERVES

The inhibition of the gastric tonus and hunger contractions by acids, alkalies, alcohol, etc., in the stomach cavity persists after section of the splanchnic nerves, but it is on the whole less complete and of shorter duration than in dogs with all the extrinsic gastric nerves intact. This applies to all the substances used in this series of experiments. A pair of tracings illustrating this diminution of the acid inhibition from the stomach after section of the splanchnic nerves are given in Fig. 1. When, as in the present series, the test with each substance is repeated at least ten times on each animal, some variations in the intensity and duration of the inhibition appear. That is to be expected, because the degree of inhibition depends on several variable factors, such as the excitability of the nerve endings in mucosa, the excitability of the Auerbach plexus and of the central nervous system, the tonus of the stomach, etc. It is therefore true that the most pronounced inhibition observed after section of the splanchnic nerves may be as marked as the feeblest inhibition obtained in the normal dogs. But when all the results in the two series of dogs are compared, there is no question but that *section of both the splanchnic nerves diminishes the inhibition following stimulation of the gastric mucosa by acids, alkalies, alcohol, etc.*

Several explanations of this fact suggest themselves. (1) Since section of the splanchnic nerves in dogs increases on the whole the tonus and the hunger contractions of the empty stomach, the diminished inhibition may be due to this greater vigor of the stomach rather than to cutting the efferent path of a long reflex. I do not think that this is the main or important factor, because the typical marked inhibition is obtained in normal dogs even when the stomach shows as vigorous tonus and hunger contractions as the maximum shown by dogs with the splanchnic nerves severed. Moreover, the inhibition is still incomplete in splanchnetomized dogs that show relatively feeble hunger contractions ("type I").

(2) The substances stimulate afferent vagi nerve endings in the mucosa, and the afferent vagi impulses via conscious or subconscious centres finally stimulate the efferent inhibitory neurones in the splanchnic system. It is well known that the vagi carry afferent fibres from the stomach mucosa and that the splanchnic nerves carry inhibitory fibres to the stomach. The present experiments give the first intimation that the afferent vagus and the efferent splanchnic systems are so intimately associated in gastric motor reflexes. It is possible that the reflex also involves the adrenal glands, so that the above inhibition is to be accounted for, in part, by the depressor action of an increased output of epinephrin.

V. THE EFFECT OF SECTION OF THE VAGI NERVES AND OF THE VAGI AND THE SPLANCHNIC NERVES

When all the records are compared it appears that section of the vagi nerves alone or section of both the splanchnic and the vagi nerves diminishes the inhibitory reflex from the gastric cavity on the whole more than does the section of the splanchnic nerves alone. A fact of greater importance, however, is the persistence of the reflex after complete isolation of the stomach from the central nervous system. *The inhibition is therefore primarily a local reflex.* The increased diminution of the inhibition after the vagi section may involve two mechanisms. It is well known that the vagi contain some efferent inhibitory fibres to the stomach motor mechanism, and may be, together with the splanchnic inhibitory fibres, involved in the long inhibitory reflex. But since the gastric tonus fibres in the vagi and the gastric inhibitory fibres in the splanchnic nerves are practically antagonistic, it is highly probable that afferent impulses leading reflexly to the stimulation of the inhibitory neurones lead at the same time to the inhibition of the tonus or motor neurones.

The reader may object that we are now discussing inferences that do not necessarily follow from the facts so far at hand. The facts, in brief, are these. The inhibition of the tonus and the contractions of the empty stomach by stimulation of the

gastric mucosa persist after isolating the stomach from the central nervous system, but the inhibition is diminished in intensity and duration after section of the splanchnic nerves, and somewhat more so after section of the vagi nerves. It has been shown that section of the vagi leaves the stomach on the whole permanently hypotonic, except during prolonged starvation, although there seems to be a gradual improvement in the efficiency of the local tonus mechanism. Is it not possible that the lessened inhibition after the vagi lesion is due to a depression of the excitability of the local afferent nerve endings in the mucosa or depression of the local reflex centre similar to the tonus depression? Our experiments do not exclude this possibility, but the results on the dogs with only the splanchnic nerves severed

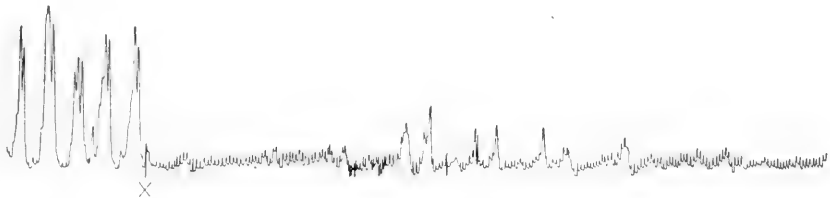

FIGURE 3. (One third the original size.) Tracing from the empty stomach of a dog six weeks after section of the vagi and the splanchnic nerves; X, introduction of 25 cc. port wine into the stomach. Showing a degree of alcohol inhibition almost as marked as in normal dog.

show conclusively that it is not the sole factor. For in these dogs there is no gastric hypotonus, and yet the inhibition from the gastric mucosa is diminished.

Another possibility has occurred to me. When the same quantity (25-50 cc.) of acids, alkalis, or alcoholic beverages is introduced into a stomach in tonus and into a stomach in hypotonus, it seems likely that the solutions will come in contact with more of the mucus membrane in the tonic than in the atonic stomach. This might result in less inhibition in the case of atonic stomach from the mere fact of stimulation of less of the afferent nervous mechanism. I have tested this possibility by introducing a greater quantity of the respective solutions in the hypotonic stomach. But if 25 cc. of acid or of beer fails to produce complete inhibition, 50 cc. of the same liquid usually also fails. This is to be noted, however, that the depression of

inhibition following splanchnic and vagi section is most marked for a week or two after these nerve lesions are made, and there is a distinct tendency to improvement in the efficiency of the local reflex *pari passu* with the improvement in the local tonus mechanism (Fig. 3). This is probably an instance of readjustment of local reflex mechanisms to a fair degree of efficiency in the absence of central tonus and accessory central long reflexes.

The experiments on Mr. V. and on normal dogs led to the conclusion that contractions of the empty stomach cannot be induced by stimulation of the gastric mucosa, that such stimula-

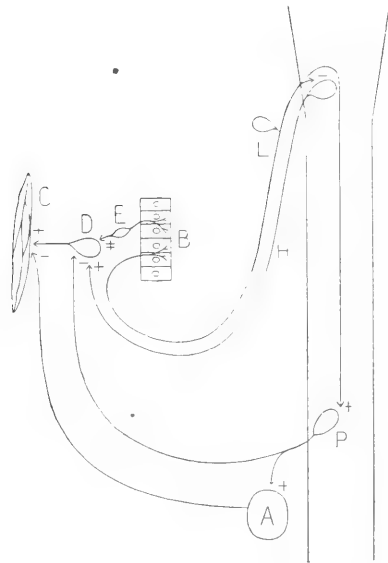

FIGURE 4. Diagram to represent the local and the long reflex mechanisms involved in the inhibition of the gastric tonus and the hunger contractions from stimulation of the gastric mucosa. *A*, adrenal gland; *B*, gastric mucosa; *C*, stomach musculature; *D*, Auerbach's plexus; *E*, local afferent neurones from the gastric mucosa to the Auerbach's plexus (these neurones are predominantly inhibitory); *H*, tonus or motor neurones to the stomach via the vagi; *L*, afferent neurones in the vagi from the gastric mucosa; *P*, neurones in the splanchnic nerves; + = stimulation; - = inhibition.

tion causes inhibition only. It was noted that one or two contractions occasionally follow immediately on the introduction of these liquids into the stomach, but it seemed probable that these contractions were due to the mechanical distension of the stomach

walls rather than to the chemical or mechanical stimulation of the nerve endings in the mucosa. These initial contractions following the introduction of acids, alkalies, or alcoholic beverages into the stomach occur more frequently in the hypotonic stomach isolated from the central nervous system. This is true even when special care is taken to introduce the substance slowly so as not to cause sudden distension of the stomach walls. I am not yet satisfied that this primary motor response is actually due to stimulation of nerve endings in the mucosa. If it is, there must be in the mucosa a few afferent nerve endings of the excitatory type, but the afferent inhibitory nerve endings are so much more numerous that the influence of the former group is completely submerged by the latter except occasionally when the stomach is hypotonic. Or else local afferent nerve endings in the mucosa are all of one type, but the type of reflex produced by this stimulation may depend in part on the tonus condition of the reflex centres (Auerbach plexus).

The local and long reflex mechanisms governing the tonus and the hunger contractions of the empty stomach demanded by the above work on dogs are diagrammatically represented in Fig. 4. It may be noted that this diagram is not intended to represent all the afferent gastric nerve components, such as those acting in various ways on consciousness, on the vaso-motor centres, etc. The adrenal glands are indicated simply as a possible factor, because conclusive data has not yet been obtained on that point.

THE TONUS AND HUNGER CONTRACTIONS OF
THE EMPTY STOMACH DURING
PARATHYROID TETANY

BY A. J. CARLSON

[From the Hull Physiological Laboratory of the University of Chicago]

THE X-ray method of investigation of the gastric movements of digestion in cats and dogs in parathyroid tetany failed to reveal tetany of the stomach and the intestines.¹ The gastric and intestinal movements of digestion may continue normal during severe tetany; and in so far as the tetany condition influences the movements of digestion of the stomach and intestines, this influence is in the direction of depression (slowing and weakening). It was also found that the gastric digestion is usually retarded by the parathyroid tetany condition.

These observations have now been extended to the empty stomach by the method of an inflated balloon in the stomach introduced through a fistula of the fundus. This permits the taking of continuous and accurate records of the motor condition of the stomach in dogs.²

The motor condition of the empty stomach in tetany is of special interest in connection with the problem of hunger, as animals in tetany show diminished desire for food in proportion to the severity of the tetany. Hunger is caused mainly by gastric contractions. If the condition of the parathyroid tetany of the skeletal muscles involved a parallel tetany of the musculature of the digestive tract one might even expect an increased hunger in tetany. The refusal of food by animals in tetany might be accounted for if the tetany leads to gastric hypotonus and absence of hunger contractions. There is a third possibility. The normal gastric hunger contractions may be

¹ CARLSON: This journal, 1912, xxx, p. 309.

² CARLSON: This journal, 1913, xxxii, p. 369.

present in tetany, but the impulses from the stomach may fail to give rise to the sensation of hunger because of the change (the tetany condition) in the central nervous system.

Observations have now been completed on three dogs. The dogs were observed every third day for two weeks, so as to secure the average normal gastric tonus and hunger contractions. Complete thyroid parathyroidectomy was then made. All three dogs ran a typical course of tetany of varying severity from day to day. Dog I died in tetany on the sixth day after the operation; Dogs II and III died in depression on the eighth and tenth days respectively.

The results of the observations on the relation of parathyroid tetany to the tonus and movements of the empty stomach were practically the same in the three dogs. *In this tetany there is depression of the tonus and contractions of the empty stomach parallel with the severity of the tetany, so that during extreme tetany the stomach is practically atonic and tonus contractions and hunger contractions are completely absent.*

The milder stages of the tetany (hyperexcitability of the motor nerves, slight tremors, twitchings, and some salivation) may coexist with considerable gastric tonus and hunger contractions, but the hunger contractions are always slower and weaker than normal.

It is well known that the course of parathyroid tetany, especially in dogs, is usually more or less periodic, the animal recovering spontaneously for periods varying from a few hours to a day or more between the tetany attacks. Dog II showed two such periods of spontaneous recovery of thirty-four and twenty hours duration. During these periods the gastric hunger contractions and the gastric tonus also returned to approximately normal conditions. A typical series of tracings from Dog II showing the parallel between the severity of the tetany and the degree of the depression of the motor activities of the empty stomach are reproduced in Fig. 1.

During what might be called the very beginning of the tetany symptoms following the operation in Dog I vigorous gastric hunger contractions were present and the contractions were on the whole of a longer duration than shown by this dog before

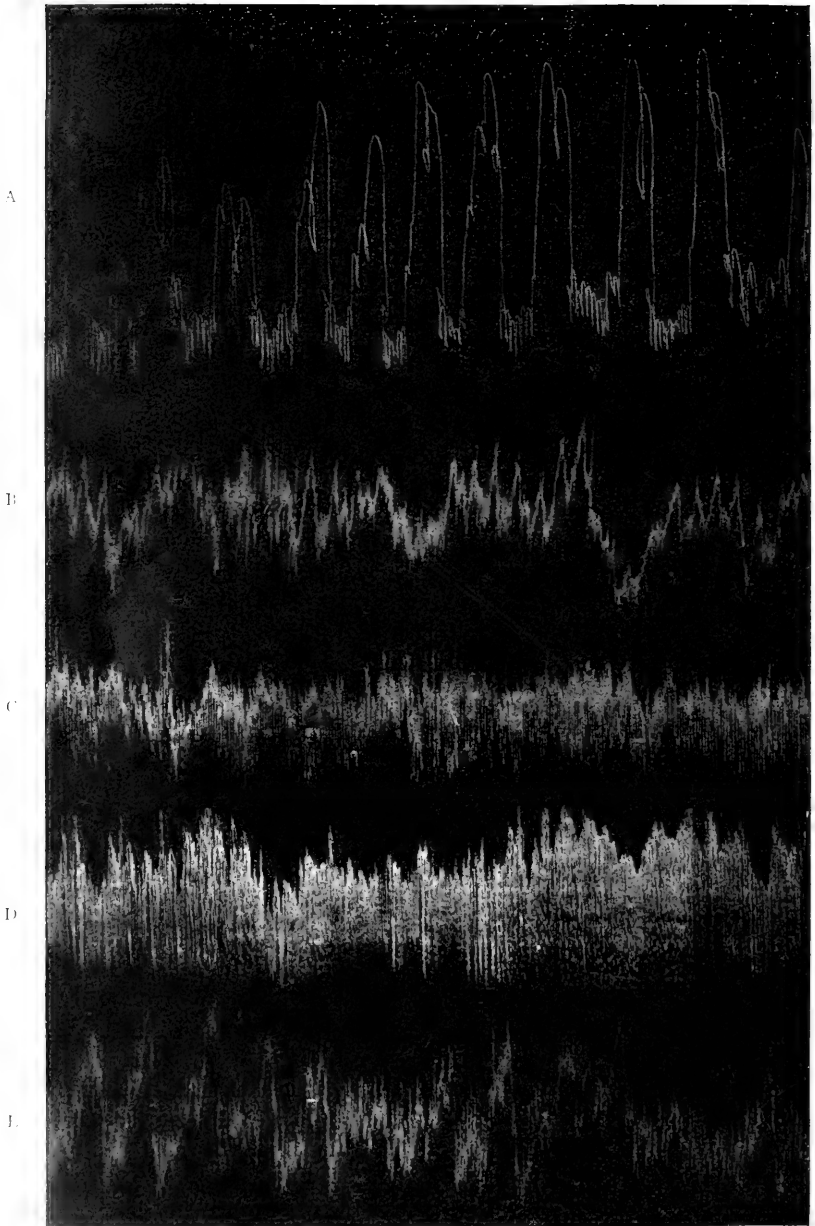

FIGURE 1

the operation. The intervals between the contractions were also relatively long. This type of contractions has been observed in normal dogs, so it is not specific for the tetany condition. Nor can the contractions be interpreted as gastric tetany. Nothing like the gastric tetany ("Type III")³ observed in normal animals (man and dog) especially in prolonged starvation was recorded in the tetany dogs at any stage of the tetany.

The relation of this depression of the gastric hunger contractions to the depression of the appetite is, nevertheless, not a direct one. During the mild stages of tetany the depression of the appetite is usually much greater than one would

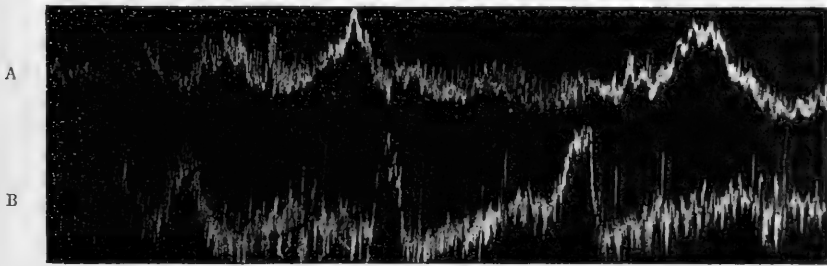

FIGURE 2

expect on the basis of the degree of depression of the hunger contractions. In strong to extreme tetany there are no gastric hunger contractions and the dogs show no appetite, but I was surprised to find that appetite may be entirely absent even though fairly strong hunger contractions are present in mild tetany, or if the dog shows some appetite the amount of food taken is very small. Thus Dog I ate only a few grams of meat at the time his stomach showed the hunger contractions of Fig. 2. The degree of hunger contractions shown in Fig. 1B and Fig. 2 is invariably associated with relatively great eagerness for food in normal dogs. It is therefore clear that the diminution or lack of appetite in tetany cannot be accounted for solely on the basis of depression of gastric hunger contractions, although this is unquestionably one of the factors. But

³ CARLSON: This journal, 1913, xxxii, p. 369.

we must also take into account either (1) a change in the central nervous system, or a (2) change in the character of the nervous impulses from the stomach.

On the whole it can be said that the condition of parathyroid tetany, in so far as it influences the stomach motor activities, depresses both the digestion movements of the filled and the hunger contractions of the empty stomach, but the movements of digestion show less depression than do the hunger contractions. Thus moderately strong tetany may leave the gastric digestion movements practically normal but completely inhibit the hunger contractions of the empty stomach. The tetany condition does not lead to increased motor activity or gastric tetany either in the empty or the filled stomach.

The cause of this depression of the gastric motor activities in parathyroid tetany is not determined. In the case of the digestion movements it was shown not to be due to splanchnic inhibition. This test has not been made in the case of the hunger movements. But one factor in the depression or complete inhibition of the hunger contraction in tetany is *the increased excitability of the nerve endings in the gastric mucosa*. Vomiting is a tetany symptom in dogs. And dogs in tetany frequently vomit with nothing in the stomach but bile or saliva. In such dogs water at body temperature introduced into the stomach through a fistula in the fundus causes vomiting. The presence of a delicate rubber balloon in the stomach, or the slight inflation of the balloon causes vomiting. This never occurs in normal dogs. The stimulation of the nerve endings in the gastric mucosa in normal animals (man and dog) causes inhibition of the gastric hunger contractions through local and long reflexes. In parathyroid tetany these nerve endings in the mucosa became so hypersensitive that they are intensely stimulated by saliva, water, bile, and gastric juice. But in addition to these inhibitory reflexes from the gastric mucosa we probably also have a direct depression of the automatic tissue in the stomach, for it is not likely that the inhibitory reflexes, even though very strong, could maintain the sustained extreme depression of the gastric motor mechanism seen in strong tetany.

In the normal dog sudden inflation of the balloon in the fundus leads to one or two strong contractions of the empty stomach. In dogs in marked tetany this leads to vomiting. Vomiting thus induced, as well as spontaneous vomiting in these tetany dogs, seems to cause some increase in gastric tonus lasting for a minute or more after cessation of the vomiting. This increased tonus may, of course, be only apparent, and due to an increased tonus of the abdominal muscles. But I am inclined to interpret the tracings as above, as I have evidence in man that strong contractions of the abdominal muscles, as in forced respiration, induce contractions of the empty stomach, probably by an associated innervation through the tonus fibres of the vagi.

When the parathyroid tetany is temporarily suppressed by intravenous injections of calcium salts (calcium lactate) the calcium injections are followed by marked depression of the tonus of the empty stomach and inhibition of the hunger contractions, if these are present. The stomach recovers from the calcium inhibition in five to fifteen minutes. The calcium inhibition of the motor activity of the empty stomach is probably due mainly to a direct depression of the automatic tissues in the stomach.

SUMMARY

1. Parathyroid tetany in dogs does not lead to increased tonus or contractions of the empty stomach, but to depression of the tonus and the hunger contractions. The degree of depression of the motor activities of the empty stomach is on the whole parallel with the severity of the tetany symptoms, and more marked than the depression of the gastric movements of digestion.

2. The hyperexcitability of the nerve endings in the gastric mucosa is a factor in this depression. The stimulation of these nerve endings leads, through local and long reflexes, to inhibition of the tonus and the hunger movements. There is probably also a direct depression of the automatic tissue in the stomach through changes in the blood.

3. The diminution of or lack of appetite for food in animals in tetany is on the whole greater than would be expected on the basis of the degree of depression of the gastric hunger contractions. The cause of the lack of hunger and appetite in tetany is therefore complex. It is due in part to the depression of the gastric hunger contractions. Other factors are the change in the brain, and in the character of the afferent nervous impulses.

THE EFFECT OF PITUITARY EXTRACT UPON RENAL ACTIVITY

BY C. E. KING AND O. O. STOLAND

[From the Hull Laboratory of Pharmacology, University of Chicago]

IT is well known that extracts of infundibular portion of the hypophysis, when injected intravenously, give rise to an increased flow of urine. Schäfer and Herring¹ assert that this effect is due to a specific stimulation of the renal epithelium by a substance contained in the extract. These observers have also suggested the possibility that the diuresis might be due to an increased blood supply to the kidney resulting from vaso-dilation. They have, however, been inclined to the former view because in a number of cases they obtained diuresis without dilation of the kidney, in fact, with constriction. Houghton and Merrill² reach the conclusion that the diuresis is due primarily to the increase in blood pressure brought on by general vaso-constriction.

The experiments reported in this paper were undertaken at the suggestion of Dr. S. A. Matthews, to determine, if possible, which of these hypotheses is correct, and to throw more light upon the mechanism involved.

All our experiments were performed on dogs. Schäfer and Herring¹ report that their results with dogs were not as constant as with other animals. We found, on the contrary, that under like conditions the constancy and uniformity of effect was very striking. There were, however, variations in the degree of diuresis on repeated injections in the same dog, which, we believe, have yielded additional facts as to the conditions under which pituitary extracts cause diuresis.

¹ E. A. SCHÄFER and P. T. HERRING: *Philosophical Transactions of the Royal Society of London, Series B*, 1906, cxcix, p. 1.

² HOUGHTON and MERRIL: *Journal of the American Medical Association*, Nov. 28, 1908, p. 1849.

The dogs chosen for the crucial experiments were large healthy animals weighing from ten to eighteen kilos. They were not prepared in any special way except that in a few cases they were not given food on the morning of the experiment. The animals were anesthetized with ether only, except in a few cases when small doses of atropin sulphate were given intravenously at the beginning of the experiment. The use of atropin sulphate was not made a routine practice, because with proper vigilance the anesthesia could be made uniform without the introduction of this drug which might complicate conditions.

Records were taken of the blood pressure, kidney volume, rate of flow of urine from the right ureter, and in a number of cases records of the changes in the volume of other organs. These records were obtained by the ordinary methods. The urine was always collected from the ureter of the free kidney.

In all the crucial experiments the extracts were injected into the femoral vein. Three brands of extracts were used: "Pituitrin," manufactured by Parke Davis & Co.; "Infundibulum" of Burroughs & Wellcome; and an extract made by ourselves. This extract was made from dried, pulverized posterior lobes of the ox. The dried material was first extracted with hot absolute alcohol in order to remove the depressor substance, and then with hot physiological salt solution. This latter extract gave results apparently identical with those obtained from commercial brands.

Effects of the First Injection of 1 cc. of Pituitary Extract.—After the animals had been anesthetized and prepared for recording the blood pressure and changes in kidney volume, there was frequently a transient anuria, probably a reflex inhibition from injury to the peritoneal wall, ureters, and kidney. No injections were made until the urine was again flowing at a uniform rate, except in a few cases in which the urine did not begin to flow spontaneously, and the injection was made to start it. It was frequently observed that the anuria was more prolonged when the urine in the bladder was of a relatively high specific gravity.

After the injection was begun there was always a latent period averaging about five seconds. This was followed by a

rather abrupt constriction of the kidney and a rise in the systemic blood pressure. Frequently the rise in blood pressure was very abrupt, in other cases gradual. The blood pressure gradually returned to normal, the period of increased pressure lasting on an average about ten minutes. The constriction of the kidney was followed by a gradual dilation, variable in extent, but a phenomenon constant in occurrence. During the period of kidney constriction the flow of urine was greatly decreased and in most cases ceased entirely. The flow of urine began again at about the same time that the kidney reached its normal size. The rate

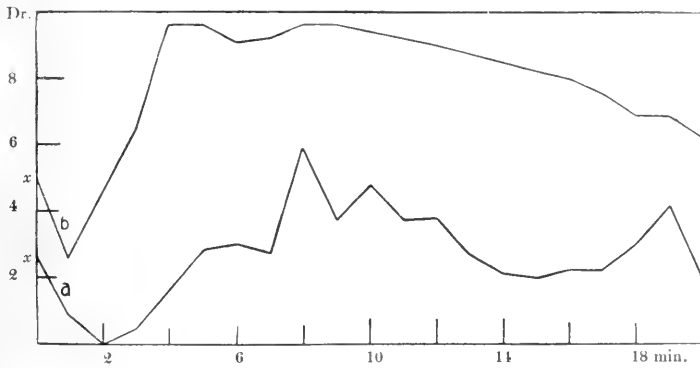

FIGURE 1

gradually increased to a rate greater than the normal, following a gradual dilation of the kidney.

This diuretic effect after the first injection of pituitary extract was obtained in every case with one exception, and in that case the right kidney was found to be atrophied and not functional. At the end of this experiment the urinary bladder, previously empty, was greatly distended, indicating that the kidney in the oncometer responded to the extract. The period of dilation and diuresis lasted on an average about twenty minutes. Following this there was a period when the rate of flow was less than normal, and the kidney became normal in size, or somewhat constricted.

Fig. 1 was constructed by averaging the results obtained on six different dogs, representing the average effect after the first injection (x) of 1 cc. of a 1 per cent extract of the posterior lobe.

(b) represents the relative changes in the volume of the kidney, and (a) the rate of flow of urine at the same time. It will be seen that the fluctuations in the rate of flow of urine were much greater than the fluctuations in kidney volume. This is accounted for by the fact that after injections there were often strong urethral contractions during which four or five drops would flow in rapid succession followed by a period of no flow until the next contraction. The systemic blood pressure nearly always returned to normal before the maximal diuretic effect was obtained. Frequently diuresis was observed with the systemic

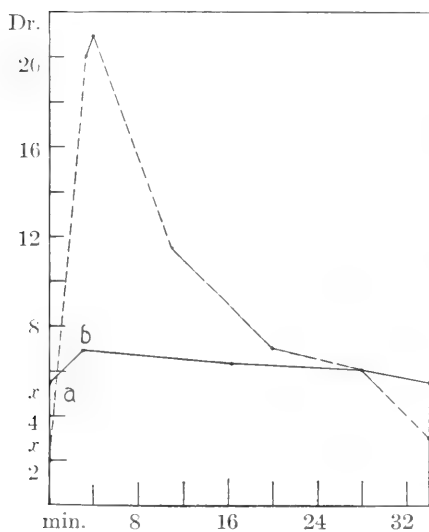

FIGURE 2

blood pressure slightly below normal. This is in agreement with the observation of others (Hoskins and Means).¹

Another series of experiments was carried out, but instead of using pituitary extract, a 20 per cent solution of glucose was used. The object of this variation was to study the changes in kidney volume during diuresis produced by a substance, the effect of which upon the vaso-motor system is not marked. 25 cc. of the glucose solution caused a marked diuresis in almost every case. Fig. 2 represents the results as averaged from six dogs, (b) representing the relative dilation of the kidney, and (a) the flow of urine at the same time.

The results just described were obtained by injection of a diuretic which does not cause great vaso-motor changes. Following this it was thought advisable to test the diuretic effect of substances other than pituitary extracts which give rise to marked vaso-motor phenomena. Epinephrin was chosen in this case.

¹ R. G. HOSKINS and J. W. MEANS: *The Journal of pharmacology and experimental therapeutics*, 1913, iv, p. 435.

Fig. 3 shows the effects of one-tenth of a cubic centimetre of epinephrin (1:1000); (a) represents the flow of urine and (b) the relative changes in kidney volume.

After a brief latent period there was in every case the typical rise in blood pressure, and at the same time a very marked abrupt constriction of the kidney. Both the blood pressure and the kidney volume returned rather rapidly toward the normal, the kidney becoming slightly dilated and remaining so for a period of from 10 to 15 minutes. During the period of kidney constriction the flow of urine was decreased, and in several cases ceased entirely, but with the return to normal size and slight dilation of

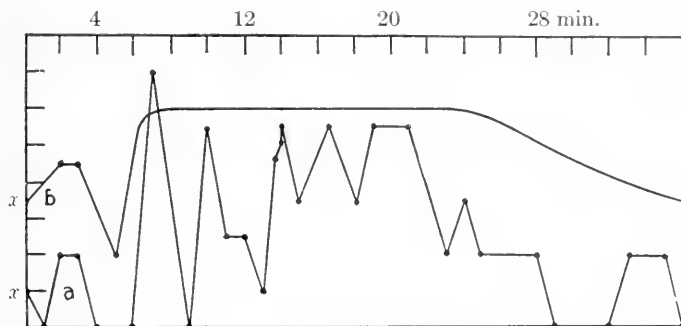

FIGURE 3

the kidney, the flow began and increased rapidly to a rate much greater than normal. This diuresis lasted until the kidney had again reached its normal size.

Finally the effects of repeated injections were studied. It has been found by others that in the dog with repeated injections there is very little or no variation in the blood pressure reaction, but that in the cat and rabbit the blood pressure is progressively less. This being the case, the dog appears to be a good animal to determine whether the diuresis is a function of the increased blood pressure. If this hypothesis were correct, then in the dog repeated injections, other conditions being constant, should give the same degree of diuresis. The graphs in Fig. 4 show the relative changes in kidney volume and urine flow in the same animal. The blood pressure curve is not represented. Our results agree with those formerly reported,—that the blood pressure response is the same each time provided the pressure is

allowed to become normal before another injection is given. It will be seen that neither the changes in kidney volume nor the diuretic effect were the same after any two successive injections. It will also be noted that the pressor effect was most marked after the first injection, and almost disappeared after the second injection. Other experiments of the same type showed the same thing. In one series the first three injections were made at brief intervals, about thirty minutes, and then an hour was allowed to pass before the next injection. After this injection the pressor effect was very marked but of short duration, and was followed

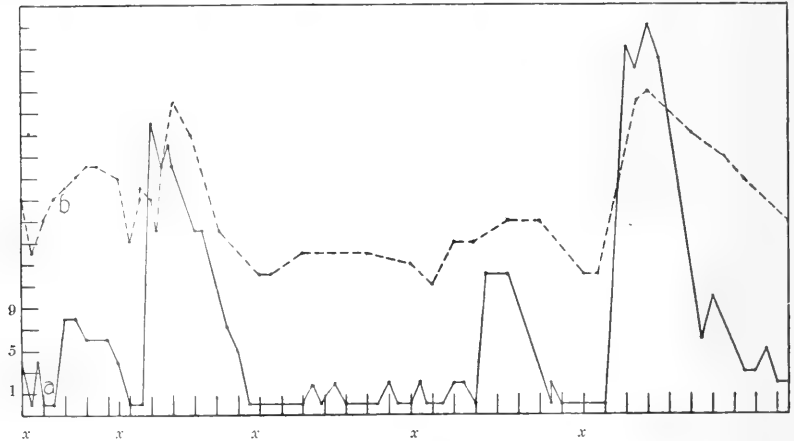

FIGURE 4

by a great dilation of the kidney and great diuresis. So great was the vaso-motor effect that typical Traube Hering waves appeared in the kidney curve. Fig. 5 is a portion of the tracing showing the contraction waves in the kidney, and also showing that the urine flowed more rapidly at intervals corresponding in time to the intervals between two successive waves.

In case great diuresis resulted, whether from the first or second injection, it was always followed by a period of urinary depression, and repeated injections failed to give rise to a rapid flow. During this period of depression either dextrose or urea caused diuresis proportional in extent to the amount injected, thus showing that the kidney's capacity for activity had not been materially lessened. We failed to obtain a single instance in

which the kidney did not dilate to some extent under the treatment just described. If on the other hand, during this period of urinary depression, both glucose and pituitrin, or urea and pituitary extract were injected the results were not so uniform. It is difficult to say for a particular injection that if pituitary extract alone or glucose alone had been injected the diuretic effect would have been greater or less than that obtained. In a few cases the diuretic effect was more marked than with dextrose alone on an average, but there was always a greater dilation of the kidney. On the other hand, in a few cases where the pituitary extract was injected after the diuresis from dextrose had begun and reached what appeared to be the maximal rate, judging from the amount of kidney dilation, the injection of pituitary extract was followed by no greater diuresis.

One experiment was carried out in order to determine whether the amount of urine secreted in 24 hours is greater when pituitary extracts are injected than when not. The extract was injected subcutaneously in 2 cc. doses twice daily. The volume secreted was not increased. The nitrogen content of the urine, however, was greatly increased.

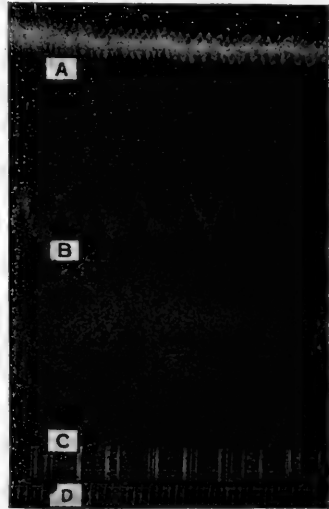

FIGURE 5. (One half the original size.) *A*, blood-pressure; *B*, kidney oncograph; *C*, urine flow; *D*, time in 6 seconds.

DISCUSSION

A survey of the experimental data and observations here presented reveals the following important facts: (a) extracts of the pituitary gland, when administered intravenously gave rise to marked vaso-motor phenomena and diuresis; diuresis from pituitary extract occurred only in connection with dilation of the kidney; diuresis following the injection of urea and dextrose was

accompanied by dilation of the kidney, but not so extensive as in the case of pituitary extracts; other substances giving marked vaso-motor phenomena, one phase of which is vaso-dilation, gave rise to diuresis; diuresis was not directly proportional to the amount of extract injected; great diuresis was always followed by a period of urinary depression, during which time pituitary extracts acted very weakly as diuretics; during this period of urinary depression other diuretics were active; if an hour or more was allowed to intervene between injections, successive injections of pituitary extract gave rise to marked diuresis.

Our primary interest in these observations consists not so much in the mere description of them, as in their significance in connection with the mechanism involved in causing the diuresis.

The diuretic effect of pituitary extracts was observed and described by Magnus and Schäfer in 1901.¹ A little later Schäfer and Herring² put forward the view that the diuresis is due to a specific stimulation of the renal epithelium. This view has been accepted by a number of observers as the most plausible explanation. (Cushing,³ Hoskins and Means).⁴ Houghton and Merrill⁵ did not come to this conclusion, but contended that the diuresis is dependent primarily on increased blood pressure. These observers came to this conclusion after doing perfusion experiments on the isolated kidney. But perfusion of any isolated organ is less satisfactory than when intact in the animal.

Lately Gesell has shown that the pulse pressure is an important factor in renal secretion. Hoskins and Means⁴ have shown, however, that pulse pressure is not an important factor in causing pituitary diuresis.

Unless we accept the "mechanical" theory of Ludwig, we are forced to assume that diuresis always results from a stimulation of the renal epithelium. In the study of each diuretic, then, the question arises whether the substance in question stimulates the epithelium directly, or whether its primary action

¹ MAGNUS and SCHÄFER: *Journal of physiology*, 1901, xxvii, p. 9.

² *Loc. cit.* ⁴ *Loc. cit.*

³ HARVEY CUSHING: *The pituitary body and its disorders*, 1912, p. 8.

⁵ *Loc. cit.*

consists in producing other effects which in turn stimulate the renal epithelium.

If pituitary diuresis is the result of direct stimulation then we should expect the same degree of successive diuresis after injection of the same amount. In our experiments, however, we found that periods of marked diuresis are followed by periods during which the same dose will not arouse the kidneys to activity. In a number of cases larger doses were administered. Only a slight diuresis resulted, but the dilation of the kidney was greater than when the original dose was administered. This failure to produce a diuretic effect cannot be attributed to fatigue of the renal epithelium, for it is known that the kidney is capable of great activity for much longer periods than in this case, and furthermore, injections of dextrose or urea never failed to produce marked diuresis.

Diuresis should also occur even if there is no renal dilation. We were not able to obtain such a result. In all our experiments constriction of the kidney was accompanied by a slowing of the urinary flow, and in cases of great constriction, by anuria.

The contentions of Houghton and Merrill,¹ in the light of our results do not account fully for the effects obtained. If pituitary diuresis is a function of the blood pressure, the kidney should be the most active at the time of highest blood pressure. The greatest flow of urine usually came after the blood pressure had almost returned to normal, and in a number of cases great diuresis occurred with the systemic blood pressure slightly below normal. It cannot be denied, however, that blood pressure may be an important factor in bringing about diuresis or anuria. It was repeatedly observed that when the systemic blood pressure rose considerably the kidney increased in size and the flow of urine was accelerated. On the other hand, it was repeatedly observed that when the blood pressure fell considerably, even in the midst of pituitary diuresis, the kidney became smaller and the flow of urine diminished.

It should then be asked why increase in blood pressure does not cause diuresis. This is a very vital point, because we observed that with repeated injections of pituitary extract, the

¹ *Loc. cit.*

blood pressure reaction is approximately the same after each injection, but that the diuretic effect is very variable. It is significant in these cases that the reaction of the kidney as to its size is also variable, and that the relative degree of diuresis and kidney dilation run parallel.

The kidney is an organ which normally is active to such an extent that the composition of the serum as to waste products remains fairly constant. Urea and water may be considered as normal diuretics, and as the substances increase or decrease in the blood, the kidneys are stimulated to more or less activity. If the blood is low in metabolites and waste substances it takes a stronger and more persistent stimulus to force the kidney to lower the composition still more. This is suggested by our repeated observations that in case the flow of urine was slow at the start, and if the urine in the bladder was of high specific gravity, the first injection of pituitary extract gave comparatively little diuretic effect. It also partially explains the fact that after strong diuresis there was a period of more or less anuria.

It is well known that the kidney can be made more active by an increase in its blood supply. An increase in the general blood pressure will increase the blood supply to the kidney, provided there is no local constriction. This might be suggested as one of the initial factors in bringing about diuresis in case of pituitary extract, were it not for the marked vaso-constriction during the period of highest blood pressure. The blood supply to the kidney during the period is diminished as is also evidenced by the anuria. But others have observed an increase in the force of the heart beat after the initial vaso-constriction. This was confirmed in our observations, and in addition we frequently noted an increase in rate. These two factors will keep the blood pressure up. The vaso-constriction is of comparatively short duration. Then, following this, with a high blood pressure, the blood supply to the kidney is increased. It is not improbable that this increase of blood pressure was one of the potent stimuli in bringing about diuresis after pituitary extract, and that it failed to excite the kidney when the substances to be eliminated were present in the blood in low concentration. This is suggested by the fact that the kidney was most refractory after prolonged diuresis.

This view is also supported by the fact that epinephrin produces vaso-constriction and increases blood pressure even more than pituitary extract, but that the diuresis following its administration is less on an average.

None of the facts and hypotheses stated above account for the dilation of the kidney so characteristic after pituitary extract. We have recorded our observation that with other diuretics such as dextrose and urea there was always some renal dilation, but this dilation was not comparable in extent to that after pituitary extract. The facts at hand indicate activity on the part of the vaso-dilator nerves of the kidney, and the existence, origin and some of the reactions of these nerves have been demonstrated by Bradford.¹ Whether the pituitary extract acts upon both constrictors and dilators, the former fatiguing more rapidly, or whether it acts first upon the constrictors and later upon the dilators we do not know. We hope to throw more light upon the point by further researches. It is not improbable that there is in the kidney a local mechanism whereby increased activity caused by any stimulus can call forth vaso-dilation and consequently increase the blood supply to the organ.

It was observed that usually the blood pressure had fallen to normal or below by the time the kidney had reached its maximum dilation. This fact in itself suggests that the fall in pressure was at least in part due to the increased blood supply to the kidney. Ranke² has estimated that under normal conditions 1.63 per cent of the blood is in the kidney at a given time, say one minute. Landergren and Tigerstedt³ have shown that in strong diuresis as much as 5.6 per cent of the blood may pass through the kidneys in one minute. The difference is enough to account for the fall. The fact that the fall in pressure is greater and more abrupt in case the kidney dilation is greater and more abrupt also supports this view.

Thus it appears that pituitary diuresis may be due to a num-

¹ J. R. BRADFORD: *Journal of physiology*, 1889, x, p. 358.

² Quoted by Howell. Taken from Vierordt's "Anatomische, physiologische und physikalische Daten und Tabellen," Jena, 1893.

³ LANDERGREN and TIGERSTEDT: *Skandinavisches Archiv für Physiologie*, 1892, iv, p. 241.

ber of co-existent factors. There is following its administration an increased blood pressure and a vaso-dilation of the kidney. These two factors, either combined or separately, will increase the blood supply to the kidney, which condition is admitted to be a stimulus sufficient to increase the activity of that organ, provided the substances in the blood to be eliminated are not too low in concentration. To these should be added the presence of a local reflex mechanism whereby increased activity brings about vaso-dilation, thus completing the ideal condition for greater renal activity.

While we do not maintain to have shown how the pituitary extract acts upon the kidney, the following evidence inclines us against the view that it acts by direct stimulation of the renal epithelium.

- (a) We were unable to obtain diuresis without vaso-dilation in the kidney.
- (b) There were periods during which the kidney responded to urea and dextrose but not to pituitary extracts.
- (c) The vascular changes after administration of pituitary extract are sufficient to account for the diuresis.

We wish to express our thanks to Dr. S. A. Matthews for encouragement and valuable suggestions and criticism throughout this work.

THE
American Journal of Physiology

VOL. XXXII

DECEMBER 1, 1913

NO. VIII

A METHOD OF EXCLUDING BILE FROM THE
INTESTINE WITHOUT EXTERNAL FISTULA

BY RICHARD M. PEARCE AND A. B. EISENBREY

*[From the John Herr Musser Department of Research Medicine, University of
Pennsylvania, Philadelphia]*

THE usual method of diverting bile from the intestinal canal is through the establishment of an external fistula. This method has several disadvantages, of which the most important is the difficulty of carrying an animal for periods of more than two or three weeks without the development of disturbing complications, as infection of the liver, or peritoneum, or, as not infrequently happens, general jaundice due to incomplete drainage. Also, the external fistula presents many difficulties in the collection of the bile and as the flow usually diminishes greatly after the first few days the amount of bile secreted may be so reduced as to prevent satisfactory chemical analysis.

During the past two years it was found necessary in connection with studies on the relation of the spleen to blood destruction to develop some method by which bile might be collected quantitatively over long periods of time. As the external fistula proved unsatisfactory, an operative procedure was elaborated by which, after removal of one kidney, the common duct was sutured to the ureter and the bile thus carried to the urinary bladder and passed with the urine. In some instances the desired result was obtained and the bile was eliminated without

apparent resorption; in other instances local obstruction at the point of anastomosis was responsible for a damming back of bile into the liver with consequent absorption and general jaundice; in a few such cases some bile was, however, passed more or less intermittently in the urine. With the latter outcome the experiment approached the conditions characteristic of jaundice in man — partial or intermittent obstruction with continual absorption and therefore a chronic jaundice — lasting sometimes for months. On the other hand, when the common-duct ureter anastomosis remained patent, the animal survived for months with complete exclusion of bile from the intestine, without absorption jaundice, and with, presumably, the recovery of all bile in the urine.

Although this experimental procedure failed to aid in the elucidation of the problem which we had in mind, largely because of the impossibility of separating, chemically, substances common to both urine and bile, it seems advisable, on account of the availability of the method for various physiologic and pharmacologic studies, to describe the operative procedure and our general results.

The general technic of the operation is as follows: The animal is placed for a day or two on a restricted soft-diet of bread and water, or bread and milk, and twelve hours before operation is given a large dose of castor oil. Under ether anesthesia, by the insufflation method, and with the most careful asepsis, an incision is made through the right rectus muscle from the costal margin to a point midway between the umbilicus and the pubis. The right kidney is isolated after ligation of its artery and vein and the upper end of the ureter with a small portion of the pelvis of the kidney is dissected free and severed with fine scissors, care being exercised to disturb the blood supply as little as possible. The kidney is then removed. The common duct is dissected free well into the duodenal wall and severed close to the papilla after being closed by a Crile carotid clamp. The upper end of the ureter, where it broadens out into the pelvis of the kidney, is then united to the distal end of the common duct by the Carrel vessel-suture method, and a fold of omentum is wrapped about the point of union and sutured in place. In dissecting both ureter and duct as much adventitious

tissue as possible is preserved and is included in the sutures. This is especially important in the case of the ureter which has a very delicate structure from which the sutures easily tear out. The incision is closed by layers, the final skin suturing being subcutaneous with iodine catgut. The wound is painted with iodine and no further dressing applied. The greatest difficulty in the operation is the approximation and accurate coaptation of ureter and duct. With a kidney lying low in the flank and a correspondingly short ureter, considerable tension must be exerted to bring ureter and duct ends together and under such circumstances satisfactory suturing is difficult. In the absence of this anatomical difficulty, a successful result is obtained in a considerable number of experiments.

Of twelve dogs operated upon in this way the result in five, representing the early period of experimentation, was unsuccessful, on account of faulty technic; two succumbed to accidents not ascribable to the operation; and five survived for periods varying from 49 to 248 days. The animals of the first group died or were chloroformed on the 2d (two) 3d, 5th, and 10th days, respectively. In all of these, the duct-ureter tube was patent and bile appeared in the urine, but faulty suturing or too great tension led to leakage with or without local necrosis and peritoneal lesion due to the action of the escaping bile or to infection. Vomiting was always a concomitant of such accidents and upon its development the animal was usually chloroformed. Post mortem examination always revealed a bile stained, sometimes bloody, fluid in the peritoneal cavity. The serosa of intestines and stomach were deeply injected and sometimes hemorrhagic. In no instance was bile found in the intestine and the gall bladder was usually somewhat distended.

Of the second group, in which early death was due to causes other than the operation, one animal succumbed to a severe broncho-pneumonia on the 14th day and the other died on the 12th day while being etherized for the purpose of dressing the wound. In the first, the anastomosis had healed without leaking, but the lumen was constricted at the point of suturing and although some bile passed to the urinary bladder, the obstruction had been sufficient to cause distention of the gall bladder

and absorption of bile with consequent jaundice. In the second animal the anastomosis had healed perfectly, bile passed freely to the urinary bladder, the feces were greyish white in color, the intestinal canal was free of bile and no evidence of obstructive jaundice was present.

The results in the five animals which survived the operation for considerable periods of time are as follows:

Dog 1319. The operation was on January 28, and the animal died on March 18, the period of survival being 49 days. Bile was passed constantly with urine and there was no evidence at any time of obstructive jaundice. The animal had a good appetite and ate well, but shortly before death showed progressive emaciation and general weakness. The post mortem examination showed perfect healing of anastomosis and no evidence of jaundice. All organs appeared normal except the kidney, which was the seat of a mild pyelonephritis, and the urinary bladder which contained an alkaline urine and exhibited a thickened congested mucosa (Chronic Cystitis). No sufficient cause for death was evident.

Dog 122. The operation was on October 2, and the animal died on December 29, the period of survival being 88 days. At first bile passed freely into the bladder in large amounts, but gradually diminished after the second week and at about the same time the sclerae and gums showed the yellowish staining of jaundice; for several weeks before death jaundice was well marked. The animal did not eat well and though various changes in diet were made, the weight dropped from 6650 before operation to 4460 on November 9; later daily exercise and an improvement in appetite led to an increase in weight on December 13 to 5060 gm. Despite this improvement, on December 23, the animal developed a typical tetany most noticeable in the fore legs and with typical fibrillation of the tongue. This improved somewhat on the 26th but before a study of calcium metabolism could be completed the animal died on the 29th.

Post mortem examination revealed complete obliteration of the common-duct-ureter tube at the point of anastomosis, thus explaining the severe jaundice, which was evident in all tissues of the body. The gall bladder and common, cystic and intrahepatic ducts, were greatly distended and filled with a thick blackish bile of mush-like consistence. The liver was bile stained, congested and more or less indurated. The left kidney was bile

stained and hemorrhagic and the seat of a well-marked pyelonephritis; in the pelvis was a whitish yellow concretion 1 cm. in length and half a centimetre in thickness. The urinary bladder presented the lesions of chronic cystitis. The mucosa of colon and rectum was hemorrhagic; otherwise the alimentary canal showed no changes. The feces were greyish white in color, fatty, and had a disagreeable odor.

Dog 1120. The operation was on December 8, 1911; and the animal was killed by chloroform on May 8, 1912, on account of the development of mange and swelling of the joints. The post-operative period was, 151 days. Bile was passed constantly with the urine, the stools were soft and light colored; the appetite was good, but the weight fell during the period of observation from 9760 to 8210 gm. No evidence of obstructive jaundice was seen. Upon post mortem examination hemorrhages were found about the joints, in the subcutaneous tissues of the neck, beneath the mucosa of the tongue, in the anterior mediastinum and about the thoracic aorta. No icteric pigmentation of skin, mucus membrane or sclerae could be discerned. The left kidney was normal in appearance and did not seem to be enlarged; its ureter was normal. The right kidney was absent and the site of its vessels was smoothly healed over. The right ureter was twice the size of the left, somewhat thickened and yellowish in color. Its lumen was free and the peritoneal covering smooth.

The gall-bladder was small and appeared to be somewhat atrophied. The hepatic ducts were very slightly thickened and enlarged and rather whitish in color. The common duct blended with the upper end of the right ureter and the line of union was difficult to make out. No communication between bile passages and intestines could be found.

The urinary bladder appeared normal except for a slightly yellow staining of the mucosa and somewhat thickened walls. The urine within it was rich in bile pigments.

The colon contained considerable soft greasy fecal material of rancid odor and greyish white color. The material in the small intestine showed no evidence of the presence of bile.

Dog 123. The operation was on October 31, 1912; and the animal died on June 23, 1913, the period of survival being 235 days or about 8 months. Bile passed readily into the bladder, but on December 16, the sclera and the mucous membranes of the mouth showed slight evidence of jaundice which continued without

becoming severe until death. The feces remained free of bile pigment. Despite exercise, frequent changes in diet, and every possible effort to maintain the general condition, progressive loss in weight occurred. This is shown by the following weights: October 29, 10,680 gm.; November 4, 9575 gm.; November 13, 8605; December 13, 7810; December 30, 7000; January 20, 6515; after January the weight remained practically constant, the lowest weight being 5960 gm. on June 2.

The autopsy showed evidence of jaundice and in the tip of the Spigelian lobe of the liver, small yellowish white masses occupying an area of about 3 cm. in diameter. The right ureter could be traced up from the bladder as a thin, normal looking structure ending in a mass of adhesions behind the pancreas. A probe could be passed readily from the lower end of the ureter into the hepatic duct, there being no appreciable constriction at the point of anastomosis. The probe, however, could not be passed into the gall bladder but on pressure bile could be forced from the gall bladder into the duct. The obstruction to the flow of bile was apparently due to the effect of adhesions. The left kidney and ureter appeared normal. The urinary bladder was somewhat bile stained and the seat of a trabecular hypertrophy with injection of the trigone and chronic cystitis. The right lung showed a few small patches of broncho-pneumonia.

Dog 1318. The operation was on January 28, 1913, and the animal was killed by chloroform, on account of the development of mange, on October 3. The period of survival was 248 days. Bile passed freely at all times into the urinary bladder and at no time did evidence of jaundice appear. The feces were greyish white in color, of foul odor and at all times free of bile pigment. Unfortunately the record of early weights was lost, but on May 10, the weight was 5970 gm., on June 19, 6650 gm., with an increase on July 22 to 6780 gm.; at the end of the experiment the weight was 6690 gm. The autopsy showed the common duct-ureter tube to be patent from gall-bladder to urinary bladder, with slight thickening of its wall at point of anastomosis. The gall bladder was slightly distended but otherwise no evidence of interference with the flow of bile was present. The remaining kidney and the bladder showed no lesions.

This summary shows a perfect operative result in five dogs, surviving for 49, 88, 151, 235, and 248 days respectively, and

without, in three, the occurrence of obstructive jaundice. In a fourth animal, complete occlusion occurred finally at the point of anastomosis and after a long period of obstructive jaundice death occurred on the 88th day; in the fifth dog which survived until the 235th day, the duct-ureter anastomosis was patent, but adhesions interfered with the flow of bile and a slight persistent jaundice occurred. These results demonstrate the possibility of utilizing the procedure for the study of the effects of absence of bile from the intestine during long periods of time without, as was possible in three of these animals, the presence of obstructive jaundice. On the other hand, the procedure when followed by obstructive jaundice, as in two of these dogs, offers a more satisfactory experimental condition for the study of the effect of chronic jaundice than does the well-known ligation experiment.

There is, however, a modification of the technic which may be used when it is desired to secure the urine free from the admixture with bile. This consists in performing an operation secondary to the common-duct-ureter anastomosis, by which the ureter is severed at its entrance into the urinary bladder, and is implanted by Coffey's method into the lower colon. This, however, is usually followed, as in one of our animals which survived the procedure for 77 days, by a well-marked jaundice, and is frequently complicated by ascending infection from the colon. This experimental procedure, the two steps of which may be completed at the one operation, provides a method of studying the influence of the absence of bile upon the processes of digestion and absorption in the upper intestine that is of especial value in that it leaves the urine free of admixture with bile.

The question of infection is not limited, however, to the colon anastomosis. In the simple common-duct-ureter anastomosis, the urine early becomes alkaline, pus cells appear in it, and as shown in the notes, chronic cystitis, at times with pyelonephritis, and occasionally pelvic calculus, occurs in the long time experiments. That this complication might seriously interfere with the successful completion of experiments in which exact chemical investigation is essential, is evident.

Lesions observed in two of the animals described above, deserve a word of special comment. In one (Dog 1120) a widespread and severe hemorrhagic condition was present. If this had occurred in connection with jaundice, the common association of hemorrhage and jaundice might be invoked as a possible explanation, but in the absence of jaundice we have no suggestion to offer. In a second animal (Dog 122) with well-marked jaundice, typical tetany developed a short time before death. The occurrence of this symptom may have been purely accidental and this possibility is supported by the fact that when the parathyroids were examined histologically they were found to contain a marked increase of connective tissue. As, however, the observations of King¹ and his associates on the increased elimination of calcium in obstructive jaundice suggested a possible disturbance of calcium metabolism, a study of the calcium balance was made. This was not completed with the dog in question on account of an early fatal termination, but with one other animal (Dog 123), the following results² were obtained:

TABLE I. CALCIUM ELIMINATION²—DOG 123. OPERATION, OCTOBER 31, 1912; DEATH, JUNE 23, 1913.

Period	Dates	Calcium output	Excess over intake
4 days	February 13-17	0.323 g.	0.255 g.
4 days	February 17-21	0.327 g.	0.259 g.
5 days	May 12-16	0.385 g.	0.289 g.

In this study the animal was placed on a constant diet of beef heart, the calcium content of which was determined. The calcium of urine and feces after incineration was determined, in each separately, by McCrudden's method with titration by potassium permanganate.

¹ KING, J. H., BIGELOW, J. E., and PEARCE, L.: *Journal of experimental medicine*, 1911, xiv, p. 159.

² For these chemical analyses and for assistance in several operations we are indebted to Dr. M. M. Peet.

The figures presented show the increased elimination of calcium as described by King, Bigelow and Pearce. The data, however, are not sufficient, even if the relation of calcium to tetany were definitely established, to allow conclusions. It would appear, however, that the occurrence of tetany, as well as the hemorrhagic condition in dog 1120 were purely accidental. This is supported by the absence of such conditions in dog 1318 which survived for 8 months.

Throughout this investigation histological examinations have been made for the purpose of determining the character of the changes in the duct-ureter anastomosis and the possibility of microscopic lesions in the various organs and tissues of the bodies. Nothing of importance has been found. In animals dying a few days after operation the point of anastomosis has shown the usual picture of necrosis and infection; in those dying after long periods, the duct-ureter tube has shown epithelial atrophy, fibrotic thickening and lymphoid cell infiltration with sometimes a dilatation and sometimes a narrowing of the lumen. In one instance (Dog 122) complete obliteration was present. The urinary bladder has sometimes shown the histological picture of chronic cystitis and the remaining kidney that of pyelonephritis. Aside from the liver which has occasionally shown evidence of bile stasis or of recent or old infection, the changes in the other organs have not been important.

SUMMARY

A method of value in the experimental study of the physiology of the bile consists in diverting the bile from the intestine to the urinary bladder by anastomosing the common bile duct and the right ureter after removal of the corresponding kidney. This procedure leaves the intestine completely free of bile and allows the collection of total secretion of bile mixed with urine. The procedure is not free from undesirable complications, as infection of urinary bladder and kidney may occur, but as animals survive with good flow of bile for periods varying from seven weeks to eight months it is more satisfactory than the external fistula. The mixture of urine and bile renders diffi-

cult however quantitative chemical examinations. If it is desirable to study the urine unmixed with bile the lower end of the ureter may be implanted in the colon, thus leaving the upper intestine free of the action of bile, and still avoiding the troubles of the external fistula. The colon implantation tends, however, to greater ease of infection. One difficulty, in either procedure lies in the fact that changes at the site of the common-duct-ureter or ureter-colon anastomosis may occasionally prevent free flow of bile and lead to obstructive jaundice. This occurred in two of our five animals. When, however, this obstruction is not so complete as to lead to early death it offers a form of chronic obstructive jaundice which is much more satisfactory for experimental study and resembles more closely that occurring in man than does that produced by ligation of the common duct.

Although we have been unable — largely because of the difficulty of studying chemically a bile-urine mixture — to solve the problem in connection with which this technical method was developed, we offer the results of our use of it, in the hope that others may find in it a method of approaching some of the problems concerning the bile, in its many relations, and perhaps also an aid in pharmacological studies.

A COMPARISON OF THE AUSCULTATORY BLOOD
PRESSURE PHENOMENON IN MAN WITH THE
TRACING OF THE ERLANGER
SPHYGMOMANOMETER

By ARTHUR W. WEYSSE AND BRENTON R. LUTZ

[From the Physiological Laboratory of Boston University]

INTRODUCTION

THE sphygmomanometer has come into such general use in practical medicine as well as in the laboratory within recent years that it becomes imperative to establish such criteria for the determination of the blood pressure by the various methods employed, that the records of different observers may be comparable. The auscultatory method seems to be particularly reliable, but there has been no conclusive demonstration of the relation of the auscultatory phenomenon in man to the record of an accurate graphic instrument. In this paper we present the results of a comparison of the auscultatory method with the tracings from the Erlanger sphygmomanometer.

THE CRITERIA FOR MAXIMUM AND MINIMUM BLOOD PRESSURE

The criteria used for the determination of maximum blood pressure with the Erlanger sphygmomanometer are: (1) a marked increase in amplitude of the pulsations traced on the cylinder; (2) a change in the direction of the trough line; (3) a change in form of the pulse wave. (Erlanger, 1904 and 1908.)

The minimum blood pressure is determined by the maximum oscillations obtained with the Erlanger sphygmomanometer. Howell and Brush (1901) showed conclusively by animal experimentation that maximum oscillations occur when the artery is subjected to an external pressure equal to the minimum blood

pressure, and Erlanger (1904) has shown with an artificial circulation, in which was inserted a piece of artery, that maximum oscillations are obtained with his instrument at minimum pressure. Hence he considers the marked decrease in amplitude of the oscillations as an index for minimum blood pressure.

In the auscultatory method described by Korotkoff in 1905 we now distinguish the five phases first recognized by Ettinger (1907), as follows; 1st, first sounds, clear; 2d, murmurs; 3d, clear sounds; 4th, dull sounds; 5th, cessation of the sounds.

All observers agree that the beginning of the 1st phase is coincident with maximum pressure. But the criterion for minimum pressure is in dispute; such observers as Fischer (1908), Lang and Manswetowa (1908), Van Westenrijk (1908), and Warfield (1912) consider the beginning of the 4th phase as the auscultatory index for minimum pressure; while Ettinger (1907), Gittings (1910), and Goodman and A. A. Howell (1910) consider the 5th phase as the correct index.

A BRIEF REVIEW OF THE LITERATURE

Korotkoff (1905), as reported by Schrupf and Zabel (1909), heard the first sound before the pulse could be palpated at the wrist, the difference being represented by from 10 to 12 mm. of Hg. He measured the minimum pressure after the "endtöne," i.e. at what is now called the 5th phase.

Ettinger (1907) compared the auscultatory with the palpatory and graphic methods. He considered the first sound as an index to maximum pressure, and the cessation of all sounds, i.e. the 5th phase, as an index to minimum pressure. Out of 232 determinations, he found that 207 times the auscultatory maximum was higher than the graphic maximum (Janeway-Massing) or the palpatory maximum (Strassburger). Out of 227 determinations of the minimum pressure he found that 130 times the auscultatory minimum was lower than the palpatory or the graphic, 18 times it agreed with them, 71 times it was higher than either, and 8 times between the two. In general he found the maximum higher and the minimum lower with the auscultatory method.

Lang and Manswetowa (1908), comparing the auscultatory method with the oscillatory method of v. Recklinghausen, found that when the first sound was heard the amplitude of the oscillations showed a marked increase. During the 3rd phase the intensity of the sounds and the amplitude of the oscillations were proportional. At the moment the amplitude began to decrease the sounds became dull, indicating the onset of the 4th phase. This first decrease in the height of the oscillations and the beginning of the 4th phase, these authors believe indicate minimum blood pressure. Experiments with two large dogs led them to the same conclusion.

Van Westernrijk (1908), comparing simultaneously the auscultatory method with Uskoff's graphic method, found no constant relation between the 4th phase and the maximum oscillations obtained with the Uskoff sphygmotonomograph. (Erlanger [1908] shows that the Uskoff sphygmotonomograph has a physical defect.) He observed, however, a definite relation between the auscultatory phenomenon and the oscillations of Pal's sphygmoscope. The marked increase in amplitude of the oscillations was coincident with the first sound, and the sudden diminution in amplitude occurred at the beginning of what is now called the 4th phase.

Fischer (1908), comparing the auscultatory method with the oscillatory method of v. Recklinghausen, found in 150 cases, normal and abnormal, the maximum determined by both methods agreed 58 times. In 92 cases the oscillatory maximum was higher than the auscultatory maximum. In these same 150 cases he determined the minimum pressure by both methods and found it agreed in 47 cases; in 97 cases the oscillatory minimum was lower than the auscultatory; in 6 cases it was higher. He concluded the 4th phase to be the most accurate index, and found in cases of long 4th phase a low minimum pressure, and in cases of short 4th phase a high minimum.

Gittings (1910), and Goodman and A. A. Howell (1910) consider the 5th phase as an index to minimum blood pressure. The latter even go so far as to say that "it is generally agreed that the disappearance of all sound is coincident with minimal or diastolic pressure." Gittings found in 41 cases out of 48 that

the minimum pressure determined at the 5th phase averaged 15.5 mm. of Hg lower than when determined by the visual method.

When our investigation was nearly completed the preliminary report of Warfield (Oct. 1912) appeared, in which he questions the accuracy of the 5th phase as an index to minimum pressure. He used one of the tambours of the Hirschfelder attachment to the Erlanger instrument, fitted with a pipette bulb and a lever, to record the auscultatory phenomenon simultaneously with the blood pressure tracing. He publishes five records (in four of which the pressure recorded is above 150 mm. of Hg) to show the relation of the tracing to the auscultatory phenomenon. The 1st phase coincides with the graphic maximum, but the relation of the 4th phase to the graphic minimum is not clearly shown by his records, yet it is evident that the 5th phase does not correspond to maximum oscillations. He does not state how many cases he has examined. He concludes that the diastolic pressure is not usually at the point of disappearance of all sound, the 5th phase. In a still more recent article (1913) he publishes tracings which demonstrate that the 4th phase coincides with the minimum pressure as recorded by the Erlanger sphygmomanometer.

In another publication (Sept., 1912) Warfield describes his experiments on three dogs, using a method by which he can measure the diastolic pressure by the auscultatory phenomenon, taking as a point of diastolic measurement the sudden dulling of the sound. He says that the sounds heard in the femoral artery of a dog are not like those heard in the brachial artery of man, but correspond in a general way. We may infer, then, that he reads the minimum pressure at the beginning of the 4th phase. By means of a maximum and minimum manometer, and an improvised plethysmograph he shows that this sudden change of sound in the artery of a dog takes place at minimum pressure.

Brief reference may be made to the paper of Taussig and Cook (1913) in which they state that minimum pressure should be read at the 4th phase.

SUBJECTS, APPARATUS, AND METHOD

In this investigation sixty-one healthy students were used as subjects. Four of them were women.

An Erlanger apparatus was used, to which was attached the tambour and writing lever of a pneumograph, and two signal-magnet levers, one to mark the auscultatory phases, and the other to record the height of the mercury column. (Fig. 1.) A Bowles sphygmometroscope was used for auscultation.

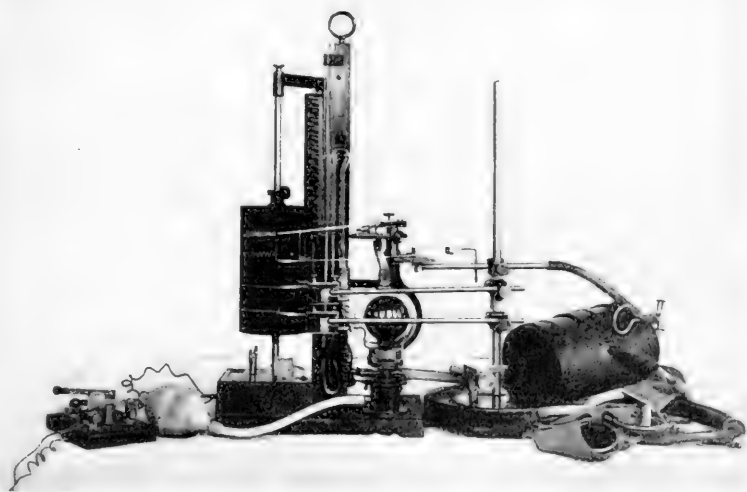

FIGURE 1. Arrangement of the apparatus.

All the determinations were made on the right arm of the subject, who was seated, so that the cuff of the sphygmomanometer was approximately on the level of the heart. After the levers were put in vertical alignment the pressure was raised to well above maximum and then lowered by the continuous escapement method. The observer recorded the onset of each phase, in some cases waiting one or two pulse beats to make sure of the change, and looked only at the manometer scale in order to record the height of the mercury every 5 mm., and to

record the auscultatory phases without being influenced by any changes in the graphic record. In this way a comparative record was made, which showed the relation of the auscultatory phases to the changes in the blood pressure tracing. The levers occupied the same relative positions in all the tracings as shown on the accompanying figures. The first or uppermost recorded the blood pressure, the second respiration, the third the auscultatory phases, the fourth the height of the mercury column.

RESULTS

The chief object was to determine the auscultatory index of minimum pressure, and incidentally to check the accuracy of the criteria for the determination of maximum pressure with the Erlanger instrument, since in former work we experienced some difficulty in many cases in obtaining satisfactory readings from the tracings.

Out of 210 comparative determinations on 61 different individuals; the graphic maximum could be read 134 times, while the auscultatory maximum was obtained 206 times; or, 76 times the graphic could not be read, and 4 times the auscultatory maximum was not recorded. These results may be tabulated as follows:

Number of subjects	61
“ “ graphic records	210
“ “ “ “ in which maximum pressure was obvious . . .	134 or 63.3%
“ “ “ “ “ “ “ “ could not be read .	76
“ “ cases in which maximum pressure was obvious by auscultation .	206 or 98.9%

Of the 134 graphic records mentioned 128 showed the auscultatory maximum equal to or only from 1 to 5 m. of Hg below the graphic maximum; 3 times it was from 1 to 5 mm. above, and 3 times from 5 to 10 mm. below. In these 134 cases, then, the graphic maximum agreed with the 1st phase in 95.5% of the determinations.

Out of the 210 cases the graphic minimum could be read 142 times, while the auscultatory 4th phase was recorded 183

times; or, 68 times the graphic minimum could not be read; 27 times the 4th phase was not recorded because the sounds became dull so gradually that the exact point could not be determined. These results may be tabulated as follows:

Number of subjects	61
“ “ graphic records	210
“ “ “ “ in which minimum pressure was obvious . . .	142 or 67.6%
“ “ “ “ “ “ “ “ “ could not be read . . .	68
“ “ cases in which the 4th phase was obvious	183 or 87.1%

Of the 142 cases mentioned, 108 showed the onset of the 4th phase equal to or only from 1 to 5 mm. below the marked decrease in amplitude of the oscillations; 28 times it was from 1 to 5 mm. above, and 5 times from 5 to 10 mm. below. In these 142 cases, then, the 4th phase agreed with the graphic minimum in 77.4% of the determinations.

In all of the 210 records the 5th phase occurred from 10 to 25 mm. of Hg below maximum oscillations, and in no way coincident with the diminution of amplitude. (Fig. 5.)

In 36.8% of the determinations no readings of the maximum pressure could be obtained with the Erlanger instrument; and in 32.3% no readings of minimum pressure could be obtained. The reason for this percentage of unsatisfactory determinations is not to be found in any peculiarities of the subjects but in factors active when the records were taken, since out of the three or four determinations made on each person two or three satisfactory readings were nearly always obtained.

Among the factors that might affect the record of the sphygmomanometer are movements of the arm, contractions of muscles under the cuff, changes in the vascularity of the arm, and the changes in blood pressure due to respiration. Movements of the arm or the contraction of muscles under the cuff occurring at the time the external pressure is about to equal the maximum blood pressure would undoubtedly alter the usual changes in the sphygmomanometric record by changing the pressure within the cuff. Changes in vascularity affecting the volume of the

arm would tend to affect the record in a similar manner, and sudden vasomotor changes or rhythmical waves of blood pressure would likewise have an effect.

Respiration has sometimes a marked effect upon the determinations. Erlanger and Festerling (1912) have shown that arterial blood pressure rises during expiration and falls during inspiration. With the rise in blood pressure there is an increase in the amplitude of the oscillations recorded, — with the fall a decrease occurs. Venous pressure as well falls during inspiration, and this coupled with the fall of arterial pressure would reduce the volume of the arm, causing a lowering of the pressure in the cuff, a condition that would cause an increase in ampli-

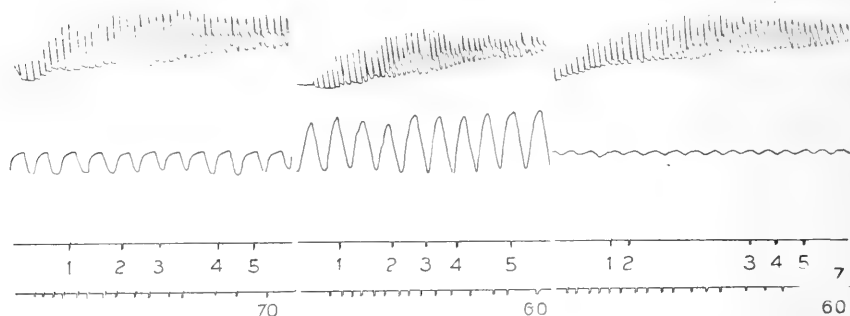

FIGURES 2 and 3. In these and all the following records the upper curve represents the blood pressure, the next curve the pneumograph tracing, the third line indicates the auscultatory phases, the lowermost line the fall of the Hg column at intervals of 5 mm. These records show clearly the relation between the auscultatory phases and the blood-pressure tracing, and also that maximum pressure occurs on expiration and minimum pressure on inspiration. Figure 2, maximum pressure 123 mm. of Hg, minimum 82 mm. Figure 3, maximum 125 mm., minimum 80 mm.

FIGURE 4. Similar to records 2 and 3, but illustrating a long 2d phase. Maximum pressure 125 mm., minimum 73 mm.

tude of the oscillations. However, this is more than offset by the greater direct effect of the inspiratory fall of arterial pressure which is manifest on the record as a decrease in amplitude. It is theoretically probable that the expiratory rise of arterial pressure, when it occurs at the time that the pressure in the cuff is about to equal the maximum blood pressure, would tend to accentuate the criteria for determining the latter; under similar conditions the inspiratory fall would tend to obscure

them. The graphic minimum should be affected as well, and a decrease in the amplitude of the oscillations should occur with inspiration.

Our records would seem to indicate that the graphic maximum occurs during expiration, i.e. on the upstroke of the pneumograph lever, and the graphic minimum during inspiration, but we are not prepared to say that this is true in all cases. Compare Figs. 2, 3 and 4. The effect of the respiratory changes on the blood pressure is clearly marked in Fig. 7, where the sounds alternate between the 3rd and 4th auscultatory phases synchronously with the respiratory movements, and also in Fig. 6, where the 1st phase disappeared as a result of inspiration

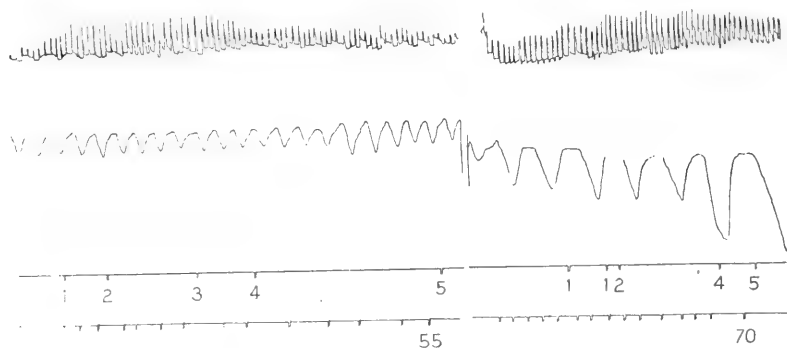

FIGURE 5. Illustrating a long 4th phase corresponding to a fall of 25 mm. of Hg, and showing the error that would result from reading the minimum pressure at the 5th phase instead of at the beginning of the 4th. Maximum pressure 120 mm. of Hg, minimum 82 mm.

FIGURE 6. This record illustrates the disappearance of the first sound on inspiration and its reappearance on expiration.

and then reappeared. The cases in which this phenomenon was observed showed a slightly greater cardiac arrhythmia than is present in most normal individuals, and in one case at least the degree of this arrhythmia varied on different occasions as in Figs. 7 and 8 which were taken on the same individual at an interval of about four weeks. We are inclined to attribute this slight increase in arrhythmia to an increased susceptibility of the heart to respiration.

Goodman and A. A. Howell (1911) note changes occurring in the phases themselves, which they call tonal arrhythmia or an

alternation of the intensity of the individual sounds, and they regard this arrhythmia as evidence of variation of the contractions of the heart. They observe also poor differentiation of the phases, e.g. cases in which murmurs may alternate with tone beats, or dull tones with sharp tones and they believe this to be an evidence of cardiac weakness. These phenomena are identi-

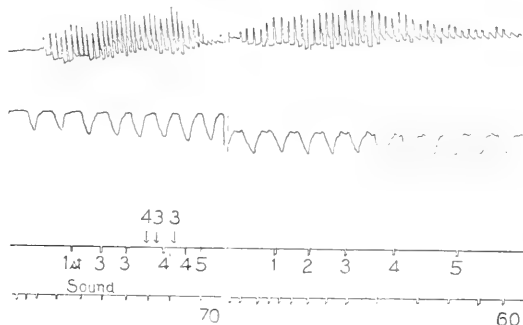

FIGURE 7. In this record no 2d phase was distinguished. The 3d phase diminished in intensity shortly after its appearance and then recovered to be followed by alternating 4th and 3d phases synchronously with inspiration and expiration.

FIGURE 8. Record taken from the same individual as Fig. 7, but about four weeks earlier and showing the absence of the alternating phases there indicated.

cal with those which we have just pointed out in our records, but these authors have not called attention to the influence of respiration on the heart beat, a factor that seems to us to be indicated by our tracings.

Goodman and A. A. Howell (1911) have studied the relative length of the various auscultatory phases, and our records confirm, in general, their results as is evident from the auscultatory tracings in the accompanying figures. The largest oscillations appear with the 3rd phase, and our tracings confirm the conclusions of Lang and Manswetowa (1908) when they say that the height of the oscillations and the intensity of the sounds are proportional.

CONCLUSIONS

1. Maximum pressure as determined with the Erlanger sphygmomanometer on normal individuals is coincident with the onset of the 1st phase of the auscultatory phenomenon.
2. Minimum pressure as determined with Erlanger's instru-

ment on normal individuals is coincident with the onset of the 4th phase.

3. Since the onset of the 4th phase is coincident with the marked decrease in amplitude of the oscillations recorded by the Erlanger sphygmomanometer, it should be considered as the index of minimum blood pressure.

4. Since the 5th phase occurs later than the last maximum oscillations, — in some of our cases (e.g. Fig. 5) as much as 25 mm. of Hg, — it should not be taken as the index of minimum pressure.

5. Maximum pressure occurs commonly, if not always, during expiration, and minimum pressure commonly, if not always, during inspiration.

BIBLIOGRAPHY

ERLANGER: Johns Hopkins Hospital reports, 1904, xii, p. 53.

ERLANGER: Proceedings of the American Physiological Society, this journal, 1908, xxi, p. xxiv.

ERLANGER: Archives of internal medicine, 1912, ix, p. 22.

ERLANGER and FESTERLING: Journal of experimental medicine, 1912, xv, p. 370.

ETTINGER: Wiener klinische Wochenschrift, 1907, xx, p. 992.

FISCHER: Deutsche medizinische Wochenschrift, 1908, xxxiv, p. 1141.

GITTINGS: Archives of internal medicine, 1910, vi, p. 196.

GOODMAN and HOWELL: University of Pennsylvania medical bulletin, 1910, xxiii, p. 469.

GOODMAN and HOWELL: American journal of the medical sciences, 1911, cxlii, p. 334.

HOWELL and BRUSH: Boston medical and surgical journal, 1901, cxlv, p. 146.

LANG and MANSWETOWA: Deutsches Archiv für klinische Medizin, 1908, xciv, p. 441.

SCHRUMPF and ZABEL: Münchener medizinische Wochenschrift, 1909, lvi, p. 704.

TAUSSIG and COOK: Archives of internal medicine, 1913, xi, p. 542.

VAN WESTENRIJK: Zeitschrift für klinische Medizin, 1908, lxvi, p. 465.

WARFIELD: Archives of internal medicine, 1912, x, p. 258.

WARFIELD: Interstate medical journal, 1912, xix, p. 856.

WARFIELD: Journal of the American Medical Association, 1913, lxi, p.

STUDIES IN FATIGUE

II. THE THRESHOLD STIMULUS AS AFFECTED BY FATIGUE AND SUBSEQUENT REST

BY CHARLES M. GRUBER

[From the Laboratory of Physiology in the Harvard Medical School]

AS a muscle approaches fatigue its contractions decrease in height. Higher contractions will again be elicited if the stimulus is increased. Although these phenomena are well-known, no adequate analysis of their causes has yet been advanced. A number of factors are probably operative in decreasing the height of contraction: (1) the using up of available energy-producing material; (2) the accumulation of metabolites in the fatigued muscle; (3) polarization of the nerve at the point of repeated stimulation and (4) a decrease in irritability, i.e., an increase in the threshold stimulus. It may be that there are interactions between these factors within the muscle, e.g., the second may cause the fourth.

The last of these factors — the effect of fatigue on the threshold stimulus — has been the subject of this investigation. The effect of subsequent rest on the fatigue threshold has also been studied.

THE METHOD

In earlier experiments the animals (cats) were anaesthetized with urethane (2 gm. per kilo body weight by stomach), but later Sherrington's method of decerebration was employed. First the cats were anaesthetized with ether and the carotid arteries ligated. It was deemed advisable to isolate and cut the sciatic next, before completion of decerebration, since the cutting of a large nerve trunk may increase blood pressure, and thus cause hemorrhage from the vessels opened in decerebration. From this

point the method was similar to that described by Forbes.¹ The vertebral arteries were clamped off by applying pressure with the forefinger and thumb, one on either side of the neck, just below the transverse processes of the axis during the time that the cerebral hemispheres were being removed from the cranium, and until the blood in the wound was sufficiently coagulated to prevent hemorrhage. In the few cases in which the lack of blood to the respiratory centre stopped normal respiration, artificial respiration was employed until the release of pressure on the vertebral arteries allowed normal respiration to return.²

The nerve-muscle preparation. — By enlarging the slit in the skin made for cutting the sciatic, the *peroneus communis* nerve was bared and along its entire length separated from the *tibialis* nerve.³ Its distal end was then fastened in a Sherrington shielded electrode, which was held in place by fastening around it with spring clips the two flaps of skin.⁴ This electrode was used in fatiguing the muscle. A second Sherrington electrode having a slit on one side, which permitted quick adjustment on the nerve, was placed between the first electrode and the muscle each time that a series of readings of the threshold and resistance were taken, and removed after each series in order to avoid possible short circuiting (from moisture) between the platinum points. Since this electrode was used only in determining the threshold, polarization of the nerve was also avoided. Although resistances were taken with each series of readings care was used to place this second electrode in a similar position each time. In the later experiments a double Sherrington shielded electrode was substituted for the two single electrodes. In this case the platinum points further from the muscle were used for stimulation during fatigue, and the others — nearer the muscle — for measuring the threshold. Here, as before, the points used in determining the threshold stimulus were removed and the

¹ FORBES: Quarterly journal of experimental physiology, 1912, v. p. 166.

² I wish to thank Dr. Alexander Forbes for demonstrating to me the method here cited.

³ The nomenclature here employed is that of Reighard and Jennings: The anatomy of the cat, New York, 1901.

⁴ SHERRINGTON: Journal of physiology, 1909, xxxviii, p. 382.

moisture wiped from them and the nerve before each threshold determination.

The skin and underlying tissues were cut away from the *tibialis anticus* muscle in two places about 5 cm. apart. Through these openings the threshold stimulus for the muscle was determined by means of platinum needle electrodes thrust into the muscle. The electrodes were removed after each series of readings and the muscle kept moist with Ringer's solution. Local polarization was avoided by reinserting the needles into fresh portions of the -exposed areas. Since it is possible to insert the needles into a muscle so that they lie next to a nerve strand, in which case the threshold is diminished, several readings were taken in order to obtain a uniform threshold.

Through another small slit in the skin the tendon of the same muscle was exposed, was isolated from its insertion, and fastened to a muscle lever by a strong thread passing about two pulleys arranged so that the muscle pulled in its normal direction. One leather thong about the hock and another around the foot just below the emergence of the tendon bound the leg to the animal holder and made a preparation having its normal blood supply unaltered except by the cutting of the *peroneus communis* nerve.

The muscle lever consisted of a pivoted steel bar, bearing a straw and writing point. The pull of the lever was about 15 gm. The lever and one pulley were supported by an iron tripod; the other pulley was fastened to the stand upon which the tripod stood. The thread from the tendon was attached to the lever directly above the point at which the spring was attached for fatigue. During threshold determination the lever without the spring was used. While fatiguing the muscle, the spring had, in the majority of cases, a tension of 120 gm. the moment the muscle began to contract, but in many cases it had an initial tension from 180 to 250 gm. The initial tension, however, was uniform during each experiment. For each 2 cm. excursion of the writing point on the drum surface the spring increased 60 gm. above the initial tension. Records of the contracting muscles were taken on a slowly moving drum in order to trace the

fatigue, and in no case was the muscle fatigued to a standstill. Weights — 120 and 200 gm. — were lifted in a few experiments; in all instances the muscle was after-loaded.

A few experiments were performed on animals in which the left *peroneus communis* nerve had been cut aseptically seven to fourteen days before the experiments. In these cases the *tibialis anticus* muscle was fatigued and the threshold determined through platinum needle electrodes thrust into the muscle itself.

The stimulating current for fatigue. — The stimulating current for fatigue was a maximum break induction shock obtained from a modified Martin key.¹ This key, made of vulcanite, is about three times the size of the Martin key and is divided similarly into two chambers — a large one and a small one — each filled with mercury and each bearing one of the poles. The chambers are connected by a small opening 2 mm. in diameter. A vulcanite disc, 8 cm. in diameter, also with an opening, revolves within the large chamber close to the partition and, except at the moment its opening coincides with the opening between the chambers, cuts the connecting column of mercury. In this manner the current is made and broken. In the later experiments a glass plate was fitted in the large chamber between the disc and partition to protect the vulcanite from wearing. A rectangular piece of vulcanite, extending to the bottom of the chamber, is placed close against the disc where it rotates into the mercury. By means of this shield the mercury surface is held stationary, and thus kept from excessive oxidation. A motor running at a uniform rate rotates the disc. The rate of make is varied by a series of pulleys on the motor and also by substituting for the original vulcanite disc other discs with two or more openings.

Because the make shock is subminimal while the break shock is maximal no effort is made to short-circuit it.

The rate of stimulation usually employed for fatigue was 120 stimuli per minute, but 240 was found quite as satisfactory and used in nearly as many cases. This rate was sufficiently slow to produce not vasoconstriction but vasodilation in the

¹ MARTIN: Measurement of induction shocks, New York, 1912, pp. 60-69.

vessels of the stimulated muscle.¹ For fatiguing the normal muscle the secondary of the inductorium was connected with the shielded electrode further from the muscle on the *peroneus communis* nerve; for fatiguing the muscle in which the nerve supply was degenerated, it was connected with the platinum needle electrodes thrust into the muscle itself.

Threshold determinations. — The method used for determining the threshold stimulus was the Martin method in which the strength of stimulus is calculated in β units.² When the threshold of the nerve-muscle was taken the apparatus for this determination was connected to the electrode nearer the muscle on the *peroneus communis* nerve, so that the kathode was next to the muscle, and separated from the fatiguing electrode by more than 3 cm. When the threshold of the muscle was taken directly the apparatus was connected to the platinum needle electrodes thrust into the muscle. The position of the secondary coil, in every case, was read by moving it away from the primary coil until the very smallest possible contraction of the muscle was obtained. Four of these readings were made, one with tissue resistance, and others with 10,000, 20,000 and 30,000 ohms resistance in the secondary circuit. Only break shocks were employed, the make shocks being short-circuited by the Martin key. Immediately after the determination of the position of the secondary coil, and before the electrodes were removed or disconnected, three readings of the tissue resistance were made.³ From these data three values for A, four for β and three values for tissue resistance were calculated as described by Martin, and Grabfield and Martin.⁴

The strength of the primary current for determining the threshold of the nerve-muscle was usually .01 ampere, but in a few cases .05 ampere was used. For normal muscle it was .05 ampere and for denervated muscle 1.0 ampere. The inducto-

¹ BOWDITCH and WARREN: *Journal of physiology*, 1886, vii, p. 416; BRADFORD: *Ibid.*, 1889, x, p. 390.

² MARTIN: *loc. cit.*, pp. 71-93.

³ MARTIN: *loc. cit.*, p. 26.

⁴ MARTIN: *loc. cit.*, pp. 71-93; GRABFIELD and MARTIN: *This journal*, 1913, xxxi, p. 301.

rium, which was used throughout, had a secondary resistance of 1400 ohms. This was added to the average tissue resistance in making corrections — corrections were made also for core magnetization. In this coil the value of K was 0.22.¹

THE EFFECT OF FATIGUE UPON THE THRESHOLD STIMULUS

The threshold for the *peroneus communis* nerve in decerebrate animals varied from 0.319 to 2.96 β units, with an average in sixteen experiments of 1.179. See Table I. This average is the same as that found by E. L. Porter for the radial nerve in the spinal cat.² For animals under urethane anaesthesia a higher average β was obtained. In these it varied from .644 to 7.05, or an average in ten experiments of 3.081. See Table II.

The threshold for the *tibialis anticus* muscle varied in the decerebrate animals from 6.75 β units to 33.07, or an average in fifteen experiments of 18.8. Ten experiments were performed under urethane anaesthesia and the threshold varied from 12.53 to 54.9, with an average of 29.849 β units. From these results it seems very evident that the kind of anaesthesia notably affects the threshold.

E. L. Porter will publish in a short time detailed observations showing that the threshold of a nerve-muscle may remain constant for hours. I have obtained the same results in several experiments. If, therefore, after fatigue, a change exists in the threshold this change is necessarily the result of alterations in the nerve-muscle or muscle set up by the fatigue process.

After fatigue, the threshold of the nerve-muscle, in the sixteen decerebrate animals, increased from an average β of 1.179 to 3.34 — an increase of 183 per cent. See Table I. In the ten animals under urethane anaesthesia the threshold after fatigue increased from a normal average β of 3.08 to 9.408 — an increase of 208 per cent. See Table II.

An equal increase in the threshold stimulus was obtained from the normal muscle directly. In decerebrate animals the

¹ See MARTIN: *loc. cit.*, p. 46; GRABFIELD and MARTIN: *loc. cit.*, p. 302.

² E. L. PORTER: This journal, 1912, xxxi, p. 149.

normal threshold of 18.8 β units was increased by fatigue to 69.54, or an increase of 274 per cent. With urethane anaesthesia the threshold increased from 29.849 to 66.238, or an increase of 122 per cent.

Fig. 1, plotted from the data of one of the many experiments, shows the relative heights of the threshold before and after fatigue. The two readings of the threshold, one from the nerve supplying the muscle and the other from the muscle directly, served as a check on the electrodes. The broken line in the curve represents the threshold (in β units) of the nerve-muscle and the continuous line that of the muscle. The threshold of the nerve-muscle is magnified ten times. In this experiment the threshold of the muscle after fatigue (i.e., at 2) is 167 per cent higher than the normal threshold (1) while that of the nerve-muscle after fatigue is 30.5 per cent higher than its normal.

Evidently a direct relation exists between the duration of the work and the increase in threshold. For instance, the threshold is higher after a muscle is fatigued for two hours than it is at the end of the first hour. The relation between the work done and the threshold is not so clear. In some animals the thresholds are higher after 120 gm. have been lifted 120 times a minute for 30 minutes than in others in which 200 gm. have been lifted 240 times a minute for the same period. The muscle in the latter did almost four times as much work, yet the threshold was lower. This may prove to be a good criterion as to the condition of the animal.

A few experiments were performed on animals in which the nerve supplying the muscle was cut seven to fourteen days previous to the experiment. The average normal threshold for the denervated muscle in 6 animals was 61.28 β units. As in the normal muscle the percentage increase due to fatigue was large.

THE INFLUENCE OF REST UPON THE FATIGUE THRESHOLD

That rest decreases the fatigue threshold of both nerve-muscle and muscle can be seen from Table III and Fig. 1. The time taken for total recovery, however, is dependent upon the amount of work done, but this change, like that of fatigue, varied widely with different individuals. In some animals the threshold

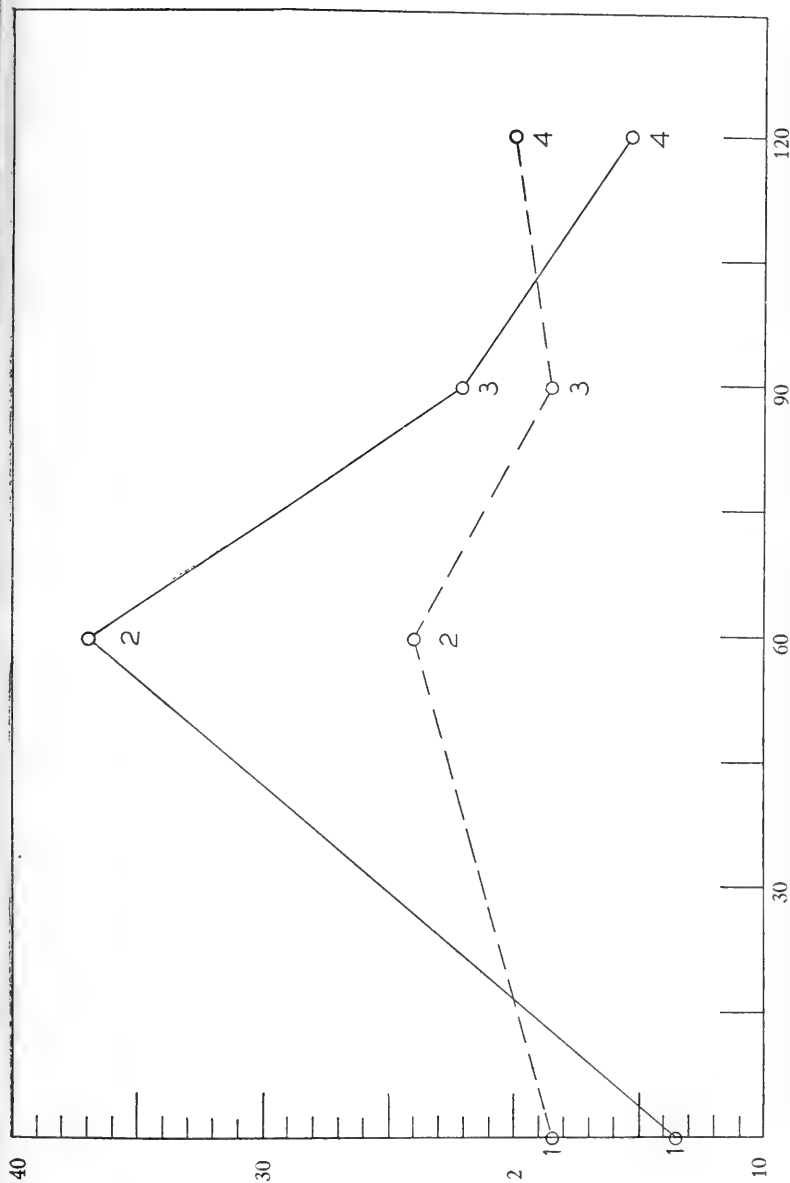

FIGURE 1. A curve plotted from the data of one experiment. The time interval in minutes is represented on the abscissa; the value of the threshold in β units is represented on the ordinate. The continuous line is the curve of the muscle, the broken line that of the nerve-muscle. The β of the nerve-muscle is magnified ten times, that of the muscle is normal.

- (1) Normal threshold stimulus.
- (2) Threshold after one hour's fatigue lifting 120 gm. 240 times per minute.
- (3 and 4) The thresholds after rest.

returned to normal in 15 minutes; in others, in which the same amount of work was done, it was still above normal even after 2 hours' rest. This may be due to the condition of the animals, — in some the metabolites are probably eliminated more rapidly than in others. There were also variations in the rate of restoration of the normal threshold when tested on the nerve and when tested on the muscle in the same animal. In Fig. 1 (at 3) the nerve muscle returned to normal in 30 minutes, whereas the muscle (at 4) after an hour's rest had not returned to normal by a few β units. This, however, is not typical of all nerve-muscles and muscles. The opposite condition — that in which the muscle returned to normal before the nerve-muscle — occurred in as many cases as did the condition just cited.

The time required for the restoration of the threshold from fatigue to normal, in denervated muscles, is approximately the same as that for the normal muscle.

SUMMARY

(1) The average threshold for the *tibialis anticus* muscle when taken from the *peroneus communis* nerve was, for decerebrate animals 1.179, and for animals in urethane anaesthesia 3.08 β units; when taken from the normal muscle directly it was, for decerebrate animals 18.8, and for animals in urethane anaesthesia 29.84 β units.

(2) The average threshold for the denervated muscle was 61.28 β units.

(3) Fatigue increases the normal threshold stimulus, on the average, between 100 and 200 per cent, but may increase it more than 600 per cent. This increase is dependent upon the duration of the work, but varies with each animal. This variation may be due to the condition of the animal.

(4) Rest of 15 minutes to 2 hours restores the normal irritability of the nerve-muscle and muscle. This decrease of the threshold depends upon the time given to rest, the duration of the work, and also upon the condition of the animal.

(5) Fatigue and rest have the same effect on denervated muscle as on normal muscle.

It is with pleasure that I avail myself of this opportunity

of thanking Dr. E. G. Martin for the use of his apparatus for these experiments, and for suggestions and instruction given to me in the use of his method. I also wish to thank Dr. Walter B. Cannon for helpful supervision of my work.

TABLE I

The Effect of Fatigue on the Threshold Stimulus of the *Tibialis Anticus* in Decerebrate cats. Measurements taken by the Martin Method from (I) the *Peroneus Communis* nerve; and (II) the Muscle directly.

I			II		
Normal β	Maximum fatigue β	Increase in per cent	Normal β	Maximum fatigue β	Increase in per cent
1.25	5.63	350.4	20.69	74.5	260.5
2.75	14.02	409.8	25.4	43.0	69.5
2.96	7.03	137.5	13.8	82.5	498.0
0.62	2.64	325.9	25.7	65.9	156.5
0.481	1.82	278.3	21.2	168.0	693.0
0.39	1.42	264.1	11.75	12.89	9.5
0.753	0.925	22.8	17.23	43.04	150.0
0.597	1.436	140.5	33.07	130.0	293.5
0.319	0.823	157.9	24.9	120.0	382.0
0.674	1.341	98.9	9.99	41.3	313.5
2.5	7.4	196.0	14.7	99.1	574.0
0.687	0.88	28.0	6.75	20.3	201.0
1.465	1.761	20.2	32.1	70.17	118.5
1.15	3.02	162.6	10.98	35.5	224.0
1.85	2.4	29.7	13.88	37.0	166.5
0.432	0.935	116.4			
Average 1.179	3.34		18.8	69.54	

I. Percentage increase of average $\beta = 183.5$
 II. Percentage increase of average $\beta = 274$

TABLE II

The Effect of Fatigue on the Threshold Stimulus of the *Tibialis Anticus* in cats in urethane anaesthesia. Measurements taken by the Martin Method from (I) the *Peroneus Communis* nerve; and (II) the Muscle directly.

I			II		
Normal β	Maximum fatigue β	Increase in per cent	Normal β	Maximum fatigue β	Increase in per cent
4.397	31.84	626.4	30.5	53.7	76.
7.05	23.7	236.3	54.9	112.9	105.5
5.45	21.5	294.5	49.3	195.	296.
1.98	2.91	46.9	22.3	51.75	132.
2.66	2.79	4.8	19.31	30.43	57.5
3.08	3.1	0.6	30.2	47.6	57.8
.644	1.64	154.6	32.7	71.3	118.
1.45	1.75	20.7	12.53	39.	201.5
1.15	1.61	40.	22.95	31.6	37.8
2.95	3.24	10.2	23.8	29.1	22.2
Average 3.081	9.408		29.849	66.238	

I. Percentage increase of average $\beta = 208$
 II. Percentage increase of average $\beta = 122$

TABLE III

The Influence of Rest upon the Fatigue Threshold of the *Tibialis Anticus* in decerebrate cats. Measurements taken by the Martin Method from (I) the *Peroneus Communis* nerve; and (II) the Muscle directly.

Time of rest H. M.	I			II		
	Normal β	Fatigue β	β after rest	Normal β	Fatigue β	β after rest
.30	.62	1.45	1.285	25.7	43.7	18.48
1.00	.432	.935	*.578	17.23	43.04	21.3
1.30	.674	1.431	1.005	9.99	41.3	30.6
1.00	2.5	7.4	1.485	14.7	99.1	47.3
.30	1.85	2.4	1.85	10.98	35.5	15.9
1.00	3.08	3.1	†1.92	13.88	37.0	15.8
.15				24.9	120.0	81.3
.15				18.7	32.3	23.5
Average	1.526	2.771	1.353	17.01	56.649	31.77

* 45 min.

† 30 min.



INDEX TO VOL. XXXII

- A**BSORPTION, of fat by stomach, 358.
 —, of water by skin, 286.
 —, relation to osmotic pressure, 1.
- Adrenalin, effect on blood pressure related to pituitrin, 241.
- Adrenal secretion, effect on muscle fatigue, 44.
- Altitude, effect on circulation and respiration, 295.
- Anemia, effect on nerve cells, 347.
- B**ILE, excluded from intestine without external fistula, 417.
- Blood, coagulation, action of thromboplastic substance, 211.
 —, preparation of thrombin, 264.
 —, thrombin and metathrombin, 266.
 —, pressure, affected by pituitrin and adrenalin, 241.
 —, auscultatory phenomena compared with sphygmomanometer tracing, 427.
 —, relation to muscle fatigue, 221.
 — salts, relation to cardiac contraction, 165.
- BURGE, W. E. The uniform rate of the destruction of pepsin by the passage of the direct electric current, 41.
- BURKET, I. R. *See* CANNON and BURKET, 347.
- C**ANNON, W. B., and I. R. BURKET. The endurance of anemia by nerve cells in the myenteric plexus, 347.
- CANNON, W. B., and L. B. NICE. The effect of adrenal secretion on muscular fatigue, 44.
- Carbohydrates, a source of fat, 200.
- Carbon dioxide, estimation, 137.
 — production of nerves, 107.
- CARLSON, A. J. Contributions to the physiology of the stomach.—V. The influence of stimulation of the gastric mucosa in the contractions of the empty stomach (hunger contractions) in man, 245.
- VI. A study of the mechanisms of the hunger contractions of the empty stomach by experiments on dogs, 369.
- VII. The inhibitory reflexes from the gastric mucosa, 389.
 — The tonus and hunger contractions of the empty stomach during parathyroid tetany, 398.
- Circulation, in high altitudes, 295.
 —, sphygmomanometer tracing and auscultatory phenomena, 427.
- Colon, receptive relaxation, 61.
- D**ENIS, W. *See* SCOTT and DENIS, 1.
 Diabetes, sugar consumption in, 184.
- E**XERCISE, effect on bulbar centres, 315.
 EISENBREY, A. B. *See* PEARCE and EISENBREY, 417.
- F**ASTING, changes in liver, 309.
 Fat, absorption in stomach, 358.
 —, from carbohydrates, 200.
- Fatigue, muscle, relation to blood pressure, 221.
 —, the threshold stimulus in, 438.
- G**ALVANOMETER, Einthoven, technique, 329.
- GESELL, R. A. On the relation of the pulse pressure to renal secretion, 70.
- GREENE, C. W., and W. F. SKAER. Evidence of fat absorption by the mucosa of the mammalian stomach, 358.
- GRUBER, C. M. *See* MARTIN and GRUBER, 315.
 — Studies in fatigue, 221.
 — Studies in fatigue. — II. The threshold stimulus as affected by fatigue and subsequent rest, 438.
- H**EART, contraction related to blood salts, 165.
- HOSKINS, R. G., and C. McPEEK. Is the depressor effect of pituitrin due to adrenal stimulation, 241.

- HOWELL, W. H. Rapid method of preparing thrombin, 264.
- Hunger, contractions of stomach, 369.
- , effect of water ingestion on fatty changes in liver, 309.
- , stomach contractions in parathyroid tetany, 398.
- , stomach, contractions on stimulation of mucosa, 245.
- I**NTESTINE, receptive relaxation of colon, 61.
- Irritability, of nerves, chemical hypothesis, 107.
- K**IDNEY, secretion affected by pituitary extract, 405.
- KING, C. E., and O. O. STOLAND. The effect of pituitary extract upon renal activity, 405.
- KITE, G. L. Studies on the physical basis of protoplasm. — I. The physical properties of the protoplasm of certain animal and plant cells, 146.
- L**IVER, fatty changes in fasting, 309.
- LUTZ, B. R. See WEYSSE and LUTZ, 427.
- LYMAN, H. The receptive relaxation of the colon, 61.
- M**ACLEOD, J. J. R., and R. G. PEARCE. The sugar consumption in normal and diabetic (depancreated) dogs after evisceration, 184.
- MCPEEK, C. See HOSKINS and MCPEEK, 241.
- MACRAE, F. W., JR., and A. G. SCHNACK. The action of thromboplastic substance in the clotting of blood, 211.
- MARTIN, E. G. On the relation of the blood salts to cardiac contraction, 165.
- MARTIN, E. G., and C. M. GRUBER. On the influence of muscular exercise on the activity of bulbar centres, 315.
- MAXWELL, S. S. On the absorption of water by the skin of the frog, 286.
- MORGULIS, S., and J. H. PRATT. On the formation of fat from carbohydrates, 200.
- Muscle, electric response in single twitch 336.
- , exercise, effect on bulbar centres, 315.
- , fatigue, relation to adrenal secretion, 44.
- , relation to blood pressure, 221.
- , the threshold stimulus, 438.
- N**ERVE CELLS, endurance of anemia, 347.
- Nerve centres, in bulb, affected by exercise, 315.
- Nerves, respiratory, 95.
- NICE, L. B. See CANNON and NICE, 44.
- O**SMOTIC PRESSURE, in absorption, 1.
- P**ARATHYROID TETANY, related to contractions of fasting stomach, 398.
- PARKER, G. H., and E. M. STABLER. On certain distinctions between taste and smell, 230.
- PEARCE, R. G. See MACLEOD and PEARCE, 184.
- PEARCE, R. M. A method of excluding bile from the intestine without external fistula, 417.
- Pepsin, destruction by electric current, 41.
- Phrenic nerve, origin, 65.
- Pituitary extract, effect on kidneys, 405.
- Pituitrin, pressor effect related to adrenalin, 241.
- PORTER, W. T., and A. H. TURNER. Direct and crossed respiration upon stimulation of the phrenic, the sciatic, and the brachial nerves, 95.
- PRATT, J. H. See MORGULIS and PRATT, 200.
- Protoplasm, physical properties, 146.
- Pulse pressure, relation to renal secretion, 70.
- R**ENAL SECRETION, relation to pulse pressure, 70.
- Respiration, in high altitudes, 295.
- , upon stimulation of phrenic, sciatic, and brachial nerves, 95.
- S**CHNACK, A. G. See MACRAE and SCHNACK, 211.
- SCHNEIDER, E. C. Physiological observations following descent from Pike's Peak to Colorado Springs, 295.
- SCOTT, G. G., and W. DENIS. The relation of osmotic pressure to absorption phenomena in the dog, 1.
- SKAER, W. F. See GREENE and SKAER, 358.
- Skin, absorption of water, 286.
- Smell, and taste, 230.
- SMIRNOW, M. R. The effect of water ingestion on the fatty changes of the liver in fasting rabbits, 309.

- SNYDER, C. D. Electromyogram studies.
 — I. On some technical procedures in the use of the Einthoven galvanometer, 329.
 — II. On the time relations and form of the electric response of muscle in the single twitch, 336.
- STABLER, E. M. *See* PARKER and STABLER, 230.
- STOLAND, O. O. *See* KING and STOLAND, 405.
- Stomach, empty, contractions in parathyroid tetany, 398.
 —, hunger contractions, 369.
 —, hunger contractions upon stimulation of the mucosa, 245.
 —, inhibitory reflexes from mucosa, 389.
- Sugar, consumption in eviscerated dogs, 184.
- TASHIRO, S. A new method and apparatus for the estimation of exceedingly minute quantities of carbon dioxide, 137.
- TASHIRO, S. Carbon dioxide production from nerve fibres when resting and when stimulated; a contribution to the chemical basis of irritability, 107.
- Taste, and smell, 230.
- Thrombin, preparation, 264.
 —, relation to metathrombin, 266.
- TROLAND, L. T. A definite physico-chemical hypothesis to explain visual response, 8.
- TURNER, A. H. Remarks on the origin of the phrenic nerve in the rabbit, cat, and dog, 65.
 —. *See* PORTER and TURNER, 95.
- VISION, physico-chemical hypothesis, 8.
- WEYMOUTH, F. W. The relation of metathrombin to thrombin, 266.
- WEYSSE, A. W., and B. R. LUTZ. A comparison of the auscultatory blood pressure phenomenon in man with the tracing of the Erlanger sphygmomanometer, 427.

665

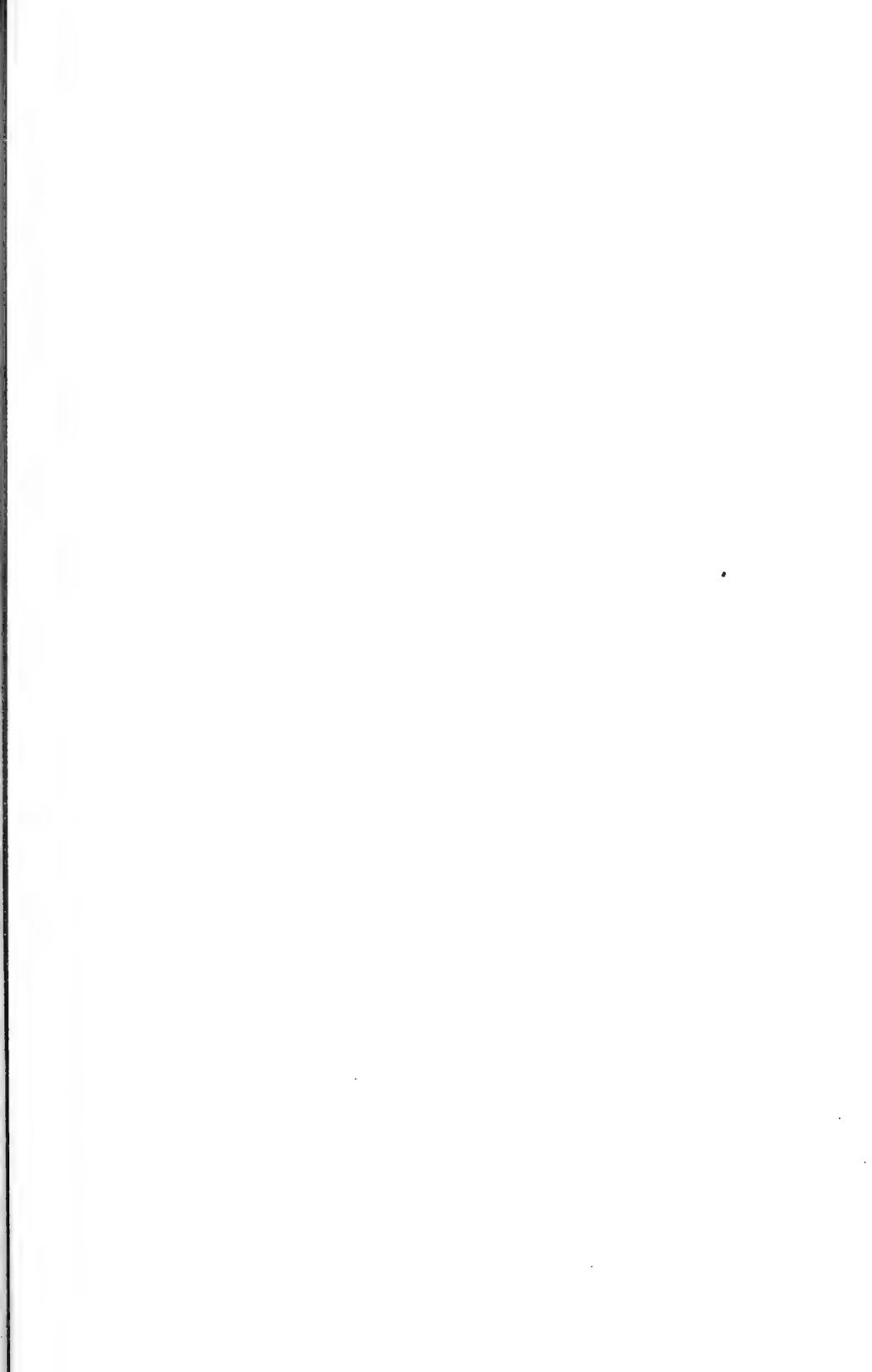

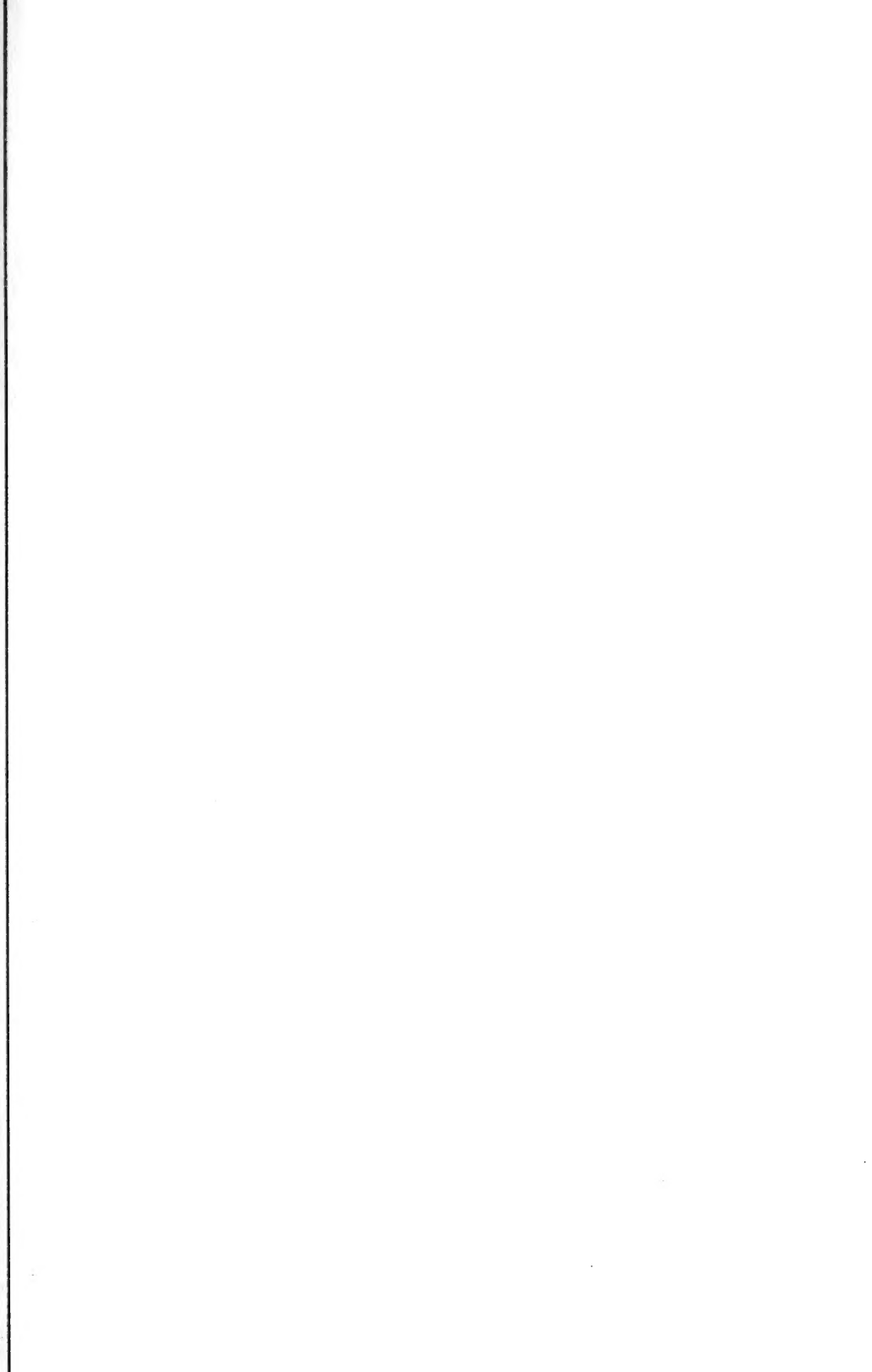



BINDING SECT. MAR 4 1966

QP American Journal of Physiology
1
A5
v.32
cop.2

1913

Biological
& Medical
Serials

PLEASE DO NOT REMOVE
CARDS OR SLIPS FROM THIS POCKET

UNIVERSITY OF TORONTO LIBRARY

STORAGE

