















505.73

1

717  
718

THE  
AMERICAN  
JOURNAL OF SCIENCE.

EDITOR: EDWARD S. DANA.

ASSOCIATE EDITORS

PROFESSORS GEO. L. GOODALE, JOHN TROWBRIDGE,  
W. G. FARLOW AND WM. M. DAVIS, OF CAMBRIDGE,

PROFESSORS A. E. VERRILL, HENRY S. WILLIAMS AND  
L. V. PIRSSON, OF NEW HAVEN.

PROFESSOR GEORGE F. BARKER, OF PHILADELPHIA,

PROFESSOR JOSEPH S. AMES, OF BALTIMORE,

MR. J. S. DILLER, OF WASHINGTON.

---

FOURTH SERIES.

VOL. XIII—[WHOLE NUMBER, CLXIII.]

WITH EIGHT PLATES.

---

NEW HAVEN, CONNECTICUT.

1902.



THE TUTTLE, MOREHOUSE & TAYLOR CO.  
NEW HAVEN, CONN.

171465

CONTENTS TO VOLUME XIII.

Number 73.

	Page
ART. I.—Experimental Investigation into the "Skin"-effect in Electrical Oscillators ; by C. A. CHANT .....	1
II.—Influence of Hydrochloric Acid on the Precipitation of Cuprous Sulphocyanide ; by R. G. VAN NAME .....	20
III.—Action of Ammonium Chloride upon certain Silicates ; by F. W. CLARKE and G. STEIGER .....	27
IV.—Studies of Eocene Mammalia in the Marsh Collection, Peabody Museum ; by J. L. WORTMAN .....	39
V.—A Cosmic Cycle ; by F. W. VERY .....	47

SCIENTIFIC INTELLIGENCE.

*Chemistry and Physics*—Chemical Reactions produced by Radium, BERTHELOT, 59.—Preparation of Nitrogen from Ammonium Nitrate, J. MAI: Atomic Weight of Tellurium, PELLINI: Artificial Spinel, DUFAY, 60.—Size of the Sulphur Molecule, BILTZ and PREUNER: Direct Gravimetric Method for the Estimation of Boric Acid, PARTHEIL and ROSE: Pressure of Light, E. L. NICHOLS, G. F. HULL and P. LEBEDEV, 61.—Chemical Effects produced by Radium Radiations, H. BECQUEREL: Induction Coil, Lord RAYLEIGH: Resistance in High Vacua, W. ROLLINS, 62.—Studies from the Chemical Laboratory of the Sheffield Scientific School, H. L. WELLS, 63.—Light; A Consideration of the more familiar Phenomena of Optics, C. S. HASTINGS, 64.

*Geology and Mineralogy*—Lamarck, the founder of Evolution, his life and work, with translations of his writings on Organic Evolution, A. S. PACKARD, 65.—Congrès Géologique international; Comptes Rendus de la VIII<sup>e</sup> session, en France, A. GAUDRY and C. BARROIS, 67.—Preliminary Description of the Geology and Water Resources of the Southern Half of the Black Hills and adjoining Regions in South Dakota and Wyoming, N. H. DARTON, 68.—Newark System of Pomperaug Valley, Connecticut, W. H. HOBBS and F. H. KNOWLTON: Influence of Winds upon Climate during the Pleistocene Epoch, F. W. HAPMER, 70.—Relative Density of Fluid and Solid Magmas, 71.—Siebengebirge am Rhein, H. LASPEYRES: New Mineral Names, 72.—Mineralogy of California, A. S. EAKLE and W. C. BLASDALE: New localities of Nephrite, A. DIESELDORFF, 73.—World's Largest Diamond, 74.

*Zoology and Botany*—Reports on the Natural History of Porto Rico, 75.—Alcyonaria of Porto Rico, C. W. HARGITT and C. G. ROGERS: Mollusca of Porto Rico, W. H. DALL and C. T. SIMPSON: Birds of North and Middle America, R. RIDGEWAY: Capillaranalyse beruhend auf Capillaritäts- und Adsorptionerscheinungen, mit dem Schlusskapitel: das Emporsteigen der Farbstoffe in den Pflanzen, F. GOPPELSROEDER, 78.—Plant Life of Alabama, C. MOHR, 79.

*Astronomy*—Leonids in 1901: Leonids at Phoenix, Arizona, D. S. LANDIS, 79.—Leonids at Havre, Montana, C. W. LING, 80.

## Number 74.

	Page
ART. VI.—Geometric Sequences of the Coronas of Cloudy Condensation, and the Contrast of Axial and Coronal Colors ; by C. BARUS .....	81
VII.—New Occurrence of Sperrylite ; by H. L. WELLS and S. L. PENFIELD .....	95
VIII.—A Cosmic Cycle, Part II ; by F. W. VERY .....	97
IX.—Studies of Eocene Mammalia in the Marsh Collection, Peabody Museum ; by J. L. WORTMAN .....	115
X.—Miniature Anemometer for Stationary Sound Waves ; by B. DAVIS .....	129
XI.—Occurrence of Fossil Remains of Mammals in the Interior of the States of Pernambuco and Alagôas, Brazil ; by J. C. BRANNER. With Plate I. ....	133
XII.—Estimation of Copper as Cuprous Sulphocyanide in the Presence of Bismuth, Antimony, Tin and Arsenic ; by R. G. VAN NAME .....	138
XIII.—Composition of Yttrialite, with a Criticism of the formula assigned to Thalénite ; by W. F. HILLEBRAND. 145	

## SCIENTIFIC INTELLIGENCE.

*Chemistry and Physics*—Apparatus for Determining the Density of Liquids, F. GIRARDET: Supposed Existence of an Oxide of Hydrogen higher than the Dioxide, RAMSAY, 153.—Atomic Weight of Calcium, HINRICHSSEN: Silver Subhalides, EMSZT: Atomic Weight of Tellurium, KÖTHNER, 154.—Compounds of Hydrogen Peroxide with Salts, S. TANATAR: Drift of the Ether, W. M. HICKS: Clearing of Troubled Solutions, G. QUINCKE: Displacement Currents, M. R. BLONDLOT, 155.—Frequency-determination of slow Electrical Vibrations, K. E. F. SCHMIDT: Bearing of the upward and downward movement of Air on Atmospheric Electricity, F. LINKE: Notes on Quantitative Spectra of Beryllium, W. N. HARTLEY, 156.—Vector Analysis, E. B. WILSON, 158.

*Geology and Natural History*—Catalogue of the Types and figured Specimens in the Palæontological collection of the Geological Department, American Museum of Natural History, R. P. WHITFIELD and E. O. HOVEY, 159.—Laccoliths of the Black Hills, T. A. JAGGAR, JR., 160.—Analcite in Igneous Rocks, J. W. EVANS: Researches on Cellulose, 1895-1900, C. F. CROSS and E. J. BEVAN, 161.—Memorial Greenhouses at the Harvard Botanic Garden, 162.

*Obituary*—CLARENCE KING, 163.—ALPHEUS HYATT: THOMAS MEEHAN, 164.



## Number 75.

	Page
ART. XIV.—Ventral Integument of Trilobites; by C. E. BEECHER. (With Plates II-V.) .....	165
XV.—Igneous Rocks from Eastern Siberia; by H. S. WASHINGTON .....	175
XVI.—A Cosmic Cycle, Part III; by F. W. VERY .....	185
XVII.—Studies of the Eocene Mammalia in the Marsh Collection, Peabody Museum; by J. L. WORTMAN. (With Plate VI.) .....	197
XVIII.—Experimental Method in the Flow of Solids and its Application to the Compression of a Cube of Plastic Material; by J. R. BENTON .....	207
XIX.—Occurrence of Monazite in Iron Ore and in Graphite; by O. A. DERBY .....	211
XX—Molecular Weights of some Carbon Compounds in Concentrated Solutions with Carbon Compounds as Solvents; by C. L. SPEYERS .....	213
—	
CLARENCE KING .....	224

## SCIENTIFIC INTELLIGENCE.

*Chemistry and Physics*—Manufacture of Sulphuric Acid by the Contact Process, KNIETSCH: Metallic Carbides, MOISSAN, 238.—Potassium Hydride, MOISSAN: Electrical Conductivities produced in Air by the Motion of Negative Ions, TOWNSHEND: Kind of Radio-activity imparted to certain Salts by Cathode Rays, J. C. McLENNAN, 240.—Radio-active Bodies, M. P. and S. CURIE: Outlines of Electrochemistry, H. C. JONES: Chemische Organisation der Zelle, F. HOFMEISTER, 241.—Beitraege zur Chemischen Physiologie und Pathologie, F. HOFMEISTER, 242.

*Geology and Natural History*—Occurrence of Chrompicotite in Canada, G. CHR. HOFFMANN, 242.—Still Rivers of Western Connecticut, W. H. HOBBS: Petrographisches Praktikum, R. RHEINISCH, 243.—Grasses of Iowa, L. H. PAMMEL, J. B. WEEMS, and F. LAMSON-SCRIBNER: Birds of North and Middle America, R. RIDGEWAY, 244.

*Miscellaneous Scientific Intelligence*—Smithsonian Institution, Documents Relative to its Origin and History, 1835-1899: Scientia, 244.

## Number 76.

	Page
ART. XXI.—Use of the Stereographic Projection for Geographical Maps and Sailing Charts; by S. L. PENFIELD	245
XXII.—Hind Limb of Protostega; by S. W. WILLISTON	276
XXIII.—Physical Effects of Contact Metamorphism; by JOSEPH BARRELL	279
XXIV.—Expedition to the Maldives; by A. AGASSIZ	297
XXV.—Flower-like Distortion of the Coronas due to Graded Cloudy Condensation; by C. BARUS	309
XXVI.—Varying degrees of Actinism of the X-Rays; by J. O. HEINZE, JR.	313

## SCIENTIFIC INTELLIGENCE.

*Chemistry and Physics*—Separation of Hydrochloric and Hydrocyanic Acids, RICHARDS and SINGER: Volumetric Determination of Copper, Antimony, Iron, etc., by Means of Stannous Chloride, WEIL, 315.—Comparison of the Properties of Hydrogen Selenide with those of Hydrogen Sulphide, FORCAND and FONZES-DIACON: Radio-active Thorium, HOFMANN and ZERBAN, 316.—Lithium Antimonide, LEBEAU: Synthesis of Formic Acid, MOISSAN: Elements of Physical Chemistry, H. C. JONES, 317.—Velocity of Sound in Air and different Vapors with Ordinary and High Temperatures, E. H. STEVENS: Chemical Action of Cathode Rays, G. C. SCHMIDT: Effects of Currents of High Frequency upon the Human Body, H. ANDRIESEN, 318.—Distribution of Electric Current on Electrodes in rarefied Media, A. WEHNELT: Stratifications of Hydrogen, W. CROOKES: Magnetic Declination Chart for the United States in 1902: Die Fortschritte der Physik im Jahre 1902; Halbmonatliches Litteratur-verzeichniss, K. SCHEEL and R. ASSMANN, 319.

*Geology*—United States Geological Survey, 320.—Fauna and Geography of the Maldive and Laccadive Archipelagoes, J. S. GARDINER: Formation of the Maldives, J. S. Gardiner, 321.—Om de sennglaciale og postglaciale nivåforandringer i Kristianiafjeldet (Molluskfaunan), W. O. BRÖGGER: Berkeley Hills; A Detail of Coast Range Geology, A. C. LAWSON and C. PALACHE, 322.—Gesteine der Ecuatorianischen Ost-Cordillere, Der-Cotopaxi und die umgebenden Vulkanberge, A. YOUNG: Der grosse Staubfall vom 9. bis 12. März, 1901, in Nordafrika, Süd- und Mitteleuropa, G. HELLMANN and W. MEINARDUS, 323.—Ricerche Petrografiche e Geologiche sulla Valsesia di E. ARTINI e G. MELZI: Influence of Country Rock on Mineral Veins, W. H. WEED: Additional notes on the Cambrian of Cape Breton, with descriptions of new species, G. F. MATTHEW, 324.—Analysis of Mount Vernon Loess, N. KNIGHT.

*Botany and Zoology*—Horticultural Experiments and Botanical Investigations at the Harvard Station in Cuba, 325.—Professor van Tieghem's Classification of Plants, 326.—Botanisches Centralblatt: Additions to the Fauna of the Bermudas from the Yale Expedition of 1901, with Notes on Other Species, A. E. VERRILL: (1) Variations and Nomenclature of Bermudian, West Indian, and Brazilian Reef Corals, with Notes on the Various Indo-Pacific Corals; (2) Comparisons of Bermudian, West Indian, and Brazilian Coral Faunæ, A. E. VERRILL, 327.—Some Spiders and Mites from the Bermuda Islands, N. BANKS: Marine and Terrestrial Isopods of the Bermudas, with Descriptions of New Genera and Species, H. RICHARDSON, 328.—British Museum Catalogues: Bermuda and the Challenger Expedition, G. W. COLE, 329.

*Miscellaneous Scientific Intelligence*—Report of the Secretary of the Smithsonian Institution for the Year ending June 30, 1901: Important Discovery in Color Photography, 329.—Lehrbuch der Meteorologie, J. HANN: American Philosophical Society: New Theory of Evolution, A. W. SMITH, 330.

*Obituary*—ALBERT RIPLEY LEEDS.

## Number 77.

	Page
ART. XXVII.—Notes on Living Cycads. I. On the Zamias of Florida; by G. R. WIELAND .....	331
XXVIII.—Crystals of Crocoite from Tasmania; by R. G. VAN NAME .....	339
XXIX.—Notes on Unusual Minerals from the Pacific States; by H. W. TURNER .....	343
XXX.—Use of the Stereographic Projection for Geographical Maps and Sailing Charts; by S. L. PENFIELD .....	347
XXXI.—Note on the application of the Phase Rule to the fusing points of copper, silver, and gold; by T. W. RICHARDS .....	377
XXXII.—Initiative Action of Iodine and of Other Oxidizers in the Hydrolysis of Starch and Dextrins; by F. E. HALE .....	379
XXXIII.—Note on the Possibility of a Colloidal State of Gases; by C. BARUS .....	400
XXXIV.—Glacial Remains near Woodstock, Connecticut; by J. W. EGGLESTON .....	403

## SCIENTIFIC INTELLIGENCE.

*Chemistry and Physics*—Determination of Carbon in Steel, LEFFLER: New Synthesis of Methane, SEBATIER and SENDERENS, 409.—Calcium silicide, MOISSAN and DILTHEY: Specific Heat, and Volumetric Determination of Vanadium, MATIGNON and MONNET, 410.—Presence of Tellurium in American Silver, VINCENT: Dissipation of Electrical Charges by Vapor, H. BEGGEROW: Hertzian Waves in Storms, M. F. LARROQUE: Electric Waves in Coils, E. LÜDIN: Measurements of Wave Lengths in the Sun's Spectrum, A. PEROT and C. FABRY, 411.—Spectrum of Gases at High Temperatures, TROWBRIDGE: Wireless Telegraphy, G. W. DETUNZELMANN: Laws of Radiation and Absorption, D. B. BRACE: Beitrage zur chemischen Physiologie und Pathologie, F. HOFMEISTER, 412.

*Geology and Natural History*—Geological Commission Cape of Good Hope, G. S. CORSTORPHINE: Western Australia: Sulphur, Oil and Quicksilver in Trans-Pecos, Texas, W. B. PHILLIPS: Untersuchung einiger Gesteinssuiten gesammelt in Celebes, C. SCHMIDT, 413.—Notes on Corals of the genus *Acropora* (*Madrepora* Lam.) with new Descriptions and Figures of Types, and of several New Species, A. E. VERRILL: Course in Invertebrate Zoology, H. S. PRATT, 414.

*Miscellaneous Scientific Intelligence*—National Academy of Sciences: American Association for the Advancement of Science, 415.—National Bureau of Standards: The Centenary of Hugh Miller: Ostwald's Klassiker der Exakten Wissenschaften: British Association Meeting at Glasgow, 1901; Discussion on the Teaching of Mathematics, J. PERRY: Basis of Social Relations, D. G. BRINTON, 416.

## Number 78.

	Page
ART. XXXV.—Fossil Faunas and their use in correlating Geological Formations; by H. S. WILLIAMS .....	417
XXXVI.—Studies of Eocene Mammalia in the Marsh Collection, Peabody Museum; by J. L. WORTMAN. (With Plates VII and VIII.) .....	433
XXXVII.—Transmission of Sound through Solid Walls; by F. L. TUFTS .....	449
XXXVIII.—New Gauge for the Measurement of Small Pressures; by E. W. MORLEY and C. F. BRUSH .....	455
XXXIX.—Hitherto Untried Form of Mounting, either Equatorial or Altazimuth, for a Telescope of exceptional size, either refractor or reflector, in which Telescope, observing-floor and dome are combined in one; by D. P. TODD	459
XL.—Occurrence of Uranophane in Georgia; by T. L. WATSON .....	464
XLI.—Internal Structure of Cliftonite; by J. M. DAVISON ..	467

## SCIENTIFIC INTELLIGENCE.

- Chemistry and Physics*—Heatless Condition of Matter, BRINKWORTH and MARTIN, 469.—Method for Assaying Pyrites, BUDDÉUS: Germanium Hydride, VOEGELEN, 470.—Compounds of Beryllium with Organic Acids, LACOMBE: Use of Floats in Burettes, KREITLING: Beiträge zur Chemischen Physiologie und Pathologie, F. HOFMEISTER: Velocity of Light, MICHELSON, 471.—Ultra-Violet of the Mercury Spectrum, H. LEHMANN and R. STRAUBEL: New Peculiarity in the Structure of the Cyanogen Bands, A. S. KING: Stationary Electric Waves, K. F. LINDMAN: Oscillatory Discharges, H. ANDRIESEN: Meteorologische Optik, J. M. PERNER, 472.—Instruments et Méthodes de Mesures Electrique Industrielles, H. ARMAGNAT: Size of Nuclei, C. BARUS, 473.
- Geology*—Geological Survey of Canada, Summary Report of the Geological Survey department for the Calendar year 1901, R. BELL, 473.—Field Operations of the Division of Soils, M. WHITNEY: Mineral Wealth of the Black Hills, C. C. O'HARRA: Corundum Twins, W. E. HIDDEN: Genesis of Ore Deposits, 474.—Coal in Michigan, its mode of occurrence and quality, A. C. LANE: Adepagous and Clavicorn Coleoptera from the Tertiary Deposits at Florissant, Colorado, S. H. SCUDDER: Acrothyra and Hyolithes—a Comparison; Hyolithes gracilis and related forms from the Lower Cambrian of the St. John Group; A backward step in Palæobotany, G. F. MATTHEW, 475.—Ostracoda of the basal Cambrian rocks in Cape Breton, G. F. MATTHEW: Fossil Mammals of the Tertiary of Northeastern Colorado, W. D. MATTHEW, 476.—Pleistocene Geology of portions of Nassau County and Borough of Queens, J. B. WOODWORTH, 477.
- Botany*—Recherches sur le développement du tégument séminal et du péricarpe des Graminées, P. GUÉRIN, 478.—Alpine plants from Tibet and the Andes, W. B. HEMSLEY and H. H. W. PEARSON, 479.
- Miscellaneous Scientific Intelligence*—Smithsonian Institution Publications: United States Coast and Geodetic Survey. Annual Report 1900, O. H. TITTMAN, 479.—Elementary Calculus, P. F. SMITH: Prize for Scientific Work by Women: Fortschritte der Physik im Jahre 1902; Halbmonatliches Litteratur-verzeichniss, K. SCHEEL and R. ASSMANN, 480.
- Obituary*—HENRY MORTON: M. ALFRED CORNU: DR. ALEXANDER BITTNER: M. HENRI FILHOL, 480.

THE

# AMERICAN JOURNAL OF SCIENCE

[FOURTH SERIES.]

---

ART. I.—*An Experimental Investigation into the "Skin"-effect in Electrical Oscillators*; by C. A. CHANT.

1. *Introductory and Theoretical.*

THE first explicit reference to the fact that, when a conductor is subjected to a periodic electromotive force, the current is not uniformly distributed over a cross-section of the conductor, is to be found in Art. 690 of Maxwell's *Electricity and Magnetism*. Upon obtaining the equation connecting the impressed electromotive force with the effective electromotive force and the inductive electromotive force he introduces terms which "express the correction of this value [of the inductive electromotive force] arising from the fact that the current is not of uniform strength at different distances from the axis of the wire. The actual system of currents has a greater degree of freedom than the hypothetical system in which the current is constrained to be of uniform strength throughout the section. Hence the electromotive force required to produce a rapid change in the strength of the current is somewhat less than it would be on this hypothesis."

It is quite certain, however, that Maxwell did not foresee the great interest and importance which the subject was destined soon to develop.

In a series of papers written between 1884 and 1887 Heaviside\* dealt with the entire question of the propagation of electric currents into conductors and of magnetization into cores when produced by a periodic electromotive force. He was one of the first to insist that the action should be considered as entering the conductor from the surrounding dielec-

\* *Electrical Papers*, vol. i, pp. 353, 429; vol. ii, p. 168.

tric. He compares the transmission of the effect into the metal to the transmission of motion into the inner portions of liquid in a cylindrical vessel when the vessel is given a rotatory vibration about its axis.

Especial attention was drawn to the subject by Hughes,\* who treated the question experimentally.

In 1886 Rayleigh† published his well-known paper in which he obtained expressions for the resistance and self-induction of a straight conductor carrying a periodic current. For very rapid oscillations the resistance

$$R' = \sqrt{\left(\frac{1}{2} p l \mu R\right)} \quad (1)$$

in which  $l$  is the length of the conductor,  $\mu$  its magnetic permeability,  $R$  its resistance to steady currents and  $p = 2\pi n$ , where  $n$  is the frequency.

In 1890 Stefan,‡ in a paper on electric oscillations in straight conductors, also obtained formulas for the resistance and self-induction. With very high frequency his expression for the resistance is

$$R' = R\pi a \sqrt{\frac{n\mu}{\sigma}} \quad (2)$$

where  $a$  is the radius of the conductor and  $\sigma$  its specific resistance. This formula is equivalent to that given by Rayleigh. He remarks that for very great frequencies metallic conductors act much as though without resistance, but electrolytes behave very differently on account of their very high resistance. He finds that for a cylindrical copper conductor 1<sup>cm</sup> in diameter, with a frequency of 50 millions, the current density at a depth of 0.004<sup>cm</sup> is only 1/100 of that at the surface; while for a tube of equal size of carbon disulphide the current density at the center is but 0.8 per cent lower than at the surface,—in other words, the current is practically uniform.

If, now, the action enters the conductor from the surrounding dielectric and is prevented from penetrating very far by the rapidity of the oscillations, it is evident that very thin layers of metal should be sufficient to ward off electrical undulations, either by absorption or reflection.

In a paper published in 1889 Hertz§ described experiments made to find out how thick a metallic film was needed to screen from his rapid oscillations. Tinfoil, Dutch metal and gilt paper acted perfectly. The thickness of the metal on the latter he estimated at 1/20<sup>mm</sup> though it was probably much

\* Jour. Soc. Tel. Engineers, Jan. 28, 1886.

† "On the Resistance and Self-induction of Straight Conductors," Phil. Mag., May, 1886, p. 382; Scientific Papers, vol. ii, p. 486.

‡ Wied. Ann., xli, p. 400, 1890.

§ Electric Waves, p. 160.

less than that amount. Chemically deposited silver failed when the film was so thin as not to be opaque to light. The thickness of this film he places at less than  $1/1,000^{\text{mm}}$ . It was probably not  $1/10$  of that thickness and, moreover, hardly continuous metal. He remarks that the action of the waves scarcely penetrates farther into the wire than does the light which is reflected from its surface. Similar experiments on the screening effect of extremely thin metal leaf are given by Lodge and others.

A calculation of the superficial shell effective in the reflection of Hertzian oscillations is given by Poincaré,\* who finds the thickness at which the effect is  $\frac{1}{e}$  of its amount at the surface,

$$\begin{array}{l} \text{for frequency, } n = 50 \times 10^9, \text{ thickness} = 0.002^{\text{cm}}; \\ \text{“ “ “ } n = 500 \times 10^9, \text{ thickness} = 0.006^{\text{cm}}. \end{array}$$

This estimate is probably too high.

J. J. Thomson has treated the “skin”-effect with considerable fulness. In a note appended by him to Art. 690 of the third edition of Maxwell† he obtains as the resistance per unit length of the conductor

$$R' = \left( \frac{\mu p \sigma}{2\pi a^2} \right)^{\frac{1}{2}} \quad (3)$$

where the symbols have the meanings given above. This, again, is the same as the values obtained by Rayleigh and Stefan.

We can obtain the relative current densities at different depths below the surface for any given frequency in the following way. Stefan‡ has shown that if  $w$  be the component of the current in the direction of the axis of  $z$ , and if it does not vary with  $z$ , the equation

$$\frac{dw}{dt} = \frac{\sigma}{4\pi\mu} \left( \frac{d^2w}{dx^2} + \frac{d^2w}{dy^2} \right) \quad (4)$$

must be satisfied.

When the depth to which the action penetrates is small the effect of curvature of the surface may usually be neglected, in which case (4) may be replaced by

$$\frac{dw}{dt} = \frac{\sigma}{4\pi\mu} \frac{d^2w}{dx^2} \quad (5)$$

\* Oscillations Électriques, p. 246 and fol.

† See also Recent Researches, p. 246 and fol.

‡ Sitzungsberichte der Wiener Akad. der Wiss., xcvi (II), p. 917, 1887.

This is Fourier's well known equation of diffusion, which Lord Kelvin\* has shown to be applicable to the motion of a viscous fluid, as of closed electric currents within a homogeneous conductor, of heat, of substances in solution, of electric potential in the conductor of a submarine cable; and, indeed, to every case of diffusion in which the substance concerned is in the same condition at all points of any one plane parallel to a given plane.

Suppose, now, the periodic current at the surface to be represented by

$$w = I \sin pt \quad (6)$$

We have to solve (5) subject to the conditions,

$$w = I \sin pt, \text{ when } x = 0 \quad (7)$$

$$w = 0 \quad \text{“} \quad t = 0 \quad (8)$$

The solution is

$$w = \frac{2}{\sqrt{\pi}} I \left[ \sin pt \int_x^{\infty} \frac{e^{-\beta^2} \cos \frac{p\alpha^2}{4\kappa^2\beta^2} d\beta}{2\kappa\sqrt{t}} - \cos pt \int_x^{\infty} \frac{e^{-\beta^2} \sin \frac{p\alpha^2}{4\kappa^2\beta^2} d\beta}{2\kappa\sqrt{t}} \right] \quad (9)$$

wherein  $\kappa^2 = \sigma/4\pi\mu$ .

As  $t$  increases the condition of affairs approaches a “permanent” state, and then (9) reduces to†

$$w = I e^{-x} \sqrt{\frac{2\pi\mu p}{\sigma}} \sin \left( pt - x \sqrt{\frac{2\pi\mu p}{\sigma}} \right) \quad (10)$$

At the surface, i. e. when  $x=0$ , the maximum value of the current is  $I$ . It becomes  $\frac{1}{e}$  of this value at a depth

$$x = \sqrt{\frac{\sigma}{2\pi\mu p}} = \frac{1}{2\pi} \sqrt{\frac{\sigma}{\mu n}} \quad (11)$$

This depth J. J. Thomson‡ and Poincaré§ take as the thickness of the “skin.” The difference in phase between the current at the surface and that at this depth is easily obtained from (10), and is

$$1 \text{ (radian)} = 57.3^\circ$$

For high frequencies this thickness becomes exceedingly small, and an object of the present investigation was to see if an oscillator behaved differently when the metal constituting

\* Report of British Assoc., 1883, p. 571.

† See Byerly's Fourier's Series and Spherical Harmonics, Art. 51.

‡ Recent Researches, pp. 260, 281.

§ Oscillations Électriques, p. 252.



it was thinner than this “skin”; and if so, what was the critical thickness in any particular case.

In the experiments to be described oscillators were used with frequencies approximately 375, 825, 2000, 3200 millions per second, respectively. Substituting these values for  $n$  in the above value (11) for  $x$ ; and taking  $\mu=1$ ,  $\sigma=1600$ , approximately, for copper or gold, 13,500 for platinum and 4,770,000 for electric-light carbon, we obtain the following table:

TABLE I.

Frequency $n$ Millions.	Thickness of “skin.”		
	Copper. cms.	Platinum. cms.	Carbon. cms.
375	0·00033	0·00092	0·01749
825	0·00022		
2000	0·00014		
3200	0·00011		

We can obtain an approximate value for the thickness of the “skin” in another way. Suppose the conductor to be a circular cylinder. From Stefan’s formula (2)

$$\frac{R'}{R} = \pi a \sqrt{\frac{n\mu}{\sigma}};$$

and assuming that, as with steady currents, the resistance is inversely proportional to the area of the section used by the current, the oscillatory current must occupy the  $R/R'$ th part of the section. Since this portion is a thin layer next the surface we have

$$\begin{aligned} 2\pi ax &= \frac{R}{R'} \times \pi a^2, \\ &= \pi a \sqrt{\frac{n\mu}{\sigma}} \times \pi a^2, \\ \text{and } x &= \frac{1}{2\pi} \sqrt{\frac{\sigma}{n\mu}}; \end{aligned}$$

which turns out to be precisely the value we obtained before (11).

Hertz\* stated that, as far as he could observe, the nature of the metal out of which his *resonator* was formed had no influence upon the phenomena, but experiments by Bjerknest† did not confirm this conclusion. He found the efficiency of the metals: copper, brass, silver, platinum, nickel, iron, to be in the order in which they are here named. By depositing elec-

\* Electric Waves, p. 45.

† Wied. Ann., xlviii, p. 592, 1893.

trolytically on the surface of a metal forming a resonator a shell of another metal, he determined what thickness he must add in order that the resonator should behave as though formed of the second metal. He used an electrometer method, and his results are shown in the following table:

TABLE II.

	Original Reading.	Final Reading.	Thickness of Layer.
Copper on iron . . . . .	13·4	105	0·012 <sup>mm</sup>
Zinc on iron . . . . .	13·4	71	0·016 “
Zinc on copper . . . . .	100	80	0·012 “
Nickel on copper . . . . .	100	40	0·010 “
Cobalt on copper . . . . .	100	10	0·003 “
Iron on copper . . . . .	100	10	0·003 “

The wave-length used by Bjerknæs was 420<sup>cms</sup> and the frequency, therefore, about 70 millions per second.

I have not been able to find any record of experiments on the thickness of the effective portion of the metal of an *oscillator* except by Preece and Righi.

The former, in describing experiments made in conjunction with Marconi on signaling without wires, says:\*

“The distance at which effects are produced with such rapid oscillations depends chiefly on the energy of the discharge that passes. A six-inch-spark coil sufficed through 1, 2, 3, up to four miles, but for greater distances we have used a more powerful one—one emitting sparks 20 inches long. It may be pointed out that this distance increases with the diameter of the spheres and it is nearly doubled by making the spheres solid instead of hollow.”

He used the regular Righi oscillator with 10<sup>cm</sup> spheres sparking in vaseline oil, from which, he says, there were emitted waves 120<sup>cms</sup> in length, with a frequency of 250,000,000 per second. How this wave-length was determined is not given.

Righi states:†

“Finally I made the perhaps unlooked-for observation that an oscillator composed of hollow spheres is less effective than one such of massive spheres. For example, when the oscillator had massive spheres of about 4<sup>cms</sup> diameter, the action on a resonator first ceased at about 11 meters; while, on the other hand, it ceased at about six meters when these spheres were replaced by hollow ones of equal external diameter and about 1·5<sup>mm</sup> of wall-thickness. Two others with yet decidedly thin-

\* Proc. Royal Inst., vol. xv, p. 472 (1897).

† Righi, *Optik der elektrischen Schwingungen*, pp. 14, 15.

ner walls gave still smaller effects. The knobs connected to the machine\* might, however, quite as well be hollow as solid, and also, within certain limits, might be of less or greater diameter without the efficiency of the oscillator being thereby affected.”

As just remarked, these are the only references to the subject that I have found. Indeed, considering the importance of the oscillating doublet, it is somewhat surprising that so little has been done in the direction of a satisfactory theory of it.

2. The Oscillators.

The oscillators were of two types,—cylindrical and spherical, respectively. The cylinders were circular in section with hemispherical ends; and were  $2.5\text{cms}$  in diameter and  $12.5\text{cms}$  long. For exciting the oscillator an induction coil capable of giving a  $12.5\text{cm}$  spark was used. It was placed in a metal-lined box and connections were made to it as follows.

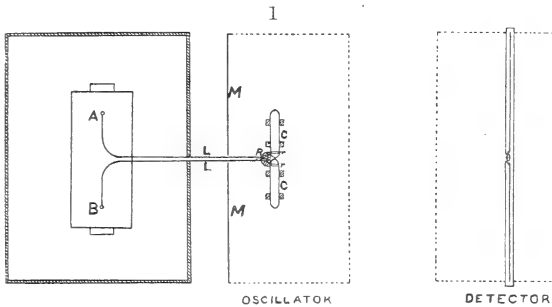

The cylinders C, D (figs. 1, 2) were placed along the focal line of a parabolic reflector M, made of sheet zinc, being held in position by wooden supports hollowed to receive them. To the ends of the wires LL, were soldered strips  $r, r$  of brush copper about  $5\text{mm}$  wide bent into circular form as shown in G (fig. 2). The ends of the cylinders were slipped into these copper holders, and a rubber band placed about the holder drew it closely to the cylinder, thus insuring good and ample contact. The wires were then led through a wooden block R (shown in fig. 2), into which they were securely wedged, and then through small glass tubes firmly held together by rubber tape; and were finally joined to A and B, the terminals of the secondary of the coil. The glass tubes passed through openings in the mirror M and the box. By this arrangement a pair of cylinders could be removed and another pair substi-

\* Influence electrical machine.

tuted for them, while the connections remained precisely the same.

The spark gap was always the same for the cylinders, being about  $0.7^{\text{mm}}$  long.

The spherical oscillators were of the Righi pattern. The spheres C, D (fig. 3), were held in circular discs of hard rubber, in which openings had been turned to receive them, by melting paraffine about them. The smaller knobs, K, K, were on the ends of jointed rods, R, R, which were held in hard rubber rods N, N, rigidly fastened to the disks carrying the spheres. By this means the knobs could be adjusted to the spheres and would remain so when the spheres were adjusted to each other. To allow this latter to be done one disc was held to the horizontal support beneath by a screw passing up

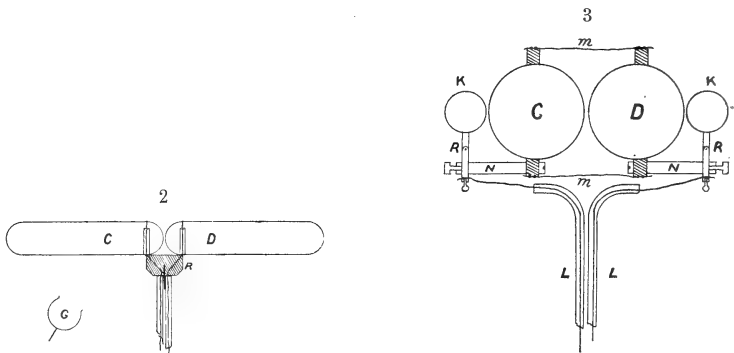

through the support into it, while the other could be slid along the support by a screw. The entire arrangement is shown in fig. 4. The spheres were of three sizes. With those  $2.5^{\text{cms}}$  and  $4^{\text{cms}}$  in diameter, knobs K, K of diameter  $19^{\text{mm}}$  were used. When the spheres had a diameter of  $10^{\text{cms}}$ , the knobs had a diameter of  $37^{\text{mm}}$ .

The membrane,  $m, m$ , was first softened by soaking for a few minutes in water and glycerine, and was then securely bound to the circumference of the hard rubber discs by cords which rested in grooves made to receive them. The membrane was such as is used as a container for the familiar "Bologna sausage," and was obtained at a large packing house. It made a perfectly oil-tight vessel, fig. 4, the largest oscillator being in action for hours without a single drop of oil escaping.

The oil used was described as *white liquid vaseline*.

When in operation the oscillator was placed in the parabolic reflector on a suitable support, seen in fig. 5, and was connected to the coil by wires, L, L, passing through tubes as in case of the cylinders.

The interrupter was that used by G. W. Pierce with his radio-micrometer.\* It consisted of a platinum-tipped rod which, by means of a fan-motor, was rapidly plunged into and withdrawn from a cup of mercury, the surface of which was kept clean by a stream of water continually flowing over it. In series with the interrupter was a pendulum contact-maker. The metallic rod of the pendulum carried a platinum wire

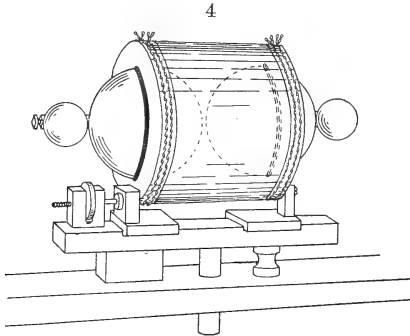

soldered to its lower end, which, as the pendulum swung to and fro, dipped into a mercury trough. By raising or lowering the pendulum, the time during which it was immersed in the mercury was shortened or lengthened. This was so adjusted that whilst the pendulum made circuit during a

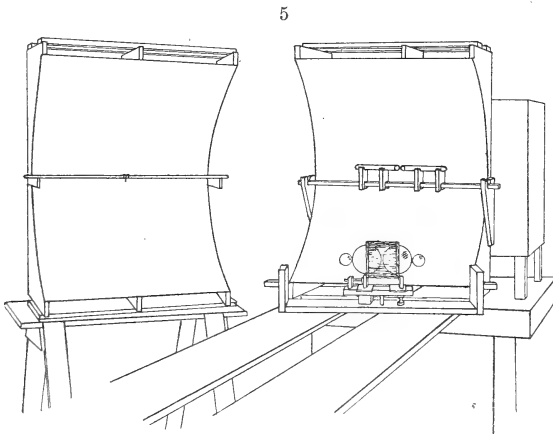

single semi-oscillation, the motor-break made about six interruptions. In addition an ordinary key was in circuit. This was pressed down while the pendulum made any desired num-

\* This Journal, vol. ix, p. 252, 1900.

ber of vibrations. For most of the work the key was depressed for 10 swings of the pendulum, that is, for about 60 interruptions of the coil. Thus in the primary circuit the current traversed in succession the primary of the induction coil, the motor-break, the pendulum rod into the mercury and the circuit-key. The battery consisted of 10 storage cells arranged in two banks in multiple, i. e., giving 10 volts of E.M.F.

The parabolic mirrors, both for oscillator and receiver, were 75<sup>cms</sup> high, 60<sup>cms</sup> wide, and had a focal length of 12·5<sup>cms</sup>. At first reflectors of but 5<sup>cms</sup> focal length were tried, but they were entirely useless, the reflected waves apparently destroying completely the direct waves.\*

### 3. *The Receiver.*

As a receiver I used the magnetic detector devised by Rutherford† and described by him in 1896. A few inches of iron wire 0·14<sup>mm</sup> in diameter were dipped in melted paraffine and, after cooling, the wire was cut into about 20 pieces. Holding these together, about 90 turns of fine (No. 40) insulated copper wire were wound upon about 1<sup>cm</sup> of their length; and after the protruding ends of the iron wire had been cut off and the fine wire had been soldered to heavier copper wires, the helix with its iron core was mounted in the end of a small glass tube, the connecting wires being drawn through the other end of the glass tube. The helix was kept in place by simply dipping the tube in melted paraffine and then allowing it to cool. The entire arrangement is shown (half size) in fig. 6. The helix is seen at H, and the ends of the wire are shown at *e, e*, curved as they were used.

On a wooden rod about 65<sup>cms</sup> long two wires (fig. 7) were fastened with soft wax, their near-together ends terminating in small mercury cups. The bar was cut out at its central portion so that the detector D could hang vertically with its ends in the mercury cups. Thus the wings became electrically a portion of the wire of the helix. The wooden bar was mounted in a parabolic reflector so that the wire lay along a focal line (fig. 5).

The method of using was as follows: The iron of the detector was first magnetized to saturation by being thrust into a helix in which a current was made to circulate. The detector was then hung so as to connect with its wings, and on placing it in the field of an electric oscillator, the surgings gathered up by the wings destroyed a portion of the magnetization of the iron. The change in the magnetization was observed in a magnetometer.

\* I had forgotten Hertz's experience. See *Electric Waves*, pp. 172, 175.

† *Phil. Trans.*, A 1897, vol. 189, pp. 1-24.

A section of the magnetometer is shown at M in fig. 8. It was of the plainest construction, consisting simply of a mirror 10<sup>mm</sup> in diameter with two small steel magnets fastened on the back by paraffine, and suspended by a silk fiber about 12<sup>cms</sup> long. Behind it was a block B, in which a small glass tube, closed at one end, was wedged. The inner diameter of this tube was approximately equal to the outer diameter of the detector

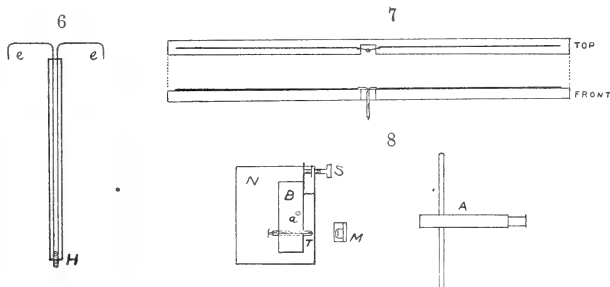

tube, so that the latter moved snugly into the former, and, when pushed in as far as it would go, was in a definite position which could easily be recovered.

The block B was fastened on the upper face of a board N by a screw *a* around which it could be given a slow motion by a screw S, thus easily making the detector approach or recede from the magnetometer by a small amount. The telescope and scale A were about 120<sup>cms</sup> from the magnetometer.

The position of the magnetometer was adjusted so that when the detector, fully saturated, was pushed into the tube T, the magnetometer deflection was 40<sup>cms</sup>, the scale being numbered so that this read zero. After partial demagnetization through the electrical oscillations, it was replaced in its position behind the magnetometer and the alteration in reading observed directly.

It was found that the detector could be removed and replaced with no observable difference in the reading; and successive magnetizations to saturation produced the same deflection.

Rutherford\* showed that the demagnetization produced by rapid oscillations is confined to the outer layers of the magnet. The diffusion of the magnetic force from the dielectric into a magnetizable substance is, indeed, similar to the passage of electrical action into a conductor. Hence for rapidly alternating currents the magnetic action is confined to the outer layers, the more rapid the alternation the thinner the layer affected. Hence the reason for using fine wire and insulating the pieces from each other. By so doing more surface is pre-

\* Loc. cit.

sented to the dielectric and the effect is greater. In some of his detectors Rutherford used iron wire  $0.07^{\text{mm}}$  in diameter, (i. e., only one-half the diameter of mine), with 160 turns of fine wire on the helix, and much longer wings. Thus he was able to obtain noticeable effects at a distance of over half a mile from the oscillator, which consisted of large plates. My detector, however, was sensitive enough for my purpose.

In the report\* on Hertzian Oscillations presented by Righi to the International Congress of Physicists in Paris in 1900, he enumerated 21 kinds of apparatus for indicating the presence of electric oscillations. Of these the magnetic detector is one of the easiest to manage and possibly the simplest for quantitative comparisons, though I know of few investigations in which it has been used.† Its sensitiveness increases as the wings are lengthened, and the greatest difficulty I experienced arose from the fact that it is especially sensitive to the surgings in the connecting wires of the oscillator. An illustration may be interesting.

A wire three meters long was stretched from one terminal of the secondary of an induction coil across to the side of the room, and sparks were made to pass between the ordinary pointed terminals of the coil. The coil was in the basement of the laboratory. A fully magnetized detector, with wings each about  $90^{\text{cms}}$  long arranged parallel to the wire running out from the coil, was placed in position by the magnetometer, giving the usual deflection of  $40^{\text{cms}}$ . The magnetometer was in a room on the next floor above, and was distant about 35 meters, with brick walls, numberless wires and other pieces of metal between; and yet, as soon as sparks began to pass at the coil the magnetometer deflection was reduced by  $2^{\text{cms}}$ .

The detector was also used to determine the wave-length of the oscillators used. The wave-length for the cylinders was found to be approximately  $80^{\text{cms}}$ ; that for the  $10^{\text{cm}}$  spheres, approximately  $38.5^{\text{cms}}$ , i. e. 3.85 times the diameter. An account of these experiments will be published later. Using these results the frequencies given in Table I were obtained.

#### 4. *Experiments on the "skin"-effect.*

During the study of the "skin"-effect cylindrical oscillators with the dimensions given above were made as follows:—

- No. 1. Solid brass.
- No. 2. Solid Norway iron.

\* Rappports présentés au congrès international de Physique réuni à Paris en 1900. Tome 2, p. 301 (Paris, 1900).

† In the June (1901) Phil. Mag. is a paper by C. G. Barkla, in which are described experiments on the relative velocities of electromagnetic disturbances along wires of different diameters, in which the magnetic detector was used as an indicator.



- No. 3 and No. 4. Copper 1.5<sup>mm</sup> and 0.8<sup>mm</sup> thick, respectively. The mantle was of copper tubing and the hemispherical ends were spun and then soldered on.
- No. 5. Solid electric-light carbon.
- No. 6. Sheet platinum, over a wooden form. The mantle was 0.0013<sup>cms</sup> thick; the hemispherical ends, which were soldered on, were 0.015<sup>cms</sup> thick.
- No. 7. Sheet silver. Mantle, 0.002<sup>cms</sup>; ends, 0.014<sup>cms</sup>.
- No. 8. Tin foil, 0.0025<sup>cms</sup> thick, on a wooden form.
- No. 9. Gold leaf laid upon a wooden form. According to manufacturer, the leaf was about 1/220,000 inch, or 0.0000114<sup>cms</sup>, thick.
- No. 10. Silver leaf laid upon wood. Thickness about 0.00003<sup>cms</sup>. Upon cylinders covered with gold leaf copper was deposited electrolytically, the thickness of the copper being in No. 11, No. 12, No. 13, No. 14, No. 15, respectively, 0.0001, 0.00015, 0.0002, 0.0003, 0.0005<sup>cms</sup>.
- No. 16. Silver deposited chemically on glass blown to the proper shape. The thickness, obtained by weighing, was approximately 0.000013<sup>cms</sup>.

In order to have the ends between which the sparks were to pass as nearly alike as possible these ends were faced with sheet platinum of a thickness 0.003<sup>cms</sup>. By means of a die discs of 1<sup>cm</sup> diameter were punched from the sheet. In the case of cylinders No. 1 to No. 4 these discs, after being given the proper spherical curvature, were soldered directly on the cylinder, after which the surplus solder was removed and the platinum polished by a buffing-wheel.

In the case of No. 5, copper was first deposited on the end, and a cap with curvature rather greater than that of the end face was cemented on with shellac. To do this a small piece of shellac was placed on the end and the cap placed in position over it. The shellac was melted by holding a hot wire on the cap, which was then pressed by the finger firmly against the end until the shellac hardened. In this way excellent contact was made all about the circumference of the cap.

No. 6 had excellent platinum faces already, and No. 7 was left without them. On all the rest caps were fastened as on No. 5, i. e., directly cemented with shellac.

Later on, some of the caps were secured in place by holding them firmly against the end of the cylinder and then depositing copper on the edge of the cap and on the cylinder where it rested. This certainly insured perfect electrical connection, and is superior to the cementing method, being more durable, but the results obtained were not noticeably better.

By referring to Table I, it will be seen that for every frequency mentioned there gold and silver leaf are decidedly thinner than the "skin" as there given; while, in the case of the lowest frequency (that of the cylinders), beside the gold and the silver leaf, the metallic portion of cylinders numbered 11, 12, 13, 14 and 16 was thinner than the calculated "skin." One would expect, therefore, that if the efficiency of the oscillator depends on the thickness of the metal constituting it, that dependence would manifest itself in the use of these cylinders; but extended and careful observation failed to detect any evidence whatsoever of such an effect.

The manner of experimenting was as follows: The cylinders were placed in position in the zinc reflector, and the connections and sparking-distance carefully adjusted. Then the magnetized detector was hung in the other reflector, which was placed directly before the first reflector with a certain distance (usually 30<sup>cms</sup> at first) between the focal lines of the two. The key was then depressed while the pendulum made ten swings, after which the detector was placed in its pocket behind the magnetometer and the change noted in the scale reading. The detector was then magnetized again and the same work performed with the mirrors at a greater distance apart. This was continued until readings at a sufficient number of distances had been secured. Then another pair of cylinders was taken and a similar set of readings obtained.

Rutherford reported that in his experiments no difference could be detected whether the first semi-oscillation in the receiver tended to magnetize the core or the reverse, but in my experiments this was very evident. For instance, on putting the detector in place at 30<sup>cms</sup> from the oscillator, a scale reading of 57<sup>mm</sup> was obtained. Next, after re-magnetizing, the detector was hung up so that the face presented to the oscillator was the reverse of that in the former case; in other words, if the detector were now raised out of its mercury cups, turned through 180° about its axis and then dropped into its cups again, its first position would have been recovered. With the detector in this second position a deflection of but 37<sup>mm</sup> was obtained. The oscillator is very dead-beat, and with the detector in the first position, the first (and greatest) pulse received by it was in the direction to demagnetize the core; in the second position this first pulse was in the opposite direction in the helix, and the total resulting demagnetization was not so great. This difference in reading gradually diminished as the detector was withdrawn from the oscillator, and at about 60<sup>cms</sup> it disappeared. In Table III is given a series of readings at distances between 30 and 90<sup>cms</sup>, the two positions of the detector being denoted by 1 and 2.

TABLE III.

Distance of Oscillator from Detector. cms.	Oscillator; position of detector; and scale reading in mm.							
	No. 1.		No. 9.		No. 11.		No. 13.	
	1	2	1	2	1	2	1	2
30	50	25	57	39	50	30	63	48
40	30	22	47	31	34	24	50	41
50	27	26	35	35	30	24	44	38
60	27	25	36	32	29	32	44	43
70	23	22	28	28	25	29	--	--
80	22	20	31	25	27	26	35	35
90	20	20	29	26	25	27	--	--

It would naturally be suspected that this reversal effect was due to the direct action of the coil or of the connecting wires; but on removing the cylinders and substituting therefor small knobs no effect was obtained. Indeed the wings of the detector were made at right angles to the wires leading from the coil to the oscillator in order to avoid such action. Moreover, if it were due to the direct action, the effect would have been more pronounced with the spherical oscillators, but such was not the case.

The readings in the table show irregularity in the action of the oscillators, though I believe it is not so great as in many experiments with electric waves, a fact due largely to the constancy of the interrupter used.

In Table IV readings obtained with various cylinders are exhibited. Each reading is the mean of the two readings obtained, at the distance indicated, by the detector in its two positions. An examination of the results will lead to the conclusion that, for frequencies as high as those here used, the effectiveness of an oscillator is not impaired by using a thin shell instead of a solid.

As stated above, the platinum caps were soldered to the iron and brass cylinders, and were then given an excellent polish. The caps on the gold-leaf and other delicate shells could not be polished in this way. They were simply rubbed clean with chamois. One would naturally expect, therefore, that the solid cylinders would perform best, but such was not the case. Indeed the brass and iron oscillators were the hardest to adjust and seemed about the *least* effective; and the gold-leaf acted so continuously better than the solid that I began to think its thinness was a determining factor. The average of the readings for gold-leaf given in the table is decidedly better than

for the brass oscillator, and numerous other readings accentuated this result. Afterwards, however, the platinum shell (No. 6) was constructed, and proved the most reliable and efficient of all. Now this shell was thicker than the calculated "skin" (Table I), and further, on wrapping two layers of heavy

TABLE IV.

Distance of Oscillator from Detector. cms.	No. of Oscillator; scale-reading in mm.															
	No. 1.	No. 2.	No. 5.	No. 6.	No. 7.	No. 8.	No. 9.	No. 10.	No. 11.	No. 12.	No. 13.	No. 14.	No. 15.	No. 16.		
30...	37	46	47	46	37	39	39	52	40	48	49	46	57	44		
	47	26	49	69	45		58		42		55		46	34		
	49		54				47									
40...	22	40	28	38	--	33	30	40	28	34	37	43	45	38		
	26			51			39		33		46					
	29						40									
50...	26	28	28	37	--	32	26	35	27	30	47	37	41	37		
	30	17	30	44			35		32		41		29			
	30			35			38									
60...	20	26	32	39	35	30	19	33	30	32	41	40	40	27		
	26			47			34		31		43		26	27		
	28															
70...	18	--	25	--	--	32	19	28	27	28	31	26	36	29		
	22						28									
80...	16	21	25	33	22	30	18	26	27	25	26	31	30	--		
	21	12		35			38		23		35		22			
	20						29									
90...	20	--	24	--	--	29	27	25	26	21	23	27	29	--		
100...	18	--	18	25	--	26	23	21	26	19	21	22	28	--		
	22		23	26			24									
120...	13	17	12	22	--	20	14	19	22	15	18	19	25	--		
	15	10		23			23		19		26		15			
140...	11	--	--	19	--	15	11	14	17	13	15	15	17	--		
	10		15	18			17									
160...	12	12	8	12	--	17	14	14	14	13	12	18	13	--		
	10	8		17			21		12		19		10			
180...	12	--	7	--	--	12	11	11	12	9	12	12	14	--		
200...	8	5	6	11	--	11	10	10	11	6	10	12	10	--		
			11	12					12							

tin-foil (thickness  $0.005^{\text{cms}}$ ) about the mantle and binding it closely there, no alteration whatever was made in its efficiency. The proper conclusion, therefore, seemed to be that, within the limits of the experiments, the thickness of the metal had no effect.

If one could obtain a thin continuous carbon shell, possibly more decisive experiments might be made, as the "skin" for carbon is comparatively thick, but such was not available.

The magnetic nature of the iron made no difference whatever; iron and brass were indistinguishable in their behavior. Silver did not appear equal to platinum as a spark-surface.

As the experiments with cylindrical shells failed to exhibit any trace of the “skin”-effect, it was decided to try with spheres, and Righi oscillators with spheres 2.5, 4, and 10<sup>cms</sup>, respectively, in diameter were constructed. By these solid brass spheres were compared with gold-leaf spherical shells of the same diameter. The latter were made by covering with gold-leaf accurately turned and beautifully polished lignum-vitae spheres of the required sizes.

TABLE V.  
Spheres 2.5<sup>cms</sup> in Diameter.

Distance of Oscillator from Detector. cms.	Detector position; and scale readings in mm.								Mean.
	I		II		III		IV		
	1	2	1	2	1	2	1	2	
			1. Solid						
30	40	44	41	40	46	39	46	35	41.4
50	27	23	24	23	18	20	25	25	23.1
100	15	13	12	8	11	10	12	13	11.8
140	10	7	9	7	8	8	11	7	8.4
200	7	7	7	4	7	4	10	5	6.4
250	7	5	6	5	5	7	8	6	6.1
300	7	6	5	4	4	5	4	5	5.0
			2. Shell.						
30	39	40	46	37	40	41	50	45	42.3
50	18	22	20	16	22	24	27	28	22.1
100	10	12	10	12	13	13	16	15	12.6
140	8	7	8	7	8	7	12	12	8.6
200	6	4	6	5	5	5	15	9	6.9
250	6	6	6	4	7	5	10	11	6.9
300	5	7	5	7	4	3	10	8	6.1

In the oscillators composed of solid spheres the brass surface was used as sparking faces. Observation showed that, in air, newly polished brass is at least equal and possibly superior to sheet platinum, and the oil dielectric prevents the rapid deterioration of the surface.

For the gold-leaf shells platinum faces were necessary. Two

were fastened on each sphere, at the extremities of a diameter, by electro-deposition of copper.

The results obtained with the three oscillators are given in Tables V, VI and VII, which explain themselves. With the

TABLE VI.  
Spheres 4<sup>cms</sup> in Diameter.

Distance of Oscillator from Detector.  cms.	Detector position; and scale readings in mm.								Mean.
	I		II		III		IV		
	1	2	1	2	1	2	1	2	
			1. Solid						
30	73	64	--	60	65	56	68	50	62.3
50	33	--	46	40	30	43	32	30	36.3
100	26	28	20	18	16	17	14	10	18.6
140	18	15	12	10	10	10	7	10	11.5
200	8	8	--	9	--	--	5	4	6.8
250	8	9	9	7	7	6	4	--	7.1
300	6	5	7	5	5	5	3	2	4.8
			2. Shell.						
30	70	43	74	60	66	48	60	51	59.0
50	32	31	40	36	28	33	33	33	33.3
100	15	14	15	16	14	15	18	16	15.4
140	7	9	15	11	10	13	11	11	10.9
200	10	9	10	6	5	9	7	7	7.9
250	8	10	8	8	6	--	6	8	7.7
300	7	7	12	7	--	--	5	4	7.0

solid spheres the first reading was usually the highest, but with the shells there were usually two or three indifferent ones to start with. This was observed with platinum faces generally. The readings recorded are: for the solid spheres, the first 8 taken; for the 4<sup>cm</sup> shells, the first 8; for the 2.5<sup>cm</sup> shells, the last 8 of a series of 14; and for the 10<sup>cm</sup> shells, all the satisfactory readings obtained.

The 4<sup>cm</sup> spheres seem to show evidence, at the distance of 30<sup>cms</sup>, of the reversal effect mentioned above, but it disappeared before a distance of 50<sup>cms</sup> was reached. With the other spheres no trace of the phenomenon can be found.

No difficulty at all was experienced in handling the smaller spheres, but the larger ones gave some trouble. But a single reading had been secured with the first pair of 10<sup>cm</sup> shells

before one of them failed. Veins appeared in the gold-leaf encircling one platinum cap. On replacing this sphere by a new one only three or four readings were secured before the other sphere of the first pair failed in the same way. This was removed and a new one put in its place, and with the pair thus formed the readings in Table VII were obtained.

TABLE VII.  
Spheres 10<sup>cms</sup> in Diameter.

Distance of Oscillator from Detector. cms.	Detector position; and scale reading in mm.								Mean.
	I		II		III		IV		
	1	2	1	2	1	2	1	2	
			1. Solid.						
50	97	117	120	80	133	78	98	95	102.3
100	81	90	88	104	78	100	66	72	84.9
200	55	57	52	43	47	40	39	45	47.3
300	34	34	37	35	38	35	29	27	33.6
500	13	14	10	10	12	10	10	9	11.0
600	9	11	8	7	6	8	6	7	7.8
700	7	4	6	5	5	3	5	8	5.4
			2. Shell.						
50	110	92	113	107	136	115	120	85	109.5
100	101	85	73	89	76	80	93	89	85.8
200	45	45	49	44	--	--	--	--	45.8
300	30	34	32	34	--	31	--	--	32.2
500	15	12	--	--	--	--	--	--	13.5
600	7	10	--	--	--	--	--	--	8.5
700	5	6	--	--	--	--	--	--	5.5

If curves be drawn with the mean readings of Tables V, VI and VII as ordinates and the distances from the oscillator as abscissae, the curve for a shell will be found to practically coincide with that for the solid sphere of the same diameter. The experiments, therefore, indicate that, both in the case of the cylindrical and of the spherical doublets, the excessively thin gold-leaf shells were quite as efficient as the solid metal bodies.

This investigation was made in the Jefferson Physical Laboratory, Harvard University; and while under especial obligation to Professor Trowbridge for his never-failing consideration and encouragement, I would express my gratitude to every member of his staff for innumerable kindnesses.

Jefferson Physical Laboratory, Harvard University.

ART. II. — *The Influence of Hydrochloric Acid on the Precipitation of Cuprous Sulphocyanide*; by R. G. VAN NAME.

[Contributions from the Kent Chemical Laboratory of Yale University.—CV.]

IN a previous contribution to this Journal\* the writer gave the results of a series of experiments upon the estimation of copper by precipitating and weighing as cuprous sulphocyanide. It was concluded from this work that the process did not lose greatly in accuracy even when quite large amounts of sulphuric or hydrochloric acid were present. In discussing the results obtained, however, no distinction was made, as should have been done, between free acid originally present in the solution and that remaining in the free state after the addition of the precipitants, ammonium bisulphite and ammonium sulphocyanide.

With hydrochloric acid the effect of the bisulphite, as will be shown, is to convert a definite quantity of acid into ammonium chloride, so that by increasing the bisulphite the free acid present when the copper is precipitated may be diminished to any desired extent.

The results obtained by precipitating copper in solutions containing various amounts of hydrochloric acid, weighing as cuprous sulphocyanide, and determining the copper in the filtrate, are given in Table I.

In neutral or faintly acid solutions cuprous sulphocyanide is precipitated in a very finely divided state and often shows a tendency to pass through the filter with the wash water as soon as the latter becomes nearly free from dissolved salts. This may be prevented by washing with a salt solution. For this reason the precipitates were washed with decinormal ammonium sulphocyanide, a medium in which cuprous sulphocyanide is even less soluble than in pure water.

An electrolytically standardized copper sulphate solution of about  $\frac{1}{5}$  normal strength was measured out in portions of 50<sup>cm</sup><sup>3</sup> for the first seven determinations. For the last four, like quantities of approximately  $\frac{1}{20}$  normal copper sulphate were taken. The required amount of strong hydrochloric acid of specific gravity 1.17–1.18 was then added, followed, after diluting, by ammonium bisulphite and ammonium sulphocyanide in the order named, the last in measured portions of a standardized decinormal solution. The ammonium bisulphite solution was prepared by saturating aqueous ammonia with sulphur dioxide.

After precipitation the mixture was allowed to stand for

\* Vol. x, 451.



TABLE I.  
Final volume 200<sup>cm</sup>3.

Cu taken. grm.	HCl sp. grav. 1.17-1.18. cm <sup>3</sup> .	HNH <sub>4</sub> SO <sub>3</sub> sat. sol. cm <sup>3</sup> .	NH <sub>4</sub> SCN approx. %/10. cm <sup>3</sup> .	Cu <sub>2</sub> S <sub>2</sub> (CN) <sub>2</sub>		Cu. grm.	Error. grm.	Cu in filtrate and NH <sub>4</sub> SCN washings.		Cu in alcohol washings.		Total Cu found. grm.
				found. grm.	Calc. as Cu. grm.			grav. grm.	color. grm.	grav. grm.	color. grm.	
1.	.3163	5	60	.6085	.3180	+ .0017	.0001	.00005	.0001	none	.3180	.3180
2.	.3163	5	60	.6076	.3176	+ .0013	.0000	.00006	.0001	.0000	.3177	.3177
3.	.3163	4	60	.6083	.3179	+ .0016	.0001	.00015	.0001	.00004	.3181	.3181
4.	.3163	6	60	.6072	.3173	+ .0010	.0002	.0003	.0000	.00007	.3175	.3175
5.	.3163	8	60	.6081	.3178	+ .0015	.0003	.0005	.0000	.00009	.3181	.3181
6.	.3163	8	60	.6078	.3177	+ .0014	.0004	.0004	.0002	.00002	.3176	.3176
7.	.3163	12	60	.6069	.3172	+ .0009	.0002	.00018	.0000	.00008	.0798	.0798
8.	.0793	12	120	.1521	.0795	+ .0002	.0008	.00054	.00007	.00005	.0801	.0801
9.	.0793	25	120	.1512	.0790	—	.0003	.00054	.00007	.00008	.0796	.0796
10.	.0793	12	120	.1518	.0793	+ .0000	.0000	.00063	.00008	.00005	.0801	.0801
11.	.0793	25	120	.1495	.0781	— .0012	.0012	.00135	.00007	.00008	.0798	.0798

forty-eight hours or more before filtering, the final volume being in every case 200<sup>cm</sup><sup>3</sup>.

The precipitates were collected upon asbestos in a perforated platinum crucible, washed thoroughly with a decinormal solution of ammonium sulphocyanide and then with alcohol to remove any excess of the ammonium sulphocyanide, dried at 105° and weighed. It should be mentioned in this connection that no distinct instance of the apparent tendency of cuprous sulphocyanide to increase slightly in weight on prolonged heating at 110°, described in the article before referred to, was noticed during the present investigation.

The tests for copper in the filtrates were made by evaporating the solution with nitric acid to a small bulk, heating in a platinum crucible over a radiator to expel sulphuric acid and decompose interfering substances, dissolving the residue in nitric acid, filtering, electrolyzing and weighing the copper.

As the gravimetric results thus obtained were not sufficiently accurate for small amounts of copper, the copper was also determined by the following colorimetric method.

The electrolytic deposit was dissolved in nitric acid and the solution, contained in a small beaker of about 15<sup>cm</sup><sup>3</sup> capacity placed against a white background, was neutralized with ammonia and made faintly acid with acetic acid. A dilute solution of potassium ferrocyanide was then added, a few drops at a time, until no further deepening of the brown color was observed. Another beaker of the same size containing the same amount of potassium ferrocyanide was placed beside the first, and after diluting its contents to a like volume a copper sulphate solution containing .00025 gram. of copper per cubic centimeter was added drop by drop from a pipette graduated to hundredths of a cubic centimeter until the brown color was identical with that in the first beaker. With amounts of copper less than .0001 gram., this method is correct to within .00002 gram. Its accuracy, however, naturally grows less as the amount of copper increases. The results obtained by the gravimetric and colorimetric methods appear in the table in adjacent columns.

Small amounts of copper were in nearly every case found in the alcohol washings, due to traces of the precipitate passing through the filter with the alcohol. Although it was difficult to entirely prevent loss in this way, in only a few instances was the quantity thus carried through large enough to cause distinct cloudiness in the filtrate. Water might have been used instead of alcohol to wash out the ammonium sulphocyanide, but the chances of loss seemed on the whole to be considerably less when alcohol was employed.

The values obtained by the weighing as cuprous sulpho-

cyanide show, with all but the largest amounts of acid, considerable positive errors. On comparing with these the values in the last column, which represent the total amounts of copper found and are obtained by adding to the figures in the sixth column the amounts of copper in the filtrates and washings as determined by the comparative method, it appears that the positive errors persist throughout. This seems to be due to the method of washing, which apparently fails to remove all the soluble impurities present, for in a number of cases where water alone was used to wash precipitates obtained from these same solutions the results were close to the theory. The use of this method of washing is however justified in this case because it reduces the chances of mechanical loss to a minimum, and accuracy in determining the amounts of copper precipitated is for the present purpose less desirable than accuracy in estimating the amounts remaining in solution.

In the first seven determinations the ammonium bisulphite and sulphocyanide were kept constant and the hydrochloric acid gradually increased. The effect is shown by the weights of copper in the filtrate, which rise fairly steadily to 0.005 gm. with the largest amounts of acid. A part of the hydrochloric acid, however, as already stated, reacts with the bisulphite forming ammonium chloride and liberating sulphur dioxide, and a similar reaction probably takes place with the ammonium sulphocyanide. As hydrochloric acid has a far greater solvent effect upon cuprous sulphocyanide than the equivalent amount of ammonium chloride, the result in both cases would be to diminish the amount of copper held in solution, unless, as hardly seems probable, the sulphur dioxide or sulphocyanic acid liberated is more active in holding up the copper than the corresponding amount of hydrochloric acid. That the weights of copper held in solution do actually decrease with an increase of either the bisulphite or sulphocyanide is readily proved.

The relation between the bisulphite and hydrochloric acid is apparent upon comparing the amounts of copper in the filtrates of the last four determinations of the table. The conditions under which Nos. 8 and 9 were made were respectively the same as those for Nos. 10 and 11 except that the quantity of bisulphite solution used was 5<sup>cm<sup>3</sup></sup> for the first pair and 2<sup>cm<sup>3</sup></sup> for the second. The losses are distinctly greater with the smaller amount.

Increasing the ammonium sulphocyanide while the bisulphite and hydrochloric acid remain constant has a similar effect. For the first seven experiments of the table the amount of ammonium sulphocyanide theoretically required was about 50<sup>cm<sup>3</sup></sup> of the decinormal solution. The excess present was therefore about 10<sup>cm<sup>3</sup></sup> or 0.076 gm. of the dry salt. In Nos. 8

and 9 the theory required about  $13^{\text{cm}^3}$  of the decinormal solution, and the excess was consequently  $107^{\text{cm}^3}$  or 0.815 gm. Making due allowance for the large amounts of acid present in these two experiments, the losses are much less than in the preceding ones.

As the reaction between the bisulphite and hydrochloric acid gives rise to a gaseous product (sulphur dioxide), it would naturally be expected that equilibrium would only be reached when one or the other of the reagents was nearly exhausted. If this is true, the measure of the amount of hydrochloric acid which can be converted into ammonium chloride by a definite quantity of bisulphite solution is the weight of combined ammonia which the latter contains. This value was found to be 0.1757 gm. per cubic centimeter for the bisulphite solution used in the above experiments. This means that if equal quantities of the bisulphite solution and of hydrochloric acid of sp. grav. 1.18 act upon one another, nearly nine-tenths of the acid may be converted into ammonium chloride. It is, however, not necessary to assume that this reaction is complete under the conditions of the experiments of the table. If with a given amount of hydrochloric acid it progresses farther when the quantity of bisulphite is increased, the results are sufficiently explained.

The limit of the reaction between the ammonium sulphocyanide and hydrochloric acid is entirely indefinite, but an increase in the amount of this salt must, as in the case of the bisulphite, cause the neutralization of a greater amount of acid and thus bring about a more complete precipitation of the copper. Very probably, the reduction in the solubility of the precipitate in the acid solution caused by the presence of an excess of ammonium sulphocyanide,\* also contributes to this effect.

From these results it is evident that even in strongly acid solutions the copper may be almost completely precipitated by sufficiently increasing the amounts of ammonium bisulphite and sulphocyanide. As far as could be judged from a limited number of determinations made in sulphuric acid solution, the above holds true for sulphuric as well as hydrochloric acid. Cuprous sulphocyanide is, however, somewhat soluble in solutions of ammonium salts, and in cases where the amount of acid is very large this may become an important factor.

The solubility of cuprous sulphocyanide in various solutions is shown in the following table, but the figures must be understood to be only approximate. Weighed amounts of cuprous sulphocyanide prepared by precipitation in the usual way,

\* See Table II.

thoroughly washed, and dried at 105°, were allowed to stand in the solutions to be tested from 40 to 50 hours. After careful filtering through asbestos the copper in the clear filtrate was estimated by the battery or, in cases where the amount was small, by the colorimetric method described above.

TABLE II.

Cu <sub>2</sub> S <sub>2</sub> (CN) <sub>2</sub> taken. gram.	Volume of liquid, 200cm <sup>3</sup> .		Cu in filtrate. gram.
	HCl sp. grav. 1.18 cm <sup>3</sup> .	NH <sub>4</sub> SCN gram.	
0.3			0.00035
0.3			0.00040
0.3		10.	0.0050
0.25		1.52 $\left(\frac{n}{10}\right)$	0.00018
0.3		0.76 $\left(\frac{n}{20}\right)$	0.00007
0.3		0.19 $\left(\frac{n}{80}\right)$	0.00004
0.3	2		0.0019
0.3	2	2.5	0.0013
0.3	2	1.77*	0.0009
0.3	2	0.19	0.0006
	NH <sub>4</sub> Cl gram.		
0.3	10		0.0031
0.3	10	0.19	0.00013
0.3	1 $\left(\frac{n}{10}\right)$ †		0.00045
0.3	1	0.19	0.00005

The solubility is lowest in dilute solutions of ammonium sulphocyanide, and the presence of a small amount of this salt lessens the solubility in hydrochloric acid, and in solutions of ammonium chloride. In decinormal ammonium chloride the solubility is greater than in ammonium sulphocyanide of like strength, but this order is reversed in more concentrated solutions.

The results of the investigation may be summarized as follows: In the presence of free‡ hydrochloric acid the precipitation of cuprous sulphocyanide by a small excess of ammonium sulphocyanide is incomplete, but not injuriously so unless the

\* Equivalent to the amount of hydrochloric acid present.

† Approximately.

‡ By free acid is here to be understood that acid which remains in the free state after the interaction with the ammonium bisulphite.

amount of the concentrated acid exceeds about 0·5 per cent of the total volume. By employing a considerable excess of ammonium sulphocyanide the precipitation can be made practically complete, at least after a few hours standing, even when the amount of acid is several times the above figure. The use of a decided excess of the sulphocyanide is advisable not only in the presence of acid but also when the solution contains much ammonium salts, on account of the reduction in the solubility of the precipitate thus brought about.\*

The result of an increase in the ammonium bisulphite in the presence of hydrochloric acid is, except for the liberation of sulphur dioxide, exactly the same as the effect produced by a partial neutralization of the acid by ammonia, namely, the formation of ammonium chloride at the expense of the acid. Unless the amount of acid thus neutralized is quite large, the solubility of the cuprous sulphocyanide in the ammonium salts formed is too small to interfere materially with the completeness of the precipitation. There is, moreover, no objection to the use of ammonia in addition to the bisulphite to neutralize an excess of acid, and where sulphur dioxide is employed in place of ammonium bisulphite, ammonia is in many cases desirable. If, finally, the amount of acid is very large it is unquestionably better to remove the greater part before precipitating the copper.

The helpful advice of Prof. F. A. Gooch throughout the course of this investigation is gratefully acknowledged.

\*See the last four determinations of Table II.

ART. III.—*The Action of Ammonium Chloride upon certain Silicates*; by F. W. CLARKE and GEORGE STEIGER.

IN our previous communications\* upon the ammonium chloride reaction, we have shown that different silicates are very differently affected by the reagent. From analcite, leucite, natrolite and scolecite we obtained new salts, in which the alkali or lime of the original mineral had been replaced by ammonium. On the other hand, prehnite was practically unattacked, while the pectolite molecule was quite thoroughly broken down, with liberation of much free silica. We now submit the results obtained with several additional silicates; results which serve to emphasize our former conclusions.

Our mode of operation has been precisely the same as before. Each mineral, in fine powder, was intimately mixed with four times its weight of dry ammonium chloride, and the mixture was then heated for about five or six hours to 350° in a sealed combustion tube. After cooling, the mixture was leached out with water, and the air-dried insoluble residue was analyzed. Determinations of free silica were effected by boiling the mineral, or its derivative, for fifteen minutes with a solution of sodium carbonate containing 250 grams to the liter. From the solution so obtained the silica was recovered by acidulation with hydrochloric acid and evaporation to dryness. In each case all of the experiments were made upon one uniform sample of material, so that the data for any one species are strictly comparable. So much premised, we may go on to consider the results of our investigations.

*Stilbite.*

The specimen selected for study was a nearly white, typical example from Wasson's Bluff, Nova Scotia. The analysis and the fractional water determinations were as follows:

Analysis.		Fractional water,	
SiO <sub>2</sub> .....	55.41	At 100°.....	3.60
Al <sub>2</sub> O <sub>3</sub> .....	16.85	“ 180°.....	6.46
Fe <sub>2</sub> O <sub>3</sub> .....	.18	“ 250°.....	3.80
MgO.....	.05	“ 350°.....	2.10
CaO.....	7.78	Low redness.....	2.95
Na <sub>2</sub> O.....	1.23	Full “.....	.06
H <sub>2</sub> O.....	19.01	Over blast.....	.04
	<hr/>		<hr/>
	100.51		19.01

\* This Journal (4), ix, pp. 117, 345; February and May, 1900.

On boiling with sodium carbonate, 1.37 per cent of silica went into solution. After ignition, only 1.03 per cent was obtained. No silica, therefore, is split off when stilbite is ignited. If the mineral were a hydrous acid metasilicate,  $H_4CaAl_2Si_6O_{18} \cdot 4H_2O$ , as has been assumed by some authorities, one-third of the silica should have been set free. Hence the metasilicate formula is to be regarded as unsatisfactory. The evidence here presented counts for something against it.

Two samples of the ammonium chloride derivative were prepared. In leaching with water the insoluble residue was washed until the washings gave no reaction for chlorine. The chlorine shown in the subjoined analyses is, therefore, present in an insoluble form, and not as adhering ammonium chloride. Dried at  $50^\circ$ , the two products gave the following composition:

	A	B
SiO <sub>2</sub> .....	60.80	60.67
Al <sub>2</sub> O <sub>3</sub> .....	18.36	18.25
CaO .....	1.86	1.46
Na <sub>2</sub> O .....	.08	.15
NH <sub>3</sub> .....	5.12	5.13
H <sub>2</sub> O .....	12.96	13.91
Cl .....	1.31	1.04
	<hr/>	<hr/>
	100.49	100.61
Less O .....	.29	.23
	<hr/>	<hr/>
	100.20	100.38

Sample B was further examined as to the presence of soluble silica, and 1.52 per cent was found. After ignition, only 1.62 per cent went into solution. These results conform to those obtained with the original stilbite, and tend to show that the ammonium derivative is a compound of the same order. In the case of the unignited substance the residue remaining after the removal of soluble silica was thoroughly washed, and then examined for alkali. It was found to contain 9.30 per cent of soda, which shows that the ammonium salt had been transformed back into the corresponding sodium compound.

From the foregoing facts it is clear that stilbite, like the zeolites previously studied, is converted by the action of ammonium chloride into an ammonium salt. That is, sodium and calcium are removed as chlorides, ammonium taking their place to form ammonium-stilbite. The reaction, however, is less complete than it was in the cases of analcite and natrolite, but whether this is due to a greater stability of the stilbite molecule, or only to a different degree of fineness in the powder upon which the operations were performed, we cannot



say. Neither have we any explanation to offer of the retention of chlorine by the ammonium derivative. Although the amount of chlorine is small, it needs to be accounted for.

If we discuss the composition of the stilbite and of its ammonium derivative, the relations between them become very clear. Neglecting the water as "zeolitic," to use Friedel's phrase, and, therefore, as not a part of the chemical molecule, and also rejecting the 1.37 per cent of soluble silica as probably an impurity, the ratios derived from the analysis give this empirical formula for the mineral:



This corresponds to a mixture of ortho- and trisilicates in which  $\text{Si}_3\text{O}_8 : \text{SiO}_4 :: 286 : 43$ ; and uniting these radicles under the indiscriminate symbol X, we have, as a more general expression,

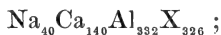

or, combining monoxide bases,



which is essentially  $\text{R}''\text{Al}_2\text{X}_2$ . Since the  $\text{SiO}_4$  groups are practically equal in number to the sodium atoms, the stilbite is probably a mixture, very nearly, of  $\text{NaAlSiO}_4$  and  $\text{CaAl}_2(\text{Si}_3\text{O}_8)_2$  in the ratio of one to seven. This is in accordance with the well-known theory of Fresenius as to the constitution of the phillipsite group, to which stilbite belongs. Stilbite is mainly a hydrous calcium albite, commingled with varying amounts of corresponding orthosilicates of soda and lime.

For the ammonium derivative similar relations hold. Taking analysis "B" for discussion, rejecting soluble silica and chlorine as impurities, and neglecting all water except that which belongs to the supposable ammonium oxide, the ratios give this formula:

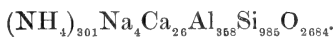

Uniting sodium and calcium with ammonium this becomes



or, more generally,

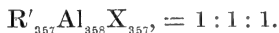

The derivative, therefore, is a compound of the same order as the original stilbite, with the ratio of 1 : 7 still holding between the ortho- and trisilicate groups. This conclusion, however, ignores the presence of chlorine, and is, therefore, inexact to some extent. We are not dealing with ideally pure compounds.

*Heulandite.*

Pure, white heulandite from Berufjord, Iceland, was the material taken for investigation. Upon boiling with sodium carbonate, 1.73 per cent of silica went into solution. From previously ignited heulandite only 1.14 per cent was extracted. No silica, therefore, was liberated upon ignition, and a hydrous metasilicate formula for the mineral seems to be improbable. Only one lot of the ammonium chloride derivative was prepared, and its composition, together with that of the heulandite, is given below.

	Heulandite.	Ammonium salt.
SiO <sub>2</sub> .....	57.10	61.24
Al <sub>2</sub> O <sub>3</sub> .....	16.82	18.00
MgO .....	.07	----
CaO .....	6.95	2.56
SrO .....	.46	----
Na <sub>2</sub> O .....	1.25	} .60
K <sub>2</sub> O .....	.42	
NH <sub>3</sub> .....	----	4.42
H <sub>2</sub> O at 100° .....	3.61	} 13.63
H <sub>2</sub> O above 100° .....	13.00	
	99.68	100.45

Here again we have the same kind of transformation as before, but rather less complete than in the case of stilbite. That the ammonium taken up is equivalent to the bases removed, is shown by a study of the ratios. Ignoring water and the soluble silica, the heulandite ratios are as follows:



or, uniting bases,



Again simplifying, this becomes



or very nearly 1 : 2 : 2, as in stilbite.

Similarly discussed, the ammonium salt gives the ratios



equivalent to



In both cases the orthosilicate molecules are few, and the compounds approximate to trisilicates very closely.

*Chabazite.*

Characteristic flesh-colored crystals from Wasson's Bluff, Nova Scotia. The analysis and fractional water determinations are as follows:

	Analysis.	Fractional water.	
SiO <sub>2</sub> .....	50·78	At 100° .....	5·22
Al <sub>2</sub> O <sub>3</sub> .....	17·18	“ 180° .....	5·70
Fe <sub>2</sub> O <sub>3</sub> .....	·40	“ 250° .....	3·92
MgO .....	·04	“ 350° .....	2·36
CaO .....	7·84	Low redness .....	4·51
Na <sub>2</sub> O .....	1·28	Full redness .....	·13
K <sub>2</sub> O .....	·73	Over blast .....	·01
H <sub>2</sub> O .....	21·85		<hr/>
	<hr/>		21·85
	100·10		

The unignited mineral, upon boiling with sodium carbonate, gave 0·86 per cent of soluble silica. After ignition only 0·53 per cent was soluble. Here again no silica is liberated by calcination, and metasilicate formulæ may be disregarded.

Two samples of the ammonium chloride derivative were prepared, which after thorough washing were dried at 40° to 50°. As in the case of stilbite, small quantities of chlorine appear in the compound, not removable by washing. The amount of change effected is also somewhat less than with stilbite, and about the same as with heulandite. The analyses of the two samples are subjoined, with the remaining alkali all reckoned as soda.

	A	B
SiO <sub>2</sub> .....	55·88	56·09
Al <sub>2</sub> O <sub>3</sub> .....	19·15	19·49
CaO .....	2·25	2·01
Na <sub>2</sub> O(K <sub>2</sub> O) .....	·35	·24
NH <sub>3</sub> .....	4·64	4·83
H <sub>2</sub> O .....	16·57	16·01
Cl .....	·95	1·35
	<hr/>	<hr/>
	99·79	100·02
Less O .....	·21	·30
	<hr/>	<hr/>
	99·58	99·72

In B, 1·50 per cent of soluble silica was found. After ignition, this was reduced to 1·12 per cent. No liberation of silica accompanies the splitting off of water and ammonia.

Upon studying the molecular ratios for chabazite and its derivative, relations appear precisely like those found for stilbite and heulandite. For chabazite itself, rejecting water and the 0·86 per cent of soluble silica, we have



or, consolidating soda with lime,

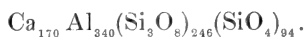

One step further and this becomes

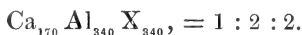

Treating derivative "B" in the same way, and ignoring chlorine as an unexplained impurity, the analysis gives



or, consolidating bases as before,

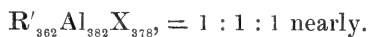

The assumption of commingled ortho- and trisilicate molecules conforms to Streng's theory of the constitution of chabazite.

#### *Thomsonite.*

The compact-fibrous variety from Table Mountain, near Golden, Colorado. Analytical data as follows:

	Analysis.	Fractional water.
$\text{SiO}_2$ .....	41.13	At 100° .....
$\text{Al}_2\text{O}_3$ .....	29.58	“ 180° .....
$\text{CaO}$ .....	11.25	“ 250° .....
$\text{Na}_2\text{O}$ .....	5.31	“ 350° .....
$\text{H}_2\text{O}$ .....	13.13	Low redness .....
	<hr/>	Over blast .....
	100.40	<hr/>
		13.13

Before ignition the mineral yielded 0.45 per cent of silica to sodium carbonate solution. After ignition, 0.68 per cent was soluble. The difference is trifling.

Two samples of the ammonium chloride derivative were prepared. In "A" the heating was only to 300°, in "B" to 350°. Analyses of the leached products gave the following results:

	A	B
$\text{SiO}_2$ .....	42.41	42.65
$\text{Al}_2\text{O}_3$ .....	30.50	31.34
$\text{CaO}$ .....	10.00	9.23
$\text{Na}_2\text{O}$ .....	2.63	2.48
$\text{NH}_3$ .....	2.45	2.67
$\text{H}_2\text{O}$ .....	11.96	11.81
	<hr/>	<hr/>
	99.95	100.18

In "A," 1.80 per cent of soluble silica was found.

In this case the amount of change is very much less than with the zeolites previously examined. Little lime was removed, and only about half of the soda. Both samples were prepared with six hours of heating in the sealed tube, and it

seemed to be desirable to determine whether a more prolonged treatment would produce any greater effect. Accordingly a third lot of thomsonite was mixed with ammonium chloride, and heated in a sealed tube to 350° for 24 hours. The leached product contained 3.40 per cent of ammonia, a distinct increase over the other findings; although the amount of transformation into an ammonium salt was still only moderate.

We have already seen that stilbite, heulandite and chabazite approximate more or less nearly to trisilicates in their composition. Thomsonite, however, is essentially an orthosilicate, with variable admixtures of trisilicate molecules. In the example under consideration, ignoring water and soluble silica, the molecular ratios give this formula:

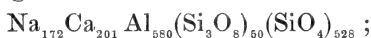

or, condensing,



Here the acid radicles are ten-elevenths orthosilicate. Ammonium derivative "A," similarly computed, gives first—



or, uniting univalent bases with line,



the fundamental ratios being practically unchanged.

It will be observed that in all of these computations of formulæ we have assumed that all the water is "zeolitic"; that is, independent of the true chemical molecules. This question, however, needs to be separately investigated for each individual species. While the assumption is valid for some of these minerals, it is not necessarily valid for all. The real chemical differences between the zeolites are yet to be determined; our work merely proves that ammonium compounds are formed, completely in some cases, partially in others. The research should be extended to cover all the zeolites; but this task we must leave to other investigators. Silicates belonging to quite different groups must now claim our attention.

#### *Ilvaite.*

This rare mineral was found by Mr. Waldemar Lindgren at the Golconda Mine, South Mountain, Owyhee County, Idaho. It occurs in jet black masses and occasional rough crystals, imbedded in quartz or calcite, and intimately associated with two other minerals which appear to be garnet and tremolite. Traces of pyrite also appear. The specific gravity of the ilvaite, as determined by Dr. Hillebrand, is 4.059 at 31°.

Upon grinding the powdered mineral with ammonium chloride in an agate mortar, a distinct smell of ammonia was noticeable. Three tubes of the mixture were heated to 350°, and one exploded because of the liberation of gas within. Upon opening the second and third tubes, a strong outrush of ammonia was observed. When the contents of these tubes were leached with water, large quantities of ferrous chloride went into solution; which, rapidly oxidizing, formed a deposit of brownish hydroxide, and interfered seriously with filtration. The greater part of the lime in the ilvaite was dissolved also. The washed residue, containing much ferric hydroxide, was partially analyzed, and enough data were obtained to show that a general breaking down of the ilvaite molecule had been effected. Apparently, also, small quantities of an ammonium derivative had been formed; but this point is uncertain. The original mineral was analyzed by Dr. W. F. Hillebrand; and his analysis, contrasted with that of the leached residue, is given below.

	Ilvaite (Hillebrand).	Residue (Steiger).
SiO <sub>2</sub> .....	29·16	43·01
Al <sub>2</sub> O <sub>3</sub> .....	·52	} 40·08
Fe <sub>2</sub> O <sub>3</sub> .....	20·40	
FeO .....	29·14	8·75
MnO .....	5·15	·85
CaO .....	13·02	2·25
MgO .....	·15	undet.
Na <sub>2</sub> O .....	·08	undet.
NH <sub>3</sub> .....	---	·88
H <sub>2</sub> O at 105° .....	·15	undet.
H <sub>2</sub> O above 105° .....	2·64	undet.
Cl .....	---	small amount.
	100·41	95·82

In the leached residue from the third tube 21·37 per cent of soluble silica was found; silica which had been liberated during the reaction between the ilvaite and the ammonium chloride. In short, ilvaite behaves towards the reagent much like pectolite, and the product is a mixture of uncertain character. The evident instability of the ilvaite molecule may account for its rarity as a mineral species. Only exceptional conditions would favor its formation.

#### *Riebeckite?*

The results obtained with ilvaite made it desirable to study, for comparison, some other silicates of iron. Among these the mineral from St. Peter's Dome, near Pike's Peak, Colo-

rado, originally described by Koenig as arfvedsonite, but identified by Lacroix as near riebeckite, happened to be available. It was treated with ammonium chloride in the usual way, and no presence of liberated gas was noticed when the tube was opened. On leaching the product with water, ferrous chloride went into solution, and ferric hydroxide with some manganic hydroxide were deposited. In the leached mass 6.90 per cent of soluble silica was found, and in the wash water from the leaching there were 6.76 per cent of soda. According to Koenig's analysis the mineral contains 8.33 per cent of soda, so that a large portion of the total amount had been extracted. There was also, evidently, a considerable breaking down of the molecule, but no definite ammonium derivative had been formed. This is shown by the following analysis of the leached residue, which is contrasted with Koenig's published analysis\* of the original mineral, in order to indicate the amount of change. In the third column of figures we give the amount of each constituent which could be dissolved out from the residue by treatment with hydrochloric acid.

	Riebeckite (Koenig).	Residue (Steiger).	Soluble portion.
SiO <sub>2</sub> .....	49.83	67.54	
TiO <sub>2</sub> .....	1.43	----	
ZrO <sub>2</sub> .....	.75	----	
Fe <sub>2</sub> O <sub>3</sub> .....	14.87	21.28	15.74
FeO .....	18.86	4.94	4.94
MnO .....	1.75	.64	.64
MgO .....	.41	none	
CaO .....	----	trace	
Na <sub>2</sub> O .....	8.33	} 1.04	
K <sub>2</sub> O .....	1.44		
NH <sub>3</sub> .....	----	.53	.53
H <sub>2</sub> O .....	.20 (ign.)	3.33	
Cl .....	----	trace	
	<hr/>	<hr/>	
	97.87	99.30	

The residue is evidently a mixture of free silica and ferric hydrate with probably at least two silicates, one soluble, the other insoluble in hydrochloric acid. The reaction itself is noteworthy because of the fact that the original mineral is but slightly attacked when boiled with strong hydrochloric acid. The other minerals so far studied by us are all easily decomposable by acids, while this one is quite refractory. The energetic character of the ammonium chloride reaction is thus strongly emphasized.

\* Dana's System of Mineralogy, 6th ed., p. 400.

*Aegirite.*

Material from the well known locality at Magnet Cove, Arkansas. Not absolutely pure, but somewhat contaminated by ferric hydroxide. This impurity is evident in a discussion of the ratios furnished by the analysis, but is not serious. It does not affect the problems under consideration. By heating with ammonium chloride the mineral was only slightly changed. In the leach water from the product there were 1.66 per cent  $(AlFe)_2O_3$ , 0.51 CaO, and 1.18  $Na_2O$ . Analyses as follows: A of the aegirite, B of the air dried, leached residue.

	A	B
SiO <sub>2</sub> .....	50.45	51.83
Al <sub>2</sub> O <sub>3</sub> .....	2.76	} 25.24
Fe <sub>2</sub> O <sub>3</sub> .....	23.42	
FeO .....	5.26	5.69
MnO .....	.10	---
MgO .....	1.48	1.58
CaO .....	5.92	5.74
Na <sub>2</sub> O .....	9.84	} 9.07
K <sub>2</sub> O .....	.24	
NH <sub>3</sub> .....	---	.26
H <sub>2</sub> O at 100° .....	.15	} .90
H <sub>2</sub> O above 100° .....	.40	
	100.02	100.31

Of the silica in the residue 4.42 per cent was soluble in sodium carbonate solution. An ammonium derivative was not formed.

From these data we see that the three iron silicates are very differently attacked by ammonium chloride; ilvaite very strongly, riebeckite moderately, and aegirite but feebly. The aegirite is the most stable, and at the same time the commonest of the three. A comparison of the aegirite analysis with that made by J. Lawrence Smith of material from the same region, shows notable differences. The mineral evidently varies in composition; the variation depending upon the relative amounts of the two silicate molecules  $FeNaSi_2O_6$  and  $R''SiO_3$ . Two samples taken from different parts of the same rock area are not necessarily identical in composition.

*Serpentine.*

In 1890 Clarke and Schneider published an investigation\* relative to the action of gaseous hydrochloric acid upon various minerals. Among these were the three species serpentine,

\* Bulletin 78, U. S. Geol. Survey, p. 11.



leuchtenbergite, and phlogopite, and the remainders of the original samples were fortunately at our disposal. The analyses made by Schneider are, therefore, directly comparable with the new data secured by us.

The serpentine, from Newburyport, Massachusetts, was but moderately attacked upon heating with ammonium chloride. Upon leaching the contents of the sealed tube with water, 0.18 per cent of silica and 5.23 of magnesia went into solution. The washed residue and the serpentine had the following composition.

	Serpentine (Schneider).	Residue (Steiger).
SiO <sub>2</sub> .....	41.47	45.42
Fe <sub>2</sub> O <sub>3</sub> , Al <sub>2</sub> O <sub>3</sub> .....	1.73	.88
MgO .....	41.70	39.54
FeO .....	.09	----
NH <sub>3</sub> .....	----	.09
H <sub>2</sub> O .....	15.06	14.01
	<hr/>	<hr/>
	100.05	99.94

The leached residue contained 1.06 per cent of soluble silica. The amount of change effected in the mineral was evidently small, and no ammonium compound was produced.

#### *Leuchtenbergite.*

From the standard locality near Slatoust in the Urals. When the contents of the sealed tube were leached with water, there passed into solution 0.19 per cent of alumina, plus iron, 2.10 of magnesia, and 2.03 of lime. The residue was not completely analyzed, but the few determinations made contrast with Schneider's results as follows:

	Leuchtenbergite.	Residue (Steiger).
SiO <sub>2</sub> .....	32.27	32.82
Al <sub>2</sub> O <sub>3</sub> .....	16.05	
Fe <sub>2</sub> O <sub>3</sub> .....	4.26	
FeO .....	.28	
MgO .....	29.75	
CaO .....	6.21	4.67
NH <sub>3</sub> .....	----	.25
H <sub>2</sub> O .....	11.47	12.11
	<hr/>	
	100.29	

No definite ammonium compound was formed, and the amount of decomposition was small. As the lime shown by the analysis is at least partly due to the presence of garnet as an impurity in the mineral, it will be interesting to determine the effect producible by ammonium chloride upon that species.

*Phlogopite.*

From Burgess, Canada. The contents of the sealed tube, after heating, showed little appearance of change. The leach water contained magnesia. Analysis as follows:

	Phlogopite (Schneider).	Residue (Steiger).
SiO <sub>2</sub> .....	39·66	45·03
TiO <sub>2</sub> .....	·56	----
Al <sub>2</sub> O <sub>3</sub> .....	17·00	} 15·07
Fe <sub>2</sub> O <sub>3</sub> .....	·27	
FeO .....	·20	----
BaO .....	·62	----
MgO .....	26·49	24·94
Na <sub>2</sub> O .....	·60	·94
K <sub>2</sub> O .....	9·97	8·69
NH <sub>3</sub> .....	----	·21
H <sub>2</sub> O .....	2·99	5·01
F .....	2·24	----
	100·60	99·89
Less O .....	·94	
	99·66	

The residue, on boiling with sodium carbonate, gave 0·40 per cent of soluble silica. From these data it appears that phlogopite is somewhat attacked by ammonium chloride, but not strongly. No ammonium derivative is formed.

As opportunity offers, this investigation will be carried further, and the reaction will be applied to other mineral species.

Laboratory U. S. Geological Survey, Oct. 12, 1901.

ART. IV.—*Studies of Eocene Mammalia in the Marsh Collection, Peabody Museum*; by J. L. WORTMAN.

[Continued from vol. xii, p. 432.]

*Mesonyx obtusidens* Cope.

Numerous remains of this species are preserved in the present collection, one specimen of which includes many parts of the skeleton. In this one the hind limbs are more or less complete, and, as the Princeton specimen which formed the basis of Professor Scott's excellent memoir on this subject\* is more or less lacking in these parts, I give herewith a statement of their principal characters.

The femur is somewhat damaged, but there is evidence to show that it was proportionally longer and much more slender than that of *Dromocyon vorax*. The tibia is also longer and decidedly more slender than that of either *Dromocyon* or the Princeton specimen. As compared with the former it is actually longer, but at least one-third less robust. Scott gives the length of the Princeton specimen as 205<sup>mm</sup>, while the present specimen measures 222 $\frac{1}{2}$ <sup>mm</sup>.

The same degree of elongation extends to the pes, figure 61, in which the length greatly exceeds that of *Dromocyon*. The fifth metatarsal, which is the only complete one in the Princeton specimen, is also notably longer. It may well be that the present specimen indicates the existence of another species characterized by the elongation and slenderness of its limbs, which are actually greater in this respect than in the modern Greyhound; but it will perhaps be best to regard it, for the present at least, as an extreme variation of *Mesonyx obtusidens*. I introduce in this connection a drawing of the hind foot of a modern dog (Bloodhound), figure 62, in order to show the comparison.

The principal characters of the foot of *M. obtusidens* may be briefly summarized as follows: The *tuber calcis* is exceptionally long and slender, indicating tremendous leverage power in the extension of the foot; the astragalus is deeply grooved upon its trochlear surface, and the head is not so obliquely placed as in *Dromocyon*. The length of the tarsus considerably exceeds that of the metapodials. The internal cuneiform is long and narrow, with a very small facet for the rudimental first metatarsal; the second and third metatarsals are of equal length and size; the fifth is shorter than the second, which is the stoutest bone of the series; the metatarsals are highly compressed and interlocking; the distal ends have a distinctly canine appearance, and the keels are confined

\* Jour. Acad. Nat. Sci. Phila., 1886.

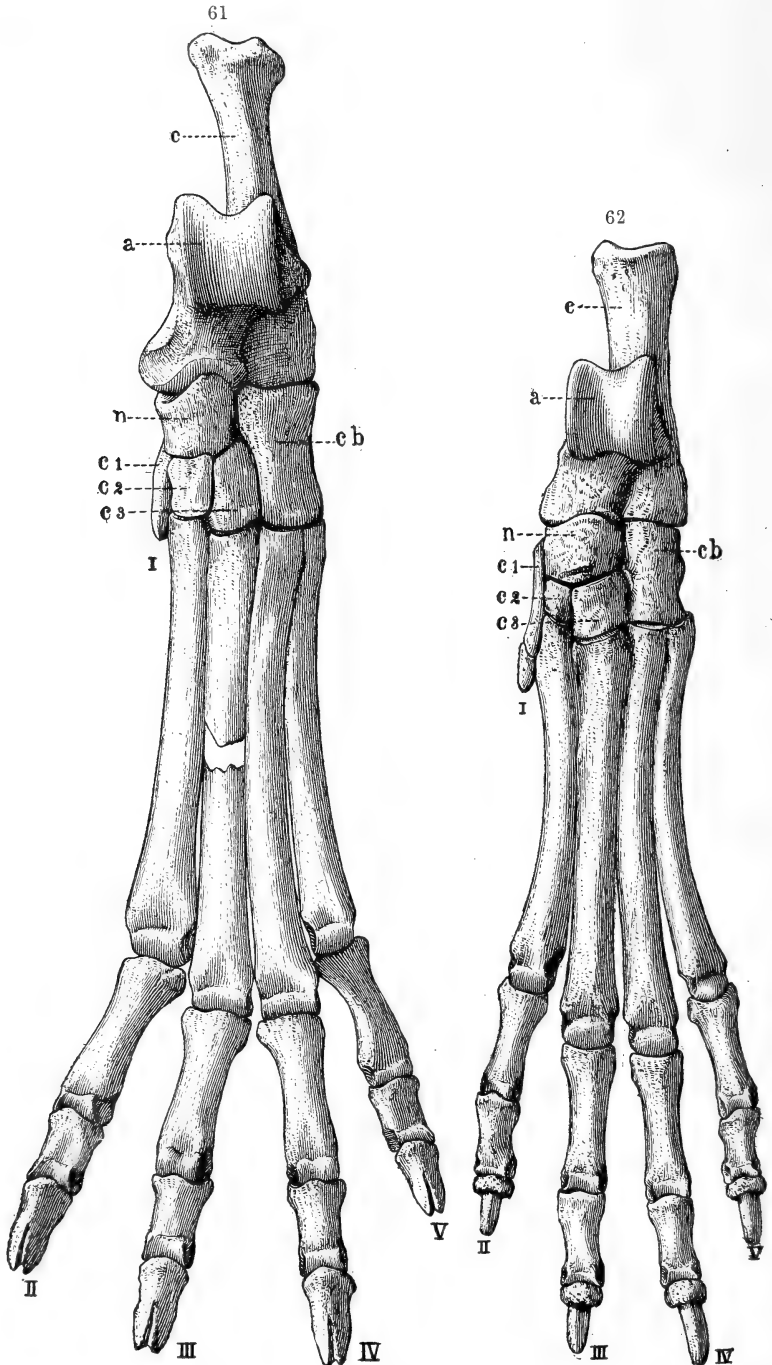

FIGURE 61.—Left hind foot of *Mesonyx obtusidens* Cope; anterior view; three-fourths natural size.

FIGURE 62.—Left hind foot of a dog (Bloodhound); anterior view; about three-fourths natural size.

Lettering as in Plate VIII.

to the plantar surfaces; the phalanges are long and slender, and the bony claws are rather narrow and deeply fissured. The measurements are as follows:

Length of tibia .....	222.5 <sup>mm</sup>
Length of foot .....	236.
Length of tarsus .....	89.
Length of third metatarsal .....	87.
Length of fifth metatarsal .....	76.
Length of second metatarsal .....	79.
Length of first phalanx, digit II .....	33.
Length of first phalanx, digit III .....	32.
Length of first phalanx, digit V .....	27.
Length of second phalanx, digit III .....	17.
Length of unguis phalanx, digit III .....	18.

*Discussion.*—Attention has already been drawn to the fact that the phylogenetic history of this subfamily is unusually complete, from the time when we first meet with it in the Torrejon Beds, up to the time of its final extinction at the close of the Eocene. Although the representatives of the last, or Uinta, stage, are not fully known, there are very good reasons for the belief that *Mesonyx* represents essentially as high a degree of perfection as the group attained. The amount of change in its osteological structure does not, at first sight, appear to be great, yet the gradual modification of the limbs and feet from the short, broad, pentadactyle, plantigrade condition of *Dissacus*, to the elongated, compressed, tetradactyle, highly digitigrade feet of *Mesonyx*, almost if not quite equal to the Greyhound in point of specialization of these characters, is an accomplishment which the modern dogs, with the advantage of a much longer existence, have only comparatively recently achieved.

#### *Origin of the Tritubercular Molar.*

The modification of the skull and teeth, while not of so pronounced a character as that of the limbs, is nevertheless very apparent. The molars of the inferior series have gradually lost the internal cusp of the trigon, and the pattern of the crown has, in consequence, assumed a simpler or premolariform structure. It is manifestly improper to say, however, that they underwent any degenerate changes, since at no point in the history of the phylum do they show any disposition or exhibit any tendency to decrease in size or become less functional than in the earliest members. The loss of this cusp is paralleled in many groups of the Carnivora, but in all such cases thus far known its disappearance has been accompanied by the development of a more perfect sectorial structure of the remaining cusps of the trigon. It is more than probable that the loss of this element, which at best is but weakly or imperfectly developed

in *Dissacus*, is to be accounted for on the ground of a better adaptation to the modified structure of the superior molars, which gradually supervened in the course of their development.

The molars and premolars of the superior series exhibit some very distinctive modifications, and as these are in such

63

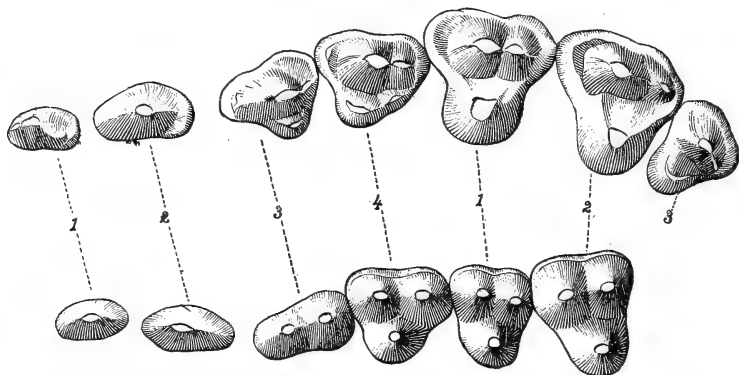

64

FIGURE 63.—Left upper teeth of *Dissacus saurognathus* Wortman; crown view; one and one-eighth natural size. (After Osborn.)

FIGURE 64.—Left upper teeth of *Mesonyx obtusidens* Cope; crown view; three-fourths natural size. (After Scott.)

strict accord with what we know has taken place in many other well-established phyletic series wherein greater complexity was attained, we may safely assume that the later condition in this group is the more advanced, specialized, or progressive. In *Dissacus*, figure 63, the first two premolars have simple premolariform crowns, with small posterior heels. The third is of much interest, in that it exhibits a transition from the simple type of tooth crown to the more complex crown of the molars. It is of the *utmost importance* to note that the principal, and, therefore, the primitive cone, or cusp, of the simple stage is located as usual about the middle of the tooth crown, and that the heel has been developed into a small but distinct cusp immediately posterior to it. At the same time an internal cusp has appeared, just internal to, or on the lingual side of, the principal or primitive cusp. The crown of the fourth premolar exhibits the same elements in exactly the same order of arrangement, but somewhat more advanced towards the true molar type. The main cusp has its position apparently changed to a slightly more external one, by reason of the increase in size of the posterior external cusp and the spreading out and enlargement of the internal cusp. A

small posterior intermediate cusp is also developed. The pattern of the crown of the first molar is almost an exact counterpart of that of the fourth premolar, with the exception that the postero-external cusp has undergone still further enlargement, and the internal cusp has increased in size until the tooth crown is now nearly triangular. The anterior cusp of the two externals is still distinctly the larger, and has a position well towards the middle of the outer border. The posterior intermediate cusp is not developed. The second molar is interesting as showing a stage of development intermediate between that of the first molar and the fourth premolar. The internal cusp is much enlarged, but the postero-external is yet small.

Having thus described at some length the first term of the series, let us now turn to the last or final stage, to discover, if possible, just what changes have been effected. It may be added, *en passant*, that every intermediate stage between the two is known, and that, moreover, from strata of intermediate position with respect to the time scale. In *Mesonyx*, figure 64, we observe that very little change has taken place in the first and second premolars. In the third, the internal cusp has disappeared and the posterior has been enlarged. In the fourth premolar the postero-external cusp has increased in size until the two externals are equal, and the internal cusp is enlarged so as to give a perfectly molariform type of crown. The position of the principal or primitive cusp is now more or less at the antero-external angle on account of the increase in the size of the postero-external, as well as the growth of the internal cusp. The crowns of the first and second molars have become fully tritubercular, the two external cusps are of equal dimensions, and are situated more or less exactly at the two external angles. The last molar has completely disappeared.

So much for the facts. Let us next direct attention to their application and general bearing upon the determination of the order of addition and homologies of the respective elements composing the mammalian tritubercular molar crown. I shall purposely limit what I have to say here upon the subject to a consideration of the superior molars, and I shall, moreover, confine my remarks as nearly as possible to the present phylum, for the reason that it offers the best and most direct evidence with which I am acquainted, and by means of which an understanding of some of the primary truths of cusp addition in the true molars of the placental Mammalia can be had. It must be remembered, however, that much evidence of a similar character in other phyletic series whose history is quite as well established is not altogether wanting.

It is and has been assumed, as one of the fundamental principles of this process, that the tritubercular stage of development was preceded by, and was the direct result of, the addition of certain new cusps to a more or less simple elongated conical crown. The evidence in support of this postulate rests not only upon the most excellent and weighty *a priori* reasoning, but is derived from the premolars of any reasonably complete and connected series of forms whose premolars were complicating and whose history can be traced over any considerable length of time. If a single tooth is selected and traced through the various stages of such a series, it will be seen that certain new cusps are added in a more or less definite way. The first step in this advance in structure is usually the addition of a cusp to the posterior border, in the form of a basal talon. The next is an internal cusp which arises from the cingulum, and by gradual enlargement becomes the main internal cusp of the tritubercular crown. It should be noted just here, however, that the exact order of appearance is by no means constant, for it may so happen that the internal cusp has appeared before the posterior, or the two may appear simultaneously. But what is of the *utmost importance* to a proper understanding of the subject, is to note that the *tritubercular crown of every complicated premolar thus far known among the placental mammals has originated by the addition of these two cusps in these situations, leaving in every case the main or primitive cusp at the antero-external angle.* Scott has demonstrated this fact so *fully and conclusively\** that it is bound to be accepted beyond any possibility of question or dispute. He has therefore designated these cusps in accordance with their order of appearance, as follows: The antero-external or primitive cusp, the *protocone*; the internal or lingual cusp, the *deuterocone*, and the postero-external, the *tritocone*.

While this order of addition and development of the cusps has thus been shown to be true of the premolars, it is held by Osborn to have been otherwise in the molars. For the sake of rendering his position perfectly clear, I quote at some length from his otherwise excellent paper on the "Structure and Classification of the Mesozoic Mammalia."<sup>†</sup> He says: "If, as now seems probable, the derivation of the mammalian molar from the single reptilian cone can be demonstrated by the comparison of a series of transitional stages between the single cone and the three-cone type, and from the latter to the central tritubercular type, the separate history of each cone can certainly be traced throughout the series in its various degrees of modification, development, and degeneration. The

\* Proc. Acad. Nat. Sci. Phila., 1892, p. 405.

† Jour. Acad. Nat. Sci. Phila., 1886, p. 242.



remarkable part played by the tritubercular molar has been unfolded by the discoveries and writings of Cope. It is undoubtedly the ancestral molar type of the Primates, the Carnivora, the Ungulata, the Cheiroptera, the Insectivora, and of several, if not all, of the Marsupialia. For example, we can trace back the quadritubercular bunodont, or parent ungulate type, to the *tritubercular*; this to the type with three cones in line, which we may call the *triconodont* type, and this in turn to the *haplodont* reptilian crown. A nomenclature may be suggested for these cones, with reference to their order of development and primitive position, to keep clearly before the mind their homologies during secondary changes of form and position. The primitive cone may be called the *protocone*; upon the anterior and posterior slopes of which appear, respectively, the *paracone* and *metacone*. After the tritubercular crown is produced by the rotation of the lateral cones, inwards in the lower jaw and outwards in the upper jaw,\* the *hypococone*, or heel, is developed, giving us the tubercular-sectorial molar." We thus have the statements clearly and distinctly set forth, (1) that upon the single cone there were at first developed cusps upon its anterior and posterior slopes giving a linear arrangement, the "triconodont stage"; and (2) that these anterior and posterior cusps rotated outward in the upper jaw, leaving the main, primitive, or principal cusp, the *protocone*, at the internal or lingual apex of the triangle, the "tritubercular stage." The primitive element or that which answers to the single conical cusp of the simple premolar is thus supposed to be homologized and located in this type of molar crown. For want of a more appropriate term I will designate this view as the Theory of Cusp Rotation or Migration.

As far as I am able to discover, the only direct paleontological evidence in favor of such an explanation is to be found in the lower molars of *Spalacotherium*, in which there is a certain appearance of this rotation of the cusps, as assumed by Osborn, but, as far as I know there are no molars of the upper jaw which furnish any support whatever to such a view. Aside from this almost total lack of evidence in its support, the objections to this explanation are of such an insuperable character that it is scarcely worthy of serious consideration. In the first place, it appears so inherently improbable that in the matter of cusp development, the premolars have had one history and the molars another, that the evidence would require to be of the most direct and positive kind even to place such a proposition on the ground of reasonable probability.

The order and manner of cusp addition, as pointed out by Scott in the premolars, are grounded upon the most indisputable facts, and hence are entirely removed from the realm of

\* The italics in this last sentence are mine.

speculation. If we now turn our attention to the case before us, we observe in *Dissacus* the structure of the molars to be so astonishingly like that of the fourth premolar, that to my mind there is not the faintest shadow of a doubt that the postero-external and internal cusps have been added to the primitive cone *in exactly the same manner, and precisely the same order*, as they have been in the premolars. The significance of the disparity in size between the external cusps, just as in the fourth premolar, is explained by the fact that the postero-external cusp is in an incomplete or transitional stage of development. It does not seem reasonable to me that any other interpretation can be placed upon it. The truth of this assertion and the correctness of this interpretation become apparent at a glance, when we compare them with the molars of *Mesonyx*, for in the latter, as we have already seen, the two external cusps are equal in size. That they became so in the course of, and as a result of, a long series of modifications reaching over nearly the whole of Eocene time, establishes beyond any possibility of doubt the further fact that in this phylum we are dealing, not with a degenerating molar crown, but with one which was progressively increasing in complexity.

It will thus be seen that in this case, the evidence is *overwhelmingly* in favor of the view that the addition of the two cusps in question has taken place in a manner very similar to, if not *absolutely identical* with, that of the premolars, and equally opposed to the view embodied in Osborn's theory of rotation or migration. If the disparity in size between the external cusps of the molars of *Dissacus* thus finds a true and satisfactory explanation, the similar condition of these cusps of the first and second molars of *Viverravus*, *Oödetes*, *Vulpavus*, *Neovulpavus*, *Uintacyon*, *Prodaphænus*, and many others, must be interpreted in the same way. It therefore follows by inference that the tritubercular molar in the entire order Carnivora has been formed in this manner, and not by any supposed rotation or shifting of the cusps, as assumed by Osborn. If in the Carnivora the tritubercular crown has been formed in the same way that it has in the premolars, what shall we say of the other orders in which we do not have the first vestige of evidence beyond that afforded by the premolars?

I have deemed this matter of sufficient importance to go into it thus fully for the reason that a very elaborate and complicated system of nomenclature has been built up by Osborn upon what I fully believe to be an erroneous foundation. The manner of origin of these cusps having been incorrectly determined, it follows that the homologies are wrong, and the names applied inappropriate and misleading. They should therefore be abandoned, since they can be productive only of confusion and error in any attempt at further progress in the subject.

[To be continued.]

ART. V.—*A Cosmic Cycle*; by FRANK W. VERY.

FORMS suggesting the existence of tremendous explosive agencies in nature are familiar to every student of astronomy. Ranyard, in his completion of Proctor's "Old and New Astronomy," has called attention to numerous examples.\* In thinking over the probable meaning of these forms and casting about for a sufficient cause for such powerful exhibitions of force, I have been led to consider an explanation which involves an extension of the doctrine of the conservation of energy. Before proposing it I must recall a few facts and commonly admitted hypotheses.

*Solar Phenomena.*

A few consequences of the contraction theory of the origin of the sun's heat may be briefly summarized:

The transformation of potential energy of position into molecular and atomic kinetic energy produces increasing temperature of the solar mass. A scattered meteor-swarm, by myriads of internal impacts between component meteors, is gradually changed from a collection of massive solid fragments into a liquid nucleus surrounded by a diminishing meteoric swarm† with an interpenetrating gaseous atmosphere; and as the liquid nucleus increases, its temperature and pressure rise until the center also becomes gaseous, and the critical stage is passed, after which no amount of pressure can liquefy the mass. Further condensation, giving increase of pressure, simply raises the temperature. But it is obvious that there must be some limit to the process, and the accepted hypothesis is that after a certain stage of condensation has been passed, radiation increases with temperature at a more rapid rate than temperature as a result of condensation.

This brings us at once to the problem of the mode of dispersal of the thermal energy produced throughout the mass. Since this dispersal can only be effected at the outer surface, there must be a transferring of thermal energy from center to surface at a sufficiently rapid rate to supply the surface output. Conduction proceeds too slowly for this purpose. Convection is competent to perform such a function up to a certain point and is also evidenced by the phenomena of the solar spots; but since viscosity, which impedes convection, increases with temperature, it may be doubted whether convection, in turn, is

\* See especially Arts. 1421, 1424, and the end of 1445.

† The zodiacal light possibly represents the last remnant of such a swarm in our own system.

able to follow the demands put upon it for the disposal of thermal energy produced by contraction. Our sun has already reached the stage where viscosity is sufficient to cause the retention of abnormal distributions of heat in particular localities, since spots frequently recur in the vicinity of the same heliographic latitude and longitude.

There is a third mode by which internal energy may be brought to the surface, namely, by some explosive force of sufficient power to overcome the enormous resistance of pressure. Such a force is witnessed in the production of explosive solar prominences whose angles of divergence prove that their point of origin is at a considerable depth. Cases of simultaneous spots or prominences on opposite sides of the sun are known. Here it is possible that an originating explosion at the very center of the sun has started a commotion powerful enough to reach the surface. At the center the pressure is presumably greatest. If this pressure is for any reason a critical one, limiting a condition of unstable equilibrium, a sudden increase or decrease of pressure may precipitate an explosion. Such an unstable condition exists when water in the spheroidal state remains suspended over red-hot metal. Sudden lowering of pressure, obliterating the intermediate layer of steam, produces complete contact of water and metal, and starts an explosion.

Within the sun, I shall assume that increase of pressure, due to contraction, accumulates from time to time until it surpasses a certain critical point, depending upon some condition of the mass which remains to be determined, and that explosion occurs (or a series of explosions), restoring equilibrium temporarily.

Since centrifugal force diminishes gravitational pressure as the equator is approached, ascensional motions produced by central explosions can more easily reach the surface near the equator. In this way a surface layer of relatively hot material will tend to accumulate in a broad equatorial zone, and where the horizontal surface temperature-gradient is steepest, let us suppose somewhat nearer the equator than midlatitude, convection storms begin, gradually approaching the equator as the disturbing layer of hot material is used up. Increasing radiation during the stormy period produces more rapid contraction and restores the central critical pressure. The solar spots being local phenomena may be influenced by various subordinate causes, such as the fall of meteoritic matter on certain regions of the solar surface, and minor irregularities of spot-sequence may be produced in this way; but the general sun-spot period, being due to the deep-seated circulation, should exhibit a constancy and stability proportionate to the magni-

tude of the operations by which it is directed. Professor Newcomb's conclusions\* on this point are entirely favorable to the view that the cause of the solar period of 11.13 years is internal and deep-seated.

If the velocities due to central explosions are great enough to enable some portions of central material not only to reach the surface but to penetrate the photosphere and emerge as coronal streamers, these must be most concentrated in the equatorial regions; also those streamers emerging in high latitudes will fall behind the general rotation as they ascend, and will appear to curve away from the axis. Since as directly viewed from the earth's northern hemisphere, the rotation is from left to right, the polar filaments on the nearer side of the sun's northern hemisphere will appear to curve to the left up to an axis of symmetry somewhat to the right of the axis of rotation. Observations on this point are conflicting, which may imply that the coronal substance is of a transparent sort, and that the brightest streamers at the poles are sometimes on the nearer, sometimes on the farther side. Spreading, or forked streamers will be produced if members on opposite sides of the pole are superposed. The general form produced by central explosive agency is masked at sun-spot maxima by luminous curving and tree-like structures emitted in various directions, especially over the sun-spot zones.

#### *Stellar Explosive Agencies.*

In seeking a possible cause for explosions of cosmical magnitude, it seems to me that we must be guided by something like the following considerations: The lower orders of material substance are successively limited. In ascending towards their sources they throw off their outer coverings and expand into fuller freedom and potency. A block of ice has but little power of internal (thermal) motion. Transformed into water it has a greater activity. As steam it lifts great weights. Resolved into its chemical constituents, it becomes a dangerous explosive. Tear its atoms asunder and gigantic solar maelstroms ensue at whose turmoil distant worlds may tremble.

The analogy should not be pushed too far. The breaking up of the atoms must follow new lines, must indeed be, in some respects, opposed to the processes which produce change of state in the molecular condition. Heat disappears in the rarefaction of matter. It should be evolved in its destruction.

The grosser material substances change with the progress of time. Their underlying atoms seem more permanent; nevertheless, these also have a history, and have passed through an

\* S. Newcomb, *Astrophysical Journal*, vol. xiii, p. 1, 1901.

exceedingly prolonged series of changes, slowly moving onward to a final dissipation. The great aggregates of elementary, atomic, and molecular movements, which we call suns and planets, may endure; but the parts of which they are composed, though their existence may comprise ages of the natural life of man, seem to be, in the nature of things, limited both as to time and as to space. A limit in space we see in the respect that matter, as such, is not infinitely subdivisible, but at certain limiting orders of magnitude critical points are reached at which the mode changes, pointing to an ultimate limit of dimension at which matter may be said to originate.

It would take too long to discuss the rich material, bearing on the subject of atomic resolution, which Sir Norman Lockyer has been accumulating for many years; nor does it seem necessary to do so in this connection, since the present suggestion, while deriving support from these valuable observations, is to a certain extent independent of them.

Lockyer's spectral researches indicate modifications in the spectra of the elements at certain stages of stellar evolution. The whitest stars have extensive outer envelopes of hydrogen and helium, but simplified metallic spectra. Mr. Frank McClean adds oxygen to the list of constituents in the atmospheres of the helium stars,\* and the photographs of stellar spectra by Sir William and Lady Huggins confirm this, the oxygen triplet ( $\lambda$  4070, 4072, 4076), and the strong nitrogen line,  $\lambda$  3995, appearing plainly in the spectrum of  $\gamma$  Orionis, and other lines faintly in this and other stars of McClean's Div. 1, *b*. The modified spectra which Lockyer attributes to proto-elements, may be phenomena analogous to allotropism, dependent on temperature conditions, but at any rate they demonstrate a lack of fixity in elemental characteristics at temperatures which forbid all union of unlike elements, so that the only changes possible are supra-elemental.

The peculiar spectra of the white stars also show a special arrangement of their constituents, or at least a special condition which prevents the exhibition of a large number of elements. We are thus compelled to include both chemical and physical facts in our classifications.

#### *Stellar Classifications.*

The arrangement of stars proposed by Mr. Frank McClean contains the essential features of a natural system, and is not too complex for the presentation of a few leading principles. Omitting minor details, we have six groups: Div. 1. Orion

\* "Comparison of Oxygen with the Extra Lines in the Spectra of the Helium Stars, etc." *Astrophysical Journal*, vol. vii, p. 367, 1898.

or helium stars. Div. 2. Sirian or hydrogen stars. Div. 3. Procyon or hydrogen-iron stars. Div. 4. Solar or calcium stars. Div. 5. Stars with unknown flutings. Div. 6. Stars with hydrocarbon flutings.

The division of stellar spectra proposed by Sir William and Lady Huggins\* rests upon the character of the hydrogen spectrum alone, and is hardly complete enough for my purpose, but its simplicity recommends it. Three conditions are noted:

“(1.) All the lines thin, defined and very distinct up to the end of the series.

(2.) All the lines winged and strong, but more or less indistinct, and incomplete in number, as the end of the series in the ultra-violet is approached.

(3.) In the photographic region the first three lines only, namely  $H\beta$ ,  $H\gamma$ ,  $H\delta$ , more or less thin and defined, the line  $H\epsilon$  diffuse, and the lines beyond practically absent, probably through excessive diffuseness.”

In addition to these features, hydrogen types (1) and (2) show a broad diffuse band of absorption from  $0.35\mu$  to  $0.37\mu$ , which is wanting in (3), and which does not seem to have been noted before. Since the intensity of this diffuse absorption is proportional to the breadth of the ultra-violet hydrogen lines, and since its position is associated with the vanishing point of their harmonic rhythmical succession, there can be little doubt that the band is due to the same substance.

Huggins' hydrogen type (2) will include McClean's divisions (2) and (3). It is suggested by Sir William and Lady Huggins that the fading out of the more refrangible members of the hydrogen series in the solar stars is due to interference with these atomic vibrations by the simultaneous vibrations of associated metals which have powerful absorption in the same region (*loc. cit.*, p. 104).

#### *Heat of the Stars.*

The question of relative stellar temperatures is of fundamental importance. Sir William and Lady Huggins, from their photographs of ultra-violet and violet stellar spectra, conclude that solar stars have hotter photospheres than Sirian. The argument is as follows: Comparing the violet spectra of such stars as *Capella*, which culminates at  $5\frac{1}{2}^\circ$  from the zenith at Tulse Hill, and *Vega*, whose meridian zenith distance is  $12\frac{3}{4}^\circ$ , and where, consequently, the spectra have been but little changed by the absorption of the terrestrial atmosphere, it is seen from photographs taken under as nearly as possible identical conditions that, although, as a whole, the violet region

\* *An Atlas of Representative Stellar Spectra*, p. 154-155.

in the spectrum of the solar star is very much darker on account of the multitude and intensity of the Fraunhofer lines, yet the narrow breadths of unabsorbed spectrum between the lines are brighter in *Capella* than in *Vega*. In the extreme ultra-violet the energy in the spectrum of the Sirian star everywhere prevails, but here it is probable that the general absorption of the short waves by the atmosphere of the solar star has increased at a more rapid rate, so that even the intervals between the absorption lines are obscure. The comparison in the ultra-violet, to be of any value, must be made beyond the broad band of diffuse absorption in the spectrum of the Sirian stars ( $0.35\mu$  to  $0.37\mu$ ), and since the general absorption of the earth's atmosphere is here both large and variable, the result might be of doubtful interpretation.

As the general absorption becomes small in the yellow, we may anticipate that the interlinear supremacy of the solar star will be found still greater in this part of the spectrum, and the test is worth trying with iso-chromatic plates. Of course it will be understood that the average brilliancy of the spectrum of a solar star through a considerable range, without regard to minor fluctuations, is relatively greater towards the red than in the violet, because of the smaller number and intensity of red absorption lines, and this seems to be even more the case in the infra-red.

Professor E. F. Nichols has determined the ratio of the total radiation from *Arcturus* and *Vega* as 2.2.\* There is no such difference of brightness in these two stars. Their visual intensities scarcely differ by 0.1 magnitude, while in the ultra-violet *Vega* is the more intense. Consequently the total radiant superiority of *Arcturus* means that it has not only absolutely, but also relatively, a greater intensity than *Vega* in the infra-red, and that the maximum energy in the spectrum of *Arcturus* is of a greater wave-length than *Vega's* maximum. This proves that the effective surface-temperature of *Vega* is the greater. The meaning of this may be open to various interpretations. It is possible that all photospheric surfaces are at substantially the same temperature, the position of the photosphere being determined by the level at which this temperature is attained, and that variations of intrinsic brightness or of distribution of energy in the spectrum are entirely due to absorption by the stellar atmospheres. In this view the photosphere of a solar star is situated at a greater depth below the surface than in a Sirian star, and the preponderance of selective (line) absorption for the violet and ultra-violet rays by the solar atmosphere, as well as the greater general obstruction to

\* *Astrophysical Journal*, vol. xiii, p. 135, 1901.



the passage of rays of short wave-length, has displaced the solar maximum towards the infra-red.

Although the temperature of the deeper portions of a star may increase as it contracts, its effective surface-temperature, as measured by its radiation, progressively diminishes. For proof of this in the case of our sun, we have only to refer to geologic evidence.

Tropical forms of life occur in higher latitudes as we go back through the geologic ages. "The general climate cannot be sensibly affected by conducted heat (from the earth's interior) at any time more than 10,000 years after the commencement of superficial solidification."\* Retention of radiation may be altered temporarily by slight modifications of the earth's atmosphere produced by volcanic eruptions or by meteoric accessions; but the continual lowering of terrestrial temperature is evidence of a steady diminution of solar efficiency, partly because the angle subtended by the solar sphere has grown smaller, and partly because the absorption of the solar atmosphere has become greater.

The safest criterion of a progressively deepening photospheric surface and increasing stellar atmosphere is the cessation of the shorter waves as a whole. If we choose the breadth of a line in the spectrum as a signature of pressure, we shall get a different estimate of the density of the stellar atmosphere according to the substance selected. Thus great breadth of the helium lines would accuse some of the Orion stars of having the densest atmospheres—hydrogen would speak for the Sirian stars to the same effect—calcium for the solar stars, and so on.

#### *Spectral Variations connected with Changes of Density.*

As helium glows in the solar chromosphere without manifesting its presence by any dark Fraunhofer lines, we are not permitted to infer the absence of a substance from sun or star by the failure of its spectral lines. Helium exists about the sun as an elevated and rarefied shell. The seldom varying breadth of its chromospheric lines from the limb up to a height of about one thousand miles, and the smaller distortion of the lines, show that, unlike hydrogen whose chromospheric lines are often broadened and distorted, the helium atmosphere is comparatively quiescent and probably greatly rarefied.†

\* W. Thomson (Lord Kelvin), *Trans. R. Soc. Edinburgh*, vol. xxiii, pt. 1, p. 164, 1862.

† In Frost's translation of Scheiner's "Astronomical Spectroscopy" (p. 189, 1894), it is said that "the D<sub>3</sub> line presents an entirely different appearance [from that of the hydrogen lines in the chromospheric spectrum], for while following the shape of the prominence in general, it never broadens at the limb, but on the contrary grows narrower, and possibly it does not touch the limb at all. This would indi-

Coronium floats at a still higher level than helium, and it likewise appears to lack representation among the Fraunhofer lines, the old supposed identification having proved erroneous. We may presume that if any other ingredient of the sun's reversing layer were removed to such an altitude as to be greatly expanded, its dark Fraunhofer lines would disappear from the spectrum, unless one or more of them might linger by virtue of extraordinary intensity.

In a different category belong those elements of great density which at a certain stage of condensation may be deeply buried and thus fail to appear, but which may afterwards be brought to the surface. In this case are those metals whose lines first begin to show feebly in the spectra of the Sirian stars.

Nevertheless, although the apparent absence of an element may be explained in some such way, these explanations do not rule out the possibility that the apparent absence or weakening of an element in a star may be due to an actual elimination. Still less can they be invoked either to prove or disprove the possibility of such a general breaking down of atomic structures as I have suggested.

Pressure produces great spectral changes. "The whole character of the spectrum of iron, for instance, is changed when we pass from the Fraunhofer lines to those seen among the spot and prominence lines; a complex spectrum is turned into a simple one, the feeble lines are exalted, the stronger ones suppressed almost altogether."<sup>\*</sup> We know that a very wide range of pressure must exist in different stars and at different stages of condensation in the same star. A first effect of condensation is an increasing heterogeneity and a separation of ingredients into successive shells of varying composition,

cate that helium has a less density near the limb than in the higher strata of the solar atmosphere." With greater dispersion, however, this constriction at the limb is not seen, but the line appears hazy and of uniform breadth through the greater part of its length, becoming fainter and narrower at its upper extremity. With still greater dispersion, according to Hale, the helium lines broaden in the lower part of the chromosphere much as the hydrogen lines do. These distinctions, therefore, depend entirely upon the brilliancy of the background of continuous spectrum on which the bright lines are superimposed. The distribution of luminosity on either side of the center of the line is not the same in these two cases. The hazy wings of the hydrogen lines diminish more gradually in intensity on receding from the center. The broad wings of helium are hard to see near the limb, consequently helium falls off very suddenly in brightness on either side of the center of a line, and it is probable that in this respect the curve of emission for a helium line (coördinates = wave-length and intensity) resembles the curve of absorption very closely, and that this is a principal cause for the feebleness of the helium absorption lines. But it cannot be the only reason, since helium appears dark in stellar spectra, and the cause suggested in the text may be an additional one for its non-appearance in the solar spectrum.

<sup>\*</sup>J. Norman Lockyer, *The Chemistry of the Sun*, p. 253.

and this will produce spectral differences according to the level of the absorption; but the spectral differences to which Lockyer refers are of another sort and favor the interpretation that there has been a breaking down of the more complex atoms and an increase of simpler atoms, either relatively by the disappearance of the more complex, or possibly by a transformation of the complex into simpler forms. If we suppose that those atoms having large atomic weights have been formed by the expenditure of a greater energy, or that their latent heat of formation is relatively very great, the transformation of heavy atoms into lighter ones will set free an amount of energy equivalent to the difference in the heat of formation;\* but whether produced by transformation or destruction of atoms, the setting free of latent heat of atomic formation ought by analogy to develop relatively larger amounts of heat, or of energy to use a more elastic term, than transformations in the more compounded states of matter; and this development of energy may increase with rising temperature and excessive condensation, until limited in another way; for since the pressures produced by gravitation must be greater in very large masses, it is probable that the explosive energy developed by atomic transformation will increase as a complex function of the mass and its condensation; and thus explosive energy may be so great as to rupture the mass when this exceeds a certain size and degree of condensation. Star clusters may have resulted from such cataclysms in stars of very great mass. So many of the spiral nebulae consist of similar curved arms emanating in opposite directions from a common center, that we seem driven to admit the existence of directed explosive forces of enormous magnitude.

On June 26, 1885, at 1<sup>h</sup> 25<sup>m</sup> Paris mean time, Trouvelot† saw two prominences of extraordinary height at opposite extremities of a solar diameter (position angles, 59° and 239°). The eastern prominence measured 10.5, or about a third of the solar diameter, and the other was nearly as large. The western prominence, which was observed in its active stage, is thus described: "Its aspect was tree-shaped, and from its base, which resembled the root of a Pandanus, rose a slightly wavy column, 5' high, perpendicular to the surface, and ramifying into numerous branches which diminished in brilliancy as they rose, for the most part becoming invisible before their summits

\* It will be noticed that the meaning of the term "heat of formation" is extended beyond its usual application; but since heat is understood to be the energy of motion of the invisible constituents of bodies, it is appropriate enough to apply the same form of speech to the corresponding activity of the atomic constituents.

† E. L. Trouvelot. "Remarquables protubérances solaire diamétralement opposées." *L'Astronomie*, vol. iv, p. 441, 1885.

could be recognized" (p. 442). M. Trouvelot says: "We knew already that great prominences show themselves quite frequently at the ends of the same diameter, and we even suspected that a relation existed between them; but as these objects often occupy quite a considerable extent upon the sun, it was difficult to determine whether their being met at diametrically opposite points was a simple coincidence, or whether they were in relation and obedient to a common cause. The observation of the 26th of June seems to be in favor of the last supposition."

Secchi says: \* "M. de la Rue has remarked that great spots are generally situated at the extremities of the same diameter. The same law also applies very often to the development of great prominences. This coincidence agrees well with the hypothesis of an action analogous to that which produces the tides."

An examination of the longitudes of the planets on June 26, 1885, shows that Mercury and Saturn were nearly in line with the earth, but the tide-raising power of the combination does not seem great enough to produce such an extraordinary effect as that of the gigantic prominences seen by Trouvelot.

#### *Evidences of Explosions within the Stars.*

As Ranyard has pointed out, instead of the doctrine that the stars are products of condensation from nebulae, could be equally well substituted the opposite one that the nebulae have been thrown out explosively from previously existing stars, without doing violence to the appearances; and it may be that both processes are real, and that a criterion for distinguishing between them should be sought.

The curved streaks of nebulosity in the *Pleiades* appear to have some connection with the stars. The largest stars: *Alcyone*, *Maia*, *Electra*, and *Merope*, are in the midst of nebulae, and some of the streaks, especially those around *Maia*, have forms which at least are not inconsistent with the supposition that they may have emanated from the star at various times.

Miss Clerke† computes as a possible minimum value of the distance of the *Pleiades*, 1,500 billions of miles, or 250 light-years. "An assemblage like the *Pleiades* distributed round our sun would extend *compactly* three-quarters of the way to a *Centauri*, its feelers and appendages indefinitely farther." ‡ The brilliancy of the brighter stars in this case is several hun-

\* *Le Soleil*, 2<sup>e</sup> ed., vol. 1, p. 192, Paris, 1875.

† Miss Agnes M. Clerke, *The System of the Stars*, p. 226.

‡ *Loc. cit.*, p. 227.

dred times that of our sun. Their masses may even now exceed the limit demanded by the explosion hypothesis.

From some of the stars, nebulous arms proceed on opposite sides. Here the explosion has not been strong enough to blow the star to pieces; but more complex interlacing structures, and clusters of stars come either from successive explosions, or from a single one of such power as to produce disruption along a multitude of diverging paths. A sufficiently powerful explosion will give free wandering stars; and globular clusters, in this view, are relatively transient associations. The ultimate fate of aggregations formed in such a manner must be to break up. The star sprays and star drift noted by Mr. Proctor in his "Universe of Stars" may have resulted from such dispersals. The government of the heavens is like that of a great republic. No regal orb compels allegiance of a host of inferiors. The solar system is a family, where the relations of parent and child are recognized; but the stellar universe is a brotherhood, in which freedom and equality reign.

This view distinctly traverses the conception which has prevailed hitherto: that star-clusters are agglomerations condensed by the attraction of gravitation. If this were so, those clusters in which the action has been going on longest should be the most highly condensed. Instead of this, we find the most open and least typical clusters, such as *Coma Berenices*, to be those which include the greatest variety of stellar spectra and the most advanced types.\*

The splitting of a star in two by a directed explosion at its center should, in general, originate two equal motions in opposite directions in the equatorial plane, for the reason that centrifugal force diminishes the pressure in this plane of which some particular diameter is liable to form a line of least resistance.

As the outer layers are not concerned in the explosion, they remain at rest and constitute inert envelopes which will be dragged along by the moving parts, retarding them and perhaps at last destroying their motion by friction. The result will be a pulling out of the material of the star into finger-like extensions whose form, persistent through the partial or perhaps complete destruction of relative motion, will depend upon the relative velocities of the original rotation and proper motion, combined with the varying velocity due to the explosion, as the motion is gradually overcome by friction.

Except in the rare case of a star without proper motion, or of one whose proper motion is in the equatorial plane, the

\*Compare E. C. Pickering aided by M. Fleming, "Miscellaneous Investigations of the Henry Draper Memorial," *Ann. Harvard Coll. Obs.*, vol. xxxvi, part 2, Table 29, p. 283, 1897.

resulting double spiral or sigmoid curve of the combined trajectories cannot lie in one plane. Moreover, the two arms will not be entirely symmetrical, but both will lie on that side of an equatorial plane through the origin of motion towards which the direction of proper motion points, and unless the proper motion is directed at right angles to the original equatorial plane, the two branches will have different curves. Figures of this sort have been found by Holden\* from a comparison of a considerable number of spiral nebulae, and Keeler's crowning work with the Crossley reflector indicates that the number of spiral nebulae is very large.

Friction during the transformation must largely overcome the original rotation. Any remnant of rotary motion is probably confined to the original nucleus or to nuclei at the tips of the horns. In the absence of original rotation or proper motion, the result of an explosion will be a straight nebulous ray, which may retain a central nucleus and two subordinate ones symmetrically disposed in the tips. Many other varieties will suggest themselves. The stars *Asterope* (Wolf No. 121), mag. 6.5; Wolf No. 129, mag. 7.0, and Wolf No. 182, mag. 7.5 in the *Pleiades*, terminating curved nebulous streamers from *Maia*, mag. 4.5, may serve as an example.

The existence of a few "run-away" stars, with velocities much exceeding those which gravitation can produce, suggests that under rare circumstances explosions may occur through a large part of a stellar volume, so that the remnant thrown off is not much retarded by the resistance of outer inert layers.

\* E. S. Holden, "On the Helical Nebulae." *Pub. Astr. Soc. of the Pacific*, vol. i, p. 25, 1889.

[To be continued.]

## SCIENTIFIC INTELLIGENCE.

## I. CHEMISTRY AND PHYSICS.

1. *Chemical Reactions Produced by Radium.*—BERTHELOT has made a series of experiments upon the chemical action of the rays emitted from a small sample of radium chloride (about 0.1g.), which had been obtained from M. Curie. The active salt was contained in a small hermetically sealed glass tube, and for the purposes of experiment this tube was enclosed in a second tube, so that the rays were obliged to traverse two glass walls where the substance to be experimented upon was in contact with the outer tube, while three layers of glass were interposed when the radium acted from without a vessel containing the substance. It is possible, if radium rays vary as light rays do, that a part of the active rays may have been intercepted by the glass. The experiments were performed in the dark, with the use of parallel experiments without radium for comparison. It was found that solid iodine pentoxide was decomposed by the radium rays, as by light, into iodine and oxygen, while concentrated nitric acid, in the same manner, became yellow. These two reactions are endothermic, hence it is shown that the rays supply chemical energy. On the other hand, it was shown that several exothermic reactions were not produced by the rays. The conversion of rhombic sulphur in carbon disulphide solution into insoluble sulphur, which is caused by the action of light and is slightly exothermic, was not produced by the radium rays. The exothermic polymerization of acetylene gas, which is induced by electric effluvia, but not by light, was not effected by the radium. Oxalic acid, which is oxidized by atmospheric oxygen even in diffused light, did not undergo this oxidation under the influence of the radium rays. It was found further, as had been previously noticed, that the glass in which the sample was contained was blackened, evidently from the reduction of lead, while near the blackened regions a violet tint, probably due to the oxidation of manganese, was observed.—*Comptes Rendus*, cxxxiii, 659.

Soon after the appearance of Berthelot's article, which has been noticed above, BECQUEREL published a note upon the same subject. Attention is there called to the fact that salts of barium containing radium are spontaneously phosphorescent, so that in making experiments with them the phosphorescent light should be cut off by the use of black paper or a thin sheet of aluminum foil. He observes that the production of ozone by radium rays, which has been noticed by M. and Mme. Curie, is an endothermic action analogous to those observed by Berthelot. The chemical action of the rays in their photographic behavior is recalled, as well as their strong coloring action on glass, porcelain, paper, rock-salt and sylvine, their alteration of barium

platinocyanide, and their destructive action upon the skin. He mentions two exothermic reactions that have not been previously noticed: the conversion of white phosphorus into the red modification, and the reduction of mercuric chloride to mercurous chloride in the presence of oxalic acid in solution. He mentions finally the interesting fact, recently observed in his laboratory, that seeds exposed to radium rays for a long time before planting do not germinate. This action is slow, for little effect is noticed after 24 hours, but it is effective after a week or more.—*Comptes Rendus*, cxxxiii, 709.

H. L. W.

2. *The Preparation of Nitrogen from Ammonium Nitrate.*—In attempting to prepare nitrous oxide,  $N_2O$ , by the decomposition of ammonium nitrate, the plan of heating this salt with a high-boiling solvent suggested itself to J. MAR. Upon using glycerine for this purpose (50g. glycerine with 25g. ammonium nitrate), and heating to  $190^\circ$ , a gas began to be given off, and this continued without further heating until the temperature fell to  $150^\circ$ . After this a regular stream of gas could be obtained by heating to  $160^\circ$  or  $170^\circ$ . It was found that the addition of a few drops of concentrated sulphuric acid to the original mixture lowered the temperature at which the gas came off at first. Upon examining the gas it was found to be nearly pure nitrogen instead of the expected nitrous oxide, and it was shown that oxidation of the glycerine to glyceric acid had taken place. It is possible that the method may be useful in preparing nitrogen on the large scale, and it may be expected that the method of oxidizing organic substances will be useful in other cases besides that of glycerine.—*Berichte*, xxxiv, 3805.

H. L. W.

3. *The Atomic Weight of Tellurium.*—According to the position of tellurium in the periodic system of the elements its atomic weight should be less than that of iodine, but the most reliable determinations that have been made in the past have given results which indicate an atomic weight somewhat above 127, while that of iodine is considered to be 126.85 (oxygen being taken as 16). PELLINI has recently made some new determinations of the atomic weight, using tellurium which had been purified by the recrystallization of diphenyl-tellurium-dibromide, and by distilling the elementary substance in a vacuum. The determinations were carried out by converting weighed quantities of tellurium into the dioxide and weighing the latter, and also by the reverse of this operation. Fairly satisfactory agreements were obtained, and the average of the results indicates an atomic weight of 127.6, which is in close accordance with the value found by several other investigators.—*Berichte*, xxxiv, 3807.

H. L. W.

4. *Artificial Spinel.*—Although this mineral has been prepared artificially by several chemists, it is interesting to notice that DUFAY has found a very simple method of forming it by means of the electric furnace. An intimate and well calcined mixture of 200g. of alumina and 100g. of magnesia is heated in a



carbon crucible for three minutes by means of an arc of 900 amperes and 45 volts. A crystalline mass is formed containing cavities lined with crystals. The crystals of spinel thus formed are colorless, octahedral, scratch quartz, have a specific gravity of 3.57 at 15°, and have a composition corresponding to the spinel formula  $MgAl_2O_4$ . It is easy to obtain colored spinels in this way by additions of small quantities of oxides of nickel, iron, chromium, cobalt, etc. Attempts were made to prepare more basic magnesium aluminates by fusing alumina with several molecular proportions of magnesia, but spinel was invariably formed, crystallized in the excess of fused magnesia.—*Bull. Soc. Chim.*, xxv, 670.

H. L. W.

5. *The Size of the Sulphur Molecule.*—BILTZ and PREUNER have made an elaborate series of determinations of the specific gravity of sulphur vapor under diminished pressures which varied from 14 to 539<sup>mm</sup> and at the temperature of sulphur boiling at atmospheric pressure, or between 447 and 450°. At the lowest pressures used the specific gravities corresponded to molecules a little heavier than  $S_8$ , and as the pressure increased the specific gravities rose rapidly to values corresponding to  $S_8$ ,  $S_6$  and  $S_4$ , and then increased very slowly. The results when plotted indicate a curve beginning at  $S_2$  at 0<sup>mm</sup> and approaching  $S_8$  at high pressures. The authors conclude that sulphur vapor consists wholly of  $S_8$  and  $S_2$  molecules, and that there is no evidence of the existence of the previously assumed  $S_6$  aggregations.—*Monatsh. f. Chem.*, xxii, 627.

H. L. W.

6. *A Direct Gravimetric Method for the Estimation of Boric Acid.*—It has been found by PARTHEIL and ROSE that it is possible to extract boric acid, from an aqueous solution acidified with hydrochloric acid, by means of ether. The extraction apparatus used is one which acts continuously, the ether being distilled and condensed in such a manner that it flows up through a spiral tube containing the liquid to be extracted and then overflows into the distilling-flask. An extraction lasting 18 hours was found desirable, and the ether finally remaining in the flask was removed in a vacuum desiccator over sulphuric acid in order to weigh the boric acid as  $H_3BO_3$ . Two test analyses on boric acid and borax gave very accurate results, and the authors state that they have applied the method to the analysis of many minerals. For the application of the process, the boric acid solution should contain neither sulphuric, phosphoric nor nitric acids, nor any considerable amount of iron. The presence of zinc and arsenious acid would also interfere with the operation.—*Berichte*, xxxiv, 3611.

H. L. W.

7. *The Pressure of Light.*—Two papers have recently appeared on this subject: E. L. NICHOLS and G. F. HULL in the *Physical Review*, November, 1901, and P. LEBEDEV in the *Ann. der Physik*, No. 11, 1901. The investigators employ similar apparatus—vanes of varying material, suspended in a vacuum. They distinguish carefully the radiometer effects from the pressure of

light effects. Professors Nichols and Mr. G. F. Hull obtain  $P = 1.05 \times 10^{-4}$  dynes; theory demanded  $P = 1.34 \times 10^{-4}$  dynes. They believe that the observations show the existence of the phenomenon. Lebedew gives complete details of the construction of his vanes, which were of many forms, and of the method of exhausting his vessel. He used the most modern form of vacuum pump, shunning as far as possible complications due to greased joints. After as complete an exhaustion as possible, a globule of mercury in the vessel which contained the vanes was heated and after a renewal of the exhausting process the vessel was cooled. The value obtained for the pressure of light on an absolutely black body was  $P = 0.0000258$  dynes. This pressure is directly proportional to the quantity of the incident energy and independent of the color of the light. Lebedew considers that the existence of the Maxwell-Bartoli pressure of light has been proved.—*Ann. der Physik*, No. 11, pp. 433-458. J. T.

8. *On some Chemical Effects produced by Radium Radiations*.—In the *Comptes Rendus* of Nov. 4 HENRI BECQUEREL states\* that the radium radiation consists of a part capable of deviation in the magnetic field, identical with the cathode rays, and a part non-deviable, a fraction of which is absorbable and the remainder extremely penetrating. Observations are brought forward to show the action of the rays on glass, the transformation of yellow into red phosphorus, the reduction of mercury perchloride in the presence of oxalic acid and the effect upon seeds. It is found that prolonged exposure to the radium radiations had the effect of destroying the power of germinating in the seed.—*Nature*, Nov. 14, 1901. J. T.

9. *On the Induction Coil*.—LORD RAYLEIGH reviews the recent papers of Oberbeck, Walter, Mizuno, Beattie, and Klingelfuss, and considers that the subject is by no means exhausted. The author maintains that highly magnetized iron cannot be regarded as a store of energy, and that the energy expended in producing the magnetization is recoverable to a very small extent. The available energy of a highly magnetized closed circuit of iron is insignificant. The question of the desirability of a condenser in the primary circuit is next discussed, and shows that with a *very quick* break the condenser only does harm. He details experiments to produce such a break; among these experiments are interesting ones with a rifle bullet. The experiments supported the view that the only use of a condenser in conjunction with an ordinary break is to quicken it by impeding the development of an arc. If a sufficient rapidity of break can be obtained by other means, the condenser is deleterious, operating in the reverse direction and prolonging the period of decay of the current. The author does not refer to the Wehnelt interrupter and other forms of electrolytic breaks, which accomplish the object which he desires.—*Phil. Mag.*, Dec. 1901, pp. 581-594. J. T.

10. *Resistance in High Vacua*; by WILLIAM ROLLINS. (Communicated.)—The statement is frequently made that the resistance

\*See also p. 59.

to the electric discharge in high vacua follows an inverse rule from that governing discharges at ordinary pressures. In air at atmospheric pressure the resistance increases for moderate distances as the length between the terminals increases, while in high vacua the resistance is said to diminish as the distance between the terminals increases.

If the latter were true it would be so discordant with known laws that I have during several years made experiments with freshly prepared X-light tubes to see what could be learned. I have concluded that the accepted opinion is not correct. When the resistance in high vacua appears to follow another rule from that governing in air it is because the true condition is masked. To show that the same law applies in both cases I mention results obtained from tubes recently prepared for experiments on burning the skin. These had the movable terminals described and figured in my Notes in *The Electrical Review* for December, 1897, and January, 1898. They were carefully prepared with heat and heavy surges during pumping to get the terminals in proper condition for the current afterward to be used in exciting them. In No. 1, the target (anode) was placed forty millimeters from the cathode. In this position the resistance to an amount of current suitable for the tube was equal to four millimeters of air at atmospheric pressure. When the distance between the cathode and target was increased to one hundred millimeters, the resistance increased to ten millimeters of air.

In No. 2, under the same conditions, the resistance was equal to eight millimeters and twenty millimeters of air. In studying the resistance of high vacua, X-light tubes are valuable as they are very sensitive, and it is important to consider the conditions which determine the production of a regular cathode stream (such as the form of the terminals, the condition of the gas amalgamated with them)—the establishment of a normal circulation of the residual gases (depending on the form of the tube and the relations of the terminals to it)—the amount of the current and the size of the surges which are sent through the tube.

11. *Studies from the Chemical Laboratory of the Sheffield Scientific School*; edited by HORACE L. WELLS.—In two volumes: Vol. I, *Papers on General Inorganic Chemistry*, pp. 444; Vol. II, *Papers on Organic Chemistry*, pp. 379. Yale Bicentennial Publications. New York, 1901 (Charles Scribner's Sons). The Chemical Laboratory, which, as "the Philosophical Department of Yale College," had its beginning in 1847, has the distinction of having been the nucleus which has developed and expanded into the vigorous department of Yale University now known as the Sheffield Scientific School. From those early days until the present time the Sheffield Chemical Laboratory has been active in research no less than in instruction. This fact is well brought out by the Bibliography given on pages 4 to 10 of volume I before us, which, however, is limited to the titles of papers (130 in number) published, or about to be published, by the officers at pres-

ent connected with the department and those associated with them in New Haven. From this abundance of material, papers have been selected to fill these two volumes of the Yale Bicentennial Publications. The first volume is confined to inorganic chemistry and includes, for example, the interesting series of investigations by H. L. Wells and others on the halogen compounds of cesium and other elements.

The second volume contains a varied collection of memoirs on organic chemistry, many of them by W. J. Comstock and H. L. Wheeler. It is obvious that the eight hundred pages available could not suffice for all the memoirs which deserved republication. Some of those not represented here include, in accordance with the plan of the work, all the early papers; also, among recent publications, a series on thermo-chemistry by W. G. Mixter; further, papers on mineral chemistry, which last, however, have in part been included in the related volume noticed on p. 398 of the November number.

12. *Light: A Consideration of the more familiar Phenomena of Optics*; by CHARLES S. HASTINGS, PH.D. Pp. 224. Yale Bicentennial Publications. New York, 1901 (Charles Scribner's Sons).—The physical student, no less than the general reader, will feel himself indebted to Professor Hastings for having taken the time from more serious labors to prepare this very lucid discussion of the fundamental phenomena of optics. The topics included are such as come, more or less fully, within the range of observation of every intelligent person; those involving the use of complex apparatus (e. g. spectroscopy and polarization) being wisely omitted. The method of treatment is uniformly simple and the language and illustrations so far as possible familiar, while the prominent place given to historical development adds much to the interest and value of the whole.

The opening chapter deals with the nature of light as a wave motion, and the resulting explanation of the phenomena of reflection and refraction; this subject is again taken up in the closing chapter, in which the different theories as to the nature of light are discussed from Newton to Maxwell and Hertz. The interference and dispersion of light and some of their consequences are concisely treated, and then follows an admirable discussion of the optical instruments, the telescope and microscope; a chapter is given also to the eye and vision. A particularly interesting portion of the work is that devoted to the varied optical phenomena of the atmosphere; these subjects are of the keenest interest to everyone and yet they are rarely described and explained in such a manner and with such fullness as to be intelligible.

While the matter in hand is to so large a degree familiar, yet there is not lacking an originality in the method of presentation which will make the book valuable and suggestive to the physical student. He will turn, however, with most interest to the appendices, particularly Appendix A, with its mathematical discussion of lens systems. The author's extensive and successful

study into the methods of improving the construction of optical glasses, both for the telescope and microscope, have enabled him to present this subject in a particularly new and valuable form.

## II. GEOLOGY AND MINERALOGY.

1. *Lamarck, the founder of Evolution, his life and work, with translations of his writings on Organic Evolution*; by ALPHEUS S. PACKARD; pp. 1-451. New York, 1901 (Longmans, Green & Co.).—A very great service has been rendered by Professor Packard in bringing to light so full an account of the views of this most important of the pre-Darwinian writers on evolution. The volume is the result of an assiduous search among the available records of his life-work to be found in the Paris libraries and in the town of Bazentin-le Petit, where Lamarck was born in 1744.

Lamarck was a contemporary of Buffon, Jussieu, Haüy, Cuvier and Geoffroy St. Hilaire; also Rousseau was a friend of his youth. He was busy proclaiming a universal theory of evolution within the walls of the Museum d'Histoire Naturelle while the Reign of Terror was raging in the streets of Paris without. For it must be noted that his was not a theory of organic evolution alone, as we now know it, but, he claimed, "that the minerals and rocks composing the earth's crust are all of organic origin including even granite" (p. 120).

His first scientific work was as a Botanist and his "*Flore Française*," published in 1778, in three volumes, was highly appreciated, won him a place in the Academy and the familiar title of "the French Linné."

His later work in Zoology is also excellent. "There has never been any lack of appreciation of his labors as a systematic zoologist," says his biographer (p. 180).

The same may be said of his descriptive work in Paleontology. His "*Coquilles fossiles des environs de Paris*" will ever rank on a par with Cuvier's "*Ossements Fossiles*" among the foundations of the new science of Paleontology. But we note that it was Cuvier who first recognized in the fossil bones of the Paris basin evidence of *extinct* species of organisms formerly inhabiting the earth; while it was Lamarck, the transformist, who denied "that any species can really be lost or extinct" (p. 129). His speculations in Geology were crude and not in advance of his age; they no longer have a place in science. In general Physiology his speculations about spontaneous generation, subtile vapours and fluids, orgasm and caloric dropped out of sight with the advance of scientific knowledge. His speculations in physical science are described by his biographer as "physico-chemical vagaries." His strenuous advocacy of theories of all kinds, without taking the pains to adapt them to the opinions of his fellow scientists, or to establish their verity by actual observation, seems to have been the chief reason for the neglect which they and he suffered in his own time.

With the advance of scientific knowledge others have discovered laws, regarding the processes of evolution, which were distinctly formulated by Lamarck, and it is the full exposition in English of Lamarck's own view upon evolution that constitutes the chief value of this volume. Although readers will still differ as to the place Lamarck deserves among the founders of the modern theory of evolution, the reading of his words clearly demonstrates that he had in mind the construction of a fully elaborated scheme of factors to account for the modification of organic beings by slow and gradual variation into the diverse organic species now living on the earth. The Lamarckian factors *use and disuse, effort* (or felt-want or need), *direct effect of environment* and *inheritance of acquired characters* are recognized forces at work in determining organic variation. There can be little doubt, also, that *growth force*, which Cope has named Bathmism, is a factor of varying, in so far at least as varying is a normal function of all living and therefore growing bodies. These factors, however, without natural selection, do not constitute a complete scientific theory of organic evolution.

In the preface, the biographer states that "For over thirty years the Lamarckian factors of evolution have seemed to me to afford the foundation on which natural selection rests, to be the primary and efficient causes of organic change, and thus to account for the origin of variations which Darwin himself assumed as the starting point or basis of his selection theory" (pr. vii).

But may it not also be said that before Darwin no theory of evolution ever succeeded in crossing the line between philosophic speculation and natural science? The theory of natural selection first won for evolution a place among the sciences.

At first Lamarck believed that species were constant in nature, but as he tells us in the appendix to "*Système des Animaux sans Vertébrés*" (written probably as late as 1801), "I am now convinced that I was in error in this respect, and that in reality only individuals exist in nature" (p. 249), "all the modifications that each living being will have undergone as the result of change of circumstances which have influenced its nature will doubtless be propagated by heredity (*génération*). But as new modifications will necessarily continue to operate, however slowly, not only will there continually be found new species, new genera, and even new orders, but each species will vary in some part of its structure and its form" (p. 250).

It was, however, not till the appearance of the "Origin of Species" that a scientific way of accomplishing this result was discovered. It is natural selection which explains how it is that organisms varying by whatever means, can have their characters preserved when favorable,—rejected when useless, and thus indiscriminate variability can be reduced to the systematic evolution,

of always closely adjusted organisms, that we see taking place in nature.

The imperfection of the theory as a whole does not, however, detract from the honor due to Lamarck for the first announcement of the particular laws of evolution for which he is already famous.

We cannot agree with Professor Packard in describing Darwin as "*pushing entirely aside the Erasmus Darwin and Lamarckian factors of change of environment*" (p. 382).

The following quotations from the "*Origin of Species*" sufficiently testify to Darwin's full appreciation of the effects of change of environment :

In chapter v of the "*Origin*," on "*Laws of Variation*" Darwin distinctly states, that the facts of variation "lead to the conclusion that variability is generally related to the conditions of life to which each species has been exposed during several successive generations." "The direct action of changed conditions leads to definite and indefinite results," and "when the variation is of the slightest use to any being we cannot tell how much to attribute to the accumulative action of natural selection and how much to the definite action of the conditions of life." And not to stop with these quotations it was the same author of the theory of natural selection who adds, "In one sense the conditions of life may be said not only to cause variability, either directly or indirectly, but likewise to include natural selection, for the conditions determine whether this or that variety shall survive." (Darwin's *Origin of Species*, vol. i, pp. 164-167. Appleton edition, 1897.)

Lamarck's great merit consists in his unswerving advocacy of the theory of specific mutability, and the clear formulation of several very important factors of organic evolution. But his theory includes several factors which science cannot authenticate, and it lacks factors which are essential to a working hypothesis of organic evolution.

We close the book, after a careful reading, with the conviction forced upon us that Lamarck's theory, pure and simple, is not an adequate substitute for the more complete and rational Darwinian theory of evolution.

Chapters are added presenting Lamarck's views on the evolution of man, his thoughts on morals and the relation of science to religion, and a brief summary of the views of the more important Neo-Lamarckians. A complete bibliography of Lamarck's works is published at the end. H. S. W.

2. *Congrès Géologique international ; Comptes Rendus de la VIII<sup>e</sup> session, en France* (by the President, ALBERT GAUDRY, and general secretary, CHARLES BARROIS), two volumes, pp. 1-1314, figures 1-84, plates i-xxii. Paris, 1901. These two volumes give an account of the proceedings of the Congress held at the time of the Exposition in Paris in 1900. Besides the reports of committees a larger than usual number of scientific papers appear.

Among the more important subjects discussed by the Congress or represented in communicated papers, are the Report on Petrography and discussion associated; the report of the international committee on glaciers; a paper by Sir Archibald Geikie, on International coöperation in geologic investigation; the establishment of a committee, upon the suggestion of Dr. P. Ehlert for devising means for the publication of paleontologic types and original descriptions of fossils; a paper on bases of geologic classification by Prof. T. C. Chamberlin; a large number (76) of important papers on geology—and the *Lexique Pétrographique* of F. Loewinson-Lessing, occupying the last 300 pages of the second volume.

C. D. Walcott presented a paper on pre-Cambrian fossiliferous rocks. H. F. Osborn one on methods of precision in the study of fossil vertebrates, in which is given a *Tableau des horizons stratigraphiques typiques et des horizons homotaxiques de l'Europe et des États-unis*.

The discussion of the Report of the Committee on Stratigraphy led to the approval of the proposition to adopt for international nomenclature the prefixes *paleo-*(or *eo-*) *meso-* and *neo-* in subdividing *systems* into *series*; thus the divisions of the 3d order of the Devonian system become Eodevonian, Mesodevonian, and Neodevonian, leaving for each country to determine the particular formations (etages) to be included in each series.

The following international committees with their American representatives were appointed: Comm. des lignes de rivages—Dawson (Canada), Chamberlin (U. S.); Comm. de Coöperation internationale—Chamberlin, Walcott; Comm. de Réproduction des types fossiles—Walcott, Williams; Comm. de Pétrographie—Adams (Canada), Hague, Iddings, Pirsson (U. S.). H. S. W.

3. *Preliminary Description of the Geology and Water Resources of the Southern Half of the Black Hills and adjoining Regions in South Dakota and Wyoming*; by NELSON HORATIO DARTON. U. S. Geol. Survey, 21st Annual Report, Part IV, pp. 491–599.—The Black Hills country is an epitome of North American geology and is probably destined to occupy a larger space in text-books and courses of instruction than any other area of similar size within the United States. For this reason the Black Hills geology deserves all the labor that is necessary to make it accurate and complete; further, the publications regarding it should be well illustrated and written with a view to their use by general readers. These preliminary papers by Mr. Darton are in the main well up to these requirements.

In the present paper some new facts are added to the geological history of the Mesozoic rim of the Black Hills uplift. The uppermost layer of what has been regarded as Carboniferous is proved to be Permian; the Red Beds and the marine Jura have been separated and subdivided; part of the *Atlantosaurus* Beds (fresh-water Jura) of Marsh are named Beulah shales (from Beulah post office in the Trias?). The idea advanced by Ward



that these shales mark the close of the Jurassic is here temporarily accepted. The reviewers believe, however, that the Jurassic also includes the overlying series of sandstones and shales (the "Lakota") which are assigned to the Cretaceous by Mr. Darton. Some variation in the deposits are to be expected, but there is no decided physical break and the presence of typically Jurassic fossils, *Stegosaurus*, *Camptosaurus*, etc., collected by Wieland, cannot be overlooked. The testimony of the fossil plants opposes nothing if it does not support this view. At the top of the "Lakota" is a very significant layer of limestone—the "Minnewaste." That the Jurassic closed here, and that subsequently markedly new conditions of plant and animal life prevailed, seems probable. The overlying series of soft rocks, the "Fuson" formations with scattering dicotyls, may, therefore, better represent Lower Cretaceous, followed by the Upper Cretaceous Dakota sandstone.

As regards the Tertiary sediments, the report contains much that is new, interesting and important. It is the first serious attempt to give in detail the distributional relations of these beds to the original dome, and it is a matter of some surprise to learn the extent to which the dome was originally covered by them. Mr. Darton remarks (p. 558): "They are found up to high altitudes in the vicinity of Lead at an elevation of over 5,200 feet and on the north end of the Bear Lodge Mountains more than a thousand feet higher." A Post-Oligocene uplift amounting to several thousand feet, and according to Mr. Darton equal to the present upslope of the plains, has taken place.

Many of the facts brought out in the present work concerning these deposits cannot fail to be of great interest at this particular time on account of the discussion now in progress regarding the manner of deposition not only of these beds, but practically the whole of the western fresh-water Tertiaries. Mr. Darton does not hesitate to express his belief that they represent true lacustrine deposits as opposed to the flood-plain and aeolian hypotheses. As regards the eastern barrier of the waters of the White River lake, about which there seems to be so much doubt, Mr. Darton says (p. 559): "The eastern margin of this lake has not been traced for any distance, but there is no great difficulty in seeing that it consisted of low hills of Pierre shale and Fox Hills beds against which the Tertiary formations now abut to the east." It is to be regretted that the author has not seen fit to enter somewhat more fully into a discussion of the evidences which led him to conclude that these beds are of purely lacustrine origin.

The facts attending the deposition of the mammalian fossils in these beds are briefly considered. The attempt to introduce new names for the old, well-known and well-established subdivisions of the Tertiary deposits is open to criticism. These subdivisions have been made upon the very best and most conclusive faunal evidences, appropriate and widely accepted names have been applied to them and there seems to be no reasons for changing

them unless they can be shown to be wrong. One important division of the White River series, the Protoceras beds, has been entirely omitted from the report.

The practical utility of the work in question in the way of application of the information gathered to the great problem of an adequate water supply for the large semi-arid region which it covers, can scarcely be overestimated. If proper advantage is taken of the knowledge which this report affords, it is likely to yield many fold what it has cost to collect and publish it.

J. L. W., G. R. W., H. E. G.

4. *The Newark System of Pomperaug Valley, Connecticut*; by WILLIAM HERBERT HOBBS. With a report on Fossil Wood by F. H. KNOWLTON. U. S. Geol. Survey, 21st Annual Report, Part III, pp. 1-162 with 17 plates and 59 figures.—This small area exhibits the features common to the Newark system of the Atlantic slope, viz: a series of sandstones with interbedded traps, much faulted into monoclines of low inclination. In the Pomperaug area the unconformable contact of the Triassic with the underlying gneiss was revealed by digging and the contacts between the several members of the Newark series show plainly the extrusive character of the basalts. The deformation of the area has been studied and mapped in great detail (chap. iv). By careful attention to scarps, offsets, the development of slickensides and fault rock, the location of springs, etc., more than 250 dislocations have been mapped. Most of these faults fall into fine parallel series and the individual fault-planes are spared with remarkable uniformity. The fault-blocks range in size from "units" to composite blocks of different orders which correspond in shape with the unit block. The resemblance of the intersecting system of parallel faults to a system of compression joints suggests compression in an east-west direction as the course of the faulting. Professor Hobbs's study of faulting is an important contribution to our knowledge of the structure of the Newark beds.

Chapter v deals with the Degradation of the Pomperaug Valley and vicinity, and shows an interesting history of the development of drainage. The stream direction is believed to be largely controlled by preëxisting faults. Faults have undoubtedly had their influence on Connecticut physiography, but the argument that the stream courses, large and small, in this region owe their existence to fault-lines is not convincing, and when this theory is enlarged to account for the river-system of the entire State (Jour. Geol., vol. ix, No. 6, 1901) the present writer believes that it rests on insufficient data.

The fossil wood from South Britain, Conn., is referred by Mr. Knowlton to *Araucarioxylon Virginianum*. H. E. G.

5. *Influence of Winds upon Climate during the Pleistocene Epoch*; by F. W. HARMER. Quart Journ. Geol. Soc., vol. lvii, pp. 405-476, 1901, with 21 maps.—More than thirty years ago, Dr. Buchan suggested that alterations in the distribution of land and water during past epochs would have reacted on climate, and

modern geologists are accustomed to use this hypothesis in explaining the distribution of fossil fauna and flora. Mr. Harmer shows, on the other hand, that wide-spread climatic changes, sufficient to determine the physical and biologic character of a region, may be produced by variations in the relative position of areas of high and low barometric pressure. The former humid condition of the Sahara and of the Great Basin, the existence of the Mammoth on the shores of the Polar Sea, the non-glaciated Alaskan regions, and the secular variations of the European and American ice-sheets, are factors which have aided the author in determining the areas of low and high barometer and the prevalent storm-tracks of the Pleistocene Epoch. Many meteorological difficulties are avoided by adopting the hypothesis that the maximum glaciation of the eastern and western continents was not contemporaneous. While giving due weight to the older theories of the cause of the Glacial Age as well as to the more recent theories of Prof. Chamberlin and Dr. Ekholm, Mr. Harmer is "inclined to think that the minor variations of the Pleistocene, the pre-historic, and the historic periods may have belonged to one great series of events, and have been alike due to the cause which gives Great Britain its variable seasons at the present day, namely, to *alterations in the directions of the prevalent winds.*"

H. E. G.

6. *The Relative Density of Fluid and Solid Magmas.*—The question as to whether contraction or expansion takes place when an igneous rock is formed by the solidification of a fluid magma, is one that had been often discussed in connection with volcanic theories. It is generally assumed that the former is the case, and the experiments of Barus, detailed in this Journal ((2), xlii, 498, 1891), are conclusive on the point. Further experiments have been recently carried on by C. DOELTER. He shows that in all the cases investigated by him, as given in the table below, the density of the molten fluid is less than that of the corresponding solid rock; there being a difference of 0.2–0.3 in most cases. In order to obtain accurate results, he remarks that it is necessary to have the molten mass at a temperature considerably above that of fusion, so that its fluidity may be complete. In the case of melanite (lime-iron garnet), for example, which fuses a little above 900°, the experiment was tried between 1050 and 1100°. Instead of using a fragment of the same material in testing, a number of different minerals of appropriate densities, and with fusing points considerably above the temperature in question, were adopted. By noting which of these sank and which of them floated in the fluid, the density of the fluid was obtained with a fair degree of accuracy. The accompanying table gives the result for two minerals and five basic rocks. It will be seen that the density of the solidified material in the glassy form is considerably less than that obtained when solidification takes place slowly and the product obtained is more or less crystalline. Furthermore, the last density approximates towards the original

density, while the glassy solid corresponds pretty closely to the fluid in the same direction. These latter results are what were to have been expected.—*Jahrb. Min.*, ii, 141, 1901.

Mineral or Rock.	Original density.	After ignition.	Fluid.	Rapidly solidified; glassy.	Slowly solidified; crystalline.
Melanite -----	3.75	----	3.55 -3.6	3.55-3.60	3.65 -3.7
Augite -----	3.29 -3.3	----	2.92	2.92-2.95	3.2 -3.25
Limburgite ---	2.83	2.85-2.88	2.55 -2.568	2.55-2.568	2.75 -2.78
Lava, Etna ----	2.83	2.84	2.586-2.74	2.71-2.75	2.81 -2.83
Lava, Vesuvius	2.83 -2.85	2.84-2.87	2.68 -2.74	2.69-2.75	2.775-2.81
Nephelinite ---	2.735-2.745	2.75	2.70 -2.75	2.686	2.72 -2.75
Leucite -----	2.83	----	2.60 -2.68	2.68-2.72	2.75-2.787

7. *Das Siebengebirge am Rhein*; by H. LASPEYRES, Mitth. aus dem Min. Institut Univer. Bonn, xii Theil.; Verh. d. nat. Ver. der preuss. Rheinl., lvii Jahr. 1900, Bonn 1901, 8°, pp. 471 with color. geol. map and 23 figs.—This work is a very careful and detailed description of the local geology of the well-known Siebengebirge. Since this is a volcanic group of mountains, so the greater part of the memoir treats of the petrography of the igneous rocks, but in addition the sediments are well described and such topics as the physiography, the local mineralogy, etc. receive adequate treatment. The work of former investigators is considered and a great amount of new material introduced. It is, in fact, a very complete geological hand-book of the region and, together with the excellent detailed map which accompanies it, will be found of great service to every visiting geologist.

L. V. P.

8. *New Mineral Names*.—A minute examination of the original MANGANOCALCITE of Breithaupt by Breusing has confirmed the results of Rammelsberg and Des Cloizeaux that it is a mixture of a carbonate and a silicate. The author shows further, however, that the silicate belongs to the triclinic system and has the probable composition  $H_2Mn_3(SiO_3)_4 + H_2O$ . For this manganese silicate the name *agnolite* (agnolith) is proposed. It is related to inesite, which, however, contains calcium and has a somewhat different ratio.—*Jahrb. Min., Beil. Bd.* xiii, 265.

MANGANOSPHERITE is a carbonate of iron and manganese not far from the oligonite of Breithaupt. It is described by Busz from the Louise mine near Horhausen, Westerwald, Germany. The composition corresponds to  $3FeCO_3 \cdot 2MnCO_3$ . It occurs in globular aggregations and fibrous forms, filling cavities and narrow cracks in basalt; hardness 4.5 to 5; specific gravity 3.63. *Jahrb. Min.* ii, 129, 1901.

ESMERALDAITE is a hydrous iron sesquioxide described by A. S. Eakle from Esmeralda county, Nevada. It occurs in pod-shaped masses of a coal-black color, surrounded by a yellowish brown

earthy material consisting of a siliceous limonite. The black mineral has a vitreous luster and is translucent in thin edges; it is brittle, with conchoidal fracture and gives a yellowish brown streak. The hardness is 2.5 and specific gravity 2.578. An analysis by W. T. Schaller gave:

Fe <sub>2</sub> O <sub>3</sub>	H <sub>2</sub> O (110°)	H <sub>2</sub> O (over 110°)	Al <sub>2</sub> O <sub>3</sub>	CaO	P <sub>2</sub> O <sub>5</sub>	SiO <sub>2</sub>	Organic
56.14	15.94	10.24	5.77	3.35	4.49	2.05	1.37 = 99.35

If all the substances shown in the analysis, except the Fe<sub>2</sub>O<sub>3</sub> and H<sub>2</sub>O, are considered as impurities, the percentage composition becomes: Fe<sub>2</sub>O<sub>3</sub> 68.20, H<sub>2</sub>O 31.80 = 100. This corresponds to Fe<sub>2</sub>O<sub>3</sub>·4H<sub>2</sub>O.—*Univ. Calif., Bull. Geol.*, ii, 315, 1901.

9. *Mineralogy of California*.—Recent issues in the series of the Bulletin of the Department of Geology of the University of California (vol. ii, pp. 315–320 and 327–348) contain contributions to the mineralogy of the State. A. S. EAKLE describes fine crystals of datolite, also pectolite occurring in veins of the serpentine of Fort Point, San Francisco; analyses by W. T. Schaller are added. The same author describes the new hydrated iron sesquioxide, esmeraldaite (see p. 72); the occurrence of coquimbite at the Redington mine, near Knoxville; also crystals of the lead telluride, altaite, with the forms  $\alpha$  (100),  $\sigma$  (111),  $\beta$  (332) from Sawmill Flat, Tuolumne County.

W. C. BLASDALE shows that the green amphibole of the Coast Range in the neighborhood of Berkeley agrees with actinolite in physical characters though somewhat peculiar in chemical composition, alkalies being present to the amount of 2½ per cent. A blue amphibole from the same region comes very near to glaucophane but differs rather widely from the crossite of Palache. Descriptions are also given of tremolite, chlorite, talc and other species.

The Mesa Grande Mountains in San Diego County have recently yielded beautiful crystals of red and green tourmaline, occurring in lepidolite and in the associated quartzite. The crystals are often well terminated and many of them are of considerable size, transparent and of great beauty. The variety rubellite is most common, but many specimens show the characteristic zonal arrangement of color both concentric and in horizontal bands. (See further remarks by Kunz on the Production of Precious Stones in Min. Resources of the U. S. for 1900.)

10. *New localities of Nephrite*.—A recently issued inaugural dissertation, by A. DIESELDORFF, describes a series of rocks and fossils from Chatham island, as also from D'Urville and Stephens islands, New Zealand. Among other results, the author has made the interesting observation that nephrite occurs *in place* in serpentine as the mother rock on D'Urville island. This, as he notes, is the first time that nephrite has been definitely located, although obtained so frequently from New Zealand. The nephrite nodules occurring in the serpentine show uralitization,

as proved both by microscopic structure and by composition; in other words, the material is uralite-nephrite. Nephrite was also obtained in rolled masses from the same locality and at other points, but in these cases showed no alteration, so that its composition corresponded closely to normal actinolite.

It is interesting to note in this connection the remarks by G. F. KUNZ, on the recent discovery of nephrite in Siberia. He says: \* "This search for nephrite in Siberia was greatly stimulated in 1897 by a command from the imperial house of Russia that material be obtained for the sarcophagus for the remains of the late Alexander III. L. von Jascewski, in charge of the Siberian division of the geological survey of Russia, made three trips to the eastern Ural Mountains for the purpose of discovering larger masses of nephrite than had been known, and if possible, of finding nephrite in place. After thoroughly studying the deposits and obtaining masses of the material in the region of the Onot, which had been visited by Alibert in 1850 and Permikin in 1865, he then wended his way towards the region of the Chara Jalga, in the bed of which river he discovered some masses of nephrite measuring 12 feet in length and 3 feet in width, but even more important than this, he found a ledge of the primitive nephrite of magnificent green color—for the first time recognized in situ in Siberia. Enough of the material was obtained from the bowlders in the streams so that for the past three years the Imperial Lapidary Works at St. Petersburg have been making a small pavilion or canopy to be placed over the tombs of the Czar and his wife. This pavilion or canopy measures 13 feet in height, and is made up entirely of nephrite and rhodonite, of which latter material the entire sarcophagus had already been made for Czar Alexander II."

11. *The World's Largest Diamond.*—The gigantic diamond found in 1893, at Jagersfontein in South Africa, first called the "Excelsior" and weighing in the rough state  $971\frac{3}{4}$  carats, was exhibited at the Paris Exposition in 1900 cut as a brilliant and valued perhaps at \$2,000,000. It is now called the "Jubilee Diamond," in honor of the celebration of the sixtieth anniversary of the accession of Queen Victoria. G. F. Kunz says† in regard to it: "It far surpasses any diamond known, not only in size, but in its faultless perfection of color, luster, and water, and it has been cut with the most skillful modern appliances, so that it is an absolutely peerless gem. The Jubilee diamond weighs 239 French international carats of 205 milligrams. The Orloff of Russia weighs  $194\frac{1}{2}$  carats; the Regent of France,  $136\frac{3}{4}$  carats; the Imperial, 180 carats, and the Koh-i-nûr,  $102\frac{3}{4}$  carats. The Orloff, moreover, is a quaint, oriental-cut stone, and if it had been cut as a brilliant would not have weighed over 140 carats. Moreover, it is not flawless. The Regent has a minute flaw, and

\* The Production of Precious Stones in 1900, from Mineral Resources of the U. S. for 1900. U. S. Geol. Survey).

† Loc. cit.

the Koh-i-nûr has a grayish tinge. As regards purity, cutting, and color the Jubilee is actually perfect, and its form is so symmetrical that when placed on the small truncated apex of its basal pyramid, the culet, it stands perfectly balanced, though measuring  $1\frac{5}{8}$  inches in length,  $1\frac{3}{8}$  in breadth, and 1 inch in depth. As originally found, it was an irregular crystal of gigantic size,  $971\frac{3}{4}$  carats. The original crystal had a black spot about the center of the mass, but by cleaving it in two this was removed, and the Jubilee diamond was cut from the larger half.

### III. ZOOLOGY AND BOTANY.

1. *Reports on the Natural History of Porto Rico*, Bulletin of the U. S. Fish Commission for 1900.

Among the additional reports received are the following :

*The Stony Corals of Porto Rican Waters*; by T. W. VAUGHAN. Pages 289-320, 38 plates.—This is a valuable report including descriptions of a considerable number of the common West Indian reef-corals (16 species), and a few from deeper water, illustrated by heliotype reproductions of photographs, except plates i, ii, which are from good drawings of the smaller species. The absence of many of the common West Indian corals is very noticeable and indicates merely that the collections of reef-corals were made without much care or energy, on this expedition. The number should have been at least doubled easily.

Many of the plates are excellent, but some are very unsatisfactory, owing either to the poor quality of the photographs used, or else to faulty reproduction. Among the least satisfactory are those of *Orbicella acropora*, *Favia fragum*, *Agaricia*, sp. and "*A. elephantotus*." But all might, just as well, have been as good as the best.

The nomenclature adopted is the same as that used by the author in his former paper, on the fossil corals of Curacoa, etc. (1901), and he here repeats the same arguments to sustain his usage. As I have recently printed a paper on the West Indian corals,\* in which I have criticized some of his conclusions and adopted a different nomenclature, in many cases, it will not be necessary to go into the details of this subject here. But it may be well to call attention to some of the more important points of disagreement, and which relate to common species.

I.—*Acropora*, 1815, versus *Isopora*, 1878, = *Madrepora auctors*.—It is well known that Linné (Syst. Nat., ed. x, 1758) did not include in his genus *Madrepora* any recognized species of the Lamarckian genus of that name, but erroneously placed *M. muricata* (in which several species were included) in his genus *Millepora*, although it agrees with his definition of *Madrepora*.

\* Variations and Nomenclature of Bermudian, West Indian, and Brazilian Reef Corals, with notes on various Indo-Pacific Corals, Trans. Conn. Acad. Science, vol. xi, pp. 63, 168, 26 plates, Dec., 1901.

He corrected this mistake in the ed. xii, p. 1279, where *Madrepora muricata* appears. Therefore, if we follow the strict rules of priority and go back to ed. x of Linné, we cannot use the name for this genus.\*

The substitute-name that has the prior claim for adoption, and which seems available, is *Acropora* Oken, 1815. This originally included three generic types:—1st, *Pocillopora damicornis*; 2d, a *Porites*; 3d, *A. muricata* (L.). The first two having been eliminated by Link, 1807, and Lamarck, 1816, *Acropora* should be restricted to the third species, which is the true West Indian *muricata*. Vaughan uses the much later and objectionable name *Isopora* Studer, 1878, originally applied to a small section of the genus in which single, prominent axial corallites do not form the tips of branches.

In my work, cited above, I have restricted *Madrepora* to the types, *M. oculata* L. and *M. prolifera* L., ordinarily referred to *Lophohelia* and *Amphihelia* E. and H.

II.—*Mæandra*, 1815, versus *Platygyra*, 1834:—It seems necessary to restrict *Meandrina* (Lam., 1801) to the type *meandrites* (L.)=*pectinata* Lam., as claimed by Vaughan and others. The next generic name, in order of publication, is *Mæandra* Oken, 1815, in which the first species (*areola* = *Manicina areolata*, authors), and also the second and fourth, belong to this group. Ehrenberg, also, definitely adopted this name nearly in the sense used here. Vaughan assumes that *M. meandrites* should be considered the type of *Mæandra*, and thus makes it a synonym of *Meandrina*. This is not logical. Oken includes in this genus one of the *meandrites*-group by mere accident, it being erroneously referred to as a variety of a true *Mæandra* (*M. labyrinthiformis* (L.)=*Diploria*), while the four other species were of the *Diploria* and *Cœloria* groups. Moreover, he founded, in the same work, a new genus (*Pectinia*) for the *meandrites*-group. This of itself would show that he did not intend to include *meandrites* in *Mæandra*. Hence I have adopted *Mæandra* Oken, in place of *Meandrina* of later authors, but I have reunited to the genus *Manicina*, *Diploria*, and *Cœloria* of Edw. and Haime, for they have no structural or generic differences. *Platygyra*, used by Vaughan, was given to a subdivision of *Mæandra* by Ehr., 1834, and would be valid had not *Mæandra* prior and better claims.

III.—*Mæandra cerebrum* (Ellis and Sol., 1786) versus *Platygyra viridis* (Les., 1877):—This is the common large, rounded, simple-ridged brain-coral that has had many and varied names, but is more commonly called *Mæandrina labyrinthica*, *M. strigosa* Dana, or *M. sinuosa* Les. Evidently none of the early names used for this species are available, except *M. cerebrum* of

\* In a letter received after this review was put in type, Mr. Vaughan authorizes me to state that he now agrees with me that *Acropora* should be used in place of *Isopora*, and in the restriction of *Madrepora* to the *oculata*-group. Also in the reunion of *Diploria*, *Manicina* (auth.), *Cœloria*, and *Platygyra* = *Mæandra* in one genus; in the use of *Mæandra*, in place of *Platygyra*; and in the use of *O. annularis* instead of *O. acropora*.



Ellis and Solander, which was clearly based on the most common form of the species. Their description, though brief, is characteristic, and they also give the vernacular name, "Brainstone," which is still in use in the Bahamas and Bermudas. Vaughan adopts *viridis*, the name of one of the color varieties of *M. sinuosa*, described by Lesueur, 1817. There can be no certainty that this variety pertained to *M. sinuosa*, for Lesueur gave to it no characters except the green color. It is well known that the green color, so frequent in coral animals, is generally due to a parasitic unicellular vegetable organism, and it may occur in almost any species of reef corals, so that one can never be certain of the difference or identity of two allied corals having this color, even in the same locality, without studying the hard parts. On this account the name *viridis* should not be adopted for this species, for it was not connected with any specific characters and therefore has no claims for recognition, even if *cerebrum* were not available.

IV.—*Orbicella annularis* versus *O. acropora*:—Mr. Vaughan follows Gregory in adopting *acropora* (? Linné, ed. xii) in place of the long used name *annularis* Ellis and Sol. The *M. acropora* of Linné is utterly indeterminable. The locality was unknown, and the diagnosis so brief and vague that it applies equally well to any one of a dozen or more species of small astréan corals, both Pacific and Atlantic. Nor did Linné refer to any figure in earlier works. It is useless and unfortunate to try to apply the name to the present species and to displace a valid and long established name by one of extreme uncertainty. I do not know any good reason for such a course, in this case. The name *acropora* (L.) should be discarded as indeterminable, both generically and specifically. There is no certainty nor probability that the Linnæan species was the same as *annularis*, nor is there any good reason to believe that the *acropora* of Esper and of Edw. and Haime were the same as the *acropora* of Linné. It is certain that the contemporaries of Linné, like Pallas and Ellis, did not thus identify this species, for they described the *annularis* under other names. Had this species been what Linné had before him, he would undoubtedly have referred to Pallas, who had already well described it as *M. astroites*, for he referred to the other species of Pallas.

V.—*Porites polymorpha* versus *P. porites*:—Vaughan unites *Porites clavaria*, *P. furcata*, and all other branched West Indian forms under *Porites porites* Pallas. We cannot follow Vaughan in adopting *Porites porites* for it, for such a course would be contrary to the ordinary principles of elimination which he, himself, employs like others in similar cases. It is true that Pallas and all writers previous to Link (1807) included nearly all the species of *Porites* then known under the name *Madrepora porites*, which was a collective or generic group. Esper eliminated one species as *M. conglomerata*, and another as *M. arenosa*. Link eliminated another, the present form, by naming it *polymorphus*. Therefore,

the specific name *porites*, if used at all, should be applied to one of the remaining species of those mentioned by Pallas, as varieties. Pallas mentions *first* in his description (p. 324) a massive, gibbous species "massæ, gibbæ, tuberosæ, tunicatæ," and on p. 395, "Notæ," he speaks first of "massa informes, gibbas," "ex India," with stars subequal to those of *Mad. astroites* = *Orbicella annularis*. This East Indian, gibbous, massive species, with large stars, was evidently a *Rhodaræa*, probably *R. calicularis* (Lam., diameter of calicles 4<sup>mm</sup>). Therefore, it seems best to restrict *porites* to that species and call it *Rhodaræa porites*, thus avoiding the repetition of *porites* and conforming with the principle of recognizing prior eliminations at one and the same time. None of the species of true *Porites* have the "stars" much more than 1.5<sup>mm</sup> in diameter, rarely 2<sup>mm</sup>.

Mr. Vaughan agrees with Brook and the writer in uniting all the West Indian forms of *Isopora* (= *Acropora*) as varieties of a single species (*Muricata* L.). The principal varieties are *palmata*, *flabellum*, *cervicornis*, and *prolifera*. To these I have recently added others: *columnaris*, *cornuta*, *perampla*, *palmato-prolifera*, *flabello-prolifera*, *surculo-palmata*, etc. A. E. V.

2. *The Alcyonaria of Porto Rico*; by C. W. HARGITT and CHAS. G. ROGERS. Pages 265-287, 4 plates and cuts in the text, Dec., 1901.—This is a very useful report, though the number of species treated is not large. In the first part there is a good general synopsis of the families and genera of Alcyonaria, with diagnoses of the genera found in the West Indies.

The species described and figured include many of the common shallow water forms, as well as a considerable number from deep water, several of which are new. A. E. V.

3. *The Mollusca of Porto Rico*; by WM. H. DALL and C. T. SIMPSON. Pages 351-524, 5 plates, received Dec., 1901.—This is an important report, for it gives descriptions of a large number of species, hitherto scattered through a great mass of literature. It includes 653 species, of which 107 species are terrestrial; 42 are described as new marine forms. A large number of species are here, for the first time, recorded from Porto Rico. A. E. V.

4. *The Birds of North and Middle America*; by ROBERT RIDGEWAY, Part I, *Family Fringillidæ*, Bulletin of the U. S. Nat. Museum, No. 50, 1901, 715 pages, 20 plates.—This rather elaborate report consists of a descriptive catalogue of the higher groups, genera, species, and subspecies of all American birds occurring north of the Isthmus of Panama, and also those of the West Indies and Galapagos Islands.

It amounts to a complete monograph of all the Fringillidæ occurring within these limits. A. E. V.

5. *Capillaranalyse beruhend auf Capillaritäts- und Adsorptionserscheinungen, mit dem Schlusskapitel: das Emporsteigen der Farbstoffe in den Pflanzen*; von FRIEDRICH GOPPELSROEDER. Basel, 1901.—It is a familiar fact that when one end of a strip of bibulous paper is dipped in an aqueous solution of coloring mat-

ter, the water will ascend faster than the dye. Schönbein appears to have been the first to turn this interesting phenomenon to account in the laboratory. Among those who witnessed Schönbein's experiments in this field was the author of the present volume. His paper is a treasury of data collected during a protracted investigation of this and allied matters. In a subsequent notice we shall hope to give some of the more striking results reached as regards plants, but we meanwhile desire to call the attention of students of Biology to this important memoir, which fills a long felt want.

G. L. G.

6. *Plant Life of Alabama*. An account of the Distribution, modes of Association, and Adaptations of the Flora of Alabama, together with a systematic Catalogue of the Plants growing in the state by CHARLES MOHR, pp. 1-921, with portraits of the author and of THOS. M. PETERS.—As is stated also on the title page, this volume is a reprint of a volume published by the U. S. Department of Agriculture, prepared in coöperation with the Geological survey of Alabama. The Alabama edition presents also a sketch of the life of Charles Mohr, prepared by Eugene A. Smith, the State Geologist.

W.

#### IV. ASTRONOMY.

1. *The Leonids in 1901*.—The leonid shower was apparently this year rather more pronounced than in the two previous years and about as strong as that in 1898. Observations were secured at the Yale Observatory on the nights of November 13, 14, 15 and 16, the latter three being clear throughout. The greatest observed frequency occurred on November 14 at about 16 to 17 hours mean time, or on the morning of Friday, November 15, civil reckoning, when a single observer noted about 50 per hour. Photographic records were obtained of two leonids, one of them at both the Observatory and a station 3 miles distant. This meteor described an orbit very closely accordant with that of the leonids in 1898.

W. L. E.

2. *Leonids at Phoenix, Arizona*; by D. S. LANDIS, Observer, Weather Bureau. (Communicated.)—The leonids observed at Phoenix, Arizona, showed to fine advantage on the morning of the 15th, owing to a perfectly clear sky. The greatest display occurred about 5 A. M., local time. The showers were not constant, but came at intervals of about two minutes. A bevy would streak the sky for a few seconds, then the number would dwindle away to a straggling few here and there, until another shower would come on. Within ten minutes four profuse and distinct showers were noted.

Twenty leonids were counted within one minute flying over a space checked off by a house top. The angle of descent seemed to be about forty degrees from the perpendicular. The path of translation was due northwest, except in cases where violent explosion was apparent, causing deflection. In one instance an

explosion was noticed wherein the main part of the leonid was deflected to the southwest, and two zigzag lances of yellow flame darted off to the northeast.

The prevailing color was white. Some were tinged with yellow, a few were bluish, and others had tintings of red both on the head and edges of the wake of light. Most of the bodies showed a brilliant white center with purplish borders. One very large one resembled a six-inch globe of cankerous fire with spicules of red and yellow radiating from all points on the surface.

The path of light behind each body spread out in a feathery fan shape, and explosions were evident in the train of light, for the larger points would fly violently into a powdery haze, scintillate in a sort of luminous effervescence, and go out.

The first appearance of a leonid coming toward you from the southeast showed a reddish point of light which quickly merged into a yellow hue mixed with blue, then flared into an incandescent splendor. As the leonid approached, the point increased rapidly in size, some to apparently six inches in diameter, then tapered down to powdery sparks which invariably showed a violet cast before disappearing.

The sizes varied from mere beads of flaring white with thin iris-colored threads behind, to globes half a foot in diameter with explosive trains of variegated lights hundreds of yards in length.

The life of some of the larger leonids was fully five seconds from the time of the first point of light to the fading away of the luminous dust into darkness.

It would have been impossible to have counted the number, for they rained down from all parts of the heavens at intervals of about two minutes apart, and the descent continued until the morning light obscured them.

November 20, 1901.

3. *Leonids at Havre, Montana*; by C. W. LING, Observer, Weather Bureau. (Communicated.)—A beautiful display of leonids, or shooting stars, was observed at this station this morning. When I stepped out of the door at 7.30 A.M. (75th meridian time) I looked up at the constellation Leo and saw four meteors in less than that many seconds. After I had filed my morning report, I met the night policeman, William Chestnut, who was waiting to tell me about the unusual number of shooting stars he had seen during the preceding hour. I explained to him what they were and showed him the point from which they radiated. We then watched these meteors for over half an hour and saw at least a hundred of them. Some were of great brilliancy, some were actually seen to radiate directly from the constellation Leo, and all seemed to emerge from within the sickle in that constellation. At intervals they came into the earth's atmosphere at the rate of one a second for at least six seconds. As long as a star could be seen in this constellation these shooting stars appeared and continued until the great circle of illumination shut off all further view of them.

November 15, 1901.

## AMERICAN JOURNAL OF SCIENCE

[FOURTH SERIES.]

ART. VI.—*On Geometric Sequences of the Coronas of Cloudy Condensation, and on the Contrast of Axial and Coronal Colors*,\* by C. BARUS.

*Introductory.*

1. THE object of the following paper is, in the first place, to map out the sequence of coronas in case of water vapor, in terms of the numbers of particles producing them, relatively. The extreme diversity of coronal display seen in moist nucleated air lends itself well to a geometric method of classification when the colors are produced by successive exhaustions. The classification is thus primarily suggested by experiment.

In the second place, I shall make certain theoretic deductions from the time losses of nuclei observed, which clear up some moot points left in abeyance in my earlier experiments on the same subject.

I purpose in the third place to contrast the color of the central patch of the coronas with the axial colors seen in the steam jet, or under like circumstances with even greater saturation, in the adiabatically exhausted drum. The coronas must in large measure be diffraction phenomena; the axial colors cannot be so explained, but are evoked by some unknown kind of absorption. The contrast is sharply brought out by the experiments.

Finally I shall make an estimate of the absolute dimensions of the water particles in action and of their number and indicate a method which I am pursuing in a quest for definite absolute results.

2. *Apparatus.*—In my first experiments tubular apparatus was used in great variety; but in these instances the colors are

\*The researches outlined in the present paper are encouraged by a grant from the Smithsonian Institution. Here I can only acknowledge my indebtedness to Secretary Langley, for his patience and confidence.

too fleeting, and if obtained artificially with nuclei, the colors are apt to be too dull for good discrimination. The charge of nuclei is removed too rapidly by the condensation; and if the tube is horizontal, two longitudinal vortices are seen immediately after exhaustion, the air rising on the outside and descending into the center. Finally there is no guaranty that the charge of nuclei added is uniformly distributed. Tubes have one advantage, however, of affording a demonstration of the occurrence of rigorously axial colors.

For studying coronal effects spherical receivers, 30 cm. or more in diameter, as used by Coulier and Kiessling, are preferable. With divergent sunlight the display is gorgeous, the colors glowing metallicly. The mantle of a Welsbach burner seen through a small hole in a screen is better for experimental purposes. The axial colors are not very vivid from the small thickness of medium traversed; but the diffraction colors are bright, particularly on blotting out the central beam with a small black circular screen. Vortices are no longer violent. They serve a useful purpose in keeping the contents of the receiver homogeneous.

As a whole, the defraction pattern is a contraction inward of dark rings as the particles, during the course of exhaustion of the nucleated moist air, grow larger. With white light these occurrences are, however, by no means a succession of ordinary coronas. The initial and particularly brilliant coronas corresponding to finer particles have colored\* central fields, and it is only after many successive exhaustions that the normal, truly white centered corona is reached.

The information first to be sought is some classification of the sequence of coronal colors and of the axial colors seen in these experiments. These contrasting phenomena are radically different. If the former are in large measure diffractions, the latter are absorptions. The axial color is always nearly complimentary to the central field of the corona. As the particles grow in size, both central color phenomena pass through Newton's series at a definite phase difference apart, but the axial colors grow faint and vanish long before the diffraction colors.

#### *Coronäs.*

3. *Loss of nuclei by exhaustion.*—Omitting preliminary results, it will now be necessary to investigate data of a quantitative character, serving to distribute the coronas in a scale of decreasing numbers of nuclei. It will not be feasible to arrive at the latter datum at once; for the number of nuclei must be

\* The narrow white sheen around the axis mentioned in the tables below is probably irregularly diffused light.

supposed to vary both with the drain due to the successive equal exhaustions and, in the second place, to causes independent of manual interference, such as are involved in the motion of the nucleus (absorption by the walls, subsidence when loaded, etc.) and its possible decay. It is my present purpose to determine the most potent cause of dissipation.

Accordingly, in the following experiments the effect of exhaustion is first fully treated. The large globe was partially exhausted and refilled about twenty times in succession, the pressures falling off from normal to about 18<sup>cm</sup> below. The air which replaced that removed was carefully filtered and the influx slow enough through pressed cotton to insure efficiency.

TABLE I.—Color sequences of successive Coronas. Axial colors. Residual nuclei. Each exhaustion from 76<sup>cm</sup> to 58<sup>cm</sup>.

$$N = 10^{n(1+bt)\log y}; \quad y = \cdot 819; \quad t = 96 \text{ sec.}; \quad b = \cdot 1; \quad N_0 = 1\cdot000.$$

Exh. No.	Coronas.	Axial color.	$N_i \times 10^3$	$N_a \times 10^3$	$N \times 10^3$	$\sqrt[3]{1/N}$
1	Yl fog, red rimmed	Bl	731	800	793	1·08
2	Do.	Bl	535	640	629	
3	Gray, rd, { gr yl	Bl	391	512	499	
4	Viol, rd, yl-gr	--	286	409	396	
5	Bl-gr, rd	Yl	209	327	313	1·47
6	Gr, prp	Or	153	262	249	
7	Gr-yl, rd, gr, rd	—	112	210	197	
8	Yl, br, gr, rd	Violet	82	168	156	
9	Yl, rd, gr, prp		60	134	124	
10	Wh, prp, yl-gr, rd, gr		44	107	98	2·17
11	Wh, bl-gr, br-rd, gr, rd		32	86	78	
12	Apple gr, rd, buff, rd		23	60	62	
13	Gr-yl, br-rd, gr, rd		17	55	49	
14	Wh, br, gr, rd		12	44	39	
15	Wh, cr, gr, rd, gr		9	35	31	3·19
16	Wh, br, gr-yl { rd gr		7	28	24	
17	Wh, bl-gr, rd, gr		5	22	19	
18	Yl-gr, bl, rd, gr		4	18	15	
19	Wh, br, gr, rd		3	14	12	
20	Do. Small ordinary coronas		2	11	10	4·69

With each exhaustion a corresponding amount of nuclei are removed with the air. Thus after  $n$  exhaustions from pressures  $p_0$  to  $p$ , the residue of nuclei should be  $(p/p_0)^n$  under isothermal, and  $(p/p_0)^{n/\gamma}$  under adiabatic conditions ( $\gamma$  being the ratio of the specific heats), admitting what is by no means the case, as will be afterwards shown, that the whole experiment is made expeditiously enough to neglect the time loss of nuclei due to the normal causes mentioned. Cf. § 4.

In two successive experiments which showed a reasonable order of agreement, the color sequences of the coronas were observed from the center outward, while the corresponding flame or axial colors were simultaneously noted; but here there is an uncertainty from the small relative thickness (30.5 cm.) of the axial layer of water particles. Table I contains the results. Where different colors were seen (which may either be errors of judgment, or real differences of closely contiguous coronas) they are noted by inserting both colors on a line. The colors being fleeting, it is out of the question to wait for rigorous isothermal conditions; neither is it certain that the colors were caught for the adiabatic state of compression. A small allowance of time after exhaustion must be granted for judgment. The general agreement of coronas obtained seemed to vouch for this method of combating, partially at least, an inherent difficulty. The computation will be made both for isothermal and for adiabatic conditions, leaving the true result to be derived below, § 5.

Ignoring decay and similarly spontaneous time losses due to the motion of the nucleus, I here obtain a scale of optical effects related to the nuclei in a given volume of air saturated with aqueous vapor and to the given exhaustions. As more particles are present the condensed water globules are finer, remembering that the medium is always identically super-saturated. Only the momentarily fixed corona following the exhaustion has a real meaning.

The axial color or color of the full flame is seen to make up a similar sequence ahead in phase and nearly complimentary in color to the central patch of the corona. This will be separately investigated below, § 7.

The advantage of a geometric distribution of coronas will appear in the attempt now to be made to remove the time loss, which is also probably geometric.

4. *Loss of nuclei in the lapse of time.*—To determine in how far such an interpretation as given in the last paragraph is admissible and to correct it for the other simultaneous losses, it is necessary to determine the decrease of nuclei when the receiver is left for long intervals as far as possible without exhaustion or manual interference. In the following experiments the time between the inevitable exhaustions (usually about 96 sec., above) is prolonged to thirty minutes or even an hour. The first column in Table II shows the number of the exhaustion (with refilling of filtered air), the second the time elapsed since nucleation, the third the color sequences of the corona obtained. These are as a rule easily recognized by comparison with Table I, and the coronal number or "order" is put in the next column. It may be noted that fogs are often



spontaneously produced without change of pressure. The bearing of this on the present results is chiefly as an error induced by the subsidence of loaded nuclei. The table contains three independent experiments.

Omitting further discussion, one infers from the obviously linear distribution of the orders of coronas in the lapse of time, either that the number of nuclei is not changed by exhaustion, correspondingly greater numbers being produced at low pressures to make good the loss, or more probably that the time losses obey similar exponential laws to the exhaustion losses. The following theory is a more rational systematization of the data in accordance with the latter view, for which other cogent evidence might be adduced.

TABLE II.—Time losses of nuclei.  $N = N_0 10^{bt \log y}$

Exh. No.	Time.	Coronas. Colors of successive annuli.	No. by Table I.	<i>b</i>
0	0 <sup>m</sup>	Nucleation	0	·08
1	27	Wh, viol, yl	4	
2	61	Wh, yl, br, gr, rd	8	
3	94	Wh, prp, yl-gr, rd, gr	10	
4	124	Wh, br, gr, rd	14	
5	160	Wh, gr, prp, yl-gr, gr	17	
6	190	Wh, br, gr, rd	20 ?	
7	292	No color	—	
Series 2.				
0	0 <sup>m</sup>	Twice nucleated	0	·14
1	50	Yl, rd, gr, rd	8	
2	80	Gr, rd, gr, rd	11-12	
3	112	Prp, br, gr, viol, rd	15	
4	140	Wh, br, gr, rd, gr	20 ?	
Series 3.				
0	0 <sup>m</sup>	Nucleation	0	·10
1	95	Wh, viol, prp, yl-gr, rd, gr	10	
2	155	Wh, prp, br, gr, rd	15	
3	185	Wh, prp, br, gr, rd	19	

Let *n* be the order of the corona (exhaustion number), *N* the number of nuclei producing it for the fixed supersaturation. Without correction for time losses,  $N = y^n$ , where  $y = p/p_0$  under isothermal, and  $y^{1/\gamma} = p/p_0$  under diabatic conditions, *p* and *p*<sub>0</sub> being the pressures before and after exhaustion.

The data of the preceding section show that *N* suffers a time loss varying as *a*+*bt* in the time *t*, where *a* and *b* are constants. Hence the above equation must be corrected to read  $N = y^{n(a+bt)}$  to admit of both losses of similar geometrical character. Finally the initial nucleation,  $N_0 = y^{n_0}$ , is not identical in the different experiments, whence

$$N = 10^{(n_0 + n(1-bt)) \log y}$$

is the final form of the equation.

If in two experiments beginning with two different nucleations,  $N_0$  and  $N'_0$ , the same corona or  $N$  is reached for different times,  $t$  and  $t'$ , and different numbers of exhaustions,  $n$  and  $n'$ , of the same ratio,  $y$ , then  $N=N'$  and therefore after reduction if for brevity  $N_0=1$  and  $n_0=0$ ,  $b=(n-n'-n_0)/(t'-nt)$ . If two identical coronas are reached, the  $n_0$  may be eliminated so that  $b=(n_1-n_2)/((t'-nt)_1-(t'-nt)_2)$ , where the first identical coronas are seen for  $N_1, n_1, t_1$ , and  $N'_1, n'_1, t'_1$ , and the next for  $N_2, n_2, t_2$ , and  $N'_2, n'_2, t'_2$ . The plan is therefore to obtain an even number of identical coronas in cases of Tables I and II, and then to compute  $b$  from equidistant groups in the way suggested. Found thus,  $b$  is constant for a given table, but varies for the different parts of Table II, for reasons not yet clear. Inasmuch as a correction of Table I is here alone aimed at, it is not necessary to insist on very accurate values, and  $b = \cdot 10$ , a mean value agreeing with the corresponding experiments with the drum below, will be taken. In this way the values  $N_1$  (isothermal,  $y = \cdot 764$ ,  $t = 1\cdot 6$  min.) and  $N_a$  (adiabatic,  $y = \cdot 825$ ,  $t = 1\cdot 6$  min.) were computed.\*

5. *Corrected value of  $N$ .*—The true value of the number of nuclei lies between  $N_1$  and  $N_a$ , nearer the latter. The actual value,  $N$ , can be neither one nor the other chiefly because of the accession of heat received from the precipitated water. The rigorous equation would be somewhat complicated; but the computation may be made sufficiently close and perspicuously by the following method of successive approximation.

Let  $\theta$  and  $\theta'$  be the original and final absolute temperatures corresponding to the pressures  $p$  and  $p'$  and the densities  $\rho$  and  $\rho'$  of the air. We have nearly  $(\theta'/\theta) = (p'/p)^{(\gamma-1)/\gamma} = (\rho'/\rho)^{\gamma-1} (1)$ . Let  $S$  be the entropy per gram of a mixture of vapor and liquid in the ratio of  $x/(1-x)$ . Then  $S = C \ln \theta + rx/\theta$ , if  $C$  is the specific heat of the liquid,  $r$  the latent heat of evaporation. Since  $C = 1$ , and the mixture is initially all vapor expanding adiabatically, the last equation leads by the aid of equation (1) to  $x' = (\theta'/r')(r/\theta + \ln \theta/\theta')$ , where  $1-x'$  is the quantity of water precipitated per gram of mixture if the heat thus evolved be neglected. Since at  $20^\circ\text{C}$ .,  $\theta = 293^\circ$ ,  $\theta' = 271\cdot 2^\circ$ ,  $r = 589$ ,  $r' = 582$ ,  $\gamma = 1\cdot 40$ ,  $p'/p = y = 58/76$ , the result is  $x' = \cdot 949$  and  $1-x' = \cdot 050$  grams.

The next approximation is an allowance for the heat evolved. The air at  $20^\circ$  contains  $17/10^6$  grams of moisture per cub. cm., and the amount of water condensed is thus  $710/10^6$  grams, the heat evolved  $\cdot 419$  calories per gram of air. Since the specific

\* I have since repeated all these results under better conditions; but the differences need not be instanced here. In case of intense nucleation such as is produced by the sulphur flame, it may require ten exhaustions of the above order  $y$  before the initial fogs dissolve into coronas.

heat of air is .237, for the given values of temperature about 5.17 cal. are absorbed per gram in the adiabatic expansion of dry air. The available calories due to condensation will thus heat this gram  $1.77^\circ$ , which is the correction to be added to  $\theta'$ .

If the above equation for  $x'$  is now again used with the new data,  $1-x' = .046$  grams of water are found for each gram of vapor. Thus  $790/10^3$  grams of water are precipitated per cubic centimeter of moist air under the conditions selected in the experiment.

I may note in passing that if  $5 \times 10^4$  nuclei are present in the saturated emanation (as found in preceding papers),  $16/10^{12}$  is the volume of each water particle or about  $2.5/10^4$  cm., its diameter initially. This agrees very well with the results obtained from the coronas below, § 10.

To find  $N$  for Table I, the equation  $N = 10^{n(1+bt) \log y}$  is given by experiment, where  $y$  is the ratio of densities before and after exhaustion. Hence, since initially,  $\theta = 293^\circ$ ,  $p = 76$  cm., and finally,  $\theta' = 273^\circ$ ,  $p' = 58$  cm.,  $y = .819$ . Inserting the above value of  $t$  and reducing  $N = 10^{-1007n}$ . With these constants the values  $N$  of Table I were computed.

6. *Relative size of particles.*—Assuming that the same amount of vapor is condensed per cub. cm. in each expansion between fixed pressures of the moist air in the receiver, the relative size of the particles may be computed for the given orders of coronas. If the size of the particle in any one case were known, all would be found absolutely. It is only after about twenty exhaustions that the ordinary normal coronas are encountered. Table I (last column) contains an example of typical cases. It shows that there is not a striking variation of diameters to correspond with the startling variation of coronas. These are thus a rather sensitive criterion of change of diameter of water particles.

#### *Axial colors.*

7. *Conical drums.*—It will next be necessary to devise apparatus to show greater intensity of axial color (the colors of the steam jet or color tube), with the necessary relation to the coronas. This was originally attempted with tubular apparatus; but in the interest of homogeneity wide conical apparatus was finally devised, either a single or a double conical drum subserving the purpose. Effective convection currents are then continually in action within, and the density of distribution is uniform, slow work presupposed. With the double drum (apices outward) not only can greater length of column be secured but small end windows of glass suffice. This instrument is thus less troublesome than the single drum, the broad glass base of which, even if thick, is liable to break explosively

after many exhaustions from fatigued elasticity. I shall here quote results for the double drum only. This was about 180<sup>cm</sup> long and 30<sup>cm</sup> in equatorial diameter, carefully blackened within to prevent reflection from the sides; for all coronas are advantageously projected against a dull black background. It was made of copper and external ribs obviated collapse. The Welsbach flame is placed at one end, the eye at the other, with appurtenances close at hand for exhaustion and filtration. The end windows were 5<sup>cm</sup> in diameter. When the axial color is specially to be observed it is best to remove the screen from the mantle and to look at the full extent of the mantle. Ground glass covering the window and illuminated by sunlight is preferable. As these colors are seen mixed with the intense glare of white light, they vanish long before the coronas, and a drum 5 or 10 meters in length will eventually be necessary. With each exhaustion all the preceding colors for smaller water particles are flashed through until the tint hovers over the most advanced of the colors. After this there is a tendency to a retrograde movement, but it soon vanishes. The same difficulty of making observations on these fleeting color contrasts obtains here as above.

The yellows and browns of the first order, which can be produced so splendidly in the steam tube, were not obtained here except perhaps as a retrogression from the blues. The other colors are given in Table III on a plan identical with Table I. Two independent series are shown with the coronal and axial colors of each. The exhaustions are necessarily kept low, which, however, is an advantage, as a more finely graded sequence of colors is obtained. If  $N=10^{u+(b\epsilon)\log y}$  as in paragraph 4,  $y = p'/p = .888$ , and  $y^{1/\gamma} = .919$ . The constant  $b$  was specially determined and found to be  $b = .092$ , agreeing sufficiently with the above to admit of the same value in the corrections. The data are omitted for brevity.

The method of paragraph 5, for computing the actual number of nuclei,  $N$ , between the adiabatic and the isothermal numbers,  $N_1, N_a$ , when extended to the double drum gives for  $\theta = 293^\circ$ ,  $p = 76^{\text{cm}}$ ,  $p' = 68^{\text{cm}}$ , the absolute temperature  $\theta' = 283.3^\circ$ , as a first approximation. Inserting these data with  $r = 582$  and  $r' = 586$  into the equation for entropy, the approximate value  $1-x' = .0243$  grams of water precipitated per gram of mixture results. This is equivalent to .204 cal. evolved per gram of air by the precipitation of the available .0143 grams of moisture. The rise of air temperature is thus .86°. Hence the new data are  $\theta = 293^\circ$ ,  $\theta' = 284^\circ$ , and these with the above values of  $r$  and  $r'$  give  $1-x' = .021$  grams. Thus 361/10<sup>9</sup> grams of water are precipitated per cub. cm. of moist air. If as before  $5 \times 10^4$  nuclei are present per cub. cm. at the

outset, the volume of each precipitated water particle is  $7/10^{12}$  cub. cm. and its linear dimensions  $2/10^4$  cm.

Finally, if in  $N = 10^{n(t+bt) \log y}$ ,  $y$  be computed as the ratio of densities at  $p, \theta$ , and  $p', \theta'$ , then  $y = .916$ ; and since  $1+bt = 1.35$  for  $t = 3.5$  min.,  $N = 10^{-512n}$ . In this way the values marked  $N$  in Table III were computed.

Discussion.

8. Color sequences.—The coronal center which corresponds

TABLE III.—Axial and Coronal Colors seen in the Drum.

$y = .916$ ;  $t = 3.5^m$ ;  $b = .1$ ; Exhaustions 76–68<sup>cm</sup>.

Exh. No.	First Series.			Second Series.			$N \times 10^3$	$\sqrt[3]{1/N}$
	Axial color.	Coronal center.	Time.	Axial color.	Coronal center.	Time.		
0	—	—	—	—	—	39 <sup>m</sup>	1,000	1.00
1	—	—	—	Viol-bl	Fog	41	889	1.04
2	Bl	—	27 <sup>m</sup>	Bl	“	44.5	790	
3	Bl	—	31	Bl	“	48	702	
4	Bl-gr	—	35	Bl-gray	Colorless	51.5	624	
5	Bl-gr	—	38	Yl-gr	“	55	555	1.22
6	Gr-yl	—	41	Gr-Yl	“	58.5	493	
7	Yl	—	45	Yl	Olive-gr	62	438	
8	Yl-or	—	48	Or	“	65.5	389	
9	Or	Olive gr	52	Or	“	69	346	
10	Or-rd	—	56	Or. rd	“	72.5	308	1.48
11	Rd	Gr-yl	59	Prp	Gr-yl	79	273	
12	Viol-rd	—	63	Prp	Gr-yl	79.5	243	
13	Viol	Or-yl	66	Viol	Yl	83	216	
14	Viol-bl	Rd	70	Viol-bl	Or-rd	86.5	192	
15	Bl-gr	Prp	73	Viol-bl	Rd	90	171	1.80
16	Bl-gr	Prp	77	Gr	Prp	93.5	152	
17	Gr-yl	Prp	80	Yl	Prp	97	135	
18	Yl?	Gr	84	—	Wh viol	100.5	120	
19	Prp	Yl-gr	87	Viol?	Gr	104	106	
20	—	Or-rd	91	Viol	Yl gr	107.5	95	2.19
21	—	Gr	94	—	Or-rd	111	84	
22	—	—	—	—	Prp	114.5	75	

to the first axial blues and blue greens of Table III is not determinable as to color in the drum. In the globe it was seen to be a diffuse red-rimmed tawny fog. The first pronounced contrast which appears is the orange-red axial color and the blue-green or green-blue field. This is usually easily obtained and is complimentary in character. The axial colors then move toward the violet and the field colors toward the yellow. After this the axial colors are already nearly white; the tinge of color is so faint that it would be hard to recog-

nize it, if the sequence of colors were not known, from the steam jet. Nevertheless, the march of the axial colors into bluish, greenish, yellowish tints, corresponds to a march of the field from yellows into reds and purples. The colors thus followed each other around the circle, apparently diametrically opposed in position. I have stated that the axial yellows, browns, etc., of the first order were not obtainable in any case, directly.

I made many attempts to strengthen the axial colors by polarized light. The results, though not negative, are not easily interpretable. Thus the purple of the second order passes between crossed nicols with immensely increased saturation. But whether the depolarization is produced within the drum or at the glass windows (which cannot be kept quite clear), or is the result of diffused light entering from elsewhere, I have not been able to determine. These results were particularly marked for columns of about one meter in length.

If the colors for the drum and for the globe be compared for the same axial flame color, the latter will be seen to be about three orders in advance of the other. This is referable to the greater initial nucleation in case of the globe where the exhaustions were greater. It implies, however, that the initial distribution was in all cases undersaturated, if indeed saturation can here be expected. Apart from this, the nuclear ratio is about the same in the two cases so far as can be made out.

There is a final outstanding observation of some importance which needs mention. In studying the time losses I noticed that after long waiting (144 min.), single exhaustions seemed to remove two orders of coronas. Similarly on allowing the apparatus fully nucleated to stand over night (say 17 hours), the first exhaustion next morning showed a faint small but definite corona of the ordinary kind, but on refilling with filtered air, the subsequent exhaustions produced no corona whatever. These results can not be associated with the spontaneous production of nuclei from benzol, for instance. The subject requires further investigation. Water is found to produce nuclei after shaking, and it may be that an electrical influence is at work; but if fresh and at rest, the air above it is usually pure relative to such exhaustions as are here in question.

9. *Time losses.*—Some conclusion must be derived as to the nature of the time loss, which in the above equation has been very fully reproduced (apart from the inevitable errors) by  $N = N_0 y^{\beta t}$ , where  $N$  is the number of particles per cub. cm., surviving in the receiver after the lapse of time,  $t$ :  $y = \cdot 825$ ,  $\beta = \cdot 1$  by experiment. Thus on reduction, if  $\beta = \cdot 0083$ ,  $N = N_0 10^{-\beta t}$ . (1)

As in my preceding papers, I will suppose that the absorption velocity of the nucleus is  $k$  cm./sec., independent of the

density of distribution. Moreover, that in a spherical receiver, nucleated at the time  $t = 0$ ,  $N$  nuclei are found per cub. cm. at a distance  $r$  from the center. The distribution is in any case concentric, but otherwise disposable at pleasure. Since the absorption of nuclei is supposed to take place at the inner surface of the receiver only, there is a continued flux outward. The solution of the problem requires some understanding as to the manner in which this flux takes place.

(1) If there is a mere motion outward for all particles, the partial differential equation is found to be  $d(r^2 N)/dt + kd(r^2 N)/dr = 0$ , of which the integral determined by Lagrange's method is  $N = N_0 e^{f(r-kt) - \ln r^2}$ , where  $f$  is an arbitrary function. This is found for an initial distribution independent of  $r$ . The result is clearly not in keeping with the actual case of experiment, as is to be inferred if the nucleus moves in all directions.

(2) The next case would be that of diffusion. The partial differential equation is  $d(rN)/dt = k d^2(rN)/dr^2$ , where  $rN$  is zero at the surface and the center and the initial condition is  $rN = rN_0$ . This equation is integrable in the well known way, but the result again fails to meet the actual condition of the experiment as set forth in the next paragraph.

(3) Remembering that the investigations above were purposely conducted in wide receivers, with the object among others of keeping the contents in a homogeneous state of nucleation through the agency of convection currents, it may be safely assumed that  $N$  is not a function of  $r$  but of time only. If this were not so the coronas would show color distortion (as they do in marked degree in benzine vapor) as well as the time changes observed. In case of water vapor, the ever present convection will not allow either the distribution (1) or (2) to persist. Hence whatever removal of nuclei takes place at the inner wall of the large receivers is a deduction or drain of nuclei from the *whole* volume of vapor, uniformly. This experimental condition simplifies the computation and offers an easy interpretation of the results obtained. In case of absorption with the adequate convection, therefore (if  $R$  be the radius of the receiver),  $-(4\pi R^3/3) dN/dt = Ak 4\pi R^2 N$ , where  $k$  is the absorption velocity of the nucleus and  $A$  a coefficient, stating what part of  $k$  is effective in view of the given degree of convection maintained. For mild convection the loss of nuclei at the surface will take place largely by diffusion through relatively fixed layers and  $A$  will be a small fraction; whereas in case of very turbulent agitation, as when the nuclei-bearing air is driven through fine bore or capillary tubes,  $A$  will be nearly one. The air is soon washed clean of nuclei. Hence (2)  $N = N_0 10^{-3Akt(\log)e^{t/R}}$ , an equation identical in form with that actually found in the experiments.

From equations (1) and (2),  $\beta = 3Ak(\log e)/R$ ; and if  $k = 18$  cm./min.,  $R = 15$  cm., then  $A = .001$ . Thus the absorption velocity found from these experiments is but 1/1000 of the value found when the saturated emanation is forcibly passed through fine bore tubes less than .5 cm. in diameter. A correlative result was instanced in my earlier experiments showing the relatively small value of  $k$  found in passing the emanation through a wide tube, 5 cm. in diameter, though I was not at the time quite clear as to the reason. With the necessarily small mean free path of the nucleus, which being large in comparison with molecules owes its slow motion chiefly to the unfavorable bombardment of many molecules, the result stated is precisely what is to be expected. It is in harmony with the preservative effects of the dilution of the saturated emanation.

In general, therefore, the absorption velocity of the nucleus depends on the violence with which the contact of the nucleus and the solid boundary is promoted. In a bundle of fine tubes of a given area the absorption is enormous, caet. par., as compared with the single tube of the same area. Nevertheless the value of  $k$  seems to reach a superior limit in case of extreme agitation. This maximum of  $k$  is the value which I interpreted as being the true nuclear velocity and used with this meaning (after allowing for the motion in all directions) in the interpretation of my electrical experiments.

10. *Estimated size of water particles.*—The rate of subsidence of the fog is not a good criterion\* of diameter, because this datum is complicated by the evaporation of water particles (apparent subsidence at the top), and by their inevitable growth, remembering that the coronas are all fleeting phenomena. Some notion of their size, and this an upper limit, may be obtained. If the fog subsides at the rate of 1<sup>cm</sup>/sec., the radius of the particle will be  $r = .0009^{\text{cm}}$ . For any other velocity expressed in terms of this normal rate,  $r = 9 \times 10^{-4} \times \sqrt{v}$ . Now the rates are never a small fraction of cm./sec., so that the radii are not liable to be much below say  $10^{-4}^{\text{cm}}$ , a datum which at first sight is surprisingly large but is corroborated by the following independent estimates.

It has been shown above that in the case of spheres the moisture precipitated per cub. cm. of air partially exhausted as stated, is  $79 \times 10^{-8}$  grams, and that with  $5 \times 10^4$  nuclei per cub. cm. in the saturated emanation, this is equivalent to an initial diameter of the water particles of about  $2.5/10^4^{\text{cm}}$ . This datum is an order of values like the preceding, whereby two results are to this degree confirmed, viz: the order of size of particles producing axial color and the number of particles estimated for the saturated emanation.

\* Air cleared of fog by the warmer walls of the receiver after exhaustion, also rises to the top.



The same method applied to the results obtained from the double drum showed  $2/10^{4\text{cm}}$  as the diameter of the particles in the first exhaustions. The smaller size here corresponds to less exhaustion.

A final estimate is obtainable from the size of the normal coronas after say twenty or thirty exhaustions. Estimating this as about twice as large in diameter as the ordinary lycopodium corona, if the particles of the latter measure  $\cdot 0032^{\text{cm}}$ , one may rate the residual water globule at  $\cdot 001^{\text{cm}}$ . Indeed Fraunhofer and Kaemtz's measurements showed particles in lunar coronas as large as  $\cdot 0017$  to  $\cdot 0033^{\text{cm}}$ , depending on the season. Thus if the final size is  $\cdot 001^{\text{cm}}$ , the initial size must have been  $\cdot 0003$  to  $\cdot 0002^{\text{cm}}$ , corresponding to twenty or thirty exhaustions. Similar results are deducible from the drum and they are thus again in agreement with the preceding estimates. Finally the normal coronas may be measured absolutely and the dimensions computed from the deviation on diffraction. This is the practical plan with which I am now engaged, and I will therefore waive further discussion.

If the independent estimates just stated be summarized, the data are clearly of an order ten times greater than would follow if the axial colors of the drum or the steam jet were produced by interference of thin plates, granting that the old vesicular theory of atmospheric condensation is disproved. I admit that data as large as those found for the water particles are contrary to my expectations.

11. *Size of nuclei.*—This has been variously estimated by the aid of Kelvin's vapor pressure equation, successively modified by the younger Helmholtz,\* and by C. T. R. Wilson.† Naturally the nuclei are supposed to be of the same size and the supersaturation carried far enough to condense water on each. Helmholtz found  $15/10^6$  to  $26/10^{6\text{cm}}$  as the size of his nuclei. Wilson finds  $8\cdot 7/10^8$  for the case of rain-like condensation, and  $6\cdot 4/10^8$  and  $5\cdot 9/10^{8\text{cm}}$  for cloudy condensation, foggy and colored. The above data for the globe similarly interpreted give  $8/10^6$  and  $18/10^8$  as the smallest radii of the nuclei on which condensation takes place.

The small size of the nucleus obtained in this way is startling, but as the method involves a huge extrapolation from the radius of capillary action (say  $5 \times 10^{-6\text{cm}}$ ) almost as far as the molecular diameter, it cannot be received with much confidence and the size of the nucleus must be left in abeyance.

On the other hand, the size of the water particle is sufficiently large to admit of the application of Kelvin's equation. Moreover, there is here a mere accretion of water upon water.

\* R. v. Helmholtz, Wied. Ann., vol. xxvii, p. 526, 1886.

† C. T. R. Wilson, Phil. Trans., London, vol. clxxxix, p. 306-307, 1897.

If the change of pressure to pass from a given to a succeeding corona, or to any recognizable change of corona, be determined by two successive exhaustions, the particles of the first corona are the nuclei of the second, and consequently the radius of the former should be determinable absolutely. With this datum for the particles of one corona, Tables I and III would furnish the diameters of all.

Unfortunately this theoretically very promising method breaks down on experiment. For, let a small exhaustion be made adiabatically at the mean pressure,  $p$ , and the mean absolute temperature,  $\theta$ . Then in the modified form of Kelvin's equation for water (density = 1), let the logarithm be expanded. If  $T$  is the surface tension of water,  $p'$  its vapor pressure, the radius of water nucleus will be approximately,  $r = 2T/R\theta (\delta p'/p' - \delta p/p)$ , (1), where  $R$  is the gas constant of water vapor and  $\delta$  denotes increments. If the condensation takes place near the freezing point, as in the above experiments, we may write  $\delta p'/p' = .076\delta\theta$ . Again, for the occurrence of adiabatic expansion  $\delta\theta/\theta = ((\gamma-1)/\gamma)\delta p/p$ . After substituting both results in equation (1)  $r\delta p = 2Tp/R\theta(.217\theta-1)$ , where  $\delta p$  is an adiabatic increment of pressure, applied to the moist air at  $\theta$  and  $p$ . Using this equation for water particle of the order of dimensions estimated above at  $\theta = 273^\circ$  and  $p = 76^{\text{cm}}$ , an exhaustion of but 1/10 millimeter is in question. Now I satisfied myself in special experiments that exhaustion as small as  $1^{\text{cm}}$  would be perceptible in color changes of the coronas, particularly in the case of certain higher orders; but the small change corresponding to  $.01^{\text{cm}}$  is out of the question. I do not see, therefore, that methods other than those based on measurements of coronas will be applicable for the determination of the absolute dimensions.

Pursuing this subject, I found that the coronas of benzol following the initial fogs are all normal, relatively large particles being precipitated at once. Hence, if  $m$  be the mass of benzol condensing, computed for given exhaustions as in § 5, and if  $d$  be the diameter of the benzol particles found by measuring the coronas, then  $N = 6m/\pi d^3$ . The number of nuclei active in different methods of nucleation may thus be found by a few exhaustions, compared with the more prolonged observation necessary for water vapor. Care must be taken, however, to make allowance by the same method for those nuclei which I recently found\* are spontaneously generated by benzol. I will soon be ready with data bearing on all these questions.

Brown University, Providence, R. I.

\* Science, Jan, 1902. With regard to subsidence of nuclei it is well to remember that the same fine clay subsides in water very gradually, but in ether almost tempestuously. A like condition of things may hold for nuclei in relation to the vapors of water and benzol, etc. There is a distinct tendency to agglomerate in the latter case and not in the case of water.

ART. VII.—*On a New Occurrence of Sperrylite*; by H. L. WELLS and S. L. PENFIELD.

THROUGH the kindness of Professor Wilbur C. Knight of the University of Wyoming at Laramie, we have received a specimen of platiniferous copper ore from the Rambler Mine, which is situated in the Medicine Bow Mountains about 50 miles southwest of Laramie. The specimen consisted chiefly of covellite (indigo-copper) with a little pyrite. It occurred to us that the platinum in this ore might exist in the form of sperrylite,  $PtAs_2$ , since this mineral, which we described\* a number of years ago, was found with sulphide ores in the Sudbury region in Canada, and since it has been shown by Walkert† that the Canadian sperrylite occurs chiefly in copper minerals; hence we made an examination of the specimen.

About an ounce of the ore was coarsely crushed, decomposed with hot, concentrated nitric acid, and the residue was treated alternately with boiling, strong caustic soda solution and nitric acid until only a very small amount of dark-colored residue remained. When this was freed from a little light-colored material by decantation, about six very small glittering crystals, resembling sperrylite, were observed with the naked eye. After the material had been dried, the crystals were readily picked out on a glass surface by the use of a lens and needle. Under the microscope the crystals showed the wonderful brilliancy of sperrylite. The largest crystal measured  $0.12^{mm}$  in diameter and was rather highly modified. Although the combination could not be determined with certainty, the forms of the cube and pyritohedron were evidently present. A second crystal was evidently a combination of octahedron and cube. Four crystals having a total weight of about  $.00004$  grams, assuming that each had a diameter of  $0.1^{mm}$  which is a generous average, were used for a chemical examination. Upon being heated in the open tube they fused as sperrylite does and gave a sublimate of arsenious oxide in white, octahedral crystals. The residue in the tube was dissolved in *aqua regia*, and the solution, upon evaporation with a little ammonium chloride, gave yellow octahedral crystals of ammonium platonic chloride. There is no doubt, therefore, that the mineral was sperrylite.

We are not sure that the ore does not contain platinum in some other form than sperrylite, but the fact that we did not observe any metallic grains with this mineral makes it probable that all the platinum in the ore exists as arsenide.

\* This Journal (3), xxxvii, 67 and 71 (1889).

† This Journal (4), i, 110 (1896).

The discovery that platinum exists in the ores of the Rambler mine is quite recent and of great interest. Professor Knight states\* that platinum is found in ores from all parts of the mine in quantities varying from .06 to 1.4 ounces per ton (.0002 to .0048 per cent.), and that it is apparently most abundant in the covellite ore. From his account it seems probable that the platinum in this mine will be of considerable commercial importance.

The occurrences of sperrylite in Ontario, in Wyoming, and, as Hidden† has found, in several places in a North Carolina district, show that the mineral is widely distributed on this continent. It is to be hoped that copper ores will hereafter be carefully examined for platinum, and that future discoveries may be made which will tend to alleviate the present threatened dearth of this useful metal.

Sheffield Scientific School,  
New Haven, Conn., Jan. 7th, 1902.

\* Mining and Engineering Journal, Dec. 31, 1901, p. 845.

† This Journal (4), vi, 381 and 467 (1898).

## ART VIII.—A Cosmic Cycle; by FRANK W. VERY.

[Continued from p. 58.]

*General Theory of Stellar Explosions.*

THREE factors enter into the problem of stellar explosive force: (1) Composition, (2) mass, (3) temperature. There must be, first, the presence of substances of an explosive nature and in sufficient abundance; next, a mass great enough to give, at a certain stage of contraction, a gravitationally produced pressure sufficient to bring on the unstable explosive condition. The second condition may therefore be defined more exactly as contraction depending on mass. The third condition—a high temperature—is in one sense an effect of contraction, and might be included in the second; but since the unstable condition cannot exist without powerful internal movements within the atoms, we may designate temperature, and its concomitant latent or internal heat, as the immediate antecedent of disruptive explosions.

Two stages of explosive instability may be distinguished:

(A) That in which the explosive force has sufficient power to rend a star completely into fragments; and

(B) That in which the force is only great enough to cast off fragments of relatively small size from a parent mass.

It is conceivable that condition (A) may be limited solely by the mass of the star, or, on the other hand, that its composition is also an essential. If some of the elements are more highly explosive than others, the unstable ones will be used up first, and afterwards only minor explosions can occur. In view of the variety in the relative stability of compounds, the second view is the more probable; and the following argument seems to be decisive in its favor: Since it is certain that our sun has been attended by the earth during ages of quiet terrestrial development, I shall assume that the sun and stars of its type have entered upon the second stage, which may be distinguished as that of planetary evolution (B), the first stage (A) being described as that of stellar evolution.

Now Mr. Maunder has shown\* that, adopting Elkins' parallax, *Arcturus*, which is a star of solar type, if of the same intrinsic brilliancy, must have a diameter 82 times that of the sun; or, taking Mr. Ranyard's more conservative statement, "we may probably feel confident that the parallax of *Arcturus* is less than a third of a second of arc, which would give a distance of at least ten light-years, and a diameter for *Arcturus*, on Mr. Maunder's assumption with regard to its intrinsic brightness, equal to about five times the diameter of the sun."†

\* E. W. Maunder, *Knowledge*, vol. xiv, p. 21, 1891.

† A. C. Ranyard, *Knowledge*, vol. xiv, p. 22, 1891.

This gives *Arcturus* a mass 125 times that of the sun, even if its mean density is no greater than the sun's, leading to the conclusion that great mass may still be associated with stage (B), which is therefore determined by the elimination of substances essential to stage (A).

Have we any evidence as to the nature of these eliminated substances? In answer to this question, I must refer to Sir J. N. Lockyer's researches,\* which indicate that helium, the metalloids, and some unknown substances, as well as (in a few cases) the substance characterized by the series of spectral lines discovered by Pickering† in  $\zeta$  *Puppis* (perhaps an allotropic form of hydrogen needing rarefaction and a high temperature for its manifestation), are distinctive of the stars which I have included in stage (A). Hydrogen at its greatest development and the metals belong peculiarly to stage (B). But there must be an intermediate stage connecting the two. Let us suppose that the metalloids are on the whole the most unstable elements and the first to be eliminated, but that before their complete extinction the first stage of condition (B) is entered—that of the Sirian or hydrogen stars ( $B_1$ )—and that there is still enough explosive energy left to cast off, but not enough to completely sever from the system such bodies as the major planets. These bodies will retain in their interior substance a larger proportion of metalloids and other light substances, giving them small density, a much more probable assumption than that their composition is the same as that of the earth and their low density due to incandescence, for since the outer planets are on this hypothesis much the oldest, they have long since cooled to terrestrial surface conditions. The abundance of hydrogen in stars of the Sirian type and the presence of hydrogen in the atmospheres of the outer planets may be noted.

( $B_2$ ). The next stage in condition (B) is that of the Procyon or hydrogen-iron stars. At this point may be placed the birth of the terrestrial planets whose mean density points to an abundance of iron and metals of similar specific gravity in their interiors.

( $B_3$ ). The explosive activity of the sun at the present time is only capable of producing cometary births; and this condition is most favorable to that quiet, continuous sunshine which is needed for life on planetary worlds.

The question: Which are the hottest stars? needs to be put somewhat more definitely. If we ask: Which stars are hottest at the center? the present hypothesis answers that the solar

\* "On the Chemical Classification of the Stars," *Proc. R. S. London*, vol. lxxv, p. 186, 1899. Not all of the lines designated as unknown are new. "Asterium" is only another name for helium (first subordinate series of "parhelium").

† E. C. Pickering, *Astrophysical Journal*, vol. v, p. 92, 1897.

stars (or possibly even the stars of the fifth division) are the hottest, for there is no probability that the development of heterogeneity has reached its limit. If we ask: Which stars have the hottest photospheres? only conditional answers can be given. We need to know the relation between the photospheric level and the layer of mean density in the cooling gaseous sphere. Which of these layers is most rapidly approaching the center? Is there a gradual change in the incandescent material which forms the photosphere, or are all photospheres alike and formed of one highly refractory substance, perhaps carbon? If the last view is held, it might be surmised that actual photospheric temperatures are closely accordant, and that effective or apparent temperature is an affair of absorption by layers above the photosphere. Since atmospheric absorption in both solar and terrestrial envelopes is greatest for rays of short wave-length, it follows on this assumption that the bluest stars are those whose photospheres are at the highest level, the yellow and red stars being those in which, by condensation and increased heterogeneity, the level of the photosphere has sunk farthest beneath the outer boundary of the stellar atmosphere.

In his Presidential Address before the British Association for the Advancement of Science in 1891, Dr. Huggins has said: "Passing backward in the star's life, we should find a gradual weakening of gravity at the surface, a reduction of the temperature-gradient so far as it was determined by expansion, and convection-currents of less violence producing less interference with the proportional quantities of gases due to their vapor densities, *while the effects of eruptions would be more extensive.*"\*

With all of this I can agree, except the words which I have italicized. Convection and explosions are not thus correlated. While a star is expanded, the internal temperature is still relatively low, and viscosity is small enough to permit quiescent convectional circulation which does not interfere with a distribution of gases approximately according to their densities. It is after viscosity has become so great as to impede circulation, and the transfer of deeper superheated matter to the surface can no longer take place quietly, that explosions bring up the denser gases violently and mingle them with the outer layers.

The earlier stages of the helium stars, in my view, belong to the quiescent convectional era, but like the quiescence of a slumbering volcano, there is, during this period, a marshaling of forces preparatory to a final catastrophe. After one or more disruptive explosions, a new stage of somewhat quiescent convection is entered upon in the Sirian stars. But as internal

\* *Report B. A. A. S. for 1891, p. 16.*

temperature and viscosity increase, explosions again become frequent or periodic.

There is a limit to temperatures in outer layers immediately below the photosphere, possibly due to viscosity alone, and at any rate partly attributable to this cause. If the photosphere shares in the thermal changes of external layers, we may get some idea of outside temperatures from the distribution of energy in the spectrum. Even if the thermal condition of the photosphere is determined by some physical property which prevents it, for example, from exceeding a certain maximum temperature, and granting that there is a continual action tending to produce this maximum and therefore constant temperature, superficial radiation will always cause the outer layer to fall a little below the maximum, and this the more as the outer atmosphere is more transmissive of photospheric radiation. Allowing for the general absorption of the terrestrial and solar atmospheres, the spectral energy-curve of the sun has its maximum at  $0.45 \mu$ , corresponding, by Paschen's law of the wave-length of maximum energy for a black body, to an absolute temperature of 6424 centigrade degrees. It is not likely that the naked photosphere of any star has its spectral maximum much beyond  $0.45 \mu$ , but the emissive power of the photosphere may not be that of an absolutely black body, in which case the temperature will be higher.

On the supposition that the photosphere shares the varying temperature of the outer layers, we might have surmised, in the absence of the interlinear comparisons, that the heat in layers near the photosphere would diminish while central temperatures were increasing, viscosity correlating the two. But it is necessary to recognize that we do not know the distribution of energy in the spectrum of the naked photosphere of a star except as revealed by interlinear comparisons, and not even then except by a further correction for general absorption. When these allowances have been made, it does not seem necessary to assume any large variation in photospheric radiation, and it appears probable that there are some special substances which are precipitable in solid or liquid form between definite temperatures, out of which the photospheric clouds are formed, and whose presence serves as an indicator of the level within the stellar sphere at which these temperatures are attained. Thus in the sun, the photospheric level appears to be about 160,000 miles\* below the limit of the coronium atmosphere.

Sir William and Lady Huggins in their "Discussion of the Evolutional Order of the Stars,"† suggest that in "the earlier subdivisions of the white-star type, it is by no means certain

\* E. W. Maunder, *The Indian Eclipse, 1898*, p. 84.

† *An Atlas of Representative Stellar Spectra*, p. 69, 1899.



that a true photosphere after the pattern of a solar one exists. In these early, and therefore still very diffuse stars, we may see deep down into the star, and the continuous spectrum may come from a thick region of dense gas."

Experiments have been made which seem to show that condensed gases may glow with a continuous spectrum, but the phenomenon is an obscure one and subject to the interpretation that we are not dealing with a pure gas, but that, in some way, complex molecules similar to those of liquids\* have been formed by the pressure. We have no examples of such spectra at very high temperatures, and even at low ones gaseous radiation is commonly limited to particular spectral regions, often very narrow, and comes from layers of small depth.†

In another place Sir William and Lady Huggins‡ say: "The progress of contraction of the stellar mass with increasing age will not only exalt the violence of the convection currents, but also increase the density of the gases, though at the same time probably, the nearer approach of the photosphere towards the star's boundary will have the effect of making the increase of density at and just above the photosphere less than it would otherwise be." I have already noted that quiet gaseous convection does not increase with age, but diminishes on account of there being greater viscosity as the temperature rises. In like manner Lane's law that a cooling sun is getting hotter would be a complete paradox, were it not understood that, at a layer of given density, the temperature must always be falling. For a short time the position of a layer of a particular density in a contracting star may travel outwards and at a more rapid rate than the temperature-change in the opposite radial direction at that point; but in the end and throughout the greater part of its history, the position of a layer of given density must travel inwards, and the photospheric layer (which, as we have seen, is possibly at constant temperature, and anyhow does not change its temperature through a very wide range), because it is able to radiate more powerfully than the gaseous layers above it, will increase its distance from the outer boundary, until in the event of final liquefaction of the region below the photosphere, we might expect to find a relatively small nucleus encompassed by a vast atmosphere. After this stage, the nucleus having ceased to contract to any great extent, the gradual condensation of the atmosphere will undoubtedly cause the limiting surfaces in question to approach.

In the scheme which I have outlined there are not two

\* See the facts concerning complex molecules of water-vapor and oxygen in my research on "Atmospheric Radiation," *Bulletin G. U. S. Dept. of Agriculture, Weather Bureau*, pp. 99-100 and 103, 1900.

† See F. Paschen, *Wied. Ann.*, vol. li, p. 34, 1894; also F. W. Very, *Atmospheric Radiation*, p. 61.

‡ *An Atlas of Representative Stellar Spectra*, p. 70.

matched classes of solar stars, one on an ascending and the other on a descending scale of temperature, as in Lockyer's classification; but each stage is passed through once for all, and the order of transition is as follows:

(A) Stars typically of great mass but small density.

(A<sub>1</sub>) Bright-line Orion stars, but little removed from nebulae. Hot and rarefied, but the heat somewhat uniformly distributed by free convection.

(A<sub>2</sub>) Orion stars with narrow dark hydrogen and helium lines. Hot and more condensed, but not to such an extent as to separate an extensive hydrogen atmosphere; moreover, metalloids prevail over metals. All of these may be looked upon as explosive stars, if of sufficient magnitude, giving rise to clusters and extensive nebulae with intimate physical and chemical connection between stars and nebulous matter.

By the subdivision of these stars of great mass, a new stage of quiescent development is begun in which small mass and thence small pressure, with viscosity, prevent disruptive explosion.

(B) Stars typically of smaller mass and of relatively great condensation.

(B<sub>1</sub>) Sirian stars. A dense hydrogen atmosphere. Condensation begun, but not yet very great.

(B<sub>2</sub>) Procyon stars. More condensed. Interior convulsions begin to bring up denser material and mingle it with the outer layers.

(B<sub>3</sub>) Solar type. Still more condensed, and very hot at the core. Complex spectra. Calcium and metals prevail.

(B<sub>4</sub>) Stars with unknown flutings of absorption, growing fainter towards the red, indicating the presence of complex molecules. Variable from outbursts of hot luminous gases.

(B<sub>5</sub>) Stars with dark hydro-carbon absorption flutings, growing fainter towards the violet. First appearance of compounds. Central condensation probably extreme, and near the limit of possible stellar life.

Stage (A<sub>2</sub>) corresponds to McClean's Div. 1, to Lockyer's A<sub>α</sub> and A<sub>γ</sub>, and to Miss Maury's Groups II to V. "The helium stars of Division 1 and the gaseous nebulae are subject to a similar law of distribution in relation to the galactic plane."\*

Condensation and development of heterogeneity go hand in hand. Explosive forces, no longer strong enough to disrupt, are gradually resumed in stage (B), and are perhaps responsible for the equally gradual disappearance of hydrogen.

Nebulae and novae are obviously near to (A<sub>1</sub>). The Orion stars, as stated, sometimes have bright lines in their spectra, the hydrogen being negatively electrified. In this group come

\* F. McClean, *Phil. Trans. R. Soc., London*, vol. cxc, p. 129, 1898.

also such close binaries as  $\beta$  *Lyrae*, in which the separation of the components by excessively rapid rotation, or possibly by rotation and explosion combined, is barely effected.

The evolution of negative hydrogen still continues in our sun; but in the stars of Secchi's third type (McClean's Div. 5)—the long-period variables—positively electrified hydrogen is found whenever bright lines occur. The increasing absorption and its banded character (pointing to molecular complexity), together with the diminished intensity of the shorter waves, indicate that the third-type stars have begun to wane.

Some of the characteristics of stellar childhood recur in old age, but others are entirely different, or even opposite.

Passing from the evidence furnished simply by the light of the stars to that afforded by their associations, I proceed to apply the theory to the phenomena of binary stars.

Of eighteen stars having spectra of composite type, given by Miss Maury,\* the majority have the brighter star of solar type. Holden† finds that among undoubted binaries having components of unequal magnitude, the brighter is usually a yellow, and hence presumably a solar star, while the fainter is a blue or purple, and therefore probably a Sirian star; but some remarkable exceptions exist, and such stars as *Sirius* and *Procyon* prove that no simple rule, depending on rates of cooling as affected by mass alone, can cover all of these cases. This diversity of development in the members of a pair appears to show that, in the first place, fission has occurred after heterogeneity had been established; and, second, that sometimes the larger star retains the greater part of the substances which go to make up a solar star, while in other cases it is the smaller star which has received the denser central parts of the composite mass.‡ This difference of composition must dominate all subsequent evolution.

While heavy materials may be ejected by long-continued explosions of minor intensity from the central into an outer shell, the lighter substances of the outer layers are not carried downward in any corresponding degree. Hence in the separation into a binary, the body composed mainly of deeper substances has been largely freed from explosive material, and is ready to enter upon the more quiescent existence of a solar star; while the companion, consisting principally of material

\* Miss Antonia C. Maury, *Ann. Harvard Coll. Obs.*, vol. xxviii, pt. 1, p. 92, 1897.

† E. S. Holden, "Note on a Relation between the Colors and Magnitudes of the Components of Binary Stars," this *Journal* (3), vol. xix, p. 467, 1880. Professor Holden finds that when binary stars have both members of the same color, the mean difference of magnitude is:  $B-A=0.53$  mag; when of different colors,  $B-A=2.44$  mag. "We do not find *isolated* stars of decided green, blue or purple colors" (p. 468); but contrast tends to an exaggerated estimate of color.

‡ See, however, the suggestion concerning the development of the Algol binaries on p. 105.

from the outer shell which has never undergone the greatest pressures, is still rich in unaltered elements, and contains an excess of elements of small atomic weight and low density. In the majority of stars of composite type, the component formed from the outer shell is the smaller, as if the separation had been that of a comparatively thin layer thrown off by centrifugal force. Where, as in a large number of optical binaries, the luminous intensities are nearly equal and the spectra similar, it is probable that the separation has been due to a central explosion, dividing the original body into two nearly equal portions of similar compositions.

There does not appear to be any distinction of orbital eccentricity in respect to spectral type. If eccentricity were gradually developed from an initial orbit, circular in every case, there ought to be some progressive change of eccentricity with change of type. Since there is none, I infer that eccentricity of stellar orbits is the immediate result of forces involved in a sudden disruption, and has been only slightly modified by tidal evolution.

Dr. See says of the eccentricity that "this element, which depends wholly on micrometrical measures, and is independent of the parallaxes and relative masses of the stars, gives the sole clue to the evolution of the stellar systems, and will some day enable us to lay a secure foundation for scientific cosmogony."\* While I cannot make eccentricity the sole clue, it is certainly a very important one, and it seems to me that its indications support the view advanced here. The radial velocities produced by an explosion will be added to those given by tidal interaction of the components of a binary system. The mean orbital eccentricity of about  $\frac{1}{2}$ , which Dr. See finds for stellar binaries, need not require so long a time for its development as we should infer from the theory of tidal evolution taken alone.

The wide gap separating stellar and planetary orbital eccentricities (0.482 and 0.039 respectively) implies a different origin in the two cases. It is suggested here that the difference is attributable to the mode of division; that in separations occurring through excessive rotation, the division is into very unequal parts; that such rapid rotations imply a considerable degree of preliminary concentration, with imperfect fluidity which is not favorable to equable division, and on the whole are more likely to prevail at later than at earlier stages; that at later stages explosions, while assisting division, become less frequent and less powerful, owing to the elimination of especially explosive substances. On the other hand, division by central explosion may be expected to give more nearly equal components, and ought to be more likely to occur at a

\* T. J. J. See, *Evolution of the Stellar Systems*, vol. i, p. 252, 1896.

comparatively early stage of condensation, before the loss of peculiarly unstable substances.

Out of a total of 117 Orion stars (Groups I to V), Miss Maury gives 36 as of Div. *b*, or having hazy lines implying rapid axial rotation. The Sirian stars (Groups VII to XI) show 46 stars in Div. *b*, out of a total of 185 stars.\* None of this division occur among the solar stars. If the Orion stars are much more expanded than the Sirian, an equal superficial velocity will not be sufficient to give centrifugal separation at the earlier stage. The Sirian stars are more highly condensed—witness the dense hydrogen atmospheres—and hence are the most likely to give birth to planets by rotary velocity.

That some of the planetary births from stars as late in stellar development as the hydrogen-iron type, may occur by centrifugal expulsion, appears certain. Lockyer obtains for *α Aquilae* a minimum equatorial surface velocity “of about 45 miles per second supposing that the axis is perpendicular to the line of sight.”† Considering that this is 34 times as great as the present solar surface rotation, it would not be surprising if some of the hazy-lined stars should furnish us with a new type of novae. That rapid rotation ceases in the solar stage implies that rotational moment has then been destroyed by a previous expulsion of planets.

At present our knowledge of systems in rapid revolution, and therefore presumably young, is confined to Algol variables and spectroscopic binaries. Professor Pickering says: “It is noteworthy that all known variable stars of the Algol class have spectra of the first type, except perhaps *R Canis Majoris*, whose spectrum is either of the first or second type.”‡ *U Ophiuchi*, *λ Tauri*, and *β Persei* are helium stars, and the low average density of the Algol variables, from  $\frac{1}{3}$  to  $\frac{1}{5}$  that of the sun,§ points to an early stage of condensation as normal in stars of the Orion type. It must also be presumed from the short period of the Algol variables that the separation of the components can be but little beyond Roche’s limit, and consequently that these bodies are at a very early stage of stellar evolution. Since the eclipsing body is invisible, or at best a red star (*U Cephei*), there must be either a great diversity of composition or an entirely different life-history for the components of an Algol variable. This diversity does indeed suggest a capture theory, but the small eccentricity of the Algol-type orbits is decisive against such a supposition. The eclipsing body cannot be a meteor-swarm, or a companion disrupted by tidal strain, for only a single body of regular figure

\* Miss Antonia C. Maury, *Ann. Harvard Coll. Obs.*, vol. xxviii. pt. 1, p. 10.

† J. Norman Lockyer, *Proc. R. Soc. London*, vol. lxvi, p. 237, 1900.

‡ E. C. Pickering, *4th Annual Report of the Photographic Study of Stellar Spectra, Henry Draper Memorial*, p. 5, 1890.

§ H. N. Russell, *Astrophysical Journal*, vol. x, p. 317, 1899.

and defined limits could give the exactly timed and sharply defined occultations observed. Moreover the two bodies do not differ greatly in size or in mass. A dark meteor-swarm would have an extent relatively much greater than a stellar body of nearly the same mass. Considering their great mass and close proximity to the primary, the obscurity of these companions remains one of the most singular facts known to astronomy. The best explanation that has occurred to me is that the companion originally separated as a complete annulus and remained long enough in the annular form to cool by reason of the extensive radiating surface, before the ring was disrupted and its material gathered into one body.

The difference of type is much less in stars of composite spectra, which, however, are not necessarily binaries. Dividing the recently discovered spectroscopic binaries into two groups, one for periods of only a few days, the other where the period is several months, I find the following distribution by spectral types, according to the divisions of McClean and the groups of Miss Maury, omitting several pairs whose periods remain unknown.

*Spectroscopic Binaries of Short Period.*

Star.	Spectrum Div. or Group.	Variation of Velocity.
A. G. C. 10534*	?	610 km.
12 Persei	Div. 3 (Group 11)	51
$\mu'$ Scorpii	" 1a	460
$\beta$ Aurigae	" 2 ( " 8)	240
$\alpha$ Urs. Min.	" 4 ( " 13)	6
$\eta$ Aquilae	" 3 ( " 12)	50
$\zeta$ Geminorum	" 4 ( " 14)	27
$\kappa$ Pegasi	" 3 ( " 12)	79
$\zeta$ Urs. Majoris	" 2 ( " 8)	156
$\omega$ Draconis	" 3 ( " 11)	71
$\theta$ Draconis	" 4 ( " 13)	50
$\circ$ Leonis	" 3 ( " 12)	97
$\lambda$ Andromedae	" 4 ( " 15)	18

Mean variation of velocity = 147 km.

*Spectroscopic Binaries of Long Period.*

Star.	Spectrum Div. or Group.	Variation of Velocity.
$\beta$ Capricorni	Div. 4 (Group 14)	40 km.
$\alpha$ Aurigae	" 4 and 3	51
$\xi$ Urs. Majoris	" 4 ( " 14)	14
$\beta$ Scuti	?	21
$\eta$ Andromedae	" 4 ( " 15)	28
$\chi$ Draconis	" 4 ( " 13)	36
$\beta$ Herculis	" 4 ( " 15)	11
$\eta$ Pegasi	" 4 ( " 14)	23

Mean variation of velocity = 28 km.

\* V Puppis.

It will be seen that the short-period spectroscopic binaries are generally of earlier spectral type and have greater variations of velocity in the line of sight.

It has been found that the large and irregularly diffused nebulae, as well as the star-clusters, congregate in or near the Milky Way. This remarkable fact has hitherto been without explanation, but it receives one if we admit that both the diffuse nebulae with their branching and curved extensions, and the clusters, which in several instances exhibit irregularly radial linear arrangements of stars, have been produced by the explosion of exceptionally large stars which are consequently most numerous in the Galaxy. May we not say that here also extremes meet, since the presence of a considerable number of these huge explosive stars implies, apparently, an equal preponderance of unusually small stars, the fragments of past explosions?

The appearance of rotation in nebulous forms cannot be reconciled with any other than a motion of a relatively temporary character. It is inconceivable that these long curved arms should retain even their partial symmetry through any considerable number of consecutive revolutions. They would surely become drawn out and inextricably entangled, if compelled to follow the mazes of such movements as occur in binary stars. This accords with the failure to find any change of position-angle in the nebulae.\*

In the absence of proper motion, the combination of motions arising from explosive and centrifugal forces will produce in the disseminated material a symmetrical sigmoid curvature, such as we see in G. C. 3614 = N. G. C. 5247, and with less perfect symmetry in Messier 99,† and in Messier 83,‡ where there are three or four branches to the spiral.

In the absence of rotation, a straight ray of nebulosity may be produced as in

N. G. C.	676	=	G. C.	400
“	4216	=	“	2806
“	4861	=	“	3340

The first of these has a central star, the second a central condensation, and the third two end stars.

Extreme vigor of rotation and repeated explosions are indicated in such complex forms as the great spiral nebula in Canes Venatici.§

According to a sketch made by Mr. Johnstone Stoney with Lord Rosse's telescope, April 19, 1849,|| N. G. C. 4631 exhibits

\* See Dr. J. L. E. Dreyer in *Monthly Notices R. A. S.*, vol. xlvii, p. 412, 1887.

† G. C. 2838 = N. G. C. 4254.

‡ G. C. 3606 = N. G. C. 5236.

§ Messier 51 = G. C. 3572 = N. G. C. 5194.

|| See *Phil. Trans. R. Soc. London*, vol. cxl, pl. 37, fig. 9, 1850.

a helical structure, something like a variously twisted rope, suggesting that it may have been produced by an explosion directed, by exception, along the axis of a rotating body.

The circular form of planetary nebulae and the presence of a single star at the precise center of a circular nebulous spot are sufficient indication of central forces in these objects, but it has perhaps been too hastily assumed that the forces are always centripetal. The recent discovery of a radial structure in certain planetary nebulae lends to these forms also the similitude of an explosive phenomenon.

The sudden dispersal of intensely heated matter through a large volume may be expected to produce by expansion either a mass of relatively cool gas or a cloud of dust. In either case, the dispersal is incomplete, because modification of motions by internal collisions prevents the escape of any considerable number of particles from the central control.

The case is otherwise if the explosive subdivision has been into a comparatively small number of distinct bodies, where the central control may be insufficient to prevent the wandering of the members to such distances that the system is eventually completely broken up.

The existence of a few stars of exceptionally great mass and late type is an objection which may be urged against the proposed theory. It seems possible to meet this objection as follows: In case the explosions resulting in the formation of a planetary nebula have eliminated most of the especially explosive material, we may surmise that a repetition of the condensation of the diffused matter will give a stable star of enormous size.

It may be granted that quasi-fluidity of a meteoric swarm, produced by internal collisions,\* supplies a needed analogy for the explanation of certain figures observed among the nebulae, resembling those of the fluid masses freed from gravitational control, which have been made known to us by Plateau, where the interaction of pressure from fluid surface-tension and rotary forces give a number of similitudes; but the existence of these simple forms among the nebulae only emphasizes the necessity for additional hypotheses to explain the numerous departures from forms which may be regarded as cases of simple rotary equilibrium; and the radial and branching features of a great number of nebulae require that the added force shall act radially and outward from a center.

The hypothesis of planetary genesis by nebular annulation through excessive rotary velocity is beset with difficulties.

\* See the mathematical researches of G. H. Darwin, "On the Mechanical Conditions of a Swarm of Meteorites, and on Theories of Cosmogony," *Proc. R. S. London*, vol. xlv, p. 3, 1888. *Phil. Trans. R. S.*, vol. clxxx. A, p. 1, 1889.



There is not a single example of a nebula with the requisite difference of velocities in the line of sight. The lines in the spectrum of a nebula are comparatively narrow. On the contrary, there are *stars* with all of the spectral lines broad and hazy, indicating large rotary velocities.

The small eccentricity of the planetary orbits forbids the supposition that the planets have been thrown off from the sun by an explosion pure and simple. Excessive rotary velocity of the parent body is necessary to account for the zodiacal and nearly circular paths of the planets. Extreme velocity of rotation would not be expected in an immensely extended and excessively attenuated nebula, but might increase from a feeble beginning after concentration into a condensed nucleus. The requisite rotary velocities, as we have just seen, are found to be associated with the stellar stage of development. Moreover the densities of the most rapid Algol binaries, which, by the present hypothesis, have only recently passed the epoch of stellar subdivision, and may be verging upon the condition requisite for planetary formation, while smaller than that of the sun, are not so small as to indicate any approach to the nebular state.

We have already seen that associated nebulae may be explained as resulting from the dispersals accompanying explosive disruption, and, besides, none of them indicate any orbital motion such as we should expect if they had been separated by centrifugal force. Consequently the planets seem to have developed from the sun after it had reached the stellar condition which is not likely to occur with a density much less than  $\frac{1}{50}$  that of the present solar stage, if we may judge from the probable densities of the Algol binaries. But this requires a body of much larger mass than is now possessed by the sun, if its volume is to reach dimensions comparable with the orbits of the outer planets. A certain amount of recession of a planet from the sun may result from tidal interaction while the planet is fluid and near the central body, but this cannot account for the actual distances.

“A numerical evaluation of the angular momentum of the various parts of the solar system will afford the means of forming some idea of the amount of change in the orbits of the several planets and satellites, which may have been produced by tidal friction.” “From the numerical values so found, it is concluded that the orbits of the planets round the sun can hardly have undergone a sensible enlargement from the effects of tidal friction since those bodies first attained a separate existence.”\*

\* G. H. Darwin, *Nature*, vol. xxiii, p. 389, 1881. See also *Trans. R. S. London*, vol. clxxii, p. 527, 1881.

There remains the possibility of planetary recession through the destruction of the matter of the sun? With a mass 100 times greater than now, a density of  $\frac{1}{50}$ , a mean radius of  $7\frac{1}{2}$  million miles, and an equatorial radius at the epoch of annulation of 10 million miles, corresponding to one rotation in  $1\frac{1}{4}$  day, a planet might be produced centrifugally whose distance would increase from 10 to 100 million miles as the material of the sun wasted. This would account for the earth, but not for the major planets, and we have no conclusive evidence that stars of such great bulk exist.

Another alternative remains. Abandoning the conception of low density, and demanding only a sufficiently rapid rotation, which is most likely to occur in a star of considerable concentration, an explosion of minor intensity at an epoch of great rotary velocity, acting radially in the equatorial plane, since centrifugal force makes this the direction of least resistance, may generate by the composition of a radial with a rapid rotary motion a long-drawn-out spiral trajectory, leading to an ultimate nearly circular orbit. This view coincides with the original cosmological suggestion of Emanuel Swedenborg,\* although he failed to discern any sufficient reason for the outward progression of the planets along spiral paths to their present orbits. I have been led to this view by a process of elimination, abandoning one hypothesis after another on account of their conflict with known facts. Again there is

\* Swedenborg's *Principia* was published at Dresden and Leipsic in 1734 in Latin. There is an English translation by the Rev. Augustus Clissold, London, 1846. As this work seems to be unknown to most astronomers, I will quote a few passages from Part 3, Chapter 4: "Reason dictates that the planets must derive their origin from causes, in time and in place; that causes are to be found in first principles; in fine that the earths in our system must have had an origin by succession." "That the sun is the first moving power in its universe." "That the planets had their origin near the sun." That a "crust, consisting of fourth finites, which is formed around the sun, is rotated in a certain gyre." "That the solar crust, being somewhere disrupted on the admission of the vortical volume, collapses upon itself; and this toward the zodiacal circle of the vortex, or conformably to the situation and motion of the elementary particles, so that it surrounds the sun like a belt or broad circle; that this belt, which is formed by the collapse of the crustaceous expanse, gyrates in a similar manner, removes itself to a farther distance, and by its removal becomes attenuated till it bursts, and forms into larger and smaller globes, that is to say, forms planets and satellites of various dimensions, but of a spherical figure." "That these bodies, separated into globes, consist of fourth finites; that they direct their course into the vortical current according to their magnitude and weight; that they continue more and more to elongate their distance from the sun, until they arrive at their destined periphery or orbit in the solar vortex, where they are in equilibrium with the volume of the vortex."

The part of the theory which predicates a vortex circumfluent to the sun and including the remotest planet, has hardly any superiority over Descartes' conception, but the idea of a derivation of the planets from the sun by centrifugal force of the rotating volume was original, and constituted a momentous new departure in scientific doctrine.

general agreement with the fundamental principle that explosions are prime factors in cosmic development.

After each separation of a planet by combined explosive and centrifugal force, the solar rotation is reduced until gradually restored by contraction of the cooling sun, when the process may be repeated. If in addition there is a gradual destruction of the solar substance, there is another factor producing recession, and one which acts at every distance. If this destruction of matter has continued throughout the solar history, and if the earliest planets have endured proportionately longer and have been proportionately more subjected to the resultant change of distance, these will depart most widely from an equable distribution, depending upon the alternation of periods of increasing rotary velocity due to contraction, and sudden slowing of rotation by explosive overthrow; and the oldest planets must have proportionately greater distances. In this way the departures from Bode's law may perhaps be explained, the law itself being an expression of the relation between contraction of the superficially cooling sphere, increasing angular velocity, and explosive epochs depending on the attainment of a critical stage of partial release from equatorial pressure by centrifugal force.

It has been generally recognized that some other origin of a nova than that of intersecting meteor streams may be found. In the light of the evidence of cosmic explosions which has now been accumulated, I wish to suggest that in the novae we have the very thing sought—the actual disruption of a star by a tremendous central explosion, and the dissipation of its substance in a great cloud of gas and meteoric dust. This partly reverses Lockyer's hypothesis. The meteor-swarm is subsequent instead of immediately antecedent to the nova. An explosion of such gigantic magnitude cannot be absolutely instantaneous. Initial velocities approaching 1000 kilometers per second are recorded. Thus *Nova Aurigae* exhibited a velocity of 800 kilometers per second in February 1892. After the revival of luminosity in August 1892, a velocity of — 225 kilometers per second was measured, and in August 1893, this had diminished to — 71 kilometers per second. The gaseous streams must have reached three times the distance of Neptune in a year and a half. It is possible that a measure of the radius of the resultant planetary nebula may some time give us the distance of a nova.\*

All of the novae show the same general sequence of phenomena. The sudden release of superheated interior sub-

\* Since this was written (April, 1901), the formation of a nebula of considerable size and rich in structure around *Nova Persei* 1901 has lent new interest to this suggestion.

stances from the depths of the star gives a continuous spectrum of extraordinary brilliancy, rich in the shorter waves, which rapidly passes into a spectrum of the Orion type with narrow dark lines of hydrogen and helium. This is followed by an enormous evolution of hot gases. The complex banded structure of the broad bright F line indicates radiation from a number of streams moving with different velocities.\* The great breadth of the lines may mean that the gas is under great pressure, or in a condition such as might be expected if intensely heated matter from the depths of a star has been opened to view by disruption.

This view of the case has been partly anticipated by Professor W. H. Pickering, although he has not predicated so profound a disturbance as the actual disruption and dissipation of a star. Assuming that the phenomenon is produced by gaseous eruptions, he says: "Prominences upon an enormous scale burst forth, spreading in every direction, and completely enveloping the star upon all sides. When they first appear, they present a spectrum of bright lines, but in a few hours the gases first emitted have receded to a considerable distance from the star, and have cooled down owing to the rapid expansion involved in their recession." "This cold advancing atmosphere produces a series of dark absorption lines." "The hot receding prominences, however, . . . . give out a light whose wave-length cannot be absorbed by the cold advancing atmosphere. They therefore shine with their full brilliancy."†

It is notable that every nova which has been examined spectroscopically at the proper stage, has exhibited this sequence:

1. An intensely bright continuous spectrum rich in violet light.

2. Paired dark and bright lines of hydrogen, etc., the dark lines on the violet side indicating approach, the bright on the red side showing recession. The lines are very broad, denoting either great pressure or a wide range of velocity in the line of sight.

3. Fading of the continuous spectrum, produced by cooling of photospheric clouds until these are entirely dissipated, leaving:

4. A purely gaseous spectrum. Pressure and differential velocity diminishing until nothing is left but a planetary nebula whose light may be due to collisions of meteorites, crystallized out of the expanded and cold gases, perhaps aided by some kind of electric or cathode discharge along filaments or sheets made up of discrete particles.

\* M. H. Deslandres, *Comptes Rendus*, vol. cxxxii, p. 620, 1901, notes the composite character of the bands in the spectrum of *Nova Persei* 1901, and assigns velocities of approach of  $-1200$  km,  $-1600$  km, and  $-1850$  km, for three strongly marked divisions.

† W. H. Pickering, *Astronomy and Astrophysics*, vol. xiii, p. 201, 1894.

In favor of this view, I note that there has never been a recurrence of a nova. The blaze is final. These stars all appear in the Milky Way, the locus of the youngest or explosive stars.

The phenomenon in its successive phases has somewhat the same sequence as a volcanic eruption. There are preliminary symptoms leading up to a climax. The violent commotion at the center of the star at first produces nothing but increased superficial circulation, exposing fresh heated surfaces of great brilliancy, but as yet with little accompanying outburst of gas, and with slight velocity in the line of sight. By the time the eruption has become fairly started, the inertia of the outer layers has been so far overcome that rapidly moving streams of gas break through to the surface, and carrying everything before them, launch out into space. For a short time the turmoil is tremendous. Velocities of every degree from excessive positive to extreme negative are met, but tending to particular values along certain streams where the chief part of the motion resides. Some portions of matter, having lost their velocity through friction and interference, are left by the way and expand to comparative coolness, giving fine absorption lines.

The broad paired dark and bright bands, in the order of intensity, belong to hydrogen, calcium, helium, the substance which gives the bright blue band in the spectrum of the Wolf-Rayet stars, magnesium, sodium, nebulum, and others of less intensity. It is essentially a chromospheric spectrum, passing by successive repressions into that of a nebula. The original motion dies out by being frittered away through friction.

#### *Antecedent Stages of Stellar Growth.*

The invisible preparation for a new star is probably of excessively long duration, involving the gradual growth of meteorites from innumerable centers of crystalline aggregation, the slow beginnings of movement under gravitation, and at last the clustering of meteor-swarms; but the bursting forth into full stellar life is comparatively sudden, although possibly not attained without more than one fluctuation. The link between nebulae and novae is demonstrated. As just stated, we have no example of the recurrence of a nova. It is hardly possible that vast interpenetrating meteor-swarms should pass through each other, attaining stellar temperatures by collisions, without experiencing a change of motion, perhaps becoming associated in orbital connection, in which case the collisions might be expected to recur with increasing frequency until the nova became a permanent star; but nothing of the sort takes place.

The speed of the meteors being very great, the temperatures

given by destruction of motion through impact would be high, and in this respect Lockyer's meteoritic hypothesis, as applied by him to the novæ, agrees with the facts. Moreover, this intense incandescence is immediately followed by a rapid refrigeration which demonstrates that the subsequent history is that of the cooling of relatively small masses. A single body of solar dimensions, raised to a temperature of the same order as that of the sun by a collision, or by any other mode, could not cool to invisibility in a few days. The flaming out of a nova is sudden. Its subsequent fading and passage to a nebula, or to invisibility, is to be attributed, on Lockyer's hypothesis, to the recession of the colliding swarms; and the cessation of high-speed impacts, together with the retention, at least for a time, of internal disturbances due to the previous collision, seems competent to explain the nebulous illumination. But there is no place in this scheme for the actual sequence of spectral changes. If produced by the meeting of meteor-swarms, the nova ought to begin as it ends. The first collisions of sparsely distributed outlying members of the swarm should give a spectrum of bright lines; these should increase in brilliancy, the continuous spectrum and greatest intensity occurring near mid passage, while the densest parts of the swarm are in mutual collision. The sequence is entirely different, and points to a sudden liberation of imprisoned forces, and to control from a fixed center, the relative velocities being none at all at first, but increasing to extraordinary proportions at the height of the episode. There may have been a meteor-swarm anterior to the nova, but, if so, it had already condensed, and it was a single body. It is possible that the darkness of a nova, before the outburst of intense light, may be caused by dense swarms of relatively cold meteors which have not yet coalesced with their primary, and which obstruct its light until dissolved in the final blaze.

The spectral relations of the new stars are with the bright-line helium stars, with which the Wolf-Rayet stars are connected through the spectrum of the principle example,  $\gamma$  Argus,\* which, in addition to hydrogen and helium (either dark, bright, or doubly reversed), shows Rydberg's principal line of the supposed new or proto-hydrogen spectrum in the blue at  $\lambda=4688$ , bright and with a breadth of 20 tenth-meters, also a very bright blue band of unknown origin at  $\lambda=4655$ , with a breadth of 30 tenth-meters.

\* See F. McClean, *Proc. R. S. London*, vol. lxii, p. 419, 1898.

[To be concluded.]

ART. IX. — *Studies of Eocene Mammalia in the Marsh Collection, Peabody Museum*; by J. L. WORTMAN.

[Continued from page 46.]

*Family Oxyænidæ* Cope.

With the Oxyænidæ we enter upon the consideration of a group of the Creodonta in which the teeth had already made considerable progress towards the more typical sectorial structure, even at the beginning of the Wasatch, in which deposits their remains are first met with. This family is represented in this horizon, as far as now known, by the single genus *Oxyæna* Cope, containing two, or perhaps three, well-marked species of fairly sizable dimensions. No species that can be placed ancestral to it have as yet been found in either of the older Torrejon or Puerco Beds, and it would appear probable that they were migrants from the north or from Asia, along with the Artiodactyle and Perissodactyle Ungulates, the Primates, certain of the Carnassidents, including the Felids and Canids, the Rodents and others, at the beginning of the Wasatch epoch. These two or three species appeared simultaneously at all the localities of the Wasatch, in the Big Horn, Bear River, and San Juan Basins, and this fact of itself would seem to indicate a very general and widespread distribution.

The probable immediate successor of the genus in the Wind River deposits is a species which Cope referred to the distinct genus *Protopsalis*; but I have pointed out\* that this genus, as far as at present known from fragmentary remains, does not differ materially from one of the Bridger representatives which Leidy described under the generic title of *Patriofelis*. It should be borne in mind, however, that this Wind River form is known from a few fragments only, and it will be somewhat surprising if, when its osteology is more completely known, it does not exhibit a stage of development intermediate between *Oxyæna* and *Patriofelis*. In the Bridger, the main *Oxyæna* line is continued in the two species of *Patriofelis*, large, powerful Creodonts in which the teeth had become much specialized and reduced in number, in a manner not dissimilar to that of the Felids. In this stage also appears suddenly, without any known forerunners in any older formation, a less distinctly specialized type, *Limnocyon* Marsh, in which the teeth are more generalized than in *Oxyæna*. The genus is represented by three or four well-marked specific modifications, one of which persisted to the close of the Eocene, in what I have

\* Bull. Amer. Mus. Nat. Hist., 1894, p. 130.

described\* as the genus *Oxyænodon*, from the Uinta. In this group, the species are of uniformly smaller size, one of which is among the smallest of the known Creodonts, and all of them, as far as I am at present aware, are characterized by shallow, remarkably thick jaws, provided with a disproportionately large symphysis. A single species of a closely allied form was described by Filhol from the Phosphorites of Quercy in France, under the name of *Thereutherium thylacodes*. This species is the latest and most specialized of the *Limnocyon* series, since, according to Filhol's figures, the last superior molar is much reduced, the first premolar has become single-rooted, and the internal cusp of the trigon in the lower molars has disappeared.

It will be observed, therefore, that we have in this family two distinctive series or lines of descent, one beginning in *Oxyæna* and culminating, according to our present knowledge, in *Patriofelis*, as I have already very fully pointed out,† and a second series beginning in *Limnocyon* and terminating in *Thereutherium*. These two series I choose to regard as two distinct divisions or subfamilies, which may be designated, according to the characteristic genera, the Oxyæninæ and the Limnocyoninæ.

Owing to our imperfect knowledge of the osteology of the Limnocyoninæ, the definition of the Oxyænidæ cannot be very fully given at present, but the teeth are sufficiently known to afford very good grounds for distinction from the other families of the Creodonts. I define it upon the dentition as follows:

Two subequal tuberculo-sectorial lower molars, in which the internal cusp of the trigon and the tubercular heel progressively decrease in size or disappear in the later forms; second inferior molar slightly larger than first; two superior molars, of which the last is transverse when present, but becomes small or disappears in advanced stages of evolution; most highly developed sectorial teeth consisting of first molar above and second molar below, but fourth premolar above and first molar below also sectorial; two external cusps of first superior molar tending to unite, and internal cusp becoming reduced or disappearing in advanced forms, as in Hyænodontidæ.

The two subfamilies may be distinguished by the following characters:

Lower jaw of considerable vertical depth and not especially thickened from side to side; symphysis not particularly enlarged; fibula not articulating with calcaneum, and trochlear surface of astragalus ungrooved, with head very oblique. Oxyæninæ.

\* Bull. Amer. Mus. Nat. Hist., June, 1899, p. 145.

† Bull. Amer. Mus. Nat. Hist., 1894, p. 163.



Lower jaw shallow and relatively very thick from side to side; symphysis much enlarged; fibula articulating with calcaneum (*Limnocyon*); astragalus considerably grooved, and head with comparatively little obliquity. *Limnocyoninæ*.

*Subfamily Oxyæninæ.*

Of the first of these two subfamilies, as already remarked, there are two known genera *Oxyæna* and *Patriofelis*; but it is not improbable that a transition or annectent form between these two will be found in Cope's Wind River *Protopsalis tigrinus*. It appears to be more or less doubtful whether we yet know the exact lines of specific descent in this group. As at present constituted, the genera may be distinguished as follows:

Dental formula,  $I. \frac{3}{3}$ ,  $C. \frac{1}{1}$ ,  $Pm. \frac{4}{4}$ ,  $M. \frac{2}{2}$ ; second upper molar present, transverse; internal cusp of first upper molar distinct; second lower molar with internal cusp and heel. *Oxyæna*.

Dental formula,  $I. \frac{3}{3}$ ,  $C. \frac{1}{1}$ ,  $Pm. \frac{3}{3}$ ,  $M. \frac{1}{1}$ ; second upper molar absent; internal cusp of first superior molar vestigial; second lower molar without internal cusp and with vestigial heel. *Patriofelis*.

*Patriofelis ferox* Marsh.

- Patriofelis* Leidy, Proc. Acad. Nat. Sci. Phila., 1872, p. 10;  
*Limnofelis ferox* Marsh, this Journal, August, 1872, p. 10, Separata;  
*Limnofelis latidens* Marsh, this Journal, August, 1872, p. 10, Separata;  
*Oreocyon latidens* Marsh, this Journal, November, 1872, p. 406;  
*Patriofelis ferox* Wortman, Bull. Amer. Mus. Nat. Hist.

The type of this species, figure 65, consists of a fragment of a left lower jaw bearing the last lower molar, together with some few fragments of the skull, vertebræ, and ribs. Professor Marsh said of it in his original description, "The tooth preserved resembles the corresponding one of the lion in its general shape, but is proportionally broader anteriorly, the base of the crown being subtrilateral in outline, with the inner side the longest." This brief description gives the main characters of the specimen very accurately, but it is important to note that more complete specimens have shown the tooth in question to be a second molar; it is not, therefore, strictly homologous with the sectorial lower

65

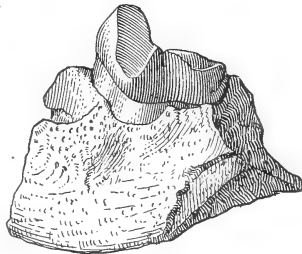

FIGURE 65.—Portion of left lower jaw, with last lower molar in place, of *Patriofelis ferox* Marsh (type of *Limnofelis ferox* Marsh); three-fourths natural size. (Type.)

molar of the lion, which is the first. This fact, however, was impossible of determination from the fragmentary specimens known at the time Professor Marsh's description appeared. The crown is composed of an anterior and posterior cusp, which represent the external and anterior cusps of the trigon, respectively; of these the posterior is broken away, but it is evident that they were laterally flattened and drawn out upon their edges so as to form a pair of effective blades, as in the sectorial molar of the Felidæ. The internal cusp of the trigon has completely disappeared, and the heel is represented by a mere vestigial spur.

The second specimen of this species was at first referred by Professor Marsh to a distinct species, *Limnofelis latidens*, together with the lower jaw of the immature individual already considered under the head of *Ælurotherium*. He subsequently removed it, using the present specimen as the type, to the distinct genus *Oreocyon*, which he established for its reception. It is now evident, however, that this species is the same as *Limnofelis ferox*, and the name *Oreocyon latidens* therefore becomes synonymous with *Patriofelis ferox*.

66

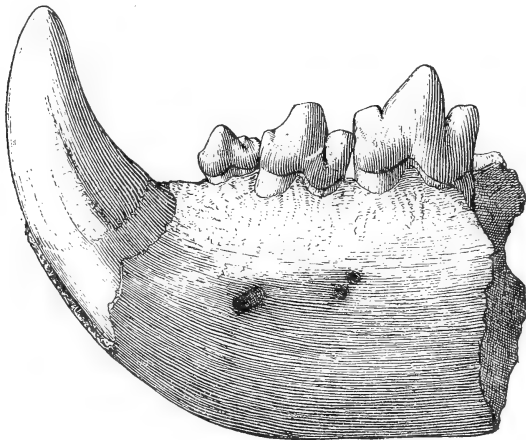

FIGURE 66.—Anterior part of lower jaw of *Patriofelis ferox* Marsh (type of *Oreocyon latidens* Marsh); side view; three-fourths natural size.

The specimen, figure 66, consists of the coössified anterior part of both mandibular rami, carrying both canines, the alveoli, and most of the roots of the incisors, the three premolars upon the left side, and the first and second premolars upon the right side. There are, in addition, some fragments of the posterior portions of the jaw, including a condyle, a well-

preserved superior premolar, probably the fourth, and the greater part of the right humerus.

The jaw is deep and the symphysis strong and heavy. The two rami are firmly coössified, but traces of the suture are plainly visible. The canines are large, somewhat laterally compressed at the base, with a recurved pointed crown. The incisors are two in number upon each side, one being placed almost directly behind the other; their roots are much compressed from side to side and they are relatively small. The first premolar of the series, which corresponds with the second of *Oxyæna*, is a two-rooted tooth implanted obliquely to the long axis of the jaw; its crown is made up of a single pointed anterior cusp, to which is added a broad posterior heel bearing a minute cusp in the center. The second premolar is similar, with the exception that there is a distinct anterior basal cusp and the heel is thrown up into a more or less cutting ridge. The third premolar is considerably larger than the two in advance of it, but the crown is composed of the same elements

as that of the second. The superior premolar, figures 67, 68, which presumably corresponds with the fourth of *Oxyæna*, is a three-rooted tooth; its crown is composed of two external and one internal cusps. Of the two externals the anterior is the larger, of a more or less conical form, having its posterior edge produced. The posterior is blade-like and smaller. The internal cusp has a thick rounded form, and is supported by an independent root. The structure of this tooth may therefore be said to be distinctly sectorial.

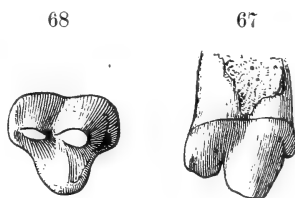

FIGURES 67, 68.—Fourth superior premolar of *Patriofelis ferax* Marsh (type of *Oreocyon latidens* Marsh); outer and crown views; three-fourths natural size.

Numerous other more or less fragmentary remains of this species are contained in the collection, but as they do not add anything to a knowledge of the osteology, which I have already described in considerable detail from the unusually complete skeleton in the American Museum,\* their consideration may be here omitted. It is a source of some satisfaction to note that the conclusions which I reached from a study of the rather fragmentary and imperfectly preserved teeth are herewith completely verified.

In my somewhat exhaustive treatise upon this subject, I was led to express the opinion that these animals were plantigrade, and probably aquatic in habit, pointing out at the same

\* Osteology of *Patriofelis*, a Middle Eocene Creodont, Bull. Amer. Mus. Nat. Hist., May, 1894.

time their relationship with the modern Pinnipedia, the derivation of which may perhaps be traceable to some member of the Oxyænidæ. In a paper recently published, Professor H. F. Osborn has dissented from these views, and expressed the opinion that these forms were terrestrial or arboreal in habits, and subdigitigrade\* in gait.

I shall proceed, therefore, to an examination of the paper in detail, and shall first consider a method there presented, by means of which we are said to be able to determine with infallible cer-

69

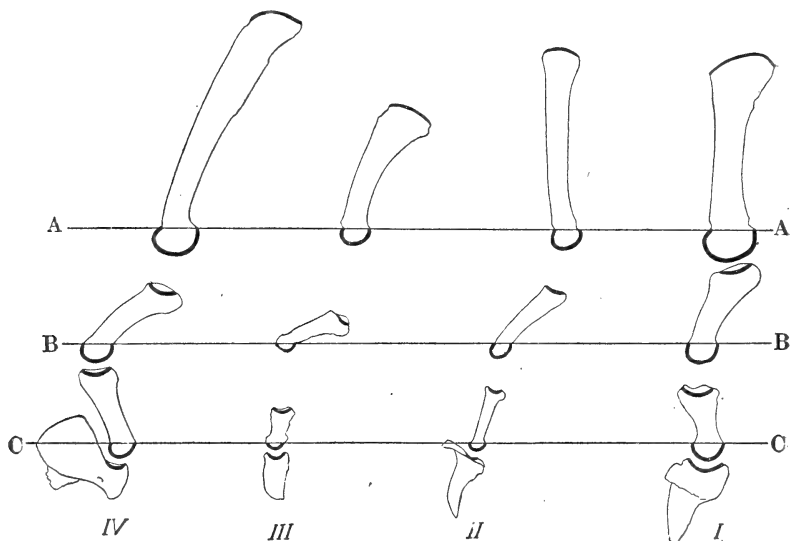

FIGURE 69—Angulation of facets in feet of (I) *Ursus*, (II) *Procyon*, (III) *Patriofelis*, (IV) *Felis*, showing increased obliquity in relation to increased angulation. A, distal facets of metacarpals; B, distal facets of first phalanx; C, distal facets of second phalanx. (Diagram after Osborn.)

tainty the gait of an animal, living or extinct, whether plantigrade, subplantigrade, or digitigrade. Professor Osborn says, p. 270: "The writer has pointed out that the angulation of the limbs in Ungulates is expressed in the angles which the proximal and distal facets make with the long axes of the shafts; *considering the shafts as perpendicular, facets in horizontal planes indicate straight limbs; facets in oblique planes indicate angulate limbs.* Exactly similar principles apply to the hand and foot of Unguiculates, as shown in Fig. 3. In the passage from *Otaria* (secondarily plantigrade), [to] *Ursus*

\* *Oxyæna* and *Patriofelis* Re-studied as Terrestrial Creodonts, Bull. Amer. Mus. Nat. Hist., Dec. 1900.

(primarily plantigrade), *Procyon* (subdigitigrade), and *Felis* (digitigrade), we see that the planes of the distal facets give certain indication of the modes of progression."

In other words, by an examination of the distal ends<sup>o</sup> of the metapodials, one can certainly tell whether these bones are carried in a plane parallel to the surface upon which the animal walks (plantigrade), or perpendicular to it (digitigrade), in the act of progression—a very important and valuable discovery if true. Now if there is any truth in this hypothesis, it appears to me that the character of the distal ends of the metapodials in two such typical and widely different-gaited animals as a cat and a bear would exhibit such marked and unmistakable differences in these particulars, that one would be able to tell at a glance whether the animal in question were plantigrade or digitigrade. As a matter of fact, however, and, I may add, of the most common observation and knowledge, the amount of difference in the distal articular surfaces of these bones in the cat and bear is so surprisingly small, that, in themselves, they do not give the faintest or slightest hint at such marked differences in gait. According to Professor Osborn's own showing in his diagram, the differences in the extent, arrangement, and planes of these facets, in the two animals, are very slight indeed. It should be here observed that in the diagram, if the metapodial of the bear is placed in its natural position with reference to the phalanges, the corresponding bone of the cat must be rotated to the left somewhere in the vicinity of ninety degrees, in order to represent the position which it naturally assumes in the foot of that animal. If, therefore, the planes of these facets fail to record a difference of nearly *ninety degrees of arc*, in determining the position of the bone in this case, it is pertinent to inquire how far they can be trusted in any other case. It is sufficiently obvious, I take it, that if the position of the metapodial is incapable of being fixed by this method, it is practically worthless in the further determination of the gait of the animal, since the position of these bones is the all-important factor in the case.

Let us next turn our attention to the phalanges. I quote again from the paper in question, p. 271. "As regards angulation, *Patriofelis* is shown to occupy a position intermediate between *Procyon* and *Felis*, with a decidedly *angulate* foot, the angles between phalanges 1 and 2 being especially acute. This proves that the metapodials, as well as phalanges 1 and 2, were raised off the ground by plantar and palmar pads as in *Felis*. Taking a conservative view, the feet of *Patriofelis* may be described as subdigitigrade in position. The straight terminal claws indicate that they entirely lacked the grasping and tearing power developed in *Felis*."

Using the previous examples, the cat and the bear, in the

matter of the distal facets of the first phalanges, I have taken the trouble to make careful and extensive comparisons of numerous species of these two types, and I find that the differences in the arrangement, extent, and planes, are as little marked as they are in the distal ends of the metapodials, and, in themselves, afford as little evidence of the difference in gait of the two animals. The conclusion is therefore obvious, and

70

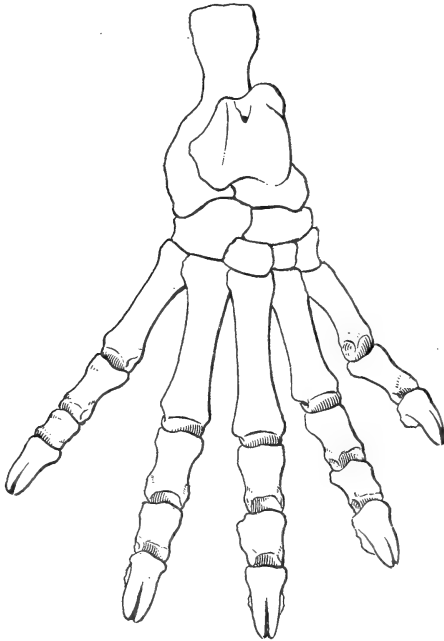

FIGURE 70.—Right hind foot of *Patriofelis ferox* Marsh; three-eighths natural size. (After Wortman.)

I think enough has been said to show that the planes of the articular facets, as applied to the feet of the Carnivora, have *little or no value* in determining whether a given animal is plantigrade or digitigrade.

Let us next direct our attention to the feet of *Patriofelis*. I find it necessary, first of all, to state that the position in which Osborn has placed the phalanges, in the diagram, instead of being less angulate than those of *Felis*, are decidedly more so. It certainly, therefore, does not occupy a position between *Procyon* and *Felis*, but a position more advanced in this particular than *Felis* itself, the fallacy of which will be evident to any anatomist at a glance. Either the diagram is wrong or the statement is incorrect, since both cannot be true.

Although there are numerous specimens of the first phalanges of *Patriofelis ferox* in the Marsh collection, after the most careful examination I fail to detect a single example in which the distal articular surface is limited in the manner depicted by Professor Osborn in his diagram. These specimens, moreover, agree perfectly in this respect, not only with the original figure, figure 70, of the American Museum specimen, published in my paper, but what is still more to the point, they agree with the photograph of the same specimen which Professor Osborn himself reproduces, figure 2, p. 169, of the paper under discussion. What more conclusive or final testimony is it possible to adduce in support of the contention that this diagrammatic representation of these facets is wrong and the conclusions drawn from them are entirely erroneous?

I am still of the opinion that we shall find it necessary to retain our old methods for judging the gait of these extinct animals, methods which have for their basis a consideration of the entire organization of the foot, and such as are calculated to help us as near to the truth as we shall ever be likely to come.

Among the living Carnivora the plantigrade foot is characterized by short slightly interlocking metapodials and spreading toes, whereas in the typical digitigrade foot the metapodials are more elongate, compressed, and interlocking, and the toes less spreading. In the former the naked plantar and palmar pads are enlarged and extended so as to wholly underlie these bones, while in the latter these pads are restricted to their distal ends. Judged upon the merits of this class of evidence, the feet of *Patriofelis ferox* were as plantigrade as those of the modern bears, a conclusion which, to my mind, is clearly indicated by every feature of its podial anatomy.

The third section of this paper is devoted to the so-called "Specialized Characters of the Oxyænidae," and upon this topic I feel it necessary, if only in the interests of clearness, to make a few remarks. In the first place it is important to note that if the term "specialized" is employed in the usual or ordinary sense, common to the subject, then out of the thirty or more characters enumerated, comparatively few can be correctly called *specialized*. I have always understood this term to denote a condition the reverse of generalized, or in other words one which is uncommon, peculiar, particular, and different from others; it is also employed in the sense of advanced. The specialized characters of the Oxyænidae should therefore be taken to indicate those which it possesses that are different from, or advanced over and above, the other families of the suborder to which it belongs. We shall presently see to what extent the characters therein enumerated are entitled to be set down as "specialized characters" of the Oxyænidae.

I will next take up these characters *seriatim*, and make such comments as appear to me to be needful and necessary in connection with each one separately. They are as follows :

- |   |   |
|---|---|
| (1) "Progressive shortening of the face and elongation of cranium with reduction of teeth and development of jaw muscles;"            | (1) I have explicitly and distinctly stated in my paper, p. 132, that the length of the face in <i>Patriofelis</i> is not known with certainty; it is, however, probably correct and a truly specialized character.   |
| (2) "high sagittal crest; (3) occiput narrow;"  | (2), (3) The occiput is unusually low and broad in certain species of <i>Limnocyon</i> , and the sagittal crest little developed; they do not, therefore, apply to the entire family.   |
| (4) "a preglenoid crest;"   | (4) Common to many other Creodonts and not true of two species of <i>Limnocyon</i> ; unknown in <i>Thereutherium</i> .  |
| (5) "a large postmastoid foramen;"  | (5) Now known to be the stylomastoid foramen; its posterior position is also characteristic of certain members of the Mesonychidæ and is not known in any of the Limnocyoninæ, except in one species where it opens below.  |
| (6) "no postglenoid foramina;"  | (6) Stated in my paper on <i>Oxyæna</i> (Bull. Amer. Mus. Nat. Hist., 1899, p. 142) as probably present in this species; also known to be present in at least two species of <i>Limnocyon</i> .   |
| (7) "mandibular condyles scroll-like (as in Felidæ);"   | (7) Also true of many other Creodonts.  |
| (8) "atlas with form and vertebral canal as in Felidæ (Wortman);"   | (8) Same character is found in other species of Creodonts, notably <i>Sinopa</i> , <i>Mesonyx</i> , and <i>Dromocyon</i> .  |
| (9) "axis with elongate spine;"   | (9) Unknown in <i>Oxyæna</i> and all other members of the family, but the same is true of <i>Mesonyx</i> , <i>Dromocyon</i> , and <i>Sinopa</i> .   |
| (10) "certain dorsals and lumbers with progressively revolute zygapophyses (as in Mesonychidæ and certain Pinnipedia, <i>Phoca</i> ;" | (10) If described as having a double tongue and groove articulation, it is a truly specialized character of the family. "Revolute" is an altogether inappropriate and incorrect expression as applied to it. Neither Mesonychidæ nor <i>Phoca</i> has this character of articulation. |
| (11) "lumbers with progressively developed anapophyses;"  | (11) Also true of other species of Creodonts, but unknown in the Limnocyoninæ.  |
| (12) "scapula, humerus, and ulna of about equal length;"  | (12) Unknown in all the Limnocyoninæ.   |
| (13) "scapula very large, spreading superiorly (imperfectly known in <i>Oxyæna</i> ), supra- and infraspinous fossæ subequal;"        | (13) Scapula practically unknown in all species of the family except <i>Patriofelis</i> .   |



- |   |   |
|---|---|
| (14) "powerful acromion and metacromion processes;"   | (14) Unknown in all the Limnocyoninae.  |
| (15) "humerus with exceptionally elongate and prominent deltoid crest, powerful supinator ridge, large entepicondyle and entepicondylar foramen;"                   | (15) Deltoid crest in two species of <i>Limnocyon</i> reduced; other characters common to all primitive Creodonts and carnivorous Marsupials and therefore not specialized.   |
| (16) "olecranon process of ulna elongate, ulna grooved anteriorly;"   | (16) True of nearly all Creodonta known, likewise carnivorous Marsupials; therefore primitive.  |
| (17) "limited rotation of forearm owing to proximal expansion of radius;"   | (17) Not true of <i>Oxyaena</i> nor any species of <i>Limnocyon</i> thus far known.   |
| (18) "feet [toes] spreading;"   | (18) True also of many other Creodonts; not a specialized character.  |
| (19) "trapezium extended transversely (as in Pinnipedia, Wortman);"   | (19) Not known in any species of Limnocyoninae; but probably a distinctive and specialized character.   |
| (20) "dorsal portion of distal metapodial facets hemispherical, ventral portion keeled (as in Fissipedia, Wortman);"  | (20) True also of all Creodonta, Carnassidentia, and Carnivorous Marsupials thus far known; therefore not specialized in any sense.   |
| (21) "digits angulate, the second phalanges strongly flexed upon first phalanges;"  | (21) According to my own view this is incorrect.  |
| (22) "subungual (retractile) processes of distal phalanges well developed (as in Pinnipedia; in Fissipedia subungual processes small, foramen vestigial, Wortman);" | (22) I prefer to believe that the introduction of the word "retractile" into my original statement is a <i>lapsus calami</i> on the part of the author, since he must surely know that a "retractile" process upon the under side of the claw is a sheer impossibility. |
| (23) "ilium expanded on superior (post-iliac) border into a broad lamina;"  | (23) Unknown in Limnocyoninae.  |
| (24) "pubic symphysis not ankylosed;"   | (24) Likewise true of all Creodonts and Carnassidents thus far known, and therefore generalized.  |
| (25) "patella large;"   | (25) No larger than in <i>Mesonys</i> , <i>Dromocyon</i> , <i>Sinopa</i> , and many others.   |
| (26) "fibula unreduced, articulating with side of astragalus but not articulating with calcaneum (progressive);"  | (26) Fibula articulates with calcaneum in <i>Limnocyon</i> , but not known to do so in any other species of Creodonts.  |
| (27) "tibia with twisted shaft and cnemial spine;"  | (27) Tibia unknown in the Limnocyoninae, but cnemial crest is present in all Creodonta known. The twisted tibia is strongly indicative of aquatic habit and is probably specialized.  |
| (28) "tibio-astragalar facet flat, obliquely placed;"   | (28) Fairly well grooved in one species of <i>Limnocyon</i> , and not very oblique. In <i>Patriofelis</i> probably specialized and indicative of an aquatic habit.  |

- |  |  |
|--|--|
| (29) "calcaneo-cuboidal facet very oblique;"                                   | (29) Not known in all species of <i>Limnocyon</i> , but probably characteristic of the family and specialized. |
| (30) "large astragulo-cuboidal facets;"  | (30) True of nearly all Creodonts.   |
| (31) "external calcaneal tubercle large (as in many Creodonts and Amphipods)." | (31) Should have been stated all Creodonts known.  |

It will thus be seen that these characters are for the most part true only of the single genus *Patriofelis* and cannot be applied to the entire family.

I pass next to a consideration of the probable habits of *Patriofelis*, and for the sake of putting the matter clearly I quote my original conclusion, which was as follows: "From the structure of the limbs more than any other feature in the osteology of *Patriofelis*, I am led to conclude that it was aquatic or semi-aquatic in habits. The broad, flat, plantigrade feet, with their spreading toes, suggest at the first glance their use for swimming." The opposite view as stated by Osborn is as follows: "In this connection a careful restudy of all the evidence led the writer to the opposite conclusion, that these were powerful *terrestrial, or partly arboreal, animals, analogous to the Cats in habits of feeding*, with analogous (not homologous) sectorials, clumsy in limb structure, without prehensile claws, and presenting no evidence of successors among the modern Carnivora."

As regards the view that these animals were arboreal or partly so, I have little comment to make; it is to my mind, however, so extremely improbable, if not impossible, that I hesitate to give it serious consideration. Its fallacy, it seems to me, is clearly evident when it is remembered that among the living Carnivora the habitual climbers are almost without exception light, agile, sharp-clawed species, capable of sufficiently swift movement to capture arboreal prey. A heavy, clumsy, blunt-clawed type like *Patriofelis* would be as much out of place in the trees as could well be imagined. We thus limit the question either to an aquatic manner of life or a terrestrial one or both, since there is no evidence that the animal had fossorial habits.

Any conclusion we may reach must take into consideration and accommodate itself to the following facts: (1) That whatever constituted the chief food supply of the animal was of such a nature as to cause unusual wear of the teeth, since in almost every known specimen that had reached maturity, the teeth are much worn; (2) that the animal was strictly carnivorous; (3) that its prey, whatever it may have been, was evidently not swift and active, otherwise it could have easily escaped so awkward and clumsy a creature; (4) that the manner of cap-

turing its prey and its habits of feeding were not analogous nor similar to those of the cats, since the evidence positively forbids the idea of any prehensile powers of the claws, one of the most preëminently distinguishing features of the Felidæ in this respect; and (5) that it was likewise not similar to that of the dogs, for the structure of the limbs disproves the suggestion of a runner.

What osteological character or characters do the living aquatic Carnivora possess, by means of which their habits could be detected if known from their skeletons alone? The various degrees of modification for a swimming habit are progressively shown by such types as the mink, otter, sea-otter, sea-lion, and seal. The mink and otter are semi-aquatic, the sea-otter more aquatic, and the sea-lion and seal almost exclusively so. The limbs, and especially the feet, exhibit the greatest amount of modification of any parts of the skeleton and the degree of this modification is proportioned to the extent of the aquatic habit. In cases of extreme specialization, as in the sea-lion and seal, the fore and hind feet are almost equally modified, but in such an example as the sea-otter, it is only the hind feet that show any considerable adaptive changes of this character. This is also true of the mink and otter, but in these types the difference between the fore and hind feet is not so great.

It is for this reason that I limit what I shall have to say to a consideration of the posterior limbs; and it should be noted that all these aquatic or semi-aquatic species are plantigrade in gait when upon land, that the metatarsals are short and little interlocking, and that the toes are spreading. Taking the foot of the sea-lion as an extreme type, it will be seen that when placed with the plantar surface upon the ground, in the direction of the long axis of the body, the articular surface for the tibia looks upwards and very much inwards, so that if the tibia is articulated it does not occupy a vertical position as in the terrestrial species, but leans very much inwards towards the median line. If made to assume a vertical position the plantar surface of the foot is turned strongly inwards. At the same time the tibia is twisted in such a way that the fore and aft planes of the articular faces of the two ends do not coincide. These characters in connection with the elongation of the phalanges constitute the chief peculiarities of the hind limbs of the aquatic Carnivora, and, as far as known, are present in all of them. With the exception of the elongation of the phalanges, *Patriofelis* exhibits these identical characteristics of the hind limbs, and if they have any significance at all, they indicate an aquatic or partially aquatic habit of the species. I have yet to discover any evidence which opposes itself to the correctness of this view.

I have suggested that the animal preyed upon the numerous

species of turtles that inhabited the Bridger lake, and this is rendered all the more probable by the presence in these deposits of coprolites of some large carnivorous Mammal, which contain fragments of turtle shell. While it is not known with certainty to what species these coprolites pertain, it is, I think, in connection with the probable aquatic habits of the species, a fair presumption that they refer to *Patriofelis*. The great wear of the teeth as well as the power of the jaws accord well, moreover, with the view that they were used for crushing the strong bony coverings of the turtles, which may be said to have literally swarmed in the tropical or semi-tropical waters of the ancient lake or river as the case may be. The suggestion of Osborn that the specialization of the teeth and the increase in the size of the jaws are reasons for disbelieving in its aquatic habits has little force. An exactly parallel case is seen in *Potamotherium* and *Lutra* (ancestor and descendant), in which the same thing has occurred. The teeth have been reduced in number, enlarged and specialized, and the jaws shortened and increased in size, notwithstanding *Lutra* is to-day preëminently a fish eater.

Touching their relationship to the Pinnipedia I have no new facts to add. I have not asserted that the seals have been derived from any known species of *Patriofelis*, but that they *may have* been derived from some as yet undiscovered member of this group, and the reasons for such a belief, which have already been fully stated, have not, to my mind, been in any way affected by this restudy of the subject on the part of Professor Osborn.

#### *Subfamily Limnocyoninae.*

As already remarked, this group appears for the first time in the Bridger and continues into the Uinta. According to our present understanding, the three or four American species appear to be best classified in the single genus *Limnocyon*, although it is not altogether improbable that two of them, when more fully known, will require to be placed in separate genera. The European representative of this subfamily, *Thereutherium*, is distinct and shows a considerable advance over the American species in the matter of tooth specialization. The two genera may be distinguished as follows:

First premolar above and below two-rooted; last superior molar transverse, relatively large, with three well-developed roots and external and internal cusps; inferior molars with moderate-sized basir-shaped heels and internal cusps. *Limnocyon.*

First superior premolar above and below single-rooted; last superior molar much reduced, vestigial; heels of inferior molars reduced, and internal cusps vestigial or absent. *Thereutherium.*

[To be continued.]

ART. X. — *On a Miniature Anemometer for Stationary Sound Waves*; by BERGEN DAVIS, P.H.D.

THE anemometer which is in such general use for measuring wind velocities possesses the convenient property of rotating in the same direction irrespective of the direction of the air currents acting upon it.

In a stationary sound wave we have the condition of an alternating current or impulse of air, the direction of whose motion is twice reversed during each complete vibration. Such alternating currents of air, if of sufficient magnitude, should act upon an anemometer in the same manner as a continuous current, provided the cups of the anemometer are sufficiently small. The writer has constructed a number of miniature anemometers which have been found to rotate with considerable velocity in a stationary sound wave. The rate of rotation varied with the position of the anemometer along the wave. It was a maximum at the middle of the loop, and the rotation ceased entirely at the nodes.

An investigation of this effect was undertaken for the purpose of determining the relation between the amplitude of vibration and the rate of rotation, and also the influence of the size of the anemometer cups.

The stationary wave used was that produced in a stopped organ-pipe speaking its first overtone. Two nodes were thus obtained, one at the stopped end and the other a short distance from the mouth. A thin rubber diaphragm was placed across the pipe at the node nearest the mouth for the purpose of protecting the interior of the pipe from disturbances that might arise from blowing. The portion of the pipe between the diaphragm and the stopped end contained one-half of the stationary wave. The side of the pipe from the diaphragm to the stopped end was removed and a glass panel substituted for it, thus rendering the interior of the pipe visible. The pipe was 68<sup>cm</sup> long from lip to stop, and 5.3 by 6.4<sup>cm</sup> in cross-section. The diaphragm was placed 16<sup>cm</sup> from the lip, as this was found to be the position of the first node. The half wave between the diaphragm and the stop was 52<sup>cm</sup> long. A centimeter scale was placed along the pipe with the zero at the stopped end for the purpose of measuring distances along the wave.

The cups of the anemometers were made from gelatine capsules such as are used for medical purposes. These capsules were divided longitudinally, each part so obtained forming a

hollow half-cylinder. The half-cylinder cups were mounted on the ends of four cardboard arms, in the center of which was a glass pivot by which the whole arrangement was supported on the point of a fine needle. Three anemometers were constructed bearing cups of three sizes. These anemometers will be referred to in this paper by the trade numbers of the capsules from which they were made.

Anemometer No. 00 carried four cups, each of which was  $.75^{\text{cm}}$  in diameter and  $2^{\text{cm}}$  long.

Anemometer No. 2 carried eight cups, two on each arm, each of which was  $.58^{\text{cm}}$  in diameter and  $1.4^{\text{cm}}$  long.

Anemometer No. 5 carried eight cups, two on each arm, each of which was  $.45^{\text{cm}}$  in diameter and  $.8^{\text{cm}}$  long.

In conducting the experiments a stroboscopic disc was used to count the revolutions of the anemometers; also a mercury manometer was employed to obtain the same pressure of blowing the pipe throughout the experiments.

The mean results of a number of experiments are given in the tables below:

*Anemometer No. 00.*

Position in pipe.	Rate of rotation.
0 .....	0
5 .....	1.45
10 .....	5.71
15 .....	9.09
20 .....	10.
25 .....	10.9
30 .....	10.34
35 .....	9.95
40 .....	7.79
45 .....	3.80
52 .....	0

*Anemometer No. 2.*

Position in pipe.	Rate of rotation.
0 .....	0
5 .....	1.66
10 .....	6.46
15 .....	9.21
20 .....	10.55
25 .....	11.3
30 .....	10.8
35 .....	10.25
40 .....	7.52
45 .....	3.1
52 .....	0

Position in pipe.	Anemometer No. 5.	Rate of rotation.
0	-----	0
5	-----	1.27
10	-----	4.28
15	-----	6.07
20	-----	8.51
25	-----	8.7
30	-----	8.16
35	-----	7.38
40	-----	5.17
45	-----	2.26
52	-----	0

These tables are plotted in the figures below. The abscissæ are distances along the wave and the ordinates are rates of rotation per second. The full lines are the observed curves and the broken lines are sine curves.

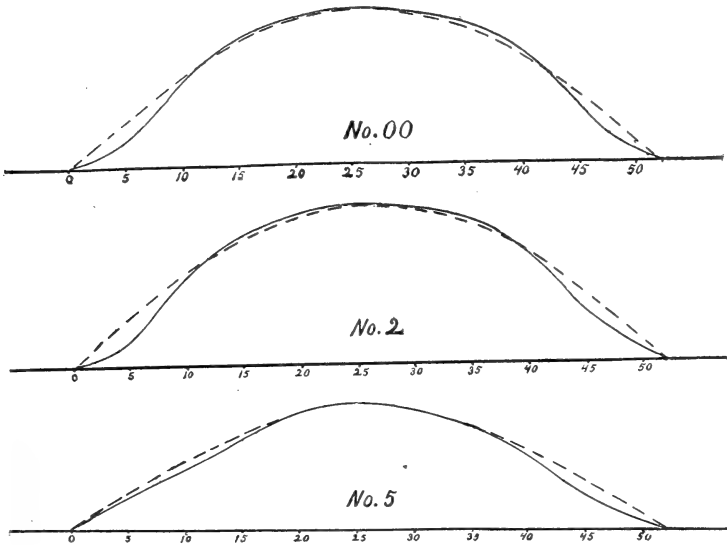

These curves correspond quite closely to the sine curves near the middle of the loop, where the amplitudes of vibration have considerable magnitude; hence one may infer that the rate of rotation is proportional to the amplitude when such amplitude is sufficiently great. The depressions in the curves near the nodes indicate that the anemometers are not so strongly affected when the amplitudes are small in comparison to the radii of the cups. The rate of rotation is nearly the same for both the No. 00 and the No. 2 anemometers, from which one concludes that there is a definite relation between

the linear velocity of the cups and the average velocity of the vibrating air. The No. 5 anemometer rotates with a somewhat less velocity in all parts of the wave. This may arise from the fact that, owing to the small size of the cups, the forces acting are very small, and hence the friction of the pivot may have an appreciable effect, as this friction factor is proportionately much larger than in the case of the other anemometers.

If we could measure either the average velocity of the maximum velocity of the vibrating air at the middle of the loop, one could easily calculate the amplitude of vibration. Since the air is executing a harmonic motion, the velocity of the cups will not bear a simple relation to the average velocity of the air, as the motion of the air, near the instant of reversal, will be slower than that of the cups and have a retarding effect even though it be in the same direction. The greater part of the impulse will be delivered to the anemometer at the time when the air is at the middle of its swing and the velocity is a maximum. For the purpose of approximate measurement I have assumed a ratio of 1 to 2.7 between the linear velocity of the cups and the maximum velocity of the air. This ratio is approximately that applied to the ordinary anemometer in measuring wind velocities.

The linear velocity of the anemometer cups at the middle of the loop was about  $117.4^{\text{cm}}$  per second, hence the maximum velocity of the air was  $317^{\text{cm}}$  per second. In order to obtain the amplitude it is convenient to know the average velocity  $V$ .

$$V = \frac{\int A \sin pt \, dt}{\int dt}$$

where  $A$  is the maximum velocity. Hence  $V = 202^{\text{cm}}$  per second.

The frequency of the pipe was 338 vibrations per second, hence the amplitude was  $2.99^{\text{mm}}$ . The term amplitude is here used to denote the total excursion of an air particle during a half period.

This value for the amplitude is somewhat greater than a corresponding value obtained by means of a new effect which was soon afterwards applied by the writer to the same problem.\*

The experiments above described were performed at the Physical Laboratories of Columbia University two years ago, but the pressure of other affairs has delayed their publication to the present time.

Göttingen, Oct. 5, 1901.

\*This Journal, September, 1900, also Physical Review, July, 1901.



ART. XI. — *The Occurrence of Fossil Remains of Mammals in the Interior of the States of Pernambuco and Alagoas, Brazil*; by JOHN C. BRANNER. With Plate I.

THE following observations, upon a region whose geology is but little known, were made on a trip from Pão d'Assucar in the State of Alagoas on the lower course of the Rio São Francisco to Aguas Bellas in the State of Pernambuco. It has long been hoped that these observations might be extended in the field, and that a study might be made of the collections of Pleistocene mammalian remains in the Museu Nacional at Rio de Janeiro, but it now seems improbable that either will shortly be done. This fragment is, therefore, published in the hope that it may be of service in directing attention to and arousing interest in the subject.

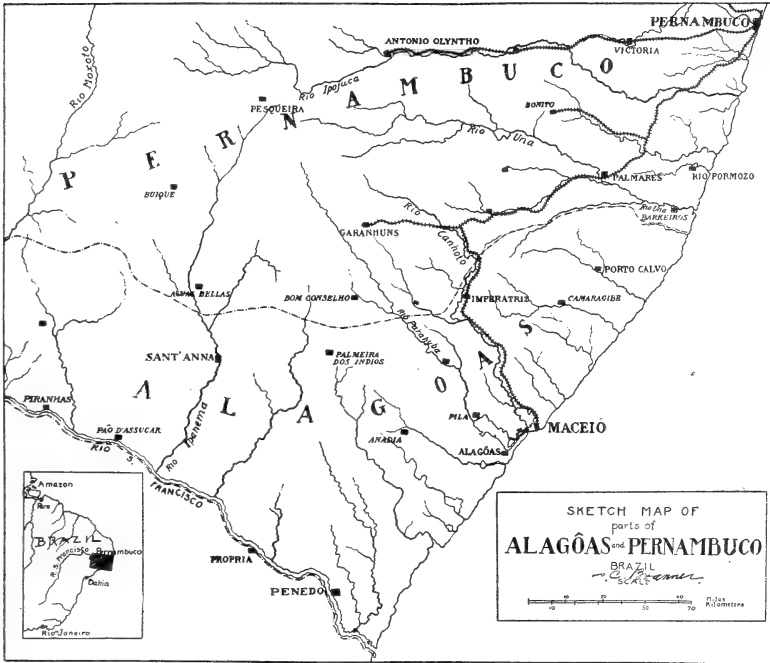

The Rio São Francisco between the falls of Paulo Affonso and Pão d'Assucar runs through a narrow channel cut in a plain of crystalline rocks—schists, gneisses and granites. The plain is a hilly one rising to an average height of fifty and sixty meters above the river, apparently an ancient baselevel. Upstream the plain extends to and beyond Piranhas, the head of navigation on the lower river. The accompanying illustra-

tion (Plate I) shows well the character of the river channel and of the topography between Pão d'Assucar and Piranhas.

The rocks of the region in the vicinity of Pão d'Assucar are all crystalline and are probably of Archean age. The sharp peak on the river near the town and from which it receives its name has the appearance of being made of stratified rocks standing on end. On the south side of the river is a series of similar hills following the strike of the beds. The rocks, however, are not sedimentary beds but dark mica schists alternating with reddish porphyritic gneiss. The beds (or the schistosity) strike southeast—northwest. Two or three kilometers up the river there are massive granites exposed on the river banks.

The road from Pão d'Assucar to Aguas Bellas passes through the villages of Meirús or Campo Alegre (three leagues from Pão d'Assucar) and Sant' Anna. The country from the Rio São Francisco at Pão d'Assucar to Aguas Bellas, in the State of Pernambuco, and thence to Pedra Pintada, ten leagues northeast of Aguas Bellas, is all of crystalline rocks—mostly granites, gneisses and schists, with a few occurrences of marble.\*

Over the surface of these rocks are here and there patches of a thin layer of water-worn materials of various sizes and mostly of quartz. The worn materials are not confined to the stream channels or to the valleys, but spread alike over high as well as low ground.

Eight leagues east of Aguas Bellas, at a cattle ranch known as the Lagoa da Lagea (Flat-Rock Lake), a quantity of large fossil bones were found about the year 1873. The rocks of the immediate neighborhood are all granites and gneisses. The surface of the rocks have weathered unevenly, and in places the soil is thin or altogether wanting. In one of the rock basins thus formed, soil, loam and water-worn bowlders had accumulated to a depth of more than a meter. An artificial reservoir was made by excavating the soil, and it was in the digging of this reservoir that a quantity of large fossil bones were found. The pool at the time of my visit was about 30 meters long by about 20 wide, and a little more than one meter deep. As nearly as I could estimate from information furnished by the man who made the excavation and from the fragments still lying about the place, more than a ton of bones

\* The occurrence of marble in this region of granites, gneisses and schists is worthy of note. One of the exposures is at Ribeiro de Baixo, two or three leagues south of Aguas Bellas and west of the road leading to Sant' Anna. The marble is white, both fine and coarse-grained, and is used for making lime. Another locality is between the Dois Riachos and Serra do Menino in the Calderão do Chão, about five leagues from Aguas Bellas. Another is on the Fazenda dos Meninos, about three leagues from Aguas Bellas at a place called Serrote de Cal (limestone ridge).

and teeth were taken from this reservoir. The best preserved and most striking specimens had already been carried away by neighbors and visitors, and some of them were said to have been sent to Bahia by the owner of the property, but to whom or to what institution they went I was unable to learn. Many vertebræ and large fragments of bone had been used along with stones to build a wall around the basin, while smaller pieces had been left exposed in heaps. From these heaps I gathered fragments enough to load three horses, and this much was sent to the collections of the *Commissão Geologica* at Rio de Janeiro. Upon the suspension of the work of the Commission shortly afterwards this material was turned over to the *Museu Nacional* in Rio de Janeiro, where it is probably still preserved. Among the specimens brought away were two pieces of tusks, several vertebræ and several broken teeth of the mastodon, the jaw and teeth of some other kind of large mammal, and pieces of bones and teeth of still other animals. Many but not all of these bones were more or less worn as if they had been trampled under foot by large animals. That this wearing was done before they were excavated is shown by the fact that in some instances the worn and broken bones were found cemented in sand and gravel, and remain as hard solid masses even after years of exposure to the weather.

Among the materials taken from the excavation was a rude unpolished stone pestle made of the fine-grained granite of the neighborhood, about 18 centimeters long, and nine or ten centimeters in diameter. It is impossible to say whether this pestle or hammer was mingled with the bones or came from the soil above them. The man who did the digging had no recollection of its location further than that it was taken out with the bones and other materials from the excavation.

I could only spend a couple of days in examining this locality. It was hoped that some digging might be done in search of additional material, but the difficulty of arranging laborers and the delay caused by lack of anything like proper tools made exploration impossible at that time. The original reservoir was made by scraping the earth with a hoe upon a dry hide and this was then drawn away by half-wild bullocks.

The occurrence of the fossil bones of large mammals at Lagoa da Lagea in the State of Pernambuco is a typical one for northeastern Brazil. Many cases have been reported of the finding of these fossils under similar circumstances in the States of Alagôas, Pernambuco, Parahyba, Rio Grande do Norte and Ceará, and it seems probable that they may be found throughout the entire area of Brazil that is subject to drouths. About three leagues from the Lagoa da Lagea on

the road leading to Pedra Pintada is a place known as Lageiro, where an excavation was made in the rock basin very similar to that already described and for similar purposes. Here again I found many fragments of bones of mastodons and of other mammals, some of them of enormous size, and others smaller than those of the mastodon.

On the road leading from Lagoa da Lagea to Aguas Bellas at a place known as Lagoa Cavada is another excavation from which it is said many fossil bones were taken. An examination of the soil thrown out at this place failed to disclose any such fossils however.

Large fossil bones were reported to me to have been found at Meirús, a small town three leagues northeast of Pão d'Assucar. I did not see either the excavation or the fossils at this place, but I learned from several intelligent gentlemen that while excavations were being made several years before for making a watering pond for cattle, bones many times as large as those of an ox were found in the soil. It was reported that when this fact became known the government sent persons to preserve these fossils and that the best of them were sent away—where I was unable to learn.

In every instance that came to my attention the fossils have been taken from what were originally ponds, pools or marshes of fresh water that have subsequently silted up and have been discovered in the digging of artificial reservoirs.

The region in which these large fossils occur so abundantly is one now subject to prolonged drouths, and I am disposed to think that the circumstances under which these bones occur suggest, at least, that the animals died of thirst. To any one visiting the drouth regions of Brazil between August and January this explanation seems to be a very natural one. The whole country is parched save the narrow strips of gradually disappearing green along the water courses. The country is but thinly populated and the chief industry is cattle-raising. Beyond these green belts one may travel for many a league without finding a sign of water. When, as often happens, the dry season is prolonged beyond its normal length, the suffering of the cattle is extreme. They are obliged to eat the pulp of the cacti that grow throughout this region, and the herdsmen obtain water for them by digging holes in the sand of the dry river beds. In long drouths, especially when they last for an entire year or even for several years, this source of water supply fails and the cattle must either be driven toward the coast, where water may be had, or they must be left to perish. Under the protection of man cattle may now survive the longest drouths, but left to themselves it is doubtful whether they



The channel of the Rio São Francisco seen from the sugar loaf hill at Pão d'Assucar, State of Alagoas; looking up stream.



could withstand the long drouths that occasionally occur in the interior of northeast Brazil. I was led to this conclusion when I first visited the interior of Alagôas and Pernambuco in 1876. I quote from Dr. J. W. Gregory's "Great Rift Valley" what seems to be corroborative evidence that in Africa large animals do perish as I have suggested :\* "Here and there around a water-hole we found acres of ground white with the bones of rhinoceros and zebra, gazelle and antelope, jackal and hyena, and among them we once observed the remains of a lion. All the bones of the skeletons were there, and they were fresh and ungnawed. The explanation is simple. The year before there had been a drouth which had cleared both game and people from the district. Those which did not migrate crowded around the dwindling pools, and fought for the last drop of water. These accumulations of bones were due, therefore, to a drouth and not to a deluge."

It is much to be desired that the fossil Pleistocene mammals of Brazil be studied systematically. The work of Lund upon the cave fauna of Brazil is classic, but no attempt has yet been made to get together the material from the ancient watering places of northeast Brazil, while the fragmentary collections in the Museu Nacional and in the hands of the other scientific organizations and of private individuals are undescribed and unknown. The only publication that has been made upon the subject is a paper by Dr. F. L. C. Burlamaqui published at Rio de Janeiro in 1855 by the Sociedade Vellosiana entitled "Noticia acerca dos animaes de raças extinctas descobertos em varios postos do Brasil."

Stanford University, California, December 10, 1901.

\* The Great Rift Valley, by J. W. Gregory, London, 1896, pp. 268-269.

ART. XII.—*The Estimation of Copper as Cuprous Sulphocyanide in the Presence of Bismuth, Antimony, Tin and Arsenic*; by R. G. VAN NAME.

[Contributions from the Kent Chemical Laboratory of Yale University,—CVI.]

IT has long been known that copper may be quantitatively separated from a number of other metals by precipitation as cuprous sulphocyanide. The additional fact that this salt is suitable for direct weighing as a means of estimating copper was mentioned, apparently for the first time by Rivot\* in 1854, and was confirmed a quarter of a century later by the experiments of Busse,† who employed the process for determining copper not only alone but also in the presence of iron, nickel, zinc and arsenic. Recent work by the present writer‡ has shown that, with the sole modification of filtering and weighing upon asbestos, Rivot's method is accurate and satisfactory.

In view of the tendency of bismuth, antimony and tin to form insoluble basic chlorides in solutions containing only a slight excess of hydrochloric acid, and the difficulty of obtaining a complete precipitation of cuprous sulphocyanide in strongly acid solutions, the estimation of copper by the above method in the presence of these metals seemed to present some difficulties. The following investigation, in which arsenic was also included on account of its close relationship with the above metals, was accordingly undertaken.

The first series of experiments yielded the results given in Table I, the method being as follows: A convenient quantity of a copper sulphate solution of about  $\frac{1}{2}$  normal strength was measured from a burette, diluted, and acidified with a definite amount of hydrochloric or sulphuric acid. If tartaric acid was employed it was added at this point, after which the solution of arsenic, bismuth or antimony was introduced and the copper finally precipitated by ammonium bisulphite and ammonium sulphocyanide. Of the last a uniform amount, 70<sup>cm</sup>³ of a decinormal solution, was used for each experiment. The ammonium bisulphite solution was prepared in the usual way by passing sulphur dioxide into strong ammonia.

Arsenic was introduced in the form of measured portions of a standard arsenious acid solution which were made faintly acid to litmus just before addition. Bismuth and antimony were taken in the form of solutions of the chlorides in dilute hydrochloric acid, the amount of acid thus introduced into the determination being in all cases taken into account.

\* Compt. Rend., xxxviii, 868.

† Zeitschr. anal. Chem., xvii, 53.

‡ This Journal, vol. x, 451.



All the determinations were allowed to stand fifteen hours or more before filtering to insure completeness of precipitation. The filtering was performed upon asbestos in a perforated crucible, the precipitate thoroughly washed with cold water, dried at 105° to a constant weight, and weighed as cuprous sulphocyanide.

TABLE I.

Final volume 500<sup>cm</sup>³.

70<sup>cm</sup>³ of approximately decinormal NH<sub>4</sub>SCN used for each experiment.

Cu taken gram.	As taken as H <sub>3</sub> O <sub>3</sub> As gram.	H <sub>2</sub> SO <sub>4</sub> cm <sup>3</sup> .	Tartaric acid. gram.	HNH <sub>4</sub> SO <sub>3</sub> sat. sol. cm <sup>3</sup> .	Cu <sub>2</sub> S <sub>2</sub> (CN) <sub>2</sub> found. gram.	Calcu- lated as Cu. gram.	Error. gram.
1. .3144	0.2	5		5	.5889	.3078	-.0066
2. "	0.2	"		10	.5978	.3124	-.0020
3. "	0.05	"		10	.5919	.3091	-.0053
4. "	0.2	"		15	.6020	.3146	+ .0002
		HCl sp. gr. about 1.17 cm <sup>3</sup> .					
5. "	0.4	15		10	.5969	.3120	-.0024
6. "	0.05	"		"	.5995	.3133	-.0011
7. "	0.6	10	1	"	.6035	.3154	+ .0010
8. "	0.5	"	1	"	.6032	.3153	+ .0009
9. "	0.4	"		"	.6015	.3144	.0000
10. "	0.2	"		"	.6024	.3148	+ .0004
11. "	0.1	"		"	.6017	.3145	+ .0001
12. "	0.1	9	1	"	.6029	.3151	+ .0007
13. "	0.01	10		"	.6022	.3147	+ .0003

The negative errors of experiments 1 to 3 of Table I are plainly due to the large amount of acid present, for they disappear when the bisulphite is sufficiently increased (experiment 4), and the deficiencies in nos. 5 and 6 may be ascribed to the same cause, for they are not found in the subsequent experiments with arsenic where less acid was used. Tartaric acid was added in three of the above determinations, but its use in separations from arsenic is obviously unnecessary.

From these results it is evident that the estimation of copper in the presence of arsenic by this method is entirely practicable in either sulphuric or hydrochloric acid solution.

When bismuth is present a much closer adjustment of conditions is necessary. Experiments 14 to 19 show the effect of attempting to keep the bismuth in solution with hydrochloric

TABLE I (continued).

Final volume 500 <sup>cm</sup> ³.								
Cu taken.	Bi taken as	HCl	Tartaric acid.	HNH <sub>4</sub> SO <sub>3</sub>	Cu <sub>2</sub> S <sub>2</sub> (CN) <sub>2</sub>	Calculated as Cu.	Error.	
gram.	BiCl <sub>3</sub> + HCl.	cm <sup>3</sup> .	gram.	sat. sol.	found.	gram.	gram.	gram.
14.	·3144	0·5	20		10	·6534	·3415	+·0271
15.	"	0·4	25		"	·5933	·3101	-·0043
16.	"	0·2	20		5	·5932	·3101	-·0043
17.	"	0·2	"		10	·6014	·3143	-·0001
18.	"	0·1	"		"	·5977	·3124	-·0020
19.	"	0·05	"		"	·5998	·3135	-·0009
Final volume 300 <sup>cm</sup> ³.								
20.	"	0·5	10	1	5	·6007	·3139	-·0005
21.	"	0·4	"	"	"	·6018	·3145	+·0001
22.	"	0·2	"	"	"	·6003	·3137	-·0007
23.	"	0·1	7	"	"	·6033	·3153	+·0009
24.	·3163	0·1	10	"	"	·6033	·3153	-·0010
25.	"	0·1	8	"	"	·6056	·3165	+·0002

acid, using no tartaric acid. In experiment 14 the free acid present during the precipitation of the copper did not suffice to hold up all the bismuth. In the others, with the exception of no. 17, the acid prevented the complete precipitation of the copper.

For experiments 20 to 25 the quantities of hydrochloric acid required were materially diminished by the addition of tartaric acid, and by reducing the total volume from 500<sup>cm</sup>³ to 300<sup>cm</sup>³. The quantities of tartaric and hydrochloric acids required were previously determined by a series of blank tests and both kept as low as possible.

The results fall fairly near the theory but average a trifle low, and the filtrates of all, even those which show positive errors, gave decided tests for copper when concentrated and treated with potassium ferrocyanide. Moreover, a slight variation in the conditions would allow some of the bismuth to be precipitated. The results therefore are hardly satisfactory.

TABLE I (continued).

Final volume 500 <sup>cm</sup> ³.								
Cu taken.	Sb taken as	HCl.	Tartaric acid.	HNH <sub>4</sub> SO <sub>3</sub>	Cu <sub>2</sub> S <sub>2</sub> (CN) <sub>2</sub>	Calculated as Cu.	Error.	
gram.	SbCl <sub>3</sub> + HCl.	cm <sup>3</sup> .	gram.	sat. sol.	found.	gram.	gram.	gram.
26.	·3163	0·5	10	2	5	·6024	·3148	-·0015
27.	"	0·4	8	"	"	·6043	·3158	-·0005
28.	"	0·3	"	"	"	·6044	·3159	-·0004
29.	"	0·5	5	"	"	·6046	·3160	-·0003
30.	"	0·4	"	"	"	·6054	·3164	+·0001
31.	"	0·2	"	"	"	·6058	·3166	+·0003

Antimony is affected to a much greater extent than bismuth by the presence of the tartaric acid, so that if enough of the latter is present, relatively little hydrochloric acid is required to hold the antimony in solution. As the amount of the tartaric acid is practically without effect upon the precipitation of the copper, these conditions are favorable for the process. Experiments 26 to 31 give the results obtained in the presence of antimony, which show that the process is practicable.

In all the experiments thus far described the excess of ammonium sulphocyanide above the amount theoretically required has been comparatively small, 70<sup>cm<sup>3</sup></sup> of the decinormal solution having been employed where the theory called for about 50<sup>cm<sup>3</sup></sup>. It has been elsewhere shown\* that increase in the amount of the sulphocyanide diminishes the effect of the hydrochloric acid present. This fact has an important application in the separation of copper from bismuth, because it is possible, even when the solution contains an excess of hydrochloric and tartaric acid above the amount required to keep the bismuth in solution, to precipitate the copper completely by employing a sufficient quantity of ammonium sulphocyanide. By working in this way in solutions more strongly acid than would otherwise be consistent with accuracy, an additional advantage is gained because the consequent retardation of the precipitation produces precipitates which can be more easily filtered than those obtained from neutral or less acid solutions.

For the experiments of Table II the precipitation was carried out in the manner just described, and as the quantity of copper employed in the previous determinations had proved rather too large to be conveniently filtered and washed in a crucible of the ordinary size, a smaller amount was taken. A new copper sulphate solution of about  $\frac{1}{20}$  normal strength was employed, the other solutions being the same previously used.

The results obtained with bismuth are given in experiments 1 to 8. For this amount of copper the theory requires about 12.5<sup>cm<sup>3</sup></sup> of the decinormal ammonium sulphocyanide, but owing to the amount of acid present the results are low until about 125<sup>cm<sup>3</sup></sup> are added, beyond which point further increase produces no effect. Carried out in this way the separation from bismuth is satisfactory and the results accurate.

Tin in the higher condition of oxidation may be successfully treated in the same manner as experiments 9 to 11 show. Tartaric acid is of material assistance in reducing the amount of hydrochloric acid necessary to hold the tin in solution, whether in the stannic or stannous state.

The estimation of copper in the presence of tin in the

\* This Journal, vol. xiii, p. 23.

142 *Van Name—Estimation of Copper as Sulphocyanide*

TABLE II.

Final volume 200 <sup>cm</sup> ³.									
	Cu taken.	Bi.	HCl sp. gr. about 1·17.	Tar-taric acid.	H <sub>2</sub> NH <sub>4</sub> SO <sub>3</sub> sat. sol.	NH <sub>4</sub> SCN approx. %/10.	Cu <sub>2</sub> S <sub>2</sub> (CN) <sub>2</sub> found.	Calculated as Cu.	Error.
	gram.	gram.	cm <sup>3</sup> .	gram.	cm <sup>3</sup> .	cm <sup>3</sup> .	gram.	gram.	gram.
1.	·0793	0·2	6	1	2	15	·1329	·0695	—·0098
2.	“	0·2	“	“	“	35	·1479	·0773	—·0020
3.	“	0·2	“	“	“	60	·1504	·0786	—·0007
4.	“	0·1	“	“	“	100	·1512	·0790	—·0003
5.	“	0·3	“	“	“	125	·1515	·0792	—·0001
6.	“	0·2	“	“	“	“	·1518	·0793	·0000
7.	“	0·2	“	“	“	“	·1519	·0794	+·0001
8.*	“	0·2	“	“	“	230	·1519	·0794	+·0001
Sn taken as SnCl <sub>4</sub> + HCl.									
9.	“	0·2	5	“	“	40	·1502	·0785	—·0008
10.	“	0·2	6	“	“	125	·1514	·0791	—·0002
11.	“	0·2	5	“	“	130	·1516	·0792	—·0001
taken as SnCl <sub>2</sub> + HCl.									
12.	“	0·2	6	“	“	125	·1529	·0799	+·0006
As.									
13.	“	0·2	“	“	“	“	·1523	·0796	+·0003
Sb.									
14.	“	0·2	“	2	“	“	·1518	·0793	·0000
As, Bi, Sb, Sn of each									
15.	·0795	0·1	“	“	“	130	·1523	·0796	+·0001
16.	“	0·1	“	“	“	“	·1525	·0797	+·0002

stannous condition requires some care, because the bisulphite is often acted upon by a solution of stannous chloride, and a slight precipitate of sulphur thrown down from a mixture of these solutions upon standing. Unless, however, the amount of tin present is more than equivalent to the copper, it may be readily oxidized to the stannic state by merely adding the sulphocyanide before the bisulphite. The tin then acts as the reducing agent and a corresponding amount of copper is thrown down, after which bisulphite may safely be added and the rest

\* Final volume 300<sup>cm</sup>³.

of the copper precipitated. Determination 12 of the table was treated in this way, but as the tin present was much more than equivalent to the copper, some precipitation of sulphur probably took place, as the high result would indicate. In all such cases it would be better to convert the tin into the higher condition by some suitable oxidizing agent before precipitating the copper. Where the weight of copper present is not desired, but merely a separation between the copper and tin, this precaution is of course unnecessary.

Experiments 13 and 14, with arsenic and antimony respectively, show that for these metals the conditions which gave good results with bismuth and tin are equally favorable.

In experiments 15 and 16 arsenic, bismuth, antimony and tin were all present to the extent of 0.1 gram. of each metal, and the results for copper are still accurate.

If cuprous sulphocyanide is precipitated in the presence of a moderate amount of free acid, using a decided excess of ammonium sulphocyanide, as was done in the experiments of Table II, the tendency of the precipitate to pass through the filter during the washing may be almost completely overcome. It is, however, more likely to appear the more rapidly the precipitation has taken place, that is, the smaller the effective amount of acid present. This tendency, in the experience of the writer, need not greatly interfere with the accuracy of the determination. If only a light pressure of the filter pump is used, the washing may generally be completed and the small quantity of copper thus lost disregarded. A very distinct cloudiness in the filtrate may be caused by an amount of copper not greater than one or two tenths of a milligram, and the loss from this cause will seldom exceed this limit. Although, on the other hand, by precipitating in strongly acid solutions cuprous sulphocyanide can be thrown down in a form that filters well, the losses from incomplete precipitation may be many times greater.

The filtrates from determinations 15 and 16, the first of which showed a distinct cloudiness, were treated with great care for the recovery and estimation of the trace of copper present. The colorimetric method described in a previous article\* was used in determining the copper, and the amounts found were respectively 0.00034 and 0.00020 gram., these figures representing the sum of the mechanical loss with that due to the solubility of the precipitate in the acid solution.

Under the conditions of Table II, the estimation of copper in the presence of arsenic, bismuth, antimony and tin, either separately or in any combination, is obviously possible. To

\* This Journal, vol. xiii, 22.

separate copper from unknown quantities of bismuth, or from mixtures containing bismuth, the procedure would be as follows: Having the copper and bismuth in hydrochloric acid solution, add tartaric acid and, after diluting if necessary, determine by blank tests with small aliquot portions of the solution how much ammonium bisulphite can be added to the whole without precipitating the bismuth. Then keeping the bisulphite well within this limit, carry out the precipitation of the copper as already described, using a considerable excess of ammonium sulphocyanide. Where bismuth is absent, antimony and tin could be treated in the same way, but the latitude possible in the adjustment of the conditions is so much greater with these metals that preliminary tests would usually not be needed. For the separation from arsenic no precautions are required beyond a reasonable degree of acidity of the solution.

The writer is under obligation to Prof. F. A. Gooch for his kind advice and helpful suggestions.

ART. XIII.—*The Composition of Yttrialite with a Criticism of the formula assigned to Thalénite; by W. F. HILLEBRAND.*

IN a paper describing the new yttrium silicate thalénite,\* the author, C. Benedicks, casts doubt on the formula assigned by Hidden and Mackintosh† to their mineral yttrialite from Llano Co., Texas, for which they deduced the formula  $R_2O_3$ ,  $2SiO_2$  or  $R_2Si_2O_7$ , in which  $R_2O_3$  includes the sesquioxid equivalents of very considerable percentages of monoxides and dioxides. Benedicks would assign yttrialite to a group of which rowlandite is the prototype and to which he believes thalénite and kainosite belong, being either plain basic salts of  $H_6Si_2O_7$  of the type  $R''R'''_4Si_4O_{15}$  or derivatives in which the fifteenth oxygen atom is replaced by its equivalent in fluorine (rowlandite) or  $CO_3$  (kainosite), as shown below.

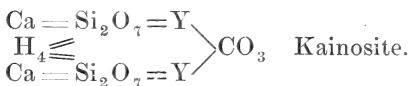
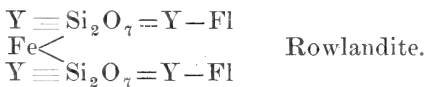
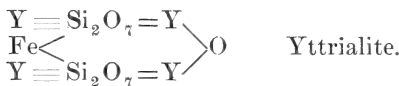
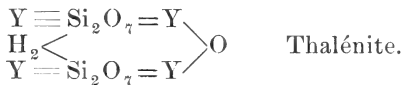

Benedicks says: "Dem Yttrialit, von Hidden and Mackintosh beschrieben, sollte die Formel  $R_2O_3$ ,  $2SiO_2$  zukommen, worin R hauptsächlich Ytter-und Thorerde ist. Dabei wird aber ca. 4% Eisenoxydul in der Analyse vernachlässigt. Wird dies nebst etwas Kalk und Bleioxyd mitgerechnet, so bekommt man die Formel  $Fe''O$ ,  $2R_2O_3$ ,  $4SiO_2$ , analog mit der des Thalénits, welche besser die Zusammensetzung des Yttrialits wiedergibt, obgleich die Übereinstimmung gar nicht gut ist."

It is, however, not true that Hidden and Mackintosh neglected to take account of the ferrous iron, etc., of their analysis. It was regarded in the derivation of their empirical formula  $R_2Si_2O_7$ . How wholly unwarranted was the substitution by Benedicks of his formula for yttrialite is shown by the molecular ratio for  $RO : R_2O_3 : SiO_2$ , which he gives as 1 : 2 : 4 instead of 1 : 3.25 : 7.42 as calculated by me from Mackintosh's figures, wherein for a sound reason I have converted his  $UO_3$

\* Bull. Geol. Inst. Upsala, iv, 1, 1898.

† This Journal, xxxviii, 477, 1889.

into  $\text{UO}_2$ , thus throwing it with the  $\text{ThO}_2$ , where it naturally belongs. The agreement is indeed "gar nicht gut."

Benedicks has made the grave mistake of counting Mackintosh's monoxide bases a second time, thus making a basic salt  $\text{R}''\text{R}'''\text{Si}_4\text{O}_{15}$  instead of the normal one  $\text{R}'''\text{Si}_4\text{O}_{14}$ , to which Mackintosh's results closely conform.

*Discussion of Benedicks' formula for Thalénite.*

Moreover, in the light of the data furnished by Benedicks himself it cannot be admitted that the formula  $\text{H}_2\text{Y}_4\text{Si}_4\text{O}_{15}$  for thalénite is established.

Water was determined by him according to Penfield's method,\* but without any hint as to the particular modification employed. If, as seems probable, the water expelled from the mineral was caused to recondense in the cooler part of the ignition tube, the latter being then weighed and again after driving the condensed water out, two serious sources of error have to be considered: (1) The  $\text{CO}_2$  present in the mineral, which would count in part as water unless a very careful correction was made, as provided for by Penfield. No mention is made by Benedicks of any such correction. (2) Nitrogen and helium are said to comprise 1.4 per cent of the mineral by weight. If so, these would introduce an error in the above water determination of contrary sign to that due to  $\text{CO}_2$ , and if the proportion of helium were large this error might be of very considerable magnitude.

In an appendix to his paper Benedicks gives an analysis of what he considers to be a very pure form of thalénite. He makes no comparison of this with his earlier analysis, nor does he deduce a molecular ratio, which I find to be 1 : 2.6 : 5.15, or 1 : 3.03 : 6.02 if small amounts of lime, magnesia, and soda are neglected, instead of 1 : 2 : 4 as required by his formula. There being no  $\text{CO}_2$  in this purer material, the value for water (if determined as above surmised) may be supposed to be affected only by the error due to nitrogen and helium. It will be seen that the neglect to regard lime, magnesia, and soda in his second analysis affects the ratio very seriously. This neglect may be justified in figuring on his first analysis because of an approximate balancing by  $\text{CO}_2$ , but it would be by no means so in the other in spite of the very satisfactory ratio obtained and leading to the empirical formula  $\text{R}''\text{R}'''\text{Si}_6\text{O}_{22}$ , which is susceptible of a variety of interpretations. It may represent a basic salt of diorthosilicic acid  $\text{R}''\text{R}'''\text{(R}'''\text{O)Si}_2\text{O}_7$ , or of metasilicic acid  $\text{R}''\text{R}'''\text{(R}'''\text{O)}_4\text{(SiO}_3)_6$ , or possibly even of other acids.

\* This Journal, xviii, 31, 1894.



Finally, if the values for nitrogen and helium are really anywhere near so great as given, an additional argument against the validity of his formula is furnished. For, in the light of Kohlschütter's recent researches\* and my own less conclusive work of a much earlier date,† it is in the highest degree probable that nitrogen and helium are not occluded in uraninite and other minerals but are in chemical combination. Now, if this is so, in a mineral containing as much as 1.4 per cent of nitrogen by weight this must, quite irrespective of its form of combination, play so important a role in the molecule as to utterly invalidate any formula based on calculations from which it is omitted. If the above percentage is made up in large part of helium, its effect, because of its low atomic weight, must be vastly greater than that of nitrogen.

Until light is thrown on the nature of the combinations these two gases form in minerals, no very positive conclusions can be reached as to the formulas to be assigned to those minerals which contain them in more than traces.

#### *Chemical investigation of Yttrialite.*

At the earnest request of Mr. W. E. Hidden, the discoverer of yttrialite, I undertook to reanalyze the mineral in order if possible to settle definitely the question of its composition. This seemed especially desirable since a large quantity of very fine material was available.

The appearance and behavior of the mineral agreed in all respects except one with those of the original description.‡ It is there stated that the strongly ignited mineral is insoluble in acid. This is a mistake, for when powdered the solubility in hydrochloric acid is even then perfect, although not rapid.

Careful examination of thin sections under the microscope showed a condition that augured ill for decisive analytical results despite the apparently fine quality of the large specimens. Distinctly foreign mineral fragments were as good as absent except for insignificant coatings of a white alteration product, presumably a carbonate, but considerable shading was apparent in the slides, indicative of alteration or intimate contamination in the mass of the mineral itself. However, after treatment with hot dilute hydrochloric acid (whereby much yttrialite was dissolved) followed by dilute sodium carbonate, the clear glassy residue appeared to be improved in appearance and the specific gravity of two samples, each composed of small grains uniform in size for each sample, had risen from 4.596 and 4.590 to 4.654

\* *Ann. der Chem.*, cccxvii, 158, 1901.

† *Bull. U. S. Geol. Surv.*, No. 78, pp. 76-78, 1891.

‡ *This Journal*, xxxviii, 477, 1889.

at 23½° C and 4.646 at 26° C. respectively. The two sizes were then mixed, giving one sample of about 4.65 sp. gr. at 25° C. That of the unpurified material analyzed by Mackintosh was 4.575.

Qualitative tests showed the absence of zirconium, glucinum, and aluminum and the presence of a little more than a trace of fluorine, of a very little carbon dioxide, besides some other gases which were set free by treatment with acids and by fusion with an alkali carbonate.

Silica was separated by two evaporations with hydrochloric acid; lead was then thrown out by hydrogen sulphide.

The earths when finally collected together free from all iron, manganese, uranium, titanium, phosphorus, calcium, and magnesium, were ignited and weighed. No filtrate from a precipitate of earth-oxalates was ever regarded as free from earths till after evaporating, igniting, and retesting. This is a needed precaution in all similar analyses.

The combined earths were dissolved in nitric acid and evaporated to dryness. A saturated solution of potassium sulphate was poured upon the dry mass, which wholly dissolved but almost at once began to deposit double sulphates. Solid potassium sulphate was then added in crystals. After twenty-four hours the precipitate was collected on a filter and washed with the precipitant solution. Twice was this precipitation repeated after first dissolving the double salts in acid, precipitating by potassium hydroxide, washing, redissolving in nitric acid, and evaporating. Then only was the extraction of the yttrium-erbium group practically complete. From the combined filtrates the soluble earths were thrown out, reconverted into nitrates, and again treated with potassium sulphate, whereby a little further insoluble matter was obtained. Yttrium-erbium oxides obtained from the oxalates gave a light-colored mixture of 265.6 Mol. W. (108.8 At. W.), which furnished a pink nitrate solution showing the erbium absorption bands strongly marked, with very faint indications of the strongest band of the didymium components.

The insoluble sulphates were converted into chlorides and thrice treated with potassium hydroxide and chlorine to precipitate thorium and cerium. From the filtrates the soluble earths were recovered and subjected to a repetition of this treatment. Their oxides after purification were light dirty brown when heated over the Bunsen flame, but grayish white when blasted. Their Mol. W. was 335.5 (At. W. 143.7); their nitrate solution was pink and gave the characteristic didymium component absorption bands altogether free from those of the erbium constituents.

Cerium and thorium were separated by a combination of the

ammonium oxalate and thiosulphate methods. The weighed thoria was pure white, the ceria of a pale salmon color.

The condition of the uranium was shown by its precipitability as tetrafluoride on dissolving the mineral in hydrofluoric acid. This reaction afforded a ready means of estimating with exactness the ferrous iron by permanganate after rapidly filtering off the fluorides precipitated in an atmosphere of carbon dioxide. Solution of the mineral in a sealed tube with dilute sulphuric acid allowed of finding the oxygen value of both  $UO_2$  and  $FeO$  by permanganate. The result thus found for  $OU_2$  agreed marvelously well with that calculated from the  $U_3O_8$  found gravimetrically in a separate portion.

*Analyses of Yttrialite.*

HILLEBRAND.			MACKINTOSH.		
		Mol. Ratios.			Mol. Ratios.
$SiO_2$	29.63	.4938	29.17		.4861
$TiO_2$	.05		—		
$ThO_2$	10.85	} .0470	12.00	} .0483	
$UO_2$	1.64 (1)		.79 (1)		
$Ce_2O_3$	3.07		1.86		
$La_2O_3$ , etc.	5.18 (2)	} .1930	2.94 (2)	} .1864	
$Y_2O_3$ , etc.	43.45 (3)		22.67 (3)		
"			5.30 (4)		
"		} .0608	4.50 (5)	} .0655	
"			14.03 (6)		
$Al_2O_3$	—		.55		
$Fe_2O_3$	.76	} .0608	—	} .0655	
$FeO$	1.96		2.89		
$MnO$	.88		.77		
$PbO$	.80	} .0608	.85	} .0655	
$CaO$	.67		.60		
$MgO$	.16				
$H_2O + 105 C.$	.32	}	} .79		
$H_2O - 105 C.$	.04				
$CO_2$	.11				
$P_2O_5$	.12				
N, He	} Diff. .31				
Fl, Alk					
<hr/>			<hr/>		
100.00			99.75		

- |                                  |                |                                   |
|----------------------------------|----------------|-----------------------------------|
| 1) Volumetrically.               | Gravimet-      | 1) Given as .83 $UO_3$ by Mackin- |
| 2) At. W. 143.8 (Mol. W. 335.6). | rically 1.62%. | tosh.                             |
| 3) At. W. 108.8 (Mol. W. 265.6). |                | 2) At. W. 162 (Mol. W. 372).      |
|                                  |                | 3) At. W. 110.3 (Mol. W. 268.6).  |
|                                  |                | 4) At. W. 110.53                  |
|                                  |                | (Mol. W. 269.06).                 |
|                                  |                | 5) At. W. 114.9 (Mol. W. 277.8).  |
|                                  |                | 6) At. W. 120 (Mol. W. 288).      |

Nitrogen (?) and helium (?) were obtained quantitatively by fusing the mineral with sodium-potassium carbonate in a current of carbon dioxide and collecting the gases in a nitrometer over potassium hydroxide. The volume was between one and two cubic centimeters per gram of yttrialite. The gases were not further examined.

The analysis is given above, together with that of Mackintosh for comparison.

The ratios of Mackintosh's analysis as calculated above by me are certainly wrong in so far as they are affected by the value for iron, which he assumed to be wholly ferrous. If corrected in accordance with the statement of my analysis, or, what amounts to the same thing for the purpose of illustration and is simpler, if my ratio is altered to conform to his statement for RO and  $R_2O_3$  bases it becomes  $\cdot0644 : \cdot1882$ , a very close agreement.

It is altogether probable that Mackintosh's separations of the earths were not so far reaching as mine, and this belief is borne out by the differences in the experimental molecular weights for the lanthanum and yttrium groups, mine being more in accordance with what might be expected and, moreover, agreeing almost exactly with those which were found by me for rowlandite in 1893, namely, 336.8 and 266.2 respectively.\*

It is of course impossible to say what disposition should be made of the small amounts of firmly held water, phosphorus, carbon dioxide, fluorine, and alkalis. The ratios of my analysis are, therefore, to a slight extent incorrect, but probably not enough to influence any conclusions that may be drawn. One thing is apparent, that the preliminary purification by acid has had no pronounced effect on the composition of the mass acted on, otherwise Mackintosh's and my analyses should show far greater differences in the main constituents.

The crude empirical formulas deducible from the ratios of the two analyses are nearly

\* The three minerals gadolinite, yttrialite, and rowlandite occur in Llano County in most intimate association, suggestive of close community of origin, a suggestion which is emphasized by the marvelous agreement for gadolinite and yttrialite, not only in the relative proportions of the trivalent earth metals but in their absolute amounts as well.

	$Ce_2O_3$	$La_2O_3$ , etc.	$Y_2O_3$ , etc.
Gadolinite (Genth).....	2.65	5.22	44.35
“ “ .....	2.66	5.01	44.45
“ (Eakins).....	2.62	5.22	41.55
Yttrialite (H'b'd.) .....	3.07	5.18	43.45
Rowlandite ( “ ) .....	5.06	9.34	47.70

This concordant testimony of three analysts may be regarded as strong evidence of the correctness of the earth separations made by them in these cases. Nearly the same relation is shown by the trivalent earth-metals of rowlandite, as seen in the table above.

Hbd.	$R''_{61}$	$R'''_{386}$	$R''''_{47}$	$(Si_2O_7)_{247}$
Mack.	$R''_{65}$	$R'''_{373}$	$R''''_{48}$	$(Si_2O_7)_{243}$

there being a slight *deficiency* of oxygen atoms in each case for the radical  $Si_2O_7$ , which is increased by allowing for the  $CO_2$  and  $P_2O_5$ .

In so far then as the character of the acid radical is concerned the results of Mackintosh's analysis are fully confirmed and there is absolutely no ground for accepting Benedicks' basic formula, which as I have already shown (p. 145) is based on a palpable error. But the ratios are not at all such as to lend themselves to ready resolution into isomorphous salts of the acid  $H_6Si_2O_7$ . By doing quite unwarranted violence to the analytical data the above formulas might be reduced to



which can be readily represented structurally as a single complex molecule or as a mixture of molecules like  $3R''''_2Si_2O_7 + R''R''''Si_2O_7$ . In neither case, however, is the type of the rowlandite molecule approached, which requires an altogether different ratio of monoxide, dioxide, and trioxide bases, nor, if the second be accepted, is it at all clear that the two molecules would be mineralogically equivalent, that is, isomorphous.

An alternative hypothesis is to regard the mineral as a mixture containing the anhydrous thorite molecule. Proceeding on this assumption and deducting all thorium and uranium and the proper amounts of silicon and oxygen, the crude empirical formulas become

Mack.	$R''_{65}$	$R'''_{373}$	$Si_{438}$	$O_{1501}$
Hbd.	$R''_{61}$	$R'''_{386}$	$Si_{447}$	$O_{1533}$

which may be interpreted as basic salts of metasilicic acid :

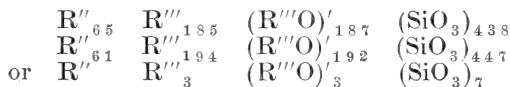

this last being easily susceptible of symmetrical representation in graphic form.

On the whole I prefer to leave the constitution of yttrialite unsettled until further evidence can be gathered, either from analyses of allied minerals or from yttrialite itself of more certain purity than any that has yet been discovered.

It must not be forgotten that the gases other than  $CO_2$  contained in the mineral may be the cause of the inability to arrive at satisfactory conclusions in the case of this and all other minerals which contain them, as I have already pointed out on p. 147.

My excuse for such a lengthy publication on a matter still unsettled is the desire to prevent general acquiescence in the grouping under one type of minerals which can by no means be regarded as proven to belong to that type, and to which yttrialite certainly does not belong.

*Summary.*

The empirical formula of Hidden and Mackintosh for yttrialite is confirmed, and it is shown that the basic formula of Benedicks rests on error and has no standing.

The formula of Hidden and Mackintosh is not, however, susceptible of representation as a simple salt of the acid  $H_6Si_2O_7$ . On the purely hypothetical assumption of admixture of anhydrous thorite, the remaining constituents afford ratios conforming quite closely to those of a basic metasilicate  $R''R'''_3(R'''O)_3(SiO_3)_7$ .

It is shown for two reasons fully discussed that the formula proposed by Benedicks for thalénite is to be regarded as doubtful.

Laboratory U. S. Geol. Survey,  
Washington, D. C., Nov. 19th, 1901.

## SCIENTIFIC INTELLIGENCE.

## I. CHEMISTRY AND PHYSICS.

1. *Apparatus for Determining the Density of Liquids.*—A very simple means for taking the specific gravity of liquids has been devised by F. GIRARDET. It consists of two perpendicular glass tubes, resembling barometer-tubes, which are open at the bottom, and are connected at the top so that suction can be applied to both tubes at once by means of a rubber tube. Each tube has behind it a paper millimeter scale extending from an arbitrary zero point a few centimeters above its bottom to 500<sup>mm</sup> or more, near the top. To take the specific gravity of a liquid, the latter is placed in a small, cylindrical, glass vessel so that one of the upright tubes dips into it, while distilled water is placed at the mouth of the other tube and in a dish of the same size. Suction is now applied until the liquid to be tested remains, when a screw-clamp on the rubber tube is closed, at a convenient point high up in the tube, say 500<sup>mm</sup>, and the height of the water is also read. Then air is admitted until the columns have fallen to points near the bottoms of the scales, for example, until the liquid to be tested is at zero, when the positions of the two columns are again recorded. It is evident that the columns thus measured are inversely as the specific gravities of the liquids; hence, since one of them is water, it is only necessary to divide the fall of the water column by that of the other liquid in order to obtain the specific gravity of the latter. The effect of capillarity is eliminated by the two readings if the tubes are of uniform caliber. In the apparatus described the tubes were of about 8<sup>mm</sup> exterior diameter, so that the quantity of liquid needed was very small. Determinations were made with various liquids, and results were obtained which agreed closely with those obtained by a Mohr's balance. Slight errors were encountered when volatile liquids were used, but satisfactory results were obtained with ethyl alcohol and with ammonia of .985 specific gravity. The apparatus is easily constructed at slight expense; it is much more accurate than ordinary specific gravity spindles, and it may be used to replace a series of these, as it is applicable to liquids which are heavier or lighter than water. Where readings are made to  $\frac{1}{2}$ <sup>mm</sup>, with columns of about 400<sup>mm</sup>, the probable error is calculated to be  $\frac{1}{2400}$  of the absolute value. The time required for the determination is only about one minute.—*Bulletin*, xxv, 936.

H. L. W.

2. *The supposed Existence of an Oxide of Hydrogen higher than the Dioxide.*—The possible existence of an oxide of hydrogen higher than H<sub>2</sub>O<sub>2</sub> was suggested by Bach a year or two ago, on the ground that when hydrogen peroxide is acidified with sulphuric acid the amount of oxygen evolved by potassium permanganate is greater than the amount calculated from the permanganate used. RAMSAY has now confirmed the fact just stated, but

he finds that the discrepancy is due to the formation of some persulphuric acid when the sulphuric acid is added to the hydrogen peroxide. He finds that when acetic acid is used for acidifying, the evolved oxygen corresponds with the theory. It is evident that these results have an important bearing upon the customary method of titrating hydrogen peroxide solutions, and that sulphuric acid should not be used in this operation.—*Jour. Chem. Soc.*, lxxix, 1324.

H. L. W.

3. *The Atomic Weight of Calcium*.—HINRICHSSEN has made four determinations of this atomic weight by igniting Iceland-spar and finding the loss in weight due to the expulsion of carbon dioxide. The material was carefully analyzed, and found to contain no impurity except ferrous carbonate corresponding to .032 per cent of  $\text{Fe}_2\text{O}_3$ . This impurity was taken into account in making the calculations. The quantity used for each experiment was about 30% of the mineral. The ignitions were made in a large bottle-shaped platinum crucible with a specially constructed electrical furnace as the source of heat. During the ignitions dry air was aspirated through the crucible in order to remove the carbon dioxide as fast as it was set free. The results, 40.144, 40.141, 40.142 and 40.141, where oxygen is taken as 16 and carbon as 12, show a remarkably close agreement and indicate that the usually accepted atomic weight, 40.0, is somewhat too low.—*Zeitschr. physikal. Chem.*, xxxix, 311.

H. L. W.

4. *Silver Subhalides*.—These compounds, which are supposed to be represented by the formulas  $\text{Ag}_2\text{Cl}$ ,  $\text{Ag}_2\text{Br}$  and  $\text{Ag}_2\text{I}$ , are of considerable interest because they are probably formed by the action of light on the ordinary halides in photographic processes. Many attempts have been made to prepare these substances in a pure condition, and it has been supposed that Vogel had accomplished this by the reaction of the cuprous halides upon silver nitrate in solution. EMSZT has now shown, however, that the products made according to Vogel are merely mixtures of the ordinary halides with metallic silver. He has shown, contrary to Vogel's belief, that metallic mercury dissolves silver from the products, and, moreover, he has found that it is possible to change the compositions of the products by simple elutriation.—*Zeitschr. anorg. Chem.*, xxviii, 346.

H. L. W.

5. *The Atomic Weight of Tellurium*.—In the last number of this Journal (page 60 of this volume) attention was called to an investigation by Pellini on the atomic weight of tellurium, in which results were obtained showing a value of 127.6, a number higher than that of iodine, and closely agreeing with the results of a number of other investigators. KÖTHNER has now made an elaborate research on the same subject, and by the ignition of the basic nitrate, a method which originated with the Americans Norris, Fay and Edgerly, he has obtained an average result which is precisely the same as that of Pellini. It seems probable that this atomic weight is now established within very narrow limits.—*Liebig's Annalen*, cccxix, 1.

H. L. W.



6. *Compounds of Hydrogen Peroxide with Salts.*—S. TANATAR has prepared a curious molecular compound of hydrogen peroxide and potassium fluoride with the composition corresponding to the formula  $\text{KF}\cdot\text{H}_2\text{O}_2$ . It forms large monoclinic crystals and is prepared by treating a very concentrated solution of the two substances—hydrogen peroxide being in excess—with alcohol, then separating the lower of two layers of liquid which form, treating again with alcohol, and evaporating in a desiccator. In a somewhat similar manner the compound  $\text{Na}_2\text{SO}_4\cdot 9\text{H}_2\text{O}\cdot\text{H}_2\text{O}_2$  was prepared. This is evidently Glauber's salt in which one molecule of water of crystallization is replaced by hydrogen peroxide. From an alkaline solution of sodium nitrate the remarkable compound  $\text{NaNO}_3\cdot\text{Na}_2\text{O}_2\cdot 8\text{H}_2\text{O}$  was produced.—*Zeitschr. anorgan. Chem.*, xxviii, 255.

H. L. W.

7. *Drift of the Ether.*—Dr. W. M. HICKS communicates a long mathematical paper on Michelson and Morley's experiment in regard to the motion of the ether. He points out that reflection produces a change in the wave-length of the reflected light. Further, when the source of light moves with the apparatus, the light incident at any instant on a plate does not come from the position occupied by the source at that instant, but from a point which it occupied at some interval before: consequently the angle of incidence alters by a small quantity of the first order as the direction of drift of the apparatus changes. The principal result of the correction is that in the experiment of Michelson and Morley the effect to be expected is the reverse of that hitherto supposed.—*Phil. Mag.*, Jan. 1902, pp. 9-42. J. T.

8. *The Clearing of troubled Solutions.*—G. QUINCKE reviews the work of previous writers on the causes of the suspension of fine particles of various substances in water. Prof. J. J. Thomson and Mr. Hardy sought the ground of this long suspension in the electromotive force at the boundary of the suspended particles and the surrounding liquid, which opposed the movement of the solid particles. Since according to Dorn electric work would be afforded by a displacement of the particles, the working would be the same as if the viscosity of the fluid should be increased. Quincke's observations do not support this hypothesis. He finds the main cause of the suspension in the hydrodynamic forces, which the swimming or slowly falling particles excite in the surrounding fluid. Quincke does not agree with Barus, Hardy and Spring, that a phenomenon of electrolysis enters. He sums up his observations under ten heads, which relate to the various phenomena observed in solutions containing suspended particles.—*Ann. der Physik*, No. 1, 1902, pp. 57-96. J. T.

9. *Displacement Currents.*—In a previous paper, M. R. BLONDLOT showed that if a mass of air is moved in a magnetic field normally to the lines of force, no electric displacement results in this mass of air. From this it follows that a mass of air which is the seat of an electric displacement should undergo no action in a magnetic field. If the principle of action and reaction is

applied to this proposition, it leads to the conclusion that a current of displacement in the air exerts no magnetic action, and consequently that the charging current of a condenser is an open current from the magnetic point of view. This is in direct opposition to one of the fundamental principles of Maxwell's theory, and choice has to be made between renouncing this theory or the principle of action and reaction.—*Comptes Rendus*, Nov. 25, 1900; *Nature*, Dec. 5, 1901. J. T.

10. *Frequency-determination of slow Electrical Vibrations*.—K. E. F. SCHMIDT places a telephone opposite the end of a resonance tube and pushes a metallic disc to and fro in the tube until the sound of the telephone is reinforced. In this way he obtains the wave-length of the note of the telephone. He gives a table of readings to show the accuracy of the method. The determinations of the position of the minima varied from each other hardly more than one millimeter, when the length of the wave was  $9.356^{\text{cm}}$ . He also used Kundt's dust figures, and obtained remarkably sharp and beautiful figures. Another method consisted in using a single straight filament in an incandescent lamp, and setting a photographic plate suspended from a pendulum in motion. The plate shows maxima and minima corresponding to the frequency of the current feeding the lamp.—*Ann. der Physik*, No. 1, 1902, pp. 225-231. J. T.

11. *The Bearing of the upward and downward Movement of Air on Atmospheric Electricity*.—F. LINKE dwells upon the fact that if at any place an electrostatic potential  $A$  exists and a conducting body of capacity  $C$  is in equilibrium, a quantity of electricity  $E_A = C \cdot A$  results. If we now bring this body to a place of potential  $B$ , then we should have a quantity of electricity  $E_B = C \cdot B$  neglecting disturbing influence of the field: the difference  $E = C(A - B)$  must become free, if no change takes place in capacity. In an electrostatic field, like that of the earth, any change of a body in the direction of the force lines must result in free electricity. The author finds in the rise and fall of charged clouds a cause of lightning potential, which to his mind is far more plausible than theories of the friction of water on ice and condensation on ions.—*Ann. der Physik*, No. 1, 1902, pp. 231-235. J. T.

12. *Notes on Quantitative Spectra of Beryllium*; by W. N. HARTLEY.\*—In a quantitative examination made in 1885 of all the known methods of separating beryllium from aluminum and from iron, the various precipitates obtained were dissolved and diluted to a known volume corresponding with the amount of bases in solution.

The solutions were spectrographically examined, and the photographs compared with others taken from solutions containing accurately weighed quantities of pure beryllia. The coil used was capable of giving a 5-inch spark in air. In place of a Leyden jar a pane of glass coated on each side with a square foot of tin-

\* Read before the Royal Society, Dec. 5, 1901; from an advanced proof received from the author.

foil was used. The electrodes\* were Ceylon graphite as in other experiments, the sole impurity in which was a trace of magnesium.

The following tabulated statement gives the wave-lengths of the lines, together with a description of the spectra photographed from solutions of different strengths :—

Strength of Solutions or Degrees of Dilution shown by per cent of Beryllium.

Beryllium wave-lengths (Rowland's scale).	1 per cent.	0·1 p. c.	0·01 p. c.	0·001 p. c.	0·0001 p. c.	0·00001 per cent.	0·000001 per cent.
3322·3	Continuous line	Half of line much weakened	Very short line	Faint indication	Extinct	Extinct	Extinct
3130·3	“	Continuous line	Half of line weakened	Half of line weakened	Line one-half shorter	Half line still strong	Nearly one-half, still strong
2649·8	“	Half of line weakened	Very short line	Very short line	Dot merely	Dot	Dot
2493·6	“	“	“	“	Very faint dot	Dot, scarcely visible	Dot, scarcely visible
2478·1	“	Continuous line	Short line	Very fine short line	Very short line	Fine short line	Fine short line

The actual length of the line 2478·1, as rendered by solutions of 0·00001 per cent and 0·000001 per cent strength, is, in the former, 0·07, and, in the latter, 0·05 of an inch. The normal length of the line at this part of the spectrum is 0·22 of an inch. The quantity of substance yielding this spectrum is equivalent to one-millionth of a milligram of beryllium. As I have pointed out in the case of magnesium,† so also is it with beryllium, that the sensitiveness of the spectrum reaction may be increased ten thousand-fold by using a larger coil and more powerful condenser, but leaving the striking distance between the electrodes unaltered. The coefficient of complete extinction was therefore practically not attainable for all the lines, or, in other words, the sensitiveness of the reaction is almost without limit.

It will also be seen from my description of the spectra, which have been quite recently re-examined, that the coefficient of extinction of the two lines  $\lambda$  3130·3 and 2478·1 had not been reached by the dilution specified.

A number of thin sections of the Dublin granite containing microscopic crystals of hexagonal form were examined some years ago. The crystals were supposed to be apatite, but a very carefully executed analysis disclosed the fact that the proportion of phosphoric acid contained in 20 grams of the rocks was almost

\* Phil. Trans., 1884, Part I, p. 49.

† Phil. Trans., 1884, Part II, p. 325.

infinitesimal, and that on warming thin sections, in which the hexagonal crystals were visible, with nitric acid and ammonium molybdate, no deposit of yellow ammonium phospho-molybdate could be detected by the microscope. A spectrographic analysis showed that these crystals were really beryls, and similar crystals a millimeter in length were picked out of the granite. They were found to contain between 10 and 11 per cent of beryllia. Since then beryllia has been separated from the alumina of feldspar obtained from the granite in Glen Cullen in proximity to a vein of coarse granite in which beryls were found by Dr. John Joly.

From numerous experiments on the analytical processes employed in the separation of beryllia from alumina, it was found that it remained combined with the sesquioxide bases in so persistent a manner as to lead to the belief that ordinary alumina might be found more often than not to contain traces of beryllia, particularly as there is no easily applied chemical test for detecting its presence in small quantities, nor a simple means of separating it. It has, however, been found that such is not the case, though gallium has been ascertained to be present in almost all minerals which contain aluminum. As they belong to the same group, the two elements aluminum and gallium may be expected to form isomorphous mixtures, which would account for their being so constantly associated in nature; but the position of beryllium in the periodic system of classification shows that a similar behavior with that element is scarcely probable.

13. *Vector Analysis*: a Text-book for the use of Students of Mathematics and Physics, founded upon the lectures of J. WILLARD GIBBS; by EDWIN BIDWELL WILSON. Yale Bicentennial Publications. New York and London, 1901. (Charles Scribner's Sons.) Pp. xiii-436.—As indicated by its title, this book embodies the substance of Professor Gibbs' lectures on Vector Analysis, with such illustrations and extensions as seemed necessary to the editor, Dr. Wilson. Since the publication, over twenty years ago, of Professor Gibbs' small pamphlet on the subject, there has been a growing need for some more elaborate text-book which should contain such theorems, examples and problems as would enable one who mastered it to apply its methods to the fields of mathematical physics and pure mathematics. University students have felt the need of such a book also, for the number of writers who are making use of the methods and symbols of Vector Analysis is increasing each year. Mention need be made of only a few, such as Heaviside, Föppl and Walker.

This is not the place nor the occasion to discuss the general question as to the usefulness of Vector Analysis: it may in fact be said to be decided. Whether new theorems can be deduced by means of it may be doubted; but no one can deny that new points of view may be obtained and that more elegant solutions may be given.

In the work under review, there is a general discussion of Vector Analysis, together with its most important applications.

As Dr. Wilson explains in his preface, the book is divided roughly into three distinct parts. In the first are treated the addition and products of vectors; in the second, the application of the differential and integral calculus; in the third, the theory of the linear vector function and a few special applications. There are seven chapters, each of which is concluded by an excellent summary and a few selected exercises.

The scope of the work may best be indicated by a résumé of the table of contents. Chapter I discusses scalars and vectors, addition and subtraction, the three unit vectors  $i, j, k$ , centers of gravity, representation of areas; chapter II, scalar and vector multiplication, reciprocal systems, kinematics and dynamics of a rigid body; chapter III, kinematics of a particle, the vector and scalar differentiating operator, divergence, curl, and combinations of these operators; chapter IV, the theorems of Gauss, Stokes and Green, and the integrating operators, "potential," "newtonian," "laplacian" and "maxwellian"; chapter V, the theory of linear vector functions and the application of various theorems in regard to dyadics; chapter VI, the description and discussion of rotations and strains by dyadics; chapter VII, applications of vector analysis to quadric surfaces and the theory of light.

From the first page to the last, the logical development is clear and forcible. Special attention is paid at every point to render the book efficient for use in a class; and anyone having an opportunity to instruct a class in Vector Analysis would certainly be most grateful to Dr. Wilson.

The book is to be recommended to every student of physics and mathematics, and the thanks of every reader are due the publisher for the excellence of the type and paper. No important typographical errors have been noted; but the absence of an index is unpardonable.

J. S. A.

## II. GEOLOGY AND NATURAL HISTORY.

1. *Catalogue of the Types and figured Specimens in the Palæontological collection of the Geological Department, American Muséum of Natural History*; by R. P. WHITFIELD, assisted by E. O. HOVEY (vol. xi, Bull. Am. Mus. Nat. Hist.) ; pp. 1-500. 1898-1901.—The completion of this catalogue of one of the most important series of Paleozoic fossils in the United States, representing as it does a large proportion of the types upon which American Paleozoic paleontology is founded, calls for special notice. From the preface of the completed work written by the able author, the following quotation is made, viz :

"This Hall collection may well be considered the standard reference collection for all workers in North American Palæozoic palæontology. Most of the 'figured specimens' in the series are those which were identified, redescribed, illustrated and published by Prof. Hall in the early volumes of the Palæontology of

New York, and therefore have almost the dignity and value of types.

Of the specimens described and illustrated in the quarto volumes of the Palæontology of New York, the Museum possesses two-thirds of those in volume i, covering the Cambrian and Lower Silurian systems; nearly eight-tenths of those in volume ii, extending from the Medina to the Onondaga stages, inclusive; three-fourths of those in volume iii, which treats of the Lower Helderberg and Oriskany Groups; more than one-third of those in volume iv, which describes the Brachiopoda of the Devonian system from the Upper Helderberg to the Chemung; about thirty per cent of the specimens illustrated in volume v, part i, which is devoted to the Lamellibranchiata of the Upper Helderberg (or Corniferous), Hamilton and Chemung Groups; and a nearly equal proportion of the Cephalopoda and Gastropoda illustrated in volume v, part ii. The collection, however, contains only about 74 of the specimens of Bryozoa given in volume vi, and about 70 of the Crustacea illustrated in volume vii of the Palæontology of New York. Much of the material for volume viii, on the Brachiopoda, was prepared for publication prior to 1876, hence a large proportion of the specimens used for illustrations are to be found in the American Museum, especially of those used for the plates bearing the name of R. P. Whitfield.

There are in this Department of the Museum 8,345 type and figured specimens, representing 2,721 species and 190 varieties."

2. *The Laccoliths of the Black Hills*; by T. A. JAGGAR, Jr. with chapter on *Experiments illustrating Intrusion and Erosion*; by ERNEST HOWE. 21st Ann. Rep. U. S. Geological Survey, Part III, pp. 163-303. Washington, 1901.—This paper presents the results of a careful and detailed study and mapping of the igneous intrusions in the northern Black Hills in South Dakota and Wyoming. A large number of laccolithic bodies are described, aided by maps and cross sections, and their geologic relations and mode of occurrence deduced. The subject is presented chiefly from the structural and dynamical side. From the facts thus presented the author derives a number of interesting and important conclusions regarding the formation of igneous masses of laccolithic character in sedimentary strata. He points out especially the importance of orogenic disturbances and deformations in promoting their origin. He also gives interesting studies showing the results of the gradual dissection by erosion of domed uplifts produced in this way. The whole constitutes a notable contribution to the literature on igneous intrusions.

In the chapter by Dr. Howe are given the results of experiments in which molten wax was forced upward from below into a mass of previously prepared sediments. The uplifts thus made simulate in all important particulars those seen in laccoliths, as shown in the photographs of the dissections. The erosion produced by a rain of fine spray shows results much like those seen in nature. The chapter as a whole is an interesting addition to

the experimental mechanics of geology, and the facts tend largely to confirm previous views regarding the origin of laccoliths, especially in respect to the importance of viscosity of the magma as a factor in their production.

L. V. P.

3. *Analcite in Igneous Rocks*.—In a recent paper on a monchiquite from Mount Girnar Junagarh, Kathiawar (Quar. Jour. Geol. Soc., vol. lvii, p. 38, 1901), Dr. J. W. EVANS shows that the isotropic base is composed of analcite. This is proved by its chemical composition, specific gravity, optical properties and reaction with acids. The author remarks that it might have all these characters and still be a structureless glass. This is true, but only as a possibility so remote that it may be said to have little practical importance. When we consider that a glass has no definite composition, and that to satisfy the properties demanded by analcite there must be five numerical factors (including sp. gr.) which must be arranged in definite ratios, the great improbability of such an agreement becomes at once evident. Adding to this agreement the capability of gelatinization, possessed by basic glasses, but so far as known not by silico-aluminous ones, and still more the improbability of glass forming under such physical conditions as have influenced the crystallization of these dikes and the probability becomes still more remote.

But Dr. Evans has called attention to still another means of discrimination, the cubic cleavage of analcite. This is quite marked in the rock from India and is clearly shown in the microphotograph of the thin section. The suggestion of the use of this character, overlooked by previous investigators, is a valuable one where it can be applied. I have studied a section from the original type of Rosenbusch, from the Santa Cruz Railway near Rio Janeiro, and under high powers the cubic cleavage of the analcite is very clear and evident, thus confirming its crystalline nature. A study of similar rocks from other localities shows in some cases this cleavage in the isotropic base, in other cases it is apparently wanting. Where the areas of the base are comparatively large it usually appears, where the amount of base is very small and the interspaces minute it cannot be detected. Often, however, in these cases the base by a more reflected light is seen to be of fine granular or even fibrous character, thus indicating crystallization of some sort.

L. V. P.

4. *Researches on Cellulose, 1895-1900*; by C. F. CROSS and E. J. BEVAN. London, 1901 (Longmans, Green & Co.).—A previous volume by these authors, in 1895, gave a comprehensive view of the subject of cellulose, up to that date. It contained, also, a full account of the interesting discovery made by them, that cellulose treated with caustic alkali dissolves in carbon disulphide, and can be recovered from this solution in a more or less pure state. The authors also described to some extent a technical product obtained by them, on carrying out this process with certain modifications of detail. This product, now known

in the arts as *viscose*, has commanded a good deal of attention on account of its applications to certain phases of textile industry, notably the dressing of cloth and the manufacture of an imitation of silk. The present volume is a convenient appendix to the former one, and brings together not only the rejoinders which the authors have made to some criticisms of their earlier work, but also some of the more important contributions to the subject of paper-pulp and the deterioration of paper. Chemists and botanists will be interested especially in the pages devoted to the constitution of cellulose or, rather, of the celluloses. The industrial applications of cellulose, although briefly treated, are presented in a manner calculated to stimulate further research.

G. L. G.

5. *The Memorial Greenhouses at the Harvard Botanic Garden* have an attached laboratory for certain lines of study in vegetable physiology. The buildings were erected specially with the design of giving ample accommodation for four or five advanced students, and an additional greenhouse, close by, is devoted to the use of a large class of elementary students of plant physiology. In the memorial building, the present equipment affords facilities for carrying on investigations in regard to the relations of plants to electricity. Use is made of currents supplied by the city electric company, not only for constant lighting, but also for experiments in connection with soil. Through suitable reduction of the voltage, provision is made for many sorts of apparatus required in the study of the effects of different currents upon plants. A set of speed-reducers connected with the motor gives wheels of all desired rates for clinostat observations of movements in all planes.

At present, researches are in progress by Mr. Plowman in regard to the behavior of plants in the magnetic field, and also when under the influence of weak currents of electricity. Mr. Jenkins is now working on the condition of roots in soil through which are passing currents strong enough to cause electrolytic action on gas- and water-pipes; Mr. Stickney is continuing studies in regard to the effects of certain poisons on plants, and Mr. Poole has in hand experiments of a novel character relative to the activities of plants in a saturated atmosphere. Mr. Miller is now closing his series of experiments in regard to the effects of a top layer of very fine soil upon the soil beneath. It has been claimed that such a layer of fine soil conserves the water in the soil under it, to such an extent as to warrant the employment of pulverizers in arid or semi-arid districts. The loss of moisture is unquestionably checked by this so-called "blanket" of dust, but Mr. Miller shows that the cover of dust must be practically pulverulent throughout in order to make it effective. The "caking" of the dust-cover, even if very slight, after a few drops of water have fallen on it, reduces greatly the efficiency of the protection.

G. L. G.



## OBITUARY.

CLARENCE KING, the distinguished geologist, explorer and author, died at Phoenix, Arizona on December 24, in the sixtieth year of his age. A notice is deferred till the following number.

The following tribute to Mr. King was unanimously adopted at a meeting of the members of the U. S. Geological Survey held at Washington on December 28th.

"It is with profound sorrow that we learn of the death of Clarence King, the first Director and, in a sense, the founder of the Geological Survey. In him we have lost not only a great scientific leader but a genial and accomplished gentleman whose personal qualities endeared him to all who knew him, and whose many acts of loving kindness have left a wide circle of friends in all walks of life to mourn his untimely death.

As organizer and, during ten years, Chief of the United States Geological Exploration of the Fortieth Parallel, he set higher standards for geological work in the United States and laid the foundations of a systematic survey of the country. He gave practical recognition to the fact that a good topographical map is the essential basis for accurate geological work.

As first Director of the present Geological Survey, he laid down the broad general lines upon which its work should be conducted and which, as followed by his able successors, have led to its present development. He established the principle that a Geological Survey of the United States should be distinguished among similar organizations by the prominence given to the direct application of scientific results to the development of its mineral wealth.

In that essential quality of an investigator—scientific imagination—no one surpassed King, and his colleagues have all profited by his suggestiveness. He was never content with the study of science as he found it, but always sought to raise the standard of geology as well as to apply known principles to the survey of the country.

King first introduced microscopical petrography into American geology and, as early as his Fortieth Parallel work, he foreshadowed the application of exact physics to questions of geological dynamics. Early in the history of the present Survey he established a physical laboratory. One result of this step was a paper on the Age of the Earth, which takes very high rank among modern scientific memoirs. Although in his last years circumstances rendered it necessary for him to devote most of his time to other occupations, he had by no means abandoned plans for geological investigation on a scale worthy of his reputation.

In Clarence King geological science in America will miss a pioneer and a leader; the Geological Survey loses its broad-minded founder and adviser, and its older members a beloved friend."

ALPHEUS HYATT, the eminent zoologist, died at Cambridge, Mass., January 15, 1902, in the sixty-fourth year of his age.

Outside of his many valuable publications in pure zoology, Professor Hyatt's chief reputation will rest mainly on his researches in the field of organic evolution. No other American has contributed so much toward the discovery of the laws of development and growth, and to an exposition of exact methods of research in evolutionary problems. The principles he enunciated constitute the foundation of a young and vigorous school of evolution, which is already making itself felt in the scientific world.

Alpheus Hyatt was born at Washington, D. C., April 15, 1838. He completed the Freshman year at Yale with the late O. C. Marsh, in the class of 1860; then, after traveling a year in Europe, he entered the Lawrence Scientific School at Harvard, and was graduated in 1862. He served during the civil war, attaining the rank of Captain. Later, he renewed his studies with Louis Agassiz, and has since been intimately identified with all the scientific interests centering about Boston. His official connections were with the Essex Institute, the Peabody Academy of Science, the laboratory of natural history at Annisquam, the Massachusetts Institute of Technology, Boston University, Teachers' School of Science, the Museum of Comparative Zoology, the United States Geological Survey, and the Boston Society of Natural History, of which he was the curator since 1881. In 1869, he was elected a fellow of the American Academy of Arts and Sciences, and in 1875 a member of the National Academy of Sciences. His name also appears in the roll of fellows and members of many other societies at home and abroad.

Among his principal publications should be mentioned: Observations on Polyzoa (1866); Fossil Cephalopods of the Museum of Comparative Zoology (1872); Revision of North American Poriferæ (1874-77); Genesis of Tertiary Species of Planorbis at Steinheim (1880); Genera of Fossil Cephalopoda (1883); Larval Theory of the Origin of Cellular Tissue (1884); Genesis of the Arietidæ (1889); Phylogeny of an Acquired Characteristic (1895); Guides for Science Teaching; and numerous essays on the stages of growth and decline in animals, and on various laws and problems of evolution.

C. E. B.

THOMAS MEEHAN, the well known botanist and nurseryman, died on November 19 in his seventy-sixth year. An Englishman by birth, he came to Philadelphia in 1848, and was soon successfully established in the nursery business. He published many horticultural and botanical papers and also the two volumes entitled "Handbook of Ornamental Trees" and "The Native Flowers and Ferns of the United States" (1878-79).

## AMERICAN JOURNAL OF SCIENCE

[FOURTH SERIES.]

---

 ART. XIV.—*The Ventral Integument of Trilobites*; by C. E. BEECHER. (With Plates II-V.)

IN previous papers by the writer, on the structure and appendages of *Triarthrus*,<sup>1-5</sup> no attempt has been made to describe or illustrate the character of the ventral integument, especially in the sternal or axial region. The specimens hitherto described were prepared to show details of the appendages, and though portions of the ventral membrane were exposed in many individuals, the subject was not considered of sufficient moment to warrant a distinct study, particularly as no characters were observed in the cuticle that had not been previously seen in more or less perfection by Walcott<sup>6</sup> in the genera *Ceraurus* and *Calymmene*. A recent discovery by Jaekel,<sup>8</sup> however, necessitates the separate consideration of this structure. This necessity arises from the fact that a positive addition to the knowledge of the trilobite anatomy may be deduced, although, as will be shown, Jaekel was apparently entirely misled in his interpretation of the nature of his discovery.

In the paper under discussion, Jaekel<sup>8</sup> states that the occasion for his publication arose from the finding of a specimen of *Ptychoparia striata*, from the Cambrian of Bohemia, in which some structures were preserved in the axis of the six anterior segments of the thorax. These, he asserts, are the proximal joints of the legs.

The specimen was preserved as a cast in a rather coarse-grained sandstone, and is exposed from the dorsal side. From certain surface indications of lines in the cast, Jaekel was led to follow these into the rock filling the axis, and succeeded in

finding a central groove, with two oblique grooves on each side. These he considered as representing the cavities left by the removal of the test from the basal joints of the legs, which thus must have been attached along the median line of the sternum. The supposed joints of the legs were filled with rock, and his attempts to separate them from the matrix resulted in failure.

In the oral region, there were still more indefinite and obscure evidences of cavities left by the removal of some ventral testaceous structure.

These meager remains in the rachis of the thoracic and oral regions have furnished data for what must be considered as the most remarkable and erroneous reconstruction of the trilobite appendages and anatomy that has appeared since the time of Burmeister,<sup>7</sup> in 1843. The latter, in the absence of any material, confessedly based his opinions of the ventral anatomy wholly upon theoretical considerations. Not only has Jaekel to a large degree set aside the evidence presented by many scores of specimens of *Triarthrus*, as described by the writer, in which each detail of structure can be verified indefinitely, but has also overlooked that afforded by the material illustrated by Walcott,<sup>10</sup> Billings,<sup>6</sup> Mickleborough,<sup>9</sup> and Woodward.<sup>12</sup> Moreover, this single specimen of *Ptychoparia* has led its describer to reconsider on a false premise the entire question of the anatomy, ontogeny, phylogeny, and affinities of the trilobite.

It is the purpose of the present article to show that numerous individuals of *Triarthrus*, as well as some material representing other genera, preserve evidence of what seems to be the same structures as those described by Jaekel in *Ptychoparia*, and also present indisputable testimony as to their correct nature. It will be demonstrated that they do not belong in any way to the appendicular system of the trilobites, but are really the buttresses and apodemes of the ventral body integument.

The marvelous state of preservation of many of the specimens of *Triarthrus*, whose appendages have been studied by the writer, affords very satisfactory indications, not only of the presence of a ventral integument, but also of some of its detailed characters. Jaekel states that in his opinion the unfavorable ("ungünstigen") preservation of *Triarthrus* has obscured the proximal structure of the legs, so that what he calls the three basal joints are equivalent to the single unjointed gnathobase of the coxopodite, as described by the writer. Inasmuch as Jaekel has never seen the original specimens described, his statement is practically without foundation. It may also be added that the types and best-preserved individuals have been

retained in the collections of the Yale University Museum. The photographic illustrations accompanying this article, it is believed, will refute his statement, and the specimens themselves would serve the same purpose more completely, since from the black nature of the rock and the nonactinic character of the fossils the photographs feebly represent the delicate structures actually preserved, which are clearly visible to the eye.

The ventral membrane of *Triarthrus*, as well as of other trilobites where it has been observed, is of extreme tenuity and only under the most favorable conditions has it been preserved. The membrane itself was a thin, uncalcified, chitinous, flexible pellicle, and thus was in strong contrast with the much thicker and calcified dorsal test.

In the preparation of a specimen to show the appendages from the ventral side, very little of the ventral membrane is commonly exposed, owing to the crowded arrangement of the legs, but when the appendages are removed it is possible to view the entire ventral integument. This process has been carried out in a considerable number of specimens, and some of the more evident characters are herewith described.

The membrane under each pleuron (pleurotergite, Jaekel), or the pleurosternite, as it may be termed,\* was smooth and extremely thin, and in the fossils it is invariably concave. This was probably the condition during life, to allow space for the biramous legs and for their infolding during enrollment. It should be noted, however, that the dorsal and ventral integuments in the fossils are generally very close together throughout, leaving but a small cavity for the soft parts of the animal. The space inside has doubtless been considerably reduced by partial collapse from the decay of the soft parts of the animal and also by the pressure of the sediments. The size of the body cavity is unquestionably more correctly shown in the specimens described by Walcott<sup>10</sup> and Mickleborough,<sup>9</sup> from the Trenton limestone and Cincinnati shales, respectively, where they have apparently suffered less compression.

Walcott showed that the membrane in *Calymmene* and *Ceraurus* was strengthened in each segment by a transverse arch, to which the appendages were attached at the sides of the axis. These arches were connected by a thinner membrane

\* Jaekel has suggested the name mesotergite to supplant the terms axis or tergum, and pleurotergite in place of pleuron or epimerum, as applied to the trilobites. This seems a useful terminology since the older terms are often loosely used and have somewhat different meanings in other groups. Applying this system of nomenclature to the ventral integument, the writer would propose the terms *mesosternite* for the membrane beneath each mesotergite, and *pleurosternite* for the membrane beneath each pleurotergite. The interarticular membranes are not included.

(the interarticular membrane), and were aptly compared to the arches in the ventral integument of many of the decapods. Similar features are present in *Triarthrus*, as illustrated in Plate IV, figure 1, and Plate V, figures 2-4, where it is seen that the interarticular membrane (Plate V, fig. 4) in a normally extended individual is somewhat less than half the length of the arches. The chitinous integument of the arches, or mesosternites, as they may conveniently be called, is thickened along the borders, and appears to be slightly incurved on the posterior edge. The arches are further strengthened by a series of median and oblique longitudinal ridges, or buttresses, which are generally progressively more developed in passing anteriorly from the pygidium along the thorax to the neck segment of the cephalon.

The ventral arch of each segment has the following arrangement of these ridges: There is first a median ridge generally extending from the posterior border entirely across the plate, but sometimes becoming obsolescent near the anterior border. Then, on each side, there is an oblique ridge making an angle of about sixty degrees with the posterior edge and extending inward, but not meeting, the median ridge, thus enclosing a subtriangular space with the anterior apex truncated. Outside of these ridges but still within the axial region there is often a second pair of somewhat more oblique ridges, enclosing rhombic areas.

The ridges are clearly produced by a thickening of the ventral integument, and can be seen when viewed from the dorsal side of a specimen in which the dorsal test and filling of the body cavity have been removed. *They are thus partly or wholly of the nature of apodemes, or plates of chitin, which pass inward from the mesosternites and divide as well as support internal organs, and they are not, therefore, in any sense the proximal joints of legs.* Besides serving in this manner they were doubtless efficient in giving the necessary firmness to the ventral arches for the attachment of muscles.

Were these observations confined wholly to the specimens of *Triarthrus*, there might still be some chance of error, although it is believed that the evidence presented by this genus alone is quite sufficient. Additional data, however, will now be given, regarding other genera and families of trilobites, described independently by other authors, and with no intention of representing the detailed characters of the ventral arches. In the search for trilobite appendages by various investigators, the ventral membrane has naturally been of secondary consideration, and in the case of Jaekel's work was of no consideration whatever.

The earliest studies and illustrations of trilobites giving some evidence of the nature of the ventral membrane are those by Walcott on the genera *Calymmene* and *Ceraurus*. The limitations of the ventral body walls of the animal were clearly shown by a marked change in the color of the rock between the white calcite filling the body cavity and the dark limestone matrix. In figure 7, Plate V, after Walcott,<sup>10</sup> showing a transverse section of *Calymmene* in the thoracic region, it is seen that the membrane in the axis, or the mesosternite, is marked by four distinct lobes representing cross sections of longitudinal folds, and also that the legs are clearly attached at the sides. These folds can in no way be construed as proximal joints of legs. The gnathobases in *Calymmene* are given in sections, in figure 3, Plate III, of Walcott's paper, and of *Ceraurus*, in figure 2 of the same plate. During a recent visit at the Museum of Comparative Zoology, the writer examined many of the sections made by Walcott during his long and successful search for trilobite appendages. The structure shown in the figure here given (Plate V, fig. 7) was verified, and other sections were observed in which the folds were more pronounced, sometimes extending as thin laminae into the body cavity, thus having the character of a normal apodeme.

The second instance to be noted, where the ventral membrane has previously been illustrated, is a specimen of *Asaphus megistus* Locke, first described by Mickleborough<sup>9</sup> from the Cincinnati shales in Ohio. In his figure, an outline of which is here reproduced (Plate V, fig. 5), there are shown a number of discontinuous longitudinal lines in the axis of the posterior thoracic region. Mr. Charles Schuchert has kindly examined the original specimen, now preserved in the United States National Museum, and writes that the longitudinal wrinkles in the axis are organic and not due to accident nor to tool marks. In the best-preserved series "there are five longitudinal ridges, a central one with two on each side." They appear in cross section as shown in the sketch furnished by Mr. Schuchert (Plate V, fig. 6).

The correct interpretation of this specimen, as illustrated by Mickleborough<sup>9</sup> and Walcott,<sup>11</sup> is: That the club-shaped bodies lying within the axis are the gnathobases attached at the sides of the axis; the curved members extending outward from the gnathobases are the endopodites; the longitudinal ridges in the ventral membrane between the inner ends of the gnathobases are the buttresses and apodemes of the mesosternites; the slender oblique rod-like bodies shown in the right pleural region in Walcott's figure are portions of the fringes of the exopodites.

The last specimen to be noted in this connection is the individual of *Ptychoparia striata*, already mentioned as described by Jaekel.<sup>8</sup> A reduced photographic reproduction of his figure (Plate V, fig. 1) is presented here for comparison with similar structures, as described in *Triarthrus*, *Calymmene*, *Ceraurus*, and *Asaphus*. From the data here deduced, it would seem obvious that the specimen shows the imprint of the ventral integument in the axial region, the dorsal test and filling of the body cavity having been removed. As in *Triarthrus*, the body has suffered collapse, thus bringing the dorsal and ventral walls quite near together. In the middle of each of the five or six anterior ventral arches is a groove left by the solution of the chitinous median apodeme, or buttress. On either side are two oblique grooves limiting two subangular areas, and outside of these are two other oblique grooves marking off subrhombic areas. The grooves in each case represent the cavities left by the removal of the chitinous thickenings of the membrane of the trilobite. Jaekel's attempt to remove the rock filling these areas naturally was ineffectual, since the latter represent the actual impression of the ventral integument. Were they simply the fillings of the hollow leg joints, as he claims, they should be readily detached from the matrix.

The foregoing descriptions and discussions of the character of the ventral integument in trilobites would have little or no scientific value, and would be about as useless as a minute analysis of the nodes and tubercles on the glabella of a *Phacops*, were it not for the fact that from them it is possible to reach some conclusions regarding the musculature of trilobites, and thus add something to the knowledge of their internal organization.

In the abdomen of a normal crustacean, as is well known, there is a pair of longitudinal dorsal muscles, the *extensors* of the abdomen. They divide into bundles, which are attached on the inner surfaces of the tergites of the somites. Likewise, on the ventral side, there is a larger pair of longitudinal muscles, the *flexors* of the abdomen, from which strands are given off and attached to each sternal arch. The strands from one somite unite with the main bundles within the cavity of the next anterior somite. In a diagrammatic form, this disposition of the ventral muscles is represented in the accompanying figure (fig. 1).

Now, since in crustacea it is of very common occurrence to have chitinous extensions of the integument within the body cavity either to divide or to support organs, as well as for the attachment of muscles, it seems a necessary conclusion to refer the thickenings and buttresses on the ventral membrane of trilobites to the same class of structures, which are usually



termed apodemes. With this interpretation, the median longitudinal ridge on the mesosternite of a trilobite would indicate the line of division between the two main ventral bundles. The first pair of oblique ridges on each side would delimit the main bundles and side strands, and show that these strands joined the main bundles obliquely within the cavity of the next anterior somite, as in ordinary crustacea. This accounts for the anterior truncation of the triangular area between the median and lateral ridges in the trilobite.

The nature of the outside pair of oblique ridges is not so plain. They may serve to divide the side ventral strands of the flexors from the bundle of muscles running from the proximal joints of the legs to the dorsal test, or they may simply mark the outside of the lateral strands.

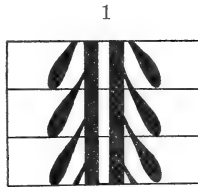

FIGURE 1.—Diagram of the axial portions of three segments; showing the ventral abdominal muscles, the flexors, represented as two heavy longitudinal lines, together with the lateral strands attached to the sternal plate in each somite and continuing obliquely forward to their union with the main bundle in the cavity of the next anterior somite.

The apodemes in general seem more strongly developed anteriorly in the thorax. Possibly, this condition may be explained on the basis that the ventral pair of the great flexor muscles received new strands at each segment from behind forward, so that near the cephalon they became large bundles for which progressively larger apodemes were formed.

It may be remarked, in conclusion, that a similar though apparently much simpler apodemal arrangement would be developed if the musculature of the trilobites agreed with that of the theoretical crustacean ancestor, or that existing in some Isopods, Amphipods, etc., in which there are no large longitudinal bundles, but motion between the somites is effected by strands running from one segment to the next anterior. If viewed in this manner, there would necessarily be two median and two lateral strands. The previous explanation seems to be more in accordance with the structures actually seen in the trilobites, which in general possessed the power of enrollment to a high degree, and would be expected to have had a well-developed and efficient system of ventral muscles.

*Summary.*—The ventral integument in trilobites is a thin uncalcified membrane, which may be divided into pleurosternites and mesosternites, corresponding to the mesotergites and pleurotergites of the dorsal test, and like them connected segmentally by an interarticular membrane.

The mesosternites are usually marked by five longitudinal ridges, or buttresses, representing thickenings of the membrane, which may be homologized with apodemal structures in other crustacea, and not with the appendicular system.

These buttresses, or apodemes, include a single median one for each mesosternite, with two others on each side extending forward and obliquely inward, and enclosing subtriangular or rhombic spaces.

The presence and disposition of these buttresses apparently afford information regarding the ventral musculature of the trilobites. A pair of flexors is indicated, together with the lateral strands attached to each mesosternite and extending forward and inward to their union with the main bundles within the cavity of the next anterior somite.

Yale University Museum, New Haven, Conn., January 24th, 1902.

#### *References.*

1. Beecher, C. E.—On the thoracic legs of Trilobites. This Journal (3), vol. xlvi, 1893.
2. ———.—On the mode of occurrence, and the structure and development of *Triarthrus Becki*. American Geologist, vol. xiii, 1894.
3. ———.—The appendages of the pygidium of *Triarthrus*. This Journal (3), vol. xlvii, 1894.
4. ———.—Further observations on the ventral structure of *Triarthrus*. American Geologist, vol. xv, 1895.
5. ———.—The morphology of *Triarthrus*. This Journal (4), vol. i, 1896; Geological Magazine, dec. iv, vol. iii, 1896.
6. Billings, E.—Notes on some specimens of Lower Silurian Trilobites. Quarterly Journal of the Geol. Soc., London, vol. xxvi, 1870.
7. Burmeister, Hermann.—Die Organisation der Trilobiten, etc. 1843.
8. Jaekel, Otto.—Beiträge zur Beurtheilung der Trilobiten. Theil I. Zeitschr. der Deutschen Geolog. Gesellschaft, Bd. liii, Heft 1, 1901.
9. Mickleborough, J.—Locomotory Appendages of Trilobites. Jour. Cinti. Soc. Nat. Hist., vol. vi, No. 3, 1883.
10. Walcott, C. D.—The Trilobite: New and Old Evidence relating to its Organization. Bulletin Mus. Comp. Zool., vol. viii, No. 10, 1881.
11. ———.—Appendages of the Trilobite. Science, vol. iii, No. 57, 1884.
12. Woodward, Henry.—Note on the Palpus and other Appendages of *Asaphus*, from the Trenton Limestone, in the British Museum. Quarterly Journal of the Geol. Soc., London, vol. xxvi, 1870.

EXPLANATION OF PLATES.

PLATE II.

*Triarthrus Becki* Green.

- FIGURE 1.—A specimen viewed from the dorsal side; showing the extent of the antennules and the limbs on the right side. Enlarged about three diameters.
- FIGURE 2.—The ventral side of a pygidium; showing at the left of the median line the form and disposition of the exopodites and endopodites. The conical ends of the joints of the endopodites are provided with bundles of stiff hairs. Owing to the concavity of the specimen, it is impossible to show it all in proper focus. Enlarged ten diameters.
- FIGURE 3.—The posterior portion of an individual viewed from the ventral side; showing the distal ends of the exopodites, with their setæ and long fringes. Enlarged nearly ten diameters.
- FIGURE 4.—Dorsal view of an individual; showing the nine pairs of anterior thoracic limbs fully extended on the left side. The jointed endopodites and fringed exopodites may be clearly differentiated. Enlarged about three diameters.
- FIGURE 5.—A still further enlargement of some of the limbs of the preceding specimen; showing in more detail the distinctive characters and arrangement of the exopodites and endopodites. Enlarged about ten diameters.

Utica slate, Ordovician, near Rome, New York.

This plate of illustrations, although very inadequately representing the actual objects, is introduced mainly to show the exquisite character of preservation of the specimens of *Triarthrus*.

PLATE III.

*Triarthrus Becki* Green.

- FIGURE 1.—Ventral view of an individual; showing the basal joints of the antennules, the biramous appendages, and the series of gnathobases. The appendages within the cephalon indicate their biramous structure like those over the thorax. They are therefore not simple as restored by Jaekel. The anal opening is shown near the extremity of the pygidium, but is obscure on account of not being in focus. Enlarged three and one-half diameters. (Original of figure 1, Plate IV, vol. xv, American Geologist, 1895.)

Utica slate, Ordovician, near Rome, New York.

PLATE IV.

*Triarthrus Becki* Green.

- FIGURE 1.—The ventral side of an individual prepared to show the character of the endopodites of the entire thoracic series. The gnathobases are distinctly seen extending obliquely inward from the sides of the axis; then follow, within the pleurosternal region, the subtriangular joints of the endopodites with more slender distal joints. The origin and course of the antennules at the sides of the hypostoma are also shown. In the middle of the axis of the mid-thoracic region, the ventral membrane is exposed, and the transverse limitations of the sternal arches and interarticular membrane may be observed. The arches show the buttresses or ridges of apodemal nature, as described in the text. Enlarged three and one-half diameters.

Utica slate, Ordovician, near Rome, New York.

PLATE V.

- FIGURE 1.—*Ptychoparia striata* Emmer. Dorsal view of the anterior portion of a specimen preserved as a cast in sandstone, and enlarged about two diameters. In the glabellar and anterior thoracic region, the filling of the body cavity has been removed from the axial region, thus exposing the imprint of the hypostoma and ventral integument with its buttresses, or apodemal structures. Reduced from the original figure published by Jaekel.  
Cambrian, Bohemia.
- FIGURE 2.—A specimen of *Triarthrus Becki* Green; viewed from the ventral side. The appendages have been removed and the ventral membrane exposed. In the glabellar region are seen the hypostoma and just below it the semicircular convex metastoma with side lappets. Below, in the axial region, the buttresses and thickenings of the sternal arches are clearly marked, as described in the text. Enlarged about nine diameters.
- FIGURE 3.—The same specimen enlarged only a little more than three diameters. The illumination is from the side opposite to that in the preceding figure.
- FIGURE 4.—*Triarthrus Becki* Green. The ventral side of the middle thoracic region of the specimen illustrated on Plate IV; showing the ends of the pleurotergites on the outside, with the joints of the endopodites within the pleural regions, and the gnathobases extending obliquely inward in the axis. The sternal arches with their longitudinal ridges and the interarticular membranes are represented. Enlarged four and one-fourth diameters. The extensions of the limbs beyond the carapace are omitted.
- FIGURE 5.—*Asaphus megistus* Locke. A reduced outline of the figure published by Mickleborough;<sup>9</sup> showing the endopodites in the pleural areas, with the gnathobases extending obliquely inward from the sides of the axis, and in the posterior thoracic median line the ridges or folds of the ventral integument. One-half natural size.
- FIGURE 6.—An enlarged profile of the mesosternal ridges of the preceding; from a sketch furnished the writer by Schuchert. The lower represents the ventral aspect.
- FIGURE 7.—Transverse section through the thoracic region of *Calymmene senaria* Conrad; after Walcott; to show the folds of the ventral integument and the basal joints of the legs, with their points of attachment at the sides of the sternal arch. Enlarged three diameters.

1

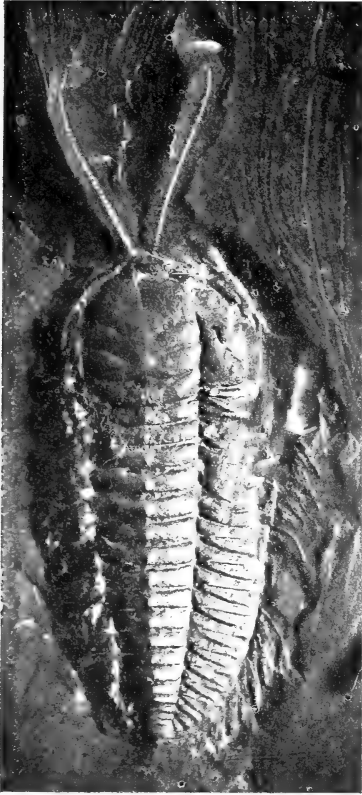

2



3

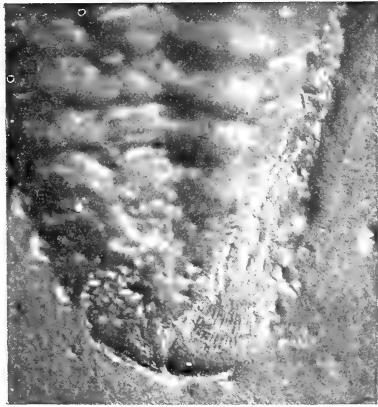

4

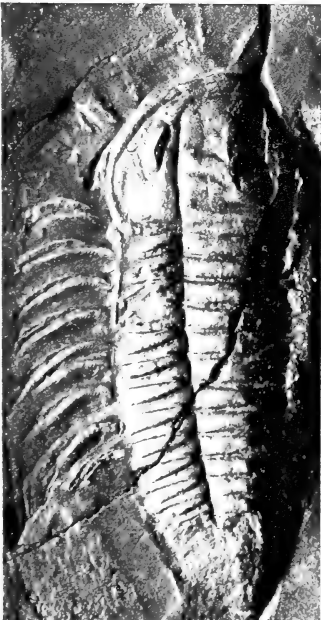

5



Appendages of Triarthrus.



1

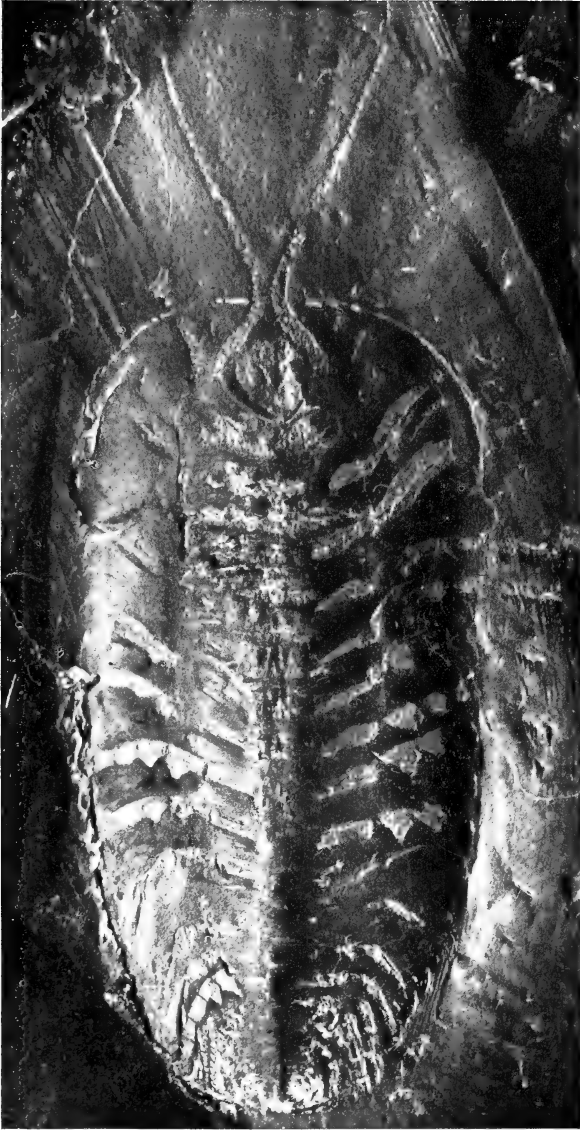

Ventral side of *Triarthrus*.





1



2



4

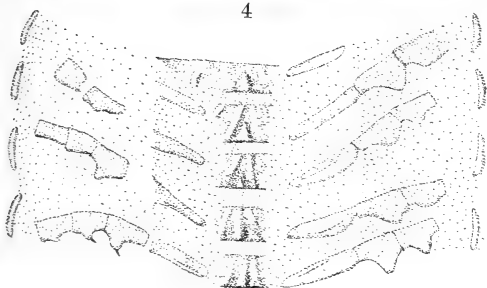

5

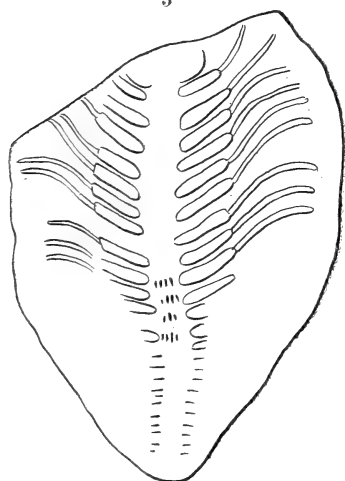

3



6

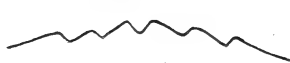

7



Ventral integument of Trilobites.



ART. XV.—*Igneous Rocks from Eastern Siberia*; by  
HENRY S. WASHINGTON.

THE rocks which form the subject of the present paper were collected near East Cape in Siberia, during the summer of 1900, by Mr. A. G. Maddren, who, through the kind offices of Dr. L. B. Bishop of New Haven, generously sent them to me for investigation. It is a pleasure to record my thanks to both these gentlemen for the interesting material thus made available for study, and which has added another to the growing list of localities of foyaitic and related alkalic rocks.

*East Cape.*

*Foyaitic.*—The most interesting rock of the suite is one—the only one—from a locality given as “South of Whalen or Itschan, East Cape.” As the locality is little known, it may be of interest to quote from a letter received from Mr. Maddren.

“The region in the vicinity of East Cape is a rugged one. Mountainous ridges of crystalline rocks come out to the seashore and form bold, rugged cliffs five to eight hundred feet in height. Between these ridges are low swampy stretches of tundra, with pebble beaches. The tops of the ridges are almost barren of vegetation, and the surface is overstrewn with frost-broken blocks of the country rock of all sizes and shapes.”

The rock is quite coarse in grain, composed very largely of an alkalic feldspar, with less nephelitic of a slightly brownish color. Scattered through these are small (up to 5<sup>mm</sup>), stout prisms of hornblende, the arrangement of which suggests a schistose structure. Minute specks of purple fluorite are also visible with a lens.

Under the microscope the feldspar is seen to be distinctly tabular, in stout individuals, generally twinned according to the Carlsbad law. They show little, if any, micropertitic development, or the moirée appearance so characteristic of soda-rich orthoclase, and it may be inferred that the feldspar is nearly pure orthoclase. The nephelitic occurs in stout individuals, xenomorphic toward the feldspar tables.

Interstitial between these feldspars and nephelitic areas, but varying much in relative amount in different parts of the sections, is a finely granular, colorless substance, of low refractive index, the irregular grains, between crossed nicols, being either isotropic or showing yellow or orange colors of the second order, and optically positive. This mineral cannot be cancri-

nite, as was thought at first, since this is optically negative, and the small amount of  $\text{CO}_2$  shown by the analysis corresponds to only 0.8 per cent of this mineral. As the analysis also shows an excess of alumina, the granular material must be regarded as hydronephelite, especially as the appearance of the aggregate agrees with the description by Diller of the hydronephelite of Litchfield, Maine.\*

The hornblende, which is seen only rarely in the sections, is of a dark olive-green, with very intense pleochroism. There is also present, in less amount, a highly pleochroic, yellowish-green biotite, in stout ragged individuals, which resembles that of the Maine Litchfieldite described by Bayley.†

The small grains of fluorite are seen here and there in the sections, the purple color being often intense and again very faint. They are usually xenomorphic toward crystal faces of the feldspars, almost never as inclusions in the latter. Small zircons are fairly abundant, for such an accessory constituent, and a few titanites were seen. One of these last includes a minute, colorless, isotropic, well-shaped octahedron, of high refractive index, the nature of which could not be ascertained.

	I.	II.	III.	Ia.
$\text{SiO}_2$ .....	55.38	53.56	55.87	.923
$\text{Al}_2\text{O}_3$ .....	23.74	24.43	21.82	.233
$\text{Fe}_2\text{O}_3$ .....	0.63	2.19	2.34	.004
$\text{FeO}$ .....	1.26	1.22	1.10	.018
$\text{MgO}$ .....	0.81	0.31	0.48	.020
$\text{CaO}$ .....	0.67	1.24	3.07	.012
$\text{Na}_2\text{O}$ .....	5.29	6.48	4.81	.085
$\text{K}_2\text{O}$ .....	10.05	9.50	10.49	.107
$\text{H}_2\text{O}$ 110°+ .....	1.12	0.93	0.34	
$\text{H}_2\text{O}$ 110°- .....	0.38	----	----	
$\text{CO}_2$ .....	0.05	----	----	
$\text{TiO}_2$ .....	trace	----	----	
$\text{ZrO}_2$ .....	0.06	----	----	
$\text{P}_2\text{O}_5$ .....	0.06	----	----	
$\text{SO}_3$ .....	0.07	----	----	
$\text{Cl}$ .....	trace	----	----	
$\text{MnO}$ .....	trace	0.10	trace	
$\text{BaO}$ .....	----	----	----	
	99.57	99.96	100.32	

I. Foyaite, East Cape, Siberia. H. S. Washington anal.

II. Nephelite-syenite. Beemerville, N. J. L. G. Eakins anal. J. P. Iddings, Bull. 150, U. S. G. S., p. 211, 1898.

III. Leucite-phonolite. Lake Bracciano, Italy. H. S. Washington anal. Jour. Geol., vol. v, p. 49, 1897.

Ia. Molecular ratios of I.

\* J. S. Diller, this Journal, vol. xxxi, p. 266, 1886.

† W. S. Bayley, Bull. Geol. Soc. Amer., vol. iii, p. 236, 1892.

As the analysis showed an excess of alumina amounting to three per cent, it was thought possible that corundum might be present. The rock powder was accordingly digested with hydrofluoric acid and the residue examined. None of this mineral was found, however, the only substances unattacked being fluorite (whose identity was thus surely established), zircon, and a little of the hornblende.

An analysis of this rock yielded the results given in I, in the other columns being given analyses of rocks of similar chemical composition from other localities.

It is seen that this foyaite differs decidedly from nearly all others in the ratio of  $K_2O : Na_2O$ , this being close to unity, while in most of these rocks the soda predominates over potash to a very considerable extent, i. e. over 1.5 : 1. Indeed, the Beemerville rock, whose analysis is given above, is almost the only one of this group which approaches the Siberian in this respect.

The close similarity of the Italian leucite-phonolite, which differs only in slightly higher ferric oxide and lime, is very interesting, as another example to be added to the rapidly increasing list of rocks which, with similar chemical composition, differ radically mineralogically. The difference here is of course to be connected with the difference in geological occurrence; the Siberian and New Jersey rocks being intrusive, while the Italian is a surface flow. This tendency of leucite to form in extrusive rocks, while it is absent in intrusives of the same chemical composition, is a well known fact, but the present case is so well marked, and the similarity in chemical composition so great, that it seems worth while calling attention to it.

As to the mineral composition, if the attempt be made to calculate hydronephelite using the extra alumina as a basis, we get 24.1 per cent of this, 4.7 of albite and only 4.5 of nephelinite. This result does not correspond with the appearance in thin section, which calls for much more nephelinite. I have, therefore, calculated the rock as free from hydronephelite, which is an alteration product, the excess of alumina remaining uncombined. As has been pointed out elsewhere, this is a marked feature of other rocks belonging to the foyaite group\*. The result is given in Ia below, the composition of the Bracciano leucite-phonolite being given in IIIa.

The albite molecule in Ia is higher than the appearance of the orthoclase would indicate, as has been said above. It must be noted, however, that the hydronephelite present would reduce the amount of this considerably, as already seen.

\* H. S. Washington, Jour. Geol., vol. ix, p. 609, 1901.

	Ia.		IIIa.
Orthoclase .....	55.5	Orthoclase .....	47.4
Albite .....	12.5	Anorthite .....	9.0
Nephelite .....	20.3	Leucite .....	12.7
Extra alumina .....	3.0	Nephelite .....	18.0
Hornblende .....	5.2	Aegirite .....	6.9
Biotite .....	3.4	Augite .....	6.0
Zircon .....	0.1		
	100.0		100.0

The calculation of IIIa is somewhat arbitrary, and is based on the assumption that all the soda, above that required for aegirite, goes into the nephelite molecule. Presumably some of it is in the feldspar, as albite, which would increase the actual amount of leucite. Judging from the sections this is very probably the case, but the relative quantities in each are quite unknown, so the simplest assumption is made above. The anorthite undoubtedly exists in the fine-grained ground-mass, as its occurrence with orthoclase is a prominent feature of the Italian volcanic rocks. It is, however, difficult to detect it, and the augite may be somewhat more calciferous than the usual run of Italian augites, i. e. richer in the diopside molecule. Its amount as calculated is also increased by the assumption, made as usual, that all the  $\text{Fe}_2\text{O}_3$  is in acmite.

In both cases the quantities of dark minerals calculated correspond well with the appearance in thin section.

From a general point of view this occurrence of foyaites is of interest, since heretofore these rocks have been observed in Siberia, and indeed in Asia outside of India, only at the Ilmen Mountains (Miask) in the extreme western part, this occurrence being long known. Recently another locality has been described by Morozewitch,\* at Marinpol, Gov. Ekaterinoslav, in southern Russia, which may possibly, indeed probably, belong to the same general petrographical province.

The foyaites of Miask differ from that of East Cape in being in general richer in soda and poorer in potash, resembling in this respect the normal types. Analyses of them are given in the Guide to the Excursions of the VIIth International Congress (No. V, A. Karpinsky, p. 22, 1897), but as the analyses differ much among themselves, and are apparently not very reliable, it seems scarcely worth while to quote them.

The Marinpol nephelite-syenites are still higher in soda, one of them giving a ratio of  $\text{K}_2\text{O} : \text{Na}_2\text{O} = 1 : 24$ , though it is not stated in the reference whether this is molecular or not, nor is the analysis given. It may be mentioned that to this pre-

\* J. A. Morozewitch, Ref. in Neues Jahrb. Centralblatt, 1901, p. 727.

dominantly albite-nephelite rock Morozewitch gives the name of "marinpolite."

*Iskagan Bay.*

All the other Siberian rocks which were sent me by Mr. Maddren come from "the head of Iskagan Bay," a small inlet in lat.  $64^{\circ} 30' N.$  and long.  $172^{\circ} 40' W.$ , about 230<sup>km</sup> southwest of East Cape. The locality is shown on the accompanying map, copied from that of Alaska of the U. S. C. and G. Survey, for the drawing of which I am indebted to Mr. H. H. Robinson.

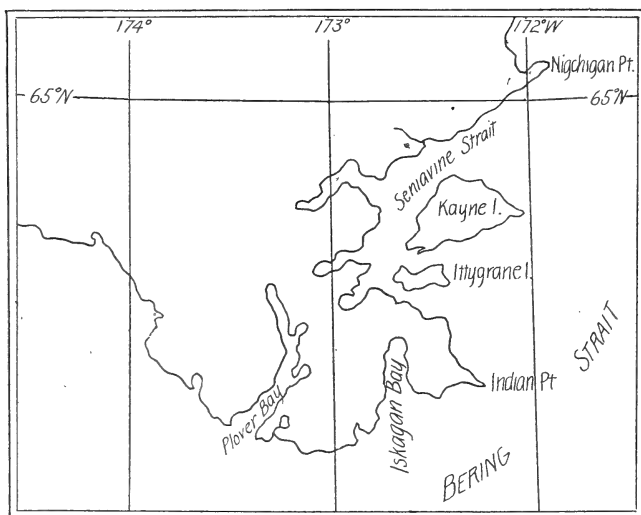

The character of the locality resembles the other, for Mr. Maddren says of it: "The Iskagan region is a very rugged and mountainous one, the shores of the bay rising up abruptly to snow-covered peaks." The specimens were collected from the talus slopes.

With one exception these rocks represent lava flows, or at least fine-grained porphyritic forms. It is, of course, impossible to say anything of their age, in the total absence of geological data, but from the partial devitrification of some of them and their general appearance, it is probable that they are not very recent.

*Comendite.*—The most interesting of these specimens is dense and compact, with a tendency to platy parting under the hammer, of a general flesh tint, sprinkled with dull greenish specks.

In thin section the rock is seen to be holocrystalline, composed almost entirely of irregular quartzes and orthoclase grains, the latter showing a tendency to automorphic development as stout prisms. A micropegmatitic intergrowth of the two is quite common. The feldspar is uniformly clouded with a brownish ferritic dust which gives rise to the megascopic color. Scattered through the mass are irregular shreds of a dark green aegirite-augite, with magnetite grains here and there. Neither zircon nor apatite was seen.

The crystallization of the  $\text{NaFeSi}_2\text{O}_6$  molecule as acmite rather than riebeckite, in such siliceous rocks, is of comparatively rare occurrence, as noted by Pirsson in describing the apparently analogous aegirite-granite-porphry of the Judith Mountains, Montana.\*

	I.	II.	III.	IV.	V.	VI.
$\text{SiO}_2$ .....	75.44	76.49	74.76	74.35	69.91	68.95
$\text{Al}_2\text{O}_3$ .....	11.98	11.89	11.60	8.73	13.76	14.00
$\text{Fe}_2\text{O}_3$ .....	0.88	1.16	3.50	5.84	2.17	2.12
$\text{FeO}$ .....	1.02	1.56	0.19	1.00	1.23	3.56
$\text{MgO}$ .....	0.10	trace	0.18	0.07	0.46	0.07
$\text{CaO}$ .....	0.33	0.14	0.07	0.45	1.39	0.23
$\text{Na}_2\text{O}$ .....	4.06	4.03	4.35	4.51	4.45	5.45
$\text{K}_2\text{O}$ .....	5.01	5.00	4.92	3.96	6.33	5.29
$\text{H}_2\text{O} +$ .....	0.68	0.38	0.64	0.25	0.12	0.05
$\text{H}_2\text{O} -$ .....	0.13	0.12	----	----	none	----
$\text{CO}_2$ .....	none	----	----	----	none	----
$\text{TiO}_2$ .....	trace	trace	trace	----	0.16	0.35
$\text{P}_2\text{O}_5$ .....	----	----	trace	----	0.11	----
$\text{MnO}$ .....	trace	trace	trace	0.22	trace	0.55
	99.63	100.77	100.21	99.38	100.09	100.62

I. Comendite. Iskagan Bay, Siberia. H. S. Washington anal.

II. Paisanite. Magnolia, Mass. H. S. Washington anal. Jour. Geol., vol. vii, p. 113, 1899.

III. Comendite. San Pietro, Sardinia. M. Dittrich anal. Rosenbusch. Elemente, p. 237, 1898.

IV. Grorudite. Varingskollen, Norway. Särnström anal. Brögger, Eruptivgesteine Christianiagesbietes, i, p. 48, 1894.

V. Aegirite-granite. Miask, Ural Mts. H. S. Washington anal.

VI. Arfvedsonite-grorudite. Frön, Norway. V. Schmelck anal. Brögger, op. cit., i, p. 139, 1894.

A chemical analysis of this Iskagan Bay rock is given in I above, with a few of the very many analyses which might have been chosen for comparison, in II, III and IV. It is

\* L. V. Pirsson, Eighteenth Ann. Rep. U. S. G. S., Pt. III, p. 559, 1898.



remarkably close to the paisanite of Magnolia, Mass., but, as the dark mineral here is riebeckite and not acmite, the Siberian rock cannot be called by this name,—an instance of the undue importance attaching to comparatively trivial characters in the present system of classification.

It also resembles the comendite of Sardinia, differing from this notably only in the absolute and relative amounts of the iron oxides. In all three, it will be noted, the ratios (molecular) of the two alkalis are very close to unity. From the most siliceous of Brögger's grorudites (IV) it differs not only in this respect, for in the Norwegian rock the soda greatly preponderates over the potash, but also in the much higher ferric oxide and lower alumina of the latter.

It is true that comendite is placed by Rosenbusch among the effusive rocks,\* as the equivalent of the hypabyssal paisanites, and that we have here no exact knowledge of the geological occurrence of the rock in question. Leaving this point aside, it would seem proper to call our rock a comendite, since the development of aegirite rather than paisanite is characteristic of this, and also because the Siberian specimen resembles a specimen of the Sardinian comendite kindly sent me by Signor Bertolio.

The mineral compositions of the Siberian and Sardinian comendites are given in Ia and IIIa below, and are seen to differ only in the relatively greater amount of aegirite as compared with augite in the latter. The two are not calculated to 100 per cent, and the difference from the totals of the analyses are accounted for by the H<sub>2</sub>O, etc., of these.

	Ia.		IIIa.
Quartz .....	31.9	Quartz .....	31.6
Orthoclase .....	30.0	Orthoclase .....	28.9
Albite .....	33.0	Albite .....	32.0
Acmite .....	0.9	Acmite .....	4.2
Augite .....	2.1	Hypersthene .....	0.5
Magnetite .....	0.9	Magnetite and hematite }	2.5

Recently aegirite-granites from Miask have been described by Pirsson† and Johnsen,‡ and, as it was thought that a chemical comparison of these with the comendite of Iskagan Bay might be of interest, an analysis was made of the Miask granite. The material for this was very generously given me by Prof. Pirsson, from the specimen already described by him, and I take this opportunity to tender my hearty thanks for his

\* Rosenbusch, *Elemente*. p. 268, 1901.

† L. V. Pirsson, *this Journal*, vol. ix, p. 199, 1901.

‡ A. Johnsen, *Neues Jahrb.*, 1901, II, p. 117.

kindness. The results are given in V above, with the analysis of a Norwegian grorudite in VI for comparison.

The Miask rock resembles that of Iskagan Bay, especially in the ratio of the alkalis, though these are here absolutely a little higher, as is to be expected, in view of the somewhat lower silica. Ferric oxide and lime are also present in somewhat greater amount, as is also alumina, but the two do not differ in any radical respect, except in the purely physical one of size of grain.

It is of interest to note that the relation of the Miask granite to the Frön grorudite is just about the same as was that between the Iskagan comendite and the Varingskollen grorudite, especially in the respective alkali ratios.

*Quartz-porphry.*—A rock which resembles the preceding is represented by a slightly worn beach pebble. It is very fine-grained and porphyritic, the groundmass composed of alkali-feldspar and quartz, with phenocrysts of the latter mineral visible. The general color is a light yellowish brown.

The microscope shows that it is composed very largely of a fine-grained, holocrystalline groundmass of alkali-feldspar and quartz in almost equal amounts, with very rare specks of magnetite. Phenocrysts of quartz and of a somewhat micropertithic feldspar, often in Carlsbad twins, are scattered through this. The groundmass is highly micropegmatitic, and closely resembles on a smaller scale the granite-porphry of the Castle Mountains.\*

It was not thought worth while to make a chemical analysis of this rock, but from the microscopical examination it is evident that it is considerably richer in silica than the preceding one, and that probably the potash and soda are present in about equal amounts (molecularly). It may, therefore, be held to belong to the same series as the comendite.

*Rhyolite.*—A magma of a distinctly less siliceous character is represented by a specimen of a very dense, dark gray rock, sprinkled with many small phenocrysts of white orthoclase and rare ones of quartz. In general appearance it much resembles the old rhyolites of Massachusetts and other eastern states.

Under the microscope it is seen to be far from fresh, composed very largely of alkalic feldspar in irregular grains and small phenocrysts, a few of which show twinning lamellae, with extinction angles which correspond to albite or an acid oligoclase. A few irregular quartz grains are scattered throughout, but the total amount of this mineral is very small. There are also shreds and specks of a black substance representing an original ferromagnesian mineral, but this can have been pres-

\* L. V. Pirsson, Bull. 139, U. S. G. S., p. 86, 1896.

ent only to a limited extent. There may have been glass in the rock originally, but, if so, devitrification has obscured it.

As no analysis was made of this rock its exact relationships cannot be discussed. It is evident, however, that it is rather more siliceous than the trachytes proper, and probably occupies in this respect a position intermediate between them and the rhyolites. The character of the feldspars indicates that it is decidedly alkalic, and with potash and soda probably in about equal amount.

*Obsidian.*—Three of the specimens are of flow rocks, highly glassy in character, but much devitrified, and offering little of interest.

One of these is purplish gray, with small yellowish spots and chains of what megascopically look like spherulites, but which the microscope shows to be at present, in great part, irregular quartz grains. A few are still true spherulites, and it is probable that they were all so originally. The groundmass, which was formerly glassy, is now thoroughly devitrified to a cryptocrystalline aggregate, apparently of feldspar with subordinate quartz. Ferromagnesian minerals are practically absent.

Another is a glassy breccia, much decomposed, of a general reddish brown color. Irregular fragments of a feldspathic rock, sometimes itself glassy, and often carrying aegirite, are cemented by a ferritic glass, which shows well marked flow structure.

The third is a dense black rock, almost wholly composed of devitrified and dusty glass, with fragments of quartz and of alkali-feldspar.

*Monzonite.*—The last rock to be described differs so much in a chemical and mineralogical way from all the others that it is highly probable that it belongs to a distinct rock series, though it also comes from Iskagan Bay. It is also the only one which was almost certainly of intrusive character.

It is of medium grain and granitic texture, composed of very white feldspar, with a little quartz, and quite abundant stout prisms and anhedral of black hornblende, though the amount of this is very much less than that of the other minerals, probably constituting from 20 to 25 per cent. of the whole.

In thin section the feldspar is seen to predominate very largely over all the other constituents, and to belong to two species. One of these is a finely striated plagioclase in partly automorphic individuals, which Lévy's method shows to be a labradorite of the composition  $Ab_1An_1$ . Along with this, but xenomorphically developed as interstitial masses, is an alkali-feldspar which, judging from the optical characters, is a predominantly potassic orthoclase. Some of this latter is cloudy

through incipient decomposition. Quartz occurs in anhedral, but its total amount is very small. It carries minute liquid inclusions.

The hornblende is olive-green, and shows the usual characters of this mineral in the dioritic rocks. It is occasionally epidotized, and some actinolite is also present, derived apparently from the normal hornblende. There are also a few grains of magnetite, which are occasionally, when embedded in orthoclase, surrounded by a zone of biotite. Some grains of titanite are also present.

Although no analysis was made of this rock, yet its systematic position is quite clear. It obviously belongs to the monzonites of Brögger, and indeed much resembles type specimens of this from Predazzo, being slightly finer in grain. The amount of quartz is also a little greater, and the Siberian rock may possibly belong to the banatites or quartz-monzonites.

Locust, N. J., December, 1901.

ART. XVI.—*A Cosmic Cycle*; by FRANK W. VERY.

[Concluded from page 114.]

*Concluding Stages of Stellar Growth.*

I have referred the gradual diminution of hydrogen after the Sirian stage to its being used up in the formation of planets and comets. To this cause is adjoined in the stars of Secchi's fourth type, the attainment of a temperature so low that hydrogen and carbon combine, whereby the last traces of hydrogen are removed. Previously to this, however, come bright-line variable stars of banded type, where either the evolution of hot hydrogen proceeds intermittently from a viscid interior, or else fresh hydrogen is added from time to time by external meteoric accessions.

The bright-line, long-period variables of Secchi's third type are connected by their spectra with the last stages of the solar type. I interpret them in this way: As condensation progresses towards its last degree, consistent with the maintenance of stellar functions, central heat becomes excessive, while it is more and more difficult for inner hot material to be transferred to the surface, because viscosity is so great as to be the precursor of final solidification. Under these circumstances, there is a recrudescence of explosive power. Central explosions, no longer of sufficient strength to disrupt the body as at the end of the Orion era, are nevertheless strong enough to break through the dense substance of the sphere, casting up above the heavy metallic vapors which rest upon the cooling photosphere, prominences of enormous size and of vivid luminosity. Chromospheric radiation begins to approach that of the photosphere in intensity. Lockyer\* has rejected the supposition as to "gigantic supra photospheric atmospheres" in these stars in favor of a primitive meteor-swarm theory, but without considering the undoubted affinities with the solar type.

The formation of a vast hydrocarbon atmosphere is the most important characteristic of the last stage of stellar evolution, constituting Secchi's fourth type. The cessation of hydrogen eruptions and the spectral change to dark hydrocarbon flutings appears to be sudden, since there are no intermediates, and perhaps coincides with central solidification and absence of further central explosions.

It would be interesting to inquire how far the change of electrification from the negative hydrogen spectrum of solar and earlier stars, to the positive hydrogen spectrum in the banded variables, may have been brought about by explosions; for it is hardly possible that the enormous electric charges con-

\* *The Meteoritic Hypothesis*, p. 352, *et seq.*

centrated at the center and periphery of a body of stellar dimensions should change sign without a literal turning inside out of the body. This argument assumes that there are actions going on at solar centers which generate electricity, and that the processes producing the original electrification of stars, formed out of the same ingredients in nearly identical proportion, must always give an external electric charge of the same sign. Since there are no exceptions to the order of brightness of the hydrogen lines in the same class, this argument seems warranted.

If the variability of the white stars found in clusters is an indication of youth, that of the red stars, on the contrary, must be attributed to some change connected with old age. In the younger stars there is tidal action due to close proximity of newly formed and as yet barely sundered masses. Periods of a few days, or even of a few hours, indicate a superabundant vigor.

The variability of the red stars has for its characteristic feature that the length of the period increases with the redness of the star, the progression from periods of 50 to 500 days being attended by a variation of color from orange to full red.\* Like the geysers, which in youth have a frequency of a few hours, but in old age spout in a period of as many days, this change points to a waning eruptive force.

Professor Hale† finds a close similarity between the 5th and 6th divisions when limited regions in the green or the violet regions are compared. This applies both to the number and relative intensity of the lines in these parts. Other regions of the spectrum are entirely different, but here again there is a close resemblance between the spectra of stars in the 5th and 4th divisions. Hence there can be no doubt that the 5th is a transition type between the 4th and 6th divisions, and that it is a truly stellar form, and not intermediate between a meteoric swarm and a star. If bright lines reappear in the spectra of the 6th division, as indicated by Professor Hale's observations, reminding us in this respect of the earliest stars, the circumstance cannot outweigh the immense discrepancy between the energy of the violet rays in the first and the last types.

There is one other fact which, if it stood alone, I am free to admit, would shake my confidence in the position assigned to the stars of the 6th division. Mr. J. A. Parkhurst finds that stars having spectra of the 6th division congregate in and near

\* Law formulated by Lockyer, "Meteoritic Hypothesis," chap. 43, from the "Catalogue of variable stars," by S. C. Chandler, *Astronomical Journal*, vol. viii, p. 81, 1888, and from Duner's "Les Étoiles à Spectres de la III. Classe," Stockholm, 1884.

† George E. Hale, *Astrophysical Journal*, vol. ix, p. 273, 1899.

the Milky Way, as do the Orion stars.\* This and the bright lines in the spectrum might incline us to group the hydrocarbon stars with those in which helium plays a leading part; but we cannot thus combine stars whose surface temperatures are the highest and the lowest known. These stars are at the opposite poles of development. Can it be that the thing which has been is the thing which shall be again, that entrance and exit communicate, or that these most ancient stars are relics of an antecedent galaxy, out of whose ashes a new starry heaven has sprung?

*Legitimacy of the Hypothesis of Elemental Destruction and Genesis.*

If the explanation of these appearances of gigantic explosive phenomena which has been suggested, is rejected, what other can take its place? And if the hypothesis is found to afford a way out of other dilemmas which have long been recognized, does not the speculation gain a weight which deserves further trial of its efficacy to explain difficulties and to stand tests? The hypothesis of elemental dissociation, or atomic dissolution, far from being opposed by known facts, is suggested by many familiar chemical decompositions. Among the many suggestions from eminent chemists which are in the same general direction, I will only refer to those of Crookes.

Sir William Crookes has represented the recurrent properties of the series of chemical elements, indicated by Mendeleeff's periodic law, by distributing the elements along a cuspidate helix, whose widening spirals express a relation between the gravitational constants of the atomic weights, determined by the successive addition of the same quantity of electricity, conferring the property of valency and special chemical attributes, combined with some thermal property; and the idea is put forth that these relationships point to some community of origin, and to some sort of evolution of elementary properties. The series is certainly very suggestive. My conception of its meaning is that the heavier atoms are the more complex, and that their formation has required a greater expenditure of energy and a longer duration of development. Like the higher forms of life, they are the last to appear in time, and are also the rarest.

"Bodies not in harmony with the present general conditions have disappeared, or perhaps have never existed. Others—the asteroids among the elements—have come into being, and have survived, but only on a limited scale, whilst a third class are abundant because surrounding conditions have been favorable to their formation and preservation."†

\* *Astrophysical Journal*, vol. viii, p. 239, 1898.

† W. Crookes, *British Association for the Advancement of Science*. Report for 1886, p. 561.

The very definition of an element is provisional and confesses "intellectual impotence." Admitting the unsatisfactory nature of the foundations of chemical knowledge, "it is important to keep before men's minds the idea of the genesis of the elements; this gives some form to our conceptions, and accustoms the mind to look for some physical production of atoms. It is still more important to keep in view the great probability that there exist in nature laboratories where atoms are formed and laboratories where atoms cease to be."\*

Heat and pressure favor the dissolution of certain chemical compounds, or the transformation of complex and unstable forms into simpler ones. The common mode of preparing pure metals is by the action of heat on complex mixtures of compounds. Chloride of nitrogen breaks up into its component elements with explosive violence by simple percussion. All compounds have temperatures of dissociation, more or less high, at which they are completely resolved into their elements. If we have hitherto failed to decompose the elements, we may infer that it is because the pressures or temperatures at our command have not been great enough.

Pressure, and not heat, is to be invoked as the prime factor in atomic dissolution. The process is not reversed by any fall of temperature, and therefore is unlike the dissociation of chemical compounds by heat. The present suggestion differs from those of Hunt and Clarke, which foresaw only an extension of processes already known. Lockyer also has predicated heat as the cause of atomic dissolution, whereas in the present view it is its consequence.

An objection to the hypothesis of elemental destruction may be urged, since, while it is conceivable that the elements may be decomposed by great pressure and intense heat, there is no permanent process in nature which does not move in cycles. If atoms can be destroyed, how and where are they reproduced? Without such reproduction the resolution of the material universe into one or more forms of matter of small atomic weight would be more probable than its actual wonderful diversity and the considerable atomic weight of its leading constituents.

As to the history of material substances in their purest or atomic forms, there are only two alternatives. Either the atoms are eternal and unchangeable, in which case suns may grow cold and disintegrate, and new systems may be built of their fragments at remote intervals,† permitting a kind of

\* *Loc. cit.*, p. 560.

† "Two bodies, each one-half the mass of the sun, moving directly towards each other with a velocity of 476 miles per second, would by their concussion generate in a single moment 50,000,000 years' heat," says Croll in his paper on the "Probable Origin and Age of the Sun" (*Quarterly Journal of Science*, July, 1877), quoted in the "Autobiographical Sketch of James Croll, with Memoir of his



alternation or slow cycle; or, on the other hand, if atoms perish in stellar foci, they must be reborn in the interstellar spaces. Is there any way in which atoms can be conceived to originate in free space? I think that we begin to have a glimmering perception of such a possibility. Although it is customary to assume that the ether is completely devoid of viscosity, the relative scarcity of the fainter stars indicates that a minute fraction of the radiation which passes through the ether from myriads of stars is retained by that medium, eventually extinguishing the rays. If retained, the radiation must perform work. The only permanent change which can be effected in the ether is the imparting of that structure which constitutes matter. It becomes increasingly probable that atoms are ethereal vortices. I have only room for the most cursory treatment of the subject.

*The Vortex Atom as a Possible Solution.*

The vortical hypotheses of Descartes were vague and posterous. Those of Swedenborg were more rational, but lacked mathematical refinement. His conception of a gathering of something like a hundred or a thousand cored vortices (somewhat similar to simple vortices of the type devised by Hicks) forming the universal luminiferous medium, which, flowing vortically in a circumscribed volume, produces a vortex of the second order, constituting one of the least particles of such atmospheres as surround the earths in the starry heavens,\* has a remarkable analogy with Professor J. J. Thomson's discoveries, from which it follows that somewhere in the neighborhood of a thousand corpuscles are consociated in the hydrogen atom.† Helmholtz's splendid studies of aerial vortex rings,‡ and Lord Kelvin's recognition§ that similar movements in a frictionless medium, such as the luminiferous ether has been assumed to be, will give the permanence required in atoms, lent considerable stability to the doctrine of vortex-atoms; and the deeply mathematical discussion of Professor J. J. Thomson,¶

Life and Works," by J. C. Irons, London, 1896, p. 320. Herbert Spencer, in a letter to Dr. Croll (*loc. cit.*, p. 322), points out that "instead of the formation of bodies thus raised to high temperature, and continuing thereafter to radiate heat for long periods as suns, the argument is rather to the effect that the heat evolved by such collisions, taking place with the enormous velocities eventually acquired by stars gravitating into clusters and coming into collision, will have the effect of dissipating the matter they are formed of into the gaseous state and eventually into a nebulous form." Letter of 24th February, 1877.

\* Emanuel Swedenborg, *Principia*, Part I, Chap. 6, Arts. 2, 20, 34, 38; Chap. 7, Arts. 3, 4, 6, 7 and 20 (subsection 1).

† J. J. Thomson, "On the Masses of the Ions in Gases at Low Pressures," *Phil. Mag.* (5), vol. xlviii, p. 547, 1899.

‡ H. Helmholtz, "On Integrals of the Hydrodynamical Equations which express Vortex-motion," translated by P. G. Tait, *Phil. Mag.* (4), vol. xxxiii, p. 485, 1867, from Crelle (1858).

§ W. Thomson, "On Vortex Atoms," *Proc. R. S. Edinburgh*, vol. vi, p. 94, 1867.

¶ J. J. Thomson, "On Vortex Motion," 1882.

leading to partial explanations of the valency of the atoms, gave the hypothesis one more analogy. But the researches of Hicks,\* by establishing relations between vortex motions and the thermal properties of the elements, have done more than all the others to give a stable foundation to the vortical doctrine.

Regarding the vortex-atom theory as almost certainly true, it seems to me probable that there is some connection between ethereal wave-motion and the origin of vortex-motion in the ether. If the reciprocating electro-magnetic motions of an ether-wave are not absolutely reciprocal or self-destructive, a minute fraction of the radiant energy of the stars will remain behind in the ether. We know from the atomic changes shown by the Zeeman effect,† and from the opposite absorptive effect in the magnetic field discovered by Righi,‡ that magnetism is able to produce a temporary change in atomic movement. Is it not possible that electro-magnetic waves originate the permanent vortex movements of the ether? In this case every stellar track must be strewn with atoms, and even in the most dimly lighted recesses of space matter is slowly forming.

The myriad-age-long history of an atom, if it could be traced, would be the story of the evolution of a particular form of motion through the accumulation of many vicissitudes. That in spite of the very great differences in these stories of elemental change, the elementary forms of matter are few in number, can only be accounted for by assuming that the number of possible forms of vortex-motion along these lines is limited by spatial conditions.

Newton in his "Hypothesis Touching Light and Color" suggests that "all things may be originated from ether,"§ but without distinguishing the substance of the ether from an attenuated form of matter.

The modern conception of the ether lends itself more readily to a theory of the ethereal origin of matter.

The different velocities with which various orders of material particles may be propelled by the electric current gives us a

\* W. M. Hicks, "Researches in Vortex Motion, Part III. on Spiral or Gyrostatic Vortex Aggregates," *Proc. R. S. London*, vol. lxii, p. 332, 1898.

† See the *Astrophysical Journal*, vol. v, p. 332; vol. vi, p. 48, p. 378; vol. vii, p. 131, p. 163; vol. viii, p. 45, p. 48; vol. ix, p. 47; vol. xii, p. 120; *Phil. Mag.* (5), vol. xlv, p. 55, p. 255, p. 503; vol. xlv, p. 197, p. 325; vol. xlvii, p. 165.

‡ A. Righi, *R. Accad. Lincei*, Atti. Ser. 5, vol. vii, sem. 2, p. 41 and 338, 1898.

§ "Perhaps the whole frame of nature may be nothing but various contexts of some certain aetherial spirits or vapors, condensed as it were by precipitations. \* \* \* Thus, perhaps, may all things be originated from aether," (Newton's Letters, etc., *Phil. Mag.* (3), vol. xxix, p. 190, 1846). He also suggests that "nature is a perpetual circulatory worker, \* \* \* and as the earth, so perhaps may the sun imbibe this spirit copiously to conserve his shining, and keep the planets from receding further from him," and thus "that the vast aetherial spaces between us and the stars are a sufficient repository for this food of the sun and planets" (p. 192).

mode of attack which is full of promise. Still more powerful are the new magnetic methods. The difference of frequency in the Zeeman components of a Fraunhofer line is constant for all the lines of a group, even through a series of homologous elements, but differs in different groups of lines for the same element.

The problem of the composition of the elementary atom has been approached by the study of

- (a) spectral series,
- (b) enhanced lines,
- (c) the Zeeman effect.

By these tokens we may conclude that the atoms are resolvable. It may be beyond our power to actually separate and sort the various component motions, but they may now be rationally conceived. A host of facts has been presented for mathematical analysis, and a problem has been set before us of even greater interest than that of the celestial motions, which heretofore has been the noblest of all.

#### *Relative Abundance and Distribution of the Elements.*

If the atoms are indeed in process of formation in space by absorption of radiation, there must be a general tendency to an average composition throughout space, and a corresponding general resemblance in the aggregates of matter resulting from concentration. There is, on the whole, a considerable similarity in stellar spectra. The divergences from a common type are not greater than might be anticipated from rearrangement of materials and thermal changes, occurring subsequently to the first concentration, with a small residual change which furnishes an argument in favor of the present hypothesis. Gaseous nebulae cannot be admitted into the argument, since the relative simplicity of their spectra is due to the absence of conditions suitable for exhibiting the radiations of their more complex ingredients, and not to actual simple composition. The rapid transformation of spectra of temporary stars to the nebular type proves this.

In opposition to the idea of an average composition of matter in all parts of space must be placed the very different densities of the planets; but since they have probably been formed from our sun long after the original aggregation, and when heterogeneity had already developed in the parent mass, this fact has no bearing on the argument. We might say the same of the differences in the composition of meteorites, if we were as confident of their origin as we are of that of the planets. On the whole, the secondary origin of comets and their meteoric products seems to be indicated.

The relative abundance of the elements remains a puzzle on any hypothesis. Oxygen and silicon prevail in the outer part of the earth, hydrogen and calcium on the outside of the sun; but the earth's mean density requires that a large part of its interior shall consist of something not far from the density of iron; and the prevalence of this substance in meteorites, as well as its relative abundance in the sun, implied by the breadth and intensity of many of the iron lines in the solar spectrum, suggests that iron may turn out to be one of the most abundant elements in nature. If so, it may be something more than a coincidence that iron is a highly magnetic element, and that magnetism has given us a means of changing, if only temporarily, such a persistent elemental property as the wave-length of spectral lines.

Until someone shall suggest criteria for the stability of different possible forms of vortex-motion, I do not see how we can go farther in this direction.

#### *Properties of the Luminiferous Ether.*

I shall not enter upon questions relating to the constitution of the unmodified ether previous to the inauguration of the ethereal movement constituting atoms: whether the ether is composed of vortex-filaments giving a fibrous structure and a quasi-elasticity; whether the rectilinear motion of an atom through the ether is to be likened to the propagation of a wave in water, where the wave advances, but not the particles of the medium; or whether, like an aerial vortex-ring, the same ethereal particles continue perpetually in an individual atom; whether, indeed, the ether can be said to have "particles" in this sense; whether the intrinsic motion of the ether is circulatory, and all change in the ether is a compounding or a propagation of rotational energy; etc. But the question of the relation of the ether to gravitation is of such importance that it must be considered. In the ninth edition of the *Encyclopædia Britannica*, Maxwell has given a computation of the density of the ether, referred to water, getting  $9.36 \times 10^{-19}$ . A numerical mistake is nearly balanced by the use of Pouillet's value of the solar constant. Correcting the error and substituting three small calories per minute on each normal square centimeter ( $0.05$  radim) for the solar constant, the density of the ether comes out  $9.17 \times 10^{-19}$ . The whole computation rests on the assumption that the amplitude of an ether-wave from the sun, near the sun's surface, is  $\frac{1}{1000}$  of the average wave-length. There is not the slightest evidence that there is any such relation between ethereal amplitude and wave-length; and the array of figures has not even qualitative value, since the method involves some unsafe tacit assumptions.

If atoms are constituted by vortex-rings in the ether, and if the weight of an atom depends on the energy or complexity of this peculiar form of vortical motion, the logical conclusion is that the absence of vortex-rings in the free ether implies absence of gravitational mass, or a density of zero. Substance there must be, using the term in a general, although not in a merely metaphysical sense; but of ordinary matter as distinguished by the possession of gravitational action, ether has none, on this supposition. Energy must be defined as the modification of ethereal rotation, or the establishment of rotation at new points in the ether. When temporary vortex filaments spring up in the ether between positively and negatively electrified bodies, this gives the energy of electric attraction—an energy which depends on the number of filaments, or lines of electric force, and their distribution, being greater when the distribution becomes more strongly asymmetrical. The formation of temporary closed vortex-filaments around an electric current gives rise to magnetic attraction. The forming of more permanent vortex-rings in the ether with resulting gravitational attraction, demands an energy which is greater when the internal motion is more complex. The destruction of a vortex-ring, or its simplification, sets energy free. We may concede that there is doubtless a preservation of entropy by some sort of mechanism, and that the system is in some way reversible; but by the “system” of which I now speak, is meant a connected train of processes as wide as the physical universe; and for the working of this system, even for a single throw, an immense time is demanded. The change from the gaseous, or ultragaseous state to that of the free ether is not like that from a solid to a liquid, or the similar transformation of a liquid to a gas, requiring the latency of a certain amount of heat. Although appearing like a rarefaction, the change in question is quite different. Its ratio to the previous changes is of the  $\frac{9}{8}$  form and cannot be guessed from the previous operators, but must be determined in a new way.

Most attempts to solve the problem and discover the properties of the ether, have proceeded on the assumption that the ether resembles a rarefied gas. In this way DeVolson Wood\* found that its specific heat must be something like five millions of millions, that of water being unity. The computation may not be without value, although it is necessary to modify the very meaning of the word “heat,” or energy of molecular motion, when treating of a substance which has no molecules, nor rectilinear motions such as the kinetic theory of gases assumes. The numerical value deduced by this computation

\* *Philosophical Magazine* (5), vol. xx, p. 402, 1885.

reminds us that the ether is a very peculiar substance, and that its properties are such as would be considered unconscionably exaggerated, if stated of ordinary matter. Consequently we are not doing violence to known facts by giving extraordinary properties to ether, nor by predicting that the change from ether to matter, or the reverse, must involve the disappearance or reappearance of an enormous amount of energy. It appears, therefore, not improbable that the destruction or simplification of material atoms is capable of setting free the forces which are required for stellar disruption. If the ether has a capacity for absorbing enormous energy in becoming converted into atoms, then this energy is set free when the atoms are destroyed, and the duration of the sun is thereby prolonged.

The remaining links in the argument are surmises, or are necessary to the completion of the cycle. Their justification is the conviction that there must be a cycle of some sort; that if we find water flowing continually down hill, there must be some process by which it gets to the top again. The suggestions are made more as questions for solution than as answers. But I may be permitted to point out that the present attempt at an answer to the question: How does the sun maintain its heat, and how long may the sun endure? reconciles several dilemmas.

#### *Solar Sustentation.*

The logical necessity for some kind of cycle in the relation of the sun to surrounding space was doubtless the foundation of Siemen's attempt to devise a working theory in which the sun was regarded as a kind of ventilating fan, drawing in fuel from a universal gaseous atmosphere of elementary composition, and casting it off as burned matter to be dissociated by radiation. The hypothesis has been so completely demolished by Hirn and others that it is unnecessary to refer to it any further than to say that it is entirely inadequate, if for no other reason, because the employment of the solar rotation as a motive power must destroy the rotation, and thus the entire scheme in a comparatively short time. But the shortness of the available time of the sun's present radiant power is also a serious difficulty which must be urged against the contraction theory, because the duration of the earth, since it has been cool enough to sustain life, is necessarily shorter than that of the sun, and yet it outspans the probable term of solar existence.

Professor See\* finds that the past duration of solar radiation at the present rate, for which Helmholtz obtained a value of 18,000,000 years by the contraction theory, assuming a homo-

\* T. J. J. See, *Astronomische Nachrichten*, vol. cl, p. 177, 1899.

geneous sphere, must be increased in the ratio of 176,868 to 100,000, to allow for heterogeneity, according to Lane's theory of the density of the sun's interior, giving a past duration of 32,000,000 years; and as contraction to one-half the present radius, giving density = 11.2 times that of water, would probably end the gaseous sun, a total duration of 36,000,000 years is inferred.

This computation, like its predecessor, rests upon Pouillet's value of the solar constant, which is too small. Lord Kelvin\* had already substituted Langley's value of the solar constant, getting 12,000,000 years for the age of a homogeneous sun, or 20,000,000 years, "taking fully into account all possibilities of greater density in the sun's interior, and of greater or less activity of radiation in past ages."

Lord Kelvin's computation by Fourier's method gives about 100,000,000 years for the earth's age,† assuming a conductivity of the terrestrial substance equal to that of most surface rocks, and an initial temperature of 3870° C. If the interior of the earth is highly conductive, cooling must have proceeded to a great depth, and a longer time will have been needed to establish the present distribution of temperature near the surface.

The mean density of the earth and other facts indicate an inner core of metallic composition. Moreover, the continental relief, as compared with the depth of the oceanic basins, and the contortion of strata by lateral compression, bear witness to a contraction, which proves that cooling of the earth has proceeded to a much greater depth than would be allowable on the supposition of a conductivity equal to that of the surface rock. Hence we have an added argument for an interior conductivity approaching that of metals. A longer duration is to be preferred for this reason.

Many regions of the earth have been invaded by volcanic action in geologically recent time. This is especially the case in those disturbed districts where most of our mining operations are conducted. The rise of temperature with increasing depth is more rapid in these places than it would be normally. The more rapid the rise of temperature, the shorter is the calculated duration of cooling. The rate of subsidence of regions where sedimentary deposits accumulate, is slow enough for the subterranean isotherms to rise into the newly formed rocks, and chemical action perhaps makes them local sources of heat and volcanic action. Some of the deepest wells in rocks which have been undisturbed since Paleozoic times give gradients of temperature much lower than the average. Instead of taking

\* W. Thomson, "On the Sun's Heat," Roy. Institution of Great Britain, Jan. 21, 1887; *Nature Series*, Popular Lectures and Addresses, vol. i, p. 397, 1891.

† W. Thomson, *Trans. Royal Soc. Edinburgh*, vol. xxiii, p. 164, 1862.

a mean of all known observations, it seems proper to choose those which give the slowest rates of thermal increment, for these are the ones which have been least interfered with by local volcanic action, and which most nearly correspond to the deeper and more stable gradients. The substitution of these slowest rates increases the time scale.

Clarence King\* has given a different method, depending on the fusion temperature of basalt as determined by Barus, and assumptions as to the average composition of the earth's outer layers, which are supposed to be basaltic. But the eruptive rocks are just those which have been, as it were, sweated out from the crust, leaving the more refractory materials behind. Grant this, and the average melting point of the residual rocks must be raised, increasing the time-estimate by this method. Taking the initial temperature of solidification as  $1741^{\circ}$  C., Clarence King finds for a thermal gradient of  $1^{\circ}$  F. in 50 feet,  $20 \times 10^6$  years, and for  $1^{\circ}$  F. in 75 feet,  $46 \times 10^6$  years, on the hypothesis of a solid earth. Neither estimate takes any account of the greater conductivity of the deeper layers. If this were done, it might be necessary to extend the computed durations several times.†

Finally, if the gradual modification of living forms by natural selection is a fact, the longest durations named are none too long for the numerous successive faunas and floras made known to us by paleontology.

We need an earth-duration of several hundred million years to meet the requirements of evolutionary theory and of thermotics. The sun, by its contraction, will give only 20,000,000. Hence the dilemma.

The hypothesis of the development of solar energy by atomic dissolution greatly extends the duration of the sun, in all probability doing away with this dilemma.

The companion hypothesis of an atomic genesis by luminous impulses, in addition, fulfills the philosophic necessity for a cosmic cycle which shall restore the ancient order, and answers the question: What becomes of the light from these myriads of stars?

Washington, D. C.

\* This Journal (3), vol. xlv, p. 1, 1893.

† See Professor John Perry, "On the Age of the Earth," *Nature*, vol. li, p. 582, 1895.



ART. XVII. — *Studies of Eocene Mammalia in the Marsh Collection, Peabody Museum*; by J. L. WORTMAN. (With Plate VI.)

[Continued from p. 128.]

*Limnocyon* Marsh.

*Limnocyon* Marsh, this Journal, August, 1872, p. 6, Separata;  
*Thinocyon* Marsh, this Journal, August, 1872, p. 12, Separata;  
*Oxyenodon* Wortman, Bull. Amer. Mus. Nat. Hist., 1899, p. 145;  
*Telmatocyon* Marsh, this Journal, May, 1899, p. 397.

A group of small or medium-sized Creodonts ranging in time from the beginning of the Bridger to the close of the Uinta epoch, and, as far as known, having the following principal characters: Dental formula  $I. \frac{3}{3} C. \frac{1}{1} Pm. \frac{4}{4} M. \frac{2}{2}$ ; first upper and lower premolars two-rooted (except in *Limnocyon dysodus*); last superior molar transverse and little reduced; two subequal inferior molars with internal cusps and moderate-sized basin-shaped heels; fibula articulating with calcaneum; astragalus moderately grooved; femur with small third trochanter; deltoid crest of humerus reduced; distal end of humerus broad, with prominent supinator ridge and an entepicondylar foramen; metapodials of fore feet short and phalanges elongated; carpus unknown.

The genus *Limnocyon* was described by Professor Marsh in August, 1872, from a series of superior teeth which were not in place in the maxillary. A second species was proposed in the same paper upon a specimen consisting of both mandibular rami, one of which contains the last premolar and first molar, together with all the alveoli. In the same paper Professor Marsh proposed a second genus, *Thinocyon*, upon an entire left mandibular ramus, containing a few of the teeth in good condition and the alveoli and roots of all the others. In June, 1899, I proposed the genus *Oxyenodon* upon a well-preserved half of a skull, in which both the upper and lower teeth are present. In May, 1899, Professor Marsh, upon my advice, placed *Limnocyon verus* as synonymous with *Sinopa*, and proposed for the second species *L. riparius*, the generic name *Telmatocyon*. The reason for this advice was as follows: The type of the genus consists of the dissociated upper teeth, in which the superior molars are almost, if not quite, indistinguishable, in structure at least, from those of certain species of *Sinopa*, and as the number in this latter group is three and no two-molared type was at that time known, it was quite naturally supposed that the type specimen of *L. verus* was a *Sinopa*.

The type of *L. riparius*, having but two subequal lower molars, was otherwise unknown, and was regarded as a distinct genus. The relationship with *Oxyænodon* was entirely overlooked. The unstudied part of the collection affords much additional material, and it is now quite evident that the number of superior molars in *L. verus* is two instead of three. The association of upper and lower teeth in this material renders it clear, moreover, that the type of *L. riparius* is the lower jaw of *L. verus*, and on this account I do not hesitate to unite them. I also arrange *Thinocyon* and *Oxyænodon* in this genus, but, as already remarked, it may be found, with more complete information, that they represent distinctive generic modifications.

*Limnocyon verus* Marsh.

*Limnocyon verus* Marsh, this Journal, 1872, p. 6, Separata.

Originally established upon a superior series of teeth of the right side, figure 71, with the first premolar only, in place.

71

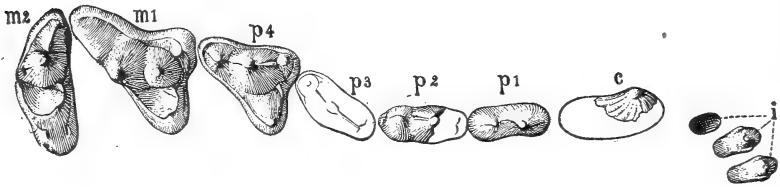

FIGURE 71.—Series of right superior teeth of *Limnocyon verus* Marsh; crown view; three halves natural size. (Type.)

The two middle incisors are present, but they do not present any characters of unusual importance; their roots are much compressed from side to side, like certain members of the Mustelidæ, and their crowns are obtusely pointed and rather narrow. The canine is represented by fragments only, but these are sufficient to indicate that it had the usual size and form of this tooth among the Carnivora; its surface is traversed by characteristic longitudinal grooves and ridges, much as in certain species of reptiles. There are apparently no traces of these grooves and ridges upon the canines of the other species of the genus (except very faint ones in *L. velox*), and it may be taken to be diagnostic.

The first premolar is two-rooted, with a conical, more or less recurved, principal cusp, and a rather extended heel bearing a small cusp; it is placed immediately behind the canine without the intervention of a diastema. The second premolar is only partially preserved in the type, but is present in many other specimens in the collection. The third premolar is missing in

the type, but in other specimens is similar to the first but larger. There is no internal cusp as in *Oxyena*. The crown of the fourth is made up of the usual elements found in the typical sectorial premolar, although certain parts are little developed. There are two main external cusps, together with a small but distinct anterior basal cusp; to these is added a relatively large internal lobe, which is placed opposite or a little anterior to the large principal external cusp. The posterior external cusp is proportionally small, and the posterior

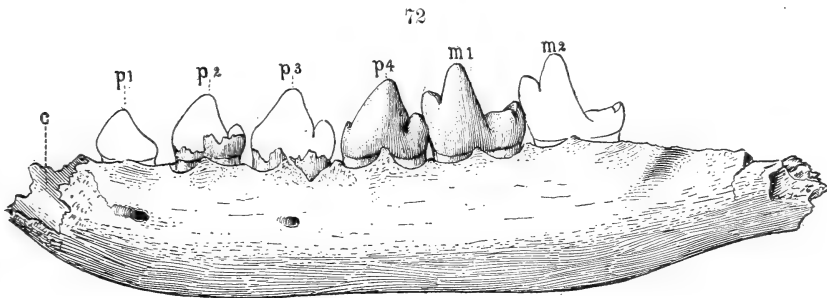

FIGURE 72.—Left mandibular ramus of *Limnocyon verus* Marsh (type of *Limnocyon riparius* Marsh); side view; three halves natural size.

border of the main cusp is little produced, so that the shear of this tooth cannot be said to be very perfectly developed. The first molar is the largest tooth of the series; its crown is composed of two principal external cusps, well separated, a strong blade-like postero-external spur, between which and the postero-external cusp is a deep vertical fissure, a basal antero-external ledge, and a large lunate internal cusp. The large postero-external spur, together with the postero-external cusp, furnish the principal shear, and constitute the chief sectorial organ of the superior series of teeth. The last molar is relatively large, three-rooted, and transverse; its crown is composed of one main external cusp, external to which, and separated by a slit-like fissure, is a sharp ridge, which has more or less of a sectorial function. The usual internal lunate cusp, together with distinct anterior and posterior intermediates, are present, but the postero-external cusp is vestigial or wanting.

The type of *Limnocyon riparius*, figures 72, 73, which I take to be the same as *L. verus*, consists of the greater part of both mandibular rami and a portion of a first superior molar. The specimen

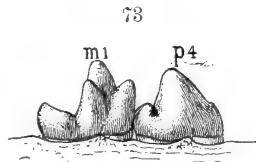

FIGURE 73.—First molar and fourth premolar of the preceding figure; inside view; three halves natural size.

does not exhibit very clearly the number of incisors, but in others which agree with it very closely, the number is three. The first premolar is two-rooted and is placed close behind the canine, without diastema. All the other premolars are likewise implanted by two roots, and are much crowded in the jaw. The fourth has a distinct posterior, but no anterior basal cusp. The crowns of all the premolars are rather thick from side to side, and the cusps are inclined to be obtuse and rounded. The two subequal molars, of which the first is preserved in the specimen, have the following characters: A moderately elevated trigon, with a large external and smaller internal and anterior cusps; a moderately well-developed shear, and blade-like modification of the external and anterior cusps; and a medium-sized basin-shaped heel. These two teeth are nearly equal in size, the last being a little the larger. The jaw is shallow vertically and thick from side to side. The symphysis is enlarged and extends to beneath the middle of the third premolar. There are two mental foramina, the larger of which issues beneath the anterior border of the second premolar. The coronoid is rather large and the angle is not inflected.

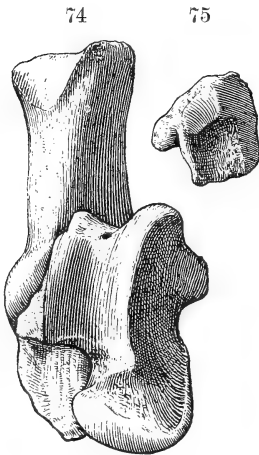
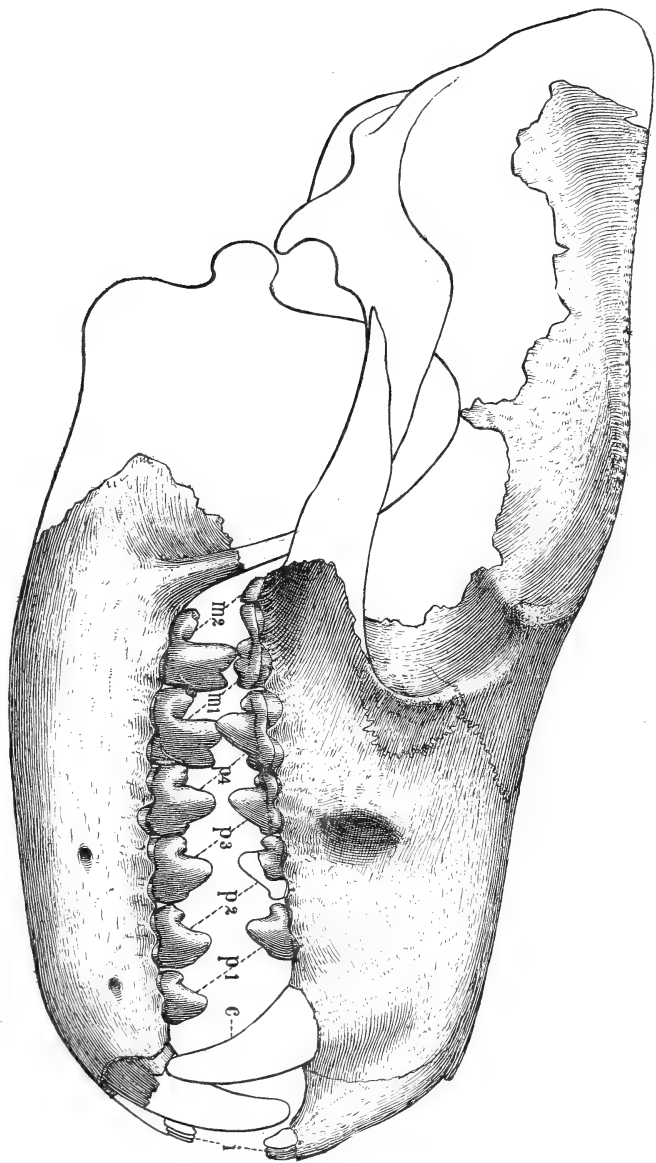

FIGURE 74.—Astragalus and calcaneum of *Limnocyon verus* Marsh; front view; three halves natural size.

FIGURE 75.—Fibula of *Limnocyon verus* Marsh; end view; showing articular surface for calcaneum; three halves natural size.

In one specimen a considerable part of the skull, Plate VI, together with certain parts of the skeleton, are preserved, from which the following characters may be stated: The face is rather short; the orbital cavity is relatively small; there is a distinct postorbital process and a sagittal crest of moderate proportions; there is apparently no anterior glenoid process, but a distinct postglenoid foramen; the mastoid is well exposed upon the postero-lateral wall of the skull, but the position of the stylomastoid foramen cannot be ascertained; the trochlear surface of the astragalus, figure 74, is moderately grooved and there is a distinct astragalus foramen, of about the same size and position as seen in that of the otter; the fibula is little reduced and has a considerable contact with the calcaneum, figure 75, as in the otter; the calcaneum has a moderately short tuber, a broad sustentaculum, and a prominent calcaneal tubercle; there were apparently five toes in the hind foot, and the phalanges were elongated, being but little shorter than those of *Lutra*.



EXPLANATION OF PLATE VI.

Skull of *Limnocyon verus* Marsh; side view; one and one-eighth natural size.



This species is the largest one of the genus thus far known, and the remains indicate an animal slightly larger than a raccoon, which it apparently resembled in its short limbs and heavy build. In one specimen the heel of the last molar is considerably larger than that of other individuals, and is very probably indicative of another species, but until better material is brought to light it is unwise to propose another name.

The principal measurements are as follows :

Type of *Limnocyon verus* :

Length of molar and premolar series .....	47.5 <sup>mm</sup>
Length of premolars .....	31.5
Length of molars .....	16.
Length (antero-posterior) of fourth premolar .....	9.2
Transverse diameter of fourth premolar (anterior border) .....	8.
Length of first molar (antero-posterior external) .....	11.5
Transverse diameter (anterior border) .....	9.5
Antero-posterior diameter of last molar (middle) .....	5.
Transverse diameter of last molar .....	13.

Type of *Limnocyon riparius* :

Length of molar and premolar series .....	46.5
Length of premolars .....	29.5
Length of molars .....	17.
Height of first molar .....	9.
Transverse diameter of first molar .....	5.
Depth of jaw at first molar .....	12.
Thickness of jaw at first molar .....	7.
Thickness of jaw at symphysis .....	8.

Measurements of other specimens :

Length of calcaneum .....	33.
Length of astragalus .....	21.5
Width of astragalus .....	16.
Length of a first phalanx of hind foot .....	19.
Length of a second phalanx of hind foot .....	12.5

The type specimen of *Limnocyon verus* was found by Mr. J. F. Quigley of the Yale party of 1871, at Grizzly Buttes, Bridger Basin, and the type specimen of *L. riparius* was found by Mr. Oscar Harger of the same party, at the same locality. Other specimens are from Henry's Fork.

*Limnocyon velox* Marsh.*Thinocyon velox* Marsh, this Journal, August, 1872, p. 12, Separata.

The type of this species, figure 76, consists of an almost complete mandibular ramus, containing the canine and premolars more or less complete, as well as the roots of the molars and the alveoli for the incisors. The number of the latter cannot be determined with certainty. Professor Marsh stated them as two, but it is more than probable that there were three, with the middle one pushed back out of position. The canine

76

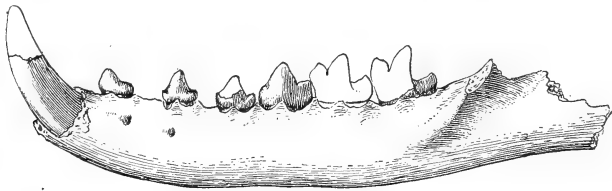

FIGURE 76.—Left mandibular ramus of *Limnocyon velox* Marsh (type of *Thinocyon velox* Marsh); side view; three halves natural size. (Type.)

is relatively large, recurved, and its surface exhibits very faint traces of the longitudinal grooving seen in *L. verus*. The first premolar is two-rooted, with an elongate heel as in this latter species. The remaining premolars resemble the corresponding teeth of *L. verus*, except that they are much smaller. The molars, of which only the heel of the last is preserved, have the same relative size and proportions as in the larger species. The jaw is unusually long and shallow, the symphysis enlarged, the inferior dental canal low in position, and the angle considerably inflected.

77

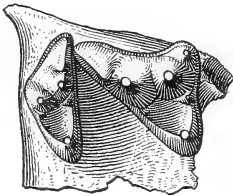

FIGURE 77.—Superior molars of *Limnocyon velox* Marsh; crown view; three times natural size.

From the numerous fragmentary specimens of this species in the collection, the following points in its structure may be stated: The last superior molar, figure 77, has two external cusps, and the antero-external basal cusp of the first upper molar is distinct and prominent; the occiput is low and broad, the sagittal crest weak, and the condyles large and divergent; there is no accessory condyloid foramen, and the stylomastoid foramen issues upon the inferior surface of the mastoid; the tympanic is not ossified into an otic bulla, and the base of the skull is broad, as in the Mustelidæ; the position of the posterior lacerated foramen is posterior and external to the petiotic, as



in the Insectivora, and not postero-lateral, as in the Carnassidentia; the entocarotid enters the tympanic chamber and divides in a manner similar to that of the modern Insectivora, the main branch grooving the outer lateral aspect of the periotic, in front of, and below the *fenestra ovalis*, the other passing between the crura of the stapes and thence into the brain case; the foramen ovale is situated well within the basi-sphenoid and the paroccipital process projects outward and backward. There is no anterior glenoid process, but a distinct postglenoid foramen, and a deep groove in the position of the alisphenoid canal; the deltoid crest of the humerus, figure 78, is little developed, the shaft is much curved, and the distal end is broad, with an entepicondylar foramen; the ulna has a relatively short incurved olecranon, and the head of the radius is subcircular; there were five toes in the manus, the pollex, figure 79, unreduced, and the phalanges, figure 80, elongate as in *Lutra*; the femur has a strong second and a weak third trochanter; its distal end is characteristically broad, with little backward extension of the condyles, and a wide intercondylar groove; the pes is unknown.

The general facies of this species is not unlike that of certain of the otters, notably *Potamotherium* of the European Lower Miocene. The likeness is seen in the low broad occiput, the weak sagittal crest, the broad base of the skull, the probable absence of the alisphenoid canal, the character of the humerus, ulna, radius, femur, and the elongated phalanges, together with probable contact between fibula and calcaneum. The character of the lower jaw and teeth, however, precludes the possibility of its being ancestral to this group. The fundamental differences are seen in the structure of the first molar, which has,

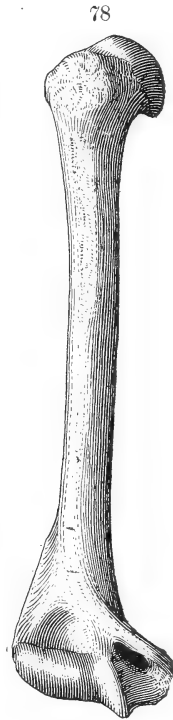

FIGURE 78. — Humerus of *Limnocyon velox* Marsh; front view; two and one-fourth times natural size.

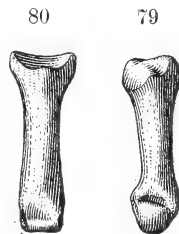

FIGURE 79.—Metacarpal of the pollex of *Limnocyon velox* Marsh; front view; three halves natural size.

FIGURE 80.—Phalanx of *Limnocyon velox* Marsh; front view; three halves natural size.

like all the Creodonts, the postero-external angle enlarged and produced into a cutting blade. It is upon this tooth that the sectorial specialization has centered, whereas in the otters it is the fourth premolar. The superficial likeness to the aquatic mustelines is very evident, however, and I do not hesitate to venture the opinion that this species was aquatic or partially so in its habits. The resemblances to the Insectivora seen in the base of the skull are very marked, and there is a possibility that the entire group may belong to this order instead of to the Creodonta.

The measurements of the species are as follows:

Type of *Limnocyon velox*:

Length of molar and premolar series .....	30·5 <sup>mm</sup>
Full length of jaw (estimated) .....	53·
Length of molars .....	11·
Depth of jaw at last molar .....	8·

Other specimens:

Height of occiput above base of condyles .....	12·
Width of condyles .....	15·
Width of occiput .....	15·5
Width of base of skull between mastoids (outside) .....	22·
Length of two superior molars .....	7·3
Width of first molar (in front) .....	4·8
Width of last molar .....	5·4
Length of humerus .....	40·5
Antero-posterior diameter of head of humerus .....	7·5
Transverse diameter of distal end of humerus .....	9·5
Length of olecranon of ulna .....	5·
Length of metapodial of pollex .....	7·5
Length of a first phalanx of manus .....	8·

The type specimen was found by Professor Marsh at Grizzly Buttes, in the Bridger Basin, and others were collected at Millersville. The horizon for the species is therefore near the base of the deposits.

*Limnocyon medius*, sp. nov.

Numerous remains of a species intermediate in size between *L. verus* and *L. velox* are contained in the collection, but unfortunately they are for the most part rather fragmentary. One specimen, figures 81, 82, which I select as the type, consists of the greater part of both lower jaws, associated with the upper molars and a part of the premolar dentition. The principal differences, besides those of size, are seen in the superior molars. In *L. verus* and *L. velox* the two external cusps of

the first superior molar are well separated, whereas in the present species these cusps are much closer together. In *L. velox*, again, the last superior molar has two external cusps, and in *L. medius* and *L. verus* there is only one. The last two

81

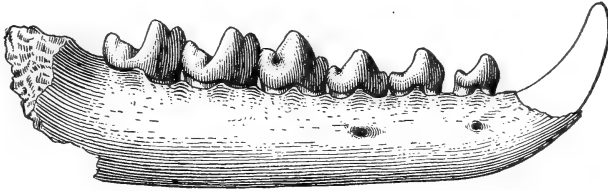

FIGURE 81.—Lower jaw of *Limnocyon medius* Wortman; side view; three halves natural size. (Type.)

species differ in the last molar, in that there is a very distinct internal cingulum in the latter, which is absent in the former.

Various parts of the skeleton are represented in the specimens, and, these apparently agree very closely with those of *L. velox*. Some parts of lumbar vertebrae are preserved in one specimen, and these show that the double tongue and groove articulations were present, as in *Patriofelis*. The deltoid crest of the humerus is reduced, the distal end is broad, and there is an entepicondylar foramen. The trochlear surface of the astragalus is little grooved, and there is a considerable contact between the fibula and calcaneum. The remains indicate an animal somewhat smaller than a Grey Fox. The measurements are as follows:

82

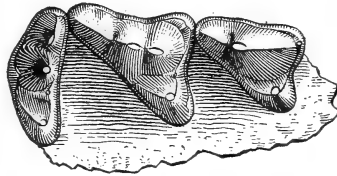

FIGURE 82.—Fourth premolar and first and second superior molars of *Limnocyon medius* Wortman; crown view; two and one-fourth times natural size. (Type.)

Length of fourth premolar and two superior molars	17· mm
Length of superior molars	10·
Width of first molar (in front)	6·5
Width of last molar	8·
Length of lower molar and premolar series	35·
Length of lower molars	13·
Depth of jaw at last molar	10·
Full length of jaw	80·
Length of humerus	65·
Antero-posterior diameter of head of humerus	13·5
Transverse diameter of distal end of humerus	13·5

The type specimen of this species is from near Henry's Fork, Bridger Basin, but others were found in the lower part of the deposits.

*Limnocyon dysodus* Wortman.

*Oxyænodon dysodus* Wortman, Bull. Amer. Mus. Nat. Hist., June, 1899, p. 145.

The Uinta representative of this genus, as far as known, while differing from the Bridger forms in rather strongly marked specific characters, had, nevertheless, not departed sufficiently from the general type to warrant the establishment of a separate genus for its reception. It may well be that the skeleton, when more fully known, will show characters which will necessitate its removal from *Limnocyon*, but upon present evidence, I choose to regard these characters as of no more than specific importance. That it exhibits a distinct advance in structure over the Bridger species, is shown by the fact that the first lower premolar has become single-rooted, the two external cusps of the first superior molar have been more closely approximated, and the last upper molar is considerably reduced in size. It would appear that this form is a direct descendant of *L. medius*, which is the most abundant species in the upper horizon of the Bridger, and that it was very probably also the forerunner of *Thereutherium*.

[To be continued.]

ART. XVIII.—*An Experimental Method in the Flow of Solids and its Application to the Compression of a Cube of Plastic Material*; by J. R. BENTON.

WHEN a solid body is subjected continuously to stress beyond its elastic limit, so that a flow of the material takes place, the behavior of its surface can be studied quite easily by ruling lines upon it and observing how they are deformed; from such observations it has been possible to draw some conclusions about the flow in particular cases. The interior of the body is much less accessible to experiment. Some information about the flow in the interior of metals has been obtained by comparing the "grain" of specimens which have been strained beyond the elastic limit with that of similar specimens which have not received such treatment;\* but it is not possible to observe the grain in the interior of the same specimen both before and after flow, nor could this method be applied to metals which do not show grain. Again, much information has been obtained by building up bodies out of plates of the substance to be investigated; after the flow of such a composite body, sections can be made through the plates, and their form observed. This method can be used in many particular cases;† in many other cases (for example, in studying the flow during flexure beyond the elastic limit) its application would involve great practical difficulties. Besides this there is a serious objection to it on theoretical grounds, on account of the interruption of continuity of the body. And although the method enables us to study the deformation of surfaces in the body, it does not so readily furnish complete information about the motion of individual points in those surfaces.

If instead of filling the body with a system of surfaces of discontinuity, we fill it with a system of intersecting lines, these objections can be overcome. Suppose that instead of each surface of discontinuity, we introduce a framework consisting of two sets of uniformly spaced parallel straight wires at right angles to each other, all the points of intersection of the wires being melted together. Such a framework, it is true, would interfere with the continuity of the body to a slight extent; but much less so than if the body were built up out of separate plates. Furthermore, it would give the means of studying the motion of the individual points in the interior,

\* H. Tresca, Proc. Inst. of Mechanical Engineers, 1867, pp. 114-143; 1878, pp. 301-345.

† Loc. cit.

since certain points on each wire can always be recognized by the intersections with other wires.

I have made an attempt to apply this method to a study of the flow in the interior of a cube compressed between two parallel plates, the faces of the cube not in contact with the plates being free.

The frames were made of fuse-wire, which was melted together at the joints. The material of the cubes experimented on was Wood's fusible alloy, it being chosen simply on account of the greater convenience of working with a substance of low melting point. Fuse-wire was used in preference to other wire because it is soft enough to follow the flow, and not cut through the Wood's metal, as harder wire might do. Only one frame was inserted in each cube; the frame was clamped in the desired position inside a cubical mould, and molten Wood's metal was poured in. After the metal had solidified, the cube was compressed gradually between the plates of a testing machine, the pressure being kept about 3000 lbs. per sq. in. Then the metal was raised to a temperature sufficient to melt it without melting the fuse-wire, and the frame was taken out. Before melting the Wood's metal after the flow, plaster of Paris was cast around it, which on hardening formed a vessel containing the metal, and prevented it from flowing away as it melted. Without this precaution there would have been the danger that the metal might have melted irregularly, and left solid masses sticking to the wire frame, which would have deformed it by their weight.

A slight difficulty occurred in the tendency of the molten metal to adhere to the fuse-wire. Coating the wires with wax did not obviate this; but the Wood's metal could be dissolved off in hot concentrated  $H_2SO_4$ .

The edge of the cube was  $1\frac{3}{4}$  in. = 4.44<sup>cm</sup> in every case. The friction between the plates of the testing machine and the faces of the cube in contact with them was not sufficient to prevent some flow along the plates.

The framework of wire was always placed in a plane perpendicular to the plates of the testing machine, and midway between and parallel to two faces of the cube. The original intention was to construct frameworks consisting each of two sets of parallel wires at right angles to each other. Preliminary experiments showed that the wires parallel to the plates of the testing machine remained nearly uniformly spaced and deviated but slightly from straight lines. They were accordingly dispensed with, and the frameworks used consisted each of a single set of wires, perpendicular to the plates of the machine.

Blue-prints of the frameworks were taken before and after flow, by pinning them on pieces of sensitive paper and expos-

ing to sunlight. The results obtained in this way are given in figs. 1-7.

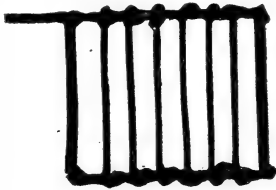

FIG. 1. Framework before flow.

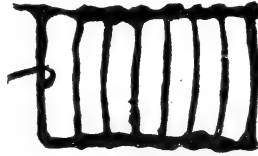

FIG. 2. Same framework after flow.

FIGS. 1, 2. The cube was compressed through a distance of  $\frac{5}{16}$  in. = 0.79 cm. The faces in contact with the plates extended so as to become squares  $1\frac{1}{8}$  in. = 4.92 cm on a side.



FIG. 3. Framework after flow.

FIG. 3. The cube was compressed through  $\frac{5}{8}$  in. = 1.59 cm. The faces in contact with the plates extended to  $2\frac{1}{8}$  in. = 5.24 cm on a side.

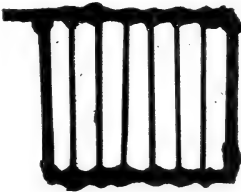

FIG. 4. Framework before flow.



FIG. 5. Same framework after flow.

FIGS. 4, 5. The cube was compressed through  $\frac{1}{8}$  in. = 2.38 cm. The faces next to the plates extended to  $2\frac{3}{8}$  in. = 6.03 cm on a side. In Fig. 5, one cross-wire is missing next to the right hand end.

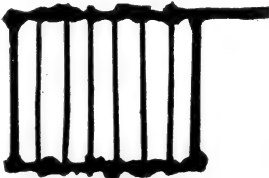

FIG. 6. Framework before flow.



FIG. 7. Same framework after flow.

FIGS. 6, 7. The cube was compressed through  $1\frac{3}{8}$  in. = 3.26 cm. The faces next to the plates extended to  $2\frac{5}{8}$  in. = 6.51 cm on a side. In Fig. 7, the cross-wire at the extreme right hand end became detached during the treatment with  $H_2SO_4$ , and is missing.

It will be observed that the wires became considerably flattened in the last stages of the flow, and that slight wavy irregularities in their form appeared, probably on account of imperfect homogeneity of the material. It is possible, however, to follow in the figures the general character of the motion, from the first stages of the flow to the last. At first the flow does not differ in any essential respect from what might be expected in view of the shape taken by the surface of the cube. But as the flow proceeds, the wires near the middle of the cube take the form of curves with two points of inflection, as shown in fig. 5, and less distinctly in fig. 7. In figs. 7, 5, and 3, a shearing of the cube parallel to the plates of the testing machine is apparent; the upper part has moved to one side, and the lower part to the other. These results are not surprising, because compression without such shearing would represent an unstable state of motion; if any cause should slightly displace the lower part of the cube with respect to the upper part, perpendicularly to the direction of the compression, then further compression would tend to increase such a displacement.

In view of this complication, it does not seem worth while to attempt to apply to the compression of a cube the mathematical theory of the flow of solids, as developed by Tresca and Saint Venant.\*

University of Chicago,  
September, 1901.

\* Comptes rendus, lxvi, pp. 1027-1032, 1244-1246, 1305-1324; lxviii, pp. 221-237, 290-301; lxx, pp. 309-311, 473-480; etc.



ART. XIX.—*On the Occurrence of Monazite in Iron Ore and in Graphite*; by ORVILLE A. DERBY.

A SMALL specimen of magnetic iron ore presented by Mr. John Gordon of Rio de Janeiro, from the fazenda Catita, on the lower Rio Doce in the state of Espirito Santo, presents a number of interesting features, among which is the occurrence of numerous and comparatively large grains of monazite in the mass of the ore. The ore fragment consists of a coarsely crystalline mixture of magnetite and ilmenite with adherent remnants of kaolinized feldspar and biotite, which show it to have been a segregated mass of oxides in the midst of a coarsely granular rock, probably a mica-syenite. The powdered ore, freed from the iron oxides by the horseshoe and electro-magnet, gives an extremely abundant residue of rather coarse fragments and well crystallized grains of corundum, monazite and zircon, and in microscopic slides these grains are found to the number of a dozen or more in the area of an ordinary preparation. They occur isolated in the mass of the oxides, but are more abundant in and about flakes of biotite when these are present. Of the three minerals, monazite is the most abundant and the most generally distributed, appearing in both the magnetite and ilmenite. Other interesting accessories that are confined to the magnetite, where they appear as delicate net-like partings in the twinning planes (something like the plates of tænite in meteoric irons), are a green spinel and a translucent brown titanium mineral. The ilmenite also gives on etching irregular bands showing it to be composed of a mixture of two substances of different color, and degree of solubility in hydrochloric acid. This and other interesting features of titaniferous iron ores from this and other localities will be more fully discussed by Dr. Hussak.

A specimen of graphite has recently come to hand from the region of the river Jequitinhonha in the state of Minas Geraes, which gives on washing a very abundant residue of heavy yellowish fragments, rarely crystals of recognizable form, that on microscopic and chemical examination prove to be monazite and zircon, the former greatly predominating. The only other recognizable element of the residue is a dirty white opaque titanium mineral that seems to be a pseudomorph after mica. The compact graphite is transversed by thin stringers of a decomposed micaceous mineral which also occurs in small isolated rounded patches, but these afford no more, if as much, monazite as the purer portions of the specimen. Several isolated flakes of graphite with an included grain of monazite were obtained. From the rarity of perfectly formed crystals

or of the rounded grains in which the mineral usually appears, the monazite seems to be in a state of strain in virtue of which it goes to pieces in the process of crushing and washing. On testing in a borax bead the oxalates precipitated from a solution of the residue, Dr. Florence obtained beautiful crystallizations of both cerium and lanthanum, the latter appearing much more abundantly and readily than in the many other samples of monazite that he has examined in this way. From this circumstance it may be concluded that the mineral presents some peculiarities of composition, but material is not at hand for a verification of this point.

The locality from which the specimen comes was visited in 1880 by Dr. Costa Sena, the present director of the School of Mines of Ouro Preto, who reports the occurrence of loose masses up to 100 kilograms in weight and of a vein from half a meter to a meter in width in decomposed granitoid gneiss in the bed of the Corrego do Emparedado, affluent of the small river São Pedro, which enters the Jequitinhonha from the left some 60 to 70 miles below the town of Calhau (Arassuahy). An analysis made at that time gave 85% of carbon, 4.7% of volatile matter and 7.2% of ash. Judging from the present specimen, which probably was about the same composition, the ash is composed for the most part of phosphates of the cerium group in the form of monazite.

Another specimen of graphite of similar appearance and mode of occurrence, from near São Fidelis in the state of Rio de Janeiro, presents the same phenomenon of an abundance of monazite as the almost exclusive non-carbonaceous accessory. On the other hand, several specimens of graphitic schist that have been examined give an abundant residue of titanium minerals (rutile in some cases, ilmenite in others), but no minerals of the rarer elements. This circumstance and the occurrence in the schistose types of graphite of a great amount of sericitic mica indicates a difference in the mode of origin of the two types of graphitic rock corresponding to the differences in their mode of geological occurrence. Unfortunately no specimens are at hand for verifying to what extent monazite is a characteristic accessory of the graphite occurring in gneiss and granite. As the two specimens examined, taken by chance, have shown it in relative abundance, it may be suspected that it will be found to be rather generally distributed. If so, its significance from a genetic point of view hardly needs to be mentioned.

São Paulo, Brazil, December 24, 1901.

ART. XX.—*The Molecular Weights of some Carbon Compounds in Concentrated Solutions with Carbon Compounds as Solvents*; by CLARENCE L. SPEYERS.

IN some preceding papers,\* it has been shown that the equation

$$\frac{n}{N+n} = \frac{p-p'}{p} \text{ or } \frac{n}{N} = \frac{p-p'}{p'} \quad (1)$$

expresses the vapor pressures of mixtures of liquids miscible in all proportions better than does the equation

$$\frac{n}{N} = l \frac{p}{p'} \quad (2)$$

The latter gives absurd values towards the limits of concentration: the former gives reasonable values throughout the range of experiment. The failure of (2) is hardly to be attributed to experimental error,† because in that case the molecular weights should show far more irregularity than they do.

Moreover with such simple assumptions regarding molecular weights as are continually being made for non-volatile solutes, it was possible to plot boiling point curves for mixtures of two liquids soluble in each other in all proportions and to state in a general way when a mixture might have a maximum boiling point.‡

Last year, J. von Zawidski§ applied Margule's equation

$$\frac{dlp}{dx} = \frac{dlp'}{dl(1-x)},$$

where  $x$  denotes the fraction of a gram-molecule of one liquid and  $1-x$  denotes the fraction of a gram-molecule of the other liquid, to a mixture of two liquids miscible in all proportions. In this differential form, the equation seemed to be unsatisfactory, and to integrate it constants of uncertain value are introduced complicating the theoretical investigation. Moreover, the equation will not agree with experiment unless molecular association is granted. Taken altogether, Margule's equation is more complicated than equation 1, far more so, and in no case does it give results more concordant with fact than equation (1) does. For one mixture, that of acetone and chloroform, equation 1 fails. But so also does Margule's equa-

\* Journ. Phys. Chem., ii, 347, 362, 1898; Journ. Am. Chem. Soc., xxi, 282, 1899.

† Bancroft, Journ. Phys. Chem., iv, 224, 1900.

‡ This Journal, ix, 341, 1900.

§ Zeitsch. Phys. Chem., xxxv, 129, 1900.

tion. The only explanation I can suggest, and one which Zawidski also suggests, is that the two components react chemically.

On reviewing the deduction of van't Hoff's law, it seemed that neither the compression of the solution nor the heat of solution of the solute had to be considered. Both of these quantities seemed to cancel out.\* It is to be understood of course that  $Q$  belongs to a reversible change. It has nothing to do with the heat of a chemical change such as the chemical reaction of a solute with solvent. For example: If  $Q$  refers to a heat of dilution, then when we remove or add solvent, which by the nature of the cycle we can do at will, then  $Q$  is either absorbed or rejected according to the nature of the solvent and solute, and when we reverse the operation, the sign of  $Q$  is reversed. But if  $Q$  refers to a heat of chemical combination, then the addition of solvent in the cycle to the solution will produce an evolution of heat and this evolution cannot be compensated in some other operation because of the nature of the cycle. See resorcinol and ethyl alcohol. With this understanding, the application of equation (2) to concentrated solution seems to be allowed by theory.

All the systems considered in the preceding papers were composed of liquids, and as there might be some disturbing action overlooked in the van't Hoff development when the solute was a volatile liquid, it seemed quite desirable to measure the relative depression of the vapor pressure for concentrated solutions of non-volatile solutes.

A few preliminary trials showed that the boiling point method was unsatisfactory, even under reduced pressure,† with such concentrated solutions. The change in temperature was too great. Moreover, theory asserts very positively that the formula for calculating the molecular weight from the change in boiling point is only valid when the heat of vaporization  $Q$  does not vary between the two boiling points. Unless these lie close together, or unless the variation of  $Q$  is taken into account, the values for the molecular weights so obtained are more or less wrong. Similarly for cryoscopic measurements.

The requirements were best met by the method of Walker‡ changing the arrangement a little, for in its original form satisfactory results could not be obtained.§ The solution was contained in a bulb tube shown by the full lines in the diagram. The solution filled the tubes to about  $d$ , about 40° of solution. The larger part of the solvent was evaporated in

\* Journ. Am. Chem. Soc., xxi, 725, 1899.

† Journ. Phys. Chem., i, 766, 1897.

‡ Zeitsch. phys. Chem., ii, 602, 1888.

§ Journ. Phys. Chem., i, 766, 1897.

bulb *a* and this was so large that the deposited solute did not stop it up; a small part was evaporated in bulbs *b*, and the slight balance, if any, in bulbs *c*. Consequently the air passed through a liquid of almost if not quite constant concentration before it got away. The tubes connecting the sets of bulbs *b* and *c* had a bore of about  $1.8^{\text{mm}}$ , so that the bubbles of air passing through were quite small. The tube *e* had a bore of about  $0.4^{\text{mm}}$  and being bent as it was none of the liquid which condensed in that part of *e* which projected above the water bath could get back into *c* but was drawn out by the current of air.

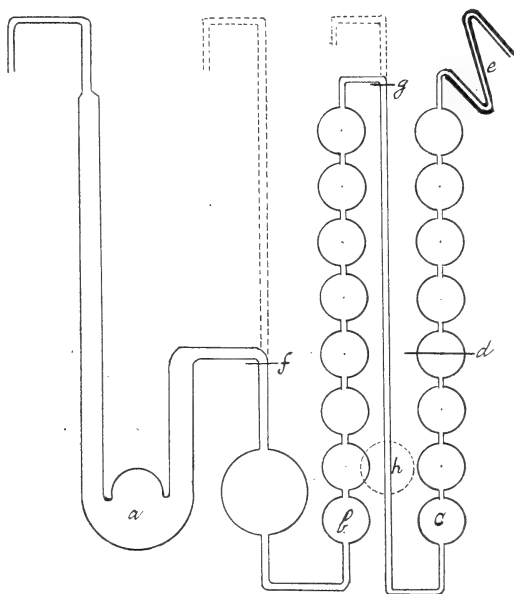

In this way traps with troublesome rubber or ground glass connections were avoided. The rest of the tubing had a bore varying between  $1^{\text{cm}}$  and  $3^{\text{cm}}$ . This is tube 1.

The solvent was contained in a tube like 1, but the part to the left of *f* was omitted, a tube running straight up and bent over instead, as shown by the dotted lines commencing at *f*. No other variation from 1. It held about  $30^{\circ}\text{C}$ . This is tube 2.

Two other tubes, just alike, consisted of a single column of bulbs each, everything to the left of *g* being cut away, a tube run straight up and bent over, and another bulb put in, *h*, as shown by the dotted lines. Each tube held about  $25^{\circ}\text{C}$ . These are alcohol tubes 1 and 2.

The four were placed in a water bath whose temperature was regulated to  $0.4^{\circ}$ .

A current of air direct from the laboratory passed through alcohol tube 1, from which it took up alcohol to saturation; then, to remove all the alcohol, through three spiral tubes containing about  $90^{\text{cm}}$  of sulphuric acid in all. The dried air then passed through the solution in tube 1 and from that into the suction apparatus.

A second independent current of air, also direct from the laboratory, passed through alcohol tube 2, then through another set of sulphuric acid tubes just like the first set, then through the pure solvent in tube 2 and on into the suction apparatus.

The loss of the alcohol tubes is proportional to the volume of air drawn through them. Let  $l'$  be the loss of one alcohol tube, let  $l''$  be that of the other alcohol tube,  $L'$  the corresponding loss of tube 1,  $L''$  the corresponding loss of tube 2. Then

$$\frac{l''}{l'} L'$$

gives what would be the loss of tube 1 if as much air passed through it as passed through the tube 2. The loss for that tube whose alcohol tube showed the smallest loss was always corrected. That is, the smallest loss of alcohol was put as the denominator in the correction, the other loss as the numerator. Let  $L_1$  and  $L_2$  be the corrected values for tubes 1 and 2. Then we may put  $L_1$  and  $L_2$  proportional to  $p'$  and  $p$  respectively in equations 1 and 2. That is,

$$\frac{aL_2 - aL_1}{aL_1} = \frac{L_2 - L_1}{L_1} = \frac{n}{N} = \frac{p - p'}{p'}$$

and

$$l \frac{aL_2}{aL_1} = l \frac{L_2}{L_1} = l \frac{p}{p'} = \frac{n}{N}$$

Since  $n = w/m$  and  $N = W/M$  we have

$$m = \frac{wML_1}{W(L_2 - L_1)} \quad (3)$$

and

$$m = \frac{wM \cdot 0.4343}{W(lL_2 - lL_1)} \quad (4)$$

The error of the method could be partly determined by using pure solvent in tubes 1 and 2, correcting the smaller loss as given by the alcohol tubes, and comparing with the observed loss of the other tube. For instance, when pure water was used in both tubes 1 and 2:

Loss of alcohol tube 2 = 4.988 grms.; loss of tube 2 corresponding to  $p = 0.960$  gm.  
 " " " 1 = 4.700 " " " 1 = 0.915 gm.  
 " tube 1 corrected =  $(4.988/4.700) 0.915$  corresponding to  $p' = 0.971$  "

$$p - p' = \frac{0.011}{0.011}$$

$$\text{Error} = \frac{11}{971} 100 = 1.1 \text{ per cent.}$$

A second experiment gave an error of 1 per cent, so that the mean error would be 1.05 per cent of the quantity measured. The temperature in this case was 41.3°. In this way, the errors given in the following table were determined. The first column gives the solvent, the second column gives the corrected value of either  $L_1$  or  $L_2$  as the case may be, the third column gives the difference between the observed maximum  $L$  and the corrected  $L$ . When —, the corrected value is greater than the observed value. The fourth column gives the percentage error and the fifth column the mean percentage error. The sixth column gives the temperature.

Substance.	L	$\Delta L$	Per cent error.	Mean per cent error.	$t^\circ$
Water	$L_1 = 1.022$	-0.010	1.0		41.2
"	$L_1 = 0.971$	-0.011	1.1	1.0	41.3
"	$L_2 = 0.597$	+0.002	0.3		32.3
"	$L_2 = 0.591$	+0.004	0.7	0.5	32.3
Methyl alcohol	$L_1 = 4.044$	+0.068	1.7		44.0
"	$L_2 = 5.220$	+0.038	0.7		44.0
"	$L_1 = 6.266$	+0.039	0.6		44.0
"	$L_2 = 5.146$	+0.048	0.9	1.0	43.8
"	$L_1 = 3.159$	-0.013	0.4		31.4
"	$L_2 = 3.360$	+0.019	0.6	0.5	32.2
Ethyl	$L_2 = 6.814$	-0.112	1.6		44.8
"	$L_1 = 5.441$	-0.033	0.6	1.1	44.8
"	$L_2 = 2.880$	-0.056	1.3		26.9
"	$L_1 = 2.022$	-0.005	0.2	0.75	26.9
Propyl	$L_1 = 1.134$	+0.012	1.1	1.1	31.3
"	$L_1 = 2.663$	-0.015	0.6		45.2
"	$L_1 = 2.254$	-0.023	1.0	0.8	45.2
Toluene	$L_1 = 1.356$	+0.003	0.2		27.5
"	$L_1 = 1.384$	-0.005	0.4	0.3	27.5
"	$L_1 = 4.700$	+0.051	1.1		45.1
"	$L_1 = 4.669$	+0.028	0.6	0.8	45.2

These errors do not represent the total errors of the apparatus because in their determinations, so far as conditions will permit, the air is completely saturated with solvent vapor. But in measurements of the relative depression of the vapor pressure tube 1 contains more or less concentrated solutions and therefore one current is not at maximum saturation and the conditions are not the same as they were when the above

table was made. However no other way was found of getting at the true error.

This method of getting the molecular weights of solutes is only useful for solutions which do not change chemically when a current of air is passed through them for twenty-four hours. Moreover, the solutions must be concentrated, because all the errors are piled up on the molecular weight to an extravagant degree when the solutions are dilute, that is, when  $p-p'$  is small. The weights of  $w$ ,  $W$ , and  $M$  are to be considered correct as given; then the effect of an error of one unit in the determination of  $p$  and of  $p'$  gives an error in the determination of  $m$  proportional to

$$d \frac{p'}{p-p'} + d \frac{p}{p-p'} = \frac{1}{p-p'} dp$$

from equation (3), and

$$\frac{dl \frac{p}{p'}}{dp} + \frac{dl \frac{p'}{p'}}{dp'} = \frac{p-p'}{pp'(lp-lp')^2} dp$$

from equation (4), which when  $p-p'$  is small, becomes

$$\frac{p'}{p(p-p')} dp = \frac{1}{(p-p')} dp \text{ approximately.}$$

A few measurements with dilute solutions are given but they are not to be depended upon, although the results seem good in some cases. For such solutions, the boiling point method is by far preferable.

The observations and molecular weights are given in the following tables. In the first column is the solute, its ordinary molecular weight, its origin and purity; in the second, the quantity of solvent in grams; in the third, the quantity of solute; in the fourth, the corrected losses of tube 1 =  $p'$ ; in the fifth, the corrected losses of tube 2 =  $p$ ; in the sixth, the differences =  $p-p'$ ; in the seventh, the molecular weight according to equation (3); in the eighth, the molecular weight according to equation (4); in the ninth, the temperature.

Let us consider each solution separately.

*Urea in water.* 50 per cent to 60 per cent urea referred, as always, to 100 parts of solution. The mean molecular weight of urea according to formula (1) is  $60.6 \pm 1.6$ ; according to formula (2) it is considerably greater,  $72.6 \pm 1.8$ . This assumes that we accept the modified van't Hoff theory. If we deny the validity of the modification, then formula (2) cannot be used at all, for the necessary data as to compressibility and heat of dilution are not known. Formula (1) much to be preferred.



Carbon Compounds in Concentrated Solutions. 219

WATER, ordinary distilled.

<i>Urea 60.</i>	Solvent.	Solute.	<i>p</i>	<i>p'</i>	<i>p-p'</i>	<i>m<sub>3</sub></i>	<i>m<sub>4</sub></i>	<i>t</i> <sup>o</sup>
From Kahlbaum. Re-	17·08	22·59	0·742	0·537	0·205	62·3±1·2	73·7±1·2	32·3°
crystallized from C <sub>2</sub> H <sub>5</sub>	16·40*	22·48	0·377	0·267	0·110	59·7±1·6	71·2±2·2	41·3
OH. Dried on steam	15·59*	23·12	0·549	0·381	0·168	60·6±1·8	73·0±1·9	"
radiator to avoid de-								
composition.								

*Resorcinol 110.*

From Kahlbaum. 4·40	13·69	21·24	0·668	0·566	0·102	155 ± 3	168 ± 6	32·3°
grams lost 0·0005 gram	13·52	27·66	0·480	0·393	0·087	166 ± 4	184 ± 4	"
in partial vacuum over	13·73*	25·87	0·492	0·412	0·080	175 ± 9	191 ± 9	41·3
H <sub>2</sub> SO <sub>4</sub> . No further	14·70*	27·65	0·651	0·540	0·111	165 ± 9	182 ± 9	"
purification.								

METHYL ALCOHOL.

From Kahlbaum. Treated with CaO for 24 hrs. Distilled off. Boiling point=65·0°. Bar.=762.

<i>Urea 60.</i>	26·26	6·34	3·933	3·506	0·427	63·1±2·4	66·9±3·0	28·0°
	26·78	6·99	3·455	3·035	0·418	60·6±2·3	64·7±2·4	"
	26·10	10·32	8·435	6·633	1·802	46·6±2·2	52·6±2·3	44·2

*Acetanilid 135.*

From Kahlbaum and	22·81	11·73	4·243	3·710	0·533	117 ± 3	123 ± 4	31·2°
from Eimer and Amend.	23·47	11·72	3·988	3·508	0·480	117 ± 5	125 ± 4	32·0
In partial vacuum over	20·47*	18·06	3·642	2·809	0·833	95 ± 7	109 ± 7	42·3
H <sub>2</sub> SO <sub>4</sub> , 3·81 grams lost	19·30*	19·67	5·878	4·336	1·542	92 ± 6	107 ± 6	43·7
less than 0·001 gram	19·21	19·77	14·08	10·58	3·50	100 ± 4	118 ± 4	44·2
in 24 hours. Dried in								
air bath at 100°.								

*Naphthalene 128.*

From Merck, marked	42·34	3·067	3·073	2·992	0·081	85 ± 17	87 ± 17	28·5°
highest purity, medi-	28·84	5·71	8·304	7·718	0·586	83 ± 12	86 ± 12	44·8
cal. Not further puri-	28·16	5·44	7·894	7·307	0·587	77 ± 10	80 ± 10	"
fied. In partial vacuum,								
4·79 grams lost 0·05								
gram in 24 hours.								

ETHYL ALCOHOL.

From Kahlbaum or Merck. Marked absolute. Not further purified.

<i>Acetanilid 135.</i>	27·15*	7·05	1·420	1·315	0·105	150 ± 4	166 ± 5	21·5°
	23·53	9·732	2·193	1·932	0·261	141 ± 9	150 ± 9	31·5
	27·73*	10·95	2·606	2·280	0·326	127 ± 4	136 ± 7	32·5
	27·51*	14·83	5·119	4·350	0·769	140 ± 2	152 ± 6	42·5

*Acenaphthene 154.*

From Kahlbaum. White	29·44	1·082	3·301	3·229	0·072	76 ± 30	76 ± 30	27·6°
crystals. Powdered and	29·10	2·069	3·856	3·749	0·107	115 ± 53	115 ± 47	44·0
dried on steam radi-								
ator. Turned yellow on								
exposure to light.								

*Naphthalene 128.*

29·31	2·425	2·128	2·065	0·063	125 ± 34	128 ± 34	27·7°
27·55	6·350	7·892	7·428	0·464	170 ± 38	176 ± 33	44·8
25·94	6·107	6·055	5·580	0·475	127 ± 18	132 ± 18	45·5

*Urea 60.*

29·84	1·659	1·509	1·442	0·067	55 ± 9	57 ± 10	27·0°
26·88	2·418	3·682	3·410	0·272	47 ± 7	49 ± 7	43·7

\* With a somewhat different apparatus.

	Solvent.	Solute.	$p$	$p'$	$p-p'$	$m_3$	$m_4$	$t^\circ$
Benzamid 121. From Kahlbaum	29.65	5.520	2.809	2.645	0.164	138 $\pm$ 18	142 $\pm$ 22	27.0°
	27.15*	8.353	4.988	4.373	0.615	101 $\pm$ 4	108 $\pm$ 6	42.2
	27.54*	8.119	5.049	4.442	0.607	99 $\pm$ 4	107 $\pm$ 7	42.2
	25.57	7.805	3.922	3.457	0.465	104 $\pm$ 10	111 $\pm$ 10	43.7
Resorcinol 110.	20.40	20.30	2.511	1.151	1.360	38.8 $\pm$ 0.5	58.7 $\pm$ 0.5	30.0°
	16.28	20.74	2.448	0.936	1.512	36.3 $\pm$ 0.1	61.0 $\pm$ 0.1	30.0°

PROPYL ALCOHOL.

From Kahlbaum. Treated with CaO for 24 hours. Distilled off. Boiling point 96.6°–96.9°. uncor. Bar. 766–762.

Acenaphthene 154.	27.36	2.167	3.642	3.541	0.101	167 $\pm$ 52	169 $\pm$ 56	45.2°
	27.08	2.176	1.756	1.716	0.040	207 $\pm$ 84	209 $\pm$ 84	45.3
Naphthalene 128.	28.70	3.035	0.957	0.898	0.059	97 $\pm$ 17	100 $\pm$ 19	29.8°
	26.52	6.970	2.124	1.998	0.126	250 $\pm$ 34	259 $\pm$ 35	45.5
	25.58	6.848	3.150	2.853	0.297	154 $\pm$ 9	162 $\pm$ 13	45.6
	23.88	6.943	2.413	2.200	0.213	180 $\pm$ 16	189 $\pm$ 16	“

TOLUENE.

From Kahlbaum. Treated with Na for 15 hours and distilled. Boiling point 110.3°. uncor. Bar. 770.

Naphthalene 128.	30.58	16.47	2.225	1.595	0.630	126 $\pm$ 1	149 $\pm$ 2	29.5°
	21.38	21.51	4.105	2.358	1.747	125 $\pm$ 2	167 $\pm$ 2	41.1
	19.08	22.34	4.200	2.260	1.940	125 $\pm$ 3	174 $\pm$ 2	45.1
Acenaphthene 154.	31.27*	6.60	1.078	0.951	0.127	145 $\pm$ 5	155 $\pm$ 11	20.8°
	25.44	9.093	1.833	1.495	0.338	145 $\pm$ 3	161 $\pm$ 3	27.5
	25.45	9.148	2.888	2.388	0.500	158 $\pm$ 3	174 $\pm$ 3	28.4
	25.91*	9.293	1.631	1.970	0.339	159 $\pm$ 3	175 $\pm$ 3	28.5°
	23.42*	10.27	2.138	1.720	0.418	166 $\pm$ 4	185 $\pm$ 6	31.3
	20.98*	14.36	2.069	1.428	0.641	140 $\pm$ 2	170 $\pm$ 4	42.5
	22.94	14.60	6.237	4.452	1.785	146 $\pm$ 4	174 $\pm$ 4	45.1
	21.01	16.93	5.519	5.672	1.847	147 $\pm$ 4	182 $\pm$ 4	51.4

*Resorcinol in water* 61 per cent to 67 per cent resorcinol. Resorcinol is associated according to each formula and neither one is to be preferred.

*Urea in methyl alcohol.* 19 per cent to 28 per cent urea. At 28°, the molecular weight of urea is 61.8  $\pm$  2.3 by formula (1) and 65.8  $\pm$  2.7 by formula (2). At 44°, the molecular weight drops very much, but a solution of urea in methyl alcohol cannot be evaporated at 44° without decomposition. Moreover, after standing 24 hours another solution of the same strength and kept at 44° had altered in density and smelled of ammonia showing decomposition at that temperature. Formula (1) to be preferred.

*Acetanilid in methyl alcohol.* 33 per cent to 51 per cent acetanilid. In all cases, the molecular weight is below the normal. But acetanilid decomposes in solution into anilin and

\* With a somewhat different apparatus.

acetic acid\* and this would account for the low molecular weight. This decomposition takes place the more rapidly the higher the temperature, and we find a considerably lower molecular weight at 44° than at 31°. Neither formula can be preferred.

*Naphthalene in methyl alcohol.* 7 per cent to 16 per cent naphthalene. These low molecular weights are probably due to some unknown source of error, perhaps to the volatility of naphthalene in methyl alcohol vapor.† It should be noticed that the corrections are very large, emphasizing the statement that this method is only good for high molecular concentrations. Boiling point determinations show normal molecular weights for naphthalene in methyl alcohol‡ at 43·5°. Neither formula can be preferred.

*Acetanilid in ethyl alcohol.* 21 per cent to 31 per cent acetanilid. The molecular weights seem to be normal; no sign of decomposition. Neither formula can be preferred.

*Acenaphthene in ethyl alcohol.* 3·5 per cent to 7 per cent acenaphthene. The solutions are too dilute. Corrections are too large. Neither formula can be preferred.

*Naphthalene in ethyl alcohol.* 8 per cent to 19 per cent naphthalene. The molecular weights indicate a normal value but the corrections are too large for a satisfactory conclusion to be drawn. Naphthalene is not so volatile with ethyl alcohol vapor as it is with methyl alcohol vapor.§ Neither formula can be preferred.

*Urea in ethyl alcohol.* 5 per cent to 7 per cent urea. The solutions are too dilute. Indications are normal molecular weights at 27·0° and decomposition at 43·7°. Neither formula can be preferred.

*Benzamid in ethyl alcohol.* 16 per cent to 23 per cent benzamid. The molecular weight is probably normal at 27°. Decomposition is indicated at 42°. Neither formula is to be preferred.

*Resorcinol in ethyl alcohol.* 50 per cent to 56 per cent resorcinol. The corrections here are very small and yet the molecular weight is about one-third the normal. This would indicate a chemical combination of resorcinol and ethyl alcohol, in agreement with what was noticed when resorcinol was dissolved in an excess of ethyl alcohol.¶ Out of thirty-nine solutions including all those considered in the present paper, the only one which evolved heat when made was this one composed of resorcinol and ethyl alcohol. Neither formula to be preferred.

\* Menshutkin, Ber. d. d. chem. Gesellsch., xv, 1516, 1882.

† Talmadge, Journ. Phys. Chem., i, 547, 1897.

‡ Journ. Phys. Chem., i, 775, 1897.

§ Talmadge, Journ. Phys. Chem., i, 547, 1897.

¶ Journ. Am. Chem. Soc., xviii, 146, 1895. This Journal, x, 449, 1900.

*Acenaphthene in propyl alcohol.* 7 per cent acenaphthene. Association is indicated. Corrections very large. Neither formula to be preferred.

*Naphthalene in propyl alcohol.* 10 per cent to 22 per cent naphthalene. The molecular weight is below the normal at 29.8° but the corrections are very large. At 45° association is strongly indicated, though the corrections are too large for this conclusion to be altogether satisfactory. Neither formula to be preferred.

*Naphthalene in toluene.* 35 per cent to 54 per cent naphthalene. The molecular weights are normal by formula (1), but abnormal by formula (2). Considerable association is indicated by the second formula. The corrections are very small. Formula (1) much to be preferred.

*Acenaphthene in toluene.* 17 per cent to 45 per cent acenaphthene. The average molecular weight is  $151 \pm 3$  by formula (1) but quite abnormal,  $172 \pm 5$ , by formula (2). Association is indicated by the latter formula. The corrections are small. Formula (1) is much to be preferred.

In not a single case then does formula (2) give very satisfactory results, whereas in several cases formula (1) does so and in no case is it less satisfactory than formula (2).

Now formula (1) is altogether too arbitrary. What right have we to use the molecular weight of the solvent in the gaseous state in preference to the molecular weight in the liquid state. In formula (2) the molecular weight in the gaseous state is to be used according to van't Hoff's theory. We have good reason to think that the molecular weight of water in the liquid state is twice or perhaps four times 18. Were we to put some such value for  $M$  in (1), the results would be very objectionable. We can, however, justify the normal value for  $M$ , that is its value in the vapor state, by adopting a view published some years ago\*; namely, that a liquid giving off vapor contains some vapor in the dissolved form, or otherwise expressed, that the simple molecules corresponding to the vapor molecules are formed inside the liquid instead of at the surface. So long as the solvent gives off simple molecules in the vapor state, so long there are dissolved simple molecules in the liquid, and these are the molecules whose concentration is changed by the solute. The complex molecules produce the simple dissolved molecules but have no direct vapor pressure of their own.

Let us consider a liquid consisting of simple molecules only whose vapor pressure is  $p$ . To this liquid, equation 3 applies directly. Now suppose that the liquid is mixed with so much of some other inert, non-volatile, liquid that the vapor pressure

\* Journ. Am. Chem. Soc., xviii, 724, 1896.

of the mixture is reduced to one-half of  $p$ , and let us dissolve in this complex solvent the same quantity of solute as we should have dissolved in the simple solvent in making a molecular weight determination, using the same weight of complex solvent as we should use of simple solvent. Then

$$m = \frac{wM}{W} \frac{p'/2}{(p-p')/2} = \frac{wM}{W} \frac{p}{p-p'}$$

This is what is supposed to be the case with water or with any other solvent whose molecules are complex. The complex molecules are altogether inert. They play the part of the inert liquid in the above complex solvent, and all we need know is the molecular weight of the solvent in the vapor state.

Put (1) in the form

$$\frac{n}{N} = \frac{p}{p'} - 1, \frac{n}{N} + 1 = \frac{p}{p'}, l\left(\frac{n}{N} + 1\right) = l\frac{p}{p'} \quad (5)$$

Integrating

$$Q = \frac{RT^2}{p} \frac{dp}{dT}$$

which is the second law of thermodynamics applied to vaporization, and remembering that under these conditions,  $dp/dt$  is negative, we get

$$l\frac{p}{p'} = \frac{Q'}{R} \frac{T_1 - T_0}{T_1 T_0}$$

Substituting in (5) we have

$$l\left(\frac{n}{N} + 1\right) = \frac{Q'}{R} \frac{T_1 - T_0}{T_1 T_0},$$

where  $Q'$  is the heat of vaporization of one gram-molecule of solvent from the solution, the quantity of solution being so great that no change in concentration is produced when the gram-molecule is removed,  $T_1$  is the boiling point of the solution,  $T_0$  that of the pure solvent, and  $R$  is the gas constant.

This equation is available for determining the molecular weights according to the boiling point method or to determine the latent heat of vaporization of the solvent. It will answer for all purposes to which van't Hoff's formula is put and is altogether independent of the osmotic theory.

A corresponding equation is easily obtained in terms of heat of fusion and freezing temperatures.

## CLARENCE KING.

OF the many rapid advances in various branches of science during the last quarter of the past century none has been more remarkable than that of geology. The fundamental cause of this advance is to be ascribed less to the brilliant discoveries and generalizations of individual investigators, of which, however, there has been no want, than to the systematic organization of geological work, which has given a sounder basis for generalization and rendered the work of the individual more effective.

In the earlier days, when only State geological surveys were carried on, and those without adequate maps, no satisfactory correlation of their results was possible; hence much time was often wasted in polemical discussions that might better have been employed in more systematic field observation. A few leading minds like Dana, Hall, Rogers, and others had made brilliant generalizations that left their impress upon the science of geology, but in cases of conflict of opinion the array of facts that could be cited to confirm or deny a given hypothesis was insufficient to produce final conviction.

It was not until the truth, that geological studies cannot profitably be confined within State lines or other artificial boundaries, had been proved by practical demonstration, that the aid of the general government was freely and permanently enlisted, and thereby geological science in America raised to its present high position.

To the accomplishment of this result the late Clarence King was the foremost and one of the most active contributors. It was he whose personal efforts created the 40th Parallel Survey, which was the first government exploration primarily devoted to geological investigation, the first geological survey in the country to make and publish topographical maps as a basis for its geology, the first to employ microscopical petrography in the study of its rocks, and the first to institute systematic geological examinations of mining districts with a view of establishing a more satisfactory theory of vein formation.

The organization of the United States Geological Survey as a permanent bureau of the Government, which naturally resulted from the work of this and succeeding government explorations, was in great measure due to his personal efforts.

It was, however, not as an organizer alone that King contributed to the advance of geological science; his writings have been of the very highest order, not only in their matter but in their manner of presentment; while his personal influence upon fellow geologists and his suggestiveness have

had an effect in raising the standard of geological work in this country, which, while less susceptible of direct estimation, has been none the less real and permanent.

He was a man of remarkable intellectual versatility, and has been probably as widely known and appreciated for his literary as for his scientific ability, though his published literary writings have been singularly few in number. The recollection of his consummate art as a conversationalist and raconteur, of the delicate wit and irrepressible humor that showed itself at times even in his scientific writings, of the kindly spirit and refined courtesy that characterized his every action, and of his irresistibly attractive smile, has left behind a mingled feeling of pleasure and regret among all who had the privilege of knowing him.

Clarence King was born at Newport, Rhode Island, on the 6th day of January, 1842. He was the only son of James Rivers and Florence Little King. His ancestors were among the early settlers of New England, and all, as far as known, of English extraction. Among them were an unusual number of cultivated men, graduates of colleges, or distinguished in the learned professions, in whom can be found traces of the many and varied accomplishments in science, literature and the arts that were so happily combined in their brilliant descendant.

Daniel King, the emigrant, who came to Lynn, Massachusetts, in 1637, was a younger son of Ralphe Kinge of Watford, Hertfordshire, England. His great-grandson, Benjamin, moved from Salem, Massachusetts, to Newport, Rhode Island, and, according to family tradition, was a man of scientific tastes, who occupied himself with philosophical instruments and assisted Benjamin Franklin in his early experiments in electricity. Samuel King of Newport, son of the latter and great-grandfather of Clarence, was a portrait painter of merit, who numbered among his pupils Washington Allston, and Malbone, the miniaturist. On his mother's side, one of King's great-grandfathers, William Little, was a graduate of Yale in 1777, and received an honorary degree from Harvard in 1786. Another, Ashur Robbins, graduated from Yale in 1772, was United States Senator from Rhode Island 1825-39, and received the degree of LL.D. from Brown in 1835. His grandfather, William Little, Jr., who died early in life, was noted as a linguist and a scholar. His grandmother, Mrs. Sophia Little, poet and philanthropist, was a woman of remarkable public spirit, energy, and decision of character, who retained her mental and physical vigor in most remarkable degree up to the time of her death in 1893, in her 95th year.

His immediate King ancestors were pioneer merchants in the then highly remunerative China trade, his grandfather,

Samuel Vernon King, having been as early as 1803 a partner in the commercial house of Talbot, Olyphant & King. Four of the latter's sons succeeded him in that business, the house later becoming known as King & Company. James, the second son, married at the early age of 21, and was obliged to leave his young wife before the birth of his first child, Clarence, in order to take the place of his elder brother in China. By a singular fatality, three out of the four brothers died in the far East, and the house of King & Company became bankrupt during the crisis of 1857 through the loss of one of the company's steamers, which, under the charge of a confidential English clerk (also named King) was carrying a large amount of specie to meet their liabilities at another port. In this disaster was involved the property of James, which had remained in the firm since his death at Amoy, China, in 1848.

The young mother, left a widow at 22, devoted herself to the education of her only son, learning with an inherited facility both classical and modern languages that she might teach them in turn to him, and thus was founded a close, intellectual companionship which lasted until his death.

King's early boyhood days were spent at Newport, but he received his principal school education in the endowed high-school at Hartford.

As a very young child he showed symptoms of a decided bent toward the study of natural phenomena, which was further developed during long summer vacations, spent in fishing, hunting and botanizing in the Green Mountains.

In 1859 he became a member of the Sheffield Scientific School, and during the two following years acquired a systematic grounding in the sciences of geology and mineralogy under the inspiring teachings of James D. Dana and George J. Brush, at that time their foremost exponents. Among his fellow students who have since become eminent in their respective professions were O. C. Marsh, Arnold Hague and Samuel Parsons. He graduated in 1862 with the degree of B.S., being among the first students of the Scientific School to receive a degree from the faculty of Yale College.

During his college course, he was a leader among his mates in athletic sports, as well as in study of nature, being captain of a base-ball team and stroke oar of a racing crew.

During the winter following his graduation, he was, for a time, a student of glaciology under Agassiz, and later became a devotee of the Ruskinian schools of art study under the leadership of Russell Sturgis.

In May, 1863, in company with his life-long friend, James T. Gardiner, whose health had broken down under too close devotion to his studies, King started on a horseback trip across the



Continent. Upon reaching St. Joe, Missouri, then the western limit of railroad communications, they were invited to join the party of a well-to-do emigrant family, whose favor King had unconsciously gained by his characteristically tender care for their children during the latter part of the railroad journey. Their line of march followed, in general, what was known as the Old Fremont route, up the North Platte river and down the Humboldt river in Nevada. The rate of travel of such a party was necessarily very slow, and the young explorers, being mounted on good horses of their own, were able to make excursions into the neighboring mountains for the purposes of exploration and study, which, owing to the hostility of the Indians, were not always without danger.

After having crossed the deserts of Nevada, they left the party to visit the then famous Comstock Lode. On the night of their arrival in Virginia City, the house in which they were staying caught fire and all their belongings were lost. Nothing daunted, King went to work at days' wages in a quartz mill to earn sufficient funds to enable them to continue their journey. In a few weeks they started again, crossing the Sierra Nevada on foot, and proceeding by boat from Sacramento to San Francisco. On this trip an incident which led to their making the acquaintance of Prof. William M. Brewer, then assistant on the Geological Survey of California, proved to be the turning point in their careers.

King's professional work as a geologist may be said to have commenced with his acceptance of the position of volunteer assistant geologist on the Geological Survey of California under Prof. J. D. Whitney. During the three years that this connection lasted the work was largely exploratory, for as yet even the geography of the country was but imperfectly known. It thus gave full scope to the enterprise, energy and powers of endurance that characterized him during his whole life. In spite of his youth, he soon became a leader, especially in the exploration of the high mountain mass of the southern Sierras discovered by him, whose highest peak, Mt. Whitney, still holds the palm as the highest point within the United States (excluding Alaska). During the winter of 1865-6 he also made an exploration of the desert regions of southern California and Arizona as scientific aide to General McDowell, which involved much hardship and no little danger.

Of even more importance for his future work was the familiar knowledge of the different varieties of volcanic rocks, acquired during field studies around the extinct volcanoes of the northern Sierras and in association with his friend Baron von Richthofen, and in which for many years he stood preëminent among geologists of his time.

King's earliest scientific achievement on the Survey was the discovery, during the study of the gold mines of the Mariposa estate in 1863, of fossils in the highly metamorphosed slates of the gold belt of California, a discovery that solved the problem of their age which had long puzzled western geologists.

In the autumn of 1866, after his return to the east, he judged that political conditions were then most favorable for the realization of a plan that had gradually been shaping itself in his mind ever since he first crossed the continent, viz: that of connecting the geology of the east with that of the west by making, under government auspices, a survey across the whole Cordilleran system at its widest point.

There had been considerable apprehension during the dark days of the Civil War lest California, physically isolated as she was at that time, should separate from the other states and set up an independent government. The subsidizing of the Transcontinental railroads was the first step towards overcoming this isolation and binding her more closely to the East. In King's judgment a second, hardly less important one, would be the development of the mineral resources of the country thus to be opened up; and this could best be accomplished by making a thorough geological survey of that region.

During the winter of 1866-7, which he spent at Washington, he was so successful in impressing this view upon Congress, that not only was a generous appropriation voted for the geological exploration planned, but King himself was placed in absolute charge of it, subject only to the administrative control of General A. A. Humphreys, Chief of Engineers.

In these days, when the West is covered by a network of railways, it is difficult to conceive the obstacles that had to be encountered at that time in carrying out so ambitious and, as some then thought, so chimerical a plan as that which King had conceived. Of the Transcontinental roads, but a few miles at either end had yet been constructed. The territories of Utah and Nevada were represented on most maps of the day as one broad desert, and it was doubted whether sufficient water and grass could be found there to support a camping party. Everything had to be specially created for the purpose, and, after the party had reached California over the Panama route, it took three months to prepare the necessary camp outfit and to carry them to their field of work. Even after this work was well under way there were times when it seemed that obstacles ahead were almost too great to be overcome, but King's energy and resourcefulness were equal to every emergency, and he soon succeeded in inspiring all of the members of his party with such confidence in his leadership and in imparting to them such measure of his own enthusiasm that they never faltered in their devotion to the work, even though

the three years originally planned were subsequently extended, by the unsolicited action of Congress, to seven.

In recognition of the legitimacy of the public demand for a direct application of the results of government geological work, King pushed first to completion a scientific study of the ore deposits of the region surveyed; more particularly of the great Comstock Lode, whose enormous silver product was then disturbing the monetary system of the country. This work, written conjointly by himself and James D. Hague, appeared as early as 1870 under the title of "Mining Industry." It was described by one of its most capable critics as "by itself a scientific manual of American precious metal mining and metallurgy." It is considered classic among works in its line and has served as a model for similar monographs which have since been published under government auspices and done so much to raise the mining industry of America to its present high position.

In 1870 he discovered on the slopes of Mt. Shasta the first actual glaciers known to exist in the United States; and in their study made observations that are credited with first suggesting the true origin of the kettle-holes and kames of New England. His later discovery in the summer of 1874, that a line of islands along the southern coast of New England were a part of its terminal moraine, had much influence in inducing the later systematic studies of the Continental glacier.

The field work of the Survey was completed in 1873, but it was 1877 before the respective specialists had been able to work up the amount of material gathered, for it was one of King's fundamental principles that abundant collections should be made in the field to illustrate all the natural phenomena observed, and the lithological collections alone numbered about five thousand specimens.

In 1874, he sent one member of his corps to Europe to study the methods of European geological surveys and to obtain the best and latest geological literature with which at that time American libraries were but scantily provided. He, also, instructed him to confer with Prof. Zirkel, then the greatest microscopical petrographer of the day, and to induce him, if possible, to visit America and study in the presence of the collectors their collection of rock specimens, for at that time no American geologist had any practical knowledge of this new branch of geology. From this visit resulted Zirkel's volume on microscopical petrography, which marked the opening of a new era in geological study in the United States.

King reserved for himself the final summarizing of the work of his assistants and the drawing of general conclusions and theoretical deductions therefrom. This he wrote in the

winter of 1877-8, and published in a quarto volume of more than 800 pages under the title of "Systematic Geology." It has been characterized as the most masterly summary of a great piece of geological field work that has ever been written, and is used to this day by university professors of geology as a model for their advanced students.

King's crowning service to geological science in America followed shortly after the completion of the 40th Parallel work. After two of his field seasons had demonstrated the practicability of geological map-making in the west, the Wheeler Survey was inaugurated under the Engineer Department of the Army, and the already existing Hayden Survey later adopted his example in making topographical maps as a basis for its geology, employing for this purpose the 40th Parallel topographers after their term of service in the latter Survey had expired. The work of these two organizations became so popular that each desired to cover the whole of the unsurveyed area in the west, and their rivalry in time became so intense that the influence of either party with Congress was used to curtail the appropriation allotted to the other. As a final result of this rivalry the time came when there was serious danger that all government aid for geological work would be cut off. It was mainly through King's influence among the leading scientific men of the country and his tactful management of affairs in Congress that this crisis was averted. The question was referred to the National Academy of Sciences, and their recommendations, which were on lines laid down by him, were finally adopted by Congress, and on March 3, 1879, a law was passed establishing the United States Geological Survey as a bureau of the Interior Department. President Hayes, after consultation with the best scientists of the country, appointed Clarence King as the first director of the new Bureau. King accepted the appointment with the distinct understanding that he should remain at its head only long enough to appoint its staff, organize its work, and guide its forces into full activity. At the close of Hayes' term, he offered his resignation, but at the President's request, he held over until after the inauguration of Garfield. The latter accepted it, on March 12th, 1881, in an autograph letter, expressing in the warmest terms his appreciation of the efficiency of King's service and his regret that he did not find it possible to remain longer in charge of the Geological Bureau.

Brief as was the duration of his administration, his influence, being exercised at the critical period of the Survey's existence, left a lasting impress upon it. He outlined the broad, general principles upon which its work should be conducted and its subsequent success has been in a great measure dependent upon

the faithfulness with which these principles have been followed by his successors.

Foreseeing the important part that the development of its mineral resources was destined to play in the future progress of the country, he judged that, while not neglecting the more purely scientific side, its work should be primarily devoted to the direct application of geological results to the development of these resources. It has been because the people at large have realized its practical success in this line that the Survey has been more richly endowed, and thus better able to carry on its purely scientific work, than any organization of its kind in the world.

King set the very highest standard for its work, and showed remarkable judgment and knowledge of character in his selection of the men who, in their respective branches, were best fitted to keep it up, as nearly as possible, to this standard. In his establishment of a physical laboratory for the determination of the physical constants of rocks, he took a step in the direction of the application of methods of exact science to geological problems so far in advance of the average standards of the day that its importance was not generally realized until long after.

In all his after life, he maintained a lively interest in the work of the Survey, and kept closely in touch with his successors in office, who frequently consulted him on important questions of policy.

After his retirement from government service, he came much less frequently into personal contact with scientific men, for he had little sympathy with that phase of scientific activity which is represented by academies and societies.

He had been elected a fellow of the Geological Society of London in 1874, and of the National Academy of Sciences in 1876. He was, also, a life member of the American Institute of Mining Engineers, but he rarely attended the meetings of any of these associations and never contributed to their proceedings. He found his recreation from business occupations rather in social intercourse with his many friends and admirers in the literary and artistic world, yet he was not forgetful of his chosen profession, and through all the varied occupations of an intensely busy life he still continued his investigations into the deeper problems of geology, to carry on which had been one of his motives for giving up administrative duties on the Geological Survey.

In his financial affairs, King had difficulties to contend with that few of his friends realized, and which would have completely discouraged a man of less sanguine and buoyant temperament.

At two successive periods in his youth, those to whom he would naturally have looked for financial support were overwhelmed by commercial disaster, leaving him to provide not only for his own wants but for those of other members of his family. In his later life circumstances entirely beyond his control more than once baffled or annulled the efforts he was making to establish himself on such a financial basis that he would feel justified in applying his entire time to his chosen pursuits in science and literature. He was consequently obliged to devote more of his time and energy to the directly remunerative side of his profession—that of the mining engineer—than he otherwise would have done. This was especially true of his later years, though even in earlier life his services had been not infrequently sought in cases of great moment.

He owed his prominent position in this profession not alone to his ability and experience as a geologist, which exceeded that of most of his fellow workers, but to his high standard of personal integrity and the rapidity and acuteness of his judgment. These qualities were early illustrated in an incident which gave him perhaps greater prominence in the financial world than any act of his life—his exposure of the diamond fraud of 1872. An apparently well authenticated discovery had been made of diamonds in sufficient quantity to affect the diamond markets of the world. Although its position was kept carefully concealed, through the intimate knowledge of the country possessed by his assistants, King was enabled to determine that it must be located in an area already surveyed by them, and at once fitted out a party to examine it. When this examination, undertaken primarily in the interest of science, had proved that the alleged discovery was an elaborate and skilfully planned fraud, it was his prompt action and unshakable integrity alone that averted a financial disaster which threatened to rival that of the Mississippi Bubble of Law.

In the many important mining suits in which he served as scientific adviser, and which involved most difficult and complicated problems of geological structure, combined with their still more difficult interpretation under the terms of the United States mining laws, he was generally intrusted with the legal as well as the scientific management of the case. As he made it a practice to never trust the eye of another, but to verify every fact by his own personal observation, he obtained such a thorough knowledge of his subject that the most skillful lawyers were unable to shake his testimony by their cross-examination.

In his examination of mines, he visited almost every part of the American continent, and thus acquired a personal familiarity with deep-seated phenomena that it seldom falls to the lot of a geologist to obtain. Hence he was exceptionally well

equipped in this, as in other respects, to carry on the investigations he had undertaken into the problems of the interior of the earth.

In 1890, Brown University conferred upon him the honorary degree of LL.D. That he received no public recognition of his later scientific work may perhaps be ascribed to its peculiarly unobtrusive character, which gave rise to the erroneous impression that he had abandoned science altogether.

It is difficult to fairly judge King's scientific publications in the light of the present day, for they were written just before the opening of an era of great change in the methods of geological investigation, a change which has thus far proved destructive rather than constructive in its results. Many of the fundamental theories of geology which prevailed at that time have been disproved or abandoned, while as yet there is no general acceptance of those which have been put forward to replace them.

In June, 1877, he delivered the address at the 31st anniversary of the Sheffield Scientific School on "Catastrophism and the Evolution of Environment." It was a protest against the extreme uniformitarianism of that day, based largely on the geological history of the Cordilleran System as developed during the work of the 40th Parallel Survey. This uniformitarianism he characteristically described as "the harmless undestructive rate (of geological change) of to-day, prolonged backward into the deep past." He contended that while the old belief in catastrophic changes had properly disappeared, yet geological history, as he read it, showed that the rate of change had not been so uniform as was claimed by the later school. While a given amount of energy must evidently be expended, he reasoned, to produce a given effect, yet the expenditure of this energy might be extended over a very long time, or crowded into a comparatively short one; and his observations showed him that at certain periods in geological history, the rate of change was accelerated to such a degree that the effect upon life produced was somewhat catastrophic in its nature.

Of his great work upon systematic geology, the larger part—that which outlines the geological history of the Cordilleran System—stands as firmly to-day as it did when written, as a correct and authoritative exposition. In view of the circumstances under which the field work was originally done, its essential correctness, even in matters of minor detail, is considered surprising by those who have since had occasion to make detailed studies of portions of the area covered.

In the more theoretical sections, while he necessarily did not take into account the great number of new facts which have

been established by more recent work, especially in the domain of microscopic petrography, he showed such grasp of his subjects, and such originality and power of thought, that his views constituted not only an important advance over those of the day, but they were suggestive of the lines of investigation that have been most fruitful in the modern advance of geological science.

For instance, in his discussion of the reason for the changes from acid to basic eruptives within the individual groups, which he proposed as a variation from the natural order in age of volcanic rocks, as laid down by Richthofen, he advanced views very suggestive of the modern conception of differentiation in eruptive magmas.

Again, in endeavoring to account for the formation of those types of granite that pass into gneiss and crystalline schists of essentially the same chemical composition, but which show no evidence of having been subjected to such excessive heat as would produce actual liquefaction, he called in the agency of the immense pressure to which such rocks would necessarily have been subjected. While the long years of combined field work and microscopic study of modern petrographers, made since King's theory was enunciated, have proved that the structure of crystalline schists *is* due to pressure, they do not go so far as he did in assuming that the end product of such mechanical pressure might be granite.

Perhaps his most enduring theoretical discussion of that time was that on hypogeal fusion, in which, accepting the validity of the physical arguments against the fluid interior of the earth, he discusses and rejects Hopkins' theory of residual lakes and Mallett's conception of local lakes produced by mechanical crushing. He then advances an hypothesis of his own which may be called that of a critical shell, or *couche*, between the permanently solid interior and the outer crust of the earth, which is above the temperature of fusion but restrained from fusion by pressure. In this, therefore, the opposing forces of pressure and temperature hold themselves reciprocally in equilibrium, but when this equilibrium is disturbed, as for instance, by a sudden change of the relative position of isobars and isotherms—say by local erosion and rapid transfer of load within limited areas—local lakes of fusion would be created. Iddings, in his "Origin of Igneous Rocks," says of King's treatment of this subject: "By the breadth of his treatment and by better and fuller data he advanced the problem of the origin of the various kinds of volcanic rocks far beyond the point reached by any of his predecessors."

In his chapter on Orography, King says, in speaking of the causes of crust motion: "I can plainly see that were the critical shell established its reactions might thread the tangled



maze of phenomena successfully, but I prefer to build no farther until the underlying physics are worked out." He was at that time already very strongly impressed with the imperfection of the then existing knowledge of terrestrial thermo-dynamics and the indispensability of more exact data in this branch of science for a rational discussion of the fundamental problems of geology.

This idea found a practical outcome a few years later in the establishment of a physical laboratory, immediately after his assumption of the Directorship of the United States Geological Survey. His earnestness and energy is shown by the fact that instead of waiting for the slow action of Congress, he defrayed the cost of the delicate apparatus necessary for this work out of his own pocket. The credit of the brilliant physical investigations carried on in that laboratory is naturally due to Professors Barus and Hallock, who conducted them, but it was King's acumen and good judgment that was responsible for their selection, and his action that made it possible for them to carry on their work. To himself, as he says ten years later in his paper on the Age of the Earth (this *Journal*, vol. xlv, Jan. 1893), he reserved the privilege of "making geological applications of the laboratory results." The experiments on the physical constants of rocks contemplated were to be directed to the determination (a) of the phenomena of fusion, (b) of those of elasticity and viscosity, and (c) of those of heat conductivity, each considered with special reference to their dependence on temperature and pressure.

The paper on the Age of the Earth, mentioned above, is his only published result, and was but an earnest of what he had planned to do. This was an attempt to advance to new precision Kelvin's estimate of the earth's age deduced from terrestrial refrigeration. It consists mainly of a mathematical discussion of the earth's thermal age as determined from various postulates presented by Laplace, Geo. H. Darwin, and Lord Kelvin, and based on Barus' determinations of the latent heat of fusion, specific heat, melted and solid, and volume of expansion between the solid and melted state, of the rock diabase. This is followed by a critical examination of other methods of determining the earth's age—by tidal retardation, by sun-age, and by variations of eccentricity. After a careful scrutiny of all the data on the effect of pressure on the temperature of consolidation, King concluded that, without further experimental data, "we have no warrant for extending the earth's age beyond 24 millions of years," an estimate which, as the result of a somewhat more extended discussion, was afterwards confirmed by Lord Kelvin himself. (*Smithsonian Report*, 1897, p. 345.)

His further investigations along the same general lines on the fundamental principles of upheaval and subsidence were in an advanced stage of completion when they were cut off by his untimely death.

It is practically impossible to adequately characterize King's literary work, for the greater part of what he did was never published, and very likely never even written. It was his habit to work out in his head any subject which interested him, even down to its minutest details, before putting a pen to paper; once this was accomplished to his satisfaction, he wrote with such ease and rapidity that the words actually flowed from his pen. Probably one reason that he did not write more was that his own literary taste was so refined and exacting that he was never thoroughly satisfied with his own conceptions. In his scientific writing, there was generally some imperious necessity that made it urgent upon him to give his results to the public in spite of the imperfections he might still see in them, but in literature such necessity rarely appeared. What he did publish he himself held in comparatively light esteem, but in the opinion of the best literary writers of the day, with most of whom he was on terms of friendly and intimate intercourse, his writings, and even more his affluent and delightful talks, disclosed a literary quality that might have given him a foremost place among American men of letters.

His one literary book, "Mountaineering in the Sierra Nevada," went through more editions in England than in this country and was very generally regarded there as far the best book of its kind that had ever been written. It was primarily a series of articles giving an account of his early experiences in California among the mountains that he loved so well and the peculiar people that he met. He undertook it, he once said, as an experiment to see if it were possible to write scenic description in such a way that the general public would read it.

Of his occasional articles in current periodicals, two appeared in the *Century* in 1886, and three in the *Forum*. Of the latter, two on Cuba, published in the years immediately preceding the Spanish War, were written under the impulse of strong feelings of sympathy with the cause of the insurgents, with whom he had come into intimate personal contact during a winter spent on the island at the country house of a friend.

Of his *Century* articles, one was a delicate tribute to his closest friend, John Hay, as one of the biographers of Lincoln; the other, a short sketch of his search for the "Helmet of Mambrino" for a fellow Cervantista, was that which more than anything he ever published disclosed the exquisite deli-

cacy of his literary touch, which rivaled that of Howells or James, and an even rarer quality of wit than Bret Harte's.

King was a man of remarkably robust physique, and showed throughout his physically arduous life powers of endurance that are rarely equaled; yet it was one of the penalties of the highly sensitive and nervous organization, which rendered possible his marvelously acute and delicate perception, that he was subject to sudden and almost unaccountable break-downs in which he suffered intensely. His last severe illness was an attack of pneumonia in the early part of 1901, which followed an examination of a mining property during very inclement weather. From this he recovered, but tuberculosis, the seeds of which were supposed to have been sown during a trip to the Klondike during the previous summer, made such rapid progress during the following months that, after several changes of climate in the vain hope of ameliorating his condition, he finally passed away, quietly and without suffering, on the 24th day of December in the year 1901.

It was part of his characteristic unselfishness that he effectually discouraged all offers on the part of friends and relations to visit him—visits which might have cheered his last lonely days in that far distant region.

S. F. EMMONS, Washington, D. C.

#### BIBLIOGRAPHY.

- "Mountaineering in the Sierra Nevada."—Boston, 1870.
- "Mining Industry" (With J. D. Hagne),  
Vol. iii of the Fortieth Parallel Reports—  
Gov't. Printing Office, Washington, 1870.
- "On the Discovery of Actual Glaciers on the Mountains of the Pacific Slope,"  
Am. Jour. Sci., 3d Ser., vol. i, p. 157, 1871.
- "Notes on observed glacial phenomena and the terminal moraine of the  
N. E. glacier,"  
Proc. Boston Soc. Nat. Hist., vol. xix, p. 60, 1876.
- "Paleozoic subdivisions of the Fortieth Parallel,"  
Am. Jour. Sci., 3d Ser., vol. xi, p. 475, 1876.
- "Notes on the Uinta and Wahsatch Ranges,"  
Ibid., p. 494.
- "Catastrophism and Evolution,"  
Am. Nat., vol. ii, p. 449, 1877.
- "Systematic Geology,"  
Vol. i of the Fortieth Parallel Reports,  
Gov't. Printing Office, Washington, 1878.
- First Annual Report of the U. S. Geological Survey,  
Gov't. Printing Office, Washington, 1880.
- "On the Physical Constants of Rocks,"  
U. S. Geol. Survey, 3d Ann. Report, p. 3,  
Gov't. Printing Office, Washington, 1883.
- "The Age of the Earth,"  
Amer. Jour. Sci., vol. xlv, Jan., 1893.
- "The Helmet of Mambrino," *Century*, p. 154, May, 1886.
- "The Biographers of Lincoln," " " p. 861, Oct., 1886.
- "The Education of the Future," *Forum*, p. 20, Mar., 1892.
- "Shall Cuba be Free?" " " p. 50, Sept., 1895.
- "Fire and Sword in Cuba," " " p. 31, Sept., 1896.

## SCIENTIFIC INTELLIGENCE.

## I. CHEMISTRY AND PHYSICS.

1. *The Manufacture of Sulphuric Acid by the Contact Process.*—In an address before the German Chemical Society KNIETSCH has given an interesting account of the development of a method for the manufacture of sulphuric acid which is evidently destined to revolutionize this great industry, in supplanting the use of the old lead-chamber method. Since 1831, when Phillips in England discovered the fact that sulphur dioxide and oxygen can be made to combine in contact with finely-divided platinum, many efforts have been made to apply this and other catalytic agents to the practical manufacture of sulphuric acid, but until within a few years the problem has remained unsolved. The success of the process at the "Badische Anilin- und Soda-Fabrik" has been due to a long series of carefully conducted experiments. A serious obstacle encountered was the difficulty of properly purifying the gases from the pyrites-furnaces so that they would not quickly destroy the activity of the platinum, which is used in the form of platinized asbestos. Traces of arsenic were found to be one of the chief causes of this trouble, and by proper cooling and washing, and by actually filtering the gases it was finally possible to remove all solid particles, so that the platinum remained effective for an unlimited time. It was found that a temperature of about  $450^{\circ}$  C. is most favorable for the reaction, hence instead of heating the platinized asbestos, as was formerly thought necessary, it has been found desirable to cool it after the process has been started. The fact that the mass action of an excess of one of the reacting gases has an important influence upon the completeness of the reaction was discovered; hence the reaction is practically complete with the gases from pyrites burners containing about three times the necessary oxygen. The process is particularly adapted to the manufacture of fuming sulphuric acid and the anhydride, but there can be little doubt that it will be the method of the future for the production of the ordinary acid. The statement is made that the production of sulphuric anhydride by this process at the "Badische" works amounted to 116,000 tons in the year 1900. The address as published gives many valuable data in respect to the physical properties of all strengths of sulphuric acid, including the melting-point, specific-gravity, specific heat, heat of solution, electrical resistance, action on iron, boiling-point, vapor-pressure, viscosity, and capillary action.—*Berichte*, xxxiv, 4069. H. L. W.

2. *Metallic Carbides.*—MOISSAN has recently published a review of the present knowledge of this subject, to which he has been the most prominent contributor. The following carbides are not decomposed by water:  $\text{Fe}_3\text{C}$ ,  $\text{Cr}_3\text{C}_2$ ,  $\text{Cr}_4\text{C}_3$ ,  $\text{Mo}_2\text{C}$ ,  $\text{WC}$ ,  $\text{W}_2\text{C}$ ,  $\text{VC}$ ,  $\text{ZrC}$ , and  $\text{TiC}$ . The iron carbide,  $\text{Fe}_3\text{C}$ , exists in

steel. It may be prepared by heating the components to 3000° in the electric furnace and pouring the mass into water. Diamonds are formed where great pressure exists in the interior of the regulus, and well crystallized  $\text{Fe}_3\text{C}$  can be separated from the product by dissolving the metallic iron in dilute acid. If the product be slowly cooled, the greater part of the carbon separates as graphite and ordinary cast-iron results. The carbides of chromium, molybdenum, tungsten, vanadium, zirconium and titanium are all well-crystallized substances produced by means of the electric furnace, and in general they are very stable in their behavior with acids, etc.

The carbides which are decomposed by water are,  $\text{Li}_2\text{C}_2$ ,  $\text{K}_2\text{C}_2$ ,  $\text{Na}_2\text{C}_2$ ,  $\text{CaC}_2$ ,  $\text{SrC}_2$ ,  $\text{BaC}_2$ ,  $\text{CeC}_2$ ,  $\text{LaC}_2$ ,  $\text{PrC}_2$ ,  $\text{NdC}_2$ ,  $\text{SaC}_2$ ,  $\text{YC}_2$ ,  $\text{ThC}_2$ ,  $\text{Al}_4\text{C}_3$ ,  $\text{Be}_2\text{C}$ ,  $\text{Mn}_3\text{C}$  and  $\text{U}_3\text{C}_3$ . Sodium and potassium carbides are prepared by the action of acetylene gas upon the metals. They are decomposed at high temperatures, hence they cannot be prepared by the electric furnace method. On the other hand, the other alkali-metal, lithium, forms a carbide at high temperatures. This is transparent and well crystallized. The alkali-metal carbides and also those of calcium, strontium and barium yield acetylene,  $\text{C}_2\text{H}_2$ , when they are treated with water. It is calcium carbide which is extensively used for the preparation of this gas. The commercial product is dark in color from impurities, but when pure it is transparent and colorless. Aluminum and beryllium carbides can be prepared by means of the electric furnace; both of these give methane,  $\text{CH}_4$ , with water, according to the following equations:

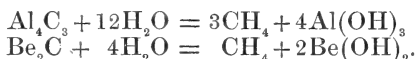

The carbides decomposable by water, that have been mentioned, give off a single gas, either acetylene or methane, when thus decomposed, but the others produce more than one product. Manganese carbide gives methane and hydrogen as follows:



Uranium carbide gives a mixture of acetylene, ethylene, methane and hydrogen; cerium and lanthanum carbides give mixtures of acetylene, ethylene, methane, and some liquid and solid hydrocarbons; yttrium, neodymium, praseodymium, samarium, and thorium carbides give acetylene, methylene and methane, and in some instances hydrogen also.

Certain metals, such as gold, bismuth, and tin, dissolve no carbon in the electric furnace, while copper dissolves very little. Silver dissolves some carbon at the temperature at which it evaporates, but most of this separates upon cooling. The platinum metals dissolve carbon readily at high temperatures, but it separates as graphite when the metals solidify.

Moissan advances the theory, somewhat similar to one proposed by Mendeléeff many years ago, that petroleum, in some instances, has been produced from carbides. He believes that

formerly all the carbon in the earth existed in the form of carbides, and that these have been gradually decomposed by the action of water.—*Zeitschr. für Electrochem.*, viii, 44. H. L. W.

3. *Potassium Hydride*.—It has been found by MOISSAN that the action of hydrogen upon metallic potassium at  $360^{\circ}$  gives a white compound which sublimes in crystals and has a composition corresponding to the formula KH. The substance is exceedingly sensitive to the action of moisture, and it takes fire at ordinary temperature when exposed to fluorine, chlorine or dry oxygen. It seems probable that Gay-Lussac and Thenard's supposed compound  $K_2H$  was a mixture of the true hydride with metallic potassium, since Moissan has found that the action of hydrogen on potassium is very slow.—*Comptes Rendus*, cxxxiv, 18. H. L. W.

4. *On Electrical Conductivities produced in Air by the Motion of Negative Ions*.—Professor TOWNSHEND (*Phil. Mag.*, Feb., 1901) has shown that negative ions produced in a gas are capable of disintegrating other molecules by collision, and thus of generating other ions. This subject has been further studied by P. J. Kirkby, whose experiments confirm Professor Townshend's general result, who finds that there is a remarkable difference in the behavior of positive and negative ions when moving in a small pressure under electric force. The negative ions have the property of disintegrating other molecules when colliding with them, while the positive ions do not appear to have this property. Professor J. J. Thomson has found from experiments with ultra violet light the mass of the negative ion to be  $3 \times 10^{-26}$  of a gram. Professor Townshend finds  $4.5 \times 10^{-24}$  as the weight of a molecule of hydrogen. This makes  $6.6 \times 10^{-23}$  as the corresponding weight for air, which is more than three times the number given by Meyer (*Kinetic Theory of Gases*, art. 121). If it is assumed that the negative ions produced by the Röntgen rays are identical with those produced by ultra-violet, the molecules of air are 2200 times the size of the negative ion according to the above numbers. If the positive ion is what remains after the negative ion is detached from it, it follows that the positive ion does not materially differ in mass from the ordinary molecule in air. It far exceeds in magnitude the negative ion, and the mean path of the latter exceeds that of the former. Professor Townshend finds  $.47^{\text{mm}}$  as the path of the negative ion in  $1^{\text{mm}}$  pressure of air. The corresponding path of the positive assumed to be equal to that of the molecule of air is about  $.094$  of a millimeter. This must be multiplied by  $\sqrt{2}$  when the ion is moving under electric force.—*Phil. Mag.*, Feb., 1902, pp. 212-225. J. T.

5. *On a kind of Radio-activity imparted to certain Salts by Cathode Rays*.—Dr. J. C. McLENNAN gives in this paper an account of a research which shows that certain salts which show no radio-activity as ordinarily prepared exhibit this property in a very marked manner on being gently heated after exposure to cathode rays. The radiation emitted was sufficient to discharge

positively electrified bodies but not negatively electrified ones, and could not impart a charge to an unelectrified body. A list of the substances is given together with an account of the instruments employed. The author thinks it probable that the salts on being heated emit a stream of negatively charged particles or corpuscles, which are drawn to the positively charged gold leaf of the electrometer by the electrostatic field and thus discharge it.—*Phil. Mag.*, Feb., 1902, pp. 195–203. J. T.

6. *Radio-active Bodies*.—M. P. CURIE and Madame S. CURIE show that in uranium, thorium, radium, and probably actinium, the radio-activity remains constant, if the chemical and physical states of these substances remain unchanged. Polonium, however, appears to be an exception to this rule.—*Comptes Rendus*, Jan. 13, 1902. J. T.

7. *Outlines of Electrochemistry*; by H. C. JONES. Pp. 106, 8vo. New York, 1901 (The Electrical Review Publishing Co.).—The volume consists of a series of articles published previously in the *Electrical Review*. The author has aimed, apparently, to present the subject of electrochemistry so that it could be understood by any one with a moderate knowledge of chemistry, and we believe he has succeeded most admirably. His chapters on electromotive force are particularly good. The same may be said of the chapters relating to the conductivity of solutions and the velocity of the ions. We wish that Professor Jones had extended the chapters on electrolysis somewhat, so as to include more of the technical applications. H. W. F.

8. *Die Chemische Organisation der Zelle*. Ein Vortrag von FRANZ HOFMEISTER. Pp. 29. Braunschweig, 1901. F. Vieweg und Sohn. Mk., 0.60.—Most writers on the functions of the living cell have built up their theories on the basis of purely morphological considerations. In this lecture, intended for the meeting of German Men-of-Science at Hamburg, Professor Hofmeister points out that the biological processes of cells are mostly chemical in nature and that therefore a new standpoint must be assumed before further advances in our understanding of these processes can be made. Even the modern physiological study of elementary organisms does not promise to throw much light on the problems involved. For protoplasm is no simple mechanical structure; its activity is rather dependent upon the chemical elements involved therein, and these are present in all their complexity in even the simplest forms of life. The author attempts to tell us what must be the make-up of the living cell in order that protoplasm—the functions of which are chemical—may accomplish its work. The manifold reactions of liver cells are selected to show how the cell is in reality a well-equipped chemical laboratory. Hydrations, oxidations, reductions, condensations,—all are accomplished through the activity of catalytic agents, colloidal in nature, which are the important agents in the chemical transformations of the cell. The rôle of the intracellular enzymes, reversible in their action, is thus presented in a new

light. The possible significance of individual peculiarities in morphological structure is also considered in this connection.

Professor Hofmeister concludes by pointing out that the consideration of the cell as a machine equipped with chemical and physico-chemical accessories does away with the necessity of calling upon other than well known forces for an explanation of the work done. There is to-day no occasion to set up the doctrine of "Ignorabimus," or to assume the existence of some additional, indefinite, *vital force*.

L. B. M.

9. *Beitraege zur Chemischen Physiologie und Pathologie*, herausgegeben von FRANZ HOFMEISTER. I. Band, 7/9 Heft. Braunschweig, 1901 (F. Vieweg und Sohn). — This number of the *Beitraege* includes the results of an elaborate chemical study of the active constituents of "immune" sera, by Dr. E. P. Pick of Prag; and five investigations of physiological-chemical interest, from the laboratory of Professor Hofmeister in Strassburg. Among the latter are contained demonstrations of the existence of phenyl-anilin as a constituent complex in the proteid molecule, as indicated by the preparation of cinnamic acid from the decomposition products (by Ducceschi and Spiro); a study of the transformations of albumoses by the gastric mucosa (Glaessner); and an investigation suggesting the preëminent importance of the liver for the synthesis of aromatic ethereal sulphates in the animal body (Embden and Glaessner). In the same number Wróblewski and his co-workers have brought new evidence of the destructive action of certain enzymes upon one another.

Heft 10/12. The ten contributions in this number cover too many departments of chemical physiology to receive detailed mention here. Attention may be called, however, to the discovery of oxyphenylethyl-amine as a product of pancreatic digestion (Emerson) and to two papers on the proteid chemistry of plants. (Iwanoff; Czapek.) Nine laboratories are represented. A survey of the table of contents of the first volume of the *Beitraege*, just completed, will, in our opinion, justify the promise previously expressed by the reviewer, that the new journal has a future of usefulness.

L. B. M.

## II. GEOLOGY AND NATURAL HISTORY.

1. *On the occurrence of Chrompicotite in Canada*; by G. CHR. HOFFMANN, of the Geological Survey of Canada. (Communicated by permission of the Director.)—This variety of chromite—a mineral hitherto found in but one locality, namely, at Dun Mountain, in New Zealand—has been somewhat recently met with, in considerable quantity, in veins or dikes in the volcanic series of the Miocene Tertiary, on Scottie Creek—a stream flowing into the Bonaparte—about nine hundred feet west of its first tributary on the south side and some seven miles east of Mundorff, in the district of Lillooet, province of British Columbia.

The mineral, which is massive, with a fine to somewhat coarse granular structure, is associated with a pale yellow serpentine,



small quantities of white to grayish-brown quartz and of white felspar, and a very small quantity of a green chromiferous silicate. It has a velvet-black color, and is opaque; in very thin sections, however, it is translucent, and brownish-red by transmitted light. The luster is submetallic. It breaks with an uneven fracture; is very brittle; and affords a grayish inclining to blackish, brown streak. It is non-magnetic. Its specific gravity, at 15.5° C., is 4.239. Before the blowpipe, both in the outer and inner flame, it remains unchanged. With borax, it gives a bead which, in the oxidizing flame, is yellow while hot, and pure green when cold; and in the reducing flame, is of a fine emerald-green color, both hot and cold. With salt of phosphorus it yields a limpid glass which, in the oxidizing flame, while hot, appears yellowish, and on cooling, assumes a fine green color; whilst in the reducing flame, the bead is greenish while hot, and bright emerald-green when cold. It is not acted upon by acids.

The mean of two very closely concordant analyses, conducted by Mr. R. A. A. Johnston, showed this mineral to have the following composition:

Chromium sesquioxide .....	55.90
Alumina .....	13.83
Ferrous oxide .....	14.64
Magnesia .....	15.01
Silica .....	0.60
	<hr/>
	99.98

The presence of the silica would indicate that, notwithstanding the great care exercised by Mr. Johnston in the preparation of the material employed by him for analysis—a matter attended with considerable difficulty, even with the aid of heavy solutions—the same was, nevertheless, not absolutely free from all traces of some of the associated minerals.

2. *Still Rivers of Western Connecticut*; by WILLIAM HERBERT HOBBS. Bull. Geol. Soc., vol. xiii, pp. 17–26, pls. i–ii.—In this paper two rivers, viz.: Still River between Danbury and New Milford and Still River at Winsted, are described and their life history traced.

3. *Petrographisches Praktikum*; by R. RHEINISCH. Erster Theil: Gesteinbildende Mineralien. Pp. 135, 8vo, 82 figs. in text. Berlin, 1901 (Gebr. Borntraeger).—The author states in his preface that this work is intended for those who desire only a general knowledge of the subject or wish to take it up by themselves. After a preliminary description of the making of thin sections and the microscope, the various important rock-making minerals are treated, with the introduction when necessary of optical or chemical means of discrimination. The work presupposes some knowledge of mineralogy, optics and chemistry. It is designedly of elementary character, for the use of beginners, and in this field should prove useful.

L. V. P.

4. *The Grasses of Iowa*; by L. H. PAMMEL, J. B. WEEMS and F. LAMSON-SCRIBNER (Bull. 1, Iowa Geological Survey), pp. 1-525, woodcuts in text 220, 1901.—This is an elaborate scientific discussion of the grasses of the state by botanists, though published as the first of the Bulletins of the Geological Survey, which is authorized to publish on subjects “of economic interest relating to the Natural History of the State.” It is a paper one would naturally look for among the agricultural reports. The illustrations present numerous histological details as well as representations of the form and modes of growth of the plants.

5. *The Birds of North and Middle America*; by ROBERT RIDGEWAY. Part I, Family Fringillidæ—the Finches. Pp. xxx, 715; with 20 plates. Washington, 1901 (Bulletin No. 50, U. S. Nat. Museum, Smithsonian Institution).—The comprehensive character of this valuable work will be seen from the statement in the preface that it is intended to describe in it “every species and subspecies, or definable form, of bird found on the continent of North America, from the arctic districts to the eastern end of the Isthmus of Panama, together with those of the West Indies and other islands of the Caribbean Sea (except Trinidad and Tobago) and the Galapago Archipelago; introduced and naturalized species being included as well as accidental or casual visitors.”

### III. MISCELLANEOUS SCIENTIFIC INTELLIGENCE.

1. *The Smithsonian Institution; Documents Relative to its Origin and History*, 1835-1899, compiled and edited by WILLIAM JONES RHEES, in two volumes, vol. ii, 1887-1899, pp. xvi, 1045-1983.—This second volume of the valuable compilation of Smithsonian Documents, noticed in the December number of this Journal (p. 473), has recently been issued and completes this important work.

2. *Scientia*.—This valuable series, published in Paris by G. Carre and C. Naud under the above name, has received the following additions:

Production et emploi des Courants alternatifs; par L. Barbillon. (Phys.-Mathématique, No. 11.) Pp. 103, 1901.

La Série de Taylor et son prolongement analytique; par J. Hadamard. (Phys.-Mathématique, No. 12.) Pp. 102, 1901.

*Knowledge Diary and Scientific Hand-book for 1902*. Pp. 112. London, 1901. Issued in conjunction with “Knowledge” (Knowledge Office, 326 High Holborn). The varied scope of this volume will be seen from the following statement of its contents. It contains original descriptive articles on the observation of comets and meteors; how to use an equatorial telescope; the microscope and its uses; aids to field botany; hints on meteorology; and monthly astronomical ephemeris. Also the paths of the principal planets for the year, illustrated with charts; astronomical notes and tables, with an account of the celestial phenomena of the year; and twelve star maps showing the night sky for every month in the year, with full descriptive account of the visible constellations and principal stars; a calendar of notable scientific events; an obituary for the year.

THE

# AMERICAN JOURNAL OF SCIENCE

[FOURTH SERIES.]

---

ART. XXI.—*On the Use of the Stereographic Projection for Geographical Maps and Sailing Charts*; by S. L. PENFIELD.

*Introduction.*—Maps are generally made by first plotting a system of parallels and meridians, which are then used as guide-lines for locating places, and tracing the outlines of countries, courses of rivers, etc. Numerous methods of plotting parallels and meridians have been employed, some based upon exact mathematical principles of projection, others upon geometrical methods of development, while others are wholly arbitrary schemes and have no mathematical justification, hence, as might be expected, the results of map drawing are quite various, and often far from satisfactory. It is of course impossible to represent the curved, bulging surface of a sphere upon a plane without distortion of some kind, and this may become very pronounced if the extent of country covered by the map is large, but still there is no just reason for the marked variations and discrepancies which may be observed on maps in general use at the present time.

It is not the object of the present communication to enter into a detailed discussion of the general subject of map projection. On the other hand, an endeavor will be made to set forth certain advantages which would result from using a well known method of projection, known as the *Stereographic*. Attention will also be called to certain misconceptions which seem to exist concerning this most admirable method of projection.

Doubtless all will agree that maps should fulfil three important requirements: First, the shapes of land and water

areas on maps should appear as nearly as possible the same as on a globe. This requires that the spaces included between the projected parallels and meridians should be nearly the same, proportionately, as on a sphere, and that angles are preserved, or but slightly distorted. Second, if a map is published with a scale of miles, it should be possible by means of it to measure distances between places with reasonable accuracy. This is a most important consideration, for most persons must rely wholly upon maps for the estimation of distances. The determination of distances by calculation, requiring a knowledge of spherical trigonometry and the use of formulas and tables of logarithms, is far too laborious to be generally applicable. Lastly, the tracks of great circles, the directions along which the shortest distances between places on a sphere are measured, should be found easily on maps, and angles should be preserved so that bearings may be taken. This last consideration is a most important factor in navigation. In the pages which follow it will be shown to what extent maps based upon the stereographic projection fulfil the aforementioned requirements.

In a previous communication entitled "*The Stereographic Projection and its Possibilities, from a Graphical Standpoint*,"\* the principles of the projection have been set forth by the present writer, and special scales and protractors were described by means of which it was possible not only to plot all kinds of problems in spherical trigonometry with facility and accuracy, but, also, to measure the parts of triangles thus plotted. A considerable portion of the paper was devoted to a discussion of the possibilities of applying the principles of the stereographic projection to *map making*, and the present article may be considered as an elaboration of the ideas there presented. It is not considered necessary to discuss again the principles of the stereographic projection, but for the benefit of those who may not be familiar with the subject a brief statement of some of its essential features may not be out of place.

*Essential Features of the Stereographic Projection.*—Stereographic maps are based upon a very simple principle of projection. The point from which the lines of projection emanate, which may be regarded as the *point of vision*, is at the surface of the sphere, and it may be imagined that one is looking as it were through a hollow earth at the surface opposite. The plane upon which the projection or map is made must be at right angles to the diameter of the sphere which passes through the point of vision. It is generally convenient

\* This Journal (4), xi, pp. 1-24 and 115-144, 1901.

to consider the plane of the projection either as passing through the center of a sphere, figure 1, or as tangent to it, figure 2, but, provided its direction is not changed, the position of the plane may be altered without in any way affecting the character of the projection; the size becomes greater as the plane is shifted to a position farther from the center.

Figure 1 is a photographic reproduction of a model constructed by the writer which needs but little explanation.

1

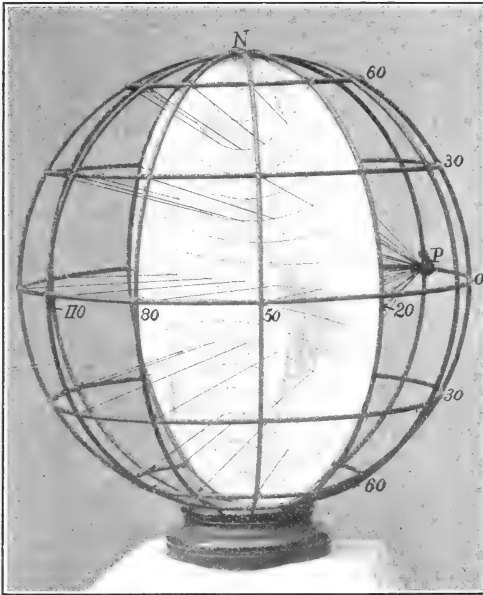

Model for illustrating the principle upon which the stereographic projection is based.

The original skeleton sphere, made of wire, is eighteen inches in diameter, and the map of the Western Hemisphere, drawn on cardboard, is inserted at the center. Following the custom of geographers, the meridian bounding the map is numbered  $20^{\circ}$  W. ( $160^{\circ}$  E.), and the plane upon which the map is drawn is at right angles to a diameter running from the intersection of the 110th meridian and the equator to the point *P*. Lines of projection are indicated by threads running from *P* to the intersections of the meridians with the parallels and equator.

Figure 2 is a diagram plotted in clinographic projection, the same as is used in drawing crystal figures. The original draw-

ing was plotted with much care on a large scale, hence the construction of the figure may be regarded as reasonably exact. It represents the lines of projection extending from  $P$  to a plane tangent to the sphere at a point antipodal to  $P$ , which, in this case, is the intersection of the equator with the

2

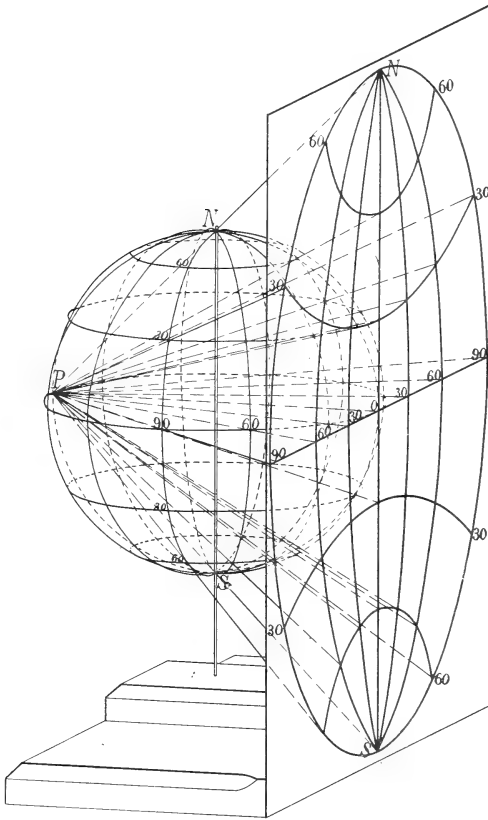

Diagram for illustrating the principle of the stereographic projection upon a tangent plane.

meridian numbered  $0^\circ$ . A bright light held close to a skeleton sphere in a position corresponding to  $P$ , would cast a shadow of the parallels and meridians upon a tangent plane corresponding exactly with the lines shown in figure 2. If figure 2 is viewed with one eye through a short cylinder made by rolling up a sheet of paper, or through, as it were, a tube formed by doubling up the hand, the lines of the drawing will

stand out with rather surprising stereoscopic effect, making the figure appear much more real. It is believed that a careful consideration of either of the figures here presented will serve to convey a clear idea of the principles upon which the stereographic projection is based.

Three kinds of stereographic maps come under consideration: (1) projection upon the plane of the equator, when the point of vision is at one of the poles; (2) projection upon the plane of a meridian, when the point of vision is at some point on the equator; while (3) if the point of vision is at any position other than the ones mentioned, the map may be considered as made on a plane tangent to the sphere at the antipodal point: such a map is said to be made upon the plane of the horizon, and the latitude and longitude of the point of tangency should be given.

Important features of the projection are as follows: As shown by figures 1 and 2, when a circle of a sphere passes through the point of vision it is projected as a straight line on the map, while all other circles are projected as *circles*,\* which appear generally as *portions of circular arcs* on maps. This is a most important feature, for no other lines can be more accurately constructed than circles, and by making use of a few simple mathematical principles it is possible to project a system of parallels and meridians, *the very foundation of a map*, with almost absolute accuracy. Angles are preserved, and the stereographic is the only true projection which possesses this important feature, although by methods of development maps are produced (the so-called Mercator's projection, for example) where angles are preserved. A given distance is represented by varying lengths on different parts of a stereographic map, but the distortion of distances is of a nature deserving most careful consideration. Starting from the center of a hemisphere, the distances from degree to degree become gradually greater as the periphery is neared; the rate of increase, however, is very slight at first. Within a radius of  $90^\circ$  from the center the maximum variation is such that the distance from the eighty-ninth to the ninetieth degree fails just a little of being twice as great as from the center to the first degree. This important subject of distortion will be considered more fully in a later paragraph. In spite of distortion, however, distances may be measured with facility and accuracy on stereographic maps, provided use is made of specially devised *Stereographic Protractors* previously described by the writer.† These may be of various forms; one of which is represented, much reduced, by figure 3, and the use of this and other forms,

\* This Journal (4), xi, pp. 8-13, 1901.

† Loc. cit., pp. 17-23.

as applied to map measurement, will be illustrated by numerous figures later. The protractor shown in figure 3 is nothing else than a series of great circles and small circles, corresponding to the meridians and parallels of half of a hemisphere, stereographically projected upon the plane of a meridian. The lines may be printed or engraved on some transparent material, such for example as celluloid, which is almost ideal for the purpose.

When the stereographic protractors were described by the present writer he was not aware that similar devices had ever been made use of before, and he is indebted to Mr. G. W. Littlehales of the Hydrographic Office at Washington for calling

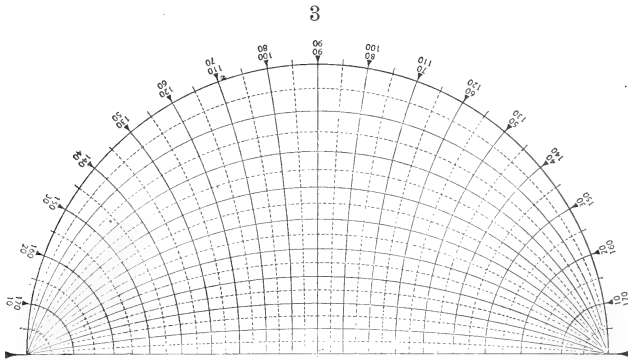

Stereographic Protractor with great circles and small circles; five degree graduation.

his attention to the fact that for purposes of navigation Chauvenet had previously suggested the use of a protractor based upon the same principles. Chauvenet's discovery seems to be known to but few, and the only information which the writer has been able to find concerning it is contained in a letter from Mr. Littlehales, as follows: "The original plates of the Great Circle Protractor now in the possession of the Hydrographic Office show by the inscriptions engraved upon them that the Protractor was originally known as Professor William Chauvenet's Great Circle Protractor. The plates appear to have been purchased by the Bureau of Navigation from Professor Chauvenet about the year 1867 and used for many years thereafter by the Hydrographic Office for the issue of prints. I am unable to discover when the method was originally devised by Professor Chauvenet."

Chauvenet seems never to have developed the full possibilities of his protractor, though they must have been evident to him; moreover, at the time his protractor was first described it could scarcely have been regarded as a wholly practical and



serviceable working instrument, for in order to bring it to anything like perfection there was needed some cheap and strong transparent material, such as celluloid, on which to print or engrave it.

*Historical.*—Before proceeding to a discussion of maps it will be well to consider briefly the history of the stereographic projection. It is said to have been invented by the astronomer Hipparchus, who lived at Rhodes about 150 B. C. It is also said that Ptolemy, sometimes called the father of geography, who lived at Alexandria about 150 A. D., employed the projection in making maps of the then known world. Almost the best description of the projection which the writer has seen appears in a publication entitled "A New and Complete Dictionary of Arts and Sciences, Illustrated with Copper Plates engraved by Mr. Jefferys, Geographer to his Majesty. By a Society of Gentlemen." Printed in London in 1764. It may be owing to Mr. Jefferys' connection with the editorial staff that the article on maps is rather more elaborate than one finds generally in such publications. At all events, the principles of the projection and methods of making maps are admirably set forth, and figures are introduced of the northern and southern hemispheres, and of a hemisphere on the plane of the horizon of London. In discussing the maps, attention is called to the distortion which they exhibit, and the statement is made that "the course and distance between places is neither with ease or exactness found in this projection." The *Encyclopædia Britannica* in its article on geography gives an admirable account of the stereographic projection, but closes the discussion somewhat abruptly as follows: "Notwithstanding the facility of construction, the stereographic projection is not much used in map making." This, as far as the writer has been able to discover, is a correct statement. Prior to one hundred years ago the projection was generally used, while of modern publications the writer knows only of a few school geographies in which the hemispheres are in stereographic projection, while for maps of limited areas it is seldom if ever used.

There seems to be a want of exact information concerning maps by those who teach geography, as well as lack of appreciation of those features which count for so much in maps, namely, facility of construction, combined with accuracy. In several treatises on Map Projection of quite recent date which have been examined, the stereographic projection is passed over hurriedly, as though it had no special value for map making, while it will be one of the chief objects of this communication to demonstrate that, all things considered, it is by far the best of all projections for geographical maps.

As an illustration of misconception concerning the projection, attention may be called to some statements and illustrations observed in a Physical Geography intended, as stated on the title page, "for the use of Schools, Academies and Colleges." In the chapter on *Mathematical Geography* the following statement concerning maps was observed: "The pro-

4

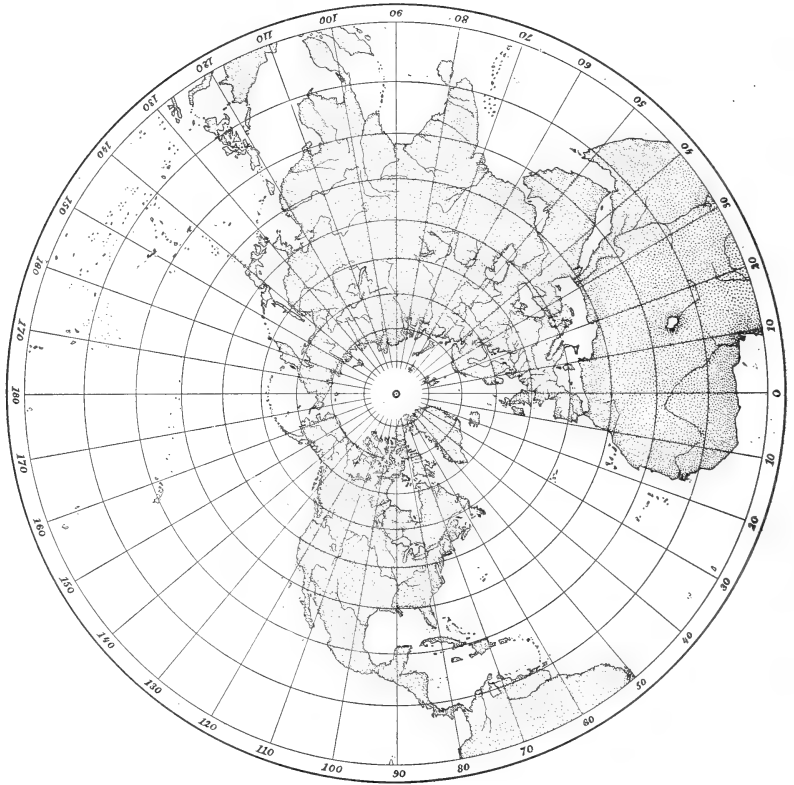

Stereographic Map of the Northern Hemisphere.

jections in most common use are Mercator's, the orthographic, the stereographic and the conical. Of these the stereographic is best adapted to ordinary geographical maps and Mercator's to physical maps." Then, after giving correctly the principles upon which the stereographic projection is based, it is stated that "the two stereographic projections in most common use are the *Equatorial* and the *Polar*," while the accompanying illustrations are not stereographic, but the so-called *globular projections* of the hemispheres, which will be referred to later.

*Projection upon the plane of the Equator.*—This is the simplest kind of stereographic projection. The meridians appear as straight lines, figure 4, and the parallels as concentric circles. The lengths of the radii for describing the parallels may be determined by projection,\* but are best taken from tables, as described in a note at the close of this article. Attention may be called to the fact that, in spite of distortion, the shapes of the countries shown on the map are admirably preserved, as may be seen by comparing the map with a globe.

In order that such a subject as Mathematical Geography may be in every way practical it must be made exceedingly simple. In the writer's earlier communication, already referred to, Plate II represented an engine divided projection upon the plane of the equator; that is, a system of meridians and parallels projected with practically *absolute accuracy*. In connection with such a plate it is now proposed to use an engine

5

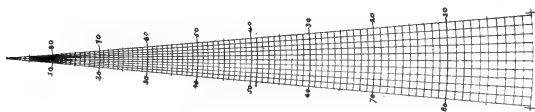

divided scale, figure 5, printed on tracing paper, which may be placed over a projection of corresponding size, between any two meridians. To locate a place of given latitude or longitude, for example New York,  $40^{\circ} 43' \text{ N.}$ ,  $74^{\circ} \text{ W.}$ , it is only necessary to adjust the scale between the appropriate meridians on the map, find the desired location, and then puncture with a needle point through the scale to the plate below. With an engraved plate one foot in diameter and an accompanying scale, figure 5, it would be crude plotting if places were not located within a quarter of a degree of their true geographical position on the plate, and, with care, errors of over five miles ought not to occur.

In figure 6 several places are shown as they were located on a  $14^{\text{cm}}$  ( $5\frac{1}{2}$  inch) diameter, engine divided plate, from the following data:

Greenwich .....	$00^{\circ} 00'$	$51^{\circ} 23' \text{ N.}$
San Francisco .....	$122 25 \text{ W.},$	$37 47 \text{ N.}$
Honolulu .....	$158 00 \text{ W.},$	$21 30 \text{ N.}$
Northern Luzon .....	$121 00 \text{ E.},$	$19 00 \text{ N.}$
M .....	$105 00 \text{ E.},$	$52 30 \text{ N.}$

\* The methods of making the projection have been given by the writer in an earlier communication. Loc. cit.

The great circles shown, such as from Northern Luzon, Philippine Islands, to San Francisco, Luzon to Honolulu, etc., were drawn on the plate. The illustration also shows a celluloid protractor, figure 3, over a portion of the plate in position suitable for measuring the distance from Luzon to San Francisco. Starting from the upper zero of the protractor, Luzon

6

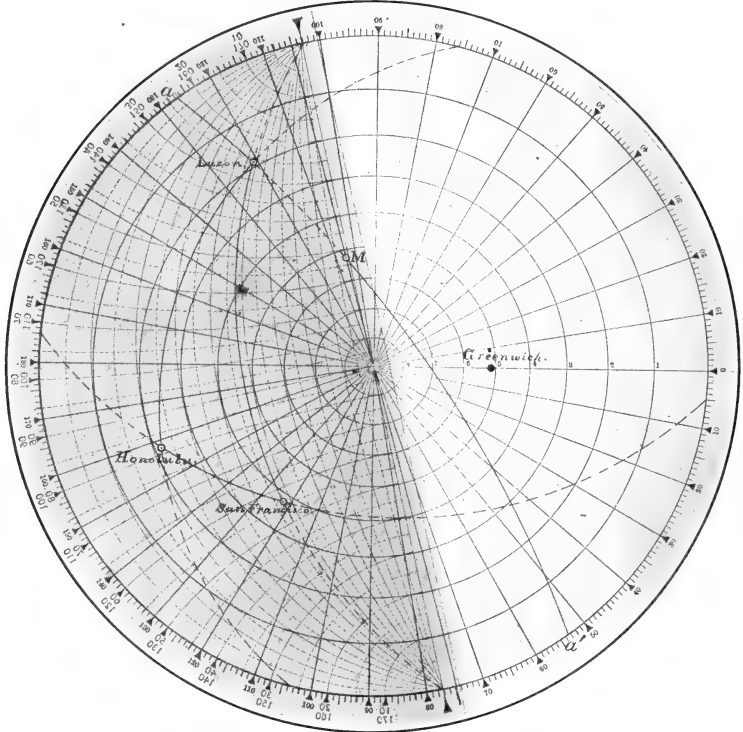

Stereographic Protractor adjusted for measuring from Luzon to San Francisco along the arc of a great circle. See Note.

is about  $26^\circ$  and San Francisco about  $124^\circ$  from the periphery, and the difference,  $98^\circ$ , is the distance. Using a protractor with finer graduation, such as shown in figure 12, the distance was

NOTE.—Figure 6 and other similar half-tone illustrations have been made from photographs of drawings over which stereographic scales, printed on transparent celluloid, have been laid. The celluloid being of a yellowish tone of color, those portions of the drawings covered by the protractors appear darker in the photographs and half-tones, and thus may be easily recognized. The lines on the original celluloid protractors are very fine, and appear still finer in the reduced half-tones, but it is believed that they are sufficiently distinct for purpose of illustration.

found to be  $97^{\circ} 50'$ , while by calculation it is  $97^{\circ} 45'$ . To measure from Luzon to Honolulu, and from Honolulu to San Francisco, along the great circles drawn on the plate, it would be necessary to turn the protractor about its center until its  $0^{\circ}$  and  $180^{\circ}$  points corresponded with the intersections of the equator with the two great circles shown in the figure. The distances, as measured with the protractor shown in figure 12, were  $75^{\circ} 5'$  and  $34^{\circ} 30'$ , as against  $75^{\circ} 7'$  and  $34^{\circ} 40'$  by calculation.

Even when it is desired to measure from the northern to some point in the southern hemisphere, it may be accomplished easily. Take, for example, from Luzon to the western entrance of the Strait of Magellan: Referring to an atlas sheet of South America, the entrance to the Strait is found to be  $75^{\circ}$  W.,  $52^{\circ} 30'$  S., hence the antipodal point,  $M$ , figure 6, is located in the northern hemisphere on the continuation of the seventy-fifth meridian ( $105^{\circ}$  E.) at  $52^{\circ} 30'$  N. Measurement is then made from Luzon to  $a$ , on the equator, and, taking up the measurement from the opposite point, from  $a'$  to  $M$ , along that portion of the great circle indicated by a full line. This distance measured with a protractor was found to be  $144^{\circ} 10'$  as against  $144^{\circ} 15'$  by calculation. Another way would be to measure from Luzon to  $M$ , along that portion of the great circle which is dashed, when the supplement value gives the desired distance from Luzon to the Strait. The track of the great circle indicated by the diagram could not be sailed, as it runs through Australia and other islands. Another and simpler method of measuring from one hemisphere to another will be indicated in a later paragraph.

In addition to facility of construction, projections on the plane of the equator are especially adapted to ready measurement of angles, since a meridian through any point, which gives a true north and south direction, is a straight line. Methods of measuring spherical angles have already been described by the writer,\* and figure 7 is an illustration, taken from crystallography, of a still simpler method of making such measurements. It is recommended to use a special protractor  $PP$ , having the lines of graduation continued to near the center, and which could easily be engraved by means of a dividing engine. From  $a$ , figure 7, to the nearest point marked  $d$  is  $45^{\circ}$ , and three great circles running from  $a$  to  $d$  intersect at the points lettered  $o$ ; the angles made by the meeting of the great circles at  $o$  being exactly  $60^{\circ}$ . To measure an angle, the protractor, printed on transparent celluloid, is centered as at  $o$ , figure 7, its  $0^{\circ}$ - $0^{\circ}$  line is made to coincide

\* Loc. cit., pp. 18 and 19.

with a diameter, and it may then be told by inspection what line of the protractor is tangent to the great circle under consideration. In the example cited it is evident that the  $60^\circ$  lines of the protractor are tangent to the great circle arcs passing through  $o$ . With such a protractor it is probable that angles could be measured to within a quarter of a degree or closer, depending upon the size of the projection.

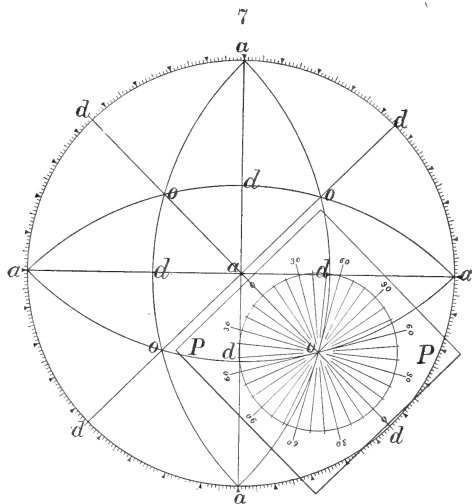

Method of measuring spherical angles at the point  $o$  by means of a transparent protractor,  $PP$ .

*Projection upon the plane of a Meridian.*—Figures 8 and 9 represent the Western and Eastern Hemispheres in stereographic projection on the meridian  $20^\circ$  W.,  $160^\circ$  E., from Greenwich. The construction of the meridians and parallels is a very simple matter. A circle of any desired size and two diameters at right angles to one another are first drawn. The points of intersection of the meridians with the equator and of the parallels with the central meridian are next determined, best from a table, while the radii of the several meridians and parallels are likewise taken from tables described in a note, at the close of this article. Attention may be called to the following interesting relations which may at times be useful. The center points about which the meridians  $10^\circ$ ,  $20^\circ$ , etc., from the periphery are described are the stereographically projected  $20^\circ$ ,  $40^\circ$ , etc., points on the equator, measured from the center. The lengths of the radii for describing the parallels  $10^\circ$ ,  $20^\circ$ , etc., from the poles are the distances from the center of the map to the stereographically projected  $20^\circ$ ,  $40^\circ$ , etc.,

points. Notwithstanding these relations and the facility with which all necessary intersections may be determined by methods of projection, as generally recommended in treatises on the stereographic projection, in practice it will be found that measurements derived from tables, as suggested, will make the work not only much easier, but, what is of far greater import-

8



Stereographic Map of the Western Hemisphere.

ance, more accurate. By making use of the graphical methods, described by the writer in a previous communication, the network of meridians and parallels may be constructed in a remarkably short space of time; in fact, this projection, though seemingly more complicated, is scarcely more so than the one made on the plane of the equator, figure 4.

Attention is invited to a comparison between the shapes of the continents as they appear on the maps, figures 8 and 9, and on a globe, when the latter is turned so as to show the

shapes of the several land areas to best advantage: also to a comparison between the shapes of the North American Continent on the two kinds of maps, figures 8 and 4. It will thus be found that the shapes of the continents have not been materially altered by mapping in stereographic projection. One effect of distortion may be seen by observing, for example,

9



Stereographic Map of the Eastern Hemisphere.

Greenland in two positions, figures 8 and 4. The shape is well shown on either map, but it appears considerably larger near the periphery than when near the center. Variation in size, however, is not a matter of so great importance, since on all maps the distances between the parallels, as measured along a meridian, give a measure of length, and in either position it may be seen that Greenland is about  $22^{\circ}$  (1320 geographical miles) long, with a width at the 70th parallel of about  $10^{\circ}$  (600 miles).



Ability to follow the tracks of great circles and to make all kinds of measurements on maps is of course a most important feature, and figure 10 gives the partial solution of the problem of navigating a ship by great circle sailing from the Hawaiian Islands, *H*, to New York by way of the Strait of Magellan, *M*. The figure represents a map (the original was 14<sup>cm</sup> diameter) with a stereographic protractor over it, so adjusted as to

10

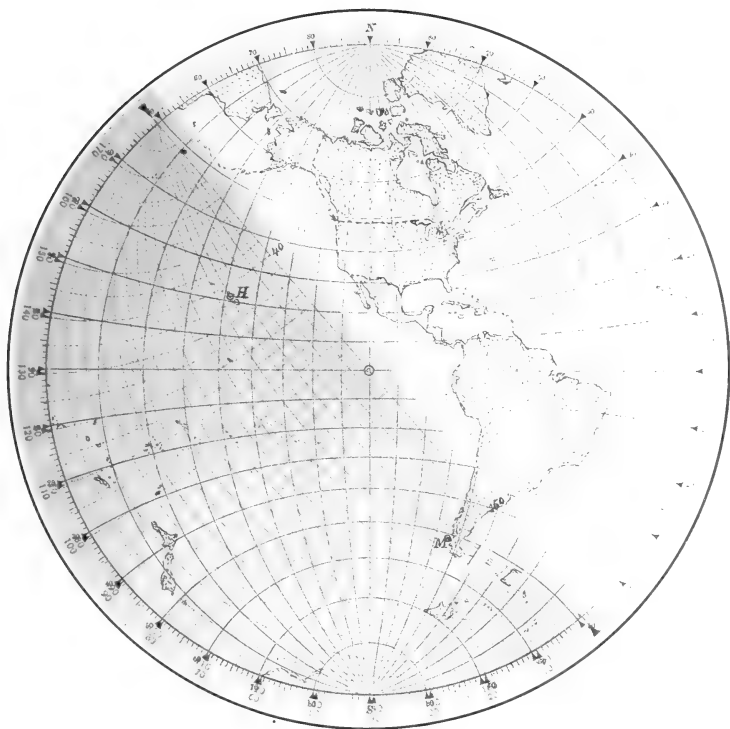

Stereographic Protractor adjusted for finding the great circle track from Honolulu, *H*, to the Strait of Magellan, *M*, and measuring the distance.

bring *H* and *M* on the same great circle, indicated by the pointer. The distance is determined by the small circles; thus, starting from the top, or zero of the protractor, *H* is at about  $43^\circ$ , and *M* at  $146^\circ$  from the zero-point, and the difference,  $103^\circ$ , is the distance. The great circle track from which bearings may be taken is the circular arc *HM*. After traversing the Strait, portions of three great circles may be followed, shown in figure 11; thus, from *M* to *a*, from *a* to *b*,

and from *b* to New York. Figure 11 illustrates another kind of stereographic protractor, designated by the writer in an earlier paper\* as No. IV, and its use in finding any great circle track, as, for example, that from *b* to New York, is almost too simple to need explanation. One has merely to center the protractor and turn it until some great circle is found which passes through the desired points or close to

11

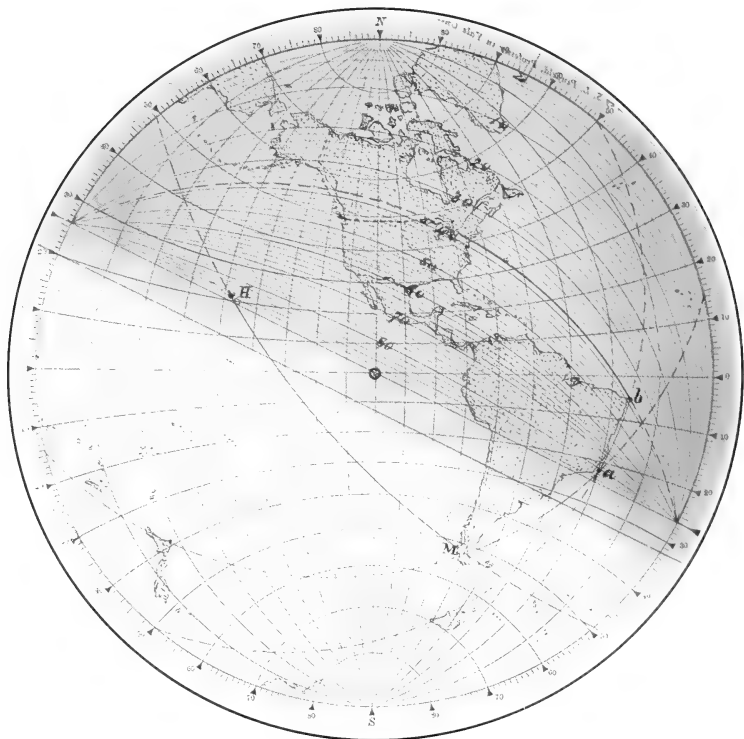

Stereographic Protractor adjusted for finding the great circle track from *b* to New York. Other great circles, *H* to *M*, *M* to *a* and *a* to *b*, have been drawn on the map. Great circles only are printed on the protractor.

them. In order to measure the distances a protractor like the one shown in figure 12 may be employed, and by using it the distances to be sailed in going from Honolulu to New York were found to be as follows: From *H* to *M*  $103^{\circ}$ , through the Strait  $5\frac{1}{2}^{\circ}$ , from the Strait to *a*  $37^{\circ}$ , from *a* to *b*  $17^{\circ}$ , and from *b* to New York  $58\frac{1}{2}^{\circ}$ , a total of  $221^{\circ}$ , or 13,260 geographical

\* Loc. cit., pp. 21 and 22.

miles. It takes but a few minutes to make such a series of measurements, and the results are accurate. Moreover the method is so simple that any one could easily be taught to use the protractors and thus learn an important lesson in mathematical geography.

Figure 12 represents the method of solving the following problem: To find the distances from New York to Buffalo,

12

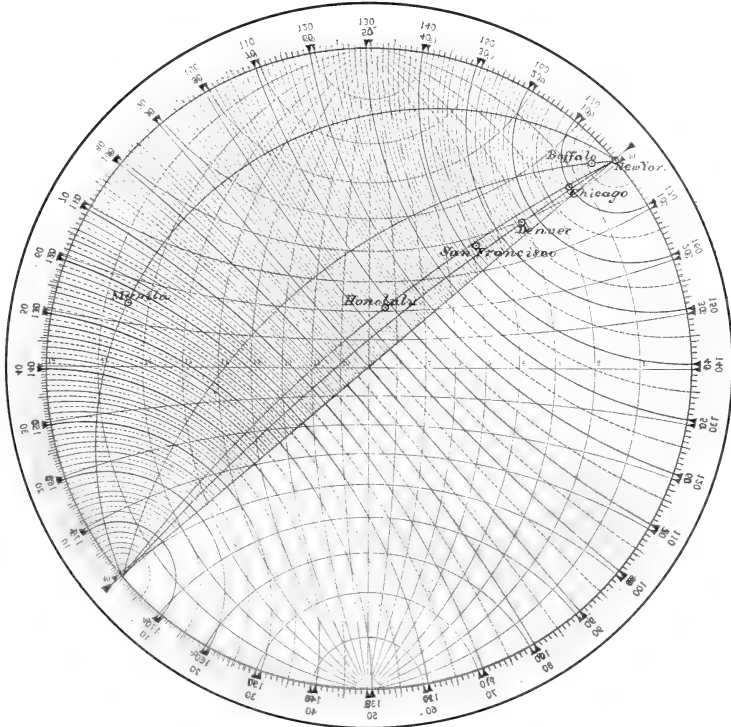

Stereographic Protractor adjusted for measuring from New York to Buffalo, Chicago, Denver, San Francisco and Manila. Small circles only are printed on the protractor.

Chicago, Denver, San Francisco, Honolulu and Manila, the latitudes and longitudes of the places being given. The places were located on a 14<sup>cm</sup> diameter, engine divided plate from the following data:

	New York.	Buffalo.	Chicago.	Denver.	San Francisco.	Honolulu.	Manila.
Lat.	40° 43' N.	42° 53'	41° 50'	39° 45'	37° 47'	21° 20'	14° 36'
Long.	74 00 W.	78 55	87 34	105 0	122 25	157 55	239 8
Long. of New York	74 00	74 00	74 00	74 00	74 00	74 00	74 00

Long. W. from New York	Buffalo	Chicago	Denver	San Francisco	Honolulu	Manila
	4 55	13 34	31 00	48 25	83 55	165 8

New York is located on the outer circle, which is taken as its meridian, at  $40^{\circ} 43' N$ . The longitudes of the remaining places with reference to New York are obtained by subtracting the longitude of New York from them, as indicated above, and they are then located at their given latitudes. A few great circles have been drawn on the plate, from New York through Denver, Honolulu, Buffalo and Manila, but for the sake of measurement it was not necessary to construct them. After locating the places, a celluloid protractor\* was placed over the plate and a photograph taken from which figure 12 has been made. Only small circles are printed on the protractor, and, as they fall close together, the scheme was adopted of representing every tenth degree by a heavy line, the intermediate even degrees by full, and odd by dashed lines. The dots within the circles represent the locations of the several places. By careful inspection of the figure it may be seen that, starting from New York, Buffalo is a little over  $4^{\circ}$ , Chicago a little over  $10^{\circ}$ , Denver about  $23\frac{3}{8}^{\circ}$ , San Francisco a little more than  $37^{\circ}$ , Honolulu just short of  $72^{\circ}$  and Manila just over  $123^{\circ}$ . The results of the readings of the protractor as stated above, and of still another plotting of this same problem, together with the calculated values, are given below:

Distances from New York.	Buffalo.	Chicago.	Denver.	San Francisco.	Honolulu.	Manila.
Calculated	$4^{\circ} 18'$	$10^{\circ} 16'$	$23^{\circ} 34'$	$37^{\circ} 9'$	$71^{\circ} 49'$	$123^{\circ} 2'$
Measured	$\left\{ \begin{array}{l} 4 \ 5 \\ 4 \ 20 \end{array} \right.$	$\left\{ \begin{array}{l} 10 \ 10 \\ 10 \ 5 \end{array} \right.$	$\left\{ \begin{array}{l} 23 \ 40 \\ 23 \ 40 \end{array} \right.$	$\left\{ \begin{array}{l} 37 \ 10 \\ 37 \ 10 \end{array} \right.$	$\left\{ \begin{array}{l} 71 \ 55 \\ 71 \ 45 \end{array} \right.$	$\left\{ \begin{array}{l} 123 \ 5 \\ 123 \ 5 \end{array} \right.$

It may be said of this and of every similar example cited in this article that measurements with the protractors have been made without knowledge of the calculated values. The superiority of the stereographic projection is evident from the results of the example just cited, where the maximum error from two independent solutions of the problem was but  $13'$  (15 statute miles) and the average error but a trifle over  $5'$ . It is further to be taken into consideration that in this example a whole hemisphere was projected within a circle of  $14^{\text{cm}}$ ,  $5\frac{1}{2}$  inches, diameter. It is of course evident that by increasing the size still greater accuracy would be attained. To locate places with accuracy on a plate with only ten degree spacing of the parallels and meridians requires some experience. In the example just cited places were located by means of the graphical methods described by the writer in a previous article. To gain an idea of how accurately measurements may be made on an engraved plate,  $14^{\text{cm}}$  diameter, using no other guide than the eye in interpolating places between the ten degree spaces,

\* Designated by the writer in an earlier paper as No. II. Loc. cit., p. 17.

the problem given above was twice plotted, and measured as shown in figure 12, with the following results:

Distances from New York.	Buffalo.	Chicago.	Denver.	San Francisco.	Honolulu.	Manila.
Calculated	4° 18'	10° 16'	23° 34'	37° 9'	71° 49'	123 2'
Measured	{ 3 50	10 15	23 50	36 45	72 00	123 00
	{ 4 10	9 55	23 40	36 45	71 50	123 00

The maximum error here amounts to 28', and the average is 12': Hence an accurate plate and a protractor is all that is needed for quickly solving problems with close approximation to the truth.

To locate places easily and at the same time accurately it is recommended to use, in connection with an engine divided plate as already described, a projection of the parallels and meridians, figure 13, printed on tracing paper. When matched over a plate of corresponding size, any place may be located by puncturing with a needle point through the protractor to the plate below.

Figure 13 is a reproduction by photo-engraving of a stereographic projection 18 inches in diameter, published by Captain C. D. Sigsbee, U. S. N., in an atlas folio entitled "Graphical Methods for Navigators."\* Captain Sigsbee's protractor is practically identical with Chauvenet's *Great Circle Protractor* and was perhaps printed from Chauvenet's original plate in possession of the Hydrographic Office. It is circular, and figure 13 represents only half of it, reduced to 14<sup>cm</sup> diameter to correspond with the engine divided plate described by the present writer. A serious objection to the use of such a protractor when on a small scale, is that the lines are so crowded as to be confusing. This difficulty, however, is to a great extent obviated by using two protractors, one having only great circles, the other only small circles, as shown in figures 11 and 12, respectively.

An excellent summary of graphical methods applied to great circle sailing, based upon the stereographic projection, may be found in a publication by Mr. G. W. Littlehales† of the U. S. Hydrographic Office, Washington.

*Stereographic Map of the World. Planisphere of the Antipodes.*—Figure 14 represents a combination of stereographic projections of the western and eastern hemispheres, which it is believed would make a most useful kind of a map. It is scarcely necessary to state that the northern and southern hemispheres might be combined in a similar manner. The important feature of the map is that any point on one of the

\* U. S. Hydrographic Office, Washington, 1896.

† The Development of Great Circle Sailing. Washington: Government Printing Office, 1899, p. 36.

hemispheres covers the antipodal point on the other. In order to accomplish this the poles are reversed, and one of the hemispheres must be like a negative in photography. Thus,

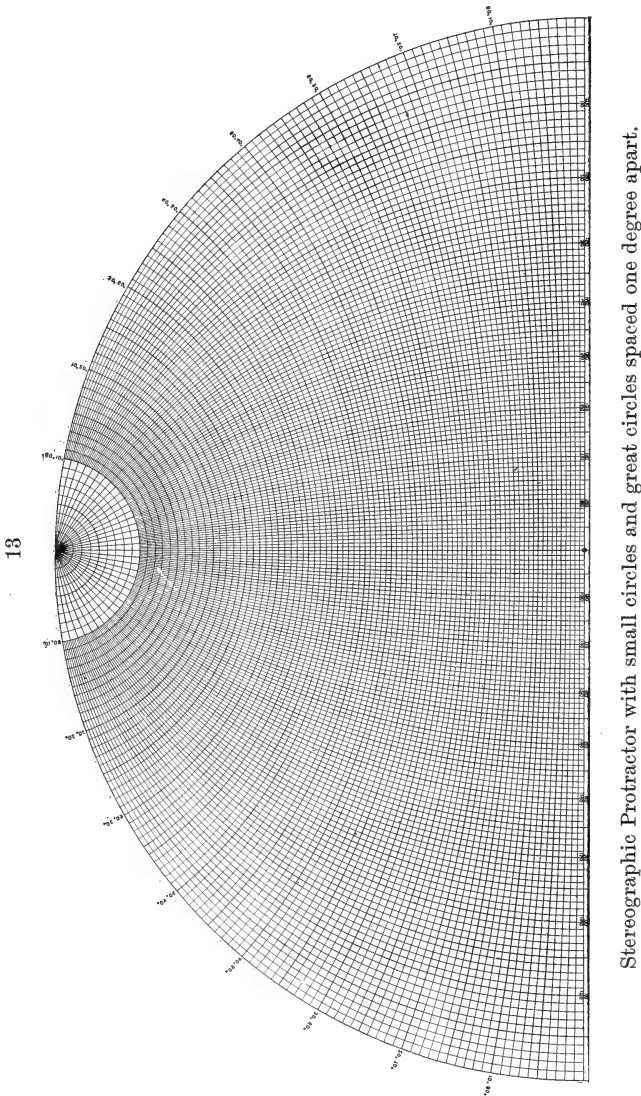

Stereographic Protractor with small circles and great circles spaced one degree apart.

in figure 14, the western hemisphere appears as we are accustomed to seeing it, while the eastern hemisphere may be made to appear right, as in figure 9, page 258, by turning

the page upside down and viewing the figure reflected from a mirror. It is believed that the reversal of one of the hemispheres is a feature that will not prove especially confusing to those well accustomed to maps. The effectiveness of the map would be much enhanced if skillfully engraved on a large scale and printed in two colors, one for each hemisphere, selected so

14



Stereographic Map of the World. Any point on one hemisphere covers the antipodal point on the other.

as to give a pronounced and pleasing effect where overlaps of land surfaces occur. Such a map, issued with a protractor, would be most useful for finding out great circle tracks, and making all kinds of measurements in mathematical geography. Some examples will serve to indicate the uses of the map, which is supposed to be accompanied by a stereographic protractor. The two hemispheres must be kept distinctly apart in thinking of the problems, and will be designated as *W.H.*, western, and *E.H.*, eastern, respectively.

To sail from the English Channel to the Gulf of Mexico; the great circle track (*E.H.*) is from *E* to *a*,  $10^\circ$ , and (*W.H.*) from *a'* to the southern end of Florida,  $52^\circ$ . Such are our imperfect ideas concerning a sphere and geographical relations, as derived from ordinary maps, that probably few imagine that in sailing the shortest distance from the English Channel to the Gulf of Mexico the course on leaving the Channel would be nearly due west, in fact a little north of west, as shown by figure 14.

From the English Channel to the Strait of Magellan; the track would be (*E.H.*) from *E* to *b*,  $27^\circ$ , and (*W.H.*) from *b'* to *b''*,  $54^\circ$ . The same great circle, if continued, would carry to Cape Horn. To proceed to the Strait of Magellan another track would be taken from *b''*, as shown in figure 11, page 260.

From Northern Luzon, Philippine Islands, to San Francisco; the track is (*E.H.*) from *L* to *c*,  $40^\circ$ , and (*W.H.*) from *c'* to San Francisco,  $57^\circ$ . The course of this great circle, skirting close to Japan and running not far from the Aleutian Islands, is different from what most people would expect from being familiar with seeing the places on a Mercator's chart.

The great circle track from Northern Luzon to the western entrance to the Strait of Magellan is (*E.H.*) from *L* to *d*,  $89^\circ$ , and (*W.H.*) from *d'* to *M*,  $55^\circ$ . The track, as shown on the map, leads through the Philippine Islands and Australia, and quite close to the Antarctic Continent. In order to sail from Luzon to the Strait two great circle tracks may be followed, thus: (*E.H.*) from *L*, keeping north of the Solomon Islands, to *e*,  $47^\circ$ , and (*W.H.*) from *e'* to *e''*,  $4^\circ$ , then from *e''* to *M*,  $100^\circ$ .

Lastly, the great circle track from New York to the Cape of Good Hope is (*W.H.*) from New York to *f*,  $64^\circ$ , and (*E.H.*) from *f'* to the Cape,  $50^\circ$ . Continuing this great circle track around the world, it leads from the Cape of Good Hope across the Indian Ocean, Australia and New Guinea to *f* in the Pacific Ocean, and from *f'* across the Pacific Ocean and the northern United States to New York. One has but to try to trace some great circle tracks on a sphere to appreciate how difficult it is to follow them exactly, while with a map, such as shown in figure 14, and a protractor they may be followed with the greatest ease.

It appears worth while to call attention to an erroneous idea concerning geography which most people brought up in the eastern part of the United States seem to have acquired during childhood, namely, that if it were possible to pass through the center of the earth and come out on the opposite side they would find themselves in China. As shown by figure 14 the



point antipodal to New York is in the Indian Ocean, about 600 miles southwest of Australia.

If the idea of having two hemispheres projected on the same plane appears to some too confusing to be regarded as practical, it may be recommended to have in addition to the customary maps of the western and eastern hemispheres, two additional ones; one with  $30^{\circ}$  W. as the central meridian, thus giving a chart of the North and South Atlantic Oceans; the other with  $150^{\circ}$  E. as the central meridian, giving a chart of the North and South Pacific Oceans.

*Generalizations concerning Maps of the Hemispheres. Comparison with a Globe.*—Before closing the discussion of maps of the hemispheres, it is desired to call attention to a few facts concerning them. Considering their size, projections made upon the plane of the equator or of a meridian, figures 4, 8 and 9, are unquestionably as good and serviceable maps as any that can be made, regarded merely as representations of the earth's surface. When one has once become accustomed to them, and understands the nature of the distortion which they exhibit, they are even more useful than a globe. The writer does not wish to be misunderstood at this point. It is best that beginners should get their first ideas of geography from a globe, and this fact is recognized by teachers, and a globe is placed in the hands of every scholar in our best elementary schools. The small and inexpensive globes which are in common use, however, are necessarily rather crude, and one has but to examine a number of them to discover that the segments of which they are built up have not been pasted on and matched very carefully. They answer their purpose admirably up to a certain point, but when it comes to accuracy they fail. Large globes on the other hand are of necessity expensive, and there is always some question as to how accurately they are constructed. When it comes to studying the details of geography from globes, other difficulties are encountered; thus, if the globe is small, but few details can be shown on it, and only a portion of a hemisphere can be seen at once; perhaps not more than a third to good advantage, while with a large globe the portion seen is still less. In order to study relations where large portions of the earth's surface must be taken into consideration, if a globe is used it must be turned in order to see its several parts, and, even when experienced, it is difficult to keep in mind correct ideas of those portions which are either out of sight or but imperfectly seen. With stereographic maps, on the other hand, a hemisphere may be admirably shown, even the whole world, figure 14. Moreover, there is no difficulty in constructing the maps with extreme accuracy, so that, with suitable protractors, reliable measurements of all

kinds may be made on them. The hemispheres shown in figures 4, 8 and 9 were drawn by the writer with much pains, the diameter of the originals being one foot. They are approximately correct, but by constructing meridians and parallels for every degree, and making use of the best coast surveys, there is no reason why, on a map of a hemisphere one

15

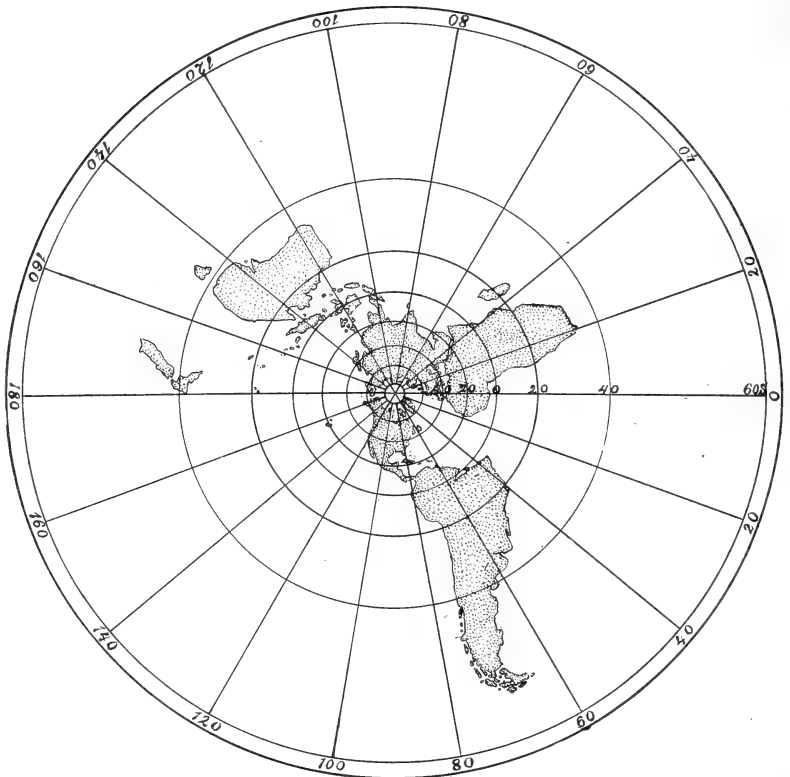

Stereographic Map of the inhabited portions of the World, extending from the North Pole to 60° south of the Equator.

foot in diameter, the outlines of all accurately surveyed land areas should not be traced within a quarter of a degree of their true geographical position. The drawing of the parallels and meridians for every degree should be for the guidance of the engraver; every tenth degree only should be shown on the completed map. The location of cities should be not far from five miles from their true position, and the maps should not be crowded by too much detail. Accurate maps as just described should have distinct educational value, and would open up new

possibilities in mathematical geography. Maps of the hemispheres two feet in diameter would not be too large for convenient use, and they could be engraved with such accuracy that remarkably exact measurements could be made on them.

*Stereographic Map including more than a Hemisphere.*—All of the inhabited portions of the world may be shown on one map, as illustrated by figure 15, which is a stereographic projection on the plane of the equator, copied from a figure given by G. W. Littlehales,\* with omission of some of the

16

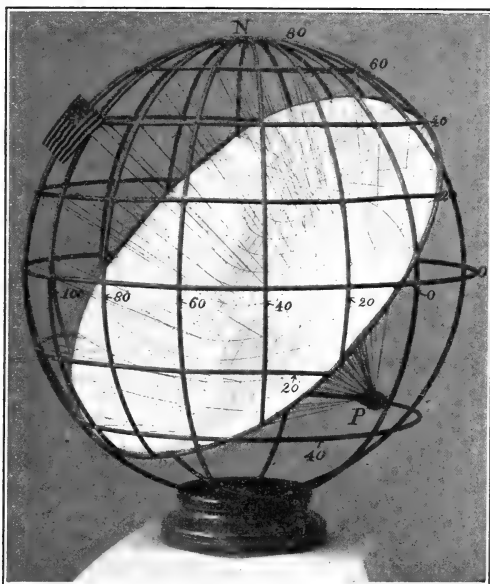

Model for illustrating the principle of the stereographic projection upon a plane at right angles to a given diameter.

details. The projection extends from the north pole to  $60^\circ$  south of the equator, and distortion on a map covering so large an area is very great. Although the land areas in the southern hemisphere appear grotesquely stretched out, they are probably no more distorted than Greenland on Mercator's projection. It is not suggested that maps of this kind should be used; the illustration is introduced merely to show some of the possibilities of the projection.

*Stereographic Projection upon the Plane of a Horizon.*—A most important feature of the stereographic projection is

\* The Development of Great Circle Sailing, loc. cit., p. 50.

that a map may be made on a plane tangent at any desired point on a sphere, or a plane parallel thereto at the center; and the results are equally satisfactory no matter where the point of tangency may be. As will be shown, the object of making this kind of a map is that any desired region may be projected at the center of a hemisphere, where distortion is

17

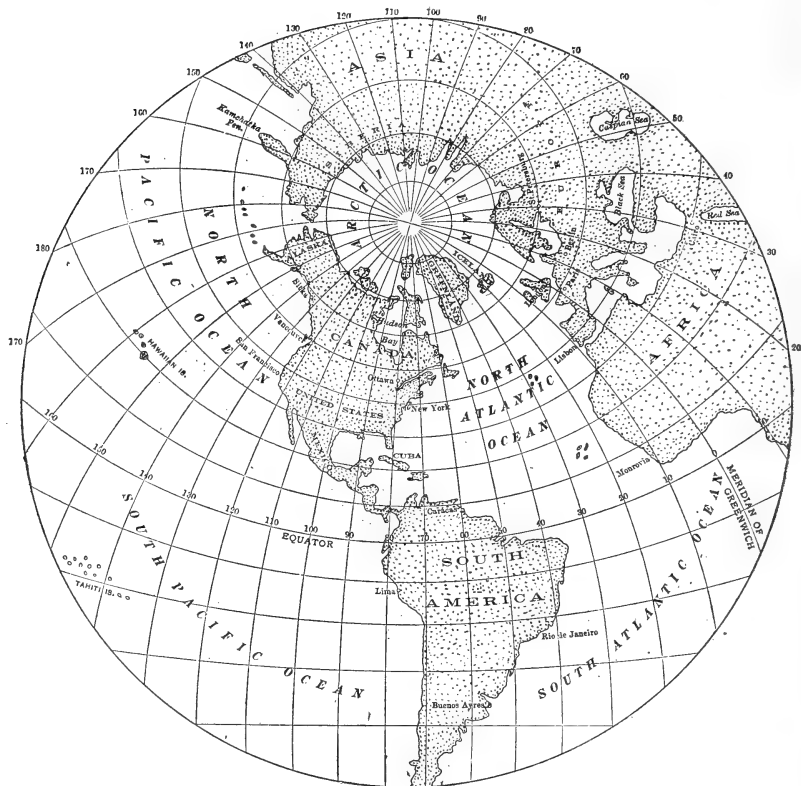

Stereographic Map of a Hemisphere upon the plane of the horizon at  $40^{\circ}$  N.,  $75^{\circ}$  W., near New York City.

least, and where, consequently, a country may be mapped with the best results. Figure 16 represents a model for demonstrating this kind of projection. The skeleton sphere is orientated with the *N. S.* pole vertical, and the meridians and parallels of the upper, front hemisphere are spaced  $20^{\circ}$  apart. The equator is easily recognized, and it is important to keep in mind two points, one, indicated by a flag, on the parallel  $40^{\circ}$  N. where it would be intersected by the meridian  $95^{\circ}$  W., the

other the antipodal point  $P$ . The plane upon which the map is drawn is at right angles to a diameter running from  $40^\circ$  N.,  $95^\circ$  W., to  $P$ . By reference to an atlas it will be seen that the point where the flag is located,  $40^\circ$  N.,  $95^\circ$  W., is near the center of the United States. The model is admirably represented by the figure, and no further description seems necessary.

Figure 17 is a projection upon the plane of the horizon at  $40^\circ$  N.,  $75^\circ$  W., very near to New York City. The projection of the parallels and meridians is the same as shown on the

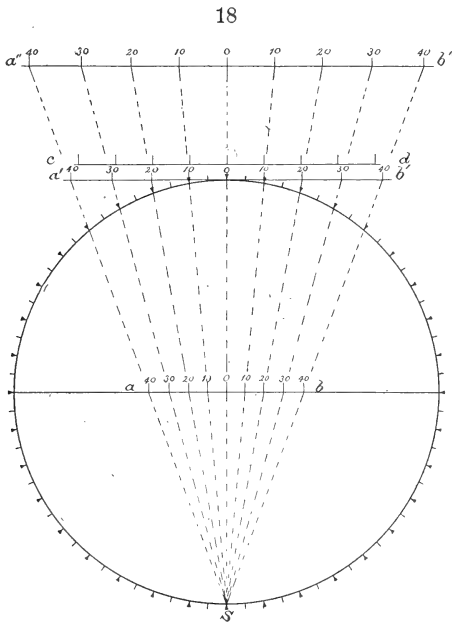

map in figure 16, but the meridians are numbered differently. The parallel  $40^\circ$  S. is a straight line on the map, and why it is thus represented is at once apparent from consideration of figure 16.

The principle of making a map on a plane tangent at any given point is not so important for the projection of hemispheres as for the mapping of limited areas, and in order to appreciate the advantages of this method of map-making it will be necessary to consider more carefully the character of the distortion near the center of a stereographic projection.

*Distortion resulting from the Stereographic Projection.*—

Figure 18 is a graphical method of representing the distortion. Let the divided circle represent any meridian with 0 as the

north and *S* the south pole. By means of lines running from *S* to the  $10^\circ$  graduation marks of the circle the several points,  $40^\circ$  either side of the center, are projected to the line *a b*, where they fix the points of a stereographic scale. As far as may be told by the eye, the scale *a b* appears equally spaced.

The lines of projection are also continued beyond the circle to the intersection with the tangent *a' b'*, where a stereographic scale is likewise determined, similar to *a b*, but relatively twice as long; or again the projection may be carried to *a'' b''*, parallel to *a' b'*, where a similar, but still more lengthened, scale is formed. At *c d* a scale has been interposed which represents spaces equal in length to  $\frac{1.0}{3.60}$ ths of the circumference

19

Assuming a diameter as 100 units, 10° on arc of a great circle = 8.72666		Increase expressed in per cent.
0° to 10° on stereographic scale =	8.74887	0.25%
10 - 20 " " " "	8.98383	1.80
20 - 30 " " " "	9.16222	4.99
30 - 40 " " " "	9.60210	10.03
40 - 50 " " " "	10.23375	17.27
50 - 60 " " " "	11.10428	27.25
60 - 70 " " " "	12.28570	40.78
70 - 80 " " " "	13.88921	59.16
80 - 90 " " " "	16.09004	84.38

of the circle, or, in other words, the distances from space to space on the line *c d* are the same as along the circumference of the circle for distances of  $10^\circ$ , following the curvature. Close inspection of the scales *a' b'* and *c d* fails to show any appreciable difference between the first lines ( $10^\circ$ ) either side of the center. If therefore a country to be mapped is not over  $20^\circ$  wide, the point of tangency may be taken at its center and the distortion resulting from the stereographic projection will be scarcely appreciable. If a country is  $40^\circ$  wide, at  $20^\circ$  either side of the center there will be perceptible, but still not very great distortion, as indicated by difference in the scales *a' b'* and *c d*. Even if the distance across a map is  $80^\circ$ , the distortion at  $40^\circ$  from the center is marked only near the periphery, and there it is not sufficiently great to seriously impair the usefulness of the map.

Still another way of representing the distortion is shown in figure 19. If a sphere is  $100\text{cm}$  in diameter, its circumference measures  $314.15927\text{cm}$ , and  $10^\circ$  of arc would equal  $8.72666\text{cm}$ . Considering a map projected upon a tangent plane of such a

sphere, figure 18, a distance  $10^\circ$  out from the point of tangency would be  $8.74887^{\text{cm}}$ , or but  $0.02221^{\text{cm}}$  longer than the distance of  $10^\circ$ , following the curvature. In like manner in figure 19 other  $10^\circ$  spaces of a stereographic scale are expressed in lengths, carefully plotted to scale, and the accompanying percentages give the increase over the length of  $10^\circ$  of arc. Thus it may be seen that in any of the stereographic hemispheres shown in earlier pages of this article there is greater distortion in the space between  $70^\circ$  and  $90^\circ$ , measured out from the center along a radius, than from the center out to  $70^\circ$ .

The foregoing examples serve to indicate that near the center of a stereographic map of any hemisphere there must be very little distortion, and in order to study the possibilities of a stereographic map of limited area, it was decided to make a projection of the United States on a large scale. The scale adopted was based upon a sphere of 1.8 meters (5.9 feet) radius, supposing the projection as made on a central plane, figure 16, page 269, and this particular scale was chosen in order to give a map corresponding in size with one issued by the U. S. Geological Survey, accompanying the Twenty-first Annual Report of the Director, 1899-1900. The dimensions of the government map are  $27\frac{1}{2}$  by  $16\frac{1}{8}$  inches, and parallels and meridians are drawn two degrees apart. Although not stated, it bears evidence of being based upon the Polyconic Projection which is used by the U. S. Coast and Geodetic Survey. The central meridian is  $97^\circ$  W. and its intersection with the parallel  $39^\circ$  N. is approximately the center of the map.

*Projection of a Map of the United States upon the Plane of the Horizon at  $39^\circ$  N.,  $97^\circ$  W.*—The essential details of making this kind of a map are illustrated by figure 20. The upper circle represents a vertical section (an elevation) through the N. and S. poles of a sphere, along what is to be the central meridian of the map. As  $39^\circ$  N. is to be the center of the map the N.S. pole is inclined  $51^\circ$  ( $90^\circ - 39^\circ$ ) from the vertical, and intersections of the meridian with the equator,  $EE'$ , the poles N.S., and the trace of the central plane upon which the map is projected,  $N'S'$ , are indicated by the graduation of the circle. P, at  $39^\circ$  S., is the point of vision. Numerous points on the central meridian are projected to the line  $N'S'$ , thus determining points which are needed in the construction of the map. The lower part of the figure represents the plane upon which the map is made, and, taken in connection with the elevation above, may be considered as a *plan*. The line  $N''S''$ , parallel to  $N'S'$ , is the projected central meridian,  $N''$  and  $S''$  being respectively the stereographically projected north and south poles. The circle I, of the same size as the meridian above, would bound the hemisphere, if the latter were fully

constructed. Having fixed the center of the hemisphere, the intersections of the several parallels with the central meridian,  $N''S''$ , may be projected down from the elevation above, and to find the center points and construct the circles which represent the projection of the parallels on the map scarcely needs

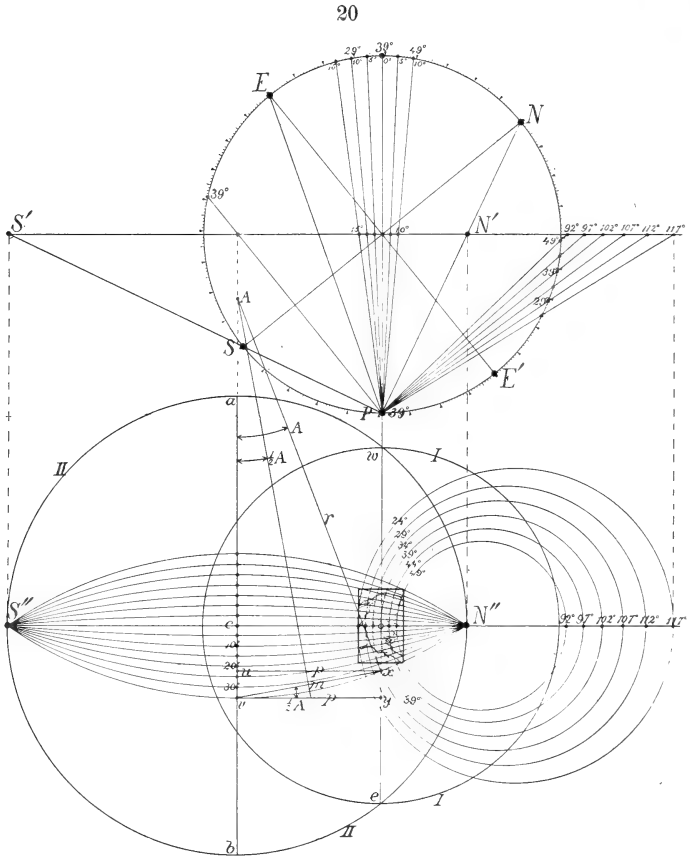

Illustration of the principles upon which a stereographic map of a limited area is constructed.

explanation. When drawing a map on a large scale the several intersections of the parallels with the central meridian, and the lengths of the radii for describing the parallels, are determined by calculation, making use of a table which will be explained at the conclusion of this article. To construct the meridians, the following principles are made use of: They are circular arcs passing through the stereographically projected north and south poles,  $N''$  and  $S''$ , and their centers must be on the line



$ab$ , figure 20, crossing the central meridian at  $90^\circ$ , just midway between  $N''$  and  $S''$ . The line  $ab$  is the stereographic projection of the parallel  $39^\circ$  S., which in this case is a straight line because  $P$  is at  $39^\circ$  S.; compare the projection of the parallel  $40^\circ$  S., figure 16, page 269. Since angles are preserved in the stereographic projection, the meridian must make equal angles with one another ( $5^\circ$ , figure 20) at  $N''$  and  $S''$ ; hence  $N''$  and  $S''$  may be considered as the poles of a projection on the plane of a meridian having a diameter  $N''S''$ , and the construction of the meridians is the same as described on page 256. In drawing a map, such as that of the United States, on a large scale, the location of the meridians and their curvature must be determined by calculation, and one example will illustrate how this may be done: On the diameter  $ew$ , passing through the center of the map at right angles to the line  $N''S''$ , it is desired to find the point  $x$  where that meridian intersects it, which is  $35^\circ$  from the center of the large circle II. Knowing the radius of the large circle II, the radius  $r$ , for describing the meridian which intersects the diameter  $ab$  at  $35^\circ$  from the center, may be found from a table described at the close of this article. A right triangle  $Aux$  may then be constructed, in which the hypotenuse  $r$  and the perpendicular  $p$  (equal to the distance from  $c$  to the center of the map) are known; hence from sine

$A = \frac{p}{r}$  the value of  $A$  may be found. Construct the chord  $vx$ ,

and from its center  $m$  draw a line to  $A$ ; the line  $mA$  bisects the angle  $A$ . Also it follows from the construction that in the triangle  $xvy$  the angle at  $v$  is equal to  $\frac{1}{2}A$ ; hence tangent  $\frac{1}{2}A = \frac{xy}{p}$ , from which the value  $xy$  may be calculated. The distance  $cv$  being known, and equal to the distance from the center of the map to  $y$ , the distance from the center of the map to  $x$  is readily determined.

A method like the foregoing was used in plotting the meridians of a large stereographic map of the United States. In addition to a construction line drawn through the center of the map, corresponding to  $ew$ , figure 20, two other lines were drawn parallel to  $ew$  at measured distances, one crossing near the top, the other near the bottom of the map. The points of intersection of the several meridians with the three construction lines were then calculated, and each meridian was drawn through the three points thus determined, making use of a large circular arc ruler. The calculation was not especially laborious, since only simple formulas were used, and the same quantities were repeated several times, so that to a certain extent the work becomes almost mechanical.

[To be continued.]

ART. XXII.—*On the Hind Limb of Protostega*; by S. W. WILLISTON.

ALTHOUGH the structure of those huge Cretaceous turtles, *Protostega* and *Archelon*, has been, for the most part, determined in recent years through the researches of Baur, Hay, Case and Wieland, little has hitherto been discovered concerning the limbs, aside from the humerus and femur. In examining the material of *Protostega* in the University of Kansas museum recently, I found a nearly complete hind limb collected by Mr. Charles Sternberg in the Kansas chalk two years ago. This is of so much interest that I give herewith a brief description and outline figure of it. The species is, I

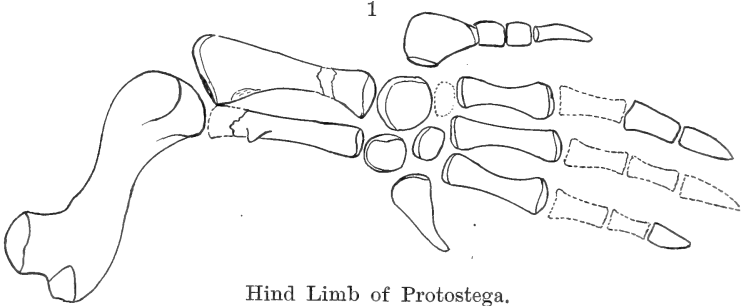
Hind Limb of *Protostega*.

suppose, *P. gigas*, though I do not feel certain. Among the various specimens of this genus I have examined there is a great difference in size, a character of doubtful value for specific separation, as well as distinct differences in the shape of the limb bones. The present specimen, for instance, is among the largest discovered in the Kansas chalk, and has the femur much more slender than in the specimen figured by Case (*Journal of Morphology*, June, 1897, pl. vi, f. 18).

The specimen had been, for the most part, washed from its matrix, and the original relation of the different bones lost, but since only the posterior part of the skeleton is present they all clearly belong to the hind limb. The bones of the fore limb, moreover, are all much larger than those of the hind. Some of the phalanges were lost and probably one of the tarsals. In the figure I have arranged the bones as they would seem to belong, though very likely some of the metatarsals and phalanges had different positions in the living skeleton.

For a review of the discussion as to the systematic position of *Protostega*, the reader is referred to the paper by Professor

Case cited above. The relationships to *Chelone* and *Thalassochelys* pointed out by Baur, Hay and Case receive additional confirmation from the structure of the limb, as will be seen in the accompanying figure. The leg, while broader and more powerful, is not essentially different in structure from that of *Thalassochelys*, and it would seem that there could hardly be longer a question as to the relationship of these forms,—*Protostega* and *Archelon*, at least,—to the Cheloniidae.

The characters separating *Archelon* Wieland from *Protostega* Cope, while not very important, would seem sufficient. Nevertheless, one can derive little justification from the different geological horizons in which the forms are found. The relations between the Niobrara and Fort Pierre vertebrates are for the most part very close. I have recognized in both horizons *Tylosaurus*, *Platecarpus* and *Mosasaurus* (*Clidastes*), as well as *Pteranodon* and *Hesperornis*, all very typical of the Niobrara deposits, and the existence of *Claosaurus* has been recently affirmed in the Fort Pierre. On lithological grounds, there is nothing separating the two groups of deposits, and I protest against the names Colorado and Montana, as perpetuating a wrong impression. On paleontological and lithological grounds there would be much better reasons for uniting the Niobrara with the Fort Pierre than with the Fort Benton.

*Description*.—The head of the femur is large, and, in life, evidently nearly hemispherical. The neck is very stout, placed at nearly right angles to the axis of the shaft and is but slightly constricted. The trochanter is large, and stout, with a large, triangular, roughened area on the posterior side for muscular attachment. The smaller trochanter is indicated by a small tuberosity. The shaft is much constricted and curved, with its convexity dorsal; it is nearly cylindrical at its middle part. The condyles are large and stout, the inner more massive than the outer one; their articular surface looks nearly backward. The tibia is much expanded superiorly, and has its articular surface at an angle of about 45° with the axis of the shaft. On its posterior surface, and margin, a little below the angle there is a strong muscular rugosity. The shaft is much narrowed below, and is again moderately expanded for the distal articulation.

The fibula is elongated and narrow, of nearly uniform width, except at the upper extremity. This portion of the bone is wanting in the specimen but that portion preserved indicates a moderate expansion superiorly. On the posterior surface, opposite the roughening of the tibia, there is a strong rugosity, produced into an angular tubercle, for muscular attachment.

Three tarsal bones are preserved, and there was probably

one more not recovered. They are all rounded and flattened. The largest, apparently the tibiale, shows a thickened cartilaginous border on three sides, elsewhere thinned. The next larger tarsal, probably the fibulare, is somewhat thicker, and has the thickened cartilaginous surface encompassing nearly the border. The third bone, the smallest, and probably belonging in the distal row, is a more thickened nodular bone, oval in shape with one side much thickened for cartilage.

The metatarsal of the first toe is a thin, broad, hatchet-shaped bone, with a proximal thickened articular border for union with the tarsus, a smaller distal surface for phalangeal articulation, a thickened, concave inner border and a strongly convex, thin, outer border.

The three metatarsals belonging to the second, third and fourth toes are moderately slender, with the extremities moderately expanded. Their relative positions I cannot give positively, but I have arranged them in the figure as they would seem to belong. They differ only a little in length; two of them have one border nearly straight, the other concave, while the shortest and stoutest has both borders markedly concave. The fifth metatarsal bears no phalanges. It is a slender, triangular bone flattened proximally, where it articulates with the tarsus; curved, cylindrical and pointed distally. It evidently was much divaricated in life.

The phalanges of the first toe were three in number, the first two short, thickened, with a concave proximal and convex distal extremity. The unguial phalanx I believe to be the slender pointed one of the three preserved. The other unguial phalanges preserved, two in number, were less slender, one much smaller than the other. One other phalanx is known, a rather short and but little constricted bone, apparently belonging in the second row.

#### *Measurements.*

Length of femur.....	360 <sup>mm</sup>
diameter of head.....	95
diameter of shaft.....	60
Length of tibia (somewhat approximate).....	270
Greatest diameters of tarsals.....	90, 65, 55
Length first metatarsal.....	110
Length fifth metatarsal.....	130
Lengths second, third and fourth metatarsals..	140, 155, 170

University of Kansas,  
Lawrence, Kansas.

ART. XXIII.—*The Physical Effects of Contact Metamorphism*; by JOSEPH BARRELL, Ph.D.

*Introduction.*—Although much has been developed in past years concerning the physical, chemical and mineralogical effects of the metamorphism produced in sedimentary beds by the contact of igneous masses, but little has been said concerning the wholesale liberation of gases from the sediments so affected, attended by shrinkages of volume and the possible results in the formation of vein fissures, impregnation deposits and new intrusion of igneous matter, owing to these causes and the changes in pressure which accompany them. Certain of these questions were suggested to the writer in 1899 while studying the geology of the Elkhorn District in Montana as a field assistant for the U. S. Geological Survey, and the following article was written in the petrographic laboratory of the Sheffield Scientific School of Yale University under the supervision of Prof. L. V. Pirsson as one chapter in a thesis on the Geology of the Elkhorn District, prepared in partial fulfillment of the requirements for the degree of doctor of philosophy.

Excluding for the moment the possible impregnation and metasomatic effects of mineralizing vapors and heated waters carrying dissolved materials into the contact rocks, the chemical effects consist in the more or less complete expulsion of carbon dioxide and combined water and the formation of the remaining constituents into new minerals. In addition, there are physical effects of considerable magnitude; the strata not only assume a greater hardness and density, but in beds of certain compositions it will be shown that there may be a shrinkage of from 25 to 50 per cent. in volume, attended with the evolution of great quantities of gases which at surface pressures and temperatures would amount to several hundred times the volume of the original sediments.

The reasons why such changes in volume have not been noted in the field probably lies in the special compositions necessary to produce the most striking effects and the fact that intrusions have often greatly disturbed the adjacent strata.

The kinds of rocks which will be least affected are those of igneous origin. In the presence of later intrusives and disregarding the temporary expansions due to the high temperatures, these will naturally suffer no appreciable change in volume and none at all in mass. The most that would be expected to occur would be the acquisition of certain characteristics due to the minerals having been exposed to long and intense reheating. On the other hand, those subject to the

greatest changes in volume and mass are carbonate rocks containing sufficient silica to combine with all the bases, to the complete expulsion of the carbon dioxide.

To determine with some degree of precision the extent of these metamorphic changes, it becomes necessary to know quantitatively the degree to which decomposition, disintegration and sedimentation affect the rocks upon which they operate. To that end the nature of these processes will first be briefly reviewed and then the completeness with which they are commonly carried out.

#### THE DECOMPOSITION OF ROCKS.

All the materials of the earth's crust which exist combined with carbon and hydrogen as carbonates and hydrates have supposedly been formed as a result of the decomposition of silicates and were once components of igneous rocks. In determining the final form in which the sediments occur two classes of action have been operative in separating the components of the igneous rocks. First, the difference in the rate of decomposition of different minerals by which the alkalis and alkaline earths are taken into solution. Secondly, the forces of transportation and sedimentation which in operation effect a more or less complete separation, gathering together the quartz as beds of sand and the particles of clay as mud banks. Since this discussion is confined to general conditions and roughly quantitative results, it is only necessary to consider the common rock-making minerals of the igneous rocks, the source of all the materials of the stratified series, though several cycles of erosion, sorting and sedimentation may have intervened between the igneous origin and the existing sediments.

The minerals necessary to consider are quartz, alkali feldspars, lime-soda feldspars, micas, hornblende and pyroxene, and the disseminated iron ores. Under the conditions of heat and pressure attending their formation they are naturally the most stable minerals. With the lowering of the temperature, however, and especially in the presence of meteoric waters bearing carbonic acid, other products possess maximum stability and the original minerals are susceptible to change in varying degrees.

The study of rock decomposition was undertaken long since by Daubree, Bischof, the Rogers brothers and others, and has latterly been studied and supplemented by G. P. Merrill\*. From the articles of the latter many of the following statements have been drawn.

\* Bull. Geol. Soc. America, vol. vi, p. 321, vol. vii, p. 349; Journal of Geology, vol. iv. p. 704 and p. 850; Rocks, Rock Weathering and Soils (The Macmillan Co.).

The Rogers brothers found in 1848 that nearly all of the common silicate minerals were readily attacked by water carrying carbonic acid, and Richard Müller in 1877 gave quantitative determinations on a number of the common species. The alkalis, lime and magnesia are dissolved as carbonates. The iron in the case of hornblende, epidote, etc. passed into ferric oxide upon evaporation of the solutions. In the action of carbonated waters upon alkaline silicates like the feldspars a limited amount of silica always goes into solution, presumably in the form of hydrate. Olivine is dissolved with considerable rapidity, and other magnesian silicates, including serpentine, are also attacked. It is found that increase of pressure renders the action more energetic. Bischof states that the alkaline silicates lose their alkalis readily to carbon dioxide with separation of free silica. If the alkaline carbonates subsequently meet lime silicates, a replacement is effected whereby the alkalis are for the time being retained in the soil, presumably as hydrous silicates, such as the zeolites.

Water not only acts as a conveyor of carbonic acid but in itself is efficient in the process of rock decay, by entering as water of crystallization into a large number of minerals of more or less stability, such as the zeolites, chlorites, serpentine, talc and kaolin.

The oxygen dissolved in water serves to precipitate hydrated ferric oxide from ferrous carbonate solutions. It is to be noted that the greater part of the hydrous silicates are pre-eminently subterranean and not sub-aerial minerals, a free exposure of oxygen, water and carbonic acid eventually destroying them.

From the original igneous minerals, then, it may be stated that weathering carried to its limit would produce as solids quartz, kaolin, limonite, calcite and magnesite, the latter combined with the calcite as dolomite; and would cause to be taken into solution all the alkalis and some of the alkaline earths. But although this is the theoretical limit of weathering, it is questionable how nearly it is ever reached.

The extreme solubility of soda feldspars over the potash one is well known. In fact, under normal conditions of weathering, orthoclase is one of the most resistant of rock-making minerals. It is true also that nearly all unmetamorphosed sediments show some protoxides which are still existent as silicates. Some idea can be gained in a general way as to the extent to which decomposition accompanies disintegration, and an examination of the unmetamorphosed sediments in thin section aided by an analysis would determine the degree for any special case. Two extremes of decomposition will be briefly considered: first *in situ*, the minimum amount neces-

sary for the disintegration of a rock, and secondly that found in material which has suffered long transportation and trituration, such as the residual clay from a limestone.

*Amount of Decomposition in situ.*—Merrill has shown in the articles to which reference has been given that in the instances studied by him the transition from fresh rock to soil *in situ* has been brought about with very little change in ultimate chemical composition—an addition (in the case of the Washington granite) of some 3·5 per cent of water, a change of the ferrous iron to ferric, doubtless more or less hydrated, and a slight decrease in the total amounts of silica, lime, potash and soda being the more conspicuous features. “It is evident that here the chief alteration in the conversion of the barren rock into arable soil is physical, attended probably with a partial change in the mode of combination of the various elements.”\*

In his investigation upon the changes taking place from fresh rock to soil *in situ* a separate analysis was made of the impalpable mud or silt derived from the soil and remaining some time in suspension in water. Of this, representing 4 per cent of the total disintegrated material, only 39·7 per cent was soluble in dilute hydrochloric acid, and a considerable proportion of the residue, as indicated by the high percentages of alkalis and lime, still consisted of unaltered soda-lime and potash feldspars, the iron and magnesia alone having been largely removed. This power of the alkaline feldspars to strongly resist decomposition, even when finely divided, is to be noted, since the study of thin sections under the microscope shows that one of the common earliest results of rock decay is the filling of the feldspars with sericite flakes or kaolin dust. From this fact alone it would be judged that the feldspars upon disintegration to an impalpable mud would be readily converted to kaolin, the final product of alteration; yet such proves not to be the case, a considerable proportion of them remaining unaltered and therefore suffering no loss of components when subjected to metamorphism.

*Decomposition in Transportation and Sedimentation.*—In the undisturbed soil of an igneous rock, however, the fullest opportunities have not yet been given for hydration, oxidation and the formation of carbonates. To test the limit to which such actions proceed under favorable circumstances, instances should be studied where transportation and sedimentation have given the fullest opportunities for complete alteration.

The residual clay from a limestone meets the requisite conditions, having been finely comminuted and subjected for a long period of time to such agencies before settling to the

\* Bull. Geol. Soc. America, vol. vi, p. 324.



ocean bottom. During the existence of the unaltered limestone the impurities would be in part protected from further decomposition by the stronger affinity of the lime for the carbonic acid contained in the percolating waters, forming soluble bicarbonates. After the solution of the lime, however, the insoluble materials would form a residual clay soil, and as long as their existence in that state continued, the water and carbonic acid would tend to effect a change into hydrates and carbonates.

In Bulletin 148, U. S. Geological Survey, page 389, are three analyses of such a residual clay, and given below. The three analyses furnish considerable data for the determination of the combinations in which the elements exist, but such an elaborate discussion is not necessitated by the work in hand. They are by George Steiger and are as follows :

ANALYSES OF CLAY, STAUNTON, VA.

	B	C	D
SiO <sub>2</sub> .....	55·90	3·09	52·81
TiO <sub>2</sub> .....	·20	·04	·16
Al <sub>2</sub> O <sub>3</sub> .....	19·92	3·96	15·96
Fe <sub>2</sub> O <sub>3</sub> .....	7·30	6·25	1·05
FeO .....	·39	·30	·09
MnO .....	none	----	----
CaO .....	·50	·30	·20
MgO .....	1·18	·43	·75
K <sub>2</sub> O .....	4·79	·28	4·51
Na <sub>2</sub> O .....	·23	·20	·03
H <sub>2</sub> O at 110° .....	2·54	----	----
H <sub>2</sub> O above 110° ..	6·52	2·10	4·42
P <sub>2</sub> O <sub>5</sub> .....	·10	·04	·06
CO <sub>2</sub> .....	·38	·38	none
	99·95	17·37	80·04

B. Residual clay from limestone, Staunton, Va.

C. Portion of B soluble in weak hydrochloric acid.

D. Insoluble portion of B.

These analyses are particularly favorable for testing the decomposition of the feldspars, there being large amounts of silica, potash, alumina, ferric oxide and water present and relatively small amounts of other components; hence errors in considering the state of combination of the latter will have but a minor effect upon determining the form in which the alkaline silicates are present.

The fully hydrated form of aluminum silicates is kaolinite, and this is the state toward which the weathered products of the feldspars approach, the fully hydrated form of the ferric

oxide being limonite. The ferrous oxide, magnesia, lime, titanium oxide, and phosphoric pentoxide may also exist more or less fully hydrated.

Computing on this basis how much combined water would exist in the clay of analysis B if it were fully decomposed and hydrated, the following is obtained :

	Per cent of elements in clay. Anal. B.	Per cent of water, if fully hydrated.
Al <sub>2</sub> O <sub>3</sub> -----	19.92	7.0
Fe <sub>2</sub> O <sub>3</sub> -----	7.30	1.2
FeO } -----		
CaO } -----		
MgO } -----	2.37	0.5
P <sub>2</sub> O <sub>5</sub> } -----		
TiO <sub>2</sub> } -----		
H <sub>2</sub> O above 110° found.	6.52	required 8.7

From this table it is seen that in this clay, subjected as it has been to most extreme conditions of weathering, the constituents are not more than three-fourths fully hydrated.

The same conclusion may be reached by looking over various reports on clays. The composition of kaolinite is: silica 46.5, alumina 39.5, water 14.0, the ratio of water to alumina being 35 per cent, yet it is seldom that more than 80 per cent of the full amount of combined water is present.

*The Limits of Decomposition.*—To sum up the foregoing discussion it may be stated that, disregarding the infiltration of elements from without, the quartz sand present in a sediment exists in its original state: the amounts of alkalis present are a measure of the incompleteness of decomposition, since upon complete weathering they are removed. If alkalis are present, some of the lime may be combined with the soda as a plagioclase feldspar, and the magnesia, in a similar manner, may exist in combination with the potash as a mica. In certain hydrous silicates small amounts of lime and magnesia may be also combined with alkalis. But beyond these small amounts they exist as carbonates and their final stage of alteration has been reached. The alumina is not usually more than three-fourths fully hydrated to kaolinite.

From these statements it is seen that the amount of combined water may be taken as an indicator of the completeness of weathering.

#### CHANGES OF MASS AND VOLUME IN METAMORPHISM.

*Expulsion of constituents and loss of mass.*—It is commonly observed that metamorphosed strata are composed of certain mineral species, most of which show habits characteristic of these rocks.

A few metamorphic minerals, such as epidote, vesuvianite and biotite, may carry as much as 2 per cent of combined water. With such exceptions the water is uniformly and completely expelled, and by that amount in which it was contained in the original strata the mass is lessened. Carbonic acid is only expelled where the siliceous impurities of the limestone are sufficient to combine with the lime set free, forming lime silicates. This ability of deeply-buried limestones to retain their carbonic acid when intensely heated, if free from other impurities, has been noted by a number of observers, and is well shown in the Elkhorn district, Montana, where marbles in some cases exist within two to four feet of the granite contact, having retained their carbonic acid under temperatures which at the surface would have led to its immediate expulsion. In a general way the losses may be tabulated as follows:

Pure Types.	Loss in Weight.
Sandstones	0 per cent.
Claystones	4 to 10 " "
Limestones	0 " "
Mixed Types.	Loss in Weight.
Arenaceous claystones	2 to 6 per cent.
Arenaceous limestones	5 to 30 " "
Argillaceous limestones	5 to 23 " "

In addition to the above, the greater *porosity* of the unmetamorphosed sediments enables them to retain a larger amount of hygroscopic moisture, to be expelled along with that in chemical combination.

*Loss of volume.*—The losses in volume are still more striking than those of mass, and are due to three causes. First, decreased porosity; second, losses of water and carbonic acid; third, crystallization into minerals of greater density. The porosity or amount of vacant space of rocks of the same composition may vary within quite wide limits, sandstones running from 5 to 28 per cent, limestones 0.2 to 13 per cent, shales probably from 5 to 15 per cent. The various kinds of hornfels probably possess a porosity of from 0.5 to 3 per cent. Taking the differences between the original and resulting porosity, the losses in volume from this source, by metamorphism in a general way, may be set down as follows:

Kinds of rocks.	Loss in Porosity.
Sandstone to quartzite	5 to 15 per cent
Argillaceous sandstone to hornfels	5 " "
Impure limestones to hornfels	1 to 5 " "

It will be shown later that the losses in volume due to the other two causes may amount to as much as 47 per cent. Thus occasionally the combination of the three may result in a shrinkage of the strata by as much as 50 per cent upon the intrusion of a neighboring igneous mass. The geological consequences of such striking changes may well be studied in some detail.

*Relation of metamorphic minerals to original composition.*—From the species and proportionate amounts of the metamorphic minerals seen in thin section, it will be desirable to determine the nature of the original sediments and thence the changes undergone in mass, volume and mineral composition. Leaving aside for the present those possible accessions connected with impregnation and fumarole action, the chemical elements will remain present as before stated except for the expulsion of a greater or less quantity of water and carbonic acid. To determine this relation of metamorphic minerals to original composition, some definite basis must be adopted. For that reason the sediments are assumed to consist of a number of stable minerals, the results of thorough decomposition. As has been shown, in argillaceous rocks such a condition is never perfectly reached, and where such have suffered changes the losses computed on the above basis must be diminished by a factor depending upon the incompleteness of the decomposition of the original rock. In strata consisting of quartz sand and carbonates, however, the changes will be strictly those shown by the following table.

The metamorphic minerals given in the table, except for the omission of biotite, are those of commonest occurrence in strata adjacent to igneous rocks. Biotite, though of common occurrence as a result of metamorphism in rocks of an arenaceous-argillaceous character, has such a complex composition that it is useless to attempt to compute from what materials it has come, unless something is known of the unmodified strata. The ferrous oxide, magnesia and alkalies present in biotite, furthermore, are indicative of an incompletely decomposed sediment, and add to the difficulties. The absence of biotite from the table for that reason, however, is not a serious matter, since the materials forming it have possessed but little carbon dioxide and a medium amount of water and consequently in metamorphism have not changed greatly in volume or mass. While the table shows in a general way and with a fair degree of accuracy the changes taking place to produce such minerals; for any special application it may be necessary to extend it in order to take in materials in the original sediments not here considered. The computations have been carried out with accuracy to the final digit and

therefore the only inaccuracies which would attend its use would be from a lack of definite knowledge in regard to the original and final composition of the sediments of any particular case.

It is seen from the above table that wollastonite is produced from a siliceous limestone, diopside from a siliceous limestone containing some quartz. Vesuvianite commonly has a small part of its alumina replaced by ferric oxide, but here it is computed on an iron-free basis. It is seen to be produced by a sediment not far in composition from that yielding grossularite, and has been observed together with it in rock sections.

In epidote the aluminum and iron are interchangeable, the molecular ratio of the two varying from 6:1 to 3:2. For this reason both zoisite, the iron free epidote, and also the alumina free epidote molecule have their relations shown to the original sediments. If it is desired to find what sediments would furnish a given compound of the two molecules, it may be done by considering the ratio which is present in the mineral of the zoisite to iron epidote molecules and their respective molecular weights, that of zoisite being 455, alumina free epidote 451. In the same way any mixture of the albite and anorthite molecules may have its relations determined, the data of each being here given.

The soda which is frequently shown to exist in hornfels by the presence of a soda-lime feldspar may have existed in unmetamorphosed strata in a variety of forms. In fresh material it might occur as a soda-lime feldspar or feldspathoid, but these being somewhat readily decomposed it would more naturally be anticipated as a hydrous silicate, especially as a zeolite. Merely to show in a general way the relations between an albite occurring in a hornfels and the zeolite minerals, analcite has been selected.

Orthoclase, being a mineral which often occurs in minor quantities in hornfels, has been introduced for the sake of completeness. The greater part of it has probably come from yet undecomposed though finely comminuted orthoclase, which under the conditions of metamorphism has collected into definable crystals. Another part, however, is no doubt furnished by some of the many hydrous alkaline silicates reacting with other materials.

Andalusite is seen to result from a clay upon the expulsion of the combined water, and is attended by the separation of a large amount of free silica, being the only mineral here considered which does not come from the union of two or more minerals of decomposition, but on the contrary breaks into two minerals during the process of metamorphism. Under that part of the table called "Results of Meta-



morphism" the percentages of the constituents are given into which the sediments break up in the production of the metamorphic mineral.

The latter is the only one of them remaining in the strata, the others escaping as gases, and thus its percentage indicates the amount of shrinkage.

On being set free the gases expand to many times the original volume of the sediments, the numbers in the table being the volume to which they expand at 0 degrees centigrade and 760 millimeters pressure, the unit being the original volume of sediments. In computing the volumes of the metamorphosed strata, the porosity factor, being a variable quantity, has not been included, but nevertheless it is seen that in all cases the shrinkage in volume is greater than the shrinkage in weight.

\* Since to use this table it may sometimes have to be supplemented, the method of computation is given below :

Grossularite,  $\text{Ca}_3\text{Al}_2(\text{SiO}_4)_3$   
 $\text{SiO}_2$  40,  $\text{Al}_2\text{O}_3$  22.7,  $\text{CaO}$  37.3 per cent.  
 Silica,  $\text{SiO}_2$ , mol. wt. 60.  
 Kaolinite,  $\text{H}_4\text{Al}_2\text{Si}_2\text{O}_9$ , mol. wt. 258.8.  
 $2\text{H}_2\text{O}=36$ ,  $\text{Al}_2\text{O}_3=102.8$ ,  $2\text{SiO}_2=120$ .  
 Calcite,  $\text{CaCO}_3$ , mol. wt. 100.  
 $\text{CaO}=56$ ,  $\text{CO}_2=44$ .

Using grossularite as a basis of computation.

$$22.7 \times \frac{258.8}{102.8} = 57.2; \text{ amt. of kaolinite required by 100 parts of grossularite.}$$

$$57.2 \times \frac{120}{258.8} = 26.5; \text{ amt. of silica brought in by kaolinite.}$$

$$57.2 \times \frac{36}{258.8} = 8.0; \text{ amt. of water brought in by kaolinite.}$$

$$40 - 26.5 = 13.5; \text{ amt. of free silica required by 100 parts of grossularite.}$$

$$37.3 \times \frac{100}{56} = 66.6; \text{ amt. of calcite required by 100 parts of grossularite.}$$

$$66.6 \times \frac{44}{56} = 29.3; \text{ amt. of carbon dioxide brought in by calcite.}$$

Thus:—

57.2 Kaolinite	}	yields	{	100. Grossularite.
13.5 Quartz				8.0 Water.
66.6 Calcite				29.3 Carbon dioxide.
137.3 Sediments				137.3

Bringing this to a basis in which the amount of sediments shall form the unit gives the following figures:—

100 parts of sediments consisting of 41.7 kaolinite, 9.8 quartz and 48.5 calcite yield 72.8 parts of grossularite, 21.4 carbon dioxide and 5.8 of water, as shown in the table.

To compute the volumes divide each weight by the specific gravity of the substance, giving the ratio of volumes. Add together those forming the original sediments and compare with the volumes of the several products of metamorphism. The computation for grossularite is as follows:—

## CONSEQUENCES OF THE ESCAPE OF GASES.

*Degree to which metasomatic additions are prevented.*—From sediments of suitable composition the escape of these large quantities of gases can not be questioned, but it may be asked how much material, especially silica, may be added to the rock mass by circulating heated waters and thus the shrinkage in volume be in part prevented. The question has greater force since such transfer of material is believed to take place where rocks are brought within the zone of weathering, large amounts of silica being taken into solution and carried downward and away from surface action to be deposited in a zone of cementation.\*

The extent to which this takes place in contact metamorphism can best be judged by field observations. Harker† has noted in the metamorphic zone observed by him that the distance of transfer of material has not exceeded one-sixteenth of an inch and the writer has noted similar features at a number of localities near the Boulder batholith in Montana. In the latter region a number of separate intrusions broke through the sedimentary rocks in the early Tertiary and the igneous activity finally culminated in the eruption of the Boulder batholith, a mass of granitic rock which under the present depth of erosion possesses a surface extension of seventy miles in latitude by forty in longitude. At‡ Elkhorn the granite contact breaks on the whole across the strata, at right angles to the strike, so that the metamorphic action may be observed on sediments of widely differing composition. Within three or four feet of the contact, absorption effects from the granitic magma are sometimes observed, but beyond this narrow limit no addition of material is to be noted.

The metamorphism has transformed the purer sandstones into massive lustrous quartzites sometimes shattered by a mesh of aplite dikelets, but showing nothing but quartz and dis-

9.8 ÷ 2.6	= 3.8	; vol. of quartz.
41.7 ÷ 2.5	= 16.7	; vol. of kaolinite.
48.5 ÷ 2.6	= 18.7	; vol. of calcite.
—	39.2	; vol. of sediments.
72.8 ÷ 3.5	= 20.8	; vol. of garnet.
21.4 ÷ .00197	= 10830	; vol. of carbon dioxide.
5.8 ÷ .00081	= 7148	; vol. of water vapor.

Dividing each of these volumes by 39.2, to compare them to the volume of the sediments as a unit, gives the composition by volume as indicated in the table.

\*C. R. Van Hise, *Metamorphism of Rocks and Rock Flowage*, Bull. Geol. Soc. Amer., vol. ix, p. 282.

†A. J. Harker, *Quart. Jour. Geol. Soc.*, vol. xlix, p. 368.

‡*Geology and Ore Deposits of the Elkhorn Mining District*, by Walter Harvey Weed, with an appendix on the Microscopical Petrography, by Joseph Barrell, 21 Ann. Rpt. U. S. Geol. Surv., p. 400.



proving the addition by circulating waters of any basic elements. Pure limestones in the same vicinity and but four feet from the granite mass are converted into white, coarsely granular marbles, whose only impurities are 5.0 per cent of wollastonite in scattered microscopic crystals and 4.5 per cent of some other mineral now completely decomposed. This indicates the presence of not more than 5 per cent of silica in the marble and shows that no appreciable addition to it has taken place.

As these are rocks, however, from which no liberation of gases with shrinkage has taken place, a better test is to observe the changes in the Cambrian limestone, Starmount formation, of the same district. These rocks where metamorphosed have an average composition as follows:

	Per cent.
Grossularite garnet .....	60.
Diopside .....	25.
Wollastonite .....	15.
	100.

This gives a total silica percentage to the rock of 47 per cent. The garnet consists of grains .05<sup>mm</sup> diameter, clustered together in areas and also scattered through the intervening minerals, colorless in plain light and taken to be grossularite, though the pyrope molecule may occur to some extent.

The diopside is later than the garnet and is ophitic over areas of from 5 to 10<sup>mm</sup>. Thirdly, the wollastonite, youngest in generation, is ophitic in similar manner to the diopside. The rocks are dense and even-grained and without cracklings or infiltrations of quartz or calcite. The thin sedimentary banding is still preserved with the same lenticular, somewhat concretionary structure observed at a distance from the igneous intrusions, and the adjacent layers, where of different mineral composition, are sharply separated from each other. Certain strata may show a few per cent of calcite, but this is distributed in a manner which indicates that it is not a secondary addition, but on the contrary is due to those beds containing originally more calcium carbonate than could combine under metamorphic action with the quartz and kaolin present. These features sharply separate the mass of Starmount strata from certain beds, which owing to special conditions do show infiltrations, as indicated by nuclei of quartz with fluorite and ore grains.

The metamorphism in rocks such as the Starmount siliceous and argillaceous limestones is strongly marked for distances of

a quarter to half a mile from the intrusions and in a minor degree extends much farther.

The final test of shrinkage and absence of infiltration would be to measure a section of these rocks and to examine their chemical composition beyond the limits of the district where free from metamorphism, and to compare these results with similar data derived from the metamorphic zone. To do this with the necessary accuracy, however, would have required much time, and the limits of the field season did not permit of the work being undertaken.

From all the evidence at hand it does not appear that except in local and special instances any infiltration has occurred. By referring to the table of metamorphic minerals previously given, it is found that the minerals of the Starmount formation in their observed proportions would originate from a sediment originally consisting of :

Quartz .....	21.3
Kaolinite .....	25.0
Calcite .....	46.6
Magnesite .....	7.1 combined with calcite as dolomite.
	—————
	100.0

In the process of metamorphism this mass of strata has lost approximately 28 per cent of its weight and 45 per cent of its volume, from 70 to 90 times its volume of water vapor and 320 volumes of carbon dioxide, the gases being measured at 0° C. and 760<sup>mm</sup>.

*The prevention of infiltration.*—The causes preventing the addition of solid material are doubtless to be found in the fact that the gases must escape and that while this is taking place recrystallization is going forward; so that by the time relief is obtained from internal pressures and heated waters would be able to make their way inward, the rock is already dense and crystalline. To realize the degree of pressure exerted by the escaping gases it is necessary to state more exactly the conditions obtaining. The individual igneous intrusions may be presumed to break through the strata with considerable rapidity and at temperatures of 1200° C. to 1500° C. But metamorphism proceeds readily at a temperature of 180° C. and for higher temperatures it would take place with still greater rapidity. The changes of dehydration and decarbonation are those requiring the absorption of heat, while the ultimate contraction of the sediments is a heat-producing operation. The final expansion of the carbon dioxide would absorb heat, but if it was able to occur only at a distance from the place of decarbonation the absorption of heat would not

enter into the problem at that point. The thermodynamics of metamorphism, however, have been discussed by Van Hise\* and need not detain us. It is evident that a massive igneous intrusion would quickly impart large quantities of heat to the adjacent rocks, more than sufficient for these operations, as fast as the conductivity of the rocks could convey it.

The result would be the rapid liberation of the water and carbon dioxide as gases far above their critical temperatures. If they were retained within the original volume, the maximum pressure would be realized, and to that degree by which their rapid escape is hindered by the friction of percolation through the rocks, this maximum would be approached. Thus the internal pressures would vary directly with the rapidity of metamorphism and the frictional resistances of the channels by which the gases escape. As they gradually became dissipated, the external gravitational and lateral pressures would cause the rock mass to shrink under conditions which it is believed would effect a continuous recrystallization, accounting for the dense character and absence of infiltration.

*Effects of wall-shrinkage upon the magma.*—The effects of the metamorphism upon the magma depends upon a number of factors, the first to be considered being the form of the intrusion. In the case of sheets and laccoliths, the cover being the principal region undergoing metamorphism, a partial subsidence of the surface would result, following shortly after the original uplift.

On the intrusion of dikes, volcanic stocks, and batholiths with vertical walls, the contraction of the margins would result in a certain relief from lateral pressure, the direction of maximum shrinkage depending upon the ratio of the gravitational to the lateral forces. This leads to the consideration of two cases.

First: If the magma were intruded at the lowest temperature consistent with fluidity, solidification would begin as soon as the latent heat of crystallization had escaped into the walls. This quantity of heat would presumably not be sufficient to produce a wide contact zone, and the alteration and shrinkage would continue after solidification. The igneous mass could no longer freely follow the shrinking wall and a partial relief from pressure would occur which might determine lines of new intrusions or open the walls of dikes or veins already present. The original intrusions would show chilled margins and coarser-grained centers with veins or dikes parallel to their walls.

Second: If the intrusion were large and the temperature

\*Metamorphism of Rocks and Rock Flowage, by C. R. Van Hise, Bull. Geol. Soc. America, vol. ix, p. 269.

sufficiently high, the rock would be coarse-grained up to the walls. The metamorphism would be practically completed before solidification began and during a period when the magma was able to act hydrostatically and transmit lateral pressures.

Under these conditions the shrinkage of the vertical walls would be largely lateral and result in a corresponding lateral expansion and vertical subsidence of the magma.

The shrinkage of both the intrusion and the metamorphic zone due to the progressive cooling after solidification had been completed, would result in the partial relief from lateral pressure and tend to mask any effects due to metamorphism alone. Thus a number of phenomena, such as the formation of pegmatite dikes and fissure veins near the margins of intrusive masses, though chiefly owing their origin to the contraction due to the crystallizing and cooling of the igneous rock, may find a minor cause in the shrinkage of the metamorphic zone, and the latter cause may be the factor which determines why at Elkhorn, Montana, aplite dikes several hundred feet wide are found localized at or near the contact between the granite and its sedimentary walls. Similar intrusions, though not on so great a scale, have been observed at other places near the margin of this batholith and have been noted in other localities and discussed by Pirsson.\*

It may be readily seen that the relations of the metamorphosing walls to the igneous activities have considerable importance, but the development of the subject would be largely speculative and the facts at hand do not at present warrant carrying it to any greater degree of refinement.

*Infiltrated strata.*—Although it has been observed that as a rule, metasomatic infiltration of the metamorphosing strata does not take place, yet there are special instances where the evidence shows that it occurs. Two such which the writer has noted are due to strata of limestone containing considerable amounts of arenaceous and argillaceous impurities being confined between others of purer limestone. In both instances the strata are tilted and the inclination has made them favorable channels for the escape of mineralizing waters. The differential shrinkage has given them the porosity of a burned brick, and the analogy is the more appropriate, since in both cases the action is one of thermal metamorphism without sufficient pressure to result in a close texture.

The first instance occurs upon Elkhorn Mountain, at Elkhorn, Montana, at an elevation of 9000 feet above the sea, where two slabs of Madison limestones metamorphosed to

\*“Complementary Rocks and Radial Dikes,” this Jour., vol. 1, pp. 394-399, 1895.

marbles are isolated from the adjacent sedimentaries by eruptions of andesite.\* These blocks are 2000 to 3000 feet long and 50 to 150 feet thick. The lower, which is separated from the upper by an andesite sheet 60 feet in thickness, is tilted at an angle of 18° to the horizontal. Within this lower marble is a three-inch band of light-colored hornstone, whose mineral composition was estimated by the microscope as follows, indicating a loss of 35 to 40 per cent in volume.

	Per cent.
Diopside .....	50
Anorthite and labradorite .....	46
Quartz .....	2
Fluorite .....	2
	100

The quartz and fluorite are scattered over the section in branching nuclei and surrounding them the diopside assumes a considerable coarseness of crystallization. The process which has evidently gone forward here is, first, a crystallization of diopside and feldspar which has left the stratum very porous. Then quartz was deposited around the cavities, which were finally filled by fluorite brought in by gases escaping from the magma.

The second instance is the ore stratum of the Dolcoath mine,† situated a quarter of a mile northwest of the town of Elkhorn, Montana.

This is a bed of altered limestone 15 to 18 inches in thickness, dipping 55° east and carrying gold together with bismuth sulphide and telluride. An examination of thin sections of the ore-bearing stratum and also the foot wall and hanging wall, gave the following results, the figures on account of the nature of the sections being only approximate.

Ore Stratum.	Foot wall.	Hanging wall.
Diopside ..... 45	Diopside ..... 30	Augite ..... 5
Garnet ..... 40	Garnet ..... 10	Biotite ..... 25
Calcite ... 12	Basic feldspar. 60	Basic feldspar. 66
Sulphides, with gold ..... 3	.....	Sulphides, no gold ..... 4
100	100	100

It is seen that even if all the calcite of the ore-bearing stratum be regarded as a primary mineral, the shrinkage in

\* Elkhorn Mining District, Montana, by Walter Harvey Weed, U. S. Geol. Survey, 21st Ann. Report, p. 449.

† Loc. cit., p. 506.

the ore stratum has been somewhat greater than in either the foot or hanging wall, since the feldspars and biotite are minerals which, as shown by the alkalis present, were formed from sediments not fully hydrated or carbonated. Moreover a microscopic examination of the ore stratum shows parallel sinuous cracks due to tension, and not to shear, and now filled with calcite. Elsewhere in the section the calcite exists as a sponge, holding garnet, diopside and ore grains within it, and its secondary nature is not so clear. The ore is associated with the calcite and also with a certain coarser crystallization of the diopside.

Thus besides the physical effects of metamorphism which have been emphasized, the problem is seen to have an economic value in furnishing a guide in the search for strata impregnated with valuable minerals.

*Relation to subordinate volcanic phenomena.*—It is commonly accepted that in regions of hot springs, geyser, and fumarole action that the causes are to be found in the circulating underground waters coming in contact with still heated masses of igneous rocks, or in the gases escaping from solidifying magmas. While these are undoubtedly the chief factors, the nature of the sedimentary rocks may be such, that in the presence of igneous intrusions they may be undergoing metamorphism and evolving considerable quantities of gases and heated waters.

These effects would be more noticeable in certain regions than in others and particularly in western Montana, where the abundant Tertiary intrusions have frequently come in contact with great thicknesses of Algonkian and Paleozoic sediments, consisting in large part of mixed arenaceous, argillaceous and calcareous materials.

Lehigh University,  
South Bethlehem, Penn.

ART. XXIV.—*An Expedition to the Maldives;* by  
ALEXANDER AGASSIZ.

[Extract from a letter to the Editor of the Journal, dated Colombo, January 29, 1902.]

I HAVE just returned from a trip to the Maldives, where I spent a little over a month examining the coral reefs of the group. The steamer "Amra," chartered from the British India Steam Navigation Co., proved a most serviceable vessel for our purpose. She carried enough coal and provisions for the trip, so we did not return to refit. She was commanded by Captain Wm. Pigott, R.N.R., who proved himself a most skilful navigator among the maze of atolls through which we steamed for over sixteen hundred miles. Both he and the officers of the "Amra" showed the greatest interest in the objects of the Expedition. Captain Pigott took charge of the sounding machine and superintended himself all the soundings we took (more than 80 in number); he became exceedingly skilful at this work, and several of the soundings were taken successfully under most trying circumstances. The "Amra" was equipped with a deep-sea Lucas sounding machine built for me by the Telegraph Construction and Maintenance Co. The machine differs radically from the American type of sounding machine developed by Captain Sigsbee with which I was familiar, and which I had in commission on all my former expeditions. Excellent as is the Sigsbee machine, the Lucas sounder has some advantages in its compactness, in being self-contained and practically automatic. But its greatest advantage lies in the use of malleable wire for sounding in place of the hard-drawn wire in use in American machines. This greatly simplifies the making of splices and lessens immensely the dangers of kinking while handling the wire. We had in addition a Sir William Thomson sounding machine for moderate depths in the lagoons or at our anchorages. I also placed on board a steam winch of the Bacon pattern with a drum large enough to hold 600 to 800 fathoms of wire dredging rope. This winch was used for deep sea towing down to 150 fms. and for the few hauls of the dredge we found time to take.

Dr. W. McM. Woodworth, my son Maximilian and Mr. H. B. Bigelow accompanied me as assistants. My son and Dr. Woodworth took a large number of photographs. Dr. Woodworth had general charge of the collections; they were intentionally somewhat limited, as we could not hope in the short time at our command to add much to the material obtained by Mr. J. Stanley Gardiner during his prolonged stay at the Maldives and Laccadives. Mr. Bigelow collected thirty species of

Medusae, interesting mainly for the geographical distribution of the genera represented. As might be expected, they were principally Hydroids, exclusive of the Siphonophores, Discophores and Ctenophores. The pelagic fauna was at times very rich and some of our deeper hauls were most productive. The surface hauls inside the lagoons were also frequently very rich, far more than in the lagoons of any other coral reef region I have visited. This may be accounted for from the open condition of the lagoons of the composite atolls of the Maldives: to this I shall call attention later on. No attempt was made to collect any plants, the collections of Mr. Gardiner having supplied the material for an exhaustive list of the flora of the Maldives.\*

We made a fair ethnological collection, the better part of which we owe to the kindness of the Sultan of the Maldives. His Highness took great interest in our work, gave us a circular letter to the chiefs of the various atolls, and in addition sent a representative and an interpreter to accompany us on our trip. Thanks to this, we were everywhere received with the greatest cordiality. I have also to thank the agents of the British India Steam Navigation Co. at Colombo, Messrs. Bois Bros. & Co., for having carried out my instructions regarding the equipment of the "Amra." We found the steamer ready for us on our arrival at Colombo. To the Right Honorable Joseph Chamberlain I am indebted for his kindness in giving me letters to the government officials at Ceylon, and for writing to His Excellency Sir West Ridgeway in regard to our proposed visit. The Governor kindly wrote to the Sultan of the Maldives notifying him of the objects of our expedition, and also gave me letters to the Sultan, which we delivered on our arrival at Male.

We started on our explorations from Male after having, on making the atoll, obtained a glimpse of the east coast of North Male as we skirted the atoll from Mirufenfurhi to Male Island itself. This stretch of coast together with the islands near Male and the adjoining faros† of the lagoon to the northwest of Male contain all that is most characteristic of the atolls of the Maldives. A glance at the chart gave us an approximate idea of the problems to be solved in the study of the coral reefs of the group.

After examining North Male we passed to Ari, then to North and South Nilandu, crossing to Mulaku, making our way to Kolumadulu, to Haddummati, to Suvadiva, and to Addu, the southernmost atoll of the Maldives. On account of

\* The Botany of the Maldivian Islands, by J. C. Willis and J. Stanley Gardiner, Ann. Royal Botanic Gardens, Peradeniya, December, 1901.

† Faro is a name given by the natives to the small atolls which rise in the interior of the large lagoons or are found on their rims.



the heavy sea we were unable either on our way south or north to stop at Fua Mulaku, an island between Suvadiva and Addu, but judging from the chart and such accounts as I could obtain, it probably does not differ from similar islands in the Maldives.

On our way north we modified our course so as to visit the faces of the atolls we had not seen on our way south, and to cross the lagoons from a different direction, taking thus a bird's eye view of the atolls and islands. Our route was further daily modified according to the position of the sun, to enable us to navigate the interior of an atoll in safety, or to take photographs as we passed, without loss of time. We also examined the atolls of the eastern chain which we had not seen: Wattaru, Felidu and South Male. From Male Island we examined the western parts of North Male, which we had not visited before, passed on to Gafaru, to Kardiva, to Fadiffolu, to South Malosmadulu, to Gadu, to middle Malosmadulu and North Malosmadulu, to Miladummadulu, crossing to Makunudu and Tiladummati. We left the Maldives through one of the passages on the east face of Ihavandiffulu, the northernmost atoll of the group, after having steamed nearly sixteen hundred miles among the atolls of the Maldives.

Although the waters within the groups of atolls on the Maldives have been most carefully sounded by Captain Moresby and Lieut. Powell, yet very little is known of the depths in the channels separating them, or of the depths on the two sea faces of the great plateau upon which the atolls of the Maldives have developed.\* The soundings give an excellent idea of the topography of the bottom of the lagoons of the composite atolls; their greatest depths is not much more than 40 fathoms. The depths indicate considerable variation over the bottom, and in some regions these changes in depth are very abrupt, from 8 to over 20 fathoms in short distances. The character of the bottom varies greatly according to the locality and its vicinity to gaps, to passes, to islands or islets or sand bars. In many cases the bottom is hard, swept clean by the currents, or covered with fragments coated with Nullipores, or it is covered with corallines or made up of fragments of broken corals, or of coarse or fine coral sand. On one occasion the claspers brought up a piece of Millepore cut off from a living cluster from a depth of 39 fathoms. This is an unusual depth for a reef builder, as in the Maldives the reef corals rarely extend below 17 fathoms; 12 fathoms is the usual depth I have observed.

\* Mr. J. Stanley Gardiner took a number of soundings across these channels, but he has not yet given the position of his casts. See the *Fauna and Geography of the Maldivian and Laccadive Archipelagoes*, vol. i, part i, p. 19, and Introduction to the above, pp. 10, 11. (Noticed in this number.)

There the sand lanes and patches which separate them, and which finally end in covering the bottom, usually begin.

The connection of the northern Maldives with Minikoi and the Laccadives, as well as the relation of the latter with the southwestern coast of India, is fairly well developed by existing soundings.\*

A good line of soundings also runs between the Northern Maldives and South India connecting with the numerous soundings taken off the west coast of Ceylon.† On our way back to Ceylon we filled a few important gaps in this line which clearly developed the existence of a wide tongue of the ocean coming from the south with a depth of over 1,500 fms., reaching north of the 9th degree of northern latitude and separating Minikoi as well as the Maldives from the Indian Continental slope.

We did not attempt to check any of the soundings. Within the atolls they exist in sufficient number for all theoretical and practical purposes, and for a party not sufficiently numerous and not properly equipped for the most delicate surveying operations it would have been hopeless to add any exact information to that already existing. Our soundings were limited to filling gaps in the existing information, such as taking the depths of the channels separating the groups of atolls as well as developing the slopes of the eastern and western faces of the Maldivian plateau.

Our soundings showed a greatest depth of 251 fms. in the center of Gallandu Channel, which separates Ihavandiffulu from Tiladummati; 769 fms. in the center of the channel between Miladummadulu and Fadiffolu. The Admiralty Charts indicate depths varying between 125 and 135 fms. in Moresby Channel between north and middle Malosmadulu, and depths varying between 100 and 140 fms. in the channel between the latter and South Malosmadulu. We found 302 fathoms between Goidu (Horsburgh atoll) and South Malosmadulu. In the center of Kardiva Channel on the two sides of Kardiva island we obtained 312 and 298 fms. with 372 fms. one and a half miles south of Fadiffolu atoll. One hundred fathoms was obtained in the center of the channel between Gafaru and North Male. Between North and South Male in the center of Wadu Channel we got a depth of 260 fathoms. In the center of Fulidu Channel separating South Male from Felidu atoll we found 374 fathoms. In the channel north of Wattaru Reef we found 283 fathoms; in Wattaru channel between Wattaru reefs and Mulaku atoll 253 fathoms, and between Mulaku and Kolomadulu the depth in the center of the channel

\* See B. A. Charts Nos. 2737 and 2738.

† See H. O. Chart No. 1591.

increased to 649 fms. Returning now to the groups of the western chain of atolls we found 231 fathoms in the Ariyaddu Channel between Ari and North Nilandu. The charts indicate 200 fathoms in the center of the channel between North and South Nilandu and between it and Kolumadulu, the northernmost of the southern single chain of atolls, we found 251 fathoms in the center of the channel.

In the wider channels separating the atolls of the southern single chain the depths become much greater. In the center of the Veimandu Channel which separates Kolumadulu and Haddummati, the depth had increased to 1,118 fms., and half way between it and Suvadiva we found a depth of 1,130 fms. In the wide channel between Suvadiva and Addu we found 1,292 fms. a little to the north of Fua Mulaku and 1,048 fms. between it and Addu. At a distance of four and a half miles to the south of Addu we ran into 718 fms. Owing to the rough weather we were obliged to discontinue our southern line, which I hoped to connect with the single sounding of 2,500 fms. between Addu and Chagos indicated on the Admiralty Charts. I believe that the "Valdiva" also made a few soundings between Ceylon and Suvadiva as well as south of Addu on her way to Diego Garcia; unfortunately I have not her list of soundings at hand, and am not able to state what light they throw on the depths separating Addu, the southernmost of the Maldives from the Chagos Archipelago.

The bottom samples of the deeper soundings were interesting as showing the existence of Globigerinae in great quantities at a comparatively short distance from the shallower parts of the Maldivian plateau. Though we did not find Globigerinae in our tows except on one occasion, Globigerinae were frequently so abundant on the bottom as to form what might be called Globigerinae sand. In somewhat shallower soundings and nearer the atolls Pteropod shells were common, and these we collected in numbers in nearly all our tows made on the outer faces of the Archipelago. In two of the soundings in the channels between the composite atolls we brought up small manganese nodules existing much in the condition in which they were dredged by the "Blake" in the Straits of Florida.

As regards the slopes of the eastern and western faces of the Maldivian plateau our soundings are of considerable importance. The soundings of Ihavandiffulu found on the charts indicate a depth of over 1000 fms. off the southwestern face at a distance of nearly twelve miles. Off the northeastern face nearly the same depth is reached in less than six miles. To the east of the northernmost point of Tiladummati, at a distance of seven miles, 781 fms. is indicated on the chart, and about 13 miles to the eastward we ran into 1,460 fms. In the center of

the channel separating the northern extremity of Makunudu and the northwestern extremity of Miladummadulu we obtained 792 fms. Eight miles west of the southern part of North Malosmadulu the depth was 1,247 fms. Off the southwestern face of Ari we ran into 1,499 fms. at a distance of eight miles. The only line we ran into deep water off the east face of the Maldives was off the center of the east face of South Male, where we found 1,270 fms. at a distance of twelve miles from Guru Island. These soundings indicate a comparatively steeper slope off the west face of the Maldivian plateau than off the eastern face.

As regards the great wide basin which separates the chain of the eastern group of atolls from the western one, beginning at the north we find as great a depth as 513 fms. in the center of the northern part of the channel separating Miladummadulu and North Malosmadulu. In the line from Fadifolu to South Malosmadulu we find 519 fms. within a mile and a half of the former, with not more than 364 fms. in the center of the channel. In the center of the channel between Gafaru and Goidu the greatest depth is 258 fms. A short line run west of North Male atoll, somewhat south of the center of the west face, indicates, from the depth of 186 fms. obtained at a distance of five miles, that the plateau of that part of the western face is quite shallow, and that Toddu and Ross atolls (Rasdu) are on its western rim. This is corroborated by the soundings on the charts off these atolls to the north of Ari, somewhat to the west and south of our line. In the center of the channel separating Ari and South Male we found 318 fms., while we obtained 194 fms. near the center of the line between South Nilandu and Mulaku, with a deepest sounding of 205 fms. three miles off the west face of Mulaku. I should add that the bottom of all the channels separating the composite atolls appears to be quite flat, the soundings drop rapidly, and generally at a distance of a mile and a half from either face they reach a depth but little inferior to the greatest depth in the center of the channels.

The greatest depths thus far obtained in the channels separating Minikoi from the northern Maldives (1,179 fms.) and the former from the Laccadives (1,197 fms.) are about those which separate the Southern Maldives from one another and from the central part of the group.

It is interesting to note that both Minikoi and the Laccadives as well as the Southern and Northern Maldivian atolls and some others to which I shall refer later have none of the characteristics of what has been called the composite Maldivian atoll, but on the contrary resemble such Pacific atolls as characterize mainly the Ellis and Gilbert groups.

A mere glance at the Admiralty Charts of the Maldives\* can-

\* B. A. Charts Nos 66a, b, c.

not fail to show at a glance how very different in structure are Makumudu, Gafuru, Kardiva, Goidu, Rasdu, Toddu, Wattaru, Fua Mulaku and Addu from such groups of atolls as North and South Male, Ari, North and South Nilandu, Felidu, the Malosmadulu atolls, of Miladummadulu and its northern extension Tiladummati, which might be called the Maldivian group of atolls par excellence; both to be contrasted again to such atolls or groups of atolls as Fadiffolu, Felidu and Mulaku, which have as it were combinations or modifications characteristic of the Maldivian atolls with features common to a great number of Pacific atolls. And finally we come to a third class of atolls like Kolomadulu, Haddummati and Suvadiva, which remind us of some of the larger atolls of the Pacific in the Marshall, Ellis and Gilbert Islands or Caroline Islands; atolls noted for the absence of shoals and of islands in the lagoons, while the typical grouping of the small Maldivian atolls along the 40 to 30 fathom line of the great Maldivian plateau forms an agglomeration of small atolls along that belt resembling the great reef flats of the Pacific atolls, but which have grown up as distinct parts and are separated by deep channels. These small atolls vary in size from a couple of hundred feet in diameter to atolls of seven miles in length. While it is true that in such clusters of atolls as those of North and South Male, of Ari, of the Malosmadulu atolls and of others, their arrangement is such as to form well-defined well-marked rims, reminding us of the rims formed by great reef flats such as are common in the Pacific, yet the structure of such groups of atolls as Miladummadulu and its Tiladummati extension misnamed as atoll gives us the key to a rational explanation of the formation of the atolls and groups of atolls in the Maldives.

The two atolls I have just named are not atolls in any sense of the word. They are so ill-defined that their division on the chart for political purposes is marked by a mere dotted line. In fact they are a great number of small atolls often separated by considerable distances as much as five to ten miles which have gradually grown up on that part of the Maldivian plateau from depths of 25 to 30 fathoms, and where they can be seen in all possible stages of growth. We examined them in detail at several points in the Maldives. Their mode of growth and the great variety of conditions under which they exist is well seen in North Male. There we see many of the future atolls existing as flats or bars or mere rings which do not rise more than five or six fathoms from the top of the plateau; others which vary in depth from the surface from three to five or seven fathoms. Others again which form rings or bars just awash or with two to three feet over the rim, and finally rings partially awash only with sand banks projecting a foot or so

above the surface. The shape of these rings or bars or flats is not necessarily circular, it varies greatly and is indirectly controlled by the topography of the bottom. Some of these faros are elliptical, pear-shaped, or crescent-shaped, varying greatly in outline and dimensions on the outer lines of the composite atolls. In some of the atolls the lagoons of the smaller atolls have been formed by the growth of coral patches or lines of corals rising at a short distance lagoonward, parallel with the outer reef flat. These patches become joined and form thus elongated lagoons or a number of secondary lagoons on the outer reef flats.

There is no evidence that these small atolls are the result of the splitting or breaking up of what was formerly a larger atoll, nor that adjoining atolls or reef flats have become united or coalesced except where the passages separating them have been of very moderate depths. No such changes are indicated anywhere from a comparison of the conditions as marked on the chart of 70 years ago and those existing to-day.

The outer slopes of these rings are covered with corals growing with great luxuriance from the edge or even far on the flats of the ring to a depth of from eight to twelve or fifteen fathoms. The superb growth of corals found in all the so-called lagoons of the Maldives is in marked contrast with the scanty growth of corals in the lagoons of the atolls of the Pacific. It seems we have a simple explanation of this in the fact that the rim of these so-called atolls in the Maldives is full of wide and deep passages. In fact, the extent of the passages is generally much larger than the space occupied by the small atolls (the atollons). As soon as the flats of the rings have reached the surface, either wholly or in part, sand bars begin to form, and these develop rapidly into islets and finally large islands more or less covered with scrub vegetation and bushes. These rings or faros either retain a central lagoon or it becomes partly or wholly filled up. In the former case they appear as small atolls with islands or islets on the reef flats; in the next stage there is only a smaller lagoon on the lee face of a larger island, or else the island has grown to occupy the whole flat of the faro with only very narrow flats on the lagoons faces of which corals grow. These larger islands are often covered with fine vegetation, large trees occupying the space inside of the outer belt of bushes growing close to the beach. The greater number of the many islands which dot the so-called lagoons of the Maldives have been formed in the manner described, and it is comparatively easy to trace the progress of development in all the stages intermediate between a mere ring not yet rising to the surface and an island with its rich vegetation such as we find either in the lagoons or on the outer edge of the Maldivian composite atoll.

The small atolls which form the outer rim of the composite atolls owe their existence to the same causes, and their development can be easily traced from a mere ring which has risen to the surface having more or less extensive flats on which islands or islets, or sand bars have been thrown up. The sea-reef flats of these outer lines of atolls are usually wider than those of the lee-face, and naturally so.

The increase in size of the islands of the outer line of atolls we find goes on much as we have observed it in the Gilbert, Ellis, Marshall and Paumotu Islands. Small islets or islands on the same reef flats are gradually united by the formation of sand spits on the lee-face of the islands, thus forming bays on the sea-face of an atoll; the spits gradually approach, become connected, and the filling up of the bay from the sea-face unites adjacent islands, their former disconnected state being indicated merely by a difference in the growth of the vegetation, a distinction which gradually disappears with years. The bay may be formed also on the lee-side by the throwing up on the sea-face of a bar on the edge of the reef flat between separate islands, and the bay may then be filled up both from the lee and weather side and thus unite separate islands or sand bars.

The existence of lagoons completely shut off from the sea in some of the atolls of the northern part of the Maldives is readily explained by their mode of formation; this can be traced in all its stages from the time the atoll consists of a crescent-shaped island occupying only a portion of the reef flat of the ring, the reef flat of the rest of the ring still enclosing a comparatively deep lagoon sometimes 6 to 7 fms. The island throws out spits from the horns of the crescent until there is only a narrow pass left between them, and finally this gap is closed by a sand or shingle beach and we have the ideal atoll, a closed ring of land enclosing a deep lagoon, which exists so rarely but is always the atoll to which one refers when discussing the coral reef question. These phenomena are well illustrated in the long line of crescent-shaped atolls occurring on the east side of Miladummadulu from Nallandu south as far as Bomasdu. Such a change from an open crescentic island flanked by a lagoon to a closed land rim surrounding a land rim may take place with considerable rapidity. Rodularmandu is represented on the chart as an open crescent-shaped island: we found it, 70 years later, a closed land ring completely surrounding a small lagoon with a depth of two fathoms. Other islands on the same reef flats have greatly increased in size by the extension of sand spits over the shallow reef flats connecting them, and it is easy to trace the amount of this growth and its comparative age by the length of these sand spits or by the quality of the vegetation on the ridge connecting them. This is well shown on such islands as Eddufaru, Milandu and many others on the east face

of the Miladummadulu bank, especially near the northern extremity of the plateau where many of the atolls, such as Hamimadu, Filadu, Kelai and others are fully as large as some of the best known atolls in the Pacific.

The formation of fresh water or brackish sinks edged with mangroves\* in some of the atolls can be traced to the same process which has formed the enclosed lagoons such as we have just described. They occur on Kendikolu, Ekasdu, Nallandu, Maddelu and Filadu. The sinks differ from the lagoons only in being shallow, having been cut off by spits and bars extending across portions of the adjacent reef flats covered only by water of a couple of feet or more in depth, while the enclosed lagoons were cut off from lagoons of atolls of considerable depth, six to seven fathoms or more. What has been written above seems to me to point to the uselessness of our present definition of atolls. There is every possible gradation between a curved open crescent-shaped bank of greater or less size and an absolutely closed ring of land surrounding a lagoon without direct communication with the sea. The evidence of a great number of atolls scattered on an extensive bank or plateau like that of Tiladummati and Miladummadulu shows that reef corals will grow upon any foundation where they find the proper depth, and that local conditions will determine their existence as fringing reefs, barrier reefs or atolls. In fact, in the Maldives, reefs that once formed an atoll may in time, when the atoll is changed into an island, become fringing reefs, a transformation which is quite common both on the outer lines of islands or on islands in the interior of the smaller plateau. The so-called composite atolls of the Maldives are merely elevations upon the greater Maldivian plateau which have given to the reef-building corals a base at the proper depth from which they have risen to the surface. In such smaller plateaus as North Male, Ari and others, there is found on the secondary plateaus in their turn a number of bases on which the atolls have grown. In the central and most of the northern plateaus the conditions of exposure to oceanic currents is such that an immense body of water is constantly flowing across the plateau during both the northeast and the southwest monsoons. Where the plateaus are smaller or not as open to the flow of currents as in such atolls as Addu, Kardiāa, Goidu, Gaffaru, Wattara, Makunudu, and others we have only a single atoll developed. And again in such plateaus as these upon which Kolumadulu, Haddummati and Suvadiva have developed, the conditions are oceanic (if we might call them so), more similar to those we have in the widely separated atolls of the Ellis, Gilbert or Marshall islands. At the same

\* Messrs. Gardiner and Willis have already called attention to the scarcity of mangroves on the Maldives.



time, the lagoons of these atolls are far less subject to oceanic circulation than those of the northern plateaus, and thus we find fewer banks or islands in the lagoons and only here and there a trace of those remarkable rings which are so characteristic a feature in Maldivian coral reef scenery. Certainly I have seen nothing so striking in my experience of coral reefs as these rings with a light-colored rim standing out from the deep blue water surrounding them like ghosts of an atoll, which had sunk, and enclosing a lighter blue or emerald colored lagoon indicative of its depth below the surface.

The conditions existing at the Maldives is repeated to a certain extent on the Yucatan Plateau where the Alacran reef—a regular atoll—rises from the plateau at a depth of about 30 fathoms. It is true that it is the only atoll on this extensive plateau. But there are also other irregularly-shaped patches of coral reefs. The absence of atolls may be traced to the fact that the plateau is not within the area of such regular trades as are the northeast and southwest monsoons in the region of the Maldives.

The strength of the prevailing winds in the Maldives has greatly influenced many of the characteristic features of its atolls. The effect of the southwest and of the northeast monsoons cannot be compared to that of the trades in the Pacific. We have nothing in the Maldives corresponding to the incessant breakers of the huge rollers which pound upon the reef flats of the Paumotu and of the atolls and barrier reefs of the Central and Western Pacific. The boulders thrown upon the reef flats are mere pigmies compared to the gigantic masses moved on some of the reef flats of the Pacific reefs. The boulder belts seem like a newly-macadamized road as compared to the quarry blocks which often line miles of the beaches of the Pacific atolls. But the same forces are at work in the Maldives only on a diminutive scale even during the prevalence of the southwest monsoon. The beaches are as a whole remarkably steep, both sand and shingle; they rarely rise to more than five or six feet, though in some of the northern atolls they are fully 12 feet high. Mr. Gardiner informs me he has seen dunes rising to 28 or 30 feet in height. Many of the islands have sinks occupying the central portion of the island; they have all been formed by the enclosure within the outer and higher sand or shingle beaches of the interior part of the island. The beaches have been gradually raised until they met the belt of vegetation which prevented the sand from raising the interior part of the island.

Wherever reef-rock was examined I found it without exception of the most modern character, a few exposures as horses on the beaches and on the reef flats would seem to indicate a slight elevation of the Maldives. The horses or outliers were deeply undercut, pitted and honeycombed, showing that they

were remnants of reef flats which once rose to a height of from three to four feet greater than they do at the present day.

If the existing conditions at the Maldives have been brought about by subsidence, it is strange we should not find anywhere on this extensive plateau, especially all the way from the northernmost atolls as far as Kolomadulu, some trace, some outlier or some central projecting rock indicating the nature of the rocks composing the underlying plateau forming the base upon which the innumerable atolls of the Maldives have been formed. The conditions are in many ways similar to those of the Lau Islands on the eastern plateau of Fiji. But there the elevation has been considerable (to a height of 1,000 feet), and everywhere indications are found of the character and age of the underlying strata. A similar condition exists in the Paumotus, where some of the tertiary elevated reefs attain an elevation of about 300 feet. At the Maldives there is, however, only evidence of a very slight elevation.

Our explorations were immensely facilitated from the existence of the admirable charts published by the Admiralty of the Survey of the Maldives by Captain Moresby and Lieut. Powell from 1834 to 1836. The accuracy of these charts is something wonderful when we remember the conditions under which the surveys were made nearly 70 years ago, with sailing vessels and row boats. In our extensive and intricate navigation among the Maldives we were guided absolutely by these charts and never found them in error. Of course some minor changes have occurred on the reef flats, such as the disappearance of an islet, or of a bank, or the addition of a sand bar and the junction of adjoining islands or islets on the same reef flats. Otherwise the charts stand to-day as they did 70 years ago, a monument to the unsurpassed skill of the surveyors of those days. It was a simple task to pick out one's work in each atoll by an examination of the chart, and thus much time was saved.

In addition to the information to be derived from the charts, Mr. J. Stanley Gardiner was kind enough on two occasions, after his return from the Maldives, to give me valuable details regarding many interesting localities. I can only close by expressing my admiration for the amount of work Mr. Gardiner was able to accomplish with the facilities at his command, and for the pluck and energy displayed by him and his companion, Mr. Cooper, in meeting, in native boats, the winds and currents which impeded their progress at every point, to say nothing of the constant discomforts to which they were subjected during their stay in the Maldives.

As soon as the necessary charts can be made, I hope to publish a preliminary report of our exploration, leaving the final report to appear whenever the illustrations and photographs taken on the trip can be prepared.

ART. XXV.—*The Flower-like Distortion of the Coronas due to Graded Cloudy Condensation*; by C. BARUS.

1. RECENTLY I described\* a series of results obtained most satisfactorily with benzol† vapor, in which the coronas met with are not closed and annular, but of a variety of patterns from oval, with the long axis vertical to the symmetrically open doubly inflected types (lyre-shaped or basin-shaped), running continuously into horizontal strata as the limiting case. These distortions are due to the non-uniform distribution of nuclei as to size, the largest having sunk deepest and the finer nuclei floating uppermost, in virtue of the precipitation mechanism. When supersaturation is produced by adiabatically cooling the benzol vapor, the condensation begins at the lower strata and then passes upward as exhaustion proceeds and higher degrees of supersaturation are reached. The evolution of coronas is peculiar in this case, and reminds one of a person throwing out his arms laterally and upward until his hands strike above his head. The sweep of coronal streamers is outward and upward symmetrically with respect to the vertical plane through the source of light. If the gradation is not too rapid, they eventually coalesce above it.

The droplets produced are finer above than below; but it does not follow that there are more particles in the upper layers. The reverse will naturally be assumed. The lower particles being larger have first received the condensation as already suggested, and have thus grown biggest, as the opportunities for growth came earliest and lasted longest.

2. It is my purpose in this paper to work out the shape of the *loci of like color* when the nucleation is not uniform as to size or number. The distributions arise from the subsidence of loaded nuclei; they are, therefore, horizontally stratified.

In figure 1, let  $o$  be the distant point source of light into which the coronas would shrink annularly and symmetrically from without inward, to a limit in a normal case. Let  $\phi$  be

\* Science, xv, pp. 175-178, 1902.

† The nuclei do not originate in the benzol itself as I first supposed, but are due (as I have since found) to the diffusion of a horizontal couche of nuclei, brooding immediately over the surface of the liquid. For this reason this residual layer is liable to escape detection on purifying the air of nuclei by exhaustion. For my purposes it is a matter of little consequence whence these residual nuclei come, and I have, therefore, not given much attention to it. The occurrence of the diffusion is the essential feature. In carbon disulphide, however, the nuclei certainly arise out of the liquid, though it is not improbable that even here they are a foreign sulphurous product. Saturation is soon reached at an enormously low but permanent vapor tension. The question will soon be discussed elsewhere.

the angle between the horizontal through  $o$  and the radius vector,  $r$ , to a line of uniform color,  $ab$ , in the distorted corona, and let  $h$  be the height of the extremity,  $c$ , of the radius vector above the datum line through  $o$ . If  $R$  be the distance of  $r$  from the eye of the observer,  $2r/R = s/R$  is the angular aperture of the corona.

Let  $\delta$  be the diameter of the particles at the level passing through  $c$ . Then if  $\delta_0$  and  $s_0/R$  be the corresponding quantities (diameter and aperture) of particles in the datum level,

$$\delta s = \delta_0 s_0 = \cdot 00144, \tag{1}$$

the number being found by experiment for normal coronas. Hence  $r d\delta + \delta \cdot dr = 0$  (2) where  $r = s/2$ . Again if the angle  $\phi$  increases counter-clockwise by  $d\phi$ ,

$$r d\phi \cos \phi + dr \sin \phi = dh. \tag{3}$$

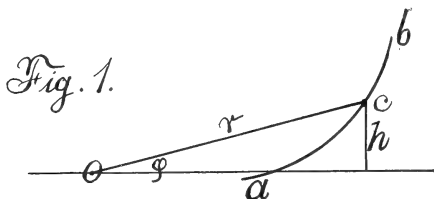

Let  $d\delta = adh$  (4) so that the diameter of the water particles is supposed to decrease ( $a$  being negative) uniformly upward. Other laws of distribution would merely complicate the problem without conducing to the present purposes, seeing that the observed facts will be sufficiently interpreted by equation (4). Combining (4), (3), (2),

$$r \cos \phi d\phi + \sin \phi dr = -(\delta/a) (dr/r) = -\cdot 00072 dr/ar^2, \tag{5}$$

by equation (1)

Put  $A = \cdot 00072/a$  and integrate (5) whence  $\sin \phi = C/r + A/r^2$ . To determine  $C$ , equation (1) is available, since for  $\phi=0, r=r_0$ . Therefore

$$\sin \phi = - (4A/s) (1/s_0 - 1/s).$$

To construct these coronas distorted in consequence of the linear distribution of size of particles, it will generally be more convenient to express  $s$  in terms of  $\phi$ , so that finally,

$$s = - (2A/s_0 \sin \phi) (1 - \sqrt{1 + s_0^2 \sin^2 \phi / A}) = - (\delta_0/a \sin \phi) (1 - \sqrt{1 + 2as_0 \sin \phi / \delta_0}). \tag{6}$$

With this equation the following table has been computed ( $a$  is for convenience entered positively). To have an average case at the datum level, put  $\delta_0 = \cdot 001^m$ , as the diameter of

TABLE.—Flower-like coronas due to graded condensation.  $s = -(2A/s_0 \sin \phi) (1 - \sqrt{1 + (s_0^2/A) \sin^2 \phi})$ ;  $\delta = \delta_0 - ah$ ;  $A = -00144/2a$ ;  $\delta_0 = 001\text{cm}$ ;  $\delta_0 s_0 = 00144$ ;  $s_0 = 1.44\text{cm}$ ;  $s_m = 2.88\text{cm}$ .

$\phi$	(1) $s$ cm.	(2) $s$ cm.	(2') $s$ cm.	(3) $s$ cm.	(4) $s$ cm.	(5) $s$ cm.	$\phi$
-90°	1.36	1.35	1.19	1.12	.97	.58	-90°
-67.5	1.38	1.35	1.20	1.14	.99	.60	-67.5
-45	1.41	1.38	1.24	1.19	1.05	.66	-45
-22.5	1.43	1.40	1.32	1.28	1.18	.80	-22.5
±0	1.44	1.44	1.44	1.44	1.44	1.44	±0
+22.5	1.46	1.48	1.61	1.72	---	---	+22.5
45	1.47	1.52	1.86	---	---	---	45
67.5	1.49	1.55	2.25	---	---	---	67.5
90	1.50	1.56	2.88	---	---	---	90

$a =$	.00005	.00010	.00035	.00050	.00100	.00500
$A =$	-14.4	-7.2	-2.07	-1.44	-.72	-.144
$2A/s_0 = \delta_0/a =$	-20	-10	-2.87	-2	-1	-.2
$s^2_0/A = \frac{2s_0 a}{\delta_0} =$	-.144	-.288	-1.00	-1.44	-2.88	-14.4
$\phi_m =$	---	---	90	43.9	20.3	3.9

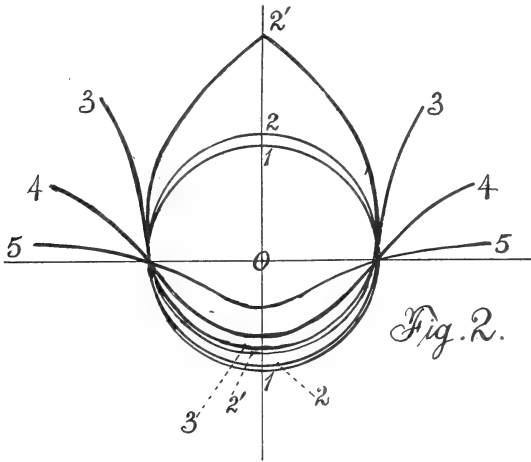

Fig. 2.

particle. The values of  $s$  are given for 9 values of  $\phi$  and for 6 values of  $a$ ; viz.,  $a = .00005, .0001, .00035, .0005, .001$ , or for  $a/\delta_0 = .05, .1, .35, .5, 1.0$ , as decrements of diameter per linear centimeter of level above  $h_0$ .

The curves showing the loci of uniform color for these different conditions are constructed in the chart and numbered 1-5 in succession. No. 1 is still very nearly circular, while

No. 2 is more oval, the members having risen above No. 1. Both curves are closed. No. 2' is the interesting transitional case between closed and open curves concerning which presently. No. 3 is already quite open and bell-shaped; No. 4 more so; No. 5 is basin-shaped, and succeeding curves would more and more nearly approach the horizontal line through the source. Naturally all curves pass through the same two points in this line.

Moreover equation (6) shows that  $s$  becomes imaginary when  $1 < (s_0^2/A) \sin \phi$  since  $A$  is negative. The final values of  $s$  and  $\phi$  are thus given by  $\sin \phi_m = -A/s_0^2$ , so that on reduction  $s_m = 2s_0 = 2.88$ . These data are also given in the table. It is further apparent that the corona will just begin to open on top when  $1 = -s_0^2/A$ , or  $\sin \phi = 1$ . Since  $A = -.00072/\alpha$  and  $s_0 = 1.44$  the gradient  $\alpha = .0035$ . This is the curve No. 2' between the conditions of Nos. 2 and 3. In all these cases the equation given strikingly interprets the opening of a harebell or what would be called campanulate efflorescence in botany.

I may add in conclusion that all the types of curves given are continually and repeatedly met with in working with volatile liquids, among which I have now examined gasoline, benzine, benzol, and carbon disulphide, at length. The law of distribution reproduces the cases as nearly as they can be tested in the fleeting coronas, though the real law is not liable to be linear and will have to be specially worked out.

Brown University, Providence, R. I.

ART. XXVI.—*Varying degrees of Actinism of the X-Rays* ;  
by JOHN O. HEINZE, JR.

ONE is often disappointed, in taking X-ray photographs, at not obtaining good impressions even when the fluoroscope shows a brilliant effect. It, therefore, seems probable that the rays which are most active in producing fluorescence are not necessarily those which act most vigorously on the photographic plate.

In order to test this hypothesis I took a number of observations in the following manner: Having at my command a powerful coil the discharges of which could be regulated with great exactness, and also having a large selection of the most approved X-ray tubes which had been exhausted under my personal superintendence and the behavior of which had been carefully studied, I made a number of exposures and noted at the same time the appearance of the object in the fluoroscope. Fig. 1 shows the results obtained.

The exposures were made through a slot in a thick lead plate placed between the tube and the negative. The latter was moved along one stop for each minute of exposure; and the intensity of the secondary current was varied with each exposure, starting at one minute with the weakest current and ending at the eighth minute with the strongest current. It will be seen that at the fifth minute the greatest actinic effect was obtained and at eight the most brilliant screen and poorest actinic light. The coil which was used in this experiment is one constructed by me

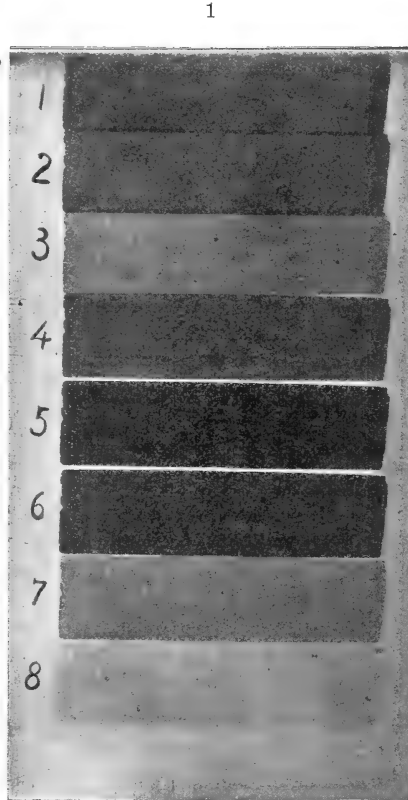

and gives very constant results. It was actuated by a liquid break which enabled me to regulate the current in a manner which would be impossible with a mechanical break. The performance of the coil bears out Lord Rayleigh's contention that the electrostatic capacity of the coil between the primary and the secondary is an important feature in the performance of a coil and that a condenser in the primary is often detrimental. My coil has no condenser and the break is practically instantaneous. There is an enormous rush of current through the primary at the maximum output.



## SCIENTIFIC INTELLIGENCE.

## I. CHEMISTRY AND PHYSICS.

1. *The Separation of Hydrochloric and Hydrocyanic Acids.*—In order to determine small quantities of chlorides in alkaline cyanides, RICHARDS and SINGER dissolve about 1.25<sup>g</sup> of the substance in 400<sup>cc</sup> of water, add 5<sup>cc</sup> of sulphuric acid to the solution, and boil for two hours in a retort, the neck of which slants upward, with replacement of the water lost by evaporation so that the volume does not become less than 300<sup>cc</sup>. In this way all the hydrocyanic acid escapes with the steam, while there is no loss of hydrochloric acid, even after boiling for more than eleven hours. The residual hydrochloric acid is readily determined by the usual method of precipitation with silver nitrate. The authors explain the difference in behavior of the hydrocyanic and hydrochloric acids on the ground that the former is but slightly ionized in solution while the latter is very thoroughly ionized in dilute solutions. Ions have little or no tendency to leave an aqueous solution with steam, while the unionized hydrocyanic acid displays its usual volatility when its solution is boiled. The time of boiling which has been mentioned, two hours, while sufficient to remove the hydrocyanic acid from a small quantity of hydrochloric acid, is insufficient when larger quantities of the latter, for instance amounts corresponding to about one-tenth of a gram of potassium chloride, are present. In this case boiling for eight or nine hours appears to be necessary. From this interesting result the conclusion is drawn that the chloride ion must tend to form a complex with hydrocyanic acid, and that this complex seems to be entirely broken up by prolonged boiling without the loss of hydrochloric acid.—*Amer. Chem. Jour.*, xxvii, 205. H. L. W.

2. *Volumetric Determination of Copper, Antimony, Iron, etc., by Means of Stannous Chloride.*—In 1878 WEIL described a method for determining these substances. The titration, according to the original plan, is carried out in a flask in the presence of very strong hydrochloric acid. During the operation the liquid is kept boiling so that air cannot enter the flask and cause an error by its oxidizing action. The end of the reaction in the cases of copper and iron is distinctly marked in strong acid solution by the disappearance of color. When antimonious acid is present with copper it is reduced with the latter by stannous chloride, but after the resulting liquid has been exposed to the air for a few hours the cuprous chloride is oxidized to cupric chloride while the antimonious chloride remains unchanged, so that the former can be determined by a repetition of the operation, and the amount of antimony present can be calculated. When ferric salts are present with copper they are also reduced by stannic chloride, but the copper can be removed by means of

metallic zinc, and after oxidation with potassium permanganate and the removal of chlorine by boiling, the iron can be determined by the stannous chloride titration. Weil now calls attention to an improvement in his process by which the disagreeable vapors of boiling hydrochloric acid may be dispensed with. He adds to 10<sup>cc</sup> of the liquid to be analyzed 30<sup>cc</sup> of hydrochloric acid and some pieces of white marble in a flask, and then runs in stannous chloride at the ordinary temperature. The carbon dioxide fills the flask and keeps out the air.—*Comptes Rendus*, cxxxiv, 115.

H. L. W.

3. *Comparison of the Properties of Hydrogen Selenide with those of Hydrogen Sulphide.*—A careful study of the physical properties of hydrogen selenide has been made by DE FORCAND and FONZES-DIACON. Several constants relating to hydrogen sulphide which were previously somewhat doubtful have also been determined in order that a comparison could be made. The results are given in the following table:

	H <sub>2</sub> S	H <sub>2</sub> Se
T, boiling-point (abs.) .....	211.4°	231°
T <sub>c</sub> , critical temperature (abs.) .....	373.2	410
$\frac{T}{T_c}$ .....	.566	.564
P <sub>c</sub> , critical pressure, atmospheres .....	92.	91.
T', melting-point (abs.) .....	187.	209
D, density of liquid at T .....	.86	2.12
$\frac{PM}{D}$ , molecular volume of liquid .....	39.53	38.11
L, heat of volatilization (calories) .....	4230	4740
$\frac{L}{T}$ , Trouton's relation .....	20.01	20.52
C, heat of formation of hydrate (calories) .....	16340	16820
t, temperature at which the hydrate has a } tension of 760 <sup>mm</sup> (abs.) .....	273.35	281.
S, solubility at + 4° (volumes) .....	4.04	3.77
“ + 9.65 “ .....	3.60	3.43
“ + 13.2 “ .....	3.35	3.31
“ + 22.5 “ .....	2.75	2.70

It is evident that the two gases show a remarkable analogy, but their properties are very different from those of water, as is shown by the following relations of the latter:

$$\frac{PM}{D} = 18.82, \quad \frac{L}{T} = 25.87, \quad \frac{T}{T_c} = .585, \quad P_c = 200 \text{ atm.}$$

—*Comptes Rendus*, cxxxiv, 281.

H. L. W.

4. *Radio-active Thorium.*—HOFMANN and ZERBAN have found that thorium preparations from bröggerite, while showing much activity in acting upon the photographic plate and upon the electroscope when freshly prepared, lose this power almost or

quite completely after being preserved in closed vessels for a few months. They believe, therefore, that the radio-activity of thorium compounds is not inherent but induced by the uranium contained in the minerals from which they are extracted. This view is confirmed by the fact that thorium from monazite sand containing no uranium is entirely inactive, while preparations from bröggerite, cleveite, samarskite, thorite and orangite are most active in the cases where the larger quantities of uranium are present.—*Berichte*, xxxv, 531. H. L. W.

5. *Lithium Antimonide*.—It has been found by LEBEAU that antimony and lithium combine with violence when they are heated together, but that the heat thus produced prevents the preparation of a definite compound. However, upon electrolyzing a mixture of the chlorides of potassium and lithium with a cathode of antimony, a definite crystalline compound corresponding to the formula  $\text{Li}_3\text{Sb}$  is produced. The same compound can be prepared by the action of lithium dissolved in liquefied ammonia upon metallic antimony. It is somewhat soluble in the ammonia, giving the compound  $\text{Li}_3\text{SbNH}_3$  upon evaporation.—*Comptes Rendus*, cxxxiv, 231, 284. H. L. W.

6. *A New Synthesis of Formic Acid*.—MOISSAN has found that the hydrides of potassium and sodium take fire at ordinary temperatures in an atmosphere of carbon dioxide. If the temperature produced by the reaction is not allowed to rise too high so as to destroy the product, it is found that a formate is produced. In the case of potassium hydride the reaction is as follows:

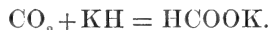

It was found also that carbon monoxide is slowly attacked by potassium hydride with the formation of formate and carbon according to the equation,



—*Comptes Rendus*, cxxxiv, 263. H. L. W.

7. *Elements of Physical Chemistry*; by HARRY C. JONES. 8vo, pp. 549. New York, 1902 (The Macmillan Co.).—This volume is designed especially as a text-book for advanced students of chemistry and physics. The author makes the point in the introduction that we are too much inclined at present to treat physical chemistry as a subject which has originated in the last fifteen years. So he has devoted much space to the work of the earlier investigators—work which was really the foundation of much that has developed in the last few years. At the same time, the modern theories and their applications are taken up very thoroughly and very well.

From the standpoint of the teacher, the treatment seems occasionally a little too mathematical, for the average student in chemistry is certainly not well grounded in higher mathematics. For instance, the relation between the specific heats of gases at constant pressure and at constant volume can be explained equally well without the use of calculus. H. W. F.

8. *Velocity of Sound in Air and in different Vapors with Ordinary and High Temperatures.*—This is a very complete study of the subject by E. H. STEVENS. He employed the apparatus described by Quincke in *Wied. Ann.*, lxiii, p. 66, 1898, which he found to be the most accurate for the purpose that has been devised. In general it consists of two cylinders. The wider, called the interference cylinder, is closed at one end and holds the gas or vapor. In the neighborhood of the mouth of the tube is the resonator of a tuning fork. The wave, spreading out from this, passes into the tube, and is reflected from the closed end, forming with the direct wave a standing wave. The wide cylinder contains also a much narrower tube, open at both ends. The end projecting from the wider tube is provided with a rubber attachment which one applies to one ear, while the other is suitably closed. One pushes this narrow tube to and fro in the wide cylinder until one finds maxima and minima. The author gives the following table of the velocity of sound and the ratio of specific heats at constant volume and constant pressure.

Substance.	t°.	Vm/sec.	k.
Dry air .....	0°	331·32	1·4006
“ .....	100	386·5	1·3993
“ .....	950	686·0	1·34
Ether .....	99·7	212·6	1·112
Methyl alcohol .....	99·7	350·3	1·256
Ether alcohol .....	99·8	272·8	1·134
Bisulphide carbon .....	99·7	223·2	1·234
Benzol .....	99·7	205·0	1·105
Chloroform .....	99·8	171·4	1·150
Acetic acid .....	136·5	.....	1·147
Iodine .....	185·5	140·0	1·303

—*Ann. der Physik*, No. 2, 1902, pp. 285–320.

J. T.

9. *Chemical Action of Cathode Rays.*—G. C. SCHMIDT controverts the hypothesis of Goldstein (*Wied. Ann.*, ii, p. 832, 1880) that the chemical action of the cathode rays is due to a very thin layer of ultra-violet light at the surface where the cathode rays strike the substance. Schmidt finds that the cathode rays are strongly reducing in their action, and work not by the production of ultra-violet light, but in such a way that the negatively charged electrons reduce the positive valency charges of the metal. The last can then no longer hold back the whole acid radical—it weakens it, in case it is unstable. With salts of which the acid radicals are not unstable there enters under the influence of the cathode rays a dissociation into ions; after a longer working eventually a small reduction.—*Ann. der Physik*, No. 2, 1902, pp. 321–332.

J. T.

10. *Effects of Currents of High Frequency upon the Human Body.*—It is often stated that high-frequency currents can be received with comparative safety. H. ANDRIESSEN points out that the strength of current is not considered in this general

statement and finds that the human body cannot bear any greater currents at high frequency than at low frequency.—*Ann. der Physik*, No. 2, 1902, pp. 369–380. J. T.

11. *Distribution of Electric Current on Electrodes in rarefied Media*.—It is noticed that luminous areas appear on the metallic terminals of Geissler tubes which are dependent on the electromotive force employed. A. WEHNELT has studied the connection between the distribution of these areas and the current developed in the tubes, and arrives at the conclusions that when the luminosity does not cover the entire terminal, the current flows only through the part covered by the luminosity; the source of the cathode stream is coincident with the spot of light on the cathode. He investigated the relations between the areas of luminosity in different forms of electrodes and found that the stream density is the same in every case between the limiting surface of the luminosity and the dark cathode space.—*Ann. der Physik*, No. 2, 1902, pp. 237–255. J. T.

12. *The Stratifications of Hydrogen*.—Sir WILLIAM CROOKES gives the details of his attempt to prepare pure hydrogen. He gives his reasons for believing that the blue components of the blue and pink strata in the stratifications produced by the discharge of electricity through rarefied hydrogen are due to a trace of mercury. Occasionally, when no mercury vapor was present a blue tint was observed which was traced to the phosphorus pentoxide tubes. The paper concludes with theoretical conclusions in regard to the causes of stratification based on the electron theory.—*Nature*, Feb. 20, 1902. J. T.

13. *Magnetic Declination Chart for the United States in 1902*.—The U. S. Coast and Geodetic Survey, O. H. Tittmann, Superintendent, has recently issued a chart of the United States, giving the curves of equal magnetic declination and also those of equal annual change for January 1st, 1902. The second series of curves, which has not always been plotted out as here, adds much to the interest of the chart.

14. *Die Fortschritte der Physik im Jahre 1902. Halbmonatliches Litteratur-verzeichniss*; redigirt von KARL SCHEEL (reine Physik) und RICH. ASSMANN (kosmische Physik). Braunschweig, 1902 (Fr. Vieweg und Sohn).—The Deutsche Physikalische Gesellschaft has undertaken the publication of a semi-monthly catalogue giving the titles of all papers published in the various departments of physics. These are given under the author's name with title in the original language and are classified into groups according to subject. Five numbers of the series (pp. 1–115) have been received, the last bearing the date of March 15.

This new publication, which is supplementary to the well-known "Fortschritte der Physik," now in its fifty-seventh volume, will be of great value to all active physicists and should be well supported.

## II. GEOLOGY.

1. *United States Geological Survey*.—The following publications have recently been issued.

MONOGRAPH XL.—Adephagous and Clavicorn Coleoptera from the Tertiary Deposits at Florissant, Colorado, with Descriptions of a few other Forms and a Systematic List of the non-Rhynchophorous Tertiary Coleoptera of North America ; by SAMUEL HUBBARD SCUDDER.

BULLETINS. No. 177.—Catalogue and Index of Publications of the United States Geol. Survey, 1880–1901 ; by PHILIP CREVELLING WARMAN. Pp. 858.

No. 178.—The El Paso Tin Deposits ; by WALTER HARVEY WEED. Pp. 15.—Three veins have been discovered ten miles north of El Paso, Texas, containing cassiterite with wolframite in a gangue of quartz. The ores are the result of deep-seated agencies and “it is believed that further exploration will develop well-defined tin veins.”

No. 180.—The occurrence and distribution of Corundum in the United States ; by JOSEPH HYDE PRATT. Pp. 93.

No. 181.—Results of Primary Triangulation and Primary Traverse, Fiscal Year 1900–1901 ; by H. M. WILSON, J. H. RENSHAW, E. M. DOUGLAS and R. U. GOODE. Pp. 228.

No. 183.—A Gazetteer of Porto Rico ; by HENRY GANNETT. Pp. 51. This bulletin contains a summary of the recent Porto Rican census and the official spelling of geographic names pertaining to the island.

No. 184.—Oil and Gas Fields of the Western Interior and Northern Texas Coal Measures and of the Upper Cretaceous and Tertiary of the Western Gulf Coast ; by GEORGE I. ADAMS. Pp. 62, with 10 plates and 4 cuts.

No. 185.—Results of Spirit Leveling, Fiscal Year 1900–'01 ; by H. M. WILSON, J. H. RENSHAW, E. M. DOUGLAS and R. U. GOODE. Pp. 207.

No. 186.—On Pyrite and Marcasite ; by H. N. STOKES. Pp. 48. The results of this investigation are given on pp. 414–420 of vol. xii of this Journal, Dec. 1901.

No. 187.—Geographic Dictionary of Alaska ; by MARCUS BAKER. Pp. 11–446. This bulletin is the result of some ten years work on the part of the Board on Geographic Names. A descriptive list of authorities is given and in the main body of the work the origin, history, modes of spelling and application of each name and in the case of Indian, Eskimo and foreign names their meaning also is given. The approved forms of spelling are shown in bold-faced type.

The Geologic Branch of the Survey has been reorganized by the appointment of C. WILLARD HAYES as Geologist in charge of Geology. This arrangement will relieve the Director of executive details and will make it possible for Bailey Willis, who since

1897 has performed the administrative work of Geology, to give more attention to the division of Areal and Stratigraphic Geology of which he has charge.

2. *The Fauna and Geography of the Maldive and Laccadive Archipelagoes*; edited by J. STANLEY GARDINER. Vol. i, part i, with plates i-v, and text illustrations 1-23, pp. 1-118. Cambridge, 1901.—This work, of which the first part is now published, gives an account of the investigations carried on by an expedition, headed by Mr. Gardiner, in 1899 and 1900. The special region studied was that of the Maldive Archipelago of Coral Islands, but a careful study was also made of the atoll of Minikoi, which forms the southernmost of the Laccadives. These two Archipelagoes lie to the south-southwest of the Peninsula of British India, although separated from it by a depth of 1,000 to 1,500 fathoms. The India Peninsula itself has practically no coral reefs, though the southern part towards Ceylon partakes of the same formation as the northern portion of that island. The part of the work now published contains an account of the atoll of Minikoi, from which some quotations are given below, and besides papers on the Hymenoptera by P. Cameron, on the Land Crustaceans by L. Borradaile, and the Nemertean by R. C. Punnett.

“The surface of Minikoi island is sharply divided into two areas, an outer, covered on the surface with large loose coral or rock masses, and an inner with sand.” In the outer area, “*Madrepora*, *Pocillopora* and other branching corals are found with their stems still unbroken while massive species have their calicles and septa even yet entire, *absolutely negating the possibility of a beach origin for the rocky area.*” At the base of the outer beach is a conglomerate which seems “to have constituted part of the original reef (which by subsequent growth fashioned the atoll of Minikoi)” and which “may be considered to prove conclusively an elevation of the atoll,” “of at least 24 feet.” An examination of all the facts indicate “that the atoll existed as such when the change of level took place,” that it has “been stationary for a considerable period of time.” “Supposing the land in the present atoll to be entirely swept away, the condition at the present day cannot be far different from that of the atoll before the change of level, allowing for its then smaller size.”

3. *The Formation of the Maldives.*—MR. J. STANLEY GARDINER closes an interesting article on the results of his expedition to the Maldive archipelago (*Geographical Journal*, March, 1902, pp. 277-296) with the following remarks on the origin of the coral atolls.\* “It [the expedition] has shown that the banks of the Maldives arise on a common plateau at a depth of about 190 fathoms. The land has been undoubtedly, by some means or other, raised above the sea, and is now everywhere on the larger banks being washed away. The atoll-reefs are growing out-

\* See the preceding notice, also the paper by Professor Agassiz, pp. 297-308, of this number.

wards on all sides, while their lagoons are increasing in area, and probably also in depth. The atolls owe their existence to the fusion of reefs lying on the circumferences of banks, together with the washing away of the reefs in the interiors of the same banks as their circumscribing reefs became more perfect. In general, the results of the expedition are in striking agreement with the conclusions drawn by Sir John Murray as to the formation of atoll reefs; but I should hesitate to apply these views to all coral-reef areas in the present state of our knowledge, to the exclusion of the subsidence or any other hypothesis."

4. *Om de sen-glaciële og post-glaciële Nivåforandringer i Kristianiafeltet (Molluskfaunan)*. Norges geologiske undersøgelse, No. 31, pp. xii, 1-731, pls. i-xix, 1900-1901; by W. C. BRÖGGER. —The terminal moraines on both sides of the Christiania Fiord were considered by De Geer as indicating the lower limit of the last great ice sheet, but the results of the investigations by Professor Brøgger in this work show that the land ice extended to the extreme boundary of the land mass in Southern Norway, and even beyond this limit.

Many new occurrences of the late and post-glacial deposits are recorded and accompanied by lists and illustrations of the contained faunas. On the basis of their molluscan fossils, these deposits are classified into a number of divisions, indicating changes in level and climate.

There was first a period of subsidence of the land after the morainic period (ra-time), which is divisible into six stages. This was followed by a period of reëlevation divided into seven stages and reaching down to the recent period. The climate during the latter part of the post-glacial uplift was somewhat warmer than at present. Brøgger agrees with Ekholm in his time-estimate of 9000 years since the formation of the Kitchen-middens of Denmark, or the beginning of the Littorina Sea in the Baltic area.

The succession of faunas and deposits is treated in great detail, and the whole work is an admirable example of exact methods of geological and faunal correlation.

C. E. B.

5. *The Berkeley Hills—A Detail of Coast Range Geology*; by A. C. LAWSON and CHAS. PALACHE. Bull. Dept. Geol. Univ. Cal., vol. ii, pp. 349-450, pls. 10-17, map. Berkeley, Cal., 1902.—The area described in this memoir is about six square miles in extent, lying immediately northeast of the town of Berkeley and long used as a subject of field drill for students in geology. The subject matter is, therefore, brought out in a somewhat detailed and popular manner for local usage and benefit. The geology comprises the description of a series of Cretaceous and Tertiary beds, folded and faulted and mingled with intrusive and extrusive igneous materials. These volcanic accumulations are of different periods and described under the heading of the sedimentary series they accompanied. They consist of rhyolites, andesites, laterites and basalts and in the lowest members of serpentines. The petrography of these rocks, accompanied by analyses, is given



by Palache, and the interesting fact is brought out that in five recurrent periods of eruption the sequence has invariably been, andesite, basalt, rhyolite in each period. This is harmonious in principle, if not in exact detail, with the general laws regarding the succession of eruptive magmas as observed in other areas.

L. V. P.

6. *Gesteine der Ecuatorianischen Ost-Cordillere, Der-Cotopaxi und die umgebenden Vulkanberge*; von A. YOUNG. (Reiss & Stübel: Reisen in Süd Amerika. Hochgebirge der Repub. Ecuador II Petro. Untersuch. 2 Ost. Cord. Berlin, 1902, 4°, pp. 275, 4 pl.).—This work, offered as an inaugural dissertation for the doctor's degree, is a further continuation of the series of investigations being carried on in the mineralogical-petrographical department of the University of Berlin, under the supervision of Prof. Klein, upon the material brought back by Reiss and Stübel.

The first half of the work contains a detailed account of the topography and physiography of the well known volcano of Cotopaxi. Its history, its varied outbreaks, its geological relations, the effect of erosion and its glaciers and glaciation are fully treated. This part is by W. REISS.

The petrographical portion, by Young, consists of a detailed and careful study of the various lavas, rock types, which are all comprised under the heads of dacites, andesites of various kinds and basalts. The descriptions are accompanied by a number of analyses. While the rocks described are of well known types, the work is, on the whole, a decided addition to our knowledge of the Andean rocks.

L. V. P.

7. *Der grosse Staubfall vom 9. bis 12. März, 1901, in Nordafrik, Süd- und Mitteleuropa*; von G. HELLMANN und W. MEINARDUS. Abhandl. k. pr. Meteorol. Instituts., Bd. II, No. 1. Berlin, 1901.—Some years ago, Ehrenberg maintained that the dust falls of Europe were derived from South America. This idea never gained general acceptance, and it is now completely disproved for the remarkable dustfall of March 9-12, 1901, concerning which the above cited memoir presents abundant and convincing data. Dust storms were observed in the Algerian Sahara during the days immediately preceding the dustfall in Europe, and a stormy sirocco prevailed over the Mediterranean; North of the Alps, direct observation at mountain observatories and the computed gradients at a level of 2500 met. indicated the prevalence of a southerly current moving at a rate of 70 kilom. an hour; and this rate agrees with that of the extension of the area over which dust spread. In the south, the dust fell from the dry sirocco; in the north it came down with rain and snow. The composition of the dust, prevailingly quartz, was such as the Sahara might furnish. Larger and heavier grains were collected in the south than in the north. In north Germany the quartz grains averaged 1:3,200,000,000 gram in weight. The total quantity of dust imported on this occasion from the Sahara is estimated at about 2,000,000 tons.

W. M. D.

8. *Ricerche Petrografiche e Geologiche sulla Valsesia di E. ARTINI e G. MELZI.* Mem. del. Istit. Lomb. di Sci. e Lett., class. di Sci. mat. e nat., vol. xviii, pp. 219-392, 4°. Milan, 1900.—The region described in this memoir lies in the Alpine portion of northern Italy, southeast from Monte Rosa and comprises mainly the basin of the Sesia and its tributaries. It consists chiefly of highly crystalline rocks, of gneisses of several types, and mica schist with lenses of crystalline limestone, lime schists and serpentine associated with large masses of granite and gabbros passing into diorites and peridotites. These rocks have been carefully studied in the field and the results attained are given with the aid of a geological map and cross sections. The petrographic study of the rocks collected is presented in considerable detail accompanied by twenty beautiful large plates reproducing micro-photographs of the various rock types. The work, besides its local value, is a considerable addition to our knowledge of the crystalline rocks of the Alpine region.

L. V. P.

9. *Influence of Country Rock on Mineral Veins*; by WALTER HARVEY WEED. Transactions Amer. Inst. Min. Engin., Mexican meeting, November, 1901.—There is discussed in this paper, first, the influence of the country rock on the shape and size of the rock fissures in which subsequently mineral material has been deposited; second, the influence which the chemical nature of the rocks may have on this mineral content. From his discussion Mr. Weed concludes that the nature of the country rock through which a vein fissure runs has determined in great part the nature of the fissure, such as its course, width, etc.; that the character of the mineral contents of a vein, which is formed wholly by the filling of an open fissure, cannot have been determined by the character of the wall rock, but that, in the case where metasomatic replacement of the fissure walls has occurred, the nature of those walls has influenced the character of the minerals deposited; lastly, that as the metasomatic processes must vary with the variation of the mineral solutions, no invariable general relation can be established between certain rock types and rich ore deposits.

W. E. F.

10. *Additional notes on the Cambrian of Cape Breton, with descriptions of new species*; by G. F. MATTHEW, LL.D., F.R.S.C. From Bulletin of Natural History Society of New Brunswick, Canada, No. xx, vol. iv, pt. v, pp. 377-425, with 5 pls.—This is a continuation of Dr. Matthew's studies on the Cambrian Faunas of Cape Breton. The present article gives (1st) new species of the Etcheminian or Basal Cambrian and (2d) a description of the Tremadoc Fauna which has been found in one of the Cambrian valleys.

The following new species and mutations are described in this paper and figured in five plates at the end. *Acrothyra*, 2 species (one already published) and 6 mutations. *Acrotreta*, 1 species, 1 mutation, and a species referred to an European form. *Acrothele*, 3 species (one already published) and 1 mutation.

11. *Analysis of Mount Vernon Loess*; communicated by NICHOLAS KNIGHT.—Loess occurs to a considerable depth on the hills in the vicinity of Mount Vernon, Iowa. On the somewhat elevated ridge on which Cornell College is located, the formation extends to a depth of 40 feet, diminishing from the summit. In general, it overlies the Kansan and Paha drifts, but it is usually absent over the Iowan. A brickyard is located in the Mount Vernon loess from which a good quality of brick is obtained. The specimen chosen for analysis was taken from the brickyard, eight feet below the surface of the earth. The analysis was made by Frank Hann in the chemical laboratory of Cornell College, under the direction of Dr. N. Knight. The following results were obtained:

SiO <sub>2</sub>	CO <sub>2</sub>	Fe <sub>2</sub> O <sub>3</sub>	Al <sub>2</sub> O <sub>3</sub>	MnO <sub>2</sub>	CaO	MgO	K <sub>2</sub> O	Na <sub>2</sub> O	TiO <sub>2</sub>	P <sub>2</sub> O <sub>5</sub>	FeO	H <sub>2</sub> O
70.86	4.70	2.97	8.91	0.28	4.13	3.12	1.18	1.69	0.59	0.40	0.10	1.10=99.88

### III. BOTANY AND ZOOLOGY.

1. *Horticultural Experiments and Botanical Investigations at the Harvard Station in Cuba*.—Through the kindness of Mr. Edwin F. Atkins, the Botanic Garden at Cambridge has been able to undertake a series of interesting studies relative to certain features of the vegetation of Cuba. Mr. Atkins has placed at the disposition of the Botanic Garden a sufficient lot of land for experimental purposes and has supplied the funds for current expenses. He has also provided adequate local labor.

The first series of experiments, covering a period of about four months, was designed to test the possibility of repeating, in the climate of Cuba, the well-known Javan studies in the pollination of the sugar-cane. The work was entrusted to the experienced hybridizer, Mr. Robert M. Grey. At the date of writing, his experiments appear to be successful in a high degree, although the present season has been unfavorable on account of prolonged drought. Mr. Grey and the assistant, Mr. Bohnhof, have now brought under cultivation rather more than one hundred different sorts of tropical and subtropical plants, and they are prosecuting the task of improvement in a systematic manner.

Mr. Ames, Assistant Director of the Harvard Garden, has lately visited the Experiment Station, and expresses himself in general as well pleased with the outlook.

Should the Experiment Station develop along the lines now marked out, it is hoped that arrangements can be made by which the establishment can freely offer its hospitality to students who may wish to get a glimpse of the interesting vegetation of the southern part of Cuba.

Colonia Limones, where the Station is located, lies rather less than twenty miles from Cienfuegos. The soil at the station is very well adapted to plants which prefer a more or less dry season in which to ripen the crop early. At a comparatively

short distance from the present Station there is another Colonia which may later be employed for the plants which demand much more moisture. Mr. Grey has collected in the vicinity certain products from the remarkable "escapes" from former cultivation. In some instances, the coffee and self-sown cotton go back to a period coincident with the beginning of the disturbances in this part of the island. In many cases, these products are of fair, in others of excellent, quality. If one can judge from the character of these products of plants which have become practically wild through abandonment, there is great encouragement to resume cultivation at the earliest practicable moment. By selection, crossing, and hybridizing, and by judicious adaptation of plants to special soils, the Station undertakes, in a modest way, to lend a hand towards the restoration of prosperity to some of the districts which have felt the effects of neglect of agriculture through civil war.

G. L. G.

2. *Professor van Tieghem's Classification of Plants.* Ann. des Sc. nat., xiv, No. 4, 5, 6.—We have had more than one occasion to call attention to the interesting suggestions made by Professor van Tieghem, in regard to defects in the accepted classifications of plants. In the present work, the author offers still further suggestions, and constructs a system which he now offers as a basis for discussion.

He takes as his basis the embryo, in its widest sense.

It is well known to our readers that the author has devoted many years of assiduous study to the investigation of the ovule. His results led him two years ago to extend the research through the Cryptogamia, and see to what extent the fertilized germ could be utilized as a safe basis of classification throughout. Although the present communication covers almost 200 pages, it is justly regarded by the author as merely a tentative "essay," in the etymological sense of the word.

It has been necessary for the author to substitute for the terms generally accepted, a set of new terms, some of which do not easily pass over from their French form into terms which could be employed in English or, in short, in any other language, except Italian. This is particularly unfortunate, for the author has selected a good Greek substratum for his new words. But we have found it difficult to turn *Tomîées*, *Adiodées*, *Macrodiondange*, etc., into forms which accord with our English usage.

Leaving this difficulty out of account, we may say that the whole paper is filled full of most interesting subjects for the systematist, and shows clearly that the last word has not yet, by any means, been said in regard to a classification of plants based on their development.

Moreover, the frank admission of the author that the suggested system has many lacunæ, large and small, some of which he points out, makes the work attractive from its transparent honesty. Commending the communication to our readers as one of the most important contributions for many years, embodying,

as it does, the results brought out in his previous "essays" in this subject, we may say that Professor vanTieghem appears to us to have indicated some of the main lines upon which the system of the future will be founded. As Sir Joseph Hooker said, in substance, long ago, the Natural System which is to express the relationships of plants faithfully, must wait until much more has become known in regard to the structure, development, and behavior of all plants. And, even then, the Natural System will present the conditions only for the time, since changes in structure, mode of development, and behavior are constantly taking place.

G. L. G.

3. *The Botanisches Centralblatt*, under its new management, preserves the best traditions of its former excellence and has, at the same time, considerably increased its range. Dr. Lotsy, of Leyden, the editor in chief, is fortunate in having the services of a goodly number of careful writers of abstracts, and he is now confronted with the serious task of judicious sifting what they report. Many persons are watching with interest the manner in which he will reduce to their proper places the notes which possess no scientific importance, in order to make room for references to contributions having permanent value. Up to the present time this work of selection has been done in such a way as to promise well for the future.

G. L. G.

4. *Additions to the Fauna of the Bermudas from the Yale Expedition of 1901, with Notes on Other Species*; by A. E. VERRILL. Trans. Connecticut Acad. Sci., xi, pp. 15-62, pl. i-ix, 1901.—In this important paper Professor Verrill records some of the results of his second expedition to Bermuda. A large number of species, including representatives of almost every group of invertebrates, as well as several fishes, reptiles and mammals, are here recorded which have not before been found on the islands. Many species of invertebrates, including especially the Tectibranchiate and Nudibranchiate Mollusks, Planarians, and Anthozoa, are described as new to science, and figured from drawings and photographs.

W. R. C.

5. (1) *Variations and Nomenclature of Bermudian, West Indian, and Brazilian Reef Corals, with Notes on Various Indo-Pacific Corals*. Pp. 63-168, Oct. to Dec., 1901.

(2) *Comparisons of Bermudian, West Indian, and Brazilian Coral Fauna*; by A. E. VERRILL. Trans. Connecticut Acad. Sci., xi, pp. 169-206, pl. x-xxxv, Dec. 1901.—Some of the results of Professor Verrill's studies on the reef corals carried on during the past forty years are included in these two articles, which together form a most important monograph on the subject.

A number of the names of genera have been changed in accordance with the rules of priority. One of the most important instances is the adoption of *Mæandra* (Oken, 1815) in place of *Mæandrina* (untenable for this group), and the union of *Diploria*, *Manicina*, *Cœloria*, and *Leptoria* with it.

Another instance is the uniting of *Mussa*, *Symphylia*, *Iso-*

*phyllia*, and part of *Ulophyllia*, under *Mussa*, the earliest name. Another important change is the adoption of *Acropora* (Oken) in place of *Madrepora* (Linné), and the transfer of the latter to *Lophohelia* (E. and H.). All West Indian forms of *Acropora* are united under *A. muricata* (L.), but a large number of forms are admitted as named varieties, some of them newly described.

The extended and detailed character of the generic and specific descriptions, and the excellence of the illustrations will serve to determine beyond question the species and varieties referred to, and this is of especial importance in a group where distinguishing diagnoses are more than ordinarily difficult to establish. Habits, methods of growth, geographical distribution and appearance of the living coral are included in many instances. The Bermudian coral-fauna "must be regarded as a detached colony of the more hardy species which have migrated from the West Indies through the agency of the northward currents, by which their free-swimming larvæ have been carried," although certain very common West Indian species are absent while others of the same genera are present in abundance. The West Indian coral-fauna is directly related to that of Brazil, although very few species are strictly identical. It is, however, totally distinct from that of Panama and the Indo-Pacific region. A few species may be identical with forms from the eastern Atlantic. The few known Brazilian reef corals present remarkable archaic characters indicating an ancient fauna that has mostly disappeared.

Especially noteworthy are the twenty-six beautiful plates of photographic reproductions which illustrate both papers. These represent the new species and varieties, as well as typical specimens of the common species. Many of the type specimens of Dana, Verrill, and others, preserved in the Yale Museum, and also rare species from the American Museum, New York, are included.

A considerable number of East Indian and Pacific Ocean corals are also described and figured, including several new species.

W. R. C.

6. *Some Spiders and Mites from the Bermuda Islands*; by NATHAN BANKS. Trans. Conn. Acad., vol. xi, pp. 268-275, January, 1902.—This is a catalogue of the spiders collected by the Yale parties in 1898 and 1901 with their distribution, and with revised lists of the species previously recorded. The number of species collected in 1898 and 1901 was 28. The total number now known from the islands is 33. In this paper three new species are described.

7. *The Marine and Terrestrial Isopods of the Bermudas, with Descriptions of New Genera and Species*; by HARRIET RICHARDSON. Trans. Conn. Acad., xi, pp. 277-310, with 4 plates, January, 1902.—This memoir is a nearly complete monograph of the Isopods of the Bermudas, for it contains revised lists of the few species previously recorded, as well as descriptions and figures of numerous new species. Of the marine forms 13

species and two genera are new ; of the terrestrial forms three are new species, one of which is the type of a new genus.

8. *British Museum Catalogues*.—The following are recent additions to the list of highly valuable and complete Catalogues issued by the British Museum of Natural History :

Catalogue of the Lepidoptera Phalænæ in the British Museum. Vol. iii, containing plates xxxvi–liv.

Catalogue of the Arctiadae (Arctianæ) and Agaristidæ in the Collection of the British Museum ; by Sir George F. Hampson. Pp. xix, 690.

A Hand-list of the Genera and Species of Birds (Nomenclator avium tum fossilium tum viventium) ; by R. Bowlder Sharpe, LL.D. Vol. iii. Pp. xii, 367.

Catalogue of the Collection of Birds' Eggs in the British Museum. Vol. i. Ratitæ, Carinatæ (Tinamiformes-Larifformes). By Eugene W. Oates. Pp. xxiii, 252 ; with 18 colored plates.

Catalogue of the Fossil Fishes in the British Museum. Part IV, containing the Actinopterygian Teleostomi of the Sub-orders Isospondyli (in part), Ostariophysii, Apodes, Percosoces, Hemibranchii, Acanthopterygii, and Anacanthini ; by ARTHUR SMITH WOODWARD. Pls. i–xix. Pp. xxxvii, 636.

9. *Bermuda and the Challenger Expedition* ; by GEORGE WATSON COLE, of Graham Court, New York City (privately printed). Pp. 1–16.—A bibliography giving a summary of the scientific results obtained at and near Bermuda by the Challenger Expedition of 1873.

#### IV. MISCELLANEOUS SCIENTIFIC INTELLIGENCE.

1. *Report of the Secretary of the Smithsonian Institution for the Year ending June 30, 1901*.—In his annual report, Professor LANGLEY gives a summary of the work done by the Smithsonian Institution in its several fields of activity. In the appendixes to the general report are more detailed statements regarding the work of the National Museum, the Bureau of Ethnology, the National Zoological Park, the Astrophysical Observatory, etc. The field work in ethnology for the year included an expedition into Lower California, and two reports of peculiar interest—one the Codex Hopiensis, the other a paper on wild rice as an aboriginal food, are announced as ready for publication. The Astrophysical Observatory gives a preliminary statement regarding the eclipse expedition to Sumatra in May.

2. *An Important Discovery in Color Photography*.—At the meeting of the Connecticut Academy of Sciences, Wednesday, Feb. 12th, Prof. A. E. Verrill exhibited several remarkable photographs in natural colors, made direct from nature by a new autochromatic process, just invented by Mr. A. Hyatt Verrill of New Haven, after several years of experimenting. One of these photographs was of a bright-colored Bermuda crab, from life ; another was a Bermuda landscape in which the beautiful tints of

the water, etc., are well brought out, as well as the soft creamy tints of the old stone residence at Walsingham, and the neutral gray of the rocks. Three other plates were copied from water-color drawings of groups of bright-colored Bermuda fishes, made from life by Mr. Verrill. The photographic reproductions of these drawings showed accurately all the tints and delicate shades of green, blue, pink, purple, yellow, and orange, beautifully blended. The colors in these pictures are peculiarly soft and natural, without the stiffness of the three-color process. The bright red colors appear to be the most difficult to render by this process, at present, but no doubt this will soon be remedied by further experiments now in progress. The photographs are on paper and are made by a purely photo-chemical process.

The process is certain to be of great value for photographing the colors of Natural History specimens and for reproducing paintings, but is not adapted for portrait work owing to the length of exposure required for the negatives. A. E. V.

3. *Lehrbuch der Meteorologie*; von Dr. JULIUS HANN, Professor an der Universität in Wien. Pp. 805, 111 figs., 8 pl., 15 maps. Leipzig, 1901 (Tauchnitz).—This admirable volume belongs to the highest class of scientific treatises. Its author is the leading meteorologist of the world, for many years director of the meteorological observatory at Vienna and for a still longer time editor of the *Meteorologische Zeitschrift*. He is the author of several smaller books, his *Klimatologie* being the chief of these, of many scientific memoirs, and of a host of shorter articles. His breadth of knowledge is shown by the completeness with which the pages of this new treatise make reference to original sources; his competence by the thoroughness with which every part of the subject is presented. Like Bartholomew's *Atlas of Meteorology* (the first published part of a projected physical atlas), which took highest rank on its appearance three years ago, Hann's *Lehrbuch* is indispensable to every well equipped scientific library and to every advanced worker in the science of the atmosphere. W. M. D.

4. *The American Philosophical Society*.—The general meeting of the Society will be held at Philadelphia, April 3d, 4th and 5th, 1902. The preliminary program gives a list of thirty papers covering a wide field of scientific subjects. See further, p. 400, Nov., 1901.

5. *A New Theory of Evolution*; by ALFRED WARD SMITH. The Abbey Press, New York. Pp. 1-256.—The author of this book believes that Economy, Efficiency and Harmony are primary and essential traits of universal progress and ought to be embodied in the theory and formula of evolution.

#### OBITUARY.

ALBERT RIPLEY LEEDS, for many years Professor of Chemistry at the Stevens Institute in Hoboken, N. J., died on March 13.



## AMERICAN JOURNAL OF SCIENCE

[FOURTH SERIES.]

ART. XXVII.—*Notes on Living Cycads. I. On the Zamias of Florida*; by G. R. WIELAND.

THE Cycads of Florida have recently been found by Webber\* to include with certainty two species, *Zamia floridana* DC., and *Z. pumila* L. It is hence not known that *Z. augustifolia* Jacqueminot,† and *Z. integrifolia* Aiton,‡ are represented in Florida at all, or if indeed these latter are two distinct species. Nothing short of the comparison of plants from many localities, both insular and from the mainland well to the south, will settle this point, and also determine whether any other species than *Z. floridana* and *pumila* are indigenous to Florida.

The excellent figure given as that of *Z. integrifolia* in L. Cl. Richards' Monograph on the Conifers and Cycads (1828) is doubtless referable to *Z. pumila* L., the broader pinnules of which give the foliage of this plant a distinctly different appearance from that of *Z. floridana*. This, however, is not given as the only reason for the presentation of carefully drawn figures of the latter species. Illustration has improved in three-quarters of a century. Moreover, the discoveries, both botanical and paleobotanical, of the last half-dozen years have added extraordinary interest to our American cycads, showing them to be of elementary and fundamental importance from the student's point of view. The classic work of Webber, and of Ikeno and Hirase, has made this especially clear.

Fortunately our abundant living cycad material may be readily had in most northern laboratories, it having been found by Webber (loc. cit.) that the fertilization processes, especially

\* Spermatogenesis and Fecundation of *Zamia*. (Pp. 1-92 and 7 plates.) Bulletin No. 2 of Bureau of Plant Industry, Washington, Dec. 28, 1901.

† Coll. III, 263, Ins. Baham.

‡ Hort. Kew. 3, p. 478. London, 1789. Ind. oec.

the formation of the motile antherozoids, may be studied for several days after the cones are cut from the parent plant, thus making it possible to study all the phenomena of fructification from cones sent north from Florida, and perhaps even from the more accessible of the West Indies. The crucial dates for *Z. floridana*, as determined by Webber (loc. cit.), are as follows:

(1) Pollination takes place the last of December and first of January.

(2) Germination of pollen and growth of prothallial apparatus from January 1 to June 1.

(3) Division of second prothallial cell, giving rise to the stalk cell and central cell, February 15 to March 10.

(4) The blepharoplasts first appear about March 1 to 20.

(5) The gradual development of the central cell blepharoplasts and prothallial apparatus continues from March 1 to May 30.

(6) The prophase of division of the central cell appears about May 20 to 25.

(7) *Spermatozoids mature mainly between June 1 and 15.*

(8) *Fecundation takes place mainly between June 1 and 15.*

In the case of *Zamia pumila*, Webber (loc. cit.) found that in 1897 maturation of the spermatozoids and fecundation took place fully three weeks later than the dates above given, although pollination and the first appearance of the blepharoplasts occurred at about the same time as in *Zamia floridana*. The latter is however much more uniformly fertilized.

The present notes are mainly based on some fifty specimens from the Miami region, obtained for me by Mr. W. S. Dickinson of Miami, Florida. These arrived in the latter part of November last in good condition for planting. The various plants taken together showed well what an exceedingly interesting plant *Zamia floridana* is in every way. All the trunks were in full and still green foliage, and many bore the already large and fine cones such as are shown in the accompanying illustrations.

As is well known, among the living cycads we find the largest ovules seen in the vegetable kingdom, although it is wholly significant that these structures are comparatively small in the Bennettiteæ. In figure 1 the curious fact is well shown that ovulate cones, even many months before the gametophytes are fairly mature, are often distinctly larger than the underground trunks which bear them. As a trunk may bear several ovulate cones, this contrast in size may become even greater. Large mature cones are several inches longer than the young unfertilized cones here figured. As in all cases, however, where the sporophylls are closely organized into typical cones, appression faces form, and to a large degree remodel and thus partially conceal the original characters of the component parts,

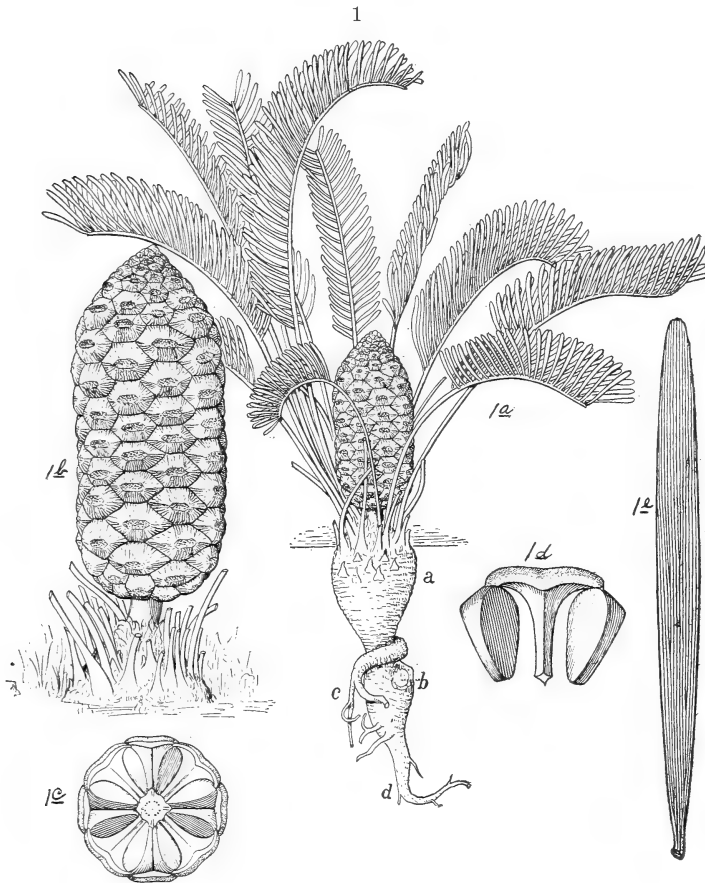
FIGURE 1.—*Zamia floridana* DC. ♀

Miami, Florida, Nov. 15, fully six months previous to fecundation.

1a.—Entire plant.  $\times \frac{1}{8}$ .

a. main trunk (underground).

b. position of an old branch.

c. secondary tap root running out from the main foliage-bearing trunk, which is itself secondary.

d. primary or original tap root.

1b.—Cone (ten-ranked) seen in 1a.  $\times \frac{1}{4}$ .1c.—Transverse section of a different cone.  $\times \frac{1}{4}$ . Eight sporophyllar ranks are seen. These cones vary much in size as well as in number of sporophyllar ranks, which may be odd or even. The number of sporophylls in each rank also varies.1d.—Single sporophyll with ovules attached.  $\times \frac{1}{2}$ .1e.—Pinnule showing dichotomous venation.  $\times \frac{3}{4}$ .

limiting especially the spaces occupied by the ovules. These do not hence reach the immense size of those borne free on the carpels of the less compactly set strobili of the genus *Cycas*,

the mature seeds of which, though not very greatly larger than the ovules, reach in the species *Cycas* (Thouarssii) *circinalis* the size of goose eggs.

For some reason the trunk shown in figure 1 branched early, without both branches surviving. Or perhaps the branch that may have arisen from *b*, figure 1, after vigorous growth, has lost connection with the original tap root. A branch or crown does not necessarily cease to grow after bearing cones.

The free branching of these cycads is one of their most interesting characteristics. A male or female plant often gives

2

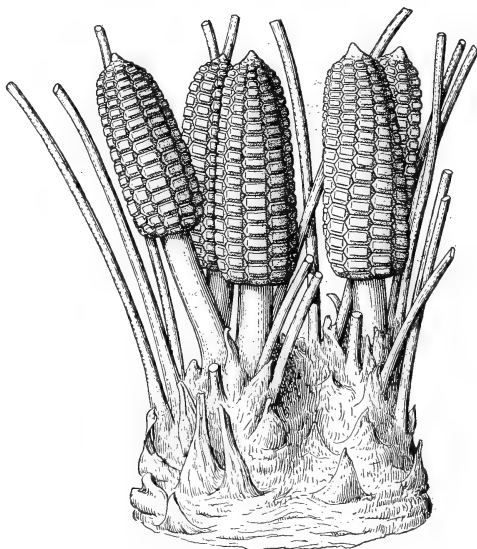

FIGURE 2.—*Zamia floridana* DC. ♂  $\times \frac{1}{2}$ .  
Miami, Florida, Nov. 15.

A slightly bifurcated trunk, bearing three cones and nine leaves on the left and two cones and ten leaves on the right. The trunk is shown as if cut away about on, or a little beneath, the ground level. In many instances only the fronds and cones appear above ground.

rise to a whole clump of the same sex. Professor Macfarland reports a plant with 39 staminate cones. Also, when a trunk is cut off below the crown of leaves several new crowns may form, and it is even said that "pieces of the trunks will grow like potato cuttings." This strong tendency to reproduce by means of branches recalls the closely branched clumps of *Cycadeoidea Marshiana* from the Black Hills. In one instance, as figured by the writer,\* there are five closely set branches, four being of very large size.

\* Yale Scientific Monthly, March, 1900.

In figure 2 is represented a typical main branch of a male trunk in full fruit which has just begun to form a second bifurcation. The other main branch, bearing a single large male cone, is not shown. In the large main branch as figured two cones are borne by the left and three by the right of the newly forming branches.

So far as can be seen on the outer surface, these *Zamia* trunks, as first dug up, are rather smooth, and do not appear at first sight to possess the outer armor of spirally arranged leaf bases so characteristic of other cycadean forms. Just below

3

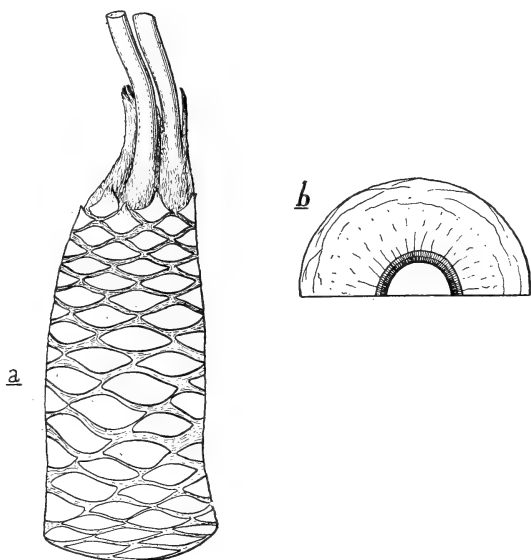

FIGURE 3.—*Zamia floridana* DC.  $\times \frac{1}{2}$ .  
Miami, Florida.

*a.* Upper third of long and slender young trunk with leaves cut away, and the surface lightly cleared of scaly and hairy material to show the slowly disappearing remnants of old leaf bases. Further down, that is on the lower two-thirds of the trunk, the leaf bases are indistinct.

All of the trunk as well as all of that portion of the petioles shown at the summit was subterranean.

*b.* Transverse section of the same trunk cut further down at thickest point, showing the central pith or *medulla*, the *xylem* or wood zone, and the *cortical parenchyma* irregularly traversed by vascular bundles. There is no armor, this being replaced by a very thin corky layer.

the petioles of the crown of leaves there is a thin and rough covering of scattering scale-like bodies and fine hairy material. Below this the trunks appear to be irregularly ridged horizontally, these ridges soon disappearing, so that the lower half or two-thirds is quite smooth in most places, and the armor of old leaf bases absent.

But that these trunks do not differ greatly from other forms is shown in figure 3. The scaly material below the crown of leaves, and, lower down, the horizontal ridges just mentioned, are the remnants of a true ramentum which is constantly disappearing below as the age and size of the trunk increase. And when this ramental material is lightly scraped off above, preferably from a vigorous young trunk, the somewhat carrot or turnip-like appearance is lost, and the spiral order of the remnants of the leaf bases of former years is clearly to be seen. The trunks of the Floridean cycads are hence, notwithstanding their subterranean habit and unusual appearance, typical in every respect. The slow elimination of the old leaf bases is doubtless due in their case to growth in a protected underground position, and may hence be a trunk habit secondarily acquired. The subordinate position of these, comparatively speaking, dwarf plants, as underbrush in large forests of pines, and in the denser "hammocks" in the case of *Z. pumila*, has, together with differential climatic change, probably, therefore, resulted in the course of time in some diminution in size, an underground habit, and nearly complete removal of the armor.

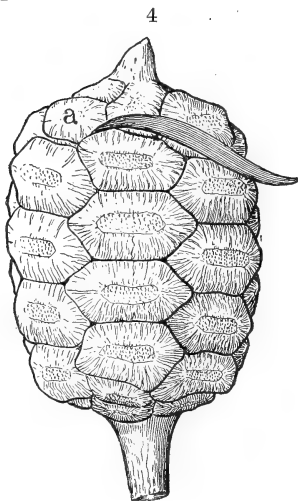

FIGURE 4. — *Zamia floridana*  
DC.  $\times \frac{1}{2}$ .

Miami, Florida, Nov. 15.

Monstrous ovuliferous cone, with sporophyll at (a) bearing a pinnule of the normal structure and form seen in this species.

Unquestionably the most interesting single point observed in the cycads sent by Mr. Dickinson was the presence on one of the cones of a pinnule of normal form and structure which had evidently grown out from beneath the outer hexagonal tip of one of the upper abortive sporophylls. Figure 4 is a faithful drawing of this monstrous cone, so far as I know the second thus far observed to bear leaf-like growths in the Cycadæ.\* When unpacked the pinnule it bore was still somewhat green. As the parent plant was in good condition and at once planted, it was thought that its examination could be somewhat deferred. But unfortunately when the cone was examined a week later, the pinnule, which was at first strongly attached, had loosened, so that its insertion was no longer distinct. The thin sections I made of the sporophyll to which it had

\* An anomalous ♀ sporophyll of *Zamia Leiboldii* Miq., bearing three sporangia, has been figured by Mr. Worsdell, Vascular Structure of the Sporophylls of the Cycadaceæ, pl. xviii, fig. 25 (a), Ann. of Bot., vol. xii, No. xlvii, June, 1898.

plainly belonged showed a strengthening of the vascular bundles next the border in contact with the base of the pinnule. But this part had suffered from wilting, so that I could not get as good evidence of attachment as I could have wished. For the sake of exactness I must explain therefore, that while my figure 5 without doubt represents faithfully the condition of several weeks earlier, it is not the condition found when the cone was examined.

This pinnule did not therefore grow in the exact position of the ovule in a normal and fertile sporophyll, but proximally on the same border.

The two outer angles of the sporophyllar rachis may then be considered as being at once spore- or pinnule-bearing. The evidence that the entire structure is a modified pinnate leaf, just as in the case of the carpophylls of *Cycas*, is overwhelming.

The first example of such monstrous cycad cones recorded, so far as I am aware, is that of an *Encephalartos villosus* Lem. described and figured by Sir W. T. Thiselton-Dyer in the *Annals of Botany* (vol. xv, No. lix, Sept., 1901, p. 549). In this case there is a very extended reversion. The barren sporophylls of the summit of the cone become more and more frond-like, until one of them rises as a distinct once pinnate frond. Although truncated, and reduced in size, this frond presents all the essential characters seen in the frond of *E. villosus*. The twelve pinnules it bears are expanded and notched in a normal manner. "The other modified carpels present," says Thiselton-Dyer, "are however so generalized that without the help of the more fully developed leaf their equivalence would be scarcely intelligible. This much is clear: *the solid expanded peltate carpophyll is nothing more than a transformed foliage leaf and capable of being replaced by it.*" The italics are mine.

The significance of such structures is unmistakable. To speak of these growths as "monstrous cones" is almost misleading. They are simply reversions exhibiting evolutionary stages which may at any time be found in fossilized forms of the ancestral line. When an *Encephalartos* reverts we find the growth preserving unmistakable characters of its genus and species; and likewise in the quite different form of reversion just described in *Zamia* the phenomenon falls within the same category. The main specific characters are preserved.

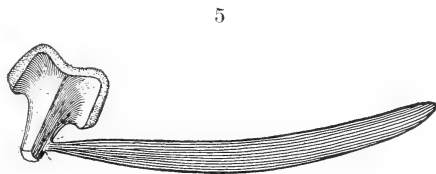

FIGURE 5.—*Zamia floridana* DC.  $\times \frac{3}{4}$ .  
Sporophyll (a) and pinnule shown in figure 4.

Having already discovered the pollen-bearing fronds of *Bennettites* (this Journal, March, 1899, and June, 1901), the description by Thiselton-Dyer interested me very greatly. I at once thought it probable that such cones might frequently occur, and that in the case of male cones there must be great likelihood of the reverted fronds *eventually being found fertile*. A few weeks later the *Zamia* cone above described was obtained. It is to be hoped that all such cases of reversion may be recorded. They promise to relieve us of the necessity for much speculation, and to be fully as important in our own morphological conceptions as have been the cones of other gymnosperms in the hands of Čelakovský, or probably much more so, because these forms yield us a knowledge of very primitive conditions. We are already in some measure guided when we attempt to form an hypothesis of the manner in which prothallial elimination must have proceeded in some marattiaceous or older fern line ancestral to the gymnosperms. At least the series from ordinary cycadean foliage leaves through the carpophylls of *Cycas* to the less leaf-like sporophyll of the cone (simply a seed-bearing branch) of *Dioon*, and the ordinary much altered sporophyll of the other cycadean genera, must be regarded as a connected one. And as I have elsewhere pointed out, the staminate fronds of the Bennettitaceæ afford concerning the coördinate changes which took place in microsporophylls an *explanatory analogy* of the most striking character. Progressive prothallial elimination, with correlated spore differentiation and alteration of the frond-like sporophytes of primitive ferns of the marattiaceous or an ancient allied group, were the basal factors in the evolution of the Cycadofilicinean and Cordaitean alliance. This subject of fundamental importance I shall treat more definitely elsewhere.

The question of the homology or equivalency of the Cycadean ovule to pinnules comes up in this connection. But I certainly think that the testimony of other unusual cones which we are almost sure to find in the course of time will be much more satisfactory than any insufficiently founded speculation, and shall therefore content myself with pointing out the opinion of Thiselton-Dyer (loc. cit.) thus conservatively expressed: “\* \* \* \* an ovule is a sporangial structure, and it is not easy to see anything in a pinna which is in any way comparable to it. Morphological conceptions must not enslave us, and I see no reason why sporangial structures, like buds, may not appear anywhere.”

Yale Museum, New Haven, Conn.  
January, 1902.



ART. XXVIII.—*On Crystals of Crocoite from Tasmania*;  
by R. G. VAN NAME.

A RECENT addition to the Brush Mineral Collection of the Sheffield Scientific School consists of a series of specimens of crocoite from near Dundas, Tasmania, purchased from the Foote Mineral Company of Philadelphia. These specimens, which are interesting on account of the diversity of development of the crystals and the unusual habit which many of them show, include both separate crystals and groups attached to the gangue. The latter is a cellular limonite more or less coated and intermixed with a black oxide of manganese (wad), but showing no trace of lead or chromium minerals other than the crocoite. In the cavities of this material, which has evidently come from a zone of oxidation, the crocoite crystals occur in irregular groups or loosely adherent masses.

Two distinct types of development are shown by the crystals. The habit exhibited by the detached crystals, and by a number of smaller individuals still in position upon the gangue, is quite different from that illustrated by Palache\* for crocoite from this locality, and is not mentioned by Dauber† in his detailed description of crocoite from Brazil, Siberia and the Philippines. Typical specimens of this habit are characterized by a remarkable elongation of the prismatic faces, the unit prism being the predominant form, and giving the crystals a nearly square cross-section, since  $m \wedge m' = 93^\circ 41'$ . Four of the crystals of this type are from 40 to 64<sup>mm</sup> in length, with a diameter measured across one of the prism faces of from 1 to 2<sup>mm</sup>, and a number of others, including several fragmentary crystals, have a relative length only slightly less. The faces of the unit prism are lightly striated longitudinally, but are in other respects smooth and even with sharp and well-defined intersections, the whole development of the prism being generally surprisingly regular. In all cases, as far as was observed, the crystals are of uniform diameter throughout and show no tendency to taper. The terminal faces upon the crystals of this type usually show a high polish and give excellent reflections. They are chiefly domes, but the base  $c(001)$  and the pyramid  $t(111)$  are often present though rarely prominent. No doubly terminated crystals of this type were observed.

With one exception all the faces observed were known forms, of which the orthodome  $k(\bar{1}01)$  and the clinodome  $z(011)$  are the most persistent. The new form is a clinodome  $j(032)$ , which was found on but one crystal.

\* This Journal, i, 389, 1896.

† Ber. Akad. Wien., xlii, 19, 1860.

A typical specimen of the habit above described is represented by figure 1.\* The faces present are the prism  $m$  (110), the clinodomes  $z$  (011) and  $w$  (012), the base  $c$  (001), and the orthodome  $k$  ( $\bar{1}01$ ). The crystal from which this drawing was made is  $64^{\text{mm}}$  in length and unusually symmetrical. Its diameter across a prism face is  $1.6^{\text{mm}}$ . To represent this crystal

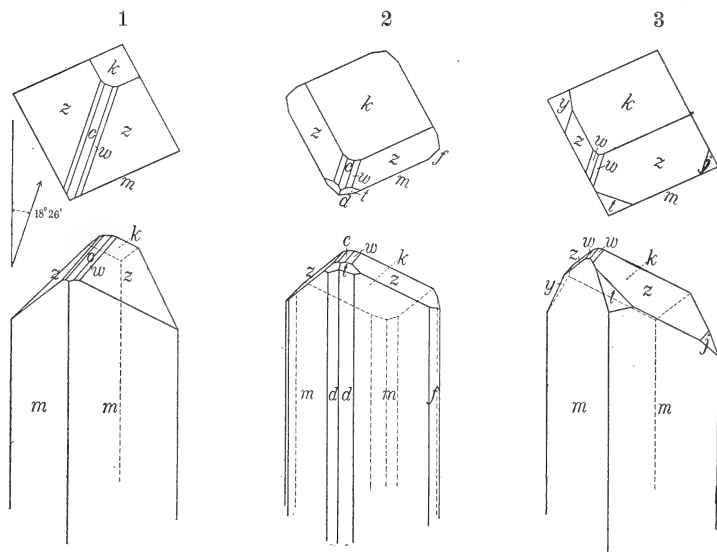

therefore in its true proportions the figure should be more than seventeen times the length here shown. Still simpler crystals of this type are terminated by the domes  $z$  and  $k$  alone.

Figure 2 was drawn from a slightly more complex crystal which shows, in addition to the forms present on the specimen just described, the prisms  $d$  (210) and  $f$  (120), and the pyramid  $t$  (111).

The crystals represented in figures 3 and 4 are unsymmetrically developed, and the relative size of the faces has been as far as possible preserved in the drawings. Figure 3 shows the crystal upon which the new clinodome  $j$  (032) was observed. It appears on only one side of the crystal, but the face is well defined, gives a good reflection and can be accurately measured. From the measurements to the two  $z$  faces, which

\* In this and all the following figures the plan is rotated through an angle of  $18^{\circ} 26'$ , as shown by the arrow, thus preserving the vertical relation between corresponding points in the plan and the clinographic projection below. This mode of representation has been used in a previous article from this laboratory by Robinson (this Journal, xii, 180, 1901), where its object is further explained.

varied very little upon repeated trial, the position of the base  $c$  was interpolated and the angle  $c \wedge j$  ( $001 \wedge 032$ ) was thus found to be  $53^\circ 10'$ , calculated  $53^\circ 18'$ . On the opposite side of the crystal the clinodome  $y$  (021) takes the place of  $j$ .

Another crystal of very similar habit but still more distorted is represented by figure 4. Here again the  $y$  face appears on one side only.

Dauber,\* among many previously unrecorded forms for crocoite, mentions but one new clinodome (085), and this he designates as doubtful. Although this index differs but little from (032), the calculated angle upon  $c$  ( $001 \wedge 085$ ) is  $55^\circ 3'$ , which is nearly two degrees larger than the measured value of  $c \wedge j$ . The index (085) can therefore hardly be assigned to the face  $j$ . Moreover, several other forms whose indices contain the 3 to 2 relation are known to occur upon crocoite.

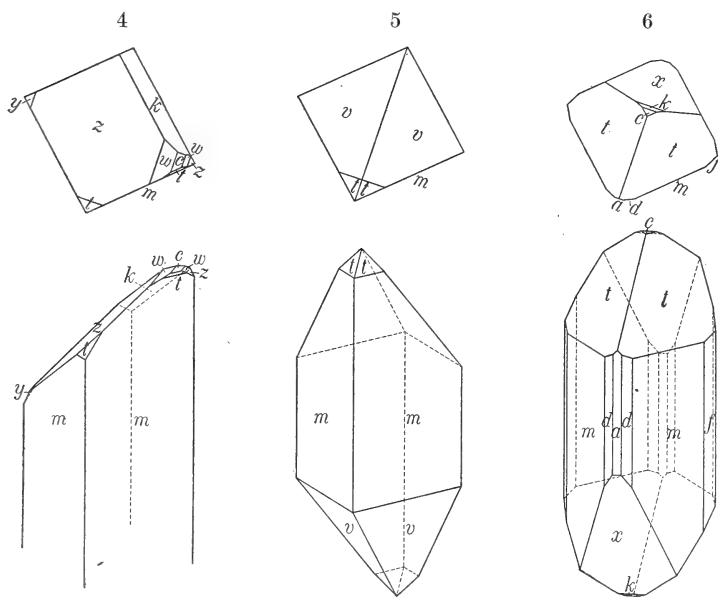

The other type of crystal referred to above is the one generally associated with this mineral, short prisms terminated chiefly by the simple pyramids  $t$  (111) and  $v$  ( $\bar{1}11$ ) with various modifications. These crystals are usually small and not infrequently doubly terminated. Two examples are illustrated by figures 5 and 6. Figure 5 represents a very common habit terminated by the pyramids  $t$  (111) and  $v$  ( $\bar{1}11$ ), and figure 6

\* Loc. cit.

shows a more highly modified crystal which has the prisms  $m$  (110),  $d$  (210) and  $f$  (120), the pinacoid  $a$  (100), the pyramid  $t$  (111), the base  $c$  (001), and the orthodomes  $k$  ( $\bar{1}01$ ) and  $x$  ( $\bar{3}01$ ).

This type of crystallization is shown by two of the specimens in the Brush collection, both of which consist of an aggregate of small, rather loosely intergrown crystals. A little of the limonite gangue is attached to each of them, and as far as can be judged the occurrence of the crystals of this type is the same as that of the slender prismatic crystals, although in no case were individuals of both types observed upon the same specimen.

A list of all the forms observed is given below. It should be noted that no attempt was made to identify any but the most prominent prismatic forms, on account of the tendency to striation which seems almost invariably to accompany any modification of the unit prism.

$a$ , 100	$c$ , 001	$t$ , 111	$z$ , 011
$m$ , 110	$k$ , $\bar{1}01$	$v$ , $\bar{1}11$	$w$ , 012
$d$ , 210	$x$ , $\bar{3}01$		$y$ , 021
$f$ , 120			* $j$ , 032

These Tasmanian crystals of crocoite with their superb color, high luster and remarkably perfect crystallization, are most beautiful natural objects, scarcely surpassed by crystals of any other known mineral.

The generous advice and assistance of Prof. S. L. Penfield, which has been constantly given during the preparation of this paper, is gratefully acknowledged by the author.

Sheffield Laboratory of Mineralogy,  
Yale University, New Haven, Conn., February, 1902.

ART. XXIX.—Notes on Unusual Minerals from the Pacific States; by H. W. TURNER.

*Mineral Phosphates.*

*Pyromorphite.*—This lead phosphate is found abundantly in the Rocky Mountains and elsewhere, but, so far as known, has not yet been reported from the Pacific slope. Mr. G. W. Kimble, of Placerville, California, sent some specimens of quartz from a vein in Mosquito Gulch, about six miles north-east of Placerville. This quartz contains a little galena, and a yellow-green mineral supposed by Mr. Kimble to be pyromorphite. The yellow-green mineral was tested by Dr. Hillebrand and found to be pyromorphite. It occurs as coloring matter in botryoidal chalcedonic quartz, coating seams and lining cavities; and also as little crystals along seams in the quartz. Mr. Kimble states that the vein occurs in gneissic rock near granodiorite, and that it contains, besides the pyromorphite and galena, a little pyrite and gold.

*Monazite.*—This phosphate of the cerium metals occurs usually in granites and gneisses, notably in North Carolina\* and Brazil,† but is known to be common in many parts of the world in sands. Mr. Waldemar Lindgren reports monazite in abundance in the Idaho Basin, twenty-five miles NNE. of Boise City. It is usually called “yellow sand.” The monazite occurs in small grains, and is presumed to have come from the surrounding granite. Its occurrence here in considerable quantity is of interest, as later it may serve as a source for the rare earths of the cerium group used in the manufacture of the mantles of Welsbach and other similar burners. North Carolina and Brazil now furnish the commercial monazite in sufficient quantity for this purpose.

*Apatite.*—As is well known, apatite is a very abundant constituent of many granodiorites and other igneous rocks, in the form of minute grains and prisms. The composition of this apatite probably varies, but to determine its character in a specific instance a gneiss was selected (No. 1743 Sierra Nevada collection) which contains a relatively large amount of this mineral. This gneiss was collected in the canyon of the North Fork of the Mokelumne River east of the mouth of Bear River. It is one of a series of old gneisses possibly Archean‡ in age.

\* H. B. C. Nitze, 16th Ann. Rept. U. S. G. S., pp. 667-693. This article gives a complete description of monazite as to its chemical composition, crystallographic character, distribution, production and bibliography.

† O. A. Derby, this Journal, vol. vii, 1899, p. 343. Mining and Scientific Press, Aug. 21, 1897.

‡ H. W. Turner, 17th Ann. Rep. U. S. Geol. Survey, Part I, 1896, p. 700.

The gneiss is composed chiefly of plagioclase, amphibole, pyroxene, reddish brown biotite, quartz, with accessory pyrrhotite, titanite, magnetite, zircon and apatite.

The heavy minerals were separated from the other constituents by means of the Thoulet solution. The magnetite was extracted with a horse-shoe magnet, and the amphibole, pyroxene and biotite with an electro-magnet. The remaining powder contained titanite, zircon and apatite. This was examined chemically by Dr. W. F. Hillebrand, who states that "the apatite contains a very small amount of chlorine, but apparently no fluorine whatsoever; at least it could not be detected. Neither does there seem to be hydroxyl replacing fluorine or chlorine." It thus appears in this instance that the apatite is neither a fluor- or a chlor-apatite.

*Vivianite* ( $\text{Fe}_3\text{P}_2\text{O}_8 + 8\text{H}_2\text{O}$ ).—Prof. H. G. Hanks\* reports this mineral from the Bree ranch in Los Angeles Co. associated with asphalt. The vivianite is in small enclosed nodules, never larger than a pea and generally smaller.

#### *Silicates.*

*Chloropal*.—In the Palmetto Mountains and in the southern part of the Silver Peak Range in Esmeralda County, Nevada, there are numerous dikes and interbedded layers of light colored acid lavas (meta-rhyolites and meta-dacites) in cherts of Ordovician age. These cherts, or rather layers of thin slate in them, contain the remains of graptolites. In one of these streaks of acid lava at a point about fifteen miles SW. of Silver Peak village, there was found a vein of yellowish-green material having the following composition.

#### *Analysis of yellow-green material.*

By GEORGE STEIGER.

	Per cent.
Insoluble less $\text{SiO}_2$ soluble in $\text{Na}_2\text{CO}_3$ after treatment with HCl .....	51.5
$\text{SiO}_2$ soluble after treatment with HCl .....	19.
$\text{Fe}_2\text{O}_3$ soluble in HCl .....	13.5
CaO " " .....	3.4
MgO " " .....	0.5
Alkalis .....	none
$\text{H}_2\text{O}$ calculated by difference .....	9.5
$\text{CO}_2$ " from CaO .....	2.6
100.0	

Leaving out the impurities, CaO,  $\text{CO}_2$ , and insoluble material and calculating to 100 per cent, we have :

\* 4th Ann. Rep. State Mineralogist of California.

SiO <sub>2</sub> soluble in Na <sub>2</sub> CO <sub>3</sub> -----	44·8
Fe <sub>2</sub> O <sub>3</sub> -----	31·8
MgO-----	1·2
H <sub>2</sub> O-----	22·2
	100·0

The composition of the yellow-green mineral thus determined corresponds nearly with chloropal.

*Diopside*.—In the Palmetto Mountains in Esmeralda County, Nevada, there are a few small areas of serpentine at or near the contact of granite and other rocks, either acid metamorphic lavas or cherts of Ordovician age. Associated with the serpentine are bunches of limestone, and at one point a streak of garnet and magnetite.

In the serpentine was found a considerable amount of a monoclinic pyroxene, which was separated and analyzed.

*Partial analysis of pyroxene No. 323 from serpentine mass.*

GEORGE STEIGER, analyst.

Silica-----	46·04
Al <sub>2</sub> O <sub>3</sub> *-----	1·21
Fe <sub>2</sub> O <sub>3</sub> †-----	5·24
MgO-----	16·98
CaO-----	25·23

This pyroxene is evidently near diopside in composition, and it is possible that it is of metamorphic origin from dolomite, as has been shown to be the case at Montville, N. J., by G. P. Merrill.‡ The serpentine is presumed to be derived from the pyroxene.

*Vesuvianite*.—It is well known that at the contact of granite and limestone various silicate minerals often form from the action of heat and vapors of the intrusive granite on the calcareous material. At such a contact in the NE. part of the Silver Peak quadrangle a silicate mineral was found associated with garnet and quartz. This silicate, freed from the associated minerals by means of the Thoulet solution, was analyzed with the following results (p. 346). Boron was looked for but not detected by blowpipe test.

#### *Sulphates.*

*Jarosite*.—On the east side of Soda Springs Valley in Esmeralda County, Nevada, at the edge of the foothills by the road to the Vulcan Copper mine, there is quite an amount of a golden-brown micaceous mineral, the origin of which was not

\* Includes any TiO<sub>2</sub> and P<sub>2</sub>O<sub>5</sub> that may be present.

† Includes any FeO, calculated as Fe<sub>2</sub>O<sub>3</sub>.

‡ On the Serpentine of Montville, N. J., Proc. U. S. Nat. Museum, vol. xxii, pp. 105-111.

## Analysis of Vesuvianite No. 186.

GEORGE STEIGER, analyst.

SiO <sub>2</sub> .....	36.80
Al <sub>2</sub> O <sub>3</sub> .....	17.53
FeO .....	1.56
Fe <sub>2</sub> O <sub>3</sub> .....	3.27
MgO .....	1.23
CaO .....	35.00
Na <sub>2</sub> O } .....	.13
K <sub>2</sub> O } .....	
H <sub>2</sub> O — .....	.10
H <sub>2</sub> O + .....	1.56
TiO <sub>2</sub> .....	.66
CO <sub>2</sub> .....	.65
P <sub>2</sub> O <sub>5</sub> .....	.07
SO <sub>3</sub> .....	none
Cl .....	none
F .....	.88
MnO .....	.48
BaO .....	none
	<hr/>
	99.92
Less O .....	.36
	<hr/>
	99.56

investigated. The nearest railroad station is Luning. Some of this material is said to have been used as a pigment for paint at the Midwinter Fair in San Francisco. The mineral was examined by Dr. W. F. Hillebrand, who made the following report:

“The mineral is a basic sulphate of sodium and ferric iron which if freed from foreign matter might agree in formula with *jarosite*. This is a potassium salt of formula

$K_2O3Fe_2O_34SO_36H_2O$ , or written structurally  $[SO_4]_2[Fe^{III}(OH)_2]_3K$ , since the water is constitutional, not being expelled below redness.”

“The pure crystallized sodium salt does not seem to have been heretofore observed. The mineral contains a small fraction of a per cent of potassium with nearly 6 per cent of sodium.”

*Nickel minerals.*

About three miles from Candelaria, Nevada, east of the road to Columbus, is a nickel deposit. Specimens sent by Mr. A. C. Dwelle were examined by Mr. E. T. Allen, of the Geological Survey, who found a sulph-arsenide of nickel, perhaps gersdorffite, and a green hydrous magnesian silicate genthite, present.



ART. XXX.—On the Use of the Stereographic Projection for Geographical Maps and Sailing Charts; by S. L. PENFIELD.

[Continued from p. 275.]

*Stereographic Map of the United States.*—A much reduced copy of the map made by the writer is shown in figure 21, and it should be said regarding it that it was drawn solely for the purpose of making a practical test of the accuracy with which measurements may be made with a scale of miles on such a projection, therefore not much detail is shown. As far as may be told by the eye, the map does not give the impression of being different from others with which we may be accustomed, but, owing to the fact that it is stereographic and so projected as to show minimum distortion, it is believed that it is the best kind of a map, embracing so large an extent of country, which can be made. The cities shown on the map were located from the following data, mostly taken from the Encyclopædia Britannica:

	Latitude.	Longitude.		Latitude.	Longitude.
Albany, N. Y. ....	42° 39'	73° 32'	Olympia, Ore. ....	47° 3'	122° 57'
Baltimore, Md. ....	39 17	76 37	Philadelphia, Pa. ....	39 57	75 10
Boston, Mass. ....	42 21½	71 4	Portland, Me. ....	43 39	70 15
Buffalo, N. Y. ....	42 53	78 55	Portland, Ore. ....	45 30	122 27
Chicago, Ill. ....	41 50	87 34	Pt. Isabel, Tex. ....	26 5	97 5
Columbus, O. ....	39 57	83 3	Raleigh, N. C. ....	35 47	78 48
Denver, Colo. ....	39 45	105 00	Richmond, Va. ....	37 32½	77 27½
Duluth, Minn. ....	46 48	92 6	San Diego, Cal. ....	32 44	117 8
Hartford, Conn. ....	41 46	72 40½	San Francisco, Cal. ....	37 47	122 25
Helena, Mont. ....	46 35½	111 52½	Springfield, Ill. ....	39 48	89 33
Indianapolis, Ind. ....	39 47	86 6	St. Augustine, Fl. ....	29 49	81 16
Key West, Fl. ....	24 41	81 46	St. John, New Brunswick,	45 17	66 5
Lansing, Mich. ....	42 46½	84 32½	St. Louis, Mo. ....	38 37½	90 15
Lincoln, Neb. ....	40 55	96 52	St. Paul, Minn. ....	44 52½	93 5
Nashville, Tenn. ....	36 10	86 49	Trenton, N. J. ....	40 14	74 46½
New Haven, Conn. ....	48 18½	72 56½	Vancouver, B. C. ....	49 18	123 6
New Orleans, La. ....	29 55	90 00	Washington, D. C. ....	38 53½	77 00½
New York, N. Y. ....	40 43	74 00			

To locate places with accuracy a sliding scale, figure 22, may be used to advantage. It consists of a system of equally spaced, diverging lines, drawn on some transparent material such as tracing cloth or parchment paper. To locate Indianapolis, 39° 47' N., 86° 6' W., for example; on the nearest meridians, 85° and 87°, the approximate latitude is marked with a soft pencil, and the scale is adjusted so that its outer lines cover the meridians at the points indicated. The lines of the scale then subdivide the space between the meridians into eight sections, each corresponding to 15'. The middle line of the scale gives the position of the 86th meridian, the next

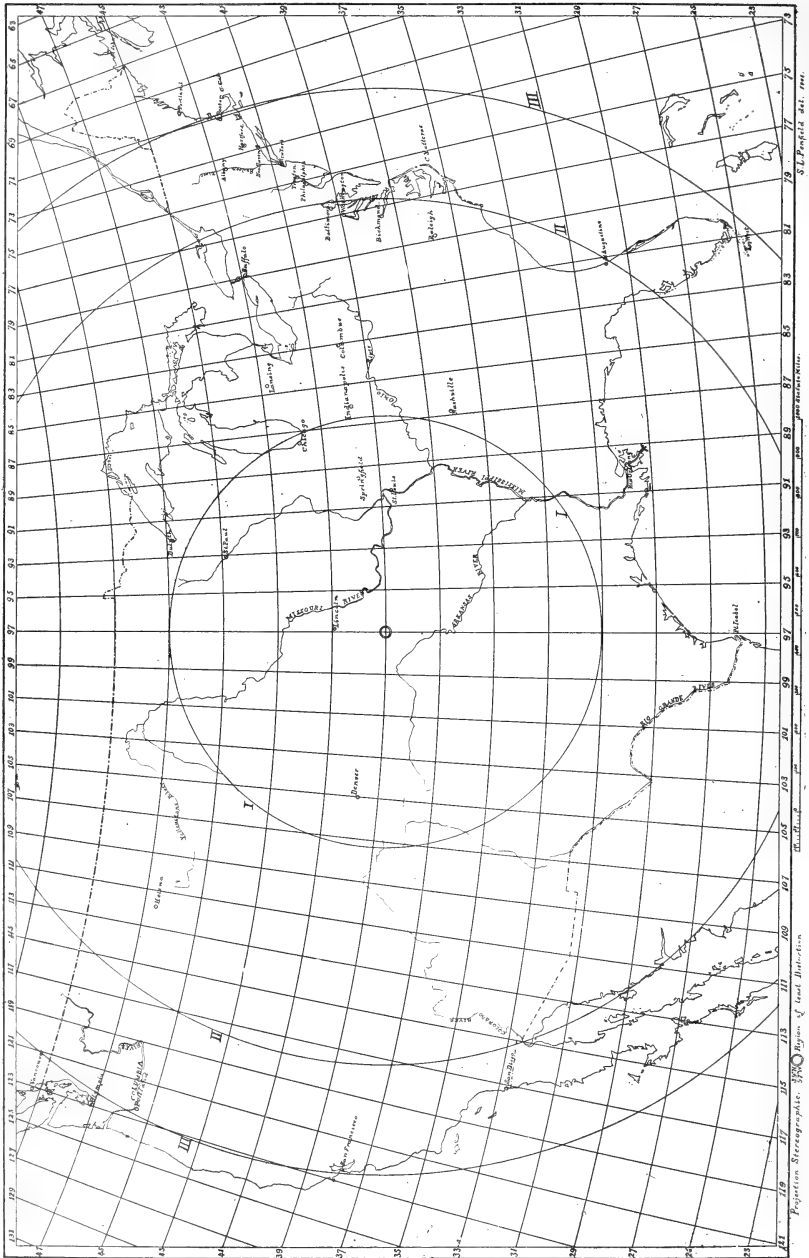

Outline Map of the United States in Stereographic Projection.

dashed line gives  $86^{\circ} 15'$ , and a point a trifle less than half way between them determines a point on the desired meridian,  $86^{\circ} 6'$ , which is then transferred to the map by puncturing with a needle point. Through the point thus found a short line is drawn parallel to the meridians, and over it the sliding scale is again adjusted so that its outer lines cover the nearest parallels,  $39^{\circ}$  and  $41^{\circ}$ , when the desired latitude  $39^{\circ} 47'$ , is located on the meridian  $86^{\circ} 6'$  by puncturing through the scale just above the dashed line indicating  $45'$ . Using the method just described, it is probable that places were located on the map within two miles of their true position, the chances being that the average error was less than a mile.

Any straight line drawn through the center of the map,  $39^{\circ}$  N.  $97^{\circ}$  W., figure 21, accurately represents the track of a great circle, and the map corresponds to so small a portion of a

22

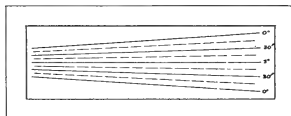

hemisphere, figure 20, that even near the periphery, where distortion is greatest, a great circle does not differ much from a straight line; this may be tested by applying a straight edge to one of the outer meridians, which show the greatest curvature. Moreover, distortion on the map is so slight that very satisfactory measurements may be made with a scale of miles, and, because of the evident importance of this simple method of making measurements, this property of the map has been very thoroughly tested. The examples chosen include distances over all sections of the map, and they are sufficiently numerous to give a satisfactory average idea of what may be accomplished by such methods of measuring. The adoption of a scale of miles suitable for a given map is a matter deserving special consideration. Taking distortion into account, it is evident that a scale of miles adapted to the center of a stereographic map, figure 21, would be too short when used near the periphery, and vice versa. As, on the other hand, the distortion over the whole extent of the map is not very great, it was assumed that a scale of miles could be found which would give, on the average, satisfactory results when applied to any part of the map. Accordingly the distance from the center of the map,  $39^{\circ}$  N.,  $97^{\circ}$  W., to a point near the periphery,  $37^{\circ}$  N.,  $69^{\circ}$  W., was selected as the basis of a scale of miles. The distance measured  $35.08^{\text{cm}}$  on the map, and was found by calcula-

tion to be equivalent to  $22^{\circ} 4'$ , or 1526 statute miles: hence by simple proportion it was determined that 1000 miles were equal to  $22.986^{\text{m}}$ . The scale of miles thus determined would be a trifle too long for the central portion of the map, too short for the outer portions, while there should be an intermediate portion for which it is approximately correct. Accordingly three circles were drawn about the center of the map, rather empirically it is confessed, which may be regarded as approximately defining certain zones to which the scale of miles is applied. The results of the measurements will be given in groups, according to the zones in which they are made. For future comparison measurements made on the polyconic map of the Geological Survey, referred to on page 273, are also given.

## GROUP I.

	Calculated.	Measured.	Error.	Corrected.	Error.	Polyconic.	Error.
Philadelphia to Trenton .....	28	28	0	---	---	34	+6
New York to Buffalo .....	297	298	+1	297	0	290	-7
New York to Chicago .....	710	711	+1	710	0	711	+1
Buffalo to Duluth .....	700	700	0	---	---	713	+13
New York to New Orleans .....	1166	1167	+1	1165	-1	1188	+22
Buffalo to Raleigh .....	491	493	+2	---	---	512	+21
Nashville to Raleigh .....	446	449	+3	---	---	468	+22
Nashville to Lansing .....	474	471	-3	---	---	479	+5
Baltimore to Columbus .....	346	349	+3	---	---	367	+21
Indianapolis to Lansing .....	223	220	-3	---	---	230	+7

In the foregoing group the distances measured fell almost wholly in the intermediate zone, between circles I and II, figure 21, for which the scale of miles is approximately correct. Since New York lies slightly beyond circle II, slight corrections, which will be explained later, have been made in three cases, but they do not materially alter the results. The maximum variation,  $\pm 3$  miles, is scarcely greater than probable errors of plotting and measuring.

## GROUP II.

	Calculated.	Measured.	Error.	Corrected.	Error.	Polyconic.	Error.
San Diego to Portland, Me. ....	2620	2617	-3	2624	+4	2657	+37
Duluth to St. Augustine .....	1311	1307	-4	1313	+2	1344	+33
Helena to Denver .....	587	583	-4	585	-2	592	+5
Lincoln to Springfield, Ill. ....	394	388	-6	392	-2	384	-10
St. Paul to New Orleans .....	1048	1040	-8	1048	0	1062	+14
St. Louis to Denver .....	794	785	-9	793	-1	796	+2
New York to Denver .....	1630	1623	-7	1631	+1	1635	+5
New York to San Francisco .....	2569	2564	-5	2570	+1	2587	+18
Portland, Ore. to New Orleans ..	2056	2048	-8	2055	-1	2093	+37
San Diego to Duluth .....	1636	1631	-5	1639	+3	1660	+24
Olympia to St. Augustine .....	2514	2507	-7	2515	+1	2546	+32

In the foregoing group all of the measurements are too low, but it is noticeable that the variation in no case amounts to ten

miles. By reference to the map, figure 21, it will be seen that the lines of measurement between the places indicated fall, for some distance at least, within the inner circle, this being the region of least distortion, for which the scale of miles is somewhat too long. By applying a correction, which consists simply of adding one mile to every hundred falling within the inner circle, and deducting one mile per hundred for distances extending beyond circle II, the corrected measurements, as shown by the table, are all remarkably close to the truth, exceeding two miles in but two cases.

GROUP III.

	Calculated.	Measured.	Error.	Corrected.	Error.	Polyconic.	Error.
Richmond to St. Augustine ----	578	583	+5	580	+2	596	+18
San Diego to Helena ----	997	1004	+7	1001	+4	1030	+33
Portland, Me. to Portland, Ore. 2529	2535	+6	2529	0	2565	+36	
Boston to Hartford ----	91	91	0	90	-1	100	+9
New Haven to Albany ----	98	99	+1	98	0	111	+13
Washington to Boston ----	393	396	+3	392	-1	411	+18
Key West to Pt. Isabel ----	961	968	+7	964	+3	975	+14
Portland, Ore. to San Francisco 534	543	+9	535	+1	556	+22	
Richmond to St. Augustine ----	578	583	+5	580	+2	599	+21
Vancouver to San Francisco ----	797	812	+15	798	+1	838	+41
Olympia to San Diego ----	1037	1054	+17	1043	+6	1086	+49
St. John, N. B. to Key West ----	1672	1703	+31	1681	+9	1754	+82

In this third group the measurements, with one exception, are all too high, but, excepting the last three measurements, to which special attention will be called, no variation amounts to as much as ten miles. By referring to the map, figure 21, it may be seen that the measurements are of distances extending beyond circle II, this being a region on the map where distortion is greatest and for which the scale of miles is too short. By applying the correction mentioned in the previous paragraph, subtracting one mile per hundred for distances falling between circles II and III, and, further, two miles per hundred for distances beyond circle III, the corrected values show but little variation from the calculated. One measurement, Richmond to St. Augustine, falls just within circle II, and belongs strictly in Group I, with an error of five miles, but it has been placed in Group III, allowing a correction of one-half mile per hundred. The last three measurements are of long stretches near the edges of the map, extending somewhat beyond circle III, but the correction applied to them gives satisfactory results. St. John, N. B., lies so far beyond circle III that the correction assigned to it is somewhat uncertain.

Thirty-three measurements are recorded in the foregoing tables, and the results indicate that with a map of the United States, accurately plotted in stereographic projection, very

close measurements may be made with a scale of miles, making no correction, or allowance for distortion. Except in the case of long stretches on the Atlantic or Pacific coasts, for which a reduction of one or two miles per hundred should be made, no uncorrected measurement between places accurately located should give an error of over ten miles. By applying very simple corrections, as indicated, it may be assumed that measurements made on any part of the map are probably correct within three miles. The error of the corrected measurements exceeds six miles in only one case, that being from St. John, N. B., which lies considerably beyond circle III, to Key West. Excepting the last two measurements of Group III, the errors of the corrected measurements amount to four miles in only two cases, and the average error is less than two miles. It is doubtful whether there is any other method of projection which will give an equally good map of so large a country as the United States, and one upon which better results of measurement may be obtained by means of a scale of miles, than those recorded in the foregoing tables. For a country containing as many square miles as the United States, but more symmetrical in shape, a better scale of miles could be adopted than the one used in making the measurements recorded on pages 350 and 351.

On the original map, from which the measurements referred to on pages 350 and 351 were made, one mile equals 0.23<sup>mm</sup> or 0.009 inch; the scale of the map being practically 111 miles to the inch. A scale of miles based on the average of all the recorded measurements was found to be 229.53<sup>mm</sup> equal 1000 miles, a most satisfactory agreement with the one adopted, 229.68<sup>mm</sup>, which, as explained on page 349, was based upon the distance from the center of the map to 37° N., 69° W., near the periphery.

No stereographic protractor has been made to accompany the map of the United States, but to make one graduated to either miles or degrees would involve no difficulties. By means of a protractor the results would be exact, considering of course the limitations of making a map and reading scales exactly. Certainly the errors would seldom amount to more than two miles, and it may also be said that it would be almost, or perhaps quite, as easy to make measurements with a protractor as with a scale of miles.

*Stereographic Map of New York State.*—It may be a matter of some interest to know whether it would be worth while to apply the principles of the stereographic projection to an area as small, for example, as New York State. Numerous methods of projection may be applied to so small an area, with results

which would be in every way satisfactory, as far as the practical use of the map is concerned, but it is believed that, in case extreme accuracy is required, one would be well rewarded by using the stereographic projection, especially as the labor involved in making the map is a matter of no special consideration. It took the writer less than three hours to make all calculations necessary for laying out the map shown in figure 23, and the work was done in duplicate in order to check possible errors. The size of the original map is  $16\frac{1}{4}$  by 12 inches, and, considered as projected on a central plane,

23

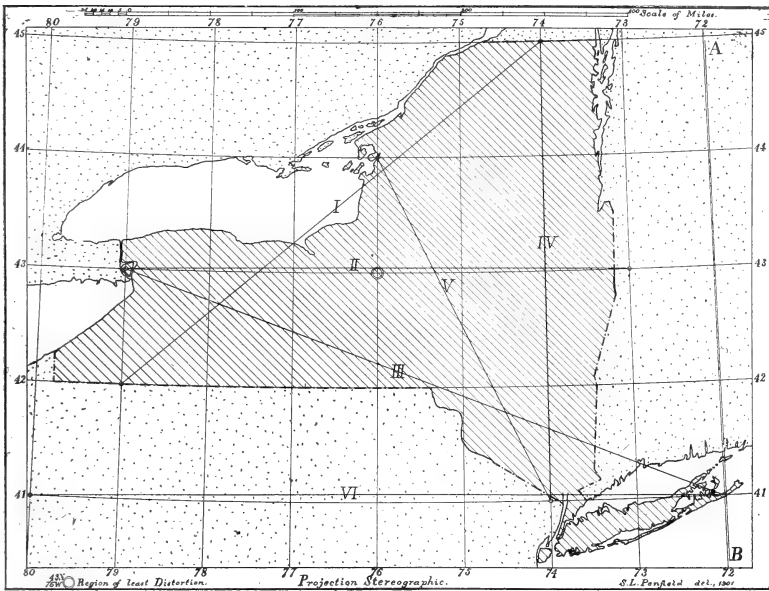

Outline Map of New York State in Stereographic Projection.

figure 16, it is based upon a sphere of 15 meters, 49 feet, diameter. The scale of miles adopted was based upon a distance of  $3^\circ$ , stereographically projected, measured from the center of the map: this gave as one mile,  $0.947^{\text{mm}}$ , or  $0.037$  inch. As a practical test of the accuracy with which measurements may be made on such a map, six measurements were made from the intersections of meridians and parallels, as indicated on the map, and given in the table, as follows:

				Calcu- lated.	Measured.	Error.
I.	From	42° N.,	79° W. to	45° N.,	74° W.	325.2    325.3    +0.1
II.	"	43 N.,	79 W. "	43 N.,	73 W.	303.4    303.2    -0.2
III.	"	43 N.,	79 W. "	41 N.,	72 W.	385.3    385.3    0.0
IV.	"	45 N.,	74 W. "	41 N.,	74 W.	276.6    276.4    -0.2
V.	"	44 N.,	76 W. "	41 N.,	74 W.	231.1    231.0    -0.1
VI.	"	41 N.,	80 W. "	41 N.,	72 W.	417.4    417.5    +0.1

It will be noticed that the maximum error given in the table does not exceed 0.2 mile, and this is to be attributed largely to the excellency of the method of projection. It should be stated that on this map, as also on that of the United States, previously cited, measurements of distances were in all cases made with a millimeter scale, and were converted to miles by simple proportion, using logarithms in making the calculations; hence, in determining the results, there was absolutely no personal bias, or possible unavoidable tendency to favor the reading of the scale so as to make the errors small. The tables show exactly what may be done on such maps, except that even better results could be obtained by those having more skill and experience in map drawing, and better appliances for measuring. On a map of so small an area as that shown in figure 23, the course of a great circle deviates but very little from a straight line. Thus, the line *AB*, at the right, is straight, and it may scarcely be told that it differs from the seventy-second meridian, which is a portion of a circular arc, drawn with a curved ruler.

*Applications of the Stereographic Projection to Navigation.*

—The writer has been given to understand that no body of men are so conservative as mariners, and that they are fully committed to the use of charts based upon Mercator's projection, to which they have been long accustomed; also that perhaps the majority of seafaring men abominate nothing so much as a chart with only curved lines on it. In spite of these strong prejudices, however, it is believed that charts based upon the stereographic projection possess so great merit, that it would well repay any navigator to study into their possibilities.

Although the shortest distance between two places on a sphere is along the arc of a great circle, it is not always best to continue to sail along the course of one great circle, for it may lead into too high latitudes, or into regions where unfavorable winds or ocean currents may be anticipated. Aside from the consideration of winds, ocean currents, and latitude, however, which must be studied into and reckoned with for each particular problem in navigation, there must always be some saving of distance from following great circles, rather than



rhumb courses. Moreover winds and ocean currents, although they may not be counted on as proceeding along great circles for any considerable distance, are likely to follow them, while they can have absolutely nothing in common with the directions of rhumb lines on a Mercator's chart. Wherever a navigator may be, it certainly would be to his advantage to be able to find the great circle, or shortest course, and the distance, to his port of destination, and also his bearings at any point along the route; all of which may be determined with ease and exactness with a stereographic chart and a protractor. Moreover, none of them may be determined directly by means of a Mercator's chart, although the bearings for rhumb courses may be found on the latter. There are some who strongly recommend the use of two charts for purposes of navigation, one gnomonic, the other Mercator's. On the former, all great circles are represented by straight lines, hence the shortest course between any two points is easily found, and may then be transposed to a Mercator's chart; but still this combination of the two charts does not give a much desired factor: the distance from any point where the navigator may be to his desired point of destination.

In order to demonstrate the practicability of the stereographic projection for purposes of navigation, a chart of the North Atlantic Ocean has been prepared, shown much reduced in figure 24. The original chart measures 17 by 27 inches, and is based upon a sphere of 1.2 meters, 3 feet 11 $\frac{1}{4}$  inches, diameter, regarding the chart as made on a tangent plane at 39° N., 45° W. Thus, although the scale is smaller than that employed in making the map of the United States, much the same data were available, as the point of tangency for both is on the thirty-ninth parallel.

To really appreciate the merits of the chart it must be studied in connection with its accompanying protractor, figure 25, which, for the purpose, need be but a small portion (that near the center) of a protractor such as shown in figure 10. As the protractor is on a large scale (agreeing with the chart) both great and small circles corresponding to every degree may be shown on it without causing confusion. With a single illustration it is possible to show the protractor in only one position, and that chosen in figure 25 indicates the way it may be applied to the problem of sailing from New York to the English Channel along the arcs of great circles. It is impossible to sail along one great circle; and to show this with the protractor it would be necessary to turn the latter about its center until one of its great circle arcs extended from New York to the Channel. The great circle which does this runs from New York City, just south of Boston, along the northern

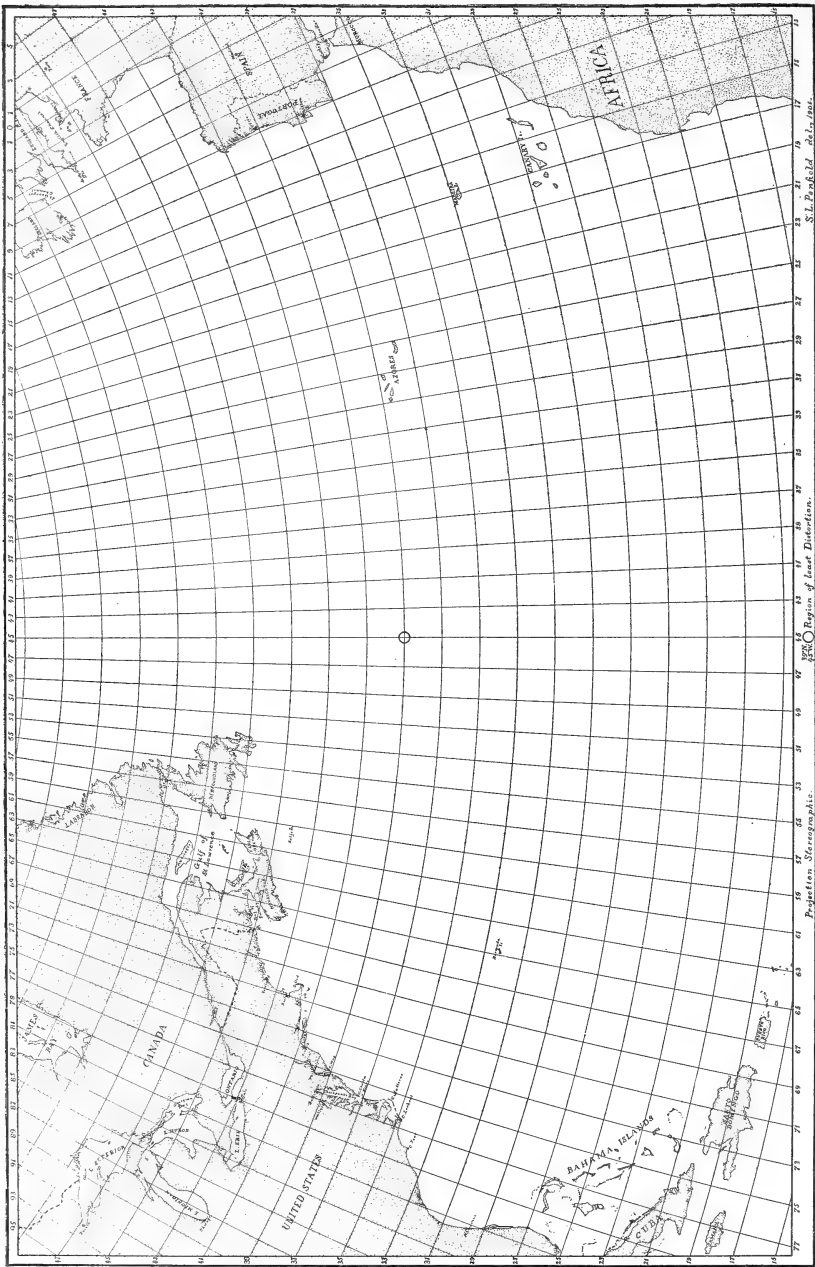
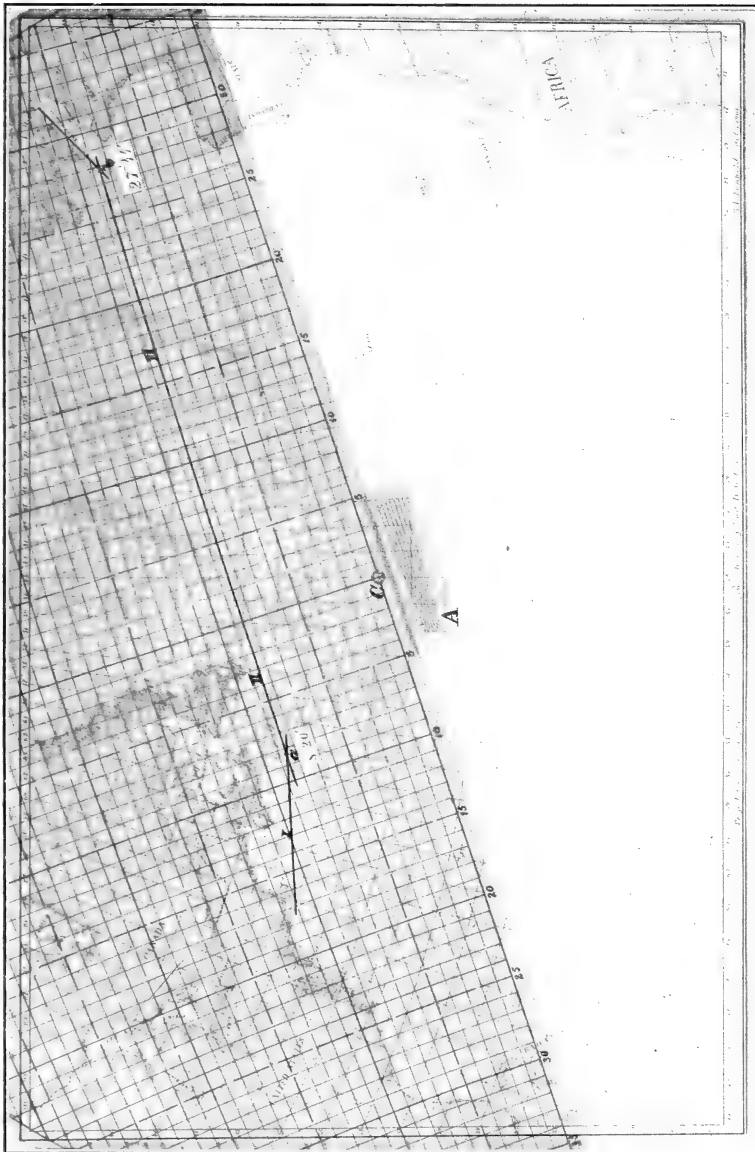

Chart of the North Atlantic Ocean in Stereographic Projection,  $39^{\circ}$  N.,  $45^{\circ}$  W. being the point of Tangency.



Stereographic Chart of the North Atlantic Ocean, partly covered by a Protractor, centered at  $39^{\circ}$  N.,  $45^{\circ}$  W. The original protractor is semicircular, the portions projecting beyond the map not being shown.

edge of Nova Scotia and through Newfoundland, a distance of  $17^{\circ}$ ; then from the eastern shore of Newfoundland, latitude  $48^{\circ} 45'$ , it stretches across the ocean for a distance of

29° 45' (1785 nautical miles) to the Scilly Islands, at the entrance to the Channel. To travel by water, a course about parallel to the south shore of Long Island may first be followed for about 3° (180 miles) to a point off Nantucket: then a great circle course marked I, figure 25, may be followed for about 8° (480 miles) to a point *a*, about 30 miles south of Sable Island: from *a*, the great circle course marked II extends for a distance of 8° 20' on one side of the center line of the protractor and 27° 44' on the other, a total of 36° 4' (2,164 miles) to a point *b*, about 30 miles southwest of the Scilly Islands. The total distance traveled along the courses indicated, from New York to *b*, is 2,824 sea miles, every portion of which may be kept track of by means of the protractor. At A, figure 25, a sliding scale is shown which is intended to be used between the small circles of the protractor for estimating fractions of a degree. Let it be supposed that a navigator has brought his ship to the point south of Sable Island, marked *a*, figure 25; he has only to turn the stereographic protractor to the position shown in the figure in order to find the great circle course leading from *a* to the point off the Scilly Islands marked *b*. Some intermediate point or points along this course being indicated on the chart, the great circle which it is desired to follow could be traced in pencil on the chart, using a curved ruler, which any ship's carpenter could make. The speed of the vessel being known by the log, the run of every few hours might be checked off, measuring the distance traveled by means of the stereographic protractor. Thus close track could be kept of the position of the vessel, which, of course, would be controlled by observations whenever possible. If driven from the proposed great circle course by any circumstance, it would only be necessary to determine the position of the ship by observations, and, by means of the protractor, to find some other great circle leading to the point of destination.

A feature of great circle sailing is that bearings must be changed at frequent intervals, the only exceptions to this being when a course is due north or south on a meridian, or east and west on the equator. Since angles are preserved in the stereographic projection, bearings may be taken with ease and exactness from a stereographic chart. Attention has already been called to methods of measuring angles, page 256, but this matter is so important to the navigator that it is considered best to add still another example, showing how an angle may be measured on a chart, such as that of the North Atlantic Ocean. Figure 26 represents a tracing from the writer's chart, figure 24, without reduction, *a* being the point of departure on the great circle *GC* leading to the English Channel. The chart, though not on a very large scale, is still so

large that short portions of great circles differ but little from straight lines; hence an ordinary protractor, printed on transparent material, may be used. To take the departure at the intersection of the great circle *GC* with the fifty-ninth meridian, figure 26, the protractor is centered at the intersection, adjusted so that its 0-0 line matches the meridian, and the departure is determined by where the great circle (more

26

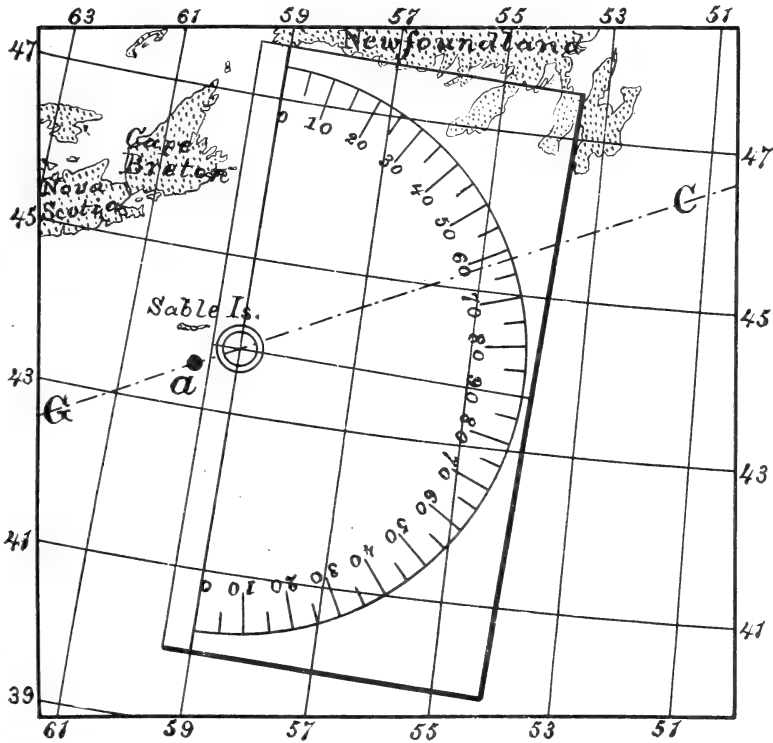

Measurement of the Angle made by the Great Circle *GC* with the fifty-ninth Meridian by means of an ordinary protractor.

strictly, a tangent to it at the point of departure) cuts the graduation of the protractor, which, as shown in the figure, is about  $61\frac{1}{2}^\circ$ . Continuing on the great circle, figure 25, the angle of departure continually increases until at the twenty-first meridian it is  $90^\circ$ , or due east, and at the intersection of the seventh meridian, near *b*, figure 25, it is about  $11\frac{1}{2}^\circ$  south of east.

The aggregate saving of time and money would doubtless

be enormous if the commerce of the world, which is now carried in ships, followed great circles, whenever it is advantageous to do so, instead of rhumb courses as indicated by the Mercator charts now in general use. To be sure, many experienced navigators practice great circle sailing, and have followed the ocean pathways for so long a time that they are thoroughly familiar with them: with stereographic charts and protractors, however, their problems would be still less complicated; in fact, the practical workings of the stereographic charts and accompanying protractors are so simple that any intelligent person would soon learn to use them, and great circle sailing would, if anything, be made even easier than rhumb sailing.

On figure 24 considerable land is shown in the upper left hand corner of the chart, and places located there are rather far from the center, where distortion is considerable. In spite of this, however, distances such as from New York to Chicago, Boston to Washington, Duluth to St. Augustine, or across the ocean from New York to Paris, were measured with accuracy by means of the protractor, the error amounting in one case to three miles, but averaging less than one and one-half miles.

*Comparison of the Stereographic with the Polyconic Projection.*—Reasons for making this comparison are because of the interest of the polyconic projection as being the one employed by the United States Coast and Geodetic Survey, which department is responsible for most of the official maps issued by our government; and also because it has been claimed that, of all methods of map projection, the polyconic is the most accurate for limited areas. It is further claimed, as one of the advantages of the polyconic projection, that parallels on the maps are of the same length as on a sphere of corresponding dimensions, which is true, but when the several cones are flattened out, or, what amounts to the same, when the parallels are plotted on a flat surface, the curves do not remain parallel, as on a sphere, but diverge as they depart from the central meridian.

One of the simplest ways to make a comparison between two maps is to draw them both to scale on one sheet, and the result of doing this with the stereographic and polyconic projections is shown in figure 27, the full lines having been traced from the writer's stereographic map, figure 21, page 348, and the dashed lines from the U. S. Geological Survey map referred to on page 273. The outline of the United States is stereographic. The central meridian is a straight line, and the spacing of this for a distance of  $12^\circ$  from the center is nearly the same on both maps. Other meridians are circular arcs on

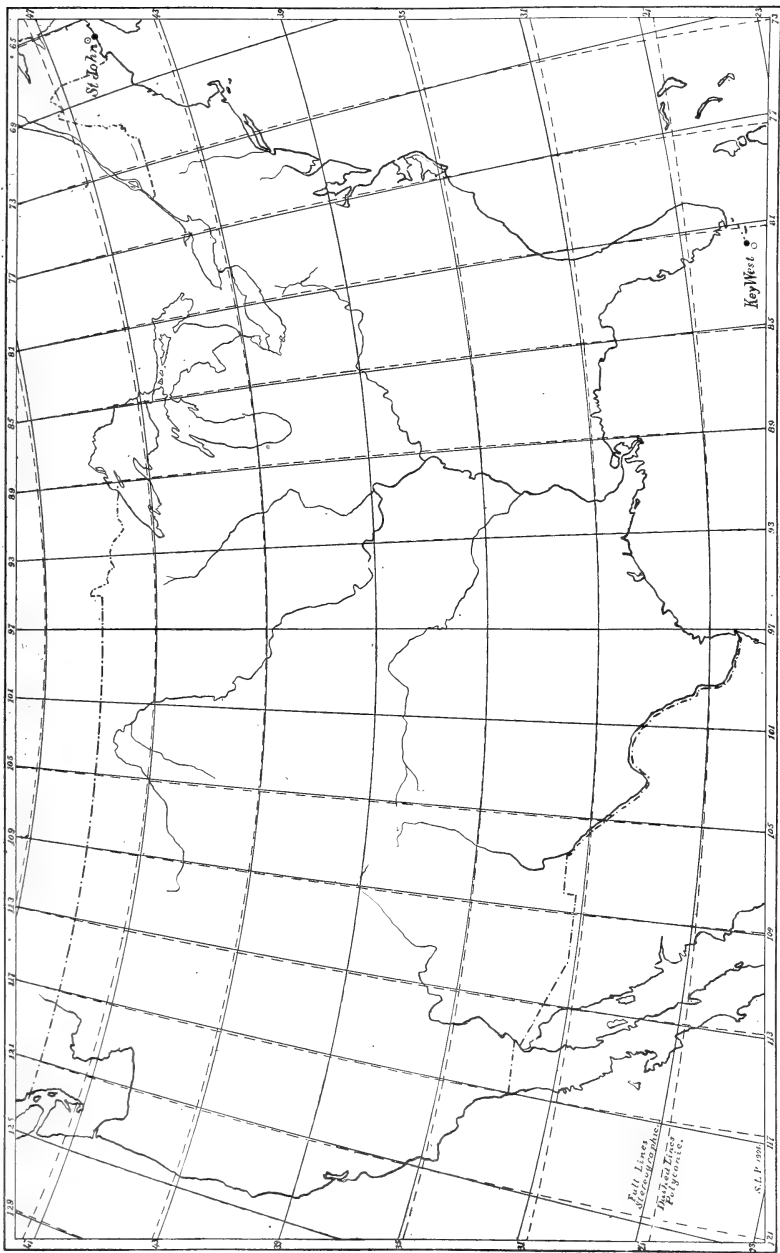

Comparison between the Stereographic and Polyconic Projections. The Stereographic is represented by full, the Polyconic by dashed lines. The outline of the United States is Stereographic.

the stereographic, irregular curves on the polyconic map. The thirty-ninth parallel is the same for both projections; while in the polyconic the twenty-seventh has a larger, and the forty-seventh a shorter, radius than the corresponding parallels of the stereographic projection. Based upon a sphere of 1·8 meters diameter, the radii for describing the three parallels mentioned are as follows :

Parallels .....	27° N.	39° N.	47° N.
Stereographic .....	148·05 <sup>cm</sup>	111·14 <sup>cm</sup>	90·22 <sup>cm</sup>
Polyconic .....	176·63	111·14	83·93

By examination of figure 27 it may be seen that near the center the two projections are nearly alike, while near the periphery there are decided differences, the stereographic showing less distortion than the polyconic. Take, for example, Key West and St. John. Their positions are indicated by dots in the stereographic, and by circles in the polyconic projection; hence it is evident that when measured with a scale of miles, their distance apart must be considerably greater in the polyconic than in the stereographic projection. Moreover, owing to distortion, the distance measured with a scale of miles on the stereographic map, page 351, is already too great. As regards the measurements made with the scale of miles accompanying the polyconic map of the survey, it should be stated in all fairness that the errors given on pages 350 and 351 are to some extent misleading, for undoubtedly exactly the same data were not used for locating places on the polyconic map as were employed by the writer. For the purpose, however, of illustrating that the stereographic projection is better than the polyconic, the comparison is a perfectly fair one. There is one noticeable feature of the measurements made on the polyconic map; namely, with two exceptions, the measured distances are too great, hence it is evident that a somewhat better scale of miles might have been chosen than the one published with the map. No scale of miles, however, would give such satisfactory results as were obtained from the stereographic map and given on pages 350 and 351.

In a publication issued by the U. S. Coast and Geodetic Survey,\* entitled, "*Methods and Results. A review of various Projections for Charts in connection with the Polyconic Projection used in the Coast and Geodetic Survey,*" a brief summary of the principal methods of map projection is given. Referring briefly to the more common projections, including the orthographic, stereographic, gnomonic or central, and some modifications of the globular, the following statements are made:

\* Report for 1880, Appendix No. 15.



"The above perspective projections, in their applications to astronomy and geography, are usually confined to the representation of a hemisphere, and but rarely to smaller surfaces. *For the purposes of land and sea charts on a large scale and consequently of quite limited extent, they are not well suited, for one or more reasons: they are generally laborious of construction when embracing limited areas, and cannot be made to satisfy any special conditions which they do not already possess, but which may be of paramount importance, or they may possess certain features which are not desirable on the chart.* We thus come to the construction of maps and charts by so-called development. These are of comparatively modern origin, whereas the preceding three principal perspective projections were all known to the ancients."

The writer has taken the liberty of italicizing two of the statements of the foregoing paragraph to which decided exceptions are taken, in so far as they relate to the stereographic projection. It may be stated, however, that the conclusion arrived at on page 12 of the survey publication just referred to, that their "investigation tends to commend the harbor, coast and sailing charts of the Coast Survey to the fullest confidence of the geographer as well as of the mariner," is wholly justifiable, provided the charts do not cover too large an area. In an example cited of an area about like that of New York State, but plotted on a somewhat larger scale than the writer's map, page 353, it is stated\* that "for so short a distance as three or four hundred miles and in latitudes below  $45^{\circ}$ , the error in distance, as compared with the arc of a great circle, is generally less than two-tenths of a mile." By reference to page 354, it may be seen that a like conclusion was obtained by the present writer from the actual measurement of distances on his stereographic map of New York State with a millimeter scale.

In conclusion, it may be stated that for an area as large as the United States the stereographic projection is better than the polyconic, and for smaller areas the same must hold true, although the differences between the two projections may then be scarcely appreciable. The stereographic projection is as good for one part of a sphere as another, which is not true of the polyconic projection: the latter, for example, would not be at all suitable for a map of the polar regions. Other advantages of the stereographic projection are that distortion is symmetrical about the center, or point of tangency, and by means of a stereographic protractor great circle courses may be indicated, and measurement of distances made, with exactness.

\* Methods and Results, loc. cit., page 12.

*Some Advantages of the Stereographic Projection over other methods of map making now in general use.*—The writer wishes it distinctly understood that he lays no claim to being an expert on the subject of map projection. It was wholly a matter of accident that in the study of crystallography his attention was called to the desirability of making the stereographic projection more generally useful, and its application to map projection followed as a natural sequence. During the rather short period which has been devoted to the special study of maps, pains have been taken to gain as much information as possible concerning modern methods of map making, and, what is at times called, map reading. This has been derived from conversations with scholars and teachers, and from examination of geographies and text books on map drawing. Some generalizations, therefore, though coming from one who is neither a geographer nor a cartographer, may not be out of place.

From an educational standpoint it seems as though decided advantages would follow from the adoption of such an excellent method of map making as the stereographic projection. From a study of figures 1, 2 and 16, pages 247, 248 and 269, or still better, of actual models, any scholar possessing the faculty of comprehending geometrical relations would see and understand what *projection* means, and would have an idea of the principle upon which stereographic maps are based. As it is now, many methods of making maps are in use, and there are few scholars, or teachers even, who have definite and correct ideas of how maps are constructed. The writer's limited experience is fully in accord with the following statement by an eminent geographer, J. W. Redway:\* "Of the principal (map) projections perhaps one in twenty is familiar with the name Mercator, while in audiences aggregating more than one hundred thousand teachers the writer has found scarcely one hundred who are familiar with the others." Map drawing, if practiced at all, seems generally to be done in the lower grades of the secondary schools in the United States, and there is something wrong about the manner of presenting the subject if teachers know little or nothing of the methods of plotting parallels and meridians, the most essential part of map drawing. On the other hand, let it be assumed that one has made a most careful study of the methods of map projection: In exceptional cases it may become necessary to draw a map, when a knowledge of how certain projections are made would be most useful. In the majority of cases, however, even a very good knowledge of the subject may be almost valueless, because the makers of maps seldom state the method of projection employed

\* The New Basis of Geography, The Macmillan Co., 1901, page 161.

in constructing them. This is a grave error, which should certainly be corrected. Every map which is published should be accompanied by a statement of the method of projection used in making the same. As it is at the present time, maps are plotted in various ways, and if one is called upon for an expression of opinion concerning any map, it is highly probable that the projection on which it is based would not be recognized with certainty. Let it be assumed that one of the simplest projections, the conical, is recognized; the map might have been made upon a tangent cone, with either central projection, figure 28, or projection at right angles to the conical surface

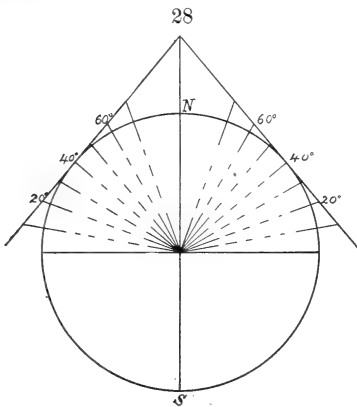

Tangent Cone, with Central Projection.

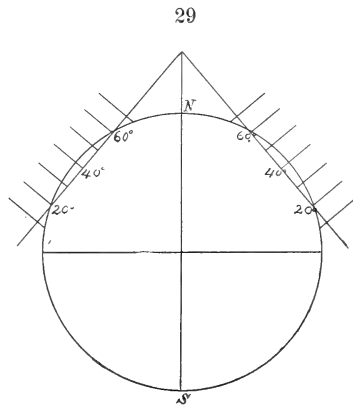

Secant Cone, with Projection at right angles to the Conical Surface.

as in figure 29; or the map might have been made on a secant cone, with projection at right angles to the conical surface, figure 29, or central projection, as in figure 28. How then may one pass judgment on a map, based on the conical projection, or some other which is not recognized with certainty, and tell, for example, whether a measurement, such as from New York to San Francisco is reasonably exact, or perhaps one hundred miles out of the way? The present writer has long entertained the belief that measurements made on maps with the scales of miles accompanying them are only approximately correct, and this has been confirmed by numerous trials. Take, for example, the stretch from New York to New Orleans: This has been repeatedly measured by the present writer with results varying from 1170 to 1236 miles, while the calculated distance is 1166½ miles. The results of map measurements made with accompanying scales of miles are almost invariably too great, according to the writer's experience. This is conspicu-

ously shown by the test of the polyconic map, pages 350 and 351, where only two measurements are too low, and by a like test on another large map of the United States (unknown projection), where, on measuring the same distance, only three results were found to be low. It was a labor well worth what it cost to show that, on a stereographic map embracing an area as large as the United States, measurements may be made with a scale of miles (taking no account of corrections) with errors seldom exceeding ten miles, and averaging only about five.

It seems to have been taken too much for granted that accuracy in map projection is a matter of minor importance. As stated in a recent publication,\* “accuracy is the one virtue that cannot possibly belong to a flat map.” This statement impresses the present writer as being far too sweeping, since there may be *accuracy* in the projection of the meridians and parallels; *accuracy* in delineating the continents and locating places; and, provided the stereographic projection and protractors are used, *accuracy* in determining great circle courses and measuring distances. To be sure, the shapes of continents can not be just the same on a flat surface as on a sphere, yet by means of the stereographic projection they may be shown with so little distortion, or with distortion of such a character, that the eye scarcely detects any change of shape. In the teaching of geography *accuracy* may be made a feature of map making and map reading, and that this is not more generally done is largely because geographers and teachers have been accustomed to use methods which, to say the least, are not the best, and in some cases are known to be poor. Why should it be recommended to draw maps upon a system of lines, equally spaced and at right angles to one another, erroneously designated, perhaps, as a projection of meridians and parallels? Scholars taught such methods may gain some facility in outlining continents, but the completed map will not look just as it should, when the country mapped is compared with the same country on a globe; moreover, such maps are quite useless for many of the purposes for which they are intended. It may be said that where such methods are followed scholars are taught to *ignore accuracy*. On the other hand, supply pupils with sheets upon which parallels and meridians based upon the stereographic projection are printed, teach them to outline countries and locate places with exactness, to construct scales of miles for maps of limited area, and test their work as to its accuracy, and something of importance has been learned. In the upper grades of high schools and academies, where mechanical drawing is taught, stereographic projections of the meridians and

\* The New Basis of Geography, loc. cit., page 157.

parallels of a hemisphere, either upon the plane of the equator or of a meridian, would be a most excellent exercise. To project the parallels and meridians for a limited area, as, for example, for a map of the United States or New York State, would be too difficult a task for any, except those who were proficient in trigonometry and possessed some skill in draughting. There is no reason, however, why the stereographic meridians and parallels should not be engraved and printed, and furnished to scholars for exercises in map drawing and measurement. A prominent educator in New England, a person of large experience, has assured the writer that there are

30



Africa, Stereographic Projection, from Map of the Eastern Hemisphere.

31

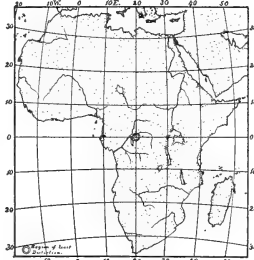

Africa, Stereographic Projection, showing minimum distortion.

32

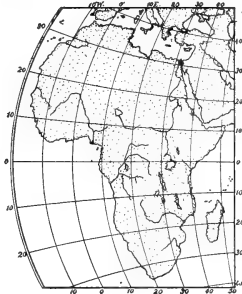

Africa, Globular Projection, from Map of the Eastern Hemisphere.

few exercises in the secondary schools which are pursued with so much zeal and enthusiasm by the scholars, as those where the character of the work is tested by its accuracy. This being the case, some simple exercises in map drawing and in making measurements on maps should prove most useful.

A method of plotting the meridians and parallels of a hemisphere, known generally as the *globular*, sometimes as the *arbitrary circle projection*, is almost invariably to be found in American geographies and atlases, and it is strange that a method having no really good features to recommend it should have received such general recognition. It is not a true projection in a mathematical sense, and differs from the stereographic in that the equator and central meridian are arbitrarily divided into equal spaces, the meridians and parallels being represented by circular arcs passing through the points thus found.\* This method of map making has been criticised

\* There is a true projection, also called the *globular*, where the point of vision is  $\sqrt{\frac{3}{2}}$  times the radius beyond the sphere. This projection is difficult to make, the circles of the sphere being projected generally as ellipses, and the final result does not look very different from the arbitrary circle, globular projection, with which it is frequently confounded.

by the present writer in an earlier publication,\* and at the present time occasion will be taken to point out more specifically some of its defects. Figures 30, 31 and 32 represent three maps of Africa, drawn about the same size and placed side by side for ready comparison. Figure 31 is stereographic, and drawn so as to show the continent, which is an especially large one, with minimum distortion. Figure 30 shows the continent as it appears near the periphery of the eastern hemisphere in stereographic projection; compare figure 9, page 258. The continent being large, its northwestern lobe extends out to that portion of the hemisphere, more than  $85^\circ$  from the center, where the distortion for such a map is near a maximum, see figure 19, page 272. Figure 32 differs from figure 30 in that the projection is globular, and the lobe, which in the former case was swelled out, is in this case unduly contracted, so that thus quite an erroneous conception of the general proportions of Africa is obtained. Notwithstanding distortion, it is believed that figure 30 gives a better idea of the shape of Africa than figure 32, as may be seen by comparison with Africa on a globe, or on a map, such as shown in figure 31, where the continent is represented with minimum distortion. The superiority of the stereographic projection is still more marked if the country represented on the map is a small one. Figures 33 to 36 represent maps of Spain and Portugal drawn with much care, the first three being stereographic, the last globular. Figure 33 is based upon a hemisphere of  $90^{\text{cm}}$  (about 3 ft.) diameter, and shows the countries with minimum distortion,  $40^\circ$  N.,  $4^\circ$  W., being the point of tangency. Figures 34 and 35 are based upon hemispheres of  $60^{\text{cm}}$  (about 2 ft.) diameter, the first showing the countries as they appear on a map of the Eastern Hemisphere, near the periphery, where distortion is considerable; compare figure 9, page 258; the second, as they appear on a map of the Northern Hemisphere, where they are nearer the center than in the previous case, consequently smaller and less distorted; compare figure 4, page 252. For giving correct impressions of the shape and size of the countries the three maps are about equally good. The distances between the parallels furnish data for measurement; hence on any one of the three maps it may be seen that Spain is about  $7\frac{1}{2}^\circ$  or 450 geographical miles long from north to south, and by measuring with dividers in an east and west direction, the two countries together are about as broad as long. To one accustomed to maps it does not much matter that in figure 34 the countries are tilted, for the meridians give true north and south. In contrast to these good maps, attention is

\* *Loc. cit.*, page 126.

invited to the globular projection, figure 36, which has been constructed in every way with as much care. Here the countries are not only narrowed in an east and west direction, but, since angles are not preserved, they are somewhat skewed; hence the map gives an entirely wrong impression of the shape and size of the two countries.

From a publication\* bearing the date 1901, and from a part

33

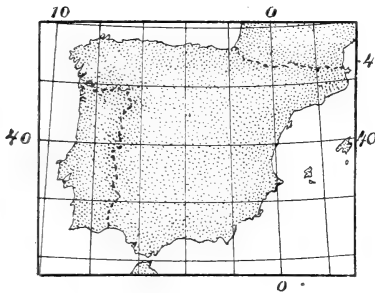

Stereographic Projection, showing minimum distortion.

34

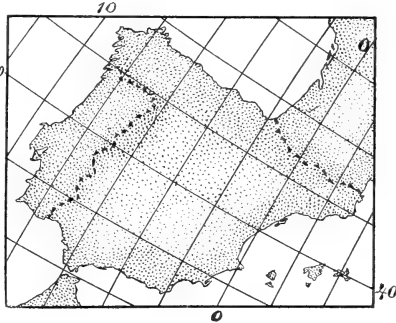

Stereographic Projection, from Map of the Eastern Hemisphere.

35

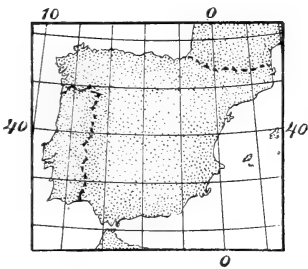

Stereographic Projection, from Map of the Northern Hemisphere.

36

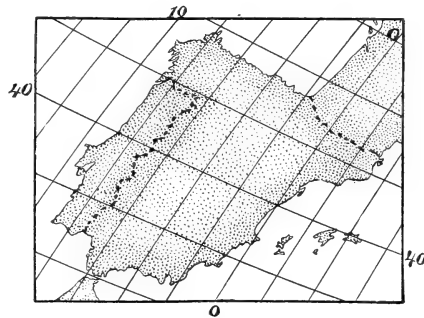

Globular Projection, from map of the Eastern Hemisphere.

of the book intended to give a critical summary of the methods of map projection, the following is quoted: Treating of maps of the hemispheres in stereographic projection: "Very small portions of the earth are shown very nearly of their proper shape, and large portions like India approximately of their proper shape, while large areas like Africa are terribly distorted. No earthly use is made of the mathematical properties

\* Maps. Their Uses and Construction; by G. James Morrison. Edward Stanford: London.

of the projection. The proper way to study the shape of individual countries is to consult the map of those countries. In a map of the world or of half of the world for general use it seems more important that the relative size and position should be clearly shown, provided the distortion is not excessive, than that minute details of shape should be retained at the expense of showing one country four times as large as another when it really is of the same size. Seeing, as has been said, that absolutely no use is made of the special quality possessed by stereographic projection, there is a good deal of reason in the contention that it is more of a mathematical curiosity than a useful map projection." Then, treating of the globular projection,

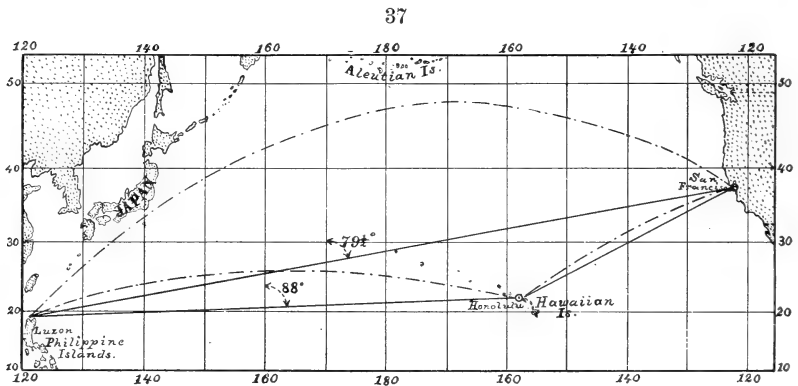

Chart of the North Pacific Ocean, showing rhumb and great circle courses from Northern Luzon to San Francisco.

"... it is very doubtful if for general purposes stereographic or any other projection is better, or even as good." In view of what has been shown in the present article, the writer wishes to express the hope that this is the last appeal that will be made for the continued use of an arbitrary method of map making, possessing no meritorious features, other, perhaps, than that it is an easy projection to construct.

Mercator's projection has its well-known advantages, but it is believed that its too general use is responsible for many erroneous conceptions of geography. All the principal lines and directions on a sphere are circles, hence to represent them by straight lines, as is done in Mercator's projection, is artificial. For the sake of illustration, let it be assumed that a ship is to travel from the Philippine Islands to San Francisco: The so-called rhumb course is represented by a straight line on a Mercator's chart, figure 37, and makes an angle of  $79\frac{1}{2}^\circ$  with the meridians. The rhumb line seems the only natural one on the chart, and the great circle course, represented by the



dashed line, which follows close to Japan and near the Aleutian Islands, seems wholly unnatural, yet transpose these same tracks to a sphere, and the great circle appears the only natural one, the rhumb course wholly unnatural. The great circle course, which may easily be followed and measured on a stereographic map, figure 14, page 265, is 5,865 miles long, about 330 miles shorter than the rhumb course. If a stop is made at Honolulu the discrepancies between the rhumb and great circle courses, as indicated in figure 37, are not very great. It is in the higher latitudes that the Mercator map is especially defective and misleading.

It is frequently claimed that for physical maps Mercator's projection is the best, because directions are preserved and all the world, excepting the polar regions, is represented on the map. In physical geography, however, rhumb courses never come into consideration, while to trace the courses of great circles and to measure distances, neither of which may be done with ease on a map in Mercator's projection, are both matters of great importance; hence, having shown how easily all kinds of measurements may be made by the use of stereographic maps and a protractor, it is believed that Mercator's projection is not as serviceable for physical maps as the stereographic projection would be.

Finally, this general discussion of maps may be brought to a close by a brief criticism of the maps of an "*Elementary Geography*" of the twentieth century which accidentally came to the attention of the present writer. In a chapter headed "*Maps and Map Reading*," "the measuring and drawing" of the school desks and school room is recommended to pupils as an exercise, it being stated that "its application to the reading of maps should be in connection with Geography." There then follows a fair sized map, designated "*Commercial Map of the World, showing Routes of Travel*." It is evidently a Mercator's projection, and, what is essentially wrong, a scale of miles is printed on the map, and no adequate description is given, although it is stated, where it is believed that scholars would not be very apt to see it, "that the northern and southern parts are drawn too wide because the curve of the sphere is not taken into account." Tracings of South America, Greenland and the scale of miles of the map referred to, are given in figure 38. A few pages beyond, maps of the Western and Eastern Hemispheres are given in stereographic projection, this being the only modern geography which the writer has seen where this projection is used. Figure 39 is a copy of Greenland as it appears on the map of the Western Hemisphere, and, considering its size, it gives a good impression of the shape of the island. Again, a few pages beyond, a

map of North America appears, and from this Greenland and the accompanying scale of miles have been traced, which are shown in figure 40. The distortion of angles is a noticeable

38

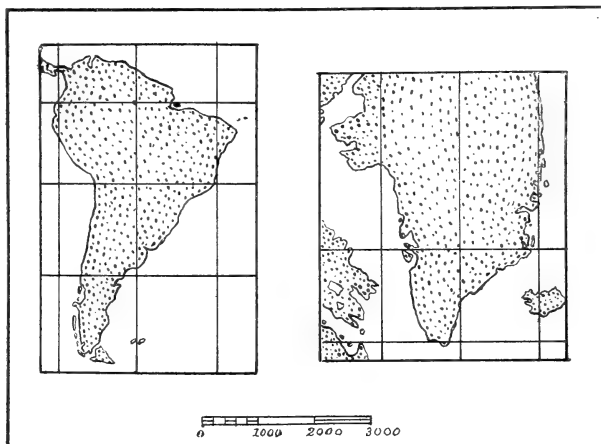

South America, Greenland, and Scale of Miles, copied from a Map in a twentieth century School Geography.

39



40

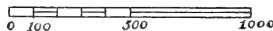
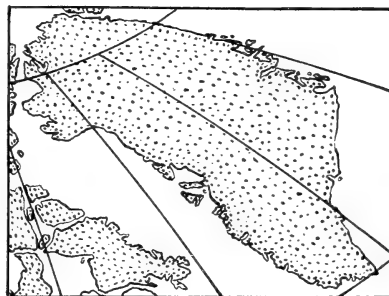

Maps of Greenland from a twentieth century School Geography.

defect of the last map, to which attention may be called. It may now be asked: what conceptions, other than absolutely false ones which some day must be unlearned, will the average scholar get from the study of these maps? Such methods applied to geography are not only unnecessary, they are misleading and harmful.

*Suggestions.*—Having shown what may be done with the stereographic projection, the writer, after having devoted

considerable thought to the subject, asks the privilege of making a few suggestions to those who may be interested in teaching geography. Models, such as shown in figures 1 and 16, pages 247 and 269, ought to be most useful for demonstrating how stereographic maps are made. Maps of the hemispheres one foot in diameter, executed with much care and accompanied by accurately engraved protractors, would serve a most useful purpose. The adoption of some of the methods indicated in this paper into schools would introduce new features of mathematical geography, which have the advantage of being simple, accurate, and useful. As far as measurements are concerned, the practical manipulation of stereographic protractors is so simple that any one could soon learn to use them. Naturally, the mathematical principles of the projection would not need to be introduced; all that beginners would need might be comprehended from studying models such as shown in figures 1 and 16. For advanced work, maps of the hemispheres two feet in diameter, with accompanying protractors, could be used to advantage, and it is probable that a stereographic map of the world, such as shown in figure 14, page 265, would be found most useful, especially as giving a ready means of solving many problems in Physical and Commercial Geography. Maps of the several continents and oceans, all drawn to one scale and accompanied by a protractor, would serve to give correct ideas of their size and shape. They should be of sufficient size to admit of all necessary detail, and accurate measurements could be made on them. Figures 41 to 46, all drawn on a small but uniform scale, serve to give an idea of this method of presentation. For a map of a single country, such, for example, as the United States, the stereographic projection is unquestionably the best that could be employed. For presenting the principles of navigation, and it is believed also for practical use, the stereographic projection has no equal.

It would doubtless be best to have the maps printed on cardboard, in order that the accompanying protractors could be used freely in connection with them, and they could be issued with the protractors in portfolios. It would not be necessary to have many maps; a few accurately engraved ones would answer all purposes.

*Expansion and Contraction.*—During the past year some attention has been paid to the behavior of paper, cardboard and celluloid under different atmospheric conditions. During the summer period, when the humidity is high, they all swell somewhat, and they contract during the winter, when subjected to the unusually dry atmosphere of a steam-heated room. The large map of the United States, page 348, the

sailing chart with its protractor, page 357, and the maps of the hemispheres, pages 252, 257 and 258, with their accompanying protractors, were made during the past summer. It happens that they were drawn upon three kinds of materials as follows; the best quality of cardboard, cheap cardboard, and high-grade, linen-backed drawing paper. At the time of writing, mid-winter, it is now found that the best quality of cardboard has shown the least shrinkage ( $\frac{1}{2}$ mm in 300mm), the second quality of cardboard comes next (1mm in 300) and the linen-backed paper third ( $1\frac{1}{2}$ mm in 300). As far as may be told, celluloid seems

41

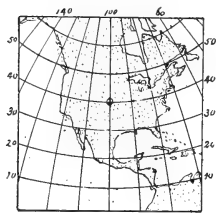

North America.

42

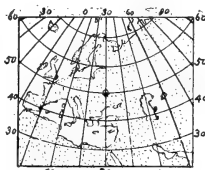

Europe.

43

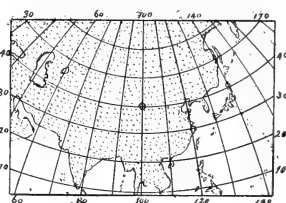

Asia.

44

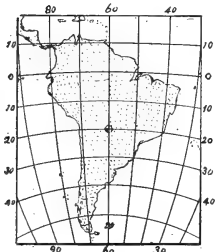

South America.

45

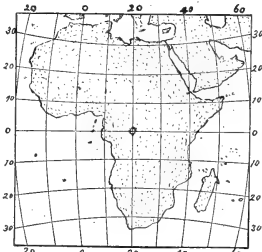

Africa.

46

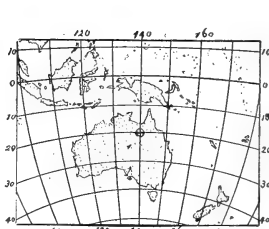

Australia.

Maps of the Continents in Stereographic Projection, all drawn to uniform scale. The small circle in each represents the point of tangency.

about intermediate between the two grades of cardboard. The protractors were made on well seasoned celluloid, nearly a year old, and they fit the maps drawn on cardboard just as well at the time of writing as at the time they were made. The engine divided scales and protractors, previously described by the present writer, have given good satisfaction throughout a whole year, the expansion and contraction of paper being not sufficiently greater than that of celluloid to cause serious trouble. Thus it may confidently be asserted that reliable measurements may be made with scales printed on well seasoned celluloid, provided they are used with maps printed at about the same season of the year and, preferably, on cardboard.

*Conclusions.*—From a mathematical standpoint there is perhaps nothing in the present communication that was not known hundreds of years ago; hence it is a matter of some interest to have shown that the stereographic is to-day the best projection for geographical purposes, in spite of the fact that geographers have not made much use of it. The principle of making a stereographic map on a plane tangent at any desired point has long been known, but the present writer is not aware that any one has ever before pointed out that maps of limited area, thus made, are probably more accurate, that is, show less distortion, than those made by other methods of projection. Certainly it is a most important feature, and why it has not been made use of before, if such is really the case, is difficult to explain. Possibly the construction of the very flat circular arcs have seemed to present too great difficulties; and, if so, the discovery of the Wulff curved ruler\* has overcome this obstacle. Without such a ruler for constructing some of the flat circular arcs, it would have been difficult to have drawn the maps shown in this article. The possibility of solving problems in spherical trigonometry by means of a stereographic protractor, which seems to have been first discovered by Chauvenet, has never become generally known. This is doubtless because it was necessary to have some such material as celluloid in order to make the protractor a successful working instrument.

It has been pointed out that in maps based upon the stereographic projection the shapes of countries are admirably shown, and that, when stereographic protractors are used with them, the courses of great circles may be traced and measurements made, both of distances and directions. Thus the requirements, mentioned at the beginning of this article as being especially desirable for geographical maps, are satisfied by the use of the stereographic projection, while no other projection combines these valuable properties.

From an educational standpoint the more general use of the stereographic projection would have many advantages, and to any one who delights in accuracy it should appeal most strongly.

NOTE.—In the writer's previous paper on the stereographic projection, the use of certain engraved scales and protractors was suggested, which have proved to be in every way satisfactory. For map work, however, it is necessary to vary the size of the projection frequently, consequently somewhat different methods must be resorted to. In place of the engine divided scales, previously suggested, tables have been prepared, giving (1) the degrees of a great circle stereographically projected upon a diameter; (2) the radii of arcs of great circles; (3) the radii of arcs of certain small circles

\* This Journal (4), xi, p. 138, 1901; *Zeitschrift für Kryst.*, xxi, p. 253, 1892.

which are frequently needed. It has not seemed that the tables in themselves are of sufficient interest to warrant their being printed as part of a journal article, but the material will be printed if there is any demand for it. For convenient use the figures are arranged as in logarithm tables. The unit of measure adopted is 100, and the tables give the real values and the corresponding logarithm for every degree. By means of the tables data for making a stereographic map of any desired size may be obtained with the greatest ease.

If there are those who wish to work out for themselves some of the problems of geography or navigation by means of the stereographic projection, so as to test its possibilities, there are now available the engine divided protractors and plates described in the writer's previous communication, and photo-engravings of the hemispheres, corresponding to figures 4, 8 and 9 of the present article, could be made, reduced to 14<sup>cm</sup> diameter to correspond with the protractors. If stereographic maps meet with sufficient favor to warrant their adoption, it will necessarily be some time before they and the accompanying protractors can be engraved and printed. Their possibilities are all that could be desired; their adoption is a matter which geographers and teachers must determine.

Sheffield Scientific School of  
Yale University, New Haven, February, 1902.

ART. XXXI.—*Note on the application of the Phase Rule to the fusing points of copper, silver, and gold*; by THEODORE WILLIAM RICHARDS.

IN an interesting and very thorough investigation by Holborn and Day,\* the fusing points of certain metals were recently studied with reference to their use as standards of temperature. As a result of this investigation, the investigators found that gold gave a very constant fusing point at  $1064^{\circ}$ ; that silver was extraordinarily inconstant in its melting point; and that copper was capable of yielding two constant melting points of  $1065^{\circ}$  and  $1084^{\circ}$ , according to the presence or absence of air.

Besides the practical importance of these results, a theoretical interest attaches to them: and since this side of the matter was not emphasized in the paper in question, this brief note is written to call attention to it.

According to the Phase Rule of Willard Gibbs, a fixed point in any system not affected by electrical or other extraordinary stress is determined by the simultaneous existence of a number of phases or other fixed conditions, two more than the number of components.

Let us apply this rule to the simple cases under review. Clearly one should expect gold to yield a constant melting point, whether in or out of the air, because its tendency to dissolve either oxygen or nitrogen is very slight; and practically only one component, the metal itself, is concerned. The three fixed conditions are of course the solid, liquid and vapor states of the gold, or perhaps more strictly speaking, solid and liquid gold and the atmospheric pressure.

On the other hand, the tendency of silver to dissolve oxygen is well known. This tendency introduces another component without introducing another phase; unless the concentration of the oxygen dissolved in the silver be determined, the number of fixed conditions is too few to determine a fixed point. But it is unusually difficult either to fix or determine the amount of oxygen which the silver dissolves in any given case.† Hence an uncertainty amounting to ten or fifteen degrees, unless oxygen is wholly excluded, is unavoidable. In the latter case Holborn and Day obtained a constant melting point,  $961.8$ , which corresponds to the two phases of the

\* Holborn and Day, this Journal (4), x, 171 (1900), also xi, 145 (1901).

† If a constant pressure of oxygen were maintained, the other fixed condition demanded by the Phase Rule would be theoretically supplied. But the great variation of the solubility of oxygen in silver with the temperature makes it very difficult to secure this constant pressure or to attain equilibrium.

single component under atmospheric pressure. Obviously the highest observed temperature is the most probable, since oxygen, or other dissolved substance, will lower the melting point of the metal.

The chief interest of this note centers in the double melting point of copper. Contrary to superficial expectation, the lower melting point of  $1065^{\circ}$ , obtained by melting copper in the air, with full opportunity for oxidation, was found by Holborn and Day to be far more constant and trustworthy than the higher one,  $1084^{\circ}$ , where every precaution was taken to exclude the air and to reduce the cuprous oxide present.

The Phase Rule at once explains this observation. When air is admitted to the surface of melting copper, the metal oxidizes, and the oxide is at first dissolved by the copper. The tendency of the copper is thus to remove molecular oxygen by converting it into cuprous oxide. Until the copper is saturated with cuprous oxide, the melting point will continue to sink as the metal oxidizes. When, however, the saturation point is reached, any additional cuprous oxide will appear as a new liquid phase, and will have no effect upon the melting point. The components are two, copper and oxygen; and the phases are four, solid copper, a solution of cuprous oxide in liquid copper, liquid cuprous oxide, and vapor.\* Hence the conditions for a fixed point demanded by the Phase Rule are present.

Since the solubility of cuprous oxide in copper undoubtedly varies with the temperature, it is clear that the adjustment of the equilibrium should be so deliberate as to allow the relieving of possible supersaturation.

The higher melting point,  $1084^{\circ}$ , of pure copper is clearly to be obtained only by the complete removal of the second component, oxygen—a process which is somewhat difficult. When this component has been removed, three phases are enough to fix the triple-point of fusion of the pure substance, as usual.

Thus in this case, as in so many others, the Phase Rule serves to classify the facts in such a manner as to make them more clearly comprehensible and more readily retained in the memory.

Chemical Laboratory of Harvard College,  
Cambridge, Mass., March 1st, 1902.

\* Since the nitrogen of the air does not enter into the reaction, it may be neglected. Its only effect is to cause a slight additional pressure on the system too small to produce perceptible result.



ART. XXXII.—*The Initiative Action of Iodine and of Other Oxidizers in the Hydrolysis of Starch and Dextrins*; by F. E. HALE.

[Contributions from the Kent Chemical Laboratory of Yale University—CVII.]

FREQUENT mention is made in the literature of the production of a red color, as well as a blue, when starch is used as an indicator in iodometric titration, and numerous formulæ have been given for making a starch solution warranted to give a blue color with iodine, and to keep without spoiling. An investigation of a loss of iodine, in titrimetric processes found to be connected with the formation of a red color, has led not only to the elimination of the loss, but also to a probable explanation of the cause of the red color, of the loss of iodine, and of their mutual relation.

The first loss of iodine was noticed in titrating a decinormal solution of arsenite with a decinormal solution of iodine. The amount of iodine needed was greater when an ordinary starch solution\* was used than it was when no indicator was used. The starch solution was made by grinding 5 grm. of starch paste with a few cubic centimeters of cold water with the addition of 0.01 grm. of mercuric iodide, pouring into a liter of boiling water, and boiling five to ten minutes. Only the clear supernatant liquid was used. An abundance of red was produced which slowly faded, and only the production of a permanent blue was taken as a reading.

The reading without starch was taken when the first tinge of yellow appeared, and to a skilled eye this reading is very sharp, and comes upon the addition of a single drop of decinormal iodine. The most important phenomenon, now noticeable, is that if a cubic centimeter of the starch solution be added after the yellow has appeared, a fine blue is produced without even a tinge of purple. This fact shows that some cause for the production of the red lies in the titration. It excludes any explanation of the loss of iodine by the formation of iodate. It excludes any explanation of the red color by some arsenic acid compound with starch when titrating an arsenite solution, or by some antimonie acid compound with starch when using a tartar emetic solution. The last statement is made because a red color has been produced by the action of arsenic acid upon certain sugars, but arsenious acid and salts of arsenic acid did not produce such a red color with the sugars. Moreover starch failed to give any such color with arsenious acid, arsenic acid, or salts of arsenic acid.†

\* G. Gastine., *Zeitschr. anal. Chem.*, 1889, 339.

† *Zeitschr. anal. Chem.*, 1882, 124. (Original not accessible.)

It is well known that starch is readily hydrolyzed by saliva, malt extract, and by many chemical reagents such as hydrochloric acid, potassium hydroxide, nitric acid, etc., down through a series of bodies, called dextrans, more or less completely to a final product, one of the sugars, usually maltose. One of the first of these dextrans is erythro-dextrin, which is colored red with iodine. It seemed possible that some such hydrolytic action might take place in the present instance. The water or the alkali, acid potassium carbonate, might cause the hydrolysis under certain conditions, e. g., as there is a loss of iodine, indications would point to an oxidizing action, and a hydrolysis may be possible because of such oxidizing action. It is also possible that the arsenious acid, or antimonious acid, becomes joined to the starch, in some such way as antimonious acid may attach to acid potassium tartrate, and that this compound is then easily hydrolyzed. A possible indication of this lies in the anomalous fact that the blue color fades first and the red last in alkaline titration, though a few drops of a starch solution will discolor a solution of erythro-dextrin, colored red with iodine, and develop the blue starch iodide.

Such a hydrolytic action upon the starch would readily explain the production of red and purple, since the formation of erythro-dextrin would furnish the red color with iodine, and the mixture of the red with the starch blue would yield varying shades of purple. The oxidizing action of the iodine would explain its loss in titration, and the two actions combined would explain the mutual relation of the two phenomena, a production of red in the end reaction and a loss of iodine.

With this explanation established, there are three ways of accounting for the loss of iodine; first, in the production of erythro-dextrin; second, in the formation of the erythro-dextrin iodide; third, in the oxidation of the erythro-dextrin down the series of achroo-dextrans.

Experimental evidence seems to substantiate the following points:

1st. The loss of iodine and the production of a red color does not take place if an absolutely pure and freshly made starch solution is employed.

2d. Ordinary starch contains, usually, at least two impurities, one coloring red with iodine, the other coloring blue, the latter being readily changed under the influence of oxygen and acid potassium carbonate to the former. These impurities tend likewise to form in pure starch, whether solid or in solution.

3d. The impurity coloring blue with iodine is identical with, or analogous to, amidulin, made by saliva digestion of pure

starch, and the impurity coloring red with iodine is erythro-dextrin, the second product of saliva digestion of pure starch.

4th. The loss of iodine is due to the formation of erythro-dextrin from this amidulin-like body, and erythro-dextrin does not use up iodine by any transformation to achroodextrins.

*Experiments showing the Loss of Iodine and its Correction.*

A few qualitative experiments on the sharpness of the reaction between iodine and starch demonstrated no loss in getting a reading under proper conditions, such as were used in the titrations.

TABLE I.

Total dilution. cm <sup>3</sup> .	n/10 I sol. drops.	Ordinary starch. cm <sup>3</sup> .	Other reagents.	Color.
75	1	1.25	-----	----
75	2	"	-----	blue
75	1	"	KI, 1 crystal (0.1-0.3 grm.)	blue
35		"	KI, few grams	reds (fading)
75	7-10	"	Na <sub>2</sub> CO <sub>3</sub> , 1 grm.	blue
75	5-6	"	K <sub>2</sub> CO <sub>3</sub> , 1 grm.	blue
75	1	"	KHCO <sub>3</sub> , 1 grm.	blue

The iodine solution used was made up in the usual way, 12.685 grm. of iodine and 18 grm. of potassium iodide to the liter. The arsenite solution in the following table contained 4.95 grm. of arsenious oxide to the liter and 70<sup>cm<sup>3</sup></sup> of a saturated solution of acid potassium carbonate.

In 5<sup>cm<sup>3</sup></sup> of iodine solution there are about 0.09 grm. of potassium iodide, and about 0.06 grm. of potassium iodide are formed from the free iodine in a titration, hence in an ordinary titration of arsenite solution by iodine enough potassium iodide (0.15 grm.) is present to bring a reading with one drop, in accordance with the experiments above. The presence of too much potassium iodide is, however, injurious to delicacy of reading. The only alkalies which can be employed are the acid carbonates. The influence of potassium iodide on the starch reaction, as well as the influence of the alkalies, has been ably shown by Lonnes.\*

Notwithstanding the fact that the following titrations were made under favorable conditions, i. e., in the presence of acid potassium carbonate and of a proper amount of potassium iodide, Table II shows a considerable loss of iodine. The action which brings about the loss, with a fixed amount of starch, must be rapid, for it seems complete when 20<sup>cm<sup>3</sup></sup> of

\* Zeitschr. anal. Chem., 1894, 409-436.

arsenite solution have been used. There is an average loss of  $0.14^{\text{cm}^3}$  of iodine solution, in these experiments, in the titration of  $20^{\text{cm}^3}$ – $50^{\text{cm}^3}$  of arsenite solution. The plain iodine readings were calculated from readings made at  $40^{\text{cm}^3}$  and  $50^{\text{cm}^3}$  of arsenite solution.

TABLE II.

The decinormal solutions were undiluted.

$n/10$ $\text{As}_2\text{O}_3$ sol. $\text{cm}^3$ .	Reading with $1.25^{\text{cm}^3}$ of starch solution to a deep blue. $\text{cm}^3 n/10$ I.	Plain iodine reading calculated. $\text{cm}^3$ .	Error. $\text{cm}^3$ .
5	5.23	5.14	0.09
10	10.37	10.28	0.09
15	15.50	15.42	0.08
20	20.70	20.56	0.14
25	25.85	25.70	0.15
30	31.00	30.84	0.16
35	36.12	35.98	0.14
40	41.20	41.08	0.12
45	46.39	46.26	0.13
50	51.54	51.40	0.14

The next set of experiments, carried out at a fixed and larger, final volume, show a decided drop in the amount of iodine lost, and the reddish tinge was not nearly so troublesome.

TABLE III.

Final volume  $110^{\text{cm}^3}$ .

$n/10$ $\text{As}_2\text{O}_3$ sol. $\text{cm}^3$ .	Reading with $1.25^{\text{cm}^3}$ of starch solution to a deep blue. $\text{cm}^3 n/10$ I.	Iodine reading calculated. $\text{cm}^3$ .	Error. $\text{cm}^3$ .
1	1.05	1.03	0.02
2	2.10	2.05	0.05
3	3.15	3.08	0.07
5	5.20	5.14	0.06
7	7.25	7.20	0.05
10	10.32	10.28	0.04
15	15.47	15.42	0.05
20	20.60	20.56	0.04
35	36.02	35.98	0.04

It is probable that even with an impure starch one can eliminate most of the error by proper dilution and by the introduction of sufficient potassium iodide to bring a sharp end reaction.

To fix the loss of iodine positively upon the starch solution and to prove that the action was a combination of oxidation and hydrolysis, the following experiments were performed.

Ia. A few cubic centimeters of hydrogen dioxide were added to 1.25<sup>cm<sup>3</sup></sup> of starch solution and diluted to 100<sup>cm<sup>3</sup></sup>. One drop of decinormal iodine brought out a fine blue color. Hence hydrogen dioxide has no oxidizing effect on starch in neutral solution.

b. As already stated,\* acid potassium carbonate by itself permits a sharp reaction. In hot solution it has no noticeable effect, since 4<sup>cm<sup>3</sup></sup> of starch solution were boiled in 100<sup>cm<sup>3</sup></sup> of water with a few cubic centimeters of acid potassium carbonate, and upon the addition of iodine to the cooled solution a single drop gave a pale blue.

c. A few cubic centimeters of both hydrogen dioxide and acid potassium carbonate were added to a little starch solution in about 100<sup>cm<sup>3</sup></sup> of water. When the color began to come, an abundance of red and purple resulted. Again, 3<sup>cm<sup>3</sup></sup> of starch solution were boiled in 100<sup>cm<sup>3</sup></sup> of water in the presence of a few cubic centimeters of hydrogen dioxide and acid potassium carbonate. Iodine added to the cooled solution produced an abundance of red and purple. In both of these experiments considerable iodine was taken up before the color came, but this had no bearing upon the phenomenon, as hydrogen dioxide and acid potassium carbonate together take up iodine, probably forming iodate. The important feature of the experiment is the production of a compound coloring red with iodine when the starch solution is treated with an oxidizing agent in the presence of the acid potassium carbonate.

II. The experiment was repeated with the substitution of potassium permanganate for hydrogen dioxide.

a. In neutral solution the starch was completely oxidized. Into an Erlenmeyer flask 4<sup>cm<sup>3</sup></sup> of the starch solution, 1<sup>cm<sup>3</sup></sup> of potassium permanganate and 120<sup>cm<sup>3</sup></sup> of water were introduced, brought to a boil and boiled for five minutes. Two drops of a very dilute solution of sulphurous acid were then added and the solution made acid in order to bleach the remainder of the permanganate. The solution was cooled and made alkaline with acid potassium carbonate. A drop of iodine produced only a yellow color, and was shown to be free iodine by the addition of fresh starch.

b. The experiment was next made in alkaline solution and resulted as in the previous experiment with hydrogen dioxide.

In an Erlenmeyer flask, 4<sup>cm<sup>3</sup></sup> of starch solution, 10<sup>cm<sup>3</sup></sup> of acid potassium carbonate and 1<sup>cm<sup>3</sup></sup> of potassium permanganate, diluted to 125<sup>cm<sup>3</sup></sup>, were boiled for five minutes. Three drops of the dilute sulphurous acid were required to neutralize the excess of permanganate in the acidified solution. The addition of iodine to the solution, cooled and made alkaline with

\* See Table I.

acid potassium carbonate, caused an abundance of red and purple.

These experiments tend to prove the presence in the starch solution of some body which is oxidized and hydrolyzed in alkaline solution with the production of erythro-dextrin. That the action is not upon the starch itself will be shown later.

An effort was now made to overcome the difficulty by varying the method of making the starch solution, and to facilitate comparison the different methods are given together.

### I. *Starch solution by heating with potassium iodide.*

In 25<sup>cm</sup><sup>3</sup> of cold water 5 grm. of pure starch were ground with 2 grm. of potassium iodide, poured into 75<sup>cm</sup><sup>3</sup> of boiling water and boiled, the beaker being protected with asbestos. The mass became mucilaginous. After fifteen minutes the volume was increased to 500<sup>cm</sup><sup>3</sup>, and the boiling was continued for forty-five minutes. The solution was filtered, forty-eight hours being required, leaving a residue of jelly-like consistency upon the filter. The method was suggested by the extreme delicacy which the presence of potassium iodide gives to the starch reaction and by certain statements made in the literature, one that concentrated potassium iodide causes starch to swell and dissolve,\* another that a solution of starch made by a somewhat similar method would keep a year without fermentation.†

### II. *Starch solution by heating with glycerine, according to Zulkowsky.†*

In 70<sup>cm</sup><sup>3</sup> of pure glycerine 5 grm. of potato starch were heated at a temperature of 185°–190° C. for half an hour with constant stirring. The starch dissolved and the solution turned through yellow to a deep red. The solution was cooled to 120° C. and poured slowly and continuously into 200<sup>cm</sup><sup>3</sup> of alcohol. The precipitate was thoroughly stirred, settled and filtered while warm. It filtered readily and was washed with alcohol until the filtrate came through colorless. The colorless residue was then dissolved in 500<sup>cm</sup><sup>3</sup> of water heated to 60°–70° C.

The product is called amorphous amylo-dextrin. It is described as non-crystallizable, coloring blue with iodine,  $(\alpha)_J = 206 \cdot 8^\circ +$ .

### III. *Soluble starch by saliva digestion.*

In a little cold water 2 grm. of starch were ground with 0.5 grm. of acid potassium carbonate and poured into 200<sup>cm</sup><sup>3</sup> of

\* Payen. Comp. Rend., lxi, 512.

† Zeitschr. anal. Chem., 1886, 37.

‡ Ber. Chem. Ges., xiii, 1395–1398

boiling water and boiled a few minutes. The solution was then allowed to cool to 40°-45° C. Meanwhile 10<sup>cm³</sup> of filtered saliva were neutralized with 0.1 per cent hydrochloric acid. A blue litmus strip, which had been dipped in acetic acid and washed, was used as indicator. The saliva was added to the starch solution at the proper temperature. In three or four minutes the solution became entirely clear, and was at once brought to a boil and boiled for ten minutes.

The addition of the alkali was to hinder the action from going beyond the first step of digestion. The boiling at the end destroyed any further action of the saliva. Starch cellulose is said to produce a feeble red or brownish color with iodine,\* hence the possible utility of this method lay in the absence of cellulose from the starch solution, since the cellulose is digested by the saliva.

Solutions were made up according to each of these formulæ. The amorphous amyloextrin was made from impure starch, the other two solutions from pure potato starch, specially procured. Table IV shows the relative sharpness of the different

TABLE IV.  
Volume 125<sup>cm³</sup>.

<i>n</i> /10 I sol. drops.	Potassium iodide.	Starch sol. cm <sup>3</sup> .	Color.
1	-----	-----	-----
2	-----	-----	faint change
3	-----	-----	decided change
4	-----	-----	light yellow
5	-----	-----	decided yellow
1	1 grm.	-----	" "
1	1 crystal	-----	" "
1	-----	1 ordinary	pale purplish
		2 "	stronger faint "
1	-----	1.5 amorphous amyloextrin	flash of blue
		3 "	" "
2	-----	1.5 "	good blue
1	1 crystal	1.5 "	" "
1	-----	1 KI starch	" "
		2 "	deeper blue
1	-----	1.5 amidulin	slight change
		3 "	very faint pink
2	-----	3 "	no change
3	-----	3 "	pale blue
2	-----	5 "	stronger " "

\* Beilstein I, 1082, line 17.

end reactions in blank. It will be noticed that the plain iodine reading is not sharp unless potassium iodide be present, and this is true of the starch solutions. The ordinary starch solution mentioned in this table and in the following table was a different one from that previously used. It was freshly prepared and hence shows a less amount of the impurity present. The burette used took four to five drops to make  $0.1\text{cm}^3$ , or approximately one drop equaled  $0.022\text{cm}^3$ .

It will be seen that the potassium iodide starch solution gave the sharpest and best end reaction, that amorphous amylo-dextrin lost one drop of iodine, and amidulin and plain iodine two drops. However, the presence of a crystal of potassium iodide rendered them all sharp to a drop, with the exception of amidulin, which explains the closeness of the results in the next table. In this their delicacy was tested in regular titration with a fresh arsenite solution, and with a slightly stronger iodine solution.

TABLE V.

Volume  $125\text{cm}^3$ .

$n/10$ $\text{As}_2\text{O}_3$ sol. $\text{cm}^3$ .	$n/10$ I sol. $\text{cm}^3$ .	Starch sol. $\text{cm}^3$ .	Color.
50	{ 49.38	1 KI starch	permanent purplish good blue
	{ 49.40		
"	49.40	1 " (4 crystals KI)	good blue
"	{ 49.40	2 ordinary	slow-fading purplish permanent blue
	{ 49.42		
"	{ 49.38	1.5 amorphous amylo- dextrin	permanent purplish deep blue
	{ 49.40		
"	{ 49.42	5 amidulin	permanent purplish deeper purple
	{ 49.44		
"	49.55	25 ordinary	abundant red

While these results are very close and the discrepancies might be ascribed to manipulation, yet the loss on  $25\text{cm}^3$  of ordinary impure starch freshly made, can hardly be overlooked. Moreover, these titrations were made at a slight dilution, and the slight loss hinted at in the case of amidulin is in keeping with later experiments. The introduction of considerable potassium iodide made no difference in the sharpness of the potassium iodide starch, and since this preparation gave the best blue color it was used in a series of parallel titrations in which readings were made with the starch blue and then with plain iodine alternately in order to eliminate accidental errors. Starch was added subsequently to corroborate the plain iodine reading, as the yellow is very delicate. The abso-



lute readings were found by subtracting one drop from the actual reading. To render the plain iodine readings sharp a crystal of potassium iodide was added in the first two titrations.

TABLE VI.  
Volume 125cm<sup>3</sup>.

$n/10$ As <sub>2</sub> O <sub>3</sub> .	$n/10$ I sol. reading by iodine color.	$n/10$ I sol. reading by KI starch blue.	$n/10$ I sol. abs. amt.		$n/10$ I sol. abs. amt. calc'd from 50cm <sup>3</sup> .	$n/10$ I sol. abs. errors in A, . . . in B.	
			A	B		A	B
cm <sup>3</sup> .	cm <sup>3</sup> .	cm <sup>3</sup> .	cm <sup>3</sup> .	cm <sup>3</sup> .	cm <sup>3</sup> .	cm <sup>3</sup> .	cm <sup>3</sup> .
--	1 drop*	1 drop					
5	4.94*	4.96	4.92	4.94	4.94	0.02—	0.00±
10	9.88	9.90	9.86	9.88	9.88	0.02—	0.00±
15	14.83	14.83	14.81	14.81	14.82	0.01—	0.01—
20	19.78	19.78	19.76	19.76	19.76	0.00±	0.00±
30	29.64	29.64	29.62	29.62	29.63	0.01—	0.01—
40	39.55	39.55	39.53	39.53	39.51	0.02+	0.02+
50	49.41	49.41	49.39	49.39	49.39	0.00±	0.00±

The most noticeable and important fact is that all loss, noted in the beginning of this paper, has disappeared, and that the plain iodine and the starch readings agree exactly except for the first two titrations, and here there is only a difference of a drop. The absolute errors are interesting as they show how the absolute values fluctuate about a standard set by the 50cm<sup>3</sup> readings. This fluctuation is limited to a drop plus or minus.

The statement has been made that starch from different sources has a varying power of absorbing iodine, e. g., that potato starch absorbs three times as much as rice starch.† To learn whether this fact had any bearing upon the question at issue, and at the same time to learn whether pure starch solutions made in the ordinary way (G. Gastine) would give as delicate readings as when boiled with potassium iodide, solutions were made from pure potato starch, pure rice starch, pure arrow-root starch and a pure soluble, so-called, starch of unknown origin. The results of titration with these solutions as indicators are shown in Table VII.

A fresh arsenite solution was made in a slightly different manner from the former. To assist in dissolving the arsenious oxide (4.95 gm.), 4 gm. of potassium hydroxide were added, not enough to entirely form di-potassium hydrogen arseniate, but more than enough to form potassium di-hydrogen arseniate. At each titration 5cm<sup>3</sup> of a saturated solution of acid potassium carbonate were added.

\* A crystal of potassium iodide was added.  
† Girard., Ann. Chim. Series (6), xii, 275.

TABLE VII.

No extra dilution. Volume about 110 <sup>cm</sup> ³.					
$n/10$ As <sub>2</sub> O <sub>3</sub> .	$n/10$ I sol.	KHCO <sub>3</sub> .	Starch sol.	Color.	
cm <sup>3</sup> .	cm <sup>3</sup> .	cm <sup>3</sup> .	cm <sup>3</sup> .		
50	{ 49·11	5	1	ordinary pure potato	pale blue
	{ 49·13				deep blue
"	49·13	"	"	ordinary pure rice	blue, slightly purplish
"	49·14	"	"	ordinary pure soluble	blue, slightly purplish
"	49·15	"	"	ordinary pure arrow- root	deep blue
"	49·15	"	"	KI pure starch	good blue
"	49·13	"	"	-----	yellow

It is at once seen that these values are coincident within a drop and that all the starch solutions are within the limits set by a plain iodine reading on the one hand and a potassium iodide starch reading on the other, though there was no dilution of the standard solutions.

To test the action of pure starch further some titrations were made with pure potato starch in varying amounts, and again with increasing amounts of acid potassium carbonate. As the loss of iodine, previously noticed, had been almost complete when 10<sup>cm</sup>³ of arsenite solution had been titrated, this quantity was used. Again there was no dilution.

TABLE VIII.

No extra dilution.					
$n/10$ As <sub>2</sub> O <sub>3</sub> .	$n/10$ I sol.	KHCO <sub>3</sub> .	Starch sol.	Color.	
cm <sup>3</sup> .	cm <sup>3</sup> .	cm <sup>3</sup> .	cm <sup>3</sup> .		
10	9·82	5	1·5	ordinary pure potato	deep blue, purplish
"	9·82	"	5	" "	deep blue
"	{ 9·82	"	10	" "	pale blue, purplish
	{ 9·84				deep blue
"	9·82	"	15	" "	deep blue
"	9·84	"	20	" "	deep blue
"	9·85	"	25	" "	deep blue
50	49·15	"	25	" "	medium blue
"	49·35	"	25	ordinary impure	abundant red

The last experiment was made to see if the conditions were the same as in the preceding experiments save for the starch, and a loss of 0·20<sup>cm</sup>³ of iodine solution seems to prove that there were similar conditions. There appears to be no loss with any amount of pure starch solution, even when 50<sup>cm</sup>³ of

arsenite solution is titrated. Especially noticeable is the fine blue color, with only a tinge of purple twice. The same thing is noticeable in the next series, by which it is seen that no reasonable excess of acid potassium carbonate causes any loss.

TABLE IX.  
No extra dilution.

$n/10$ As <sub>2</sub> O <sub>3</sub> . cm <sup>3</sup> .	$n/10$ I sol. cm <sup>3</sup> .	KHCO <sub>3</sub> . cm <sup>3</sup> .	Starch solution. cm <sup>3</sup> . ordinary pure potato.	Color.
10	9.82	5	1.5	deep blue
10	9.82	10	"	deep blue
10	9.83	15	"	deep blue
10	9.82	20	"	deep blue, purplish
10	9.81	25	"	deep blue

As still further corroborative proof a solution of tartar emetic was made up as follows.\* Tartar emetic was recrystallized, dried by exposure to the air and pulverized; 16 gm. were weighed out and dissolved in 200–300<sup>cm<sup>3</sup></sup> of water; 20 gm. of tartaric acid, dissolved in a little water and filtered, were added and also 1<sup>cm</sup> of strong hydrochloric acid. The solution was diluted to one liter. The significant fact about the following titrations is the absence of any red colors, such as are historically connected with antimony titrations. Indeed, Fresenius† speaks of the red as giving the closer reading.

TABLE X.

Volume. cm <sup>3</sup> .	$n/10$ Tartar emetic. cm <sup>3</sup> .	$n/10$ I sol. cm <sup>3</sup> .	Starch sol cm <sup>3</sup> . pure potato.	KHCO <sub>3</sub> . cm <sup>3</sup> .	Color.
100	10	9.58	1.5	10	blue, no red
100	10	9.58	1.5	10	blue
75	10	9.56	-----	10	yellow
125	50	47.75	1.5	25	blue, (purplish tinge)
125	50	47.75	-----	25	yellow

The average of the 10<sup>cm<sup>3</sup></sup> readings (absolute) multiplied by five equals 47.73. The absolute 50<sup>cm<sup>3</sup></sup> reading (47.75–0.02) equals 47.73. Evidently even tartar emetic causes no loss on pure starch, for the 50<sup>cm<sup>3</sup></sup> reading agrees with the plain iodine reading for the same amount and with the 10<sup>cm<sup>3</sup></sup> titrations.

The severest test of all was then made on the pure potato starch solution. With it were tried the two oxidizing experiments with hydrogen dioxide and potassium permanganate.

I. Into an Erlenmeyer flask 100<sup>cm<sup>3</sup></sup> of water, 10<sup>cm<sup>3</sup></sup> of acid potassium carbonate, 4<sup>cm<sup>3</sup></sup> of the starch solution and 5<sup>cm<sup>3</sup></sup> of

\* Gruener, this Journal, vol. xlv, Sept., 1893.  
† Fresenius, Quant. Anal., 6<sup>e</sup> Auf., II, 818.

hydrogen dioxide were poured, brought to a boil and boiled five minutes. The solution was cooled and iodine was added. A few drops brought out a fine blue with perhaps the barest trace of purple.

II. Into an Erlenmeyer flask 100<sup>cm</sup><sup>3</sup> of water, 10<sup>cm</sup><sup>3</sup> of acid potassium carbonate, 4<sup>cm</sup><sup>3</sup> of the starch solution and 1<sup>cm</sup><sup>3</sup> of potassium permanganate were poured, brought to a boil and boiled five minutes. The permanganate faded to a light brownish yellow. The solution was made acid and the excess of permanganate was faded with a few drops of very dilute sulphurous acid. The solution was then cooled, made alkaline, and iodine was added. A few drops produced a blue. There was not a trace of red.

These facts substantiate the statement that pure starch causes no red color, nor loss of iodine, in alkaline titration of arsenite solution or of tartar emetic. If any purplish tinge occasionally occurs it is no hindrance to the reading and it causes no appreciable loss of iodine, since under most advantageous conditions the loss is but slight, even with an impure starch.

With an impure starch the reading from the first permanent color, whether red or blue, is nearest to the correct value. The readings with impure starch may be compared with plain iodine readings and a correction applied, since the loss for a constant quantity of starch is constant in the titration of 20–50<sup>cm</sup><sup>3</sup> of arsenite solution. It is better to titrate with considerable dilution, e. g., 150–200<sup>cm</sup><sup>3</sup>, and to add a crystal of potassium iodide if necessary, since the production of red is at a minimum and less troublesome, and the loss of iodine is hardly appreciable. With impure starch fresh solutions should be frequently made.

#### *Experiments showing the Cause of the Trouble.*

The foregoing experiments have shown that pure starch is not attacked by iodine, hydrogen dioxide, or potassium permanganate in the presence of acid potassium carbonate, and that impure starch is attacked. There were found in the impure starch employed two impurities, one of which colors red with iodine, and the other under the influence of nascent oxygen and acid potassium carbonate is changed to a body which colors red with iodine. These two impurities were separated from the starch in the following manner. A solution was made of the impure starch. To two separate portions iodine was added.

I. Iodine was run in to excess, and the resulting starch blue was precipitated by dilute sulphuric acid and filtered. The excess of iodine was shown by its action on the filter paper

and by the color of the filtrate, which was yellow. This latter fact showed that the dextrins present, if such they were, had been included in the starch blue. An attempt to wash them out with water completely failed. The principle suggesting this and the following experiment was the greater solubility of the dextrin iodide than of the starch iodide, and the fact that it is not precipitated by dilute sulphuric acid, when alone.

II. With care iodine was run in just sufficiently to use up the starch present with but the barest excess, so as to include no dextrin iodides if possible. The starch iodide was then precipitated with dilute sulphuric acid and filtered. That there was no excess of free iodine was shown by the lack of action on the filter paper and by the color of the filtrate, which at first came through of a pale blue color and finally came colorless. The precipitate was well washed. To a few cubic centimeters of the filtrate a drop of iodine was added, and at once a red color was produced with no trace of blue. Enough dextrin was present to completely hide the pale blue of the earlier portions of the filtrate.

This pale blue compound, though separated in less quantity, proved to be the more interesting body, for to it was due the loss of iodine in titration. No method was found, however, of separating it from the erythro-dextrin, though its distinct character is shown by the following experiments. A few cubic centimeters of the filtrate above mentioned were colored deep red with iodine, and separate portions were shaken with chloroform, carbon disulphide, and amyl alcohol. At once these solvents became colored with free iodine respectively purple, purplish red, and yellow, and the watery solution of the dextrins was left of a pale blue color, proving that the dextrin coloring blue had a stronger affinity for the iodine than the dextrin coloring red. A drop of iodine added to the water, without shaking, colored it red, showing that the erythro-dextrin was still present in the water, i. e. the blue-coloring dextrin held the iodine from the erythro-dextrin.

The next noticeable and interesting feature about this blue-coloring dextrin is its difference from starch in that its iodide is not precipitated either by dilute or concentrated sulphuric acid. Hence this body seems to be intermediate between starch and erythro-dextrin; first, because its iodide is more stable than erythro-dextrin iodide; and second, because its iodide is more soluble than starch iodide.

Examination was made of the amorphous amylo-dextrin solution, and of the amidulin solution, since these were bodies coloring blue with iodine and probably intermediate between pure starch and erythro-dextrin.

The amylo-dextrin iodide blue was readily precipitated by

dilute sulphuric acid. The amidulin iodide blue was not precipitated by dilute sulphuric acid nor by concentrated sulphuric acid. Both amyloextrin and amidulin were tried with permanganate and acid potassium carbonate with the following results.

I. In an Erlenmeyer flask 100<sup>cm</sup><sup>3</sup> of water, 10<sup>cm</sup><sup>3</sup> of acid potassium carbonate, 1<sup>cm</sup><sup>3</sup> of potassium permanganate and 25<sup>cm</sup><sup>3</sup> of amyloextrin were boiled five minutes. The permanganate faded to a yellow color. The solution was made acid and the excess of permanganate was faded by a few drops of dilute sulphurous acid. The solution was then cooled, made alkaline, and iodine solution was added. Two drops brought out a blue with a trace of purple, due possibly to the presence of a trace of impurity, since the amyloextrin was made from impure starch.

II. In an Erlenmeyer flask 100<sup>cm</sup><sup>3</sup> of water, 10<sup>cm</sup><sup>3</sup> of acid potassium carbonate, 1<sup>cm</sup><sup>3</sup> of potassium permanganate and 25<sup>cm</sup><sup>3</sup> of amidulin were boiled five minutes. A brown precipitate formed and was filtered off. The filtrate was clear and colorless. It was cooled and iodine was added. A deep red color was produced, equal to and identical with the color given by erythroextrin with iodine. There was a loss of about two drops of iodine.

Tests were made with amidulin in regular titration.

TABLE XI.

A					
Volume.	$n/10$ $As_2O_3$ .	$n/10$ I sol.	$KHCO_3$ .	Amidulin.	Color.
cm <sup>3</sup> .	cm <sup>3</sup> .	cm <sup>3</sup> .	cm <sup>3</sup> .	cm <sup>3</sup> .	
125	50	49·29	5	-----	pale yellow
135	50	49·40	5	25	deep red, to deep purple
100	----	2 drops	*	25	good deep blue
100	----	2 drops	-	(1 grm. KI) 25	purplish
B					
	$Sb_2O_3$				
125	50	47·75	25	-----	very pale yellow
150	50	47·82	25	25	deep red, to deep purple

The two experiments in A in blank show that two drops are necessary for a reading in any case. One gram of potassium iodide, the amount present in an ordinary titration, tended to give a purplish hue to the blue. This is probably analagous to the action of an excess of potassium iodide upon the starch iodide.† Both phenomena seem to be distinct from the hydrolytic action.

Though the titrations were at a fair dilution, yet the table shows a loss of about 0·08<sup>cm</sup><sup>3</sup> of iodine solution. Allowing

\* On addition of acid potassium carbonate the solution turned purplish, and the blue showed a tendency to fade.

† See Table I.

two drops for the amidulin reading and one drop for the iodine reading, the absolute values in A are 49.36 and 49.28 with a difference of 0.08<sup>cm<sup>3</sup></sup> of iodine solution. The abundant production of a red color is as important as the loss of iodine.

In B with antimony there is a similar loss of iodine and production of a red color, but it is no more striking than with arsenic, and the loss is no greater. It is noticeable, however, that toward the end the tartar emetic fades the iodine somewhat more slowly than arsenious acid and hence the red sometimes appears a little sooner and lingers somewhat longer.

Titration without dilution and with increasing amounts of amidulin present were now made. The colors mentioned were all permanent, and the last color mentioned was as nearly as possible of the same shade of purple.

TABLE XII.

<i>n</i> /10 As <sub>2</sub> O <sub>3</sub> . cm <sup>3</sup> .	<i>n</i> /10 I sol. cm <sup>3</sup> .	No extra dilution.		Color.
		KHCO <sub>3</sub> cm <sup>3</sup> .	Amidulin. cm <sup>3</sup> .	
10	9.85	5	----	yellow
10	{ 9.86 9.88	"	5	deep purplish red
				deep blue, purplish
10	{ 9.91 9.94 9.96	"	10	deep red
				deep reddish purple
				deep blue, purplish
10	{ 9.89 9.91	"	15	deep purplish red
				deep blue, purplish
10	{ 9.90 9.93	"	20	deep red
				deep blue, purplish
10	{ 9.94 9.96 9.98	"	25	very deep red
				deep purplish red
				deep blue, purplish

There is apparent in this table a loss of iodine increasing very slightly with the increase of amidulin, somewhat irregular because of possibly much varied conditions, such as volume, rapidity of running in the iodine, amount of stirring, etc. The conditions with 10<sup>cm<sup>3</sup></sup> of amidulin present seem to have been exceedingly favorable for the development of the phenomena under consideration, as the red produced was very abundant and the loss of iodine was nearly as much as with 25<sup>cm<sup>3</sup></sup> of amidulin present.

That the erythro-dextrin of the impure starch is identical with the erythro-dextrin of saliva digestion of starch was proven in the following manner. A solution of impure starch was dialyzed for twelve days. The product which came through became colored a faint brown upon adding iodine. This was due to its extreme dilution. On concentration it gave a rich red with iodine.

Some pure erythro-dextrin was made as follows: To 200<sup>cm</sup><sup>3</sup> of a 1 per cent pure starch solution at a temperature of 40° C was added 0.25 grm. of acid potassium carbonate and 10<sup>cm</sup><sup>3</sup> of filtered saliva. Not a trace of erythro-dextrin, as shown by testing with iodine every few minutes, appeared for twenty minutes, and in thirty minutes the last traces of amidulin, as shown by the iodine test, had disappeared. The solution was at once boiled to stop further action of the saliva, and the erythro-dextrin was precipitated with three to four times its volume of alcohol and filtered. The precipitation was only partial and filtration was very slow. The erythro-dextrin, washed with alcohol, was redissolved in 200<sup>cm</sup><sup>3</sup> of warm water.

Both of these solutions were tested by the polariscope for rotation of polarized light. Of each solution ten readings were made with the sodium flame and the average was taken. The percentage strength of the solution was determined in two different ways. In the case of the erythro-dextrin by saliva digestion, 25<sup>cm</sup><sup>3</sup> portions were drawn from a burette into weighed beakers and evaporated to dryness over sulphuric acid in a vacuum dessicator. Duplicates gave 0.0422 and 0.0424 grm. of dextrin. Hence 100<sup>cm</sup><sup>3</sup> contained 0.1692 grm. of erythro-dextrin. The readings with the polariscope were all very close and gave a result of 0.26°+. As a 1<sup>decim</sup> tube was used

$$(a)_D = \frac{.26}{.001692} = 153.66^\circ +.$$

A previous attempt was made to precipitate the dextrin by alcohol and ether and to filter on a Gooch crucible, but it failed of complete precipitation.

A slightly different course was taken with the dialyzed erythro-dextrin, as the above method was rather long and tedious. As a preliminary test, portions of the erythro-dextrins, dialyzed and by saliva, were evaporated to dryness on the water bath. No change seemed to have taken place. Both preparations were just as soluble as before evaporation and gave a rich red with iodine. Hence 25<sup>cm</sup><sup>3</sup> portions of the dialyzed dextrin were drawn from a burette into small weighed porcelain dishes and evaporated to dryness. In this way the percentage strength of the solution was found to average 0.0716 grm. per 100<sup>cm</sup><sup>3</sup>. The readings with the polariscope were again very close and gave 0.22°+. As a 2<sup>decim</sup> tube was

used  $(a)_D = \frac{.22}{.000716 \times 2} = 153.63^\circ +$ . The degree of rotation is so close to that of the saliva digested starch product that the identity seems certain.

That the loss of iodine in titration is due to the formation of erythro-dextrin from amidulin and not achroodextrins from erythro-dextrin is shown by the following experiments:



To 5<sup>cm</sup><sup>3</sup> of the erythro-dextrin which had been separated from the impure starch solution, acid potassium carbonate was added and then arsenite solution and iodine solution were introduced successively eight to ten times. No diminution of the red color was appreciable.

The erythro-dextrin by saliva was then tried in titration. First the sharpness of the reading was tried.

TABLE XIII.

Volume. cm <sup>3</sup> .	n/10 I sol. drops.	Erythro-dextrin. cm <sup>3</sup> .	KI.	Color.
100	1	10	3 small crystals	yellow
	2			brownish red
	3			deeper red
	4			deeper red
40	1	10	1 small crystal	brown red
	2			deep red

Erythro-dextrin is not so sensitive to iodine as starch or amidulin. However, in concentrated solution and in the presence of a moderate quantity of potassium iodide the reaction is sharp to a drop.

TABLE XIV.

n/10 As <sub>2</sub> O <sub>3</sub> . cm <sup>3</sup> .	n/10 I sol. cm <sup>3</sup> .	No extra dilution.		Color.
		KHCO <sub>3</sub> . cm <sup>3</sup> .	Erythro-dextrin. cm <sup>3</sup> .	
10	9.89	5	----	yellow
"	9.88	"	10	light brownish red
"	9.89	"	20	deep red
"	{ 9.87	"	30	faint red
	{ 9.90			very deep red

This table shows conclusively that there is no loss of iodine by action on erythro-dextrin even in large quantities and though the volume was concentrated. Sufficient potassium iodide was present in the iodine solution, or was formed in titration, to give readings as sharp as that of plain iodine.

If one reads to the first permanent color, whether purplish, red, or blue, there can be no loss of iodine from the formation of the erythro-dextrin iodide, but if one reads always to the blue it may take a drop or two to cover the red. This is well illustrated in the readings with amidulin in Table XII. That the red forms at all in the presence of starch seems to be an anomaly, since starch will pull the iodine away from the erythro-dextrin iodide forming starch iodide, but a possible explanation may be that, as the reaction between the arsenite solution or tartar emetic and the iodine becomes slower toward the end, an excess of iodine is present for a few moments and both the

iodides are formed together. The arsenious acid in alkaline solution fades the blue first, leaving the red to fade more slowly. This is also true of sulphurous acid. In alkaline solution a very dilute solution of sulphurous acid may be made to fade the blue leaving a trace of the red, but the endurance of the red is usually but momentary as the reaction is so very rapid; but in acid solution sulphurous acid fades the red first and the blue last, even when abundant red is present such as is caused by the permanganate experiment with impure starch or amidulin. This latter fact may explain why in titration of iodine by thiosulphate one is not bothered with the production of red hues.

The presence of amidulin in the impure starch cannot be said to be absolutely established, since it has not been chemically isolated from the solution and examined by itself, but the circumstantial evidence seems substantial.

1st. Impure starch causes a loss of iodine which is accompanied by the production of a compound coloring red with iodine when used in a titration of arsenite solution or tartar emetic by iodine.

2d. The same red-coloring compound is produced from impure starch by boiling with potassium permanganate and acid potassium carbonate or by treatment with hydrogen dioxide and acid potassium carbonate, hot or cold.

3d. Pure starch neither causes a loss of iodine nor is it acted upon in presence of acid potassium carbonate by iodine, hydrogen dioxide, or potassium permanganate, to form the red-coloring compound.

4th. The red-coloring compound found in the impure starch was proven to have the same power of rotating polarized light as erythro-dextrin, and pure erythro-dextrin caused no loss of iodine in regular titration with arsenite solution.

5th. A compound coloring blue with iodine whose iodide was not precipitated by sulphuric acid was found in the impure starch.

6th. The latter impurity, the compound coloring blue, is intermediate between starch and erythro-dextrin, since its iodide is more stable than erythro-dextrin iodide and more soluble than starch iodide.

7th. Pure amidulin causes a loss of iodine in titration of arsenite solution, or of tartar emetic, by iodine solution, and is acted upon in the presence of acid potassium carbonate by iodine, hydrogen dioxide, and potassium permanganate, as above to form a compound coloring red with iodine.

8th. Amidulin iodide is not precipitated by sulphuric acid.

9th. Amidulin is intermediate between starch and erythro-dextrin both because its iodide is more stable than erythro-dextrin iodide and more soluble than starch iodide and because it is intermediate in saliva digestion of pure starch.

10th. Erythro-dextrin is the first product of hydrolysis of amidulin, and since erythro-dextrin was proven to be present in the impure starch it is probable that the blue-coloring compound is identical with amidulin from which erythro-dextrin is formed.

So it appears that the colors found in iodometric titrations in which ordinary starch is used as an indicator are probably due to the admixtures of the starch blue or possibly of the amidulin blue with the red of erythro-dextrin derived from amidulin by hydrolysis initiated by the oxidizing effects of the iodine. Pure starch, containing neither amidulin nor erythro-dextrin, gives only blue in the iodometric titration. Starch, on the other hand, which has undergone partial hydrolysis is likely to contain both amidulin and erythro-dextrin. It is not strange that both amidulin and erythro-dextrin should be present as impurity in starch since they both stand in the order named as the first two dextrins produced from starch, as shown by saliva digestion of starch, as also by malt-extract digestion of starch. Starch both in solid state and in solution tends to pass through these stages of hydrolysis. Germ growth rapidly appears in solutions of pure amidulin and pure erythro-dextrin with the destruction of these bodies in the form of hydrolysis to dextrins lower in the series. Some dry pure starch, which stood in a cardboard box during the summer, shows the tests for a slight amount of amidulin; some dry amidulin, wrapped in filter paper, has gone over to erythro-dextrin almost entirely.

A few words may be said in closing this article on the mechanism of the reaction which is believed to take place. The production of the various dextrins from starch is commonly considered a progressive hydrolysis. Associated with the formation of erythro-dextrin from amidulin during oxidations by iodine there is a loss of iodine, and this loss would naturally be attributed to oxidation of amidulin. That the hydrolysis of amidulin to erythro-dextrin can take place, however, without oxygen is evident from the fact that amidulin or erythro-dextrin may be produced successively by digesting starch with saliva in an atmosphere of hydrogen; for two such digestions were carried on, all oxygen being previously boiled out of the starch solution and a current of hydrogen passed in during the digestion. The question arises, then, as to why the hydrolysis, which acid potassium carbonate even upon boiling is incapable of producing, takes place readily in the presence of an oxidizer. There are present in starch and the dextrins several sugar nuclei, and, in the formation of dextrins, maltose, and sometimes isomaltose, is said to be formed in increasing quantity as the dextrin molecules decrease in size. Maltose is readily hydrolyzed to dextrose, and dextrose is fairly easily

oxidized to gluconic acid or dextronacid,  $\text{CH}_2(\text{OH})\cdot(\text{CH}\cdot\text{OH})_4\cdot\text{CO}_2\text{H}$ , e. g., chlorine or bromine will cause the reaction thus:\*

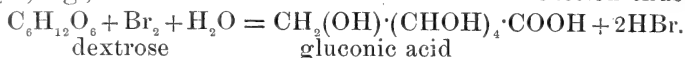

Habermann† oxidized dextrin by the same reaction to dextronacid, as he named it, but Herzfeld‡ proved conclusively that chlorine or bromine oxidizes dextrose, maltose, and dextrin to the same acid, gluconic acid, i. e., that gluconic acid, maltonacid, and dextronacid are identical; and that the discordant results of other experimenters are due to the constant production, by bromine at least, of saccharic acid, as a by-product. It is possible that one or both of these acids may be produced by the action of iodine. Now the action of the weak oxidizer iodine appears to be strengthened by a catalytic action of the arsenite. That the arsenite is not essential to the action, however, is shown by the fact that iodine in presence of acid potassium carbonate will induce the slow formation of erythro-dextrin from amidulin in the absence of arsenite. In a corked flask, 20<sup>cm<sup>3</sup></sup> of amidulin, 10<sup>cm<sup>3</sup></sup> of acid potassium carbonate, 5<sup>cm<sup>3</sup></sup> of iodine solution, and 5<sup>cm<sup>3</sup></sup> of water were set away. After standing some time the blue color changed to purple. The red increased and finally, after six months time, the free iodine disappeared entirely and the solution became colorless. A few drops of iodine added to a few cubic centimeters of the solution turned it a deep red. A thorough shaking with chloroform removed the iodine from the erythro-dextrin red and left a mere trace of blue, showing that a bare trace of amidulin was still left. The action was not due to germ growth; first, because the amidulin and the erythro-dextrin formed from the amidulin would have been destroyed in a much shorter time; secondly, because the potassium iodide present prevents germ growth; and lastly, because there was no visible evidence of germ growth.

Schönbein§ has suggested an oxidizing action of iodine upon starch in the following experiment. He heated in a closed vessel for an hour at 100° C. a mixture of a solution of iodine in water and of dilute starch paste. On cooling, the solution did not become blue, but reacted feebly acid, and on introducing dilute sulphuric acid and several drops of potassium nitrite became blue at once. Mercuric nitrate formed a recognizable amount of mercuric iodide.

It seems probable that iodine may further the hydrolysis of amidulin by oxidizing a sugar nucleus to an organic acid, and

\* Habermann, *Ann. Chem.* (Liebig), clv, 121; Kiliani, ditto, ccv, 182.

† *Ann. Chem.* (Liebig), clxii, 297.

‡ *Ibid.*, ccxx, 335 ff.

§ Schönbein, *Journ. prakt. Chem.*, lxxxiv, 402.

the decomposition of the amidulin molecule once started, the residue may quickly undergo hydrolysis. No attempt has, as yet, been made to discover such an acid, since its formation must be but slight. Some indirect experiments bear weight upon the question.

1st. A starch solution was digested to the erythro-dextrin stage and somewhat beyond by saliva. A test for sugar with 50<sup>cm<sup>3</sup></sup> of Fehling's solution resulted in a heavy reduction.

2d. Into 25<sup>cm<sup>3</sup></sup> of impure starch solution iodine was run in regular titration with 50<sup>cm<sup>3</sup></sup> of arsenite. An abundance of red was produced. The solution was precipitated by silver nitrate to get rid of potassium iodide and most of the arseniate. The excess of silver nitrate was precipitated by hydrochloric acid. The filtrate was made just alkaline and was added to 50<sup>cm<sup>3</sup></sup> of boiling Fehling's solution. There was no sign of reduction, which goes to show that whatever sugar was produced in the hydrolysis of the amidulin impurity in the starch to erythro-dextrin must have been oxidized. In corroboration of this view of the oxidizing effect of iodine in initiating the hydrolysis may be mentioned again the action of hydrogen dioxide and potassium permanganate in the presence of acid potassium carbonate upon impure starch and upon amidulin in forming erythro-dextrin.

Somewhat similar to the nascent action upon amidulin of the oxygen produced by iodine in oxidizing arsenite seems to be the action of the oxygen produced in the following phenomena. Fr. Goppelsröder\* claims that many salts hinder the starch iodide reaction, e. g., potassium alum, ammonium, potassium, sodium and magnesium sulphates. As the color, the most important feature for our consideration, slowly develops in his experiments, he mentions it as a reddish tinge, reddish violet cast, bright red violet, etc. He produced his iodine by mixing dilute solutions of potassium iodide, ammonium nitrite, or potassium nitrite, and sulphuric acid with his starch and salt solutions. The iodine was freed by the oxidation of the potassium iodide by the nitrite. Here also are conditions, resulting in the presence of nascent oxygen from the nitrite, which in the presence of acid as a hydrolytic agent may have attacked even the starch, thus setting up the hydrolysis which formed erythro-dextrin. Very dilute sulphuric acid in the cold has little effect of itself on starch or dextrin, and the slight amount of erythro-dextrin produced, as indicated by the colors mentioned, would suggest the possibility that amidulin was present in the starch used, as an impurity.

It remains to thank Professor Gooch for his many useful suggestions.

\* Ann. Phys., ccix, 57.

ART. XXXIII.—*Note on the Possibility of a Colloidal State of Gases*; by C. BARUS.

1. IN a survey of the diffusion rates of nuclei derived from the same source and under otherwise like conditions, but suspended in different media (i. e., in air saturated with different vapors), the occurrences may be classified with reference to two extreme types: The first includes vapors derived from the strongly ionizing liquids like water, methyl alcohol, ethyl alcohol, etc. In these cases the coronas obtained on successive condensation by the exhaustion method are always regularly annular, or at most distorted in color only. With water vapor the coronas do not even show color distortion. With the alcohols the coronas may show the colors of two successive coronas\* in the upper and the lower halves of the same rings, but there is no distortion of form appreciable.

The second type of phenomena are observed with vapors derived from the non-ionizing liquids, like the hydrocarbons gasolene, benzine, etc., carbon bisulphide, benzol, toluol, etc., in which the successive coronas show gradually increasing distortion of form. If the original corona is annular and the distribution of nuclei therefore uniform, the following coronas pass through campanulate distortion† and finally become mere color strata.

2. The effect of the successive precipitations is a disturbance of the original homogeneous nucleation. The degree to which the uniform distribution will be kept up depends, therefore, on the rate of diffusion of the nucleus. It follows that the nuclei of the first group must diffuse very rapidly so that all parts of the receiver continually contain about the same number per cubic centimeter. The effect of removal of nuclei by loading is thus quickly wiped out. On the other hand, the diffusion of nuclei in the second group (non-electrolytic solvents) is enormously slow, by comparison. It is quite possible to observe the air in the lower half of the receiver full of nuclei, while the upper half is air free from nuclei, or to bring about other similarly stratified conditions evidenced by semi-coronas, quarter coronas, etc. Indeed when foreign nuclei are introduced they are usually seen on exhaustion to be distributed in layers, usually in couches immediately over the surface of the liquid. The rates of diffusion are here easily measured and of the order of  $\cdot 01$  to  $\cdot 02$  cm/sec.; whereas in the case of electrolytic solvents, measurement is difficult, not only because the diffusion is over 100 times faster, but because the advance of

\* This Journal, xiii, p. 81-94, 1902. †Ibid., xiii, pp. 309-312, 1902.

nuclei into pure air is a branched design, like the roots of a tree. Finally, unless the vapor tension of the liquid is too small (as in petroleum), only normal coronas\* need be expected to occur in the cases of the vapors of non-electrolytes.

3. It follows from all this that the nuclei derived from the same source and under otherwise like conditions must be relatively very small in case of the vapor of an ionizing liquid, and relatively very large in case of the vapor of a non-ionizing liquid. So far as its apparent origin is concerned, the same nucleus differs enormously in size with the medium in which it is suspended. It must consist, moreover, of clusters of many molecules, the clusters having a given average size for a given vapor.

4. The next inference to be drawn is some notion of the chemical composition of these nuclei. For convenience merely, they are usually supplied by introducing into the receiver air which has passed over phosphorus, or burning sulphur, of a flame, or glowing charcoal, etc. They may be obtained, however, without putting anything material into the receiver, by passing the X-rays through it. So far as the behavior of the resulting nucleus here in question is concerned, there is no qualitative difference. Hence one must look upon the gaseous contents of the receiver as containing the stuff out of which the nuclei are made. The inquiry is thus narrowed down to this: which of the gases involved (air and vapor) is made colloidal in the manner specified. If the air be selected, then there is no immediate reason for the enormous difference of size of nuclei of the same origin in electrolytic and non-electrolytic solvents. If the vapor be selected, then the difference of size corresponds to the electro-chemical differences of the liquids. But it is quite premature to attempt further decision than to state that clusters of gaseous molecules of specific average size are aggregated in each medium.

I have already called attention† to the similarity of this aggregating behavior of the nucleus to that of particles of clay suspended in the corresponding liquids, or to many colloids. It does not, therefore, seem unreasonable to look upon the nucleated gas in the receiver as possessing properties which may be summarily referred to as a colloidal state of the gas in question.

5. The agency which holds the nucleus or molecular cluster together is presumably the electron. One should, therefore, anticipate greater conductivity in case of the much more mobile nuclei of the first type (vapor of ionizing liquids) than in the sluggishly moving nuclei of the second type (non-ionizing liquids), though it is not certain that the electron resides

\* This Journal, xiii, pp. 81-94, 1902. † Science, xv, p. 517, 1902.

permanently with the same nucleus. One may note that the smallest nuclei occur in liquids of greatest, the largest nuclei for liquids of least specific inductive capacity, an inference already drawn for ionizing solvents in a different connection by others (cf. Nernst's *Theoretische Chemie*, p. 365).

Finally, the order of condensation here implied should be noticed: the electron by its mere presence condenses the nucleus or molecular cluster, the latter being always so small an aggregation of molecules as to remain optically quite inappreciable. The nucleus (for Kelvin's thermodynamic reasons) condenses the visible water globules of the coronas seen on exhaustion. The uniformity of nuclei obtained by shaking liquids may also be thus accounted for, supposing that the available electric charges are produced by friction. Their persistence in the presence of electrolytes (HCl, etc.) follows more naturally than by the concentration hypothesis adopted provisionally, elsewhere. An interesting feature is the side light thrown on the nature of cohesion. In the nucleus the electron is saturated wholly or partially by a definite average number of molecules, small in electrolyzing and large in non-electrolyzing liquids. However the nucleus may be produced, whether from phosphorus, the flame, etc., from a charged point, by the X-rays, etc., or from a comminuted electrolyte as in shaken nuclei,\* it is conceived to be a molecular cluster held together by one or more electrons. The cluster owes its diffusion velocity to molecular bombardment in the usual way. This velocity will, therefore, decrease as the conditions† favorable to unilateral bombardment decrease, or as the nucleus increases in size from molecular dimensions, indefinitely.

It seems to me that with these experiments one is approaching the true relations of the nucleus and the ion. Whether these relations will continue to hold for liquid electrolytes I hesitate to affirm: but if a definite ion must travel in a definite solvent within a definite nucleus, then the present theory predicts Kohlrausch's law and other allied facts which it is better to assert in connection with quantitative results.

Brown University, Providence, R. I.

\* *Science*, xv, p. 426, 1902.

† See my "Experiments with Ionized Air," *Smithsonian Contributions*, Washington, 1901.



ART. XXXIV.—*Some Glacial Remains near Woodstock, Connecticut*; by JULIUS WOOSTER EGGLESTON.

THE glacial drift near Woodstock, Connecticut, assumes, within a comparatively limited area, forms so numerous and varied as to render this locality an exceptional one for study. The topography here owes its characteristic features to the work of the continental glacier. Woodstock is situated on a long, smooth ridge of hard gneiss and quartzite, trending nearly north and south at an elevation of 619 feet above sea-level. To the east, one looks across a trough-like valley somewhat over three hundred feet deep and two miles broad, to another ridge of equal height and like character. The crests of both ridges together mark the upland level, the uplifted peneplain of the physiographer. Eastward and westward are repeated north and south ridges, all nearly this same height and with valleys between, giving the country a somewhat linear character. In the bottom of the valley east of Woodstock lies Woodstock or Senexet Pond. It is a deep body of clear, sweet water fed by springs and, from the north, by the somewhat doubtfully named inlet, Muddy Brook. It is about a mile and a quarter in length and five-sixteenths of a mile in width at its broadest part, tapering northward gradually to its inlet. Southward it maintains its breadth for some distance and then rapidly narrows to a deep outlet which winds through narrow bordering meadows and broadens one-half mile southward into a smaller pond. The outlet of this lower pond winds a mile southward to the little village of Harrisville, where it passes between considerable hills, narrowing meanwhile sufficiently to permit of damming for milling purposes. Low meadows immediately adjoin the main lake on all sides except the southeastern. Here for a third of its length, a bold flat-topped bank covered with pines rises almost abruptly somewhat over forty feet above the lake. A southern extension of it, separated by a tiny stream, is somewhat lower. Across the lake from here, but further back from the shore, the level top of another bank may be noted twenty feet above the water-level and traces of still another about the same distance above it. Northward, where the meadows broaden, the banks rise gradually to about twenty feet. It is at this level that the most striking features of the region occur. These are knolls and ridges ranging from ten to thirty-five feet in height above the general level. They are in some instances beautifully moulded in rounded curves and all arranged more or less parallel with the trend of the valley. They occur frequently on both sides of the lake at the same general level, but are most abundant on

the northeastern border. Well back from these formations on the middle eastern side (and the western side as well), where

1

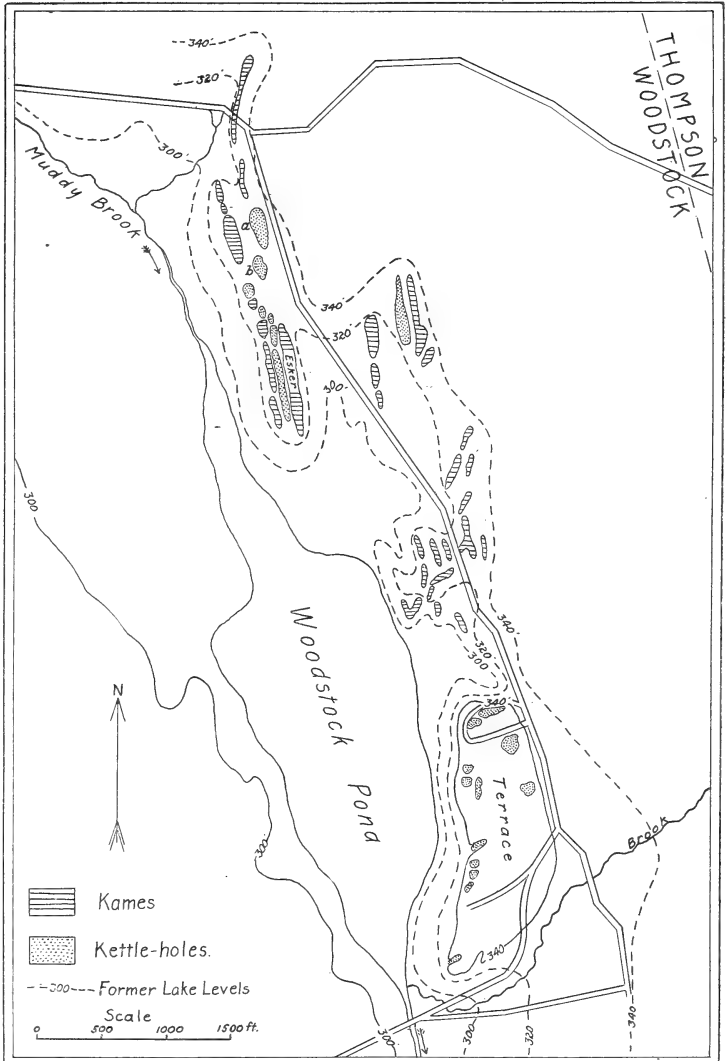

MAP OF WOODSTOCK POND, CONN.

the meadows are particularly broad, may be traced gently sloping banks of drift rising to meet the wooded slopes of the border-ridge of the valley at about fifty feet above the present

lake-level. The woods are thickly strewn with glacial boulders. Rounded hollows or basins, occasionally marshy, occur frequently between the knolls or upon the level top of the wooded bluff. To the north, a mile beyond the lake, may be seen a well-rounded lenticular hill with its longer axis set in the general valley-direction. It is known as Sampson's Hill. These together constitute the important features of the region, and their general relations as well as the details of glacial topography on the east side of Woodstock Pond are shown on the accompanying map (fig. 1).

*The glacial hypothesis.*—In studying a region of glacial action, it is well to keep clearly in mind the fact that at least two periods of work may be postulated—one when the ice-sheet actually covered the entire surface, and the other during its retreat, when its southern border moved northward. The work of the first would be due to the ice and the streams draining it beneath. Such work consists mainly in the removal of all loose material and its deposition elsewhere. In some places, notably where small inequalities of surface-level occur, subglacial streams may deposit much of their burden of debris and their work become actually constructive. Supposing work of this kind to have continued throughout the glacial period, upon the retreat of the ice these accumulations of roughly stratified material in subglacial channels would be exposed as individual mounds or more or less linear groups of knolls and ridges.

During the second period—that of retreat—all valleys more or less blocked with glacial debris would be flooded with water and many of these knolls and ridges drowned beneath the waters of swollen lakes. Much of their material would be worked over by lake-waters and, if floating ice abounded or another slight glacial advance took place, a cap of coarser, unstratified material would be strewn over them. With the lapse of time, the passing of both periods, and the coming of the present, a topography might be expected which would be the resultant of all these factors.

In the Woodstock area the topographic details are in entire harmony with the glacial theory. We have a trough-shaped valley evidently smoothed by some more powerful agent than water alone. Its bordering walls and the neighboring hills, all smoothed and rounded in a north-south direction, are witnesses to the abrasive force of a great, southward-moving sheet of ice. At the bottom of the valley are the remains of a lake known, even in the memory of man, to have been considerably larger but now slowly diminishing. It requires but little effort to imagine the time when the meadows were completely submerged and the three-hundred foot contour was the approxi-

mate shore-line. Another flight of the imagination and the shore-line stands at three-hundred-twenty feet. Still another would bring one to the time when the high three-hundred-forty foot level was maintained.

*Evidences of a flooded lake.*—As witness to the truth of the hypothesis of a flooded lake with successive stages of draining, there is the evidence of the series of levels indicated by the flat-topped banks already noted. These surfaces are exactly what might be expected to arise as the lake-waters receded and exposed the bottom. The meadows, even now partly flooded in seasons of heavy rain, are quite level till near their border, where they rise gradually to the three-hundred foot contour in a manner exactly similar to a gently sloping lake-shore. The three-hundred-twenty foot level is only partially marked. There is a slight development of a flat-topped, narrow bank or terrace on either side of the lake to mark a possible halt at that stage. The three-hundred-forty foot level is much better marked. The great bank to the southeast is a terrace plainly marking a former shallow in the lake, when its waters stood just at that level. The basins on its surface are kettle-holes, hollows left by masses of stranded ice about which the waters heaped the gravel. The southern half of this bank may be a lower terrace at the three-hundred-twenty foot level, or possibly it has been worn down by later action, from an originally higher level. Both portions consist of stratified sand and gravel brought from the hills by streams, the course of which may be indicated by the small surviving stream. This stream has worn a considerable valley down the hillside, though most of its course is at present lost beneath drifted boulders. Both parts of the terrace are apparently matched by developments of equal height across the lake.

Besides these terraces as evidences of higher level, there are the drift-banks well back from the middle eastern portion (the "arm" or "bend") of the lake-shore. These without doubt mark the rise to high shore-level. Whether another level existed above them is not certain, but, judging from the abrupt rise in the land beyond, it seems probable that there did not and that they mark the high-level of the expanded lake. This is about fifty feet above the present level. If such were indeed the high-level of the glacial Woodstock Lake, its extent must have been much greater than the present. It probably included the southern lake, possibly several smaller northern ponds, and much of Muddy Brook. Its outlet was located near Harrisville, where there is much probability of a deep obstruction of drift forming a dam between the hills. A length of four miles and a maximum breadth of a mile is a reasonable approximation to the dimensions of the former lake.

*Evidences of earlier glacial work.*—The knolls and hillocks are the principal witnesses to the work of the earlier period—that of the ice and its draining streams. Sampson's Hill to the north is undoubtedly a drumlin, a hill formed mainly of debris accumulated beneath and moulded by the ice. Its lens-shape with the longer north and south axis and its similarity to typical drumlins justify this opinion. It rises one-hundred-fifty feet above the knolls about the lake and is a beautiful and prominent landmark. Sampson's Hill apparently marks the starting point from which the lines of hillocks shown on the map trail off. As the subglacial streams entered this part of the valley (probably existing at the time), for some reason a large amount of debris accumulated here, while the remainder was irregularly piled along the valley. Most of this latter deposition took place in irregular mounds and broken ridges or kames, but there are occasional very symmetrical mounds and at one place a short esker is developed extending seventy-five rods with a maximum height of thirty-five feet. A second, lower and broken ridge runs parallel to this and only eight rods west of it, with a considerable trench, or better a succession of hollows, between. Both ridges arise at nearly the same point, but the eastern alone merits the name of esker. At their termination in what was apparently an arm of the glacial lake, both merge and fan out broadly with a gentle descent, as if the material had been deposited in standing water. The general direction of the esker is south (S. 3° W.) and it exhibits what has been noted with other eskers, a change of height with change of direction. This esker reaches the greatest height of any of the formations in the region mapped. It is noticeable that when grouped in broken lines or kames the ridges take the general esker-direction, except when quite near the present lake, where there is a tendency to turn towards it.

Wherever any of these knolls have been excavated, they invariably show a main mass of roughly stratified sand and gravel frequently spread over with coarser unsorted material or till. Some of the sand layers are of extreme fineness and whiteness. The terrace likewise is coated with till in places, and, beneath layers of sand and gravel, layers of clay have been discovered. The till-covering of the kames and knolls was probably left by the melting ice-sheet, while that upon the terrace may have been deposited from masses of ice floating in the lake.

Kettle-holes have been mentioned upon the terrace where they are most numerous, generally more or less oval in shape and ranging from three to ten rods in length and from a few to ten or fifteen feet in depth. Six of the most prominent of these are indicated upon the map and as many smaller ones

might be mentioned. Those lying near the edge of the terrace have been drained down its slope. Kettles also occur among the knolls and kames of the more northern portion of the map. Here occur two large examples (kettles (a) and (b) on the map), respectively sixteen and eight rods in length and about twelve feet in depth. Both are now occupied by swamps. Besides these there are a number of smaller kettle-like hollows, together with the trench or run between the main esker and its parallel ridge. It is probable the ice lingered long in these hollows after the ridges were exposed. Mention should also be made of a small, muddy pond to the east near the border of the supposed arm of the glacial lake. It appears to occupy another kettle-hole or trough between two ridges.

The above facts are the data at hand in this portion of the Woodstock region for the support of the hypothesis stated earlier in this paper, that the details of the topography of the area are the combined result of a period of ice-advance followed by one of retreat and consequent flooding and ponding of the blockaded valley.

State School of Mines, Golden, Colo.

## SCIENTIFIC INTELLIGENCE.

## I. CHEMISTRY AND PHYSICS.

1. *Determination of Carbon in Steel.*—The usual method for determining carbon in steel by combustion involves the preliminary solution of the metal in ammonium cupric chloride or some other solvent. This process is a long one, and there is some uncertainty in regard to obtaining all the carbon in the insoluble residue. The fact that it is possible to determine carbon in steel by direct combustion will doubtless be welcomed by all steel-works chemists. LEFFLER has succeeded in accomplishing this much-desired operation. A porcelain combustion-tube ( $20 \times 1\frac{1}{2}$  inches) containing a few inches of copper oxide is used.  $2\frac{1}{2}^s$  of borings are mixed with  $6^s$  of red lead and transferred to a porcelain boat ( $4 \times \frac{3}{4}$  inches). The boat is put into the hot tube after the calcium chloride tube and potash-bulbs have been attached, purified air is passed through, while the part of the tube containing the boat is raised to a very high temperature. This is accomplished by using an asbestos arch, shaped like a muffle, in place of the usual tiles of the combustion-furnace. The asbestos is perforated with numerous holes for the passage of gas and air, as well as for the products of combustion, and over the part of the tube containing the boat a second, larger asbestos arch is placed for increasing the temperature at that place. With a good hot furnace the combustion is complete in half an hour, even when air only ( $2\frac{1}{2}$  liters) is passed through. When drawn from the hot tube, the contents of the boat can be easily scraped out with a suitable piece of metal, and the boat may be used over and over again. The use of borings which have passed through a sieve of 20 meshes to the lineal inch is recommended, but, by increasing the period of heating, fragments as large as peas and pieces of sheet steel have been satisfactorily burnt. Leffler gives many results of combustions made by the direct method, which are compared with the old method. These are very satisfactory, with a tendency, as might be expected, for slightly higher results with the direct process.—*Chem. News*, lxxxv, 121. H. L. W.

2. *New Synthesis of Methane.*—Marsh-gas, or methane,  $\text{CH}_4$ , has been formed by the action of a mixture of carbon bisulphide and hydrogen sulphide upon red-hot metallic copper; by the ignition of barium formate, the latter having been prepared from potassium formate produced by the slow absorption of carbon monoxide by caustic potash; by the action of a mixture of carbon bisulphide and water-vapor on metallic iron; by the action of hydriodic acid gas upon carbon disulphide; by the action of hydriodic acid upon phosphonium iodide in a sealed tube at  $120\text{--}140^\circ$ ; by the action of electric sparks upon a mixture of carbon monoxide and hydrogen; and by the action of water upon aluminum carbide and other carbides. SEBATIER and

SENDERENS have now produced this gas by the action of finely divided metallic nickel upon mixtures of hydrogen and carbon monoxide or of hydrogen and carbon dioxide. In each case the only products are methane and water vapor. In the case of carbon monoxide the reaction takes place readily at 250°, but it ceases when the temperature is allowed to fall below 180°. A slightly higher temperature is required for the reduction of carbon dioxide. The nickel used for this purpose should be freshly reduced at a temperature approaching 300°.—*Comptes Rendus*, cxxxiv, 514.

H. L. W.

3. *Calcium silicide*.—MOISSAN and DILTHEY have re-investigated the compound  $\text{CaSi}_2$ , which was first obtained by Wöhler, and has since been prepared by several other chemists, but with conflicting statements in regard to its properties. The method of preparation consisted in heating an intimate mixture of equal weights of silicon and calcium oxide in a carbon tube in an electric furnace. It is necessary to interrupt the heating as soon as the mass has fused, for the prolonged action of carbon on the fused mass gives calcium carbide, and finally silicide of carbon. The following reaction takes place :

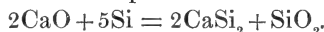

The silica unites with the excess of lime, forming calcium silicate. The calcium silicide thus produced has a metallic appearance and forms brilliant crystals of a grayish color. Its specific gravity is about 2.5. When heated in the air it is only superficially oxidized, but it burns when exposed to cold fluorine and when heated in contact with chlorine, bromine and iodine. Water acts slowly upon the powdered substance with the evolution of hydrogen. Cold, concentrated hydrochloric acid attacks the substance with the production of a mixture of hydrogen and hydrogen silicide, while the dilute acid produces with it only hydrogen.—*Comptes Rendus*, cxxxiv, 503.

H. L. W.

4. *Specific Heat, and Volumetric Determination of Vanadium*.—MATIGNON and MONNET, by the use of iron-vanadium and aluminum-vanadium alloys have obtained the values .1258 and .1235 for the specific heat of vanadium. These values taken in connection with the accepted atomic weight, 51, give the values 6.4 and 6.3 for the atomic heat, which are in accordance with Dulong and Petit's law. The authors state that they determine vanadium very simply and accurately by oxidizing  $\text{V}_2\text{O}_4$  to  $\text{V}_2\text{O}_5$ , by means of potassium permanganate. The reduction is made by a current of sulphur dioxide in sulphuric acid solution ; then the excess of the gas is boiled off. The end of the reaction in the titration is very sharp and the color is persistent. Aluminum does not interfere with the determination. In the case of the iron vanadium alloy the separation of iron was effected by fused potassium hydroxide, or better by attacking the powdered alloy directly with sodium peroxide. The latter operation gives a rapid separation and it is recommended for the determination of vanadium in steels, etc.—*Comptes Rendus*, cxxxiv, 542.

H. L. W.



5. *Presence of Tellurium in American Silver.*—An account is given by VINCENT of the detection of tellurium in some ingots of silver, which came to France from America. The silver was of high fineness, but it was very brittle, and it cracked when it was rolled. It was, therefore, fused with five per cent of potassium nitrate, and after two such treatments it presented the usual degree of malleability. The slag produced by the fusions just referred to, upon examination, was found to contain tellurium, but no selenium. The result shows that a small quantity of tellurium has a profound effect upon the physical properties of silver.—*Bulletin*, xxvii, 23. H. L. W.

6. *Dissipation of Electrical Charges by Vapor.*—In a paper published in 1886, Exner attributed atmospheric electricity to the carrying of electricity by rarified water vapor from the earth's surface into the upper regions of the atmosphere. In support of this hypothesis, Mascart claimed to have shown that the vaporization from an electrified layer of water is greater than from an unelectrified one. L. J. Blake, however, had been led to an opposite conclusion. Pellat confirmed Mascart's result, and showed a source of error in Blake's investigation. HANS BEGGEROW has now examined the question with all possible modern refinements, and concludes that electrification has no influence on the vaporization of layers of water, solution of carbonate of soda, alcohol, ether, solution of acetic acid, acetic acid, saltpeter acid, and quicksilver; both positive and negative charges were used.—*Ann. der Physik*, No. 3, 1902, pp. 494-515. J. T.

7. *Hertzian Waves in Storms.*—M. FIRMIN LARROQUE discovers that with very distant thunder storms the suppression of the horizontal plate of his receiving apparatus rendered the system inert, and the vertical portion of the apparatus had no effect upon the sensibility of the apparatus. He concludes that in this case the electrical oscillations are horizontal. If the storm was not more distant than 300 kilometers the inverse effect was observed. This experiment seems to show that the electrostatic surgings over the surface of the earth play an important part in wireless telegraphy.—*Comptes Rendus*, March 24, 1902. J. T.

8. *Electric Waves in Coils.*—EMIL LÜDIN connects a coherer to one end of a coil of wire, and, after the making or breaking of a battery current through the coil, measures the resistance of the coil. In another experiment he extends a wire from the end of the coil, and stretches another independent wire parallel to this end wire; the independent wire contains a coherer. He finds maxima and minima along this latter wire and measures the wave lengths. He points out the bearing of his results on disturbances in the Marconi receiving circuit, caused by the coils of the relays.—*Ann. der Physik*, No. 3, 1902, pp. 584-588. J. T.

9. *Measurements of Wave Lengths in the Sun's Spectrum.*—A. PEROT and CH. FABRY have compared 33 lines in the sun's spectrum, directly with the green cadmium lines wave length,  $508.58240\mu\mu$  according to Michelson. Their first results differ

from Rowland's, principally in the tenth place of one wave length. They show that Rowland's determinations of consecutive wave lengths are very close and accurate, but that there are systematic errors in wave lengths far removed from each other.—*Comptes Rendus*, cxxxiii, p. 153, 1901. J. T.

10. *Spectrum of Gases at High Temperatures*.—At the late general meeting of the American Philosophical Society held in Philadelphia, April 4, Professor TROWBRIDGE gave an account of his work on the dissociation of gases at very high temperatures.

The same spectrum is obtained with very powerful electric discharges in oxygen, hydrogen, and rarified air. This spectrum becomes a continuous one in the less refrangible portion. The spectrum of argon can be obtained in tubes very carefully filled with hydrogen, and probably arises from minute traces of air. Singular dark lines, due to some selective reversibility in the silver salt, are also noticed in the spectrum of water vapor. One very marked one occurs at approximately wave length 4227. A longer account of dissociations at high temperatures will soon be published in this Journal. J. T.

11. *Wireless Telegraphy*; by G. W. DE TUNZELMANN. Second edition. Pp. 104. London, 1902 (Office of Knowledge).—This is a simple and popular account of a subject which at the present time occupies a position of peculiar interest before the public.

12. *The Laws of Radiation and Absorption*. Memoirs by Prévost, Stewart, Kirchhoff, and Kirchhoff and Bunsen. Translated and edited by D. B. BRACE, Ph.D. Pp. 131. New York, 1902 (The American Book Company).—The series of Scientific Memoirs, under the general charge of Professor Ames, to which attention has been repeatedly called in these pages (see vi, 199, 504; viii, 400), has recently been enlarged by this volume on the Laws of Radiation and Absorption, edited by Professor D. B. Brace. It contains translations of the classical memoirs by Prévost, Stewart, Kirchhoff, and Kirchhoff and Bunsen. A brief biographical sketch of each author is also given, and finally a bibliography of leading papers on the subject. Physicists will be gratified to learn that the continued publication of volumes in this most useful series is to be looked for.

13. *Beitraege zur chemischen Physiologie und Pathologie*, herausgegeben von F. HOFMEISTER. II. Band, Heft 1/3. Braunschweig, 1902 (F. Vieweg und Sohn).—The present number of Hofmeister's *Beitraege* contains seven communications from almost as many laboratories. Of particular interest is an experimental contribution by Hugo Wiener of Prag, in which the synthetic formation of uric acid in both birds and mammals is apparently demonstrated. Pauli and Rona have presented the first part of an extensive investigation on the behavior of colloids (gelatin). A paper by Kraus and Sommer gives new evidence that the so-called "fatty degeneration" in phosphorus poisoning is to be interpreted as an infiltration process. The *Beitraege* contain further papers on the chemistry of malignant

growths (Petry); on the physiology of the pancreas (Herzog); on the poison of spiders (Sachs); on the chemical nature of abrnri (Hausmann); and on the differentiation of animals upon the basis of chemical differences in their muscle-plasma (Przibram).

L. B. M.

## II. GEOLOGY AND NATURAL HISTORY.

1. *Geological Commission Cape of Good Hope.* GEO. S. CORSTORPHINE, Geologist. Annual Reports 1898 and 1899.—The annual reports of the Geological Commission of the Cape of Good Hope describe general reconnaissance work covering a large part of Cape Colony. The Carboniferous conglomerates have received particular attention and the "evidence of glacial action in the Dwyka Conglomerate has accumulated to such an extent that doubt can no longer remain that the rock owes its peculiarities to such action." "The Transvaal conglomerates, associated with the coal, are also unmistakably of glacial origin."

2. *Western Australia.*—Annual Progress Report of the Geological Survey, 1900, 34 pp., Perth; Wm. Watson, Government Printer.—The operations of the Western Australian survey for 1900 were for the most part confined to mining and water resources.

3. *Sulphur, Oil and Quicksilver in Trans-Pecos, Texas.* University of Texas Mineral Survey, Wm. B. PHILLIPS, Director. Bull. No. 2. 43 pp.—Perhaps the most important work done by the Texas Mineral Survey during the year 1901 was the examination of the sulphur deposits of El Paso County, which were found to be of considerable commercial importance. As to the origin of the sulphur, "the richer bluish ores have been formed from sulphur waters at a time when they were above ground, and probably through the agency of certain algæ which are plentiful in the sulphur springs to-day."

4. *Untersuchung einiger Gesteinssuiten gesammelt in Celebes;* von C. SCHMIDT (Anhang z. Materialien zur Naturgeschichte der Insel Celebes von P. und F. Sarasin; vol. iv, Geol.-Geog. Beschreib., 4°, pp. 28, Wiesbaden, 1901).—The rocks described in this paper were collected by the Drs. Sarasin in their explorations. Short descriptions are given of the microscopical examination of a number of kinds from various localities, the rocks comprising various lavas, massive rocks and crystalline schists of well known types. The greatest interest attaches to a suite from the mountain group of the Peak of Maros near Macassar, where the investigation of both material in place and transported stream bowlders shows that a magmatic center of foyaite-ijolite rocks occurs. Among the lavas are found trachytes, both of Drachenfels and Ponza types, phonolite (which forms the top of the peak), glassy andesite and basalts including leucitic varieties. Related rocks are basaltic porphyry and gautéite (Hibsch.), which were not found in place but are believed to represent the related dike rocks. The

massive granular rocks comprise several varieties of shonkinite, which, as pointed out by the author, are remarkably similar to the Montana types both chemically and mineralogically. We append the results of the analyses of the various rocks.

	SiO <sub>2</sub>	Al <sub>2</sub> O <sub>3</sub>	Fe <sub>2</sub> O <sub>3</sub>	FeO	MgO	CaO	Ma <sub>2</sub> O	K <sub>2</sub> O	H <sub>2</sub> O	TiO <sub>2</sub>	P <sub>2</sub> O <sub>5</sub>	Total.
1	47.65	19.32	3.93	4.92	3.90	6.15	3.58	4.61	5.15	0.75	1.23	101.19
2	57.15	19.13	3.24	2.04	2.25	2.90	4.15	7.05	1.57	0.38	0.38	100.19
3	61.45	19.64	2.19	0.22	1.00	0.60	4.10	7.58	2.37	0.40	---	99.55
4	58.00	22.52	1.37	1.01	0.85	0.90	6.93	7.72	1.71	0.19	---	101.20
5	61.15	22.07	1.05	1.02	0.40	0.75	5.86	7.01	0.71	0.20	---	100.22
6	55.52	20.05	2.52	2.40	2.10	3.15	3.44	7.49	1.42	0.70	0.51	99.30
7	48.05	13.94	2.67	5.98	7.81	7.25	2.72	6.56	1.66	1.10	1.15	98.89
8	50.15	15.86	2.44	5.39	5.30	8.40	4.13	5.00	1.50	1.00	0.86	100.03
9	52.80	19.99	3.63	3.40	3.20	4.22	3.10	7.74	1.18	1.00	0.70	100.96

1, "Trachydolerite" from Kau, 8 kil. N. of Maros Peak. 2, "Vitrophyric trachydolerite." Boulder 3 kil. N. of Maros Peak. 3, "Trachyte" (Ponza type), boulder in brook of Gentungan, 5 kil. S.W. of Maros Peak. 4, "Phonolite" Top of Maros Peak. 5, "Bostonite" boulder in brook at Gentungan. 6, "Gautéite" boulder at Gentungan. 7 and 8, "Shonkinite" same loc. 9, "Shonkinite with syenitic habit." Same loc. Above analyses by Dr. Hinden.

In addition bostonite-phonolite breccias and trachytic tuff or trass are mentioned. A more complete description of this interesting series is promised in the future.

L. V. P.

5. *Notes on Corals of the genus Acropora (Madrepora) Lam. with new Descriptions and Figures of Types, and of several New Species*; by A. E. VERRILL. Trans. Conn. Acad., vol. xi, pp. 207-267, 7 plates, January, 1902.—This memoir includes a revised list of about 120 species studied by the author, with their distribution, and very detailed descriptions and figures of a considerable number of the original type specimens of species formerly described by Dana and the author, and of several new species. The figures are excellent reproductions of photographs, most of them considerably enlarged to show the details of structure.

6. *A Course in Invertebrate Zoology. A Guide to the Dissection and Comparative Study of Invertebrate Animals*; by HENRY SHERRING PRATT, Ph.D. xii and 120 pages. (Ginn & Company.)—A glance at the preface shows that the author's ideas as to what such a laboratory guide should be have arisen from practical experience in teaching, and an examination of the body of the work convinces one that these ideas have been admirably carried out. The directions for the dissection of each of the thirty-four types are so complete and independent that shorter or longer courses can be planned, the forms taken up in any desired order and the microscope used or not as is convenient. Almost the entire attention is given to directing the student in his work, and statements which can be made by the teacher to the class as a

whole are omitted. One great advantage which this book possesses over most of its kind lies in the fact that organs are taken up in such sequence that one specimen should suffice for the entire dissection.

R. W. H.

### III. MISCELLANEOUS SCIENTIFIC INTELLIGENCE.

1. *National Academy of Sciences.*—The annual meeting of the National Academy of Sciences was held in Washington, April 15–18; it was largely attended and full of interest. Professor Alexander Agassiz, elected President of the Academy a year since, presided during the sessions. The following gentlemen were elected members: William W. Campbell of Mt. Hamilton, California, George E. Hale of Chicago, C. Hart Merriam of Washington, D. C., William Trelease of St. Louis, Missouri, Charles R. Van Hise of Madison, Wisconsin.

The titles of papers presented for reading are as follows:

HENRY F. OSBORN: Evolution of the Titanotheres III; models and restorations. Homoplasy and latent homology. A correction. Evidence that North America and Eurasia constituted a single zoological realm during the Mesozoic and Cenozoic, and that correlations can be established as a basis for uniformity of geological nomenclature.

ALPHEUS S. PACKARD: Monograph of the bombycine moths of America, including their transformation; with a revision of the known genera. Part III. Sphingicampidæ.

ALEXANDER AGASSIZ: On the coral reefs of the Maldives. On the theory of the formation of coral reefs.

J. MCK. CATTELL: Psychophysical fatigue.

EDWARD L. NICHOLS: On some optical properties of asphalt.

CHARLES S. PEIRCE: The classification of the sciences. The postulates of geometry. The color system.

WILLIAM SELLERS: The compulsory introduction of the French Metrical System into the United States.

ASAPH HALL: The disintegration of comets.

IRA IBSEN STERNER: A new computation of the coefficients of precession and nutation.

E. C. PICKERING: The distribution of the stars. The variability in light of Eros.

H. P. BOWDITCH: The physiological station on Monte Rosa.

JAMES M. CRAFTS: On catalysis.

T. W. RICHARDS: The atomic weight of cesium. The significance of changing atomic volume.

EDWARD W. MORLEY: Determination of the weight of the vapor of mercury at temperatures below 100°.

ARTHUR SEARLE: Biography of Professor William A. Rogers.

HENRY L. ABBOT: Biographical memoir of General J. G. Barnard.

JOHN S. BILLINGS: Biographical memoir of General Francis A. Walker.

C. A. WHITE: Biographical memoir of J. S. Newberry.

S. C. CHANDLER: The present aspect of our knowledge as to the constant of aberration.

2. *American Association for the Advancement of Science.*—The fifty-first meeting of the American Association for the Advancement of Science will be held at Pittsburg, Pa., June 28th to July 3d. In connection with this meeting Dr. I. C. White proposes to guide a party for a week in the study of the Coal

Measures, and Mr. M. R. Campbell will conduct an excursion to the abandoned channels of the Monongahela River.

3. *National Bureau of Standards*.—In Circular of Information, No. 1, S. W. STRATTON, Director of the National Bureau of Standards, announces the organization of the bureau and explains the work which it is prepared to do at the present time.

4. *The Centenary of Hugh Miller*.—It is proposed to commemorate the 100th anniversary of the distinguished Scotch geologist, Hugh Miller, who was born at Cromarty, on the 10th of October, 1802. The committee having the matter in charge hope to secure funds sufficient to justify the foundation of a Hugh Miller Institute. Subscriptions may be sent to John M. Clarke, State Hall, Albany, N. Y.

5. *Ostwald's Klassiker der Exakten Wissenschaften*. Leipzig, 1900-1901 (Wilhelm Engelmann).—The following are recent additions to this valuable series :

Nr. 119. Versuch über die Hygrometrie (II. Heft 1783); von Horace Bénédict de Saussure. Pp. 170.

Nr. 120. Die Anatomie der Pflanzen (I. und II. Theil); von Marcellus Malpighi (London 1675 and 1679). Pp. 163.

Nr. 121. Versuche über Pflanzenhybriden (zwei Abhandlungen 1865 und 1867); von Gregor Mendel. Pp. 62.

Nr. 122. Sechs Beweise des Fundamentaltheorems über quadratische Reste; von Carl Friedrich Gauss. Pp. 111.

Nr. 123. Einige geometrische Betrachtungen (1826); von Jacob Steiner. Pp. 125.

6. *British Association Meeting at Glasgow, 1901. Discussion on the Teaching of Mathematics*; edited by JOHN PERRY. (The Macmillan Co.) Pp. 101.—An exhaustive report of a full and thorough discussion contributed to by thirty-two of the most able and experienced educators of England. Any teacher of mathematics who feels himself in danger of dry rot should secure the book.

The two points brought out with special emphasis and unanimity are that the elementary notions of the Calculus and Analytical Geometry should be taught to school boys as early as formal Geometry and that England must get rid of the study of Euclid.

7. *The Basis of Social Relations*; by DANIEL G. BRINTON, A.M., M.D., LL.D., Sc.D. Edited by LIVINGSTON FARRAND. New York: G. P. Putnam's Sons. Pp. 204.—At his death (1899) Dr. Brinton had this work approximately complete, and the editor has made only slight changes in it. The doctrine of the psychological unity of man is plainly stated and the variations resulting from physiological and pathological causes is explained in some detail (pp. 23-123). Part II deals with the Natural History of the Ethnic Mind and contains chapters on the Somatic Environment, the Social Environment, and the Geographic Environment. The book commends itself to the general reader and has an added interest in the fact that it is the last word of one of America's most distinguished ethnologists.

THE

# AMERICAN JOURNAL OF SCIENCE

[FOURTH SERIES.]

ART. XXXV.—*Fossil Faunas and their use in correlating Geological Formations\**; by HENRY S. WILLIAMS.

[By permission of the Director of the U. S. Geological Survey.]

IT has long been the practice of geologists to recognize fossils as the best available means of determining the systematic correlation of geological formations. And in making correlations by fossils it is probably true that the degree of likeness, expressed by numbers of identical species, is taken in general as the measure of the contemporaneity of the formations compared. As a means of gaining a rough approximation to contemporaneity this principle may be safely followed. The geological systems may thus be recognized in different parts of the world, and from comparisons of the faunas of the Paleozoic systems it has been estimated by the writer that a later and an earlier, and in some cases a middle division of the grand systems, can be distinguished throughout the known world by this method of interpretation of identity of species into contemporaneity. The plan of restricting uniformity of correlation, in an international scheme of classification, to systems and divisions of the systems to be indicated by the prefixes eo-, meso-, and neo- to the system name, is based upon this calculation.†

When, however, the attempt is made to correlate formations on a firm basis, and to trace or estimate the limits of local formations by means of fossils, some more accurate method than mere identity of species is demanded.

The reasons for this conclusion are various; among which is the fact that very many single species, whose range has been

\* Read before the Connecticut Academy, Feb. 12, 1902.

† Journal of Geology, vol. ii, p. 157; Comptes Rendus, Congrès Geol. Internat., vii, cl and cli; Comptes Rendus, viii, p. 202.

established by thorough study of the successive formations in which they occur, range through a third and often a half of one of the standard geological systems.

With such a long range for the life period, it has been in some cases established that the variation between the earliest and latest known representatives of the species is not greater than the variation among representatives of the same species found buried together in the same stratum of rock. Having established such long range and such long persistence of specific characters, and associated with plasticity of the varietal characters for a few well studied species, it seems reasonable to infer that simple specific identity cannot be taken as proof of contemporaneity within narrower bounds than the life endurance of the species.

A second reason for not resting implicit confidence on this method of correlation is the frequently observed fact, that parts of the geological column of different sections, which upon satisfactory stratigraphic grounds are known to be stratigraphically equivalent, contain different fossils. If two such faunas were to be observed one above the other, the difference in fossils would be naturally interpreted as difference in time, while the fact of stratigraphic equivalency proves their contemporaneity. Since the non-identity of fossils is consistent with contemporaneity, the reverse is to be inferred, viz: that identity of fossils may be consistent with non-contemporaneity.

A third observation also may be cited against the principle: In a continuous section it is often the case that the topmost beds of one formation are followed abruptly, but without apparent unconformity, by the next following formation containing a majority of new species.

The abrupt change in the fossils, in such a case, cannot be taken as evidence of the total stopping of the old fauna or of the beginning of the new, but rather as the result of a shifting laterally of the conditions in which the faunas have lived, across the locality in which the sedimentation was made.

It is thus shown that a sufficient amount of doubt is thrown upon the reliability of simple identity of single fossils in determining equivalency of stratigraphic horizon (except in a broad sense) to call for a discussion of some more accurate method of correlation.

In the following pages is given a synopsis of the results of a prolonged series of investigations directed toward the discovery of the true time element in fossil faunas. It will be assumed that the reader is familiar with the distinction between a stratigraphic formation (which is a more or less uniform lithologic unit, and constitutes the thing which is represented



on a geologic map by a definite color, and is defined and discussed in literature under a definite name), and a fossil fauna (which is the aggregate of fossil remains representing once living animals which were associated together at the time of sedimentation of the formation in which they were buried). The geological column is made up of the successive formations, which would be exposed by a vertical section through any part of the earth's crust. In common usage the geological time-scale is constructed by applying chronologic terms, like age, period, epoch, etc., to the several formations of the geological column. The reference of each formation to its proper place in the scale, is established not by lithologic likeness but by faunal likeness. So far as common usage goes, the epochs or ages are the time equivalents of the formations and not of the faunas by which the time relations of the formations are established.

Further, it is a generally accepted belief that each geological formation occupies a definite place in such a theoretical time-scale. This belief carries with it the further conclusion that, if we determine the limits (below and above) of a given formation in the rocks of a particular locality, the recognition of the same formation in another section (fifty or a hundred miles distant, for instance) carries with it the inference that the second section of the formation represents the same interval of geological time.

These are ideas that constitute the working hypothesis of field geologists everywhere; and, although they may be applied as general, and not absolutely exact rules, they are used pretty commonly in what is called correlation. For instance, when the statement is made that the Independence Shales of Iowa are, or are not, equivalent to the Hamilton Formation,\*—the meaning is that the formation which outcrops at Independence, Iowa, and specifically is named the "Independence shale," was, or was not, formed by deposition at the same time in which the Hamilton formation was forming over the area now called New York State.

Now the fact basis of that affirmation is not the recognition of the same constitution or thickness of the rocks in the two regions, but it is an opinion based solely upon the evidence of fossils occurring in the rocks.

The assumption, at the basis of the opinion, is that the fauna present in the rocks of the Hamilton formation represents a period of time which is recorded by the deposits of sediments called Hamilton in New York, and therefore that the same species seen in different regions can be relied on as evidence of the same portion of time.

\* Iowa Geol. Survey, vol. viii, p. 205, etc., 1897.

Let us examine the validity of this assumption: Do divisions of the geological column, proven by paleontologic evidence to hold the same fauna, represent the same interval of time in different local sections?

An attempt was made to test this question in the case of the Catskill formation. A paper was written\* in which it was demonstrated by comparison of sections in various parts of New York and Pennsylvania, that the sediments, which by lithologic, stratigraphic and paleontologic characters may be classified as a single formation, occupy a different systematic position in the geological column of areas a few hundred miles apart. In general, it was shown that when the time-scale is measured by the marine invertebrate faunas, the Catskill formation begins at the horizon of the Hamilton in the eastern sections and further west first appears at the horizon of the Ithaca or Portage, and in central and western New York and Pennsylvania does not appear till after the Chemung formation was well advanced. Nevertheless it could not be stated that the Catskill formation occupies the same place with the Chemung formation. For that would make the names partly or wholly synonymous.

It could not be stated that the Chemung is not antecedent in time to the Catskill when the formations are transformed into epochs, for that would mean that the two epochs are not distinct. So long as the formational nomenclature alone is used, the only way to state the facts is to say that the Catskill is not a good formation on account of its irregular position in the time-scale.

In Dana's Manual, last edition, the relation of the Chemung and Catskill on the basis of this interpretation is defined in the words: "They (these Catskill beds) are now believed to be a contemporaneous formation parallel in its deposition with that of the off-shore and deeper waters of the Chemung period, or Chemung and Hamilton periods, to the westward" (p. 576).

The fact is thus clearly brought out that the Catskill as a formation has as much title to recognition as the Hamilton or Chemung. So long as we have but one nomenclature, it is as reasonable to say that the Hamilton and Chemung belong to the Catskill period, as to give the latter prior place in the list of formations of the time-scale. But there are two sets of facts; and the real reason for the neglect of the Catskill formation in the time-scale is that its fauna is not as definite and significant as the fuller and more widespread marine faunas of the Hamilton and Chemung formations. The indefiniteness in its relation to a time-scale which was demonstrated for the Catskill formation, it is believed, is characteristic of all

\* The Journal of Geology, vol. ii, pp. 145-160, 1894.

formations; and the facts are at hand to show that the actual limits of a fauna, when followed laterally with great care, so as not to lose track of the stratigraphic continuity, transgress the limit and run higher up as we cross the outcrops; and that it may be said with truth, that marine faunas of the same general nature, but of different place in the succession in any particular section, may lap over each other stratigraphically. These facts I have been able to demonstrate in respect to the relations of the faunas of the Devonian, which I and a number of geologists who have been trained to use the necessary precision in observing and reading the fossils, have brought to light. The result reached has been this, viz: the evidence is conclusive that the fauna of the Hamilton formation, which will be called the *Tropidoleptus fauna*, prevails in the rocks in eastern New York upward, beyond the place of the Genesee shales, to and beyond the interval occupied by the Ithaca formation of the Cayuga Lake section, and is seen in a few cases of definite, pure successional faunules up to the part of the section occupied by the Chemung formation, whose fauna may be called the *Spirifer disjunctus fauna*. This same interval, stratigraphically considered, is occupied by the Portage formation of the Genesee River Valley section, in which no trace of the Hamilton species and only slight trace of the species of the Ithaca formation are present, as determined by a careful search of the rocks from bottom to top.

In the elaboration of these facts it was necessary to form a nomenclature with which to handle the several different groups of facts for their discussion in relation to each other, to the element of time, and to the position in the structure scale.

Fauna and flora are terms well understood where only one point of time is considered; but where, in addition to the geographical distribution of species, we have also to deal with the geological range, it becomes essential to consider the fauna more exactly.

Geologically the element of evolution comes in, and a geological fauna is not only a set of species situated in or inhabiting a restricted geographical area; but geologically a fauna must be conceived of as changing its position, and as determined by the preservation of the equilibrium of the several species constituting it.

This equilibrium is expressed in terms of relative numbers and strength of the species of the fauna. In every aggregate of living species, the individuals of one species are abundant and vigorous in growth; others are less so but common; others still are rare and inconspicuous, while an occasional species is represented only by a very occasional specimen.

When a fauna is geologically considered, it is of first importance to note these characteristics, for by them we discover the relative dominance of the species in the faunal aggregate. And the dominant species, by the fact of being dominant, show that they have conquered the difficulties presented to their continuing life, and in the struggle for existence have thereby proven themselves to be the fittest to survive in the particular conditions they occupy. To express this characteristic of evolutionary strength of an organism, the term *bionic* has been proposed. The term was defined in the following words:

*"The bionic quality of an organism may, then, be defined as its quality of continuing, and repeating in successive generations, the same morphologic characters."\**

This quality of continuing and repeating the same morphologic characters is expressed in successive strata by the occurrence of the same fossil species; it is expressed geographically by the same species occurring in different geographic areas.

The relative *bionic values* of different species are expressed by the relative number of individuals in a faunal aggregate, and hence the equilibrium between the several species of a fauna is expressed in terms of the numbers of individuals of each species living together under a common set of conditions. Looking then at faunas from this bionic standpoint, we have a delicate test of the time relations of the faunas which is of extreme value in establishing correlations. For the integrity of a fauna expressed in terms of its dominant species can be conceived of as continuing only so long as the relative bionic values of each of the species remains constant. Any slight change of conditions, or incursion by migration of other species, may upset the bionic equilibrium, as will be expressed in terms of relative frequency of the constituent species of each faunule (that is, the local sample of the general fauna under consideration).

Having established this method of recording and measuring the time significance of a fossil fauna, its use in making correlations becomes evident. We have here a means of distinguishing the effects of change of geographic conditions (*viz*: geographical distribution) from change coincident with passage of time (*viz*: geologic range).

In the same section we may discover, by noting the bionic values of the successive faunules, how long the integrity of the fauna is preserved, and whether any evolution of species takes place during that life period of the fauna. So long as the same species continue to be the dominant species in the successive faunules, the faunal integrity is preserved. When

\* "The discrimination of time-values in geology." Journ. Geol., vol. ix, p. 578.

the dominant species are permanently replaced by other species, the change in fauna has become apparent. This can be observed, although in the meantime there may have appeared faunules of entirely different composition intercalated between successive stages of the prevailing fauna.

Again, the distribution of the fauna becomes at once evident when we deal with the dominant species in sufficient number to represent the fauna in its characteristic expression.

The testing of this method has been carried out in detail by the United States Geological Survey in the study of the Devonian faunas, of which, I believe, we have now a fuller set of statistics illustrating this law than of any other system in the whole geological column. The statistics have been worked out regarding these faunas to a degree which enables us to give figures, and state definite results of correlation.

The Hamilton formation has been carefully studied by many workers, but only within a few years have the statistics been brought out with sufficient precision to make them available for the determination of the bionic values of the several species of the fauna. The fauna of the Hamilton formation of New York State is called the *Tropidoleptus fauna*; the fauna of the typical Chemung formation is the *Spirifer disjunctus fauna*; the fauna of a zone intermediate between them in central New York is the *Productella speciosa fauna*, and the zone is generally known as the Ithaca formation. The relative position of the Hamilton, Ithaca and Chemung formations is well established on stratigraphic grounds; but the correlation of the formations is not so clearly understood. The bionic method makes it possible to say that the *Tropidoleptus fauna* lived on in the eastern New York area till after the *Spirifer disjunctus* stage had been reached in the western part of New York state. To establish these facts the statistics of 146 local faunules of the Hamilton formation in eastern New York and Pennsylvania have been examined, gathered chiefly by Prof. C. S. Prosser.\* Faunules from 76 zones examined in the 1224 feet of section of the Hamilton formation at Cayuga Lake, made and tabulated by Dr. H. F. Cleland, and reduced to 25 temporary stages of the faunal history, were studied.† The Eighteen Mile Creek section worked out by Mr. Grabau‡

\* Classification and distribution of the Hamilton and Chemung series of central and eastern New York. 15th and 17th Ann. Repts. State Geologist, N. Y., 1895 and 1900. The Devonian System of Eastern Pennsylvania and New York. Bull. 120, U. S. G. S., 1894.

† A study of the fossil faunules in the Hamilton formation of the Cayuga Lake section in central New York. A Thesis for Doctor of Philosophy degree (given by Yale University in 1900), by Herdman F. Cleland.

‡ The faunas of the Hamilton Group of Eighteen Mile Creek and vicinity, in western New York, by Amadeus W. Grabau. 16th Ann. Rept. of State Geologist, N. Y., 1898.

have yielded 35 separate zones, of which the faunules have been accurately noted.

The number of species in the first set of statistics is 172; in the second 234; and in the third 163. In the first set of statistics the geographically dominant species are ascertained. A list of 12 species is derived which are reported from over 32 of the 146 localities examined—the five more dominant ones are from over 50 of the 146 localities. When the localities are grouped in 5's lying most nearly together, so as to eliminate the imperfection of the collecting, the best 5 of the 12 species occur in 26 out of 30 of these groups of localities; and all the 12 species of the dominant list occur in 17 out of the 30 groups. The evidence is clear that we have in such a list the species which possessed the highest bionic value in distribution.

The list in order of dominance is as follows:

	A	B	C	D
1. <i>Spirifer pennatus</i> (Atw.) . . .	113	30	26	33
2. <i>Tropidoleptus carinatus</i> . . . .	89	27	22	30
3. <i>Spirifer granulatus</i> . . . . .	59	28	11	15
4. <i>Chonetes coronata</i> . . . . .	57	26	10	16
5. <i>Palæoneilo constricta</i> . . . . .	56	27	2	5
6. <i>Nucula bellistriata</i> . . . . .	42	23	4	8
7. <i>Ambocelia umbonata</i> . . . . .	40	22	4	8
8. <i>Nuculites triqueter</i> . . . . .	38	22	1	7
9. <i>N. oblongatus</i> . . . . .	35	21	1	3
10. <i>Nucula corbuliformis</i> . . . . .	33	17	4	3
11. <i>Athyris spiriferoides</i> . . . . .	32	24	2	5
12. <i>Phacops rana</i> . . . . .	32	18	1	4

A—number of times in the 146 faunules;

B—number of times in 30 groups of 5 faunules each;

C—number of times marked abundant (*a*), and

D—number of times marked common (*c*).

The figures in the columns to the right signify that the first four species of the list are decidedly the more abundant in individuals, in the faunules, as shown by the figures in the fourth and fifth columns. This list, then, gives us the expression of bionic dominance in distribution and frequency in the faunas of eastern New York and Pennsylvania.

The analysis of the Cayuga Lake and Eighteen Mile Creek faunules will give the range-bionic values. Fourteen species out of the 234 were found to be dominant in being the more frequently represented (all of them 16 or more times) in the 25 successive zones; 9 of this list are also in the dominant list, based on geographical distribution and frequency in the eastern area.

Analysis of the Eighteen Mile Creek statistics shows that there is a list of 12 species which are in 14 or more of the 35

zones distinguished by Mr. Grabau; 12 out of a total of 163 named species. Of these 12 species dominant in range at Eighteen Mile Creek only four are in the first list. There is evidently a change in the composition of the fauna on passing westward across New York state.

Taking these lists thus obtained, expressing the bionic values of the species of highest rank in the several faunas, a table of standard dominant species of the *Tropidoleptus* fauna may be compiled. In forming such a table the following three particulars are used in discriminating the bionic strength of the species, viz:

I. Geographic frequency of occurrence in 146 sample collections (faunules) of the Hamilton formation in eastern New York and Pennsylvania;

II. Frequency of recurrence vertically in 25 zones of the whole Hamilton section of Cayuga Lake section in central New York;

III. Frequency of recurrence in 35 zones of the Eighteen Mile Creek section of the Hamilton formation in western New York.

The lists of species, to the extent of 12 to 15 in number, presenting the highest bionic value in each of the three cases, were compared on the basis of their relative bionic values, the averages obtained and the 12 species presenting the highest total values are given in the following list, with the values reduced to percentage in relation to highest possible bionic value. The highest possible bionic value, or 100 per cent, would be expressed by representation of the species in every one of the sample faunules examined for each case.

The species of the list are, thus, those showing the greatest bionic power of endurance in geographic distribution and in geologic range for the region and range under consideration.

*Tropidoleptus fauna.*

Standard list of dominant species for the New York-Ontario Province, with bionic values of species expressed in percentage.

1. <i>Spirifer pennatus</i> .....	79%
2. <i>Phacops rana</i> .....	58
3. <i>Tropidoleptus carinatus</i> .....	56
4. <i>Ambocœlia umbonata</i> .....	54
5. <i>Athyris spiriferoides</i> .....	47
6. <i>Palæoneilo constricta</i> .....	45
7. <i>Spirifer granulatus</i> .....	36
8. <i>Chonetes coronata</i> .....	36
9. <i>Nuculites triqueter</i> .....	33
10. <i>Nucula corbuliformis</i> .....	33
11. <i>Nuculites oblongatus</i> .....	31
12. <i>Nucula bellistriata</i> .....	20

The first ten species of this list exhibit, by the method used in measuring them, a bionic value of 33 per cent and over in the fauna to which they belong, and, therefore, they may be regarded as the characteristic species of the fauna for the region examined. They maintain their position of bionic dominance, geographically, over the eastern half of New York and down into Pennsylvania; and geologically, throughout over a thousand feet of thickness of sediments called the Hamilton formation.

The introduction of evidence from other faunules of the same region slightly modifies the percentages, but the differences are not greater than might be expected from the imperfection of the statistics themselves.

For instance, I have examined another group of 37 faunules from the Unadilla region, recorded by Prosser.\* In a list of the ten species with highest bionic index, are eight of the standard list. If they are incorporated with the eastern faunules already tabulated, the result is the same for the first twelve of the resulting list, based upon the total (146+37 =) 183 faunules.

The Hamilton species from Ontario, Canada, given by Whiteaves in his revised list† includes eight of the twelve dominant species of our list, but the facts of abundance, rarity, or frequency are not noted by Whiteaves, hence the actual bionic relations of the species cannot be stated.

Among the few species recorded by Rominger‡ as occurring in the Michigan area are named five of the standard list.

In the list of species from Milwaukee, recorded by Teller & Monroe,§ are named four of the standard ten.

In Mr. Weller's list of species for southern Illinois|| are mentioned three of the standard ten species.

In Indiana, Dr. Kindle¶ has recorded from the Sellersburg faunule three of the standard list.

The Iowa Devonian lists show only a single species of the standard dominant species of the fauna (viz: *Phacops rana*), and the Devonian of Manitoba, Saskatchewan and McKenzie River regions, which has been studied by Dr. Whiteaves,\*\* shows not a single species of the typical list.

\* The Devonian section of central New York along the Unadilla River. 46th Ann. Rept., N. Y. State Museum, pp. 256-288, 1893.

† Revised list of the fossils of the Hamilton formation of Ontario, Geol. Surv. Canada, Contrib. Can. Paleontology, vol. i, p. 412, 1898.

‡ Geol. Surv. Michigan, vol. iii, pp. 38 and 63. 1873-1876.

§ Jour. Geol., vol. vii, pp. 272-283, 1899.

|| Jour. Geol., vol. v, pp. 625-635, 1897.

¶ 25th Ann. Rept. Dept. Geol., etc., Indiana, pp. 530-775.

\*\* Geol. Surv. Canada; Contr. Canadian Paleontology, vol. i, pts. iii and iv, 1891 and 1892.



A manuscript catalogue, furnished me by Prof. Prosser for the western Maryland region which he is now working up, contains every one of the standard list of ten—there are 132 entries.

On the basis of these facts it is evident that there is a limited geographical extension of the fauna; as we follow it southward west of the Cincinnati anticlinal, it becomes considerably modified; the Iowan area and the northern extension of the Devonian across central British America neither contain the *Tropidoleptus* fauna, although they do contain a fauna which is believed to be of Meso-Devonian age. The affinities of the Meso-Devonian faunas in Iowa and the Manitoba-Saskatchewan region (as I have previously suggested\*) are more closely akin with the European Devonian than with the *Tropidoleptus* fauna, which is distributed along the Appalachian trough and as far around as into the Michigan embayment, and (which is of much more interest) is also conspicuous among the Devonian faunas of South America.

Knowing then what are the characteristics of the *Tropidoleptus* fauna in its typical region in North America, its presence may be recognized by the dominance of the dominant species, or several of them associated together. By this test we discover that, although the *Productella speciosa* fauna is quite distinct from it and is known to follow, by several hundred feet, the top of the Hamilton formation of Cayuga Lake, its time-equivalence is with the later life period of the *Tropidoleptus* fauna.

This is shown by the fact that the faunules occurring at the same horizon in the eastern part of the state maintain the bionic equilibrium peculiar to the *Tropidoleptus* fauna; and by the second fact that above the typical Ithaca formation, in the midst of the *Spirifer disjunctus* fauna, occur faunules in which the dominant characteristics of the *Tropidoleptus* fauna are still found associated with species not found either below in the Hamilton formation of that meridian or in the *Tropidoleptus* fauna in its metropolis area.

The details of these facts have been more fully elaborated by Dr. E. M. Kindle since my own statements regarding the general facts were stated.†

In Dr. Kindle's list of the species of the Ithaca formation, based upon the analysis of 54 faunules, not a single species of the ten standard list species of the *Tropidoleptus* fauna appears until we reach the thirteenth species in rank of the Ithaca list; and the second one is nineteenth in bionic rank in the Ithaca list. This shows plainly that the *Productella* fauna is not

\* Proc. A. A. A. S., xli, p. 169.

† Bull. 3, U. S. Geol. Surv., 1884; Bull. 6, Am. Paleontology, 1896.

the *Tropidoleptus* fauna although there are a considerable number of so-called Hamilton species in the Ithaca formation. As this latter formation is traced eastward, however, the species of the *Tropidoleptus* fauna increase in it, and the dominant *Tropidoleptus* species take higher bionic rank; so that the fauna of the Ithaca formation, in its eastern extension, contains two of the standard dominant species of the Hamilton formation among its twelve dominant species as evidenced by 67 faunules.

That this *Productella* fauna is actually distinct and younger than the *Tropidoleptus* fauna is shown by the fact that there are 21 species in it which are characteristic of the Ithaca formation at Ithaca which is known to be above (by several hundred feet) the top of the Hamilton formation and Genesee shale. These 21 species are not known to occur in the Hamilton formation in any of its exposures; and among them are seven of the ten most dominant species of the Ithaca formation.

If a step be taken further westward, it is known that the total sediments (of some 1000 feet thickness) from the top of the Genesee to the true Chemung, with its *Spirifer disjunctus* fauna, in the Genesee valley, contain none of the dominant species of either the Hamilton or Ithaca formations; I refer to the typical Portage formation.

Again, we have positive evidence of a colony of the *Tropidoleptus* fauna within at least fifty feet of the typical horizon of the Chemung formation in Chemung County; and also in the midst of the Chemung or *Spirifer disjunctus* fauna at Owego, as I announced in 1884.\*

These evidences of the *Tropidoleptus* fauna are so clear that if we were to find them in an isolated region, no hesitation would be taken to calling the formation holding them Hamilton, except that a few species of much later age are associated with them.

The typical species of the *Tropidoleptus* fauna are such as

*Tropidoleptus carinatus* abundant,  
*Ambocelia umbonata* "  
*Phacops rana* rare but with several specimens.

It also contains such characteristic species as

*Spirifer marcyi*, and probably *S. granulatus*,  
*Cypricardella bellistriata*,  
*Goniophora hamiltonensis*,  
*Macrodon hamiltonia*,  
*Loxonema delphicola*, and  
*Modiomorpha mytiloides*.

\* Bull. 3, U. S. Geol. Survey, p. 24, 1884; also Proc. A. A. A. S., xxxiv, p. 226, 1886.—this is the stage A<sup>6+</sup> of the *Tropidoleptus* fauna, called in that paper Middle Devonian fauna A; also p. 230.

The faunule from Owego, to which I made reference in my papers of 1884 and 1886, was so characteristically Hamiltonian in its species that at that time it was difficult to believe that the zone in which it occurred was not out of place. But the recent rediscovery of the zone at Waverly by Dr. Kindle, and a comparison of the forms, leaves no doubt as to the actual position of the recurrent Hamilton faunule in the midst of the Chemung formation. The species of this faunule are given in the following list.

1130  
A. Recurrent *Tropidoleptus* fauna from Cemetery Hill, Owego, Tioga Co., on side hill above, and southeast of the old Erie depot, collected by H. S. Williams (U. S. G. S. station 1130 A).

1. <i>Spirifer marcyi</i> var.	aa	Hamilton
2. <i>Ambocelia umbonata</i>	aa	Marcellus-Chemung
3. <i>Cypricardella bellistriata</i>	aa	Hamilton
4. <i>Tropidoleptus carinatus</i>	c	Hamilton
5. <i>Leiopteria bigsbyi</i>	c	Hamilton
6. <i>Phacops rana</i>	r	Hamilton
7. <i>Productella speciosa</i>	r	Portage-Chemung-Kinderhook
8. <i>Coleolus acicula</i>	r	Genesee
9. <i>Loxonema delphicola</i>	r	Hamilton
10. <i>Camarotoechia</i> cf. <i>prolifera</i>	r	Marcellus-Hamilton
11. <i>Goniophora hamiltonensis</i>	r	Hamilton
12. <i>Modiomorpha mytiloides</i>	r	Hamilton
13. <i>Spirifer</i> cf. <i>granulosus</i>	rr	Hamilton
14. <i>Chonetes setigera</i>	rr	Marcellus-Waverly
15. <i>C. lepida</i>	rr	Marcellus-Chemung
16. <i>Macrodon hamiltoniae</i>	rr	Hamilton
17. <i>Lingula</i> sp.	rr	----
18. <i>Pterinea</i> sp.	rr	----
19. <i>Grammysia</i> sp.	rr	----
20. <i>Palæoneilo</i> sp.	rr	----
21. <i>Aviculopecten</i> sp.	rr	----

It will be observed that of the sixteen species, specifically identified, all but two are Hamilton species. One of the exceptions is *Productella speciosa*, which has been reported from Portage, Chemung and Kinderhook formations, and the other, *Coleolus acicula*, is a Genesee species. Eleven of the sixteen have not been hitherto reported from above the Hamilton formation; while the other four range both below and above that formation.

On the principle of specific identification, therefore, this faunule belongs to the genuine *Tropidoleptus carinatus* fauna, of which it contains four of the dominant species of the standard list.

The species of the Waverly fauna, collected and identified by Dr. Kindle, are as follows, viz:

1462 B.	Tropidoleptus faunule as a colony in Chemung formation, Waverly, N. Y. 1462 B, (U. S. G. S.), identified by E. M. Kindle (1902).	
1.	<i>Tropidoleptus carinatus</i>	a Hamilton
2.	<i>Ambocelia umbonata</i>	a Marcellus-Chemung
3.	<i>Rhipidomella vanuxemi</i>	c Cornif.-Hamilton
4.	<i>Spirifer marcyi</i>	c Hamilton
5.	<i>Cypricardella bellistriata</i>	c Hamilton
6.	<i>Productella lachrymosa</i>	c Chemung
7.	<i>Delthyris mesacostalis</i>	c Ith.-Chemung
8.	<i>Camarotoechia contracta</i>	r Portage-Waverly
9.	<i>Schizophoria</i> cf. <i>tioga</i>	rr Portage-Chemung
10.	<i>Leptodesma matheri</i>	rr Chemung
11.	<i>Glyptodesma erectum</i>	rr Hamilton
12.	<i>Pterinopecten</i> sp.	rr
13.	<i>P. crenicostatus</i>	rr Chemung
14.	<i>Modiomorpha</i> cf. <i>concentrica</i>	rr Hamilton
15.	<i>Cyrtina hamiltonensis</i>	rr Up. Held., Ham., Ptg., Chem.

The commonly reported range by formations is given in the column on the right.

In this faunule, it will be observed, the abundant and common forms are, with the exception of *Productella*, chiefly found in the Hamilton formation.

Nevertheless the faunule occurs in the rocks after the *Spirifer disjunctus* fauna has occupied the region in force with its typical development; thus showing that in time the two faunas were coexistent in separate areas in their normal bionic strength. That is to say, in the areas of their geographic metropolis, each fauna maintains its bionic equilibrium as expressed in frequency and dominance of species.

The importance of this case of recurrence of the *Tropidoleptus* fauna is so great as to call for every precaution as to its verity. The intrinsic evidence of its Chemung horizon was not present in the Owego faunule. There are no species there which might not occur as low as the Ithaca Group. But the faunule collected at Waverly contains *Delthyris mesacostalis* with a distinctly strong median septum, which is wanting or very slightly developed in the specimens of the Ithaca formation; also a single specimen of *Schizophoria tioga*, nothing like which is known in the typical fauna of the Ithaca formation. The *Productella lachrymosa* is not so strongly of the true *lachrymosa* type as to make it certain that it may not be an extreme variation of *Productella speciosa*. The *Leptodesmas*

are so variable that the form *L. matheri* is not conclusive of post-Ithaca stage.

In my collections from the Waverly-Chemung cliffs, however, *Tropidoleptus* was discovered above the first appearance of *Spirifer disjunctus* and other typical members of the *Spirifer disjunctus* fauna. These facts are intrinsic evidence, therefore, that the combination of species, so much like the typical *Tropidoleptus carinatus* fauna of the Hamilton, is here present in a part of the rock section occupied in general by a typical *Spirifer disjunctus* fauna.

The fact that the combination of species is the normal combination seen in the undisputed Hamilton formation shows that its equilibrium has not been disturbed and, therefore, that the life history of the fauna of the Hamilton formation has not ceased; while the faunas above and below in the cliffs in Chemung narrows is evidence that the geological horizon is that of the typical Chemung formation. The lapping of faunas of the same kind seems to be established by evidence beyond dispute, and correlations must be made with recognition of such a possibility in cases where the direct evidence of the fact may be wanting.

When we attempt to correlate formations with this knowledge before us, it is evident that the life period of a fauna is not what it appears to be in any particular section. Whenever the succession is sharply defined by the stopping of one fauna and the abrupt beginning of another, in full or decided strength, the evidence should be interpreted as positive that the boundary between the two consecutive formations does not make the end of one fauna and the beginning of the succeeding one. It is to be interpreted rather as only a well advanced stage into the later one, and the vigorous period of persistence of the other. This, interpreted into comparative terms, would result in showing that the two faunas lap over each other in time.

My studies convince me that this is frequently the case in respect to the boundary lines of our formations. The abrupt transition from one formation to another with a different fauna is convincing evidence that the abruptness of the change in fossils is due either to absence of strata (i. e., an apparent or concealed unconformity) or else to migration of the faunas across the area.

This principle must be recognized in making correlation, if we would reach correct interpretation of the facts.

The laws discovered in the statistics above reported may be summarized as follows:

A *geological fauna* may be defined as an aggregation of species living together, the several species of which hold a definite value in relation to each other.

The relative value of the constituent species is expressed in terms of the abundance or rarity of the individuals of each faunule sample, viz: *bionic value*.

The purity or integrity of the fauna may be recognized by the list of its *dominant species*.

The *geographical distribution* of the fauna may be recognized by the presence of the dominant species and their holding their standard dominance in the list of species with which they are associated in the faunule.

The region, over which the bionic equilibrium of the fauna is expressed by occurrence of the same dominant species, is the *metropolis of the fauna*.

The *geological range* of a fauna is recognized by the persistence of the bionic equilibrium of the species.

Two faunas may coexist in time in distinct geographical areas; but in the same area, the two faunas can appear in their integrity only by displacement by which the bionic equilibrium will be disturbed. Hence two faunas in their purity will always appear in succession in any single section.

As the geological changes are, in general, in one direction for any particular region, the *shifting of faunas* is likely to be in the same direction for long periods of time, and thus the recurrence of two distinct faunas is rare. Occasionally oscillation of two faunas can be recognized in a single section; this fact may be interpreted as migration back and forth over the same region. The occurrence of two faunas each occupying a distinct metropolis will thus rarely ever show itself in lapping of the faunas; but occasionally evidence of the coexistence of the faunas will be seen in the intercalation of a colony of one of the faunas in the midst of the other. The *lapping of faunas*, stratigraphically, is the necessary interpretation of the coexistence of two faunas at the same period of time.

Yale University, New Haven, Conn.

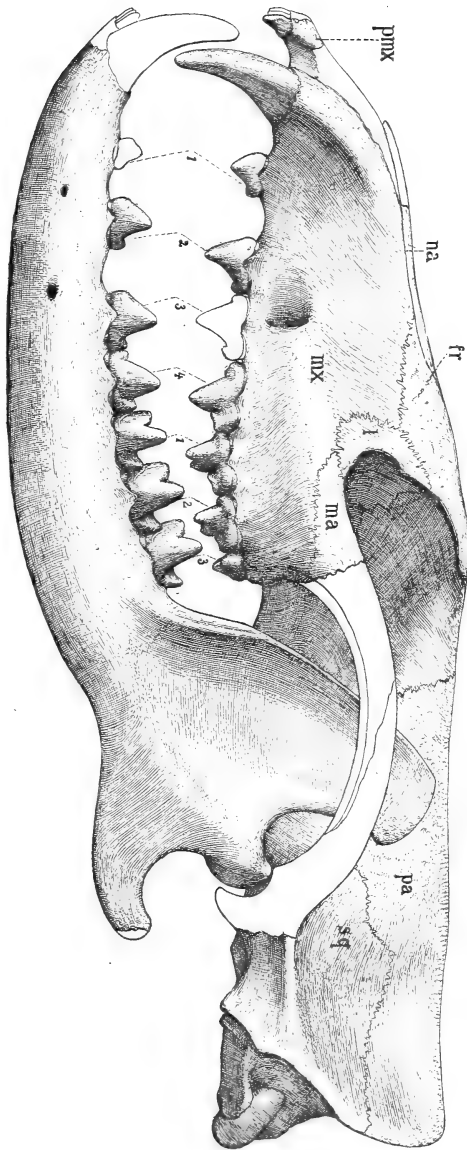

EXPLANATION OF PLATE VII.

Skull of *Sinopa agilis* Marsh ; side view ; natural size ; combination of the type and another specimen in the collection. *pnx*, premaxilla ; *na*, nasal ; *fr*, frontal ; *mx*, maxillary ; *ma*, malar ; *pa*, parietal ; *sq*, squamosal.





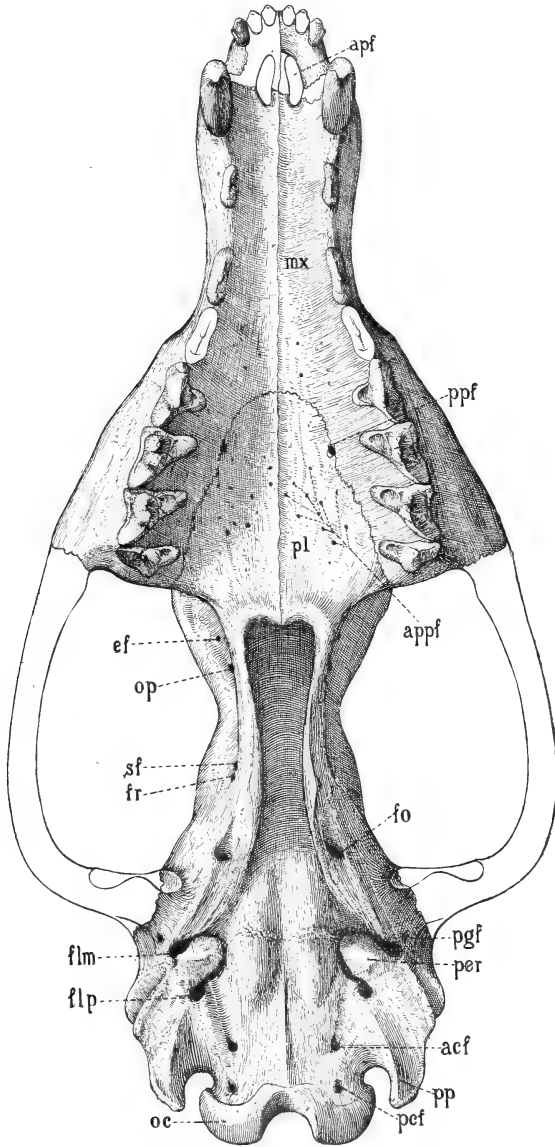

EXPLANATION OF PLATE VIII.

Skull of *Sinopa agilis* Marsh; inferior view; natural size; combination of the type and another specimen in the collection.

*apf*, anterior palatine foramen; *ppf*, posterior palatine foramen; *appf*, accessory postpalatine foramina; *fo*, foramen ovale; *pgf*, postglenoid foramen; *per*, periotic; *acf*, anterior condyloid foramen; *pp*, paroccipital process; *pcf*, posterior condyloid foramen; *oc*, occipital condyle; *flp*, foramen lacerum posterius; *flm*, foramen lacerum medius; *fr*, foramen rotundum; *sf*, sphenoidal fissure; *op*, optic foramen; *ef*, ethmoidal foramen; *pl*, palatine; *mx*, maxillary.



ART. XXXVI.—*Studies of Eocene Mammalia in the Marsh Collection, Peabody Museum*; by J. L. WORTMAN. (With Plates VII and VIII.)

[Continued from p. 206.]

Family *Hyænodontidæ*.

STILL another group of the Creodonta is the family Hyænodontidæ, which, like so many representatives of the Carnivora already noticed, appears suddenly in the lower stages of the Middle Eocene or Wasatch deposits, without any previous announcement in the way of ancestors in the underlying Torreon. The present association of the genera in this family is very different from that adopted by Cope, Scott, and Schlosser. For example, Cope placed *Hyænodon* by itself in a separate and distinct family; *Pterodon* was arranged in the Oxyænidæ; while *Sinopa* (*Stypolophus*), *Proviverra*, *Quercytherium*, and *Didelphodus* were classified in the family Leptictidæ. Both Scott and Schlosser arranged *Oxyæna*, *Protopsalis*, *Hemipalodon*, *Pterodon*, *Dasyurodon*, *Thereutherium*, and *Hyænodon*, in the family Hyænodontidæ, at the same time placing *Patriofelis* in the Palæonictidæ. The genera *Sinopa*, *Proviverra*, *Quercytherium*, and *Didelphodus* were placed by them in a distinct family, Proviverridæ. The first important advance over this arrangement of the genera into family groups was made in 1894,\* when I pointed out that *Oxyæna* and *Patriofelis* are nearly related types, and should be classified in the same family; that *Protopsalis* is probably the same as *Patriofelis*; that neither of these genera is closely related to *Hyænodon*; but that *Hyænodon* and *Sinopa* (*Stypolophus*) are closely related to each other. In the same year, Osborn and myself added *Pterodon* to the two last-mentioned genera, from a consideration of the teeth.† The close relationship of *Proviverra*, *Cynohænodon*, and *Quercytherium*, to *Sinopa*, was then well known, and the inference was clear that these forms follow *Sinopa* wherever placed in the classification. In further elaboration of these views, I published in 1899‡ a brief classification of the three families Hyænodontidæ, Oxyænidæ, and Palæonictidæ, which, I may add, forms the basis of our present understanding of the arrangement of these three important groups of the Carnivora.

As regards the definition of the Hyænodontidæ, if we leave out of consideration *Palæosinopa* and *Didelphodus*, which more probably are members of the Insectivora rather than of the Creo-

\* Bull. Amer. Mus. Nat. Hist., 1894, pp. 152, 156. † Ibid., 1894, p. 237.

‡ Ibid., 1899, pp. 139, 140.

donta, we shall have little difficulty in distinguishing it from the Oxyclænidæ on the one hand, and the Oxyænidæ on the other. In the former of these families, none of the superior molars are of a pronounced shearing type, but seem (according to Matthew) to have been tending more in the direction of a tubercular than of a sectorial structure.\* From the Oxyænidæ the family under discussion may be distinguished by the circumstance that it is the *second molar* above and the *third molar* below that were becoming the most specialized carnassials; whereas, in the Oxyænidæ, it was the *first molar* above and the *second molar* below that were thus specialized. In the Carnassidentia, as I have pointed out on a former page (337), the axis of sectorial development has shifted still further forward, and involves the *fourth premolar* above and the *first molar* below. Another important dental character of this family is the comparatively small size and weak development of the first molar below and frequently of the corresponding tooth above as well. This is a conspicuous feature of all the later species, particularly those of *Hyænodon* and *Pterodon*, and is also seen in nearly all species of *Sinopa*, although less strongly marked.

The progressive characters of the teeth consist in the gradual loss of the internal cusps of the superior molars, the complete fusion of their primary external cusps, and the loss of the third molar. In the inferior molars, the heels or talons decrease in size and disappear, and the internal cusp of the trigon becomes rudimental or wanting.

#### *Sinopa* Leidy.

*Sinopa* Leidy, Proc. Acad. Nat. Sci., Phila., 1871, p. 115;  
*Stypolophus* Cope, Pal. Bull., No. 2, Proc. Amer. Philos. Soc., 1872, p. 446;  
*Prototomus* Cope, Report on Fossil Vert. N. M., Ann. Rept. U. S. G. S. W. of 100th Mer., 1874;  
*Limnocyon* Marsh, in part, this Journal, 1872, p. 122.

The only genus of the family thus far known to be represented in the Bridger fauna is *Sinopa*, described by Leidy from the lower part of the horizon in 1871. It first appears in the beginning of the Middle Eocene or Wasatch, and is represented by at least six fairly distinct specific modifications in these beds. One very well known species comes from the Wind River beds, while at least four are now known from the Bridger. The definition of the genus is as follows:

A group of small or medium-sized Creodonts, with a complete dentition, having the superior molars with well-developed internal

\* There is as yet no evidence sufficient to determine the position of this group satisfactorily. They have always been assumed to be Placentals, and have been placed among the Creodonts. They may quite as well be Implacentals, as far as any very good evidence to the contrary is concerned, or they may prove to be Insectivores, with numerous transitional or Implacental Metatherian characters.

cusps, more or less fused or well-separated external cusps, and with anterior and posterior external angles produced into shearing blades; with first premolar above, and first and frequently second below, spaced; with first lower molar more or less reduced, and becoming progressively smaller and weaker than the others; and with pentadactyle limbs, in which the ungual phalanges are compressed, curved, and sharp-pointed.

*Sinopa rapax* Leidy.

*Sinopa rapax* Leidy, Proc. Acad. Nat. Sci. Phila., 1871, p. 115;  
*Stypolophus pungens* Cope, Proc. Amer. Philos. Soc., 1872, p. 446.

The type species of this genus was described from a lower jaw fragment, carrying the fourth premolar and first molar in good condition, together with the heel of the second and the roots of the third. The specimen, although fragmentary, was well described and figured by Leidy, and it is possible to refer other material to it from the same horizon. Cope in speaking of his genus *Stypolophus* says: \* “Dr. Leidy has applied the name *Sinopa* to some flesh-eaters of the Bridger epoch without distinctive generic description. An examination of the typical specimen of the *S. vorax* [*rapax*], which Dr. Leidy kindly

83

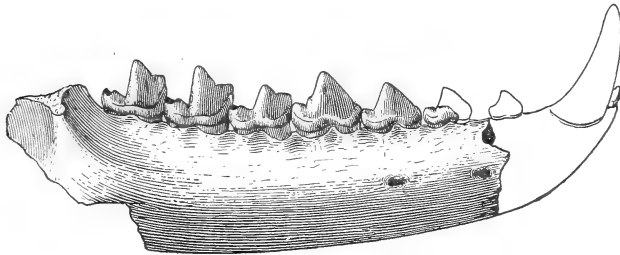

FIGURE 83.—Lower jaw of *Sinopa rapax* Leidy; side view; natural size.

permitted me, shows that it differs from *Stypolophus* in the rudimental character of the heel of the last molar, if the specimen is not deceptive. It is otherwise identical in the last four inferior molars.” Now Leidy’s specimen is deficient in the matter of the last molar, and it is not possible, according to his figure, to make out anything concerning the crown more than what is stated in the description, which is as follows: † “The last molar is a two-fanged tooth like those in advance, but is not quite so wide, and a small portion of the back of the crown indicates it to have been of less thickness.”

There are two specimens in the Marsh collection, consisting of considerable portions of the mandibular rami. One is a

\* Tertiary Vertebrata, 1884, p. 289.

† Extinct Vertebrate Fauna of the Territories, 1873, p. 116.

right lower jaw of a young adult, figures 83, 84, containing all the molars and the three posterior premolars, in an almost perfect condition. The second specimen is more fragmentary,

84



FIGURE 84.—*Sinopa rapax* Leidy; crown view of three lower molars; natural size.

but the anterior portion of the ramus is sufficiently preserved to show the roots of the anterior premolars and the canine.

The teeth agree so perfectly, both in measurements and structure, with Leidy's type of *S. rapax*, that I do not hesitate to refer them to this species. Containing, as they do, almost the entire lower dentition, including the last two molars, it is possible to compare them with Cope's type of *Stypolophus pungens*, which is also a jaw fragment carrying the second and third molars. The Marsh specimens agree quite as well with the Cope specimen as with that of Leidy, from which it is evident that all refer to one and the same species. I therefore unite them under Leidy's name *Sinopa rapax*.

The characters of the species, as revealed by these specimens, are as follows: The first lower premolar is single-rooted and separated from the canine and second premolar by short diastemata; the second, third, and fourth are not spaced, but are in contact; the first molar is the smallest and the second is slightly larger than the third; the trigon of the first molar is considerably less elevated than that of either the second or third; the heels of the molars are relatively wide and basin-shaped, that of the third or last being noticeably smaller and narrower than the others; the edge of the rim surrounding the heel is interrupted on its postero-external border by a moderately deep notch, which, when seen from the outside, gives the heel the appearance of being bicusped.

There is also in the collection a fragment of an upper jaw, which includes the fourth superior premolar somewhat damaged and the first and second molars in fairly good condition. I place the specimen in this category more by exclusion than by any real evidence which it exhibits. The size of the teeth corresponds very well with those of the lower jaw, and they display just such characters as we should expect to accompany the lower series above described. Their chief characters are the following: The fourth premolar has a large internal cusp and a well-developed blade-like postero-external cusp; the first and second molars are subequal, the internal cusps are relatively large and lunate, the two primary external cusps are well separated, and the antero-external angle of the second is not produced into a cutting blade. I give the following principal measurements:

Length of inferior molar and premolar series from base of canine .....	55·mm
Length of premolars .....	32·
Length of molars .....	23·
Depth of jaw at second molar .....	18·
Length of fourth superior premolar and first and second molars .....	23·
Width of first molar .....	7·
Width of second molar .....	9·

The more perfect of the lower jaws was found by Professor Marsh, at Grizzly Buttes, where Dr. Leidy's type was collected. No locality is given on the labels for the other two specimens.

*Sinopa agilis* Marsh.

*Limnocyon agilis* Marsh, this Journal, 1872, vol. iv, p. 202 ;

*Stypolophus breviculcaratus* Cope, Proc. Amer. Philos. Soc., 1872, p. 469.

The materials from which this species was originally described consist of the larger part of the skeleton of a young individual, somewhat crushed. There are represented numerous vertebræ, ribs, limb bones, an almost complete fore foot, and considerable portions of the skull, with nearly the entire dentition. Fortunately, this specimen is supplemented by a second skeleton of a somewhat older individual, in which the skull is very well preserved, but the teeth are considerably worn. This specimen also includes numerous parts of the remainder of the skeleton, so that between the two a very accurate understanding of the osteological structure may be had. Upon the most careful comparison, there is no doubt of the specific identity of the two specimens, and I have accordingly not hesitated to use all the skull material in the restoration of the skull represented in the accompanying plates, VII, VIII.

*The Skull.*—The general appearance of the skull is not unlike that of many living Carnivores, exhibiting an unusually narrow, elongate type, with a remarkably straight, superior outline, and with crests and arches of moderate proportions. The skull, as a whole, is much smaller in proportion to the rest of the skeleton than is usually the case among the Creodonts. In length, it holds nearly the same relation to the tibia and humerus as that seen in *Herpestes*, and, except for the length of the face in *Sinopa*, the other proportions are not very different. This feature gives the skeleton a much more modern appearance than many of its contemporaries. The brain case is exceptionally long and narrow, the postorbital constriction, which is well marked, being placed a little posterior to the middle of the cranium. The facial portion is not unlike that of some of the Canidæ, relatively long and narrow, with a considerable constriction posterior to the roots of the

canines. The nasals, of which the extreme anterior portions are missing, are narrower in front than behind, as in the carnivorous Marsupials, although the posterior widening is not nearly so marked as in this group. They terminate posteriorly in a pointed extremity, which is situated near the center of an unusually broad and deep frontal depression. The nasals are not so wide posteriorly as to restrict the contact between the frontals and maxillaries, as is the case in certain of the carnivorous Marsupials, and in *Dromocyon* already described, so that this feature of the skull is decidedly more Carnassident in appearance. The maxillary is large and has a form common to the carnivorous skull. The posterior suborbital region, however, is exceptionally broad, and is in every way more extensive and primitive looking than in any of the Carnassidents. Owing to the large facial development of the lachrymal, the maxillary lacks considerable of reaching the rim of the orbit. The infraorbital foramen is of goodly size, and issues a short distance above the hinder edge of the third premolar, about as in the fox. As already stated, the lachrymal is relatively large and spread out upon the face, having about the same proportions and degree of facial development as that of the opossum. It is perforated by a distinct lachrymal canal, which lies wholly within the rim of the orbit. The zygomatic arches are not preserved in either specimen, but, if we are able to judge by their roots, they may be said to have been intermediate in stoutness between those of the dog and of the opossum. The anterior part of the malar is preserved, and this, as is usually the case, furnishes the lower anterior boundary of the orbit. In the Carnassidentia, it joins the maxillary by means of a bifurcated extremity. In the fossil, the lower ramus of this bifurcation is very slightly developed—a condition which approximates that of the opossum, in which it is entirely wanting.

The frontals are rather broad anteriorly and terminate opposite the infraorbital foramen, in triangular extremities which do not meet the ascending processes of the premaxillæ. The position of the inconspicuous postorbital processes is indicated by the termination of the strongly-marked, rapidly diverging anterior branches of the sagittal crest, which furnish the posterior boundary of the frontal depression. The sagittal crest is not well preserved, but enough is shown to indicate that it had about the same relative degree of development as that of *Gymnura* and the Dasyures. The form of the brain case is much like that of certain of the civets, except that it is longer, narrower, and of less capacity; it is conical in front with a slight median swelling, after which follows a relatively long subcylindrical posterior portion. The parietals and



squamosals exhibit about the same relations as those of the dog, with the possible exception that the squamosal is larger. The parietal foramina, which in this region form such a conspicuous feature of the skulls of so many of the Creodonts, are very small; in fact, in the specimen under consideration, the one on the right side is practically absent.

The lambdoidal crest is only moderately developed, showing about the same degree of elevation as that seen in the living insectivorous genus *Gymnura*, which the superior and occipital portions of the skull resemble somewhat closely. The occiput is not very broad, and rises almost vertically to the plane of the long axis of the skull. It overhangs the condyles but very slightly, in marked contrast with its great backward projection in some of the Creodonts. The condyles are relatively very large, obliquely placed, and well separated. In comparison with those of a red fox, in which the size of the two skulls agrees very well, the occipital condyles of *Sinopa* are quite one-third larger. The extent to which the mastoid portion of the periotic is exposed upon the posterolateral wall of the cranium cannot be made out with certainty, but it appears to be very little, if any.

The base of the skull is in a state of excellent preservation, and its anatomy can be quite fully determined. The basioccipital is broad, and at the point of its articulation with the basisphenoid exhibits two prominent tubercles, separated by a longitudinal groove. The office of these eminences, which are roughened for muscular attachment, was doubtless for the origin of the *recti capiti*. The paroccipital is large, considerably flattened from above downward, and has a very marked outward and backward direction, as in the Insectivora. Just how much of this, however, is due to crushing, it is difficult to say, but it appears to be natural. The mastoid, which is separated from the paroccipital by a groove, is prominent, as in the Marsupials. The petrosal portion of the periotic is not covered by any tympanic bulla below, and if a tympanic bone were present it was not attached to the skull. There are, moreover, no expansions of the alisphenoid contributing to the formation of an otic bulla, as is so frequently the case in the skulls of the Marsupials and Insectivores. The petrosal portion of the periotic, when seen from below, appears as a small rounded eminence, near the outer posterior extremity of which, in a deep transverse groove, is seen the opening of the *fenestra rotunda*. In the Carnassid skull, this transverse groove is absent, and the opening of the fenestra is larger and somewhat tubular in appearance. Above, and anterior to this, is seen the opening of the *fenestra ovalis*, into which the base of the stapes is received. The absence of any groove leading

to the *fenestra ovalis* from below may be taken as conclusive evidence that the course of the entocarotid artery was essentially different from that in the modern Insectivora. Just external to the *fenestra rotunda* may be observed the peripheral termination of the fallopian aqueduct, through which the facial nerve made its exit from the skull. In front of the occipital condyle is placed the opening of the main condyloid foramen, and at some little distance in advance of it is the accessory or second condylar foramen—so constant a feature of the Marsupial skull, and occasionally found among living species of the Insectivora. Its office is apparently unknown. Immediately posterior to the petrosal eminence is situated the rather large elliptical opening of the foramen lacerum posterius, the size of which, in connection with the almost vestigial condition of the postglenoid foramen, would seem to indicate that the chief venous channel through which the cranial cavity was drained, made its exit at this point. A broad, but distinct, groove internal to this foramen leads forward to the fissure between the petrotic and basioccipital, thence into the foramen lacerum medius situated in the angle at the junction of the petrotic, basioccipital, and basisphenoid. That this was the point of entrance of the entocarotid artery is clear from its close resemblance to the corresponding parts in the skull of all of the Carnassidentia. In this important particular, it is therefore fundamentally different from the Insectivora and Marsupialia, and like the Carnassidentia. The foramen ovale is large and is placed as usual opposite to the glenoid cavity, at a considerable distance from the posterior edge of the alisphenoid. Just in advance of this foramen, and almost within the same aperture, is a small, but distinct, foramen leading into the *antrum* of the basisphenoid. In the opossum, this foramen is large and opens further in advance of the foramen ovale, but is connected with it by a distinct groove. Its office in this latter species is the transmission of a vein, a branch of which gains access to the cranial cavity through a small foramen in the floor of the pituitary fossa. There is no alisphenoid canal, but a slight groove marks the forward course of the ectocarotid at this point. The foramen rotundum and the sphenoidal fissure present separate openings, and are situated in a deep groove above the pterygoids. The opening of the rather large optic foramen is above, and considerably in advance of these two. Above and in advance of this, again, is the opening of the ethmoidal foramen for the passage of a branch of the nasal nerve.

The region of the glenoid cavity is considerably broken, but there is enough preserved to indicate that there was a strong postglenoid process, behind which is a small postglenoid

foramen. The pterygoids are well developed and the postnasal gutter is long and deep, much as in the dog and other typical Carnassidents. The posterior edge of the palatines is thickened and lies considerably behind the last molar. The palatal region is narrow in front and widens rapidly behind, being rather concave from side to side. The posterior palatine foramina have their usual position opposite the first molar, and behind them, in the palatines themselves, are numerous smaller accessory foramina. The incisive foramina are not well preserved, but there is evidence of their having had the usual slit-like openings.

The lower jaw is long and slender, with a well-curved inferior border. The coronoid is wide and much elevated, the masseteric fossa well marked, and the angle produced into a long slightly inflected hook. The condyle is placed rather high and has the scroll-like pattern of many of the Carnivora.

*The Dentition.*--The teeth exhibit very marked progress toward the extreme sectorial structure of the later and more specialized members of the family. The dental formula is  $I. \frac{3}{3} (?)$ ,  $C. \frac{1}{1}$ ,  $Pm. \frac{4}{4}$ ,  $M. \frac{3}{3} = 44$ . Of the superior series, the outer incisors have much the same form as the corresponding teeth in the Carnassidents. The canines are long, pointed, and curved. The first premolar has a compressed, bluntly pointed crown, and is implanted by two roots about midway between the canine and second premolar, with a considerable interval or diastema in front and behind it. The second premolar has a more pointed principal cusp, which is inclined to be hook-shaped; there is in addition a small posterior basal talon. The third premolar is missing. The fourth has all the usual elements of the superior sectorial of the Carnassidents, but it is much less perfect as a shearing organ. The external parts of the crown include a low indistinct basal cusp in front, a slightly flattened conical principal cusp, and a posterior blade-like extension separated from the main cusp by a deep vertical fissure. There is a distinct lunate internal cusp. The first and second molars are subequal in size, the second being slightly larger than the first. The antero-external angle of the first is less distinct than that of the second, in which it is produced into a short, transverse, shearing blade. In other respects, the structure of the two teeth is the same. The two primary external cusps are connate for the greater part of their extent, only the points being separated. The posterior spur is enlarged, blade-like, and, in connection with the drawn-out posterior edge of the more or less fused externals, constitutes the chief shearing apparatus of the upper jaw. There is, in addition, a somewhat reduced internal lunate cusp, which, upon its anterior rim, supports a small intermediate. The last molar is transverse

and reduced; its antero-external angle is produced into a strong blade-like spur; the postero-external is wanting, and the internal is large.

In the lower jaw, the incisors and canines are unknown. The first premolar is small, single-rooted, and separated from the canine in front and second premolar behind by diastemata. The second premolar is two-rooted and also separated from the tooth in advance and the one behind by considerable intervals. The third and fourth are in contact. The first molar is the smallest of the three, and not only differs from its fellows in this respect, but the cusps of the trigon are less elevated. In all of them the trigon is well developed, the shear is little oblique, and the internal cusp is much reduced. The heels are relatively small, with a high single posterior cusp and a faint median ridge, that of the last molar being the largest.

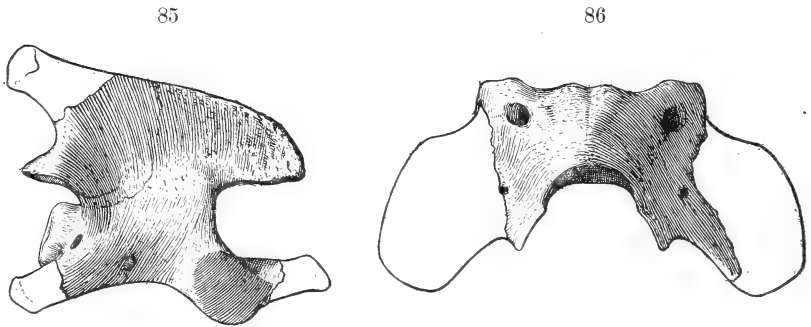

FIGURES 85, 86.—Atlas and axis of *Sinopa agilis* Marsh; natural size. (Cotype.)

While many other parts of the axial skeleton are preserved, they are not sufficiently perfect to merit a very detailed description. Of the series of cervical vertebræ, the atlas and axis, figures 85, 86, and the body of the third or fourth are present. The chief characters of these bones are the following: The transverse process of the atlas is relatively large, extends well behind the articular surfaces for the axis, and is thickened and perforated at the base for the passage of the vertebral artery; the further course of the artery forward is similar to that of the cat; the *sinus atlantis* is large, the cotyles deeply cup-shaped, the superior arch broad from before backward, and the inferior ring narrow and complete; the axis has a large, laminate, hatchet-shaped neural spine, which overhangs the odontoid in front; it is broken behind, but was presumably well extended; the odontoid is rather small and peg-like; the transverse spines are long, pointed, and pierced by the vertebrarterial canal; the ventral surface of the centrum has a very strong median keel, which increases rapidly in depth poste-

riorly, and on either side of this is a deep longitudinal cavity whose lateral boundary is furnished by the unusually dependent edge of the transverse process, much as in the fox; a third or fourth cervical centrum exhibits an elongated, depressed form, with strong median keel. The dorsals have elevated spines and comparatively small centra. The lumbar increase rapidly in size posteriorly; they have large strongly-interlocking zygapophyses, which exhibit distinct traces of the double tongue and groove articulation; they also develop distinct anapophyses.

The sacrum is relatively much longer and stouter than that of the fox, and its transverse diameter is proportionally quite as great, which latter fact would indicate a pelvic outlet of goodly proportions. This, in connection with the proportional size of the skull, is in marked contrast with the conditions in *Dromocyon* previously pointed out (p. 424). It may be here remarked that the same proportionally small pelvic outlet associated with the large head is also true of some species, at least, of *Hycenodon*. There are three cöossified vertebræ in the sacrum, the two anterior only of which contribute to the formation of the auricular process for the attachment and support of the ilium—an essential and very constant feature of the Carnassidentia. Among the Marsupials generally, only one of the vertebræ, the anterior, furnishes this support, while in the living Insectivora, as many as three vertebræ are thus involved. The size of the sacrum is apparently in relation to the long and powerful tail, of which the numerous caudal vertebræ give ample evidence. These bones do not differ, as far as can be observed, from the caudals of other Creodonts.

Of the appendicular skeleton, many parts are preserved. The scapula, while represented by numerous pieces, is not sufficiently complete to furnish any information of its general form or outline. The glenoid cavity betrays some resemblances to that of the opossum, in the extent of the transverse diameter and the large size of the coracoid. In this latter feature,

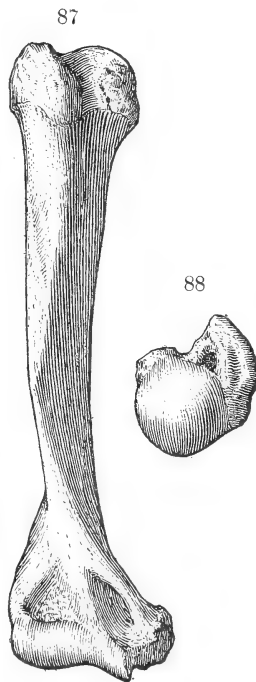

FIGURES 87, 88.—Right humerus of *Sinopa agilis* Marsh; front and proximal end views; three-fourths natural size. (Cotype.)

it differs from *Hyænodon*, in which the coracoid is very short and vestigial. The humerus, figure 87, may be said to be intermediate in structure between that of the more generalized Carnassidents and the opossum. In its general outline, it bears a close resemblance to that of *Hyænodon* and differs markedly from any of the Insectivora. Its chief characters may be stated as follows: The head, figure 88, is not very pointed behind; the greater tuberosity is thick and rises to a level with the head; the lesser tuberosity is distinct and separated from the greater tuberosity by a moderately wide bicapital groove; the deltoid crest is long and powerful, extending down more than half the length of the shaft; the distal end is characteristically broad, with unusual development of the internal condyle and supinator ridge; there is a large entepicondylar foramen, imperforate anconeal and anticubital fossæ, and a distinct division of the articular surface into trochlea and capitellum.

The bones of the fore arm are not complete, both ulna and radius being represented only by their proximal and distal ends. The ulna, as in *Hyænodon*, is much less reduced, in comparison with the size of the radius, than that of the Carnassidents; it has a long, slightly incurved, and proximally grooved olecranon, a deep sigmoid cavity, and a moderately well-developed styloid process. The head of the radius is cup-shaped, subcircular, and capable of extensive pronation and supination, much more so, in fact, than that of *Hyænodon*, in which the ulnar contact is much flattened. The distal end is considerably expanded, of a trihedral form, and has a deeply impressed articular surface.

With the exception of the magnum, trapezoid, and centrale of the carpus, one phalanx, and a few inconsiderable fragments, the manus, figure 89, is complete. As compared with that of a specimen of *Hyænodon crucians* in the Marsh collection, the carpus agrees very closely in all the more important characters. The chief osteological features of the foot may be briefly stated as follows: The scaphoid, lunar, and centrale are free;\* the lunar, upon its distal ulnar side, shows a considerable articular surface for the unciform, upon which it partially rests; internal to this is a larger facet by which it articulated with the head of the magnum; the pisiform, cuneiform, and unciform exhibit the usual form and relationship of the more generalized carnivorous type; the trapezium is large

\* The superior articular surface of the scaphoid is not well represented in the accompanying drawing; it should be made to extend much further forward.

and supports a somewhat divergent pollex, which, however, is in no degree opposable; there are five metapodials arranged in the usual manner; they have but moderately developed interlocking articulations, and the toes are spreading; the third

89

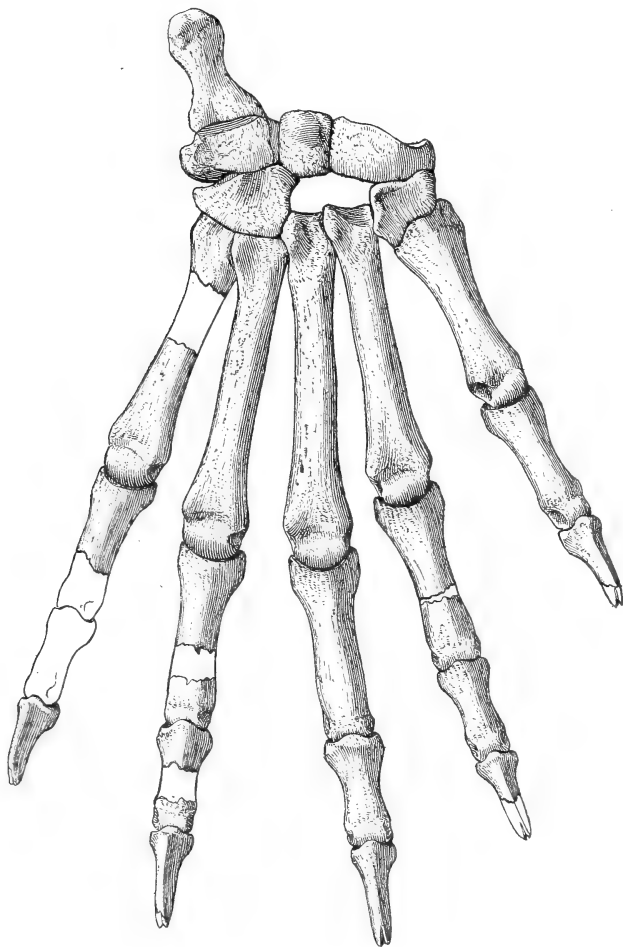

FIGURE 89.—Right fore foot of *Sinopa agilis* Marsh: three halves natural size. (Type.) The superior articular surface of the scaphoid is not well shown. As drawn, it appears to have great vertical depth in front, which is not the case.

metacarpal is the longest, and the second and fourth are about equal; the first is the stoutest and the fifth the smallest of the series; the phalanges are elongate and slender, and the bony

claws are compressed and pointed, figure 90, but at the same time slightly fissured at their extremities.



FIGURE 90.—Terminal phalanx of forefoot of *Sinopa agilis* Marsh; three halves natural size. (Type.)

Although the magnum, trapezoid, and centrale are missing, the distal articular facets of the lunar render it certain that the position of the centrale was entirely under the scaphoid, as in *Hyænodon*. In this connection, I wish to call attention to a specimen of *Hyænodon* in the present collection, which agrees very closely with *H. crucians* of Leidy. A portion of the carpus is preserved, and it is of much interest to note that the scaphoid, lunar, and centrale, figure 91, are coössified, with the remains of the sutures still visible. This carpus differs from the one figured by Scott,\* in that the lunar has a



FIGURE 91.—Coössified scaphoid, lunar, and centrale, of *Hyænodon crucians* Leidy; natural size. a, top view; b, front view; c, inner view.

large contact with the unciform, and the centrale lies wholly upon the radial side of the lunar, under the scaphoid.

Of the pelvic girdle, the ilium is considerably expanded, and has a strong downward and outward curvature, as in *Hyænodon*; the peduncle is short and the tubercle for the *rectus* is large and rugose. The ischium is elongate and slightly expanded at its distal end. The pubis is not preserved.

The femur has a strong resemblance to that of *Hyænodon*; the hemispherical head is supported by a moderately short, stout neck; the *fovea* is distinct, the digital fossa deep, and the major trochanter rises almost to a level with the head; the trochanter minor is large, and the third trochanter is distinct and placed at a considerable distance down the shaft. The distal end of the bone exhibits the characteristic thickening of the lower end of the shaft, just before joining the condyles, as well as the general clumsy appearance seen in *Hyænodon*. The patella is relatively small, elongate, and narrow. The tibia, figures 92–93, is also markedly *Hyænodont* in character. The cnemial crest extends more than half-way down the shaft; the internal malleolus is large, and the trochlea is little grooved. The fibula is not so much reduced as it is in *Hyænodon*, but, as in that genus, there is a large contact with the calcaneum. The calcaneum, figure 94, has a moderately elongated tuber, and very convex astragalar and concave sustentacular facets.

\* Jour. Acad. Nat. Sci., Phila., 1886.



The astragalus, figure 95, has a rather obliquely placed, vertically flattened, rounded head, a slightly grooved trochlea, and a vertical fibular facet. The astragalus foramen is distinct and

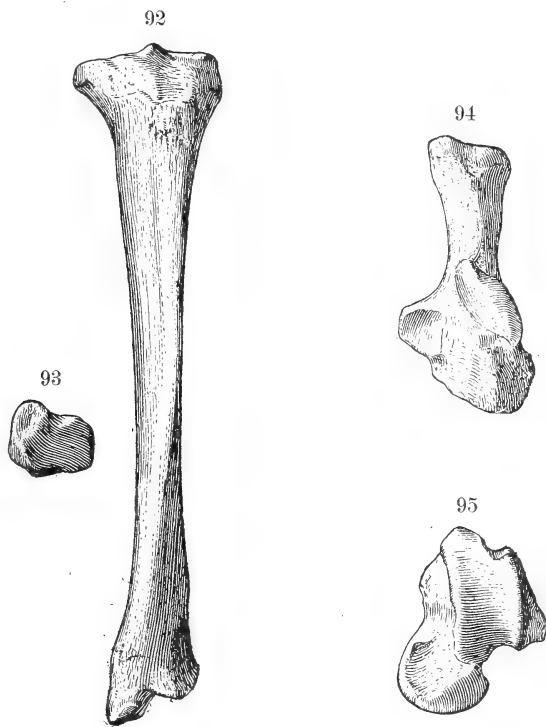

FIGURES 92, 93.—Left tibia of *Sinopa agilis* Marsh; front and end views; three-fourths natural size. (Cotype.)

FIGURE 94.—Left calcaneum of *Sinopa agilis* Marsh; dorsal view; one and one-eighth natural size. (Type.)

FIGURE 95.—Left astragalus of *Sinopa agilis* Marsh; dorsal view; one and one-eighth natural size. (Type.)

occupies its usual position. The remainder of the pes is unknown.

The principal measurements are given herewith :

*Measurements of the Type.*

Length of superior molar and premolar series, including canine .....	68·mm
Length of superior molar and fourth premolar .....	29·
Antero-posterior diameter of fourth superior premolar .....	9·
Antero-posterior diameter of first molar .....	9·
Antero-posterior diameter of second molar .....	8·

Antero-posterior diameter of third molar.....	3 <sup>.mm</sup>
Transverse diameter of fourth premolar.....	5.5
Transverse diameter of first molar.....	7.
Transverse diameter of second molar.....	9.
Transverse diameter of third molar.....	8.
Length of inferior molar and premolar series, from posterior base of canine.....	66.
Length of inferior molars.....	24.
Antero-posterior diameter of first molar crown.....	7.5
Antero-posterior diameter of second molar (not type)...	9.
Antero-posterior diameter of third molar (not type)...	8.5
Length of manus.....	74.
Length of humerus.....	113.5
Length of third metacarpal.....	32.
Length of first phalanx, third digit.....	16.
Length of second phalanx, third digit.....	10.
Length of claw, third digit.....	9.
Length of sacrum.....	49.
Transverse diameter of sacrum.....	27.
Length of pelvis (estimated).....	128.

*Measurements of the Church Buttes Specimen.*

Total length of cranium.....	149 <sup>.mm</sup>
Length from incisive border to termination of palate ..	81.
Length from posterior border of palate to condyles ..	68.
Width of condyles.....	23.
Width of palate at and including second molars.....	40.5
Width of palate between canines.....	12.
Length from anterior border of orbit to condyle.....	94.
Length from anterior border of orbit to incisive border	58.5
Height of axis.....	27.
Length of humerus.....	115.5
Length of tibia.....	118.5

The type specimen was discovered by Professor Marsh, at Grizzly Buttes, and the cotype by R. Son, at Church Buttes, Bridger Basin, Wyoming.

[To be continued.]

ART. XXXVII.—*The Transmission of Sound through Solid Walls*; by F. L. TUFTS, PH.D.

IN a previous article\* the author gave the results of some experiments on the transmission of sound through materials pervious to air, and it was shown that such materials behave in the same way with respect to sound transmission and to the flow of air currents through them. In the present paper experiments are described which were undertaken for the purpose of studying the transmission of sound through materials impervious to air.

On account of the increased noisiness of cities and the desirability of excluding these noises from offices and dwellings, a knowledge of the laws governing the transmission of sound through various materials is becoming daily of greater importance, and the present investigation was, in fact, suggested by certain difficulties which had been encountered in excluding noises from telephone booths. The experiments, described below, were undertaken for the purpose of ascertaining the essential qualities which a wall must possess in order to render it impervious to the sound waves transmitted to it from the air.

Consider, for example, a sound wave traveling in air, and suppose it to impinge upon a solid wall; there are three conceivable ways in which the sound may be propagated through the wall to the air on the other side:

First, if the wall is pervious to air, the sound may be transmitted through the air in the pores of the material. The laws governing this kind of transmission were investigated in the previous paper.

Second, if the material is impervious to air, the sound may be transmitted as an elastic wave in the material of the wall; or,

Third, the pressure of the sound wave against the wall may produce a slight displacement of it, and the sound may thus be transmitted as a vibration of the wall itself.

The apparatus used in studying the transmission of sound from the air on one side of an impervious wall, to the air on the opposite side, is shown in cross section in Fig. 1. A and B are two three-inch "gas unions," each fitted at one end with a "bushing" which reduces the opening to one inch. In these bushings, respectively, are screwed pieces of one inch gas pipe, *a* and *b*, about one foot in length. Rubber tubes, *c* and *d*, are passed through these pipes and are cemented in at their ends with beeswax. The rubber tubes are connected to

\* This Journal, vol. xi, May, 1901, page 357.

a T-tube at *g*. One arm of the T-tube is provided with an ear piece, *h*, which can be inserted in the ear of the observer. The iron pipes, *a* and *b*, were inserted in openings in an eight-inch brick wall, and the observer could thus be placed in a

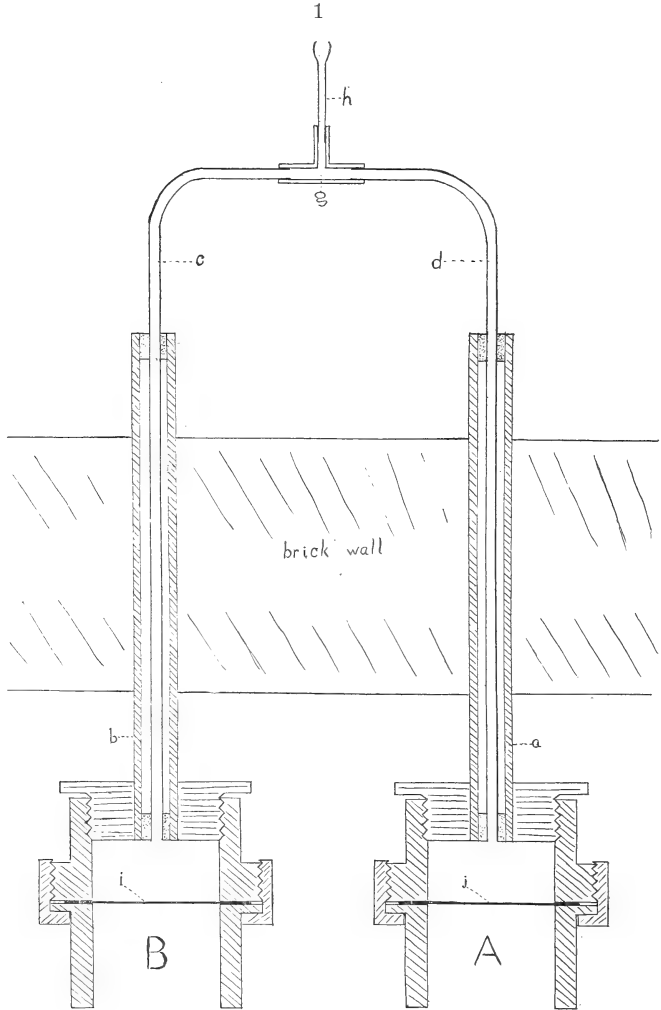

room adjoining the one in which the sound was produced. The materials, the transmission of sound through which was to be investigated, were cut into discs about  $10.5\text{cm}$  in diameter, and clamped in the unions at *i* and *j*, respectively. The application of a little cement rendered the junction air tight.

Various sources of sound were used in these experiments,

but that which proved the most satisfactory was obtained by dropping a metal ball upon a pine board, the height through which the ball dropped being adjusted until the sound was sufficiently intense to be heard through the discs under investigation. An observer in the adjoining room, with the ear-piece, *h*, in his ear, could, by alternately closing and opening the rubber tubes, *c* and *d*, easily ascertain which of the two discs transmitted the loudest sound.

The rigidities of the discs were measured in the following way; an upright index was cemented to the disc under investigation, and a microscope, provided with a micrometer ocular, was focused on a mark on the index. The disc was then subjected to a pressure of air through the tube, *c* or *d*, and the displacement of the index read off in the microscope. The excess of pressure of the air on the inner surface of the disc over the atmospheric pressure was measured by a suitable manometer. From the data thus obtained the displacement of the center of the disc, for a pressure of one gram per square centimeter of surface, was calculated. The value of this displacement is of course a measure of the rigidity of the disc. The following are some of the results obtained with the apparatus just described.

I. A lead disc  $10.5^{\text{cm}}$  in diameter and  $.012^{\text{cm}}$  thick, and a glass disc of the same dimensions, were clamped in the two unions respectively, and the intensities of the sounds transmitted through the two discs compared. It was found that the lead disc transmitted sound better than the glass one. The displacement of the center of the lead disc, for a pressure of one gram per square centimeter of surface, was  $.000106^{\text{cm}}$  and of the glass disc  $.000053^{\text{cm}}$ .

II. A disc of white pine  $.65^{\text{cm}}$  thick was compared with a disc of leather of the same thickness. Both discs had been treated with paraffine to render them impervious to air. The displacement of the center of the pine disc was  $.000013^{\text{cm}}$  and of the leather disc  $.000212^{\text{cm}}$  for a pressure of one gram per square centimeter of surface. It was found that the leather disc transmitted sound very much better than the pine disc.

In both of the above cases the more rigid disc was found to be the poorer conductor of sound, although, in both cases it was composed of a material much better suited to the transmission of an elastic wave than the less rigid disc.

III. A brass disc  $.015^{\text{cm}}$  thick was braced by soldering to it a few cross strips of brass. This disc was compared with one formed of two thicknesses of cardboard treated with paraffine. The total thickness of the cardboard disc was  $.44^{\text{cm}}$ . The displacements of the two discs for a pressure of one gram per square centimeter of surface were found to be the same,

viz:  $\cdot 00008^{\text{cm}}$ . It was also found that they transmitted sound equally well, although the cardboard disc was nearly thirty times as thick as the brass disc.

IV. A disc was built up of ten sheets of cardboard treated with paraffine. The total thickness was  $\cdot 70^{\text{cm}}$  and the displacement of the center for a pressure of one gram per square centimeter of surface was  $\cdot 0002^{\text{cm}}$ . This disc was compared with a single disc of cardboard  $\cdot 22^{\text{cm}}$  thick and which gave about the same displacement. It was found that the two discs transmitted sound equally well, although one consisted of many layers while the other was of a single homogeneous material.

V. The braced brass disc used in experiment III, above, was compared with a disc cut from the same piece of brass, and which had a small mass of brass soldered to its center. The total mass of the two discs was thus made the same. The displacement of the center of the loaded brass disc, for a pressure of one gram per square centimeter of surface, was  $\cdot 0022^{\text{cm}}$  while that of the braced disc was  $\cdot 00008^{\text{cm}}$ . The loaded disc transmitted sound very much better than the braced disc. Even the noises from the street which entered the room could be easily heard through the loaded disc, while nothing of this kind could be heard through the braced disc.

An examination of the above cases, I to IV inclusive, makes it evident that the amount of sound transmitted through the discs as an elastic wave in the material, must be negligibly small as compared to that transmitted as a to and fro vibration of the disc itself; were this not so, then in case IV, where the two discs possess the same rigidity, one would expect the sound heard through the single homogeneous disc to be louder than that heard through the built-up disc with its many reflecting surfaces. In other experiments, where comparatively rigid discs of materials well suited to the transmission of elastic waves, were compared with less rigid discs composed of materials not so well suited to the transmission of such waves, it was found in every case that the less rigid disc transmitted sound better than the more rigid one in spite of its unfavorable composition. The experiments, therefore, show that when sound is transmitted from the air on one side of the disc, through the disc, to the air on the opposite side, the transmission takes place almost entirely as a to and fro vibration of the disc.

The experiment described under V shows that the effect of mass in a wall is of minor importance as compared to rigidity. The lead disc, in I, had nearly six times the mass of the glass disc, but even this great increase in mass was more than compensated for by the fact that the lead disc gave a displace-

ment twice as great as the displacement of the glass disc for the same pressure.

In order to investigate the effect of the mass of a wall on its conductivity for sound, two cardboard discs of the same dimensions were used. Both were treated with paraffine, and when clamped in the unions, both gave displacements of  $\cdot 0004^{\text{cm}}$  for a pressure of one gram per square centimeter of surface. The intensity of the sound heard through the two discs was, as far as could be judged, the same. The discs were  $\cdot 22^{\text{cm}}$  thick, and each weighed 17 grams. To the center of one of the discs was now cemented a mass of lead weighing 34 grams, and it was found that this cut down the intensity of the sound transmitted through the disc by a very appreciable amount. The effect due to the addition of a mass of five grams could be readily detected if the mass was cemented to the disc at its center, but not when the mass was cemented about half way between the center and circumference. This experiment shows that, other things being equal, the wall possessing the greatest mass will be the poorest conductor for sound. When the mass is uniformly distributed through the disc, however, a very slight increase in rigidity will more than compensate for a very considerable decrease in mass. For example, a lead disc, weighing 145 grams, was compared with a disc of red cedar, weighing only 17 grams, the lead disc gave a displacement of  $\cdot 00008^{\text{cm}}$  and the red cedar disc a displacement of  $\cdot 00005^{\text{cm}}$  for a pressure of one gram per square centimeter. It was found that the lead disc transmitted very perceptibly better than the red cedar disc, although it contained over nine times the mass.

It is a common practice in the construction of telephone booths to make them of two, and sometimes of four walls, separated by air spaces, and there seems to be an opinion that such a form of construction is better adapted for the exclusion of sound than one in which the same amount of material is put into a single wall. In order to test the relative merits of the two types of construction, six discs were cut out of cardboard and treated with paraffine in order to render them impervious to air. In one of the unions three of the discs were placed, and separated by cardboard washers, so that an air space of two millimeters was left between the discs. In the other union three discs were clamped in contact. It was found that the discs separated by air spaces transmitted sound better than the discs which were placed in contact. The same experiment was repeated using brass discs and with a similar result. The increased rigidity obtained by placing the discs in contact more than balanced any advantage there might be in having the intervening air spaces.

In all of the experiments above described the source of sound, as has been stated, was a single pulse obtained by dropping a metal ball on a pine board. Some of the experiments were repeated using an organ pipe as the source of sound. In this case it was found that the results might be much influenced by the pitch of the note used. If the natural period of vibration of a disc was in unison with the source of sound, while that of another less rigid disc was not, the transmission might be greater through the more rigid disc.

In conclusion, it may be stated that the experiments described above are representative of many others of a similar character. In every case the rigidity of the disc was found to be the main factor in determining the intensity of the sound transmitted from the air on one side of the disc to the air on the opposite side. The only other factor which seemed to have an appreciable influence on the transmission of sound through the disc was its mass. It was found that of two discs having the same rigidity the one possessing the greatest mass was the poorest conductor of sound. The effect of increasing the mass of a disc is, however, many times smaller than the effect of increasing its rigidity.

The above experiments show that the commonly accepted analogy between the transmission of sound and that of light does not hold where the sound is transmitted from the air on one side of a solid medium, through the medium, to the air on the other side. In such cases it has been found that an entirely different principle is involved, and that the transmission takes place as a to and fro vibration of the wall itself, and not as an elastic wave traveling through it.

Physical Laboratory of Columbia University,  
New York City.



ART. XXXVIII.—*A new Gauge for the Measurement of Small Pressures*; by EDWARD W. MORLEY and CHARLES F. BRUSH.

IN 1888 and again in 1889, one of us constructed two gauges of a new form, intended for the direct measurement of small pressures. About three years ago, a third instrument of the same kind was used by us for the measurement of the pressure of the vapor of water; the time required for a measurement was rather long, and we accordingly constructed two more instruments of a somewhat different form, in which

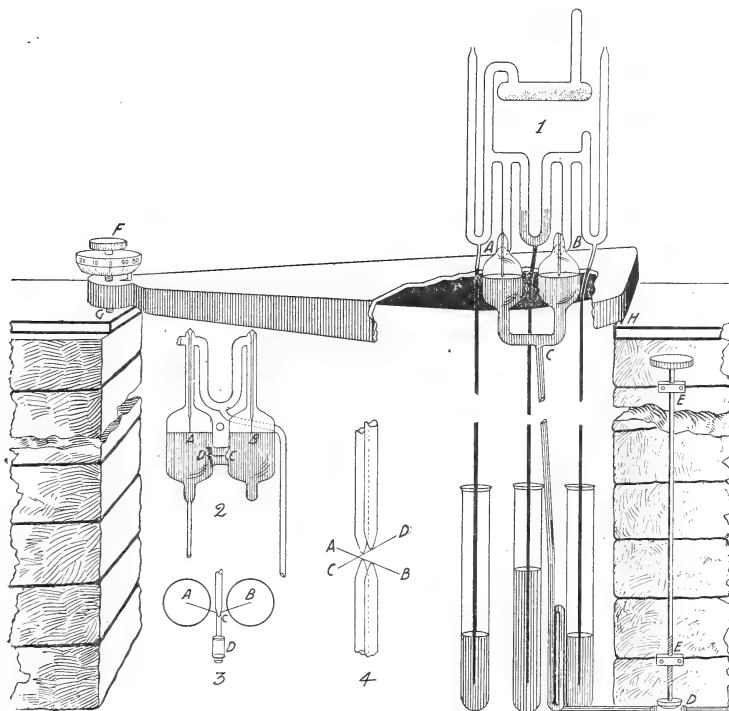

the time needed for a reading is no more than that required by a filar micrometer. We shall now describe both forms; not only the somewhat costly apparatus which economizes time when many measurements are to be made, but also the simple and less expensive form which may well serve where but few measurements are required.

In figure 1, *ab* is a siphon gauge, consisting of tubes about five centimeters in diameter, connected below by a smaller

tube. Within these tubes are fixed two platinum points, on the same level. The points must be rather accurately shaped. To this U-shaped gauge is connected the tube *c*, and a thick-walled rubber tube *d*, which can be compressed by the screw *e e*; *d* is continued by a glass tube used to adjust the level of the mercury in *a b* when the apparatus is set up, and then closed by fusion. By means of the screw and the rubber tube, the level of the mercury in *a b* can be adjusted with any needed degree of accuracy.

This gauge is firmly cemented into a metal girder or beam. This beam rests on two points at *m*, and on the point of a micrometer screw at *n*.

The instrument has to be mounted on a stable support. Ours is placed on a brick pier having a recess for the tube *c*. On the tops of the two projecting parts are cemented two glass plates; on one of them rest the two points *m* and on the other the point of the micrometer screw *k*. Guard rings keep the points in the assigned position.

The method of using the apparatus is simple. We must first determine the reading of the micrometer when the pressure in *a* and *b* has been made the same by putting them in free communication by the mercurial valve shown. We turn *k* till the depressions made by the two points in *a* and *b* seem equal. Then we lessen the compression of *d* and so lower the level of the mercury in *a b* till one of the depressions is barely perceptible. These two steps are repeated; we equalize and then reduce the depressions till they are equal when made the *minimum visibile*. The reading of *k* is then the reading for equality of pressure in *a* and *b*.

The method of comparing the depressions requires no optical assistance. The observer places himself so as to see the image of a horizontal window-bar reflected by the two mercury surfaces. Moving his eye so as to cause the image to pass across the depressions, their dimensions are easily compared. As they are made smaller by lowering the level of the mercury, the error of comparison becomes smaller. When they are barely visible, this error may easily be made less than 0.00002 cm.; after some practice, of course.

When we wish to measure the difference of pressures in *a* and *b*, we make a new reading in the same way. The difference between the readings, taken with the length *m n*, and the value of a turn of the screw, will define the inclination which has been given to the apparatus in order to make the two points again tangent to the two surfaces of mercury. The linear distance between the points is determined when the apparatus is constructed; in our instrument, this was done by measuring with a cathetometer while the tubes *a b* were

still open at the bottom. Knowing the inclination and the distance  $a b$ , we know the difference of level between the two points, and therefore the difference of pressures. One arm of the gauge  $a b$  is permanently connected with a McLeod gauge and a mercurial pump, and care is taken that this side shall be filled with a gas for which the McLeod gauge may be trusted.

With this apparatus, a measurement can scarcely be made in less than three minutes; even after much practice. We have accordingly constructed two instruments in which we still utilize the principle of measuring the tilting of the apparatus needed to bring mercury levels to the fiducial points, but in which Mr. B. has applied a very different method of reading. At  $a b$ , figure 2, are the two arms of the gauge, seen in horizontal section through the fiducial points. At  $c$  is a pair of mirrors so placed that, in a microscope at  $d$ , the two points  $a b$  are seen side by side. These two mirrors are wrought on the end of a glass rod some six millimeters in diameter. They are mounted on a spherical base, so that they can be rotated in any desired way about a point in their intersection. They can also be moved in the direction  $c d$ .

The two arms of the gauge, the mirrors, and the microscope, are all rigidly fixed to a support whose inclination is determined by a micrometer screw. Since the points, mirrors, and microscope are all moved together, vision of the points always takes place under precisely the same conditions.

The amount of mercury in the gauge is capable of adjustment, somewhat as in the first form, but the adjustment does not require to be so delicate.

When, with suitable illumination, we look in the microscope, we can not see the surface of the mercury, but we see two images of each point. One image of each point is seen directly, and one image is seen by reflection from the surface of mercury. It is important that the ends of the points shall be small hemispheres. Suitable adjustment causes the four images to appear as in figure 4. When a difference of pressure is to be read, the micrometer screw tilts the whole apparatus, and the two tangent lines  $a b$  and  $c d$  are quickly made parallel, when the reading is taken. Ten seconds may well suffice, especially if the eye is assisted by an eyepiece micrometer with parallel lines. It will of course be noticed that the reflection from the surface doubles the distance to be measured.

In the instruments which we have used, which were intended only for the measurement of small pressures, we made our U-tube less than an inch long. To do this with tubes six centimeters in diameter required us to connect the two vertical arms by a horizontal cross-piece, so that our apparatus looks more like the letter H than U. To secure

uniformity of temperature, we made this connecting tube two centimeters in diameter. With such freedom of communication, anywhere in a city, there is a continual slight oscillation of the mercury between the two arms of the gauge. Accordingly, in the second apparatus constructed, we damped the oscillation by putting a thin metallic diaphragm in the connecting tube. This may consist of a platinum cone tied in place with a wire and a wedge of glass, as suggested by figure 3.

An important matter in the construction of such a gauge needs mention. It is but through a small part of the surface of a glass tube that good definition of the points can be had with the microscope. One must select a number of such places in his stock of glass tubes, and mark the best of such favorable places. In the completed apparatus, the selected areas are brought to the predetermined position.

The mounting of the apparatus has to be about as stable as that of an astronomical instrument. It must be so designed that distortion shall not be caused by changes of temperature. In our gauges, a massive cast-iron standard rests on a isolated stone pier. On this, moving in trunnions like those of a transit instrument, is carried the plate to which gauge, mirrors, and microscope are fixed. With such stability, and with many precautions, we have been able to measure small pressures with a mean error not much greater than the ten-thousandth part of a millimeter.

It may be noted that in the first form of gauge it is best to use points of platinum, for glass points can not well be given the form permitting most convenient manipulation, that of a right cone of small angle. The adhesion of mercury and glass also causes much loss of time. In the second form, where the points must end in minute hemispheres, and where actual contact of mercury and the point is not required, glass points can be used, but the ease with which platinum points can be given a proper outline in the lathe speaks in their favor.

NOTE—Since this paper was written, we have learned that Lord Rayleigh has used with success a gauge much resembling the first form used by us; he determined the inclination given the gauge in making the points tangent to the mercury, by observing with a reading telescope the inclination given to a mirror carried with the gauge.

Adelbert College, Cleveland, Ohio.

ART. XXXIX.—*On a Hitherto Untried Form of Mounting, either Equatorial or Altazimuth, for a Telescope of exceptional size, either refractor or reflector, in which Telescope, observing-floor and dome are combined in one*; by DAVID P. TODD, Director Amherst College Observatory.

NEARLY all the great telescopes of the world have in turn signalized their extraordinary power by an important astronomical discovery. Sir William Herschel's reflector first brought to light the planet Uranus; Lord Rosse's Leviathan, the spiral nebulae; the 15-inch Cambridge telescope, Saturn's dusky ring; the 18-inch Chicago refractor, the companion of Sirius; the Washington 26-inch, the satellites of Mars; the 30-inch Pulkowa objective, the nebulosities of the Pleiades; and the 36-inch Lick telescope revealed a new satellite of Jupiter.

With such a record is it not safe to predict farther advance with larger telescopes still? There is as yet no indication that a refracting telescope of five or even six feet aperture would fall short of a gratifying success to its projector. Two American opticians, of wide experience and high competency, can be relied upon to grind and figure such an object glass. To be most effective, it must be as thin as possible—which means that its focal length must be very great. Therefore the question of a suitable mounting becomes all important.

The difficulties inherent to the conventional type of mounting practically prohibit any great increase of size, because the tube is hung at or near the middle. This is in many respects the least advantageous point. The tube should be rigidly supported at or near both ends, as well as in the middle. If, then, we invoke the fertile resources of the modern bridge engineer, and his relatively light but rigid constructions of steel, the fixedness of axis in all positions of the great telescope becomes a requisite easily met.

The object of this paper is to outline one method of applying modern engineering resources to the mounting of a telescope of exceptional proportions.

A sphere 100 feet in diameter can readily be designed and built, with an interior, meridional rib-structure so rigid that flexure deformation will not exceed a small fraction of an inch. We coat this sphere, first with steel plates, then with oak planks about three inches thick. These not only allow the exact spherical figure to be trued up, but also, like the wooden sheathing sometimes employed on men-of-war, permit attachment of an outer coating of copper,—or better still, of Tobin bronze.

We float this sphere, in such manner as to admit the utmost ease of motion in any required direction. Masonry of brick or stone is built, about 25 feet in depth, and perhaps 100 to 120 feet square. This is constructed in the shape of a zonal basin with Portland cement, and its interior is smoothed up to exact figure, by erecting a platform above the center of the basin, and swinging from it a convex trowel attached to a radial arm.

The sphere is of course assembled and erected piecemeal *in situ*. A small amount of wood-preserving liquid is added to the basin, as the sphere is built up; and this suffices to keep it always just floated, thus making it very easy to turn into any desired position for attaching one part after another. When the steel coating of the sphere is finished, the wooden jacket is next put on, the structure all the while floating in preservative, till this exterior of oak is complete and trued up to figure. Then the bright metal sheathing begins. When finished, the preservative is withdrawn, and water substituted therefor. Only a few barrels of water poured into the basin will be required to float the sphere and all its subsequent appurtenances. The water is made part of a circulatory system, and warmed in winter to prevent freezing.

If we are content with a telescope a little short of 100 feet in focal length, the object glass may be set in the surface of the sphere. On its opposite side, the eyepieces, spectroscopes, photographic cameras, and other accessories are capable of permanent and rigid attachment to its internal rib-work.

The observer is there, too; but free to move about on a swinging platform, a good model of which is furnished by the glass crystal of an ordinary ship's chronometer. The platform maintains itself always horizontal, no matter in what direction the axis of the telescope is pointed.

But a sphere of 100 feet diameter very readily admits the possibility of a telescope approaching 200 feet in length, if we attach a tube 100 feet long to the exterior of the sphere. This method of mounting the objective is illustrated schematically in the engraving (fig. 1).

At intervals of perhaps 30 feet, girdling rings are attached to this exterior tube, and to these are fastened guy-rods which anchor in the outside of the sphere, thereby holding the outer end of the tube rigidly in position, even if the weight of the objective in its cell should be as much as a ton.\*

\*The author is not unaware of certain objections to the design proposed, and others may be suggested. The effect of temperature inequality is one. An obvious objection arises from the vibration which it is natural to suppose a variable wind pressure would induce. But the open-air telescopes of Sir William Herschel, Lord Rosse, and Lassell were subject to this difficulty also. Experiment with a model of perhaps one-quarter or one-third the full size seems to the author the best method of testing the validity of these objections.

Tube, objective, and guy-ropes are all counterpoised by means of permanent weights on the interior of the sphere, adjacent to the self-adjusting observer's platform (not shown). An objective weighing a ton is counterpoised by a mass of three tons. The mirror for a great reflecting telescope might form the counterpoise.

When not in use the sphere is revolved until the exterior tube comes down to a nearly horizontal position, and the objective is weather-proofed underneath a removable roof (not shown), something like that of a transit-room. The objective is then accessible in all weathers, for adjustment or other requisite service. With the tube in this position, the observer and his assistant enter the sphere through a door in the tube close to its juncture with the sphere itself. They walk along an internal *trottoir*, till they reach the adjustable platform. This is maintained always charged with its maximum load; if additional observers go in, their equivalent weight is removed from the platform, and deposited outside the sphere before observations begin. In this way, the sphere

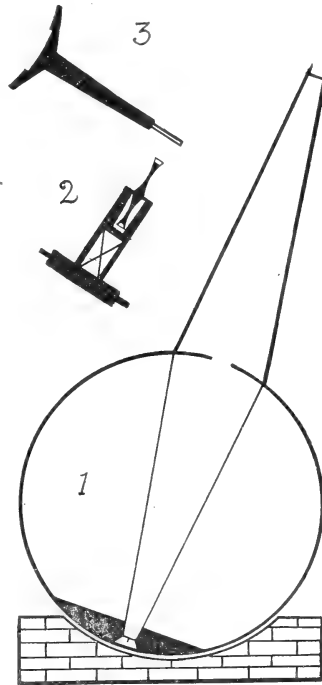

is kept submerged to a constant depth—a requisite, the design of which will be apparent farther on. From this platform and out through the opening extends an electrical cable, with perhaps twenty independent circuits, each of which controls an exterior automatic apparatus, whose action very readily gives to the sphere any rapid motion that may be desired, as follows:

- (1) In altitude.
- (2) In azimuth.
- (3) In declination.
- (4) In right ascension.

These motions suffice for any necessary pointing of the telescope. I need not here go into the details of these automatic mechanisms further than to say, that the specified motions may be obtained by means of rubber-faced wheels, strongly mounted in swinging forks or levers (fig. 2), and

engaging the outer surface of the sphere. Three wheels for each coördinate, mounted in proper planes, all press against the outside of the sphere simultaneously, and electric motors then turn them at the speed required. The sphere can, of course, be revolved in but one coördinate at a time; and the cable connection enables the observer inside the platform to throw into gear any treble set of wheels he may desire.

Above the platform, or alongside it, are the automatic setting devices, one for the horizon system, and another for the equinoctial system of coördinates. At the zenith of each of these is an index, which shows, as a vernier on graduated circles, the pointing of the tube. These setting-systems are gimbal-mounted and pendulum-controlled, the antique armillary sphere furnishing the basis of their design.

A peculiar sort of finder is essential—with a duplex coudé tube, so that its eyepiece can be brought close to the eyepiece of the great tube.

Slight differences of poise in the sphere and its appurtenances are compensated through the instrumentality of radial rods, upon which travel masses of a few hundred weight, by means of rack-and-pinion motors. Thus the sphere's center of gravity is easily adjusted to exact coincidence with its center of figure.

Probably the moving sphere and all its accessories will weigh not far from 2000 tons, and it must be as susceptible of delicate adjustment and subsequent following-motion as is a telescope of the usual German or English type of mounting. Quite obviously such a great telescope will require clockwork of exceptional power.

Two or three methods of clock-motion are feasible: I will outline but one. A huge polar axis (fig. 3) is built into the exterior masonry due south of the sphere, and its upper end terminates in four arms, each of which carries a large shallow cup, of the exact spherical concave. These cups are faced on the inside with rubber belting; and when the chuck is in action—(telescope clamped in right ascension)—they push with a few hundred pounds stress against the sphere. Two rubber-faced wheels, on the northwest and northeast sides of the sphere, oppose the poleward thrust of the chuck. They are of course mounted parallel to the equatorial plane. We depend upon the polar axis and opposing wheels to preserve the axis of rotation of the sphere invariable. This axis passes in a constant direction through the center of figure of the sphere. We apply the clock power, not to the polar axis itself, but to an opposing pair of rubber-faced wheels, whose planes are coincident with the sphere's equator. There is thus the distinct advantage of a driving wheel 100 feet in diameter.



An electric motor, or gas engine electrically controlled, will be found well adapted to this delicate service; but in order that the movement may be perfectly steady, care must be taken to provide a considerable excess of the power actually necessary to set the sphere in motion.

I have given much attention to the question of slow motions. Several different schemes are possible, and all admit of automatic control and action through the multiplex cable. Should it be desired to maintain the utmost delicacy of adjustment in the field, for spectroscopic or micrometric work or long-exposure photography, it may be found best to provide a sliding collimator-plate, to which the tail-piece is rigidly attached. Corresponding and appropriate collimation of the objective would not offer any serious mechanical difficulties.

No one familiar with observatory construction will fail to notice that this projected type of instrument combines telescope, observing-chair and dome all in one. I have made an attempt to estimate the cost of such an astronomical establishment, but the largest present element of uncertainty pertains to the sphere itself.

As the sphere will not need the ordinary running-gear, we cannot be far wrong in estimating double the cost of a hemispherical dome. This will make,

Approximately .....	\$175,000
Allow for a 5-foot objective .....	75,000
For the masonry and cement basin .....	5,000
For the clock-work and motions .....	10,000
For the tube and eyepiece accessories ....	10,000
	<hr/>
	\$275,000

I need hardly add that some of the unique advantages of M. Loewy's equatorial coudé are available with this type of mounting; for by sealing the internal tube, the sphere or a part of it can be kept at a comfortable temperature by electric heaters. And if such a telescope were installed on a high mountain, the barometric pressure of sea-level might be mechanically maintained within a compartment of the sphere, housing over the adjustable platform. By connecting with exterior rooms through closed passage-ways, this might readily be so contrived as to safeguard the observer against those serious effects of *mal des montagnes*, which hitherto have precluded the permanent astronomical occupation of mountain elevations much in excess of 8,000 feet.

Amherst, Mass.

ART. XL.—*On the Occurrence of Uranophane in Georgia;*  
by THOMAS L. WATSON.

[Published by permission of W. S. Yeates, State Geologist of Georgia.]

THE object of this paper is to describe the occurrence of the rare mineral uranophane from a new locality. State Geologist Yeates first observed the occurrence of the yellow mineral at Stone Mountain, Georgia, in the early nineties, and later had Mr. R. L. Packard examine the material chemically in the laboratory of the Georgia Survey. During 1898 and 1899, while engaged in a field study of the Georgia granites, the writer independently noted the occurrence of this mineral at the same locality, as a thin, yellow incrustation coating the faces of many of the joint planes cutting the Stone Mountain granite mass. Specimens were carefully collected and studied in the laboratory of the Survey in Atlanta.

So far as the writer can ascertain, uranophane is reported from only one locality in the United States, namely, Mitchell County, North Carolina.\* Here the mineral is found incrusting and penetrating gummite as an alteration product at the mica mines. Under the title "On Some New Mineral Occurrences in Canada," G. Chr. Hoffman† of the Canadian Geological Survey has recently described the occurrence of uranophane from Ottawa County, Quebec. According to Hoffman, the mineral in Quebec is associated with "gummite, uraninite, black tourmaline, white, light gray, pale olive-green and bluish green apatite, spessartite, monazite, and green and purple fluorite, in a coarse pegmatite vein composed of white and light to dark, smoky-brown quartz, microcline and muscovite, which traverses a gray garnetiferous gneiss." The mineral is further described as an alteration product of gummite, occurring "in small bright lemon-yellow fibrous masses, sometimes in immediate contact with the gummite found coating the uraninite or, *per se*, embedded in the albite immediately surrounding the tourmaline and often invading the latter." In both Quebec and North Carolina the mineral is an alteration product of gummite, and, in this particular, its occurrence is similar for the two localities, while in Georgia the occurrence is entirely different, as will be noted in the following description.

At Stone Mountain, Georgia, sixteen miles east of Atlanta, the mineral uranophane is found as a distinct incrustation, coating the faces of many of the joint planes, which cut the granite boss. It varies from a sulphur-yellow to lemon-yellow in

\* Dana, E. S., A System of Mineralogy, 1893, p. 699.

† This Journal, vol. xi, pp. 152-153, 1901.

color, the former predominating, and forms an irregular coating not exceeding one-eighth to one-sixteenth of an inch in thickness, usually less. It is tipped or coated with the clear, colorless, and transparent, drop-like forms of the mineral hyalite. The two minerals are so intimately associated that it is almost impossible to effect a complete separation of them.

The Stone Mountain granite, with which the uranophane is associated, is a light gray, medium-grained, biotite-bearing muscovite granite, composed of quartz, orthoclase, microcline and soda-lime (oligoclase) feldspar, muscovite and biotite, with sporadic microscopic accessories. Fresh specimens of the granite were analyzed by Packard in the Survey laboratory with the following results:

SiO <sub>2</sub> .....	72.56
Al <sub>2</sub> O <sub>3</sub> .....	14.81
FeO .....	0.84
CaO .....	1.19
MgO .....	0.20
Na <sub>2</sub> O .....	4.94
K <sub>2</sub> O .....	5.30
H <sub>2</sub> O (ignition) .....	0.70
Total .....	100.54

Several tests were made by the writer on separate portions of the granite for the presence of uranium, with negative results. The yellow powder gave the usual tests before the blowpipe for uranophane. Packard carefully separated, by means of a lens, a small amount of the yellow mineral from particles of the granite and other possible impurities for chemical analysis. 0.1310 gram of the powder was used, which gave:

SiO <sub>2</sub> .....	18.55
U(UO <sub>4</sub> ) <sub>2</sub> .....	47.18
(UO <sub>2</sub> ) <sub>2</sub> , Fe <sub>2</sub> O <sub>3</sub> , P <sub>2</sub> O <sub>5</sub> .....	4.95
Al <sub>2</sub> O <sub>3</sub> .....	6.33
CaO .....	6.64
MgO .....	1.98
H <sub>2</sub> O (ignition) .....	13.28
Total .....	98.91

As Packard remarks, the above result clearly indicates that the material was not entirely free from impurities. A second weighed portion was accordingly selected amounting to 0.5120 gram of the dull lemon- or sulphur-yellow mineral and treated with HNO<sub>3</sub>, which after digestion left a residue weighing 0.2460 gram, yielding 0.2660 gram for analysis. This gave:

$U(UO_4)_2$  61·28, corresponding to 60·14 per cent of  $UO_3$ ; CaO 6·01.

Accepting then the percentages of  $SiO_2$  and  $H_2O$  in the first analysis, and those of  $UO_3$  and CaO in the last, as representing the composition of the mineral; and disregarding the percentages of  $Fe_2O_3$ ,  $Al_2O_3$ ,  $MgO$  and  $P_2O_5$ , and recalculating the four essential oxides to a basis of 100, the ratios become:

	I.	II.	III.
CaO -----	6·01	6·14	·109 = 1
$UO_3$ -----	60·14	61·37	·213 = 1·95
$SiO_2$ -----	18·55	18·93	·315 = 2·88
$H_2O$ -----	13·28	13·56	·753 = 6·90
	97·98	100	

I. Analysis of uranophane from Stone Mountain, Georgia, from which the small percentages of  $Al_2O_3$ ,  $Fe_2O_3$ ,  $MgO$  and  $P_2O_5$  are omitted.

II. Analysis I recalculated to a basis of 100.

III. Molecular ratios of II.

The molecular proportions given under column III correspond to the formula  $CaO \cdot 2UO_3 \cdot 3SiO_2 + 7H_2O$ , which indicates one part more of  $SiO_2$  and  $H_2O$  than is required by the formula for uranophane,  $CaO \cdot 2UO_3 \cdot 2SiO_2 + 6H_2O$ . The discrepancy in these two constituents is easily accounted for, however. The  $SiO_2$  is increased by the presence of finely divided mineral particles from the granite and hyalite, it being quite impossible to effect a complete separation of the uranophane from these two. The amount of available material was so small that it was impossible to separately determine the combined and uncombined water, and under the total water given in the analysis, it is reasonable, at least, to assume that a small fraction of it is hygroscopic (uncombined) water. What now appears then as a slight variation from the exact formula for uranophane, disappears when the above facts are considered.

A comparison of the above analysis of the Georgia mineral with several by Genth and von Foullon of the uranophane from Mitchell County, North Carolina, and one from Kupferberg, Silesia, quoted by Dana,\* shows very close agreement. The reported occurrence of uranophane in granite at Kupferberg in Silesia appears in this particular to be similar to that in Georgia.

Geological Laboratory of Denison University,  
Granville, Ohio.

\* Op. cit.

ART. XLI. — *Internal Structure of Cliftonite*;\* by JOHN M. DAVISON.

GRAPHITE crystallized in the isometric system was first found by Haidinger in the Arva meteoric iron; afterwards by Fletcher in the Youndeggin and Cocke Co. irons and was named by him cliftonite. Huntington afterwards found it in the Smithville iron.

Fletcher thought these crystals were pseudomorphs after pyrite. Rose and Brezina hold that they have been altered from diamond to graphite.

In dissolving a troilite nodule from the Smithville iron the writer found a number of these crystals. Some were loose in the residue from the aqua-regia solution, and all of these were cubo-octahedral in form, the planes of each being equally developed. The crystals were from 0.13<sup>mm</sup> to 0.23<sup>mm</sup> in diameter. Other crystals of about the same size were attached to larger pieces of uncrystallized graphite, seemingly in form of a curving string of compressed cubes or plates. On two of these plates angles of 120° and 104° could be roughly measured. Other angles seemed to be 90°.

To see whether the cliftonite crystals occurred also in the kamacite and tænite a piece of the Smithville iron of about the size of the troilite nodule was dissolved. In the insoluble residue fragments of graphite and a single hexagonal plate of graphite were found but not one of the cliftonite crystals.

Four of the cubo-octahedrons were mounted in Canada balsam and carefully ground with a fine hone. The grinding was parallel to a face of the cube. On each, as the cube face enlarged, a square appeared lying within, its sides parallel to the planes of the octahedron and turned 45° from the edges of the cube. As the grinding went on this square enlarged to a maximum and then decreased, thus showing that the embedded form was not a cube but an octahedron which was being ground normal to a solid angle.

Measurements on two of the crystals gave these successive sizes of the squares :

Cliftonite crystal	0.23 <sup>mm</sup> × 0.24 <sup>mm</sup>	Cliftonite crystal	0.15 <sup>mm</sup>
inner square	0.04	inner square	0.07
“ “	0.08	“ “	0.06
“ “	0.10	“ “	0.05
“ “	0.06	“ “	0.04
“ “	0.03		

\* Read before the Rochester Academy of Science, April 14, 1902.

In the case of the smaller crystal the grinding had reached or passed the center of the internal octahedron before the first measurement was made. In neither case was the grinding pushed to disappearance of the internal form.

This internal structure confirms the view that cliftonite is not a pseudomorph after pyrite, for it would be impossible to reproduce the internal structure of pyrite under the conditions of the case. But it is not so clear that diamond has here been changed to graphite rather than that graphite has crystallized in a form differing from telluric graphite because of differing conditions.

Carbon crystallizing from molten iron under atmospheric pressure takes the graphite condition with hexagonal form. And, as Moissan has shown, it may, in some cases, under greater pressure take the diamond condition with isometric form. Why may it not under somewhat different circumstances take the graphite condition with isometric form having a hardness greater than hexagonal graphite, as Brezina found cliftonite to have?

The curving string of plates was likewise examined for internal structure, but none was found.

With the cliftonite crystals were a few transparent particles, some of which withstood fusion with sodium carbonate and four evaporations with hydrofluoric acid and presumably were diamond fragments.

Rochester, N. Y.

## SCIENTIFIC INTELLIGENCE.

## I. CHEMISTRY AND PHYSICS.

1. *The Heatless Condition of Matter.*—BRINKWORTH and MARTIN, with apparent seriousness, have made a curious extension of the kinetic theory. Assuming that heat is due to molecular motion, they suppose a solid to be placed in an infinitely strong and unyielding cylinder, made of a heat-conducting substance, and slowly compressed. As the compression proceeds the molecules are driven closer together, heat is evolved, but this is conducted away. Ultimately the molecules will be driven into absolute contact and will be so tightly pressed, the one against the other, as to be absolutely unable to move relatively to each other. Therefore, in this condition the molecules can possess no kinetic energy or relative motion of any description; but, according to the kinetic theory, the temperature of a body is measured by the kinetic energy of its molecules. Here we are dealing with a very remarkable case: we have a solid at the absolute zero of temperature in the midst of a medium of much higher temperature, and yet the solid (on account of the enormous pressure to which it is subjected) is unable to take up the surrounding temperature, but persists in its heatless state. If the pressure be released, the solid immediately regains the power of acquiring heat from neighboring bodies, and its temperature will rapidly rise from absolute zero until it reaches that of the surrounding material. It appears from the above to be a necessary consequence of the molecular theory that at a very great pressure matter must be reduced to a peculiar condition in which it will not obey the law of thermal equilibrium. Now the pressure at which this remarkable physical condition becomes manifest depends upon the nature of the material, and will alter with the temperature. As the temperature falls and the kinetic energy of the molecules becomes less, a smaller pressure will suffice to bring the molecules into contact. At ordinary temperature the pressures will be terrific—probably beyond our experimental power; but at very low temperatures a moderate pressure will probably suffice to bring about this condition. Pressure, however, is made up of two parts, external and internal, the latter being due to molecular attraction; therefore, even if the external pressure be zero, yet the molecules will be under a very considerable internal pressure, and the very interesting conclusion must be drawn that to this internal pressure alone there must correspond a definite temperature above absolute zero at which this new condition is induced in a substance. The usual assumption, therefore, that all substances can be cooled continuously and uniformly down to the absolute zero, is incorrect. At a minimum temperature depending upon the total pressure, the temperature of each substance will drop more or less abruptly and of its own

accord to absolute zero, no matter whether the surrounding objects be at absolute zero or not. The authors give a name, heat-point, to the temperature at which a substance will begin to vibrate its molecules under the influence of heat.

It should be added that the authors assume that rotary molecular motion would be stopped by pressure, and that they disregard intra-molecular vibration. Their deductions are based upon an entirely unproven assumption; but if it is a true one its bearing upon the condition of matter in the interior of the earth, for instance, is interesting.—*Chem. News*, lxxxv, 194. H. L. W.

2. *New Method for Assaying Pyrites*.—To determine gold and silver in ores consisting chiefly of iron pyrites, BUDDÉUS places 100 or 200<sup>g</sup>, according to its richness, of the finely pulverized substance in a covered, smooth clay crucible and heats to redness in a muffle for one-half to three-quarters of an hour, until all trace of the sulphur flame has disappeared. The mass, which is loosely aggregated, is transferred to a dish or beaker of about 1000<sup>cc</sup> capacity, any dust being removed by means of a camel-hair brush. It is then treated with 250 or 500<sup>cc</sup> of a mixture of equal volumes of strong hydrochloric acid (free from arsenic) and water, and, after standing for about an hour in a warm place, the same quantity of the acid mixture is added, and the whole is boiled for some time. Ferrous sulphide, which forms the greater part of the ignited substance, is thus dissolved, leaving the gold and silver in the residue. When the sulphide is completely decomposed the liquid is diluted with water until the vessel is nearly full, and filtered. The residue is washed two or three times with water, then dried, transferred with the filter-paper to a Hessian crucible of 150 or 300<sup>cc</sup> capacity, mixed by means of a spatula with 50 or 100<sup>g</sup> of assay lead and 5 or 10<sup>g</sup> of borax, and finally fused in a muffle. It is of advantage to use 100 or 200<sup>g</sup> of a mixture of equal parts of acetate of lead and caustic soda instead of assay lead. After cooling, the crucible is broken, and the lead is cuppelled. Gold and silver are then parted as usual. The method appears to be more accurate and less expensive than those usually employed.—*Chem. Zeitung*, xxiv, 922. H. L. W.

3. *Germanium Hydride*.—VOEGELEN has discovered the fact that when hydrogen is evolved by means of sodium amalgam or zinc and sulphuric acid from solutions containing germanium, the gas contains a small quantity of germanium hydride. The hydrogen burns with a bluish-red flame which deposits a bright mirror upon porcelain. Mirrors are formed also when the gases are led through hot glass tubes, as in the Marsh test for arsenic. These have a tin-white color, and show a red color in transmitted light and a green color in reflected light. When the gases are passed through silver nitrate solution, a compound of germanium and silver is precipitated. Attempts to condense the germanium hydride by cooling the hydrogen with solid carbon dioxide and ether were without success, hence the hydride was not obtained in a pure condition. From the analysis of the precipitate pro-



duced by silver nitrate, and by another indirect method, it was shown that the gas probably has the composition corresponding to the formula  $\text{GeH}_4$ , corresponding to Winkler's tetraethyl compound  $\text{Ge}(\text{C}_2\text{H}_5)_4$ .—*Zeitschr. anorg. Chem.*, xxx, 325. H. L. W.

4. *Compounds of Beryllium with Organic Acids.*—LACOMBE has prepared a series of basic beryllium salts with a number of fatty acids. The acetate has the formula  $(\text{C}_2\text{H}_3\text{O}_2)_2\text{Be}_2\text{O}$ , while the formate, propionate, the normal and isobutyrate and the isovalerate have analogous compositions represented by the formula  $\text{A}_2\text{Be}_2\text{O}$ . The remarkable property of these salts is their volatility. The best means of purifying them is by distillation under diminished pressure. The formate is insoluble in all solvents, while the higher members become soluble, and may be recrystallized readily. The author was unable to prepare the normal salts of beryllium with these acids, such as  $(\text{C}_2\text{H}_3\text{O}_2)_2\text{Be}$ , while with strong mineral acids no salts of a type corresponding to the organic salts could be made.—*Comptes Rendus*, cxxxiv, 772.

H. L. W.

5. *The Use of Floats in Burettes.*—An elaborate study of the use of burette-floats has been made by KREITLING. It was found that Erdmann's floats, as well as the so-called spherical floats, give irregular results in comparison with those obtained without the use of any float, and this was the case with different burettes and with floats of varying calibre. The causes of the variations could not be satisfactorily explained, but the conclusion was reached that it is not advisable to use any float whatever in a burette.—*Zeitschr. angew. Chem.*, xv, 4.

H. L. W.

6. *Beiträge zur Chemischen Physiologie und Pathologie*, herausgegeben von Fr. Hofmeister. II Band, 4 Heft. Braunschweig, 1902. (Fr. Vieweg und Sohn.)—In an experimental study of the action of salt solutions isotonic with the blood, HAAKE and SPIRO have ascertained that even small quantities of such solutions slowly introduced into the circulation call forth diuresis. Sodium chloride solutions are peculiar in producing less marked effects. E. FULD has contributed a long paper on the reaction of rennin with milk, with particular reference to the relation between clotting-time and the quantity of enzyme present. The theory of rennin action is also discussed. In a second paper Fuld presents analyses of compounds of metaphosphoric acid with various proteids. While some of these synthetic products are quite constant in composition, they differ distinctly from the natural phosphorus-containing proteids. NEUBERG and HEYMANN report an investigation of the nature of the carbohydrate groups in the so-called pseudo-mucin of ovarian cysts, in which they have demonstrated that chitosamin occurs.

L. B. M.

7. *Velocity of Light.*—The Decennial Publications of the University of Chicago, 1902, contain a suggestion by Professor MICHELSON of a new method for determining the velocity of light. The author reviews the previous results, contrasts the astronomical methods, the electrical and the optical methods, and proposes

a combination of the Foucault and the Fizeau methods. Instead of a revolving toothed wheel of Fizeau, he suggests the use of a stationary grating, and by a double reflection of light from stationary and revolving mirrors, and proposes to measure the eclipses the light suffers from the gratings. Figures accompany the original article which make the author's plan clear. He estimates that the velocity of light can be measured to a probable error of only 5 kilometers.

J. T.

8. *Ultra-Violet of the Mercury Spectrum.*—HANS LEHMANN and R. STRAUBEL give a table of wave lengths, extending from wave length 221.31 to 193.04. They used the Berolina-Kupferdruckplatten of Gebhard, and developed with glycin. The apparatus consisted of an Abbe spectrometer, with collimator, prism and camera. Quartz fluor spar lenses were employed. The prism was a Cornu right and left quartz. The source of light was a Geissler tube with mercury electrodes.—*Ann. der Physik*, No. 4, 1902, pp. 909-911.

J. T.

9. *A new Peculiarity in the Structure of the Cyanogen Bands.*—ARTHUR SCOTT KING gives a description of a band structure of the carbon arc spectrum, beginning at wave length 3465 and ending at 3274. Another band runs from 3203.84 to 3128.—*Ann. der Physik*, No. 4, 1902, pp. 791-800.

J. T.

10. *Stationary Electric Waves.*—The subject of wireless telegraphy lends great interest to investigations upon the reflection of Hertzian waves from mirrors. K. F. LINDMAN has studied the subject under the following heads:

- (1) The dimensions of the mirror were great in comparison with the wave lengths.
- (2) The indicator was a resonator with a thermo element.
- (3) The thermo resonator was rectilinear.
- (4) The thermo resonator was circular.
- (5) The indicator was a resonator with spark gap.
- (6) The dimensions of the mirror were of the order of the wave lengths. An important conclusion is, that the parabolic reflector of the oscillator should not be shorter than the wave length, in case the focal length of the mirror is a quarter wave length.—*Ann. der Physik*, No. 4, 1902, pp. 824-850.

J. T.

11. *Oscillatory Discharges.*—H. ANDRIESEN calls attention to the importance of oscillatory discharges in the use of condensers. Such discharges often occasion greater ones than the calculation of tension, capacity, and periodicity would indicate, and therefore break down insulation which would resist non-oscillatory discharges.—*Ann. der Physik*, No. 4, 1902, pp. 909-918.

J. T.

12. *Meteorologische Optik*, von J. M. PERNTER, Professor an der Universität in Wien und Director der Centralanstalt für Meteorologie und Erdmagnetismus. I. Abschnitt: pp. 1-54. Wien und Leipzig, 1902 (Wilhelm Braumüller).—The aim of this work is to present all that is known concerning the optics of the atmosphere, and, as no author has attempted the same task hitherto, it promises to be of great value. Part I treats in a clear and inter-

esting way of the apparent form of the sky, its causes and its consequences. It is to be shortly followed by three others, treating, respectively, of the phenomena due to the aeriform components of the atmosphere, of those due to the exceptional presence of foreign bodies (halos, coronas, etc.), and of those attributable to the constant presence of small particles. C. S. H.

13. *Instruments et Méthodes de Mesures Électriques Industrielles*; par H. ARMAGNAT. Deuxième Edition, revue et complétée, 599 pp. Paris, 1902 (C. Naud).—The first part of this useful book, constituting a half of the whole volume, contains a general description of the familiar laboratory instruments for electrical measurements and of their modes of use. Excellent features of the discussions are the statements concerning the limiting accuracy of the various methods. The second part, occupying about one hundred pages, is devoted to industrial appliances for electrical measurements. The remainder of the volume, constituting the third part, is given to a description of the methods employed in electric and magnetic measurements, both refined and industrial. It is in this part that the ordinary reader will find most that will appear novel to him. The volume as a whole is clearly written, clearly printed, and adequately, if not admirably, illustrated. C. S. H.

14. *Note on the Size of Nuclei*; by C. BARUS. (Communicated.)<sup>1</sup>  
—If in case of nuclei produced by shaking solutions, we regard the nucleus as so constituted, that a central electron forms a closed field with the charge due to friction uniformly distributed\* over the surface; if, moreover, the excess of vapor pressure at a surface of radius  $R$  is eventually equal to the electrical surface pressure, we may write  $2T\rho/R = 2\pi e^2/(16\pi^2 R^3 K)$ ; whence  $R^3 = e^2/(16\pi T\rho K)$ , where  $e$  is an electron ( $7 \times 10^{-10}$  electrostatic units),  $T$  the surface tension of water (81),  $\rho$  its vapor density ( $17 \times 10^{-6}$ ),  $K$  its specific inductive capacity (80). From this follows for the radius of the nucleus  $R = 4.5 \times 10^{-7}$ , which (in the light of other data to be adduced at length elsewhere) seems to be a reasonable value. A nucleus smaller or larger than this will either grow or evaporate, respectively, to the critical radius here implied.

## II. GEOLOGY.

1. *Geological Survey of Canada, Summary Report of the Geological Survey department for the Calendar year, 1901*; by ROBERT BELL, Acting Deputy Head and Director. 269 pp.—Since the death of the late director of the Canadian Geological Survey, Dr. G. M. Dawson, March 2, 1901, the administration has been in charge of Mr. Robert Bell. The appropriation for the year was \$115,900. There were 31 parties in the field during the summer season, and 12 publications were completed and issued. Among the important investigations were those of

\* As, for instance, by rotation.

McConnell in the copper regions of White Horse district; Leach and McEvoy on the coal basin of Fernice in the Crow's Nest Pass coal field; Dowling on the western side of Hudson, where rocks formerly represented as Laurentian were shown to be of Lower Cambrian age; Barlow on the Sudbury nickel and copper district; Adams on the Haliburton district; Chalmers on the superficial deposits of the interlake peninsula of Ontario exploiting for gas, petroleum and water; Laflamme made investigation of the Middle Silurian of Anticosti, bringing in numerous fossils; Bailey and Poole on the Carboniferous deposits of New Brunswick. These and many other lines of research are the steady progress of previous years.

H. S. W.

2. *Field Operations of the Division of Soils*; report for 1900 by MILTON WHITNEY, Chief of Division U. S. Dept. Agriculture. 473 pp.; 51 pls.; 47 figs.; also 24 colored soil maps.—The work of the Division of Soils for 1900 covered a wide area. The eastern division, in charge of C. W. Dorsey, made surveys in Maryland, Pennsylvania, Ohio and North Carolina; the western division, in charge of Thomas H. Means, was at work in Utah, Arizona and California. 4,465 square miles were mapped on a scale of one inch to the mile. The laboratory work for the division included investigation on the physical and chemical properties of soils.

3. *The Mineral Wealth of the Black Hills*; by CLEOPHAS C. O'HARRA. South Dakota Geol. Survey, Bull. No. 3. Pp. 82; pl. 22.—Dr. O'Harra of the South Dakota School of Mines has described the economic mineral deposits of the Black Hills and includes in his treatise a general summary of the history, conditions, and apparent possibilities of their development.

4. *Corundum Twins*; by W. M. E. HIDDEN. (Communicated.)—

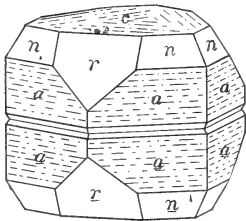

Crystals of corundum, gray and ruby-red in color, twinned parallel to the base  $c(0001)$ , have been found sparingly in the "In situ" mine (of ruby, pink and gray corundum), Coler Fork of Cowee Creek, Macon County, North Carolina. They were first observed by the writer in 1898, upon crystals from a feldspar vein. The two best examples measure six millimeters in diameter and length. They are characterized by reentrant

angles ( $n, 224\bar{3}$ ) on the prismatic faces ( $a, 11\bar{2}0$ ) and some slight natural corrosion. (See figure, drawn by Mr. John C. Blake of the Yale Mineralogical Laboratory.)

5. *Genesis of Ore Deposits*; published by the American Institute of Mining Engineers.—During the past few years several important papers on ore deposits have been published by the Institute of Mining Engineers. These have now been collected into a single volume. The first paper, from which the book takes its title, is the celebrated treatise by Franz Pösephny which was

given by him to the Institute in 1893. The other papers of the volume are entitled: Some Principles Controlling the Deposition of Ores, by C. R. Van Hise; The Secondary Enrichment of Ore Deposits, by S. F. Emmons; The Enrichment of Gold and Silver Veins, by W. Lindgren; Problems in the Geology of Ore Deposits, by J. H. L. Vogt; the Role of Igneous Rocks in the Formation of Veins, by J. F. Kemp; The Caliche of Southern Arizona, by W. P. Blake; The Character and Genesis of Certain Contact Deposits, by W. Lindgren; The Formation of Bonanzas in the Upper Portion of Gold Veins, by T. A. Rickard. Many of these papers have grown out of the discussion of Prof. Van Hise's original and valuable contribution. The different writers, with one exception, agree with him in his main conclusions. Prof. Van Hise has contributed a concluding chapter in which the chief points of the discussion are reviewed and summarized. A valuable appendix to the volume gives an index of all the papers on ore deposits which the Institute has published. W. E. F.

6. *Coal in Michigan, its mode of occurrence and quality*; by ALFRED C. LANE, State Geologist, constituting vol. viii, pt. ii, Geol. Survey of Michigan. Pp. 232, 9 plates and 9 figures. 1902.—The author discusses the origin, occurrence, analyses and tests, erosion and disturbance and development of Michigan coal. As to the geological horizon of the coal seams he makes the following statement, based upon paleontological analyses made by Messrs. Girty and David White of the U. S. Geological Survey, viz: "All the indications are that all our series are low down in the Coal Measures (Mesocarboniferous), in fact in that section of it known as the Pottsville formation, 'seral conglomerate' or 'millstone grit' a part of the series which was once supposed to be below any important coal seams, though it is now known that some of the best coals of the United States, the Lykens Valley of Penn., the Pocahontas and New River of West Va., the Sharon Marsillon and Mercer Coals of Ohio, belong to this series (p. 41). H. S. W.

7. *Adephagous and Clavicorn Coleoptera from the Tertiary Deposits at Florissant, Colorado*; by SAMUEL H. SCUDDER. U. S. G. S. Monograph XL, 148 pp., 11 pl., 1900.—This is a second instalment toward the history of fossil coleoptera, the first of which was published in 1893 as Monograph XXI, and contains an account of the non-rhynchophorous coleoptera of North America, 210 species of which are now known belonging to 26 families and 125 genera. The beautiful plates illustrate the new species; and in their proper places all the species of each genus are recorded, thus giving a summary of present knowledge of the extinct forms of the groups considered. H. S. W.

8. *Acrothyra and Hyolithes—a Comparison; Hyolithes gracilis and related forms from the Lower Cambrian of the St. John Group; A backward step in Paleobotany*; by G. F. MATTHEW. Trans. Roy. Soc. Can., vol. vi, section iv, pp. 93-122.—Dr. Matthew believes that the Pteropoda and the Brachiopoda

may have originated from the worms. He also believes that Dawson was correct in ascribing the plant remains near St. John to the Devonian.

9. *Ostracoda of the basal Cambrian rocks in Cape Breton*; by G. F. MATTHEW. *Can. Record Sci.*, vol. viii, No. 7, pp. 437-468.

10. *Fossil Mammals of the Tertiary of Northeastern Colorado*; by W. D. MATTHEW. *Mem. Amer. Mus. Nat. Hist.*, Vol. i, Part vii, pp. 355-447, 1901.—This extensive memoir upon the fossil mammals of the Oligocene and Loup Fork beds of Colorado contains much that is new, interesting, and important to the student of paleontology, and is a notable contribution to the extinct mammalian fauna of this country. That which is perhaps the most novel feature of the paper, however, is the conclusion that the unlaminated clays of these beds are of eolian origin, and that the sandstones and laminated clays represent river deposits accumulated upon a flood plain. The old view of the lacustrine origin of these sediments which has been held by all the leading geologists of this country for many years past, is regarded as untenable and is rejected. The evidence which the author regards as in favor of this hypothesis is classified and considered as follows: (A) The Stratigraphic Evidence, under which are grouped (1) objections to the lacustrine hypothesis on account of the size of the supposed lake, and the absence of distinct terraces; (2) great thickness in the west near the mountains, with gradual thinning out to the eastward, is thought to be evidence in favor of flood plain action rather than deposition in a lake; (3) the manner in which coarse beds are intercalated among the fine sediments, if lacustrine would indicate "frequent, spasmodic, and extensive changes in the level of the lake"; (4) the absence of thick marginal deposits and the character of the erosion of the sediments are opposed to their lacustrine origin; (5) absence of conglomerate beds at the base of the formation; and (6) lack of lamination of much of the clays, are all thought to be opposed to their disposition in a lake. (B) Paleontological Evidences. These are held by the author to be much more convincing than those derived from the stratigraphic arguments, and he does not hesitate to affirm that, "The burden of proof that climatic and geologic conditions were so widely different from modern times as to sustain a huge inland sea of fresh water in the now arid Plains, lies not with the opponent but with the exponent of the lake theory." The argument derived from the paleontological evidence consists, according to the author, of the fact that the fauna of the clays is a strictly terrestrial fauna, and different from that contained in the sandstones. The fact that there are no aquatic invertebrates, fish, aquatic reptiles or mammals, but large numbers of land tortoises, together with peculiarities of occurrence and preservation of the fossils contained in the sediments, are believed to place insuperable difficulties in the way of a belief in the lacustrine origin of these deposits.

In order to examine the arguments therein set forth even in the most imperfect manner, would require a greater amount of space than is possible to devote to a brief review of this kind. I can therefore mention only a few of the more important objections which can be urged against this hypothesis. They are as follows: (1) If the absence of lamination in clays is proof of their eolian origin, then we must suppose that all of the unlaminated clays of the Jurassic, Dakota, Laramie, Puerco, Wasatch, Wind River, Bridger and Uinta, have been deposited in the same way; but there is abundant and incontestable proof that many such beds, at least, were laid down in water; otherwise how can we explain the presence of aquatic invertebrates? (2) sticky, plastic clay, of which much of the White River deposit consists, is not easily moved by the agency of the winds; (3) all the phenomena of deposition of these sediments can be more easily and fully explained by delta action, with its ever present flood plain accompaniments, and has, moreover, the advantage of much greater probability and plausibility; (4) it is extremely doubtful if any flood plain deposits are now being made, except in the vicinity of the mouths of rivers where they empty into an ocean, sea or lake; (5) our knowledge of the habits of the extinct mammalia is yet too imperfect and lacking in exactness to afford in itself a very secure foundation upon which to build profound geological theories; (6) the oligocene deposits of the Laramie Basin, presenting the same lithological characteristics and containing the same mammalian fauna as those of the Plains, are surrounded by well-defined mountain barriers; they contain abundant remains of fishes in the clays, as well as other very convincing evidence of their lacustrine origin. Much other evidence could be cited, but lack of space forbids.

The paleontological part of the work is well presented and contains many discoveries of importance. Among these may be mentioned the additional characters of the curious sciuro-morph rodent *Mylogaulus*, the skull and jaws of an extinct marten, an extinct mole, the first ever found in the American Tertiaries. A new and plausible explanation of the probable uses of the enlarged canines of the saber tooth tigers is also given. Some large giraffe-like camels are described and much additional detailed information of many groups presented. The announcement that Primates are absent in the American Oligocene had been made by the reviewer nearly two years previously. J. L. W.

11. *Pleistocene Geology of portions of Nassau County and Borough of Queens*; by JAY BACKUS WOODWORTH. N. Y. State Museum, Bull. 48, pp. 618-666, 9 figs., 9 pl.

## III. BOTANY.

1. *Recherches sur le développement du tégument séminal et du péricarpe des Graminées*; by PAUL GUÉRIN. Paris, 1899.—The structure of the pericarp and the seed-coat in the *Gramineæ* is a subject that has not been studied very much hitherto, and it seems as if most authors have confined themselves to the study of those genera or species as are of purely economical value, the Cereals for instance. The results of these studies are, however, very diverse, so that we have not reached any definite conclusion as to the real structure of the pericarp and seed-coat before and after fecundation has taken place. Nevertheless the Gramineæ have recently been classified under Van Tieghem's "Inséminées" on account of some observations made by Jumelle, who claims that both the external and internal integument of the ovule in the Gramineæ become reabsorbed after fecundation; thus the fruit develops as an achæmium, enclosing a seed with no seed-coat. This statement is very much in opposition to the explanation given by Kudelka and Johannsen, who arrived at the conclusion that only "the external" integument becomes reabsorbed, while the internal integument persists and grows together with the pericarp.

Not until a few years ago has the subject been taken up again by Dr. Guérin, but this author has not confined himself to studying Cereals alone, but has examined a number of representatives of each of the thirteen tribes which are generally recognized as constituting the order Gramineæ. The structure of the pericarp and of the integuments of the ovule has been studied very carefully and compared with the final composition of the fruit and seed-coat after fecundation. Several very instructive illustrations accompany the anatomical sketch, and show very plainly the changes that take place in the ovary before and after the fecundation of the ovule. But the results gained by Dr. Guérin's painstaking studies are not in accordance with those presented by Jumelle, thus there seems to be no foundation, so far, for classifying the order among the "Inséminées."

To do full justice to this important work of Dr. Guérin, it would be necessary to give a detailed account of all the facts, as presented, and we regret that the space assigned does not allow more than a brief abstract of some of the results; we must refer to the paper itself for further details. The author confirms the observations of Kudelka and Johannsen, that only the outer integument becomes reabsorbed after fecundation has taken place, and the formation of the seed-coat is, thus, solely due to the persistence of the inner integument. The mature seed is invariably surrounded by a seed-coat, even if the inner integument may, sometimes, become partly reabsorbed, but never completely so. The inner integument consists generally of one or two layers of cells, and the innermost layer is, as a rule, the



highest developed and acquires large dimensions in some genera, viz: *Uniola*, *Phænosperma*, etc. The seed-coat is closely adherent to the pericarp in the *Gramineæ* with the exceptions of *Eleusine*, *Dactyloctenium* and *Zizaniopsis*. The epidermis of nucellus may, also, persist as a hyaline covering or it may be developed much further and serve for the protection of the seed, as in *Bromus* and *Brachypodium*. The fruit is an achæmium in *Eleusine*, *Dactyloctenium* and *Zizaniopsis*; it is a somewhat modified caryopsis in *Sporobolus* and *Crypsis*, but in all the other genera examined the fruit is a true caryopsis. A seed-coat is, thus, always present, but the structure is often obscure and not readily perceived, unless the tissues have been studied at the younger stages of both fruit and seed.

T. H.

2. *Alpine plants from Tibet and the Andes.* Abstract of a paper by W. B. HEMSLEY and H. H. W. PEARSON, read before the Linnean Society. (Journ. of Botany, London, 1900, vol. xxxviii, p. 238.)—Students of alpine floras may be interested to learn that in Central and Northern Tibet, at an elevation of from 15,000 ft. to 19,200 ft. above sea-level, the following orders predominate: *Compositæ*, *Leguminosæ*, *Cruciferæ*, *Ranunculaceæ* and *Gramineæ*. At 19,000 ft., the greatest altitude on record for flowering plants, Deasy and Pike have recorded: *Corydalis Hendersonii*, *Arenaria Stracheyi*, *Saxifraga parva*, *Sedum Stracheyi*, *Saussurea bracteata*, *Gentiana tenella*, *G. aquatica*, an unnamed species of *Astragalus* and of *Oxytropis*; at a lower elevation, c. 17,000 ft., *Allium Semenovii* was found in great abundance.

In the Bolivian Andes, Sir Martin Conway collected 7 species from 18,000 ft. or above, two being as high as 18,700 ft. These, the highest Andine plants on record, are: *Malvastrum flabellatum* Wedd. and *Deyeuxia glacialis* Wedd. 39 species were observed above 14,000 ft., and these belong to 34 genera and 21 orders, of which 15 are included in the *Compositæ*; of the 34 genera, *Blumenbachia* is the only one that is endemic to South America.

T. H.

#### IV. MISCELLANEOUS SCIENTIFIC INTELLIGENCE.

1. *Smithsonian Institution Publications.*—The following papers form parts of vol. xli of Smithsonian Miscellaneous Collections:

Index to the Literature of the Spectroscope (1887–1900 both inclusive); by ALFRED TUCKERMANN. Pp. 373.

Bibliography of the analytical Chemistry of Manganese (1785–1900); by HENRY P. TALBOT and JOHN W. BROWN. Pp. 117.

Chemical Societies of the Nineteenth Century; by HENRY CARRINGTON BOLTON. Pp. 15.

2. *United States Coast and Geodetic Survey. Annual Report 1900*; by O. H. TITTMAN, Superintendent. 712 pp., with numerous maps and illustrations.—The field work of the Coast Survey during 1899–1900 was widely distributed over the United States,

and parties were sent also to Alaska, Porto Rico, Hawaii, and the Phillipines. Appendixes to the report include: The Boundary Line between California and Nevada; The International Latitude Service in Maryland and California; Outlines of Tidal Theory.

3. *Die Fortschritte der Physik im Jahre 1902. Halbmonatliches Litteratur-verzeichniss*; redigirt von KARL SCHEEL (reine Physik) und RICHD. ASSMANN (kosmische Physik). Braunschweig, 1902 (Fr. Vieweg und Sohn).—Numbers 6, 7, 8 (pp. 117-175) have recently appeared. See note in this Journal, vol. xiii, p. 319.

4. *Elementary Calculus*; by PERCEY F. SMITH, Professor of Mathematics in the Sheffield Scientific School of Yale University. 12mo, 89 pp. (American Book Company).—The design of the author is to give in the compass of from thirty-five to forty ordinary class-room exercises a thorough knowledge of the essentials of the differential and integral calculus, together with sufficient practical applications to exhibit the scope of the subject and furnish the student facility in the use of his tools. Such a course will be a wise economy of time for many students, and will bring a knowledge of this great science to many others who would never undertake to master a more formidable treatise.

W. B.

5. *Prize for Scientific Work by Women*.—The Association for maintaining the American Women's Table at the Zoological station at Naples and for promoting Scientific Research by Women, announces the offer of a second prize of one thousand dollars for the best thesis written by a woman, on a scientific subject embodying new observations and new conclusions based on an independent laboratory research in biological, chemical or physical science. Theses must be presented before Dec. 31st, 1904, to Mrs. Ellen H. Richards, Mass. Inst. Technology, Boston, Mass.

#### OBITUARY.

HENRY MORTON, President of Stevens Institute of Technology, at Hoboken, N. J., died May 9th at the age of sixty-six years.

M. ALFRED CORNU, the eminent French physicist, since 1867 Professor at the École polytechnique in Paris, died in April last at the age of sixty-one years.

DR. ALEXANDER BITTNER, chief geologist in the Imperial Geological Institute at Vienna, died recently at the age of fifty-two years.

M. HENRI FILHOL, Professor of Paleontology at the Jardin des Plantes, Paris, died recently at the age of sixty-eight years.

# INDEX TO VOLUME XIII.\*

## A

- Academy**, National, meeting at Washington, 415.  
**Agassiz A.**, Expedition to the Maldives, 297.  
**Alabama**, Plant Life in, Mohr, 79.  
**Alps**, igneous rocks of, 324.  
**American Museum of Natural History**, Catalogue of Palæontological collection, 159.  
 — Philosophical Society, meeting at Philadelphia, 330.  
**Andes**, igneous rocks from, 323.  
**Armagnat, H.**, Electrical Measurements, 473.  
**Association**, American, meeting at Pittsburg, 415.  
 — British, meeting at Glasgow, 416.  
**Atmospheric electricity**, effect of air movements on, Linke, 156.

## B

- Barrell, J.**, physical effects of contact metamorphism, 279.  
**Barus, C.**, coronas of cloudy condensation, etc., 81; flower-like distortion of coronas, etc., 309; possibility of a colloidal state of gases, 400; size of nuclei, 473.  
**Beecher, C. E.**, ventral integument of trilobites, 165.  
**Benton, J. R.**, experimental method in the flow of solids, 207.  
**Bermuda** and the Challenger Expedition, Cole, 329.  
 — isopods of, Richardson, 328.  
 — report on the fauna of, Verrill, 327.  
 — spiders and mites from, Banks, 328.  
**Birds**, see **Zoology**.  
**Black Hills**, geology and water resources, 68; laccoliths of, 160; mineral wealth, 474.  
**Botanisches Centralblatt**, 327.

## BOTANY.

- Alpine plants from Tibet and Andes, Hemsley and Pearson, 479.  
 Botanic Garden, Harvard Memorial Greenhouses, 162.  
 Cellulose, researches on, Cross and Bevan, 161.  
 Cycads, living *Zamias* of Florida, Wieland, 331.  
 Graminées, Recherches sur les, Guérin, 478.  
 Grasses of Iowa, Pammel, Weems and Lamson-Scribner, 244.  
 Horticultural experiments at the Harvard station in Cuba, 325.  
 Plant Life in Alabama, Mohr, 78.  
 Plants, van Tieghem's classification of, 326.  
*Zamias* of Florida, Wieland, 331.  
**Brace, D. B.**, laws of radiation and absorption, 412.  
**Branner, J. C.**, fossil remains of mammals in Brazil, 133.  
**Brazil**, fossil remains of mammals in, Branner, 133.  
**Brinton, D. G.**, Basis of Social Relations, 416.  
**British Museum Catalogues**, 329.  
**Brush, C. F.**, gauge for measurement of small pressures, 455.

## C

- Calculus**, Smith, 480.  
**California**, Berkeley Hills, geology, Lawson and Palache, 322; Mineralogy of, Eakle, 73.  
**Canada** geol. survey, 473.  
**Cape of Good Hope**, Geol. Commission, 413.  
**Cathode rays**, chemical action of, Schmidt, 318.  
 — radio-activity imparted to certain salts by, McLennan, 240.  
 — See **X-Rays**.

\* This Index contains the general heads, **BOTANY**, **CHEMISTRY** (incl. chem. physics), **GEOLOGY**, **MINERALS**, **OBITUARY**, **ROCKS**, and under each the titles of Articles referring thereto are mentioned.

- Celebes**, igneous rocks from, 413.  
**Cells**, chemical organization of, Hofmeister, 241.  
**Challenger Expedition**, Bermuda, Cole, 329.  
**Chant, C. A.**, skin-effect in electrical oscillators, 1.  
**Chemical Laboratory of Sheffield Scientific School**, studies from, Wells, 63.  
**Chemische Physiologie und Pathologie**, Beiträge, 242, 412, 471.  
**Chemistry**, Physical, Jones, 317.  
 — Electro, Jones, 241.
- CHEMISTRY.**  
 Ammonium chloride, action on silicates, Clarke and Steiger, 27.  
 Beryllium, notes on quantitative spectra of, Hartley, 156.  
 — with organic acids, Lacombe, 471  
 Boric acid, gravimetric method for estimation of, Partheil and Rose, 61.  
 Burette floats, use of, Kreitling, 471.  
 Calcium, atomic weight, Hinrichsen, 154.  
 — silicide, Moissan and Dilthey, 410.  
 Carbides, metallic, Moissan, 238.  
 Carbon compounds, molecular weights of some, Speyers, 213.  
 — in steel, Leffler, 409.  
 Cells, chemical organization of, Hofmeister, 241.  
 Copper, antimony, iron, etc., volumetric determination of, Weil, 315.  
 — estimation of, as cuprous sulphocyanide in the presence of bismuth, etc., Van Name, 138.  
 Formic acid, synthesis of, Moissan, 317.  
 Germanium hydride, Voegelen, 470.  
 Hydrochloric acid, influence on cuprous sulphocyanide, Van Name, 20.  
 — and hydrocyanic acids, separation, Richards and Singer, 315.  
 Hydrogen, oxide higher than dioxide, Ramsay, 153.  
 — peroxide with salts, compounds of, Tanatar, 155.  
 — selenide and sulphide, comparison, deForcand and Fonzes-Diacon, 316.  
 Iodine, initiative action of, Hale, 379.  
 Liquids, determination of density, Girardet, 153.  
 Lithium antimonide, Lebeau, 317.  
 Methane, synthesis of, Sebatier and Senderens, 409.  
 Nitrogen, preparation from ammonium nitrate, Mai, 60.  
 Potassium hydride, Moissan, 240.  
 Pyrites, new method for assaying, 470.  
 Radium, chemical reactions, Berthelot and Becquerel, 59.  
 Silver subhalides, Emszt, 154.  
 Sulphur, size of molecule, Biltz and Freuner, 61.  
 Sulphuric acid, manufacture by contact process, Knietzsch, 238.  
 Tellurium, atomic weight, Köthner, 154; Pellini, 60.  
 — in American silver, presence of, Vincent, 411.  
 Thorium, radio-active, Hofmann and Zerban, 316.  
 Vanadium, specific heat, Matignon and Monnet, 410.
- Chicago University**, Decennial Publications, 471.  
**Clarke, F. W.**, action of ammonium chloride on silicates, 27.  
**Climate**, cause of Pleistocene, 70.  
**Color photography**, discovery in, Verrill, 329.  
**Colors of coronas**, etc., Barus, 81, 309.  
**Colorado**, fossil mammals from the Tertiary of, Matthew, 476.  
**Congrès Géologique international**, 8th session, 1900, 67.  
**Connecticut**, fossil wood from, 70.  
 — glacial remains near Woodstock, 403.  
 — Newark system of Pomeraug Valley, 70.  
 — Still rivers of western, 243.  
**Coral Reefs**, Maldive and Laccadive, Gardiner, 321.  
 — — the Maldives, Agassiz, 297.  
**Corals**, notes on, Verrill, 414.  
 — of Bermuda, 327; of Porto Rico, 75.  
**Coronas** of cloudy condensation, Barus, 81.  
 — flower-like distortion of, Barus, 309.  
**Cosmic cycle**, Very, 47, 97, 185.  
**Cuba** horticultural experiments at Harvard station, 325.  
**Cyanogen** bands, structure of, King, 472.  
**Cycads**, living *Zamia*s of Florida, Wieland, 331.

## D

**Darton, N. H.**, geology and water resources of Black Hills, 68.

- Davis, B.**, anemometer for stationary sound-waves, 129.  
**Davison, J. M.**, internal structure of cliftonite, 467.  
**Derby, O. A.**, occurrence of monazite in iron ore and graphite, 211.  
**Dustfall of March, 1901**, in North Africa, Hellman and Meinardus, 323.

## E

- Eggleston, J. W.**, glacial remains near Woodstock, Conn., 403.  
**Electric charges**, dissipation by vapor, Beggerow, 411.  
 — conductivities produced in air by the motion of negative ions, Townsend and Kirkby, 240.  
 — currents, displacement of, Blondlot, 155.  
 — — of high frequency, effects on the human body, Andriessen, 318.  
 — measurements, Armagnat, 473.  
 — oscillators, skin-effect in, Chant, 1.  
 — oscillatory discharges, 472.  
 — resistance, in high vacua, Rollins, 62.  
 — vibrations, slow, Schmidt, 156.  
 — — determination of frequency, Schmidt, 156.  
 — waves in coils, Lüdin, 411.  
 — — stationary, Lindman, 472.  
**Electricity**, movement of air on atmospheric, Linke, 156.  
**Electro-chemistry**, Jones, 241.  
**Electrodes**, distribution of electric current on, Wehnelt, 319.  
**Emmons, S. F.**, obituary notice of Clarence King, 224.  
**Ether**, drift of, Hicks, 155.  
**Evolution**, new theory of, Smith, 330.

## G

- Gardiner, J. S.**, Fauna and Geography of Maldives and Laccadives, 321.  
**Gases**, possibility of a colloidal state, Barus, 400.  
 — spectrum of, at high temperature, Trowbridge, 412.  
**GEOLOGICAL REPORTS AND SURVEYS.**  
 Canada, 1901, 473.  
 Cape of Good Hope, 413.  
 United States, 320.  
 Western Australia, 413.  
**GEOLOGY.**  
 Berkeley Hills, geology, Lawson and Palache, 322.  
 Black Hills, geology and water resources of, Darton, 68; laccoliths from, Jagger, 160; mineral wealth, 474.  
 Cambrian of Cape Breton, Matthew, 324.  
 — Acrothyra and hyolithes, Matthew, 475.  
 — ostracoda in rocks of Cape Breton, Matthew, 476.  
 Coal in Michigan, Lane, 475.  
 Dustfall of March 1901 in N. Africa, Hellmann and Meinardus, 323.  
 Eocene Mammalia in the Marsh collection, studies, Wortman, 39, 115, 197, 433.  
 Faunas, fossil, and their use, Williams, 417.  
 Fossil mammals from the Tertiary of Colorado, Matthew, 476.  
 — wood from Connecticut, 70.  
 Glacial formations and fauna, Norway, Brögger, 322.  
 — remains near Woodstock, Conn., Eggleston, 403.  
 Laccoliths of the Black Hills, Jagger, 160.  
 Loess, analysis of Mount Vernon, Iowa, Knight, 325.  
 Mammals, fossil, in Brazil, Braner, 133.  
 Metamorphism, physical effects of contact, Barrell, 279.  
 Mineral veins, influence of country rock on, Weed, 324.  
 — wealth of the Black Hills, 474.  
 Newark system of Pomperaug Valley, Conn., Hobbs, 70.  
 Ore deposits, genesis, 474.  
 Palaeobotany, backward step in, Matthew, 475.  
 Palaeontological collection, American Museum Natural History, catalogue, Whitfield, 159.  
 Patriofelis ferox, Marsh, 117.  
 Pleistocene epoch, influence of winds upon climate during, Harmer, 70.  
 — geology of Nassau Co., N. Y., Woodworth, 477.  
 Protostega, hind limb of, Williston, 276.  
 Siebengebirge am Rhein, das, Laspèyres, 72.  
 Sinopa agilis Marsh, 437.  
 Sulphur, oil, etc., in Texas, 413.  
 Tertiary of Colorado, coleoptera from, Scudder, 475.  
 — Colorado, origin of deposits, Matthew, Wortman, 476.  
 Trilobites, ventral integument of, Beecher, 165.

Gibbs, J. W., Vector Analysis, 158.  
Guérin, P., Recherches sur les Graninées, 478.

## H

Hale, F. E., initiative action of iodine, etc., 379.  
Hartley, W. N., notes on quantitative spectra of beryllium, 156.  
Harvard Botanic Garden, memorial greenhouses, 162.  
Hastings, C. S., Light, 64.  
Heinze, J. O., Jr., actinism of the X-Rays, 313.  
Hertzian Waves, Lindman, 472; in storms, Larroque, 411.  
Hidden, W. E., corundum twins, 474.  
Hillebrand, W. F., composition of yttrialite and thalénite, 145.  
Hobbs, W. H., Newark system of Pomperaug Valley, Conn., 70; still rivers of western Connecticut, 243.  
Hoffmann, G. C., chrompicotite in Canada, 242.  
Hydrogen, stratifications of, Crookes, 319.

## I

Induction coil, Rayleigh, 62.  
Iowa, loess from, 325.

## J

Jones, H. C., Electro-Chemistry, 241; Physical Chemistry, 317.

## K

King, Clarence, obituary notice of, 163, 224.  
Kirkby, P. J., electric conductivities produced in air by motion of negative ions, 240.  
Knowlton, F. H., fossil wood from Connecticut, 70.

## L

Lamarck, Life and Work of, Packard, 65.  
Landis, D. S., Leonids at Phoenix, Arizona, 79.  
Leonids in 1901: at New Haven, Connecticut, 79; at Phoenix, Arizona, 79; at Havre, Montana, 80.  
Light, Hastings, 64.  
— pressure of, Nichols, Hull and Lebedew, 61.  
— velocity of, Michelson, 471.  
Ling, C. W., Leonids at Havre, Montana, 80.

## M

Magnetic declination chart for the United States, 1902, 319.  
Maldives, expedition to, Agassiz, 297; formation of, Gardiner, 321.  
— and Laccadives, Fauna and Geography, Gardiner, 321.  
Marsh collection, studies of Eocene Mammalia, Wortman, 39, 115, 197, 433.  
Mathematics, teaching of, 416.  
Matter, heatless condition of, Brinkworth and Martin, 469.  
Matthew, W. D., fossil mammals from the Tertiary of Colorado, 476.  
Metamorphism, physical effects of contact, Barrell, 279.  
Meteorologie, Lehrbuch, Hann, 330.  
Meteorologische Optik, Pernter, 472.  
Michigan, coal, Lane, 475.  
Miller, Hugh, centenary of, 416.  
Mineralogy of California, Eakle, 73.

## MINERALS.

Aegirite, Arkansas, 36. Analcite in igneous rocks, 161. Apatite, 343.  
Chabazite, Nova Scotia, 30. Chloropal, Nevada, 344. Chrompicotite, Canada, 242. Cliftonite, 467. Corundum twins, 474. Crocoite, Tasmania, 339.  
Diamond, the world's largest, 74. Diopside, Nevada, 345.  
Esmeraldaite, Nevada, 72.  
Heulandite, Iceland, 30.  
Ilvaite, Idaho, 33.  
Jarosite, Nevada, 345.  
Leuchtenbergite, Ural Mts. 37.  
Manganocalcite, 72. Manganosphærite, Germany, 72. Monazite, Idaho, 343; in iron ore and graphite, Brazil, 211.  
Nephrite, New Zealand, 73. Nickel minerals, 346.  
Phlogopite, Canada, 38. Pyrites, 470. Pyromorphite, California, 343.  
Riebeckite, Colorado, 34.  
Serpentine, Mass., 36. Sperrylite, Wisconsin, 95. Spinel, artificial, 60. Stillbite, Nova Scotia, 27.  
Thalénite, 146. Thomsonite, Colorado, 32.  
Uranophane, Georgia, 464.  
Vesuvianite, 345. Vivianite, California, 344.  
Yttrialite, composition, 145.  
Mohr, C., Plant Life in Alabama, 78.  
Morley, E. W., gauge for measurement of small pressures, 455.

## N

- Norway**, glacial formations, Brögger, 322.  
**Nuclei**, size of, Barus, 473.

## O

## OBITUARY—

- Bittner, Alexander, 480.  
 Cornu, Alfred, 480.  
 Filhol, H., 480.  
 Hyatt, Alpheus, 164.  
 King, Clarence, 163, 224.  
 Leeds, A. R., 330.  
 Meehan, Thomas, 164.  
 Morton, Henry, 480.  
**Oscillatory discharges**, Andriessen, 472.  
**Ostwald's Klassiker der Exakten Wissenschaften**, 416.

## P

- Packard, A. S.**, Life and Work of Lamarek, 65.  
**Penfield, S. L.**, new occurrence of Sperrylite in Wisconsin, 95; use of stereographic projection for maps and charts, 245, 347.  
**Pernter, J. M.**, Meteorologische Optik, 472.  
**Petrographisches Praktikum**, Rheinisch, 243.  
**Phase rule**, application of, Richards, 377.  
**Physik**, die Fortschritte der, im Jahre, 1902, Scheel und Assmann, 319, 480.  
**Porto Rico**, Alcyonaria of, 78.  
 — Mollusca of, Dall and Simpson, 78.  
 — Natural History of, 75.  
 — Stony Corals of, Vaughan, 75.  
**Pratt, H. S.**, Invertebrate Zoology, 414.  
**Pressures**, gauge for measurement of small, Morley, 455.

## R

- Radiation and absorption**, laws of, Brace, 412.  
**Radio-active bodies**, Curie, 241;  
 Thorium, Hofmann and Zerbán, 316.  
**Radio-activity** imparted to certain salts by Cathode rays, McLennan, 240.  
**Radium radiations**, chemical effects, Becquerel, 62.

- Resistance** in high vacua, Rollins, 62.  
**Richards, T. W.**, application of the phase rule, etc., 377.  
**Rivers**, Still, in Western Connecticut, Hobbs, 243.

## ROCKS.

- Analcite in igneous rocks, 161.  
 Comendite from Siberia, 179.  
 Foyaite from Siberia, 175.  
 Gesteine der Ecuatorianischen Ost-Cordillere, Young, 323.  
 Gesteinssuiten, Untersuchung einiger, gesammelt in Celebes, Schmidt, 413.  
 Igneous, from Eastern Siberia, Washington, 175.  
 — relative density of fluid and solid magmas, Doelter, 71.  
 Petrographical studies in Alpine Italy, Artini and Melzi, 324.  
 Petrographisches Praktikum, Rheinisch, 243.  
**Rollins, W.**, resistance in high vacua, 62.

## S

- Scientia**, 244.  
**Scientific work** by women, prize for, 480.  
**Sheffield Scientific School**, Studies from chemical laboratory, Wells, 63.  
**Siberia**, igneous rocks from Eastern, Washington, 175.  
**Smith, P. F.**, Calculus, 480.  
**Smithsonian Institution**, origin and history, Rhees, 244; publications, 479; annual report for 1901, 329.  
**Social relations**, Basis of, Brinton, 416.  
**Soils**, report of the Division of, 1900, Whitney, 474.  
**Solids**, experimental method in the flow of, Benton, 207.  
**Solutions**, clearing of troubled, Quinke, 155.  
**Sound**, transmission through solid walls, Tufts, 449.  
 — velocity in air, Stevens, 318.  
 — waves, anemometer for stationary, Davis, 129.  
**Spectrum**, cyanogen bands, King, 472.  
 — of gases at high temperatures, 412.  
 — ultra-violet of mercury, Lehmann and Straubel, 472.  
 — wave lengths in solar, 411.

- Speyers, C. L.**, molecular weights of some carbon compounds, 213.  
**Standards**, National Bureau of, 416.  
**Stars**, evolution of, Very, 47, 97, 185.  
**Steiger, G.**, action of ammonium chloride on silicates, 27.  
**Stereographic projection** for maps and charts, Penfield, 245, 347.  
**Sun's spectrum**, wave lengths in, Perot and Fabry, 411.

## T

- Telescope**, untried form of mounting, Todd, 459.  
**Texas**, sulphur, oil, etc., 413.  
**Tibet** and the Andes, Alpine plants from, Hemsley and Pearson, 479.  
**Todd, D. P.**, untried form of mounting for a telescope, 459.  
**Townshend**, electrical conductivities produced in air by the motion of negative ions, 240.  
**Tufts, F. L.**, transmission of sound through solid walls, 449.  
**Turner, H. W.**, unusual minerals from the Pacific States, 343.

## U

- United States Coast Survey**, 479.  
 — Geological Survey, 320.

## V

- VanHise, C. R.**, ore deposits, 474.  
**VanName, R. G.**, influence of hydrochloric acid on cuprous sulphocyanide, 20; estimation of copper in the presence of bismuth, etc., 138; crocoite from Tasmania, 339.  
**VanTieghem's** classification of plants, 326.  
**Vector analysis**, Gibbs and Wilson, 158.  
**Verrill, A. E.**, Review of Stony Corals of Porto Rico, 75; fauna of the Bermudas, 327.  
**Very, F. W.**, cosmic cycle, 47, 97, 185.

## W

- Washington, H. S.**, igneous rocks from Eastern Siberia, 175.  
**Watson, T. L.**, uranophane in Georgia, 464.

**Wells, H. L.**, Studies from the Chemical Laboratory of Sheffield Scientific School, 63; new occurrence of Sperrylite in Wisconsin, 95.

**Western Australia**, geological survey, 413.

**Wieland, G. R.**, living Cycads, Zamias of Florida, 331.

**Williams, H. S.**, Life and Work of Lamarek, review of, 65; fossil faunas and their use, 417.

**Williston, S. W.**, hind limb of Protostega, 276.

**Wilson, E. B.**, Vector Analysis, 158.

**Winds**, influence of upon climate during the Pleistocene epoch, Harmer, 70.

**Wireless telegraphy**, de Tunzelmann, 412.

**Wortman, J. L.**, studies of Eocene Mammalia in the Marsh collection, 39, 115, 197, 433.

## X

**X-Rays**, varying degrees of actinism of, Heinze, 313.

## Y

**Yale Bicentennial publications**, 63, 64.

## Z

**Zoology**, Invertebrate, Pratt, 414.

## ZOOLOGY.

Alcyonaria of Porto Rico, Hargitt and Rogers, 78.

Birds of Middle and North America, Ridgeway, 78.

— of North America, Ridgeway, 244.

Corals of Bermuda, West Indies, etc., Verrill, 327.

— Stony, of Porto Rican Waters, Vaughan, 75.

Fauna of the Bermudas, Verrill, 327.

— Maldives and Laccadives, Gardiner, 321.

Isopods of the Bermudas, Richardson, 328.

Mollusca of Porto Rico, Dall and Simpson, 78.

Spiders and mites from Bermuda, Banks, 328.



VOL. XIII.

JANUARY, 1902.

Established by BENJAMIN SILLIMAN in 1818.

THE  
AMERICAN  
JOURNAL OF SCIENCE.

EDITOR: EDWARD S. DANA.

ASSOCIATE EDITORS

PROFESSORS GEO. L. GOODALE, JOHN TROWBRIDGE,  
W. G. FARLOW AND WM. M. DAVIS, OF CAMBRIDGE,

PROFESSORS A. E. VERRILL, HENRY S. WILLIAMS AND  
L. V. PIRSSON, OF NEW HAVEN.

PROFESSOR GEORGE F. BARKER, OF PHILADELPHIA,

PROFESSOR JOSEPH S. AMES, OF BALTIMORE,

MR. J. S. DILLER, OF WASHINGTON.

---

FOURTH SERIES.

VOL. XIII—[WHOLE NUMBER; CLXIII.]

No. 73.—JANUARY, 1902.

---

NEW HAVEN, CONNECTICUT.

1902.

---

THE TUTTLE, MOREHOUSE & TAYLOR CO., PRINTERS, 125 TEMPLE STREET.

# AMERICAN CRYSTALLIZED CINNABAR.

Possessing the color, brilliancy and transparency of cut rubies. Coming direct from the well known California mines, the new find offers the best *quality* of this highly prized rarity which we have yet seen. The crystals range from 1 to 4 mm. or more diameter, and are generally grouped in protecting cavities. Their remarkable lustre and gem-like aspect give an added value to their crystallographic perfection. A habit of parallel grouping of the crystals adds to their showy character. This collection is comparatively small, yet is a result of the long continued efforts of a mine official. At less than the Spanish prices they find immediate sale.

## ENGLISH MINERALS.

**Quartz-coated-Fluors.** A large lot containing a few record-breaking specimens. They afford one of the most charming combinations known. Bright and translucent purple cubes coated with clear quartz crystals—the “Little Falls Diamond” quality. A few superb museum groups.

**Fluors** of the ordinary (and some extraordinary) types. Bubble inclusions, etc. Prices one-half the figures lately obtained.

**Brilliant Sphalerite.** Crystals sprinkled attractively over white druses of pseudomorphous quartz—a new and pretty type.

**Witherite.** Groups of doubly terminated crystals. To be had only from old collections. The local supply was long since exhausted.

**Calcite.** Numerous and familiar forms.

**Pearl Spar and Golden Barites.** Of the first quality.

## OTHER RECENT ACCESSIONS.

“**Mexican Onyx**” *from Arizona.* Superior to the Mexican article. In handsome cabinet size slabs, polished on one side.

**Electrum in Quartz,** Nevada. An-unusually rich piece.

**Beryl.** Well terminated and symmetrical hexagons.

**Halite.** In limpid cubic cleavages.

**Argentiferous Galena, Copiapite, Alunite, Alunogen, Epsomite, Pyromorphite, Cerargyrite, Brucite, etc., etc.**

## ILLUSTRATED COLLECTION CATALOG.

Describes systematic collections arranged for practical study and reference; from small elementary sets to the extensive and complete collection required by a university museum. Detached crystals. Series illustrating hardness and other physical characters. Laboratory minerals at lowest prices prevailing in Europe or America.

## FOOTE MINERAL CO.,

FORMERLY DR. A. E. FOOTE,

The Largest and Best Equipped Mineral Supply-House in the World.  
Highest Awards at Nine Great Expositions.

ESTABLISHED 1876.

PHILADELPHIA,  
1817 Arch Street.

PARIS,  
24 Rue du Champ de Mars.

# ANOTHER SERIES OF FINE MINERALS



Will be placed on sale about January 1st, embracing the second portion of the large collection announced last month. Special circular announcement will be sent to all customers requesting same. This second lot will contain many specimens more beautiful and less expensive than the first part, in which were included such expensive minerals as *gold, silver, platinum, palladium, platinumiridium, chilenite, arquerite, amalgam, proustite, pyrrargyrite, alexandrite.*

Though thousands of specimens worthy of special mention have recently been received, we are constrained to pass them over in silence this month to again call attention to

## THE PRE-EMINENT EXCELLENCE OF OUR COLLECTIONS

All of which have been recently thoroughly revised and brought up to date. We regret exceedingly that the great pressure of work devolving upon our Mr. English has so long delayed the anticipated publication of a new catalogue. Though much work has been done upon it, we cannot promise it soon. When issued this catalogue will present in detail the merits of our collections, which are but crudely described in our current catalogue. In the meantime we beg intending purchasers to communicate with us and we shall be pleased to send them such manuscript descriptions as will convince them that our collections are unapproached by any others in the market.

## CRYSTAL COLLECTION No. 1

Contains 100 most carefully selected loose crystals, each labeled with printed label and accompanied by cherry mouting block, and either lacquered-brass crystal holder of best make or wooden crystal stand, as may be preferred by purchaser. A new feature is the catalogue of the collection which gives the form of each crystal, for example: "37. Calcite, Bigrigg Mine, England. Unit prism (m), scalenohedron (v), striated rhombohedron (e), rhombohedron (M), oscillatory combination of scalenohedron with second order prism (a)." Though the catalogue greatly enhances the value of the collection, and though the crystals included are of far better quality than formerly and much more completely illustrate the six systems, our price remains only \$50. The crystals are classified in accordance with Dana's textbook.

## OUR BLOWPIPE COLLECTIONS

Have just been revised (October, 1901), and any student buying one of them will find it of inestimable assistance in his laboratory work. The leading works on determinative mineralogy have been studied from beginning to end in order to make it certain that everything needed by a student of any one of these books is included in our collection of 200 specimens at \$8.00, while the smaller collections, 100 for \$3.50, 50 for \$1.50, 25 for 75c., contain the most important of the species. All of these collections are put up in handsome quartered oak compartment boxes without extra charge.

## MANY OTHER COLLECTIONS

Are described in our catalogue and special circulars. Each is the best of its class in the market. Our "Dana" and "Manhattan" and "Moses" Collections have a world-wide reputation.

GEO. L. ENGLISH & CO., Mineralogists,

Dealers in Educational and Scientific Minerals,

3 AND 5 WEST 18th STREET, NEW YORK CITY.

## CONTENTS.

	Page
ART. I.—Experimental Investigation into the "Skin"-effect in Electrical Oscillators ; by C. A. CHANT .....	1
II.—Influence of Hydrochloric Acid on the Precipitation of Cuprous Sulphocyanide ; by R. G. VAN NAME .....	20
III.—Action of Ammonium Chloride upon certain Silicates ; by F. W. CLARKE and G. STEIGER .....	27
IV.—Studies of Eocene Mammalia in the Marsh Collection, Peabody Museum ; by J. L. WORTMAN .....	39
V.—A Cosmic Cycle ; by F. W. VERY .....	47

### SCIENTIFIC INTELLIGENCE.

*Chemistry and Physics*—Chemical Reactions produced by Radium, BERTHELOT, 59.—Preparation of Nitrogen from Ammonium Nitrate, J. MAI: Atomic Weight of Tellurium, PELLINI: Artificial Spinel, DUFAU, 60.—Size of the Sulphur Molecule, BILTZ and PREUNER: Direct Gravimetric Method for the Estimation of Boric Acid, PARTHEIL and ROSE: Pressure of Light, E. L. NICHOLS, G. F. HULL and P. LEBEDEV, 61.—Chemical Effects produced by Radium Radiations, H. BECQUEREL: Induction Coil, Lord RAYLEIGH: Resistance in High Vacua, W. ROLLINS, 62.—Studies from the Chemical Laboratory of the Sheffield Scientific School, H. L. WELLS, 63.—Light; A Consideration of the more familiar Phenomena of Optics, C. S. HASTINGS, 64.

*Geology and Mineralogy*—Lamarck, the founder of Evolution, his life and work, with translations of his writings on Organic Evolution, A. S. PACKARD, 65.—Congrès Géologique international; Comptes Rendus de la VIII<sup>e</sup> session, en France, A. GAUDRY and C. BARROIS, 67.—Preliminary Description of the Geology and Water Resources of the Southern Half of the Black Hills and adjoining Regions in South Dakota and Wyoming, N. H. DARTON, 68.—Newark System of Pomperaug Valley, Connecticut, W. H. HOBBS and F. H. KNOWLTON: Influence of Winds upon Climate during the Pleistocene Epoch, F. W. HARMER, 70.—Relative Density of Fluid and Solid Magmas, 71.—Siebengebirge am Rhein, H. LASPEYRES: New Mineral Names, 72.—Mineralogy of California, A. S. EAKLE and W. C. BLASDALE: New localities of Nephrite, A. DIESELDORF, 73.—World's Largest Diamond, 74.

*Zoology and Botany*—Reports on the Natural History of Porto Rico, 75.—Alcyonaria of Porto Rico, C. W. HARGITT and C. G. ROGERS: Mollusca of Porto Rico, W. H. DALL and C. T. SIMPSON: Birds of North and Middle America, R. RIDGEWAY: Capillaranalyse beruhend auf Capillaritäts- und Adsorptionserscheinungen, mit dem Schlusskapitel: das Emporsteigen der Farbstoffe in den Pflanzen, F. GOPPELSROEDER, 78.—Plant Life of Alabama, C. MOHR, 79.

*Astronomy*—Leonids in 1901: Leonids at Phoenix, Arizona, D. S. LANDIS, 79.—Leonids at Havre, Montana, C. W. LING, 80.

VOL. XIII.

FEBRUARY, 1902.

Established by BENJAMIN SILLIMAN in 1818.

THE  
AMERICAN  
JOURNAL OF SCIENCE.

EDITOR: EDWARD S. DANA.

ASSOCIATE EDITORS

PROFESSORS GEO. L. GOODALE, JOHN TROWBRIDGE,  
W. G. FARLOW AND WM. M. DAVIS, OF CAMBRIDGE,

PROFESSORS A. E. VERRILL, HENRY S. WILLIAMS AND  
L. V. PIRSSON, OF NEW HAVEN.

PROFESSOR GEORGE F. BARKER, OF PHILADELPHIA,

PROFESSOR JOSEPH S. AMES, OF BALTIMORE,

MR. J. S. DILLER, OF WASHINGTON.

FOURTH SERIES.

VOL. XIII—[WHOLE NUMBER, CLXIII.]

No. 74.—FEBRUARY, 1902.

WITH PLATE I.

NEW HAVEN, CONNECTICUT.

1902.

THE TUTTLE, MOREHOUSE & TAYLOR CO., PRINTERS, 125 TEMPLE STREET.



Published monthly. Six dollars per year, in advance. \$6.40 to countries in the Postal Union. Remittances should be made either by money orders, registered letters, or bank checks (preferably on New York banks).

# AMERICAN CRYSTALLIZED CINNABAR.

Possessing the color, brilliancy and transparency of cut rubies. Coming direct from the well known California mines, the new find offers the best *quality* of this highly prized rarity which we have yet seen. The crystals range from 1 to 4 mm. or more diameter, and are generally grouped in protecting cavities. Their remarkable lustre and gem-like aspect give an added value to their crystallographic perfection. A habit of parallel grouping of the crystals adds to their showy character. This collection is comparatively small, yet is a result of the long continued efforts of a mine official. At less than the Spanish prices they find immediate sale.

## ENGLISH MINERALS.

**Quartz-coated-Fluors.** A large lot containing a few record-breaking specimens. They afford one of the most charming combinations known. Bright and translucent purple cubes coated with clear quartz crystals—the “Little Falls Diamond” quality. A few superb museum groups.

**Fluors** of the ordinary (and some extraordinary) types. Bubble inclusions, etc. Prices one-half the figures lately obtained.

**Brilliant Sphalerite.** Crystals sprinkled attractively over white druses of pseudomorphous quartz—a new and pretty type.

**Witherite.** Groups of doubly terminated crystals. To be had only from old collections. The local supply was long since exhausted.

**Calcite.** Numerous and familiar forms.

**Pearl Spar and Golden Barites.** Of the first quality.

## OTHER RECENT ACCESSIONS.

“**Mexican Onyx**” from *Arizona*. Superior to the Mexican article. In handsome cabinet size slabs, polished on one side.

**Electrum in Quartz**, Nevada. An unusually rich piece.

**Beryl.** Well terminated and symmetrical hexagons.

**Halite.** In limpid cubic cleavages.

**Argentiferous Galena, Copiapite, Alunite, Alunogen, Epsomite, Pyromorphite, Cerargyrite, Brucite, etc., etc.**

## ILLUSTRATED COLLECTION CATALOG.

Describes systematic collections arranged for practical study and reference; from small elementary sets to the extensive and complete collection required by a university museum. Detached crystals. Series illustrating hardness and other physical characters. Laboratory minerals at lowest prices prevailing in Europe or America.

## FOOTE MINERAL CO.,

FORMERLY DR. A. E. FOOTE,

The Largest and Best Equipped Mineral Supply-House in the World.  
Highest Awards at Nine Great Expositions.

ESTABLISHED 1876.

PHILADELPHIA,  
1317 Arch Street.

PARIS,  
24 Rue du Champ de Mars.

# WONDERFUL EPIDOTES FROM ALASKA.



By far the finest Epidotes ever found in America. They rival the famous Tyrolese specimens but are entirely different. They occur in groups of stout, highly lustrous, black crystals, generally twinned and often doubly terminated. They are one of the most important mineral finds ever made. 50c. to \$30.

## A NEW LOT OF GRAFTONITE.

Further work at the Graftonite locality has yielded another but very small lot of specimens. The remarkable and entirely unique intergrowth of Graftonite and Triphylite observable in every specimen (as shown in the accompanying illustration) makes this rare species one of unusual interest. 25c. to \$3.50.

## CHOICE DEKALB DIOPSIDE CRYSTALS.

Our present stock, recently greatly enriched, includes many crystals not only beautifully transparent, but also uncommonly perfect in form. How different they are from the ordinary lifeless pyroxene crystals! 25c. to \$2.00.

## CANADIAN CORUNDUM.

A recent visit to the now famous Craig Mine and to all the other prominent Canadian corundum localities has yielded us by far the best assortment of matrix groups of corundum crystals we have ever seen. The contrast between the large brown corundum crystals and the salmon-colored feldspar in which they are imbedded, makes these specimens very attractive. 25c. to \$2.50. Loose crystals, 10c. to \$1.00. Fine cleavage masses, 25c. to \$2.50.

## DIAMOND CRYSTALS.

A small lot of choice diamond crystals was lately secured. Excellent octahedrons, etc. \$2.00 to \$17.50. We also have a few of the 25c diamond crystals still left; when these are gone such crystals will probably bring 50c. each, owing to the rise in prices due to the South African war.

## A THIRD SERIES OF FINE MINERALS

From the large collection which we recently purchased will be placed on sale about February 1st. It will include many choice specimens of the silicates such as fine Beryls, Tourmalines, etc. In the second installment were many startlingly fine *Tyrolese Epidotes*, Dauphiné *Axinites*, *Zircon* crystals up to nearly 6 inches in length, a large number of splendid feldspars, calcites, pyroxenes, rare species, etc.

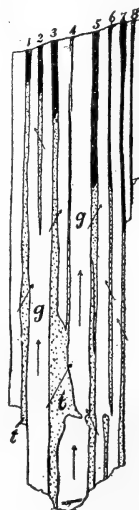

124-page ILLUSTRATED CATALOGUE, giving Dana Species number, crystal system, hardness, specific gravity, chemical composition and formula of every mineral, 25c. in paper.

44-page ILLUSTRATED PRICE-LISTS, also BULLETTINS and CIRCULARS, FREE.

GEO. L. ENGLISH & CO., Mineralogists,  
Dealers in Educational and Scientific Minerals,  
3 AND 5 WEST 18th STREET, NEW YORK CITY.

## CONTENTS.

	Page
ART. VI.—Geometric Sequences of the Coronas of Cloudy Condensation, and the Contrast of Axial and Coronal Colors; by C. BARUS .....	81
VII.—New Occurrence of Sperrylite; by H. L. WELLS and S. L. PENFIELD .....	95
VIII.—A Cosmic Cycle, Part II; by F. W. VERY .....	97
IX.—Studies of Eocene Mammalia in the Marsh Collection, Peabody Museum; by J. L. WORTMAN .....	115
X.—Miniature Anemometer for Stationary Sound Waves; by B. DAVIS .....	129
XI.—Occurrence of Fossil Remains of Mammals in the Interior of the States of Pernambuco and Alagoás, Brazil; by J. C. BRANNER. With Plate I .....	133
XII.—Estimation of Copper as Cuprous Sulphocyanide in the Presence of Bismuth, Antimony, Tin and Arsenic; by R. G. VAN NAME .....	138
XIII.—Composition of Yttrialite, with a Criticism of the formula assigned to Thalénite; by W. E. HILLEBRAND. ....	145

### SCIENTIFIC INTELLIGENCE.

*Chemistry and Physics*—Apparatus for Determining the Density of Liquids, F. GIRARDET: Supposed Existence of an Oxide of Hydrogen higher than the Dioxide, RAMSAY, 153.—Atomic Weight of Calcium HINRICHSSEN: Silver Subhalides, EMSZT: Atomic Weight of Tellurium, KÖTHNER, 154.—Compounds of Hydrogen Peroxide with Salts, S TANATAR: Drift of the Ether, W. M. HICKS: Clearing of Troubled Solutions, G. QUINCKE: Displacement Currents, M. R. BLONDIOT, 155.—Frequency-determination of slow Electrical Vibrations, K. E. F. SCHMIDT: Bearing of the upward and downward movement of Air on Atmospheric Electricity, F. LINKE: Notes on Quantitative Spectra of Beryllium, W. N. HARTLEY, 156.—Vector Analysis, E. B. WILSON, 158.

*Geology and Natural History*—Catalogue of the Types and figured Specimens in the Palæontological collection of the Geological Department, American Museum of Natural History, R. P. WHITFIELD and E. O. HOVEY, 159.—Laccoliths of the Black Hills, T. A. JAGGAR, JR., 160.—Analcite in Igneous Rocks, J. W. EVANS: Researches on Cellulose, 1895-1900, C. F. CROSS and E. J. BEVAN, 161.—Memorial Greenhouses at the Harvard Botanic Garden, 162.

*Obituary*—CLARENCE KING, 163.—ALPHEUS HYATT: THOMAS MEEHAN, 164.



VOL. XIII.

MARCH, 1902.

Established by **BENJAMIN SILLIMAN** in 1818.

THE  
AMERICAN  
JOURNAL OF SCIENCE.

EDITOR: EDWARD S. DANA.

ASSOCIATE EDITORS

PROFESSORS GEO. L. GOODALE, JOHN TROWBRIDGE,  
W. G. FARLOW AND WM. M. DAVIS, OF CAMBRIDGE,

PROFESSORS A. E. VERRILL, HENRY S. WILLIAMS AND  
L. V. PIRSSON, OF NEW HAVEN.

PROFESSOR GEORGE F. BARKER, OF PHILADELPHIA,

PROFESSOR JOSEPH S. AMES, OF BALTIMORE,

MR. J. S. DILLER, OF WASHINGTON.

FOURTH SERIES.

VOL. XIII—[WHOLE NUMBER, CLXIII.]

No. 75.—MARCH, 1902.

WITH PLATES II-VI.

NEW HAVEN, CONNECTICUT.

1902.

THE TUTTLE, MOREHOUSE & TAYLOR CO., PRINTERS, 125 TEMPLE STREET.



# AMERICAN CRYSTALLIZED CINNABAR.

Possessing the color, brilliancy and transparency of cut rubies. Coming direct from the well known California mines, the new find offers the best *quality* of this highly prized rarity which we have yet seen. The crystals range from 1 to 4 mm. or more diameter, and are generally grouped in protecting cavities. Their remarkable lustre and gem-like aspect give an added value to their crystallographic perfection. A habit of parallel grouping of the crystals adds to their showy character. This collection is comparatively small, yet is a result of the long continued efforts of a mine official. At less than the Spanish prices they find immediate sale.

## ENGLISH MINERALS.

**Quartz-coated-Fluors.** A large lot containing a few record-breaking specimens. They afford one of the most charming combinations known. Bright and translucent purple cubes coated with clear quartz crystals—the “Little Falls Diamond” quality. A few superb museum groups.

**Fluors** of the ordinary (and some extraordinary) types. Bubble inclusions, etc. Prices one-half the figures lately obtained.

**Brilliant Sphalerite.** Crystals sprinkled attractively over white druses of pseudomorphous quartz—a new and pretty type.

**Witherite.** Groups of doubly terminated crystals. To be had only from old collections. The local supply was long since exhausted.

**Calcite.** Numerous and familiar forms.

**Pearl Spar and Golden Barites.** Of the first quality.

## OTHER RECENT ACCESSIONS.

“**Mexican Onyx**” from *Arizona*. Superior to the Mexican article. In handsome cabinet size slabs, polished on one side.

**Electrum in Quartz,** Nevada. An unusually rich piece.

**Beryl.** Well terminated and symmetrical hexagons.

**Halite.** In limpid cubic cleavages.

**Argentiferous Galena, Copiapite, Alunite, Alunogen, Epsomite, Pyromorphite, Cerargyrite, Brucite, etc., etc.**

## ILLUSTRATED COLLECTION CATALOG.

Describes systematic collections arranged for practical study and reference; from small elementary sets to the extensive and complete collection required by a university museum. Detached crystals. Series illustrating hardness and other physical characters. Laboratory minerals at lowest prices prevailing in Europe or America.

---

## FOOTE MINERAL CO.,

FORMERLY DR. A. E. FOOTE,

The Largest and Best Equipped Mineral Supply-House in the World.  
Highest Awards at Nine Great Expositions.

ESTABLISHED 1876.

PHILADELPHIA,  
1317 Arch Street.

PARIS,  
24 Rue du Champ de Mars.

# Fine Gem Sphene Crystals



The third installment of the old collection which we recently purchased was placed on sale February 15th. 1000 specimens of very unusual excellence aroused an enthusiasm among collectors not seen for a long time. The beautiful yellow Sphene crystals from Switzerland, so transparent and gemmy, were greatly admired. So rich an assortment has never before been seen on sale in New York. Prices 50c. to \$10.00.

Highly modified gem **Beryls**, a few choice **Emeralds**, beautiful **Essonite Garnets** from Ala, **Uvarovites** from Urals, gem **Rubellites** from Elba, extra good steep-pyramidal **Brown Tourmalines** from Gouverneur, splendid **Rose Apophyllites**, **Harmotome**, **Gmelinite**, **Gismondite**, **Datolite**, **Diopase**, **Pyromorphite**, **Mimetite**, **Erythrite**, **Ilvaite**, **Pyrosmalite**, **Brazilian Topaz**, and such rare species as **Hamlinite**, **Leuchtenbergite**, **Dipyre**, **Aeschynite**, **Sarcolite**, made this accession one long to be remembered. Notwithstanding the heavy sales, many most excellent specimens still remain.

## WONDERFUL ALASKA EPIDOTES.

Though we bought hundreds of these fine specimens, but few remain, as collectors in all parts of the world have been eager to obtain them. To no less than ten European countries, including far-away Russia and Greece, have we sent these Epidotes during the past month or so. If you want them, hurry in your order. 50c. to \$30.00.

## CANADIAN CORUNDUM.

A recent visit to the now famous Craig Mine and to all the other prominent Canadian corundum localities has yielded us by far the best assortment of matrix groups of corundum crystals, and the salmon-colored feldspar in which they are imbedded makes these specimens very attractive. 25c. to \$2.50. Loose crystals, 10c. to \$1.00. Fine cleavage masses, 25c. to \$2.50.

## CHOICE DEKALB DIOPSIDE CRYSTALS.

Our present stock, recently greatly enriched, includes many crystals not only beautifully transparent, but also uncommonly perfect in form. How different they are from the ordinary lifeless pyroxene crystals! 25c. to \$2.00.

## A NEW LOT OF GRAFTONITE.

Further work at the Graftonite locality has yielded another but very small lot of specimens. The remarkable and entirely unique intergrowth of Graftonite and Triphylite observable in every specimen makes this rare species one of unusual interest. 25c. to \$3.50.

124-page ILLUSTRATED CATALOGUE, giving Dana Species number, crystal system, hardness, specific gravity, chemical composition and formula of every mineral, 25c. in paper.

44-page ILLUSTRATED PRICE-LISTS, also BULLETINS and CIRCULARS, FREE.

**GEO. L. ENGLISH & CO., Mineralogists,**

**Dealers in Educational and Scientific Minerals,**

**3 AND 5 WEST 18th STREET, NEW YORK CITY.**

## CONTENTS.

	Page
ART. XIV.—Ventral Integument of Trilobites; by C. E. BEECHER. (With Plates II-V.)	165
XV.—Igneous Rocks from Eastern Siberia; by H. S. WASHINGTON	175
XVI.—A Cosmic Cycle, Part III; by F. W. VERY	185
XVII.—Studies of the Eocene Mammalia in the Marsh Collection, Peabody Museum; by J. L. WORTMAN. (With Plate VI.)	197
XVIII.—Experimental Method in the Flow of Solids and its Application to the Compression of a Cube of Plastic Material; by J. R. BENTON	207
XIX.—Occurrence of Monazite in Iron Ore and in Graphite; by O. A. DERBY	211
XX.—Molecular Weights of some Carbon Compounds in Concentrated Solutions with Carbon Compounds as Solvents; by C. L. SPEYERS	213
—————	
CLARENCE KING	224

### SCIENTIFIC INTELLIGENCE.

- Chemistry and Physics*—Manufacture of Sulphuric Acid by the Contact Process, KNIETSCH: Metallic Carbides, MOISSAN, 238.—Potassium Hydride, MOISSAN: Electrical Conductivities produced in Air by the Motion of Negative Ions, TOWNSEND: Kind of Radio-activity imparted to certain Salts by Cathode Rays, J. C. McLENNAN, 240.—Radio-active Bodies, M. P. and S. CURIE: Outlines of Electrochemistry, H. C. JONES: Chemische Organisation der Zelle, F. HOFMEISTER, 241.—Beitraege zur Chemischen Physiologie und Pathologie, F. HOFMEISTER, 242.
- Geology and Natural History*—Occurrence of Chrompicotite in Canada, G. CHR. HOFFMANN, 242.—Still Rivers of Western Connecticut, W. H. HOBBS: Petrographisches Praktikum, R. RHEINISCH, 243.—Grasses of Iowa, L. H. PAMMEL, J. B. WEEMS, and F. LAMSON-Scribner: Birds of North and Middle America, R. RIDGEWAY, 244.
- Miscellaneous Scientific Intelligence*—Smithsonian Institution, Documents Relative to its Origin and History, 1835-1899: Scientia, 244.

VOL. XIII.

APRIL, 1902.

Established by **BENJAMIN SILLIMAN** in 1818.

THE  
AMERICAN  
JOURNAL OF SCIENCE.

EDITOR: EDWARD S. DANA.

ASSOCIATE EDITORS

PROFESSORS GEO. L. GOODALE, JOHN TROWBRIDGE,  
W. G. FARLOW AND WM. M. DAVIS, OF CAMBRIDGE,

PROFESSORS A. E. VERRILL, HENRY S. WILLIAMS AND  
L. V. PIRSSON, OF NEW HAVEN.

PROFESSOR GEORGE F. BARKER, OF PHILADELPHIA,  
PROFESSOR JOSEPH S. AMES, OF BALTIMORE,  
MR. J. S. DILLER, OF WASHINGTON.

FOURTH SERIES.

VOL. XIII—[WHOLE NUMBER, CLXIII.]

No. 76.—APRIL, 1902.

NEW HAVEN, CONNECTICUT.

1902.

THE TUTTLE, MOREHOUSE & TAYLOR CO., PRINTERS, 125 TEMPLE STREET.

Published monthly. Six dollars per year, in advance. \$6.40 to countries in the Postal Union. Remittances should be made either by money orders, registered letters, or bank checks (preferably on New York banks).

# AMERICAN CRYSTALLIZED CINNABAR.

Possessing the color, brilliancy and transparency of eut rubies. Coming direct from the well known California mines, the new find offers the best *quality* of this highly prized rarity which we have yet seen. The crystals range from 1 to 4 mm. or more diameter, and are generally grouped in protecting cavities. Their remarkable lustre and gem-like aspect give an added value to their crystallographic perfection. A habit of parallel grouping of the crystals adds to their showy character. This collection is comparatively small, yet is a result of the long continued efforts of a mine official. At less than the Spanish prices they find immediate sale.

## ENGLISH MINERALS.

**Quartz-coated-Fluors.** A large lot containing a few record-breaking specimens. They afford one of the most charming combinations known. Bright and translucent purple cubes coated with clear quartz crystals—the “Little Falls Diamond” quality. A few superb museum groups.

**Fluors** of the ordinary (and some extraordinary) types. Bubble inclusions, etc. Prices one-half the figures lately obtained.

**Brilliant Sphalerite.** Crystals sprinkled attractively over white druses of pseudomorphous quartz—a new and pretty type.

**Witherite.** Groups of doubly terminated crystals. To be had only from old collections. The local supply was long since exhausted.

**Calcite.** Numerous and familiar forms.

**Pearl Spar and Golden Barites.** Of the first quality.

## OTHER RECENT ACCESSIONS.

**“Mexican Onyx”** from *Arizona*. Superior to the Mexican article. In handsome cabinet size slabs, polished on one side.

**Electrum in Quartz,** Nevada. An unusually rich piece.

**Beryl.** Well terminated and symmetrical hexagons.

**Halite.** In limpid cubic cleavages.

**Argentiferous Galena, Copiapite, Alunite, Alunogen, Epsomite, Pyromorphite, Cerargyrite, Brucite, etc., etc.**

## ILLUSTRATED COLLECTION CATALOG.

Describes systematic collections arranged for practical study and reference; from small elementary sets to the extensive and complete collection required by a university museum. Detached crystals. Series illustrating hardness and other physical characters. Laboratory minerals at lowest prices prevailing in Europe or America.

## FOOTE MINERAL CO.,

FORMERLY DR. A. E. FOOTE,

The Largest and Best Equipped Mineral Supply-House in the World.  
Highest Awards at Nine Great Expositions.

ESTABLISHED 1876.

PHILADELPHIA,  
1317 Arch Street.

PARIS,  
24 Rue du Champ de Mars.

# CHOICE JAPANESE AXINITES



Early in April we will place on sale a shipment of minerals recently received direct from Japan. The major part of this shipment is Axinites of a very peculiar and interesting habit. The curious curved crystals are sharp and brilliant and are of various shades of light and dark clove-brown to greenish and yellowish-brown. Sizes range from  $1\frac{1}{2} \times 1\frac{1}{4}$  to  $4 \times 5$  inches. Prices: 50c. to \$15.00.

## A LARGE QUARTZ TWIN.

Accompanying the Axinites were several Quartz twins, one of which is the largest and one of the finest we have ever secured. It measures six inches (!) from tip to tip and is reasonably perfect. Price: \$25.00.

## CORNISH MINERALS.

Cornish *Bournonites*, *Tetrahedrites*, *Pharmacosiderites* and *Bindheimites* are not often offered at low prices. A shipment just in brings us over 100 specimens of these minerals, which will be sold at 25c. to \$1.50 each.

## SEVERAL CONTINENTAL SHIPMENTS

Have arrived or are en route, containing many hundreds of choice specimens.

## LOOSE TWINS OF SPHALERITE.

Just arrived. A new lot of 375 of the Missouri Sphalerite crystals and twins which were so popular that our stock last fall was quickly exhausted.

## THE LAST INSTALLMENT OF THE GREAT COLLECTION

Recently purchased is now on sale. It contains a surprisingly large number of very rare specimens and many choice examples of such desirable minerals as *Wulfenite*, *Scheelite*, *Crocoite*, *Torbernite*, *Autunite*, *Barite*, *Celestite*, *Erythrite*, *Boracite*, *Apatite*, etc. Over 4,000 specimens were included in this collection and many most excellent ones are still in stock.

## WONDERFUL ALASKA EPIDOTES.

A goodly number, though comparatively few, of these splendid specimens are still in stock.

## OTHER RECENT ADDITIONS.

*Canadian Corundum* crystals loose and in the matrix; *Graftonite*; gemmy *Dekalb Diopside* crystals; *Diamond* crystals; *Titanite* twins; etc., etc.

---

124-page ILLUSTRATED CATALOGUE, giving Dana Species number, crystal system, hardness, specific gravity, chemical composition and formula of every mineral, 25c. in paper.

44-page ILLUSTRATED PRICE-LISTS, also BULLETINS and CIRCULARS, FREE.

---

GEO. L. ENGLISH & CO., Mineralogists,

Dealers in Educational and Scientific Minerals,

3 AND 5 WEST 18th STREET, NEW YORK CITY.

## CONTENTS.

	Page
ART. XXI.—Use of the Stereographic Projection for Geographical Maps and Sailing Charts; by S. L. PENFIELD	245
XXII.—Hind Limb of Protostega; by S. W. WILLISTON	276
XXIII.—Physical Effects of Contact Metamorphism; by JOSEPH BARRELL	279
XXIV.—Expedition to the Maldives; by A. AGASSIZ	297
XXV.—Flower-like Distortion of the Coronas due to Graded Cloudy Condensation; by C. BARUS	309
XXVI.—Varying degrees of Actinism of the X-Rays; by J. O. HEINZE, JR.	313

### SCIENTIFIC INTELLIGENCE.

*Chemistry and Physics*—Separation of Hydrochloric and Hydrocyanic Acids, RICHARDS and SINGER: Volumetric Determination of Copper, Antimony, Iron, etc., by Means of Stannous Chloride, WEIL, 315.—Comparison of the Properties of Hydrogen Selenide with those of Hydrogen Sulphide, FORCAND and FONZES-DIACON: Radio-active Thorium, HOFMANN and ZERBAN, 316.—Lithium Antimonide, LEBEAU: Synthesis of Formic Acid, MOISSAN: Elements of Physical Chemistry, H. C. JONES, 317.—Velocity of Sound in Air and different Vapors with Ordinary and High Temperatures, E. H. STEVENS: Chemical Action of Cathode Rays, G. C. SCHMIDT: Effects of Currents of High Frequency upon the Human Body, H. ANDRIESEN, 318.—Distribution of Electric Current on Electrodes in rarefied Media, A. WEHNELT: Stratifications of Hydrogen, W. CROOKES: Magnetic Declination Chart for the United States in 1902: Die Fortschritte der Physik im Jahre 1902; Halbmonatliches Litteratur-verzeichniss, K. SCHEEL and R. ASSMANN, 319.

*Geology*—United States Geological Survey, 320.—Fauna and Geography of the Maldive and Laccadive Archipelagoes, J. S. GARDINER: Formation of the Maldives, J. S. Gardiner, 321.—Om de sennglaciale og postglaciale nivåforandringer i Kristianafjeldet (Molluskfaunan), W. C. BRÖGGER: Berkeley Hills; A Detail of Coast Range Geology, A. C. LAWSON and C. PALACHE, 322.—Gesteine der Ecuatorianischen Ost-Cordillere, Der-Cotopaxi und die umgebenden Vulkanberge, A. YOUNG: Der grosse Staubfall vom 9. bis 12. März, 1901, in Nordafrika, Süd- und Mitteleuropa, G. HELLMANN and W. MEINARDUS, 323.—Ricerche Petrografiche e Geologiche sulla Valsesia di E. ARTINI e G. MELZI: Influence of Country Rock on Mineral Veins, W. H. WEED: Additional notes on the Cambrian of Cape Breton, with descriptions of new species, G. F. MATTHEW, 324.—Analysis of Mount Vernon Loess, N. KNIGHT.

*Botany and Zoology*—Horticultural Experiments and Botanical Investigations at the Harvard Station in Cuba, 325.—Professor van Tieghem's Classification of Plants, 326.—Botanisches Centralblatt: Additions to the Fauna of the Bermudas from the Yale Expedition of 1901, with Notes on Other Species, A. E. VERRILL: (1) Variations and Nomenclature of Bermudian, West Indian, and Brazilian Reef Corals, with Notes on the Various Indo-Pacific Corals; (2) Comparisons of Bermudian, West Indian, and Brazilian Coral Fauna, A. E. VERRILL, 327.—Some Spiders and Mites from the Bermuda Islands, N. BANKS: Marine and Terrestrial Isopods of the Bermudas, with Descriptions of New Genera and Species, H. RICHARDSON, 328.—British Museum Catalogues: Bermuda and the Challenger Expedition, G. W. COLE, 329.

*Miscellaneous Scientific Intelligence*—Report of the Secretary of the Smithsonian Institution for the Year ending June 30, 1901: Important Discovery in Color Photography 329.—Lehrbuch der Meteorologie, J. HANN: American Philosophical Society: New Theory of Evolution, A. W. SMITH, 330.

*Obituary*—ALBERT RIPLEY LEEDS.



Established by BENJAMIN SILLIMAN in 1818.

THE  
AMERICAN  
JOURNAL OF SCIENCE.

EDITOR: EDWARD S. DANA.

ASSOCIATE EDITORS

PROFESSORS GEO. L. GOODALE, JOHN TROWBRIDGE,  
W. G. FARLOW AND WM. M. DAVIS, OF CAMBRIDGE,

PROFESSORS A. E. VERRILL, HENRY S. WILLIAMS AND  
L. V. PIRSSON, OF NEW HAVEN.

PROFESSOR GEORGE F. BARKER, OF PHILADELPHIA,  
PROFESSOR JOSEPH S. AMES, OF BALTIMORE,  
MR. J. S. DILLER, OF WASHINGTON.

---

FOURTH SERIES.

VOL. XIII—[WHOLE NUMBER, CLXIII.]

No. 77.—MAY, 1902.

---

NEW HAVEN, CONNECTICUT.

1902.

---

THE TUTTLE, MOREHOUSE & TAYLOR CO., PRINTERS, 125 TEMPLE STREET.

Published monthly. Six dollars per year, in advance. \$6.40 to countries in the Postal Union. Remittances should be made either by money orders, registered letters, or bank checks. (preferably on New York banks).

# MONTANA TOURMALINITIC QUARTZ.

We have lately secured direct from the locality an unusually large and fine lot of this interesting gem mineral. The occurrence was referred to in a former announcement, when two small lots arrived. The present collection embraces over 1200 crystals varying from 1 inch to 18 inches in length. A rough stem or "core," densely coated and filled with Tourmaline needles, sometimes protrudes from the end of the crystal including the most Tourmaline. This would indicate an unsuccessful attempt at Quartz crystallization in the presence of an excess of Tourmaline, the penetrating needles generally lessening in number as the opposite and perfect end of the crystal is approached. The Quartz is of the smoky variety, the inclusions giving it a greenish tinge. Excellent examples, some doubly terminated, from 1 to 3 inches long, 10c. to 30c. each. Cabinet specimens 50c. to \$3. Museum crystals at higher prices.

**Polished Cross-Sections** are of exceptional beauty and interest, showing the delicate needles branching in every direction. Some exhibit shadowy hexagons concentrically arranged, indicating the crystal growth.  $1\frac{1}{2}$  to 4 inches diameter, 50c. to \$4.

## AMETHYST CAPPINGS.

In the same find are a few choice Amethyst crystallizations arranged in paralleled groups, often capping the smoky Quartz in a unique manner. 50c. to \$6 for the larger. Excellent Amethyst crystals 10c. to 30c. each.

*Send your list of Desiderata.* Many acquisitions find no mention here because sold before an announcement can be prepared. With the list before us a gap in your collection can often be filled.

## EDUCATIONAL COLLECTIONS.

For 26 years we have supplied mining schools, universities, colleges and secondary schools throughout the world with mineralogical material. During that period the quality of our elementary and advanced collections has steadily improved, so that to-day the highest grade of study specimens are offered at unprecedentedly low prices. An inspection of our Laboratory List will show that European minerals are sold not simply below American prices, but often at lower rates than prevail in Europe. The wide connections of our European house alone permit this economy to the consumer, our prices being the same on both sides of the Atlantic. If in Paris this summer favor us with a call—15 minutes from the Opera Quarter.

### Illustrated Collection Catalog Free.

The Largest and Most Complete Stock of Scientific and Educational Minerals in the World. Highest Awards at Nine Expositions.

---

## FOOTE MINERAL CO.,

FORMERLY DR. A. E. FOOTE,

PHILADELPHIA,  
1317 Arch Street.

PARIS,  
24 Rue du Champ de Mars.

# NEW BOLIVIAN MINERALS.



A new importation enables us to sell **Franckeite** and **Cylindrite** at half former prices. Choice cabinet-size specimens at 75c. to \$2.50. Select any of the old lot at half the old prices. These are two new and interesting tin minerals which should be in every collection.

## CRYSTALLIZED ROSCOELITE WITH GOLD.

A few small but excellent specimens from California at \$1.25, \$1.50 and \$2.00.

## OTHER NEW ARRIVALS FROM CALIFORNIA.

*Gold.* A suite of small specimens of rare associations and forms.

*Colemanite.* A little lot of extra good groups of bright crystals, 25c. to \$3.50.

## FINE CRYSTALLIZED DIASPORE.

Quite a large number of fine specimens of crystallized Diaspore were lately secured. These are the final clean-up of the Massachusetts locality and no more are likely to come into the market. Nevertheless, we offer these at not over half our former prices; 25c. to \$2.00. Extra good cabinet-size specimens of crystalline diaspore, pure masses, 25c. to \$1.50.

## MOST BEAUTIFUL MARGARITE.

The best we have ever had, and a large lot, 25c. to \$1.25.

## MOHAWK MINE MINERALS.

A new lot of 50 specimens has just been determined, greatly enriching our stock of Mohawkite, Stibiodomeykite and Domeykite. Pure masses of each at most reasonable prices.

## NOVA SCOTIA HOWLITE.

24 choice nodules of this rare mineral, 50c. to \$1.25.

## AN IMPORTATION FROM ELBA.

Worthy of extended notice, but because of the host of fine new arrivals crowded in at the end. *Iridescent Hematites* extra fine and large, \$4.00, \$5.00, \$6.00; large and choice *Pyrite* crystals and groups, 75c. to \$5.00. *Crystallized Lepidolite*, *polychrome Tourmalines*, etc.

## OTHER RECENT ADDITIONS:

*Hauerite* in very good loose crystals; *Harmotome* in excellent groups from Oberstein; *Arsenic* in splendid large mamillary crusts; *Bindheimite*, the best lot ever on sale; *Tetrahedrite*, in groups of large crystals coated with *Chalcopyrite*; *Bournonites* well crystallized and cheap; superfine cleavable *Orpiment*; *Diamond* crystals; crystallized *Hematite* and *Quartz*, beautiful and cheap; over 4,000 excellent specimens from an old collection including many rare old-time specimens.

124-page ILLUSTRATED CATALOGUE, giving Dana Species number, crystal system, hardness, specific gravity, chemical composition and formula of every mineral, 25c. in paper.

44-page ILLUSTRATED PRICE-LISTS, also BULLETINS and CIRCULARS, FREE.

GEO. L. ENGLISH & CO., Mineralogists,

Dealers in Educational and Scientific Minerals,

3 AND 5 WEST 18th STREET, NEW YORK CITY.

## CONTENTS.

	Page
ART. XXVII.—Notes on Living Cycads. I. On the <i>Zamias</i> of Florida; by G. R. WIELAND .....	331
XXVIII.—Crystals of Crocoite from Tasmania; by R. G. VAN NAME .....	339
XXIX.—Notes on Unusual Minerals from the Pacific States; by H. W. TURNER .....	343
XXX.—Use of the Stereographic Projection for Geographical Maps and Sailing Charts; by S. L. PENFIELD .....	347
XXXI.—Note on the application of the Phase Rule to the fusing points of copper, silver, and gold; by T. W. RICHARDS .....	377
XXXII.—Initiative Action of Iodine and of Other Oxidizers in the Hydrolysis of Starch and Dextrins; by F. E. HALE	379
XXXIII.—Note on the Possibility of a Colloidal State of Gases; by C. BARUS .....	400
XXXIV.—Glacial Remains near Woodstock, Connecticut; by J. W. EGGLESTON .....	403

### SCIENTIFIC INTELLIGENCE.

*Chemistry and Physics*—Determination of Carbon in Steel, LEFFLER: New Synthesis of Methane, SEBASTIER and SENDERENS, 409.—Calcium silicide, MOISSAN and DILTHEY: Specific Heat, and Volumetric Determination of Vanadium, MATIGNON and MONNET, 410.—Presence of Tellurium in American Silver, VINCENT: Dissipation of Electrical Charges by Vapor, H. BEGGEROW: Hertzian Waves in Storms, M. F. LARROQUE: Electric Waves in Coils, E. LÜDIN: Measurements of Wave Lengths in the Sun's Spectrum, A. PEROT and C. FABRY, 411.—Spectrum of Gases at High Temperatures, TROWBRIDGE: Wireless Telegraphy, G. W. DETUNZELMANN: Laws of Radiation and Absorption, D. B. BRACE: Beitrage zur chemischen Physiologie und Pathologie, F. HOFMEISTER, 412.

*Geology and Natural History*—Geological Commission Cape of Good Hope, G. S. CORSTORPHINE: Western Australia: Sulphur, Oil and Quicksilver in Trans-Pecos, Texas, W. B. PHILLIPS: Untersuchung einiger Gesteinssuiten gesammelt in Celebes, C. SCHMIDT, 413.—Notes on Corals of the genus *Acropora* (*Madrepora* Lam.) with new Descriptions and Figures of Types, and of several New Species, A. E. VERRILL: Course in Invertebrate Zoology, H. S. PRATT, 414.

*Miscellaneous Scientific Intelligence*—National Academy of Sciences: American Association for the Advancement of Science, 415.—National Bureau of Standards: The Centenary of Hugh Miller: Ostwald's *Klassiker der Exakten Wissenschaften*: British Association Meeting at Glasgow, 1901; Discussion on the Teaching of Mathematics, J. PERRY: Basis of Social Relations, D. G. BRINTON, 416.

Established by BENJAMIN SILLIMAN in 1818.

THE  
AMERICAN  
JOURNAL OF SCIENCE.

EDITOR: EDWARD S. DANA.

ASSOCIATE EDITORS

PROFESSORS GEO. L. GOODALE, JOHN TROWBRIDGE,  
W. G. FARLOW AND WM. M. DAVIS, OF CAMBRIDGE,

PROFESSORS A. E. VERRILL, HENRY S. WILLIAMS AND  
L. V. PIRSSON, OF NEW HAVEN.

PROFESSOR GEORGE F. BARKER, OF PHILADELPHIA,  
PROFESSOR JOSEPH S. AMES, OF BALTIMORE,  
MR. J. S. DILLER, OF WASHINGTON.

FOURTH SERIES.

VOL. XIII—[WHOLE NUMBER, CLXII.]

No. 78.—JUNE, 1902.

WITH PLATES VII-VIII.

171465

NEW HAVEN, CONNECTICUT.

1902.

THE TUTTLE, MOREHOUSE & TAYLOR CO., PRINTERS, 125 TEMPLE STREET.

# MONTANA TOURMALINITIC QUARTZ.

We have lately secured direct from the locality an unusually large and fine lot of this interesting gem mineral. The occurrence was referred to in a former announcement, when two small lots arrived. The present collection embraces over 1200 crystals varying from 1 inch to 18 inches in length. A rough stem or "core," densely coated and filled with Tourmaline needles, sometimes protrudes from the end of the crystal including the most Tourmaline. This would indicate an unsuccessful attempt at Quartz crystallization in the presence of an excess of Tourmaline, the penetrating needles generally lessening in number as the opposite and perfect end of the crystal is approached. The Quartz is of the smoky variety, the inclusions giving it a greenish tinge. Excellent examples, some doubly terminated, from 1 to 3 inches long, 10c. to 30c. each. Cabinet specimens 50c. to \$3. Museum crystals at higher prices.

**Polished Cross-Sections** are of exceptional beauty and interest, showing the delicate needles branching in every direction. Some exhibit shadowy hexagons concentrically arranged, indicating the crystal growth.  $1\frac{1}{4}$  to 4 inches diameter, 50c. to \$4.

## AMETHYST CAPPINGS.

In the same find are a few choice Amethyst crystallizations arranged in paralleled groups, often capping the smoky Quartz in a unique manner. 50c. to \$6 for the larger. Excellent Amethyst crystals 10c. to 30c. each.

*Send your list of Desiderata.* Many acquisitions find no mention here because sold before an announcement can be prepared. With the list before us a gap in your collection can often be filled.

## EDUCATIONAL COLLECTIONS.

For 26 years we have supplied mining schools, universities, colleges and secondary schools throughout the world with mineralogical material. During that period the quality of our elementary and advanced collections has steadily improved, so that to-day the highest grade of study specimens are offered at unprecedentedly low prices. An inspection of our Laboratory List will show that European minerals are sold not simply below American prices, but often at lower rates than prevail in Europe. The wide connections of our European house alone permit this economy to the consumer, our prices being the same on both sides of the Atlantic. If in Paris this summer favor us with a call—15 minutes from the Opera Quarter.

### Illustrated Collection Catalog Free.

The Largest and Most Complete Stock of Scientific and Educational Minerals in the World. Highest Awards at Nine Expositions.

---

**FOOTE MINERAL CO.,**

FORMERLY DR. A. E. FOOTE,

PHILADELPHIA,  
1317 Arch Street.

PARIS,  
24 Rue du Champ de Mars.

# THE BEST COLLECTIONS OF MINERALS



INCLUDE ONLY

## Thoroughly Typical Specimens of Educational or Economic Importance.

We regard an excellent collection sold at a low price one of the best advertising investments we can make.

### COLLECTIONS ILLUSTRATING PHYSICAL PROPERTIES

In no department of mineralogy is it so important to have typical specimens as in physical mineralogy. Our collections are sure to give satisfaction.

- No. 1. **Structure and Form**, results of imperfect crystallization. 16 large specimens mounted on cherry blocks, \$12.00.
- No. 2. Same, but specimens smaller and in pasteboard trays, \$6 00.
- No. 3. **Cleavage**, 5 large specimens, mounted on cherry blocks, \$1.25.
- No. 4. Same, but specimens smaller and in pasteboard trays, 75c.
- No. 5. **Fracture**, 6 large specimens mounted on cherry blocks, \$3.00.
- No. 6. Same, but specimens smaller and in pasteboard trays, \$1.50.
- No. 7. **Tenacity**, 5 large specimens mounted on cherry blocks, \$2.50.
- No. 8. Same, but specimens smaller and in pasteboard trays, \$1.25.
- No. 9. **Scale of Hardness**, 9 large specimens and Diamond crystal, mounted on cherry blocks, \$10.00.
- No. 9a. Same, but with smaller Diamond, \$5.00.
- No. 10. Same, but specimens smaller and in pasteboard trays, \$3.50.
- No. 10a. Same as No. 10, omitting the Diamond, \$2.50.
- No. 11. Same, 10 specimens in handsome quartered oak box with 1½ inch compartments, \$1.50.
- No. 11a. Same as No. 11, omitting the Diamond, 75c.
- No. 11b. "Elite" Scale of Hardness, 10 specimens, all, except talc in crystals, enclosed in pocket-size leatherette case lined with velvet and satin, \$1.50.
- No. 12. **Specific Gravity**, or **Density**, 40 specimens, mounted on cherry blocks, \$25.00.
- No. 13. Same, 25 specimens, mounted on cherry blocks, \$15.00.
- No. 14. Same as No. 13, but specimens small and included in quartered oak box with one inch compartments, \$7.50.
- No. 15. **Luster**, 15 large specimens, mounted on cherry blocks, \$7.50.
- No. 16. Same, but specimens smaller and in pasteboard trays, \$3.75.
- No. 17. Same, 8 most important specimens in No. 15, mounted on cherry blocks, \$3.50.
- No. 18. Same as No. 17, but specimens smaller and in pasteboard trays, \$1.75.
- No. 19. **Color**, 56 large specimens, mounted on cherry blocks, \$28.00.
- No. 20. Same, but specimens smaller and in pasteboard trays, \$14.00.
- No. 21. Same, 25 of most important specimens, mounted on cherry blocks, \$12.00.
- No. 22. Same as No. 21, but specimens smaller and in pasteboard trays, \$6.00.
- No. 23. **Diaphaneity**, 5 large specimens, mounted on cherry blocks, \$2.50.
- No. 24. Same, but specimens smaller and in pasteboard trays, \$1.00.
- No. 25. **Scale of Fusibility**, 6 large specimens, mounted on cherry blocks, \$2.50.
- No. 26. Same, but specimens smaller and in pasteboard trays, \$1.00.
- No. 27. Same, 6 specimens in quartered oak box with 1½ in. compartments, 60c.

*Other Physical Collections will be announced later.*

124-page ILLUSTRATED CATALOGUE, giving Dana Species number, crystal system, hardness, specific gravity, chemical composition and formula of every mineral, 25c. in paper.

44-page ILLUSTRATED PRICE-LISTS, also BULLETINS and CIRCULARS, FREE.

GEO. L. ENGLISH & CO., Mineralogists,  
Dealers in Educational and Scientific Minerals,  
3 AND 5 WEST 18th STREET, NEW YORK CITY.

## CONTENTS.

	Page
ART. XXXV.—Fossil Faunas and their use in correlating Geological Formations; by H. S. WILLIAMS .....	417
XXXVI.—Studies of Eocene Mammalia in the Marsh Collection, Peabody Museum; by J. L. WORTMAN. (With Plates VII and VIII.) .....	433
XXXVII.—Transmission of Sound through Solid Walls; by F. L. TUFTS .....	449
XXXVIII.—New Gauge for the Measurement of Small Pressures; by E. W. MORLEY and C. F. BRUSH .....	455
XXXIX.—Hitherto Untried Form of Mounting, either Equatorial or Altazimuth, for a Telescope of exceptional size, either refractor or reflector, in which Telescope, observing-floor and dome are combined in one; by D. P. TODD	459
XL.—Occurrence of Uranophane in Georgia; by T. L. WATSON .....	464
XLI.—Internal Structure of Cliftonite; by J. M. DAVISON	467

### SCIENTIFIC INTELLIGENCE.

- Chemistry and Physics*—Heatless Condition of Matter, BRINKWORTH and MARTIN, 469.—Method for Assaying Pyrites, BUDDÉUS: Germanium Hydride, VOEGELEN, 470.—Compounds of Beryllium with Organic Acids, LACOMBE: Use of Floats in Burettes, KREITLING: Beiträge zur Chemischen Physiologie und Pathologie, F. HOFMEISTER: Velocity of Light, MICHELSON, 471.—Ultra-Violet of the Mercury Spectrum, H. LEHMANN and R. STRAUBEL: New Peculiarity in the Structure of the Cyanogen Bands, A. S. KING: Stationary Electric Waves, K. F. LINDMAN: Oscillatory Discharges, H. ANDRIESSEN: Meteorologische Optik, J. M. PERENTER, 472.—Instruments et Méthodes de Mesures Electricque Industrielles, H. ARMAGNAT: Size of Nuclei, C. BARUS, 473.
- Geology*—Geological Survey of Canada, Summary Report of the Geological Survey department for the Calendar year 1901, R. BELL, 473.—Field Operations of the Division of Soils, M. WHITNEY: Mineral Wealth of the Black Hills, C. C. O'HARRA: Corundum Twins, W. E. HIDDEN: Genesis of Ore Deposits, 474.—Coal in Michigan, its mode of occurrence and quality, A. C. LANE: Adepagous and Clavicorn Coleoptera from the Tertiary Deposits at Florissant, Colorado, S. H. SCUDDER: Acrothyra and Hyolithes—a Comparison; Hyolithes gracilis and related forms from the Lower Cambrian of the St. John Group; A backward step in Palæobotany, G. F. MATTHEW, 475.—Ostracoda of the basal Cambrian rocks in Cape Breton, G. F. MATTHEW: Fossil Mammals of the Tertiary of Northeastern Colorado, W. D. MATTHEW, 476.—Pleistocene Geology of portions of Nassau County and Borough of Queens, J. B. WOODWORTH, 477.
- Botany*—Recherches sur le développement du tégument séminal et du péricarpe des Graminées, P. GUÉRIN, 478.—Alpine plants from Tibet and the Andes, W. B. HEMSLEY and H. H. W. PEARSON, 479.
- Miscellaneous Scientific Intelligence*—Smithsonian Institution Publications: United States Coast and Geodetic Survey, Annual Report 1900, O. H. TITTMAN, 479.—Elementary Calculus, P. F. SMITH: Prize for Scientific Work by Women: Fortschritte der Physik im Jahre 1902; Halbmonatliches Litteratur-verzeichniss, K. SCHEEL and R. ASSMANN, 480.
- Obituary*—HENRY MORTON: M. ALFRED CORNE, DR. ALEXANDER BITTNER: M. HENRI FILHOL, 480.

313













SMITHSONIAN INSTITUTION LIBRARIES



3 9088 01298 5644